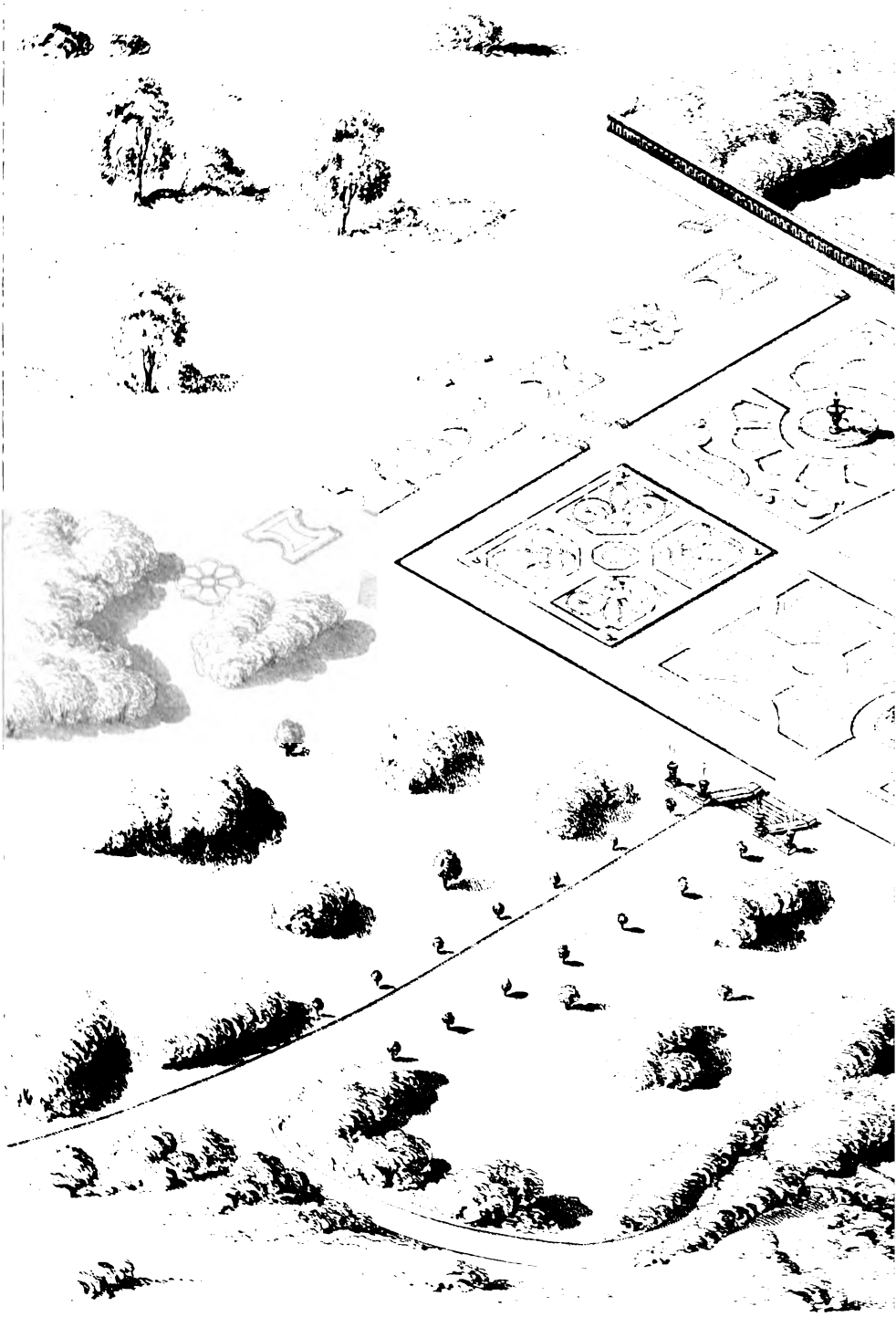




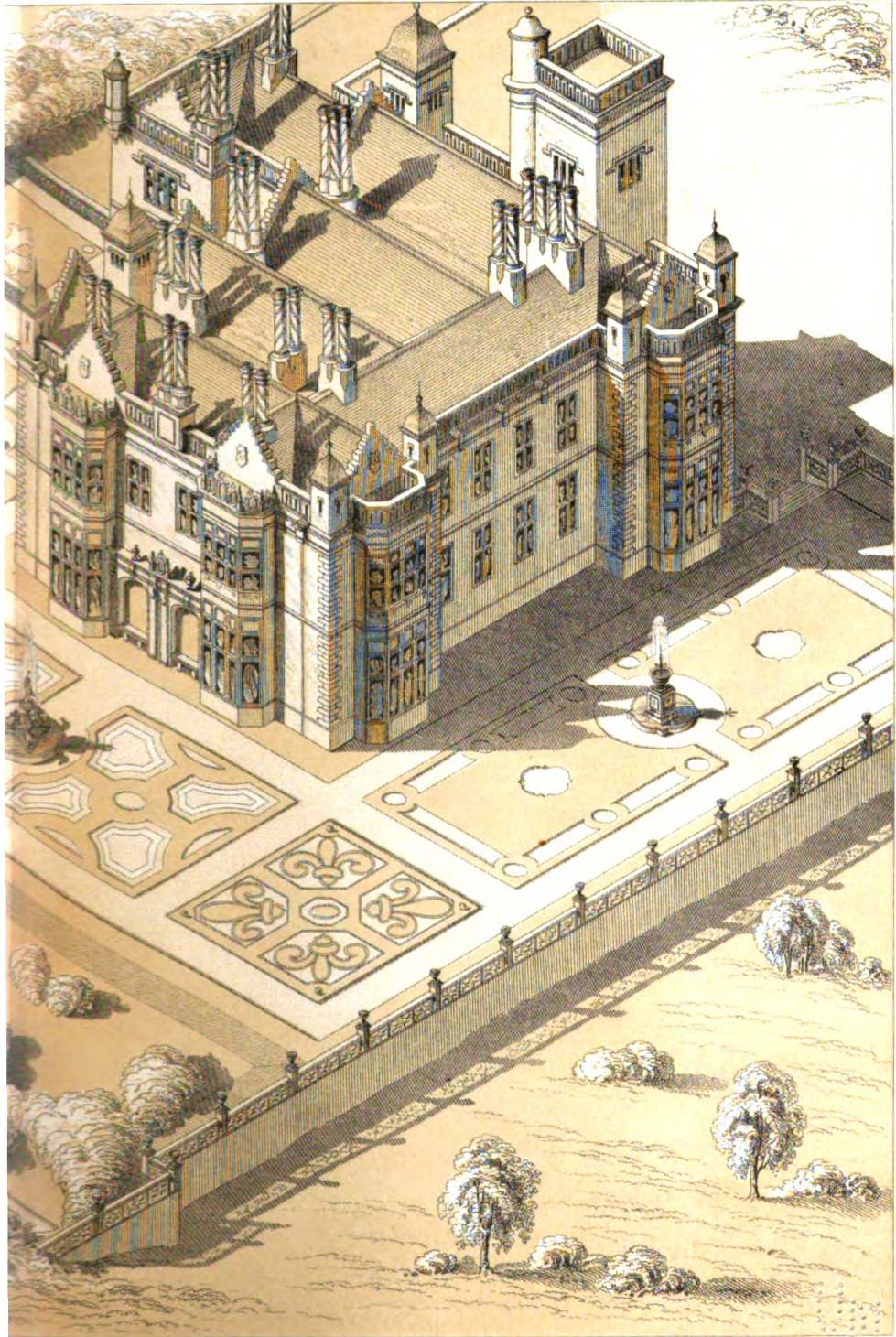
**THE**  
**BOOK OF THE GARDEN**

PRINTED BY WILLIAM BLACKWOOD AND SONS, EDINBURGH.





AN OBSCURE VIEW OF THE



Engraved by W.A.K. Johnston-Edin.

FIELD HOUSE AND GARDEN.

W. & A. G. & Co. London.

10

11

THE  
BOOK OF THE GARDEN



BY

CHARLES M'INTOSH

F. R. P. S. F. R. S. S. A.

CORRESPONDING MEMBER OF THE LONDON HORTICULTURAL SOCIETY, THE MASSACHUSETTS  
HORTICULTURAL SOCIETY, AND THE ROYAL CALIFORNIAN HORTICULTURAL SOCIETY, ETC.  
LATE CURATOR OF THE ROYAL GARDENS OF HIS MAJESTY THE KING OF THE  
BELGIANS AT CLERMONT AND BRUSSELS, AND NOW OF THOSE OF HIS  
GRACE THE DUKE OF SUCCELRUCH, AT DALKEITH PALACE.

IN TWO VOLUMES

VOL. I.—STRUCTURAL

WITH 1073 ILLUSTRATIONS

WILLIAM BLACKWOOD AND SONS  
EDINBURGH AND LONDON  
MDCCCLIII



100  
100  
100  
100  
100

## TO HER MAJESTY THE QUEEN.

MADAM,

BY PERMISSION MOST GRACIOUSLY ACCORDED, I HAVE THE HONOUR OF DEDICATING THIS PORTION OF MY PROFESSIONAL LABOURS, "THE BOOK OF THE GARDEN," TO YOUR MAJESTY. I REGARD THIS ACT OF CONDESCENSION ON THE PART OF MY SOVEREIGN AS THE GREATEST MARK OF DISTINCTION THAT A HUMBLE INDIVIDUAL COULD WISH FOR OR EXPECT. INDEED, DURING THE COMPILATION OF THIS WORK—AMIDST THE MANY DUTIES I HAVE HAD TO DISCHARGE TO ONE NOT MORE EXALTED IN RANK THAN ESTEEMED FOR HIS MANY VIRTUES, WHOM I HAVE THE HONOUR TO SERVE—AND WHEN OFTEN BOWED DOWN WITH FATIGUE IN BODY AND MIND, I HAVE BEEN CHEERED AND SUSTAINED BY THE HOPE THAT, IF SPARED TO COMPLETE MY TASK, MY HUMBLE ENDEAVOURS TO PROMOTE A SCIENCE, WHICH YOUR MAJESTY'S EXAMPLE HAS DONE SO MUCH TO ENCOURAGE, MIGHT BE HONOURED WITH A PLACE ON THE SHELVES OF YOUR ROYAL LIBRARY. PERMIT ME ALSO, MADAM, HUMBL Y, YET SINCERELY, TO RECORD WITH GRATITUDE THE OBLIGATIONS I HAVE LONG BEEN UNDER TO MEMBERS OF YOUR MAJESTY'S AUGUST FAMILY, WHOM, WITH YOUR MAJESTY, YOUR ROYAL CONSORT, AND BELOVED FAMILY, MAY GOD LONG PROSPER AND PRESERVE.

MADAM,

I HAVE THE HONOUR TO BE

YOUR MAJESTY'S MOST OBEDIENT,

MOST LOYAL SUBJECT AND SERVANT,

CHARLES M'INTOSH.

DALKEITH PARK,  
*January 1853.*



# CONTENTS.

	PAGE
INTRODUCTION.—GARDENING AS AN ART OF DESIGN AND TASTE, CONSIDERED AS REGARDS ITS ORIGIN, PROGRESS, AND PRESENT STATE, .	1
<b>CHAPTER I.—THE FORMATION AND ARRANGEMENT OF CULINARY AND FRUIT GARDENS IN GENERAL,</b> . . . . .	<b>11</b>
§ 1. PLAN, . . . . .	11
2. EXTENT, . . . . .	<i>ib.</i>
3. FORM, . . . . .	12
4. SUPPLY OF WATER, . . . . .	14
5. SITUATION, . . . . .	19
6. SOIL, . . . . .	25
7. FRUIT-TREE BORDERS, . . . . .	27
8. PRINCIPAL ENTRANCE, . . . . .	32
9. SHELTER, . . . . .	34
10. STYLE, . . . . .	36
<b>CHAPTER II.—GARDEN WALLS,</b> . . . . .	<b>65</b>
§ 1. ASPECT OF WALLS, . . . . .	65
2. FOUNDATIONS OF WALLS, . . . . .	66
3. MATERIALS FOR GARDEN WALLS, . . . . .	68
4. COPINGS FOR GARDEN WALLS, . . . . .	69
5. TRELLISED GARDEN WALLS, . . . . .	74
6. HEIGHT OF GARDEN WALLS, . . . . .	75
7. ARRANGING WALLS TO SUIT VARIOUS SITUATIONS, . . . . .	76
8. COLOUR OF GARDEN WALLS, . . . . .	77
9. CONSTRUCTION OF GARDEN WALLS, . . . . .	78
<b>CHAPTER III.—HOTHOUSE-BUILDING,</b> . . . . .	<b>108</b>
§ 1. GENERAL PRINCIPLES, . . . . .	108
2. ANGLE OF ELEVATION, . . . . .	134
<b>CHAPTER IV.—HEATING AS APPLIED TO HORTICULTURAL ERECTIONS,</b> . . . . .	<b>140</b>
§ 1. PRELIMINARY REMARKS, . . . . .	140
2. HEATING BY FLUES, . . . . .	145
3. HEATING BY HOT-WATER PIPES, . . . . .	153
4. THE TANK MODE OF HEATING, . . . . .	192
5. HEATING BY HOT-AIR STOVES, . . . . .	213
6. HEATING BY STEAM, . . . . .	228
7. BOILERS AND PIPES, . . . . .	231
8. HOTHOUSE FURNACES, . . . . .	251
9. CAUSE OF CIRCULATION OF HOT WATER, . . . . .	263

	PAGE
CHAPTER V.—VENTILATION, . . . . .	271
CHAPTER VI.—FRUIT-HOUSES, . . . . .	299
§ 1. VINERIES, . . . . .	299
2. PINERIES, . . . . .	380
3. PEACH-HOUSES, . . . . .	346
4. CHERRY, FIG, PLUM, AND APRICOT HOUSES, . . . . .	355
5. TROPICAL FRUIT HOUSE, . . . . .	358
CHAPTER VII.—PLANT-HOUSES, . . . . .	360
§ 1. CONSERVATORIES, . . . . .	360
2. GREENHOUSES, . . . . .	385
3. ORANGERIES, . . . . .	399
4. HEATH-HOUSES, . . . . .	402
5. ORCHID-HOUSES, . . . . .	405
6. THE AQUARIUM, . . . . .	412
7. WINDOW GARDENING, . . . . .	420
CHAPTER VIII.—PITS AND FRAMES, . . . . .	429
§ 1. PITS AND FRAMES HEATED BY FERMENTATION, . . . . .	429
2. PITS HEATED BY SMOKE FLUES, TANKS, HOT-WATER PIPES, AND STREAM, . . . . .	438
3. CUCUMBER AND MELON HOUSES, . . . . .	459
4. MUSHROOM-HOUSES, . . . . .	466
5. CONSERVATIVE PITS, . . . . .	471
CHAPTER IX.—MISCELLANEOUS GARDEN STRUCTURES, . . . . .	475
§ 1. GARDENERS' HOUSES, . . . . .	475
2. THE FRUIT-ROOM, . . . . .	486
3. ICE-HOUSES, . . . . .	497
4. TANKS AND CISTERNS, . . . . .	513
5. APIARIES, . . . . .	522
CHAPTER X.—DETAILS OF CONSTRUCTION, . . . . .	532
§ 1. GLASS AND GLAZING, . . . . .	532
2. LIGHTS OR SASHES, . . . . .	545
3. RAFTERS AND ASTRAGALS, . . . . .	545
4. WALL-PLATES, . . . . .	549
5. COVERING THE ROOFS OF GLASS HOUSES AND PITS, FOR THE EXCLUSION OF COLD OR THE RETENTION OF HEAT, . . . . .	551
6. ESPALIER RAILINGS, . . . . .	556
7. FOOTPATHS, . . . . .	560
8. PAINTING, . . . . .	562
9. CEMENTS, . . . . .	565
10. ON THE PRESERVATION OF TIMBER USED IN HOTHOUSE-BUILDING, . . . . .	567
11. ON THE DURABILITY OF MATERIALS, . . . . .	571
CHAPTER XI.—LAYING OUT FLOWER-GARDENS, . . . . .	573
§ 1. PRELIMINARY REMARKS ON THE CLASSIFICATION OF STYLES, . . . . .	573
2. SITUATION OF THE FLOWER-GARDEN, . . . . .	578
3. FLOWER-GARDEN FENCES, . . . . .	579
4. PLANTING WITH A VIEW TO PRODUCE EFFECT, . . . . .	580
5. THE ARBORETUM, . . . . .	584
6. THE PINETUM, . . . . .	587

# CONTENTS.

ix

	PAGE
CHAPTER XI.—LAYING OUT FLOWER-GARDENS,— <i>Continued</i> ,	590
§ 7. EDGINGS,	590
8. THE RESERVE FLOWER-GARDEN,	591
9. DISPOSAL OF THE GROUND,	592
10. HARMONY OF COLOURS,	593
 CHAPTER XII.—GEOMETRICAL FLOWER-GARDENS,	 604
§ 1. THEIR GENERAL ARRANGEMENT, &c.,	604
2. FOUNTAINS,	631
3. VASES AND URNS, DIALS AND MURAL DECORATIONS,	637
4. STATUES,	648
5. SEATS,	650
6. TEMPLES AND ARBOURS,	651
7. MAUSOLEUMS, CENOTAPHS, OR SEPULCHRAL STRUCTURES,	654
 CHAPTER XIII.—GARDENESQUE STYLE OF FLOWER-GARDENS,	 655
§ 1. THEIR GENERAL ARRANGEMENT,	655
2. FOUNTAINS AND VASES,	674
3. BASKETWORK,	676
4. BRIDGES,	679
5. TRELLISWORK, GATES, FENCES, AND TREE-GUARDS,	683
6. MOSS-HOUSES, SEATS, AND RESTING-PLACES,	687
 CHAPTER XIV.—PICTURESQUE STYLE OF FLOWER-GARDENS,	 693
§ 1. THEIR GENERAL ARRANGEMENT,	693
2. ROCKWORK,	701
3. HERMITAGES, ARBOURS, MOSS-HOUSES, AND SEATS,	705
4. BRIDGES,	713
5. RILLS, RIVULETS, AND CASCADES,	715
6. RUSTIC FENCES,	717
 CHAPTER XV.—PRACTICAL DIAGRAMS EXPLANATORY OF THE RULES FOR LAYING OUT GARDENS, MORE PARTICULARLY FOR FORMING CURVED LINES,	 719
 CHAPTER XVI.—TOWN AND SMALL SUBURBAN GARDENS,	 725
 APPENDIX,	 738
 INDEX,	 756

# LIST OF ILLUSTRATIONS

ENGRAVED ON COPPER.

- I. SUBURBAN GARDEN.
- II. THE SAME IMPROVED.
- III. VILLA GARDEN.
- IV. ISOMETRICAL VIEW OF HOTHOUSES IN THE KITCHEN GARDEN, DALKEITH PALACE.
- V. PLAN OF KITCHEN GARDEN, DALKEITH PALACE.
- VI. GROUND-PLAN OF POLTALLOCH GARDEN, WITH ELEVATION.
- VII. END ELEVATION OF VINERIES, &c., POLTALLOCH GARDEN.
- VIII. CAST-IRON GUTTERS.
- IX. VIEW OF HOTHOUSES, FROGMORE.
- X. PLAN OF THE ROYAL GARDENS, FROGMORE.
- XI. EWING'S GLASS WALLS.
- XII. PROPOSED COVERED GARDEN, DALKEITH PALACE.
- XIII. RANGE OF HOTHOUSES ON CURVILINEAR PRINCIPLE.
- XIV. VIEW OF PALM-STOVE AT KEW.
- XV. CIRCULAR CONSERVATORY, DALKEITH PALACE.
- XVI. PLAN AND ELEVATION OF CONSERVATORY, SION HOUSE.
- XVII. CONSERVATORY IN CONNECTION WITH TOWN DWELLING-HOUSE.
- XXVIII. METALLIC CURVILINEAR-ROOFED VINERY.
- XIX. CONSERVATORY FOR FIRST-CLASS RESIDENCE.
- XX. CONSERVATORY AND FRUIT-HOUSES AT KILLIKEE.
- XXI. DOMICAL CONSERVATORY.
- XXIII. CONSERVATORY AND PROJECTED FLOWER-GARDEN, GROVEFIELD.
- XXIV. PART OF THE FLOWER-GARDEN AT HOLLAND HOUSE CALLED THE BOX-GARDEN.
- XXV. GEOMETRICAL FLOWER-GARDEN.
- XXVI. ITALIAN FLOWER-GARDEN, CHRISWICK VILLA.
- XXVII. PORTION OF GARDEN IN GEOMETRIC STYLE, IN COLOURS.
- XXVIII. GARDEN IN GEOMETRIC STYLE, IN COLOURS.
- XXIX. ISOMETRICAL VIEW OF NUTHILL HOUSE AND GARDEN.
- XXX. GROUND-PLAN OF PALM-STOVE AT KEW, AND FLOWER-GARDEN SURROUNDING IT.
- XXXI. ARCHITECTURAL FLOWER-GARDEN, OXFORDSHIRE.
- XXXII. GARDEN IN GARDENESQUE STYLE.
- XXXIII. GARDEN IN THE REFINED PICTURESQUE STYLE, IN COLOURS.
- XXXIV. ARCHITECTURAL GARDEN FOR A RESIDENCE IN SCOTLAND, IN COLOURS.

\*.\* There is no Plate XXII., in consequence of subjects that were expected to require two Plates for their illustration having been found capable of being comprised in one; and some of the subsequent Plates having been previously engraved, the numbering could not be corrected.

# BOOK OF THE GARDEN.

## INTRODUCTION.

### GARDENING, AS AN ART OF DESIGN AND TASTE, CONSIDERED AS REGARDS ITS ORIGIN, PROGRESS, AND PRESENT STATE.

GARDENING, as an art of design and taste, is of very ancient date ; and was, perhaps, with the exception of glass-houses and the modern arrangements connected therewith, in a high state of perfection two thousand years ago. As a cultural art, it is unquestionably the most ancient of any.

The gardens of Solomon, the earliest of which we have any certain account, are described as having been of a quadrangular form and surrounded by a high wall—the exact form and arrangement still in most general use. They contained aviaries, wells, and streams of water, indispensable in warm climates ; and, in accordance with the practice of the times, a seraglio, which, according to Parkhurst the commentator, was at once a temple of worship and of pleasure.

The gardens of Cyrus, and other Persian kings, were distinguished for their romantic situations, great extent, and diversity of uses and products, and were in their day reckoned amongst the wonders of the world.

The celebrated hanging-gardens of Babylon furnish us with the first notice of terraces being introduced into gardens ; and although Herodotus and others are silent on the subject, it is not improbable that these terraces had their mural decorations of parapets, vases, &c., as we learn that they were planted with trees of various kinds, arranged in rows on the side of the ascent as well as on the top. We also learn that the different

terraces and groves contained fountains, seats, parterres, and banqueting-rooms, and combined the minute beauties of flowers and foliage with masses of shade and extensive prospects. Indeed, most of the elements of a modern architectural garden are clearly alluded to in connection with these ancient ones, if we except the great varieties of flowers and plants. Even in these, however, they were not altogether deficient ; for we learn from Xenophon's "Memorab." (lib. v. p. 829,) that "wherever the Persian king Cyrus resides, or whatever place he visits in his dominions, he takes care that the Paradieses [or gardens] shall be filled with everything both beautiful and useful the soil can produce."

The gardens already noticed must be considered as strictly architectural. The grove of Orontes, described by Strabo as being nine miles in circumference, and in existence in his day, may be regarded as the earliest recorded example of what has in our own time been denominated a park, or a large garden in the picturesque style. We are led to infer this from the description of this garden drawn by Gibbon in his "Decline and Fall of the Roman Empire," who says it was "composed of laurels and cypress, which formed in the most sultry summers a cool and impenetrable shade. A thousand streams of the purest water issuing from every hill preserved the verdure of the earth, and the temperature of the air ; the senses were gratified with har-



monious sounds, and aromatic odours; and the peaceful grove was consecrated to health and joy, to luxury and love."

Both Lord Bacon and George Mason considered gardening as rather a neglected art in Greece, notwithstanding the progress there made in architecture. The former says, "that when ages grow to civility and elegancy, men come to build stately sooner than to garden finely, as if gardening were the greater perfection." The vale of Tempé, the Academus at Athens, and other public gardens of the time, seem, however, to show that considerable progress had been made in the art.

Pausanias expressly says of the gardens of the Academus, "that they were highly elegant, and decorated with temples, altars, tombs, statues, monuments, and towers." From the nature of the climate and habits of the people, the early Grecian gardens were adapted to the wants and enjoyments of those who took pleasure in them. Hence shade, coolness, freshness, breezes, fragrance, and repose, were the qualities chiefly sought after—"effects of gardening," as Mr Loudon justly observes, "which are felt and relished at an earlier period of human civilisation than picturesque beauty, or other poetical and comparatively artificial associations with external scenery; for although gardening, as a merely useful art, can claim priority to all others, yet as an art of imagination it is one of the last that has been brought to perfection. In fact, its existence as such an art depends on the previous existence of pastoral poetry and mental cultivation; for what is nature to an uncultivated mind?"

As the Greeks copied their gardening from the Persians, so did the Romans theirs from the Greeks. Of the early style of gardening amongst the Romans we know little. Varro and Cicero seem to ridicule the vast edifices projecting into the sea, the immense artificial elevations, the plains formed where mountains stood, and the vast pieces of water dignified with the appellations of *Nilus* and *Euripus*, constructed at great labour and expense by Lucullus—compared with which our modern gardens are mere toys. About this period the culture and arrangement of odoriferous trees and plants were

attended to; so that the planting of trees adjoining each other, whose odours assimilated together, was then as much a study with the gardener as the harmonious arrangement of colours is at the present day. Cicero and the elder Pliny say that the quincunx manner of planting was also in general practice; and from the Epigrams of Martial we learn that clipped trees, an important part of the tonsile style, were invented or introduced by Cnæus Matius; and, according to Propertius, statues and fountains were also about the same time generally adopted.

The description of Pliny's garden by Dr Falconer and Malthus, and the design in Castell's "Villas of the Ancients," clearly prove that both the French and Dutch styles of laying out gardens were founded upon that example. "The terraces adjoining the house," as Loudon observes; "the lawn declining from thence; the little flower-garden, with the fountain in the centre; the walks bordered with box, and the trees sheared into whimsical artificial forms; together with the fountains, alcoves, and summer-houses, form a resemblance too striking to bear dispute." And as Walpole also observes, "All the ingredients of Pliny's garden correspond exactly with those laid out by London and Wise, on Dutch principles; so that nothing is wanting but a parterre to make a garden of the reign of Trajan serve for the description of one in the reign of King William." Examples of nearly the same kind of gardens are to be found both in France and Germany; and such are by no means rare in Italy at the present day.

The use of glass in the construction of plant-houses must have been early known to the Greeks and Romans, as the "gardens of Adonis," mentioned by some of their most eminent authors, were no doubt of this kind. This may be evidently inferred from what Plato in his "Phædon" says in reference to them, that "a grain of seed, or the branch of a tree, placed in or introduced into these gardens, acquires in eight days a development which cannot be obtained in as many months in the open air." Columella, an author on rural affairs of the highest credit, says, "Rome possesses, within the precincts of her walls, fragrant trees—trees of precious perfumes, such as grow in the

open air of India and Arabia. These gardens are embellished with the myrtle and the crocus in flower: there you see the balm tree of India and the cinnamon tree covered with leaves, as well as the tree of frankincense. Italy, this fertile land, yields willingly to the wants of her cultivators, and has learnt to contain the fruits of the whole universe." The same authority says, "It was for Tiberius to show that cucumbers might be grown *ferè toto anno*, which was done in frames filled with warm dung." But perhaps the most conclusive evidence is that of Seneca, who remarks, "Do those not live contrary to nature who require a rose in winter, and who, by the excitement of hot water, and an appropriate modification of heat, force from the equinox of winter the lily bloom of spring?" The same writer details at considerable length a mode of heating by hot water almost identical with that of Perkins, as common in his time.—(*Vide Art. "Heating by Hot Water."*)

During the dark ages, gardening, like all other arts, languished; but upon the revival of learning, the invention of printing, and the Reformation, commerce began to flourish and peace to prevail, and Italy shared to a certain extent in those blessings. The family of the Medici revived and patronised the art of gardening in Italy; and their gardens, which were of the geometric and architectural style, long served as models for most of Europe, and continued to be imitated in France, Germany, and Britain, until the introduction of the English, or, as it has been called, the natural style,—the conception of Bridgeman, Kent, Wright, Brown, Emes, Price, Knight, and Repton, aided by the pens of Addison, Pope, Shenstone, George Mason, Whately, Gray, and Mason the poet.

Garden architecture, so far as hot-houses are concerned, has made little progress in the south of Europe, because the climate is naturally sufficiently warm to render them all but useless. There are, however, instances of plant-houses both in Spain and Portugal—as at Madrid, Coimbra, and Montserrat. These countries are, at the same time, not deficient in architectural gardens,—having, it is presumed, upon the authority of Jacob, (*vide "Travels in the South of Spain,"*)

still the remains of Moorish gardens existing. Other travellers inform us that the walks of their gardens are paved with marble, bordered with parterres planted with evergreens, and shaded with orange trees; and, however strange it may appear to us, they have contrivances under these walks by which they can force up jets of water between the joints of the pavement; and, as Sir John Carr remarks, "they take much pleasure in directing the water of these reversed showers against the ladies." Fountains, alcoves, terraces, statues, trellis-work, temples, grottoes, covered seats, and bowers, are the principal features of Spanish and Portuguese gardens.

The Dutch and French styles of gardening very much resemble each other—the characteristics of both being symmetry and abundance of ornament. The gardens of the former are more confined, crowded with frivolous and often ridiculous embellishments, and almost invariably intersected with canals of still and frequently muddy water. So partial are these people to water even to this day, that, however limited the space, it must have its place, even if reduced to a muddy ditch. The humidity of the climate being favourable to the growth of green-sward, we see there grassy walks, terraces, and slopes; and these, with their straight canals, may be said to form the really distinctive character of their grounds.

Evelyn describes the Dutch gardens at the Hague in his day as being "full of ornament,—close walks, statues, marbles, grottoes, fountains, and artificial music." And Sir James Edward Smith, more than a century afterwards, says he found one of these gardens as full of serpentine walks as the other was full of straight ones—evidently a first attempt to imitate the English style. There are, however, many good specimens of the older style—for the Dutch are a people not fond of changes. At Alkmaar, Utrecht, and elsewhere, specimens exist where "the grand divisions of the garden are made by tall thick hedges of beech, hornbeam, and oak, and the lesser ones by yew and box. There are avenue walks, and berceau walks, with openings in the shape of windows in the sides; verdant houses, rustic seats, canals, ponds, grottoes, fountains, statues, and other devices;" and, as

Dr Neill remarks, in his "Horticultural Tour," "Everything in these gardens has its counterpart. If there be a pond, or walk, or statue, or a group of evergreens, on one side, the same may with confidence be predicted on the other side of the garden; so that the often-quoted couplet of Pope, 'Grove nods at grove,' can nowhere be better exemplified."

Such a style is, perhaps, better than any other adapted to the country—for there are no inequalities of surface upon which to exemplify an English garden; and to attempt producing undulation artificially would cause the overflowing of the lower parts with water in order to procure the material for elevation. We have frequently, however, seen attempts to effect this by the erection of immense brick domes, and covering them over with mould.

The French style may be said to have arisen about the middle of the seventeenth century, during the luxurious reign of Louis XIV. In this reign the arts in France flourished, and that of gardening received a fresh impulse by his munificence and the talent of Le Notre, the most celebrated gardener of his time in Europe. Le Notre's style rapidly spread in all improving countries. It was, as will be seen hereafter, adopted very extensively in Britain; and, strange to say, continued in great repute in this country fully half a century after the introduction of the English or natural style had been fully established.

The celebrated gardens of Versailles constituted Le Notre's grandest effort, and are said by Bradley to be the sum of everything that has been done in gardening; while Agricola, a German author, says of them, that "the sight of Versailles gave him a foretaste of Paradise." Against these high encomiums, however, might be quoted condemnations as strong—though these latter must be taken with some modification, inasmuch as those who pronounced them were advocates for the natural style, then just coming into vogue. Thus Lord Kames says of these gardens, that they would "tempt one to believe that nature was below the notice of a great monarch, and therefore monsters must be created for him, as being more astonishing productions;" and Hirschfeld looks upon them

only as models of a particular class or character of garden. Gray the poet, and Mr Loudon, consider them imposing when filled with company; and Lord Byron says, that "such symmetry is not fit for solitude."

Whoever has visited Versailles must be well aware that there is seldom solitude there; and also that no other style of garden would have been so well fitted to the ends in view.

The English style was introduced into France in 1762, and embraced with a warmth more characteristic of the mania of imitation than of the genius of invention. Prior to the Revolution, many gardens were altered to the English style, chiefly by Blaikie, a native of East Lothian, long settled in France, and the Chevalier Jansen, an Englishman. Since that time many of the fine old French gardens have been demolished, and what is called the English style adopted; which, according to the ideas of most Frenchmen, as Blaikie observes, consists in abundance of crooked walks, an opinion in which too many Englishmen appear to concur.

The garden artists of France have been few in number: the most eminent were Girardin, Morel, and Delille. Nor does either landscape gardening or garden architecture appear to be much cultivated there, even at the present time.

The erection of the first hothouses in France occurred towards the end of the reign of Louis XIV., by M. Fagon, in the Jardin des Plantes; and the example was soon after imitated by M. Senior, both for himself at St Germain-en-Laye, and also for Louis XV. at Trianon. These buildings were described by Combes, in the "Ecole Potagère," about the year 1730. Since then, considerable improvement has taken place in hothouse building in that country; but certainly these erections are still far behind the English, both as regards elegance of design and correctness of principle in the details. Throughout Germany, and the whole of the north of Europe, the Italian and French styles prevailed until the partial introduction of the English or natural manner in 1750, when the Garten der Schwobber was laid out near Pymont in Westphalia.

The first magnificent attempt at hot-

house building in Europe was certainly that of Francis the First of Austria, in the erection of the botanic hothouses at Schoenbrunn in 1753, in five ranges, and extending altogether to the length of 1290 feet, many of them being thirty feet high. These hothouses have been described by travellers as the most magnificent in their day of any in the world. Hot walls were introduced into Saxony by the Earl of Findlater, a Scottish nobleman, who long resided near Dresden; and this, we presume, was the first instance of their being used out of Britain. Magnitude in erection—the consequence of wealth and cheap material—was attained on the Continent long ere it was attempted in Britain. The extensive conservatories of the Duc d'Artemberg at Enghien, and those in the botanic gardens at Brussels, are familiar instances; but, both in design and execution, these bear no comparison with similar structures more recently erected in our own country.

In regard to priority, we ought to remark that, so early as 1645, a greenhouse was erected at the solicitation of Jungerman, a celebrated botanist, in the botanic garden of Altorf, in Saxony, considered at the time the finest garden in Germany.

It may here be remarked, however, that Solomon Caus, the most eminent garden architect of his day, contemplated not only to build an extensive orangery in the celebrated gardens of Heidelberg, but also to heat it with steam, prior to 1620,—as in that year he published "*Hortus Palatinus Heidelbergæ*," in which are given plans of these gardens as originally designed by him.

Landscape gardening, and the adoption of the English or natural style, were, soon after their establishment with us, introduced into Germany; and whether from a greater amount of baronial wealth, the spirit of enterprise, or the love of imitation, it is certain that greater progress has been made in the art in that country than in any other on the Continent. Germany has also produced some eminent landscape gardeners and garden architects, the most popular of whom was F. L. Von Skell of Munich, the author of a meritorious work "*On Gardening as an Art of Design and Taste*."

In Russia, although the climate is adverse, many of the nobles are rich, and

they, as well as the Emperor, have most extensive hothouses and gardens. The introduction of a taste for either cannot be carried back beyond the time of Peter the Great. Within that period all the styles of garden already noticed have been in vogue: at present, the English style, introduced by the celebrated Empress Catherine about 1768, is the most popular.

The celebrated winter garden belonging to the Taurida Palace at St Petersburg is described by Storch in very glowing terms. As gardens of this description may ere long be erected in this country, the following account of this one, by the authority above mentioned, may not be out of place here:—"Along one side of the vestibule is the winter garden, an enormous structure, only separated from the grand hall by a colonnade. As, from the size of the roof, it could not be supported without pillars, they are disguised under the form of palm trees. The heat is maintained by concealed flues placed in the walls and pillars; and even under the earth leaden pipes are arranged and filled with boiling water. The walks of this garden meander amidst flowering hedges and fruit-bearing shrubs, winding over little hills, and producing at every step fresh occasion for surprise. The eye of the beholder, when weary of the luxuriant variety of the vegetable world, finds recreation in contemplating some exquisite production of art. Here a head from the chisel of a Grecian sculptor invites to admiration; there, a motley collection of curious fish in crystal vases suddenly fixes our attention. We presently quit these objects to get into a grotto of looking-glass, which gives a multiplied reflection of all these wonders, or to indulge our astonishment at the most extraordinary mixture of colours in the face of an obelisk of mirrors. The genial warmth, the fragrance and brilliant colours of the noble plants, the voluptuous stillness that prevails in this enchanting spot, lull the fancy into sweet romantic dreams,—we imagine ourselves in the blooming groves of Italy; while nature, sunk into a death-like torpor, announces the severity of a northern winter through the windows of the pavilion." This immense house, however, was defective in some of its most important

details. Thus, for example, it had an opaque roof, the light being admitted by the side-windows only; and the heating by stoves, flues in the walls or pillars, and leaden pipes kept full of boiling water by manual labour, was another imperfection. With us, glass roofs may be constructed to cover any extent of space, and the supports may be so arranged as that they shall be ornamental rather than otherwise. Hot water can be made to circulate in pipes concealed from view, and carried to any extent. This house was, however, perfect in other respects: it was attached to the palace, and thus could be enjoyed at all seasons, as all conservatories or private winter gardens ought to be.

Gorinki, one of the seats of the Razumovsky family, has also most magnificent conservatories of great extent, forming wings to the palace—indeed, of such extent as to be, with the exception of those at Kew, Chatsworth, and the Regent's Park, unequalled in Britain.

With these examples before us, we need not despair of seeing in Britain whole gardens covered with glass, for the cultivation of plants, fruits, and vegetables. When these shall appear, structures may be expected of far more elegant construction, and arranged upon the most perfect principles. The man of taste and wealth, in any part of Britain, may have his garden adapted to the climate, and affording the products, of any part of the world he pleases. Instead of the constant failure of crops of our ordinary fruits, and the limited period of most of our finest vegetables, we shall have certainty in the one case, and a perpetual supply in the other. The flower garden will be as gay at Christmas as it is at present at Michaelmas; and, in addition to all this, both the mind and the body will enjoy pleasing exercise in contemplating the perpetual display of Flora's richest gems, and in the enjoyment of walking exercise at seasons when the climate of our country denies us that recreation in the open air. Such is a brief outline of the progress of gardening, considered as an art of design and taste, on the continent of Europe.

Within the last few years a taste for ornamental gardening and the erection of hothouses has been rapidly extending in

North America. Nor are our Transatlantic brethren neglectful of horticultural literature—a convincing proof that the seeds of improvement have been sown in a fertile soil. A. J. Downing has published a work on "The Theory and Practice of Landscape Gardening as adapted to North America, with remarks on Rural Architecture," &c. This book possesses very considerable merit, and has passed unscathed the severe ordeal of English criticism. Several works on pomology have issued from the American press—a department in horticulture in which the American collectors eminently excel. "The Horticultural Magazine," conducted by Mr Hovey of Boston, is a work of merit, a perusal of which will give a good idea of the advanced state of the art of which it is the vehicle, in the United States. The cultivation of exotic plants, and the laying out of grounds, occupy much of their attention at the present time. The English style of landscape gardening appears to be with them the most popular; and, strange as it may appear to many, Rhododendrons, Kalmias, and many other plants originally introduced into this country from America, are now amongst the chief articles sent out for the decoration of their grounds.

Gardening, as an art of design and taste in Britain, can scarcely be traced historically beyond the time of Henry VIII., who laid out Nonesuch in Surrey as a royal residence. The gardens there, we are informed by Hentzner, were ornamented with fountains, trellis-work, cabinets of verdure, columns and pyramids of marble. The first kitchen garden enclosed with walls we can recollect having read of was that of Nonesuch, which boasted walls fourteen feet high. Here, also, we meet with an account of the first bowling-green, which is described as being in front of the palace, surrounded with a balustrade of freestone. Parterres and labyrinths, however, are of much older date, being described as not uncommon in the time of Henry III.; although others date their origin from that of Elizabeth.

There can be no doubt, although history is almost silent on the subject, that considerable progress had been made in laying out architectural and geometrical gardens long before the time of the eighth

Henry; for it is not to be supposed that all the details handed down by Hentzner, Leland, Hollinshed, Bray, Daines Barrington, and others, would be found in the splendid gardens of Nonesuch alone. The art must therefore have been introduced by some whose names are now lost; and, in all probability, it would be imported direct from Italy, which, about that period, took the lead in horticulture in Europe. We may here remark, that if Dr Walker—considered a high authority—is correct in his surmises, architectural gardens existed so early as the sixth century in Scotland; for he says, (*Essays*, vol. ii., p. 5,) in describing the monastery of Icolmkill in the Hebrides, as it existed about the end of the eighteenth century, that “on a plain adjoining the garden of the abbey, and surrounded by small hills, there are vestiges of a large piece of artificial water, which has consisted of several acres. Its banks had been formed by art into walks; and, though now a bog, you may perceive the remains of broad green terraces passing through the middle of it, which have been raised considerably above the water.” Whatever merits these gardens had, the execution of them must be assigned to the monks, who, no doubt, both in England and Scotland, introduced Italian gardening, as well as the fruits and plants of other countries. That their gardening operations disappeared with the dissolution of the monasteries by Henry VIII. is probable. The state of Scotland till the Union was such, that we may readily infer little attention was paid to gardening, more especially as a work of art.

James I. of Scotland is thought to have introduced partially the gardening of England, such as it was in Henry V.'s reign, and as he saw it while a prisoner in England. James III. has left vestiges of his taste for geometrical gardens in what is still called the Knott, or raised platform, in the vale below Stirling Castle, said to have been the site of the royal gardens.

Cardinal Wolsey, about the middle of Henry VIII.'s reign, laid out Hampton Court garden; much of which, including the labyrinth, still exists as a monument of the grandeur of that day. These gardens were, however, further improved and extended by Charles II. in the French style, after the manner of Le Notre.

Summer-houses, *jets d'eau*, labyrinths, and statues, were in high estimation during Elizabeth's reign, as were also parterres of great intricacy and design, as may be learned from the “*Gardeners' Labyrinth*,” published at that time. The same taste prevailed during the time of her successor, although an attempt was made by Bacon to overturn it, but without success. At this period Lord Verulam's garden was in high repute. Le Notre visited England by invitation of Charles II., and fully introduced the French style, by carrying it out at Hampton Court, Greenwich, St James's Park, &c. The Duke of Devonshire, the Earl of Essex, and Lord Capel, were at this time great promoters of the art; as were also Lady Brook, Lord Craven, Lord Pembroke, the Duke of Lauderdale, Lady Clarendon, Lord Northampton, &c. The celebrated John Evelyn, the author of the “*Sylva*,” &c., Waller the poet, Sir William Temple, Sir Henry Capel, Sir Robert Clayton, &c., all shone conspicuous in the higher departments of garden refinement. It is somewhat singular that both hothouses and icehouses should have been first built in this country during this reign.

The Earl of Essex sent his gardener, Mr Rose, to study in France; and we presume this to be the first instance of an English gardener having such an opportunity. He was appointed on his return royal gardener, and fruited the first pineapple produced in Britain. A painting in Kensington Palace represents him presenting this pine to the king. Orangeries and banqueting-rooms appear to have been the earliest buildings connected with gardens in this country. The latter are spoken of by Daines Barrington as being first erected at Beckett in Berkshire, by Inigo Jones, and are described as having consisted of one apartment, with a cellar below. One similarly constructed is stated to have existed about the same time at Hampton, Middlesex. Of the former—the orangeries—those of Loader an anchormith, the Duke of Lauderdale, Sir Henry Capel at Kew, and that of the Carews of Beddington, in Surrey, appear to have been the first. We do not, however, think these were dedicated to the culture of the orange alone, but that they contained plants of a similar nature also.

The term orangery was long, as it is at present almost universally on the Continent, considered as synonymous with greenhouse. The orangery at Beddington, it may be here remarked, was not a permanent structure, but only a portable shed erected over the trees, (which were planted in the natural soil,) in autumn, and again removed in spring.

From all we can learn, it appears that the first greenhouses, if we except those of the Romans already alluded to, were those of Jungerman, at Altorf in Saxony; and in England that of Loader, those in the botanic garden at Chelsea, that of Sir Henry Capel at Kew, that of the botanic garden at Oxford, and John Evelyn's at Deptford—the last said to be pretty, but with an indifferent stock in it.

In this reign, as we learn from Evelyn, parterres, flower-gardens, orangeries, groves, avenues, courts, statues, perspectives, fountains, aviaries, terrace-walks, and shorn shrubs were much in vogue. King William introduced clipped hedges and trees, splendid wrought-iron gates and railings, as well as alcoves and urns—which latter, Daines Barrington says, were then first seen in England. Vegetable sculpture and embroidered parterres now reached their highest point in England. This was a very natural consequence, as at that period these things had arrived at great perfection in the native country of the king; and it was natural that he should introduce the improvements of his own land into that over which the sovereignty had been assigned him.

Architectural or geometrical gardening appears to have been little attended to in Ireland. The remains of the terraced or hanging gardens at Thomastown, with their verdant amphitheatre, supposed to have been the scene of occasional dramatic performances, show that here at least the ancient style had been fully carried out. Sculptured evergreens are found occasionally to exist, and vestiges of the Dutch style are sometimes to be met with.

During the fifteenth and sixteenth centuries, the gardens of Falkland Palace, Scone Palace, Holyrood House, and Moray House, are historically mentioned, although there can be little doubt that many others existed in Scotland at

and prior to this period. The first attack made on the geometrical style occurred in the reign of Queen Anne, who ordered the parterres before the grand terrace at Windsor to be covered with turf. Wise, afterwards partner with London, but at first royal gardener, planted the gravel pits in Kensington Gardens as a shrubbery, intersected with winding walks: this may be considered the first attempt at the natural style, and it called forth the warm approval of Addison. Bridgeman succeeded Wise, and began his reformation by setting aside vegetable sculpture, and introducing wild scenes and cultivated fields. He still, however, retained clipped alleys, although he left the masses through which they passed to grow into a natural state. The great era of architectural and geometrical gardening in Britain may be stated to have been from the beginning of the reign of William and Mary to the middle of that of George II. During this period all the finest gardens in this style in England were laid out or finished, beginning probably with Hampton Court, and ending with Cannons and Exton Park; which latter is supposed to have been the last laid out in the style upon an extensive scale.

The first examples of the natural or English style of laying out gardens, were that of Pope at Twickenham, now no longer existing, and that of Addison at Bilton, near Rugby, which was, a few years ago, nearly in its original state. These were, however, upon a small scale. The higher examples which claim early date are probably Stowe, Pains Hill, Esher, Claremont, Hagley, the Leasowes, Persfield, and Woburn Farm, near Weybridge.

The celebrated Lord Kames first introduced the modern style into Scotland, although he retained a portion of the ancient manner also, as appears by his "Essays on Gardening and Architecture." He carried his ideas into effect at Blair-Drummond; but his views not being comprehended, few for years after followed his example. Most of the places in Scotland, for long after the introduction of the natural style, were laid out in Brown's manner by his pupil Robertson. As examples of this may be mentioned Duddingstone and Livingston entirely; while Dalkeith, Hopetoun, Moredun, Niddry,

Dalhousie, and various others, were partly remodelled. The Whites, father and son, succeeded the last artist in extensive operations; and they also were imitators of Brown. To this may in a great degree be attributed the monotonous appearance of most places in Scotland laid out during the beginning of the present and part of the last century.

The erection of the first glass-houses in Scotland took place about the beginning of the eighteenth century,—said to have been those of James Justice of Crichton, author of one of the earliest Scottish works on gardens. Subsequent to them were raised those of Moredun, near Edinburgh, still existing, and noted for the abundance of fruit produced in them, and those of Lord Sommerville at the Drum. Towards the latter end of last century extensive ranges of hothouses were constructed, amongst which we may name those at Dalry, Dunkeld, Wemyss Castle, Dupplin, Dalkeith, Abercainey, Eglinton Castle, and many of less extent.

The earliest hothouses for the cultivation of fruits, of which we have any positive account, were those of the Duke of Rutland at Belvoir, erected in 1705. These originated from the failure of the inclined walls recommended by N. Facio de Douillier; who, prior to this date, had published a curious work, entitled "Fruit Walls improved by Inclining them to the Horizon."

The pine was cultivated about the same period by Mathew Decker, at Richmond, in low houses or pits; and peaches and grapes also became known early in the season at the tables of the great.

Forcing melons and cucumbers, in hotbeds in the Dutch manner, was practised long before; and in all probability the use of these beds was introduced from Holland, in the time of William and Mary. The first pines produced in this country were fruited in such pits; and it is highly probable that the strawberries and cherries which Daines Barrington alludes to, as appearing on the royal table of Charles II. on the 23d of April 1667, were also so produced. Since the commencement of the present century, gardening, as an art of design and taste, has made rapid strides towards perfection, more especially in the departments of hothouse building, heating, and ventilat-

ing; and we rejoice to see the geometrical style reviving in our best modern flower gardens—a style of all others best adapted to a rich and luxurious age.

Amongst the best gardens constructed or greatly improved in England, during the last few years, may be especially noticed, as entitled to the first place, the kitchen and forcing garden of her Majesty at Frogmore, which, for design and execution, may be considered as the model of perfection. Those at Chatsworth, Eaton Hall, and Trentham, although in parts of ancient date, have all been greatly remodelled and improved: the colossal conservatory at the former place being, until the appearance, more recently, of the tropical conservatory in the royal gardens at Kew, without a rival in the world. The amiable and talented architect of the conservatory at Chatsworth, Sir Joseph Paxton, while yet a very young man, astonished the horticultural world by his performances; and has more recently gained a degree of reputation, by his splendid conception of the Crystal Palace, which will hand down his name to the latest posterity, and associate it with those of Inigo Jones and Sir Christopher Wren. The improvements recently effected at Eaton Hall and Trentham are carried out with great taste and judgment, the Italian flower garden of the latter being one of the most complete in England. The remodelled state of the Royal Botanic Gardens at Kew renders these worthy of the country, and of our enlightened and gracious Sovereign, to whom they belong; and they will, we predict, remain long unequalled in Europe. The Royal Botanical Society of London has exhibited a splendid specimen of garden architecture in their garden in the Regent's Park; and although as yet unfinished, it affords sufficient evidence of the talent of Mr Robert Marnoch, who, we believe, was the principal designer of that structure.

It might be considered invidious, were we to particularise many excellent private gardens which claim our utmost approbation. Indeed, such are so numerous that we find our space insufficient to do adequate justice to them. The establishment of the Horticultural Society of London has done much to spread a taste for refinement in garden-



ing in Britain ; and to Professor Lindley gardeners owe much, for his labours in the higher walks of botanical and horticultural literature. The establishment of provincial botanic gardens—as those at Liverpool, Birmingham, Sheffield, Manchester, Hull, &c.—and the formation of horticultural societies in almost every town in the kingdom, together with a more general diffusion of education amongst operatives, have all tended to place the horticulture of Britain above that of any other country in Europe. Nor has the sister island been altogether behind, as we have the fine botanical gardens of Trinity College and Glasnevin, near Dublin, both conducted by eminent curators—the former under the direction of Dr Mackay, assisted by Mr Bains ; and the latter solely managed by Mr Moore.

Belfast has also a botanic garden, which, although supported upon the same principles as other provincial gardens of the same kind, stands pre-eminent above all of them in high keeping and richness of collection.

Scotland possesses gardens, and their remains, supposed to be coeval with some of the most ancient in England—of which that at Barncleugh may be given as an example. Yet, from causes we need not refer to, gardening, as an art of design and taste, has made less rapid progress there than in England. Still, in the cultural departments, she is not behind her richer and more favoured neighbour. The construction of gardens and the erection of hothouses began early to be attended to, as will appear from our previous remarks ; and although these are upon a less magnificent scale compared with Chatsworth, Trentham, &c., still we have gardens of more than ordinary merit. Those at Dalkeith and Drumlanrig are by far the most extensive: the flower gardens at the latter place are equal in extent and keeping to any others in the empire ; and were it not that they are somewhat deficient in sculptural and

artistic decorations, they would vie with, if not surpass, any in Britain. On the table-land on which the fine old baronial castle stands, the geometric style is carefully preserved on the east and west sides, covering a very considerable space ; while on the south a spacious terrace-walk, of great length and breadth, stretches itself out, enclosed by a rich stone balustrading, over a parapet wall upwards of twenty feet in height. Under this wall two flights of sloping grass terraces descend, the grounds in front of each being laid out in strict accordance with the upper grounds. Beyond this the gardenesque style occurs ; while beyond it the picturesque style leads the eye imperceptibly into the natural grounds in the distance. Nor are these splendid gardens upon a limited scale—they extend over a surface of upwards of twenty acres ; and the effect, when seen from the terraces around the castle, is imposing and grand. These gardens, as they at present exist, have all been designed by the present Duchess of Buccleuch, whose taste in matters of art is only equalled by her great amiability, benevolence, and high moral worth.

The most perfect specimen of a flower garden in Scotland, although upon a small scale, is unquestionably that of Tyndal Bruce, Esq. of Falkland, at Nut-hill. This garden is truly a work of art, the conception of a master mind ; and, so far as it was finished when we saw it, is a very perfect model of the modern Italian style. It surrounds nearly three sides of the mansion, and is enclosed within parapet walls, with highly ornamental balustrading, vases, &c., while fountains and other artistic objects are placed with great taste and judgment throughout.

The botanical gardens of Edinburgh and Glasgow rank high amongst similar institutions, and are ably conducted. The former was one of the first established in Britain ; and certainly, in point of collection, ranks next to the royal gardens at Kew.

## CHAPTER I.

### THE FORMATION AND ARRANGEMENT OF CULINARY AND FRUIT GARDENS IN GENERAL.

In laying out a new garden, there are various important points to be kept in view, of which the following are the principal,—Plan, Extent, Form, Supply of Water, Situation, Soil, Fruit-tree Borders, Entrance, Shelter, Style. These will be considered in the order in which they stand.

#### § 1.—PLAN.

Before commencing operations, a well-studied plan should be prepared, adapted to the situation, circumstances, and requirements, and upon a scale sufficiently large for the most minute details to be clearly laid down on it; without which all must go on at random, and errors be induced, for the rectifying of which unnecessary labour and expense will be incurred. Besides a general ground-plan, others will be necessary, particularly where the erections are to be upon a large scale, and of various constructions: these are denominated working drawings, and must be very correctly executed, as it is from them, and the specifications detailing the quality of the work, that the tradesmen make up their estimates, and afterwards take their measurements for their respective departments. On the ground-plan should be laid down the exact lines and directions of all drains, and water and gas-pipes, so that these may be readily got at in case of their requiring to be added to or repaired. The depths of soil should also be indicated.

If we examine the majority of gardens in Britain as they at present exist, it will appear pretty obvious, without special inquiry into the causes of such disarrangement, that no definite plan was made out in

the first instance, and that all after additions have been thrown in, as it were, at random. Hence the confusion and want of unity so conspicuously displayed in many gardens of high standing. This ought not to be the case. A well-arranged plan is as necessary in commencing a garden as in beginning to build a mansion, if unity and system are things worth caring for. The whole of the projected arrangements of a garden should be laid down on paper, and submitted to competent examination. The execution of the different parts may be carried into effect at once, or progressively, according to the wants and wishes of the owner. Thus the walls may be built, artificial shelter planted, if required, the ground drained, levelled, and trenched, so that the fruit-trees may be early planted, as it requires some years to bring the majority of them to a fruit-bearing state.

The building of hothouses, pits, &c., may follow—erecting those first which may be more immediately wanted, and leaving others to a more convenient season. By having all the arrangements laid down in detail in the plan, these suggestions can be the more readily acted upon, and without causing confusion or after alterations. It will, however, be found by far the most economical and satisfactory way to carry on the whole at once.

#### § 2.—EXTENT.

The size or extent of a garden must always be regulated according to the supply expected to be required from it, and also by whether it is to be strictly a kitchen and fruit garden, or this com-

bined with the flower garden, and by the proportion of its extent intended to be occupied with flowers. Other circumstances have also to be kept in view. Some families, for instance, require a large supply of vegetables, while others do not; and others prefer growing the general crops of coarser vegetables in the fields, as being supposed of better quality than if they were grown in a highly-manured garden;—and in this they are right. Some, again, require a constant supply all the year; while others, from various causes, require it at stated periods only. From these remarks it will be manifest that it is no easy matter to determine the exact sizes of gardens to suit such a variety of circumstances.

We may however remark, that, in making a new garden, it is best to err on the safe side, by enclosing rather too much than too little, as the extra expense in the first erection is much less than would be the case were additions found necessary afterwards. There is no inconsistency, nor any great extra expense, in having a little more ground enclosed than may be barely necessary to afford the general supply, as by this means a regular rotation of cropping may be better carried out, by allowing a portion to lie in fallow, and so be renovated and improved for future crops; and, should circumstances require, this excess is at all times ready to be brought into use.

The sizes of gardens in this country vary from one to twelve acres, enclosed within walls. Some few exceed the latter extent, as the royal gardens at Frogmore, and that at Dalkeith Palace—the former containing thirty-one acres, and the latter twenty. Those at Chatsworth embrace twelve acres, Petworth fourteen acres, Belvoir Castle eight acres, Tottenham Park four acres, Lambton Castle eight acres, &c., &c. From two to six acres may be taken as the general size, exclusive of the orchard and flower garden. Marshall, in "Introduction to Gardening," says, "The size of the garden should, however, be proportioned to the house, and to the number of inhabitants it does or may contain. This is naturally dictated; but yet it is better to have too much ground allotted than too little; and there is nothing monstrous in a large garden annexed to a small house. Some families

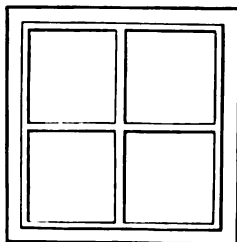
use few, others many vegetables; and it makes a great difference whether the owner is curious to have a long season of the same production, or is content to have a supply only at the more common times. But to give some rules for the quantity of ground to be laid out, a family of four persons (exclusive of servants) should have a rood of good working open ground, and so in proportion."

All gardens should have a slip of ground surrounding the walls, as by that means the latter are made available on all sides. This slip should be enclosed with wire-fencing, or otherwise, so as effectually to exclude hares and rabbits. The next best external fence is undoubtedly a ha-ha, or sunk fence, with a holly or quick hedge on the top, which, as far as regards security from intrusion, is better than a twelve feet wall, and in damp soils is valuable as tending to the thorough drainage of the ground enclosed. In this slip the coarser kinds of vegetables should be cultivated, and all the smaller fruits, and standard fruit trees, unless where the more systematic arrangement is followed of having the kinds of garden all distinct from each other.

### § 3.—FORM.

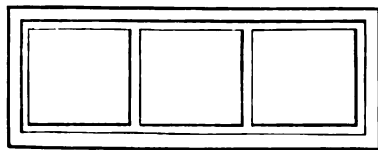
Much has been said on the form most proper for a kitchen garden, more especially that part enclosed by walls.

Fig. 1.



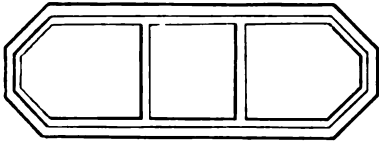
Authors have recommended forms of various kinds, which, according to their respective opinions, have possessed all the merits requisite. The majority, however, agree in giving the preference to a square or oblong, figs. 1, 2. The form

Fig. 2.



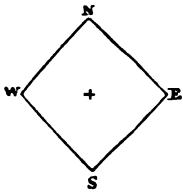
suggested by Abercrombie was an oblong, having the angles or corners cut off, fig. 3,

Fig. 3.



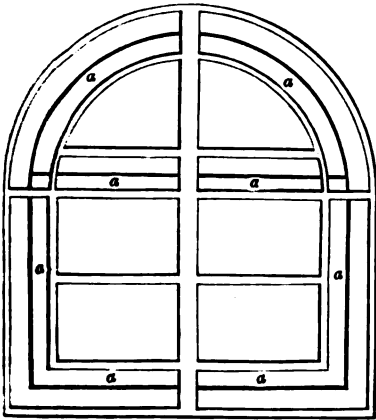
with a view to equalise the benefits of aspect between the inner and outer sides of the wall. Hitt recommended a geometrical square or rhomboid, fig. 4, so arranged by the compass that each wall should derive equal benefit from the sun.

Fig. 4.



M'Phail and others recommended a square or oblong figure, as being most convenient for cropping; while Nicol added to these forms semicircular projections, as on fig. 5, on the north side of the

Fig. 5.



majority of gardens designed by him. The dark lines *a a*, &c., represent the walls: the double outer line being an exterior walk. Circular, oval, and irregular figures have been adopted, as well as other geometrical forms, all of which, under peculiar circumstances, are perfectly admissible. As examples of circular gardens, as they are less common, we may instance that of Locke King, Esq., near Weybridge, in Surrey, and that of J. Arbuthnot, Esq. of Mavis Bank, near Lasswade, which latter is of the exact area of the Coliseum at Rome. The house

is in the Italian style; and hence there was no absurdity in the original proprietor adopting this form and extent in his garden. One of the gardens at Pitmaston is of a circular form: the intelligent owner, long known as an amateur horticulturist, did not, however, suppose that it afforded any advantage. Circular gardens are objected to by some, as being more liable to injury from wind than any other form, and by others as being more expensive in erection.

The following diagrams, figs. 6 and 7, show the internal arrangements of circular gardens.

Fig. 6.

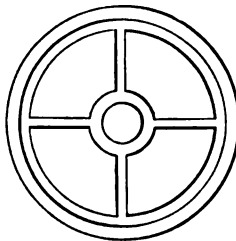
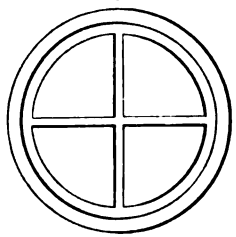


Fig. 7.



We may here remark, that the outer lines in our figures represent the walls, while the inner double lines indicate the direction of the walks: the whole should be surrounded by an exterior fence, that the entire surface of the walls may be made available for fruit trees.

So long as hot-houses continue to be erected against the north walls of gardens—and we see no positive reason why they should be so placed—we think the square or oblong forms the best; but as regards a garden without glass erections against its walls, any figure that harmonises with the natural lay of the ground and the surrounding scenery may with all propriety be adopted.

A garden with walls and other erections, built upon architectural principles, can never be in good taste if of an irregular form. Any geometrical form may in such cases be adopted; but those having long straight parallel lines will have the best effect.

In the internal arrangement of a kitchen garden, of whatever form, there is one rule which should never be departed from, namely, setting off the principal walks parallel with the walls. The subdividing walks should be so laid down, in

number and direction, as to form the area into compartments, or, as they are called, quarters, of convenient sizes for the purpose of cropping, and also for examining the crops,—as shown in the preceding diagrams.

The advocates for picturesque beauty have all objected to the formation of gardens of regular forms, as not harmonising with the surrounding scenery. In this they are so far right; for few things destroy the effect of a fine park more than the straight lines and stiff formality of a square or oblong garden, particularly when placed in a conspicuous situation. Such gardens must either be hid by artificial means—an object not always easily effected—or recourse must be had to irregular forms, so chosen as to suit the lay of the ground. Now that the merits of span-roofed hothouses are fully appreciated, there can be no objection to such forms; and if the garden is laid out in the mixed style, a very good effect may be produced. Man is, however, so much the creature of habit, that it will be long ere irregular gardens become general, although few, we think, can entertain any doubt as to their utility and fitness for many situations.

In many cases great and unnecessary expense has been incurred in the erection of a stiff and formal garden, where, had the form and style been adapted to the situation, a much happier result would have been attained. In most cases where the ground is naturally much out of level, all other circumstances being favourable, there should the irregular form be adopted.

#### § 4.—SUPPLY OF WATER.

An abundant supply of this element is indispensable in every garden. Although the fact is admitted by all, yet how seldom do we see, even in gardens otherwise very complete, this matter attended to, at all events to the extent to which it ought to be! The consequences of this neglect are, the loss of crops in dry weather, and the incurring of an annual expense equal, in a few years, to all that would be required to bring an abundant supply to the most difficult situation. Rain or soft river water is the best; but spring

water, when naturally or artificially freed from those mineral ingredients which many springs contain, and which are injurious to vegetable life, may be used with safety. An immense waste of rain water takes place annually in every garden; for if we calculate the quantity that falls on every square yard of surface—which, according to Waistell, averages 126 gallons per annum throughout Britain—and multiply that by the superficial contents of all the roofs, whether glass, tiled, or slated, we shall find a supply greater than is generally supposed, in too many cases allowed to saturate the ground, or be carried off in drains, and consequently lost, instead of being collected in adequate reservoirs. As an example of this, we may state that in the kitchen gardens at Dalkeith there are 5,866 square yards of roofing, exclusive of pits, giving 739,116 gallons of water per annum: the whole of this roofing is provided with cast-iron gutters, which deliver the water into cast-iron tanks and stone cisterns distributed throughout the hothouses and gardens. Pipes are also laid to convey the water to different parts of the kitchen garden, and at convenient distances are placed taps which supply half-hogshead tubs, neatly painted, and set clear of the ground on brick piers, to serve as temporary supplies during summer. These are removed during winter, when no watering is required; and the permanent cisterns, of which there are many, constructed of iron or stone, are allowed to remain. Most of the cisterns attached to the hothouses are placed over the furnaces, where the water becomes slightly warmed, and is taken through the back walls in pipes immediately over the hot-water boilers, which are all within the houses. Every house has its own supply. In one of the Orchid houses is a reservoir 42 feet long, 4 feet broad, and 3 feet deep; this, together with the other cisterns, contains 1000 cubic feet of rain water, exclusive of the main reservoir under the cellars, containing 2110 cubic feet. Into this latter reservoir all the drains empty themselves, and the superfluous water is carried off by a common sewer beyond the boundary of the garden. We have given these details to show what can be effected by collecting the rain water that is in general allowed to pass away to

waste. From the reservoir under the cellars the water is pumped up to a large supply-cistern, which is elevated sufficiently to carry the water to all parts of the gardens by its own gravity. Great as the consumption of water must necessarily be in such an establishment, still a considerable quantity is allowed to pass off in the common sewer, but sufficient is retained to answer all purposes required. Even were it otherwise, we could easily increase the size of our large reservoir, or even build another.

The situation to which we have been referring is so elevated above the surrounding grounds, that to have brought water by artificial means would have required some miles of pipes, or entailed the expense of machinery to have thrown up the water from the river Esk, which lies considerably below; and even in either of these cases, almost the same extent of tanks and cisterns would have been required. Ponds and large basins of water have been recommended to be formed in kitchen gardens. The former occupy space, and tend to increase the humidity of the atmosphere, and hence to reduce its temperature, as may be instanced in the gardens at Dysart House. The latter have a degree of unmeaning stillness unless accompanied with fountains, which, however appropriate and even necessary as decorative objects in the flower garden, associate indifferently with the surrounding objects in a garden merely of culture, unless that garden be in the architectural style,—in which case fountains are perfectly admissible, either placed in the centre, as is the case in the royal gardens at Frogmore, or in front of the hothouses, or in connection with some of the other buildings.

We have lately constructed a tank 30 feet long, 4 feet deep, and 4 feet broad, for a supply of liquid manure for the purpose of irrigating and watering particular crops, but quite disconnected with the supply described above. This tank is fed by the waste water from our own house, with additions when required from a contiguous pump, and is enriched by the drainings of some piggeries, with a bag of soot, guano, or pigeons' dung occasionally thrown into it. This liquid manure is conveyed to a part of the garden several feet above the general level,

into a stone cistern four feet square and the same in depth; from thence it is taken in leaden pipes, and distributed by flexible pipes, which can be lengthened or shortened according to circumstances.—(For the construction of tanks and cisterns, *vide sect. TANKS AND CISTERNs.*)

The great advantage of irrigation has been known for ages, more especially in Egypt, Persia, and other warm, highly cultivated countries. The application of liquid manure, although not entirely unknown to the ancients, has only of late years, comparatively speaking, been attended to in this country. A striking instance of the utility of this mode of fertilising has for years been given in the neighbourhood of Edinburgh, where lands which, within the recollection of persons still living, brought not more than five shillings per acre, have, for many years, by means of irrigation supplied by the drainage of a part of the city, realised from £15 to £35 per acre per annum. If, then, irrigation, more especially by liquid manure, be found thus important for agricultural purposes, how much more so may it be expected to prove advantageous to the horticulturist! Indeed, we hold it as a fixed principle that no water should be applied to the roots of fruit trees or culinary vegetables unless in a highly enriched state. Our own practice is, when our liquid-manure tanks fall short of the required supply, to add soot, guano, or pigeons' dung, to the water used; and years of experience have proved the great utility of the practice.

The late eminent garden architect, Mr John Hay, paid great attention to this subject of water; and the examples he has left us, in the gardens at Lundie House, Castle Semple, and Dalmeny Park, all designed by him, show the correctness of his principle. That the expense of bringing and distributing water in these gardens has long ago been repaid to the owners, is beyond a doubt. "Water is supplied" to Dalmeny gardens "from a reservoir situated on an eminence a considerable height above the garden walls. Around the whole garden, 4 inches below the surface of the ground, a groove, between 2 and 3 inches deep, has been formed in the walls to receive a  $\frac{3}{4}$ -inch pipe for conducting the water. About 50 feet distant from each other are

apertures through the wall  $2\frac{1}{2}$  feet high, and 10 inches wide, in which a cock is placed, so that, on turning the handle to either side of the wall, the water issues from that side. The nozzles of the cocks have screws on each side, to which is attached at pleasure a leathern pipe with a brass cock and director, roses pierced with holes of different sizes being fitted to the latter. By this contrivance all the trees, both inside and outside the walls, can be most effectually watered and washed in a very short space of time, and with very little trouble. One man may go over the whole in two hours. At the same time the borders, and even a considerable part of the compartments, the whole, indeed, by adding additional lengths of pipes, "can be watered with the greatest ease when required. The convenience and utility of this contrivance must at once be perceived by every practical horticulturist."—*Encyc. of Gard. and Edin. Encyc.* art. "Horticulture."

This arrangement is excellent for wall fruit trees, and affords an abundant supply for the purpose; but for watering the borders and main compartments of a garden we prefer flexible and portable pipes, such as are used for fire-engines, because they are capable of discharging more water, and can be carried to any part where water is required. The expense, in the first instance, is about the same; and although these flexible pipes are more liable to decay than the others, they have the advantage of being more easily repaired, and can be employed for a variety of purposes, while, if properly taken care of, they will last many years. This mode of introducing a supply of water by Hay is deserving of notice, as it was in his day a step in the right direction; and, strange as it may appear, it was the most important improvement effected by him in garden architecture. We may, however, remark, that  $\frac{3}{4}$ -inch pipes are much too small, and that the expense of cutting a groove in the wall for their reception was a useless outlay. The same object could have been much better attained by employing a pipe of larger calibre, say not less for the mains than  $2\frac{1}{2}$  inches, laid under the walks, with a vertical branch at every 50 feet. To these a flexible tube as a director could be attached, and the force of water directed

against the trees, the operator standing upon the gravel walk, thus obviating any treading on the border, and having the trees better presented to his eye. Besides, another nozzle of larger size, affixed to the upright branch, would admit of a flexible pipe being attached to it for the purpose of watering, or, if necessary, irrigating the quarters of the garden.

It frequently happens that water may be got at a level sufficient for irrigating the ground, but without sufficient pressure to be applied to the wall trees. This is easily remedied, and that without the expense of constructing a large reservoir: for as the pressure is in proportion to the depth of water, and not to the surface it covers, it follows that a hollow cylinder or pipe, say 3, 6, or 9 inches in diameter, and 10 feet in height, will give the same amount of pressure on the orifice of the delivery-pipe (if less in diameter than the above) as would a reservoir 10 feet deep and as many acres in area. A pipe, therefore, of any convenient diameter may be placed perpendicularly upon the top of one of the walls, or over the cistern, tank, or well of supply; and if its base be at an equal height with that of the wall, and its top 10 feet above that level, the water pumped into it will have pressure sufficient to syringe the wall trees in a very extensive garden.

We prefer laying the pipes under the walks to enclosing them in a groove in the wall in Hay's manner, because they are more easily got at in case of requiring to be repaired. For their preservation we usually enclose them between two drain-tiles, the one laid over the other, which separates the metal from the soil, and leaves it surrounded with air.

Water may be brought to a garden from any distance by various means. The most simple is through leaden, iron, glass, or earthenware pipes, from a fountain-head considerably above the garden level,—as the water will flow, so long as the pipes remain air-tight, over any inequality of surface, and discharge itself within a few feet of its original level: but if it can be brought the greater part of the way in an open drain or rivulet, so much the better. In this case, however, there must be an uninterrupted declivity during its whole course. Pumps may be

attached to existing machinery, such as mills, &c., and the water propelled through pipes to any distance, and to any reasonable altitude. Wells may be sunk, and the water pumped up by steam, manual labour, or horse power.

Artesian wells may be bored, and not only an abundant supply of water be obtained, but even that water at a considerably elevated temperature, as is the case at Sion House gardens and elsewhere. A curious and simple mode of this operation is described by the late Sir Andrew Halliday in his work on the West India colonies. Excellent practical directions for obtaining water by this means will be found in "The Engineers' and Mechanics' Encyclopædia," art. "Boring," and in various works on civil engineering.

In situations where water cannot be got from higher levels so as to be brought by its own gravity into the garden, or where circumstances prevent the collecting a sufficiency of rain water, hydraulic or steam power may be applied: in default of all these, boring the stratification and forming artesian wells must be had recourse to. This art, comparatively new amongst us, has for centuries been in operation in China, and for ages in the south of France and Italy. We believe that there are few situations where a supply of water may not be obtained by this means; but the water will not, in all cases, flow to the surface, and this particularly tends to occur in flat countries. From this cause the value of these wells is greatly lessened. Sometimes it will rise to within 20 or 30 feet of the surface: in such cases a well must be sunk, into which the water will flow and form a reservoir, and from this it must be brought up by means of a pump. At other times, it will rise to the surface and flow into a basin or pond, and sometimes it will rise to a considerable height above it, and form a jet or fountain. Various theories have been propounded with regard to these wells—the one most generally entertained, however, being that of the perforation reaching a bed of gravel or other porous stratum, with which communicate, from a higher level, subterranean sheets of water, fed and supplied by the continual filtration of water, dew, snow, &c., from the surface

of our globe. "The theory of these interior streamlets," says Dr Ure, "becomes by no means intricate. The waters are diffused, after condensation, upon the surface of the soil, and percolate downwards through the various pores and fissures of the geological strata, to be again united subterraneously in veins, rills, streamlets, or expanded films, of greater or less magnitude or regularity."

Fig. 8.

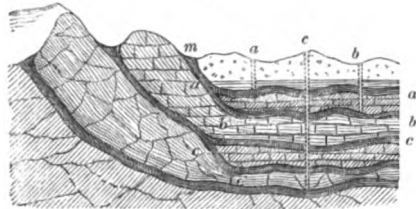


Fig. 8 "represents the manner in which the condensed water of the heavens distributes itself under the surface of our globe. Here we have a geological section showing the succession of the several formations, and the sheets or laminæ of water that exist at their boundaries as well as in their sandy beds. The figure shows also very plainly that the height to which the water reascends in the bore of a well depends upon the height of the reservoir which supplies the sheet of water to which the well is perforated. Thus, the well *a* having gone down to the aqueous expanse *aa*, whose waters of supply are derived from the percolation *m*, will afford rising waters which will come to the surface; whilst in the well *b*, supplied by the sheet *bb*, the water will spout above the surface; and in the well *c* it will remain short of it. The same figure shows that these wells often traverse sheets of water which rise to different heights. Thus, in the well *c*, there are five columns of ascending waters which arise to heights proportional to the points whence they take their origin. Several of these will be spouting or overflowing, but some will remain beneath the surface."

When water is thus obtained, it should be allowed to flow into a reservoir or pond, sufficiently capacious to hold a supply, in which it may become softened by exposure to the sun and air. The application of the hydraulic ram, or the process of boring or forming an artesian well, although rather expensive in the first

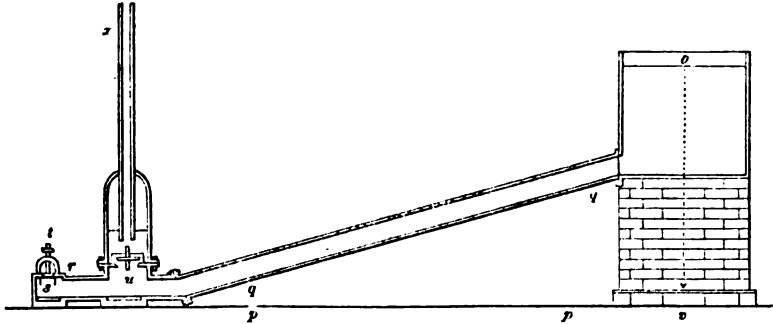


instance, will be found the cheapest in the end, as, when once put into operation, it is scarcely possible for them to get out of working order; and hence all the expense of pumping, and the necessary repairs attending it, are dispensed with. Various hydraulic powers might be employed for this purpose: the simplest and best is the

*belier hydraulique*, or water-ram. We say the best, because it is effective, and of such simple construction as to be scarcely ever out of order, and, when once set in motion, it goes on incessantly without any external aid, so long as it is supplied with water.

Fig. 9 represents this machine, and the following description explains its action:

Fig. 9.



“ Suppose *o* to represent a cistern or reservoir, or the source of a spring which is constantly overflowing or running to waste, by means of a channel a few feet lower than itself, as at the level line *pp*. Instead of permitting the water to run over the sides of *o*, let it be conducted to the level *pp* by means of iron or other pipes, *qq*, connected with the side of the reservoir, and terminating by an orifice, *r*, in which a conical or other valve, *s*, is placed, so as to be capable of effectually closing the pipe when such valve is drawn upwards: *t* is an adjustable weight fixed on to the spindle of the valve *s*, by means of which the valve is kept down and open; any water, therefore, that is in the cistern *o*, will flow down the pipe *qq*, and escape at the orifice *r*, so long as the valve remains down; but the instant it is raised and shut, all motion of the water is suspended. Thus situated, the adjustment of the weight *t* must take place; and by adding to, or subtracting from it, it must be made just so heavy as to be capable of sinking or forcing its way downwards against the upper pressure of the water, the force of which will depend upon the perpendicular distance from the surface of the water in *o* to its point of discharge at *r*, represented by the dotted line *ov*. But the water, by moving, acquires a momentum and new force, and consequently is no longer equal to the column *ov*, to

which the valve has been adjusted, but is superior to it, by which it is enabled to overpower the resistance of the weight *t*, and it carries the valve up with it, and closes the orifice *r*. This is no sooner done than the water is constrained to become stationary again, by which the momentum is lost, and the valve and weight once more become superior, and full, thus reopening the orifice and permitting the water to move again; and as the pressure of the water and the weight of the valve each become alternately superior, the valve is kept in a constant state of vibration, or of opening and shutting, without any external aid whatever. Such is the principle upon which the motion of the water in the pipe *qq* is produced; but the momentum generated cannot be instantly annihilated, and it is not only of sufficient power to raise the valve *s*, but likewise to burst open the lower end of the pipe *qq*, unless a sufficient vent be provided by which this accumulated force can escape: accordingly, a second valve, *u*, is placed near the lower end of the pipe *qq*, and is made to open upwards into the air-vessel, having a discharging pipe *x*; and consequently, whenever the valve *s* is closed, the water, which otherwise would have flowed from the orifice *x*, now opens the valve *u*, and enters the air-vessel, until the spring of the contained air overcomes the gradually

decreasing force of the momentum, when the valve *u* closes, and that at *s* opens, to permit the water to make a second blow or pulsation. In this way the action of the machine continues unceasingly, without any external aid, so long as it is supplied with water and remains in repair."—*Library of Useful Knowledge*, vol. "Natural Philosophy."

*Legg's Improved Self-acting Hydraulic Engine* is also a useful machine for this purpose, and is capable of conveying from 1 gallon to 20 per minute to a distance of 2000 yards, and to a point elevated 500 feet or upwards, with a fall of  $2\frac{1}{2}$  feet, giving not more than a continuous overflow of 1 pint. With this quantity of water as the moving power, the engine will supply about 10,000 gallons in twenty-four hours; and when the moving power is greater, the supply thrown up is proportionately increased. It has some advantages over the ram, especially as being cheaper, and wrought with less water. It is not liable to get out of repair, and will draw water from a spring 30 yards or upwards distant from the apparatus.

*Lucas's Self-acting, Force, and Lift-Pump*.—We have not had an opportunity of seeing this machine in operation, although we have heard much said in favour of it. It may be fixed in any situation where a small supply of water can be procured. It is simple in construction, and not liable to get out of working order; yet, should that happen, we are informed by Sir Joseph Paxton it may be readily adjusted. The appendages can be fixed to any description of pumps, whether such are already fixed or otherwise. The waste water is very trifling, a very small quantity being sufficient to work it, which, if requisite, can also be raised.

In situations where a running stream can be brought to flow through the garden, as is the case at Hopetoun House, it is of great service, as well as a beautiful object; but in general these streams flow through the lowest part of the grounds, and consequently are less valuable than if they were higher. The situation at one time fixed on for a new garden at Yester House, the property of the Marquis of Tweeddale, upon which we were consulted, has a copious running stream passing along the highest part of the ground, which we, in

conjunction with Mr Shearer, his Lordship's very intelligent gardener, purposed should be retained, ornamented, and rendered fit for the purposes required. Much, however, as these streams are to be desired, it would be well to have provision made for turning them off during winter.

### § 5.—SITUATION.

The situation which a culinary and fruit garden ought to occupy, requires, we think, more consideration than appears to have been in general given to the subject. Mr Loudon says "The situation of the kitchen garden, considered artificially, or relatively to the other parts of a residence, should be as near the mansion and the stable-offices as is consistent with beauty, convenience, and other arrangements." Nicol, on the same subject, observes, "In a great place the kitchen garden should be so situated as to be convenient to, and, at the same time, concealed from the house." The same authority remarks in "Kalendar," (p. 3,) "Sometimes we find the kitchen garden placed immediately in front of the house," which he considers "the most awkward situation of any, especially if placed near, and so that it cannot be properly screened by, some sort of plantation. Generally speaking, it should be placed in the rear or flank of the house, by which means the lawn may not be broken and rendered unshapely where it is required to be most complete."

As an instance of placing the garden on the flank of the house, and where it is completely shut out from it, yet at a most convenient distance, we may mention that at Trentham Hall, where this is most completely effected. Still, however, we think that it is too near the house, and may at some period, if it has not already, be found in the way of future improvements. The gardens at Claremont afford another instance of this kind, where much of the beauty of the park is destroyed merely for the sake of a supposed convenience; and the same may be said of Welbeck, Knowlesly, and many others. The two latter are, however, in the rear of the mansions to which they belong, and at present do not interfere with them in any way.

In considering the subject of situation, it is proper to remark that convenience to the mansion and offices is all very well, so far as regards places of inconsiderable extent, and where the kitchen garden is to be in the mixed style—that is, having flowers cultivated in the borders in juxtaposition with culinary vegetables. But in large establishments, where nothing should be seen from the mansion but park, lawn, and flower-garden scenery, the kitchen garden should not only be removed from the house, but should be placed as near to the boundary of the park as is compatible with other arrangements, that it may be as little in the way of ulterior alterations and improvements as possible; and also that access to it, both for carting and for the labourers employed, may be had without these having to pass through the park or pleasure-grounds. This is exemplified in the kitchen garden at Chatsworth, which is near the boundary of the park; and the situation chosen by ourselves for the new gardens at Dalkeith is also upon its margin, so that all communication, except that from the family, is made direct from the public road. An ill-placed garden, like an ill-placed house, will ever be a source of annoyance to the owner, as neither can be removed without great expense, and a loss of enjoyment for a number of years.

These remarks, as we have already noticed, are applicable to places of great extent only. With villa residences the case is different; in these the kitchen garden may be attached to the offices, so that a free communication may take place between the kitchen, the stables, and the garden, but without interfering with either the entrance or the lawn fronts. "In general," says Mr Loudon, in reference to small places, "it is desirable to have the kitchen garden close to the stable offices, so as to make some use of the walls of the latter for training fruit trees, and to shorten all the lines of communication for servants, as also the walk to the garden from the lawn front. Wherever it is practicable," in such places, "the farm should adjoin the kitchen garden, and, as it were, follow in the train of offices and useful appendages. In this view of the general arrangement of a villa and its offices, it appears that

all the latter should be placed on one side of the dwelling-house, so as to leave the three other sides free. Wherever three sides of the dwelling-house are not free to be disposed of as the combined judgment of the landscape-gardener and architect may direct, either the case must be anomalous, or some gross fault must have been committed. We would strongly recommend this to be kept in view both by architects and their employers as a leading principle in determining the position of the offices" and garden "relative to that of the house."

Many bad situations have been chosen merely because the soil happened to be good in them. No doubt a good natural soil is greatly to be desired, and proves a considerable saving of expense; but, notwithstanding this, an eligible site should not be sacrificed to this point of soil, as soil can be artificially made, or the bad may be removed and good substituted. The older gardeners depended much upon soil; and to this may be traced the origin of many situations which have been abandoned, and of others which, although they remain, have been a source of annoyance for ages.

Another mistake frequently fallen into in the selection of a site for a garden, is that of choosing a low and consequently a damp one, under the mistaken notion of having shelter from winds, &c. Such situations are condemned by almost all writers on the subject, although adopted by most of them in practice. Dr Darwin in his "Phytologia," Professor Bradley, Lawrence, Switzer, Abercrombie, Forsyth, Nicol, &c., all agree in urging the avoiding low situations. Forsyth (Treatise on Fruit Trees, p. 286) says, if the garden "be situated in a bottom, the wind will have the less effect upon it; but then damps and fogs will be very prejudicial to the fruit and other crops." Switzer says, (Pract. Fruit Gard.) avoid low situations and bottoms of valleys, because there is often a sourness in the earth that cannot be eradicated; and in this uncertain climate of ours heavy fogs and mists occur, which hang so long on the fruit and leaves in low situations that not only vegetation is retarded, but also the ripening of the fruit." And Dr Darwin (Phytologia, sect. 15) makes the following truly prac-

tical remarks: "The greater warmth of low situations"—a warmth, however, which is only experienced during the drought and heat of summer—"and their being generally better sheltered from the cold north-east winds, and the boisterous south-west winds, are agreeable circumstances; as the north-east winds are the freezing winds, and the south-west winds being more violent, are liable to do much to injure standard fruit trees in summer by dashing their branches against each other, and thence bruising or beating off the fruit; but, in low situations, the fogs in vernal evenings, by moistening the young shoots of trees and their early flowers, render them much more liable to the injuries of the frosty nights which succeed them, which they escape in higher situations." On the other hand, too high and exposed situations are also to be avoided on account of the boisterous and cutting effects of the winds, and also because such situations are colder than those less elevated. Nor should gardens be placed near ponds of stagnant water, for those in such situations can seldom be rendered sufficiently dry at bottom, and the air must consequently be damp, and the attraction of frosts great.

The slope of the ground should always be towards the south, or a point or two to the west of south, so as to secure the benefit of the evening sun. On this point, however, Abercrombie observes, "When the sun can reach the garden at its rising, and continue a regular influence, increasing as the day advances, it has a gradual and most beneficial effect in dissolving the hoar-frost which the past night may have scattered over young buds, leaves, and blossoms, or setting fruit. On the contrary, when the sun is excluded from the garden till about ten in the morning, and then suddenly darts upon it with all the force derived from considerable elevation, the exposure is bad, particularly for fruit-bearing plants in the spring months: the powerful rays of heat at once melt the icy particles, and immediately acting on the moisture thus created, scald the tender blossom, which drops as if nipped by a malignant blight." An entirely easterly aspect is, however, not to be recommended, as by such an arrangement the sun would cease to shine on it shortly after

mid-day, while an entirely western one would only benefit by the afternoon's sun.

"Gardens of great fertility and earliness are often to be met with on the sides, or near the bases, of hills, particularly if sheltered from the coldest points by lofty rocks—the reflection or concentration of the rays of heat from them rendering the situation peculiarly adapted for bringing crops of the most delicate kinds to perfection at an early season. Situations of this kind are not only desirable on account of these advantages, but are generally very romantic and picturesque, or may be rendered so by judicious decoration."—*Pract. Gard.*, p. 8.

Gardens out of the side of a hill may be very advantageously laid out in terraces, the only difficulty being getting the manure and fresh supplies of soil conveyed to them without the aid of mechanical power. And situations frequently present themselves on the sides of hills, where irregular gardens of great beauty, shelter, and warmth, may be established.

In regard to level, Switzer, Nicol, and others recommend a fall of one foot in twenty or thirty towards the south. The latter says that the garden, "if quite flat, seldom can be laid sufficiently dry; and if very steep, it is worked under many disadvantages. It may have a fall, however, of a foot in twenty, without being very inconvenient; but a fall of a foot in thirty is most desirable, by which the ground is sufficiently elevated, yet not too much so." Many excellent gardens have, however, a much greater declivity than this, as instanced in those at Hoptoun House, and the lower parts of those at Dalkeith: in both cases they in some parts fall as much as one foot in four, and are both noted for precocity, and for the preservation of the crops during winter.

Of all situations for a garden, those that are shaded by high buildings and lofty trees are the worst; because, as Forsyth justly observes, "a foul stagnant air is very unfavourable to vegetation; and it is also observed that blights are much more frequent in such situations than in those that are more open and exposed." They are also late, being shaded from the sun in early spring, and cold and damp in winter from a similar cause. An open and exposed situation is preferable to one so circumstanced.

In regard to the situation of suburban villa gardens, or where the property is of limited extent, the subject will be made more intelligible by giving a specimen or two of such grounds generally; and, as examples of great merit, we extract Plate I. from the "Encyclopædia of Farm and Villa Architecture," being, as Mr Loudon informs us, a suburban villa of two acres and half in extent, and within a mile and a half of London, built and laid out by an architect for his own residence. "In this plan, *a* is the main entrance; *b* the entrance-portico of the house; *c* the kitchen and stable-court; *d* the stable and coach-house; *e* a door in the wall bounding the entrance-court, by which the grounds may be entered without passing through the house; *f* a circular group to be filled with geraniums, or other showy greenhouse plants, during summer; *g* a billiard-room, with a concealed entrance in the back of an alcove seat, the room lighted from the roof; *h* a rosary, in the shape of a horse-shoe, a dial being placed in the centre; *i* a basin, with a bronze fountain in the centre, in the form of a dolphin, which spouts up water to a considerable height: the margin of the basin is of marble, surmounted by pedestals and vases; and the space of lawn between it and the walk is varied by choice herbaceous plants; *k* rubbish-ground, with gardener's working-sheds, for pots, tools, &c., as well as for protecting, during winter, the vases and statues, which are set out in summer; *l* a grotto, having the appearance of a rock externally, and partially covered with ivy and creepers; *m* is an American garden, comprising a choice collection of shrubs and plants, and ornamented with several select statues and vases, the pedestals of which only remain during winter; *n* is a collection of herbaceous plants; *o* summit of a wooded knoll, covered with an open grove of pine trees; *p* shady grass walk for the hottest days of summer; *q* wire-fence on the top of a concealed wall, which admits an interesting view of the country beyond; *r* wall and fruit border facing the south; *s* the gardener's cottage; *t* a plot devoted to aromatic herbs; *u* the melon ground, sunk three feet beneath the general surface of the garden, and surrounded by a hedge of box; *v* kitchen garden; *w* a high knoll,

with a steep side, covered with rock-work and creepers on the west, and crowned with a terminal statue of colossal dimensions, from the antique, supported on a pedestal of granite; *x* fruit wall and border, with western aspect; *y* octagon bower, having in the centre a magnificent bacchanalian vase, from the antique; and *z* a descent of three steps from the drawing-room to the garden." The part marked with the polar needle is a small sheet of water, the surface of which is nearly twenty feet below the level of the walk in front of the house; or the same space may be left as a grass lawn, as it is not in all places that water can be obtained or retained. The objects in laying out the grounds of this villa were, to obtain a sufficient extent of walks for all necessary exercise and recreation within the boundary wall; to produce as much variety as possible, independently of architectural beauty and distant scenery; to include a small kitchen garden; to mature the best hardy fruits; and to display a collection of the most select ornamental trees, shrubs, and flowers. For this purpose the more choice peaches and nectarines are placed on the wall *r*, having a south aspect; the grapes to be covered with glass, on the same wall, next the gardener's house; and figs, apricots, and the more choice cherries, plums, and pears on the wall *x*, having a western exposure. Apples are distributed through the grounds, and also such pears, plums, and cherries as will bear in the climate of London, on standards. One or two specimens of walnuts, sweet chestnuts, mulberries, quinces, medlars, azaroles, true service, cornels, and similar fruit trees are also distributed through the grounds. There is a collection of rock plants on the rocky precipice which forms the steep side of the peninsula *w*; of herbaceous plants in the circle *n*; of American trees, shrubs, and herbaceous plants in the circle *m*; of bulbs among the rose-trees at *h*, and in the circle *f*, among the pelargoniums; both of which are taken up when they have done flowering, and the bed filled with box-trees, and similar shady evergreens in pots. In the other planted parts of the grounds are select trees, shrubs, and flowers, grouped so as to have all the species of each genus at no great distance from

one another, and so as not to repeat any genus twice, except those including fruit trees, American evergreens, and bulbous-rooted plants. These are distributed generally, in order to harmonise with the whole. In the melon ground the frames are supported on brickwork, in an improvement on M'Phail's manner, with narrow paths of brick between each range of frames, and with the dung-linings covered with boards, so that the whole is as clean, orderly, and neat, as a flower garden, at all seasons of the year."

So highly did Mr Loudon estimate the merits of this suburban garden that he says—"Considering the size of this villa, its completeness, and the extent of its accommodation, conveniences, and luxuries, exceed any thing of the kind we have ever before met with." And further, he observes, "We shall, however, sum up our opinion in one sentence, which is,—that, taking the place altogether, we do not believe there is such another in the neighbourhood of London."

No one has studied the subject of suburban gardening more fully than did our lamented friend, the late Mr Loudon; and as we hold his opinions on these matters in high estimation, we shall here transcribe a brief critique by him on the villa in question. "Notwithstanding these encomiums," he says, "we are aware of some objections which may be made to the laying out of the grounds as shown in the plan, Plate I. It may be objected to the plan that the lines are too formal and unbroken; but it must be recollected that scarcely any of these lines, except those of the walks, can be recognised as lines in reality. The plan is in short a working plan, calculated to show the gardener what ground is to be dug and planted, and what is to be laid down in grass, together with the direction of the gravel walks. The single trees and small shrubs, which are indicated in the plan by crosses x x, will break all the lines, both of the dug groups and the water, and produce an effect altogether different from that shown in the plan. Even the spreading of the shrubs over the margins of the dug groups will totally destroy that appearance of lines, which forms the prominent features of the plan as it appears on paper. However, independently

altogether of the breaking of these lines by vegetation, there is a certain degree of beauty which belongs to lines and forms simply considered, and without any reference to the substance of which the forms are composed. Now, the question is, how far our architect has succeeded in this kind of beauty. In most parts of the plan we think his success perfect; but in others we should perhaps have made some variation; and the principle by which we should have been guided in so doing would have been that of adopting the forms to their local situation alongside of the walks. The extent, however, to which we should have done this is not great. The effect which we should desire from such a plan as that before us we have endeavoured to show in Plate II.; and this is, as nearly as possible, the actual effect on the grounds. The great beauty which in Plate II. is added to Plate I., is that of intricacy; which is a main source of visual enjoyment by nourishing curiosity, keeping alive attention, and stimulating the process of examination. The mind takes delight in penetrating into recesses, and making discoveries of new beauties at every step; in tracing, in the forms of nature and chance, something of those of art; in bringing shape and figure out of apparent irregularity and confusion; and in finding everywhere the principle of connection and co-operation towards the formation of a beautiful and expressive whole. The kitchen garden is not to be considered as having any beauty as such, farther than that it produces good crops of vegetables. It is placed and arranged so as not to interfere with the idea of extent, which is always an idea to be cherished in a limited space, and which in England is sought after by most people, as creating allusions to the extensive parks and pleasure-grounds of the aristocracy. The full and characteristic beauties of a kitchen garden are only to be obtained when it is surrounded by walls and laid out in right lines; but such a garden would have totally destroyed the effect aimed at in the place before us."—*Encyc. of Farm and Villa Arch.*, p. 834.

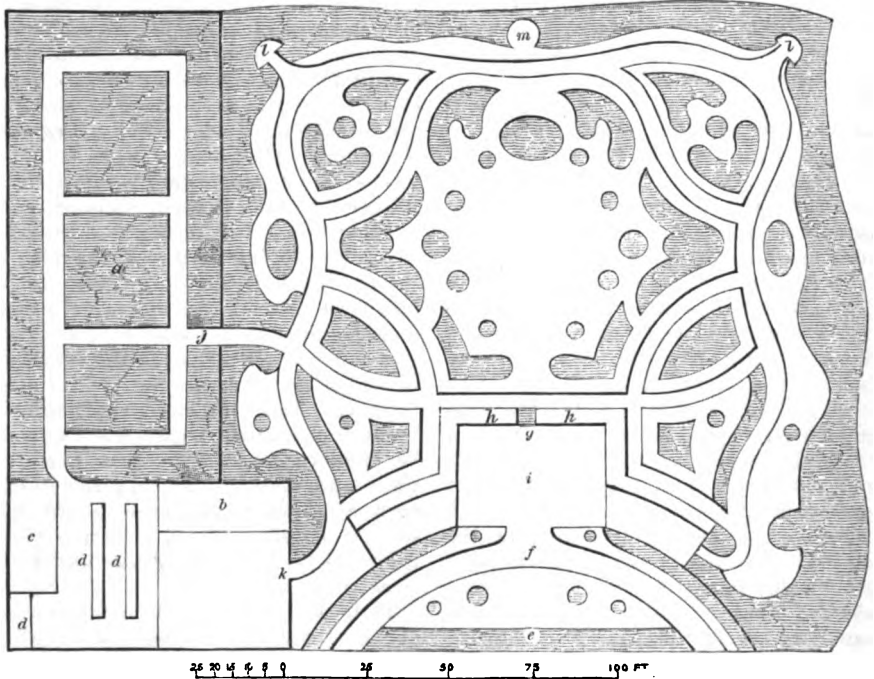
Plate III. exhibits the relative connection between a villa residence of moderate size, with the garden and

grounds. This design was composed by the late James Main, Esq., for the work last quoted. The kitchen garden contains about 2 acres, and is surrounded by lawn and pleasure-grounds, the whole being separated from the park by a fence, as shown by the dotted line. This fence may either be of wire, open iron railing, or a sunk fence, or ha-ha, as may be deemed most expedient. "Beyond the general plan, *a* is the entrance-court and offices; *b* the back-yard court, with two dung-pits surrounded by low walls; *c* drying-ground; *d* conservatory, with flower garden around; *e* ice-house, formed under a raised mound planted with evergreens; the door is in the sunk fence, indicated by the dotted line which encloses the whole of the dressed ground and the kitchen garden; and *f* the melon ground; *g* compartments for asparagus, sea-kale, rhubarb, and other articles, with two mushroom-sheds, marked 1 and 2; *h* slips enclosed by thorn or holly hedges, the outside borders planted with small fruit-trees, and fruit shrubs; *i* range of hothouses; *k* vinery; *l* mould-yard; *m* orchard; *n* aquarium and rock-work; *o* gate to the

cart-road, the coach-yard, mould-yard, and sheds; *p* basin of water in the centre of the garden; *q* lines of approach to the entrance-court." The advantages of this disposition of the house, offices, and pleasure-grounds of a villa, Mr Main observes, "are the compactness and unity of design which it presents. Everything, whether useful or ornamental, necessary to render such a residence complete, is here included within the sunk fence. From the endless walk within this fence is seen, over a foreground of lawn and trees and shrubs, the scenery of the park and the features of the surrounding country, whatever they may be. Various statues, sculpture, vases, and other architectural ornaments, may be distributed among the flower-beds near the house, and along the endless walk. A gardener's house may be placed in the orchard, or behind the vinery at *k*, exactly in the centre of the range of glass; and the living and sleeping rooms should be so high as to overlook the whole of the garden and the orchard."

The annexed fig. exemplifies a suburban or villa residence, containing many

Fig. 10.



conveniences, and suitable to a private family, or retired tradesman.

The ground is laid out in the gardenesque style, with abundance of walks, and those so united as to do away as much as possible with all necessity for returning by the same route. The boundary is closely planted with ornamental trees and shrubs, so as completely to shut out the enclosing wall, and prevent the smallness of the space from being detected; as well as to screen the kitchen garden which is placed at *a*, and the greenhouse *b*, vinery *c*, with the pits *d d d*, from the lawn or pleasure-ground. The house stands at *e*, with a semicircular terrace *f* in front extending to the steps *g*, which lead to the principal part of the lawn. A border of flowers is placed along the front of the house, succeeded by a semicircular plot of grass upon which four small circular beds are placed, for scarlet geraniums, or other equally showy plants, during summer. These beds are raised a foot at the centre, and their margin is encompassed with a stone edging 9 inches deep. When the plants are removed in autumn, their places are supplied with highly ornamental vases, set on 2-foot pedestals in the centre of each plot, and the soil between the base of these pedestals and the stone border is covered with green moss. A vase of corresponding style is set on the ends of the parapet *h h*, on each side of the steps, but not close to them. A broad gravel walk, in connection with the opening windows of the dining-room and drawing-room, runs parallel with the semicircular grass-plot, and is separated from it by a narrow border of flowers. On passing from the semicircular gravel walk we arrive at a square plateau of gravel, *i*, with two side-wings of grass. The gravel walks are carried through the grounds in such a manner as to give the greatest possible extent of promenade. These walks, however, lead to points of importance or interest—as, for example, one leads to, and enters the kitchen garden at *j*, another to the greenhouse and pit ground at *k*, while the branches from the main walk, at the lowest or farther part of the lawn, lead to two resting-seats *l l*, and also to a summer-house at *m*. Dwarf flowering and evergreen shrubs occupy the larger beds,

while showy herbaceous plants, bulbs, and annuals, are placed in the circular clumps dotted amongst them. The kitchen garden is connected, yet shut out from sight both from the lawn and windows; and the buildings connected with the greenhouse, vinery, and pits, are enclosed within walls also screened with shrubbery.

We give these as specimens of situation and arrangement, as they can be illustrated on the scale here aimed at. To give similar examples for places of great extent, it would be requisite that these should be accompanied with a map of a great part of the park. We have chosen these illustrations as suitable to a numerous class of proprietors, many of whom may not choose to call in the aid of a garden architect; and also as we consider them excellent models of what ought to be found in villa residences, and grounds of limited extent.

We have also given these examples of villa gardens, because we regard them as perfect of their class. To attempt to extend the subject further would be attended with small advantage: the principles, however, which have been laid down form the general rules; and from them the intelligent reader will be able to draw such conclusions as will aid him in applying them to his circumstances and taste. It would be superfluous to go at large into the kitchen or fruit garden details of villa gardens, as these will be found in another part of this work. Ample directions on those heads, and also under the head FLOWER GARDEN—on the disposal and formation of villa flower gardens—will be hereafter given. (For more relating to situation, see article STYLE.)

#### § 6.—SOIL.

A good soil, even in an indifferent situation, may make a good garden; but a bad soil, let the situation be what it may, cannot make a good one. It is, however, fortunate, that although the art of man can change or amend the situation only to a very limited extent, he has the power to make the soil what he pleases. An entirely new and proper soil can be formed on the surface of that which is bad; or, if the original level is not to be



departed from, the bad soil can be removed, and a better substituted. Important though soil be, let it always be a minor consideration compared with situation, shelter, and aspect.

The older gardeners, such as London and Wise, Switzer, Hitt, Justice, Bradley, Abercrombie, and others, too often sacrificed situation for soil; and perhaps some modern artists have erred in the opposite extreme, and depended too much on manure and other adventitious aids, in endeavouring to secure their object.

The nomenclature of soils is in such an imperfect state, that it is very difficult to find terms by which to express what may be called a good, bad, or indifferent garden soil. M'Phail recommends "a sandy loam, not less than 2 feet deep, and good earth, neither of a binding nature in summer, nor retentive of rain in winter, but of such a texture that it can be worked without difficulty at any season of the year. If it can be done, a garden should be made on land the bottom of which is not of a spongy, wet nature. If this rule can be observed, draining will be unnecessary; for when land is well prepared for the growth of fruit trees and esculent vegetables, by trenching, manuring, and digging, it is by these means brought into such a porous temperament that the rains pass through it without being detained longer than necessary. If the land of a garden be of too strong a nature, it should be well mixed with sand, or scrapings of roads, where stones," particularly flints, "have been ground to pieces by carriages."

Walter Nicol was of opinion that several kinds of soil were necessary in the same garden; and the same view has been advocated by Dr Neill. "It is a happy circumstance," says the former, "that in many instances we meet with different soils in the same acre. In the same garden they should never be wanting; and where nature (or natural causes) has been deficient, recourse must be had to art—inasmuch as the variety of fruits and vegetables to be cultivated require different soils to produce them in perfection." It would, however, be absurd to argue in favour of a scheme to provide a different soil for each description of vegetable.

Forsyth recommends a deep soil "of a mellow pliable nature, and of a moderately dry quality; and if the ground

should have an uneven surface, by no means attempt to level it; for by that unevenness, and any little difference there may be in the quality, you will have a greater variety of soil adapted to different crops. The best soil for a garden is a rich mellow loam; and the worst, a stiff heavy clay. A light sand is also a very unfit soil for a garden."—*Treatise on Fruit Trees.*

Loudon says, "A soil should be sufficiently tenacious to adhere to the roots of plants, though not so much so as to be binding, which would certainly retard their progress and extension in search of food. Hence a loam of a middle texture, or rather inclining to sand, may be considered as the most suitable soil for the purpose here in view—and that on a double account, viz., the greater part of the valuable kinds of kitchen vegetables delight in such a soil, and it is worked at less expense than a stiff one; and in severe droughts it is neither apt to crack or be parched, nor in hard frosts to throw out tender plants and seeds."—*Encyc. of Gard.* p. 724.

Where soils are not found naturally existing similar to those above, art must be called in to modify or change them. We have stated elsewhere that this is both practicable and necessary; and indeed, where the aspect and situation are good, no expense should be spared in forming good soil, even to the degree of making it entirely artificial. This has been done to a very great extent in the gardens at Dalkeith, where the original good soil was in many cases not more than 3 inches deep; the field, chosen on account of its favourable situation, having been used for years previously as a gravel pit, and as the gravel had been removed, the excavations were filled up with all the rubbish collected in the park. The first operation, after arranging the necessary levels, was to open a trench along the centre from side to side, 30 feet in breadth, and to cast out the heterogeneous material to the depth of 4 feet. The bottom of this trench being properly levelled, we began to fill it up with surface soil taken from various parts of the grounds, such as that on which our buildings were to be placed, and the foundations of drives and walks, which we formed simultaneously to a great extent, loading out with gravel, and loading in with soil. In addition to this,

we stripped a considerable extent of old park land, and indeed collected what we could find suitable for the purpose wherever it could be conveniently spared. In this manner did we proceed, trench after trench, until the whole of the principal or square garden was completed—removing nearly 14,000 cubic feet of gravel, and replacing it with a corresponding quantity of good soil. The soil is of a rather light loamy nature in this part, resting on a fine alluvial gravel to the depth of from 2 to 5 feet, below which is a bed of clay of unknown depth. Draining became unnecessary on account of the depth of the cellars, which extend along the whole length of the principal garden: under these is the larger reservoir already alluded to, built in the solid clay, and supplied by the rain water, which, passing through the made soil, percolates through the gravel stratum, and finds its way along the surface of the clay in drains into the reservoir, which is capable of retaining a sufficiency of water of excellent quality for all our purposes.

In regard to the depth and quality of soils, we may observe that much, as regards both, depends on locality. In wet districts, such as the west of Scotland, where a much greater amount of rain falls than on the eastern shores, a lighter and shallower soil should be preferred. Thus in the new gardens in progress of formation at Poltalloch, situated within a mile and a half of the sea on the west coast of Argyllshire, and surrounded by very lofty mountains, and where, we have been informed, 60 inches of rain fell during the last year, (1850,) the soil is of a light sandy, loamy texture, resting on sharp, alluvial sand, and the angle of inclination considerable towards the south. We are making the soil only 2½ feet deep; while that at Dalkeith, as we have mentioned, is 4 feet deep—the fall of rain having been there last year (1850) only 18 inches; but this is somewhat below the average.

Strong clayey soils in wet localities should be avoided, nor are they by any means the most proper for garden purposes anywhere. Although capable of producing excellent crops, these crops do not come away freely in spring, and consequently the productions are late in coming to maturity.

In regard to the improvement of soils, all are capable of amelioration, where the expense is gone to. Strong tenacious soils are ameliorated by drainage, by the addition of sand, by burning, and by exposure to the weather; while light, sandy soils can have consistency given them by the addition of loam or clay. Beyond this, a chemical analysis should be made to ascertain what parts necessary for the food of plants are wanting, and these should be added; while counter agents should be employed to correct such ingredients as may exist injurious to the productions required. (For chemical analysis of soils, *vide* vol. ii., ANALYSIS OF SOILS AND MANURES.)

#### § 7.—FRUIT-TREE BORDERS.

Many conflicting opinions have been published of late years on the proper formation of fruit-tree borders. The most important of these coincide with our own conviction as to three general principles to be kept in view regarding them—namely, a dry bottom, proper breadth and depth, and leaving the surface uncropped with flowers or vegetables.

The first operation in forming thoroughly-prepared fruit-tree borders is the excavation of the natural soil, whether good or bad, that a proper bottom or foundation may be made. Presuming that, when the walks were formed, a drain has been carried under them, the bottom of the border is then to be laid in a sloping direction from the wall to this drain, sufficient declivity being given to allow any water that may find its way downwards to fall into the drain. At one time we practised and recommended forming the bottoms of borders like a solid floor, in order to render them impervious to the roots of the trees, with a view to prevent these extending into an uncongenial subsoil; and immediately upon such floors we formed the border. Experience has since taught us that it is better to lay upon the bottoms thus formed a drainage 12 inches thick of broken stones, brickbats, or other similar durable draining material, and on that the prepared soil for the trees. Nor is it without advantage to the trees that subterranean aëration be admitted to their roots. This may be effected in a variety of ways, the most

simple of which is laying in 6-inch drain-tiles across the borders at distances of from 6 to 10 feet asunder, embedded amongst the drainage referred to. These cross drains should communicate with two similar ones laid along the back and front of the border in a longitudinal direction; and at convenient distances tubular metallic ventilators should be placed vertically along the two latter, so that air may be admitted and allowed to circulate through the whole system of the drainage.

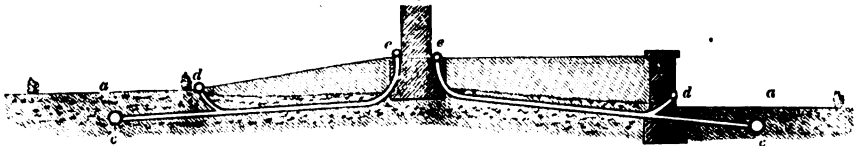
All borders should slope up from the walk to the wall, in proportion to their breadth: a border 12 feet wide should be at least 12 inches higher at the back than at the front—a circumstance which should be taken into consideration when the

walls are building, that additional height may be allowed.

Sloping the borders in this manner tends to render them drier and warmer, while the roots of the trees will also derive some advantage from the rays of the sun acting on the surface: this is the more necessary to be observed in cold, late situations, and where the soil is naturally cold and clayey. In forming new borders allowance must be made for sinking, which the soil will do more or less, according to the quantity of decomposable matter in it.

The annexed diagram, fig. 11, will elucidate the remarks just made—*a a* are the gravel walks; *b* the parapet wall; *c c* the drain under the walks; *d d* the

Fig. 11.



openings of the air-drains communicating with the drains under the border, embedded in the drainage, but not jointed close on the upper side to admit of the air passing through amongst the drainage, and so to the roots of the trees; *e e* the openings of the drain-pipes close to the bottom of the wall.

In the above diagram we have shown the border on one side of the wall finished with a dwarf parapet wall; in the other, the border is laid in the usual manner, only having a much greater inclination towards the walk.

So important do we hold the elevation of borders for fruit trees, particularly in cold and wet situations, that we would prefer three parts at least of their depth being above the general ground level, and that the front next the walk should be enclosed with a parapet wall of brick or stone work, equal in height to three-fourths the depth of the border. This would in no way affect the expense of the walls, as, instead of sinking the foundations under the original soil, they might commence on its surface, if found to be sufficiently sound.

Such a departure from long-established rules will, we doubt not, meet with that share of opposition which innovations,

however valuable they may in reality be, have to contend with. When, however, it is considered how much of our success in producing healthy trees and abundant crops depends upon the proper formation of fruit-tree borders, we should set antiquated prejudices at defiance, and be guided only by the force of reason. Supposing the fruit-tree borders should form a platform a foot, or even more, above the level of the walks, the effect would be to give a greater *apparent* height to the walls themselves; while it would secure the roots within proper limits, and place them in a condition to derive the full benefit from the solar influence, of which they would be deprived if, as at present, sunk under the general surface. Architecturally speaking, borders so constructed would form the base on which the walls stand; and, having a stone or brick boundary, with a substantial coping, next the walk, would form a part of the walls, and this the more especially if the latter are built upon architectural principles.

The views we have endeavoured to detail in this article, with the exception of the parapet wall, which we believe to be an original idea, we are glad to find agree in all essentials with the opinions expressed by Mr Errington—certainly the

highest authority we have in all matters relating to fruit trees.

We have elsewhere shown the propriety of elevating hothouses upon terraces to give effect to them, as well as for the more completely forming the external borders for the roots of peaches and vines. If the rule is good in the one case, it is certainly so in the other, as walls form, next to hothouses, the most prominent features in a well-designed garden.

We have on a former occasion (*vide* "Practical Gardener," 2d edition, p. 227) recommended paving the bottoms of borders with "tiles, paving bricks, or flagstones, at least for all the better kind of trees." This recommendation we do not rescind, but would add the drainage just described, above this paving. Whatever bottom may be made, it is absolutely necessary that it should be so constructed that all superfluous water may be effectually carried off. This is the more necessary in strong retentive soils, where digging out the border and placing under it an impervious flooring, without proper attention being paid to the drainage, is little better than forming an ill-constructed water-tank. We saw this very lately exemplified in a very conspicuous degree, in the case of a gentleman who consulted us upon the failure of his vines, and who had made his border, as he said, exactly upon the plan laid down in the "Practical Gardener." When the border was opened up, it was at once seen he had most effectually rendered the bottom water-tight, the sides being naturally a strong clay as well as the natural bottom; but he had entirely neglected running a drain along the front to take away the superfluous water, so that the whole mass of border was a complete puddle, and the longer it continued the worse it would become. How he could have mistaken or overlooked the directions in the work above named is rather singular, for at p. 225 it is thus written—"In preparing borders for fruit trees, the first consideration is to render the bottom perfectly dry by draining; indeed, this precaution ought to be taken to a certain degree, even where the bottom is naturally dry, in order to guard against accidental floods of water, or a long series of wet weather in autumn, as their roots are very impatient of too much wet. Where the bor-

ders are to be well done, the natural soil should be entirely taken out, to the depth, under the ground level, of 30 inches or 3 feet: the bottom should be rendered smooth, with a considerable fall from the wall, sufficient to allow any water that may collect to run freely off towards the walk, under which should be a well-formed drain of the best materials the place can afford." Those who profess to rely on the directions laid down by authors, should in fairness follow those directions to the very letter.

In regard to the depth of fruit-tree borders, opinions are at variance—some advocating deep ones, while others prefer those that are shallow. Of course, a good deal depends on climate and situation, and also on the kind of trees to be planted. For example, the pear requires both a stronger and deeper soil than the vine, and the plum rather more than the apricot, although these two are much more nearly related.

The following proportions of depth for different fruits are those given by different authorities: For peaches and nectarines, Nicol recommends 30 inches; for pears and plums, not less than 3 feet on the average—that is, 2 feet 9 inches at the wall, and 3 feet 3 inches at the wall, or thereby; for apples, cherries, and figs, an average depth of about 30 inches. On this subject Forsyth, in his "Treatise on Fruit Trees," scarcely offers an opinion; and even Harrison is next to silent on it, only remarking, in a general way, that the "depth should be 3 feet at the wall, and 2 feet 6 inches at front." No border should be made deeper than 1½ foot, according to Rogers. The majority of modern writers on this subject agree in making borders much shallower than formerly was the case. The principal argument in favour of this theory is the great advantages of getting the roots of the trees in some degree under our command, and brought within the influence of solar heat.

The writer of the Calendar of Operations in the "Gardeners' Chronicle," 1842, (p. 712,) makes the following sensible remarks:—"For the formation of fruit-tree borders no general rule can be laid down which would be applicable to all cases: the practice must be regulated by the quality of the soil and the nature of the

subsoil." After strongly recommending complete drainage, and a soil rather strong than light, he proceeds—"The depth of soil should be governed by its texture and quality. Of such as is now treated of, a strong loam, 2 feet in medium depth, will be amply sufficient for the support of any tree whatever. If of a more clayey nature, 15 inches at the wall, gradually deepening 6 inches to the front of the border, is a proper depth. In very light soils a greater depth should be given, say 2 feet, or 2 feet 6 inches. As we would diminish the depth, so likewise we would increase the width of the wall borders. Some writers have advised them to be as wide as the wall is high; but this is a very objectionable rule. For a 12-foot wall—and for permanent trees, none should be lower—the border should be at least 18 feet wide: if 20, so much the better; but in that case the necessary walk along the front might be made to pass over the prepared ground, so that the roots of the trees might extend under it. In all cases the surface of the border ought to be somewhat higher than the level of the walk—more or less according to circumstances. Where a garden is so unfortunately situated that thorough drainage is impracticable, the borders for the finer kinds of wall trees may with great advantage be elevated a foot or more above the general ground surface."

On the formation of borders, Rogers, an excellent practical authority, observes—"In excavating the bottom there is danger lest it become a reservoir for water, which, without such a piece of ditching, would not be attracted there at all. If the subsoil be any kind of clay or earth retentive of water, it is not well to disturb it, unless any water lodging in the excavation can be speedily drained away. On such a substratum it is better to raise the border to the requisite depth by a proper soil brought on than to sink the bottom. If the bottom be naturally wet, it should be effectively drained, and some pains should be taken to prevent the roots being invited into it. This is not easily done unless the whole bottom be closely paved: no other material will prevent the descent of the roots, if invited by nutritive matter or humidity."

Harrison proposes, in the case of a wet

bottom, to lay the foundation with an incline from the wall to the walk of 12 inches, and to run a drain close to the wall, and another parallel with it, at the front of the border; these drains to be open stone ones, so that the water may be completely carried away from the border. Over the entire surface of the floor of the border a stratum of moderate-sized gravel, stones, or brickbats broken small, to the depth of 3 inches, is to be laid; and upon this 1 inch in thickness of fine gravel, or road-grit, when the whole is to be well rolled or beaten firm together. Over this another stratum of gravel or small stones 3 inches thick is to be laid and rolled to an even surface, but not so as to bind them very close together. For borders in a hot and dry situation, or where the substratum is too open, he proposes the following: The border is to be of the same depth and inclination from the wall as the last, as also the position of the two drains. The bottom of the border is then to be covered with 6 inches of strong clay, and when beaten or rolled to an even surface, 2 inches of moderate-sized gravel or stones are to be laid on; over that 1 inch of small gravel or road-grit, which is to be well rolled down; and afterwards 2 inches more of small stones or gravel, which, being rolled to a smooth surface, finishes the floor.

A very good and economical impervious bottom may be made by pitching the inclined bottom with stones of any kind, and filling the space between completely with concrete—or floors may be made entirely of concrete. Wherever impervious floors are adopted, the greatest possible care should be taken that they are effectually drained.

Concreting the surface of fruit-tree borders has been much advocated of late years, both for those of forcing-houses, and also for those of the open garden. In cold, damp situations, such borders have their advantages, more especially in localities where much rain falls: they also completely prevent the injury done to the roots of trees by deep digging and cropping the border. During autumn, winter, and spring, the borders so treated are kept dry; and during summer, if the concrete is of a dark colour, which it ought to be to harmonise with the surrounding ground, and which it can readily

be made by mixing coal ashes with the material, it will absorb the heat, causing the roots to come to the surface of the soil and lie warmly under the concrete, where they are found to luxuriate in great health and vigour. The most certain means of insuring healthy trees and well ripened wood and buds, is to induce the roots to range as near the surface as possible; for the farther they descend from it, no matter how rich the border may be, they will continue to grow too long in autumn, producing strong watery shoots, that no season we have will sufficiently mature. This, along with their penetrating into a cold, and perhaps a bad subsoil, lays the foundation of canker, and all other diseases to which fruit trees are liable.

The principal objection started against concreting the surface of the borders is, that the roots are excluded from the air; and this is to a certain extent true, and comes in direct collision with the under ventilating process equally advocated by many. For ourselves, we have no objection to surface concreting, providing air is admitted to the roots from below. Ventilate and drain below, and concrete above by all means; the intention of the former being to keep the roots dry and to feed them with atmospheric air, from which, no doubt, all trees and plants derive a large portion of their food; while the purpose of the latter is to keep the roots dry, by preventing an unnecessary quantity of rain from saturating the soil around them, and also to increase the temperature of the border by the absorption of solar heat. Now, as this is the real utility of surface concreting, it does not follow that the whole surface should be hermetically sealed down. Holes of 2 inches in diameter may be made in the concrete without affecting the absorption of heat to any sensible extent: these openings may communicate with the drainage below by means of earthenware tubes, thickly perforated with holes to assist in the circulation of air; they may be easily closed up when the rainy season approaches; and, even if they were not so, no moisture could get at the border, as it would fall immediately upon the drainage, and so pass off. Surface concreting has also been objected to by some, from a dread that the borders would become too

dry. This, however, does not appear to be the case after several years' trial. Evaporation is prevented from going on, (at least into the free air,) so that the soil remains almost stationary as regards humidity. We lay boards, slates, and tiles between our strawberry rows and other crops during dry weather, to keep them moist by preventing evaporation from going on so rapidly as it would otherwise do. Concreting is the same thing upon a larger scale. It has been recommended by some to form vaults under such borders. Of the utility of such a plan there can be no doubt; and, where material for the purpose is easily procured, the expense is trifling—as all that is required is to build brick or rubble stone piers, or open walls, 1 foot or 18 inches high, in lines across the border, and to cover them with rough pavement, on which to lay the soil for the trees. Air-shafts at back and front should be built, and the air allowed to circulate under them. Very deep as well as very broad borders are objectionable, even in the best soils, as the roots will have too much scope to run through, and hence an over-luxuriant state will be brought on, and the trees will be for years less productive of fruit.

The extreme of refinement in the formation of wall-tree borders is illustrated by one lately constructed by the Marquis of Tweeddale. A border for peaches and apricots 20 feet broad, and covering an area of 300 square yards, has recently been constructed at Yester, chambered below, and heated by hot-water pipes, as in the vineries which will hereafter be described.

If Mr Shearer, the Marquis's intelligent gardener, is correct in his calculations—and of his correctness we have no doubt—that a chambered border as thus constructed, even without the aid of fire heat, is 9° increased in temperature over one not chambered, then would we say, every border in the kingdom should be so constructed.

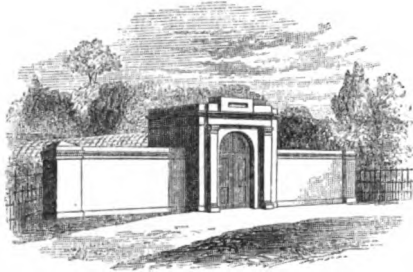
The application of manure in the formation of fruit-tree borders should be studiously avoided, unless in a very decomposed state; and that soil is very unfit for the purpose which requires artificial enrichment: nor should manure, at any time, or under any circumstance, be applied to the roots of fruit trees.

## § 8.—PRINCIPAL ENTRANCE

This should always, if possible, be placed in the centre of the south wall; and next in preference, either at one of the ends of it, or in the centre of the east or west walls. "The object of this," Mr Loudon observes, "is to produce a favourable first impression on the spectator, by his viewing the highest and best wall (that on the north side) in front; and, which is of still greater consequence, all the hothouses, pits, and frames in that direction. Nothing can be more unsightly than the view of the high north wall of a garden, with its back sheds and chimney-pots, from behind; or even getting the first *coup d'œil* of the hothouses from a point nearly in a parallel line with their front. The effect of many excellent gardens is lost or marred for want of attention to this point, or from peculiarity of situation."—*Encyc. of Gard.*, p. 721. The fine gardens at Harewood House are an instance of this defect; while those at Clumber, Taymouth Castle, Preston Hall, and Salton Hall, are perfect in this respect.

Wherever the mansion or principal building has any pretensions to architectural display, and where the garden is of sufficient consequence to merit such an appendage, the principal entrance to it should be in keeping with these buildings, and in general in the same style. The main entrance to the gardens at Woburn Abbey, of which the annexed fig. 12, taken from "The Hortus Woburn-

Fig. 12.

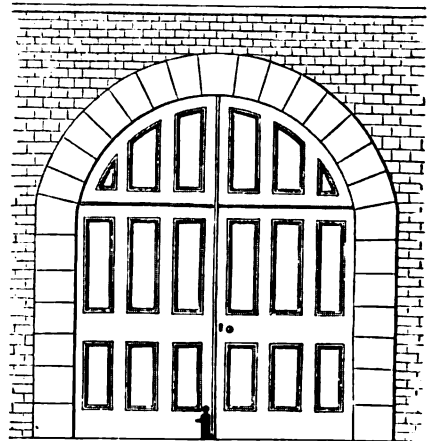


ensis," is a representation, is one of the best we have seen. It is situated in the centre of the west wall, that being in the most direct line from the abbey, and more suitable, on account of the ine-

quality of the ground, than had it been placed at the centre of the south or front wall. This entrance is about 80 feet from the west wall: it consists of a handsome architectural building, and is connected with the garden by a neat iron arch trellising, measuring 80 feet in length, 8 feet wide, and about 12 feet in height, which is covered with different kinds of creepers. The main entrance to the kitchen gardens at Taymouth is a lofty Gothic gateway, perhaps a little too high for its base or the size of the garden, but not so when contrasted with the magnificent scenery that surrounds it.

The entrance to the gardens at Drumlanrig is through a piece of flower-garden ground of considerable extent; it opens upon the principal range of hothouses from the centre of the east wall. The entrances to those at Dalkeith open from two points as marked on the plan, (Plate V.,) being the nearest and most direct way from the house. Both of these are at the south-east side, the one winding through the lower garden or orchard, which is of very diversified surface, and terminating at the centre of the south wall by an arch and open pair of iron gates, which face the front range of hothouses. In passing through the large or central walled garden, two large gateways, fig. 13, one at each end of the

Fig. 13.

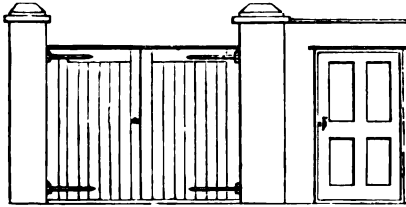


plant stove, which is the centre house of this range, open upon the back ranges of hothouses with the three ranges of pits in front. The other entrance, also on the south-east side of the garden, opens upon

a gently-sloping lawn planted with rare or curious shrubs, as single specimens, and proceeds through it to a massive gateway similar to fig. 13, only without the stone margin, the wall projecting 4 inches in front, and 2 feet on each side, and being neatly tuck pointed; this gateway is in the centre of the east wall of the principal walled garden, having a bird's-eye view of the hothouses on the right.

The exits are by two plain gateways, with door for foot passengers, fig. 14, at

Fig. 14.



the north-west and north-east sides. All the entrances are sufficiently large to admit a carriage to drive through, the narrowest of the principal walks being 7 feet broad, while some are much broader.

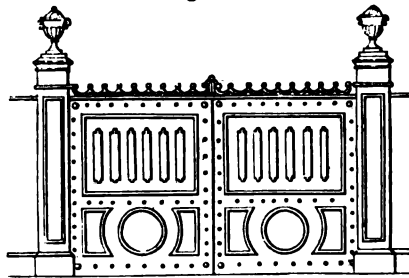
As there is no attempt at architectural display in these gardens, for very substantial reasons, none has been introduced into the walls or gateways,—it being considered in better taste to have them substantial and plain.

Hitherto the north-east exit gateway has been more used than any of the others as an entrance; as in driving in at this point, part of the town of Dalkeith and the surrounding scenery are seen to much greater advantage than from

any other point in the neighbourhood. The view is, indeed, considered a very fine one, having the sloping lawn before alluded to in the foreground, a very handsome new church, and rich old plantations in the middle, and in the distance the Moorfoot hills, Roman camp, &c. Nor is this entrance to be objected to, merely because it enters at one end and behind one range of hothouses. It has another long range, two ranges of pine stoves, and three long ranges of pits, on the right; and on the left, a respectable front elevation of offices, in course picked ashlar, with oak-grained doors and windows; with a bird's-eye view of the principal part of the garden seen through a handsome iron palisading.

Fig. 15 is a specimen of a garden gate designed by us for a contemplated garden, where all the details are to be

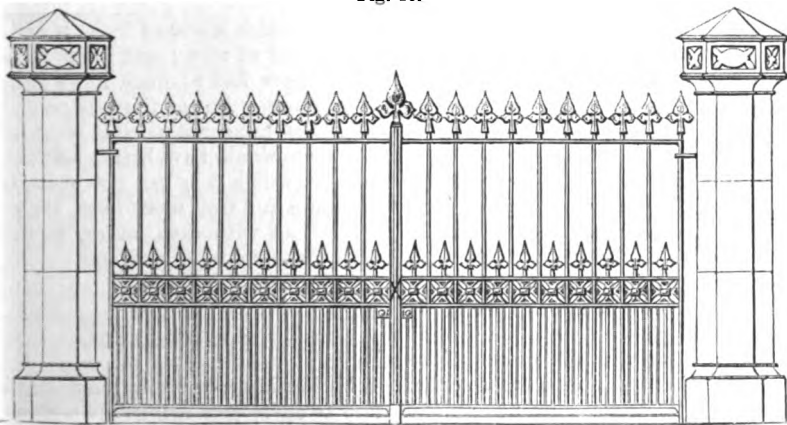
Fig. 15.



highly enriched with ornaments. This gate, we may observe, forms the connection between the flower garden and kitchen garden.

Fig. 16 exhibits a design for open

Fig. 16.





railing garden entrance gates, which would be suitable for an architectural wall. The principal objection, however, to such gates is the draught of cold air which they admit, and which closely-framed wooden ones exclude. In former times great taste was displayed in the formation of wrought-iron garden gates: they have, however, disappeared along with the architectural and geometrical style, as being out of keeping with the simplicity of the modern manner. But to such extremes has this reformation been carried, that the splendid gates of the olden gardens have long since given place to mere holes in the walls, often scarcely sufficiently wide to admit a wheelbarrow.

Fig. 17 represents a design for a gateway in connection with a castellated mansion.

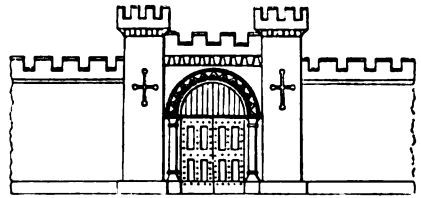
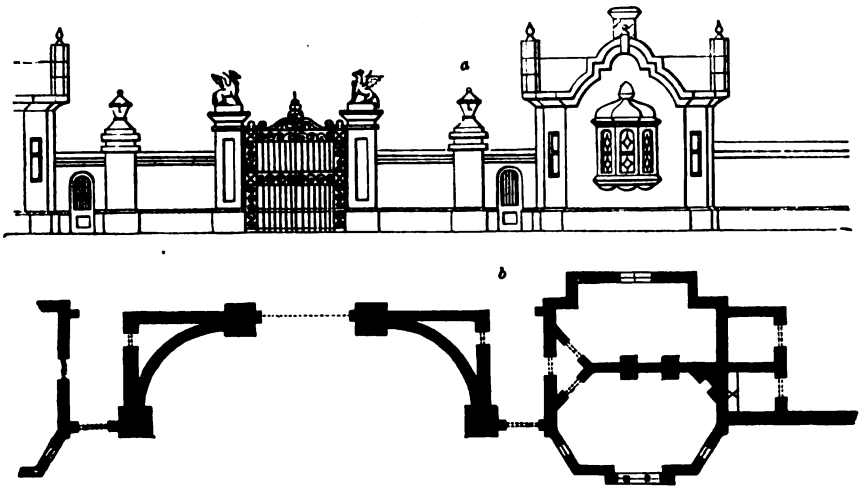


Fig. 18 one for a gateway and porter's lodge, in connection with a mansion of a highly architectural character, *a* showing the elevation, and *b* the ground-plan.

The principal entrance to the new

Fig. 18.



garden at Poltalloch is in quite a different style from those already noticed. In proceeding from the mansion, a carriage-drive leads to the centre of the west front of the kitchen garden. (1.) It is proposed that the extensive wire fence at that point should be furnished with a wrought-iron gate, and an arched passage of trellis-work, covered with roses and climbing plants, as far as the walk which separates the slip from the fruit-tree borders. The intention of this covered walk is to hide the crops in the slips, and to prevent the eye from being attracted by any side-view objects until it is brought to bear on the whole of the principal garden and hothouses at once. An architectural stone entrance might

have been preferred by some, as associating better with the mansion, although at a considerable distance from it and completely out of view; and such, no doubt, would have had a much more imposing appearance. But as there is no building immediately near it, such as walls, offices, &c., there would have been a want of connection, which does not now exist, as the iron gate and iron fence form the proper connection with each other, as well as with the surrounding objects.

#### § 9.—SHELTER.

*Shelter* is necessary in most situations; and to effect this artificially without pro-

ducing shade, or interrupting the free circulation of pure air, is a very nice point in the formation of a garden. We believe that more mischief has been done by carrying the attempt to secure shelter to an extreme extent than by the reverse. No doubt shelter is necessary to break the force of the east, north, and west winds; but if this can be effected by other means than that of forming plantations, so much the better. Natural shelter is to be looked for and obtained from local circumstances, such as rising grounds on all sides except the south. Artificial shelter is obtained by building walls, forming plantations, or taking advantage of plantations already existing; but these must by no means approach so near as to create shade, or to intercept the rays of light and sunshine. Forsyth appears to have been amongst the first who traced the injurious effects of surrounding gardens with trees to its real cause; for, after recommending shelter from the north and east, to prevent the blighting winds from affecting the trees, he says, "At the same time there ought to be a free admission of the sun and air. On that account, a place surrounded by woods is a very improper situation for a garden, as foul stagnated air is very unfavourable to vegetation; and it is also observed that blights are much more frequent in such situations than in those that are more open and exposed." This opinion is confirmed by Mr Towers, who assigns the following as the cause: "Experience has amply proved," he says, "the correctness of Forsyth's opinion on the prevalence of blight in situations surrounded by woods. I believe that prevalence to be dependent on the phenomena of conduction, effected by the proximity of innumerable vegetable points, by which the chemical constitution of the atmosphere is somewhat changed, so that the juices of the plants partake of the change, and acquire a saccharine quality. Insects are thereby enticed, but not produced; and in every case of blight, it appears much more probable that the altered or diseased juices invite the insect than that it is imported by this or that current of the air, whether it blow from the east or from any other point." Wherever trees abound, the air becomes tainted, and malaria is engendered, injurious both to vegetables

and animals. In such situations vegetable and animal matter is undergoing decomposition in proportion to the density and extent of the plantations; the noxious gases thus formed, being prevented from being dispersed by the agency of wind, accumulate until disease takes place in the foliage and tender branches, and renders them fit for the food of innumerable insects whose term of existence appears to be almost proportioned to the quantity of food thus prepared for them. In forming shelter by plantations, Dr Neill lays it down as a rule not to be departed from, "that there should be no tall trees on the south side of a garden, to a very considerable distance." Indeed, we may add, at such a distance as to render any shelter from them of no avail; "for during winter," he adds, "and early spring, they fling their lengthened shadows into the garden, at a time when every sunbeam is valuable. On the east they must be sufficiently removed to admit the early morning rays. On the west, and more particularly on the north, trees may approach nearer, perhaps within less than 100 feet, and be more crowded—as from these directions the most violent and coldest winds assail us."

The following calculations, made some years ago by order of the Royal Society of London, are worth the attention of those who design or lay out gardens. In England the prevailing winds are as follows:—

South-west, . . . . .	112 days.
North-east, . . . . .	58 "
North-west, . . . . .	50 "
North, . . . . .	16 "
South, . . . . .	18 "
West, . . . . .	53 "
East, . . . . .	26 "
South-east, . . . . .	32 "

Westerly winds prevail most during July and August; north-east during January, March, April, May, and June; north-west from November till March. The north-east wind is less frequent during February, July, September, and December; and the north-west less frequent during September and October than in any other months.

The following is the average taken near Glasgow, and may serve for the west of Scotland:—

North-east,	. . . .	104 days.
North-west,	. . . .	40 -
South-east,	. . . .	47 -
South-west,	. . . .	174 -

According to Dr Meek, in "Stat. Acc. of Scotland," (vol. v.) during seven years' observation, the average is as follows:—S.W., 174 days; N.E., 104; S.E., 47, and N.W., 40 days. It has also been calculated that the prevailing winds in Great Britain are the S.W. and N.E.; and the same holds good throughout Europe.

The prevailing winds in Ireland are the west and south-west; a peculiarity easily accounted for from its geographical position.

Fig. 19.

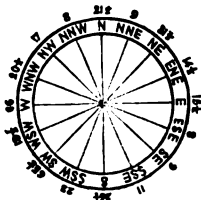
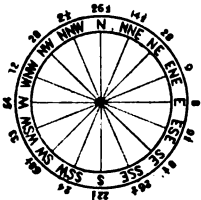


Fig. 20.



The following diagram, fig. 19, is for the year 1842, and fig. 20 for 1843, taken from the meteorological table kept at Inveresk, county of Mid-Lothian, by Mr M'Auslane, which may be depended on for accuracy. We give two years, to show how variable the direction of the winds are; still they indicate to us the points most to be guarded against.

§ 10.—STYLE.

From the earliest ages kitchen gardens appear to have been laid out in what may be called the mixed style—that is, having flowers, fruit, and culinary vegetables indiscriminately cultivated together; and, even at this day, we find this to be the prevailing mode of arrangement. However much we may wish to see these departments distinct, as we think they ought to be still, there are considerations of great weight which influence such matters, and often overrule the taste of the artist who may be employed to design them—such, for instance, as the circumstances or wishes of the owner, in combination with the prejudices which attend long confirmed habits.

How far the mixed style is in good taste, or consistent with the highest degree of good cultivation, is very doubtful. Our opinion is, that in large places all the departments should be distinct from one another, though so connected as to form a complete whole; unless in cases where it may be deemed expedient to have the fruit and kitchen garden at a distance from the mansion, and the flower garden and shrubbery near to it. It is always in good taste, as well as convenient, to have the flower garden near the mansion, whether the place is large or small, and also to have the plant-houses at a reasonable distance from it, so that they may be visited at all seasons without difficulty. For example, in the case of a highly architectural mansion, of whatever style, the conservatory may be so placed and arranged as to form a part of the building: the flower garden may surround one, two, or more sides: the shrubbery may connect these with the kitchen and fruit gardens at a moderate distance; or, if at a great distance, the latter may be reached by walks or drives through the park or plantations. In smaller residences the whole may be brought nearer together, but still be so arranged as that each shall be complete in itself. Even descending to villa residences, the same arrangement may be carried into effect. So far as good cultivation is concerned, we may observe that we hear much of the damage done to fruit trees by digging about their roots. We believe this evil does very extensively prevail; and it is impossible that culinary vegetables can be cultivated to perfection if grown under the shade and drip of trees, deprived of fresh air, and excluded from the beneficial effects of sunshine; while nothing can be in worse taste anywhere, save in a cottage garden, than to see beds of flowers in juxtaposition with beds of cabbage and potatoes.

To illustrate these views, we have endeavoured to show in some of our present designs this separation of parts. We have stated above that there are circumstances which lead to an acquiescence in the mixed style, and the following may be given as examples.

The splendid new kitchen garden at Frogmore is partly of this kind; for, at the terminations of the principal range of

fruit-houses are placed two plant-houses ; and of the smaller houses or pits behind, several are devoted to the culture of plants. With these exceptions, the culinary and fruit garden is without plants or shrubs, save some well-arranged beds of flowers on the terrace, in front of the principal range. It should be observed, however, that these are chiefly houses for providing flowering-plants for the decoration of her Majesty's private apartments, there being no other belonging to the Crown at Windsor : hence they may be denominated cultural-houses—that is, houses adapted for culture, and not for display.

The new gardens at Dalkeith afford another example where the fruit and plant houses are within the walls of the kitchen garden—there being ten houses for fruit and nine for plants already existing, exclusive of the larger conservatory, which is placed in a small flower garden in another part of the grounds. A botanical collection of hardy plants occupies a triangular compartment, which separates the higher or principal part of the garden from the lower, (*vide* Plate V.) This appeared to be expedient, as the former is in the regular style, while the latter is irregular both in outline and surface ; and, although it forms a connection between both, interferes with neither.

A grassy lawn occupies the eastern side, where the principal entrances are, and is dedicated to single specimens of rare and choice shrubs, bounded on two sides by a conservative wall and border, covered with plants, and on the two others by a marginal parterre and border of American plants. The great extent enclosed within the walls, which almost became necessary from local circumstances, and the great taste her Grace the Duchess of Buccleuch has for botanical plants, led, soon after the making of the garden, to the formation of a collection of plants, certainly not exceeded in number of species by any private collection in the kingdom. This was not, however, contemplated in the original plan ; as the flower garden and principal plant-houses were designed to have occupied the space between the mansion and the kitchen garden.

We state these things to clear ourselves from the charge of inconsistency in re-

commending one thing and practising another.

The same style is exemplified at Drumlanrig Castle, where also there are several plant-houses in the kitchen garden, as well as a botanical collection of hardy plants. There is there, however, one of the most extensive flower gardens in the kingdom, placed, exactly as it ought to be, near and around the castle. In such cases as those we have detailed, the taste of the owner overrules the system we have endeavoured to inculcate—and very properly ; for, although the artist has the privilege to suggest, the owner has undoubtedly the power to decide.

It is probable that a similar taste led the respective owners of the following gardens to adopt the same views—viz., Chatsworth, Trentham, and Eaton Hall. These also have plant-houses and fruit-houses in the kitchen garden ; but, for the most part, they are houses for culture and for replenishing legitimate plant structures—each of these cases having splendid flower gardens detached, and, as they ought to be, adjoining the respective mansions.

At Bicton the forcing-houses are united to the plant-houses, which is almost the only objection that can be urged to the arrangement of that fine place ; the more so as they are in the flower garden, and as the kitchen garden is dedicated to culinary purposes alone, quite apart from the flower garden, and exceedingly well concealed. At Sion, Wentworth, and Woburn, each department is as distinct as could possibly be desired.

At Belton House, Thoresby Hall, Clumber, Welbeck, Belvoir, Harewood, Burghley, The Grange, Tottenham Park, &c., the kitchen gardens are almost without flowers, or plant-houses either. Such we think not only consonant to good taste, but well adapted for the carrying on the various operations required. Most of the latter named places have respectable flower gardens, and plant-houses connected with them.

The kitchen gardens in Scotland are in general in the mixed style ; and hence so few really good flower gardens are to be met with in that country. They in many instances exemplify very clearly the mistake fallen into by adopting this style, as many of the most necessary

operations requisite in a well-managed kitchen garden accord ill with that trim aspect and polished surface which is a leading feature in a well-kept flower garden.

The kitchen garden at Dalkeith—of which Plate IV. is a general view of the hothouses, and Plate V. a general ground-plan of the whole—is both in the irregular form and in the mixed style, as has been already noticed.

The following references to the numbers, on both the Plates, will show the arrangement of the buildings:—1 1 1, vineries; 2, heath-house; 3, tropical plant-house; 4, greenhouse; 5 5 5, peach-houses; 6, plant-house, having a northern exposure; 7 7 7 7, pine-stoves and vineries combined; 8, greenhouse; 9, camellia-house, on the ridge-and-furrow principle; 10 10, orchid-houses, span-roofed; 11, greenhouse, pavilion-roofed; 12, fig-house; 13, greenhouse, span-roofed; 14 14, plant-stoves, span-roofed; 15, cherry, plum, and apricot house, (the last four not yet erected); 16, pine pit; 17, cucumber pit; 18 18 18 18, pine pits; 19, plant pit; 20, propagating pit; 21 21, cold pits, one for alpine plants, and the other for greenhouse plants; 22, cold pit; 23, heated pit for asparagus and plants during winter—for cucumbers, young pines, &c., during summer; 24 24 24, close heated sheds behind the pine-stoves, in which rhubarb, sea-kale, &c., are forced during winter; 25 25 25 25, water-closets, under which are tanks for liquid manure; 26, room for cleaning and arranging vegetables; 27, fruit-room; 28 28, foreman's sitting and sleeping rooms; 29, seed-room; 30, potting-room; 31, carpenters', glaziers', and painters' shop; 32 32 32 32, men's rooms, consisting of sitting-room and three bed-rooms, with kitchen underneath; 33, store-room; 34, cow-house; 35, open sheds; 36, wash-house; 37, dairy; 38, gardener's house; 39, summer-house; 40, stables; 41, lodge.

The cisterns on the surface are marked  $\times$ , the liquid manure tanks  $\times \times$ , and stoke-holes  $\times \times \times$ .

The following letters refer to the disposal of the ground:—*a a a* vine borders; *b b b* flower borders in front of plant-houses, as there are no roots there to be injured; *c* borders of peach-houses; *d d* herb ground; *e e e e* quarters in the prin-

cipal or square garden; *fff* quarters for vegetables upon a higher level; *g* manure yard; *h h h* yards; *i* propagating ground; *k* yard for coals, ashes, composts, &c.; *l* nursery ground; *m m*, &c., quarters in lower garden of very unequal surface; *n* river North Esk; *o* Lugton bridge; *p* Bridge-End village; *q* new road to Edinburgh; *r* old do.; *s* back or service road to the garden; *t t t t* a small garden in a dry, warm, sheltered situation for tender plants; *u* grass lawn; *v v* botanical arrangement of hardy plants; *w w* covered wire-trellised walk for creepers; *x* grass lawn, on which are planted single specimens of choice and curious shrubs, with a marginal scroll-flower border along the top.

The following capital letters refer to the entrances: A A A A, are the principal; B the entrance for labourers, being the nearest to the town; and C C C the entrances from gardener's house; D is a cast-iron circular flower stage for placing plants on during summer; E old dial; F F summer-houses or bowers; G G grass terrace bank.

All the brick walls are built hollow, and those surrounding the square or principal garden are heated by hot water circulating in 4-inch pipes; they are 12 feet high and 20 inches broad, coped with stone, with only half an inch of projection, for reasons which will be given hereafter, (*vide* COPING,) and placed on a rubble-stone foundation 2 feet thick, varying in depth according to the soundness of the ground. The other walls vary, according to the lay of the ground, from 8 to 10 feet in height, part having 2-inch projecting coping, the remainder none at all. The gateways in the middle of the south and east walls, as well as those at the ends of the plant-stove, are sufficiently wide to admit of a carriage being driven through; the others are of the usual size, 7 feet by 3½. All the gateways in the exterior walls are also as large as the first mentioned, the only ordinary sized ones being those leading through to the compost yard *k*, behind, and two others.

The front range of hothouses, as well as the pine-stoves 7 7 7 7, are in the lean-to fashion, with glass to within 6 inches of the ground, and rest on a polished stone base or plinth. The tropical plant-stove, however, has 2 feet of stone

base, which is carried round the ends and polished. They are ventilated by opening the front sashes, and by wooden ventilators at the top of the back wall, in Atkinson's manner. Every alternate upper sash of the roof opens also. A series of cellars extends the entire length of this range, the whole width of the offices, and 8 feet high. These are lighted and ventilated by long, narrow area windows; and under the floor is a capacious drain, into which all the drainage of the upper garden is led, as well as the overflow of the cisterns. Along this drain, and under the buildings, are formed large tanks, supplied by it, and which are constantly kept full, but can never overflow, as the drain carries off the surplus.

In these cellars, also, the furnaces are placed; and over those parts separated off for the stoke-holes are placed cisterns filled from the roof, which keep up a supply of tepid water: this is conveyed into the hothouses by leaden pipes immediately over the boiler. The latter are all within the houses, to economise heat, and placed under the floor, and covered with a cast-iron grating to preserve their covers. The smoke, as will be seen by the various sections, is got rid of behind without soiling the glass.—(*Vide PINERIES, VINERIES, &c.*)

These cellars are appropriated for a tool-house, root cellar, mushroom-house, onion cellar, store cellar, kitchen for the men; and for various purposes are found exceedingly useful, in addition to keeping the rooms and offices above quite dry and comfortable.

The stoke-holes for the wall furnaces are in vaults under ground, having a space arched over on both sides, for the reception of the ashes and fuel. The openings to them are covered with wrought-iron grating. The chimney-pots are removed when the fires are not in use. The fruit-tree borders are 2½ feet in depth, and the quarters of the square garden 4 feet, resting on an alluvial gravel of from 2 to 5 feet in thickness, under which is a bed of clay, depth unknown. This accounts in part for the abundant supply of water, as the rain which falls on the surface percolates through and is retained in the gravel stratum, the clay below being impervious; still the soil is perfectly dry. The gravel within the

square garden was excavated to the depth of 4 feet on an average, and carted away to make walks and roads in various parts of the park and pleasure-grounds, the good soil from these being returned in the carts to make up the difference, so that the whole soil of this part of the garden is artificial and good.

It will be naturally asked, why remove so much gravel?—why not have laid the artificial soil on the top of it, and hence have saved half of the expense? The reason was, the ground was above the level of the surrounding parts, especially on the western side, as will be seen by the terrace bank G G; so that, had we laid on the 4 feet of artificial soil, the surface would have been too much elevated to accord with the surrounding grounds, besides depriving us of the shelter from the west and south-west winds afforded by the rising grounds at these points, and considerably increased by thus lowering the level. Besides, we held it necessary to have the ground occupied with the hothouses perfectly level, to admit of a passage through them, without having recourse to steps which are very objectionable, and therefore should be avoided. It is also proper, where the garden is in the regular style, that all the tops of the walls should run parallel with the level of the borders and walks, particularly from east to west. All steps, or ramps, should be avoided in walls running from north to south, unless the fall of the ground is considerable towards the latter point.

The grassy lawn, *x*, slopes considerably towards the east, and occupies that space between the east wall of the garden, and the plantation of old and splendid trees intervening between it and the mansion, which is now forming into an arboretum. It is intersected with drives and gravel walks—the river North Esk running through it, and separating it from the bowling-green and pleasure-grounds surrounding the house. A conservative wall, H, bounds two sides of this lawn.

The triangular piece of ground *v* *z*, occupied with the botanical collection of hardy plants, is a piece of ground intervening between the square garden and the wall I I. This was originally part of the boundary wall of the park, which we retained and heightened for a peach wall

to succeed the crops of the hot wall in front of the garden, because its line suited the disposition of the ground beyond it, marked *mm*, &c., and occupied as a market garden, noted for precocity and abundant crops for many years. The north side of the wall alluded to is covered with a holly hedge, which we removed from the old garden, in pieces of about 3 to 4 feet each, and which is the same height as the wall, 9 feet. The ground marked *m m* is very irregular in surface, and divided into compartments to suit the various falls. It is planted with standard fruit trees in lines, about 50 feet apart: the spaces between the trees, and in the same line with them, are planted with gooseberries and currants, leaving the quarters between the lines open for kitchen crops. In this ground there is a great variety of soil, as well as of aspect—points we consider of some importance in a kitchen and fruit garden, particularly the former, where such varieties of crops naturally exist.

The references *o*, *r*, and *s*, will show that the situation we have chosen is on the outskirts of the park—which we consider to be of advantage in a large place, as it admits of a free communication with the public roads, &c., and hence prevents the inconveniences so often complained of, of carting on the approaches, and having the work-people and visitors passing through the park, and disturbing that quiet and private enjoyment in general sought and expected in parks and pleasure-grounds. There is also another advantage of having a large garden on the outskirts of a park—namely, that it is never likely to come in the way of after improvements or alterations.

According to our original plan, the gardener's house was to have been placed at *K*, upon rising ground, from whence a general view of all the hothouses and most of the principal garden would have been secured. Circumstances, however, led to an alteration in this part of the plan, and the present house, 38, was adopted—one of the best and most commodious gardener's houses in the kingdom, and quite in accordance with the liberality of His Grace, who provides every member of his various extensive establishments with houses not merely comfortable, but in fact far superior to those of servants in general.

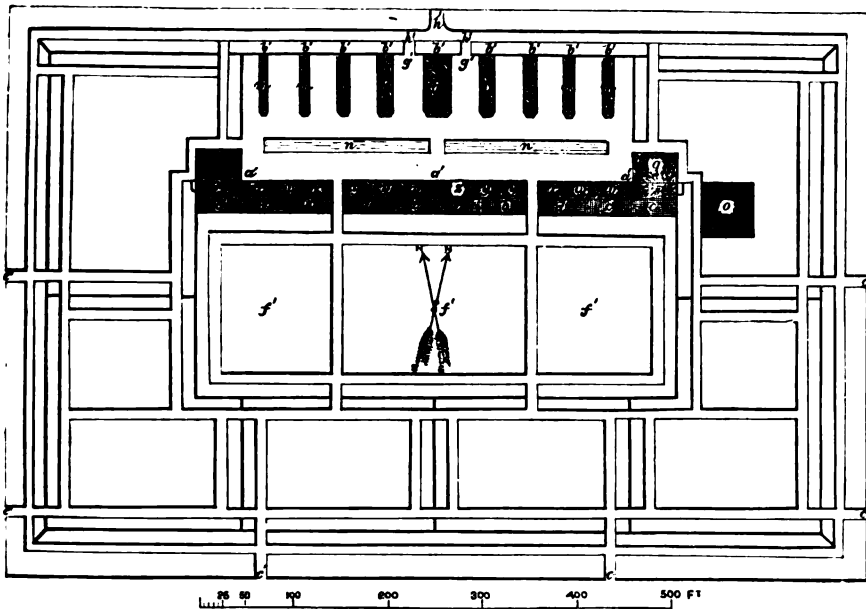
From the natural disposition of the ground, it rising 8 feet on the west, at the terrace bank *G G*, and falling as much as 50 feet on the east, leaving only room for the carriage-entrance to be brought in, it follows that it would have been impossible, even had it been desirable, to have placed the immense quantity of glass in one continuous line, as exemplified at Frogmore. We therefore filled up the spaces at each end of the front range with a very handsome cast-iron balustrade, and placed the four pine-stoves, 7 7 7 7, in a line with the cold pits, 21 21, 22, 23, and exactly opposite to the balustrade openings, so that in viewing them from either of the side-walks, they present the appearance of a second range behind the front one. The effect is good, and the convenience of the arrangement has met with commendation.

For the way in which water is supplied, *vide art. WATER*; and for liquid manure, *vide TANKS AND CISTERNS*. Plans in detail will be found in the articles *VINERIES, PEACH-HOUSES, PINERIES, GREENHOUSES, PITS, WALLS, &c.*

As an example of a garden upon the largest scale and adapted to a first-rate residence, and considered merely as a culinary and fruit garden, of nearly 12½ acres in extent, we offer the subjoined plan, fig. 21, designed by us two years ago for a nobleman since dead. The surface to be rendered level, or with a slight inclination to the south-south-east, or south-west, or to points intermediate between these, (*vide direction of the arrows*); but, in whatever direction the fall is, it must be uniform, so that the copings of the walls may run parallel to it. The whole to be enclosed with a ha-ha or rabbit-proof wire fence, as shown by the outer line in the illustration. The principal feature in this garden is convenience, extent of walling, and uniformity of plan.

References to the plan: *a a* peach-houses, each 50 feet long, 20 feet broad, and 8 feet high from the ground to the bottom of the valleys; the trees to be grown as dwarf standards, or trained over the roof according to taste; *b b* vineries of the same dimensions and principles as the peach-houses; *c c* pine-stoves, each 50 feet long and 15 wide; *d* late vinery, 50 feet long and 15 feet wide, to be heated

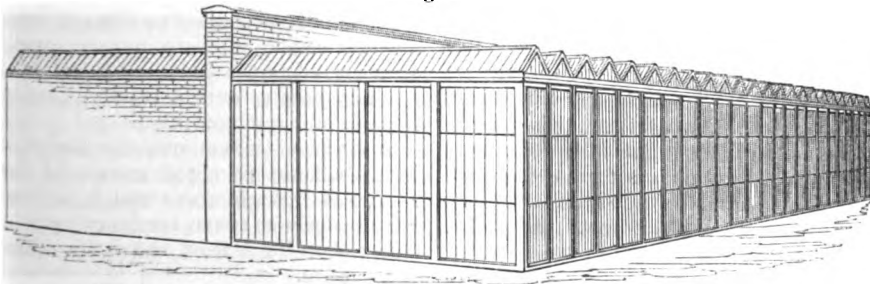
Fig. 21.



by the same boiler as *c c*, with stopcock placed at its connection with *c c*; *e* early vinery, of the same dimensions; *f* early peach-house, of the same dimensions; *g* fig-house, of the same dimensions.

The whole of this range to be on the ridge-and-furrow principle, (*vide* fig. 22,) of the same height at the back as at the front, which is to be 8 feet high from the floor to the under side of the gutters or valleys

Fig. 22.



—the ridges to rise 20 inches. The whole of the front to be of glass, in frames 6 feet 6 inches wide, and resting on an ashlar plinth 7 inches thick and 18 inches broad, on which are to be battened down two round iron rails, upon which the sashes are to run: the sashes are to be provided with concave castors of gun-barrel metal in their bottom rail, to facilitate their movement; their top rails moving in a groove formed on the under side of the wall plate, which is to rest on square

tubular columns, through which the rain water descends. These sashes are also made to pass each other, for the purpose of ventilation during summer, and for gaining access to the houses.

The valleys or gutters are to be of cast-iron, as shown by Plate VIII., and supported in the middle by a longitudinal bar of iron, 4 inches deep by 2 inches in breadth, which is itself supported by ornamental tubular cast-iron columns, 4 inches in diameter: through these



last the rain water from the roof is to descend, and to be conveyed to tanks sunk under the floors. This range is divided into three compartments, to admit of a convenient passage to the grounds and houses behind. Each of these compartments is again divided into three, and separated by glass partitions, in all respects similar to the front; so that they may be thrown open, or entirely removed, when desired, throwing the three compartments into one. The glass partitions will, of course, be placed under the valleys above them. The whole of this range, as well as the offices behind it—which are to be of the same height, and roofed upon the same principle, only covered with corrugated plates of galvanised iron instead of glass—are to stand on a platform or terrace, 3 feet above the general level of the walk in front, to give effect to the glass, which would otherwise be wanting in this respect, and also to prevent an unnecessary depth in the cellars behind: this walk is to have a straight parapet wall enclosing the houses and the border for the roots of the trees, finished on top with a stone coping 4 inches thick, with a 4-inch projection, with ornamental vases set on pedestals at equal distances. Through this parapet 9-inch fire-clay pipes are inserted, which, passing through the drainage of the border, discharge air amongst the roots of the trees, as well as into the houses, through perpendicular pipes 6 inches in diameter, brought 6 inches above the surface, and covered with wire grating—over which are light metallic covers, for the regulation of the quantity of air to be admitted.

A cast-iron grating footpath, 3 feet broad, passes along the front of each range, close to the glass; and others, 2 feet in breadth, pass, at convenient distances apart, from the front to the back of all the houses excepting the pine-stoves, whose floors are to be of polished Caithness pavement, with cast-iron gratings let into them for the escape of air from the air-drains laid under them.

The beds for the pines are to be formed of Caithness pavement, the outer sides polished; while the floors for the plants to stand on are to be of the pavement in its natural state, but closely jointed. On such beds the pine plants may either be

grown in pots, or planted out in prepared soil. Bottom heat is to be secured by hot-water pipes laid in the cavity under the floor of the beds; while atmospheric heat is to be obtained by pipes running round the beds a little above the level of their surface. The other houses are to be heated by hot-water pipes placed 1 foot clear of the ground, and made to pass round each house, increasing the number of flow-pipes according to the size of the house or the temperature required. The back wall, separating the hothouses from the offices behind, is to be 2 feet higher than the apex of the ridges. This wall is to be built hollow, and provided with a general smoke flue, into which all the other flues will enter, and discharge the smoke through one tall ornamental chimney-stalk in the centre of the range. This flue should have at least three courses of solid brickwork over it, set in cement, which with a 3-inch coping will keep it perfectly dry. The top ventilation is effected at the ends of the ridges close to the back wall, which are there made double, leaving a space, 9 inches wide and 3 feet in length, open, which is covered with a metallic shutter, moving in a groove on each side, and all connected together by an iron rod placed above, and resting on the ridges; to which rod an iron arm is attached at its middle, moved backwards and forwards, according to the amount of air required, by a chain passing over a pulley fixed in the back wall, and acted upon by passing over a roller moved by a single cranked handle.

A range of cellars extends the whole length of the principal range, 14 feet wide, and 7½ high, under which is placed a main drain or sewer, for carrying off all superfluous water from the roofs, drains, cisterns, &c.

It has been already noticed that the back offices are to be of the same height as the glass-houses in front, and roofed on the ridge-and-furrow principle, covered with corrugated plates of galvanised iron. They are of course to be reduced to an equal height within by lath and plaster ceilings, and to be all provided with ample ventilation through the roof,—a matter too much neglected in garden offices, and especially so in lean-to roofs facing the north.

It will be observed that a new feature

is here presented in regard to carrying both the roofs of the glass-houses in front, and those of the offices behind, all through on a level. The ridge-and-furrow mode of roofing suggests very clearly that this is the best way of roofing all such buildings. It enables us to dispense with a lofty back wall, both expensive and useless, casting its shadow over a considerable space of valuable ground, and rendering, by excluding the sun, the buildings so damp as to be of little use. It will also be observed that in this extensive range doors are entirely dispensed with, excepting such as may be required to gain admittance into the potting rooms, &c., behind. The whole fronts and ends of the houses form, as it were, a multiplicity of doors, admitting ingress and egress every 6 feet, either for passing from one to the other, or for stepping out on the border in front: this should be provided with a cast-iron footpath, laid on iron rails, as will be shown in art. FOOTPATHS.

The reference *h* shows the tropical fruit-house, (for section of which *vide* art. TROPICAL-FRUIT HOUSE,) 62½ feet long and 20½ feet wide, upon the curvilinear roof principle; *i* cherry-house, 60½ feet long and 15 feet wide, upon the span-roofed principle; *k* apricot and plum house of the same dimensions and principle as the last; *l* pine pits, with span roofs, each 62½ feet long and 13 feet wide; *m m m m* melon, cucumber, or young pine pits, the same length and breadth as the last; *n n* water tanks, into which all the rain water is conveyed after the cisterns in the house, or over the furnaces, are supplied; and if that is not sufficient, an additional supply may be thrown in by a pump or otherwise: these tanks should be 2 feet above the ground level, to give pressure for carrying the water in pipes to any part of the garden, unless the ground slope towards the south sufficiently carry it by its own gravity; *o* is the head gardener's house; *p* men's rooms, consisting of a kitchen and dining or mess room, with closets for pantry, &c., on the ground-floor, sitting or reading room, and bedrooms above; *q* office, seed-room and fruit-room, the two former up-stairs; *r* carpenter's, glazier's, and painter's shop; *s* store-room; *t* tool-house; *u* packing-house, with a supply of water for prepar-

ing vegetables for the kitchen; *v v* potting houses; *w* pot room; *x* room for kitchen apples and pears; *y y y y* open sheds for mould; *z* onion-house, &c., extra store-room; *a' a' a'* are the stoke-holes of the principal range, leading down to the cellars: water-closets should be placed in convenient parts of the cellars, with water-tight tanks under them, supplied from the nearest cisterns with water, and emptied when necessary by a small portable pump, and used as liquid manure; *b' b' &c.*, stoke-holes to span-roofed houses and pits. The smoke of these is to be carried along the back wall towards the centre, unless in the case to be suggested hereafter, as regards the large central or tropical fruit-house. The intention of thus directing the smoke from all the furnaces of those houses to one point, is to get rid of it by means of one tall ornamental chimney-shaft, similar to that of the front or principal range; and also, as the back wall is built hollow, it may become considerably warmed, and hence ripen tender fruits on the spaces of wall between the ranges of glass: *c' c' c' c'* principal entrances; *d'* private entrance to gardener's house; *e'* private entrance for the labourers; *g' g'* arched gateways; *h' h' h'* cart entrance; *f' f' f'* principal kitchen garden, into which no fruit trees are to be admitted, except against the walls: these are to be planted in the exterior divisions. The walks should be at least 8 feet wide, to admit a pony carriage to drive freely all round, as well as to admit carts in winter to draw in manure, &c. With these objects in view, the corners of the box-edgings should be rounded off a little, to facilitate turning from one walk to another. The gateways *c'* and *g'* should be sufficiently wide for this purpose; the others need not be of so large a size.

The interior walls of such a garden we would propose to be 10 feet in height, built hollow, and heated by hot-water pipes all round, if in the climate of Scotland. The exterior ones, excepting the south wall, which should only be 10 feet, should be 12 feet in height, as affording greater shelter and scope for the hardier kinds of fruit trees.

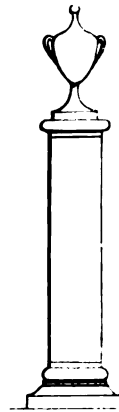
By surrounding the whole with a ha-ha, or rabbit-proof wire fence, not only is a greater extent of ground enclosed at

little additional expense, but, what is of far greater importance, the whole outer surface of the exterior wall may be covered with fruit trees—an advantage not always taken into due consideration. At the four exterior corners of the walls will be seen projections which extend the whole breadth of the borders, for the purpose of breaking the force of the winds; and, with a like intent, the door and gateways should also be carried up with projections 2 feet in breadth, and 5 inches thick, on each side of the wall, which will also give them a massive and stronger appearance. These projections should be carried up the whole height of the walls, whatever may be the height of the open ways. It may also be here observed, that, as the furnaces and stoke-holes of the principal range are placed in the cellars under the offices, and those of the curvilinear and span-roofed houses and pits behind the back wall—each of the latter being covered in with a neat close shed, with a small depôt for coals on one side and for ashes on the other—the whole of the filth and confusion of fuel, dust, and ashes is completely out of sight. The enclosing also of the furnaces economises fuel, and regulates the draught of the fire. To render the smoke from the curvilinear or span-roofed houses as little offensive as possible, each furnace discharges its smoke into flues placed in the garden wall, in different courses, and all brought to terminate in a lofty ornamental chimney-shaft exactly in the centre. By these means the wall becomes a heated one, which, added to the shelter afforded, and the reflection of heat from the glass, makes it well suited for peaches, apricots, and the finer sorts of fruit—even for the hardier kinds of vines, if not in too northern a latitude. The whole area of this forcing-ground is to be gravel, which will not only become more agreeable to walk upon, but will add somewhat to the warmth of the surrounding air. There would be no impropriety in having an 18 inch or 2 feet border along the sides of the houses having span or curvilinear roofs, bordered with a stone edging, as these borders would derive a considerable heat from the side walls of the houses, and be found valuable for preserving salads during winter, or bringing them forward in spring. The bottoms of the roofs,

being provided with proper water gutters for taking the rain water to the tanks, would keep these borders dry. The only thing to be guarded against would be the falling of the snow from the roofs; but this could be provided against by placing ornamental cast-iron parapets, 6 inches in height, on the bottom of the astragals, or on the inner edge of the water gutters, which would prevent the snow sliding over, and retain it until it became melted. In this plan no arrangement has been made for stabling or cart-sheds, as these are sometimes detached from the kitchen garden and placed in some convenient part of the park, or at the farm or secondary stables. These, however, might very properly be placed at either of the ends of the back wall, upon their outer or northern side.

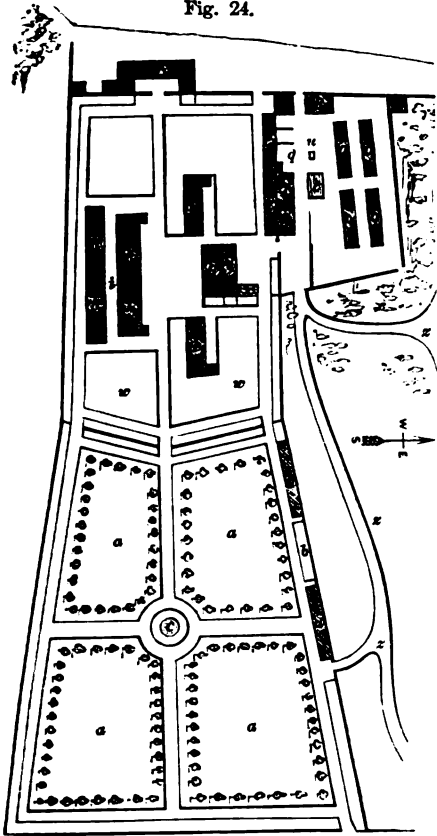
Water is to be laid on all over the garden, in 1-inch leaden pipes, placed under the walks, these pipes being enclosed be-

Fig. 23.



tween two courses of 3-inch drain-tiles: this precaution is necessary, for the protection of the pipes from frost. Ornamental cast-iron tubes, fig. 23, should be set upright at every 100 feet, close to the edging, or, better still, at the intersection of the walks, or in the corners, with caps to remove; and in them the branch-pipes from the mains below should be brought up, with cocks to deliver the water into neatly-painted tubs, from which it can easily be removed by watering-pots to where it is required. These pipes may be so constructed as to have a stopcock, with a screw nozzle or union joint, to which flexible pipes may be attached and carried through the quarters between the crops; and, if there is a sufficient force of water, the wall trees may be watered at the same time. Water-cocks, at convenient distances, to supply portable water-tubs, are far more convenient and useful than having one or two stationary cisterns in a large garden. It will also be well if the pipes are so laid—as can easily be done—that they shall fall all to one or more lower points, at each of which a tap should be placed to let off the water entirely during winter.

The annexed design, fig. 24, is that of a kitchen garden existing in Ireland, Fig. 24.



pits in front—and we have no doubt but such is the case; *kk* pine pits, 50 feet long by 14 feet wide each; *l* gardener's house; *oooo* pits for succession pines, melon and cucumber pits, heated with dung linings; *p* stable; *q* open sheds; *r* mushroom-house; *s* potting shed; *t* a large open tank; *u* pump; *w w* strawberry quarters; *x* fruit-room; *y* room for under gardeners; *z z* approach to the garden.

This garden is well adapted to the situation, and although very convenient, is wanting in effect, from the way in which the forcing-houses and pits are scattered about. This has no doubt arisen here, as in most other places where it occurs, from the want of a properly digested plan of operations to begin with; this showing the great necessity of a regular plan being determined upon when a garden is commenced. If all cannot be done at once, part can, and the remainder may follow in succession. We give it as an example of what may be called a garden without design.

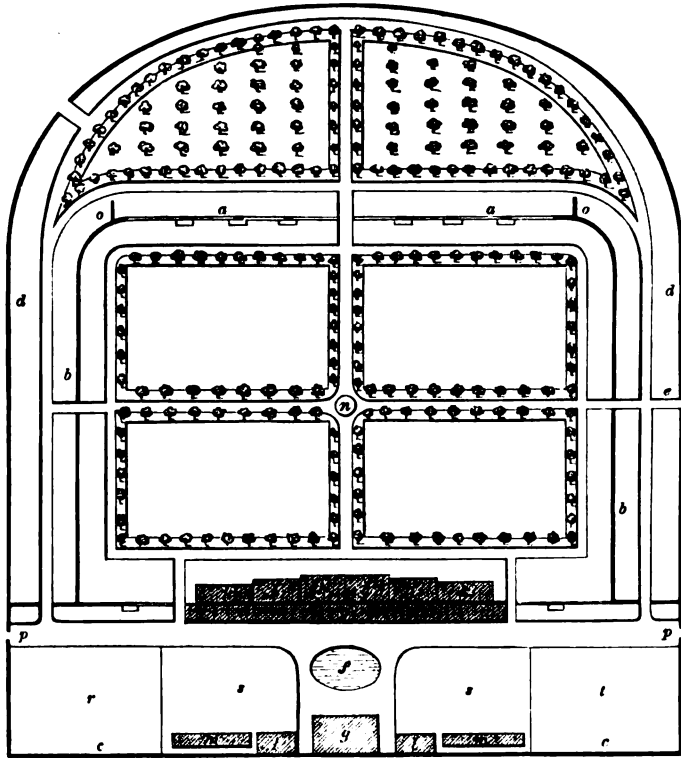
Fig. 25 exhibits a kitchen and fruit garden in the mixed style; the front, or south wall, *a a*, is built hollow and heated by smoke flues, the stoke-holes being shown behind, as are also the walls at each end of the range of hothouses. We have introduced smoke flues in this case, as some prefer them, on account of their being heated in sections of short lengths, with the purpose of giving a longer succession of crops. No doubt two hot-water boilers and pipes would do all that six fires do, as shown by the number of stoke-holes in the present case—as the pipes would be provided with stopcocks, so that one portion might be heated separately from the others; only it would be necessary to heat that division nearest the boiler first, and so on towards the ends, so that, while heat is communicated to the extreme ends, the divisions nearest the boiler must be heated also. This is the only argument that can be used in favour of smoke-flued walls—viz., that any one or more divisions may be heated while others remain cool; while, to accomplish this with boilers and hot water, it would be necessary to employ a separate boiler to every two divisions, with stopcocks to heat either the one or the other as might be desired: for that reason we

which may be characterised as in the convenient, although not in the systematic style. The following references to the figures will explain its details: *oooo* kitchen-garden quarters or divisions; *c* a basin of water, 50 feet in circumference, with a grass edging 3 feet broad, and a tree planted opposite the centre of each walk; *dd* two peach-houses, each 67 feet in length by 8 feet in width; *b* a vinery for early forcing. The peach-houses *dd* are not forced—the climate being damp, they come in after the forced peaches are over; *ee* are forcing peach-houses, each 41 feet by 8; *ff* two vineries, each 37 feet long by 14 feet in breadth, for late grapes; *g* greenhouse; *ll* vineries for early forcing, with pits in them for pines, if desired; *i* vine border, 9 feet in width, the roots in which are supposed to be warmed by the pine

have given this example. The references *b b* are the principal side walls, which may be either of brick or stone, according to local circumstances. They are not intend-

ed to be heated; therefore if of stone they may be built solid; but if of brick, by all means let them be hollow, or faced with brick and grouted with concrete, or left

Fig. 25.



open as shown in several forms in sect. GARDEN WALLS, to save material. The north or back wall is marked *c c*, to be 12 feet high for shelter, as far round as the gateways *p p*; *d d* the outer fence, which may be of rabbit-proof wire, a ha-ha with a hedge upon the top of it, or a wall not exceeding 6 feet in height; *e e* principal entrance; *f* reservoir of water to be supplied from the roofs of the hothouses and other buildings, after the cisterns in the houses are filled—and, should the supply thus obtained not be sufficient, by pipes from some other source; *g* gardener's house; *h h* pine-stoves; *i i* vineries; *k k* peach-houses; *l l* greenhouses; *m m* pits for young pines, melons, and cucumbers; *n* cistern of water in the centre of the garden; *o o* projecting walls to break the force of the wind; *p p* gateway entrances into the back court and offices; *q* back

sheds, divided into compartments for various purposes, but by all means having cellars under them through their whole extent. Dwarf standard fruit trees are shown along the sides of the walks; but the principal supply of fruit is to be expected from the semicircular piece of ground in front, which is planted as an orchard, with dwarf and standard trees, having gooseberries, currants, raspberries, strawberries, &c., planted under and between them. The space marked *r* is ground for sea-kale, asparagus, rhubarb, &c., intended for forcing; *s s* ground for flowering-plants. The borders in front of the hothouses are to be left uncropped, except opposite the pine-stoves, which, if not planted with vines, as they ought to be, may be filled with annuals. Water-closets are to be placed in the cellars, provided with water-

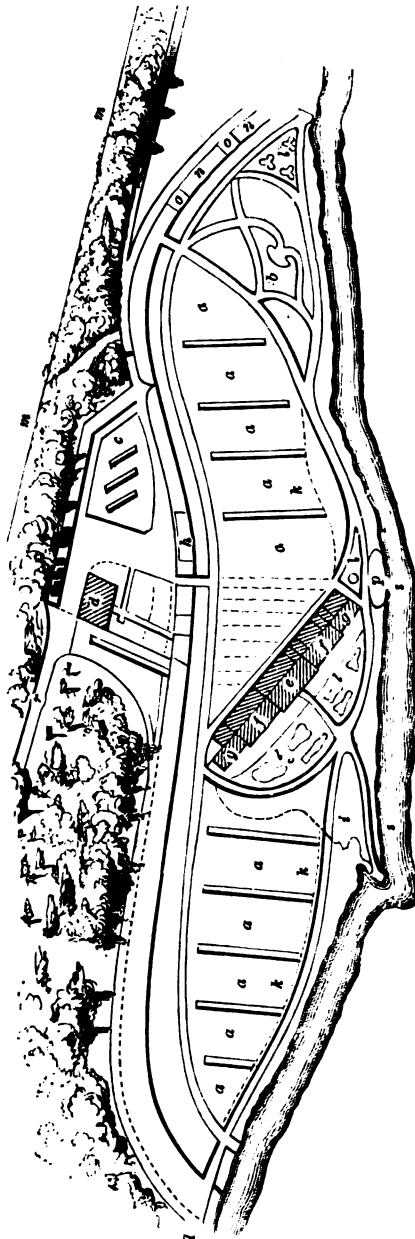
tight tanks under them, and a portable pump for emptying these in the shape of liquid manure. The reference *t* shows the compost yard enclosed on two sides with an evergreen privet hedge, or 6 feet wall. Against the end wall of this compartment should be a range of open sheds for mould, &c.

As specimens of irregular gardens we may instance two in our own neighbourhood—namely, those of Hopetoun House and Dalhousie Castle. The former is one of the oldest gardens in Scotland, but was much improved and altered in its arrangements about thirty years ago. It occupies two sides of a valley, giving both a north and south exposure, with a small stream of water flowing down the middle. The latter, fig. 26, occupies a sloping bank on the north side of the river South Esk. It was designed by the late Mr John Hay of Edinburgh, and is thus described by Mr Archibald, once gardener there: “The plan is certainly very different from, and in effect far surpasses, the ordinary mode of enclosing gardens by straight walls, in the form of squares or parallelograms—the wall here, which is 15 feet in height, having been built in a curved and winding direction, to suit the adjacent ground. The situation has been much admired by every person of taste who has visited it: one particular beauty consists in the natural fence on the south side, being perpendicular, rugged rocks, to the depth of from 30 to 40 feet to the bed of the river, with a walk along the top. The range of glazed houses is 203 feet in length, consisting of a greenhouse in the centre, 36 feet; two vineries, 77 feet; and two peach-houses, 45 feet each; with an excellent room on a level with the top of the greenhouse stage, where are deposited some beautiful specimens of natural history, and a few useful books on botany, gardening, agriculture, &c.”

The following references to the annexed plan will explain the arrangement: *a a*, &c., quarters for vegetables and small fruit; *b* border for American plants; *c* melon ground; *d* gardener's house; *e* greenhouse; *f f* vineries; *g g* peach-houses. The offices behind contain fruit-room, mushroom-house, potting-shed, gardener's room, water-house, tool-house, coal-shed; *h* open shed; *i* bank of rhododendrons;

*k k k* line of variegated hollies; *l l l l* flower-beds on grass; *m m* sunk fence; *n n* four divisions of flued wall; *o o* stoke-

Fig. 26.



holes; *p* shrubbery borders; *q* walk towards the castle; *r* cart-road to the garden, and *s s* South Esk.

This is an instance of a well laid out garden, in which the arrangements are adapted to the natural disposition of the ground-level and situation, without being shaded; and, although now in a state almost of ruin, it offers the best specimens we know of, excepting Hoptoun House garden, of one of such size and pretensions laid out in the irregular style. With improvements in heating the hothouses and pits, and a few other modern additions and amendments in these structures, this might be made a garden of peculiar interest.

In gardens of an irregular form, all dead walls of buildings within them should be carefully avoided; and hence the span-roof, or ridge-and-furrow principle, should be carried out in all glass-houses, having the sides all round glass to within a foot of the ground, so that these structures, from whatever part of the ground they are viewed, may be seen with equal advantage. This can more readily be accomplished, as the necessary accommodations of potting sheds, &c., may be in cellars under ground.

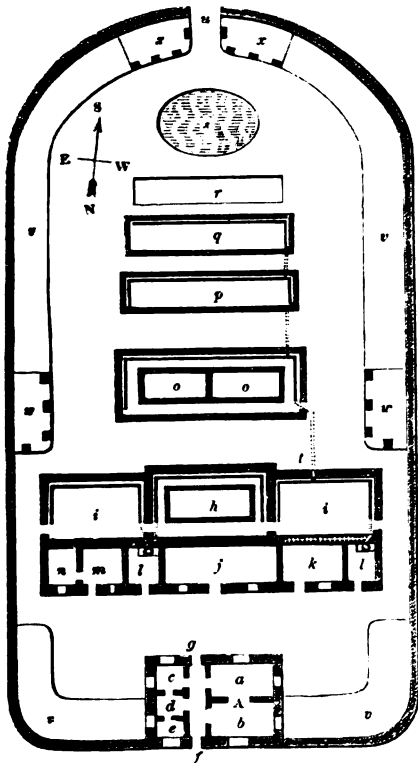
As a specimen of a fruit and culinary garden combined, with little pertaining to the flower garden, we may instance that of the Duke of Bedford at Woburn Abbey. This is thus detailed by Mr Forbes in his excellent description of the gardens and grounds of that princely residence, published under the very appropriate title of "*Hortus Woburnensis*":—"The space enclosed within the walls contains about four English acres, and is a parallelogram in form, surrounded by a broad slip, which, being planted with a selection of the best sorts of apples and pears, as standards, gives the exterior of the garden the appearance of an orchard." This garden, as is usual with those of the same extent, is divided into four quarters, having a single row of fruit trees planted along the sides of the walks, and trained in the French or weeping form, *quenouille*, which checks the flow of the sap, and throws the trees into a bearing state much sooner than if they are allowed to grow in the natural or upright form. Trees thus trained never attain a great diameter through their branches, and, therefore, they cause much less shade or interception of the sun and air to the vegetables growing around or underneath them.

The hothouses occupy the greater part of the south side of the north wall, terminating at one end by Mr Forbes's house: this wall at both ends of the hothouses is built hollow, and heated with hot-water pipes, (*vide* HOT WALLS.) The forcing-ground is in the rear, but at a sufficient distance so as not to be shaded during winter. This department consists of three ranges of pits, two of which extend to about half the length of the garden, and are heated by dung linings in the usual way. The two pits farthest back are heated by hot water, and the spaces between them are paved with bricks, which appear to be the best material the situation affords. "An apartment is fitted up in the centre of the range of hothouses for the entertainment of company in the fruit season: the ceiling of this room is ornamented by paintings of several kinds of birds, and the floor is inlaid with different kinds of oak. On the walls are hung two magnificent fruit-pieces, painted by G. Lance, Esq., whose accuracy in the delineation of fruit is universally admired."

Few gardens have so complete a range of offices behind as this has. It would have been, however, more complete had a range of cellars been carried under them, as exemplified at Dalkeith. The offices at Woburn consist of open cart-sheds, tool-house, foreman's room—the latter word we would rather have had to read in the plural—onion-room, root-room, store-room, room for dessert apples and pears, room for kitchen apples and pears, seed-room, office, &c. The head gardener's house is placed outside the north-west corner, and is one of the best in the kingdom. The principal range of glass consists of three vineries in 28, 35, and 39 feet lengths, and 12 feet in width, at one end; and at the other, three peach-houses of the same dimensions, having between them a citron or lemon house and a fig-house. In the centre of the range is the room for company noticed above, with a commodious waiting-room behind. In the melon ground is placed a pinery for fruiting plants, a range for succession plants for the same, with other pits for bringing on the younger stock, as well as for melons, cucumbers, &c., to which latter purpose there is a considerable extent of ground devoted.

The annexed, fig. 27, is a plan of a forcing-garden upon a limited scale, and

Fig. 27.



room; *d* pantry; *e* larder; *c* staircase leading to sunk or area floor, in which is placed a kitchen under *a*, cellar under *b*, water-closet under the stairs under *c*, coal and fuel closet, and the other apartment under *d e*. The stair is carried up in *c*, and leads to the bed-room floor, in which are three bed-rooms with wall closets in each; *f* front-door entrance, with porch—not however shown, and *g* the entrance from garden; *h* vinery; *i i* peach-houses; *j* fruit and seed room; *k* store-room; *l l* stoke-holes, and stair leading down to a range of cellars underneath, in which is a mushroom-house, tool cellar, root cellar, and water-closet; *m* men's sitting-room; *n* men's bed-room; *o o* pine-houses and vineries combined, or with *h* to be wrought separately, if desired; *p* melon and cucumber pits; *q* pine pits; *r* pits for forcing asparagus, salads, late cucumbers, &c.; *s* cistern of water, into which is collected by pipes all the rain water that falls on the various roofs, after the cisterns placed over the furnaces, and the soft-water tank at the gardener's house, are supplied. The ground is supposed to be level.

The vinery *h*, and early peach-house *i*, on the left hand, are heated by one boiler placed in the cellar behind, from which also pipes are taken through the mushroom-house under the fruit-room *j*. The other boiler heats the late peach-house *i*, the pine and grape houses *o o*, the melon and cucumber pits *p*, and occasionally the pine pit *q*. As during a great portion of the year the late peach-house *i* will not require artificial heat, the pipes are taken diagonally from the boiler, which is placed in the cellars, through under the border, in a barrel drain stuffed with charcoal, to the point *t*, and so continued till they enter the vineries *o o*, and from them in like manner to the pits *p* and *q*. Stopcocks are placed at the points where the hot water is to be shut off, or turned on, according to circumstances. When all the stopcocks are open, the water will circulate to the extreme point and return again to the boiler in the same line, but at a lower lever. The cart-entrance gate is shown at *u*; *v v v v* are borders for fruit trees to cover the walls. If no local circumstance prevents the walls from being enclosed externally by a wire fence, a border may be made and trees planted therein;

adapted to a country residence where the fruit, kitchen, and flower gardens are apart from it. We have placed the gardener's house here as being more convenient for night-work. The garden is enclosed with 10-foot walls, and placed, in regard to exposure, two points to the west of south. Such an exposure has been advocated by garden architects, and has been noticed in this work in reference to kitchen gardens, with a view to extend the solar influence to as late a period of the day as possible, and also to prevent those accidents which often happen to forcing-houses, when dull, cloudy mornings are suddenly followed by bright sunshine, which often causes the foliage of plants to suffer from the sudden transition from shade to bright solar influence, unless the precaution of early ventilation is attended to.

On the plan, *A* is the gardener's house, in which *a* is sitting parlour; *b* dining-

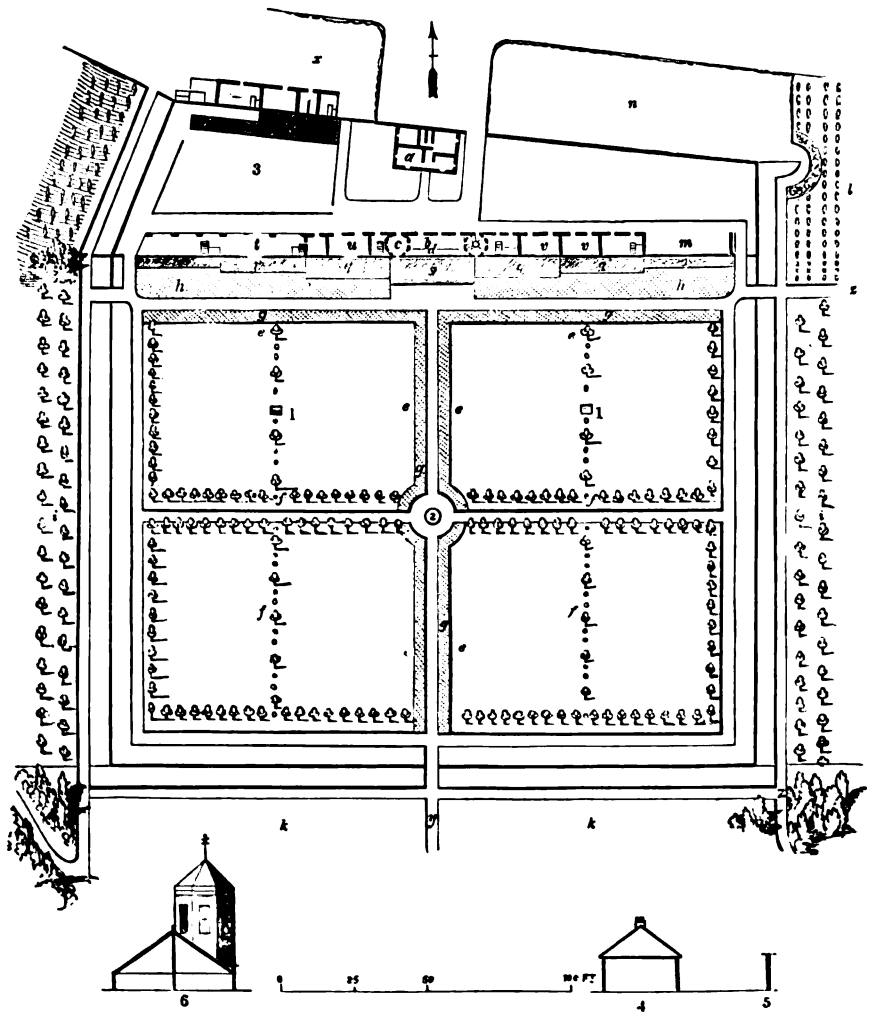


but if this should not be the case, then the trees within may be trained over the wall, and as far downwards on the opposite sides as may be consistent with security from hares, sheep, and other sources of injury. The ground around and between the hothouses and pits should be laid down dry and covered with gravel. The smoke from the boilers and men's rooms is to be carried in flues in the back walls of the hothouses, and made to discharge itself by one chimney placed in the centre, or in two, one rising at each corner of the fruit-room. *x x* are open sheds for tan, mould, and other matters requir-

ing to be kept dry; *w w* potting sheds. We have not extended the quantity of glass beyond the requirements of an ordinary family; but from the arrangement it will be seen that this may be done to any required amount, simply by an extension of lines.

As an example of Hay's style of laying out kitchen gardens we offer the annexed, fig. 28, which, for convenience and arrangement, is very complete; and if the proprietor would substitute hot-water pipes for smoke flues, and tanks instead of fermenting materials for bottom heat, and adopt the mode of ventilating recom-

Fig. 28.



mended in this work, all of which changes are contemplated, it would be a perfect specimen of a garden for a country gentleman. The plan is drawn on a scale of 1 inch to an imperial chain of 66 feet. The following reference will explain the details: *a* gardener's house; *b* tool-house; *c* seed-room—over each of which is a fruit-room; *d* balcony communication between the two towers, of one of which, 6, is the elevation shown above the roof of the greenhouse; *ee*, &c., espalier; *ff* dwarf-trained apples and pears; *gggg* flower borders; *hh* flower beds with a row of standard roses in front; *ii* orchard; *kk* flower garden, through which the principal entrance passes; *l* gooseberry and currant ground; *m* space for greenhouse plants during summer; *n* nursery; *o* pine-house; *p* pine pit; *qqq* vineries; *rrr* peach-houses; *s* greenhouse; *t* open sheds; *u* men's lodge; *vv* offices; *x* compost ground; *y* principal entrance from the mansion; *z* secondary entrance from do.; 1, pump wells, which seem rather out of place—a basin of water in the centre, 2, would have been more convenient; 3, melon ground. One feature in this garden, in which it differs from any one we have seen, is the two lofty octagon towers behind the north wall, one of which serves for a staircase leading to the balcony over the greenhouse, from which the whole garden is seen; the other is used as a fruit-room, or may be used as a tea-room, library, or small horticultural museum. The gardener's house is commodious and comfortable—a part of garden arrangements too often disregarded.

There is water laid on to the hothouses, but, from local circumstances, it is too limited in supply; and an evident neglect has been shown in no provision having been made to collect the rain water from the roofs, &c. Cellars for roots, mushroom, forcing sea-kale, rhubarb, &c., would be an improvement if they had been placed under the back sheds and offices. 4 is section of gardener's house; 5, section of garden walls; 6, elevation of the octagon towers.

The flower garden here, very properly, is outside of the kitchen garden, and occupies the space marked *kk* on the plan. It forms the connecting link between the garden and the park, and through it the main entrance walk has to pass before

entering the kitchen garden. The flower borders, marked *gg*, along the sides of the principal walk leading to the range of hothouses, seem, as it were, a continuation of the flower garden, which may be said to terminate in the flower border in front of the houses, the centre one of which is a greenhouse. Had this house not existed there, we would have wished to have seen the side borders along the principal walk, and those in front of the houses, otherwise occupied. It ought, however, also to be observed, that as the sides of the principal walk beyond the border are hedged off with a well covered espalier rail, little of the kitchen garden crops is to be seen.

Hay's great error, as well as that of his contemporaries, was not in general arrangement, but in details. In none of these did he err more than in the unnecessary height he gave to most of his forcing-houses in front, and the high angle of roof elevation which led to back walls of great height, and to an internal space not easily heated by smoke flues, without heating them to an extent eminently injurious to the trees that grow within these houses. We have no great objection to ascend a few steps on entering a range of hothouses, but, having gained the summit, we must protest against having to descend again, and still more to see the peaches so far removed from the glass, or our eye so far below the fine crops of grapes produced in these houses.

This artist appears to have paid little attention to a general ground-level, but to have built his houses, for the most part, upon the inclination natural to the ground. Hence one end of a house is often found three or four feet above its level at the other end,—a sad mistake, which can only be, and that imperfectly, remedied by steps and stairs.

The new garden at Poltalloch, on the princely property of Neill Malcolm, Esq., on the west coast of Argyllshire, Plate VI., forms a square of 300 feet on the side, enclosed within hollow 20-inch walls of composition bricks; the front and side walls being 11 feet in height, while that on the north side is 19 feet as far as the hothouses extend, ramping down in two breaks to the height of the side walls. The walled garden is surrounded by slips enclosed with a rabbit-proof wire fence;

those on the east and west sides being 16 yards in breadth, while that in front is 23 yards, and the enclosed ground on the north 33 yards, rounded off at both ends, as is also that on the south side. The interior is divided into four quarters by the two principal walks intersecting each other at the centre. These walks are each 9 feet in breadth—those surrounding the quarters being 7 feet. The fruit-tree borders are 12 feet wide and  $2\frac{1}{2}$  feet deep, while the quarters are 3 feet in depth—the whole soil being artificially made, and resting on a dry bottom of alluvial gravel. The ground without the walls is formed of a like depth. The finished level of the ground falls to the south 1 foot in 10; and the exposure is three points to the east of south, on dry elevated ground, sheltered from the north by a high hill, well planted, and on the other sides by young plantations; yet in no way shaded, but fully exposed to the sun, from morning till late in the afternoon, and commanding an extensive and beautiful view over a large tract of mountain scenery. The hothouses, of which there are eleven ridge-and-furrow ones, are seen on Plate VI., fig. 2. To these a lean-to house at each end is to be added. They stand on a terrace, 15, four feet above the ground-level, and furnished in front with a parapet wall of corresponding height, with flights of steps at the centre and two ends, 18 18 18, finished with hand-rails and vases. These parapets are in five divisions or breaks, each parallel to the hothouses opposite to them, which are of unequal lengths, the longest being in the centre. The terrace walk, 14, is 9 feet in breadth throughout, with borders between it and the ends of the houses for tender plants.

The following reference to the Plate will explain the details:—Fig. 1, 1, lean-to house for the finer sorts of pears; 2, cucumber house; 3 melon house—the two latter heated by hot water under the beds of soil, as well as by pipes for atmospheric heat, the plants being trained under the roof; 4, greenhouse; 5, 6, and 8, vineries; 7, tropical-plant house; 9, peach-house; 10, fruiting pine-house; 11 and 12, succession pine-houses,—all provided with bottom and atmospheric heat by hot-water pipes; 13, apricot-house in the lean-to form; 16 16 show the openings

of the subterranean ventilation, which is provided by 9-inch fire-clay spigot and faucet pipes, the ends of which, projecting through the parapet wall, are finished with an ornamental moulding, and the orifice covered with wire grating, to prevent the entrance of vermin. These tubular ventilators pass under the terrace walk, and are carried forward under the footpaths, towards the boilers, or their neighbourhood; so that the air, becoming warmed, and consequently lighter, at these parts, rises readily into the house, and causes a draught from without along their whole length. Thus a supply of fresh air is constantly flowing inwards, and is increased in proportion to the heat maintained within; while, in passing along, it is allowed to escape into the house through apertures in the pipes at regular distances, and which rise from under the footpaths through ornamental iron gratings placed in the stone pavement and trellised footpaths. Both of these latter are used, the first in the plant, melon, cucumber, and pine houses; and the second in those dedicated to peaches and vines. Each alternate line of air-tubes, after passing under the terrace walk and front parapet of the houses, rises into the hollow wall which separates each house from that adjoining it, and discharges fresh air, as will be seen hereafter by fig. 35.

17 is a sheltered border between the terrace wall and the narrow gravel walk in front, and may in such a climate be available for half hardy plants; 19 are the stoke-holes for the hot walls: these are sunk under ground, with iron gratings set in stone kerbs, by which admittance is got to the vault in which the furnaces are placed. These vaults are 6 feet by 12, having on one side of the furnace a space for coal, and on the other, one for the ashes, which are to be supplied and cleaned out once a-week; 20 are stoke-holes similarly constructed, for the use of the two end houses; 21, water-closets; 22 22, open sheds; 23, tool-house; 24, fruit-room; 25 store-room; 26, potting room, opening in from the plant-stove; 27, sitting-room for men; 28, bed-room for ditto; 30, potting room opening in from fruiting pine-stove; 31, large reservoir, 30 feet long, 6 feet broad, and 3 feet deep, to supply which, pipes are laid from the mansion,

as well as from the shoots which collect the rain water that falls on the roofs of the back offices; from this reservoir pipes are laid to supply the cisterns within the hothouses, should the rain which falls on their roofs be at any time too limited in quantity for the supply required. This reservoir, as well as all those within the houses, is formed of large slabs of Caithness pavement, half checked, and jointed with white lead, over which joints a thick coating of pitch is laid; the corners are secured together with leaden cramps, which are in all cases preferable to iron ones, as being not subject to oxidation. Under the range of offices behind are capacious cellars extending their whole length and breadth, and 9 feet in height; the sharp alluvial gravel into which they are sunk being highly favourable, they are in consequence completely free from damp. This is still further guarded against in the following way: between the front wall of these cellars and the solid ground is an area 15 inches wide, sustained by a retaining 10-inch wall. This area is covered over, but is sufficiently ventilated, openings being left on each side of the windows, which give light and air to the cellars. In these cellars, also, the furnaces are placed. Under the floor of the cellar is placed a 9-inch spigot and faucet pipe-drain, into which all the overflow water from the cisterns, &c., is conducted, and, flowing towards the centre, is discharged through similar pipes passing under the centre houses, and under the middle walk of the garden, by which it is conveyed beyond the boundary of the southern slip, where, should it be required, a reservoir may at any time be formed. 43 43 are two stone cisterns set on surface of ground, and supplied by leaden pipes from 31.

Few situations present a better opportunity for obtaining a copious supply of water than this does, as the supply for the mansion is abundant, and brought both from a great distance, and from an altitude giving a pressure that will throw the water 50 feet in height. But here the natural humidity of the climate renders this of little consequence, as, by a very correctly kept rain-gauge, the fall of that element is shown to average 60 inches per annum.

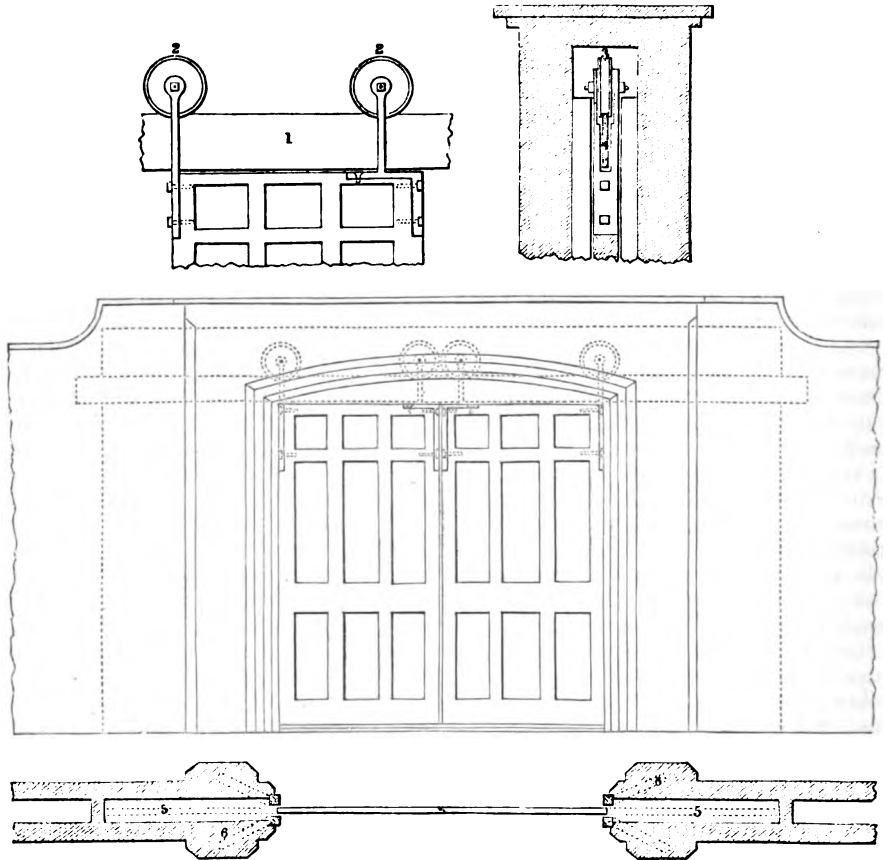
32 is an enclosure within a holly hedge, to be used as a compost-yard, and for pits and frames, and similar purposes; 33 is the situation for gardener's house, being the nearest point to the mansion, from which a service-road is to be formed, entering the garden at 34; 35 is the principal entrance from the mansion, from which a drive through the grounds is to be formed—the walk through the centre of the garden, as well as that which passes round the exterior of the walled enclosure, being 9 feet in breadth, admits of a pony carriage to drive all round, while it is convenient during winter, when manure, &c., may be carted in. Fig. 3 is a plan of the hollow walls, showing the bonds and cavities; fig. 4, a section of the same, showing the concrete foundation, the hot-water pipes, and projecting coping, which is here used 6 inches broad, to keep the walls dry, and consequently warmer. These walls are built with piers, each panel being intended for one tree when fully grown; but at present the piers are planted with riders of the hardier kinds of fruits—the intention of the piers being to break the power of the wind, which often blows with great force in this locality. The doorways in the walls are constructed with massive piers and arches, and are tuck-pointed, while the walls themselves have their joints cut to equal thicknesses, and drawn in with black coal. The last three courses of the walls are built solid, to prevent the escape of heat upwards, they being all heated by 4-inch hot-water pipes. The coping is of composition bricks, two of which cover in the roof of the wall, and which are moulded 10 inches thicker at the one end than at the other, the better to throw off the rain which falls on them—the centre of the coping being higher than at the edges. Fig. 5 is the elevation of garden walls, showing the piers and panels for fruit trees.

All the doors of the garden are hung upon the suspension principle, and not hinged in the usual manner. They are made to run back, when opened, into the centre of the wall, the large ones being in two parts, while the smaller are only in one. This mode of arranging both gates and doors, particularly if of large size, has many advantages.

Fig. 29 shows the principle in detail. 1 is an iron bar 4 inches by 3, placed in form of a lintel, and extending rather more than half the width of the door into the hollow of the wall; upon this bar the wheels 2 2

(attached to the side rails of the door by an iron bar on each side) are made to run, the whole weight of the door being suspended by them. Half the door is run back, when open, within the wall at

Fig. 29.



both sides, guided by the iron rail, 5, secured to the stone sill; and the door frame is tied into the wall at top and bottom by the iron holdfasts 6 6. The section, 3, in the right-hand corner of the fig. shows how the suspension wheels are attached to the side rails of the door, and the plan of the piers is shown at the bottom of the figure. In order to break the force of the wind from sweeping along the surface of the walls, when blowing in certain directions, projecting wings are carried from the ends and corners of the walls to the full extent of the border, and these are of a corresponding height with the walls.

No fruit trees are intended to be planted within the gardens, excepting those on the walls. The front slip and two end ones, as far as where the entrance and the corresponding walk on the east side intersect them, are to be devoted to this purpose; and all the apples and pears, plums and cherries, are to be dwarf standards, in six rows, 11 feet apart in the line, and the same with eleven rows of gooseberries and currants of sorts, 6 feet asunder. The ground between the trees is not intended to be cropped.

A plan of this part of the garden is made out upon a large scale, and kept in the garden office—each tree being named on

the plan in the position it occupies, saving the trouble of labelling every individual tree, and also preventing confusion from the labels being lost or obliterated. The raspberries, gooseberries, and currants are arranged by themselves, and can thus be more conveniently protected from birds by a covering of netting.

The north-west slip is to be occupied with asparagus, and the north-east one to be cropped with sea-kale, next the compost yard. Jerusalem artichokes, globe artichokes, horse-radish, &c., and other permanent crops, are to be alternated by asparagus placed at the other side of the garden, in due course of rotation.

The ground around the gardener's house is to be laid out in the shrubbery and flower-garden style. In the cellars, provision is made for the cultivation of mushrooms, for forcing and blanching sea-kale, rhubarb, chicory, &c., and also for storing carrots, beet, and other edible roots.

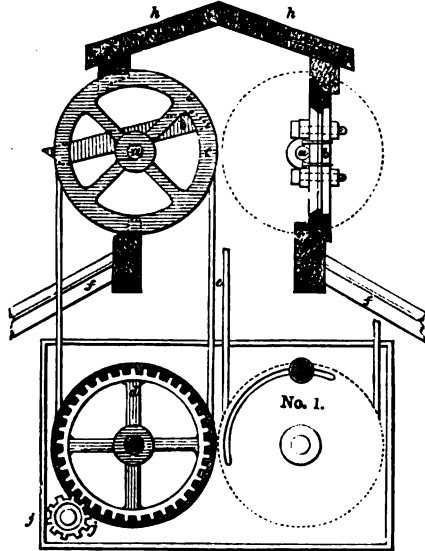
The hothouses—as will be seen by Plate VI., fig. 2, which is the elevation—are differently constructed from those in general use. Although divided by cross glass partitions, to facilitate the operations of culture, they may be said to form one large house upon the ridge-and-furrow principle. Ventilation is effected, as already noticed, by subterranean air-drains through the floors and cross partitions, and also by openings in the front parapet, each 4 superficial feet in area, furnished on the outer side with highly ornamental cast-iron gratings, sunk 2 inches within the face of the wall, in the form of panels, and on their inner side with wooden ventilators (*vide sect. VENTILATION*) upon the louvre principle, and made to open and shut to any extent by a lever handle by the sides of the doors—affording, with the air-drains already noticed, a greater amount of ventilation than is employed in hothouses in general.

It will be sufficiently obvious that, by this mode of admitting air, two important essentials are secured—namely, a constant supply during night, and at all seasons, or what Dr Lindley has very properly denominated *aëration*: and this supply of air brought to a temperature nearly that of the house within, before it reaches the tender foliage and shoots of the plants.

Such air is, likewise, sufficiently charged with humidity, and also with the natural atmospheric gases entirely unchanged or deteriorated, while it is equally distributed through the lower parts of the house—the very parts, according to the usual modes of ventilating, where the air remains unchanged, accumulating gases of the most unhealthy description.

Top ventilation is secured through the ridges, which extend the whole length of each division, and which are made to open, by a very simple mechanical appliance, their whole lengths simultaneously. Fig. 30 will explain this mode of

Fig. 30.



ventilation as applied to the centre house, of which the following is the description:—

A longitudinal bar, *a*, 1 inch diameter, runs along the centre of the sashes, having flat palms welded on it opposite the side style of moving sash *b b*. Close to each of these palms are journals turned to suit the pillow-blocks, which are screwed on the fixed standard of the ventilator. This fixed standard is the mullion which divides the space into panels, and connects the roof part *h h* with *g g*, as will be seen between *a a* in fig. 32. These pillow-blocks are brass, and of the shape shown; they are fitted on close to the edge of the standard, and up to the shoulders of the palms, and keep the moving sashes in their proper

position. On the end of each rod is fixed by a key a pulley *c*, about 12 inches diameter, which corresponds with a pulley, *d*, fixed on an axle, and moving in a cast-metal case which is fixed into the wall about 3 feet from the floor. Around those two pulleys, and attached to each, is a neat light chain *e*; when the under pulley is moved round, the upper one also moves, and either opens or shuts every alternate top ventilator simultaneously.

The under pulley is moved by a brass nob being fixed into one of the arms of the pulley, and works round a circular slit made in the outside plate of the case, as seen in No. 1.

When the ventilators are heavy, and a long range is wanted to be moved, a small spin-wheel, about 10 inches diameter, may be fixed on the same axle as the under pulley, and in the corner of the case is placed an axle, with small pinion, about 3 inches diameter, *j*; this pinion is moved by a small organ handle, and when turned round it moves the wheel and pulley with a power of nearly four to one—consequently the ventilator sashes are shut and opened with great ease.

The axles work in bushes cast on the front and back plate of an iron box built into the recess of the wall, which recess extends from the case to the top of the greenhouse, to allow room for the double chain of the two ventilators to run freely up and down. The great advantages of this ventilation are the simplicity of its movement, and its preventing snow or rain from being blown into the house, while, at the same time, all the ventilators may be kept open.

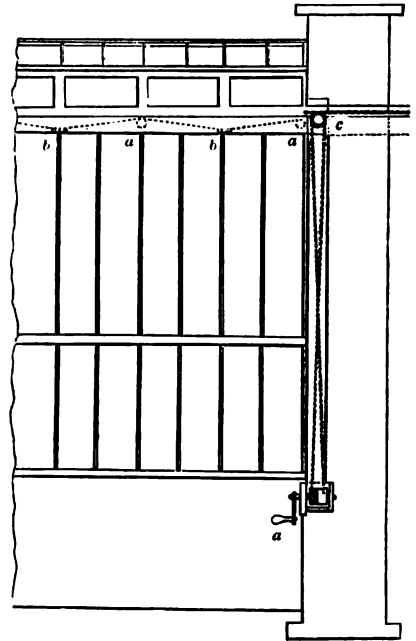
*ff* are the astragals of roof; *gg* is the bottom of the lantern frame which forms the ventilators; *hh* roof of lanthorn, of which the top and sides are glazed.

The whole of the roofs and gables are fixtures, with a view to prevent the breakage of the glass, which is 21 oz. to the foot, and in pieces 3 feet in length by 12 inches in breadth. The intention of ventilating by the sides instead of at the top of the lantern part of the ridge is, that air may be admitted during rain or snow. As both sides of the ventilation are acted upon by separate movements, one side may be opened while the other is shut, or both may be opened at the same time. Every alternate panel is a fixture, but

the opening one on one side is placed opposite to the fixed one on the other. The whole of the machinery is placed in a recess in the back wall, and covered with a facing of wood to keep the wheels and chains dry; the axle of the pinion *j* projecting 2 inches over the facing, so that the handle or key which moves the wheels may be applied with greater facility.

Fig. 31 shows a different mode of ventilation, which is applied to all the other houses. Instead of every alternate sash

Fig. 31.



or panel being made to move outwards, as in the last example, here they move longitudinally into a groove, provided for the purpose, in the top and bottom rails of the upright part of the lantern, and are acted upon by a small metallic chain connecting all the movable panels on each side together. These chains are made to pass alternately over and under small pulleys, *bbbb*, and the motive power is given by turning the crank handle *a* in the right hand direction, when it acts on a rack and pinion *c*, which pushes forward every alternate panel, from half-an-inch opening to its full extent; and, by reversing the movement of the same handle, they are drawn back again by the same

power. That water may not lodge in the under groove, the bottom of it is bevelled slightly outwards, and spaces 4 inches long and half an inch deep are cut out on the under side of it, so that the water may escape, as well as to allow a free circulation of air to pass under the lower sides of the panels, which, for this purpose, as well as for facilitating their movement, are set on small gun-barrel castors. A separate chain and pulley is attached to each side set of ventilators: this might be easily avoided by connecting the movement at top; but as in that case it would require to be thrown off and on gear to suit the side intended to be opened, it is questionable if the double movement is the best.

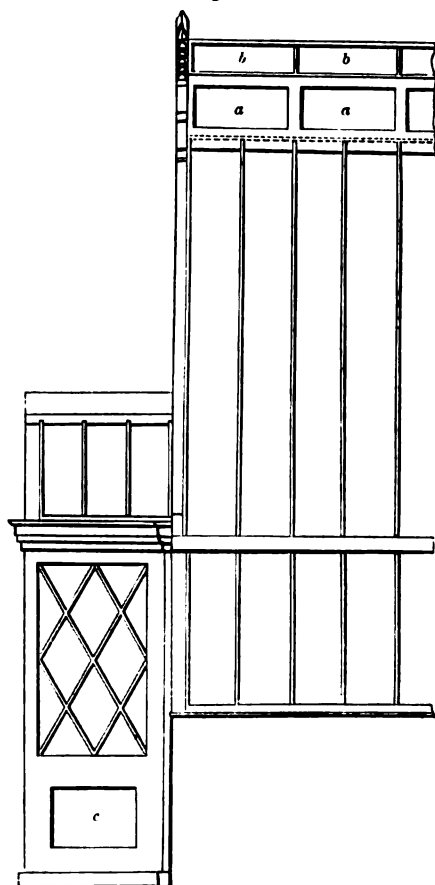
Plate VII., fig. 1, shows the end elevation of the vineries, peach-houses, greenhouse, pine-stoves, &c.; and fig. 2 the arrangement made for opening and shutting the doors, by running them back in front of the walls behind the wooden architraves, instead of hanging them in the usual manner. We should also observe that the doors are suspended from above, thereby securing a greater facility of movement.

Plate VII., fig. 3, shows the end elevation of the centre house, with the porch or lobby, and, in connection with fig. 4, the section, exhibits the inner door partly open, and partly run back into the centre of the wall at *c*; *a* is the lobby; *c* the stone plinth or base on which the framework of the porch rests; *b* is the outer door in two parts, hung in the usual manner, as it would be impossible to hang it upon the same principle as the others.

Fig. 32 is a side view of the lobby, and one side of its roof, with the side and roof of the house, and the side and roof of the ridge-ventilator at top. The sides *a a* are in panels on both sides alike, each alternate panel being a fixture, while the others are movable, and are in this case made to swing outwards, being attached to a common axle of 1½-inch iron rod, the whole length, and acted upon as shown in fig. 31, and already described. The top of this ventilator, as is the case with all the others, is a fixture, and glazed in panels, *b b*, the same length as the side ones. By this means roof ventilation can be effected during rain, as the glass on the top projects over the framework of the other parts of the venti-

lator. The side openings have each a separate moving power; so that, when the

Fig. 32.



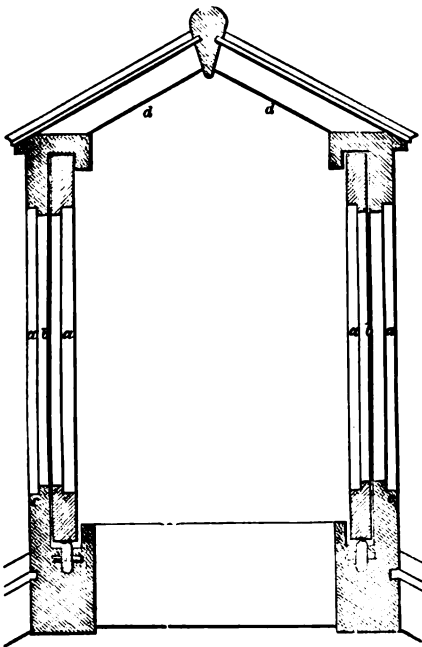
wind or rain is from the west, the eastern sides may be opened, and *vice versa*.

Fig. 33 shows the section of the top ventilators, with the roof astragals attached thereto. In this case the glass panels *a a a a* are shown on each side of the pilasters *b b*, which connect the top and bottom parts together. The inner panels are fixtures, while the outer ones are the movable ones; these run in a groove at top and bottom, and are furnished with brass rollers to facilitate the movement. These movable panels are attached together, and connected with a chain placed in a box built in the back wall, which, passing over a pulley, is wound up or unwound by a key. To prevent water resting in the groove in



which the under side of the moving panels run, holes are cut in a slanting direction in the battens at *c c*, by which

Fig. 33.



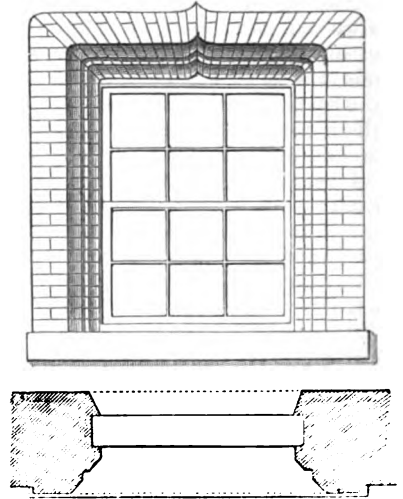
it can readily escape. These battens form the proper ridge of the roof, and are themselves supported by ornamental cast-iron columns and arches; and from them arms project, which, being attached to the straining bars of iron placed under the astragals, tie the whole roof together in a most effective manner. *d d* are the rafters that tie the top of the ridge, and are placed above the pilasters *b b*.

Plate VI., fig. 6, shows the elevation of the back offices, with the chimney-pots, which are of an ornamental character, on the top of the front wall, instead of, as is usual, on the top of the back wall of the hothouses. The smoke flues are carried from the furnaces through the party walls of the offices, rendering them dry and slightly warm; while the smoke and unconsumed carbonaceous matter are prevented from falling on the glass roofs.

The openings near the ground are the area windows, which give light to the cellars. The windows and doorways are margined with light-coloured composition bricks, tuck-pointed, and are con-

structed as shown in fig. 34—the rest of the wall being of red brick, the joints neatly cut out and drawn in with black coal.

Fig. 34.



A glance at the elevation of the hothouses will show that the third house from each end of the span-roofed ones rises considerably above the one next it. Without some precaution, snow falling from the side of the roof of the one would break the glass in the others. To guard against this, an ornamental cast-iron parapet 6 inches in height, cast open, is planted on the cast-iron half gutter, which extends from front to back: this has spaces between it and the gutter 1 inch in height, so that the melted snow may pass under it and fall into the full-sized gutter at the bottom of the roof of the adjoining house, while the bulk of snow will be prevented from falling along with it, as it is retained by the parapet until it is melted.

All the gutters between the various roofs are of cast-iron, (*vide* Plate VIII.) and are so constructed that the rain water collected in them escapes through a 3-inch iron pipe at the ends nearest the back wall, and is conveyed to the cisterns, which are all within the houses, and sunk under the surface. From these the water for pot-watering is easily lifted out, while the operation of syringing is effected by a small portable engine, the suction-pipe of which is flexible, and is thrown into the cistern, while the force

of the engine waters every part of the house—thus obviating the labour of conveying water from place to place.

The gutters employed in these erections are, we think, a great improvement on those hitherto used. They are the joint invention of ourselves and Mr Meiklejohn of the Westfield Foundry, and were originally intended for using in the proposed square garden at Dalkeith—allusion to which will be made in another part of this work. They are of cast-iron, 4 inches diameter at the top, and are shown in Plate VIII., fig. 1, *a*. They have dovetailed mortices cast in them for the reception of astragals, which are fitted in with white lead. The upper dotted line, *b*, shows a bar of iron cast at the same time, 6 feet apart from each other, intended for supporting a narrow plank to walk on when repairs are effecting. The under dotted line *c* shows a perforated grating of cast-iron, in 3-foot lengths, resting on the shoulders of the gutter, and not fastened down, so that they may be removed at any time for clearing the bottom of the gutter of leaves, or any sediment that may accumulate. Their use is to preserve a clear passage under them for the escape of melted snow, which, without this precaution, would, in a half-melted state, choke up the discharge, and, in the event of frost succeeding, might be extremely injurious to the roof. When the length

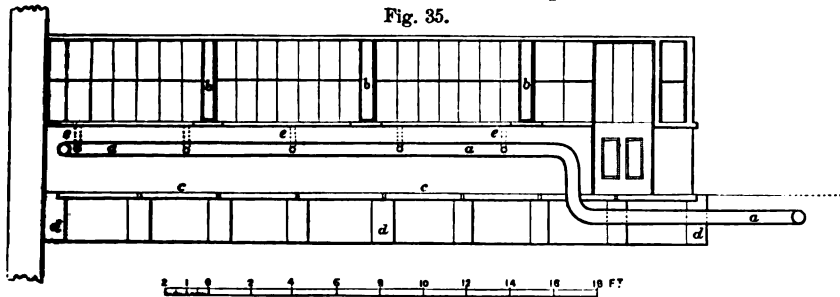
of the gutters is so great as to require several supports, they are supported on tubular cast-iron columns, *d*, which, while they sustain the superstructure, also carry away the rain water or melted snow.

The wooden astragals *e* are shown of the same size. Instead of the usual rebate for the glass and putty, they have a groove cut in them, *f*, into which the glass is fitted with scarcely any putty whatever—no portion even of what is used being exposed to the weather; an important improvement, and one tending to render the roofs more water-tight, as well as to avoid the annual expense of puttying and painting. On one side of the astragal the groove is cut deeper than on the other, to facilitate the introduction of the glass in cases of repairs.

Plate VIII., fig. 2, shows an external or end gutter on the same principle: it is shown as resting on the end wall of the building.

Plate VIII., fig. 3, shows a half gutter used in cases where two houses adjoin, and are of unequal height. Fig. 4 shows the mode of joining these gutters to perpendicular columns, as well as where joinings occur, even when not above the support.

Fig. 35 shows the partitions between these houses, with part of the ventilation. The parapet walls are supported on 10-inch brick piers, *d d*, linteled over with Caithness pavement, *c c*, 3 inches thick



and 20 inches broad. These piers are the same thickness as the walls, which are built hollow, to receive the 8-inch fire-clay air-pipes *a a a*, admitting air from their orifices in the terrace wall, and, after passing under the terrace walk and front passage of the houses, rising by the side of the doors, and passing on to the back wall. Five of these air-pipes have 3-inch bent pipes, *e e e*, &c., attach-

ed to their sides: these are carried up, as shown by the dotted lines, to the top of the partition wall—one set of pipes on each side of the partition, as is more clearly shown in the ground-plan. These 3-inch pipes are opened and shut by a simple contrivance by the side of the doors, so that any extent of air desired may be admitted at pleasure. The tubular columns *b b* rest on the parapet wall,

and support the gutters above them, to which the astragals of the roof are fixed. It will here be seen that the whole of this range of houses is supported on these tubular iron columns, the iron gutters, and iron arched supports in the centres of the houses; while no part of the metallic material is exposed to the external atmosphere, excepting a portion of the valleys or gutters.

For further details *vide arts.* GREEN-HOUSES, PLANT-STOVES, PEACH-HOUSES, VINERIES, CUCUMBER AND MELON HOUSES, PINERIES, &c.

Fig. 36 shows a section through the centre hothouse *i*, the terrace walk *k*, and parapet wall in front *l*; *g* represents the back wall of the house, with the space indicated by the dotted lines, in which is enclosed the mechanical apparatus for

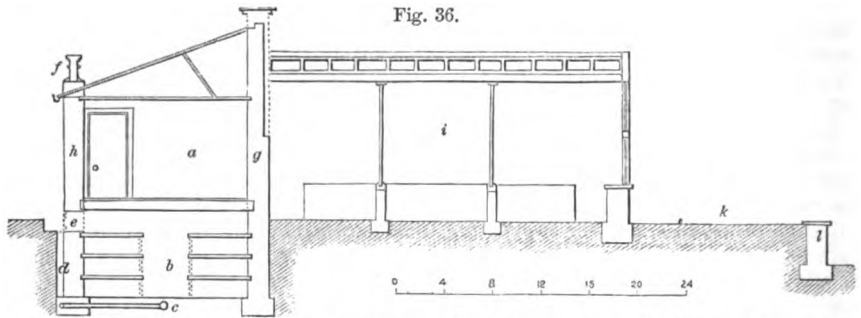


Fig. 36.

opening and shutting the top ventilation; *h* the front wall of back offices; *f* chimney-tops, the smoke being brought from the furnaces through 20-inch party walls; *e* area windows to light the cellars; *d* blind area, 18 inches wide, and covered over at top to keep the walls of the cellars dry; *b* section through mushroom cellar; *a* section through rooms behind; *c* a 9-inch tubular drain, extending the whole length of cellars, into which all the superfluous water from the roofs and cisterns is conducted. This drain passes under the centre house, and under the middle walk of the garden, and is discharged into a reservoir in the outer slip, the overflow from which is led off into the park.

those of many of the aristocracy of Britain. Some years ago, an inquiry was instituted into the condition, management, and actual utility of maintaining, at a very considerable expense, about a dozen pieces of ground, many miles apart, enclosed within walls, most of which had abundance of glass structures, such as they were, extending, if brought together, over some acres of ground, and in all containing somewhere about fifty imperial acres, devoted to the culture of fruits and vegetables. From such sources the royal table was badly supplied, both as to quantity and quality; indeed, so much so, that a nobleman once connected with the court put the question to us, whether the supplies could not be better provided from Covent Garden market, than by continuing on the old system. On this there could be but one opinion, except for the effects such a course would have on horticulture as a progressing, useful, and pleasing science.

The most perfect specimen of a garden in the mixed style, we can offer to our readers, is unquestionably that of her Majesty's at Frogmore, of which Plate IX. is a perspective view of the range of hothouses, while Plate X. is a plan of the ground. It is unequalled by any other in the world, either in extent or in judicious arrangement. This is at last as it ought to be. Previous to the creation of this splendid garden, and the extensive improvements at Kew, the gardens of the sovereigns of this mighty empire were below mediocrity, when compared not only with those of the other sovereigns of Europe, but with

An official committee was appointed, in January 1838, to inquire into and report upon the state of all the royal gardens. This committee was composed of three gentlemen highly qualified for the task. After mature deliberation, they recommended the disposal of the kitchen gardens at Kensington by sale, and the building, with the proceeds, a new garden at or near Windsor, as being

most central to the royal residences. They at the same time recommended the breaking up of the kitchen garden at Kew, and annexing the ground to the Royal Botanic Garden there, which has also been completely remodelled: this also has been done with the best effects. The almost useless establishments at Cranbourne Lodge, Windsor, Buckingham Palace, Osborne, &c., were recommended to be demolished, and that at Cumberland Lodge to be dismantled, saving only the large viney in which is the celebrated vine—although a cutting taken from the large vine at Hampton Court is in every respect its rival.

The gardens at Hampton Court have since been let on lease, and the whole gardening establishment of royalty concentrated in that at Frogmore.

To those of our readers who know something of the locality, and who may not have had the satisfaction of seeing these splendid new gardens, we may observe that they are not situated within the Frogmore Lodge grounds, occupied by her Royal Highness the Duchess of Kent, but in a field considerably to the south, and formerly constituting a part of Windsor Park. They are now about being enclosed within the park by the removal of the public road to Windsor from Datchet, Staines, &c., to a line of far greater interest and beauty, although, from the former point, somewhat more circuitous. By this judicious arrangement our beloved sovereign has the enjoyment of a private park around her royal residence, in which are placed all those domestic appendages which every proprietor of land she reigns over has, or wishes to have, around his mansion, and of which the garden is not the least important in their estimation.

By a parliamentary return published in 1849, it appears that the expense of constructing this new garden was estimated at £44,962, 6s. 3d., viz.—

Ground-works, . . . . .	£1,000	0	0
Garden-walls, and other general works, . . . . .	9,332	6	11
Building gardener's house, pine pits, forcing-houses, stables, and sheds, . . . . .	17,906	16	8
Metallic hothouse, . . . . .	8,921	16	9
Hot-water apparatus, . . . . .	3,908	13	3
Carry forward,	£41,069	13	7

Brought forward,	£41,069	13	7
Building a tank near Windsor Castle for a supply of water to the garden, . . . . .	1,745	5	3
Other expenses connected with building, &c., . . . . .	1,028	7	6
Plans and superintendence, . . . . .	1,118	19	11
Total, . . . . .	£44,962	6	3
From this was deducted for old material, &c., arising from the sale of Kensington kitchen garden, &c., . . . . .	3,422	17	2
First cost of Frogmore garden,	£41,539	9	1

Since that time considerable additions have been made, and are still in progress, which, it is probable, will exceed the sum deducted above, and may raise the total expense of these gardens, up to the present time, to perhaps £50,000 in round numbers—a sum by no means extravagant for such an undertaking.

The following brief description of this garden is taken from notes made on the spot a few weeks ago, when we spent a day with our old and much valued friend Mr Ingram, the excellent superintendent, whose modesty is only equalled by the great ability he has displayed in every department under his charge.

The area of enclosed ground extends over 31 imperial acres,—a considerable addition having been recently made towards the south, in the shape of a broad slip of ground stretching the whole length of the garden, including the breadth of the east and west slips. This part, being at the greatest distance from the houses, is cropped with the heavier and coarser kinds of culinary crops, and fruit trees. From the centre of this point, however, it is not improbable that a carriage entrance may be made from the new road now forming, by which the visitor, on entering the walled garden, will have presented to his view the elevation of the finest range of glass in any garden in Europe. Another entrance is now opening, by which access may be got from the west. The present, which is the most convenient on arriving from the castle, or home park, is at the east end of the range, through a modest but massive gateway, with porter's lodge on one side, and a covered resting-place on the other. No sooner is this gate opened than the visitor finds himself on the end of a spacious terrace walk, 1132 feet in

length, and 20 feet wide. On the right-hand side of this walk is a grass margin,  $2\frac{1}{2}$  feet broad, which separates the walk from the borders in front of the hot-houses: these extend nearly the whole length of the garden, and are, during summer, most tastefully planted with the choicest flowering plants. The geraniums, in particular, we noticed were not crowded together, but planted so that each plant developed itself completely, without interfering with those around it. And here, we may remark, we saw the best existing collection of scarlets, many of them produced by Mr Ingram's skill in hybridising. On the opposite side the grass verge is 4 feet broad, breaking into semicircles, within which are flowering plants of the most showy description. The rest of the ground, to the edge of the terrace wall, is planted with the choicest herbaceous plants. This terrace walk is connected with the walks of the main garden by flights of steps as shown in the perspective view, furnished with elegant vases set on square plinths. At the bottom of the wall is a border extending its whole length, divided into rectangular beds for showy annuals, &c.

In some beds, in front of one of the cherry-houses, we observed a very choice collection of hybrid phloxes, in great variety, and of exquisite beauty. These, with a few other beds near them, and those on the terrace, constitute the out-of-door floral display in these gardens.

The walls are 12 feet in height, of a peculiarly well coloured and well burnt brick. They are built solid, and finished with a substantial stone coping projecting 4 inches over the face. The ends which terminate next the hothouses are furnished with eagles, in Austin's artificial stone. As will be seen by the ground-plan, Plate X, the walls extend round three sides of the main garden, the front one stretching the full extent of the slips; while beyond it is another of similar length, continued round the three sides parallel to the others, but extending so as to become connected with the back wall of the garden, which encloses the ground occupied by smaller houses, pits, &c. Cross walls extend from these ones, and divide the south, east, and west enclosed slips into separate gardens, each devoted to particular crops. Thus

there is one whose walls are covered with cherries, and the ground planted with strawberries; another with its walls of plums, and its ground-surface cropped with celery; another with pears on the walls, while the area within is occupied by asparagus, &c.

By this arrangement shelter is obtained, and a systematic style of cropping is carried out. In planting the walls, Mr Ingram has, with great propriety, kept every species of fruit by itself: thus we have whole walls of pears, peaches, apricots, cherries, plums, &c.

The ground-plan will sufficiently explain the disposal of the central or kitchen garden, which differs little from other gardens, further than in the systematic manner in which the crops are arranged, and their general excellence. In the centre, where the principal walks intersect each other, there is placed a fountain of polished Peterhead granite, provided with various kinds of jets, and rising out of a circular basin, 30 feet in diameter. In connection with this fountain are the water pipes, which are carried all over the garden under the walks, by which means the whole surface might be irrigated if required.

The fruit trees planted by the sides of the walks are trained down to arch-wired trellises not exceeding 4 feet in height. This is done that they might not intercept the view of the whole garden within the first line of walls from the principal terrace in front of the hothouses. The standard apples and pears in the outer slips are trained chiefly in the *en queue-nouille* manner, to prevent shade, as well as to secure to the fruit the full benefit of the sun.

The soil throughout is naturally of the best quality—a rich, workable, pretty strong loam, which may, to a certain extent, account for the extraordinary healthiness and productiveness of the fruit trees. Their arrangement, we ought not to omit stating, is fully up to the highest standard.

A convenient court-yard for manures and composts, with stabling, &c., is placed near the north-west corner, so as to be as much out of sight as possible. This is not shown in our plan.

The beautiful range of glass roofs, with their mechanical appliances, is the work of Mr Clark of Birmingham. They

are all on the lean-to principle. The rafters are of iron, capped with wood, to lessen the action of conduction both of heat and cold: the sash bars are of copper, and hollow, also to counteract expansion and contraction. They rest upon brick parapets in front, and lean to a wall of the same material at the back.

The footpaths throughout all the houses, both in the principal range and in those of minor importance behind, are of polished white pavement, kept so milky white, that one is almost ashamed to put one's foot upon it. They are in long pieces, and are supported on brick piers, so that the roots may have freedom to run under them.

The heating apparatus, which is all on the hot-water system, is by Messrs Bailey of Holborn, and is most satisfactorily fitted up. The boilers used are of wrought-iron, and saddle-shaped,—the stopcocks upon the most improved principle.

The pipes, in general, are 4-inch, some having evaporating pans cast on their upper sides; while a  $\frac{3}{4}$ -inch pipe, finely perforated, supplied from the mains, discharges water over the close pipes, for the purpose of causing extra humidity.

The ventilation is very complete. That at front is effected by a simple mechanical power, consisting of brass-toothed segments, working on pinions, attached to a wrought-iron rod, which extends the length of each house, and is made to revolve by means of a ratchet-wheel and catch at the end of the house. Two revolutions of the handle cause the whole front lights of a house 50 feet in length to open or shut, less or more, simultaneously. This is the case with all the houses in the principal range, excepting the two long vinerias, which have a movement at each end; but this is unnecessary, as the same power would produce the same effect on the larger houses, which are 102 feet in length.

Top ventilation is obtained by causing the alternate roof-sashes, which are furnished with rollers, to slide up and down by means of a quadrant-wheel jack, the handle of which, when loosened, lets the sash slide down to any extent required, while a counter motion draws it up again.

Near the top of the back wall openings are left outside of the roof, and above every

fixed light. These openings are fitted with a neat iron grating, (*vide art. VENTILATION*;) and under them, immediately under the glass roof, are iron flaps hung at their centres, and attached to a common axle, acted upon by the handle of a six-threaded engine-cut screw a foot long: this is made to revolve by turning a handle 4 feet from the floor. Patent copper-wire rope is employed for letting down and drawing up these lights.

The ventilation, heating, &c., of the subordinate structures behind are somewhat on the same principle, excepting the two span-roofed cherry-houses, which we have elsewhere described.

The immense ranges of pits for various purposes, extending in all, we believe, to the extent of 1185 feet, with 480 feet in addition, now building—making in all 1665 feet—are heated by hot water alone, or by hot water and fermenting material, alone or combined, according to circumstances. They are for the most part considerably sunk in the ground, and have, what we much approved of, cast-iron copings both at back and front. The sashes of these are of necessity movable, and are either in one or two lengths, according to the width of the pit. The asparagus pits will be found described in sect. PITS OF VARIOUS CONSTRUCTIONS.

Recently, two very well constructed houses have been erected between the two cherry-houses, and were, when we saw them, filled with cucumbers in full bearing, and young vines in pots, of a growth we have never before seen approached. These houses may be said to be of the unequal span form—that is, having the front glass roof much longer than that of the back. The mode of training the vines here appeared to us novel, elegant, and correct in principle. In one of these back houses we remarked a singularly novel and excellent method of withdrawing the vines after their wood has been ripened.

The whole external walls of the garden are surrounded by a wooden fence, excepting on the east side, where a brick wall, formerly existing, has been taken advantage of,—by which means the whole surface of these extensive walls is rendered available for fruit trees.

The following references will explain our plate of the ground-plan of the garden:

1, stove and greenhouse; 2, pine-stoves; 3, peach-houses; 4, apricot and plum house; 5, vineries; 6, succession pine pits; 7, fruiting pine pits; 8, cucumber pits, &c.; 9, store pits; 10, melon, French beans, &c., pits; 11, cherry-houses; 12, asparagus beds forced by hot water; 13, dwelling-house; 14, foremen and men's rooms; 15, mushroom-house; 16, fruit-rooms; 17, seed-room; 18, store-rooms; 19, open sheds; 20, potting sheds; 21, workmen's rooms; 22, washing-sheds for vegetables; 23, tool-sheds; 24, porter's lodge; 25, principal entrance; 26, gates and doorways; 27, apricot walls; 28, peach and nectarine walls; 29, cherry wall; 30, plum walls; 31, pear walls; 32, currant and gooseberry wall; 33, fig, mulberry, &c., wall; 34, dwarf plums along side of walk; 35, dwarf apples along side of walk; 36, 37, pears on trellis along side of walk; 38, dwarf cherries; 39, flower border and beds; 40, flower beds; 41, vine borders; 42, fountain; 43, compost and dung yard; 44, stable, cart sheds, &c.; boiler houses.

The houses in the principal range are arranged as follows: Commencing at the eastern gate entrance, we enter a greenhouse 50 feet long, 16 feet 6 inches wide, 16 feet 6 inches high at back, and 7 feet in height at front. The plants are arranged upon a platform having a stone passage round it: to the roof and back wall are tastefully-trained creepers of the most interesting kinds, while the platform is equally richly tenanted; for it ought to be noticed that Frogmore is not a botanic garden, but one for the culture of the most showy and useful plants. The next is a fruiting pine-stove 51½ feet long, 14½ feet wide, 3 feet 3 inches high in front, and 10½ feet at back. Bottom heat is secured by means of hot-water pipes laid amongst the gravel, upon which a bed of loam 1 foot in depth is placed, and on this the plants are set; and, judging from the appearance of the plants, this mode of culture, which is by no means common, is most conducive to their welfare. We next enter a house 56 feet 3 inches in length, 15 feet 6 inches wide, 3 feet 8 inches high in front, and 12

feet 6 inches at back, devoted to the culture of plums and apricots; and from that pass into the late vinery, a magnificent house 102 feet in length, 16 feet 6 inches broad, 4 feet 3 inches high in front, and 13 feet 6 inches at back, loaded, when we saw it, with fruit of superior quality, and the vines in the highest state of vigour. Next is the latest peach-house, 56 feet 3 inches long, 15 feet 6 inches broad, 3 feet 8 inches high in front, and 12 feet 6 inches at back: the trees are trained under the roof and 15 inches from it, four trees filling the whole space. Last, in this half of the range, comes an early vinery, chiefly planted with Hamburgs, 52 feet 6 inches in length, 14 feet 6 inches broad, 3 feet 8 inches high in front, and 10 feet 6 inches at back. After passing the curator's house, the same extent of glass, style, and arrangement follows, terminating with a plant-stove corresponding with the greenhouse from whence we started. Each house is separated from the next to it by a glass corridor 7 feet square, with doors opening through to the premises behind—thus, without breaking in upon the uniformity of the elevation, affording a great convenience in carrying on the necessary operations.

The walks throughout the garden are sufficiently broad to admit a pony carriage to drive all round, and also to allow the carting in manure during winter. The elevation of the range of back offices has a good effect, the doors and windows being margined with splayed bricks and semi-Gothic tops, which gives to the whole a tinge of architectural effect. The mushroom house is fitted up with slate shelving, and the fruit-room with wood. All the offices have an abundant supply of water, and the stoke-holes are all under cover within the range, so that no appearance of coal or ashes is to be seen. The principal entrance to the garden from the castle is by a spacious gravel drive recently finished. We believe this was formed under the direction of his Royal Highness Prince Albert, who, with her Majesty, takes the greatest interest in this splendid garden.

## CHAPTER II.

### GARDEN WALLS.

#### § 1.—ASPECT OF WALLS.

THE existence of fruit-tree walls, like that of hothouses, may be traced to a very early period. Generally speaking, however, the majority of even the best gardens in former times were fenced and sheltered by hedges, which, so far as shelter and fencing are concerned, were found sufficient, though they were inadequate to the exclusion of hares and rabbits.

The chief use of walls is for accelerating and securing the ripening of the best kinds of fruits, such as the peach, apricot, and vine, which without their aid could not be ripened in our climate. According to the calculations of Mr Gorrie, "the influence which walls have in increasing the temperature of the air immediately in contact with them, is estimated at 7° of south latitude. The mean temperature of a south wall, or within a few inches of one, is equal to the mean temperature of the open plain of 7° farther south. Hence it is that grapes which ripen in the open air at Bordeaux require a south wall in the neighbourhood of London, which is 7° farther north."

All authors agree in regard to the utility of walls for ripening the best kinds of fruits; but considerable difference of opinion exists as to the aspect they should present to the sun. Switzer in his "Practical Fruit Gardener," (p. 312,) says that south walls have been considered the best for ripening fruits, but that later experience and observation have not confirmed that opinion. For, he says, "when the days are long and the heat of the sun in its greatest strength,

it is too late before the sun shines on them, and it leaves them early in the afternoon. Besides, when it is mid-day, the sun is so much elevated above the horizon, that it shines but faintly and very sloping upon them, which makes the heat to be much the less, inasmuch as a smaller quantity of rays fall upon such a wall—it being visible that, both before and after noon, the sun shines hotter than when it is in its highest meridian—whence it is natural to infer, that walls with a little inclination, either to the east or west, are the best aspects; and of the two, the east and south-east are to be preferred to the west or south-west, though they are as much exposed to the sun as east walls are. In my opinion," he continues, "a south wall, inclining about 20° to the east, is preferable to any other, inasmuch as the sun shines as early on it as on a full east wall, and never departs from it till about two o'clock in the afternoon."

With a view to obtain a comparatively equal degree of solar heat, Hitt recommends having no direct south wall at all, and arranges his garden as shown in fig. 4. In respect to aspect he says, in "Treatise on Fruit Trees," (p. 33,) "The sun's rays continue no longer upon the south-west wall than three in the afternoon, which is best for all our tender fruits; for as apricots, peaches, and nectarines blossom early in the spring, at which time our climate is frequently attended with frosty nights, destructive to both blossom and fruit, the sun's rays, darting in lines at right angles upon the wall at nine o'clock, dissolve the congealed moisture much sooner than if they darted upon it at right angles at noon, which



they must do, if the wall stood due south. It is true, a south wall will receive more sun by three hours—that is, from about three in the afternoon till near six, (in the vernal equinox;) but that is no great advantage, for before that time of the day the air will be sufficiently warmed. Besides, if the wall be built full south, it will not be so proper for fruit trees as a south-east aspect; for in the middle of the day the sun will cause the trees to exhale their juices faster than their roots can absorb them, which will render the fruit smaller, and the pulp harder and worse flavoured, than those which receive the heat more regularly. The south-east wall receives the sun about nine o'clock, and affords a proper situation for most of the best kinds of winter pears. Some kinds of grapes, peaches, and nectarines will ripen against it; and this has one equal advantage compared with the south-west wall—viz., that of the sun's rays striking obliquely upon it at noon. The north-west aspects of walls receive but little sun, for it shines not upon them till three in the afternoon; but they will serve for fruits which ripen in summer—as cherries, plums, &c." We should here observe that both Switzer and Hitt are writing of the climate of England.

Dr Walker, in "Essays on Natural History," (p. 258,) in reference to the climate of Scotland, observes, that "the six warmest hours of the day are from eleven to five o'clock;" and that "it is not a wall of a south-east, but of a south-west aspect that enjoys that heat."

Nicol, in reference to the same country, says, "The best aspect for a fruit wall in Scotland is about one point to the eastward of south, such walls enjoying the benefit of the morning sun, and being turned a little from the violent west and south-west winds. South-east," he continues, "is for the same reasons accounted by many a better aspect than south-west."

The majority of authorities that we have consulted agree in giving the preference to a few points east of south; and in accordance with these opinions we invariably adopt the same course.

Intimately connected with aspect is the form of a garden. That is usually square or oblong; but why these forms

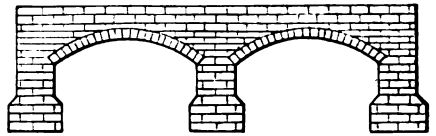
are chosen is not easy to determine. We have, however, many specimens of other forms, all possessing merits of a greater or lesser degree, as has been already shown in Chap. I., § 3, FORM.

Of garden walls we have now great variety, in regard alike to structure and material.

## § 2.—FOUNDATIONS OF WALLS.

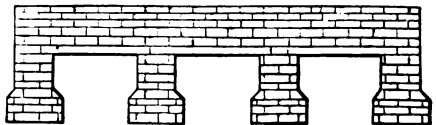
Wherever stone is to be procured conveniently it should be used for this purpose, as being not only more solid and durable, but also, in general, cheaper than brick. The ground should be excavated until a proper solid soil is reached, and the basement of rubble stone carried up to within 6 inches of the finished ground-level. This basement requires to be somewhat broader than the intended superstructure, so as to leave a scarcement or projection of at least 4 inches on each side beyond the upright of the wall. Much has been said, particularly by the earlier writers on horticulture, on the necessity of having all garden walls founded on arches, fig. 37, or piers linteled over with flag-

Fig. 37.



stones, fig. 38, with the view of allowing the roots of the trees free scope for passing under them. This we think a matter

Fig. 38.



of small account, under any circumstance. There are some cases, however, where the practice would be anything but expedient, particularly where the walls of a garden are built close to the trees which afford it shelter, as their roots would much more readily find their way through the openings, and luxuriate in the prepared soil of the fruit-tree border, than the roots of the fruit trees would seek the opposite side. We may here, however, remark, in

passing, that it is anything but advisable to build walls so close to shelter trees, as to admit of their roots reaching the borders; for, where this is practised, half the utility of the walls is completely lost. Hence it is always better to surround the garden with slips of ground, themselves enclosed by ha-ha's, hedges, or other fences, and thus leave both surfaces of the walls all round clear for the training of trees. Inverted arches may be used where the foundation is bad; but where this is the case, it almost naturally follows that the site is not a suitable one for a garden.

The best of all foundations is concrete; and such foundations, unless for the purpose of preventing the roots of shelter trees from passing under them, need not, in almost any soil, be more than 2 feet deep, as they form one solid piece throughout the whole length, and are not liable to settlement. Concrete foundations are of great antiquity, as well as concrete walls, and are, if properly prepared, the strongest and most durable of any.

It is somewhat remarkable that this most valuable discovery of modern engineering is, after all, only the revival of an ancient practice, well known to the Romans and the Moors. Abundant instances of foundations thus formed by them exist to the present day. Modern attention was first directed to this substance so recently as the building of Waterloo Bridge. In excavating for the foundation of the piers, the workmen came upon a solid mass, which they described as a block of granite, surrounded with the loose sand that forms the bed of the river, and which was so hard as almost to resist all their efforts to break it up. This mass was found to have originated by the accidental sinking of a barge of lime some time before, the cargo of which had cemented together the loose gravel into a solid mass. The engineer, Mr Rennie, drew the attention of Sir Robert Smirke to the circumstance: he availed himself of the hint, and afterwards laid most of his foundations with concrete, not one of which has ever been known to fail. He even, when the Customhouse of London was in danger of falling, from the insecurity of the piling which was used for a foundation, underset the whole of the walls with concrete to the depth of 15 feet, or until he came to a solid founda-

tion. The late Mr Atkinson suggested to Brunel, the engineer of the Thames Tunnel, to lay a bed of concrete formed of Mulgrave cement, lime, and gravel, shot out of barges, across the bed of the river, above the line of the tunnel; and there is little doubt that, if this idea had been acted upon, the tunnel would have been constructed at much less expense, and without the disastrous consequences which attended it.

The following is the process for forming these foundations. The trench being dug out to the desired width and depth, "coarse and fine gravel is thrown in, just as it comes from the pit, to the thickness of about 4 inches; it is then grouted with thin hot lime, just enough to bind the gravel together, and afterwards rammed quite hard. Course after course must then be laid, and so treated, till the mass reaches within about 6 inches of the ground line. The proportion of hot lime to the gravel is about one-eighth part only. Others use lime in the proportion of one to five of loamy gravel, but much depends on the quality of the lime. In countries where gravel is not common, dry brick rubbish, broken stones, flints, or any material that will bind into one mass, will answer."—*Architectural Magazine*, vol. i. p. 284.

A better plan, however, is to mix the concrete on the surface in convenient-sized heaps, and to erect a scaffolding, so that the concrete may be carried in hods, or wheeled up to the platform in barrows, and thrown into the trench from a height of 8 or 10 feet, and merely levelled on the surface, to prepare it for the first course of bricks. Falling from this height consolidates the mass better than ramming it, as above recommended. Where the soil is loose, or where the foundation is to be above the surface-level, a framework of strong planking should be provided, in the form of a trough, 30, 40, or more feet in length, and of the depth and breadth required for the foundation. In a day or two these planks may be removed, and carried forward until the whole is completed. When the concrete is fully set, the operation of building on it may be commenced.

The concrete employed for the foundations of the Crystal Palace was composed of large stones mixed with one-

seventh of sand, and one-seventh of lime, the whole being incorporated with a sufficient quantity of water.

As an illustration of the economy of this kind of foundation, a rood of work can be done in most localities for less than £4—a price much below even that generally charged for common rubble.—*(Vide ESTIMATES AND PRICES.)*

### § 3.—MATERIALS FOR GARDEN WALLS.

Of all materials, bricks are unquestionably the best, as they are warmer and more convenient for training trees upon than any other. They are also, if the bricks are well burned, equally durable, if not more so, than stone, and admit of being built hollow, for the purpose of being heated either by hot-water pipes, tanks, or smoke flues; while, at the same time, even when the duty on bricks was considerable, walls of them could be built cheaper than of common rubble stone. Forsyth, in "Treatise on Fruit Trees," (p. 325,) goes so far as to say, "Where brick cannot be got, it is better to dispense with walls altogether, or to adopt wooden ones." Much as we prefer brick walls, we must protest against this opinion, as many excellent walls have been built of stone, and useful ones of various other materials.

In England, garden walls are usually of brick—that article being the common building material: in Scotland, of brick, and often of stone, as the latter is the material natural to the country. Out of Britain fine garden walls are not to be found—for even the brick ones on the Continent are very inferior, both in material and workmanship, to our own. The celebrated vine and peach walls at Thomery, described in the "Pomona Française," were long built of mud plastered over; but, some years ago, stone walls built with mud as a substitute for lime mortar, and even stone walls laid dry, after the manner of the "stone dykes" for enclosing fields in Scotland, were substituted in their place; a circumstance which proves two facts—namely, the greater wealth of Britain, and the small importance attached to walls in France, so far as the ripening of the fruit is concerned.

Hollow bricks are an improvement which will be noticed elsewhere. They are one of the advantages which have been derived from the removal of the excise duty on this material. They may now be manufactured of any size, and, by the addition of fire-clay, be made to resemble stone ashlar. Composition bricks, formed of common clay, fire-clay, and pounded iron-stone, when thoroughly burned, are the most durable of any; and, from their close texture, they are incapable of absorbing more than a very small quantity of water: hence, next to dark-coloured whinstone, they are the most durable and warmest of any.

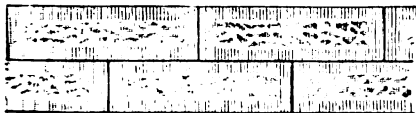
Dark-coloured whinstone (the greenstone and basalt of mineralogists) is considered by Nicol the best material next to brick. In the gardens of the Caledonian Horticultural Society of Scotland are specimens of stone walls of various kinds. Of these, we believe the general opinion is in favour of the dark whinstone, as it absorbs and retains heat more than any other, by reason of its near approach to black, and of its close texture or grain, causing it to repel moisture better, or rather to retain it less, than any other stone.

Subsequent experiments in the same garden led to the following results as regards a sloping wall inclined to the horizon at an angle of about 50°, a wall coloured black, and a perpendicular wall, and also as between perpendicular walls of freestone, whinstone, and brick. The sloping, the black, and the freestone walls indicated the same temperature at six o'clock in the evening; the average of the brick wall at that hour was a degree lower during the month of April. This wall, however, being more porous, and retaining a greater quantity of heat, showed during the month of May a considerably higher temperature than any of the others—owing, of course, to the increased influence of the sun. We suspect, however, another cause for this increase of heat—namely, the month of May being a dry month, less moisture was probably absorbed than in the previous or after months. The average temperature of the sloping wall at one o'clock in the afternoon was 7° higher than that of the brick wall. The dark-coloured whinstone, (basalt,) at the same hour, was only 3° lower

than the sloping wall: the freestone, at the same hour, 5° colder than the sloping wall, or 2° below the whinstone. At six in the afternoon the sloping wall was 2° warmer than the freestone and brick walls, and 5° warmer than the whinstone wall, which at this hour was found to be the coldest of all. During frosty weather, and when hoar-frost forms, the sloping wall becomes 2° or 3° colder during the night than any of the others. These experiments are the result of calculations by the thermometer. It would be equally interesting to have a statement of the periods of fruit ripened from the same walls, taking the same year.

The best stone walls are those that are built in regular courses; but these courses should not exceed 9 inches in thickness, nor be less than 3, the thickness of an ordinary brick. The stones should be squared and hammer-dressed, or picked—a way of dressing the surface with a pick or pointed end of a hammer; or they may be done in broached ashlar, with droved margins, (or draughted and broached)—that is, wrought round the joints with a chisel, about three-fourths of an inch on the face, and the remaining part of the face, roughly done with the pick, as in fig. 39. This style of building

Fig. 39.



makes beautiful walls, particularly if the mortar joints are properly pointed and drawn clean off.

The following materials are more or less used for garden walls; but as they will be noticed more in detail in their respective places, we shall only enumerate them here—concrete, clay, slate, wood, pavement, iron plates, reeds, flints, scoria, and latterly glass.

#### § 4.—COPINGS FOR GARDEN WALLS.

Great difference of opinion exists as to the benefits derived from projecting copings. We believe that the majority agree with us in preferring them to be of a portable description, as their presence

is as great a benefit during spring as it would be injurious during summer. All walls require to be coped sufficiently to exclude the wet from penetrating into them, as much as a house requires to be thoroughly roofed. This is, we believe, admitted by all. The extent of projection is the question at issue.

The advantage is admitted by Leslie in art. "Cold," *Encyc. Brit.*, Wells "On Dew," &c. The Comte Lelieur, and most of the French cultivators and writers, approve of projections nearly a foot in breadth—most of which, however, are permanent—and that on walls not exceeding 10 feet in height. At Montreuil, and most of the celebrated peach gardens round Paris, the projection is from 4 to 5 inches; and, according to "The Pomona Française," on the walls at Thomery, where the finest grapes are grown, the copings project 9 or 10 inches over walls which do not exceed 8 feet in height.

Lawrence, Millar, Forsyth, Atkinson, Nicol, &c., recommend portable copings, as tending to protect the blossom in spring, which are to be removed in summer, as they would then be injurious by excluding rain, light, and air.

We may safely conclude that portable copings are preferable to permanent ones, so far as protection to the trees is concerned, and that their utility is not only confined to spring, but embraces autumn also. The following suitable remarks on this subject by Mr Errington, in "Gardeners' Chronicle," 1846, (p. 821,) although not quite in accordance with our own experience, are deserving of especial attention, as coming from so excellent a source. "The benefits of copings in September and October," he says, "are perhaps even greater than in spring. I think it would not be asserting too much to say, that at that period alone, in effect, they add a fortnight to the length of our summer; or, in other words, they produce results equivalent to a fortnight's fine weather. The rationale of these operations is," he thinks, "the interception of radiation. Be that as it may, a wall with a good coping will be found warmer after sunset, for some hours, than one without a coping. The objections in point of excluding the dews and rains are of no weight, as it is quite

certain that first-rate fruit is, and has been, produced under copings. For my own part, I am disposed to look on a wall wet with rain in the summer as a disadvantage rather than otherwise, such being a robber of heat, which can be ill spared, more especially in peach walls. With regard to the width of copings," he thinks "that from 7 to 9 inches at the least should be provided; and if twice that width in the months of April and May, it would be a benefit. One-half of this entire width should be movable at pleasure, and might be composed of boards on brackets."

The permanent copings in some parts of the gardens at Dalkeith project only half an inch over the walls; but this is of less consequence there, from the very limited quantity of rain that falls in our locality. It arose from the circumstance that, the copings of the former garden having been in a good state, we were induced to use them on the walls of the new garden; and as the latter are built hollow, for the purpose of heating them by hot-water pipes, they are somewhat broader than the old ones were. We would not, however, have given more than 2 inches on each side of a projection, had we used new coping instead. We may here, however, remark, that on

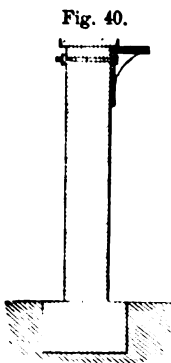


Fig. 40.

the western coast, where the rain falls in great quantity, we would recommend permanent copings, from 4 to 6 inches in breadth. The portable coping used by us under these circumstances is boarding 9 inches broad, supported on iron brackets, fig. 40, fixed in the wall, to which the boards are secured by screws. The brackets used in the

London Horticultural Society's garden, fig. 41, are also permanent, for the support of similar portable copings; but, as our diagram will show, they incline considerably, in order more effectually to throw off the water. The best material for copings is decidedly stone



Fig. 41.

pavement; and the longer each piece is, the fewer joints there will be. For the mere preservation of the wall, a projection of 2 inches on each side will be sufficient. The pavement may be of any thickness, from 2 to 6 inches, the joints half checked, and jointed with white lead or mastic, and the under edge of the projection throttled—that is, having a groove about a quarter of an inch deep, and as much in breadth, running the whole length, for the purpose of causing the water that falls on the top to drip clear of the wall. To render the coping still more secure—as we have done in the walls at Dalkeith—they may be batted together near the outer edges with leaden instead of iron bats.

As regards the thickness of copings, we may remark that heavy copings—say 6 inches thick—are no doubt the best for the wall, as their weight keeps it more steady; but then they have too massive an appearance, unless the wall is above the average height, and of an architectural character. Copings under 2 inches in thickness, although they will keep the wall as dry, have a meagre appearance, and add little or nothing to its stability, unless cast-iron coping, afterwards to be noticed, is used.

Caithness pavement is the best stone this country affords for coping walls. It is naturally flat, hard, and tenacious, standing all weathers. It can be got from one quarter of an inch to three inches and a half in thickness; and becomes so hard that masons' irons can scarcely cut it after being exposed to the weather; but it saws easily, when newly quarried, and, from being truly flat by nature, requires no dressing for ordinary purposes, but only to be cut square with a saw when first taken out of the quarry. To purchase it to advantage, the dimensions wanted should be sent to the purveyor, where it will be cut to the size required, and even dressed to a uniform thickness. When used for slabs or pavement for conservatory floors, it may be polished by the stones being rubbed against one another; and, when finished and oiled, it looks as well as Tourney marble. It stands the heat equally well, and hence is well adapted for flues—as proved by the late Sir John Robison, who heated a portion of this

stone red hot, and quenched it in cold water, without its cracking or appearing to lose its peculiar tenacity. As regards cost, we have purchased many thousand feet at fourpence-halfpenny to fivepence per square foot: it may be procured in lengths of six feet and upwards.

Arbroath pavement, and also Hailes, are excellent for this purpose; but as both need the operation of the chisel, they become far more expensive, from the labour they require.

Earthenware copings—that is, bricks of various forms and lengths—are often used where stones are expensive, and even common-sized bricks laid along the top as headers, projecting 2 or 3 inches over the face of the wall on both sides, and kept down by a third course laid over their inner ends. Now that the manufacturer is allowed to make his bricks of any form or size he pleases, very durable copings are made of considerable dimensions. The only objections to these large bricks is the difficulty of getting them straight out of the kiln; and the larger they are, the more liable are they to become crooked.

Slates have been used, and, when sufficiently thick, make a neat and desirable coping. They may be procured from the Bangor and other quarries in Wales, Ireland, and Cornwall, in lengths of 6 or 7 feet, from 1 to 3 or 4 inches thick, and of any required breadth. We know of no material more durable, and of so elegant an appearance as these. They have been in use as copings in the gardens at Ashted Park in Surrey, and elsewhere, for upwards of half a century.

Roman cement has been much used; but it is better adapted for the climate of London than that of Scotland, and, unless properly tempered and laid on, it will not be satisfactory. Copings made of it require to rise considerably in the centre, to allow the water to pass freely off.

Both plain and pan tiles have been used for coping walls, but neither have a neat or substantial appearance; and they are liable to be displaced by high winds.

In many parts of the south of England—and we have observed the same on the Continent—the coping of walls is formed of straw thatch, and made to project, even over low walls, 10 or 12 inches.

Where stone copings are used, they should be  $3\frac{1}{2}$  or 4 inches thick at the centre, and not less than 2 at the plinth, being bevelled off to either side on the upper surface, so that the rain that falls on the wall may be equally divided, and not thrown all to one side, as has been erroneously recommended. On this part of the subject Nicol judiciously remarks: "It may be right to throw the whole of the water to the side not covered with fruit trees; but it is wrong to throw it all to the worst aspect, if that aspect be planted; but doubly disadvantageous to the trees placed on it, if there be any disadvantage in the rains falling upon them—which, indeed, is questionable, except perhaps just when the fruit is ripening off. The quantity of rain that falls on an ordinary wall is but trifling; and if even a light breeze of wind prevail at the time, it is generally dashed against the foliage in dripping, is scattered and dissipated. In short, it is quite as well for the trees that there be no projection at all, if the coping be fixed." As regards the protection of the wall, considered merely as such, a projection of 1 inch is as good as a foot. Many builders think otherwise; but experience and observation have convinced us to the contrary. Hence very good copings are made of hammer-dressed stones, set on edge—a plan generally adopted in the case of park walls.

Lead has been used, and, so far as keeping the roof of the wall dry, nothing can be better; but in the case of lead, projections must be dispensed with, as well on the ground of expense as of the effect which a coping of 2 or more inches in thickness gives to walls, and which of course cannot be given with lead.

Asphalte—a preparation of comparatively modern invention—has been tried for wall coping, and found to answer the purpose completely. It requires to be laid on in a semi-fluid state while warm; therefore a boarded frame must be arranged on the top of the wall, to give the asphalte the necessary form.

Glass copings—the most indestructible of all materials—will, we have no doubt, ere long be brought into use. The coarser qualities of this imperishable article may be procured in lengths of 6 or 8 feet, and of any reasonable breadth, and in thick-

ness of from half an inch and upwards. If laid on a solid bed of mortar or cement, it will last for ages.

Cast-iron copings may be advantageously employed where stone is expensive; and next to Caithness pavement, slate, and glass, they will prove the most durable of all. Such copings should be cast in pieces from 4 to 5 feet in length and half an inch in thickness, having a flange, as shown in fig. 42, cast on both edges of their under surfaces, of a depth equal to the thickness of an ordinary brick. Where no projection is desired, they should be cast to the exact thickness of the wall: laid on a bed of mortar, they will keep the wall perfectly dry, as well as retain the upper course of bricks in their proper place. When a projection is to be used, then the last course of bricks should be laid so as to project over both bases of the wall, say from 2 to 4 inches. The plates are then, in such cases, to be cast of a corresponding breadth. If the edge of the flanges hang down one-fourth of an inch below the brick, the drip will fall clear of the wall.

Cast-iron plates, enamelled with glass on all sides, as exemplified in the recent improvement, by the same process, in the case of pipes for conveying water, are likely also to be employed, under certain conditions, for this purpose. Their form and manner of setting on should be the same as the above.

On the utility of copings, the following reasonable remarks are made by a correspondent in the "Gardeners' Chronicle":—"The object sought to be attained by planting trees against a wall is to accelerate their growth, so as to enable them to mature their fruit-bearing wood, and afterwards, by the aid of the increased heat and shelter which the wall affords, to stimulate them to produce fruit that shall be of a superior size and excellence. It is worthy of remark, however, that it is not always the trees most favourably situated in these respects that are the most healthy and fruitful; on the contrary, we often find them more liable to disease and the attacks of insects. The cause of this may be sometimes owing to the soil, but it may possibly also proceed

from the coping being made to project farther than it ought—in consequence of which the leaves are deprived of the advantages they would obtain, during the growing season, from the genial rains of the day or the heavy dews of night. Some persons argue that, unless the copings project so far as to carry off the drip from the trees, they are worse than useless. Others contend for a coping that shall only project one or two inches; and a few have advocated copings of a foot or more in width. Between these opinions it is difficult for one who is not conversant with such matters to determine which plan is the best. Were he to adopt the practice usually followed in cases of doubt, and choose a middle course, it might happen, in doing so, he had committed as great an error in fixing on a coping of 6 inches, as on one a foot wide. So far as our experience goes, we believe that the advantages of a wide coping have been much overrated, and that the drip which falls on the trees from a narrow one is not by any means so injurious as has been imagined. We admit that in spring, when the trees are in blossom, a wide coping may be useful, but it ought to be temporary, and

removable immediately after the fruit is fairly set. The accompanying sketches may serve the purpose of drawing attention to the subject. Fig. 43 we consider one of the worst copings for a garden wall that can be used; although, no doubt, excellent crops have been grown under such a structure. The harbour it affords to all sorts of ver-

min is a great objection to it. Fig. 44 is the sort of coping in general use where stone or slate is plentiful. It answers the purpose effectually, if care be taken to keep the joints well filled with cement. A small groove underneath the edge would be an improvement. In fact, no coping can be said to be complete without a groove, or some other contrivance, to prevent the water from running down the wall."

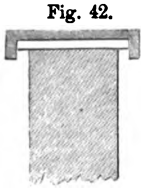


Fig. 42.

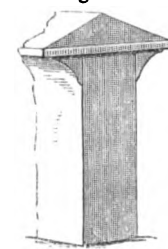


Fig. 43.

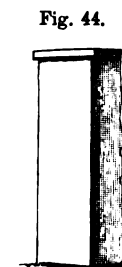


Fig. 44.

Fig. 45 "is probably the most common way in which garden walls are coped ;

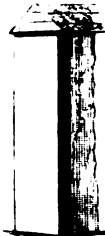
Fig. 45.



and, when well done, it will stand for many years, provided the bricks are laid in cement. To obviate the necessity of a groove in this case, the inner end of the bricks is to be bedded a little thicker, so as to cause them to incline outwards, but not so much as to cause this to be observable, unless to the practised eye."

Fig. 46 "is a mode of coping frequently resorted to where stone or large slate cannot be obtained ; and it answers very well. A thin wall plate of wood is laid along the edge, to secure the first row of slate. The middle of the wall is then ridged up with small pieces of stone and lime, into which the other rows of slate," or plain tiles, "are made fast by small wooden pins, and the whole secured by a row of tiles on the

Fig. 46.



ridge ; the latter are sometimes coloured to imitate slate, or coated with coal tar."

Fig. 47 "is one of the best forms of coping, and may be either of stone or cement. The latter is the cheapest, and may be moulded to various forms by an experienced workman. If the materials are good, and the right proportions of sand and cement used, a coping of this kind will last a number of years, and successfully resist the action of the weather. Several moulds of the proper length and shape are first prepared. A certain

Fig. 47.



portion of cement and sharp fresh-water sand is then wetted up and thoroughly incorporated, no more being made at one time than is considered sufficient to fill one of the moulds. The mould, before using, must be completely coated with oil. A layer of cement is then spread equally over it, in which two or three flat tiles are placed across and embedded. Some more cement is added, and a couple of tiles placed lengthways along the middle, for the purpose of strengthening it, as well as to save the cement. The

whole is then filled with the remainder of the cement, and smoothed off. In a few minutes it hardens sufficiently to be knocked out of the mould, and is afterwards placed on a level airy spot until it is dry. This was the late Mr Atkinson's plan, and is that in use in the gardens of the Horticultural Society."

On the subject of projecting copings for fruit-tree walls, we have the following reasoning and proposed substitute by Mr Archibald Gorrie, certainly the most scientific resident gardener Scotland can boast of. After alluding to the undecided state of opinions on this subject, he proceeds:—"On the other hand, however, it must be conceded, that garden walls are generally built for affording a higher temperature, in order to raise the finer fruits, natives of warmer climates. It is also well known that the earth radiates heat in the night-time, and under a clear and still atmosphere ; as any substance that intercepts the escape of such radiated heat into the blue expanse, adds considerably to the elevation of the temperature on the lower side of that substance compared with that indicated on its upper surface. Whether this proceeds from the 'frigorific rays' being arrested in their downward course, according to some who insist that cold is a body, or from radiated heat being arrested and returned to the earth's surface, by projecting coping or other substance : be the cause which, or what it may, few, I believe, of my brethren, in this intellectual age, are so unscientific as to deny the result. Taking it for granted, then, that in clear and calm nights projecting copings preserve a greater degree of heat on the surface of the wall and border immediately under that coping, and that the difference of temperature in favour of a projecting cope may vary from four to eleven degrees, according to circumstances, it will readily be conceded that, in this variable and cold climate, the advantage afforded by a projecting cope should not be rejected. This granted, the question now occurs—how are its objectionable parts to be done away with? The expense of an 18-inch projecting cope is of itself no joke, and adds considerably to the estimate of building a new garden wall ; and, after that expense has been incurred, there is an appearance of gloom and heaviness ill adapted



to the light and natural appearance which should always characterise a garden."

From observing the advantage of the protection afforded by the leaves of a fig tree to a peach tree under it, our intelligent authority turned his attention "in quest of some ornamental plant which might be trained on a light trellis from the ground upward to the top of the wall, at right angles from the wall, and occupying the same breadth across the border as the trellised projection at top; the supporting trellis to stand at the extremities of the shoots of the peach and other tender fruit trees, or at equal distances from their stems." The plant Mr Gorrie fixed on for this purpose was the double Ayrshire rose. "Its rapid growth points it out as giving effect in the shortest time; its deciduous nature leaves both projecting and side trellises open in winter, to admit of the larvæ (grubs) and ova (eggs) of insects being swept off by the broom, or subjected to the chilling blasts of December, and exposes the young wood to the full play of the wind, at a season when cold acts as a stimulus, and promotes the future rapid energy of vegetation in spring."—"The leaves of this rose tree expand early in spring, when their aid is wanted in exposed situations; and where plants of it are trained on side trellises, they contribute to produce a calm serenity along the face of the wall, while those on the projecting trellis become sufficiently close for repelling terrestrial radiated heat, and throwing it back on the wall and border; thus, in both instances, contributing towards the protection of the tender blossoms, and the setting and maturity of the fruit. The force of dashing rains is modified by the projecting cope, while they are allowed to fall on the foliage in gentle and refreshing showers, as filtered through the projecting live cope—a cope which can easily be rendered close or open according to the wish or fancy of the gardener; and which, in point of taste, utility, cheapness, and elegance, can never be matched by the clumsy projections of wood or stone."—*Gardeners' Magazine*. We make this long quotation because it contains much of the philosophy of the subject.

The *Aristolochia sipho*, *Ampelopsis hedera*, and other rapid growing deciduous

runners, might be used for the same purpose, and while they afforded shelter during the growing season, would leave the trees exposed to the action of the atmosphere during winter.

Horizontal shelters were strongly recommended by Lawrence, one of our oldest authors on gardening, as a protection against perpendicular frosts, and hence he suggested building in thin tiles in parallel rows along the face of the wall, leaving spaces between them for allowing the branches to pass through. The same object might be attained by employing portable wooden shelters kept 2 or 3 inches from the wall, excepting the topmost one, which should be laid close to it. These protections need be no other than long boards, 6 inches broad, placed about 3 feet apart, and laid upon, and fastened to, permanent iron studs driven into the wall. The boarding to be removed when danger of frosts is past.

#### § 5.—TRELLISED GARDEN WALLS.

"Walls are often trellised, particularly hot walls, and also mud, flint, and stone walls—the former to protect the branches from excessive heat, and the latter to facilitate the training of the trees," and preservation of the walls. "In Holland and France this practice is very prevalent, and such trellises are usually formed of spars of wood. Of late years the use of iron and copper has become so very general, that even the whole

Fig. 48.



Fig. 49.



extent of some garden walls is trellised with wire of these metals. Wire of one-sixteenth of an inch in diameter is considered a good size, although some use it much stronger. These wires are stretched horizontally—in some cases vertically—at from 6 to 15 inches apart, according to the sort of tree to be trained. The wire is fastened to the wall by cast-iron or copper nails, with eyes," as in the annexed sketches, figs. 48, 49, "which are either built in when the wall is made, or driven in afterwards. Many advantages are attributed to the practice of

trellising walls—amongst which may be stated, the preservation of the wall, the greater uniformity of heat to the branches, the almost impossibility of insects finding shelter, and the economy of time in arranging the branches. As a substitute for trellised walls, when the preservation of the wall is a consideration, many, "and ourselves amongst the number, "use studs, or eyed nails," similar to those figured above, "projecting about half an inch from the wall; to these studs the branches are fastened" (Practical Gardener, 2d edition, p. 41) by passing twine, after being saturated with pyroligneous acid, through the eyes. The old system of using shreds and nails should be abandoned, as not only extremely destructive to the wall, but as incurring an unnecessary annual expense in the purchase of nails and shreds, as well as affording shelter for insects, and an excellent nest for them to lay their eggs in. The constant practice of driving in nails by the thousand, and pulling them out again, is most destructive to a wall, and tends more than anything else to bring it to decay. These eyed studs cost very little, if more than the common cast-iron wall nails in ordinary use. They are driven in, if in a new wall, before the mortar becomes fully set; and if in an old wall, at any time as the trees advance to require them. They should be set in lines, and *always in the joints, never in the bricks*, and at distances apart according to the kind of tree to be secured to them. When once in, they do not require to be ever removed; and should, as will sometimes occur, any of them come in contact with the larger branches, they are easily broken off close to the wall by the use of a blunt chisel and hammer. All the walls at Dalkeith are furnished with them, as well as many gardens where we have been consulted.

Trellised walls are much used in France; but this appears to be for the purpose of moderating the excessive heat during the day: with us, the heat is not so great as to require such a precaution. Indeed, experience seems to prove that the practice is rather injurious than beneficial, while the expense of trellising a wall with either galvanised iron or copper wire is very considerable. The best mode of construction, however, is

to secure upright wrought-iron bars to the wall by bats  $1\frac{1}{2}$  inch in breadth, at a distance of from 6 to 8 feet apart, these uprights being perforated with holes 9 inches apart for peaches, and 12 inches for other fruit trees. The wires are drawn through them in a horizontal direction, and firmly secured at the extreme ends with nuts and screws. The cost of trellising a wall in this manner, if under 10 feet in height, will be from eight to ten shillings per lineal yard.—(Vide ESTIMATES and PRICES.)

One objection to iron wire for such purposes is its liability to rust; and although much has been said in favour of galvanised iron and paints of various kinds, we confess we have our doubts as to the efficiency of either the one or the other. A preparation has been used by Dr O'Shaughnessy for coating the Indian telegraph wires with, which we think deserves attention in this country for coating all sorts of exposed iron-work, as it is not only cheap, but is said on good authority to have resisted the heat and damp atmosphere of India. It is made by boiling one-fourth of resin with three-fourths of fine sand. As soon as the composition becomes cool, it is as hard as a stone.—(For other modes of protecting iron, vide PRINCIPLES of HOTHOUSE BUILDING.)

### § 6.—HEIGHT OF GARDEN WALLS.

The majority of opinions upon this subject are in favour of walls from 10 to 12 feet high. Some, however, advocate them being much higher; while others contend for their being below the last of these heights. Our own opinion is, that 10-foot walls for a garden of from 2 to 3 acres' extent are sufficient, and that 12-foot walls are sufficient for gardens of the largest size. In conformity with this opinion, we have built the principal walls at Dalkeith exactly 12 feet high—except, of course, such as have hothouses built against them—and the secondary or surrounding walls from 8 to 10 feet. It is always better to extend the walls in length, than to lessen the length by increasing the height.

Nicol, one of our best garden architects, after approving of their being from

10 to 12 feet, says "that height being very convenient for the operations of pruning, watering, gathering the fruit, &c., and admitting of a sufficient expansion of the branches of most trees. But the height of garden walls should be regulated by the extent, or by the apparent extent, of the ground enclosed by them. The apparent extent is mentioned as well as the real extent, because it often depends on the form and cast of the ground in how much the eye shall be pleased. If it be a square, it will seem less than it really is, and, if a lengthened parallelogram, larger; and, according to its flatness or its elevation, the eye will be deceived.

"A small spot surrounded by high walls has a bad effect and a gloomy appearance. The walls being of different heights gives relief. In a garden of an acre, being a parallelogram of the best proportion, and gently elevated, the north wall may be raised to the height of 14 feet; the east and west walls to 12, and the south wall to 10 feet above the ground-level. If the ground slope considerably, the breakings in the respective heights of the walls will be less—they may be only a foot; and the relief will be the same, or nearly the same, to the eye, in ranging along their surfaces. In a garden of greater extent, the walls may be raised to a greater height; but by no means in proportion, if it extend to several acres. The extreme height of the north wall of any garden should never exceed 18 feet; and containing, suppose 4 acres, the east and west walls should be 15, and the south wall only 12 feet high, in order that it may give the necessary relief to the eye. In a garden 400 feet long, and 300 feet broad, which forms a handsome parallelogram, and contains something above two English acres, if the ground lie on an easy slope, a very eligible height for the north wall is 16 feet; for the east and west walls, 14; and for the south wall, 12. But if the ground be quite level, or nearly so, the north wall being the same height, the east and west walls should be only 13½ feet, and the south wall 11 feet in height; or the east and west walls may only be 13, and the south wall 10 feet high, if it be a dead level."

Hothouses being in general built against

the north wall, it follows that its height should be regulated by them; but in gardens where there are no hothouses, we see no reason why a greater height than 12 feet should be indulged in.

Rogers, in his excellent work on Fruit Trees, p. 136, says:—"Low walls are much more convenient in the management of the trees than those requiring ladders to perform the necessary operations; and all fruit trees extending horizontally are for the most part more fertile, and certainly easier defended, and under more control, than if trained upright, and high out of reach; so that two walls 6 feet in height, with trees planted at good distances from each other, will yield, during any term of years, much more fruit than one wall 12 feet in height. Besides, high walls are by no means necessary for the crops of either a fruit or kitchen garden. A free ventilation is necessary at all times. The effects of high winds are much less to be dreaded than those of foul stagnated air, pent up all round with lofty walls."

#### § 7.—ARRANGING WALLS TO SUIT VARIOUS SITUATIONS.

Where the ground is level, or falling gradually to the south, little more is required than to erect the walls so that their coping may run parallel to the ground surface, and in such cases the proportions given in the last article will suffice; for it is of great consequence to the good effect of the garden, when finished, that the walls be arranged to suit the cast of the ground. On this subject Nicol makes the following judicious remarks: "In designing and laying out a modern garden, a degree of taste, as well as of fitness or propriety, ought to be displayed—the basis of which is the right placing, proportioning, and constructing of the walls. If these be properly set down, so as to answer the cast of the ground, and be raised to proper heights, according to its extent, the rest is easy, and follows as a matter of course.

"In this particular branch of gardening, utility and simplicity ought to go hand in hand, otherwise true taste will

be wanting. It is not in curves, circles, and ogees, we shall find satisfaction. The walls, if the ground will admit of it, should all run in direct lines. They may be built level, or they may be inclined, so as to suit the general cast of the ground; but the nearer to a level, the better they will please. The eye is distracted, and the idea totters, in beholding any building apparently unstable. We can look upon a mast placed oblique, or on a tree growing aslant, with firmness and satisfaction, because we know the one is supported by ropes, and the other by roots; but on a wall running much off the level, we look with a degree of distrust and fear."

After some remarks regarding shelter and situation, he proceeds: "If the north wall can be placed quite level, and also the south wall on a lower level, and so as that the east and west walls shall fall from north to south a foot in thirty, or in twenty-five—and if the ground be lengthened from east to west in the proportion of three to two, the extent being 2 or 3 acres—on such a spot may be erected a garden that will not fail to please.

"Next, on a spot of the above, or of similar dimensions, sloping so to the south, and not level from east to west, but sloping a few feet (perhaps one in fifty) to the east—in this case the walls should run directly parallel to each other, both with respect to latitude and to inclination; otherwise the eye will be displeased with the distorted appearance of the coping when at the full height. Next, all as here described, and the ground sloping to the south and to the west; and next a dead level spot,—in which case particularly the walls should be of different heights. But ground falling to the north, or very much distorted, should be avoided, as being very unfit for erecting walls or other buildings upon: on which a complete modern garden cannot be formed, without considerable difficulty and a great additional expense.

"In all cases, the wall should be free and open, especially the south, east, and west walls, that they may be covered on both sides with fruit trees. They are erected at a very considerable expense—and why should a yard of their surfaces be lost? They should be sheltered by distant

plantations, if the ground be not naturally sheltered, and may very properly be surrounded by shrubbery or standard fruit trees, provided these do not come too near them, or shade them from the sun. If a clear border and walk, the breadth of 20 or 30 feet, intervene between the wall and the shrubbery, the trees planted against them will be sufficiently free and exposed."

Many large and excellent gardens, it must be admitted, could be instanced where no regard has been paid to the above rules, but which have been enclosed with walls, without regard to straight lines or parallel heights. These, however, are not models to copy from, but to avoid, if the object is to have a symmetrical garden claiming any pretension to artistic taste. Nor can such gardens have the same appearance of order and design as those where the rules of art have been attended to. There is an exception, however, to this rule—namely, as regards gardens of irregular outline and greatly diversified undulation of surface. The walls in such cases should run so as to accord with the general lie of the ground; and of such gardens there are many excellent examples.

### § 8.—COLOUR OF GARDEN WALLS.

Walls are in general left of the colour of the materials of which they are composed. It appears, however, by experiments repeatedly made, that dark-coloured walls absorb and radiate more heat than those of any other colour, and hence are supposed to accelerate the ripening of fruit grown against them somewhat sooner. The property of a black colour to absorb and radiate heat is undeniable: whether, however, blacking walls, when completely covered with the branches and foliage of trees, is likely to have much effect on the fruit, is, we confess, a refinement in gardening we have never been able to feel very fully satisfied regarding.

On this subject we extract the following answer to a correspondent in "The Gardeners' Chronicle," 1842, (p. 161): "The quantity of solar heat absorbed and reflected must together be the same, whatever the colour of the materials may

be, all other circumstances being equal. A dark-coloured wall absorbs more, and reflects less, than a light-coloured one; but in the case of either dark or light coloured, the amount of heating rays impinging on them is the same. Reflected solar rays, being of less intensity than those that are direct, do not scorch the bark of trees; and with still less reason can such an effect be attributed to the gradual radiation of heat from your blackened wall. Direct solar rays will raise a thermometer, placed against a south wall, as much as 100° Fahr. above the freezing-point, and the exposed parts only of naked stems are frequently injured. The parts of such stems as are next the wall, and consequently most exposed to its radiation, have not been noticed to be injured, so far, at least, as our observations have extended: nor is it likely; for the heat from this source will rarely, if ever, be equal to 50° above the freezing-point, or half as much as that occasioned by direct solar rays." It clearly appears that the colour of walls is practically of no importance whatever, although in theory it may seem to be so. The best colour, therefore, is that of well burned bricks for new walls, and that of Mulgrave cement for such old ones as have been repaired.

"The radiation during night and in cloudy weather," says Loudon, "is in proportion to the absorption during sunshine; the one operation neutralises the other. If, indeed, we could insure a powerful absorption from a bright sun during the day, and retain the radiation by a canvass or other screen during the night, a considerable increase of temperature might probably be the result; but the number of cloudy days in our climate, in proportion to those of bright sunshine, is not favourable to such an experiment. White walls will heat the air around the leaves most through the day, from reflection, as these are seldom close to the wall; and the extreme cold will not be so great at night, which is most dangerous. Black-coloured walls, though they absorb heat during the day, will not retain it to give off at night, as it will be conducted through the wall, in great part, during the day, and any little retained be speedily radiated off in the early part of the night." If there be any

colour worse than another, it is certainly that of cherry red bricks, possessing in themselves no extra property of absorbing heat from the sun, and of all colours harmonising least with the surrounding scenery. The nearer, therefore, bricks are brought to a subdued stone colour—and this can be readily done in the making—so much the better. It was long supposed that colour had great influence on radiation and absorption. By exposing variously coloured surfaces to the heat of the sun, their absorbing power was found to be in the following order—black, blue, green, red, yellow, and white. Hence it would naturally be expected, that the radiating powers of differently coloured bodies would be in this order, and that by painting a body of a dark colour we should increase its radiating power. Such, however, is not the case—for the absorption and radiation of *simple heat*, or *heat without light*, depends on the nature of the surface rather than on colour. Heat of low temperature, or that which proceeds from bodies at a low temperature, becomes less connected with colour the lower the temperature. Hence sun heat, which is at a low temperature in northern latitudes, can have little greater effect on a dark-coloured wall than on walls of other colours.

#### § 9.—CONSTRUCTION OF GARDEN WALLS.

Garden walls are variously constructed with a view to economy, utility, and effect—as the following examples will sufficiently show.

*The solid brick wall.*—This is the most common as well as the simplest of all walls; and where the height does not exceed 6 or 7 feet, 9 inches—that is, the length of a common brick—will suffice for the thickness, this being found sufficiently strong without the aid of piers. When from 7 to 12 feet in height, 14 inches—that is, the length of one brick and breadth of another—will be required; walls of greater height ought to be 18 inches thick, or the length of two bricks. Such walls are found to be sufficiently strong even when hothouses are built against them, as they have a resisting support from the necessary sheds and

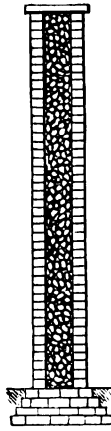
offices behind. The great objection to 9-inch walls is, that both sides cannot be wrought fair—in other words, both surfaces will not be even. This arises from difference in the length of the bricks; for although all are cast in the same mould, yet, from some contracting more than others during the process of drying and burning, a difference of half an inch often takes place in their length. This might to a certain extent be remedied by selecting those to be used as headers, that is, those which are laid lengthways across the wall; the others, of greater or less length, could be used as stretchers, or such as are laid lengthways on the wall. It may be argued that bats, or half or broken bricks, might be used, as both ends could be laid, so as to be fair on both sides; but the bond or tying together of the wall, which is the real use of the headers, would not be effected, and consequently the strength of the wall would be greatly lessened. 9-inch walls are all very well when only one side is to be wrought fair, as against banks, in the case of ha-ha's, &c. 9-inch hollow walls may be wrought fair on both sides, but not with common bricks, as will be noticed hereafter.

It ought to be remarked here, that the English brick is about  $8\frac{3}{4}$  inches long, though generally called 9 inches; whereas the Scottish brick is 10 inches long, and hence such walls are in Scotland called 10-inch walls. But since the duty has been taken off bricks, they may be made of any size; and, consequently, the thickness of walls ought not to be calculated by inches, but by bricks and half bricks, according to their size.

*The solid brick and concrete wall, fig. 50.*—This method of construction is often adopted to economise bricks, and is as follows: The sides are carried up brick on bed, and, whatever thickness is intended, the space between is filled up with rough gravel, stone chips, broken brick-bats, or any dry, hard material. As the building goes on, thin hot lime grouting is poured into the heart of the wall till all the spaces between the packing are completely filled. This adheres to the side brickwork, and cements the whole together into one solid mass. Some bricklayers run in headers, or bricks laid across the wall, with a view to tie the

sides together, at distances of a few feet apart; but this is quite unnecessary, the

Fig. 50.



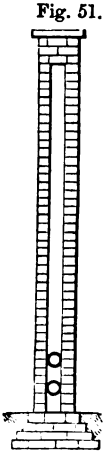
strong adhesion of the grouting to the inner sides of the bricks being quite sufficient. Where walls are put up to suit temporary purposes, this plan should not be adopted, as it is almost impossible to separate the bricks from each other after the concrete has become fully set. By this plan it will readily be seen that a great saving of bricks is effected. For example, a 14-inch wall, built solid, requires 3620 bricks per rod English, whereas, by this plan, 1210 are sufficient, being the number required to build two 4-inch walls only. If we add to this the expense of the concrete, we shall find that the brick and concrete wall is much the cheapest and most durable, both being of the same thickness.

*The brick and stone wall.*—This kind of stone wall is often built in Scotland, where stone is cheap, and bricks in general expensive—the object being to save the latter, and at the same time have all the advantages of a brick wall on one side, usually the south. The principal part of the wall is built with stone and faced with brick, on what is called brick-on-bed fashion. This is in very few cases a cheap wall, the extra labour on the stone part raising its cost to that of a brick wall throughout.

*Hollow brick walls.*—Of these there are now several kinds, all having peculiar merits, the chief of which are, saving of material, and rendering them at the same time capable of being heated by smoke and hot air, or hot water either in cast-iron pipes or gutters. Hollow walls, in consequence of a circulation of air constantly going on through every part of their interior, are much drier than solid walls, and hence much warmer.

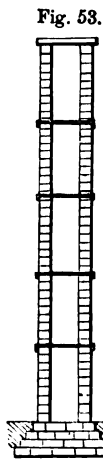
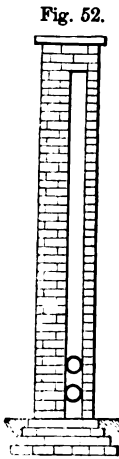
The principal walls in the new gardens at Dalkeith are hollow, 12 feet high, and 18 inches thick. They are constructed as follows:—Upon a solid rubble stone foundation, rising to within 6 inches of the surface, nine courses of bricks are laid on bed, and form the side of the wall; the tenth course on each side has

headers laid across and meeting in the middle at every 3 feet, which binds the wall; these headers, being 10 inches long, have 2 inches cut off the end of each, and have a whole brick laid over them; the open space below is occupied with the hot-water pipes, as in the annexed diagram, fig. 51. The same process is carried on upwards, only changing the place of the headers so that they shall not be immediately above each other. The three last courses at the top are built solid, to prevent the escape of heat through the coping.



Walls built upon this principle, as well as figs. 53 and 54, afford an equal degree of heat to both surfaces, and hence are valuable for east or west walls.

Fig. 52 represents another form of this wall, adapted to south aspects, or where



the heat is required on one side only—the front being in 5-inch and the back in 15-inch work. Fig. 53 represents the section of a hollow wall, the sides of which are tied together by means of pieces of thick hoop-iron bent at the ends and turned down 3 inches on the outer sides. And fig. 54 shows another economical wall tied in a somewhat similar manner; but to prevent the iron from being seen, the bent part is let 2 inches into the middle of the bricks, a portion of them being pierced with holes before they are put into the kiln. Iron wire, half an inch in diameter, will be found sufficiently strong for this purpose. Such walls as the two last may be heated by causing the smoke and hot air to pass through them from top to bottom; and

the soot can be cleared out by removing portions of the coping and brushing it down to the bottom, from whence it can easily be removed by making openings at convenient distances, or better by having openings, with sliding cast-iron covers, built in the walls near the ground. Such walls may also be heated by hot-water pipes, or open gutters running along the bottom. These walls are an invention of our own, with a view to save material—1210 bricks only being required for a rod of work, while, at the same time, provision is made, as described, for heating them.

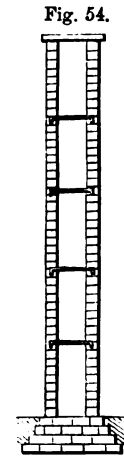
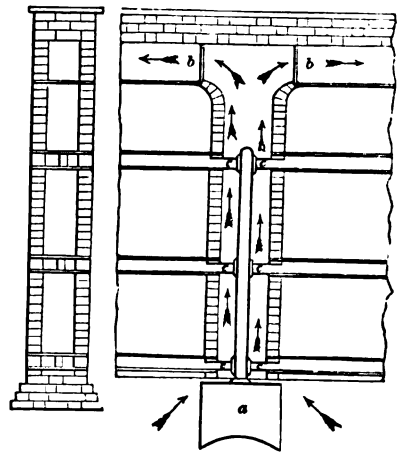


Fig. 55 represents the cross and longitudinal sections of a hollow wall heated

Fig. 55.



upon the tank principle, and as exemplified by us in the garden of James M'Fee, Esq., of Langhouse, near Greenock, for the first time, where it has given every satisfaction. We also had the honour to furnish the late Earl Talbot with drawings for a similar wall for his garden at Ingestrie Hall, Staffordshire.

These walls, as in the preceding examples, are constructed of 4-inch sides, and are 12 feet high, and 18 or 20 inches broad, according to the length of the

bricks used—of course leaving, in the former case, the opening within 10 inches wide, which admits of a flow and return gutter of 4 inches each. The bottom and top of these tanks are formed of Caithness pavement three-fourths of an inch thick, and cut to exactly the outside width of the wall, or Bangor slates of the same breadth, half an inch thick, and of as great lengths as can be conveniently procured to lessen the number of joints, may be substituted. These joints, in all cases, should be half-checked, and put together with the best white lead. The flow and return water may be separated by having a thin slate partition set on edge, and inserted into a groove cut in the centre of the pavement forming the floor or bottom of the tank. Three courses of tanks may be used for a 12-foot wall, but one or two will be sufficient for those of less heights—as the smoke and heated air, passing the boiler, may be conveyed either along the top or bottom of the wall, so that no heat from the fuel may be lost. The three courses next the top are built solid, to prevent the escape of heat through the coping.

The longitudinal section shows the boiler *a* under the wall, from the top of which two 4-inch cast-iron pipes rise—the one to deliver the hot water to the tanks, and the other to convey the cold water back to the boiler again. Only one pipe can be shown: the other stands immediately behind it. Nozzles, *c c c c*, are attached to these pipes, each furnished with a stopcock, the handle of which passes through the wall, to facilitate the operation of turning off or on the water to any portion of the wall intended to be heated. By this arrangement it will be seen that the whole or any part of the wall may be heated at pleasure. The smoke and heated air which pass the boiler, and which are in most cases completely lost by passing upwards through the chimney, ascend as indicated by the arrows, and may be made to pass along to the right hand or to the left by means of dampers placed in the flue at *b*. The boiler should be placed in the middle of the space to be heated, if the walls are level, as by that means the water has only to travel half the distance before it re-enters the boiler to become heated

again. Indeed, in regard to all modes of heating walls by hot water, this arrangement of the boiler should never be departed from, unless in cases of difference of levels, when the boiler should be placed at the lowest point.

Objections will be started to this mode of heating, by some, on the plea that such tanks cannot be made water-tight for any length of time; and by others, that the walls must be rendered damp by evaporation. The latter has in no case been borne out by experience, as the evaporation is confined to the depth of the tank; and if the water is withdrawn by a waste pipe in autumn, at a time when it is heated to its utmost extent, the heat in the material will dry up the water absorbed, and leave the tanks as dry as any other part of the wall. The only consideration of moment to be thought of is the difference of expense between such a mode of heating and that of pipes, and this can only be fairly estimated by local circumstances.

*Dearn's hollow brick wall.*—Mr Dearn, an English architect of considerable eminence, has invented several walls, built on the hollow principle, both to economise material and render the walls less liable to damp. The subjoined diagrams, figs. 56, 57, which show the elevation and section of part of a wall, copied from the

Fig. 56.

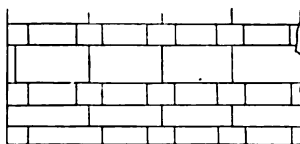
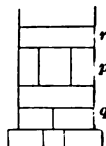


Fig. 57.



“Encyclopædia of Cottage, Farm, and Villa Architecture,” will show the principle. “The three lower courses *q*, the upper one of which is proposed to be level with the floor, are intended as a footing to the superstructure, and are laid in what is called the old English manner, consisting of alternate courses of headers and stretchers. The next course above is a stretching course on edge, *p*, and the backing course is like it, leaving an interval between of the width of half a brick: these are then covered with a heading course laid flat; and the same system is pursued until the whole height required be attained.”



Fig. 58 is a plan of the upper course of the footing, showing the manner of bonding the angles. The dotted lines denote the course above of heading bricks laid flat. The two bricks on edge, marked *ss* at the angle, will be reversed in every other course.

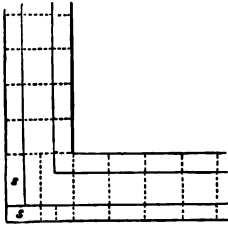


Fig. 59 shows the elevation of a wall so constructed. The advantages of Dearn's hollow walls are a saving of one-third of the number of bricks, as 4500 are required for a rod of reduced brickwork, according to the usual mode of building; whereas 3000 are sufficient according to Dearn's plan. Nor is it only in bricks that the saving is effected: half the mortar will suffice, and the labour is just the same.

Fig. 59.

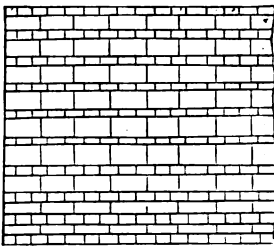


Fig. 60 exhibits the elevation, fig. 61 the section, and fig. 62 the plan of another mode of building hollow walls, recommended by the same architect. Instead of the brick-on-edge courses, half bricks may be used as stretchers; and to provide these half bricks economically, and without the trouble of cutting them with the trowel, as is usually done, he proposes to cut them half through with a sharp knife,

Fig. 60.

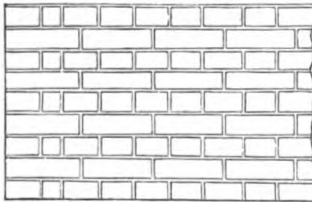


Fig. 61.

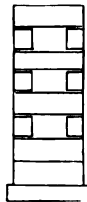
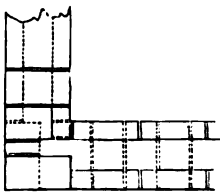


Fig. 62.

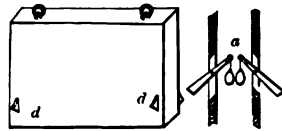


or piece of wire, while in a soft state, prior to their being put into the kiln: after burning they will separate easily by giving them a slight stroke on the part opposite to where they have been already partially separated. This was a great saving formerly; for, had they been moulded half brick size at first, they would have been charged double duty,—that is, each half brick would have been charged the same as a whole one. In the section, fig. 61, the three courses of footing are shown solid; the elevation only represents the wall above the footing or ground-level.

Hollow walls of 14 or 18 inches in thickness may be constructed by running up the sides of bricks, either on edge, or better on bed, to the height of eight or ten courses, and running a course of headers through the wall, of bricks made corresponding in length to the thickness of the wall; or these may be laid in 3 or 4 feet apart, and the course made good with half-sized common bricks.

*Hollow stone walls.*—Stone walls may be built hollow, with a view to heat them, either by causing the smoke and hot air to circulate through them, or by hot water in glass, earthenware, or metal pipes. In constructing them, two long 2-inch planks are set on edge parallel to each other, and kept separate to any distance by coupling screws. These are placed in the centre of the intended wall, and the sides are carried up in rubble, or coursed stones, as high as the planks. The screws are then slackened, which allows the planks to come together, and so be easily lifted up, and set for another course. Headers, or stones sufficiently long to go through the wall, are set in at convenient distances, to bind the sides together. The late Mr Loudon proposed, in building hollow stone walls, to employ a hollow light deal box, fig. 63, "3 inches in thickness, 3 feet long, and 2 feet deep;

Fig. 63.



this box to be used as a gauge for preserving the vacuities of the proper width. It has two rings in its upper side, by which means it may be easily drawn up to about two-thirds of its height, at which

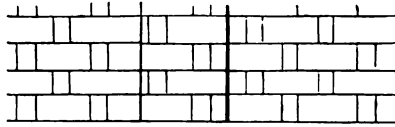
height, two catches, *a a*, at each end, will fly out by means of weight at their tails, as shown at *a*; and these will hold the gauge-box in its proper station till it may require again to be raised." It will readily be seen that, by the use of this box, the vacuities will be perpendicular; whereas, by using planks in the way described above, they will be horizontal, and calculated for the circulation of heat by either of the means proposed, which the perpendicular vacuities would not admit of. The great advantage of hollow stone walls is to resist damp, and hence they are well adapted for dwelling-houses.

Stone walls, built sufficiently thick to admit of the interior being filled up with loose stones without mortar, are warmer than solid ones of the usual size, particularly in the case of walls having a southern aspect; because the heated air from the sun, passing through the south side, is retained amongst the loose stones, and prevented from passing through the north or cold side by conduction—the cold side having a tendency to abstract the heat from the south or warmer side. Hence all south walls, of whatever material, should be of greater thickness than those facing the east or west, if it is wished that the greatest amount of heat should act on the south side; because, from the much greater cold on the north side, it is continually abstracting heat from the warmer side opposite to it. Walls with east and west exposures are more uniform in temperature on both sides, as they are not subject to the same rule—they receive heat equally, and part with it equally.

*Silverlock's hollow brick wall.*—This wall is the invention of Mr Silverlock, a respectable nurseryman at Chichester, and has been extensively used both for garden walls and dwelling-houses. "It is constructed of bricks set on edge, each course or layer consisting of an alternate series of two bricks placed edgewise, and one laid across, forming a thickness of 9 inches, and a series of cells, each cell 9 inches in the lengthway of the wall, 4 inches broad, and  $4\frac{1}{2}$  inches deep. The second course being laid in the same way, but the position of the bricks alternating, or breaking joint with the first, the result will evidently be a hollow wall, with communicating vacuities of the above stated dimensions, equally distri-

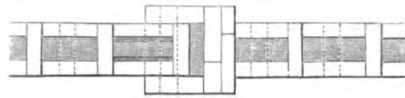
buted from the bottom to the top of the wall. Fig. 64 shows the elevation of such a wall, which differs only from the hollow

Fig. 64.



wall of Dearn in being carried up in Flemish instead of English bond. Fig. 65 shows the manner in which piers may

Fig. 65.



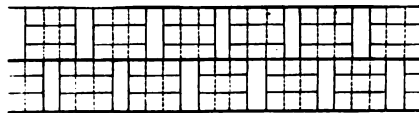
be built in such walls, so as to project equally on both sides, for application to the east and west walls of gardens, both sides of which are equally valuable for training fruit trees; and fig. 66, how a

Fig. 66.



pier may be built on one side only, for application to the north and south walls, the south sides of which are chiefly valuable for fruit trees. The saving in this wall is one brick in three, but the bricks and mortar must be of the best quality. One great advantage of these walls is, that they admit of being equally heated throughout, by a tube of hot water conducted along the interior, just above the surface of the ground. It is evident that brick walls on the same plan might be built of 18 inches or 2 feet in width, or indeed of any width, by joining two 9-inch hollow walls together, as in fig. 67, which, if a garden wall, might be

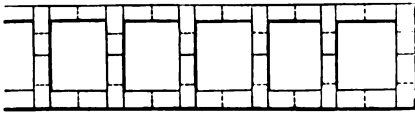
Fig. 67.



heated on one side, without being heated on the other, by carrying up the heading

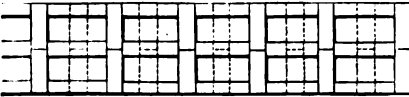
courses solid from the bottom, as in fig. 68, or better with a brick-on-edge wall in

Fig. 68.

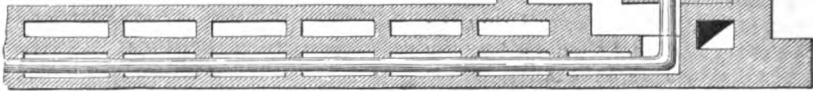


the centre, as in fig. 69. A wall of this construction, with the bricks flat, would

Fig. 69.



form one of the very cheapest and best possible for a fruit garden. For a 14-inch wall, bricks might be made of that length; and for a wall of 2 feet or more in thickness, the interior might be entirely hollow, with cross-walls every 4 or 5 feet. To save bricks in the cross walls, and also to admit of the free transmission of heat from one division to another, they might be built in what is called the pigeon-hole manner, viz., each stretching



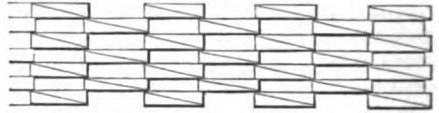
wall not covered with glass. "The pipes are introduced along a cavity that commences within a few inches of the bottom of the wall, and is continued to the top, but is connected by piers that are carried up about 4 feet apart, which unite the back and front of the wall together, and render it, although hollow, equal to a solid wall in strength: they are also found more economical in the erection, as there is a considerable saving of materials."—FORBES in *Hortus Woburnensis*.

We have shown the ground-plan of this hot wall because it is different from those adopted by ourselves, and is in fact a double hollow wall—Mr Atkinson's object being to prevent the loss of heat by its passing through the north side.

*Hitché's patent rebated brick wall* is thus described in the "Supplement to the Encyclopædia of Cottage, Farm, and Villa Architecture:"—"The bricks are much larger than usual, and the walls are said to be stronger, and twenty per cent

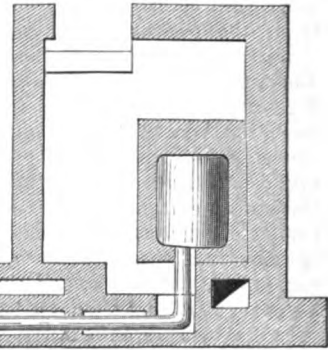
course having alternate vacancies, by leaving out every other brick, as fig. 70. —*Encyc. of Cottage, Farm, and Villa Architecture.*

Fig. 70.



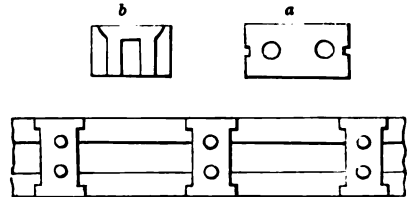
The hot-water walls at Woburn Abbey, of which fig. 71 is the plan, deserve especial notice as being one of the best examples exhibited of that mode of heating. They occupy those parts of the north

Fig. 71.



cheaper. Fig. 72 represents a longitudinal section of a 9-inch header, and a part

Fig. 72.

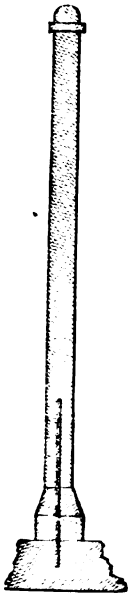


of one course of 9-inch work. From this it will be seen that the headers and stretchers are rebated together, and form two external faces of brickwork enclosing a hollow space, or series of hollow spaces. Each of the headers has two dowel-holes through it in the direction of its height, and is hollowed out on the under side, as shown in the fig., so that these spaces communicate with one another by means of the dowel-holes throughout the whole extent of the wall. Now, into each of

these chambers, as each course is laid, a concrete, properly compounded of gravel and lime, is introduced, and the whole, when finished, is thus rendered a solid and well combined mass.

"The appearance presented by walls built in this manner is uniform and bold—each brick being 5 inches high and proportionably long. Very little mortar is required for laying the bricks; so that, if affected by frost, the work may be repaired at small cost. For garden walls, bricks are specially made with two dowel-holes in them, so that iron rods or oaken stakes may be passed through, thus stringing them together, the interstices being filled up with concrete: *a* shows the plan of one of these bricks, and *b* exhibits a section of garden walling constructed with them. A

Fig. 73.

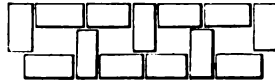


footing of concrete, about 12 inches in thickness, is first thrown in. Upon this is laid one course of 9-inch work, and one course of splayed bricks, made for the purpose, from whence commences the 6-inch walling of dowelled bricks, terminating with a bead-brick and coping of the same material, set in cement. At certain intervals angular piers are formed to strengthen the wall; and iron rods, as before mentioned, are introduced in various places. One of the latter is shown in fig. 73, passing through the bottom courses into the concrete. The cost of a wall thus constructed, with 6-inch bricks, including the coping and piers, but exclusive of the concrete footing, is about five shillings per yard, (being little more than the price of wooden fencing,) and a similar wall may be built of 4-inch bricks for four shillings per yard. For horticultural purposes the patentee has occasionally glazed the face of his bricks: this is the case with a garden wall in the garden at Hampton Court Palace, built by him several years ago." This wall we have frequently seen, and can testify to its great merits. The specimen alluded to

is trellised with copper wire run lengthways, and fastened by eyed holdfasts in the wall; for such a wall would soon be ruined by the barbarous system of driving nails into it.

Fig. 74 shows the plan of another mode of building hollow brick walls, 14

Fig. 74.



inches thick, with only a small number of bricks additional to those required for a 9-inch wall. The following description and plan is from the "Encyclopædia of Cottage, Farm, and Villa Architecture:"—"Fig. 64 shows the plan, or first course of bricks, of such a wall, and all the rest is mere repetition. Walls built in this manner may be carried to the height of 10 or 12 feet without any piers, and hence they are suitable for the walls of gardens. For the purpose of heating, two courses of cross-bond may be left out, on a level with the surface of the ground, in order to leave room for a hot-water pipe," or hot-water gutter, "which, in consequence of the vertical vacuities, will heat the whole wall."

In regard to the economy of such a wall Mr Loudon makes the following calculations:—"If we suppose that only half the amount of cross-bond is used, then the saving of bricks will be still greater. A rod of solid 9-inch brickwork requires 4500 bricks; a rod of hollow 14-inch brickwork, such as fig. 74, requires 3600; and a rod with only half the amount of cross-bond shown in the figure, requires 3200 bricks. If the whole of the brickwork were set on edge, then, for a common 9-inch wall, hollow, the number of bricks required per rod will be 3000; for a 14-inch wall, hollow, but with bricks set on edge, the number required per rod will be about 2800; and for a wall, brick on edge, with only half the cross-bonds, the number per rod required will be about 2500."

Brick walls  $7\frac{1}{2}$  inches thick may be used for gardens, and, by a peculiar mode of laying them, the walls may be made fair on both sides, and sufficiently strong. The following is the mode of constructing them as described in the work last quoted:—"These  $7\frac{1}{2}$ -inch brick walls are formed of bricks of the common size, and

of bricks of the same length and thickness, but of only half the width of the common bricks, by which means they can be 'worked fair' on both sides.

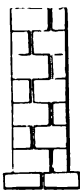
Fig. 75.



These are laid side by side as in fig. 75, in which *a* represents

the first course, and *b* the second course. The bond, or tying together of both sides of the wall, is not obtained by laying bricks across, (technically headers,) but by the full-breadth bricks covering half

Fig. 76.



the breadth of the broad bricks, when laid over the narrow ones, as shown at *b*, and in the vertical section, fig. 76. Besides the advantage of being built fair on both sides, *there being no headers, or through-and-through bricks, in these walls, the rain is never conducted through them, and the inside of the walls is consequently drier than the inside of a wall 9 inches in thickness. The only drawback that we know against them is, that the narrow or half-breadth bricks must be made on purpose.*"

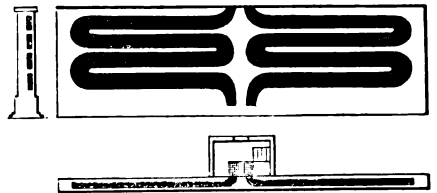
Since the restriction has been taken off brickmakers as to size, by the abolition of the duty, bricks may be made of any form or capacity we please; therefore some of the ingenious contrivances we have stated may shortly become obsolete, and bricks yet be made of a size to imitate stone ashlar, and perforated or hollowed out to admit of heating, and lessening the weight upon the foundations. We have, indeed, already an example of a large house in Edinburgh built of fire-clay bricks, which at the distance of only a few yards may readily be mistaken for a polished ashlar building. The stone sills, lintels, and rebates of the doors and windows are all of the same material.

Amongst the latest improvements in brickmaking, we may notice Roberts' patent hollow bricks, employed in the construction of his Royal Highness Prince Albert's model houses, erected in Hyde Park. By the form adopted by Mr Roberts, a perfect bond, running longitudinally through the centre of the wall, is secured; all headers and vertical joints passing through it are avoided; internal as well as external strength is

obtained; whilst, by the parallel longitudinal cavities, ample security for dryness is afforded, and great facility presented for ventilation, as well as for the conveyance of artificial heat. The saving effected by the use of these bricks, when made at a fair price, is stated in the "Builder" to be from twenty-five to thirty per cent on their cost, with a reduction of twenty-five per cent on the quantity of mortar, and a similar saving on the labour, when done by workmen accustomed to them. On making inquiry, we learn that the cost of these bricks, delivered in London, is nearly £9 per thousand. If such is the case, we cannot see how the saving above stated is made out.

*Flued walls, fig. 77, have been long in use, but are now superseded by the use*

Fig. 77.



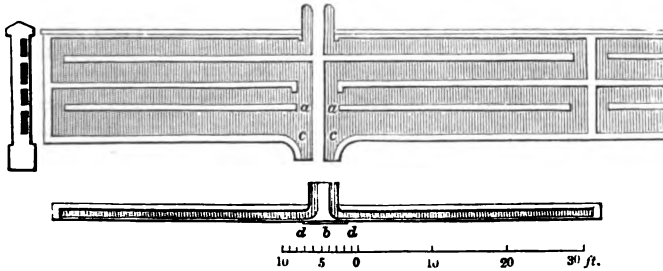
of hot water. The disadvantages of flued walls are, that the heat is not equally distributed—those parts nearest the furnace being too hot, while those most remote from it are not heated at all; the soot accumulates in them, and is not easily removed; and, beyond either of these objections, an ordinary furnace will heat only something like 400 square feet, or 40 feet in length of a wall 10 feet high, while the same amount of fuel will heat nearly as well 3000 square feet, or 300 feet in length of a 10-foot wall, if hot water is employed. In such a case the boiler should be placed under the middle of the wall, and the circulation be carried on to the right hand, and also to the left, 150 feet each way. Were it possible to circulate heated air, unaccompanied with smoke, with a force sufficient for it to travel at the same rate as hot water, there would be advantages attending flued walls, such as they have hitherto not possessed. In the present state of horticultural improvement, we do not think that flued walls will in future be attempted further than

for conveying the smoke and heated air that passes the boiler along them, for the purpose of economising the heat which would otherwise escape at the chimney top—the great dependence being on the heat from the water to effect the end in view.

The best flued walls we have seen are those exemplified in the garden at Erskine

House. These were described by Mr Shiells, the very intelligent gardener there, in the "Gardeners' Magazine," (vol. iii. p. 670,) accompanied with the annexed diagram, fig. 78: "Our mode of heating these walls," says the author, "is simple but effectual. As will be seen" by the illustration, "there is an open space, with a

Fig. 78.



damper placed immediately over it, where the smoke and heated air enter the wall from the furnace at *a*; this damper regulates the heat through the whole wall. I found, when the damper was drawn about 4 inches, a sufficient portion of the smoke and heated air passed through the two under flues to produce the necessary degree of heat in these flues; and, after passing through these, being again united to that part ascending through the opening left at *a*, the whole body of smoke then ascends, and passes through the third and upper flues, by which these are heated a little more than the lower ones. This" Mr Shiells "considers a great advantage, because the upper part of the wall is more exposed to the cold air, and less benefited by the reflection of heat from the ground; besides, the shoots there are generally more luxuriant and spongy, and consequently later in ripening. No trellis is required for this wall; for, if the damper be properly fixed, there is no danger of overheating any part of it; the only part where danger from overheating is to be apprehended is where the heat enters from the furnace, which is 18 inches from the wall, and 2 feet below the surface of the ground. To prevent the roots of the trees on the south side of the wall from being injured by the heat, 4-inch brickwork is carried up, opposite the furnace, to within a few inches of the surface, with a 2-inch cavity *b*. As the heat rises above the surface,

it enters the wide space *c*, from whence it is immediately directed through the wall. I have," Mr Shiells observes, "however, a yard or two of the wall, at the warm end of the under flues, a little thicker, *d*, as flued walls are always warmest towards the top of the flues." The idea struck Mr Shiells, "that if one, two, or more bricks (according to the depth of the flues) were built across the upper ends, they would, by confining the draught of smoke towards the bottom of the flues, tend to equalise the heat in them. This did not answer" his expectation, "for it retained too much of the heat in the under and third flues, which caused a deficiency in the second and upper ones; but having bricks run across the upper part of the cooler ends of the second and upper flues is of considerable advantage, as a means of retaining the heat in these flues, and making the heat throughout more equal and uniform, and requiring less fire; indeed, walls upon this construction never require large fires.

"If it were desirable to warm the upper part of the wall only, by withdrawing the damper, and applying a small fire, this would be accomplished without warming the lower part of the wall. Depth of flues, 2 feet 6 inches, 2 feet, 2 feet 3 inches, and 1 foot 6 inches; width, 7½ inches; bottom of lowest under flue, 1 foot from the surface; top of upper flue, 7 inches from the coping; thickness of the wall, about 1 foot 9 inches. By

reducing the open space *a* in the flued wall to about 30 inches, the damper may be dispensed with; but by retaining it, the heat can be regulated according to circumstances."

We have made this long extract, because we are convinced that this is the most complete system of heating by smoke flues hitherto accomplished. We do not, however, think it by any means so good as heating by hot water, whether in pipes or gutters.

*Ewing's patent glass walls.*—The application of glass in the construction of garden walls is only one of the many uses to which this most imperishable of all materials may be applied. We had thought of the probability of such an application at a very early time in the preparation of this work, not dreaming, however, that such an application was soon to be realised. We confess that our ideas went no further than securing durability and elegance at a cost much less than that of the unsightly brick and still more unsightly stone walls hitherto in use, by employing glass in the way we have described pavement and slate walls to be constructed. It was therefore with much pleasure that we were privately informed, some months ago, of Mr Ewing's invention; and this pleasure was increased when we were favoured by him lately with drawings of it. The accompanying plate and description will clearly show their construction. But, first, we should state something of the advantages expected to be realised from their use, as well as the disadvantages, if any, that may exist.

We believe Mr Ewing's walls will insure complete protection to the blossoms in spring, which open walls do not afford; that they will ripen many fruits, and consequently the young wood of various kinds of fruit trees too delicate to withstand with impunity our variable climate—which walls, as at present constructed, do not in all situations and seasons sufficiently accomplish; that they will improve the flavour of the fruit by keeping it dry, and consequently increasing the temperature around it; that they

will present to us the means of ripening the peach and the grape at much less expense than in the cumbersome and expensive peach-houses and vineries, as too often at present constructed, and of economising fuel—as the space to be heated, when artificial heat is required, is small when compared with that of ordinary hot-houses. Another important advantage is their excluding rain, while they admit nearly as much light to the trees as if they were in the open air, and at the same time permit the fullest amount of ventilation to be given in all weathers. They will secure the preservation of the young wood and foliage during the evaporating and blighting winds of spring, and sudden changes through the summer, by which alone the health, and consequently the age, of the trees will be preserved and prolonged. And last, although not least, they will permit the abandonment of brick and stone walls, which are both inelegant and expensive structures.

These are the general advantages, so far as they can be stated at present, in the absence of practical experience.

That objections will be started to this innovation upon long-cherished usage is certain. Let us now inquire as to the grounds of these. The angle of elevation, upon which so much stress has been laid by some, is here comparatively disregarded, as these glass walls stand perpendicular to the earth's surface, or nearly so. Would not, therefore, a departure from the perpendicular be better adapted for the transmission of the rays of solar heat and light to the trees within?\* The amount of heat gained by hollow glass walls, when solar rays only are depended on, may amount during the day, when the requisite ventilation is in full operation, to about 6° or 8° above that of the external air. This, no doubt, is a considerable additional degree of temperature, but it would be much greater if there were a heat-absorbing and heat-reflecting medium placed within the walls; for neither the foliage nor branches would absorb or reflect that element. Any opaque body introduced would greatly diminish their transparency, which, barring this objection,

\* Since our plate was engraved and issued, we have heard from Mr Ewing that this suggestion has to some extent been anticipated: his glass walls being now constructed 4 feet wide at bottom, and 18 inches at top, and thus receiving some degree of inclination.

is one of their principal merits. Slate would be an excellent material for this purpose, and, we believe, the only one that could be advantageously employed, as it is both a good absorber and reflector of heat. Wood would be objectionable, on account of its being a positive non-conductor of heat, unless it was painted black, and coated with asphalt; and metal would absorb and reflect heat during the heat of the day, but would also absorb cold during the cold at night, thus rendering the extremes of day and night temperature much greater than they are under present circumstances.

These walls, as at present projected, are intended to range from north to south, and, without the intervention of an opaque reflecting body, will afford to the trees light and solar heat from the time the sun's rays strike them in the morning until they diverge from them in the afternoon—the astragals and sash frames breaking the full force of the rays at noon: they thus possessing one of the chief merits of ridge-and-furrow roofs.

With an opaque body in the centre of the wall, the trees would be circumstanced exactly like trees upon an east and west exposure, protected by a glass screen in front—the former deriving advantage only from the morning, and the latter from the afternoon sun. On a southern exposure, with a heat-absorbing and reflecting body between, such as slate, the southern side only would derive much benefit from the sun—the north nothing but protection from rain and cold, with a very limited supply of heat. But on the other hand, instead of constructing these walls with a double glass surface, were they constructed with a single surface of that material, and that used on the south side only, great advantages would be gained by extending in length a single surface instead of a double one. A glass wall upon the principle shown by fig. 107, having hot-water pipes placed along the bottom, is in our opinion the very perfection of the principle; for with that appliance to insure a due temperature, the walls running even from north to south, peaches and grapes might be ripened to full maturity, air and light being so abundantly supplied; and it is probable that on these the success depends more than on heat, whatever amount of it may have been obtained with a deficiency

of both or either. Glass walls constructed on Mr Ewing's principle must afford a much greater amount of these elements than fruit-houses as at present constructed. As to the accumulation of solar heat, we cannot see how this can be calculated upon, because the rays of heat, having passed through the glass on one side, will escape by passing through the other, leaving the trees within in a temperature little above what they would have if placed against a south wall. But we have in the hollow glass walls full security from atmospheric injuries, the trees being protected from frost, snow, and rain—and, what in our opinion is of vast importance, enjoying a complete security against those evaporating and blighting winds of spring, which in our climate are even worse than frost itself. The trees being enclosed, admits of their being fumigated or sulphurated, which cannot be effected with a shadow of advantage in the case of trees on open walls. Under both the modifications of opening, ample means are presented for carrying on the necessary operations of pruning, disbudding, thinning, and gathering the fruit. The covering in at the top is of vast importance, as the trees will be kept dry, which, in certain conditions of the atmosphere, will be equal to several degrees of temperature.

The simplicity of the construction is very perfect, substantial, and cheap. Could we see how, without lessening the transparency, the solar heat could be arrested from passing directly through, we would without hesitation prefer them, for general and late crops of peaches and grapes, to most ordinary fruit-houses. For the securing and hastening the ripening of apricots, plums, cherries, the finest Flemish pears, and the best French and American apples, and for the conservation of exotic plants, we think them invaluable. For early forcing, we would have our doubts, even with hot-water pipes; for, although the internal space to be heated is small, the loss of heat in consequence of so large a surface of glass, without any absorbent body in connection with it, must be great.

Nevertheless, with all the objections we have stated, we hail the invention as one that will be found to possess many important advantages over brick and stone walls. The respectability of the inventor,



and the high standing of the parties to whom he has intrusted the manufacturing manipulations, will be a sufficient guarantee that the works will be creditably executed.

Glass walls upon Mr Ewing's principle are at present erecting in the fine gardens at Bodorgan, and at other places under his direction; a short time will prove either their merits or defects. It would, indeed, be too much to expect that any new invention should be all perfection at first, and more especially one so widely different from structures hitherto employed to effect similar ends; all of these, however, being defective in one important feature—namely, complete protection from atmospheric influences. Whatever success may attend the employment of such structures, one thing is certain, that the move is in the right direction; for in gardens of the first order we must now have elegance in design, as well as mere utility.

Plate XI. shows the elevation, ground-plan, and sections of Ewing's glass walls.

Fig. 1, A, elevation of a wall 9 feet high, glazed with 16-ounce sheet glass, in framed sashes, constructed so as to slide upon a double iron rail set on stone blocks, and forming the base of the cast-iron framework which constitutes the body of the wall. These rails, being separated from each other as much as the thickness of the sashes, readily pass each other when admission to the trees is required; or indeed, as in similar cases, may be entirely removed by running them out at each end. The lower edge of the bottom sash-rail is hollowed out, and provided with castors, which, being hollow in the middle, ride on the rails and move with great facility. The top rails run in a groove formed for them in the iron coupling, which ties the tops of the upright iron columns together—the intention of this movement being to enable the owner to get free access to the trees, for carrying on the necessary operations of culture, &c. The alternate sashes are shown open.

Fig. 1, B, is elevation of a wall of the same dimensions; but instead of the sashes moving as in the above, they are here opened by means of pivot-hinges attached to the top and bottom corners of one of the side rails; and by the provision shown by fig. 7, may be opened simultaneously to any extent required.

It will be observed in this case, that the sashes are about one-third narrower than in the former case, to render them less liable to accident when open.

Fig. 2 is the ground-plan of both the above forms, showing the iron rails as secured to the stone plinths on both sides of the wall.

Fig. 3 shows the framework bolted down to the stone plinths; the roof, which is in glass panels, shut down; the rones or gutters on each side of roof, for taking off rain water; and the double trellis in the centre, to both sides of which the trees are to be trained.

Fig. 4 shows the trellis arranged along the inner sides instead of in the centre, as in fig. 3. The top is also shown open for the purpose of ventilation, and two hot-water pipes are placed near the surface of the ground.

Fig. 5 shows a double trellis in the centre. The top ventilation is also somewhat different from the last.

Fig. 6, showing the end view, requires no explanation.

*Spencer's glass walls.*—These walls have recently been brought into notice by Mr Spencer of Bowood, to whom we are indebted for our diagram and description. In some important points they differ from the glass walls of Mr Ewing—indeed, so much so as to rank rather in the character of narrow span-roofed houses than as glass walls. They have the advantage of affording more accommodation within: the glass is placed at a better angle of elevation than those we have just described, although in this respect Mr Ewing has made provision to construct walls with the same slope also. We think Mr Spencer's design would have been more complete had the copings at the top been of glass instead of zinc, for the purpose of admitting the perpendicular rays of light and heat. The idea of having the glass removable is good, so far as the culture of plums, cherries, pears, &c., is concerned; but we fear that peaches, nectarines, vines, and apricots, would require the protection of the glass during winter even in the south of England—and certainly so in the north of England and Scotland. Another merit they have in our estimation, is the economy of construction, which must be considered another step

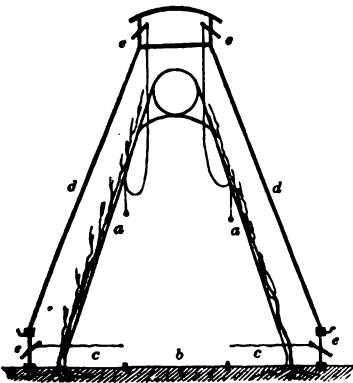
in the right direction, in doing away with the antiquated, expensive, and labour-wasting details of ponderous rafters and framed sashes.

The following description will explain our fig. 79 of the section, while fig. 80 is a section of the astragal. The width of

The operations of culture, as will be seen, are carried on from within; and from the general construction, many plants may be protected in these walls during winter. With a hot-water pipe placed at each side, between the trellis and the glass, and a simple mechanical appliance, to effect simultaneous ventilation both at the bottom and the top, we would have in such a structure all that is required for ripening wall fruits in very great perfection, and at comparatively little cost—indeed, much about that required to erect a common brick wall. Neither Mr Spencer nor Mr Ewing hold out their respective inventions as completely adapted to *very early* forcing, but as accelerators and protectors only; and so far as this goes, both are entitled to our fullest approval.

*Wooden walls* have the property of affording shelter from the winds; but their non-conducting nature unfits them for attracting or reflecting solar heat, at least to such an extent as to be of much utility to trees trained upon them. They may indeed, by being covered with coal tar, asphalt, or perhaps other mineral matter, particularly of a black colour, be somewhat improved. Wooden walls are colder in winter and spring than brick ones; but this circumstance is often an advantage, by retarding the blossoming of the trees, and lessening the risk of their being injured by spring frosts. It has been suggested to construct wooden walls hollow, and to fill the space between the boarding with pounded charcoal, coke, or clinkers, as means of absorbing heat during the day, and giving it out during the night. The heat that would pass through an inch-and-half board would be so trifling that it could never be calculated upon to be of the least practical utility; besides, such walls would be much more expensive than those with a single surface of boarding. Many authors have advocated their use; and amongst them Nicol, who says that he has “constructed many hundred lineal feet of wooden walls.” In one particular that authority differs from most others, inasmuch as he places them out of the perpendicular by inclining them “considerably towards the north—fig. 81—presenting a surface at a better angle,” as he thought, “with the sun, than if they were upright.

Fig. 79.



the structure at the bottom is 8 feet, tapering to 18 inches at the top. The ends of the house face the south and north. The astragals are of iron, and fixed into a top and bottom rail: they are formed flat at top, and on them the glass is laid, and kept in its place by a bead, which is screwed down, having a thin strip of Indian rubber between it and the glass, both to keep the glass steady and also to prevent its being broken by pressure or concussion. We would have placed a similar piece under the glass also, for a like purpose. No putty is used. The astragals are made to take out of their fittings, and when the beads are unscrewed the glass is readily removed, and packed by until again required. The coping at the top, and the ventilators at the bottom, are of zinc or galvanised iron. The glass is 18 inches in width: *ee* are the ventilators; *dd* astragals; *aa* a trellis for training the trees on; *cc* border; *b* foot passage along the centre. On

Fig. 80.

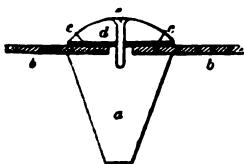
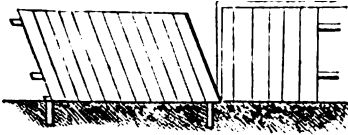


fig. 80, *e* is the screw; *d* bead; *c* Indian rubber, placed between the glass and astragal; *bb* glass; *a* astragal.

They are placed on sloping ground, and range in five ranges or lines, due east and

Fig. 81.

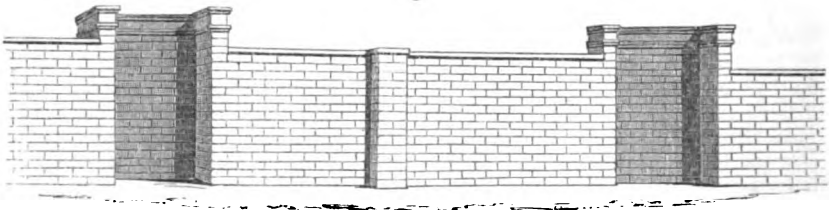


west, at the distance of 7 yards from each other—the southernmost being 5 feet high, and the northernmost 7—composed of imbricated boards pitched over to give them durability: the supports are set on (not in) blocks of stone, which are sunk in the earth, and firmly laid on solid foundations." Such walls, we ought to observe, are available on one side only for the purpose of training trees against, a circumstance that will ever be an objection to them. Wooden walls, formed of well-seasoned larch, will last for many years; and we apprehend that it would be advantageous to have the uprights made of cast-iron, set in stone blocks, with their sides grooved to the depth of 2 inches, and the boarding, 2 inches thick, let into the grooves, but not fastened to them: the whole boarding could thus be removed during winter, and the blossoming of the trees be retarded until the danger of

spring frosts was passed. The uprights would require, however, to be not more than 4 or 5 feet apart, so as to prevent the boarding from warping. If the boarding shrink a little during the heat and drought of summer, it will fall again into its place without showing any crevice when these are over. In regard to colouring wooden walls, there is no doubt coal-tar or pitch somewhat increases the warmth of them; but we question whether the benefit arising from that is enough to compensate for the disagreeable effect that the black colour produces. As to the preservation of the timber, we believe it would last longer without than with such application. The split oaken pales used in England for park palings sufficiently prove the durability of timber when fully exposed to the atmosphere: they last for ages without paint or preparation of any kind.

*Architectural walls.*—Under certain circumstances these walls are admirable, particularly in situations where the mansion, offices, &c., are strictly architectural. The walls in the kitchen garden at Claremont afford an instance of the correct taste of Sir John Vanbrugh, who built them to harmonise with the original mansion. These walls, shown by fig. 82, still

Fig. 82.



remain a monument of his massive style, although the noble mansion with which they were associated has long been demolished, and another built in its stead.

We may here correct an error fallen into by Mr Loudon in the "Encyclopædia of Gardening," &c., who says that these gardens were constructed from designs by Brown. This is not the case. The kitchen garden was constructed by Vanbrugh, and the present mansion built by Brown. It is said to have been the only house entirely erected by that artist, although he altered and added to many. Our authority for this was the late Sir John Soane, who received his first lessons in architecture

from Brown while the mansion was building. Brown executed this edifice so much to the satisfaction of Lord Clive, that he employed him to remodel the grounds, which remain in nearly the state in which he left them, and form one of the earliest examples of his peculiar style. We have seen a print of Claremont as it existed in the time of the celebrated Duke of Newcastle; the arrangement, as shown by it, was strictly geometrical. Not a vestige of it, however, remains at this day, excepting the garden walls and a lofty obelisk with the Newcastle crest on the top. Brown levelled the terraces and filled up the basins of water; while many of the

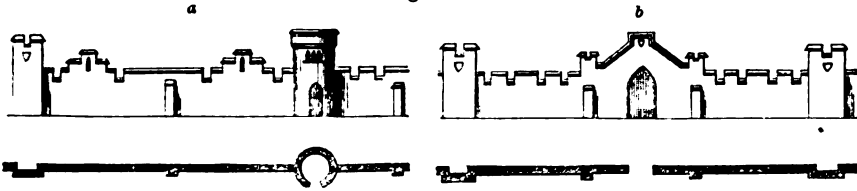
sculptured ornaments and mural decorations remained as useless lumber, and were used in forming the foundations of a conservatory built by Government for the lamented Princess Charlotte, and scarcely finished at her death.

London and Wise, eminent in their day as garden architects, constructed several garden walls both in England and Scotland upon architectural principles, some of which still remain. The walls in the botanic garden at Oxford are of a highly architectural character. They are 12 feet

in height, with a coved Gothic cornice on each side, under an elevated Gothic coping. They are also of stone, laid in deep courses and smoothly dressed, associating well both with the antiquities and architectural structures for which that ancient city has been so long conspicuous. A slight attempt at the architectural style was exemplified in the celebrated Adam, at Blair-Adam in Kinross-shire.

An excellent specimen of an architectural wall, fig. 83, *a* and *b*, in the Norman-Gothic style, has within these

Fig. 83.



few years been built by Mrs S. Erskine of Dunimarle, near Culross, and is intended to associate with the mansion now building in the same style, all from designs by that excellent lady. We have had the honour of being consulted by her in regard to connecting this wall with the mansion by a conservatory, of which an elevation will be seen in its proper place, in which the finest collection of orange trees exists that we have seen in Britain, with the exception of those at Hampton Court.

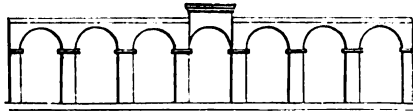
We have already stated, that under certain circumstances architectural garden walls may be built. It would, however, be unwise, at least it would be a violation of good taste, to have an architectural garden near or belonging to a mansion totally devoid of architectural character. We have been mildly rebuked by our late respected friend Mr Loudon for not giving a certain degree of architectural display to the walls of the new gardens at Dalkeith. Our reasons for not doing so were, first, that our instructions were to make a plain and useful garden; and next, that, had we built them upon architectural principles, they would not have harmonised with the mansion, from which they are not far distant.

Architectural walls have advantages even so far as culture is concerned. The breaks and projections afford shelter from the cold, cutting winds of spring; and

this, no doubt, led partially to the adoption of them.

*Piered, arched, niched, or recessed walls.*— These have had their advocates since the days of Switzer; modern artists, however, seldom adopt them. The arched wall, fig. 84, has a massive and imposing effect,

Fig. 84.

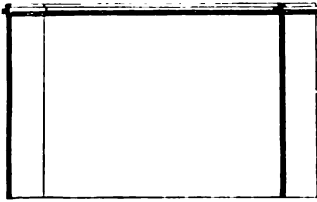


and if the arches are sufficiently wide to admit of a tree each, the effect is increased, and the protective advantage rendered more obvious. The piers may be planted with the hardier sorts of fruit trees, trained upright and round the arches: or, in a mixed garden, roses or other ornamental plants may be trained upon them, either for ornament, or for affording shelter to the fruit trees, as recommended by Mr Gorrie.

Walls may be built with piers for greater strength, as well as for breaking the force of the wind in sweeping over their surface. These piers, however, should not project far, nor should they be near together: each panel, as in fig. 85, should be proportioned so as to hold one full-grown tree. In high and exposed situations, we would by all means admit of piered walls, if only for the shelter they afford: in low and sheltered situations,

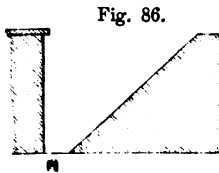
where their utility in this respect may be questioned, we would dispense with them

Fig. 85.



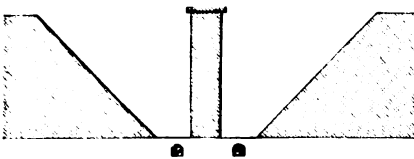
altogether, unless in connection with other architectural buildings.

*Sunk walls* are not so frequently met with as they ought to be. We believe that we were amongst the first to direct attention to them, and certainly the first who published diagrams of them, (*vide Practical Gardener*, p. 36.) In high and exposed situations, where shelter might be difficult to provide, their utility must be obvious. The trees should be planted on the sloping bank, and bent so as to reach the wall; and for this purpose half standards are the best. To guard against damp, a drain should be carried along close to the bottom of the walls, as shown in the diagrams; and in the case of fig. 86,



the trees may be planted behind the top and trained downwards. Objections have been made to sunk walls, on account of their supposed liability to become damp, and consequently cold. This objection cannot hold good so far as regards fig. 87, for it is to all intents and purposes

Fig. 87.



as dry as one built on the surface, if not more so. As regards fig. 86, no damp will affect it if, in the course of construction, it is drained, or packed behind with loose rubble stones, flints, or brickbats, and small openings are left near its bottom for the admission of air and drainage of water, should such ever be required. Sunk walls are not an idea of our own;

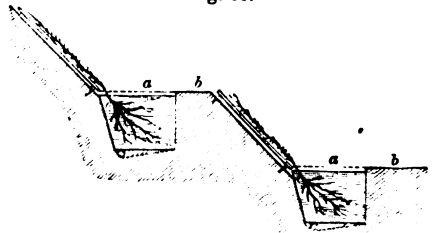
we have seen them in use, and had as fine fruit from them as from any other, and certainly much earlier.

The only instances of sunk walls we know of, were those once existing at Abercairney, in Perthshire; those at Walton, near Felixstow, Suffolk; and at Silverton Park, in Devonshire.

*Inclined walls.*—We have already noticed that Nicol used wooden walls, and approved of them having an inclination, so as to present a better aspect to the sun than erect ones do. The inventor of inclined walls appears to have been De Douillier, tutor to the Marquis of Tavistock. He exemplified his theory in the then celebrated gardens at Belvoir Castle, about the beginning of the eighteenth century, and also wrote a book upon their supposed merits. They were opposed by Switzer, Lawrence, and Millar, but have to a certain extent been approved of by some writers of more modern times. M. Stoffels of Mechlin, or Malines, states, in the "Horticultural Society's Transactions," "that he had an opportunity of comparing the effect of a sloping and a perpendicular wall in the same garden, for the growth of peach trees, and that the result was greatly in favour of the former." A correspondent in the "Gardener's Magazine," (vol. ii. p. 7.) suggested a wall of this kind. It consisted of two 4-inch walls, worked in cement, 5 feet apart at the bottom, and inclining on both sides, so as to meet at the top in the width of a single brick. He proposed planting the trees inside, and taking them through a hole about the middle of the wall, and to heat the interior with fermenting material—plans not very reconcilable with good practice.

Inclined walls may very readily be

Fig. 88.

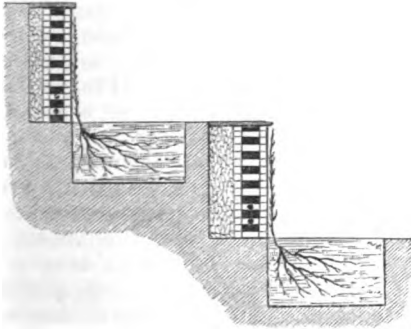


constructed upon the principle exhibited in fig. 88, which represents a sloping

bank cut out in terraces, the base of each incline being formed into a border *a a*, well drained, and prepared for the trees to be planted in, with walks in front, as at *b b*. The inclines are covered with Welsh slates, which are powerful conductors of heat, set clear of the ground the thickness of a brick set on edge: the slates being drilled with small perforations, in straight lines—the lines, say a foot distant from each other, and furnished with eyed nails, to which the branches are to be tied.

*Terraced walls* have many advantages, particularly in cold and exposed situations; they can also be constructed upon surfaces where ordinary walls cannot. To render them dry, they should be built hollow, as in the annexed fig. 89, and backed with loose rubble

Fig. 89.



stone, coarse gravel, or flints, to separate them from the ground behind, with prepared borders and a walk in front. With regard to height, this must be regulated by the inclined plane of the ground; but they may be from 4 to 20 feet in height. Intermediate heights, however, will be found the most suitable. Both terraced and inclined walls may be formed in situations in which scarcely any other use could be made of the ground; and if the exposure is favourable towards the south, they will be found amply to repay the cost of erection.

*Inclined walls* were exemplified some years ago by Mr Creelman of Portobello, near Edinburgh: an account of his way of constructing them, with an engraving, was published in the fourth volume of the "Caledonian Horticultural Society's Memoirs," of which the following is the

substance. Advantage was taken of a rising piece of ground near the centre of the garden, and two "sloping or almost horizontal walls, of a circular or rather a horse-shoe shape," were built. This circle was "formed into two terraces, one above the other, with a walk between, somewhat more than 3 feet wide. The walls (if they may be so called) are formed merely of bricks laid flat on the surface of the ground, without any lime. The ground slopes at an angle of about  $10^{\circ}$ , and the wall is inclined to the surface, also at an angle of about  $10^{\circ}$ —*i. e.*, the bricks are raised some inches at the upper or back part. These almost flat walls are 7 feet wide, the bricks being very hard burned." From this it appears that most of the advantages of inclined walls may be obtained at a cheap rate: for example, where the ground is naturally steep and inclining to the sun, or rendered so by throwing up banks, all that is required in these cases is training the trees to a wire trellis, set to the desired angle of inclination, and covering the surface under it, say at the distance of 2 inches, with hard burned bricks, even such as are unfit for building purposes; or where dark-coloured granite is to be had, the ground may be paved with this. One disadvantage would arise from laying either the bricks or granite close to the ground, inasmuch as they would be kept too damp and cold; but this could be readily rectified, as they might be elevated 6 or 8 inches from the ground by laying them on bricks set on edge, or by building parallel walls of greater height under them. By this arrangement a circulation of air would be passing continually under them, and thus they would be kept free of damp from beneath. Whatever advantages these walls may have, it is clear that it is gained by sacrificing the surface of the ground they occupy.

We have seen in the vicinity of Folkestone, Kent, inclined walls, which have been found extremely valuable; but then the nature of the situation should be taken into account. This was a high, steep bank, forming a natural half-moon-like concavity, probably the remains of ancient excavations: the centre of this concavity pointed nearly due south, so that the ends formed what may be called an east and west aspect. A high bank

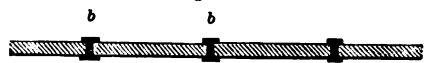
surrounded the whole, thickly planted with pines and shrubs of lower growth: a situation suitable for the purpose could not have been more perfectly made by art. So much in advance were the fruit trees upon the inclined walls in this situation, to what they were upon perpendicular ones in every respect the very counterpart of them, that the fruit ripened invariably—so said the proprietor—from a month to six weeks earlier upon the former than upon the latter. An old gravel pit, chalk pit, or stone quarry, if the aspect is towards the south, is an excellent situation for forming inclined fruit-tree walls—inasmuch as the ground occupied is of little or no account, and the elevations formed, whether by the operation of previous excavations or by the hand of nature, cost nothing; whereas, to provide the same by artificial means would be attended with considerable expense, and in all probability would not answer the purpose so well. The sides of such excavations being smoothed, and brought to the desired form, require no further preparation than paving the surface with bricks laid flat in mortar. We know of few purposes to which such places as are named above could be so well applied as that of planting them with fruit trees. The advocates for the proper inclination of walls will ask, To what angle were these walls referred to set? We believe that little attention was paid to this particular point, but it would be reasonable that they should be placed so as to be perpendicular to the sun's rays at the time, or perhaps a little before the fruit may be expected to ripen. A species of inclined wall may be seen in almost every village in England, where the branches of fruit trees or vines are allowed to grow and are trained over the roofs of houses; and the precocity of the fruit under such circumstances is well known. In estimating the value of inclined walls, we may observe that they present a better angle to the sun's rays at certain seasons of the year than perpendicular ones; but whether this is equal to the cold produced by dampness, and by perpendicular frosts, is extremely doubtful. Damp they must be, compared with perpendicular walls, whether reclining entirely on the ground or partially elevated above it.

*Walls of slate, glass, Arbroath, Caithness, or Yorkshire pavement.*—These, although new features in garden architecture, might be used with great advantage; but of course, like cob or mud walls, they would require to be trellised for the purpose of conveniently attaching the trees to them. These materials can be got of any reasonable size. The mode of constructing them is as follows: Upon a solid foundation, erect cast-iron uprights, or standards like *a a* or *b b* in figs. 90, 91—between these

Fig. 90.



Fig. 91.



set the slates or pavement on edge, either grooved as in fig. 90, or plain as in fig. 91. For a 6-foot wall, slates or pavement can readily be procured, so that one piece shall form the height of the wall, or two pieces a 12-foot one, or, of course, any intermediate height. It would, however, be better, for appearance sake, to have them all of one width, so that the standards may stand at equal distances. Such walls would be exceedingly durable; and they must also be economical in construction, where the material requires no working, except the sawing of them to the required lengths and breadths. This is the case with Bangor slates and Caithness pavement, both of which may be raised in flags of any thickness, and of even surface, requiring no artificial dressing. Such walls have been recommended for forming fire-proof partitions by the late Sir John Robison, in the "Encyclopædia of Cottage, Farm, and Villa Architecture," from which our diagrams are taken.

We have used Caithness pavement very extensively where exposed both to excessive heat, and also to all the changes of the atmosphere without, and entirely concur in the high opinion of it given in the work just referred to. "As regards strength and hardness, it is not equalled by any paving stone used in London; it completely resists the action of the severest frosts; it neither scales, flakes, nor becomes slippery; and from not being porous, it dries rapidly after rains: in

fact, none of the objections so common to the Yorkshire paving, or any other freestone, seem to apply to the Castlehill Caithness paving.

Mr R. Mallet of Dublin, an architect of great taste and ingenuity, has recommended, in the "Gardeners' Magazine," vol. ix. p. 193, the use of slate walls for garden purposes. He proposes to employ cast-iron uprights, the spaces between being filled in with slabs of slate. The section of these uprights to be as in fig. 92: they are to be placed in the plane of the wall, and supported by being set on blocks of stone in the foundations.

Fig. 92.

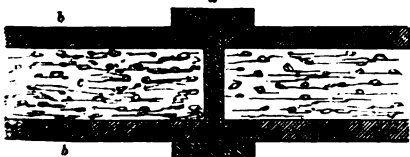


When slates, boards, or flags are used, the breadth of the rebate in the iron post may be considerably less—say an inch, as in fig. 93. Slate 'walls,' of great strength and durability, might be made by filling up the spaces with two surfaces of slate, distant three or four inches, with gravel and grout, or rammed puddle, as in fig. 94, in which *a* is the iron upright, *b* the slates,

Fig. 93.



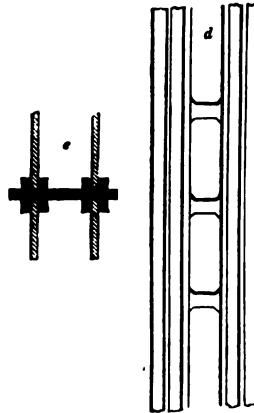
Fig. 94.



and *c* the puddle or filling-up matter. Slates thus placed, from the inertia and non-elasticity of the mass, would almost resist fracture; a blow of a hammer would only punch a hole through, without shattering the slate." Or they may be left hollow; but we question if they could be heated with safety. Slate walls made in the way recommended by Mr Mallet, "with the addition of eyes cast on one side of the iron uprights for the wires of a trellis, and the slates painted black, would appear to be," he thinks, "the best garden walls that could be erected. They could harbour no insects, would not be eaten out by nailing, would look better than brick walls, and the tops of the uprights would be available for rolling blinds, &c., for protection. Per-

haps the deep violet colour of the slates would be the best possible for garden walls, which" he has "deduced from some recent observations on the rays of light and heat. These slate walls might be hollow—viz., filled with rounded pebbles, and nothing else, and thus be heated by steam occasionally, or be entirely hollow, with a double rebate, and perforated uprightly, and become long smoke flues of great depth and thinness, as in fig. 95, in which *d* is the side view of an upright, and *e* a cross section or plan."

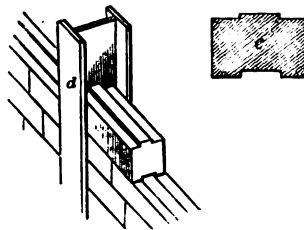
Fig. 95.



Such walls would be both economical and useful, and certainly far more elegant than those in common use. We differ, however, in opinion from Mr Mallet, in regarding them as capable of being heated more especially by flues, as the slates would not stand the heat near the furnaces; and as for jointing them with tar, as he proposes, to prevent the escape of smoke or steam, we consider it the very worst material that could be employed for that purpose.

The same intelligent architect has also suggested, in the work last quoted, a brick wall supported with iron uprights, and the spaces filled in with rebated bricks, as shown in annexed fig. 96.

Fig. 96.

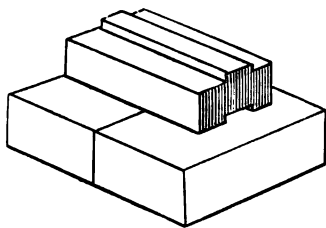


"A 4-inch wall built in this way, with posts at every 4 feet," Mr Mallet thinks, "would be as strong and stiff as an ordinary 14-inch wall, and, excluding the original expense of brickmaking and foundry apparatus, would not cost above one-third of the expense. The bottom



course of bricks should be laid across, under the surface, as in fig. 97. In fig.

Fig. 97.



96, *c* is a cross-section, and *d* a portion of the cast-iron upright, with the bricks placed in its grooves. These bricks lock into one another, and thus may be put together and stand without cement; or they might be merely dipped into thin grout before laying together, and thus their staunchness insured. Rebated bricks of this kind would be as easily made as common ones; and the rebate, like that of a sash, would prevent water from flowing through. The bottom course of bricks should be laid across, under the surface, as in fig 97, to form a broad foundation."

All walls constructed of pavement, slate, glass, &c., being of course narrow, if not built double, with a solid or hollow centre, will require a coping, both for effect, and for the protection of the trees that may be trained upon them. This can readily be added by employing the same material. Walls thus constructed are considered to be of all others the most elegant.

*Concrete walls* are of great antiquity. They are constructed as follows: The excavation for the foundation—the latter being also of concrete—is made to the required depth and width. The depth in this case depends on the subsoil in a much less degree than where no concrete is used—and hence the great utility of concrete in situations where a solid basis cannot easily be reached; for, within a few days of its being finished, it becomes united together into one solid mass throughout its whole length and breadth. When the foundations are brought to their proper height, a strong framework of planking should be made on both sides of the intended wall, and exactly as far apart as the thickness of the wall is designed to be. The greater the length this framework is, the better—as, by the time the operation of filling in the concrete has arrived at the end, the planks at the part

first done may be ready for removal, and for setting a course higher: this, however, should not be attempted until the concrete has become fully set. The framework is then to be lifted up for another course, which course should be only about 18 inches thick. This process is continued till the entire height of the wall is done. When the frame is set, gravel, just as it comes from the pit, and pretty coarse, is laid within the frame to the depth of 4 inches; hot lime grouting is then poured over it in sufficient quantity to cement the whole together; and the same process is followed till the wall is finished. When thoroughly dry, any cavities on the surface may be made good, and the whole rough-cast, plastered, or cemented, according to circumstances. Such walls should be coped with stone, brick, or other similar material; for, like all other walls, the dryer they are kept the better. The proportion of hot lime to the gravel is about one-eighth part only, although some make the proportion one to five, particularly where loamy gravel is used.

The Chinese construct concrete walls much in the same way as described above, only using sifted sand and quicklime in the proportion of about 15 to 1.

*Clay walls.*—Denson, in "The Peasant's Voice," (p. 31,) describes a mode of building mud walls practised in Cambridge-shire as follows: When a sufficient quantity of clay is dug, it is wrought up with straw, and moulded in a frame 18 inches in length, 6 deep, and from 9 to 12 inches in diameter, in the same manner as the brickmaker moulds his bricks. The lumps thus formed are dried in the sun, and, when sufficiently hard, are laid exactly like bricks, and jointed with mortar. The foundation is formed of stone or burned bricks level with the ground surface; and when finished, the wall is plastered or roughcast over, which gives it a clean and neat appearance. Such walls are usually coped with thatch, with broad projections on both sides to keep them dry.

*Cob walls* are the mud walls of Devonshire, where they are common both for garden walls and even for respectable-looking two-storey houses. A house of this description was pointed out to us last year, said to be upwards of two hundred years old. The construction of cob walls is thus described in the "Encyclopædia

of Cottage, Farm, and Villa Architecture," (p. 417)—These walls are made 2 feet thick, and are raised upon a foundation of stonework. After a wall is raised to a certain height, it is allowed some weeks to settle before more material is laid on. The first rise is about 4 feet, the next not so much, and so on—the layers diminishing in thickness as the work advances. The solidity of cob walls depends much on their not being hurried in the process of making them; if hurried, they are apt to swerve from the perpendicular. The sides are pared down as each layer is finished, and the building commences early in spring, in order that the roofing, which is of straw thatch, may be got on before winter. Such walls should be furnished with long metallic-eyed nails when newly finished, or trellised afterwards, for the purpose of fastening the trees to them.

In estimating the merits of cob or mud walls, the late Mr Loudon very justly observes, "that earth or mud walls are not in use in any district in Britain which is in an advanced state of improvement: they appear to be chiefly suitable to a rude state of society, where every man is his own builder, and where mechanical skill and good tools for working in timber and stone are scarce." Mud walls are by no means uncommon in many parts of the south of England; and, if properly prepared and kept dry at the top, are known to last for ages. The great principle of their preservation depends on their being built on a solid and dry foundation, kept well thatched on the top, and properly trellised. They are more economical than wooden walls, and no doubt attract a greater degree of solar heat.

These walls are common in Germany, and are there formed of well mixed clay and straw, used in a state neither very wet nor very dry, and well rammed between two movable boarded sides, retained in their position by a frame of timber, which form between them the section of the wall: these boarded sides are placed inclining to each other, so as to form a tapering wall when finished.

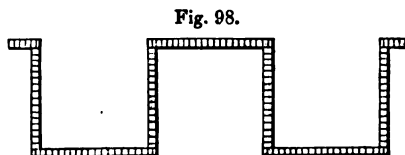
*Flint walls* are of great antiquity, and are very common in countries where this material abounds. The following description of their formation is from the "Land-

scape Architecture of Italy," by Gilbert Laing Meason. "Build up the flints in frames, and pour cement," (concrete we presume,) "into the interstices: the foundation should be on brick arches"—this we, however, consider as superfluous—"and the cement may be composed of thoroughly-burned chalk slacked with water, to reduce it to the finest dry powder; and then sifted and added to two parts of rough sharp sand, with small sharp gravelly stones. The whole should be mixed together dry, and a sufficient quantity of water should be poured upon it, to make it into a liquid paste, which should be used immediately. The slacking of the lime, the mixture, and the application to the walling, should follow one another without delay. A quantity of the sand and powdered lime should be at hand to throw into the moulds, in case the mortar should appear too thin. By such management this cement requires not age to harden it."

From the roughness of the surface such walls require to be trellised, or furnished with eyed studs to fasten the trees to. Flint walls are in common use in many parts of Hampshire, and are there built with common mortar, much in the same way that rubble stone walls are in Scotland. Those who are acquainted with the breaking of flints, contrive with apparently little trouble to make very respectable-looking walls.

*Clinker or scorïa walls.*—The large clinkers or scorïæ formed in furnaces, particularly in those employed in the manufacture of iron or glass, make excellent and durable walls. Their construction is in all respects similar to that of flint walls; and like them they require to be trellised or furnished with eyed nails.

The following are examples of economical walls, of which fig. 98 represents



what is called the square fret wall. It is 4 inches thick, and is formed by joining a series of half squares, "the sides of which are each of a proper length for training

one tree during two or three years." It is admirably adapted for nursery culture. Fig. 99 is a self-supporting 4-inch wall,

Fig. 99.



"formed in lengths of from 5 to 8 feet in alternate planes, so that the points of junction form in effect piers 9 inches by  $4\frac{1}{2}$  inches."

Fig. 100, is a zigzag or angular wall, "in which the angles are all right angles,

Fig. 100.



and the length of their external sides one brick or 9 inches. This wall is built on a solid foundation, 1 foot 6 inches high and 14 inches wide. It is then commenced in a zigzag, and may be carried up to the height of 15 or 16 feet, of one brick in thickness; and additional height may be given by adding 3 or 4 feet of brick on edge. The limits to the height of this wall are exactly that of a solid wall of 14 inches thick—that being the width of the space traversed by the angles or zig-zag. This style of wall may be used as a fence or shelter wall merely; but the unevenness of the surface renders it unfit for training trees against it.

The angular and serpentine walls, figs. 101, 102, have two avowed objects,

Fig. 101.



Fig. 102.

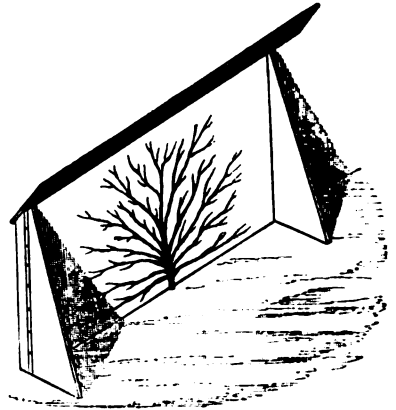


namely, shelter and economy. It has been calculated that walls built upon this principle—the centres of the segments composing the line being 15 feet apart—

might be carried to the height of 15 feet, and only 9 inches thick; and that a 4-inch wall built on the same principle might be carried 7 feet high.

Walls upon an inclined surface, and in exposed situations, may be sheltered as in fig. 103, by having portable wooden wings

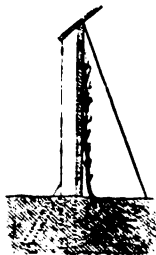
Fig. 103.



set at distances, so as to enclose a tree in each space. They will break the force of the winds, which often sweep along the face of a wall with great power, destroying both blossom and foliage. In some of the oldest gardens we have seen yew hedges planted across the border, to afford shelter in the same way; and were it not that the roots of such hedges rob the border, their utility otherwise is undoubted.

Reed walls, or screens, are very common on the Continent. They are sometimes made portable, being formed in panels so that they can be removed at pleasure, and at other times are fixed structures. These were exemplified in the gardens at Hylands, in Essex, at a time when Dutch gardening was carried on to a considerable extent. They are, however, of far too perishable nature to be much used in this country.

Fig. 104.



Walls of slate, boarding, or felt, may be erected as shown in fig. 104. The slanting coping is of boarding, amply protecting the southern, or best side, but at the same time in-

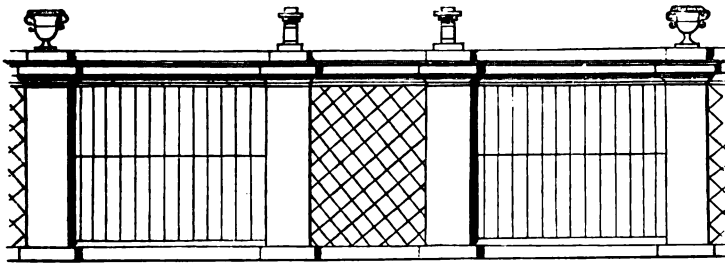
jurious to the northern, or worst side, by throwing all the rain in that direction. The diagonal line shows the direction of cords, or wooden rods, to prevent the canvass screens from being blown against the trees by the wind. During the day the canvass is rolled up, and is fixed under the coping to keep it dry.

*Screen walls* are projecting walls placed at right angles with the main ones, and are sometimes carried across the borders at their full height, at other times partly so, and sometimes in a slanting direction from the top of the wall to the walk. When placed at 100 or 200 feet apart in

exposed situations, they afford advantages in breaking the force of the wind. Some have, and with evident success, used boarded projections from 2 to 6 or 7 feet, fixed to the wall by massive hinges, so that they could be removed with little trouble, and indeed set to any angle that might be deemed most expedient. Such a mode of shelter was employed in the old gardens at Drumlanrig; and, we believe, remained till these gardens were dismantled about twenty years ago.

*Conservative walls*, fig. 105, owe their origin to Sir Joseph Paxton, who has long most creditably discharged the

Fig. 105.

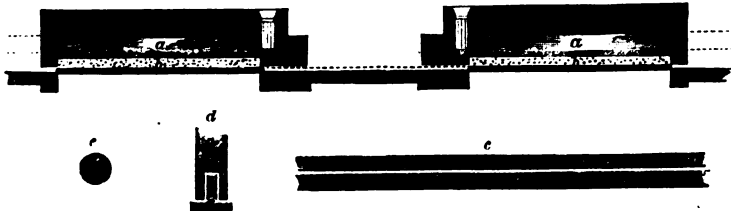


duties of curator of the gardens at Chatsworth, and now discharges the responsible duties of general director of the Duke of Devonshire's immense properties both in England and Ireland. From his excellent "Magazine of Botany" we have taken our drawing and the substance of our description. Sir Joseph observes that, in forming a wall of this description, a south or south-west aspect is desirable. It is also of importance to give an ornamental character to it by throwing it into compartments or panels, by projections at equal distances from each other, by an appropriate cop-

ing, and by chimney-tops and vases surmounting these projections, as in the accompanying figure. The situation of the conservative wall at Chatsworth requires it to be highly ornamented, or rather to be strictly architectural, as it is so near to the most splendid architectural mansion in England. The principles, however, of a conservative wall having all the advantages of projections and recesses, and suited to situations having few or no architectural pretensions, may be carried out in a plainer manner.

The above figure "is an elevation of a highly ornamental conservative wall,

Fig. 106.



which may be extended either way to any required length. By referring to the ground-plan, fig. 106, part will be seen,

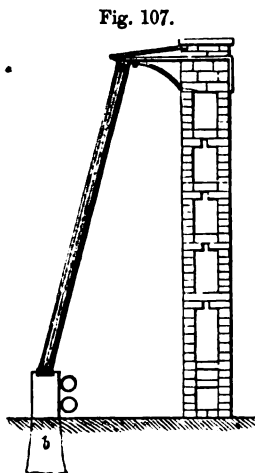
on a parallel scale. This shows the furnaces at the back, in the form of gratings; the flues *a a*, which are carried

under ground, from one division to another; and the space for plants *b b*. The elevation will be perceived to consist of plain pillars, crowned by the chimneys connected with the flue, and by simple vases over the intermediate pillars. The space between the pillars supporting the chimneys stands much more forward than the rest, and is faced by a trellis. The receding parts can be covered at pleasure with a glazed light or lights, which, when not wanted, can be made to slide on rails behind the projecting portions. The rail at the back of the screen wall is shown on a larger scale, at *c*; and the bottom of the sliding light, with its revolving roller, is exhibited at *d*. A side view of the roller inserted at the base of the sash-frame is given at *e*. A review of the chief features of the plan will leave the following general ideas: The wall is composed of alternate prominent and retiring compartments. Each of the former includes two stone pillars, which stand out a little beyond all the remainder, and are to be left uncovered; while between them is a division, over which is extended a trellis for supporting the hardier kinds of climbers, and those that demand no protection. The recesses are capable of being covered in cold weather with glazed sashes, which can be placed out of sight in a moment, whenever it is safe to remove them, by sliding them behind the other divisions. In these recesses the tenderest greenhouse plants may be cultivated and trained against a trellis, which could not be

shown in the figure. Thus are combined a handsome architectural elevation, and the means of having some of the finest exotic plants exposed in summer, without danger, and in a condition incomparably

more healthy and attractive than they ever attain in the greenhouse."

A conservative wall, having no architectural pretensions, may be constructed upon the principle of the annexed figures. The section, fig. 107, shows a hollow brick wall which may be heated by hot-water pipes



placed near the bottom, or placed as shown in figure, having a portable projecting coping 18 inches in breadth. This coping is supported upon iron brackets, the upper part of which pass through the wall, and is turned down behind, or fastened with a broad-headed nut and screw, for greater strength. These brackets are fixtures. The wooden coping is fixed to the brackets by thumb-screws, and is let into a shallow groove under the stone or other permanent coping, unless in cases where the coping projects more than 2 inches, in which

Fig. 108.

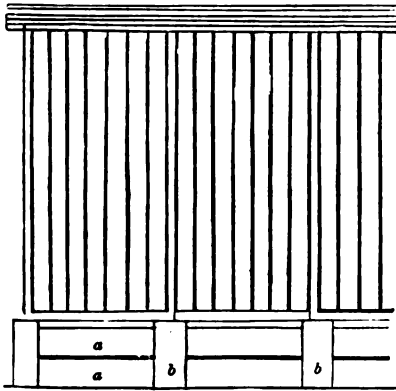


cases the groove would be unnecessary. In front of the wall are placed, at the distance of 6 feet apart, stone or cast-iron pillars *b*, on figs. 107 and 109, rising 18 inches above the surface of the ground. Upon these are laid cast-iron rails, fig. 108, the whole length of the wall, and 8 inches broad, having two beads cast on their upper side, quite parallel to each other. The space between the surface of the ground and the bottom of the rails is to be filled in with boarding, as seen in the

elevation, fig. 109, *a a*, it being considered expedient to keep the glass sashes quite clear of the ground, that they may not be injured by damp. Corresponding iron rails, but lighter in construction, are attached to the points of the brackets at the top of the wall; hence the extra strength required in these brackets over those in ordinary use. These rails above and below being fixed in their places, the whole is then ready to receive the glass sashes, which

are to be placed at a suitable angle of elevation, and move along the top and bottom rails with freedom. The top and bottom rails of the sashes are hollowed out, and furnished with hollowed gun-metal rollers, of an oblique form, suitable to the angle the sashes are to

Fig. 109.



be placed at, which embrace the iron beading, and cause the sashes to run freely along them. Each sash overlaps the other about 2 inches when shut; and as every other sash moves upon the same line of rail, it can pass the other alternate sash without interruption, and can be totally removed when no longer required for the protection of the plants. This we think the simplest of all conservative walls; and as the materials, with the exception of the stone supports and brackets, which are permanent, can be removed when no longer required, and used for the ripening of peaches, grapes, figs, &c., on any ordinary wall—having only to be fitted with brackets and stone supports, for the reception of the rails—such walls are worth the attention of all who have gardens, whether large or small.

The stone supports may be made the pedestals of vases or ornamental flower-pots during summer, and the brackets may easily be covered with branches of shrubs or creepers during the same period. All the operations of culture are performed from the outside; and in winter the border, as far as the roots are supposed to extend, is covered with coal ashes or other non-conducting material.

As glass is now one of our cheapest articles of manufacture, it is scarcely necessary for us to suggest substitutes. However, we may observe that thin canvass, previously steeped in a tan-pit, transparent cloth, or patent felt, may be employed;—the two former ranking next to glass, on account of their transparency; the latter being only adapted to ward off cold, but without the advantage of affording light to the plants.

Viewing glass screens like fig. 109 as a medium for ripening fruit, the objection, which is a perfectly valid one, will be made, that they are placed at an angle badly suited for that purpose. Hence we ought to explain, that such coverings are intended only for the protection of exotic flowering plants during winter and early spring—the plants then requiring protection, but not excitement; and only when no longer required for such a purpose are they to be employed for the ripening of fruit upon a portable structure, and for that purpose they may be placed at an angle by which the fruit and foliage may derive to the fullest extent the advantage of the solar rays.

Another mode of arrangement may be adopted; and those who may object to the 2 feet or so of wooden framing occupying the space between the surface of the ground and the bottom of the under rail, may prefer it. This is, to lay a stone plinth from 6 to 12 inches in thickness, supported on an arched or piers foundation, to admit of the roots extending themselves; this plinth is to be permanent, and on it the rails are to be laid, all other particulars being the same as in the preceding case. In front of this plinth a gravel or pavement walk should be constructed, at least equal to half the height of the wall, if for the protection of flowering plants only, as it is desirable that the eye be brought near to them. If an architectural coping and slightly projecting piers are indulged in, vases should be introduced along the top, while a corresponding stone plinth should form the outer side of the walk, whether pavement or gravel, having its complement of vases or other mural decorations corresponding with those on the top of the wall.

Stone blocks may be built in the wall instead of iron brackets, as described in

the "Gardeners' Magazine," (vol. ii. p. 431,) of which the annexed cuts are a representation. To these rafters may be attached, and covered with glass sashes, supported at the bottom on a plinth of stone or portable framing of timber. Fig.

Fig. 110.

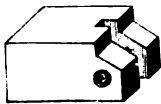
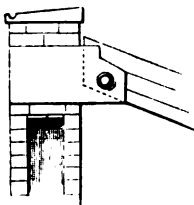


Fig. 111.



110 shows the stone block to be built in the wall; fig. 111 the top of the wall with the block in its place, and the end of the rafter inserted into it, and kept in its place by an iron bolt. The coping is shown as throwing the rain water to the back of the wall, into a groove cut in the stone, from whence it is taken away by small leaden pipes placed at proper

distances. The wall is built hollow, and heated by hot-water pipes.

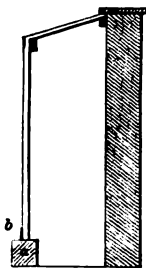
Referring again to the "Magazine of Botany," we find that the plants on the conservative wall at Chatsworth are covered "in winter with canvass curtains suspended from an iron rod placed beneath a movable wooden coping, and fastened at the bottom, at short distances, by means of rings and hooks. The hooks are fixed to a board about 10 inches broad, which runs along the bottom, and is attached by hinges to a framework firmly set in the ground. When the curtains are drawn back the board lies partly over the border with the hooks towards the earth, and makes a convenient path to stand upon whilst dressing the trees. The curtains are opened and closed by cords moving on pulleys: in the daytime they are neatly drawn up and secured to the projecting buttresses. There are two to each compartment—hence, to cover the wall, these meet in the middle; and as one curtain is provided with eyelet holes, and the other with rings to pass through them, they are readily fastened together by running a cord through each of the rings from the top to the bottom of the wall. The whole, except the board into which the hooks are driven, can be entirely removed in summer."

*Dick's protecting frame* may be considered as a species of conservative wall,

the intention of the inventor being to preserve not only the blossom in early spring from the effects of frost, but also the fruit when ripe from the attacks of flies, birds, and wasps. A figure and full description of it will be found in the "Transactions of the Horticultural Society of London," and also in our "Practical Gardener." It is most effective in principle, but by far too complicated in its construction to give it superiority over other modes of protection of simpler forms.

Fig. 112 represents a more simple and effective method, well suited for protecting half-hardy plants trained against a wall.

Fig. 112.

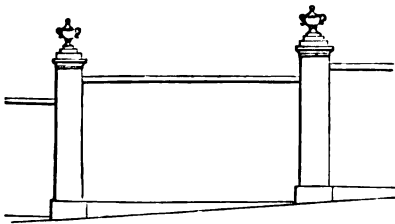


continued in a sloping direction from the top of the upright part of the rafter to the wall, to which it is secured by being screwed to brackets permanently fixed into the top of the wall. A 3-inch batten is fastened to the ends of the rafters close to the wall, and another, 6 inches by 3, set edgewise, to the ends of the sloping part farthest from it, having  $1\frac{1}{4}$ -inch ties between them, placed over the uprights; to these, patent asphalt roofing felt is secured in autumn, and left on until all danger of frost in spring is past, forming a roof perfectly water-tight. Along the front of the upright part of the rafters, close to their bottom, is fixed a flooring board *b*, of the usual size; to the 6-inch batten is nailed thin semi-transparent canvass which reaches to the bottom board, and is there furnished with small brass rings 3 or 4 feet asunder, which are hooked on to studs fixed opposite to them in the board, keeping the whole tight. When it is required to open this screen for the purpose of exposing the plants to the air and sunshine, it is drawn up to the top by means of brass rings sewn on to the inner side, through which cords are run in the manner often applied to

the drawing up and down of window-curtains. The canvass being thin, as much light passes through it as through the inferior qualities of glass; and being at a little distance from the plants, and the whole kept dry by the felt roofing, it has been found that plants have stood the winter under such protection as well as if in an ordinary greenhouse without fire heat.

The best of all ways of forming conservative walls, now that glass is so cheap, would be to have portable structures with glass sashes, to fit up in autumn and remove in spring. During summer, they could be employed in a variety of ways, of which the ripening of the finer kinds of pears is perhaps not one of the least important. A conservative wall, where the ground is of unequal level, or with a sloping surface, may be constructed as in the annexed diagram, fig. 113. The

Fig. 113.



panels formed by the projecting piers should be regulated in lengths according to the rise of the ground, so that the breaks along the top may not be too great. Its height also should be arranged to suit the circumstances of the place, as well as its architectural character. Walls much out of the level cannot be very conveniently heated by flues, but they may be so by hot water, placing the boiler at the lowest point. The piers should terminate in vases, and project from 1 to 2 feet, according to the height of the wall; this also should determine their breadth. The coping should be massive, and project not less than 12 inches. Under the coping, and near its front, should be fastened strong rods of wire, upon which the protecting curtains should be hung, running with rings upon the wire rod, so that they may be drawn aside in fine weather, and secured to the piers. Or they may be so arranged as to draw up and remain under the projecting coping.

If the wall do not exceed 9 or 10 feet in height from the ground to the under side of the coping, a permanent iron rail, with double grooves  $1\frac{1}{2}$  inch in width and the same in depth, may be laid along its front, and in a line with the outsides of the piers—a corresponding one in wood being fixed to the front of the coping in autumn, and removed again in spring. Between these rails, canvass or felt framed shutters may be placed, which will exclude the frost and wet; and as they, by this arrangement, will readily pass each other—being alternately in different grooves—ventilation and exposure can be readily given to the plants. The border in which the plants are set should be exceedingly dry; and as a walk, of necessity, will pass along the front, their roots getting into it will be no disadvantage, as the less such plants are nourished, and the drier their roots are, the better they will ripen their wood, and consequently stand the winter better. If the situation of the wall is such as to admit of it, both sides may be alike; and it matters little what aspect it is set to. Should one side face the south, there are plants which prefer that exposure; while many others will stand on a northern exposure better than on a south one.

Regarding the style or construction of a conservative wall, the late Mr Loudon very properly observes that it should not be a "common erection, presenting only a flat perpendicular surface and a horizontal line. At top, it may have piers at regular distances, terminating in caps surmounted by vases above the height of the wall, but arranged in form and proportion so as to harmonise with the conservatory or house. In the case of a Gothic or Elizabethan building, these piers and their terminating ornaments should of course vary accordingly. Instead of piers, the face of the wall might be broken by arched recesses; and while a more delicate kind of plant occupied that part of the wall which formed the back of each recess, a much hardier kind might be trained to the projections between them.

"Where the style was Gothic, the wall might be covered with a series of piers and intersecting arches; and if the piers and imposts of the arches were covered with ivy, and the rest of the wall with



deciduous plants, the effect, more particularly in winter, would be very striking. An excellent plan for varying such a wall is, to form the ground-plan in a zigzag line, with piers at the angles—in which case the length of each angle may be 10 feet, and the deviation from a straight line from 2 to 3 feet. In going along the walk in front of such a wall, one series of angles would meet the eye, and in returning, another series. A temporary veranda, in which the framework is to be covered with hurdles clothed with thatch, or with canvass fixed to framework, or oiled paper, forms a very good protection for plants while in their dormant state, but requires to be removed much sooner in spring, when they begin to grow, than a glass roof; because, when the plants begin to grow under an opaque roof, they become etiolated and blanched for want of light. In general, conservative walls should be flued, in order to give the power of assisting the ripening of the wood in autumn." This, in a cultural point of view, is of much importance, as the better the wood is ripened, the better it will withstand the cold in winter. Conservative walls might often be formed by constructing piers or buttresses against the dead walls of offices, whose backs look into the pleasure-ground; and instead of their being an eyesore, they might be thus transformed into very interesting objects.

*Permanent studs for garden walls.*—Garden walls, of whatever material they may be constructed, are expensive erections; and if properly built and taken care of, they will last for ages. To insure durability, all walls, when first built, ought to be furnished with either cast-iron eyed or headed nails, pushed in to the joints, before the mortar or cement is set: 9 inches apart each way may be taken as the minimum, and 15 inches the maximum distance apart. To these the trees should be secured by soft twine previously steeped in pyroligneous ether. This will not only be found an immense saving of material ever after, but will secure the wall against those annual defacements which arise from driving in and pulling out thousands of nails, both in the joints and in the bricks. We have long given up the use of nails and shreds, and cannot too strongly recommend all who wish for the preservation of their walls to follow

our example. Previous to using these studs, they should be made red hot, and thrown into a vessel of boiled oil with a little red lead, to give them a brick colour, as well as to prevent corrosion and insure durability. When once in, they never require to be removed; and hence the joints and bricks are secured from injury. Should at any time a stud be in the way of a large branch, it is easily broken off by the surface of the wall. Since we introduced the use of the eyed nails, some fourteen years ago, we believe Mr Croskill of the Beverley Foundries has manufactured several millions of them.

In old gardens the walls, in course of time, by the use of the nail and shred system, became so defaced as sometimes to require to be entirely taken down and rebuilt, or otherwise repaired—a danger which the use of the permanent studs completely obviates.

"The walls at Trentham had become so battered and disfigured that it was necessary to repoint them, and to plaster up the holes in the bricks, in order to bring the whole to an even surface. To conceal this patchwork, the walls received a coat of stone colour, and by this means all insects were effectually smothered. This is repeated once in two or three years, taking care not to let the material fall on the branches. The proportions of the ingredients used in forming the colour are as follows:—16 lb. umber, 4 lb. ochre, 1 lb. lamp-black, and 4 quarts of coal-tar; these are boiled together in 30 gallons of water, and applied to the walls as hot as possible."—FLEMING in *Journal of Horticultural Society*.

We use for the same purpose best Roman cement made into a thin paste, with sour milk and sweet wort,—that is, an infusion of malt,—and lay it on with a common whitewash-brush quite cold, giving it three coats, the one following the other as the wall dries.

The following explanation of the technical terms used by bricklayers, in connection with such work as garden walls, will be useful to the general reader.

Those bricks which lie in the same direction as the line of the wall are called *stretchers*; those crossing the wall are *headers*; and, when smaller pieces are used, they are called *closers*. The object of arranging bricks as stretchers and headers

is to gain strength, or what is in practice called *bond*. The rows of bricks are designated *courses*. *Grout* is mortar thinned with water: it should be used moderately hot—that is, made of newly-slacked lime: it is often used in solid brick walls, whose centres are packed with *bats*, or fragments of bricks, flints, small stones, &c. It sets rapidly, and cements the whole well together. When a course of bricks is laid, having two stretchers and a header placed alternately, (the headers of every course resting on the stretchers of the course below,) the arrangement is called Flemish bond. When a course consists entirely of stretchers, and the course over it entirely of headers, it is called old English bond. When several courses of stretchers have only one course of headers, it is called *running bond*. Flemish bond is generally preferred by workmen, as the perpendicular joints are more easily kept, by which means their work looks better and is less troublesome: the practical difficulty they have to contend with is, that in the header courses, the joints which show outwardly being multiplied, they are apt, if not attended to, to overrun those of the

course beneath, when either a straight joint must occur, or a closer must be inserted. For every wall above one brick in thickness English bond is preferable; but for walls of a single brick in thickness, Flemish bond is best, if the joints are kept perpendicular over each other in the alternate courses. Closers should never be allowed except in the quoins, where they necessarily must occur, in order not to weaken the work. The following four particulars should be carefully attended to in brick-building: first, That the foundations be set off perfectly level, so that each course may lie perfectly horizontal, to provide a level bed for the course above it; secondly, That they be placed so that the joints of each course may be directly over the solids of the course next below it; thirdly, That the joints be kept perfectly perpendicular; fourthly, That no more mortar be used than is absolutely necessary to produce adhesion—and for this reason it is usual to restrict the workmen to joints not exceeding five-sixteenths of an inch for each bed of mortar. Walls with such joints will not only look better, but will be both stronger and more durable.

## CHAPTER III.

### HOTHOUSE-BUILDING.

#### § 1.—GENERAL PRINCIPLES.

IMPROVEMENTS in hothouse-building appear to bear no comparison with the improvements that have taken place of late years in other departments of horticulture. This seems sufficiently proved by the fact, that so few—not more than half-a-dozen cases—of even very modified improvements have been exhibited in the Crystal Palace. Of these we notice two model greenhouses by Mr Dench, in which the metallic sashes are galvanised, and corrugated galvanised iron plates are employed to form the outside of the front parapet wall, while plain plates are used inside, as substitutes for a brick wall. Some parts of the woodwork are left plain, while others are covered with thin plates of iron. If we are to have metallic hothouses, let us have them out and out; but all combinations of wood and iron, such as those here presented, are behind the intelligence of the age. The other improvements exhibited in the Crystal Palace appeared to us to possess neither novelty nor merit. What Mr Dench's motive may be for substituting plates of iron for brick in the parapet walls we know not. This much is certain, that they are neither so cheap nor so capable of resisting cold.

Viewing the Exhibition, therefore, in a horticultural point of view, we are compelled to confess our great disappointment at its presenting so few specimens of improvements in this department. We had, indeed, glass of all shapes and sizes; but we looked in vain for specimens of glazing, although a matter of so much importance. Even the almost worn-out subject of heating seemed to have been lost

sight of, if we except a few of those health-destroying toys called "hot-air stoves." From the painting of the interior, so artistically carried out by Mr Owen Jones, the ornamental hothouse-builder may take useful hints; and future conservatories at least may bear some evidence of the improved taste of 1851.

We need not refer to the original construction of hothouses, either in this country or on the Continent, further than to remark that they were by no means calculated for the preservation of tender exotic plants, and still less for the production of tropical fruits—as they were little other than large rooms, having windows in front, more in number and of larger size than those used in dwelling-houses. The first improvement on these was the adoption of what has been called the lean-to roof; this, till about the beginning of the present century, continued to be the form in general use, and for some purposes it will probably continue to be so. Various improvements, more especially as regards their internal arrangements, mode of heating, &c., were projected, and carried into beneficial effect by the garden architects of the day; amongst whom the late Thos. And. Knight held a conspicuous position, and revived the views laid down by Boerhaave about a century previously, as to arranging the angle of the roof to the situation and purpose for which the house was principally intended.—(*Vide* sec. ANGLE OF ELEVATION.)

Sir George M'Kenzie, a few years afterwards (1815,) proposed what he thought to be the best form of roof for the admission of the greatest possible quantity of the sun's rays—namely, a hemi-

spherical figure or globe; but as this figure seemed to be unattainable in practice, he then proposed to make the roof the segment of a circle. This may be said to have been the most scientific improvement suggested up to that period; and out of it arose the various modifications known as curvilinear roofs, of which many exemplifications are to be met with, but certainly not so many as might have been expected. Long before this, however, we should have observed, span-roofed houses were in use. These possess many of the properties of the curvilinear form, without being so expensive in the erection. We were long opposed to curvilinear houses on account of the expense, more especially those of the lean-to form, or those which, although the roof was curved, still retained the opaque back wall, a mode of construction which to us appeared to be only a very slight improvement indeed over those in common use with straight roofs, and one certainly not proportionate to the extra expense of their formation.

The improvements in hothouse-building may be said to be now only "beginning to begin;" and there is, no doubt, a wide field open for the exercise of judgment and invention.

A writer in the "Annals of Horticulture" observes: "There is yet much remains to be realised in the erection of houses for the cultivation of plants, not only as regards their number and dimensions, but also their arrangement and details. We seldom see more than the same kind of flat lean-to or span roofs—the same kind of formal stages where the plants are grown in pots—and the same kind of formal beds when the latter are planted out in borders of prepared soil. Even refinements or elegances of construction fail to invest such buildings with any character of distinctness or novelty, owing to the sameness or monotony which forms the basis of the design."

The last and greatest improvement in hothouse roofs is certainly that of the ridge-and-furrow form, first suggested by the late Mr Loudon about the year 1816, and afterwards so completely wrought out by Sir Joseph Paxton in the large house at Chatsworth, and elsewhere, and more recently by covering in nearly 20 acres for the Great Exhibition in

Hyde Park, the most stupendous erection hitherto constructed of iron, timber, and glass, and exemplifying most clearly the possibility of extending the same kind of pillared covering over any space, however large.

A third claimant has, we may observe, very recently, in "The Builder" and other papers, come forward, not only to share with Mr Loudon and Sir Joseph Paxton the merit of this discovery, but in reality to claim the whole merit to himself. We are not so much surprised at the claim made by the reverend gentleman, as at his extreme modesty in not asserting this supposed right long ago—the more so, as he has been a frequent correspondent in several horticultural periodicals during a considerable number of years. From our own personal intimacy with the late Mr Loudon, we know that the ridge-and-furrow principle of roofing was thought of by him long before any exemplification of it had been attempted in Britain. To Sir Joseph Paxton, however, the merit belongs of bringing this greatest of all improvements into practical use; and even had the idea been entertained by others, it is questionable if many would have had the boldness or the means to have brought it to perfection.

Mr Loudon's first idea of this mode of roofing suggested itself to him after reading a paper by Sir George M'Kenzie, published in 1815 in the "Transactions of the Horticultural Society of London," "on the form which the glass of a forcing-house ought to have, in order to receive the greatest possible quantity of rays from the sun."

The Rev. Mr Carlisle, the claimant to whom we have alluded above, has lately stated, in a letter to the editor of the "Morning Herald," that, so early as 1828, when he began to make his gardening experiments, he "spent considerable time on the laws of optics and the formation of a glass roof embracing three aspects, in order to prolong the heat, and obviate the necessity of late fire-forcing." He calls his invention the Vandyke roof. "In the midst," he says, "of hail-storms rushing like eddies from all points of the compass, I tried at various times the comparative merits of the common flat roof and the Vandyke

model. The flat had generally more than one half the panes of glass broken, while the Vandyke remained uninjured." He also invites the inspection of the curious to his domicile, and gives reference to several roofs of this description which he constructed for various individuals; but none of them are dated earlier than thirteen years ago, at which time the large conservatory at Chatsworth was in existence.

"This style (the ridge-and-furrow) forms the basis of the plan which promises to subvert the monotonous interior arrangements" hitherto followed, "inasmuch as, when applied on a grand scale, it facilitates the covering of larger areas of ground, in which the absolute necessity of departing from long-cherished arrangements must eventually lead to great improvements in this respect. But now, as even generally applied, this style of building leaves the interior unchanged—for the same mode of disposing of the plants is in most cases followed. This ought not to be. Gardens would lose half their charms were we to see the same thing imagined everywhere. It is, in fact, in the endless variety, in connection with intrinsic beauty, of which they admit, that their fascinations rest. And why should it not be so with horticultural erections for the growth of exotic vegetation? Why should these, which are to a certain extent invested with the additional charm of variety, be deprived of the charm of that variety? Why should we not have groves, and lakes, and flower gardens, and rocks, and caverns, with their appropriate vegetation within as well as without? In the former case, their beauties would be available either for admiration or study at all seasons; in the latter, the fickleness of our climate often acts as a preventative to both these exercises."—*Annals of Horticulture*.

The greatest advantage of a ridge-and-furrow roof is, that any extent of area may be covered without internal walls. Indeed, no walls whatever are required, as the sides and ends may be glass close to the ground—the whole being supported on cast-iron tubular columns, with cast-iron valleys or gutters. A good idea of the effect and practicability of roofing over a whole garden may be obtained by a careful examination of some of our most

extensive railway stations—that at Derby, for example, which we believe could be extended over a hundred acres if required.

Plate XII. and the description are of a garden covered with glass, upon the ridge-and-furrow principle, and heated by hot-water pipes and vases, upon a principle we believe to be efficient, and at the same time ornamental. The working drawings were prepared by us in 1840, with a view to its being erected at Dalkeith. The temperature intended to be maintained was that sufficient for repelling frost, in order to the formation of a garden in which a supply of flowers, and the more delicate kinds of fruit and vegetables, might be procured throughout the year.

Plate XII., fig. 1, is an exterior elevation in projection, supposed to stand clear of all other buildings, and upon an elevation of 3 feet above the surrounding ground, enclosed within a parapet, and surrounded by a broad gravel or pavement walk.

The building in question was intended to be simple and plain in all its details; but there is no reason why an expression of architectural character should not be given to it, by employing architectural columns for the support of the valleys instead of plain ones, and carrying a cornice or frieze along above them, with appropriate ornaments planted on the pediments. These things, with an architectural parapet surrounding it—with the necessary flights of steps leading to the terrace, and appropriate balustrading and vases—would give effect, which, whatever be the style of architecture, cannot fail to please. The Doric, Ionic, or Corinthian orders may be adopted, as may best harmonise with the style of the mansion; nay, even the Gothic or old English may, with certain modifications, be substituted.

Fig. 2 is the elevation of the whole of the upright sashes and pediments, from the plinth to the plate under the gutters, all of which are movable, being made to run on two lines of iron rails attached to the top of the plinth, and in two checks or square grooves in the wall-plate under the ends of the gutters. Or if a deep cornice or frieze is indulged in, these movable sashes may be hung upon the suspension principle, by which their movement will be greatly facilitated.

The bottom rails of the sashes being

provided with concave gun-barrel metal rollers, their movement along the rails will be easily effected. The whole of these sashes may be removed if desired; the one half running on the inner line of rails can be taken out at one end, and those on the outer rails at the opposite end. Bottom ventilation is secured by running each sash either wholly or in part behind the one next to it. The four centre sashes are shown in the fig. as out. The space between the upright or supporting cast-iron columns is 20 feet, and the height from the stone plinth to the bottom of the gutters is 10 feet. The supporting columns of the sides and ends are square, and hollow, for the purpose of taking down the rain water to the tanks under ground. The columns in the interior of the house are round and tubular. The reason of the exterior ones being square is, that the sashes may fit closer to them than they could to circular ones, for the exclusion of cold.

The pediments are carried up perpendicular to the front, and are fixtures. The whole structure stands upon a stone plinth, 6 inches above a pavement or gravel walk, which goes all round, 10 feet in width and 3 feet above the outside ground-level, and reached by a flight of five steps placed at the middle of each of the four sides, at which the entrances are, as shown in the ground-plan. This walk is enclosed with a balustrading of ashlar, 2 feet from the top of the pavement and 5 feet above the general ground-level, divided by piers placed so as to correspond with and be opposite the upright columns. The compartments are divided by pilasters 18 inches broad, projecting 4 inches beyond both sides of the wall, and rising 9 inches above it for the reception of ornamental vases.

Fig. 3 is a cross section from east to west, showing the roof supported on tubular columns, through which the rain water passes down to underground tanks. The columns in this direction are 20 feet apart, and the roof is supported as is shown in fig. 4 upon a larger scale—thus giving strength without crowding the interior with too many columns. The rafters, ridges, suspension-rods, and gutters, are of iron; the astragals for the reception of the glass are of wood, and supported in the middle by an iron purlin 3 inches

by 1 inch—*a*, in fig. 4—which ties the rafters together, and also keeps the astragals in their proper places, as each is screwed down to the purlin, as well as mortised into the ridge and also into the gutter, each of these being cast with a dovetailed mortise for the reception of the astragals. The sides of the rafters are cast with a groove in them instead of a rebate for the reception of the glass, and the astragals are provided with similar grooves, so that the usual fixing in of the glass with putty is dispensed with. The ridge is of two plates of iron, to which the rafters are fixed; but the sides of the ridge are kept apart by iron studs, leaving a clear opening of 9 inches along the whole length of the ridge for top ventilation; and over that space is placed the lantern system of ventilation, as shown at fig. 31, by which by one movement the whole openings of a ridge 300 feet in length can be opened simultaneously.

Fig. 5 shows part of the elevation of one side of a ridge, and also the longitudinal section of the building in the direction of from north to south. In this case the upright columns are 40 feet asunder. They also are tubular, for conveying down the rain water. The same principle of suspension is shown here and upon a larger scale in fig. 6, as in figs. 3 and 4. A very slight inclination is given to the bottom of the gutters from the points at the centre between the columns, to drain off the water. This is so slight, that casting the bottom of the gutters one quarter of an inch thicker at *a*, in fig. 6, than at the ends where they meet over the upright columns, will be found sufficient for the purpose. And even that inclination can be given by a slight bend in the process of casting, without altering the thickness of the metal.

Fig. 7 is the ground-plan, 240 feet long and 220 feet broad. The entrances are in the centre of each side and end, with walks 8 feet in breadth intersecting the space into four divisions. A border extends all round between the glass sides and the walk, and another between the walk and the principal divisions. A circle of gravel occupies the centre, in the middle of which is an ornamental cast-iron grating 4 feet in diameter, a portion of which opens so as to admit of free access by a stair to the vault below,

fig. 9, in which the heating apparatus, &c., is placed. Along each side of the two centre walks, and the inner side of the outer surrounding one, are placed highly ornamental cast-iron vases, (fig. 8,) supplied with hot water from the boilers underneath; a line also of vases is carried diagonally across the space from the centre to each corner, their use being to act as radiators of heat during autumn, winter, and spring—those by the sides of the walks to be furnished with specimen plants in pots during summer, when not required for heating. These vases have movable tops which fit into grooves partially filled with water, which renders them steam-proof when a dry atmosphere is required; while, by removing these tops, or even a portion of them, a humid atmosphere is at the command of the owner.

This mode of heating may startle some, and therefore requires explanation. The mains which proceed from the boilers are 4-inch pipes laid 4 inches clear of the surface; those which run parallel with the walks serve for margins to them; those in the diagonal lines are the same height above it. The vases are placed over the mains, which have nozzles cast on them at the proper distances; the hot water rising from the mains ascends up the centre of the vases, as shown by the arrows; and as the heat is given off by radiation round the outer surface, and the water becomes cooled, it descends round the sides of the vases into a hollow moulding, which, communicating with four 1-inch pipes, two only of which can be shown in the section, (fig. 8,) delivers the colder water into the conducting hot-water pipe from whence it came. Three distinct boilers are placed, as shown in fig. 10, for each quarter of the structure—being twelve in all—one of which communicates with the diagonal line, the other two deliver their water along two sides of the division, all three terminating at the corners *a a a a* on ground-plan fig. 7, and, descending, enter one general return-pipe under the diagonal line, back towards the boilers, where they branch off into three separate pipes, one to each boiler. By this means there are ninety-six radiating vases to heat the atmosphere of the structure, in addition to the extent of piping. To lessen the amount of heat,

the flow-pipes in the diagonal lines may be left unheated, or indeed, any number of the others may be shut off by stop-cocks. From the extent of radiating surface offered by these ninety-six radiators, we presume that most of the heat taken from the furnaces will be diffused through the atmosphere to be heated; and this, with the great length of pipes laid round the sides of the walks, and supplied by twelve boilers, must give heat sufficient for the purpose intended.

At the bottom of each column for the conveyance of the rain-water should be placed a reservoir under ground, and from each of these should be laid a pipe to convey their superfluous water to the grand reservoir *a* in fig. 9, from which the supply for the boilers may be taken. Each of the smaller reservoirs should be covered with a piece of pavement, as a plinth on which the column is to stand; and in it should be a small hole into which a pipe attached to a portable pump can be introduced, for the purpose of drawing up the water for watering, syringing, or even for filling up the vases while heating is going on.

These vases are employed under the impression that they will be more ornamental, and will give out more heat by radiation, than if the heat depended entirely on the pipes laid parallel to the surface.

Fig. 9 shows a section of the vault under ground; *a* being the reservoir for receiving the whole of the superfluous water; *b b* the direction of the flow-pipes from the boiler; *c c* the flues; *d* the stair leading to the vault; *e e* the area for attending the furnaces, &c.

Fig. 10 shows the ground-plan of the vault; *a a*, &c., the boilers, of which there are twelve; *b b*, &c., the flow-pipes rising perpendicularly from the boilers to the horizontal mains; *c c*, &c., the direction of the smoke flues after leaving the furnace and circulating towards *d*—the main flue into which they all unite, and which is carried under ground parallel to the tunnel or passage, and close to it—being also furnished with smoke-traps for the purpose of extracting the soot, till it reaches beyond the garden, where the level rises, and the smoke is carried up into a shaft in an adjoining wood; *e e* is the general reservoir; *f f f f* are spaces

for coal, ashes, &c. : a supply of the former may be laid in at once to last a month, and a general clearance of the latter may take place at the same time. The tunnel *d*, through which the main flue runs, is sufficiently capacious—being 7 feet wide by 7 feet high—to form a passage from the exterior to the vault, through which the operations of attendance are carried on, the fuel brought in, and the ashes removed. Through this passage, which is enclosed with a door at the extreme end, as well as through three under-ground drains, placed under the three other principal walks, a supply of air is admitted to assist combustion in the furnaces; which, when heated, by circulating through the vault, passes through the grating above into the centre of the building.

Having so far described this structure, it remains for us to say something regarding the uses to which it may be applied.

A garden of this extent and cost may be expected to afford the owner both gratification and profit. The arrangement in such a case should be of the mixed style—that is, such as to afford fruit, flowers, and vegetables in perfection, and at those seasons when they cannot be had otherwise.

The borders, therefore, that run parallel with the walks we would dedicate to flowers, a great portion of which may be in pots plunged in the ground; while others of the more popular kinds, such as geraniums, heliotropes, pole and standard tender roses, fuchsias, and similar free-flowering plants, may be planted in the free border, as they will continue to flower for years with very little intermission. Plants requiring shade may also be placed here, such as Russian violets, lily of the valley, &c., in a portable state. Indeed with such an extent of borders, a perpetual display of flowers may be kept up. Or, instead of dividing the whole by straight walks, the interior may be laid out in the flower-garden style, the only objection to which would be its interfering with the direction of the pipes. This, however, could be remedied by carrying the hot water under ground, and discharging it into large metallic cisterns, which could be covered with stages for plants, or otherwise hid; while, at the same time, in addition to the heat radi-

ated from the vases, abundance of temperature could be secured, and many plants brought nearer to the glass. Close to the columns, through the interior of the house, we would plant vines and figs, which, particularly the former, would produce abundance of fruit at seasons when it is otherwise scarce. Branches of them might be trained under the ridges and gutters with good effect, as well as along the suspension bars. Peaches, plums, apricots, cherries, &c., may be grown in large tubs or boxes, and made to produce fruit when it could not be had in the open air. Early varieties of gooseberries, currants, and raspberries, could be forwarded. The better kinds of strawberries could be accelerated two or three months before their natural season, and the Alpine varieties, by a peculiar mode of treatment, be kept in fruit nearly all the winter. Oranges, lemons, tomatoes, and citrons would reach perfection, and some of the extra tropical fruits also be ripened.

Of vegetables, we may mention peas, kidney beans, cauliflower, scarlet runners, young potatoes, salads of all kinds, &c., which could be had throughout the year.

So far as regards trees, like peaches, plums, apricots, and cherries, which require a season of rest, they should be in a portable state, so that they may be taken out when their wood is ripe. Vines and figs, natives of warmer climates, may remain permanently within. The roof may also be partly covered with creeping plants of an ornamental kind, so trained as to create little shade for those that grow under them.

From our calculations, &c., as to the proposed erection we have described, and with those improvements upon it that the intelligence of gardeners may yet suggest, we believe that it would be much cheaper to cover in a whole garden in this way at once, than to build walls, and to erect a variety of separate hothouses, pits, &c. It may be said that in such a garden the temperature would be throughout the same; but this is easily remedied, as portable glass partitions can be employed to partition off any portions which it may be desired to keep at a higher temperature. For example, a glance at the ground-plan in our Plate will show that either of the four quarters, into which the space is divided, may be partitioned off, or the



spaces from the sides to the first or even second lines of columns may be separated from the rest by a glass screen, constructed in a similar way to the sides of the building, fitting the partitions to either side of the columns, so as to clear the trussing-rods, and to the edge of the valley above—while their lower edges may run on iron rails fixed to permanent stone or iron sills, or portable wooden ones.

It will be observed that the principle of roofing here illustrated is not very different from that adopted at railway termini. It is to these that the idea is due. Such roofs have not as yet been employed in hothouse-building; but that, variously modified, they are adapted for the purpose of roofing in large areas, none will dispute. The upright supports, as well as the suspension-rods, can all be turned to good account, as they present us at once with the means of cultivating, to the very highest degree of perfection, plants of scendant habits, amongst which are many of our most gorgeous flowers. The columns of support not only afford us a ready means of getting rid of the rain which falls on the roof, but a proportion of them may be made radiators of heat, by causing hot water to circulate through them.

The glass we proposed to use was 21 ounces to the foot, and in sizes 1 foot by 3.

Winter ventilation was to be effected chiefly by bringing in a supply of air through 9-inch fire-clay tubular pipes, their outer orifices being in the parapet wall all round at 10 feet apart, and their inner openings dispersed over the floor of the house.

A house of this altitude is well adapted for the cultivation of fruit-bearing trees and flowering plants of considerable size; but it will at the same time occur to the experienced eye of the practical cultivator that the roof is, especially towards the ridges, too high for the successful cultivation of plants of very dwarf habits—that is, the plants close to the ground would be too far from the light. These could, however, be accommodated, by placing them on suspended shelves near to the glass. Another advantage such a structure would afford, during winter, would be the conservation of crops already grown, such as lettuce, endive, cauliflower, early varieties of brocoli, cardoons,

celery, &c., which could be taken from the open ground in autumn and transplanted into the coldest parts of the house—cardoons, celery, cauliflower, and brocoli, &c., being laid in, as the technical phrase is, by the heels. Only those who have a large winter supply to provide for, can fully appreciate such an accommodation. Gardens covered with glass are one of those additions to modern luxury which may be looked forward to.

Nor is it at all improbable that suspension-roofs may yet be adopted for covering large conservatories, the fulcra for the suspended chains being placed at the four corners—*vide* "Mechanics' Magazine," vol. xxxiii. p. 500, where the principle of Dredge's suspension-bridges is noticed. A better method still would be to extend the tubular iron columns which support the ends of the metallic gutters to a sufficient height above the valleys, and employ them as the fulcra for suspending the roof from *without*, instead of by perpendicular columns and tension-rods from *within*, as has hitherto been done in roofs of extraordinary size.

Another advantage which this form (the ridge-and-furrow one) possesses is, that the rays of the sun are presented more perpendicularly to the glass in the morning and afternoon, when they are weakest, and more obliquely at noon, when they are strongest.

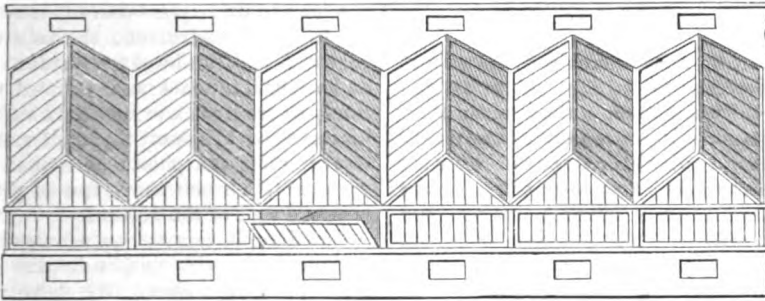
In the course of a lecture lately delivered by Sir Joseph Paxton before the Society of Arts in London, he explains the principles of this improved roof as follows: "In the construction of glass houses requiring much light, there always appeared to me to be one important objection. In the plain lean-to or shed roofs, the morning and evening sun—which is, on many accounts, of the greatest importance to forcing fruits—presented its direct rays at a low angle, and consequently very obliquely, to the glass. As at those periods most of the rays of light and heat were obstructed by the position of the glass and the heavy rafters, so that a considerable portion of time was lost both evening and morning, it consequently became evident that a system by which the glass would be more at right angles to the morning and evening rays of the sun would obviate the difficulty, and remove

the obstruction to the rays of light entering the house at an early and a late hour of the day." This led him to the adoption of the ridge-and-furrow principle for glass roofs, which places the glass in such a position that the rays of light in the mornings and evenings enter the house without obstruction, and

present themselves more perpendicularly to the glass at those times when they are the least powerful; whereas at mid-day, when they are most powerful, they present themselves more obliquely to it.

The following diagram will show the construction of such roofs. Fig. 114 is the elevation of a lean-to house of this

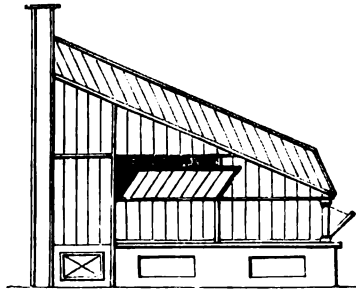
Fig. 114.



description. The whole roof is of necessity a fixture, excepting the angular lights under each ridge, which may be made movable by being hinged at their bottom sides, opening outwards, and being kept at any angle of depression by a sliding rod of iron attached to their apex, and made to slide up and down in a dove-tailed groove of iron, fastened to the under side of the crown of the ridge. This rod should have a spring catch, acted upon from within, which would open out the angular sashes to any extent, and keep them so till again acted upon in a contrary direction. Ventilators of the common form are placed in the back wall, opposite to each ridge, and are opened and shut upon the ordinary principle. This ventilation is to be used in the warmest weather, or when the greatest quantity of air is wished to be admitted. In ordinary cases, the ventilators shown in the front parapet wall are used, and the corresponding ones in the top of the back walls—only the external openings of which can be shown in the elevation; and for ordinary purposes these will be found sufficient. Front ventilation may also be easily obtained by making the front upright sashes pass each other, running on an iron rail fixed to the top of the stone parapet, or by their being made to open as shown in the elevation.

Fig. 115 is the end elevation of the same house, showing ventilation which ought to exist at both ends, if the house

Fig. 115.



stands insulated; also the ventilators in the parapet wall, and the mode by which the front sashes are thrown out.

Fig. 116.

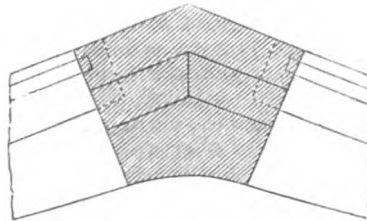
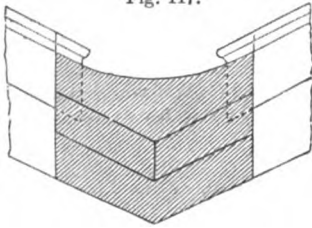


Fig. 116 shows the ridge rafter, one-fourth the full size; and

Fig. 117 the valley rafter, also one-fourth the full size.

Fig. 117.



The ridge rafters should always be in one piece, as being the more readily rendered waterproof, unless when their framing and glazing are done before they are put up. In this case each side of the ridge must form a sash in one or more pieces, as regards length; the top and bottom rails—that is, the ridge and gutter rails—must then be so fashioned, that when put up they may form one, and their joining must be made good with white lead, and covered with lead or copper. Where the stretches are long, without perpendicular tubular supports or suspension-rods, it will be better to construct the gutter rafter of cast-iron, and to screw the bottom rail of the wooden ridge to it. The iron gutter will act better as a drain for the rain water than a wooden one would do, and to a certainty would be waterproof; while, even though the wooden gutter is covered with zinc, lead, or copper, this seldom prevents the water from finding its way into the house; and as the gutter itself must in such cases be kept perpetually damp, its destruction is certain to follow, and it will be the first part of the structure to give way.

The ridge and valley rafters are shown above as if of timber. Wooden gutters or valleys should, however, be used for very temporary purposes only, such as the Crystal Palace, in which this material was used; and, notwithstanding all the care taken of them, the leakage through them in it was serious. In Plate VIII. we have shown a form of gutter which has been used in the new gardens at Poltalloch and elsewhere. The idea of this gutter arose when we were engaged making out the drawings for the proposed covered garden which has been just described, so long ago as 1840: and although that design has not been executed, it has been seen by many; and we have long

ago been perfectly satisfied as to the practicability of covering in any space, however great, with glass upon the ridge-and-furrow principle. This gutter is so constructed that all necessity for wooden ones is entirely removed. For description and detailed drawings of it, *vide* Plate VIII. and page 59.

With ridge-and-furrow roofs there is no necessity for having glass houses on the lean-to principle—indeed, they *ought not* to be so constructed: the valleys and ridges should run level from side to side; and except in cold and exposed situations, where a back or northern wall may be rendered necessary for shelter, it will be better for the plants, as well as more elegant, if all the sides are of glass to within a foot of the ground.

Sir Joseph Paxton recommends the pediments to rise perpendicular to the front upright sashes. We have placed all ours at an angle of about  $22^\circ$ , the angles of the roof being  $25^\circ$ . This is, however, merely a matter of taste. A rather massive wooden or cast-iron cornice should cover the front wall-plate, which will give the appearance of finish to that part of the elevation, and may be made to serve, at the same time, for taking away the water that comes off the roof. It is, however, better in most cases of this kind to make the water pass down through the cast-iron columns which support the front of the house, and which, with a view to this, as well as for economy of metal, should be cast hollow. This plan is not so applicable to houses of the lean-to form, as the front sashes of these do not always reach to the ground; but for all houses whose points of support are brought down to the ground, this practice should be followed.

In regard to the transparency of ridge-and-furrow roofs, Mr Loudon remarks: "If we take the area of the bases of the ridges as the total area of the roof, and then deduct from it the space occupied by the bars forming the sides of the ridges, and the ridge pieces and gutters," these roofs "will not appear to admit the same proportion of light as a roof in one plane; but the practical result will be different, in consequence of the sun's rays being twice in the day perpendicular to one-half of the roof, the advantage of which to the plants will far more than

compensate for the obscuration produced by the greater proportion of sash bars, which, operating chiefly at mid-day, and in very hot weather, is rather an advantage than otherwise."

The plan, sections, and elevation shown on Plate XIII. were made out last year for a nobleman intending to make a new garden; they have not, however, yet been executed. In the designing of this plan, we were anxious to produce a range of glass upon the curvilinear or span-roofed principle, yet so constructed that the roofs of the forcing-houses might be removable, as shown in figs. 125, 126, 127, with the view at once of obtaining the greatest amount of solar influence, and of producing a range different from anything of the kind hitherto seen. The situation was to be the centre of the garden, and the direction of the houses such that they should have their ends *a* and *b*, as shown on ground-plan fig. 1, facing the north and south; *c c* lobbies or vestibules for entrance, glazed all round; *d d* two vineries, one for early and the other for late crops—the vines planted inside, the range being intended for a wet locality; but as the side walls are to be on piers, the roots may extend outwards if they choose—the vines to be trained over the roof 18 inches distant from the glass; *e* early peach-house; *f* second peach-house, the trees to be standards grown in tubs and boxes, with the view of being removed, after the fruit is gathered, to the open air, to make way for some of the finest figs, also grown in a portable state; *g* house for standard peaches, apricots, and plums, not to be forced, but intended to come in before those on the open walls,—the trees in the latter house to be planted out, three parts of the roof being straight, as shown on fig. 2, so that the two upper sashes may be opened or removed altogether after the wood is ripened; *h h*, fig. 1, two pine-stoves, heated with tanks and hot-water pipes, as shown in section fig. 5—the bottom and sides of the tanks to be of wood, and the top covered with slates. These tanks are supported on piers, as the space under both the pine-stoves is formed into cellars to be entered by the stairs *g g*, on fig. 4, which is plan of cellars, and a corresponding one at the end of the other pine-stove also. The hot-water pipes in all the houses are to

run parallel with the side walls, in which ventilators, *bb*, &c., on figs. 2, 3, and 5, are placed. The doors in the peach-houses, fig. 1, *i i*, are to be 4 feet wide, to get out the trees with safety and ease. The ventilation in all those houses, excepting the centre one, is to be by ventilators in the side walls, shown at *b*, &c., and by openings in the ridge along its whole length, as shown at *a* in sections. Fig. 3 is the cross section of the peach-houses and vineries, and fig. 2 is that of the central house, which is arched under for supporting the border above. The floors of the pine-stoves are of pavement in three breadths of 5½ feet each, the ends which join the side walls being let into them, and their other ends, as well as the middle course, being supported on 10-inch brick piers. The cellars are intended for keeping a supply of fuel, to be supplied by the area stairs *c* on fig. 5. They are lighted and ventilated by area windows *a a a*, &c., as shown in plan of cellars, fig. 4; *b* is the position of the furnace and boiler for south end pine-stove and vinery; *c* the same for that of north end ones; *d* the same for early peach-house and half of central house; *e* that of succession peach-house, and other half of central house. The flues are indicated by the broad dark lines, all of which terminate in the centre chimney *f*. These flues are all enclosed within an outer flue, to which a supply of cold air is admitted by tubes through the side walls, which, entering into the hot-air flue, drives it out upwards into the hothouses through brass ventilators fixed in the pavement floor; *g g* are the stairs already referred to.

The roofs of the smaller houses are to be of wrought-iron sash-bar, without rafters: the centre one is to have the moving sashes of wood, resting on cast-iron rafters, as they will be much lighter, and better adapted for moving up and down, as well as for being removed, if deemed necessary, after the wood is fully matured. The lower part, however, of this roof to be filled in between the rafters with wrought-iron astragals, and fixed. On figs. 2 and 3, *c c* is the ground-level. A border, 4 feet wide, surrounds the range on all sides, and also a gravel walk, 7 feet in breadth—beyond which are the kitchen-garden quarters, laid out in the usual manner. All the rain water from the roofs

is to be collected in gutters along the top of the parapets, and conveyed in pipes into two large tanks, *h h*, on fig. 4, under the centre house, and pumped up as required.

The passages are to be laid with Arbroath or Caithness pavement, polished on the upper side, and laid on brick piers in all the peach-houses and vineries, to give scope to the roots of the trees. The sides of the pavement footpaths are to have a stone edging 4 inches in height, and rounded off at top. The doors, excepting the outer ones of the lobbies, are to be in two pieces; and instead of being hinged and opening sideways, are to move on a rail at bottom and in a groove at top, and to run back the whole of their breadth behind the partitions which divide the houses.

Cast-iron frames, with sliding doors, are to be built in the sides of the hot-air and smoke flues, and also at the bottom of the upright shaft, for the purpose of extracting the soot—as the cleaner the flues are kept, the less smoke will pass out at the chimney-top, and the less heat also.

To lessen the labour of watering, a pipe may be led from the water-tanks under the pavement, and a branch brought up into each house, with a brass screwed nozzle, to which a small portable pump may be attached, to draw up the water into each division.

The piers for supporting the roof of the cellars and floor of the pine-stoves and centre house are shown in the plan of the cellars. The sides and ends of the pine beds are to be of Caithness pavement, polished on the sides next the passage on top, and down 3 inches on the inner side.

Fig. 6 shows the elevation of the whole range.

As an instance of hothouse-building combining economy and utility, we may instance a glass garden, now in course of erection for J. Duncan, Esq. of Burnhead, to whom we furnished the plans. The intention was to produce a useful structure at a moderate cost—the object of the proprietor being to secure the ripening of such of the finer fruits as do not thoroughly ripen in the open air of our climate, and to have certain kinds ripe earlier than they would be even on southern walls; and also to secure a supply of salads, and the choicer kinds of vegetables, as well as a profusion of flowers, both early in spring and through-

out the winter. The whole length of this winter garden is estimated at 533 feet, by 14 feet wide within: 111 feet in length are already finished and planted. Along the front and ends is set, upon a pierced foundation, an ashlar plinth 7 inches in thickness and 18 inches broad, the top of which is level with the floor within—its thickness forming an easy step from the gravel terrace walk in front. The back is a brick wall already existing, and covered with peach and nectarine trees. The exposure is to the south. Along the front and ends are set in the plinth square, hollow, cast-iron fluted columns, 8 feet in height, and 3 by 5 inches on the side. These are set 10 feet apart, centre from centre; and on them and on the back wall rest the cast-iron valleys or gutters,  $3\frac{1}{2}$  inches by  $4\frac{1}{2}$ , having a fall of 1 inch in their length to drain off the water that falls into them from the roof. This is delivered through an opening immediately above the hollow columns, which convey it to tanks under ground, where it is reserved for the supply of the trees and plants within. One of the tanks contains 16,000 gallons of water: from this it is pumped up into a cistern placed on the top of the back wall, to which a flexible tube is attached, for the purpose of watering the trees and plants, as a substitute for a water-engine. The glass panels forming the front and ends are divided into two parts, every alternate one of which is fixed, while the other is framed, and made to run on an iron rail below and in a groove above, behind the fixed panel next to it—these movable sashes being for the double purpose of securing abundance of front ventilation, and for gaining admittance to the interior. The ridges are of Baltic timber, into which the top ends of the astragals are mortised—their lower ends being secured to the edges of the cast-iron valleys. The pediments in front stand perpendicular, and are fixed; while wooden-framed ventilators are built into the back wall, in the parts under the ridges, and corresponding with the pediments in front. These ventilators are 2 feet long and 1 foot broad in the clear, and are opened or shut more or less simultaneously by being connected to each other by a  $\frac{3}{4}$ -inch rod of iron, having a weight suspended at each end on the balance principle, the elevating or

depressing of which opens the whole, and keeps them at any extent of ventilation—or shuts them up entirely. The situation being exposed, the back wall—as exemplified in the Crystal Palace—is carried as high as the tops of the ridges, to break the force of the wind. The roof is glazed with Hartley's rough sheet-glass, 26 oz. to the square foot, to prevent the sun's rays from scorching the foliage within: the front is glazed with transparent sheet glass, 16 oz. to the square foot, so that in walking along the terrace in front the whole of the interior is seen through the glass. The mode of glazing is upon the groove principle, by which no putty is exposed to the weather. The whole is painted a soft stone colour externally, and internally in blue, white, and yellow lines; and the back wall is also coloured white, to increase the reflection of light. Around the back, front, and ends, is placed a neat cast-iron octagon grating footpath  $1\frac{1}{2}$  feet broad, kept 18 inches clear of the building; and similar footpaths connect the back and front together, for the convenience of walking on when examining the fruit, or carrying on the necessary operations of culture. As the ground is rather on the incline, the boiler is placed at the west end, being the lowest part—the 4-inch hot-water cast-iron pipes running in a single line along the inner sides of the back, front, and end footpaths. This single course of pipes is deemed sufficient at present, as a very moderate degree of temperature is kept up; but should a higher temperature be hereafter desired, provision is made for securing it by having small perforated flanges, with a screw-pipe within them, cast in their upper sides, to which metallic radiators can be attached. These radiators are in the shape of neat vases, and can readily be screwed on or removed from the flanges when required. Dwarf and standard fruit trees—consisting of peaches, nectarines, cherries, plums, apricots, and the finer pears—are planted in rows across the house, and under every second ridge; while the ground below is cropped with the choicer kinds of culinary vegetables, and the border between the footpath and front and ends planted with verbenas, salvias, scarlet geraniums, &c.—fuchsias and other free-flowering plants being set in groups through other parts of the inte-

rior. Free-flowering creepers are planted in the border in front, and trained to wires attached to the tubular columns, as well as to the under side of the valleys along the roof. A suspended shelf for strawberries in pots is placed close under the roof in front. Large specimens of plants are grown in vases and in tubs, which, when wintered within this structure, are set out during summer to decorate the terrace walk round the mansion. Cherries, plums, and figs are kept in a portable state, to be taken in to produce their fruit, and removed afterwards to the open borders.

The estimated cost of this erection, covering 1554 superficial feet, is £200.

The temperature from solar influence alone ranges from  $8^{\circ}$  to  $10^{\circ}$  above that of the open air. In warm sunshine, under the shade of the trees, it will rise to from  $20^{\circ}$  to  $40^{\circ}$  higher than the temperature in the shade out of doors.

The most complete specimen of hot-house architecture that this or any other country can boast of, is the large palm-stove in the Royal Botanic Gardens at Kew, of which Plate XIV. will give a perfect idea as regards its external appearance. It is from the design of Decimus Burton, Esq., an architect to whom this country is much indebted for the various specimens of his art already displayed. Practical suggestions were supplied by the amiable and talented director of the gardens, Sir William Jackson Hooker, and the intelligent curator, Mr Smith. We have seen this house in various stages of its progress, and often since it was finished, and think the workmanship highly creditable to Mr Turner, the builder—the more especially as many of the scantlings are of great weight, and of a size exceeding anything of the kind hitherto executed, if we except those of the Paxtonian glass palace.

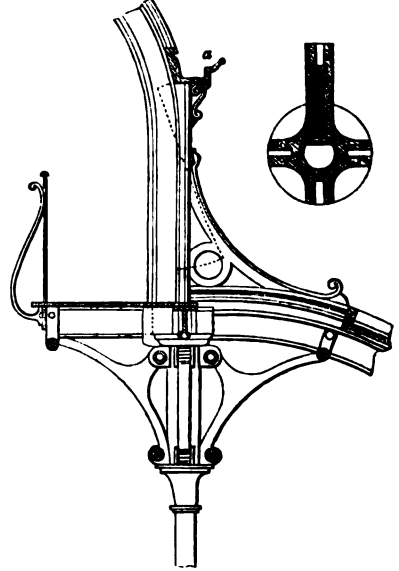
The length of this house is 362 feet 6 inches within, of which 137 feet 6 inches is taken up with the central or higher part, which is 100 feet in width, and 63 feet in height, exclusive of the lantern or upper part, this being 6 feet high. The ends or wings are each 112 feet 6 inches in length, 50 feet wide, and 27 feet high, also exclusive of the lantern. The foundations are formed of concrete, upon which large granite blocks are laid, into

which the ribs are set in cast-iron sockets. The framework, if we may so term it, is composed of 9-inch wrought-iron ribs, 12 feet 6 inches asunder, and 42 feet long, in lengths of about 12 feet, and welded together, and brought to the required curve. The top part of these lower or main ribs is supported by cast-iron tubular columns, which also serve as footing for the bottoms of the ribs, constituting the upper part of the centre division, as well as to support the bearers for the balcony which is extended round the centre division of the house, and which is reached by two elegant spiral stairs. A continuous curb of the same scantling as the ribs connects the column heads, *vide* figs. 118 and 119. "The whole of the ribs are braced together, and strutted by wrought-iron tie-rods, passing through cast-iron tubes, which act as purlins. These purlins, or connecting bars between the ribs, are new in construction: they are formed of a small  $1\frac{1}{4}$ -inch round bar, welded in long lengths; and, passing through the ribs, they form a continuous tension-rod all round the house at each purlin, (which are 9 or 10 feet apart,) with means of straining them as tight as possible. This tension-bar is enclosed within a tubular bar of wrought-iron, exactly fitted between the ribs, acting as distance-pieces in opposition to the strain of the tension-bars. This knits the entire structure together."

The upper roof of the centre part is supported, as has been already noticed, by 20 tubular cast-iron columns, ten on

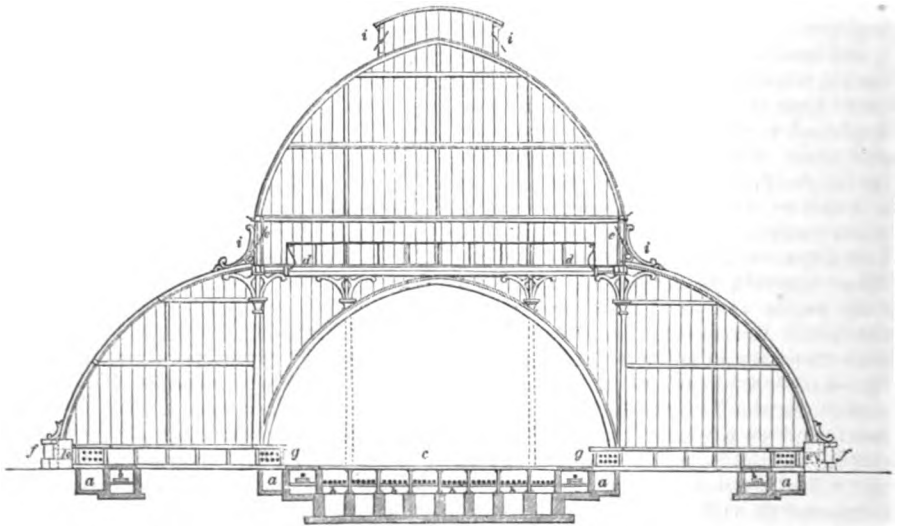
Fig. 118.

Fig. 119.



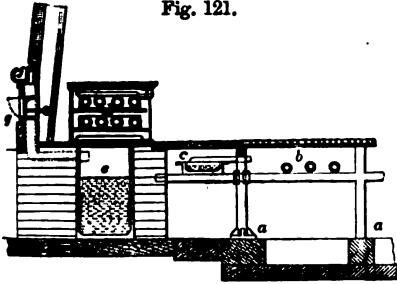
each side, in a line with the sides of the wings. These columns carry down the rain water collected in the gutter of the upper roof into tanks formed round the whole of the interior of the building, as shown at *a a a a* in transverse section, fig. 120, and at *e* in fig. 121. The water from the lower roof is received into the

Fig. 120.



terns gutter, forming the upper part of the pedestal or plinth of the building *f*, in fig. 121, and is carried from thence into

Fig. 121.



the same tanks. So impressed are we with the advantage of radiated heat, that we would have suggested connecting four of these upright supporting columns on each side with the hot-water pipes below, and in severe weather caused a circulation of hot water to flow through them, which could be easily effected by having a division in the centre of each pillar, so that the hot water would ascend on one side and descend on the other; or indeed the circulation would go on without any division whatever: the hot water would ascend through the centre of the column, and, as it cooled, it would descend down the sides.

The following references are to the transverse section, fig. 120:—

- a. Cement tanks for water from the roof.
- b. Hot-water tanks below the path.
- c. Open iron flooring.
- d. A gallery all round the centre part.
- e. Ventilation.
- f. Projecting pliers or buttrees to set a vase on.
- g. Stone flagged paths.
- h. Hot-water pipes.
- i. Ventilation.

The heating, we are glad to see, is upon the hot-water principle. Twelve boilers, upon Burbidge and Healy's patent, are employed, with 28,000 superficial feet of pipe, box, tanks, &c., *b c d*, in fig. 121, placed under stone table *d*, stone passage *c*, and the perforated iron floor *b*; and vapour is produced by valves in the tanks. The hot-water pipes being placed under the perforated iron floor is a good arrangement, as the heat will not be much obstructed in its way upwards; but why not have made the stone passage *c*, as well as the stone table *d*, also of perforated iron work? A great interruption must take place, in both the latter cases, to the free ascent of the heat. We are glad, however, to see that the stone table *d* does not form a connection with the sides of the house,

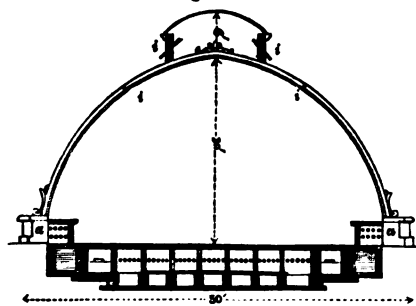
which would have added considerably to the evil we complain of.

The boilers, six only of which are shown—*f f*, &c., in ground-plan, as half only of the plan is shown—are placed in two vaults beneath the house, indicated by the dotted lines. Each boiler has its own set of pipes to heat, so that, according to the temperature required, one or more boilers may be set in operation. The vaults in which the boilers are placed are capacious, giving ample room for carrying on the necessary operations, as well as for containing the necessary supply of fuel. They communicate with the coal-yard and chimney tower by means of a tunnel 550 feet in length, which, besides containing the smoke flues, contains also a railway, with iron waggons, to convey fuel and to remove the ashes. The floor of the house, as shown in ground-plan, fig. 123, excepting the stone-pavement passages, is formed of perforated cast-iron gratings, in pieces of about 4 feet square, so that they can be easily taken up and laid down: they are supported on malleable-iron bearers and cast-iron uprights, set on blocks of stone, *vide* fig. 121, *a a*.

There are entrances at both the extreme ends, and also at both sides of the centre or higher division. A spacious terrace, with the necessary steps, surrounds the whole, and being somewhat elevated above the ground level, gives the appearance of solidity and breadth of base for the stupendous structure to stand on. The lower or front ventilation is shown at *g* in fig. 121.

Fig. 122 is a transverse section of the wings, showing the rolling sashes in the

Fig. 122.



upper part of the roof at *d*, and also the vertical sashes in the lantern *d*. The same figures indicate the openings in the higher lantern in transverse section, fig.

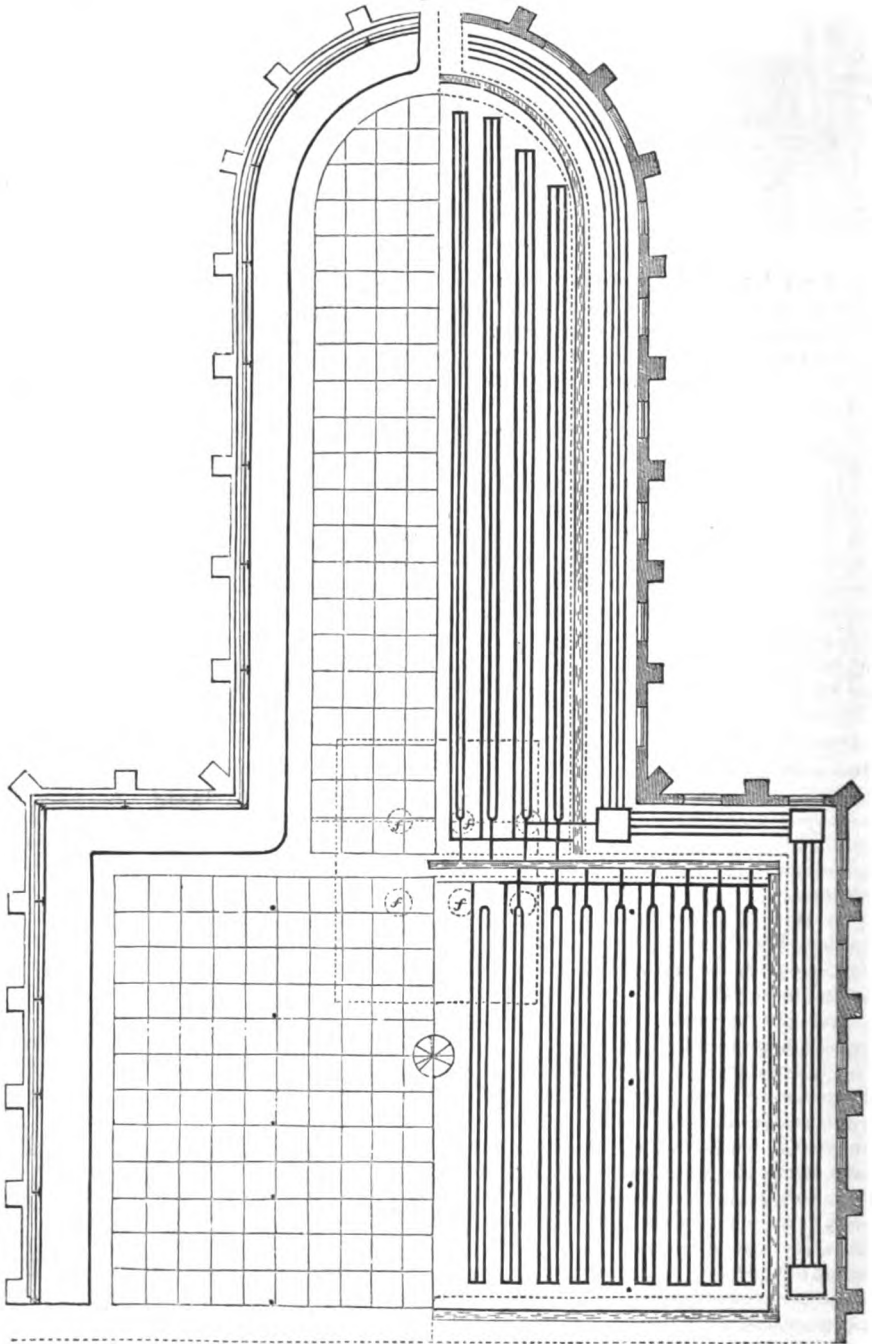
q



120, and the vertical openings on a level with the colonnade, and the rolling sashes under it, also in transverse section. The

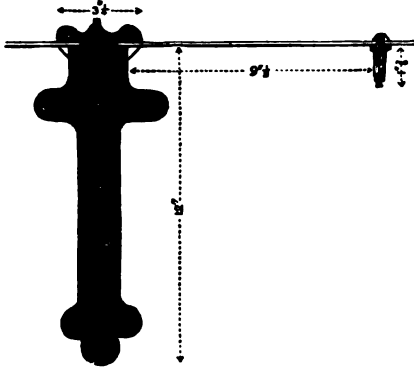
ventilators in the parapet wall, *vide g*, fig. 121, and all the others, are opened and shut by a simple application of machinery.

Fig. 123.



The rafters are 12 inches deep,  $1\frac{1}{2}$  inch in the narrowest part,  $5\frac{1}{2}$  inches through the rebates, and  $3\frac{1}{4}$  inches at the crown, *vide* fig. 124.

Fig. 124.



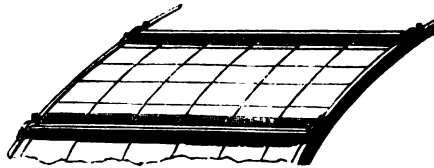
The house is glazed with sheet glass, 21 ounces to the square foot, in panes 3 feet 2 inches by  $9\frac{1}{2}$  inches. A green tinge is given to the glass by means of oxide of copper, with a view to counteract the effects of white sheet glass on the plants below—a plan suggested by Mr Hunt of the Museum of Economic Geology, and exemplified by him in this house for the first time. Our figs., with slight alterations, are taken from "The Builder."

A great mistake has been fallen into in the construction of the general smoke flue, by not having it placed within a chamber surrounded by air, so as to prevent the abstraction of its heat, and the exclusion of damp, to which it is at present so subject as to render it scarcely possible to make the smoke pass through it, notwithstanding its length and great height of chimney.

*Curvilinear houses.*—In regard to curvilinear roofed houses, none, we think, will deny them the merit of elegance in appearance, and of capability of admitting abundance of light; but many object to them on the ground of insufficient ventilation, and of the impossibility of removing them, either in whole or in part, at certain seasons of the year; this latter objection being common to them with all houses having fixed roofs. We see little difficulty in overcoming these objections, as a reference to various methods of ventilation will show; and we have a model before us of a curvilinear

house so constructed, intended for peach houses and vineries, which will form the subject of our next plate, and in which we shall show that the whole of the glass roof may be removed with almost as little trouble as that of a lean-to house of the ordinary description. We are not aware that any plan has hitherto been adopted to effect this end, of removal of the roof in the case of such houses—an end which, if carried into effect, would materially lessen the objections with which such roofs have been very justly charged. We all know the great advantage which peaches and vines, in moderate climates, enjoy in houses where they can be freely exposed to the action of the weather, from the period of their buds and wood being fully matured, till they are again to be excited into growth; and that exposure is more necessary in the case of trees early forced, than in those the ripening of whose fruit is kept back to a later period of the season. This has hitherto been with us, as well as with most cultivators, a prominent objection to curvilinear houses, because their roofs are fixed, and all the ventilation in general given to them cannot entirely remedy this defect. We propose, therefore, that the rafters of these houses should be constructed of deck-beam metallic bars, 3 inches thick and 4 inches deep—that they be fixed in a massive stone coping on the parapet walls, and joined together at the top, and 6 feet apart centre from centre, with a rebate on each side 1 inch in breadth, and 2 inches deep, for the reception of the sashes, and kept in their proper place by straining bars, of which one on each side of the roof of smaller houses, and two on each side of larger ones, will be sufficient, with one along the apex or ridge, to tie them all together. The rafters are to be provided with a wooden coping, projecting 1 inch on each side over the side styles of the sashes. The

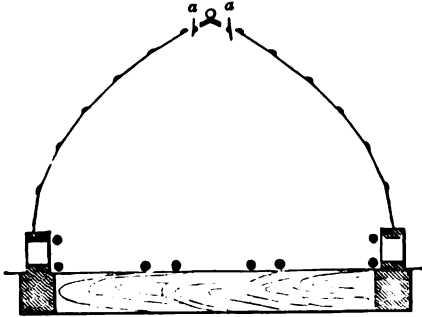
Fig. 125.



sashes, fig. 125, are to be of well-seasoned timber, and, taking the house of which

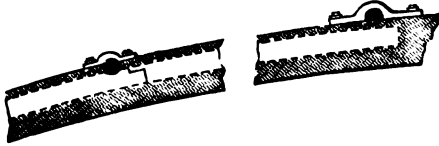
fig. 126 is a section as an example, will be 5 feet 10 inches long, and 3 feet  $2\frac{1}{2}$

Fig. 126.



inches in breadth, excepting the uppermost range on each side of the ridge, which should only be 19 inches in breadth, as they are to be made to open for top ventilation, as shown in fig. 126, *a a*, where they move on an axle extending the whole length of the house, to which they are attached at their centres; they are shown open. The top and bottom rails are to be 2 inches by 3, and half-checked, so as to lap over each other  $1\frac{1}{2}$  inch, to carry over the rain water; and the side rails or styles are to be 2 inches square, and to rest 1 inch on the rebate of the rafters on each side;—thus reducing the opaque space of the rafter and styles to 3 inches, and that of the top and bottom rails to the same breadth. Each sash is to be furnished with four brass pivots attached to the top and bottom rails, 6 inches from each corner, and  $\frac{3}{4}$  of an inch in diameter, as shown in fig. 125. These pivots are to repose in brass sockets sunk in the rafter, and to be kept in their places by

Fig. 127.



brass clasps over them, as shown upon a large scale in fig. 127, which is a portion of the rafter. These clasps are screwed down at each end. The astragals are to be also of wood; and, on account of their being so short, they will cut out of boarding without much waste, as the radius is so small. From this it will readily be

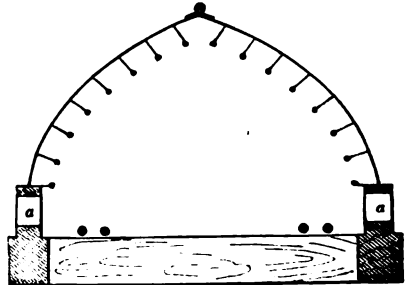
seen that, when the roof has to be removed either wholly or in part, all that is required is to unscrew the brass clasps, and to lift the sashes out; and these, being only 6 feet by 3, may be removed with the greatest safety. If rough plate glass is used, then one piece, bent to the required curve, may be employed to fill in each of these sashes, and if of the thickness of  $\frac{3}{4}$  of an inch, this will be stronger and less liable to breakage than if smaller panes and astragals were employed.

We consider the removal of the roof sashes much more practicable, and admitting of greater advantages than that of adopting the poly-prosopic principle, which requires complicated machinery to move, besides placing the sashes in a position of great danger from winds while they are set open. Another advantage attending the entire removal of the sashes is, that, during the time they are not in use, they can be thoroughly painted, glazed, or repaired.

One objection to curvilinear houses, and we think a very serious one, is the difficulty hitherto experienced in procuring sufficient ventilation for them. This, to a certain extent, is chargeable on all fixed roofs; and we have been, in general, too sparing in providing openings sufficient to effect this purpose.

In the case before us, we would divide the parapet walls on both sides, and at the ends also, into as many spaces as possible, leaving only 3-foot piers between each; and as the walls are to be 3 feet in height, each ventilator (*a a*) on fig. 128

Fig. 128.



may be 18 inches in height: their lengths will be found by dividing the length of the house into equal parts. The top ventilation is secured by openings in the roof near its apex, as shown in fig. 126.

Fig. 128 shows the mode of training the vine or the peach under such roofs.

That forcing-houses glazed all round, whether curvilinear or span-roofed, will eventually come into general use, there can be little doubt, the more especially as glass is now so much reduced in price, and also because the advantages of such houses are becoming daily more evident. Our former objection to them was their great expense when compared with lean-to houses; but that objection is now removed, as well as that which was founded on their insufficient ventilation, more complete modes of ventilation having been discovered.

Of all forms of curvilinear structures, that of the semi-globe is the best calculated for the admission of solar light and heat, because, on account of its form, the sun's rays will be perpendicular to it every moment that it shines, and at every time of the year; and by it the greatest amount of light will be admitted when it does not shine. It is, however, the worst form in which to maintain artificial heat, on account of the great loss of heat through the larger surface of glass. The semi-dome is preferable to the semi-globe, on account of the back side being opaque, and, consequently, reflecting both heat and light. This form is, however, objectionable in several respects; and, in particular, on account of the rays of light losing their influence on the plants after passing through glass roofs, in proportion to the distance of the plants from the glass.

*Metallic hothouses.*—Regarding the merits or demerits of metallic hothouses, opinions appear to be still as much at variance as they were twenty years ago. Heating and ventilating are now much better understood than they were in those days; and, with this increase of knowledge, some of the evils of metallic houses have disappeared. On this subject Mr Marnock observes—"It cannot be denied that iron hothouses are more susceptible of external changes of temperature, whether from heat or cold, than such as are built of wood; but if two houses properly constructed, and equally and fully provided with the means of ventilation, were to be compared, and the amount of difference in the fluctuation and changes occasioned by the iron roof, as compared with the

one made of wood, were carefully ascertained, it would be found much less than is generally supposed. We ought, however, to state, that in small erections—such as amateurs are in the habit of building—the inconveniences occasioned by the sudden fluctuations of temperature are much sooner felt than in large structures, and still more, of course, under iron than under wood roofs. As these fluctuations depend very greatly on the size of the house, the evil is much aggravated when the structure is small, from the fact that the smaller the volume of air contained within, the more speedily is it heated and the change felt. Iron houses of small dimensions do, therefore, require more attention in shading and giving ventilation than houses of the same size with wooden roofs. Metallic roofs have, however, this advantage—in dull weather they admit more light, and in winter this is often important. For large structures we decidedly prefer iron. Where the internal area is extensive, and contains a large volume of air, the temperature is, in this case, much less susceptible of change. The form of the roof can also be made more elegant than with wood; and the free admission of light, when the plants become large and shade one another, is of the utmost consequence. For forcing-houses of large dimensions, where the trees—whether vines or peaches—are kept a proper distance from the roof, we also think iron preferable to wood. With regard to the contraction and expansion of metal roofs, we never found this practically of the least importance, either for good or evil, though we think this quite likely to be felt in cases of ill-contrived and improperly fitted up roofs." After enumerating the following metallic houses—viz. the large conservatory in the Regent's Park Botanic Garden, that in the garden of the Horticultural Society at Chiswick, the palm-house at Kew, the ranges at Sion House, Eaton Hall, the Botanic Gardens at Glasnevin and Belfast in Ireland, and several places on the Continent, all exceedingly ornamental works of design and taste—Mr Marnock concludes by observing, "Still we think it right to repeat, that for small structures attached to dwelling-houses, where an efficient gardener and ample means are not at command, wooden roofs

are, for the reasons above stated, preferable to iron." This opinion coincides with that lately expressed by Professor Lindley, and long entertained by ourselves. Condensation goes on more rapidly in metallic houses than in any other, and more so in roofs of a flat pitch than in those more upright. This is the case in all houses, particularly in cold weather; but it takes place more especially in those having metallic roofs, as, in addition to the cold surface of the glass, which will be nearly the same in both, we have a considerably increased amount of condensation from the metal also. The excellent paper by the late Professor Daniel, published in "The Transactions of the Horticultural Society," brings this and its consequences before us in a very clear light: by reason of the abstraction of the necessary humidity which ought to exist in the atmosphere of a properly regulated hothouse, by its coming in contact with, and condensing upon the cold glass and still colder metal, the air within becomes so completely dried up as to be totally unfit for vegetation. The leaf of a vine, for example, in its young and growing state, requires an atmosphere, the degree of saturation of which is  $800^{\circ}$  nearly; now, if the saturation falls  $300^{\circ}$  below this, the leaves will be dried up and perish. The authority above quoted says, "The heat of the glass of a hothouse at night cannot exceed the mean of the external and internal air; and, taking these at  $8^{\circ}$  and  $40^{\circ}$  respectively,  $20^{\circ}$  of dryness are kept up in the interior, or a degree of saturation not exceeding  $528^{\circ}$ . To this, in a clear night, we may add at least  $6^{\circ}$  for the effects of radiation, to which the glass is partially exposed, which would reduce the saturation to  $434^{\circ}$ ; and this is a degree of drought which must be nearly destructive. When it is considered that a temperature at night of  $20^{\circ}$  is no very unfrequent occurrence in this country, the saturation of the air may, upon such occasions, fall to  $120^{\circ}$ . That is to say," Dr Lindley observes, when remarking on the above quotation, "instead of the moisture in the atmosphere surrounding vine leaves amounting to 7 or 8 parts in 10, which is what they require, it may not amount to more than  $1\frac{1}{4}$  in 10, which is fatal to them."

The doctrine laid down by Professor Daniel, and subscribed to by Professor Lindley, involves the inference that the humidity abstracted from the atmosphere of the house, by the latter being brought into contact with the cold surface of glass, is decomposed or entirely lost. Be this as it may, one thing is quite certain, that the excessive conduction of both heat and cold, together with the loss of humidity, in whatever way this ensues, have been regarded by most cultivators as one of the great evils chargeable to metallic hothouses.

The advantages and disadvantages of metallic hothouses are thus stated by Mr Loudon, who, it should be observed, had a strong feeling in their favour. He says, "The material of fixed roofs is generally iron, as being less bulky in proportion to the strength required, most durable, and admitting, in the case of curvilinear roofs, a curvature to be formed at less expense than it could be of timber. In those roofs, in general, no other bars or opaque bearers are required than those for securing the glass, and hence their simplicity and unity with regard to component parts, and the equal degree of transparency in every part of the surface." The same authority goes on to say, "In general, it may be observed, that till lately gardeners had a prejudice against metallic roofs. We shall here, as briefly as possible, enumerate these objections, which are expense, rust, breakage of glass, abduction of heat, and attraction of electricity." In regard to expense, he says, "Metallic houses are, in general, more expensive than wooden ones; but they admit more light, and are more durable and elegant." To this we answer, that the difference in cost is from one-third to one-half, and often more; the difference of light admitted, especially now that large glass is within our reach, is so trifling as to be practically considered of no account. That they are more durable would, at first sight, appear feasible enough; but experience has not proved this to be the case; indeed, the very reverse seems established, for we know of wooden houses that have existed for a century, but of no metallic house that has stood half the time. That they are more elegant we do not deny.

As regards rust, Mr Loudon observes, "That all ordinary metals are liable to rust is undeniable. This objection cannot be got rid of. The reply is, take into consideration the advantages of light and durability, and that careful painting will in a great degree prevent it. Knight observes, that if one-third of the sum requisite to keep a wooden roof properly painted be expended upon an iron roof, no injury will be sustained from the liability of that to suffer from rust." Neither of these gentlemen, in their enthusiasm to recommend iron roofs, appears to have taken into consideration that the incipient seeds of the disease of corrosion have been implanted before the roofs are painted at all; and let them be painted as often as they may, the disease is still progressing, in a way somewhat analogous to the decay of unseasoned timber; and so far as relates to the latter, paint is rather injurious than beneficial. Galvanised iron was not in use in those days; and, after all, even this process may turn out as little to the preservation of the metal as painting could. Were iron secured against the effects of corrosion until it was erected in a roof, glazed, and painted, then, and not till then, would we subscribe to the above opinion. We, however, believe that means may yet be discovered to prevent the oxidation of iron, and all other metallic bodies whatever.

The breakage of glass by contraction and expansion in iron roofs, and the yielding-in of copper and other over light ones, has been admitted by most who have had the superintendence of them. This is denied by the advocates for them, more especially as regards those of wrought or cast iron; though it is partially admitted by them in the case of copper, or compound metallic roofs, "where weakness produces a bending in the sash, or where corrosion or unequal expansion of improper mixtures of metals, as iron cased with copper, occasions a twisting of the bar: cast-iron or solid wrought-iron frames have never been known to occasion the breakage of more glass than wood." This opinion may be very well in the study, but it is not so good in the field. "The expansibility of copper is greater than that of brass, and that of brass greater than that of iron, in the proportion of 95, 89, 60; consequently, copper is about

one-third more likely to break glass than iron. But when it is considered that a rod of copper expands only 100,000th part of its length with every degree of heat, and that iron only expands the 165,666th part, the practical effects of our climate on these metals can never amount to a sum equal to the breakage of glass." Glass neither expands or contracts, neither is it elastic; the expansion, therefore, taken even at the low calculation above stated, is quite sufficient to effect breakage to as great an extent as we or any other have asserted, more especially if light glazed. "The power of metals to conduct heat is an objection which, like those of rusting and additional expense, cannot be denied. The reply is, the smaller the bars, the less their power of conduction; and a thick coat of paint, and the covering of half the bar by the putty requisite to retain the glass, also lessens this power. It is added, heat can be supplied by art; but solar light, the grand advantage gained by metallic bars, cannot by any human means be supplied otherwise than by the transparency of the roof." This is all very well, but may not too much light be admitted to plants in a strictly artificial climate? else why do we use obscured glass and shading? Notwithstanding these objections, we are quite aware that such roofs must be used in such structures as the large palm stove lately erected at Kew, the conservatories in the Regent's Park, Sion House, &c.; and also that the large house at Chatsworth, and Messrs Loddige's palm stove, would have been much more elegant in exterior appearance had they been so constructed. To those who build such lofty houses, we say, by all means employ iron, if you can afford the cost, and take the necessary precautions to ventilate them properly. After all that has been said against metallic houses of great height, so far as the conduction of heat is concerned, we believe the most important thing has been next to neglected,—namely, sufficient means of ventilation, more especially at or near the top.

We still maintain that properly-constructed wooden houses, *without rafters or framed sashes*, built on the ridge-and-furrow principle, with metallic valleys to carry off the water, are much less expensive in erection; equally, if not more durable

than metallic ones; sufficiently light for all useful purposes, if large squares of glass are used; and decidedly far more easily managed as regards heating. The only exception we can make in favour of metallic houses upon a small or moderate scale is, that the metal being capable of being formed into curves without loss of material, it is better adapted for curvilinear houses than wood. We lately had the satisfaction of seeing two magnificent houses of wooden construction very much to our mind, namely, that of Messrs Lumcombe and Pince at Exeter, for the cultivation of Camellias, 200 feet long, 22 feet wide, and 16 feet in height; and the other, still more spacious, built a few years ago by Asheton Smith, Esq., at Tedworth Park, near Salisbury, 300 feet long, and 140 feet broad—in itself a complete garden under glass. The interior contains two longitudinal beds or borders, intersected by a circle of gravel in the middle, and a transverse walk in the centre of the house, while one of great breadth passes down the middle from end to end; there are also two narrow walks on each side parallel with the sides, and separated from them by a narrow border.

On the merits of metallic roofs, we have the following very judicious remarks by the editor of the "Gardeners' Chronicle," vol. i. p. 57: "The advantages of iron roofs for hothouses are, that they are more durable than wood, and allow a far greater quantity of light to pass through them than wooden roofs, the difference being as 7 to 23, or even 30, in favour of iron; and this is a most important property, when we consider that the healthy action of plants is in proportion to the quantity of light which reaches them. The disadvantages of such roofs are that they rapidly heat, and as quickly cool down. They are, however, liable to sudden changes of temperature, which can only be guarded against by great attention, which is expensive, and by a large consumption of fuel.

"We should say, use iron if you prefer success and beautiful form to cost, and can rely upon the attention of your people; but employ wood if you are obliged to study economy." These remarks are perfectly true so far as they go, with the exception of the assertion of greater dura-

bility, which is very questionable; and as to the vast difference in the quantity of light transmitted, we think that very much overrated, unless the talented editor intends to contrast wooden houses of the worst possible construction with metallic ones of the lightest and best forms.

All curvilinear houses should be of metal, as the waste of material, in forming them of wood, would be great. All lofty houses, such as those at Kew, should also be of that material; but for houses of moderate height, and for ordinary purposes, we greatly prefer wood.

It must, however, in fairness be admitted, that great improvements have of late years taken place in the material and construction of metallic roofs. The expense is very greatly reduced, and the evils of conduction, both of heat and cold, are somewhat lessened since the repeal of the duty on glass, by the use of larger squares thus placed within our power; consequently much less surface of iron is exposed, as rafters and the heavier pieces are, or can be, entirely dispensed with. Galvanised iron, if properly manufactured, is less liable to corrosion than the metal originally used, and anti-corrosion paints greatly counteract this evil.

A more recent discovery, however, appears to claim some attention, namely, the patent taken out by Messrs Grissell and Redwood, "for improvements in coating metals with other metals. The patentees claim the use of borosilicate of lead in a fluid state, over the surface of melted copper or brass, or of certain alloys in the process of coating iron by immersion; also the process of coating iron with copper, by the action of fused chloride of copper."—*Vide* CHEMICAL RECORD. The more recent process of coating iron with flint glass, on Messrs Johns and Co.'s principle has, we believe, been already made trial of on hothouse roofs. Cast-iron, which is less liable to corrosion than malleable iron, was discarded on account of its liability to break, unless used of a large size: this defect, also, has very recently been mitigated. Experiments made at the Crane Foundry on the relative strength of cast-iron, chilled and unchilled, showed that the process of chilling gave a very great increase of strength. The experiment shows a much

larger per-centage. The following experiment was tried on four bars, cast in the form of a double-faced railway rail,  $1\frac{1}{4}$  inches deep,  $\frac{1}{2}$  an inch wide at top and bottom, and  $\frac{1}{4}$  of an inch at the centre. The length of each bar was 18 inches, with 15 inches between the supports. No. 1 was cast in green sand; No. 2 in dry sand; No. 3 cast in a chill; and No. 4 in a chill, and afterwards annealed.

- No. 1 weighed 32.5 oz., bore 1232 lb., and deflected 0.130 inch.
- No. 2 weighed 30.5 oz., bore 1006 lb., and deflected 0.114 inch.
- No. 3 weighed 34.75 oz., bore 784 lb., and deflected 0.053 inch.
- No. 4 weighed 34.5 oz., bore 2520 lb., and deflected 0.140 inch.

The advantage in favour of cast-iron, treated like No. 4, is evidently little less than one hundred per cent over No. 1, and three hundred per cent over No. 3.

With such improvements in lessening the quantity of metallic surface and adding so much to its strength, we think metallic roofs are now placed in a different position from that which they formerly occupied; while ventilation is supplied both more abundantly, and upon more correct principles. A deficiency of ventilation no doubt long tended to increase the prejudice, if so it may be called, against metallic roofs.

In the erection of plant structures, the error of carrying them too high ought to be avoided. To suppose that we can produce head room for many of the palms and other tropical trees to develop themselves fully in is truly ridiculous. The very circumstance of giving increased height to such houses has the tendency to draw up the plants to an unnatural degree, quite out of all proportion to their other parts. Nor can the observer see these plants to advantage confined within the narrow circumference afforded even in the largest houses hitherto erected. Whoever wishes to examine the beauties of a well-grown timber tree would certainly not fix the spot of observation close to the trunk; nor can the grandeur of a forest be appreciated by wandering amongst the naked stems.

All extra lofty houses hitherto erected have been most unsatisfactory; and as the great majority of flowering plants

are of no extraordinary altitude, why should we attempt to accommodate a few at the expense of the many?—why accommodate the loftier palms, and still loftier *Araucarias*, which rarely, if ever, reward us by a sight of their insignificant flowers, and neglect the thousands of moderate-sized shrubs and plants which exhilarate and surprise us by the splendour and perfume of their gorgeous blossoms?

There is no great difficulty in the erecting of these very lofty houses; but there is in the management of them afterwards, both in regard to ventilation and heating. The large domical conservatory which at one time graced Bretton Hall, and was then the wonder of the age, and which was erected at a cost of somewhere about £10,000, was defective in a very great degree as regards the culture of the plants within it. We are informed by Mr Marnock—who was gardener at Bretton Hall at the time of its existence—in his excellent *Journal* for 1845, p. 633, that it was 60 feet high, and of a conical form. In the management of the temperature, he says, “During mild weather all went on very well, and especially in summer, when the external air could be admitted into the house with impunity, and without risk to the plants; but throughout the winter, and especially when the external temperature was low, and the winds frosty and boisterous, then arose the difficulty, and mischief to the plants was unavoidable. To explain this—to those at least who are at all conversant with the nature and properties of heat—it will only be necessary to remark, that, after all that can be allowed for or said in behalf of radiated heat in maintaining the temperature of a hothouse on a level with the pipes and the floor, the practical effect is not to be mistaken; the heated, and of course rarified, particles of air, as they come in contact with the hot-water pipes—or, as in the case to which we refer, steam pipes—rush upwards, in order to give place to the colder and denser particles; and as heat is generated below, it ascends as rapidly upwards, till the upper part of the lofty structure is heated to excess. In the large house to which we refer, the difference of temperature in ordinary



weather in winter between the upper dome and the parts near the floor, where the small and delicate plants were arranged, was usually 15° Fahr.; and in very severe weather, when much artificial heat was required, the difference became much greater. At such seasons the glass round the base of the lower dome has many times been thickly coated with ice, when the higher parts of the loftier trees were exposed to a temperature of at least 90° or 100°, the practical effects of which upon the plants were ruinous." Such are the remarks of one whose capability of judging we hold in the highest estimation. The following remarks by the same excellent authority are in accordance with our own opinion: "All stoves or glass structures for the cultivation of flowering, and of course fruit-bearing plants, ought to be so constructed as to admit of being protected at night by a covering of some kind, to prevent the waste of heat by radiation, so that comparatively very little artificial heat would be required at that season; and this is especially desirable with respect to lofty houses containing plants which require to be kept at a high temperature. No cultivation can be congenial or successful in such cases, when constant and incessant supplies of artificial heat require to be maintained to meet the waste, whether occasioned by radiation, or by imperfect fitting and glazing. The effect of all this upon the plants generally is to keep them constantly under excitement, and for ever green and growing. No mode which we have yet seen proposed for the erection of lofty stoves has presented any means of meeting or preventing the evil to which we refer. Such structures—that is, lofty ones—are of course desirable; but they are entirely unfit for the perfect culture of tropical plants—palms, and indeed all the tall-growing kinds of endogenous plants, excepted."

The ventilation of this house was effected by horizontal ventilators placed in the parapet wall, and also by upright windows at the meeting of the lower and upper domes, as well as by a skylight which was raised by weights under the terminating coronet at the top.

Certainly the large house at Chatsworth, the extensive range at Sion, and

others of similar colossal dimensions, have been most inefficiently ventilated towards the top; and from this some of the evils alluded to have arisen. The arrangements made in the new range of lofty houses at Kew, although said to be upon the newest and most complete principles, and having all the errors of previous erections as beacons for their guidance, has been found nearly as defective as those that have gone before them.

On the subject of inefficient ventilation in metallic houses in general, we here quote the opinion of Mr Niven, who has had great experience in these matters, and is withal a strenuous advocate for such roofs. He says: "I conceive, from most I have seen in the way of metallic houses, that they have suffered much in point of character from the want of sufficient means of ventilation; bearing in mind the great increased medium for the reception of the solar rays by the curvilinear form of roof, as well as its much increased surface of light compared with the opaque roof of the wooden house, with its heavy shadowing rafters. Taking these circumstances into consideration, I am only surprised that the damage arising from defective means of ventilation has not been greater than what I have witnessed. This, however, is not the fault, it has been merely the misfortune, of the metallic house.

"The natural tendency of heated air to ascend must always make the highest parts of a lofty house much hotter than the bottom, notwithstanding the heating apparatus being placed under or near to the floor level; and without sufficient outlet, the top must become so intolerably heated as that no plant can possibly exist in it. On the other hand, if too copious ventilation is provided at the top, the heated air will escape, causing an enormous waste of fuel. That all supplies of fresh air should be admitted at or near to the floor is quite obvious, and that it, by being so admitted, should become moderately heated before reaching the plants, is equally clear; but to regulate the whole atmosphere of a large and lofty house, without an unnecessary waste of fuel, is a desideratum much wished to be attained. A well-appointed circulation in all parts appears to us to be the most effectual plan; and, so far as

the economy of heat is concerned, such a circulation should be adopted as would cause a great portion of the heated air at the top of the house to descend to the floor, or under it, to become amalgamated with fresh air from without, and so keep up an ascending and descending current. By the application of mechanical power, the heated air at the top might be drawn down to air-chambers under the floor, through tubes fixed to the under sides of the rafters or curvilinear ribs that form the structure; and also a supply of cold air could be made to ascend through similar tubes, and be made to diffuse itself at any height or heights that may be deemed necessary. At all events, insufficient ventilation has hitherto been the great defect of extra lofty houses."

The new conservatory at Trentham—which is a very handsome architectural screen, separating the kitchen garden from the pleasure-ground—is a house very much to our mind, as, while it is capacious, it is not too lofty. The length is 89 feet, and the breadth 60 feet. The roof is a series of spans 9 feet wide, and rising 3 feet to the centre of the span. The sides are 9 feet in height, and are all glazed to the ground, while ventilation is amply provided for.

In regard to form, we may here observe, that of all other figures, the domical is the worst. And we are not alone in this opinion. The late Mr Loudon, in referring to the destruction of that immense house, the *Anthæum*, attempted to be erected at Brighton, but which unfortunately fell to pieces long before it could be finished, says of such forms: "When, however, it is seriously contemplated to grow house plants in quantity together, and to a large size, a square or parallelogram will be found the most advantageous ground-plan, with a ridge-and-furrow roof, supported on cast-iron pillars, which might be raised as the plants advance in size. Such a house, whatever might be its extent, would be a mere repetition of two or three very simple parts in straight lines, and would therefore cost very little—at least not one half per superficial foot so much as a dome of such proportions as the *Anthæum*."

"A dome is calculated to have a very grand appearance when seen from with-

out, and also, if comparatively empty, when seen from within; but when filled with plants, the domical form, and the circumstance of its being without interior supports, pass for nothing. Any one will be convinced of this who has had an opportunity of examining the exterior and interior of the dome at Sion, or of that once existing at Bretton Hall. Circular houses, composed of a succession of roofs supported by pillars, are totally different constructions, and are scarcely more expensive than the square or parallelograms which we recommend, while their interior effect is equal to that of any dome whatever. Let it not be forgotten that the vastness of the hemispherical roof is totally lost in the interior, when the house is entirely or even in part filled with trees." The correctness of this opinion is every day confirmed by the circumstance of this form of roof being entirely discarded.

One great mistake has been fallen into by most hothouse builders and garden architects, namely, not giving their structures sufficient height of base. We in general see houses otherwise faultless built upon the general ground-level of the garden they are placed in. This certainly should not be the case, for by it the borders are often injured by damp, and the furnace fires drowned out in times of heavy rains, where proper provision for draining them has either not been made, or where it has been impossible to do so; while, in addition to all this, the houses themselves are deficient in effect for want of elevation. All houses should stand above the ground-level from 2 to 3 feet, according to their size and the length and importance of the range. The borders, if they are fruit-houses, will then have a sufficient slope towards the walk, and the houses be looked up to when viewed from thence. More elegant structures, such as conservatories, should stand high, and be terraced around with all the accompaniments of parapets, steps, &c.; or, for greater effect in the case of forcing-houses, when the range is extensive, the borders may be made level and made good at the front next the walk with a stone ashlar or a brick wall, divided into compartments by running up at equal distances pilasters finishing above the wall in square plinths, on which to place vases

or caps according to taste and circumstances. In long ranges, this retaining wall may be in a straight line, whatever may be the breadth of the houses, though perhaps it would be better that it should be in breaks corresponding with their respective breadths. In this latter case, however, it will be necessary to have, as is usually the case, the highest and broadest house in the centre. By this plan, also, ample means will be offered for subterranean ventilation, the openings of the air-drains being in the retaining wall, and covered with ornamental revolving brass ventilators, the air being conducted in tubular earthenware pipes under the borders; or where these do not exist, as in the case of plant-houses, or where the roots are confined within the walls of the house, as should be the case in wet and cold countries, it is brought under the terrace walk, which should, according to all principles of good taste, occupy their place. The air thus admitted can be diffused regularly over the house, and made to ascend from under the pathways, by the sides of the walls near the surface of the floor; and those disastrous consequences may be avoided, which always follow the admission of cold air immediately upon the young tender leaves and shoots.

In regard to magnitude, we believe that hothouses may be carried to any extent of area, provided the height does not exceed certain limits. What these limits are, experience has not as yet taught us; but that the strength of a structure is diminished as its magnitude is increased, appears to be fully admitted. The following reasoning is given by Dr Lardner in his recently published "Handbook of Natural Philosophy," &c.—"If any structure be increased in magnitude," says this authority, "the proportions of its dimensions being preserved, the strength will be augmented as the squares of the ratio in which it is increased. Thus, if its dimensions be increased to a twofold proportion, its strength will be increased in a fourfold proportion; if they be increased in a threefold proportion, its strength will be increased in a ninefold proportion, and so on. But it is to be considered, that by increasing its strength in a twofold proportion, its volume, and consequently its weight, will be increased in an eightfold proportion; and by in-

creasing its dimensions in a threefold proportion, its volume and weight will be increased twenty-seven times, and so on. Thus it is apparent that the weight increases in a vastly more rapid proportion than the strength, and that, consequently, in such increase of dimensions, a limit would speedily be attained at which the weight would become equal to the strength, and beyond this limit the structure would be crushed under its own weight. On the other hand, the more beyond this limit the dimensions of the structure are kept, the greater will be the proportion by which the strength will exceed the weight. All works, natural and artificial, have limits of magnitude, which, while their materials remain the same, cannot be exceeded."

In regard to economy in construction, and also for houses in which very early and very late crops are to be expected, long narrow houses will be found more satisfactory than those of a very great breadth; and those with steep roofs more so than those with flat ones, as in both cases much depends on their being placed at such an angle of elevation as will present these roofs most favourably to the sun's rays when it is low in the horizon, and also because the plants are nearer the glass. On this subject Mr Loudon remarks, "There is another reason in favour of narrow houses, where perfection of growth and economy are objects, which is, that a considerable portion of the heat by which the temperature of hothouses is maintained is supplied by the sun. The power of the sun, therefore, will be great on the atmosphere within inversely as its cubic contents, compared with the superficial contents of the glass enclosing it. Thus, supposing one house to be 20 feet high and 20 feet wide, and another to be 20 feet high and only 10 feet wide, the contents of the former will be exactly double that of the latter; at the same time, instead of containing double the surface of glass on its roof, it will scarcely contain one-third more, being nearly in the proportion of 28 for the house of double volume, to not 14, or one-half, but 22, for the one of half the internal capacity. In the wide house every square foot of glass has to heat upwards of 7 feet of air; in the narrow house, only about  $4\frac{1}{2}$  feet." The experience of ages confirms

the opinion that, for early and for very late forcing, narrow houses with a very steep roof are the best, as they give so small an amount of air to be heated by the solar rays ; and those rays are admitted at a proper angle when the sun is low in the horizon, and above it only for a short time. For general crops to ripen during summer, the case is different ; and therefore wider houses and roofs at a much lower angle have their admitted advantages. This is still more the case when the plants, such as peaches and vines, are trained close under the roof. For plant-houses the case is different, as these require to be of greater breadth, so that the plants may have room to develop themselves on all sides, and be on all sides equally exposed to light and air. There is no doubt a limit as to breadth in this case also, for beyond a certain distance the rays of light and heat cease to be useful. What that distance is, is dependent on circumstances. A certain portion of the light which passes through the glass is refracted—that is, it leaves the transparent medium at a different angle from that at which it fell upon it ; and by this change the light is weakened, so that, at a very short distance from the surface of the glass, it becomes dispersed and transfused in the atmosphere, in which state, in hothouses, it has no longer the same power on the vital energies of plants.

For the angle of elevation, *vide* art. ANGLE OF ELEVATION.

Vineries require to be of a greater breadth than peach-houses, on account of the different habits of the plants. An error generally fallen into is, making the former too narrow when they are intended for a general crop.

In regard to breadth as well as height, there are thus limits beyond which it would be vain to go, if the health of plants is to be a consideration ; for beyond certain limits the rays of light, after passing through glass, however pure, cease to be useful to them. What these limits are has not been as yet, we believe, accurately determined, though it is desirable that it were so. Light would not reach plants, in a state to be beneficial to them, near the ground in the centre of the transept of the Exhibition glass structure ; nor is it even certain that the large elms would long exist in it, even presuming them to

be in the vigour of youth instead of the decrepitude of old age. They exist at present, and may do so for a short period, because their foliage is so close to the glass roof. The plants brought in during the Exhibition gave evident proofs of their distance from the glass, and all the art of man could not keep them in anything like healthy appearance. Extreme in width and height together must be avoided, but width with moderate height is quite another affair : for, supposing a glass structure covering 50 or 100 acres, if the height do not exceed 10 or 12 feet, then would plants of 2 or 3 feet in height thrive in it ; and in another whose height did not exceed 4 or 5 feet in height, plants of lower habits might be cultivated. If we exceed those limits, be the form of the structure what it may, then we must furnish it with plants or trees of a proportionate height. So great is the influence of light on plants, that even at these moderate limits the plants would be found striving by elongation to reach even nearer the glass. We believe, were a plant put under a structure whose sides were constructed upon the principle of the slides of a telescope, that as they were drawn upwards the plant would follow to almost any height—striving, in fact, to get to a proper distance from the glass—the light from the sides towards the bottom being useful to the plant only during winter, when the sun is low in the horizon ; during summer, when it is nearer the perpendicular, such parts would be of comparatively little use. In very low houses, say not exceeding 8 feet in height, and where the glass reaches to the ground on all sides, if they are so isolated as to be unshadowed by trees or buildings, their breadth may be increased, because the plants in no part would be farther from the glass than some 5 or 6 feet, or at least they may be so placed as to be so. Such houses, however, would be better adapted for summer than for winter, as at the former season the sun would be high in the horizon, and his slightly oblique rays would pass through the roof from May till September ; and judging from what experience has taught us in the case of peaches and vines, trained at nearly similar distances from the glass, a degree of success might be expected. During winter, little light directly useful to plants would reach

them, on account of the perpendicular sides being at a most unfavourable angle to the sun's rays. We see no reason why a whole garden, however large, may not be enclosed within a glass covering 8 feet from the ground. Yet even with this height it would be found advantageous to paint the interior white, and to introduce reflectors of light to the fullest extent possible. Loftier structures, no doubt, may be indulged in by those who wish to grow timber trees within them. In botanic gardens there may be a plea for growing such specimens; in gardens for the production of fruit and flowers there is none. One of the reasons why plants thrive so much better in pits than in large and lofty houses, is their nearness to the glass; and this is also the reason why peaches and grapes are grown by being trained close under its inner surface. All good cultivators place their most choice and delicate plants as near to the glass as possible; and one of the most successful of all our pine-growers keeps his plants so near the roof as to be compelled to take out a square of glass occasionally, to allow the crown of the fruit to shoot up through into the open air. While all kinds of theories have been started, and experiments made, on hothouse building, few have bestowed a passing thought on the distance that the light rays will penetrate into a glass house. The angle of elevation has been carefully calculated; the extent of radiating surface, and the length of pipes for securing the necessary amount of heat, have been determined; yet, so far as we know, no one has yet calculated one of the primary necessities of vegetable existence, when subjected to artificial treatment. "The heat of the sun is the cause of growth, and its light the cause of maturity, in the vegetable kingdom;" yet no one can say whether the beneficial effects of light extend to the distance of 6 inches or 60 feet beyond the inner surface of the glass.

*Hothouse trellises.*—Trellises for training trees to in hothouses were long made of timber, which was both expensive and heavy in appearance, while it also required frequent repairs. This material is seldom now used, having given place to copper or galvanised iron wire run through wrought-iron studs, brackets, or upright supports. The advantage of the former is, that it is not liable to rust, on

which account it has been much used for trellising garden walls as well as hothouses. The recent improvements by which iron is coated with glass, copper, brass, lead, zinc, &c., may not inappropriately be applied to trellises for such purposes. Iron wire of the common sort is now pretty well supplanted by what is called "prepared charcoal wire," which is so prepared that its elasticity is preserved, upon which so much depends. Galvanised wire is also now used, as the process to which it is subjected greatly prevents oxidation. All iron trellises, if not prepared as above, should be regularly painted with anti-corrosive paint, which may be made of any colour.

The direction of the wires should always be vertical or horizontal, and all whimsical forms should be disregarded, as only increasing expense without one rational advantage.

For various modes of constructing trellises, *vide art. ESPALIER RAILS.*

## § 2.—THE ANGLE OF ELEVATION.

Regarding the angle of elevation—that is, the proper slope of glass roofs—much has been said and written, and little has been done to carry the correct theory into general practice. Hothouse builders, in general, content themselves by determining the length, breadth, and height supposed to be most convenient to existing circumstances, without troubling themselves further, or without going into those mathematical calculations necessary to arrange the slope of the roof to the latitude of the place, or the purpose for which that roof is intended. Hence the same angle of elevation is found in Cornwall and in Ross-shire, the difference in latitude and the sun's inclination being seldom thought of.

This subject appears to have attracted the attention of Boerhaave about the beginning of the last century, and was taken up by Linneus, and still further pursued by Faccio, Adanson, Miller, Speechly, and Williams of New York. The late T. A. Knight published hints on this subject in the first volume of "The Horticultural Society's Transactions;" and Sir George Mackenzie, in 1815, determined "that the form of glass roofs best

calculated for the admission of the sun's rays is a hemispherical figure;" and this Mr Loudon at first considered as "the ultimatum in regard to the principle and perfection of form." The following quotation bears on this subject:—"The theory of the transmission of light through transparent bodies is derived from a well-known law in optics; and the influence of the sun's rays on any surface, both as respects light and heat, is directly as the sine of the sun's altitude; or, in other words, directly as it is perpendicular to that surface. If the surface is transparent, the number of rays which pass through the substance is governed by the same laws. Thus, if one thousand rays fall perpendicularly upon a surface of the best crown glass, the whole will pass through except about a fortieth part, which the impurities of even the finest crystal, according to Bouguer, will exclude; but if these rays fall at an incidental angle of  $75^\circ$ , two hundred and ninety-nine rays, according to the same author, will be reflected. The incidental angle, it will be recollected, is that contained between the plane of the falling or impinging ray, and a perpendicular to the surface on which it falls. The benefit derived from the sun's influence on the roofs of hothouses depends, as far as respects form of surface, entirely on this principle. Boerhaave applied it to houses for preserving plants through the winter, and, of course, required that the glass surface should be perpendicular to the sun's rays at the shortest day, when most heat and light were required. Miller applied it to plant stoves, and prefers two angles in the roof—one as the upright glass, to meet the winter's sun nearly at right angles, and the other as the sloping glass, to meet it at an angle of  $45^\circ$  for summer use, and the better to admit the sun's rays in spring and autumn. Williamson prefers an angle of  $45^\circ$  in all houses, as do most gardeners, probably," Mr Loudon observes, "from habit; but Knight prefers, in forcing-houses at least, such a slope of roof as shall be at right angles to the sun's rays, at whatever season it is intended to ripen the fruit. In one of the examples given, ("Horticultural Transactions," vol. i. p. 99.) his object was to produce "a large and highly-flavoured crop, rather than a very early crop of grapes; and he, accord-

ingly, fixed upon such a slope of the roof as that the sun's rays might be perpendicular to it about the beginning of July, the period about which he wished the crop to ripen. The slope required to effect this purpose, in latitude  $52^\circ$ , he found to form an angle of  $34^\circ$  with the plane of the horizon. In the application of the same principle to the peach-house, ("Horticultural Transactions," vol. i. p. 206,) in order to ripen the fruit about midsummer, the roof was made to form an angle with the horizon of  $28^\circ$ . Both these houses, Knight informs us, produced abundant crops perfectly ripened."—*Encyclopædia of Gardening*, p. 583.

Abercrombie says, "The diagonal side of a glass case designed for a course of forcing to begin 21st December, may be  $55^\circ$ ; 22d January,  $50^\circ$ ; 21st February,  $46^\circ$ ; 21st March,  $40^\circ$ ." Too much importance, he says, must not be attached to the angle of inclination in the glass work.

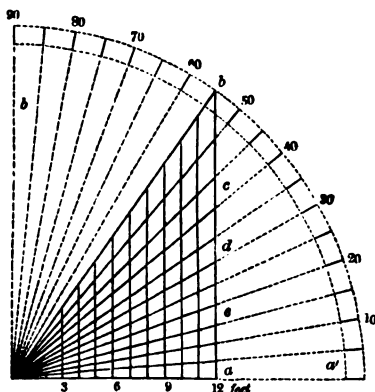
W. P. Ayres, in arranging the roof of his cucumber-house so as to obtain the perpendicular solar rays in December in latitude  $53^\circ$ , adopts an angle of  $75^\circ 28'$ ; for January,  $71^\circ 52'$ ; for February,  $62^\circ 29'$ ; and for March,  $51^\circ 41'$ ;—which latter comes again into operation in September.

The calculation of the inclination of angles, for the better determining the slope of hothouse roofs, is very differently practised on the Continent and with us. We calculate from the perpendicular line of the quadrant, while they calculate from the base or horizontal line. A very excellent article on this subject will be found in "Paxton's Magazine of Botany," vol. ii. p. 257, from which the following extract and diagrams are taken. Alluding to the above modes of calculating, Sir Joseph observes: "Both systems are equally good when understood; but an understanding is requisite, because an angle of  $70^\circ$ , which with us is well known to be a very flat roof, is with the French very steep; and the same slope as our  $70^\circ$ , on their system, is an angle of  $20^\circ$ . Likewise, an angle of  $15^\circ$ , which in our calculation is very steep—only fit for early peach-houses and other fruit-houses, where the trees are trained to the back wall—is, by the French calculation, very flat, and unfit for early forcing." See the angle  $15$ , in the annexed scale, fig. 129.

"An example or two will probably

explain the subject better than words. Supposing a house for early forcing was required to be built 12 feet wide, and the

Fig. 129.



roof to form an angle of  $55^\circ$ . Now, to accomplish this, it would be necessary to raise the back wall as much as 17 feet higher than the front, as  $ab$ . Again, for a house of the same dimensions, with an angle of  $45^\circ$ , the back wall would require to be 12 feet higher, as  $ac$ ; with an angle of  $35^\circ$ , only 8 feet 4 inches higher than the front,  $ad$ ; with an angle of  $20^\circ$ , only 4 feet 4 inches higher,  $ae$ ; with an angle of  $10^\circ$ , which is the usual slope of frames, only 2 feet 2 inches.

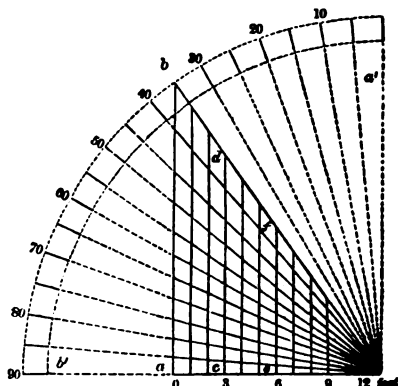
“Of course, houses of less width require less elevation at the back to give the required angle. For instance, a house 6 feet, with a roof at an angle of  $45^\circ$ , will only need the back wall to be 6 feet higher than the front. Also, a frame 3 feet wide, having an angle of  $10^\circ$ , would only require the back to be 7 inches higher than the front.

“It will always be useful to remember that a perpendicular equal to the width of the house always gives an angle of  $45^\circ$ .

“The English gardeners calculate inclinations from the perpendicular, which, in drawing plans for building, may be explained by the annexed scale, (fig. 130,) wherein the side  $b'$  of the quadrant is made the base, instead of  $a'$ , which, of course, reverses the whole order of calculation, making the first inclination  $85^\circ$  instead of  $5^\circ$ . Supposing it is desired to build a house 12 feet wide, with the angle of the roof  $35^\circ$ , the elevation of the back wall must be precisely the same as, in the French scale, is required for  $55^\circ$ ;

viz., 17 feet higher at the back than the front, as  $ab$ ; the same angle, 9 feet wide, the back 12 feet 8 inches higher,

Fig. 130.



the front, as  $ab$ ; if only 6 feet wide, the back need only be 8 feet 6 inches higher than the front, as  $ef$ ; and so on in proportion, measuring according to the annexed scale.

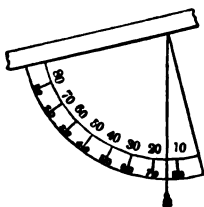
“It will also be seen that, by this scale,  $80^\circ$  is the common angle of a frame, and exactly corresponds with  $10^\circ$  on the other mode of calculation, and therefore, of course, requires the same elevation—viz., 7 inches at the back more than the front.

“To find the angle of the roof of any hothouse, it is merely necessary to place the side  $a'$  of the quadrant in a parallel line against the side of the roof, for our way of calculation, and the side  $b'$  for that of the French, and the plum-line, hanging perpendicularly, will immediately give the required angle.”

These two scales deserve attentive study, and are so simple, and at the same time so complete, that all who are interested in the subject should attentively peruse them.

The following very simple directions for finding the angle of roofs are laid down by Mr Loudon.

Fig. 131.



“The instrument,” he says, “used by gardeners for taking the angle of roofs is a maho-gany quadrant (fig. 131) of about 6 inches radius, with a line and plummet, the quadrant being

applied as in our figure." Gardeners generally take the angle formed by the rafter and plumb-line, and call that the angle of the roof; but the true angle is that formed by the rafter and horizontal line, as elsewhere noticed. "If the quadrant is numbered both ways, the proper angle is immediately obtained."

To find the angle of elevation formed by the roofs of hothouses, the following very plain and practical rules have been given in the "Gardeners' Chronicle," 1843, p. 721. There are many other ways to find this out, and those who have studied trigonometry will recollect the problems bearing on the case. We adopt the two following, as they are sufficiently simple to be understood by very moderate capacities:—

"By means of a Gunter's scale and a pair of compasses, the pitch or elevation of roofs may be found easily as follows: Draw a horizontal line, and from the end of this another at right angles, by a square or otherwise; on the former, set off as many equal parts, say half-inches, as the house is feet in width, between where the outer side of the rafter touches the front-wall plate and the back wall; and on the other as many of such parts as the back wall is feet in height, measuring from a point on a level with the front-wall plate to the under side of the rafter at top. A line drawn between the points marking the above measures will form the slanting side of a triangle, corresponding with the pitch or elevation of the roof. It only remains to ascertain the number of degrees which the angle contains. With the distance of 60° form a *line of chords*, marked *cho.* on Gunter's scale; place one foot of the compasses in the angular point, and with the other describe an arc, intersecting the lines representing the base and roof; the distance between these lines at the points of intersection by this arc, will extend from the beginning of the line of chords to the number of degrees which the angle contains, or, in other words, to the number of degrees of elevation. Or a simple way is the following: Describe the triangle *abc*, on which let *a c* represent the width, and *b c* the height of the back wall above

the front-wall plate; then place the instrument called a protractor, with its middle line at *a*, and the line *a b* will intersect on the protractor the angle required."

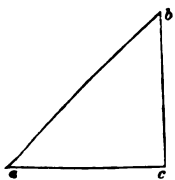
In following out the same subject, we cannot do better than transcribe the following data for determining the angles of glass roofs as laid down by Wilkinson. "The angle contained between the back wall of the forcing-house and the inclined plane of the glass roof, always equals the sun's altitude, when its rays fall perpendicular on that plane, provided that the inclination of the plane to the horizon be at an angle not less than 28° 2', nor greater than 75°. Within the above limits the sun's rays are perpendicular twice in the year—once in going to, and once in returning from, the tropic. Hence, then, having determined in what season we wish to have the most powerful effects from the sun, we may construct our houses accordingly by the following rule: Make the angle contained between the back wall of the house and its roof equal to the complement of the latitude of the place, less or more, the sun's declination for that day on which we wish its rays to fall perpendicularly. From the vernal to the autumnal equinox, the declination is to be added, and the contrary. Thus, to apply those principles to the slope of roof recommended by Knight for ripening grapes in July, say at London, we have—

Latitude of London,	51° 29'
Sun's declination on the 21st of July,	17° 31'
	33° 58'

— or 34° nearly.

In continuation, Mr W. says, "As we want the genial warmth of the sun's rays most in spring, therefore, for general purposes, that construction would perhaps be best which gives us the greatest quantity of perpendicular rays then. If the inclination were 45°, the sun's rays would be perpendicular about April the 6th and September the 4th; and as the rays would vary very little from the perpendicular for several days before and after the 6th of April and the 4th of September, the loss of rays arising from reflection would, as appears from the annexed table, be nearly a minimum. Even at the winter solstice, the loss by the obliquity of the angle of incidence would be only two in one thousand more than when the rays

Fig. 132.



and *b c* the height of the back wall above



are perpendicular, as appears by Bouguer's table of rays reflected from glass.

"Of one thousand incidental rays, when the angle of incidence is

87° 30',	584	are reflected.
85°,	543	-- --
82° 30',	474	-- --
80°,	412	-- --
77° 30',	356	-- --
75°,	299	-- --
70°,	222	-- --
65°,	157	-- --
60°,	112	-- --
50°,	57	-- --
40°,	34	-- --
30°,	27	-- --
20°,	25	-- --
10°,	25	-- --
1°,	25	-- --

—*Hort. Trans.* ii., p. 227.

"Now, if we suppose a roof," says Mr Loudon, "in one plane, with the sun shining on it at six o'clock in the morning, and at six o'clock in the afternoon, at an angle of 85°, which would be the case in March and September, fully one-half of the rays which fell on the roof would be reflected; while in the case of a ridge-and-furrow roof, if it shone on half the roof—that is, on one-half of each of the ridges—at any angle, with a perpendicular not exceeding 30°, at the same periods only two per cent of the rays would be reflected. Suppose, then, the area of the entire roof, taken as one plane, to be 100 square yards, and, to facilitate calculation, that only 100 rays fell on each yard, then the total number which would enter through the roof in one plane would be 50,000, while those that would enter through the ridge-and-furrow roof would be 99,000, or very nearly double the number."—*Suburban Horticulturist*.

The majority of gardeners and hothouse builders appear to agree in fixing upon 45° as being the angle for hothouse roofs for general purposes, not only as being that at which the rain water will drain most freely from it, but, according to these views, as being that most favourable for plants in general.

In regard to the angle of roofs losing heat by radiation and conduction in proportion to their height, we have the following reasoning by Mr Perceval in the "*Gardeners' Chronicle*:"—"The loss by radiation," he says, "must be the same at all angles; but the cooling effect of the wind will be greater on a high-pitched

roof than on one that is flatter, though I believe the difference in this respect (except inasmuch as it increases the length of the rafter, and, therefore, the cooling surface of the glass,) will generally be too small to be of any practical importance. The effect appears to me to arise in this manner: the wind being supposed to move horizontally, the force with which it strikes the glass will be as the sine of the angle which the roof forms with the horizon; and the greater the force of the blow, the more particles will there be brought into contact with the glass; and this effect will be the same as that of an increased velocity of the wind. On this latter subject Mr Hood has given some interesting and ingenious illustrations in his book; and I think his rules for the cooling effect of wind at different velocities will apply to this question. He has shown the cooling effect of wind on glass to be as the square root of the velocity—or that the velocity must be increased four times to produce twice the cooling effect. Now, the force of a blow being as the square root of the velocity of the striking body, and as the sine of the angle of incidence conjointly, we shall find that, if two glass roofs be severally pitched at 30° and 40°, the force of the wind upon them, at equal velocities, will be simply as the sines of these angles, or as 50 is to 64: this will be equivalent to increasing the velocity of the wind from 1.0 to 1.28, and the cooling effect will therefore be as the square root of these numbers, or as 1.0 is to 1.13. But this will only apply to that part of the heat given off by conduction—the radiation not being affected by this cause. And Mr Hood has shown, in his book, that at common temperatures the loss by radiation from glass is nearly two-thirds of the whole effect; therefore the loss, by increasing the angle of the roof 10°, will be one-third of the above amount, or about one-thirtieth more than a flatter roof would be. This effect, of course, is only on the roof, all the rest of the house being entirely unaffected by this cause; therefore we are justified in concluding, that the pitch of the roof makes but little difference in the cooling effect, except by the increased length of the rafter."

For Speechly's opinion of the angle of elevation, *vide* VINERIES.

“Light, to a certain extent, follows the same laws as heat. It is received by radiation from the sun, reflected by smooth surfaces, transmitted and refracted by transparent substances, such as water and glass; concentrated by reflection from concave surfaces, and dispersed by reflection from surfaces that are convex. Light, however, differs from heat in the impossibility of retaining it after the absence of the sun; whereas heat can be retained by enclosing heated bodies in non-conducting mediums, and by reflecting it back to the surfaces from which it is radiated. The radiation of light is greatest when the radiating rays strike the surface at a right angle, and the least when the angle is most oblique; because, in the former case, the rays are reflected on every side, and consequently the surrounding objects are illuminated proportionably; and in the latter case the greater number of rays pass off at one side, and illuminate less effectively the surrounding medium. The reflected rays are always returned from the surface on which they radiate, at an angle equal to the angle of incidence: if the reflecting surface be a plane, the reflected rays will be parallel to each other; if the surface be convex, they will be divergent, and consequently dispersed; and if it is concave, they will be convergent, and hence concentrated. Smooth and shining surfaces reflect most light, and rough and dark surfaces least; and with respect to colour, white reflects almost all the rays of light which fall upon it, and black absorbs them all. When light falls on a transparent medium, a portion of the rays is transmitted through it, and a portion is reflected from its surface. The latter portion follows the same laws as the light which is reflected from opaque surfaces; and the portion which passes through it is refracted—that is, it leaves the transparent medium at a different angle from that in which it fell upon it; and by this change the light is also weakened, so as, at a very short distance from the surface of the transmitting medium—as of glass, for example—to be dispersed and transfused in the atmosphere, in which state, in hothouses, it has no longer the same power on the vital energies of plants. We are not aware that the cause of the inefficiency of light, after it has passed

through glass and reached a certain distance, has been fully explained; but the fact is well known to gardeners, who in hothouses invariably place the plants they wish to thrive best at the shortest distance from the glass. As the quantity of light which passes through glass at the roof of hothouses is, all other circumstances being the same, greatest when the plane of the roof is at right angles to the plane of the sun's rays, so the slope of the roof is, or ought to be, adjusted to the direction of the sun's rays at that season of the year when its light is most wanted. As in houses for early forcing, the greatest deficiency of solar light is in the winter season, when the sun is low, so the roofs of such houses are made steep, in order that the sun's rays may be received at a larger angle. Summer forcing-houses, on the other hand, have less steep roofs, so as to receive most benefit from the sun in April, May, and June, when forced fruits are ripening. A greenhouse in which no fruit is ripened, but in which abundance of light is required all the year, has commonly perpendicular glass to receive a maximum of light during winter; and a sloping roof of glass at an angle of  $45^\circ$ , which is found favourable for the admission of light at every season, as well as for throwing off rain.”—*Suburban Horticulturist*.

After all that has been said on the angle of elevation, it is not at all strange that no particular angle should be fixed upon as the true one; because that which would be a very proper angle for a peach-house, for instance, at Torquay, would be a bad one at Thurso, the difference of latitude being considerable. That for early forcing, anywhere, would be improper for a late forcing-house in the same latitude. It therefore follows that the angle of elevation, if of the importance some attach to it, and which to a certain extent we do not deny, must be made to correspond with the latitude the house is placed in, and also to suit the purpose for which that house is intended.

The following may be given as an example in addition to what has been said above. To obtain the perpendicular rays of the sun in December, it would be necessary, in latitude  $53^\circ$ , to place the glass at an angle of  $75^\circ 28'$ ; in January,  $71^\circ 52'$ ; in February,  $62^\circ 29'$ ; and in March,  $51^\circ 41'$ ; and so on, if the object is to secure the greatest amount of solar influence.

## CHAPTER IV.

### HEATING AS APPLIED TO HORTICULTURAL ERECTIONS.

#### § 1.—PRELIMINARY REMARKS.

WAIVING consideration of the theories which philosophers have advanced regarding the nature and properties of heat, let it be our task to consider its application to the purposes of horticulture, and endeavour to elucidate its use, on correct principles, in the various departments of that science.

As man advanced in civilisation and luxury, artificial heat became necessary to him, first for warming his dwelling, and afterwards to produce those exotic rarities for his table which his native climate had denied him. For this latter purpose heat has been employed for ages; but it must be acknowledged that, until within a very recent date, it has been in every instance applied upon the most unphilosophical principles imaginable, not only in respect of the production of an unhealthy atmosphere and uncertain temperature, but also as regards the consumption of an unnecessary quantity of fuel. Nor are the opposite results all the advantages which modern improvement has made in this case:—economy, neatness, and order have taken the place of filth, waste, and confusion. As healthy an atmosphere is now produced in all well-regulated hothouses as there is in the open air; and instead of difficulties presenting themselves in heating a moderate-sized pine-stove, we find none, now, in heating an entire garden, whatever may be its extent.

In preparing these pages, we have consulted every work of merit in which heating, so far as regards our present subject, is treated of, and have examined upwards of one hundred and twenty different modes of applying heat by combus-

tion alone, exclusive of the different methods of obtaining it by the fermentation of various substances. Many of these methods are absurd, as may well be supposed; and among these are not a few of very recent date, and of high pretensions. We have no interest whatever in one mode of heating more than another; and having had opportunities, not only of seeing most of them in operation during the last forty years, but also of practical experience both in the erection and working of many of them, we think we have a right to express our opinion of them unbiassed and freely. We thought at first of selecting plans only of those which we considered of greatest utility; but as there is at present so great a diversity of opinion amongst gardeners, and so much self-interest among tradesmen, with no small amount of adherence to the old fashions amongst some of the old-school practitioners, it has seemed better, as it is more fair, to give condensed descriptions, accompanied by illustrations, of all the various methods worthy of notice, offering our opinion on their merits or defects *en passant*. This arrangement may have its advantages, as we have more than once seen some very old modes of heating brought out as new, which it may expose, while it may also assist in the creation of ideas, and important improvements may yet be brought out of plans that have been long considered obsolete. In a work of this kind we consider it as much our duty to point out the defects as to recommend the merits of any particular system or subject under our consideration.

The most primitive mode of heating was that employed by the Dutch, which

must have been in use towards the end of the fifteenth or beginning of the sixteenth century, for at that period their gardens contained many of the plants of the East Indies. The system is still very generally met with throughout Holland and the Netherlands, although many instances occur of more modern methods being adopted. It consisted of the common stove of the country, placed at one end of the hothouse, *inside*, the smoke and heated air being carried along the middle or front in earthenware tubes about 10 inches in diameter, and smaller at one end than at the other, so as to admit the end of the one entering that of the next, the joints being secured with soft clay or cement. This method was also in use in this country, only with the improvement of having the fire placed outside the house, and burning in a small furnace similar to those used at present for heating wash-house boilers.

Another mode of heating then adopted on the Continent, and in some places still continued, was by a small iron waggon mounted on wheels, and filled with burning charcoal, which was drawn backwards and forwards through the house in severe weather. Strange as it may appear to many, such an apparatus was, not long ago, in use in the Botanic Garden at Oxford, and was in all probability introduced by Bobart, a German, who was the first curator in that garden.

These earthenware or can flues have been improved by using well-prepared fire-clay instead of common brick earth, which makes them much stronger and more durable, and at the same time their form is changed to the spigot and faucet joint, by which means they are rendered more secure. A still farther improvement has taken place by making them square, egg-shaped, and rounded at top.

Another mode of heating was and still is employed on the Continent, for warming orangeries and large plant-houses, consisting of a common iron stove placed within the house, the smoke and heated air being conducted through iron pipes suspended from the roof or otherwise, as circumstances may direct. This is the most dangerous mode of heating imaginable, and ought to be entirely exploded.—(See section, HOT-AIR STOVES.)

Brick flues constituted the next step towards an improved mode of heating, and those first used in this country were merely drains built under ground. These were followed by the broad and deep flues of the Dutch, built on the surface, but not separated from it. These are in very general use still throughout France and the Netherlands, and almost exclusively so in Russia and the north of Germany. About the same period, flues were built in the solid walls in this country, and placed in the front, or more generally in the back wall of the house. The obvious defects of these modes of heating require no comment.

The detached brick flue was adopted in this country about the end of the last century, and, under different modifications, still continues in pretty general use. These, if well built and properly managed, have their advantages. They are less expensive and more quickly heated than steam or hot-water pipes, and therefore useful in repelling sudden attacks of frost in plant-pits and greenhouses. The space they occupy and their heavy appearance militate against their being used in greenhouses of the first order, unless they are placed under the stages or plant-tables, as in figs. 133 and 134, or under the floor, as in fig. 135, in which latter case they should be

Fig. 133.

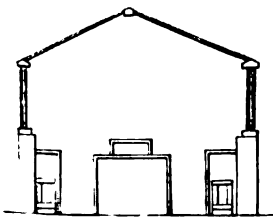


Fig. 134.

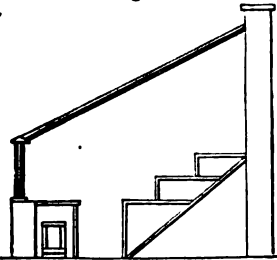
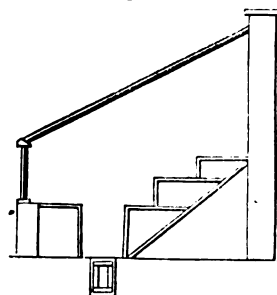


Fig. 135.



carried through a chamber, the sides, bottom, and top of which should be clear of the flue at least 3 inches, and not more than 6. The small quantity of air thus surrounding them would soon

become heated, and should be admitted into the house through neat brass ventilators, either circular, as figs. 136 and 137, or longitudinal, placed in the floor immediately over the flue, and from

Fig. 136.

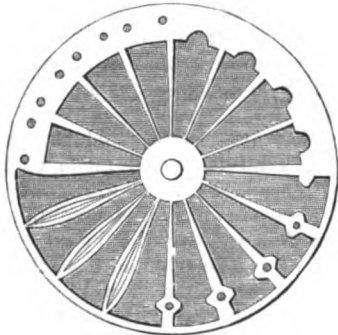


Fig. 137.

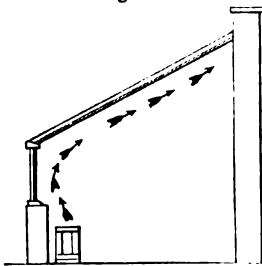


4 to 6 feet asunder. By such an arrangement the fire might be kindled in the evening upon the appearance of frost, and these ventilators opened, in case of need, to their full or half capacity. The heated air, if not required, could be allowed to escape by a small tube built into the extreme end of the chamber, and communicating with the external air, and regulated by a similar ventilator. But this will seldom be required. A similar ventilator should be built in the wall of the chamber near the fireplace, by which a fresh supply of air would be admitted, and propel the heated air in the chamber through the ventilators in the pavement into the house. All underground flues, however, lose much of their heat by its being absorbed by the walls, &c., which surround them, and they can only be recommended when it becomes absolutely necessary that they be placed out of sight. Flues, tanks, and the supports of hot-water pipes, should be built upon a solid foundation, to prevent fractures and settlements. Those in plant-houses, where the ground may be supposed to be undisturbed, may be safely placed on a foundation made of two courses of brick laid in cement or grout; such as are intended for peach and grape houses, where the borders may extend under them for the range of the roots, should be always built on arches or piers, linteled over with stone, according to local circumstances.—(Vide GARDEN WALLS, figs. 37, 38.)

It is always dangerous to build flues on wood, although we have seen examples of this. Flues and hot-water pipes should if possible be carried round the front and ends of the house, not only because these are the coldest parts, but because the heat ascending from those points naturally rises and floats towards the highest parts, completely cutting off the entrance of cold from without.

Such is the view hitherto taken by most practical men of the operation of heat as respects hothouses. This, however, is perhaps not the most philosophical mode of diffusing heat equally throughout any structure, as may be seen by a glance at fig. 139, by the direction of the arrows. That portion of the house, indeed, shown at the bottom of the back wall without arrows, is usually occupied with the footpath in forcing-houses, and in ordinary greenhouses is seldom used for plants; and, so far as ordinary practice goes, all is well enough. We should also here observe that the atmosphere of all glass houses is coldest nearest the roof, on account of the loss of heat by radiation, which is, at common temperature,

Fig. 138.



nearly two-thirds of the whole effect. The experiments of Hood prove that "1 square foot of glass will cool 1.279 cubic feet of air as many degrees per minute as the internal temperature of the house exceeds that of the external air: that is, if the difference between the internal and external temperature of the house be 30°, then 1.279 cubic feet of air will be cooled 30° by each square foot of glass; or, more correctly, as much heat as is equal to this will be given off by each square foot of glass." This calculation is taken, presuming the air externally to be still, but in high winds the loss of heat will be much greater; hence houses placed in exposed situations are more difficult to heat than such as are more sheltered.

In estimating the extent of radiation in glass houses, it will be found sufficiently accurate for ordinary purposes to take the whole surface of the sashes, and deduct one-eighth of the amount for the wood-work; for in hothouses, where glass of a small size, say 6 inches by 4, or 6 by 8, is used, the surface of the astragals and rails fully amounts to this quantity; but in roofs without framed sashes, and having glass 9 to 12 inches broad, the amount to be deducted will be much less; and in the case of metallic houses, as the radiation will be quite as much from the metal as from the glass, no deduction whatever must be made.

Heating upon scientific principles, even as regards dwelling-houses, was very little understood in this country until the arrival of Count Rumford, who gave an impetus to it by the publication of his essays, and the production of the grates known by his name. The late Walter Nicol and John C. Loudon were amongst the first who effected improvements in heating hothouses, and both began at the right end, by constructing improved furnaces. Hay and Stewart also directed their attention to this matter; but, so far as we can learn, it was Count Rumford and Dr Black who first used double furnace-doors and ash-pit registers, and these, with slight modifications, have remained in use ever since. The utility of double doors is obvious. They are not only more durable, but they also keep in the heat, and prevent a current of cold air from entering into the furnace, and of course passing rapidly over the fire, so as to be

less capable of heating the flue or boiler than that air which is admitted through the ash-pit register, and has to pass through the fire before it enters the flue. The supply of air is also graduated by being admitted through the ash-pit door, this securing a more steady combustion.

In 1805, the late Mr Loudon published "A Treatise on Improvements in Hothouses," one of the earliest productions of that eminent man, who during his life did so much for the advancement of horticulture. In that work he describes an *improved furnace and flue*, which, although it has been condemned by many, and ourselves amongst the number, still, upon more mature deliberation, we now admit to have certain merits. The intention of the author appears to have been to economise fuel, by collecting heated air above and around the furnace, and so bringing it into the house. This is the foundation of all improvements in heating; for it is beyond a doubt, that not one-half of the heat produced by the fuel in most furnaces is directed to the object intended, chiefly in consequence of the bad construction of the furnaces, by which an unnecessary quantity of air is admitted, tending to hasten the consumption of the fuel, and drive the heated air rapidly through the flues and out at the chimney top, accompanied with volumes of smoke and an immense quantity of unconsumed carbonaceous matter, most of which ought to have been consumed, and to have afforded its quota of heat. Experiments have been made, which prove that the loss of heat by this latter waste is as 975 to 1160.

The great objection to the admission of heated air into houses by such means, is the introduction of noxious gases, consisting of sulphuretted, phosphorated, and carburetted hydrogen, besides various compounds of nitrogen and carbon, all of which are highly injurious to both animal and vegetable life. Certainly these effects are not so great where the air is heated by passing over bricks only; but no hot-air furnace exists without a portion of metallic material being used in its construction; and hence the difficulty of applying the heat generated above and around most furnaces to the greatest advantage, and at the least possible risk of deteriorating the atmosphere to be heated.

That an immense economy of heat may be effected by introducing cold air into a chamber round the sides and over the top of every hothouse furnace, is obvious, as this air will become heated without any extra expenditure of fuel, and may be conveyed to a considerable distance if required. This we have frequently exemplified, and very recently upon rather an extensive scale in heating St Mary's Chapel in Dalkeith Park. This beautiful edifice is heated with hot water, and a smoke-consuming furnace placed in a chamber under the vestry. Over the boiler and furnace is formed an air-chamber of fire-bricks, 6 feet by 4, and 18 inches high, which is supplied with air by two ventilators, opening into the cellar in which the furnace is placed: as the air becomes heated, it is forced forward into the drains or chambers under the floor in which the hot-water pipes are placed, by the pressure of the cold air from without. This not only throws a constant current of heat into the building, but at the same time equalises the distribution of it, so that it is as warm at one part as at another. Nor is this the only advantage of admitting a supply of air moderately heated in a brick chamber. The effects produced on the animal economy by inhaling air which has passed over heated metallic surfaces, such as hot-water pipes, and more especially hot-air stoves or tubes, are sufficiently known. The small particles of animal and vegetable matter which the air always holds in suspension become decomposed, and resolved into their various elementary gases, according to the intensity of heat they are subjected to; and the hygrometric water of the atmosphere is almost entirely decomposed, the oxygen entering into combination with the iron, and the hydrogen mixing with the air. The salubrity of the air is greatly changed by these operations, and it becomes highly deleterious to animal life. But heat generated in a brick-built chamber, and not brought to too high a temperature, as in the above case, is by no means of so deleterious a character, because the hygrometric water of the atmosphere is not decomposed, as would be the case if the air was heated to a high temperature in a metallic chamber, or made to pass over a metallic surface such as the top of a

boiler, the bricks having no affinity for oxygen such as that possessed by heated metal. The top of the boiler in the case above referred to is covered with 2-inch fire-tiles, and, to render the heated air as little hurtful as possible, a shallow vessel of water is placed in the hot-air chamber, which can be supplied through the ventilators.

Hood, in his excellent treatise on heating, very properly remarks: "As the power of iron to decompose water increases with the temperature of the iron, the limit to which the temperature of any metallic surface ought to be raised, which is used for radiating heat for the warming of buildings, should not much, if at all, exceed 212°, if the preservation of health is a matter of moment. The importance of this rule cannot be too strongly insisted on. It ought to be the fundamental principle of every plan, for upon it depends the wholesomeness of every system of artificial heat."

As the heat in hot-water pipes rarely exceeds 180° or 200°, the decomposition of water by that heat is immaterial compared to that produced by steam, which is seldom under from 220° to 230°, and infinitely less than that by heated air, which frequently has to pass over metallic bodies red hot, as is often the case where hot-air stoves are employed.

Heating by hot water is undoubtedly the most wholesome form yet adopted, and, in its various modifications, it may be applied to all kinds of structures. The temperature it produces is uniform and moderate, when compared with hot-air stoves, flues, or steam. There are a few cases, however, which should be noticed, where heating by hot water would be attended with more expense than is necessary; and these are, small green-houses and nurserymen's plant-houses, where only half hardy plants are kept, and where a well-constructed flue can be introduced without occupying useful space. These only require heat sufficient to exclude frost, and they might be heated by an Arnott's, White's, or other stove, *placed outside* the building. In ordinary winters it might not be necessary to use the stove above a dozen times; and, as frost in general sets in pretty suddenly, these houses would, by such means, be heated in less time than by a hot-water boiler and pipe.

In estimating the relative merits of the different modes of heating, we should also consider that the difference in the quality of fuel is very variable; and even in that most common of all combustible material, coal, we find a great difference in its heating powers, arising from its differences of chemical composition. Experiments have been made by Watt, Rumford, Black, and many others, as to the amount of heat procurable from Newcastle coal of a fair average quality. According to Watt, 1 lb. of coal will boil 45 lb. of water taken at 55° of temperature. Black's computation is, that the same weight of coal will boil 48 lb. of water taken at a mean temperature; while Rumford makes it capable only of heating 36½ lb. to the same degree, the temperature of water being 32°. If we take the medium, therefore, of these experiments, the result will be, that 1 lb. of coal will boil 39 lb. of water taken at a temperature of 32°. From these data we can readily determine the quantity of coal necessary to heat any given length of pipe of hot water; for as 100 feet in length of a 4-inch pipe contains 544 lb. of water, 13.9 lb. of coal will be required to raise the temperature of this quantity of water 180°—that is, from 32°, or freezing point, to 212°, the boiling point. And, again, if the water loses 1° per minute, the above quantity of coal will supply 100 feet of pipe during three hours, provided the temperature remains constant in the atmosphere to be heated.

## § 2.—HEATING BY FLUES.

Having in a preceding section remarked on flues generally, we shall now proceed to consider them individually.

The Chinese, from the earliest ages, used flues in the walls of their houses, as well as under the pavement of the floors of their rooms: the latter of these they call the *ti-kang*, and the former the *tong-kang*, the heated air and smoke of which ascend into the spaces of a hollow wall,—a mode of wall-building long known in the Celestial Empire. The large orangery built by Sir William Chambers, and still existing in the Royal Gardens at Kew, was heated by the latter means.

*Earthenware or can flues.*—It has been

VOL. I.

already observed that these are of various kinds, the most primitive being tubes

Fig. 139.



of brick earth, tapering at one end, so as to join more readily with each other, *vide* fig. 139; they are usually about 2 feet in length, and 10 inches in diameter.

*Fire-clay flues, with spigot- and-faucet joints*—fig. 140. These are a great improvement

Fig. 140.



on the last, as they are stronger, less liable to warp in burning, and have a much neater appearance. They can also be jointed so as to prevent the escape of gaseous matter. They have been successfully used as an economical substitute for cast-iron pipes for circulating hot

Fig. 141.



water. They can be moulded with elbow turns, as in fig. 141; and are set on earthenware chairs, fig. 142, to clear them of the ground, and to keep them steady. In heating by hot water, the pipes are supported by similar chairs hollowed out both above and below.

Fig. 142.



The modifications of fire-clay flues are the square, fig. 143, egg-shaped, fig. 144,

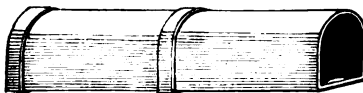
Fig. 143.



Fig. 144.



Fig. 145.



and round-topped, fig. 145—very excellent improvements, both in strength and

T

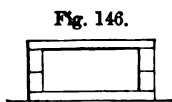


appearance. We have lately had specimens of fire-clay flues of the pattern fig. 143, made in lengths of 6 feet each, and tubular ones, 1 foot clear in diameter, of the same length—thus lessening the number of joints, and forming in either case the most elegant of all flues. The sides are 2 inches thick, and are carried clear of the ground by reposing on chairs of the same material supported on brick piers.

Very elegant and useful flues can be made of fire-clay tiles, 3 feet long, 1 foot broad, and  $2\frac{3}{4}$  inches thick. These tiles are to be set on edge, having bottoms and covers of similar dimensions, and to be half-checked, so that they may fit into each other; and, to render them more secure, they may be battled together with iron clamps, placed inside, and flush with the inner surface of the flue—the holes for the bats being formed before the tiles are burnt.

Flues of the above descriptions, if made from 2 to 3 inches thick, become, in fact, a modification of our best brick flues, having fewer joints, and having a more elegant appearance. The advantage of earthenware and fire-clay flues are, that they can be erected at much less expense, and are much sooner heated than any other. On this latter account they are valuable in greenhouses and pits for half hardy plants, where heat is required to be got quickly up to repel sudden attacks of frost. An improvement on these flues is, to leave the sides of the tiles of the usual thickness, and to hollow out their centres to half the thickness—that is, to form each tile into a separate panel, similar in principle to the bricks used in Gowen's flue, noticed below; and, for greater elegance, a neat moulding may be carried round the inner side of each panel. They may also be portable, and removed when not required. In this case it will be best to pack the joints with well-prepared fire-clay; but if intended to be permanent, they should be jointed with cement or mastic.

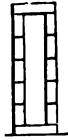
*Broad flues*—fig. 146—have been recommended by Stevenson in "Caledonian Horticultural Society's Memoirs." The only advantage of them,



however, is a slower draught, rendering

them fit only for situations where powerful fires are kept up.

Fig. 147. *Narrow and deep flues*—fig. 147—were recommended by the late Mr Oldacre, some time gardener to the Emperor of Russia. The advantage of these, we confess, we could never clearly see.



*Flues in solid walls*—fig. 148. These are now seldom used, unless for carrying

off smoke from detached flues running parallel to the fronts of houses; and also, in cases where hot water is employed, it is better to take the smoke, and consequently the heat that passes the boiler, along the back wall, as exemplified in some of the pine-stoves in the gardens at Dalkeith. These flues give out a certain portion of heat, which it is better to employ than to lose by its escaping at the chimney-top. By leaving square openings over them, a considerable degree of heat is thrown into the house from the top and side, and the sheds behind are kept both dry and warm by the heat that escapes from the opposite sides of the flues.

The *embrasure flue*—fig. 149—is an invention of Sir George Mackenzie's, and

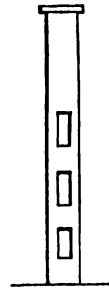


Fig. 149.



recommended by him as exposing a much greater heated surface in proportion to its length than the ordinary or straight flue. The merits of this flue have been said scarcely to counterbalance the extra expense of erection; we, however, think differently, and have seen them work admirably, as any one acquainted with the nature of heat will readily see by the diagram.

Fig. 150.



*Gowen's flue*—fig. 150—requires bricks and covers to be made on purpose: they are of the usual thickness at the base,

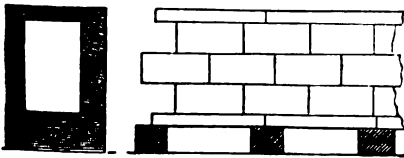
which, in building, makes them as strong as ordinary flues. The bricks and covers are hollowed out in the middle to half their thickness, by which means the heat is sooner transmitted through them, and in consequence heats the house sooner than if the bricks were of the usual thickness, thereby answering the purpose for which they were intended.

*Flag-stone flues.*—Where stone of a proper quality for standing heat is to be had, very neat flues may be constructed of it. The thickness of the stone should not be less than 2 inches, in lengths as great as can be got, to lessen the number of joints. The joints should be all half-checked and finished with fire-clay. The sides should be secured by being battled with iron bats, placed inside, and flush with the surface of the stone. Caithness pavement is well adapted for this purpose, as it stands the heat well, and can be had of any reasonable length, say 10 feet, and of any thickness; and if rubbed or half-polished, it would have a very elegant effect.

*Cast-iron flues.*—These have been recommended as being very durable; but the action of the heat on metallic substances is such as to render their adoption anything but advisable. Sir George Mackenzie has recommended triangular flues of this material, covering their surface with a mixture of clay and sand; this, however, would only lessen their deleterious effects to a very limited extent.

*Common or detached flue*—fig. 151.—This was the first real improvement in flue-

Fig. 151.



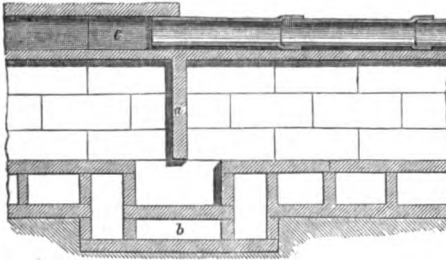
building. Flues of this description vary in dimensions from 9 to 12 inches in width, and from 12 to 18 inches in height. They are built of regular and well-sized bricks placed on edge; but where a great and constant heat is required, they should be on bed, being thus much stronger, and, when once heated, retaining their heat much longer. They ought to be neatly jointed with well-prepared ground mortar,

and washed inside with thick grouting, but plastered neither inside nor out. The foundations being formed as already recommended, and brought to a proper level, the bottom or floor of the flue should be formed of pavement or tiles, as may be most convenient, and elevated upon brick piers, so as to raise it about 6 inches above the finished floor of the house. This is for the purpose of keeping the flue free from damp, which would have a tendency to cool the air in it, and to obstruct the draught or current of smoke and heat, which are both lighter than cold and particularly damp air, as well as of preventing the loss of heat by absorption. The best covering is pavement that will stand the heat, or tiles either of brick earth, or fire-clay. For greenhouses, where a moist heat is not required, they may be level on the top; but for forcing-houses and plant-stoves, they may be hollowed out in the middle to hold water, for the purpose of raising steam or vapour, by pouring water upon them. Although we recommend this provision to be made for steaming, we do not by any means approve of the manner in which this operation is too frequently performed—namely, by pouring unnecessary quantities of water on them. Little at a time should be put on, and this frequently repeated. When the tiles are porous, much of this water filters through into the interior of the flue, chilling the temperature in it, and checking the draught. It is a good plan to have such covers glazed by the potter, or painted with oil colour, to prevent infiltration. But the most uniform of all evaporations is obtained by setting shallow earthenware or copper vessels along the top of the flue, and keeping them full of water. The coverings of flues seldom project over the face of the bricks, particularly where tiles are used. When pavement is used, it sometimes projects  $1\frac{1}{2}$  or 2 inches by way of protection to the flue; but this projection, to a certain extent, prevents the direct ascent of the heat. Often, when tiles are used, they are narrower than the external breadth of the flue, the deficiency being made good by chamfering the space off with mortar. In laying on the covers, whether stone or tiles, it will be well to place under every joint a slip of hoop-iron 3 inches wide; this is not

seen, and tends greatly to strengthen the joint, and prevent the escape of smoke or noxious gas.

*Loudon's chamber-flue*—fig. 152. The leading feature in this flue, as will be

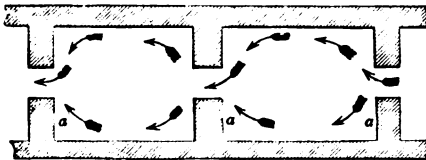
Fig. 152.



seen by a glance at the annexed sketch, is the division of it into chambers or compartments. The one nearest the furnace is 20 feet in length, the others are 10 feet. These chambers are formed by placing perpendicular partitions *a*, of bricks, from the covers to within a brick and a half of the bottom. The object of the intelligent designer was, that each compartment should be filled with smoke and heat before it reached the next, and that the whole flue should thus be charged with heat before any escaped at the chimney-top. This flue was of the usual width, but it was found to be soon choked with soot at the dip *b*. It has been long since disused, as well as the hot-air flue on the top of it, *c*. As there is such a rage at the present time for heating by means of hot air, we shall not be much surprised to see the hot-air flue of Mr Loudon brought again into use by some of the advocates for that mode of heating.

*The Dalkeith chamber-flue*—fig. 153—is 4 feet wide, and 3 feet high, and is divided

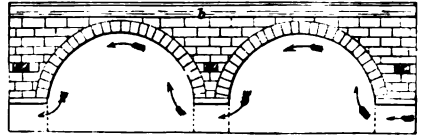
Fig. 153.



into chambers by cross 9-inch walls, *a a* in ground-plan—reducing the size at each of these parts to 10 inches in breadth and 18 inches in height. How far such

a sized flue, under ordinary circumstances, would be advisable, it is difficult to say; but there are many cases where its adoption is of advantage. In the case at present described, it forms the base of a hot-water tank *b*, in longitudinal section, fig. 154, and is intended to communicate heat

Fig. 154.



to the water, as well as by its sides to the atmosphere of the house. The sides are 4 inches thick—that is, the breadth of one brick—excepting opposite to the partitions. The roof of the flue is formed by a series of arches—*vide* longitudinal section—having for their support the cross partitions; and over them, when levelled up, is the bottom of the tank laid in cement. The shaded square in the longitudinal section represents air flues which pass right through, and, communicating with the vacuity between the flue and front wall, admit the air from the ventilators in that wall into the body of the house in a genially heated state.

This flue draws well, and very little heat escapes at the chimney-top, although the whole length from the boiler to the top is only 67 feet. The other cases to which we think flues of this magnitude and construction applicable, are pine or other pits requiring bottom heat; and, if care be taken to keep an aperture of a few inches between the flues and the side walls, to prevent the loss of heat by absorption, we are satisfied that a great saving in fuel would be the result. The contractions at the partition walls increase the draught, while the heat has time and space to expand itself in the chambers, and slowly to find its way into the house. So great a mass of building, when once heated, will retain its temperature a long time. Such a method, however, should only be applied to pits or houses where the temperature is required to be kept both uniform and high. Our opinion is, that this flue will heat the tank sufficiently for tropical plants without the aid

of a boiler at all. Fig. 155 is a section through the flue and tank; and fig. 156 is a cross section through the boiler and furnace, and end flue of the house, showing the ventilation in front at *a*, the air entering by it, ascending into the house through the space between the front wall and tank, and also through square flues passing under the tank, and through

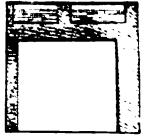
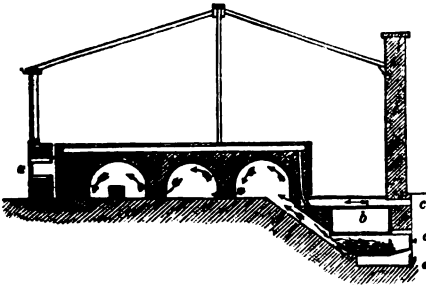


Fig. 155.

Fig. 156.

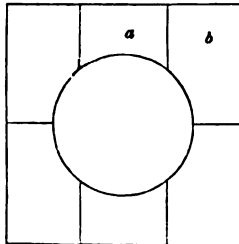


the bridges that divide the large flue into chambers. These small air-flues are shown by the shaded squares in the longitudinal section; *b* is the leaden boiler; *c* the register for admitting cold air from without to pass over the boiler, and so on into the flue; *d* the furnace; *e* the ash-pit; *f* the leaden flow-pipe carrying the water from the boiler to the tank; the return-pipe is close to it, but cannot be shown. The arrows show the direction of the smoke. In consequence of this house being converted into an aquarium, these flues, after existing for six years, have been removed.

Amongst recent improvements in flue-building, we may notice that our intelligent friend, Mr Lyle, surgeon, Newburgh, has lately erected a flue of greater calibre than usual, and arched over instead of being covered with tiles. This flue has also a rather singular feature—namely, it increases in size as it recedes from the fire, which is said to economise fuel and maintain a uniform heat. It has been stated as an objection to this theory, that as the air becomes expanded its capacity for heat is multiplied, and, consequently, less heat would be evolved from it. This is, however, asserted by Mr Lyle not to be the case: “as to the property of expanded

air possessing a greater capacity for heat than air more dense, this is perfectly correct; but I wish,” he says, in the “Gardeners’ Chronicle,” “to explain a fallacy that has been fallen into on the application of that principle. The rule for air, as well as all other gases, is, that its capacity for heat enlarges in nearly an inverse ratio to its density—that is, at half the density it has nearly double the capacity; or, in other words, in the former that it will take nearly double the quantity of heat that it would in the latter, to raise it to the same degree of temperature: this is the cause of difference of climate at different altitudes under the same parallel of latitude.” A mistake has been fallen into by imagining that “because hot air moves along a flue gradually enlarging from the fire end, that this air must gradually expand also in the same proportion, and must have its capacity for heat increased, absorb it, and that it does not give it off to the walls of the flue. But the very reverse of this is the fact—the air in the flue, instead of expanding and becoming more rarefied in its course, contracts, or becomes denser; and it does this because it gets colder in its passage along the flue. Air doubles its bulk for every 480° of increased temperature; and hence, in its progress along the flue, for every degree of heat it loses, it contracts  $\frac{1}{480}$  in volume, or gets by that fraction more dense; and, of course, in proportion, diminishes its capacity for heat, giving it off in a sensible state to the brickwork around. The plain effects of a brick flue gradually enlarging from the fire are these:—1st, A current of hot air diminishes in velocity as it recedes from the fire, so that, where the air is hottest, it has least time to give off its heat, and where coldest, most time for this purpose. 2d, The radiating surface increases where the temperature gets

Fig. 157.



lowest, and compensates as much as possible for that deficiency.”

Circular flues have been recommended by Mr Walsh, the bricks for which are made for the express purpose;

and, for straight lines of flues, are of two moulds only, as *a* and *b* on the annexed fig. 157 will show. With two additional moulds to give the necessary bevells, bricks can be made to suit any direction the flue may take. Were it not for the patent, such bricks could be made by any brick-maker, and at little more cost than those of ordinary shape.

The advantage of circular flues, over all other forms, is their securing a greater uniformity of draught. We would, however, have moulded the bricks so as to have shown a cylindrical form externally—a form certainly more agreeable to the eye than that of any of the forms in general use.

We have elsewhere stated that smoke flues have one advantage over steam or hot-water heating—namely, the power of throwing heat into a hothouse or greenhouse in much less time, and hence of repelling sudden frosts in the latter structure in particular. Steam cannot be generated speedily; and, from the best authorities, we find that a hot-water apparatus, however well constructed, is liable to the same defect, as it is proved that it will take as many hours to acquire a temperature of 200° as the pipes are inches in diameter, and it will also cool in the same ratio. For example, the water in a 4-inch pipe will take four hours to arrive at that temperature: it may, indeed, be heated to that point in one hour if the apparatus is properly constructed, but to effect this, four times the quantity of fuel will be consumed that would be sufficient if properly applied; and if we take into consideration the extra waste of heat at the chimney-top, which, under such circumstances, increases very rapidly, we may safely set it down at five or six times the quantity of fuel consumed unnecessarily. The economy of fuel ought always to be considered in every mode of heating; and we are confident that one-sixth of the quantity would suffice for a greenhouse heated with a good flue, to what would be consumed under the above circumstances.

One of the most frequent complaints made against the use of smoke flues is the inconvenience, not to say anything of the dirt and disorder, attending the process of cleaning them. This may, however, in a great measure be got rid of by having cast-iron frames provided

with flange covers made to fit accurately, and placed on the top, or in the side of the flues at convenient distances. Two rings are fixed to these covers, so that they may be easily lifted up to enable a labourer to extract the soot in the regular way. Here we may, however, observe that the soot should be wetted as it is drawn to the opening, which will prevent its flying about the house. These metallic covers may be so formed as to act as evaporating pans to restore that humidity to the atmosphere, of which all modes of heating have greater or less tendency to deprive it, and of which it is naturally possessed.

Mr Saul of Lancaster has suggested—and we know that the idea has been acted upon in a most satisfactory manner—to build rollers on all the salient angles of the flues, and one at the top of the upright chimney; over the end of this and the rest of the rollers a conducting endless chain passes, to any part of which a brush is fixed, which, by being drawn backwards and forwards, cleans the flue of soot. It is, however, necessary in this case to have a door made at the bottom of the chimney, through which access may be got to the chain, and by which the soot may be extracted. Of course, the chain is a fixture, and remains always in the flue. This is upon the same principle recommended by Mr Lyon for sweeping house chimneys, to prevent the inhuman practice of sending children up—a practice it would be difficult to find the origin of, and which has been very wisely prohibited by our Legislature.

A prejudice has arisen against smoke flues, from the carelessness of those having the management of them in not attending to keep them clear of soot. So long as the flue draws, and the smoke finds its way out at the chimney-top, all is allowed to go on without regard to the vast unnecessary consumption of fuel in consequence of the flue being coated with soot, which is of itself one of the greatest non-conductors of heat, and is, in fact, charcoal in a more completely burned state. We know that gardeners often delay cleaning their flues, because by the usual method bricklayers are required to open them up and to rebuild them, which operation costs money and creates dirt and confusion. By adopting the flue recommended above, the first of these will be

saved, and the second greatly remedied, as a useful labourer can do the whole, and this at times when the houses are not likely to be visited by their owners. The value of the soot, as a manure, is equal to the expense of cleaning them, and the saving of fuel will be considerable.

Regarding flues, we hold that they should be built much larger than they in general are, for reasons elsewhere given, particularly those by Mr Lyle of Newburgh; and, as an improvement even on these, we would suggest the introduction of fire-clay tubes placed either vertically, fig. 158, or

Fig. 158.



fig. 159, and about 18 inches asunder at the end farthest from the furnace, and

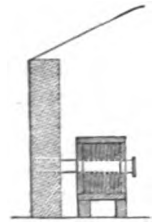
Fig. 159.



say 3 or 4 feet apart nearest the fire. The ends of these tubes being open in whichever position they are placed, a circulation of air would necessarily pass through them in consequence of their being exposed to the internal heat of the flue. Thus they would operate in the same way as the hot-water pipes alluded to in section **VARIOUS MODES OF HEATING.**

And where the flue passes along near the front of the house, which is the most usual position for them, tubes may be made to pass through the parapet wall, fig. 160,—thus admitting air from without, which, being heated in passing through the flue, will be found exceedingly beneficial to the healthy state of the atmosphere within.

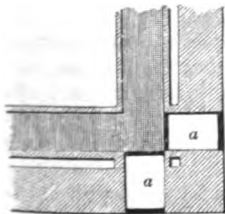
Fig. 160.



the healthy state of the atmosphere within.

In the case of a hothouse projecting in front of the rest of the range, or in case of a house standing by itself, the flues may be readily cleaned by having an opening 9 inches square through the end, and also the front parapet, as at *a*, fig. 161, to be

Fig. 161.



secured by a cast-iron door set in a frame, both at the inside, and one also at the outside of the wall, and communicating with the flue. These, when opened, will admit of a brush fixed to a handle, to which additional lengths can be screwed on, to brush down the soot as far as the middle of the house. The brush being withdrawn, a hoe to draw out the soot, the exact width of the flue, is then to be introduced, and the handle lengthened by screwing on the detached lengths of the brush handle. The same operation, performed at the other end of the flue, will clear it from end to end. The end flues may be cleaned out in the same way, as will appear sufficiently obvious from our diagram. By this means the usual filth and confusion which attend the opening of the flues within the house will be completely obviated. If the parapets are built of stone, as is frequently the case, particularly in Scotland, a 9-inch block of stone, with a folding-down ring in its face, may be substituted for the iron doors. In this case, however, it would be as well that the stone be in length equal to the thickness of the parapet, and that the flue at these parts be also built into the parapet, to prevent the smoke from escaping by the space between the parapet and the flue.

A precaution against the bursting of flues, from the explosions which may arise by the ignition of inflammable gases, has been exemplified for years in the gardens at Pitmaston, near Worcester. It consists of a hinged iron safety-valve, framed in iron, and set in the brick-work at the end of the flue. It is 8 inches by 6, and opens into the external air. It is kept closed by its own weight; but internal pressure, resulting from the explosion of inflammable gases in the flue, would throw it open and allow of their escape.

Notwithstanding all that has been written and experimentally proved regarding the great waste of heat, even when the very best kind of boiler or furnace is used, by its escape into the chimney, still we see few attempts made in practice to remedy this, or to turn that heat to advantage. That a portion of heat will thus pass by the boiler or over the furnace is quite certain, and to arrest it all would be impossible; to

allow it to escape at the chimney is a waste of fuel, and a convincing proof of the insufficiency of the system. The flue must be had recourse to in some shape or other, and be so conducted as to allow the heat in it to find its way either into the house heated by the pipes, or into some other attached to it. We have, in the case of pine stoves, and other houses requiring the greatest amount of constant heat, placed a flue along the back wall, with openings over it, so that the side and greatest part of the top may radiate heat into the house; and as such houses have, or ought to have, enclosed sheds behind them, the other side of the flue heats them at the same time, and thus renders them dry and fit for store-rooms, for forcing sea-kale, rhubarb, chicory, &c. In some cases we have turned the heat, after passing the boiler, into the pit or vault under the pine bed, dividing it longitudinally into two, by carrying a 9-inch wall up the centre, leaving a space of 18 inches in width at both ends to admit of the circulation—the smoke travelling along the front flue first, and returning by the back one, and escaping by the chimney over the boiler. Such flues being of a large size—say, for a pine pit, 8 feet wide within—they may be each 3 feet wide and 2 feet in depth. To render them perfectly smoke-tight, they are well parged within. The pavement forming the floor of the beds, on which the pots are plunged, or the border formed, if the planting-out system is adopted, forms the roof, which is supported on a scarcement at both sides, and the 9-inch wall in the middle. This pavement is closely jointed, and over it is 6 inches of drainage, upon which the pots or soil are set. Earthenware tubes are set at intervals upright through the bed, resting on the drainage and upon the top, through which liquid manure—chiefly diluted cow or other urine—is poured, for the purpose of affording those ammoniacal gases which the old dung-beds supply in so eminent a degree, and for which they, so far as this is concerned, are so superior to all other modes of heating whatever. These tubes also enable the cultivator to keep the bottom of the bed, or the bottoms of the pots, in a proper state as regards moisture,

which, without such a provision, would be apt to become dried up, from the drying properties of the flues underneath. By these means we think we obtain all the heat the fire is capable of affording, always deducting that amount necessary for carrying the smoke out at the chimney-top. The flues, being large, are not speedily choked with soot; the draught is moderated, and time given to the heat to ascend through the top, and to warm the whole mass of building constituting the sides of the pits, which, when once heated, continue to give it out, even long after the fires may be extinguished. Sufficient bottom-heat will be obtained by this means to render the application of tanks or hot-water pipes unnecessary. Flues of the ordinary dimensions will not do for this purpose, as they so soon become choked with soot. These heated pits, we need scarcely remark, should be cleared of soot at such times as the plants are about being arranged, or fresh beds formed for them; and this is easily effected by lifting a piece of pavement at both ends, when the accumulated soot will be found an excellent manure, as it will be arrested in its progress, little of either it or of smoke passing out at the chimney. Indeed, were there no other advantage attending this plan than the absence of smoke, it would amply repay the expense.

The heating capabilities of flues have been variously estimated; but as much depends on the construction of the house to be heated, mode of glazing, &c., no very correct data can be laid down. It has, however, been stated as nearly approaching the true amount, that one fire will heat 3000 feet to a stove temperature, if the structure be span-roofed or curvilinear, having all its sides of glass; while, in the case of lean-to houses, one fire will heat 5000 cubic feet to that temperature for the former, and 3000 feet for the latter form.

With regard to size, the average may be taken at 10 inches in breadth, and 15 inches in height internally; and the furnace for such a flue, at 2 feet in length, 18 inches wide, and the same in height.

We have just been favoured with drawings of a highly ornamental fire-clay flue,

recently registered by the Grangemouth Coal Company, which promises to be a valuable addition to this mode of heating. The general appearance of this flue is that of a highly ornamental balustrading—the base or plinth forming the flue proper, the top rail and balusters forming the radiators of heat, as well as the elegant vases which surmount the whole. This flue is, however, only adapted to peculiar situations.

### § 3.—HEATING BY HOT-WATER PIPES.

An invention so important as that of heating by the circulation of hot-water soon became extremely popular, and, as a natural consequence, men of science turned their attention to the subject. The most prominent of these were Bonnemain, Count Rumford, the Marquis de Chabannes, W. Atkinson, A. Bacon, Kewley, Fowler, Weeks, Perkins, Bailey, Cottam and Hallen, Walker, Tredgold, Hood, Eckstein and Busby, Price, Smalley, Stephenson and Co., Rogers, Ainger, Penn, Burbidge and Healy, Corbett, Davis, Smith, Thompson, Watson, Kendall, Wood and Co., Garton and Jarvis, Alecock, Barchard, Bramah, &c.

Notwithstanding all that has been written on the system of heating by hot water, it is somewhat extraordinary that its history has only of late been traced beyond the period of the French Revolution, when M. Bonnemain applied it for the purpose of hatching chickens for the Paris market.

Sir Hugh Platt, at a much earlier period, not only hinted at the possibility of heating plant-houses by steam, but also says that hot water might be used for the same purpose. He also recommends it as a substitute for steam in the process of making gunpowder: "To dry this substance without all danger of fire," he says, "a vessel of lead, pewter, latten, or copper to be made, having a double bottom, between which bottoms you may convey scalding water in a pipe, which water may be also heated at another room." And, farther on, he says: "A vessel may be made to brew or boil in, by making a fire under a brass boiler, and conveying the steam or water into a wooden tub or receptacle." It is

said that the late Anthony Bacon first took his idea of heating by hot water from having seen some rustics boil a leg of mutton in a wooden horse-pail which communicated with the fire by a gun-barrel.

Rudolph Glauber proposed to heat brewers' vats by connecting them, by means of a metallic pipe, with a kettle placed on a fire. We are also informed by "Stuart on the Steam-Engine," vol. ii. p. 587, "that Sir Martin Triewald, a Swedish gentleman, who for many years lived at Newcastle-on-Tyne prior to 1716, about which time he retired to his native country, described a scheme for warming a greenhouse by hot water instead of by vegetable fermenting substances. The water was boiled outside of the building, and then conducted by a pipe into a chamber under the plants. It does not appear that either Sir Martin or Sir Hugh Platt had any idea of the circulation, or of causing the cold water to re-enter the boiler. Triewald's plan was adopted in St Petersburg in 1812; and, about the same time, Count Zubow in that city heated tanks of water by causing steam-pipes to pass through them. About the same time, Mr Braithwaite of Kendal heated his office by a small boiler, having its furnace enclosed in a small cast-iron case placed against the wall. A pipe was led from this boiler to the condenser, which was a copper vessel, 18 inches in diameter, placed under his writing-desk. The steam gave out its heat to the water in the condenser, which was found, when once heated, to retain the heat for many hours. That the Romans were to some extent acquainted with heating by hot water is quite clear, for Seneca speaks of *dracones*, or small brass pipes, made in a serpentine form, and placed in a fire, so that water entering cold at one end of the pipe or *draco*—so called from its convolutions through the furnace—came out boiling at the other end. He also mentions the *miliarium*, which appears to have been a large leaden vessel or tank containing water, in the middle of which was a furnace having its bottom and sides formed of brass. The *dracones*, or small brass tubes, were bent round the inside of this furnace, and enveloped in the flame, upon, we may presume, the same principle as Perkins'



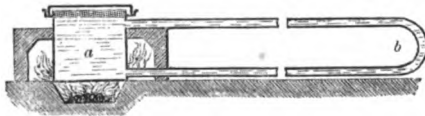
coil of pipes. One end of the *draco* was inserted into the *miliarium* near its bottom, and the other near its top, (just as our modern hot-water pipes are placed in relation to the boiler.) The water entering at the lower orifice was discharged hot from its upper end, and the entire mass of water in the *miliarium* was heated by this circulation in the *draco*. Cameron, in his account of the Roman baths, gives a figure of an ancient coil-boiler, no doubt formed by a Roman workman, which probably was the type of Perkins' modern system of heating by very similar means.—*Vide* p. 157.

It would tend little towards practical utility to give even a very condensed description of the respective merits of all the systems of hot-water heating. We shall endeavour, however, to explain the principles of such of them as we consider to be of most importance.

Passing by the arguments that have been adduced in regard to the first inventor of this system of heating, we may state, that whatever knowledge the first three and the fifth of the names mentioned above had of the theory, it is quite certain that none of them brought it into useful operation for heating horticultural buildings.

Mr Atkinson's system was the first that was exemplified in a perfect state. It may be termed the horizontal mode, as the water was made to flow from the boiler *a*, to the reservoir or turn of the pipes *b* upon a perfect level, as will be seen by a glance at the accompanying diagram, fig. 162 ;

Fig. 162.



and however far most of the others have essentially differed from it in some feature or other, still the principle remains unchanged.

The construction was as follows : A square or rectangular cast-iron boiler, open at the top, of sizes varying from 3½ to about 12 cubic feet (according to the heat required) in internal capacity, was placed over a well-constructed furnace, the fire burning under it, and being carried round two or more of its sides in flues 9

inches wide. To this boiler were attached two cast-iron pipes usually fixed to it by flange joints ; or sometimes by having nozzles or short pieces of pipe cast on the boiler about a foot in length, to which the pipes were attached upon the spigot-and-faucet principle ; the joints being made good with rust, or filings or borings of iron mixed with sal-ammoniac and water, driven as hard as possible into the joints by means of blunt chisels—a collar of hemp or thick millboard being first introduced, to prevent the packing from falling into the pipes. Lead was and still is sometimes used, as are also joints of hemp and white lead, and both are useful for temporary purposes, as they may be separated again with little trouble. The rust joints are the most secure as well as most lasting ; for soon after they are formed they become as hard as the iron itself, and quite as difficult to break ; indeed the joint of a cast-iron pipe attached in this way is the strongest part of it.

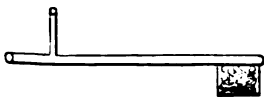
At the extremity of the space to be heated, according to Atkinson's views, was placed a cistern or reservoir exactly level with the top of the boiler, with a view to equalise the temperature by means of the heated water it contained. The boiler and reservoir were then connected by the pipes. The top of the boiler was covered with a wooden cover 2 inches thick, and fitted into a flange or groove in the top, into which a little water was poured to keep steam from escaping, this simple process being usually termed a water-joint. The reservoir was covered with an iron cover fitted in the same way. The wooden cover was used in the one case to prevent, by its non-conducting properties, the escape of heat ; while the iron cover was used in the other for a diametrically opposite purpose. The boiler was in general set in a niche in the back wall, and within the house, to prevent the waste of heat. This is the most simple of all modes of heating ; but, as will readily be seen, it is capable of operating only upon a perfect level. The same intelligent gentleman, however, constructed boilers with closed tops, by means of which he was enabled to carry heat about 30 feet above the boiler. He not unfrequently dispensed with the reservoir, and made the return by an elbow bend at the extreme end of the pipes. If this

mode did not give the rapidity of motion to the water which some others do, it has the advantage of never getting out of order; and the boiler being open at top, admits of its being cleaned out as often as is desired, without either trouble or expense. For a very great majority of situations this mode of heating is admirably adapted; and indeed, wherever it can be employed, it has not been superseded. Intimate as we were with Mr Atkinson—so much so, indeed, that we were privy, along with the late Mr Tredgold, Mr Barrow, and Mr Turner, to all his experiments long before they were made known to the public—we never saw his boilers furnished with a waste-pipe for emptying them of their contents, a precaution that should never be neglected, more especially where close-topped boilers are used.

We have thirteen arrangements of apparatus upon the horizontal principle in operation in the Dalkeith gardens, and we are quite satisfied with them—as much so, indeed, as with any other of the many in use in the same establishment.

Bacon's original apparatus consisted merely of a single cast-iron pipe, which, so far as we recollect at this distance of time—having seen it at work in his garden at Aberdare in Glamorganshire, in 1828—was about 9 inches in diameter. One end of the pipe was placed in the fire, and it was closed at the other; an upright piece of pipe was attached to it about 18 inches from the end, and rising about 6 inches above it. The result, as may be expected, was an immense waste of fuel and little or no circulation. Mr Bacon afterwards

Fig. 163.

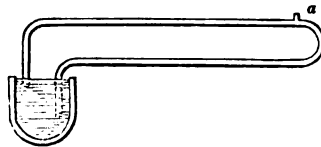


a perfect idea of Mr Bacon's apparatus.

Kewley, whose system was upon the siphon principle, was the next who brought into operation any really useful improvement, because he increased the circulation to a more rapid rate than that secured by the horizontal method, and the extraction and delivery of heat consequently became greater in proportion to the quantity of fuel consumed—the water never being heated to the extent to generate steam, nor the heated air and smoke

which escapes by the chimney-top being nearly so hot as when water is brought to the boiling point, and often much higher. This latter remark does not, however, apply to the horizontal principle, as, if all is properly arranged and conducted, no steam should in it be generated.

Fig. 164.



The annexed diagram, fig. 164, will show the operation of

Kewley's principle. The boiler is open at the top, the upper or flow-pipe dipping only a few inches below the surface of the water when the apparatus is filled, the lower or return pipe descending to nearly the bottom of the boiler. A small tube is inserted in the top of the upper pipe where it turns at *a*, (and this point must always be the highest that the pipe attains to,) for the purpose of extracting the air from the pipe by means of an air-pump, without which precaution the water would not circulate. As the water in the boiler is hottest nearest the surface, it follows that the heated particles will much sooner flow into the upper pipe than into the longer and under one, which receives only the less heated particles, and those only which rise *immediately under its base*. The circulation here is governed by the same laws as elsewhere stated, (*vide CAUSE OF CIRCULATION*;) as the water flows along, it gives out its heat, and as it returns to the boiler it becomes colder and more increased in gravity, causing it to flow into the boiler with greater force.

It has been suggested, and with good reason, that if this long or return pipe were made to pass down the outside instead of the inside of the boiler, the circulation would be increased; and the only objection to this plan is the greater difficulty of stopping the ends of the pipes, which in this system is done by having two plates of iron so contrived that they can be screwed closely enough to the mouths of the pipes, as not only to exclude the water, but also to resist the air when forced against them when the air-pump is applied, to prove the soundness of the joints.

Mr Kewley long made a sort of mystery

of his method of making joints. That it was necessary that they should be perfectly air-tight, is obvious; hence the more care was required in packing them. We believe that his joints were what is called rust joints, already noticed, and consisted merely of a paste formed of iron filings or borings, obtained at the iron-works, mixed with sal-ammoniac and water: a collar of hempen cord loosely spun is first introduced, and when driven hard in, the rust is introduced a little at a time, and also packed as hard as possible. A chemical combination takes place in a short time, and the joint not only becomes perfectly air and water tight, but is also rendered incapable of separation. Spigot-and-faucet joints are now universally used, instead of the old flange joints, which were less secure and looked ill, and were formed by covering thick millboard with white lead, and bringing the ends of the pipes together with screws and nuts. These joints are now only used in cases of alterations; as, for instance, if additional pipes are to be attached to those already in use, a saddle-joint, which is a species of flange, may be employed, the heads of the bolts being within the pipes, and the nuts on the flange without.

Fowler, an engineer of some eminence, shortly afterwards followed Kewley, and published a description of his thermosiphon in the "Gardeners' Magazine." His system appears to be merely a modification of Kewley's, its peculiarity consisting in lengthening out the returning pipe, by which means the water would, by giving out its heat during a longer run, become much heavier and colder; and hence, by flowing more rapidly into the boiler, would destroy the equilibrium, and consequently draw the hot water up the other leg with greater rapidity. A glance

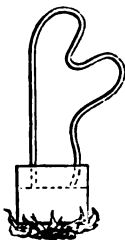


Fig. 165.

at the annexed sketch, fig. 165, will show this; and also make evident how very little his system differs from that of Kewley, already described. One objection to this principle is, that the friction must be increased in consequence of the bends in the returning pipe.

Weeks, a cotemporary of Kewley and Fowler, has shown various modifications

of heating by hot water. One of these we shall here notice, as it was the first successful attempt to secure a circulation under the level of the boiler. For effecting this end, Mr Weeks calculated that it was necessary to raise the water to a height above the boiler equal to the depth it was intended to carry it under it. This was done by using a close boiler with a tube rising from the top to the required height; or where a boiler was dispensed with, as in the annexed diagram fig. 166, a system of pipes was placed round the fire-place: *a* is a section of the fire-place; *b* is an upright tube communicating with

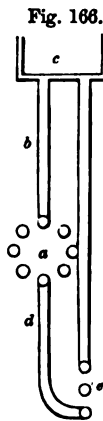


Fig. 166.

these pipes, and also with another vessel *c*, and the lowermost is connected by the tube *d* with one or any number of pipes under the level of the boiler at *e*. When the fire is lighted in *a*, the water circulates freely through all these pipes as the heated water ascends into the vessel *c*, and the cold water is displaced and flows into the pipes round the fire through the pipe *d*, from the pipes at *e*, &c. "The substitution of tubes round the fire, instead of a boiler over it, is not absolutely necessary to the suc-

cess of the plan, though by tubes the circulation is greatly increased.

"Any close boiler with the tube *b* attached to its cover, and communicating with an open vessel fixed at any height, such as *c*, having another pipe similar to *d* fixed to it, will circulate the water from such a vessel to a point below the bottom of the boiler, nearly equal to the balance of atmospheric pressure, or say 30 feet below it." The principal use of causing water to flow below the level of the boiler is to enable the pipes to be carried under foot-paths, and in cases where the stoke-hole cannot be got sufficiently deep to be rendered dry by drains. This is sometimes the case in low and wet places; we would rather, however, render the stoke-hole dry, by building it in a tank made impervious to the entrance of water both at bottom and sides. Various improvements have been made by Weeks in his modes of heating, one of which is as follows. The boiler used is about 4 feet

long, 18 inches wide, and the same in height, forming a kind of long arch, and is composed of inch-and-quarter pipes. Its power of heating is great, in consequence of the extent of surface exposed to the fire, and the small quantity of water contained in the pipes.

Another important improvement made by Weeks, is in admitting pure air from without, and warming it before it is diffused through the house, creating not only a species of warm ventilation, but also causing a gentle circulation of the air throughout the house—an idea entertained by the late Mr Penn in his system of heating, but which had not been found to operate satisfactorily in practice.—(Vide PENN'S "System of Heating.") To effect this, Weeks has introduced 2-inch pipes, in lengths of about 4 feet each, within the ordinary 4-inch heating pipes; one end of these small pipes is passed through the side of the 4-inch ones and opens into the house, while the other end also, passing through the side of the pipe in an opposite direction, opens into the free air outside the house. As will be anticipated, these small pipes enter the house at distances of 4 feet apart; and the current of air is so great as to keep the leaves of the plants in constant motion, the heat averaging from 160° to 170°. This, although a highly ingenious plan, is not unattended with expense; other contrivances will be hereafter noticed which act as well, with greater simplicity and at less cost.

From "Newton's Journal" we extract the following,—part of the specification given by Weeks of his improvements in raising, lowering, or conveying heated water; these improvements are founded on the four following particulars: "First, in applying a cistern to the boiler for the purpose of supplying it with water, without making that cistern a part of the boiler, but only connected thereto by a tube; secondly, in a method of raising heated water to any required height, for the purpose of warming the upper parts of the building, without employing pumps or siphons; thirdly, in the employment of a large ascending pipe, with a smaller returning pipe within it, which shall convey the water, after it has parted with a portion of its heat at an elevated situation, back again to the cistern, and thence into the boiler; and, fourthly, in the

adaptation of smaller pipes for conducting the heated water to any particular part of the building, while main pipes or tubes may be closed, and out of action."

Perkins' high-pressure apparatus, figs. 167 and 168, created a considerable sen-

Fig. 167.

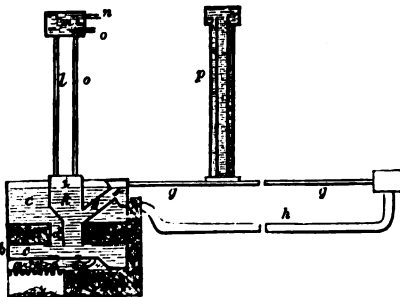
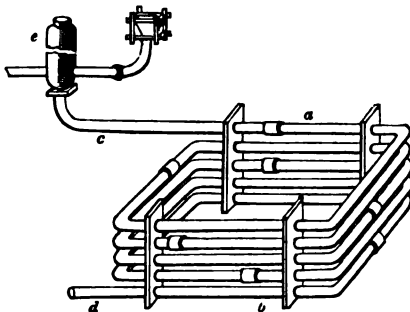


Fig. 168.



sation in the horticultural world at the time of its first appearance, not only on account of the smallness of the pipes employed, dispensing with a boiler, &c., but also the high temperature he was able to produce. We must, however, observe that this system is much better adapted for heating dwelling-houses, public buildings, &c., than for hothouse purposes. Instead of a boiler, a coil of small iron pipes *a b*, only  $\frac{1}{4}$ -inch bore, is here used, and placed in the furnace surrounded with the fuel. The flow or delivery pipe *c*, being a continuation of the uppermost pipe of the coil, and without any alteration of size, is carried round the apartment to be heated in general close to the bottom of the skirting board, and, returning, is joined to the lowest turn of the coil *d*, being hermetically sealed. An expansion pipe  $2\frac{1}{2}$  inches in diameter, *e*, is fixed vertically or horizontally to the highest part of the small pipe, having an

opening for filling the apparatus with water. This opening in the expansion-pipe is placed near to its lowest extremity, and when the pipes are charged with water, this aperture is secured with a strong screw. The expansion-pipe is capable of containing 1-12th as much water as is contained in the whole of the smaller pipes. The greatest care must be taken that this pipe be kept empty, else the expansive force of the heated water, which is irresistible, would burst the pipes.

To show the power of this apparatus, we may mention that the average heat of the pipes is in general 350°, which is equal to a pressure of 135 lb. per square inch, and that in different parts of the pipe there has been found a variation of temperature amounting to 200° or 300°. This variation is owing both to the intensity of heat in the furnace, and also to the proportion the surface of the coil-pipes bears to the surface of the radiating ones. The variation in temperature has been observed to amount to from 220° to 550°, the latter being equal to a pressure on the pipes of 1100 lb. per square inch, or upwards of 71 atmospheres. "It may be admitted," says Bernan, in "History of Heating," &c., "that the hazard of bursting is nearly relative; for as Mr Perkins proves his pipes, when cold, to resist a pressure of 2800 lb. per inch, there may be, and perhaps is, less danger in working his apparatus at a pressure of 1100 lb. on the inch, than a Trevithic engine working under 50 lb. on the inch. We know, however, from experience, that from use the material of the pipes loses its original tenacity, and that pipes which have, when cold, resisted the pressure stated by Mr Perkins, when heated, have given way even below the temperature at which they had long been worked with safety. The fear of danger, if its actual presence in the average of cases be disputed, is no doubt greatly increased by the knowledge that no method has been devised to regulate the pressure in the sealed pipes, like the safety-valve of a steam-engine, nor any means to prevent a careless attendant on the furnace at any time endangering the safety of the apparatus. In many cases the high temperature of the pipes is objectionable, from surfaces at 300° or 400°, rendering the air insalubrious by decomposing the

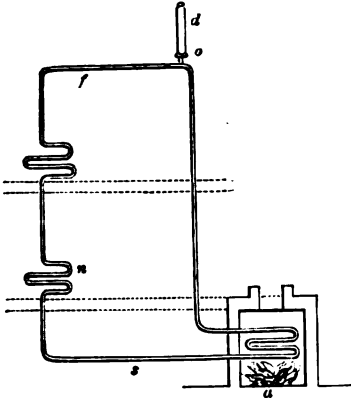
animal and vegetable matters suspended in it. On this account a high-pressure pipe is not superior to a German stove, whose surface is generally about 300°; and a pipe at this temperature cannot be placed without danger near combustible materials."

The maximum pressure in high-pressure steam-boilers is only from 45 to 48 lb. per square inch, while the pressure on the coil of pipes in this system varies from 10 to 24 times that amount, according to the intensity of heat in the furnace. "As there are no means of regulating the temperature in hermetically-sealed pipes, so there can be none for limiting the pressure which they sustain." The apparatus may to all appearance be perfectly safe at the time of inspection, and, in a few months afterwards, if in the hands of unskilful or careless people, it may be exceedingly dangerous. The coil-pipes, being at all times exposed to such an intense heat, will become thinner and thinner, until they give way at last, when the consequences may be disastrous. While we are quite sensible of the great ingenuity of this invention as a most powerful heater, we are equally alive to the danger attending it; and therefore we would never think of applying it to hot-house heating. The small size of the pipes, and the facilities they afford of being placed behind skirting-boards, and conveyed under floors in dwelling-houses and public buildings, have rendered this system popular amongst house architects. It would be well for them, however, to consider how far they place in jeopardy of fire the buildings into which they introduce pipes heated to upwards of 400°, and placed amongst combustible materials. These considerations have led us to enter more fully into the merits of the system than we had originally intended.

The four following diagrams from Bernan's "History of Heating and Ventilation," will more clearly explain Perkins' principle. In fig. 169, "A coil of wrought-iron pipe of small diameter, placed in a furnace *a*, is continued and conducted through the building, and the necessary quantity of surface is given by forming coils *n* of the pipe, which are placed in the rooms or spaces to be heated; and the pipe is finally returned, as at *s*, into the furnace, where it is joined

to the coiled pipe, and thus forms an endless pipe. At the highest point of

Fig. 169.

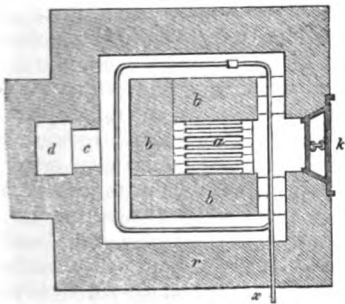


the heating-pipe *f* is another pipe *d*, of a larger diameter. This is called the expansion-pipe, into which the water rises as it expands in heating, to prevent the apparatus bursting. The filling-pipe *o* rises to the level, and no higher, of the upper part of the expansion or safety pipe.

"The tubes being thus arranged, the whole series, except the expansion-pipe, is filled with water by means of a force-pump applied to the filling-pipe *o*; and as it is of importance to free the endless pipe thoroughly from air, the water is pumped several times through the tube until this is accomplished. The endless pipe being thus filled with water, and the expansion-pipe empty, every part of the apparatus is strongly and hermetically closed. The endless pipe having a bore of about half-an-inch, and being a quarter of an inch thick, is capable of sustaining a very great pressure.

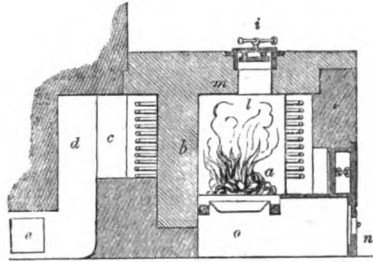
"Fig. 170 is a plan of the furnace taken above the grate.

Fig. 170.



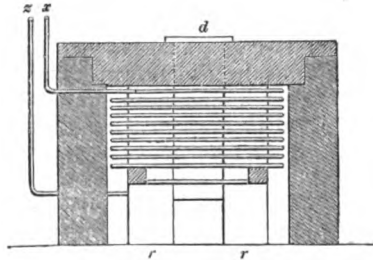
"Fig. 171 is a longitudinal section taken through the centre of the furnace.

Fig. 171.



"Fig. 172 is a section, supposing the front wall of the furnace to be removed;

Fig. 172.



*rr* a wall of common bricks, 9 inches thick, which encloses the furnace on its four sides; *bb* a wall 9 inches thick, formed of Welsh fire-lumps, that enclose the fire-chamber on three sides. From the face and ends of this wall fire-bricks project, to support the coiled pipe *a*, placed in the flue. The intention of this wall is to prevent the too rapid abstraction, by the coil, of the heat from the fire, which comes in contact with it at the opening in front only, where the hot gases turn into the back and side flues in which three-fourths of the furnace or boiler coil is placed. The roof of the furnace is formed of Welsh lumps, in which is an opening *m* fitted with a movable cover, for supplying the furnace with fuel, (coke or anthracite coal being preferred.) The ash-pit *o* is enclosed with a door *n*, in which there is a register; *k* is a double fire-door to an opening in the wall, for clearing the fire-place and furnace bars from dust and scoria. This has a dead plate, to separate the ash-pit from the heating flues; *x*, heating-pipe, rising from the boiler coil which passes round the internal wall in

the flue, and is thus defended from the radiant heat of the fuel on all sides but one: this heating-pipe is continued from the upper part of the fire-chamber into the building;  $z$  is the return-pipe which enters the lower part of the furnace, and passes through the bearing bars of the fire grating to prevent their overheating."

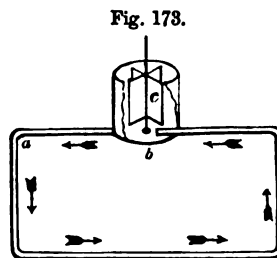
The want of an equal diffusion of heat in these pipes arises from the friction and number of bendings, and hence the same quantity of fuel expended in the furnace will not heat the same amount of air as it would do were the temperature more uniform in them. In regard to the quantity of pipe used in the furnace coil, it appears from pretty correct data that it should amount to from a seventh to a fourth of the whole extent of heating-pipe employed; and although by this system the pipes become much sooner heated than by any other, it does not follow that the room or hothouse to which it is attached will be warmed sooner than by a well-appointed hot-water apparatus of more simple construction.

"This great rapidity of heating is, however, no advantage in many situations. The apparatus being as quickly cooled as it is heated, and its general temperature rapidly fluctuating at every variation of the combustion in the furnace, in all places where permanency and uniformity of temperature are essential, the low-pressure apparatus, in which a great body of water acts as a regulator as well as a reservoir of heat, is to be preferred; and it is obvious that the same quantity of heating surface, at the same temperature, in every variety of warming apparatus, heats the same quantity of air. From the comparatively small surface of pipe exposed to the radiant heat of the furnace, and the high temperature at which the smoke escapes from it, the coiled-pipe boiler has been thought much less economical of fuel than the low-pressure boiler. It is not found to be so in practice. All circumstances being similar, the high-pressure coil requires about the same quantity of fuel that is necessary for a common boiler."—BERNAN in *Hist. of Heating, &c.*

The mode of connecting Perkins' hot-water pipes is both ingenious and secure. They are of wrought-iron, and are  $\frac{1}{4}$  of an inch thick; the iron of which they

are made, being rolled out into sheets of the requisite width and thickness, is then brought close at the edges and welded together. They are in general 12 feet in length, and are screwed at each end, and proved, by hydraulic power, to resist an internal pressure of 3000 lb. to the square inch; and from the ductility and purity of the metal, they are easily bent, when cold, into coils of different sizes and shapes. Mr Richardson, in a very interesting work on warming and ventilation—evidently written in support of this mode of heating—thus describes the mode of joining the pipes: "When two tubes are to be joined, the ends are placed within a socket forming a right and left hand-screw, the edge of one tube being flattened and the other sharpened; they are then screwed so tight, that the sharpened edge of one pipe is indented in the flattened surface of the other. The great advantage of these joints is, that they can be taken to pieces in the event of alterations being required, which is in all other cases a very different affair."

*Eckstein and Bushby's method*—fig. 173.—The merits of this invention are, that motion is given



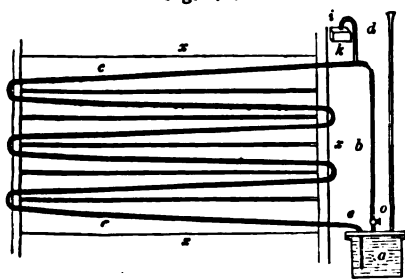
by means of a fly built in the chimney, and turned by the smoke of the boiler flue. It is a happy application of dynamical principles to overcome one of the most constant of nature's laws by the development of an antagonist force. The plan has, however, seldom been adopted, although it is capable of being applied in cases otherwise difficult, and which cannot, by the more simple apparatus, be effected. A peculiar singularity in this invention is, that the boiler may be placed in a garret, and the hot water forced downwards. The boiler, which may be either open or closed, has a pipe  $a$  fixed to its circumference, which may be carried in any direction, either upwards, downwards, or horizontally, but finally must return exactly to the centre of the boiler at  $b$ . The float  $c$  is fixed on centres, and revolves freely in the boiler. The rapid rotation of the

float imparts centrifugal force to the water, causing it to rise higher at the sides than at the centre of the boiler; and the velocity with which the float moves determines the extent of this deviation from the level.

According to Hood's calculations as to the circulating power of this apparatus, it would appear that, if the velocity of rotation be such as will impart a centrifugal force sufficient to raise the water in the boiler 1 inch higher at the periphery than in the centre, there will then be a pressure of  $246\frac{1}{2}$  grains on the square inch upon the pipe *a* more than upon the pipe *b*, if the temperature of the water be about  $180^{\circ}$ . This additional pressure, he observes, will allow the water in the pipe *a* to descend 42 feet below the boiler, if it does not lose more than  $6^{\circ}$  of heat before it return back again through the pipe *b*; if it loses  $10^{\circ}$ , it will descend only  $25\frac{1}{2}^{\circ}$ .

*M. Bonnemaisin's mode of heating.*—Fig. 174 shows a section of this early mode of

Fig. 174.

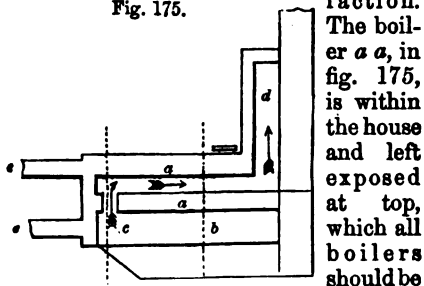


heating, in which *a* is the boiler; *d* a feed-pipe; *o* a stop-cock, for regulating the quantity of ascending hot water; *b* the pipe by which the hot water ascends from the boiler into the heating pipes *c c*. These heating pipes have a gradual slope towards the boiler, to which the water returns by the pipe *e*, carried nearly to the bottom. In this way the water, cooled by being circulated through a long series of pipes, is being constantly returned to the lower part of the boiler, where it receives a fresh amount of heat; and being thus rendered lighter, rises up the pipe *b*, and descends the inclined planes of the pipes, losing a portion of its heat by the way, and, at the same time, increasing in density; the velocity of the current depending on the difference between the temperature of the water in the boiler and that in the descending pipe. At the highest point of

the apparatus is a pipe *i*, furnished with a stop-cock for the escape of the air which the cold water holds in solution on entering the boiler. The water that rises along with it is received into the vessel *k*. The arrangements of this apparatus are excellent: they have been taken as a model in many subsequent methods, although, as has been remarked by Tomlinson in his useful "Treatise on Warming and Ventilating," the merits of the inventor have not always been acknowledged. This method is correct in principle as regards sufficient length of piping, in which respect almost every other is defective.

*Watson's mode of heating.*—This mode of heating differs in some of the details, particularly in the boiler, from most others, as will be seen by the annexed cuts. It has been used by the inventor for some years, and has given satis-

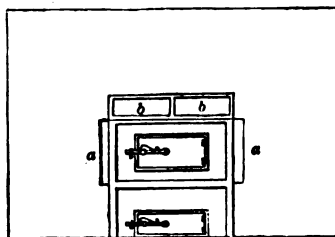
Fig. 175.



faction. The boiler *a a*, in fig. 175, is within the house and left exposed at top, which all boilers should be

where economy of fuel is an object. From the furnace *b* the heat passes up through the under part of the boiler, through the opening shown at *c*, as indicated by the arrows, and continues on between the upper and underparts of the boiler until it reaches the flue which proceeds horizontally along the back wall of the house *d*, finally escaping by an upright flue at the farther end. The hot-water pipes, *e e*, are of the usual size, and

Fig. 176.

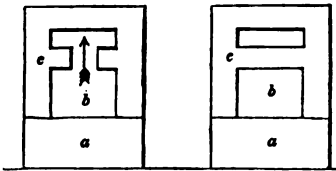


laid in the usual position. An aperture, *a a*, on each side of the door frame, (fig. 176),



is left open for the admission of cold air, which, being heated in passing the sides of the furnace, flows into the flue, increasing the draught, and carrying in a considerable quantity of heat. Two bricks are left movable over the door frame *b b*, for the purpose of taking out the soot. Fig. 177 shows section

Fig. 177.



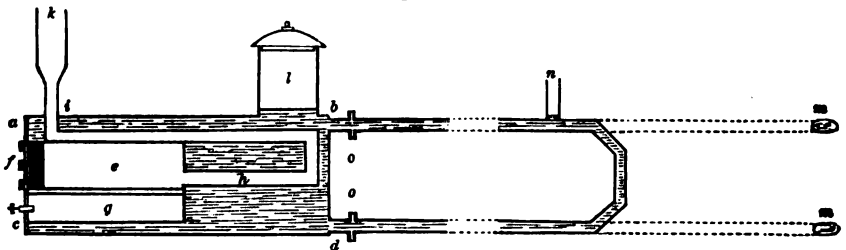
of the ash-pit *a a*; fire-place *b b*; and boiler *c c*. This boiler presents a very considerable surface to the fire, the lower part being exposed on all sides excepting the end next the furnace door, and the upper part of it along its bottom and one end. The whole of the upper surface of the boiler, by being uncovered, excepting where the 4-inch side of the flue rests, is giving out its heat to the house.

*Cruikshanks' mode of heating by hot water.*—Mr Cruikshanks has detailed his

method at length, accompanied with the necessary illustrations, in "The Horticultural Society's Transactions," vol. i. p. 513, new series. A condensed account of it appears in "Paxton's Magazine," vol. ii. p. 249, from which we make the following extract:—"The writer suggested the mode of heating the water to a friend in France, who had built a small greenhouse in front of his dining-room, where there was no convenient place to erect the brickwork for a common boiler, nor any chimney into which a flue could be turned. It occurred to him that, by having a small cylinder boiler constructed like those originally employed in the high-pressure steam-engine, containing the furnace in a smaller cylinder within the first, and surrounded by the water, no brickwork would be required; and that by burning a mixture of charcoal and cinders, the inconvenience of smoke would be avoided, and sufficient draught obtained by a moderate length of stove pipe passing through the roof. This plan was adopted, and answered completely.

Fig. 178 is a vertical longitudinal section; *a b c d* the outer cylinder or boiler, 3 feet long and 1 foot in diameter; *e* the

Fig. 178.



fire-place; *f* the door, lined with a mixture of fire-clay and pumice-stone; *g* the ash-pit, furnished with a drawer of sheet-iron. The fire-place and ash-pit are contained in the inner cylinder, which is half the length of the boiler, and 9 inches in diameter. From the back of the fire-place, an elliptical flue *h* proceeds nearly to the end of the boiler, then returns again towards the front, and passes out at *i* into the chimney *k*: *l* is a cylinder for supplying the boiler with water, and allowing for its expansion when heated; *m m* the water pipes, connected with the boiler by screws or flanges at *o o*. The pipes are elliptical,

which shape combines in some measure the strength of the circular with the extended surface of the flat form. The pipes are only 12 feet long, but the circulation is so rapid that the boiler would serve for a much greater length; *n* is an air-pipe.

"This small apparatus has answered so well, and appears to offer so many advantages over a boiler set in brickwork, that the author has been led to consider how the plan might be improved upon, and applied to heating houses of larger dimensions with any sort of fuel. This might probably be accomplished by constructing the apparatus according to one

or other" of the plans offered, figs. 179 and 180, "where the same general principles are followed as in that already described; but the boiler and furnace are so formed that a smaller quantity of water is contained between them com-

pared with the surface exposed to the heat from the fire, and the arrangement of the parts is better calculated to promote a rapid circulation of the water in the pipes. For this purpose the cylinder *l*, fig. 179, instead of being placed at the same end

Fig. 179.

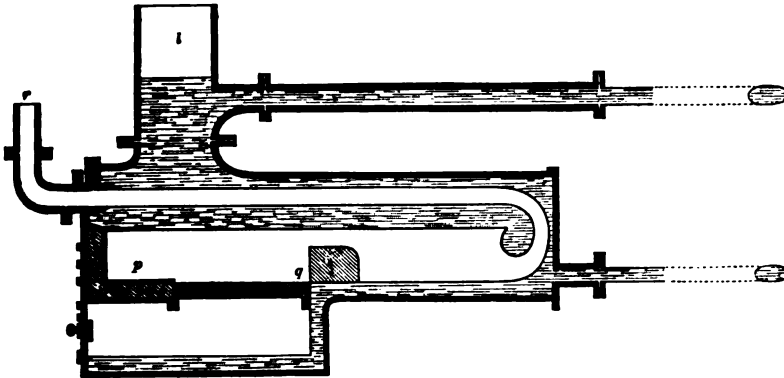
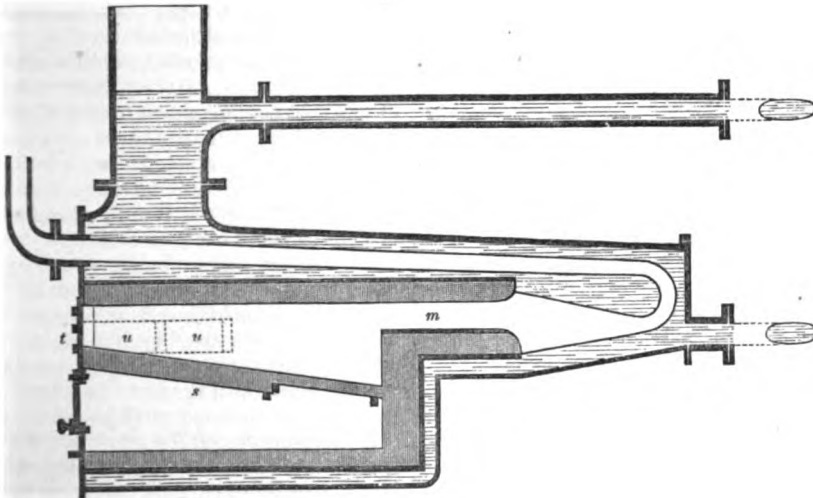


Fig. 180.



of the boiler as the pipes, as in fig. 178, is removed to the opposite end, and the upper end is connected with it; consequently the water enters from the lower pipe at one extremity of the boiler, passes through its whole length over the surfaces of the furnace and flue, becoming gradually heated in its passage, and then rises through the cylinder into the upper pipe, thus flowing in a constant and regular current through the whole apparatus. In fig. 179, the front of the fire-place, where ignited fuel would be inconvenient,

is occupied with a large fire-tile 'dead plate,' *p*, on which a supply of fuel may be heated, previous to its being pushed forward on the grate: *q* is a bridge formed of fire-clay, in one piece, which may be removed when the flue requires cleaning. The flue, instead of passing through the top of the boiler, is brought out at the front, where it turns upwards, and is intended to be carried into a common chimney. Thus, the furnace and flue being fixed only to the front, and unconnected with any other part of the boiler,

the whole may be removed in a few minutes should any repair be necessary."

This furnace, "though well adapted for burning coke, cinders, or dry wood, would perhaps not answer well for coal, as the smoke would be so much chilled, by contact with the metallic surface of the fire-place, that the flue would be liable to become foul. This might be prevented by constructing the furnace as in fig. 180, lining it throughout with fire-brick: *s* is an inclined plane of fire tiles, on which the fuel is to be spread when first put into the furnace: *t* are air-passages, between the fire-bricks and the case of the furnace, leading from the front, and having openings, *u u*, into the fire-place, at the joints of the bricks, above the inclined plane. A regulated supply of air being admitted through these openings, would mix with the vapours rising from the coal, and in a great measure effect the combustion of the smoke in passing over the fire, and through the heated passage *m*. The boiler should be placed within the house, either under the plant stage, or in a pit sunk below the level of the floor; the end only being built into an opening in the wall, for the purpose of supplying the fire with fuel from the back sheds."

Sir Joseph Paxton, in reviewing the preceding plan of heating, with his usual intelligence and good sense offers the following remarks, which are in accordance with our own opinion. Although we have not had any opportunity of seeing the apparatus in operation, we perfectly comprehend the advantages likely to arise from its use; the principle of which is, that heat would be thrown much sooner into a greenhouse, upon the approach of a sharp frost, for example, by this means, than by those in more general use; and if this can be effected, it will render heating by hot water perfect. The following are the remarks to which we have referred:—"Mr Cruikshanks seems confident that on this principle a much greater proportion of the heat generated by the combustion of the fuel may be communicated to the atmosphere of the house, and that with less loss of time than by any of the methods now in use. The flue, or flues, surrounded with water, may doubtless be constructed in such a manner, that the heated air and vapours

passing through them may be so far deprived of their caloric as to enter the chimney at a temperature little above that of the water; and beyond this point the economy of fuel cannot possibly be carried. To limit the loss of heat by the chimney is, of course, a desideratum in any mode of warming buildings; but it appears to be overlooked in many plans proposed for the purpose, especially in those for employing oil and other fluids, at a temperature considerably above the boiling point of water. As the heated air and vapours must necessarily enter the chimney at a higher temperature than that of the fluid in the boiler, the loss of heat will be greater in proportion as that temperature is increased.

"There is another circumstance connected with the plans alluded to, that does not appear to be taken into consideration at all—the great capacity of water for heat, compared with most other fluids—oil, for instance, or mercury. Water, it is well known, in being heated any number of degrees, absorbs twice as much caloric as an equal bulk of oil or mercury; and, consequently, a given bulk of water at 212°, in cooling down to 60°—that is, in losing 152° of sensible heat—will warm the surrounding atmosphere as much as an equal bulk of oil or mercury would do in cooling from 364° to 60°, or in losing 304° of sensible heat, as indicated by the thermometer. Such being the case, if oil or mercury, or almost any substance that can be named, could be compared in point of economy, safety, and cleanliness as a material, with water at or under the boiling point, still it would be inferior to water in point of economy as regards the consumption of fuel."

The apparatus represented by fig. 178 is constructed of copper, and costs about £9: for a house 30 feet in length, it would not cost £13. In the plans, figs. 179 and 180, the outer case or boiler is supposed to be cast-iron, as well as the case of the furnace in fig. 180, and all the other parts in copper. The whole might be made of cast-iron; but there would be a risk of its cracking in those parts exposed to the fire. Plate-iron or tin-plate might be employed, either wholly or in part; but cast-iron and copper would perhaps be preferable materials. With respect to the pipes, when made of sheet-copper, or zinc,

or tin-plate, they are better calculated to disperse the heat than those of cast-iron commonly used, which are, perhaps, except in point of strength, the worst that can be employed. They expose a smaller surface in proportion to the water they contain, than pipes of any other shape; and from the thickness of metal—never less than three-eighths of an inch, and frequently more—they oppose a direct obstacle to the ready transmission of the heat from the water to the surrounding atmosphere.

“No reservoir is attached to the apparatus above described; but on a large scale it would, of course, be necessary, the quantity of water being small, and there being no mass of brickwork to act as a reservoir of heat. This purpose, however, is evidently much better answered by a cistern of water within the house than by a boiler and brickwork, from which much heat is dissipated in the back shed; but to prevent loss of time in applying the heat in severe weather, it should be so connected with the pipes that the water in them may be sufficiently heated to warm the house before it is allowed to pass into the reservoir.”

*Rogers' mode of heating.*—Experience, according to Mr Rogers, led him to adopt a conical form of boiler in preference to the cylindrical one he commenced his experiments with. He also abandoned copper on account of its being corroded in a few months by the sulphur disengaged from the coke. He at first had doubts as to the prudence of adopting cast-iron, thinking that the unequal expansion might cause the boiler to crack—not at all an unfrequent circumstance when that metal is employed; and also that, on account of the greater thickness required, that metal would be longer

in heating than copper—a supposition entertained by many, though practically the difference is scarcely perceptible. The following is the description in his own words, taken from the “Gardeners’ Magazine,” xvi. p. 132:—

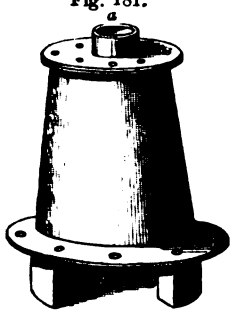
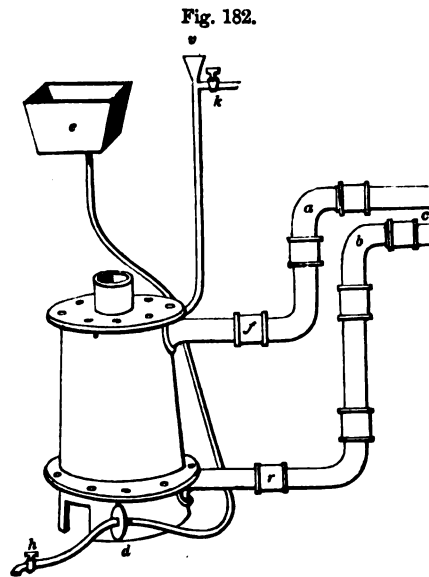


Fig. 181 “is a front view of the boiler

as at present constructed of cast-iron: the interior, a sugar-loaf-shaped cone (indicated by the dotted lines, fig. 183,) being the furnace, which is filled with fuel from an upper orifice, *a*. A circular fire-grate is fixed just within the bottom of the boiler; and the aperture *b*, seen in front, is intended solely to remove clinkers which may form, or fuel when the fire is extinguished: at other times it is closed with a fire-brick plug, and should never be opened except when absolutely necessary.”

Fig. 182 “is a side view of the boiler, where it is represented as attached to a

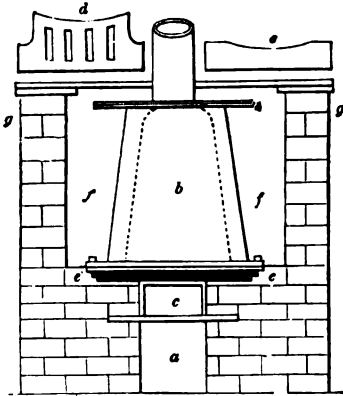


range of pipes; *f* and *r* are the flow and return pipes, and *d* a flange for examining and cleaning the boiler when necessary. Into this flange is fixed a small pipe, which, being connected upwards with the supply cistern *e*, and downwards with the cock or tap *h*, serves to fill and empty the apparatus. The supply-cistern *e* acts also as an expansion-cistern, to receive the volume of water increased by heat.”

Fig. 183 “shows the most convenient mode of setting the above, exhibited by a front view. A solid base being built, with an aperture in its centre open to the front, as high as the desired depth of the ash-pit, the boiler is fixed upon it, and the brickwork carried up to its lower flange or rim. The side walls should then be

raised in 4-inch work, level with the top of the boiler, or as shown in our fig.: *a*

Fig. 183.



is the ash-pit; *b* the boiler; *c* the aperture in front of the boiler, closed with fire-brick; *e* and *d* two bars, one for supporting the fire-brick plug, and the other fitting to the rim of the boiler, to support a slate which encloses the front; *f f* is the chamber around the boiler, filled with sawdust as a non-conductor of heat; and a layer of sawdust extends over the top of the boiler under the slate slab *g g*, which is fitted over the brick-work, an aperture being cut in it to allow the throat of the furnace to pass through."

The chimney rises from the top of the boiler, in which is placed a small door for supplying the fuel. "This chimney must not exceed 4 or 5 feet in height, and its area must in no case exceed the area of the mouth of the furnace." A damper is also placed in the chimney to regulate the draught. "The aperture of the boiler, which is closed with fire-brick, and the front of the ash-pit, should also be closed by a door or blower, having a regulator to admit or exclude draught. A blower is preferable to a door, as hinges are always liable to rust, and then break or strain; and it is important to be able to close the ash-pit pretty accurately."

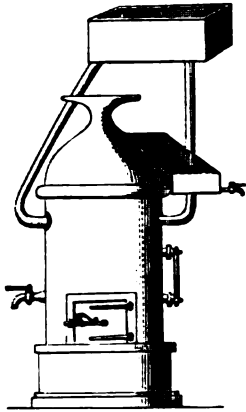
Fig. 182, already referred to, exhibits a side view of the boiler and the connection of the pipes. "In the first place," says Mr Rogers, "the whole of the pipes should if possible be above the boiler. One foot is sufficient; but, when convenient, the higher the better. When 2 or 3-inch pipe is used, the pipes may rise uniformly

about 1 inch in 20 feet from *a* and *b* to *c*, on which, being thus the highest point of the pipes, an air-cock is placed. But if 4-inch pipes be employed, it is better that *a* should be the highest point, and the air-cock placed there; and that the pipes should fall uniformly 1 inch in 20 feet from *a* to *c*, and from *c* to *b*; indeed, this is generally the best arrangement, where not inconvenient." Why the position of the pipes should be thus reversed because they differ in size, will be found explained in section CAUSE OF CIRCULATION. "From *b* the return pipe *r* should descend either perpendicularly, or with as steep an inclination as possible to the bottom of the boiler. The supply cistern *e* must be so placed, that its bottom is not lower than the highest point of the pipes. The top of the steam valve, *v*, should be level with the supply cistern. Just below the valve on the steam-pipe may be fixed a small cock, *k*, connected with a pipe laid into the house, by which, whenever the water boils, the house may be steamed. In small apparatuses this will happen pretty frequently; but in large houses, in order to insure this advantage, a stop-cock or sluice should be placed on the flow-pipe *f*, by which the circulation being intercepted, the water in the boiler may at any time be raised to the boiling point in a few minutes." This mode of heating has been popular, and justly so; and one of its most striking advantages is the long duration of steady heat, rendering it valuable to amateurs who do not keep people for the purpose of attending to their fires. It is adapted also to large as well as small houses, or pits, and has been known, when properly regulated, to maintain its heat for twelve hours without attention. The boilers are so constructed, that they may be taken to pieces to be thoroughly cleaned, which all boilers require less or more according to the purity and quality of the water used in them.

*Rettie's mode of heating.*—The object here aimed at is to combine the principles of heating by hot air and hot water at the same time. The figs. 184 and 185 will show the construction, the former being an elevation, and the latter an interior section of the apparatus. Mr R. explains its operation as follows:—"The inner casing which contains the fire has a double or

outside casing cast upon it, with two openings, one on each side, called the

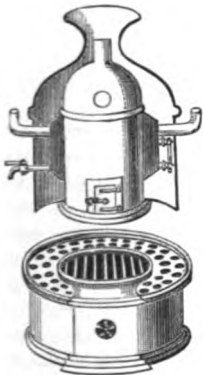
Fig. 184.



ingress and egress pipes; the one conveying the cold water, and the other taking away the warm, which causes the circulation within the cistern; while the third case or outside covering is placed about 4 inches from the double covering, leaving sufficient

room for a continued current of air to proceed into the chamber to be heated. It is here where so many blunder. Air ought not to be roasted or boiled; it ought to be gradually heated to a certain temperature, and that temperature must not range beyond 85° to 95°." Mr Rettie taking summer heat at 75°, which is the temperature he aims at producing in structures heated upon his principle. On the cut

Fig. 185.



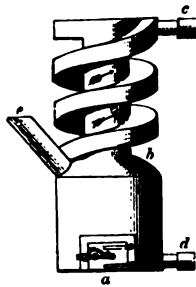
a steam gauge-tube of glass will be seen, which will show at all times the height of water in the boiler and cistern; the draught and consequently the combustion of fuel are regulated by a well-contrived air-tight door and ash-pit register.

For heating greenhouses and conservatories, where a more powerful and more permanent apparatus might be found difficult to place, this would be found a useful substitute, as for such purposes it might be fitted up in a portable state, having the pipes attached to it by union or flange joints. To be of use as a radiator of heat from its sides, or for heating air made to pass between the outer casings, it would require to be placed inside the house.

For heating greenhouses and conservatories, where a more powerful and more permanent apparatus might be found difficult to place, this would be found a useful substitute, as for such purposes it might be fitted up in a portable state, having the pipes attached to it by union or flange joints. To be of use as a radiator of heat from its sides, or for heating air made to pass between the outer casings, it would require to be placed inside the house.

*Sampson's mode of heating.*—The spiral boiler, of which the annexed cut, fig. 186,

Fig. 186.



will give a very perfect idea, will be seen from its construction to possess a very important advantage over most others. The fire is placed under the boiler, as in most other cases; but the smoke and heat which, in others, rapidly pass off in the direction of the flue or chimney, in this pass upwards through the boiler, and for a considerable way above it, around which the spiral portion of the boiler is continued, abstracting the heat from the flue as far as the set-off of the flow-pipe. The direction of the flue is indicated by the arrows; *a* is the place for lighting the fire; *b* hole; *c* flow-pipe; *d* return-pipe; *e* cylindrical feeder for fuel, with air-tight cover. The simplicity of its construction enables any mason to fit it up with the greatest ease; indeed, all that is required is merely to enclose it within a casing of brickwork.

*Cottam and Hallen's system*—Figs. 187 and 188.—These highly respectable en-

Fig. 187.

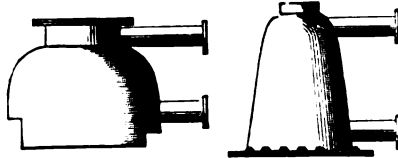
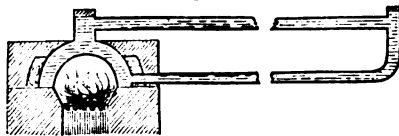


Fig. 188.



gineers were amongst the earliest improvers in heating by hot water, and their boiler is considered to this day as being amongst the most effective. It is of the horse-shoe shape, and forms the roof of the fire-chamber, thereby lessening the amount of building, and that in a part of the furnace which, in general, is the first to give way. The edges of the boiler are set upon brickwork, and the heat may

either be brought to play upon half of the exterior surface of the boiler, by being made to turn at the throat into a narrow flue which encompasses the boiler; or if the boiler is set on open brickwork, the flame will play round a large portion of its surface, while the bottom, forming the top of the furnace, has the whole force of the fire acting on it.

*Burbidge and Healy's boiler and furnace.*—Fig. 189 is a section of the boiler,

Fig. 189.

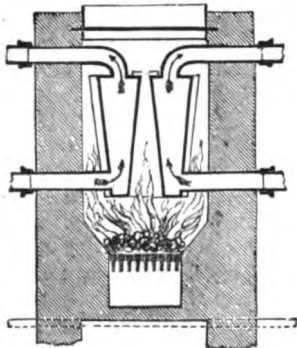


Fig. 190.

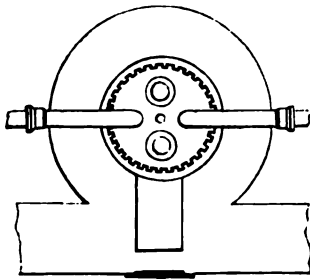
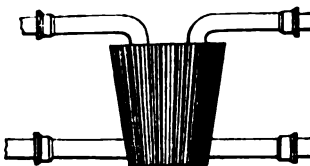


Fig. 191.



and brickwork; fig. 190, plan of the same; and fig. 192, elevation of boiler, with its ribbed surface. By reference to these figures, it will be seen that the plan of the boilers and containing-furnace is circular—the boiler being composed of two truncated cones, one inserted within the other in such a form as to enable the fire to act powerfully upon its sides, and to offer a most extensive surface to its action; the whole surface of the boiler being exposed to the joint action of the fire and heated fluids, as well as a considerable portion of the conducting-pipes. It will also be observed that the sides of the boiler are ribbed, which adds greatly to the surface exposed to the fire, and to the strength of the boiler. The set-

ting of this boiler is simple, and the soot easily removed. In no place is the fuel in contact with the boiler: in every case where it is so, we apprehend great loss of fuel from the rapid abstraction of heat, causing imperfect combustion. This apparatus is greatly improved by having Sylvester's patent fire-doors, which are fitted with great accuracy, admitting of the utmost precision of regulation—a point of the greatest importance in arranging the action of the fire. An evaporating pan forms a cover to the top of the furnace, easily removed and replaced, for the purpose of cleaning the boiler. It also acts as a reverberator, and should, under ordinary circumstances, be filled with non-conducting materials, such as fine sand; and in cases where the boiler is fixed inside the house, it may be the means of rapidly saturating the atmosphere with moisture by evaporation. By placing the boiler within the house in a niche in the back wall, and managing the fire from without, a great saving of fuel will be the result.

Corrugated boilers, such as the above, have been adopted with the view of gaining increased heating surface by their projections; but this application has been found liable to some objection, the draught being sometimes impeded by soot collecting in the interstices between the ribs—although some are cast with external ribs, of a form which obviates this inconvenience. Wrought-iron boilers have been constructed, by the insertion of iron pins into those parts acted on by the heat, and projecting into the furnace and flues, so as to catch the effect of the flame; but those do not appear to stand high in public estimation.

We observe an important notice in Messrs Burbidge and Healy's prospectus, namely, that if a correct plan of a house or pit to be heated be forwarded to them, the whole apparatus will be supplied, so that any intelligent labourer and bricklayer can put it together without the aid of any mechanic whatever.

The following are given by Messrs Burbidge and Healy as the powers of their boilers, viz.,—

A 10-inch ribbed boiler will heat from 50 to 70 feet of 4-inch pipe, and from 25 to 40 feet in length of a forcing pit.

A 12-inch boiler from 80 to 125 feet of pipe, and from 40 to 65 feet of pit.

A 14-inch boiler from 150 to 250 feet of pipe, and from 65 to 100 feet of pit.

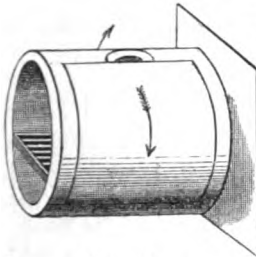
An 18-inch boiler from 300 to 400 feet of pipe, and 150 feet of pit.

A 24-inch boiler from 600 to 800 feet of pipe. And a 10-inch plain boiler 30 feet of pipe, and from 12 to 20 feet of pit. If 3-inch pipe, one-third more. If 2-inch pipe, as much more.

The above quantities are rough estimates, which may be varied by enlarging or contracting the fire, or by regulating the fire door. It is possible to heat a much larger quantity of pipe with the boiler, but it would be at a great loss of fuel.

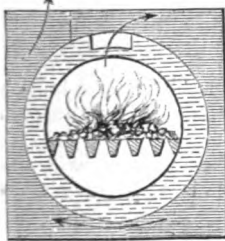
*Garton and Jarvis' cylindrical horizontal boiler*—figs. 192, 193, and 194.

Fig. 192.



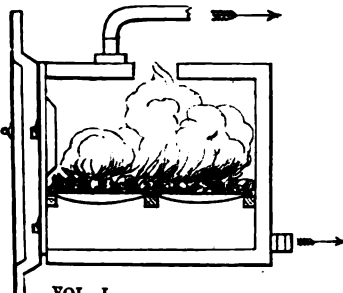
Messrs Veitch's nurseries at Exeter, where we had an opportunity of fully examining both it and the one following, in June last, and found them working well.

Fig. 193.



The interior and exterior surfaces are equally acted upon by the fire, rendering them both powerful in heating and economical in the consumption of fuel. The figs. exhibit different views of this boiler, fig. 192 showing the perspective; fig. 193 the end section; and fig. 194 the section.

Fig. 194.



VOL. I.

Fig. 195.

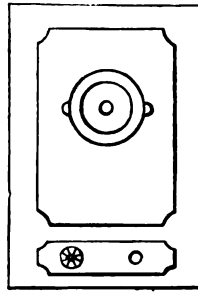


Fig. 196.

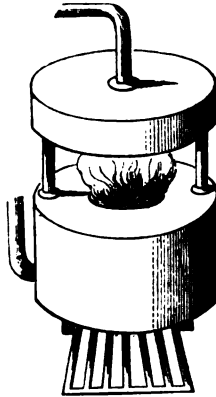


Fig. 197.

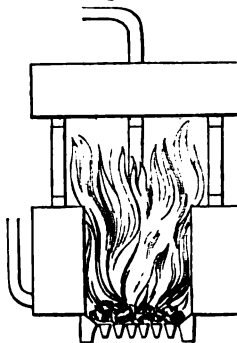


Fig. 198.



*Garton & Jarvis' double drum-boiler*—figs. 195 to 198.— This boiler is also at work in the spirited establishment above mentioned, and is considered by Mr Jas. Veitch, jun., to be equal to the last, and especially so in small houses, and that they have been found to be the best boilers in their establishment. Fig. 196 is a view of the door and frame; fig. 197 the perspective; fig. 198 the section; and fig. 199 is a section of the door and frame.

*Stephenson's double cylindrical boiler*—figs. 199 and 200.—

This boiler is somewhat different from the conical boiler of the same firm. In this the fuel is supplied at the top of the dome. The chief advantage, however, which this boiler has over the conical is derived from an inner-cylindrical boiler, which presents a larger extent of surface to the action of the fire, and serves at the same time as a hopper to contain a supply of fuel. The inter-

Y



nal boiler extends from within 8 inches of the grating on which the fuel burns to the top of the dome; it is connected at its base with the external boiler by

Fig. 199.

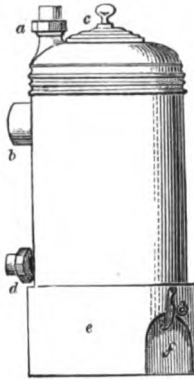
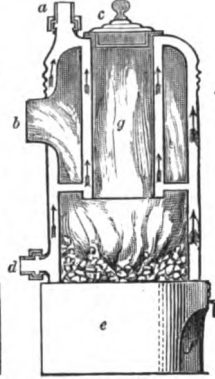


Fig. 200.



two pipes, and also has free communication with it at the top. The two boilers are separated from each other by a space of about 2 inches, and the fire acts upon both in a very equal degree. The flow-pipe proceeds from the top, as in the conical boiler, and the return-pipe enters at the bottom, while the pipe for conveying away the smoke is placed at one side. This boiler is made of copper, and is portable, so that it can be removed when not in use; and it has the peculiar merit of requiring no setting or brick-work. It is also considered by Messrs Stephenson to consume its own smoke better than most others. The consumption of smoke, it should, however, be observed, in all similar furnaces, depends very much upon the management of the fire. Fig. 199 is an elevation of the boiler; *a* and *d* are brass unions which connect the boiler with the pipes, *a* being the flow, and *d* the return. *b* is the smoke-pipe, which may be continued to any required height, and carried in any direction most convenient for the escape of the smoke. *c* is the movable dome through which the fire is supplied with fuel. *e* is an iron stand with revolving grating bars, for the convenient removal of clinkers, ashes, &c.; *f* the ash-hole. Fig. 200 is a vertical section of the same boiler. The letters of reference apply as in the last figure; *g*, shown on this one alone, is a hopper for fuel.

*Stephenson's improved conical boiler* is

placed on a stand connected with two branches of pipes. Thus one boiler may be used to heat several buildings, either together or separately, the distribution of the heat being regulated by a stop-valve fixed to each leading pipe. The boilers can be connected with pipes of any diameter by small iron or leaden pipes.

Fig. 201 is a geometrical elevation of this boiler: *a* and *d* are brass unions which connect with small pipes; *b* is the smoke-pipe; *c* is the door for fuel; *e* is an iron stand with revolving grating, as in the cylindrical boiler last noticed.

Fig. 202 is a vertical section, showing the fuel resting on the grating bars, the

Fig. 201.

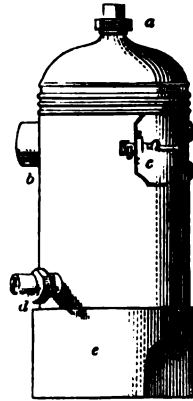
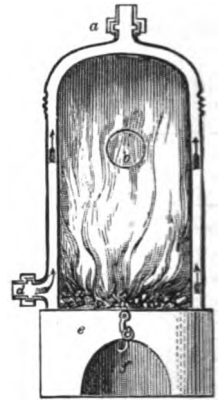


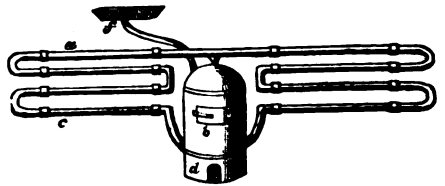
Fig. 202.



smoke escaping at *b*. The arrows indicate the water-way entirely surrounding the ignited fuel.

*Wood & Co.'s improved copper conical boiler*—fig. 203.—This apparatus differs

Fig. 203.

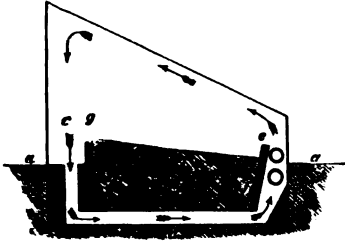


from most others in respect of a greater quantity of pipes being used, and this we are disposed to consider a merit. It may be detached from the pipes when required, as they are connected by union screws. It wastes but little water, therefore a small cistern only is required. The pipe which connects the cistern with

the boiler, as well as that for conveying away the smoke, may be placed in such parts of its periphery as may be most suitable. *a*, flow-pipe; *b*, door to admit the fuel; *c*, return-pipe; *d*, stand for the boiler; *e*, ash-hole; *f*, cistern.

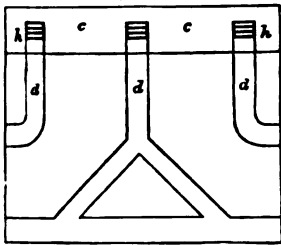
*Barchard's system of heating*—figs. 204

Fig. 204.



and 205.—This plan, although somewhat

Fig. 205.



similar to Penn's, is founded upon sufficiently rational principles, both as regards heating and circulation of the air. From Mr

Barchard's communication in "The Gardener's Chronicle" we copy the annexed diagram, and the following abridged description. The house in which the experiment was made had been formerly a pine-stove, heated in the usual manner by hot-water pipes extending along the front and ends. To carry out the object Mr Barchard had in view, and which he is "inclined to think is the gist of Mr Penn's system, that of obtaining a moist air instead of a dry or burnt one, it was only necessary to sink some small drains through the walk at the back of the house, below the level of the bottom of the pit," formerly used for tan, "and thence to carry horizontal drains across it, bringing the mouths of them up immediately under the water pipes, the effects of which," he thought, "would be to heat the upper stratum of air in the drains, which, rising thereby, would cause the change thus taking place in its volume to be supplied from the drains or air-holes at the back; and farther, thinking that

he "might promote the draught slightly thereby," he "caused the slates in front of the pipes," which formerly formed the front of the tan-pit, "to be inclined a little to the wall, so as to narrow the space above them."

This modification of heating answered all his expectations, not only so far as heating and ventilation are concerned, but the disagreeable burnt-like smell, so often complained of in hothouses, was completely got rid of. To prove this, some months afterwards he had all the air-holes in the walk shut up, which produced in a few hours afterwards the unpleasant smell of heated air: on opening them again this smell ceased to exist. Humidity is obtained by the simple process of throwing water occasionally down the air-holes, and would be more effectually accomplished if each of the air-drains were formed like a gutter at the bottom, and filled with water by a pipe running along their upper ends, regulated by a cock, so that they could be filled at pleasure. The heated air passing over the surface of these gutters would take up a sufficiency of humidity. And to render the apparatus more complete, a similar pipe could be placed along their lower ends, by means of which the water could be lessened or entirely withdrawn at pleasure.

The following will explain the different parts:—"a ground line; b pit; c walk in the house; d d d drains; e water-pipes round three sides of the house; f side of pit made of slates; g wall standing above the pathway; h h mouths of drains."

*Walker's mode of heating.*—A very ingenious mode of heating by hot water has recently been patented by Mr Walker of Manchester, the principal feature in which is exposing a much greater heated surface to the radiating process than has hitherto been attempted. The boiler and pipes are much the same as in ordinary cases; but square ornamental pedestals about 3 feet in height are attached to the flow-pipes. These pedestals are charged with hot water, and are intersected within with numerous square tubes,  $\frac{1}{4}$ -inch square, extending all the height of the pedestal. The air within these tubes speedily becomes heated by conduction from the water, and, being open at bottom and top, becomes highly rarefied, and

produces a circulation which continues as long as there is heat in the water. Heat is given out to the house by radiation from the outer surfaces of the pedestals, and circulation of heated air through the tubes in the centre of the latter.

*Johnston's mode of heating.*—A very similar mode of heating, by employing pedestals or cylinders as the means of diffusing heat by radiation, was, long prior to Mr Walker's invention, practised by Mr Johnston, gardener to his Grace the Duke of Wellington. The water was heated in two small copper vessels placed within an Arnot's stove slightly altered. From these it was conveyed in pipes so connected with union joints that they might be taken to pieces to alter their position, or be removed altogether when not required. The stove is placed in a niche in the back wall of the conservatory, or it may be placed under the floor if more convenient. Along the floor of the house upright cylinders are placed; but these might advantageously be removed, and highly ornamental vases substituted. The water is led to each by means of a small pipe, with a corresponding one for its return to the boiler. Each of the cylinders is 18 inches in diameter, and the same in height, and has thirty tubes 1 inch in diameter placed inside, of a height equal to the height of the cylinders. The water is supplied by a valve near the top of the cylinders, covered with an ornamental cup, which is movable. Heat is thus given off by radiation from the surface of the cylinders. As in Walker's method, the air which passes through these tubes becomes heated in consequence of being surrounded by heated water, and is in this modified state admitted into the house. It appears that such an apparatus as we have described has been found sufficient to heat the conservatory at Strathfield-saye, 67 feet in length, 27 feet broad, and 21 feet in height. The consumption of coke for such a stove is exactly one bushel per day, half of which is supplied in the morning, and half in the evening. In regard to priority of invention in the case before us, there is no doubt Mr Johnston is entitled to it rather than Mr Walker—the principal difference between the two being, that Mr Walker places his pedestals on the top of the flow-pipes of an ordinary hot-water

arrangement, while Mr Johnston attaches his cylinders by means of small pipes, through which the hot water flows. In the former case the pedestals are fixtures, while in the latter they can be removed with the greatest facility. The idea of increasing the command of heat by radiation from either pedestals or cylinders is good; and for conservatories, which require so little artificial heat, we think that this principle might be applied with great advantage and effect by having hot water brought under the floor, and made to circulate through ornamental vases distributed through the house, which, when not required for this purpose, could be filled with plants. The actual utility of the pipes within the radiators employed by both these gentlemen, we think very questionable—for water will circulate in a vase, and, we think, give out as much heat by radiation from its surface as will be found sufficient, without the complication of these external tubes at all.

There are various modes by which conservatories, greenhouses, &c., may be heated upon very similar principles to the above; and in the former case, where elegance of form and design is, or rather ought to be, a consideration, we cannot offer a better example than fig. 206, given in WALKER'S "Hints on Ventilation," &c., who says, "When it is necessary that the heating surface should stand within the apartment to be warmed by it, a very compact arrangement has been devised and patented, in which the conducting property of iron has been advantageously employed by the use of square blocks perforated all through from top to bottom by square openings or cells, with their divisions between them. Several such blocks" (according to the space to be heated, and the temperature required) "are enclosed in an iron case or box, open at top and bottom; and heat being applied to the outside of each block by the introduction of steam or hot water, the entire mass of each block becomes heated, and imparts heat to the air contained in its cells, which then rises into the apartment, its place being supplied, and a continuous current maintained, through any fresh-air flue over the mouth of which the set of blocks may be placed." In the case of hothouses, this supply can readily be obtained by bring-

ing in air from without the house in an underground drain or tube, the orifice of which opens under the case or heating-box. And, indeed, were it not always better to make use of the pure air of the external atmosphere, the air of the house itself close to the floor would be amply sufficient, and this would reach the cellular arrangement, as it is elevated some inches above the floor level, the heat-box being supported upon four legs. "The blocks and their cases, which may be denominated the honey-comb or cellular arrangement, will present more heating surface to the air than can be obtained within a given space by any other form. The case itself is also a valuable heating surface; and, by the addition of a few ornaments screwed on its outside, a neat and portable heat-box is obtained. One of the forms in which these heat-boxes have been made is represented in fig. 206, perspective view, and

Fig. 206.

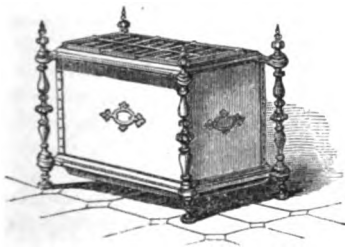
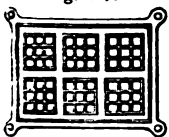


fig. 207, plan. The remarkable aggregation of heating power thus attained in a small space will be best understood when it is stated that in a heat-box measuring 27 inches long, 18 inches wide, and 16 inches high, 80 feet of effective surface are collected."—WALKER'S *Hints on Ventilation*.

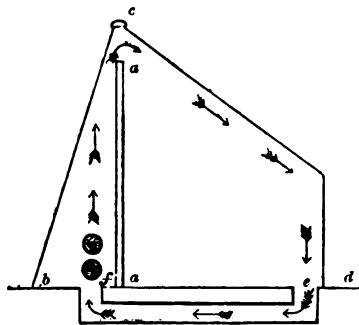


One or more of these boxes may be placed in a large conservatory, and will be found not only useful, but ornamental. The hot water can readily be brought to them in a small pipe from the nearest boiler, the flow-pipe in particular being embedded in charcoal placed in a dry drain under the floor. Its connection with the pipes within the box should be by a union screw-joint close to the floor, so that in spring, when artificial heat is

to be dispensed with, the whole can be removed until again required. These, or modifications of the same principle—that is, employing portable radiating heating-cases—is, of all others, the most complete and elegant method of heating highly ornamental conservatories. In them pipes can never, in good taste, be applied on the surface of the floor; and to place them in air-drains under it is a sacrifice of heating power.

*Penn's system*—fig. 208.—The originator

Fig. 208.



of this mode of heating was the late Mr Penn of Lewisham, Kent: it has suffered as great a degree of public disapproval as almost any other method proposed. In 1840 a notice of it was published in the "Gardener's Magazine," and a panegyric pronounced upon it which it by no means deserved. Two very extraordinary features in this mode of heating are, that the hot-water pipes are placed *without the house*, contrary to all precedent, and that it is attempted to bring the heated air in at the top of the house, and to make it descend. The following is the substance of a critique upon it from the "Gardener's Chronicle," from which the diagrams, figs. 209 and 210, are also taken: the former of these represents the interior of a greenhouse, "of which *aa* is the back wall, and *cd* the glass front. The triangle *cfb* indicates a back shed, in the bottom of which, at *f*, are placed the hot-water pipes; at *c* the back wall is pierced immediately below the summit; *f* and *e* are the mouths of a drain which passes under the house from front to back. We are informed that the air, being heated by the pipes *f*, rises in the direction of *c*, and, passing through the apertures beneath *c*, takes a direction downwards from *c* to *d*;

that in the meanwhile the cold air at *e* presses downwards into the drain, in consequence of the abstraction of air from *f*, and, rushing along in the direction *ef*, produces a general circulation of all the air of the house: in other words, the pipes *f* act so as to suck the cold air out of the house along the drain *ef*, and having heated it, send it upwards again into the house through the aperture *c*, when it again descends to *e*.

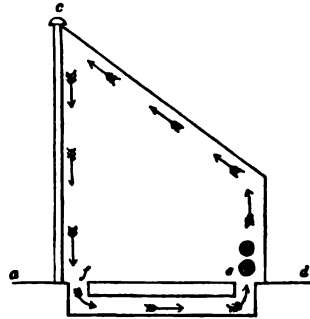
"It would be extremely difficult to conceive anything more unphilosophical than this singular contrivance. In the first place, the whole heating apparatus is placed on the outside of the house it is intended to heat; and this alone must, from the nature of Mr Penn's other arrangements, cause an immense waste of heating power; and, in the next place, the heated air is forced downwards, in the opposite direction to that which it would naturally take;—in order to effect which a still further heating power is to be provided, for no circulation, such as would be required to produce the necessary temperature of a greenhouse in cold weather, can be thus maintained, if at all, except by an extraordinary creation of heat at *f*. It is clear, therefore, that one part of the supposed advantages of Mr Penn's method—namely, that of economising fuel—does not belong to it."

It appears to have been Mr Penn's object to effect ventilation and circulation of the air within the house—both matters of very great importance. If by ventilation we are to understand the admission of a supply of fresh air, then, in this case, we have none; for, presuming that there is a circulation, it is only of the air in the shed flowing into the house, and the air of the house flowing back again into the shed. This is certainly the case in cold weather, when supplies from the external air are shut out, and therefore the same air, or nearly so, keeps circulating until it can be of little use to plants; and if the shed and house were perfectly air-tight, it would soon become dangerous to breathe in it.

The commentator on the above mode of heating has shown by the opposite diagram, fig. 209, "a plan of heating without loss of heat or departure from established principles, which would have

effected the circulation attempted by

Fig. 209.

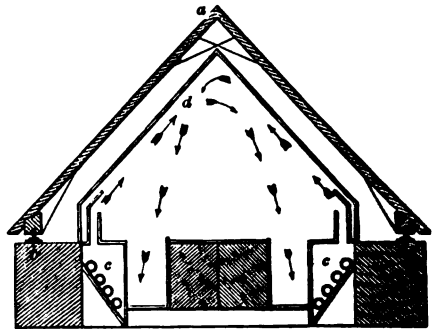


Mr Penn. "Suppose," says he, "in the annexed diagram, *acd* represented the section of a greenhouse: if *fe* is the drain, and the pipes are sta-

tioned at *e*, no principle would be violated, no heat would be lost, and a circulation would be established all round the house in the direction of the arrows."

A very fair trial was given to Penn's system by Sir Joseph Paxton in heating an orchid house at Chatsworth, of which the annexed fig. 210 is a section. This

Fig. 210.



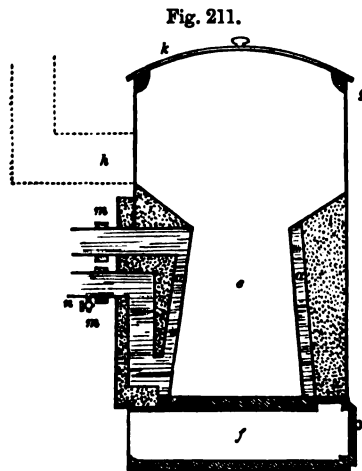
house is covered with a thatched movable roof *a*, travelling upon rails placed on the side walls at *b b*, and almost sufficient of itself to repel ordinary frosts. Notwithstanding, four courses of pipes were laid all round the house, and double the quantity of fuel consumed that would have heated it sufficiently upon any of the ordinary methods of hot-water heating; while Mr Penn was left uncontrolled by Sir Joseph, who, with great liberality, wished to give the system a fair trial. He not only failed in heating the house, but the expense was above £130 greater than Walker of Manchester had contracted to do it for. *cc* is the casing in which the pipes are enclosed; *d* the roof of the house.

It may be asked, why republish this system, which has been so generally condemned? We do so because it may act as a beacon to warn future experimentalists, and also on account of the judicious reasoning brought out in testing its merits. The knowledge of failure is often as useful to us as that of success.

*Coldridge and Sons' heating apparatus.*—The boiler used by this firm is in the form of a long cylinder, about 6 feet 6 inches in height, by 18 inches diameter; it has a spiral flue from bottom to top, in which are sundry flues for cleaning out the soot. A double valve is placed at each extremity of the pipe, for the purpose of controlling the heat, or of stopping the circulation when required; there is also an open cylinder, with a floating index, to facilitate the escape of air, and to show the elevation of the water in the boiler. When the machine is set to work, the valves are shut until the water boils; the pipes are then opened, the immense perpendicular column of rarefied particles is propelled forward with inconceivable rapidity, and the whole line of pipe attains a high degree of temperature in a few minutes, and in less than an hour arrives at its maximum of heat. The action is so powerful that the atmosphere in the building is speedily warmed to any temperature required: should it be too hot, the circulation can be instantly stopped by means of the valves, and the temperature lowered to any point required. The superior advantage of this apparatus appears to consist chiefly in the boiler. It is customary with many to use boilers of small dimensions, which are capable of absorbing but a very small part of the heat generated in the combustion of the fuel; consequently the greater part of the heat is carried up the chimney and expended to no purpose. To set this in a clear point of view, it may be necessary to observe, that as an equal quantity of cooled particles will be brought back by the returning-pipe as there were hot particles set in motion by the leading-pipe, it follows that, in a boiler of very small dimensions, these cooled particles would occupy nearly the whole external surface, and would require to be re-heated at every successive circulation; whereas in the cylinder boiler above described they would occupy but a small space at

the bottom, while, the water above being already heated, the circulation would proceed with greater rapidity. In other words, if the boiler be large, the particles of water would be heated with more rapidity than they could possibly circulate through the area of the pipes, and the result would be, that a surplus quantity of heated water would be retained in the boiler, until the whole quantity had attained a high degree of temperature, in which case the quantity of cooled particles brought back by the returning-pipe would have but little effect in lowering the temperature of the whole mass; whilst the hot particles at the upper surface of the boiler would keep up the circulation without interruption, and the contrast of the temperatures between the leading and returning pipes (on which the action depends) would be consequently greater, in the ratio of the difference between the proportions of a small boiler and a large one.

Fig. 211 is an economical and portable hot-water apparatus invented by Charles



H. Smith, Esq., of Edinburgh, a landscape-gardener of respectability. It is intended for heating frames and pits, and will be found a useful appendage in the gardens of amateurs—the more so, as it can be readily moved from one pit or frame to another. The fuel employed is coke or gas cinders; and, when properly ignited, the combustion goes on so slowly as to require attendance only once in twelve or fifteen hours. This control over combus-

tion is attained by regulating the supply of air to the furnace to the lowest extent possible, so as merely to keep up the required heat in the boiler, and prevent the fire from becoming extinguished. The boiler is a modification of Rogers' conical one, which, Mr Smith observes, is no very new invention, having been employed by the Union Canal Company at the suggestion of the late Sir John Robison, for warming their passage-boats, twenty years ago. Mr Smith's boiler is fitted into a sheet-iron case, with a cast-iron bottom and ash-pit door, which is grooved to fit the frame closely for the exclusion of air. The boiler *a* is surrounded with sand, having a sand-joint for the door at top *g*. No air is admitted to the fuel except that which enters the furnace through the register in the ash-pit *f*, and on this the steadiness and slowness of combustion depends. The fuel is supplied by removing a part of the top at *k*, and the smoke passes off through the pipe *h*. The pipes are placed as in the section fig. 212, *b b*, either ver-

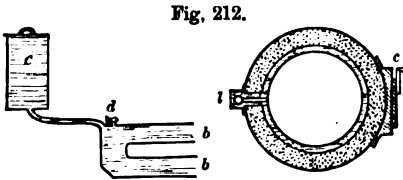


Fig. 212.

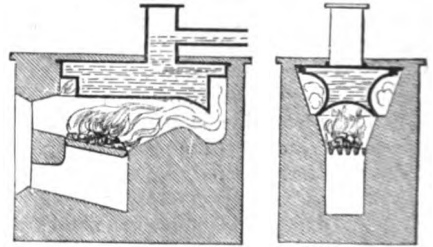
tically, as here shown, or horizontally, as may be most convenient; and Mr Smith suggests that they should have a gradual rise from the boiler to the highest point to which they may be carried. An air-cock *d* and expansion-cistern *c* are placed at the highest point, the latter being connected with the pipes by a small tube. The furnace *e* is placed in the centre of the apparatus; a piece of sheet-iron *l* is bolted to the case, at which point the pipes are connected or disconnected with the boiler by coupling-screws *m*, while *n* is a tap for drawing off the water, and *f* is the ash-pit. According to the length the pipes may be carried, coupling-screws are attached, so that the whole heating power can be shortened or lengthened at pleasure, as well as taken to pieces in case of a change of position being desirable. Mr Smith recommends, when the apparatus is likely to be portable, that the

pipes be made of copper; we see no reason why 2-inch leaden ones would not do as well, and they would be much cheaper. The boiler is to be placed outside the pit or frame, and protected by a wooden covering.

The following diagrams of boilers we prefix to this article. The pipes, &c., being attached to them in the usual manner, we do not deem it necessary to specify them under the denomination of any particular mode of heating, as they may be applied to almost any of those already described.

*Neeve's boiler*, of which the annexed fig. 213, presents a transverse and a longitu-

Fig. 213.

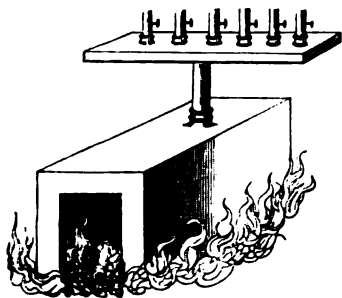


dinal section. Mr Neeve was an early improver on hot-water boilers; and being in his youth the principal assistant of the late Mr Tredgold, he completely understood the subject both in theory and practice. On this subject, after acquiescing in the correctness of the rules laid down regarding the surface of pipe, &c., he says, "Still I think that the calculation for the size of the boiler is not sufficiently clear; for a furnace may be so constructed, that although a given quantity of fuel may be consumed in a given time, yet a great portion of the heat from that fuel may escape through the flue, without being of service to the boiler." This is substantially true; and no boiler has yet been invented that will take up all the heat from the fire burning under it, as water is capable of extracting only a certain amount of calorific, and beyond that point it cannot go. Hence, under all circumstances, a certain amount of heat must be lost, unless it can be turned to account by passing through a flue or otherwise, after passing the boiler, or unless the quantity of fuel can be so graduated as to heat the water in the boiler to the desired point and no more—a matter, we presume, of no small difficulty.

With the view of remedying this defect so far, Mr Neeve proposed to vary the length of the boiler according to the length of the pipes employed; and therefore he recommends a rectangular figure rather than a square or circular one. Proceeding on the well-known fact that the bottom of a boiler is far superior to the sides for absorbing heat, he lengthens out his boiler, and, as we think, very properly forms it with a slight dip at *c*, which must have a tendency to prevent the flame from passing too rapidly over the bottom; the flue also passing round the end and sides of the boiler, as shown in transverse section, exposes nearly the whole surface to the action of the fire.

*Waldron's boiler*, fig. 214.—This boiler is 3 feet long, 2 feet 6 inches wide, and

Fig. 214.



the same in depth. The fire is made in the middle, and spreads around the outside of the boiler, leaving only 6 inches of water over it. The fire-place is 18 inches wide, and 3 feet long, which, from the small quantity of water contained in the boiler, speedily heats the pipes attached to it. Not only is this boiler different from most others in shape, but it has another peculiarity almost its own, namely, an iron box fixed to its top, from which issue as many pipes as there are houses or pits to heat, allowing one pipe for each. Each of these pipes has a stopcock at its base to turn the water off or on any house, as may be required. A similar box is fixed to the side of the boiler near its bottom, in which all the return-pipes terminate. As this boiler is a close-topped one, a safety as well as feeding pipe is attached to it, both for the purpose of supplying it with water, and also to admit of the escape of air that may accumulate in it. When one house

VOL. I.

only is to be heated, of course the box is to be dispensed with, the flow and return pipes being fixed in the ordinary manner.

Fig. 215.

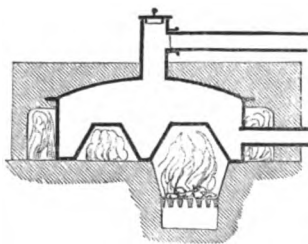


Fig. 216.

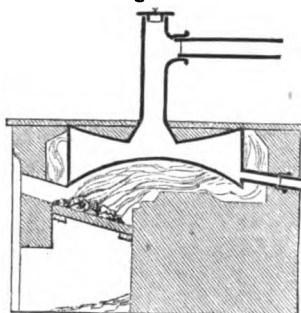


Fig. 217.

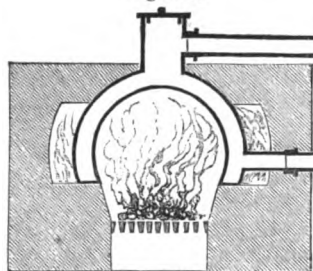
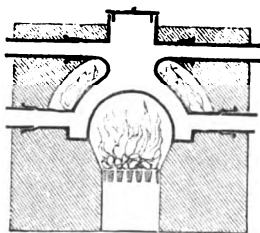


Fig. 218.



low cylinder, and the latter a bottle-shaped boiler—are both also well adapted for heating rapidly, as they present a large surface to the action of the fire, and contain a limited quantity of water. Both are adapted for heating greenhouses and

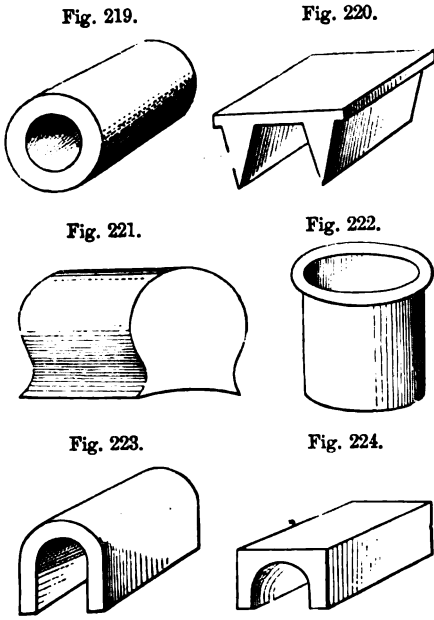
*The Scotch distillers' boiler*, (fig. 215,) and also another upon a somewhat similar principle, (fig. 216,) are both calculated for obtaining a large portion of fire and flue surface to a small capacity of water; they are both, however, complicated in form, and would be expensive if of a size too large to be cast in one piece. They have, for the most part, been constructed of copper. *Bailey's boiler*, fig. 217, and *Cotta and Hallen's*, fig. 218,—the former

Z



other cases where only a small reserve of heat is required for the night.

Figs 219 to 224 present other forms, all of which, except the third and fourth,



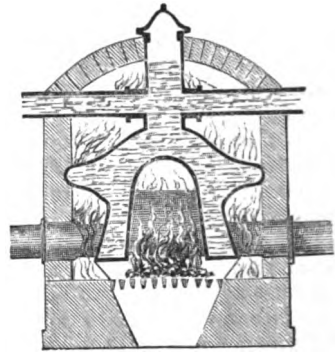
contain but a small quantity of water in proportion to their heating surfaces. We have elsewhere explained that it is not necessary to have a boiler of great capacity, as the return-pipe is continually bringing in a fresh supply of cold water in proportion to the rate of discharge of hot water by the upper or flow pipe. Fig. 219 appears to be the form best adapted for leaden boilers, the expansion and contraction being more equal than in boilers of other forms; they are thence less liable to lose their shape, or to cause unequal thickness in the metal.

*Atkinson's original boiler*, fig. 225, contained a greater quantity of water than was absolutely necessary. It had, however, this advantage, that when once heated it continued to give out its heat longer than those of less capacity.

*Thomson's boiler* — fig. 226 — made known by us some years ago in "The

Greenhouse and Stove," presents a great surface to the action of the fire, and, from

Fig. 226.



the mode of setting, allows full scope for the flame to play round it.

*Burbidge and Healy's new boiler*—fig. 227. This boiler has been extensively

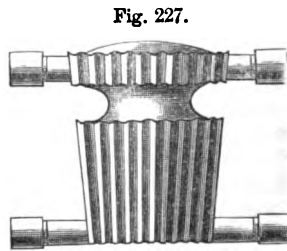


Fig. 227.

employed in the establishment of the royal gardens at Kew, and elsewhere, and is spoken highly of "as being superior" to some of those used in the same gardens. "The fire plays," says our informant, "beautifully all round it;" but he adds, "I think that there is a great deal in setting them properly. It is 2 feet 6 inches in diameter at the top, 1 foot at the contraction, and 2 feet at the bottom, and 3 feet deep. It is calculated to heat about 200 feet of 5-inch pipe, and 360 feet of 3-inch pipe. Here at last we have an instance of what may be done by a small boiler, and we are quite sanguine as to the result. The form, however, of this boiler is bad, as that of all circular boilers is; a long shallow form would have produced the same effect with a much less quantity of fuel."

These eminent engineers have also another form of boiler in use in the same establishment, upon the sides, bottom, and interior surfaces of which the heat of the fuel is made to play.

*Dalkeith wrought-iron boiler*.—Fig. 228 is a section of a boiler of which we have

several in the gardens here, and find them to answer all our expectations, excepting as regards durability, in which respect experience has taught us to prefer cast-iron ones—still, however, retaining the saddle-backed

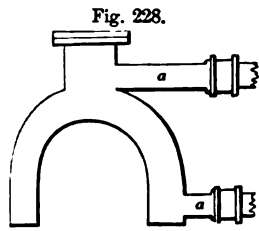


Fig. 228.

or arched form, which has many advantages over all others. Mr Glendinning has recently very correctly stated, in the "Journal of the London Horticultural Society," that this form, although one of our oldest, has merits which would have made it wise "had we endeavoured to improve it,—if, indeed, it is capable of improvement. The arched boiler," he observes, "is at once simple in shape, of efficient power and easy application. No boiler hitherto contrived so perfectly combines these important points, for, while it is possible to get up a boiler with more heating surface, there has invariably arisen some corresponding disadvantage." In principle they differ little from those of Cottam and Hallen's, and the Messrs Bailey's, already noticed. Ours are either made water-tight at top, by having the lid screwed down to the top of the boiler, or left open when the circulation is upon the horizontal principle—the lid in this case being provided with a flange all round, which fits loosely into a groove round the top of the boiler, and is rendered steam-proof, by filling the groove with water before setting the flange of the lid into it. Two short pieces *a a*, or nozzles, are cast on the boiler, and to these the pipes are secured. They are set upon six fire-bricks, which allows the heat to play around their sides, ends, and top, as high as the bottom of the flow-pipe, at which part they are covered over with fire-tiles. The fire is made under them, so that their concave bottom and sides forms the sides and roof of the furnace. They are thus completely enveloped in heat; and being narrow within, they soon become heated, and also being from 3 to 4 feet in length, according to the heating power required, they abstract a great amount of heat from the fuel.

*Fowler's boiler.*—Boilers upon the prin-

ciple exhibited by fig. 229 have been erected by Fowler of Temple Bar, London.

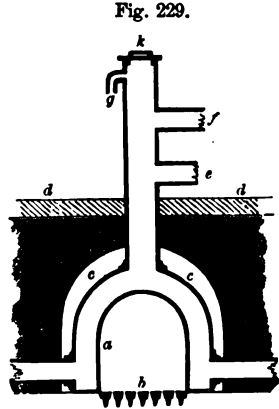
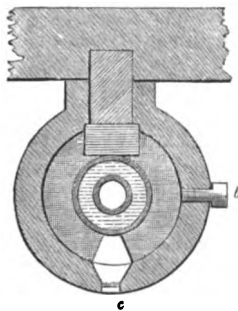


Fig. 229.

*a* is the fire-place or oven; *b* the fire-bars or grating; *c c* the roof of the furnace over the boiler, built with fire-brick and covered with a stone coping *d d*; *e e* are pipes which go round the house and return in the usual manner; *f* is a single pipe for giving supplementary heat, or it may be wrought at the same time as the others; *g* waste or expansion pipe; *k* lid of the boiler. This boiler, like the last, is well adapted for abstracting heat from the fuel, being surrounded on all sides by the fire. There is no pressure of building upon it as in many others, but the pressure of water upon it is considerable; hence, we need hardly say, the material and workmanship must be of the best kind. This boiler is also of malleable iron, and longitudinal in shape, like a large drain-tile, whose sides, like that used by ourselves, (*vide* last diagram) form the furnace. Those boilers, of whatever form, which are not surrounded on one side by water and the other by the fire, must always have less or more fuel to waste.

*Bailey's new boiler.*—A very ingenious

Fig. 230.



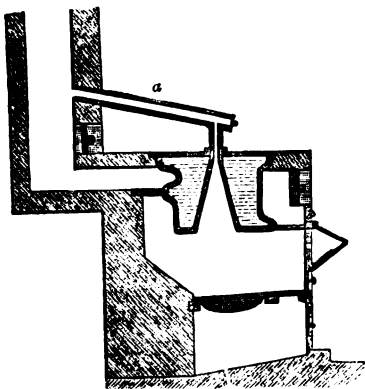
and effective boiler (figs. 230, 231, 232) has recently been manufactured by Messrs D. and G. Bailey, High Holborn, London, one of which was lately pointed out to us in the garden of the London Horticultural Society, where

it has been some time in operation, and has given satisfaction. The body of the

boiler is cast-iron with a malleable-iron cover bolted on; but its greatest peculiarity

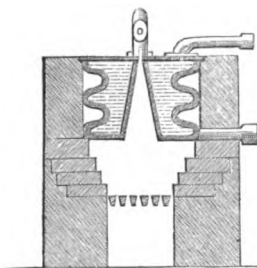
they pass through the breastwork of the building, and empty themselves into the

Fig. 231.



is what is called the combustion-pipe *a*, fig. 231, which forms a current for

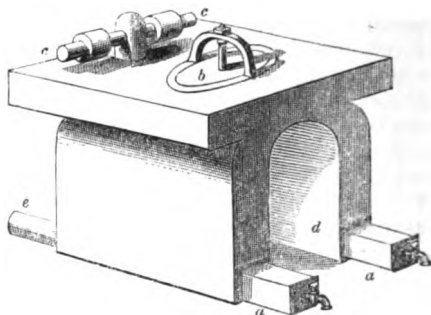
Fig. 232.



the smoke to pass upwards through the centre of the boiler. What effect this may have on the consumption of the smoke we could not learn, but that it must add to the heating power is sufficiently clear. A large surface also of the boiler is exposed to the action of the fire, and as it contains only a small quantity of water, it consequently heats rapidly. *b*, fig. 230, is the flue door for extracting soot from around the boiler; *c* a similar door at the bottom of the chimney, for a like purpose. Our figures show a plan of the boiler, and also two perpendicular sections taken at right angles through it.

*Williams' boiler*—fig. 233—is of excellent construction, formed of wrought-iron plates securely riveted together. To us the great improvement in this boiler over most others is the contrivance for cleaning it out—a most essential point, and one sadly neglected. The square pipes *a a*, to which the cocks are attached, are secured to the front part of the boiler by flanges, so that they can be removed with ease when the boiler is to be cleaned out;

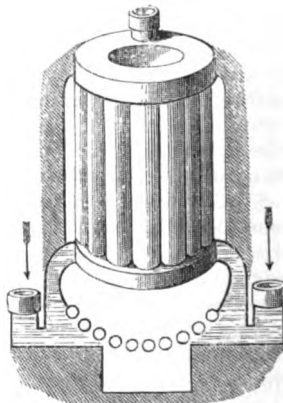
Fig. 233.



stoke-hole. A man-hole, *b*, is placed on the top in the usual manner, but is somewhat larger than usual, which is an improvement; and when the square pipes are removed, the interior can be completely cleaned out. The flow-pipes *c c* branch from a nipple on the top furnished with sockets, to which the pipes are attached. The fire is made at *d* in the middle of the boiler, which forms the sides and roof of the oven, the flames passing round the outsides which form one side of the flues; *e* is the return-pipes; the top is level, and projects over the tops of the side flues, thus not only securing them, but also gaining an additional degree of heat. Altogether, we consider this one of the very best of boilers.

*Weeks and Co.'s improved boiler.*—These enterprising hothouse-builders have recently invented an improved boiler, which

Fig. 234.



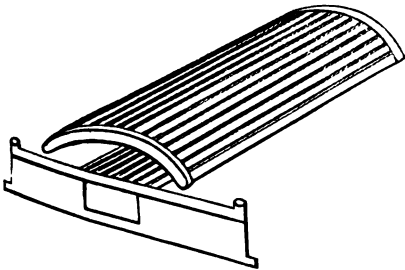
they have exhibited in the Crystal Palace, forming one of the few specimens present there of implements adapted to horticulture. This boiler, of which the annexed cut, fig. 234 is a representation, has much novelty as well

as merit to recommend it. It is con-

structed of upright tubes placed over the fire, and united together at top and bottom. The furnace bars are hollow tubes through which the return-water passes before entering the upper part of the boiler, thereby causing a very rapid circulation, and being said to produce double the effect from the same quantity of fuel.

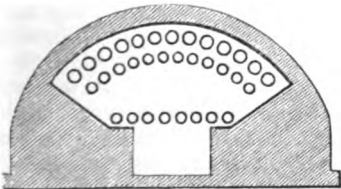
This highly respectable firm have also recently brought into notice another form of boiler, which they call the saddle-shaped pipe-boiler, with hollow furnace

Fig. 235.



bars; a representation of it is given in the annexed cut. They very properly assert that such tubular boilers are not only powerful in their effects, but also that this power of heating is attained with a considerable economy in fuel, while the house to be acted upon is heated with greater rapidity than by any boiler of a different construction. Fig. 235 shows the plan, and fig. 236 the section.

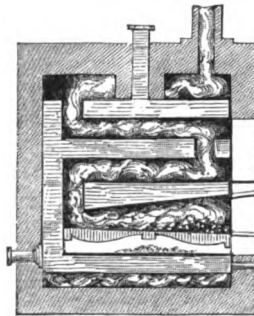
Fig. 236.



*Kerslake's universal flue boiler.*—We have here a most effective and fuel-saving boiler, as all those are where so great a portion of surface is brought into immediate contact with the heating material. The longitudinal section, fig. 237, shows its principle. From the back of the fire-place the flues are connected within the boiler, so that very little heat can escape before traversing the interior of the boiler three times, then around a flue at the sides

before ascending the chimney, thus making it both effective and economical in

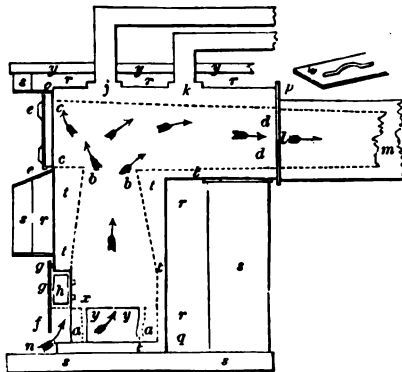
Fig. 237.



the consumption of fuel to very great extent. These boilers have been extensively used in the neighbourhood of Exeter, in which city they are manufactured either in cast or wrought iron, and they are highly recommended by Mr Barnes and other gardeners of eminence who have them in operation.

*The Captain boiler*—fig. 238.—Under this rather singular appellation an anony-

Fig. 238.



mous correspondent has communicated the following details of its merits to the editor of "The Gardeners' Chronicle." After pointing out some of the defects of the present modes of heating, he proceeds: "The following is a plan of a boiler intended purposely to remedy some of these defects. Every particle of fuel burnt in it must give a return to the owner."

"I think," he says, "the Captain will do a tenth more work than any boiler yet in use, or the same work at a tenth less cost of fuel. It differs from all others now in use, not only in shape, but in principle." The following are the dimensions of its parts: "These, of course, can be enlarged or diminished to suit any size or range of buildings: *a a* is an opening

for the grate and ash-pit, 15 inches square by 12 inches high. A movable iron grate, *x*, is placed inside of this space, the bottom or floor of which is just 6 inches from the bottom of the boiler. It stands on four legs, *y*, and it has two front bars, 2 inches apart, the highest of which comes to within 2 inches of the boiler. It has no back to it or sides, and can be removed at pleasure. Projecting 2 inches from it to the front are four iron brackets, to rest a couple of fire-bricks on when the front is to be closed; *b b* is the neck of the furnace. It is 10 inches square; it is 16 inches from where the furnace begins to incline inwards, at each of its four faces; it is 18 inches from the opening for the grate; and exactly 24 inches from the floor of the grate, *x*, upon which the fuel rests. Below this there is the ash-pit, 6 inches, making 2 feet 6 inches; the lower portion of which, for 14 inches up, is a square of 15 inches, from which it gradually diminishes at each of its four faces to 10 inches at its neck. The front line of this neck is about  $4\frac{1}{2}$  inches inside the feeding mouth at *c*; *c c* the feeding mouth for putting in the fuel. It is 15 inches broad by 12 inches high, having a tight-fitting door *e e*; *d d* is the farther end of the boiler and the commencement of the flue. It is 10 inches square, and 24 inches from the back line of the neck of the furnace *b b*; *e e* is the door. It has its top and sides inclined to fit the shape of the boiler completely when pushed in close. The lower line is horizontal: *f* is the blower to regulate the draught. It is very simple, but may give place to a more scientific method, if desired, although it would be quite as effectual in practice as any now in use, and much more simple. It has four holes *g* near its top, to hang on two hooks in the boiler. By using either of these holes, the space below for the admission of air to the under side of *x* is enlarged or diminished; *h* are the two fire-bricks which rest on the four brackets from *x*, and should fill up the space exactly before the fire-bars to the boiler *j k*. The flow-pipe *j* is just over the furnace; *k* is the return-pipe. These pipes, and also those proceeding from them through the houses, are square, 4 inches in diameter, and will therefore expose," according to the author's opinion, "one-third more radiating surface than round pipes

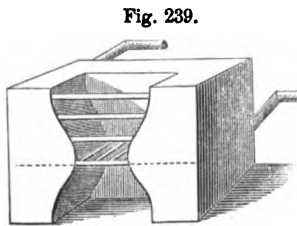
of the same diameter, and of course require one-third less piping to do the same work. These pipes are both fixed to the top of the boiler, the only difference being that the pipe *j* has the advantage of being just over the source of heat; *l* is the commencement of the flue, 10 inches diameter. To derive all the advantage of the fuel consumed, the flue should always pass through one or all the houses. In 'the Captain,' less heat will escape by the flue than with other boilers, because the heat from the furnace will strike directly under the flow-pipe, and then it must pass through the boiler 2 feet more before it reaches the flue. It will pass chiefly along the upper surface directly under the pipes, which surface is purposely made descending, thereby detaining the heat as long as possible inside the boiler, as heat descends with difficulty. Notwithstanding the advantages of this arrangement, there will always an immense quantity of heat pass into the flue, as soon as the fuel has become ignited throughout, which will generally be towards morning, when it is least desirable to throw the heat away. To save this," the author "has shown how the flue is to be brought inside the house without the possibility of damage; *m* is a thin metal trough, 12 inches square, open at top: the flue (also of thin metal) passes through this, being clear of it all round. This trough is to be partly or wholly filled with water as required, and a cover of some kind, *v*, or even a roll of coarse canvass, to be used when wanted. The trough should be a little clear of the floor, in order that the heat may be given out from all its faces. If this flue be made quite straight through the houses, the cleansing of it out (it not being intended to return, the chimney being placed at the far end) will be a very easy matter. From *n* to *o* the height of the boiler is 3 feet 10 inches; from *o* to *p* its length is 3 feet  $2\frac{1}{2}$  inches; from *n* to *q* its breadth is 19 inches. The space all round the boiler, and at top and bottom, for water, is generally 2 inches only, except where the sides and top of the furnace slope in, when it becomes rather more. It is not in the boiler-house that a large quantity of heated water is wanted; *r r r r* is a space of 3 inches all over and around the boiler in every direction, except under it, (and it may be

under it too,) for sawdust or any non-conducting material; the masonry is outside of this—*s s s s* is masonry. This may be of any thickness. In the sketch it is only  $4\frac{1}{2}$  inches, or half brick, except where the boiler rests upon the wall of the houses, where it is 9 inches thick; *t t t t* is water of the boiler, all round the fire in every direction, except the feeding-mouth and ash-pit; *y y* is a stone slab resting on the sawdust above the boiler, with holes 4 inches square for the pipes to pass through."

Simple and economical heating-apparatuses have been too little apparently cared for by inventors generally, and hence that numerous and very zealous portion of the gardening community, amateurs, are year after year left to mourn over their dead and dying stock of plants, with no other alternative before them than a recurrence to a yearly trial of their good nature and zeal—buying or begging. Mr Smith's apparatus, described at page 175, will be found a useful appendage to the amateur's garden, and modifications of it, or of several others illustrated in this work, might be employed with economy and satisfaction. One of the most homely we can suggest would be placing one, or at most two, earthenware vessels, capable of containing three or four gallons of water each, such as are used for holding spirits, and called in Scotland greybeards, within a plant frame or pit of three or four lights or sashes, the whole frame about 14 feet in length—setting them on the surface amongst the plants, so as to present their surface clear on all sides for the radiation of heat. By a simple contrivance a small pipe could be secured to the bottom of each, and brought without the frame or pit, for the purpose of allowing the water, when reduced in temperature, to escape, while a fresh supply of hot water could be let into them by means of another small pipe bent into the bung-hole, having its other extremity without the pit, and slightly bent upwards to receive a funnel, into which heated water from the kitchen boiler could be supplied three times or so during the twenty-four hours. This, with carefully covering the glass, as recommended elsewhere for pits in this work, would preserve the majority of greenhouse plants from the most severe

frosts. A small Stephenson's boiler, set under a wooden or stone covering without the pit, and having 2-inch leaden pipes attached to it by union joints, close to the wall, would, if the pipes were carried around the inside of the walls of a pit, heat, sufficiently for conservative purposes, a range 50 feet in length and 6 feet in width. A prejudice has all along existed against employing leaden pipes for heating purposes; but experience has proved to us that, if laid on a uniform base of wood, or suspended along the face of a wall by proper hold-fasts, they last for years, give out heat as well as cast-iron ones, while their being capable of being bent at the angles, their occupying a very small space, and their capability of being readily removed, altered, or replaced, renders them exceedingly valuable for heating the pits of amateurs. During summer the boiler may be removed, cleaned, and put carefully aside till again required, while the pipes may remain stationary. When the amateurs' pits are placed near to the kitchen or to any of the offices, where a boiler is fixed, leaden pipes attached to the kitchen range boiler, or any other, by the means noted above, may be made the means of supplying heat to a considerable extent of pits, the pipe connecting the boiler and pits being imbedded in charcoal, or in a wooden bore stuffed with sawdust, by which little of the heat will be lost by abstraction during its passage.

Fig. 239 shows how such pipes are connected with a kitchen range or the



fire-grate of a sitting-room. Such a boiler, in the figure before us, may be cast in one piece,

or be constructed of plates bolted together, and so form a boiler around the back and sides of the fire. The flow-pipe is attached near its top, at the left-hand corner, is carried through the wall behind, and so on in the most direct line towards the pits; while the return-pipe, following a similar course, returns to the boiler, and

enters it near the bottom at the right-hand side. It must, however, be carefully borne in mind, that no part of the flow-pipe should dip to a lower level than that of the point from whence it started, nor the return-pipe dip deeper than the part where it enters the boiler. An air-tap, about the size of an ordinary quill, should be fixed in the flow-pipe at its highest point, for the escape of air, which, if allowed to exist in the pipes, would completely arrest the circulation of the water. The want of this precaution has been the cause of many an excellent hot-water apparatus being condemned, which otherwise would have wrought admirably. Such an arrangement as this will in no way interfere with domestic arrangements, as a stopcock can be placed on both the flow and return pipes, either close to the boiler within or close to the wall without, as may be most convenient. Such a magazine of heat as a boiler so constructed will add greatly to the heat of the room in which it is placed, and that without requiring any additional fuel. It is for many reasons desirable that the top of kitchen-range boilers should be open, at least so far so as to render their being occasionally cleaned out more convenient. In such cases the pipes in the pits must be upon an exact level with the top of the boiler; but where such boilers have fixed tops, the pipes may be at any height above them, as the heated water will ascend to them, and the water, when deprived of its heat, will return to the boiler upon the common principle of hydraulics. The boiler need not, however, be the whole depth of the fire-grate, but only reach as far as the bottom of the fire-bed, as marked by the dotted line in our figure.

A greenhouse or conservatory of considerable size, attached to the house, may be heated by the same means, and even if 20 or 30 feet distant; as may also pits at 100 feet from the boiler, provided care be taken to place the pipe which connects the boiler with the radiating pipes in the greenhouse or pits in a non-heat-conducting or heat-abstracting medium. This is by no means a new mode of heating greenhouses attached to dwelling-houses, as it was recommended twenty years ago by the late Mr Anderson, curator of the Chelsea Botanical

Gardens. We are only surprised that so simple and economical a mode should have been so long known, and seemingly so little used.

*General remarks on heating by hot water.*—After upwards of twenty-five years' experimenting upon heating with hot water, there appears to us to be only three distinct principles—namely, Atkinson's horizontal, Kewley's siphon, and Eckstein and Busby's rotary float circulator. The rest, although differing in form of boiler, and position and extent of radiating surface, present really no new feature in their principles.

Since the introduction of tank-heating, the hotwater-pipe system is undergoing a species of condemnation by some, little short of that pronounced against the old flues. Their cry is, that the heat it produces is dry and parching, whereas that secured by the other is moist, and all that we can desire. Now, it ought to be kept in mind that heat produced by combustion is exactly the same, whether produced by a smoke flue, a hot-water pipe, or a gutter or tank, excepting that in the latter case it is accompanied with a considerable degree of humidity if the gutter is open at top. Heat produced by fermenting materials, such as stable manure, is quite a different thing; and, could it be as economically applied, which it cannot, and its heat as readily commanded as that by the use of combustible materials, it should never be abandoned until we discover means of producing the same gaseous fertilising constituents which it contains. Water from tanks produces pure steam without much fertilising property; and, unless this is properly provided against, causes too humid an atmosphere. Hot-water pipes produce no steam as they are generally applied, and hence the heat from them is much the same as that from smoke flues, with this advantage, that they are not so easily overheated, give out no injurious gases, and retain their heat much longer, while they do not absorb so much of the humidity of the air as smoke flues do. But, either with smoke flues or hot-water pipes, the atmosphere of a house or pit may be kept as humid as there is any necessity for. Flanges have been cast on the top of hot-water pipes, and saddle-shaped trays have been placed

on them, for holding water for creating moisture; and, with care, these have answered the purpose: but they have invariably been attached to the upper pipes, whereas they ought to have been placed on the lower ones. The return-pipes, under ordinary circumstances, are seldom under 90° or 100°—a temperature quite sufficient, if partially covered with water, to raise a much more congenial steam than could be got from the upper ones, which are often much too hot for this purpose. Indeed, a very judicious plan is to place a wooden or brick-and-cement trough under them, and keep it supplied with water, when required, from the cistern over the boiler. Hollow tiles have been used for the tops of flues for the purpose of generating steam, to make up for the humidity abstracted from the atmosphere of the house by the absorbing properties of flues. These have the effect of scalding the tender foliage when water is put on them while much heated; and when applied at a low temperature, the water is absorbed by the material to such an extent as greatly to impede the draught by creating dampness in the flue. The nearest approximation to the natural climate in the tropics must be that produced by the fermentation of vegetable and animal substances. "In hot moist regions in the tropics," says Mr Solly, in "Rural Chemistry," "plants grow with far more rapidity, and vegetation is more vigorous than in temperate regions. In tropical countries, decay proceeds far more rapidly than it does in our own country. Carbonic acid and ammonia, the food of plants, are produced in greater quantity than here; whilst, from the greater power of the sun, plants are able to assimilate more of those substances than they can in colder countries." The great desideratum at present, now that we have a command of both heat and moisture, is to find means of supplying those indispensable gases by impregnating the atmosphere of our plant-structures with them.

Wherever artificial heat is employed, it has a tendency to dry up the humidity of the atmosphere of the space heated: no matter whether the apparatus be hot water, hot air, or brick flues—all have a similar tendency, although not in exactly the same degree. Artificial means must,

therefore, be used to counteract this tendency. The following excellent remarks upon this subject are by Mr J. Rogers, in "Horticultural Society's Transactions:"—"Closely connected with the subject of heating, is the providing an adequate degree of moisture in the atmosphere heated; indeed, it is upon this, above everything else, that the perfection or imperfection of an artificial climate depends; and it is by no means one of the least advantages of hot-water pipes, that they do not, like smoke flues, dry the atmosphere by absorbing its moisture. But this negative advantage falls far short of what is necessary. The air of all buildings artificially heated is dried by condensation upon the glass, and by the continued escape through open laps or crevices of saturated or moist air, whose place is supplied by cold and dry air. To imitate nature, it is, therefore, necessary to provide a constant supply of moisture equal to the waste by these two causes. The means adopted to supply moisture to the atmosphere is by sprinkling the floor and the plants, and by troughs upon the heating-pipes. Sprinkling the floor is a very imperfect and inefficient expedient: the greater part of the moisture so bestowed sinks into the earth, and very little, indeed, finds its way to the atmosphere of the house;—for the air in contact with the floor of a house is generally nearly saturated, having lost its capacity for moisture by losing its heat; and it is only when it has reached the pipes and been again heated that it becomes capable of taking up moisture, and in this thirsty state it generally has to seek its moisture among the plants. "The most effectual mode," Mr Rogers thinks, "of producing a moist atmosphere, is by considerable supplies of water above the level of the pipes, which supplies ought always to exceed by a few degrees the mean temperature of the house. The troughs commonly employed are objectionable only in as far as they are much too small, and, becoming quickly empty, afford a very temporary supply. To be really efficient, such troughs ought to be at least 1 foot in width by 5 or 6 inches in depth, and they should extend the whole length of the house, affording something like 1 square foot of water-surface for every 15 square feet of glass in the roof. In orchid houses,



and those destined to the cultivation of tropical plants, a still greater surface of water is desirable; and, for this purpose, slate cisterns placed immediately over the heating-pipes, as broad as the front shelves, and from 1 foot to 15 inches deep, may be advantageously employed. Their temperature will always exceed that of the house by a few degrees; and the great surface affords an abundant though gradual supply of moisture;—they act also as partial reservoirs of heat, and afford the only efficient means of cultivating the beautiful but much-neglected tribe of stove aquatics.

“In the few houses where cisterns are introduced, they are in general provided more for ornament than use: the position in which they are placed, and the materials of which they are constructed, forbid their being warmed; and, in fact, the temperature of the water contained in them is always some degrees below that of the house. It may be observed, that this arrangement meets the necessity of the case with exceeding accuracy; for condensation is greatest, and consequently the atmosphere is most rapidly dried, when the external air is coldest, and a great artificial heat is maintained;—and at this very time the increased heat of the pipes increases the evaporation from the cisterns. But to insure this result, the cisterns employed must be above the level of the heating-pipes, and, if possible, directly over them.”

There is, we think, one objection to Mr Rogers' plan of placing the troughs or cisterns over the hot-water pipes—namely, their preventing the radiation of the heat upwards. So far, therefore, as providing a humid atmosphere is concerned, we would prefer having the troughs under the return-pipes, as already stated; and as for obtaining a supply from cisterns in which tropical aquatics are cultivated, it would be better to conduct a small branch-pipe from the main ones into such cisterns;—for it is an admitted fact, that the water in such cisterns is never sufficiently heated to suit the nature of the plants cultivated in them. A still better plan would be to place an open gutter or evaporating cast-iron pan along the top of the kerbs or parapets—or, indeed, in any part of the house most convenient; and into it

lead a small pipe of hot water, either from the main pipes or direct from the boiler. This pipe should be furnished with a cock, to let in the hot water when evaporation is required; a return-pipe of the same dimension, attached to the same end of the gutter at which the supply is admitted, will draw it off and return it to the source from whence it came.

The following very judicious remarks on heating by hot water form part of an excellent paper read before the “Horticultural Society of London,” by John Rogers, Esq. After alluding to the various methods adopted, acknowledging the great advantages of hot water over all other modes of heating, and stating the saving in fuel to be equal to twenty-five per cent, in well-arranged apparatuses over well-arranged and well-managed flues—observing, however, at the same time, that many of the modes even at present in use are so defective as to be actually consuming a greater amount of fuel than ordinary furnaces—he proceeds to say: “This remark applies not merely to the earlier apparatus, where the power was inadequate to the work required, but even to the best-constructed modern ones; and the waste of fuel arises from a misunderstanding of the nature of a hot-water apparatus, and from an attempt to make it do that which, if it be properly constructed, it is impossible that it should do.

“It is a great desideratum with gardeners, as far at least as my experience goes, to get up heat in a short time; and their ordinary test of the excellence of a hot-water apparatus is, how speedily they can get the water to boil. Where an apparatus is properly constructed, this can seldom be effected without a most extravagant waste of fuel. The water in a hot-water apparatus, constructed on the most perfect principles, will take as many hours to heat to the boiling point as the pipes which contain it are inches in diameter,—and it will also cool in the same ratio. Four-inch pipes will accordingly take four hours to reach the temperature of 200°; and they can be heated to the boiling point in one hour, only by the consumption of four times as much fuel as would suffice if properly applied;—or, in fact, allowing for the waste of heat by the chimney, which increases under

such circumstances very rapidly, five or six times as much fuel as is really necessary will be consumed by a gardener zealous of the honour of his apparatus. It is of course possible, by having a furnace and boiler excessively large in proportion to the pipes, to construct an apparatus with 4-inch pipes which shall boil in an hour; but the necessary consequences will be, that such a furnace would burn, during every hour of the night, four times as much fuel as can possibly be effective in heating the building to which it is applied.

"If a house is to be heated rapidly, the pipes should be of the smallest diameter which is consistent with a free circulation; but it must be borne in mind that such pipes will also cool with equal rapidity;—and if the heat is to be maintained through the night, the furnace must be so constructed as to contain a large quantity of fuel, but only to allow of a very slow consumption. Now such a furnace, though theoretically very easy, and practically not very difficult of construction, requires an almost scientific nicety of management not to be expected from common gardeners. There are, moreover, several objections to small pipes, one of the most material of which is this—that, the motion of water within them being retarded by friction, in a much larger degree than in large pipes, they can never be brought to so high a mean temperature. So that under similar circumstances of pressure, &c., 200 feet of 1-inch pipe could never be made to produce the same effect as 50 feet of 4-inch pipe, though their surfaces would be nearly equal.

"A little consideration will enable us to determine, whether such rapid communication of heat be really essential to the efficiency of a heating-apparatus. In hothouses, where permanent heat is required, it is evidently unnecessary. The only place where it may be desired is in buildings where occasional heat only is required. The real desideratum is, a furnace so constructed that it shall contain fuel enough to supply the pipes with as much heat as they can radiate during the night, and which may be depended upon for burning steadily and perfectly whatever fuel is put into it—not with that accurate precision requisite where

the temperature of the house depends upon the exact amount of combustion per hour, but sufficiently slow to allow the water to absorb the greatest possible portion of the heat generated. With such an apparatus, the fire being once effectually lighted, the gardener need be under no apprehension that the heat during the night will prove insufficient, though it may be several hours before the pipes attain their maximum temperature.

"I have dwelt somewhat at large on this point, because it is one on which much mistake exists, and under this misapprehension the best apparatus may be condemned as defective, and a very imperfect one preferred and adopted in its stead;—that which is commonly adopted as a criterion of excellence being really a proof of defective construction.

"There can be, on the whole, no doubt that 3-inch or 4-inch pipes are exceedingly preferable to smaller ones, where economy of fuel and uniform adjustment of the temperature for several hours are the primary objects. Where ornament or great economy of space is important, and economy of fuel is not much considered, smaller pipes may be employed; but where rigid heating is considered essential, I believe it will be found best to have recourse to the old expedient of brick flues;—and their attendant inconveniences must be considered as the price paid for this advantage, real or imaginary.

"The next point to be noticed is the absolute amount of heat produced by any hot-water apparatus, which depends on the proportion between the surface of pipe and the surface of external glass in the building. The laws both of cooling by the glass and of radiation from the pipes have been so ably and so accurately treated by Mr Hood," in his excellent treatise so often quoted in this work, "that there is nothing to desire on this head. Almost all the earlier apparatuses are incompetent to the work required of them, the quantity of pipe being utterly insufficient to produce the heat required; while, the boiler being large, and of very defective construction, a vast quantity of fuel was burned to waste. The gardener, finding his heat deficient, naturally stokes up the fire and throws on fuel, in the hope of

increasing it; but the only result of his labour is the more rapid destruction of the boiler itself. Until the publication of Hood's work above mentioned, the principle of circulation in hot-water apparatus was very little understood; most erroneous notions prevailed on the subject; and where the principles were unknown, and opportunities of experiment comparatively few, it was not to be wondered that practice was very defective. It must, however, be observed, that if the earlier apparatus were mostly deficient in the quantity of pipe employed, many of those more recently erected err in the opposite extreme. The error arises not from any defect in the data or in the calculations, but from assuming, as the minimum of external air, a temperature which very rarely occurs in this country, and which lasts for so very short a time that no building has time to cool down to a corresponding temperature.

"The next point which requires notice is the expediency of heating several houses from the same boiler. Now, to this arrangement there is not the slightest objection, provided the same number or extent of houses is always to be heated at the same time—that is to say, several hothouses, all of which require permanent heat, but different temperatures, may be advantageously heated from one boiler. In like manner a range of greenhouses always requiring heat at the same time, to exclude frost, may be worked from one boiler, though different degrees of heat are required in them; and even if one of these sometimes requires, as it probably would, a slight degree of heat when the others require none, this may be arranged without difficulty or inconvenience. But serious inconveniences will arise from any attempt to heat two buildings, in one of which occasional, and in the other permanent, heat is required; and this inconvenience will be great in proportion to the size of the buildings, especially if, as is generally the case, the hothouse is small, and the greenhouse or pits more extensive. The same inconvenience will also be felt if two vinerias, one to be forced at a later period than the other, are to be heated from one boiler. The reason is briefly this, that the capacity of the furnace for fuel, the area of its bars or its consuming power, and the boiler-

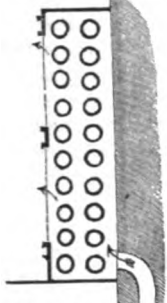
surface or absorbing power, are all calculated with reference to a certain quantity of pipe; by urging the fire to the utmost power which is consistent with a proper duration of its heat, the pipes to which it is ordinarily attached are heated to their maximum, and the maximum heat is produced as required in the building. If, at this time, an additional extent of duty is laid on the boiler, by opening the sluices which connect it with the pipes of a greenhouse or pits, the temperature of the ordinary service-pipes is reduced, and the hothouse receives a diminished quantity of heat just when it requires most. On the other hand, if the common boiler be constructed of a size and power adequate to the double service, it will, when applied to the hothouse only, constantly overheat it; and this effect can be prevented only by throwing open the furnace door, and allowing the fuel to burn to waste;—for, be it observed, it is the area of the furnace bars which regulates the consumption of fuel. It is true that, by means of dampers and skilful management, some remedy may be found for these evils; but, nevertheless, they will exist to a greater or less extent, and the arrangement above mentioned should never be willingly adopted.

"The different temperature of stoves to be heated from the same boiler may be regulated with the most philosophic accuracy, by allotting to each house quantities of pipe bearing a different proportion to their respective surfaces of glass. The difference thus established will be maintained for all temperatures, unless accidental circumstances of exposure to wind or imperfect glazing should cause a variation, and the general heat of all may be regulated by attention to one fire."

Hitherto, for the most part, hothouses have been heated by pipes laid in a horizontal direction, and generally running parallel to the ends and front of the house; and in nine cases out of ten the extent of piping has been far too limited to effect the purpose required, or to take the heat from the boiler so fast as it is generated: hence an enormous waste of fuel is constantly going on. Where it is inconvenient to add to the number of pipes, radiators may be attached to them, or coils of smaller pipes may be placed in convenient parts of the house, either in

the corners, or by the sides of the walls, or, indeed, in any part where they would not interfere with the general arrangement. One of the simplest of these forms is a stack of 2-inch pipes, arranged

Fig. 240.



one above another in a double row, with a case of open work in front, as shown in fig. 240, as suggested by Walker, but which indeed is only a revival of the Marquis de Chabanne's principle. A case of this kind, 6 feet long, 1 foot wide, and  $3\frac{1}{4}$  feet high, would contain 60 feet

of heating surface, or nearly the half of that usually employed to heat a whole vinery. These, however, should be distributed equally over the house to equalise the temperature, and be supplied with cold air entering near their bottom—as shown in our cut—to equalise its distribution. There are cases, also, where such stacks of pipes might be set in niches in the walls, and thereby economise space: the number of pipes, of course, to be regulated by the temperature required, and their supply of heat conveyed from the boiler by a pipe of larger calibre. "For this purpose," says Walker in "Hints on Ventilation," "more compact forms than pipes are desirable, in order to reduce the space occupied. The simplest of these forms consists of flat hollow plates of iron, set up on edge parallel to each other, having a thin space within them, of 1 inch wide, for the reception of the vehicle of heat, and fixed at intervals of  $1\frac{1}{2}$  inches apart. The number must be determined by the extent of heating surface required; and any number of them may be connected together by a horizontal pipe running along the top, conveying the hot water to each plate, and another along the bottom, connected by a branch from each for returning the water which has parted with its heat again to the boiler. The quantity of heating surface obtainable in this form in a given space, compared with pipes, is nearly as 3 to 2, or half as much again. This form of heating surfaces has long been used for manufacturing purposes;" but, so far as

we know, it has not been applied in hot-house-heating. "Such radiators might be advantageously employed in affording bottom heat to pine-

Fig. 241.

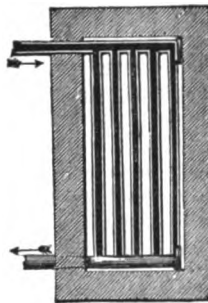


Fig. 242.

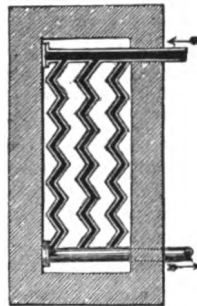


Fig. 243.

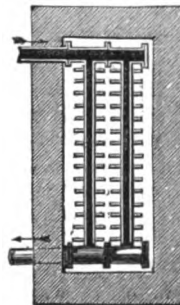
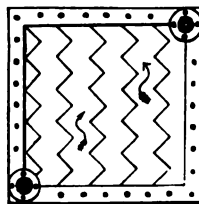


Fig. 244.



more immediately into contact with the hot surfaces, by passing it up through

beds, &c., and forms, as in figs. 241, 242, and 243, laid flat, increasing or diminishing the number of plates, according to the heat required. Fig. 241 is the simplest of these modes, which is here shown in plan; fig. 242 is a modification of this form of heating surface, having a corrugated or zig-zag outline; but as the corrugations cause each plate to occupy a greater width, there is no space saved nor advantage gained by this alteration in the form of surface. A better arrangement than the last has been used, similar to that shown at fig. 241, but having thin parallel projections cast on the outsides of the plates, which increases the heating surface obtainable in a given space in the proportion of 4 to 2, or twice as much as compared with pipes. This is shown in plan, fig. 243. Mr Haden has patented a sharply corrugated form which he gives to these projections—see side view, fig. 244. This is intended to bring the air

winding channels; and also, by the obstructions and hindrances caused by the angles projecting over the passages, to cause fresh particles of air continually to impinge on the surface. There does not, however, appear to be much gained practically by compelling the air to pursue this tortuous course. What is gained in *temperature* will be lost in *time*. It has been objected to these modes of increasing heating surfaces by projections, that there will be diminution of efficiency from the ends of the projections not being in such close contact with the steam, water, or other vehicle of heat that may be employed, as the sides of the plates. But within proper and moderate limits as to the length of the projections, this objection has not been found to hold good in practice, which will be more obvious when we consider that iron is one of the best conductors of heat, while air is a very slow absorbent; and consequently, that for some limited distance heat will travel through the metal more rapidly than the air can take it up, unless blown through the hot chamber with great rapidity."—WALKER'S *Hints on Ventilation*.

"Whatever be the arrangements adopted for heating by hot water, two considerations must be specially attended to, namely, sufficient strength to bear the hydrostatic pressure, and freedom of motion for currents of water of varying temperatures, and consequently of varying densities. As fluids transmit their pressure equally in every direction, a column of water rising from a strong vessel to a certain height may be made to burst the vessel with enormous force. Thus a tube, whose sectional area is 1 inch, rising to the height of  $34\frac{1}{2}$  feet from the bottom of a vessel of water, will, if the tube be also full of water, exert a bursting pressure on every square inch of the inner surface of such vessel of one atmosphere, or 15 lb. If the sectional area of the tube be increased, the pressure remains the same. If a boiler be 3 feet long, 2 feet wide, and 2 feet deep, with a pipe 28 feet high from the top of the boiler, when the apparatus is filled with water there will be a pressure on the boiler of 66,816 lb., or very nearly 30 tons. This will show the necessity for great strength in the boiler, especially when it is considered

that the effect of heat upon it is to diminish the cohesive force of its particles. But even supposing the apparatus were to burst, no danger would arise, because water, unlike steam, has but a very limited range of elasticity. The boiler just described would contain about 75 gallons of water, which, under a pressure of one atmosphere on the square inch, would be compressed about 1 cubic inch; and if the apparatus were to burst, the expansion would only be 1 cubic inch, and the only effect of bursting would be a cracking in some part of the boiler, occasioning a leakage of the water."

Heating by hot-water pipes and tanks or gutters, in all their modifications, is a most decided improvement on the old, unsteady, and expensive mode of heating by means of fermenting materials. There is, however, one advantage peculiar to the old mode of heating, namely, the supply of ammonia and other gases to the plants from the stable dung during the process of fermentation. This is also to be attained, as recent experiments have proved, by the introduction of liquid manures of the most powerful kinds, in various ways, in structures heated by the new method. Mr Fleming of Trentham, by mixing pigeon's dung with the water in the tanks, in the proportion of 1 ounce of dung to 1 gallon of water, has obtained a supply of this invigorating gas, which seems to be so essential to vegetable life, and probably others also. It is, and has long been known to the best cultivators, that plants of all kinds thrive better in pits heated by fermenting manure than anywhere else. Now, this increase of vigour is well known not to arise from any difference in the humidity of temperature that may exist between the two methods of heating, but from a deficiency of ammoniacal gas in the one case, and an abundance of it in the other. We apprehend that by mixing the manure with the water, as in the case alluded to, in the tanks or pipes, the insoluble parts will find their way into the boiler, and hence cause the formation of incrustations in them, which tend so much to their decay. We adopt a different course to attain the same end, namely, by watering the beds and floors over the tanks with urine, or rich liquid manure, and also by placing shallow vessels, kept filled with the

same, in various parts of the houses. In some cases we have used an evaporating-pan placed under the return-pipe, so that it may be half covered with liquid, enriched with both pigeon's dung and guano.—*Vide* section 4, "Heating by Tanks and Gutters." From this will be seen the advantages of combining the tank or gutter principle with that of hot-water pipes as hitherto applied.

Heating by hot water, for horticultural purposes, has many advantages over steam, because by it a sufficient and more uniform temperature can be maintained at less expense, and with no danger. It is seldom the case, nor is it at all necessary, that hot-water pipes should reach  $212^{\circ}$ ; for if they did so, steam would be generated, and would escape at the top of an open boiler, or at the vent air-hole or expansion-tube in one that is closed. To obtain steam in the first instance, the water in the boiler must reach  $212^{\circ}$  at the least; and to keep it at or above that point, must of necessity require a greater consumption of fuel. On this subject, Hood's remarks are excellent. "The weight of steam at the temperature of  $212^{\circ}$ , compared with the weight of water at  $212^{\circ}$ , is about as 1 to 1694; so that a pipe which is filled with water at  $212^{\circ}$ , contains 1694 times as much *matter* as one of equal size filled with steam. If the source of heat be withdrawn from the steam-pipes, the temperature will soon fall below  $212^{\circ}$  and the steam immediately in contact with the pipes will condense; but, in condensing, the steam parts with its *latent heat*,—and this heat, in passing from the latent to the sensible state, will again raise the temperature of the pipes. But as soon as they are a second time cooled down below  $212^{\circ}$ , a farther portion of steam will condense, and a farther quantity of latent heat will pass into the state of heat of temperature,"—that is, a state of heat measurable by a thermometer, whereas latent heat is incapable of being measured by any instrument whatever,— "and so on, until the whole quantity of latent heat has been abstracted, and the whole of the steam condensed, in which state it will possess just as much heating power as a similar bulk of water at the like temperature—that is, the same as a quantity of water occupying 1-1694th

part of the space which the steam originally did."

By experiments made by the above authority, it has been proved that a given bulk of steam will lose as much of its heat in one minute, as the same bulk of water would in three hours and three quarters. And farther, admitting that the heat of cast-iron is nearly the same as that of water, if two pipes of the same calibre and thickness be filled, the one with water and the other with steam, each at  $212^{\circ}$  of temperature, the former will contain 4.68 times as much heat as the latter; therefore, if the steam-pipe cools down to  $60^{\circ}$  in one hour, the water-pipe will take four hours and a half to cool down to the same point. In a hot-water apparatus, we have, in addition to the above, the heat from the water in the boiler, and of the heated material in and about the furnace, which continues to give out heat for a long time after the fire is totally extinguished; whereas in a steam apparatus, under the same circumstances, we have no source of heat excepting the pipes by which it is conveyed—giving an advantage in favour of hot water over steam as regards its power of heating hothouses, and maintaining heat, after the fire ceases to burn, in nearly the proportion of 1 to 7—that is, hot water will circulate from six to eight times longer than steam under the above circumstances.

Heat is given off from bodies by two distinct processes—RADIATION and CONDUCTION. "In the radiation, the rays of heat diverge in straight lines from every part of a heated surface, and also from extremely minute depths below such surface. These rays, like rays of light, are subject to the laws of refraction and reflection, and their intensity decreases as the square of the distance. When we approach an open fire, or the surface of a stove, we feel its heat by radiation; and it has been ascertained that, at the ordinary temperature of hot-water pipes, about one-fourth of the total cooling effect is due to radiation. But the amount of radiation of a body heated above the temperature of the surrounding atmosphere, depends greatly upon the nature of its surface. If a vessel of hot water, coated with lamp-black, radiate 100 parts of heat within a given time, a similar

vessel, containing water of the same temperature, coated with writing paper, will radiate 98 parts of heat; rosin, 96; China ink, 88; red lead or isinglass, 80; plumbago, 75; tarnished lead, 45; tin scratched with sand paper, 22; mercury, 20; clean lead, 19; polished iron, 15; tin-plate, 12. In order to ascertain the velocity of cooling for a surface of cast-iron, Hood selected a pipe 30 inches long,  $2\frac{1}{4}$  inches diameter internally, and 3 inches diameter externally. The rates of cooling were tried with different states of the surface: first, when covered with the usual brown surface of protoxide of iron; next it was varnished black; and finally the varnish was scraped off, and the pipe painted white with two coats of lead paint. The ratios of cooling  $1^\circ$  were found to be, for the black varnished surface 1.21 minutes; for the iron surface, 1.25 minutes; and for the white painted surface, 1.28 minutes. These ratios are in the proportion of 100, 103.3, and 105.7; but as the relative heating effect is the inverse of the time of cooling, we shall find that 100 feet of varnished pipe,  $103\frac{3}{4}$  feet of plain iron pipe, or  $105\frac{3}{4}$  feet of iron pipe painted white, will each produce an equal effect. Leslie found that tarnished surfaces, or such as are roughened by emery, by the file, or by drawing strokes or lines with a graving tool, had their radiating power considerably increased. But according to Melloni, the roughness of the surface merely acts by altering the superficial density, which varies according as the body is of a greater or less density, previous to the alteration of its surface by roughening."—TOMLINSON *on Warming, &c.*

With the view of abstracting the superfluous heat which is found to surround all furnaces and boilers, and which, in general, is allowed to diffuse itself through the building which encloses the boiler, or go to waste in the stoke-hole, and to carry it into the interior of the house to be heated, the following system is practised by Mr Henderson of Oxton Hill nursery, Birkenhead, in some houses recently erected under his superintendance:—"The boiler we now use is so constructed and fixed as to become a generator of heat, both by water and air; the fuel, first acting on the bottom of the boiler, passes into the flue surrounding

it; the division between the flue and air cavity is built with fire-brick pargeted, and, to prevent the possibility of any escape of smoke or gas, is enclosed in a case of sheet-iron; the flow of air to the cavity is supplied through a cold air-drain, and, after traversing the cavity and becoming heated, it passes into a chamber formed over the boiler—thus taking up in its passage any heat given out at the top of the boiler before entering the house by the hot-air drain. By the grating we have not only the power of returning the cold air from the house, but also of throwing in a stream of fresh air from outside the house, thus enabling us to keep up a supply of uncontaminated air to the plants, yet with 'the chill off.' We have also the means of circulating the air in the hot chamber, there being a communication with the drain and an outlet by tubes through the plunging-bed. By this means the atmosphere of the house may be kept to any degree of moisture, by evaporation from the troughs which heat the plunging or planting-out materials in the bed."

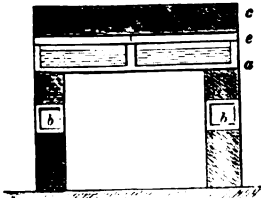
#### § 4.—THE TANK MODE OF HEATING.

This method of obtaining bottom heat has of late become very popular, affording uniformity of temperature accompanied with any degree of humidity the operator desires, without the manual labour attendant on former systems. To those conversant with the history of horticultural improvements, it was by no means unknown, long before Mr Rendle either published his treatise on it or applied it in practice. In stating this, we do it merely as a horticultural statistical fact, of which we believe that gentleman was not aware at the time he published his first account of the system. Circumstances of this kind are not at all uncommon in regard to inventions; for we have known, more than once, two individuals, at the very same period, totally unknown to each other, and, in one case, living in different countries, bringing out identical inventions at the same time.

The late Mr Smith of Hopetoun House, so long ago as 1832, heated his pine-pits by open tanks or gutters, the water being made to circulate under the beds.

To Mr Rendle, the very respectable nurseryman at Plymouth, we are, however, mainly indebted for bringing this excellent mode of obtaining bottom heat into general notice. Mr R. recommends wooden tanks made of the best Memel pine, and covered at top with slates closely jointed with cement or Aberthaw lime, to prevent a superfluity of steam from escaping into the house. The tanks are to be supplied with water from a cistern placed without the house. "In some cases," he says, "I would recommend that piers be constructed on which the tank could be made to rest. There would then, underneath the tank, be formed an open chamber, which would be of great utility, and well adapted for

Fig. 245.



forcing sea-kale or rhu-barb." The annexed cut, fig. 245, will show a section of the tank—*a* the tank; *b* the flue; *c* the board for enclosing the plunging material; *e* the slates for covering the tank.

The flue, as here shown, meets the objections to a certain extent thrown out against this mode of heating, as being of itself insufficient to heat the atmosphere of the house, as well as the bed in which the plants are set, because it will give out a considerable amount of heat by radiation from the sides; and, indeed, although the heat from the top does not directly enter the house from the cover, yet the tanks give off heat by conduction to the brickwork above, and ultimately this heat is diffused through the house. But, if the tanks are supported on piers, as stated in the treatise, and shown in the figure, we cannot see how the flues can be carried around the house—for how are they to pass the spaces between the piers? If the tank is supported on two walls extending to their whole length and breadth, then this difficulty disappears. Were the sides and ends of the tank, as here shown, constructed of slate, pavement, brick, or cast-iron, then a considerable amount of heat would pass through them, perhaps enough to maintain the required tem-

VOL. I.

perature of a small house. This, however, cannot be expected from tanks whose sides and ends are of wood. Mr Rendle seems aware of this deficiency of heat, and very properly says, "In cases where the heat from the flue is not sufficient to warm the atmosphere of the house, it is better, although not absolutely indispensable, to have carried round the tank, close by its sides, a 2-inch cast-iron pipe, which could be joined to the tank," &c.

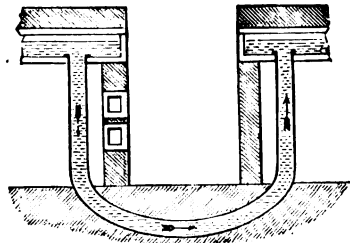
Mr Rendle very properly objects to wrought-iron tanks, on account of their liability to corrode; but is favourable to the use of cast-iron ones—stating, however, which is true, their greater expense than those of wood. Wooden tanks coated with lead, say 5 lb. to the foot, he remarks, will answer every purpose, and would last for years. This, however, we may observe, depends greatly on the water to be used in them.

Similar tanks coated with zinc or copper he would not recommend; and very properly, for the first is of too temporary a nature, and the last far too expensive.

Brick and cement tanks, he is of opinion, might be used advantageously; and tanks of slate of good quality he "would always give a preference to;" and recommends, in their construction, "that the joints be true and evenly filled, and cemented together with red lead, as well as strengthened with cramps when requisite."

Fig. 246, from Mr Rendle's treatise, shows a connection between two tanks

Fig. 246.



where a passage intervenes. By placing a stopcock on the siphon, the circulation may be carried on in one or both, at the will of the owner.

Mr Rendle deserves well of his country for the reform he has so eminently been the means of bringing about; and although it does not clearly appear that he

2 B



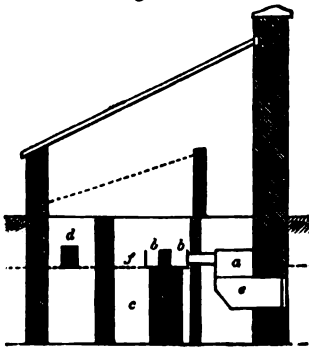
was the first inventor of this mode of heating, he certainly has the merit of being the first who brought it into general notice. The tank method is much more economical, and more steady in its operation, than heating by hot-water pipes, where bottom heat only is required; but even its most strenuous advocates must admit, that, for atmospheric heat, flues or hot-water pipes must be employed in some shape or other.

Mr Cameron, in 1830, heated melon-pits at Beaconsfield by placing wooden tanks lined with lead under the mould, into which he introduced a 2-inch leaden pipe, connected with the pipes and boiler that were used to heat the atmosphere of the pit.

Shortly afterwards Mr Weeks of Chelsea applied the same principle, by using brick troughs or tanks, through which he circulated hot water in iron instead of leaden pipes. In both cases the tanks were covered with spars of wood laid across them, and about 2 inches apart; and over this a covering of thick turf, upon which the mould was laid. A more unfit covering could scarcely have been devised. Mr Weeks heated a plant-house for Mr Knight of the Exotic Nursery by a hot-water boiler of great length, with which was connected a cast-iron tank 4 feet broad, and extending the whole length of the house, and divided in the middle, causing a flow and return. This tank was formed of plates of iron bolted together, leaving an aperture for the water of about 1 inch in depth.

Mr Davidson of Stackpole Court heated by tanks, as did also Messrs Beaton, Corbett, and others, long prior to the Plymouth system being made public. The Hon. Robert Clive, about the year 1830,

Fig. 247.



heated a house upon almost the same principle as that of Mr Rendle, as will be readily seen by a glance at the opposite diagram. Fig. 247 is part of the sec-

tion of the house—*a* the boiler, *bb* the tanks, *c* the passage under the bed, *d* the flue, *e* the furnace. From the above it will be seen how little this arrangement differs from Mr Rendle's. In principle it differs nothing; and it would be almost all that is required were the internal passage *d* dispensed with, saving all the expense of building under the dotted line *f*. If a supply of cold air were brought into this passage to become heated, and then admitted into the house, all of which could be easily accomplished, we would have in this invention of 1830 the constituent principles of the inventions of 1842, 1845, and 1847.

Tank-heating was also exemplified years ago by Count Zubow in St Petersburg, who introduced pipes charged with steam into a large cistern of water, (vide *Trans. Hort. Soc.*, 1820, p. 430;) and also in the Bristol nurseries, upon the same principle, shortly after the above date. The Messrs Bailey of Holborn employed triangular troughs, fig. 248, in lengths

Fig. 248.



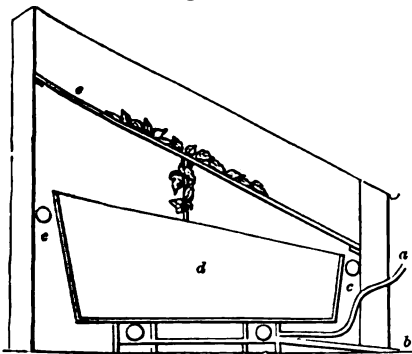
of about 12 feet, and 2 or 3 feet wide. These they attached to the hot-water pipes, with the view of affording due humidity by evaporation.

Prior to 1842, Mr Green of Cheam had pits in use, heated upon the tank principle, for the culture of cucumbers during winter. Their dimensions are as follows:—The back walls are 5 feet high, the front ones 2½; they are 5 feet wide, inside measure; and all of 9-inch brickwork. A trough or tank is carried along the centre of the bottom in the following manner, and extends the whole length: a floor of two courses of brick is laid in cement, and 2 feet wide; the sides are formed of bricks set on edge, and properly cemented to hold water. Heat is communicated by means of 2½-inch pipes, brought from a boiler employed to heat a neighbouring house, and made to pass along the back and front of the pit; and the return-pipes are brought into the trough described above, which is kept either full or partly full of water, as required. The water is supplied by a small

pipe, and another takes it off when it is necessary either to change the water or to withdraw it entirely. The plants are grown in large pots, kept about 4 inches above the water in the trough; the branches being trained to a trellis, and the fruit allowed to hang suspended.

Mr Green also plants in a bed formed in the following manner: over the tank are laid strong stakes to support rough boarding; but this is so arranged that a space is left open, both at front and back of the bed, for the purpose of allowing the vapour to ascend. It will be seen by this description that atmospheric heat is obtained from the small hot-water pipes, and the bottom heat from the tank below. This is one of the earliest examples of the tank mode of heating, and would be very complete if, instead of boarding, slates or thin pavement were used, with apertures in them for the ascent of vapour. Wood is not only a bad conductor of heat, but liable to decay, and this might happen at a time when the plants were in full bearing. In the annexed diagram, fig. 249, the pipe for supplying the

Fig. 249.

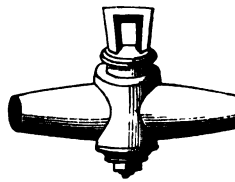


tanks is shown at *a*, and the other for withdrawing the water from them at *b*; *c c* are hot-water pipes for heating the atmosphere; *d* the bed in which the plants are set; *e* the trellis to which they are trained.

Excellent as the tank system of heating is, it is rather too much to expect that it is sufficient to heat the atmosphere of even a moderate-sized pit, far less that of a large pine-stove; although it may afford quite sufficient heat for the roots of the plants. The provisions made

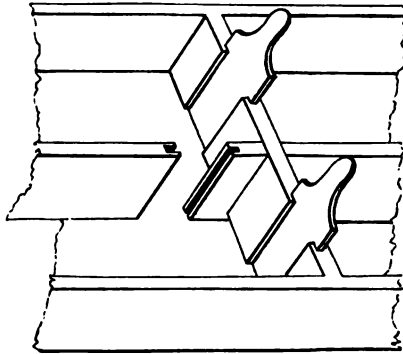
both by Mr Rendle, and also by ourselves, for admitting a portion of heat from the tanks into the atmosphere of the house, are only well so far. It will be found necessary in all cases, particularly upon a large scale, to have means for heating the atmosphere irrespective of the tank; and this can readily be effected in various ways, such as by pipes connected directly with the boiler, and used for heating the at-

Fig. 250.



mosphere, while the tank heat should be employed for the bottom heat only. This can be regulated by properly constructed stop-cocks in the pipes, fig. 250, and also by sluices, fig. 251, placed in the tanks.

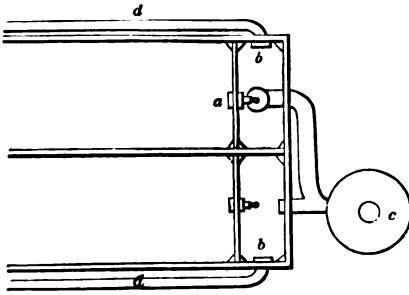
Fig. 251.



The mode of heating we have adopted at Dalkeith, wherever the tank is employed, is to have a secondary supply from pipes or flues, as may be most convenient. The tanks, of themselves, were they even powerful enough to give atmospheric as well as bottom heat, would, unless exceedingly well jointed and kept in repair, give out too much humidity for plants in general to thrive in, unless it be tropical plants and orchids. It may often happen with regard to a house heated by a tank, that at some particular season a dry atmosphere may be required, such, for example, as the prolongation of a late crop of grapes. This could never be obtained from the tank alone; but with pipes attached to the boiler, irrespective of the tank, such could be got with the greatest ease—namely, by shutting off the

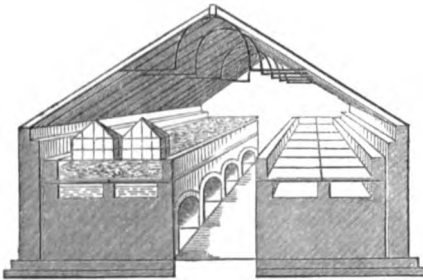
circulation from the tank, after withdrawing the water in it, and using the hot-water pipes alone. Mr Rendle's provisions to remedy this defect are thus described by him in "The Gardeners' Chronicle," and the annexed woodcuts also given, which exhibit part of the ground-plan, fig. 252, and perspective

Fig. 252.



view, fig. 253, of a propagating-house in his highly respectable establishment.

Fig. 253.



"The water enters the tank at *a*, and, by means of plugs or valves at the apertures *b*, can be made to circulate round the tanks and pipes, or be made to pass through the tanks or pipes separately:" *c* is the boiler; *d d* the hot-water pipes, irrespective of the tank.

This is a very efficiently heated house, and reflects great credit on Mr Rendle.

Objections have been made, and questions put, as to whether the pipes used in conjunction with the above plan should not be kept exactly level with the tanks. To this we answer, that the pipes may be under or upon a level with the tank, in ordinary cases; or they may be elevated considerably above it, by adopting the siphon system. It is well, in our opinion,

in all cases connected with hot-water heating, where it can be done, to adopt the level or horizontal mode of circulation. It is the simplest, as well as equally efficient with any other, therefore the best; and it should never be departed from, unless where obstacles occur that may render a deviation from it expedient. To circulate water in pipes upon a higher level than that of the tank, the flow-pipe should be placed at least 2 inches higher in the water than the return-pipe; and at the highest point to which the flow-pipe is carried, let there be an air-cock or means for attaching an air-pump, to draw off the air that may accumulate in the pipes. Tanks to which a siphon-pipe is to be attached should have a depth of at least 6 inches of water, the more completely to prevent the entrance of air into the pipes. Or a hollow basin may be formed in the tank a foot or more in depth, into which the ends of the siphon-pipes may dip; and as that never can be without water while any remains in the tank, the exclusion of air from the pipes may be safely calculated upon.

Opinions are at variance in regard to the proper depth of water in the tanks. The shallower they are, we believe it is admitted on all hands, the sooner they will be heated; and the deeper they are, the longer time will be required. It has also been disputed, whether the larger or smaller quantity of water employed requires most fuel. Mr Sherwood, an intelligent correspondent in "The Gardeners' Chronicle," after expressing his doubts that the saving of fire is attributable to the use of a large body of water, observes on this subject, "Whether the quantity of water be large or small, it merely transmits the heat given off in the combustion of the fuel to the air of the house. As the air is constantly being cooled, a continual demand of heat is made on the radiating surface, to maintain the desired degree of temperature. Now, through whatever medium this heat may be imparted to the house, the quantity of fuel necessary to produce it will always be pretty much the same. If a large body of water yields twice as much heat as a smaller quantity, it is because it has first received twice as much as the other. My opinion," he continues "is, that the most economical qualities of a heating apparatus

consist in its having as much surface of boiler presented to the fire as possible, and the most effectual prevention of loss of heat through flues, &c. ; and having an equal distribution of heat throughout the house, by means of a quick circulation of water, whether through pipes, gutters, or tanks. These advantages once secured, the question as to quantity of water is to be regarded as one of convenience, rather than one of expense."

There is as much heat given out from 2 or 3 inches in depth of water as from 2 or 3 feet, provided the fire be kept constantly burning. The shallower the water, the sooner will the house be heated ; and the deeper it is, the longer will the heat continue to be given out. Mr Rendle appears to advocate a depth of from 8 to 12 inches, and reasonably enough observes, that if this body of water be once heated, it will maintain the temperature of the house or pit long after the fire may be extinguished ; or when once this, or even a greater body of water is heated, the fires may be allowed to go out altogether for a time. Thus, for example, to do away with attendance during the night, the water could be heated during the day. It does not appear to us quite clear how firing during a part of this time only tends to the economy of fuel—a subject one should never lose sight of.

To generate a large body of heat in a chamber or compartment from which it could escape only at the will of the operator, is a desideratum in horticulture. This we have long thought of ; indeed the idea arose from a perusal of Dr Anderson's work, many years ago, in which he proposes to collect and store up solar heat during warm days, in a chamber attached to the house to be heated. Over air we seem to have little control, either as a conductor of heat or as a medium to hold it in suspension. Water is quite a different thing, for it is heated readily ; and when once charged with caloric, it retains it for a time, and gives it out gradually. This object, we think, can be effected by rendering, as we intend to do at Dalkeith, the whole pit of a pine stove, originally intended for tan or leaves, a waterproof cistern, filling it with water, and heating the whole mass by connecting it by flow and return pipes with the boiler. The fire may then be greatly re-

duced, or indeed for many hours, nay, days, entirely extinguished—more especially during summer, when bottom heat is required artificially at a time we have sufficient atmospheric heat naturally. It is, under all circumstances, important to have the tanks covered, so as to exclude earthy or other matter from getting into them, which would find its way into the boilers, and soon destroy their bottoms. This covering should, however, only be of slates or thin pavement, both of which are cheap and durable, and readily allow the heat to pass through them. The joints should also be made quite tight with cement. Iron covers, as well as iron tanks, are objectionable, on account of their tendency to corrode, and for other reasons elsewhere stated. There is no doubt but that iron radiates heat better than wood, earthenware, or stone ; but whether what is gained in this respect is not more than lost in others, is questionable.

Wooden tanks may be used with every propriety where the heat is required to rise perpendicular from them ; and if made of good Baltic timber, they will last for years, as may be seen exemplified in any brewhouse, where coolers have lasted for half a century. They ought to be of inch-and-half deal, grooved and tongued, and the joints put together with white lead. It would be an advantage, also, to tie the sides together, by running a small iron rod every 6 or 8 feet, headed at the one end, and having a nut and screw at the other, to be placed within 2 inches of the top of the tank. It is a great mistake to cover either wooden or other tanks with wood, as its well known non-conducting powers prevent the heat from rising. For this reason, close wooden troughs are the most proper vessels for conveying hot water through places *not requiring to be heated*, such as connecting the tanks in one range of pits, &c., with those in another running parallel, or in conveying the water from the neighbourhood of the boiler to a house or pit at some distance from it. Metallic pipes may be also used for this purpose ; but they should be invariably enclosed in a wooden case, or packed round with sawdust, charcoal, or other non-conducting medium, to prevent the escape of heat.

Brick tanks, properly cemented, are

cheaper than metallic ones of the same capacity. They are also exceedingly durable, and give out heat best of all, next to iron ones. Very elegant and durable tanks may be formed of large Welsh slates or Caithness pavement, which may be procured of almost any size and thickness; and we have no doubt but that glass tanks will be ere long as common as any at present in use.

Where narrow tanks, or what may be called the gutter mode of circulation, is adopted, well-prepared fire-clay tubes, perforated on their tops, may be advantageously employed. In the construction of brick tanks, we believe that too thick a coat of cement has been in general used. We have in practice found it better to make the cement into the consistency of thick paint, and to lay it on with a common whitewash brush, one coat after another, until all the pores of the bricks and the joints between them become completely saturated and closed. This is an operation that can be done by any handy labourer, and which might be repeated at times when the tanks are unemployed. The tanks thus finished may be, with advantage, painted over with two or three coats of oil. A great mistake was fallen into soon after the introduction of the tank system of heating; and we mention it here, because we know the practice is continued by some who know no better, by covering them over with faggots or hurdles, and then with turf and straw, upon which the beds to be heated were formed. This was done with a view, no doubt, of allowing vapour to ascend, to keep the mould at the roots of the plants moist. This it did to a very injurious extent, rendering the whole a mass of puddle, as well as choking up the tanks, and ruining the boilers with the sediment. When brick tanks are used, the very hardest bricks should be employed, or composition or glazed bricks would be preferable, as they would absorb a very limited quantity of water: and hence the advantage of constructing tanks of Welsh slates or Caithness pavement, which are known to absorb the smallest amount of water of all known building materials.

*Rendle's mode of tank-heating.*—We have had an opportunity of seeing Mr Rendle's mode of tank-heating in full operation,

in the exceedingly well-managed nursery of Messrs Veitch and Son, at Exeter. The sketch we made at the time has been mislaid; we, however, again draw upon that fertile source of information in such matters, "The Gardeners' Chronicle," from which the annexed figs., 254, 255,

Fig. 254.

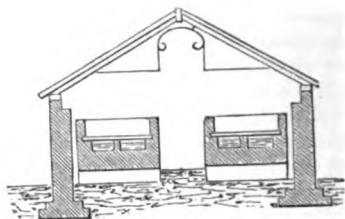
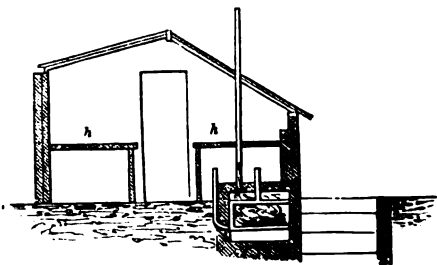


Fig. 255.



256, and 257 are taken, as well as the description by Mr Veitch, jun. The house in which we saw it is used as a propagating-house, and a better we have not seen. So far as the heating is concerned, the system may be applied to houses of various descriptions. "The tank is formed of brick arches worked in cement, with brick sides, the whole being well coated with cement. The top is of slate, cemented down. The sides of the bed are also formed of brickwork. The material used for plunging is a clear sharp sand, which we find retains the heat for a considerable time. In one part of the bed we have put soil, and the cuttings planted out in it have rooted most rapidly. We would draw your attention," says Mr J. Veitch, "to the simple yet efficient manner in which we regulate the heated water by means of the apparatus *d*. By this contrivance we can heat only one division of the house at a time, or only half of either, or both divisions; and while all can be heated at

one time, yet each bed may be regulated to a different degree of heat, thus forming four distinct beds to be heated as circumstances may require. These apertures are formed with short pieces of

4-inch iron pipe, cemented into the brick-work, and the circulation is regulated by having plugs to fit the pipes. This plan, though so simple, we believe to be new; and the advantages arising from it must

Fig. 256.

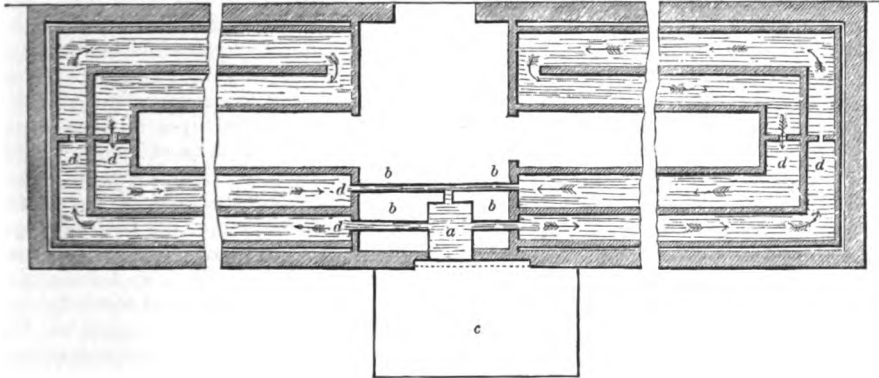
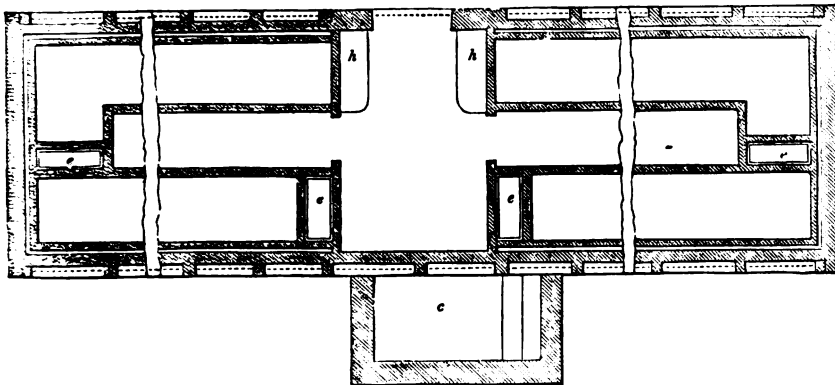


Fig. 257.



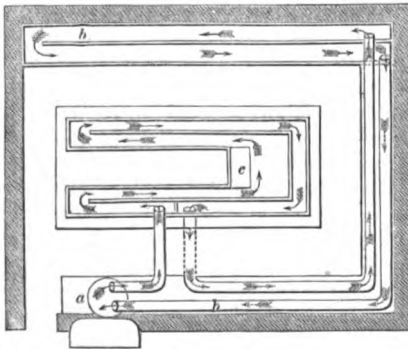
be apparent to every one. Steam, if required, may at any time be obtained by opening the doors at which access is procured to the apertures for increasing or diminishing the circulation of the water." The following will explain the figure: "*a* represents the boiler, &c.; *b* flow and return pipes; *c* stoke-hole; *d* plug-holes for stopping the circulation of hot water, if bottom heat is required only for one house, or for part of one house; *e*, doors for getting access to the plug-holes, and also available for steaming the house; *h*, potting benches." The house is 51 feet 9 inches long, 11½ feet wide, and 6 feet 9 inches high under the ridge.

*Corbett's system of open pipe or tank heating.*—This method, for which Mr Corbett took out a patent in 1839, seems little, if at all different, from that described by Dr Neill in the article "Horticulture," in the "Encyclopædia Britannica," as practised as early as 1832 by Mr Smith, in the gardens of the Earl of Hopetoun, and also exemplified much about the same time by Mr Jones of Birmingham, in the nursery of Mr Knight, at Chelsea. As a mode of heating, it has its advantages. The troughs used by Mr Corbett in the nurseries of Messrs Lucombe and Pince, at Exeter, and which Mr Pince pointed out to us last year, and

spoke in the highest terms of, are of cast-iron, 8 inches deep, 6 inches wide at the top, and 4 at the bottom. Very neat wrought-iron covers, in 3-feet lengths, are placed over them, which may be removed at pleasure, as a drier or damper atmosphere may be required. We would suggest, as an improvement, to cast these troughs with a groove, say one inch deep, and a quarter of an inch wide, and to turn down the edges of the wrought-iron covers in form of a flange to nearly the same depth as the groove. If the groove be filled with water, and the covers thus prepared and placed in the troughs, very little, if any, moisture would escape through the water-joint, as it may be termed. With the alteration we have stated, we think this mode of heating might be very advantageously employed for general purposes. With the covers on, a complete system of horizontal heating would be attained, just as at present when pipes are used, and in that condition heat would be obtained without humidity; while, when moisture was required, it is only necessary to remove one or more of the covers.

*Huyshe's mode of tank-heating* is very similar to Rendle's, though it differs in this particular, that the depth of water in his tank is 18 inches, instead of 4, 6, or 8, recommended by Rendle—for we find all these depths given. The following is a brief description of Mr Huyshe's stove, of which the annexed diagram, fig. 258, is a plan:—*a* is a conical boiler; *b b* are

Fig. 258.



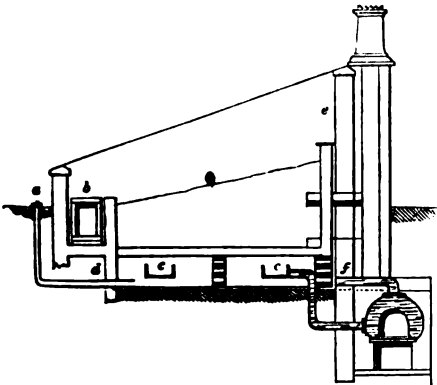
the tanks; *c* a lid to open, to examine the state of the water, and to admit steam if necessary—which, we think, will seldom

be the case. As the tanks are disconnected, the hot water is admitted into the one in the centre of the house by a cast-iron pipe. The water having circulated round this tank as shown by the arrows, it passes, by means of another iron pipe, along the back and one end of the house to the front tank; and after circulating round it, is returned to the boiler by another pipe under the flow-pipe in the usual manner. To obviate showing a section of the house where the proper position of the pipes would appear, they are here shown as being parallel to each other. Over these pipes is placed a stone shelf, for the reception of plants in pots. As the top of the boiler is level with the floor of the house, the pipe passes under the back passage, and rises into the first tank. These tanks are formed of boarding  $2\frac{1}{2}$  inches thick, one of oak, the other of elm, and supported on oak blocks 3 inches thick, to preserve them from decay, but more especially to promote a freer circulation of hot air through the house. The boarding is placed lengthways, and not across, which gives far fewer joints, the bearers under them being about 2 or 3 feet apart. The bottom and sides are bolted together by iron bars  $\frac{3}{8}$  of an inch thick, passed through the wood, and screwed up tightly. Each tank is divided by an elm board  $1\frac{1}{2}$  inch thick, and is covered with common roofing slate of the sizes called princesses, 24 inches long, and 14 inches broad. These slates were laid on just as they were received, and the joints secured with wetted clay. To render them more secure against vapour, we would have jointed them with the best cement, covering the joints at least 3 inches broad. It is most important, in all cases of tank-heating, to exclude the entrance of steam into the house, unless admitted by the operator. Mr Huyshe finds that, after this volume of water is once heated, fire applied about six hours in the twenty-four is sufficient to keep up the required temperature. He also finds by observation that, if the water is kept at  $114^{\circ}$  or  $115^{\circ}$ , the house temperature will be  $70^{\circ}$  at night. With regard to the loss of heat in tanks of 18 inches in depth, Mr Huyshe asserts that, by experiment, he finds only a loss of  $4^{\circ}$  from the evening till eight o'clock next morning, no fire being used during

the time. By lighting the fire about five or six o'clock in the evening, he finds he can keep the water in his tanks at from 112° to 116°—a heat quite sufficient for all useful purposes. It is a pity that Mr Huyshe has not stated with equal precision the season of the year at which he made the above experiments.

*The Honourable Robert Clive's improved mode of tank-heating*, fig. 259.—This we consider an excellent mode of heating with tanks or gutters, and smoke-flue combined. The principal feature, however, in this plan, is the supply and circulation of air made to pass over the tanks, and afterwards diffused through the house. The following sketch and description will illustrate its principle:—“*a* is an air-pipe, whose orifice is at the ground-level, and which passes under ground into a hot-air chamber, which it enters at *d*. A plug at *a* being removed, cold air rushes down into the chamber, passes through a pigeon-holed wall at *f*, rises through a cavity at *e*, whence, loaded with vapour, it is admitted into the house when occasion requires: *c c* are two zinc open troughs, 12 inches by 3, filled with water, communicating with a saddle-backed boiler, and passing along the house into a chamber covered with wood,

Fig. 259.



on which the pine-beds rest; *b* is the smoke flue.” Remove the wooden covering, and substitute for it Bangor slate or thin pavement, and cast-iron for zinc troughs, and this pit will be complete.

*Mitchell, of the Union Road Nursery, Plymouth*, has published in “*The Gardeners' Chronicle*” the annexed section, figs.

VOL. I.

260, 261, with description, of what we think a very excellent pit. The walls

Fig. 260.

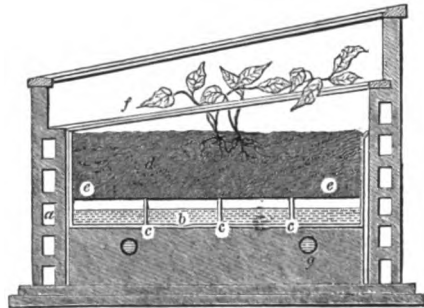
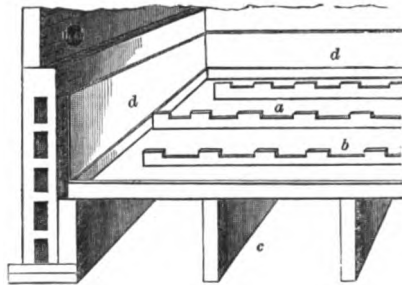


Fig. 261.



are built hollow, and with bricks on edge.

Fig. 260 is the section; *a* walls of the pit; *b* tank; *c* cross walls by which the top or roof of the tank is supported; *d* bed of earth for plants; *e* drainage; *f* trellis to which the shoots of “cucumbers or melons” are trained; *g* pipes for heating the atmosphere. Fig. 261 represents the internal section: “*a* interior of the tank; *b* partitions with apertures in their upper edges for the circulation of heat; *c* cross walls, by which the tank is supported; *d* sides of the bed.”

“The tank, in the accompanying sketch, is supported on cross walls, which are 3 feet apart, and a vacancy of 2 inches is left between the sides of the tank and the walls of the pit, for the purpose of readily transmitting the heat given out by the sides and bottom to the atmosphere. The interior of the tank is 6 inches deep; it is divided longitudinally by three partitions;—the middle one runs the whole length of the tank, dividing it into two separate compartments, each having its flow and return. In the upper edges of

2 c

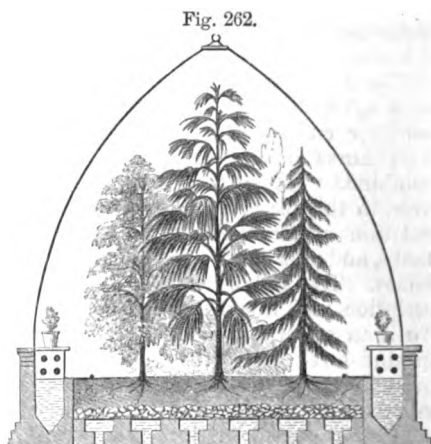


these partitions are apertures 12 inches in width, 2 inches in depth, and 6 inches apart, by means of which the heat and steam from the hotter parts of the tank can act regularly on the cooler—thus equalising the temperature throughout the whole of the superincumbent materials. In the chamber underneath the tank are 4-inch cast-iron pipes, (*g* in section,) in which hot water circulates for heating the atmosphere of the pit; and in order that the water may circulate freely in these pipes, the top of the boiler should be placed on a level with them. These pipes, as well as those that lead to the tank, are furnished with valves of a simple construction, by which the flow of water can be regulated as circumstances may require." Mr Mitchell's "reason for placing the pipes underneath the tank is, first, because it saves room; and, second, because in this way the whole atmosphere of the pit is kept in constant circulation, whereby ventilation is in a great measure superseded during the short days of winter, when cold renders the admission of air hazardous." The beds are prepared by laying 3 inches of drainage over the tank covers at *ee*; and the trellising is made in convenient pieces, so that it may be taken out or put in with perfect ease. The hot-water pipes being placed under the tanks admits of the whole being wrought with one boiler, which could not be done, unless the siphon principle were adopted, were the pipes brought up to the level of the top of the bed. External air should be admitted into the vault under the tanks, which would increase the circulation, and drive the heated air out of the vault by the two openings between the tank and bed and the side walls. This is altogether a very excellent pit.

*Glendinning's mode of tank-heating.*—Mr Glendinning has shown, in a series of sensible papers on heating and ventilation, (published in "Gardeners' Chronicle,") a system of tank or gutter heating for the borders of conservatories. There is no doubt, as is remarked by this intelligent gentleman, that one of the principal causes of failure in the cultivation of tropical plants in conservatories has been in maintaining a high atmospheric temperature, while at the same time the roots of the plants have been imprisoned in a

soil many degrees colder than that of their native country.

We shall quote his own words, which are as follows:—"The accompanying woodcut, fig. 262, will show a mode of

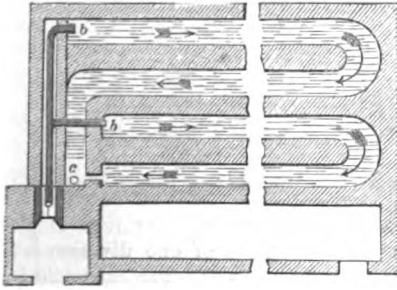


heating the bed of soil in a conservatory with the greatest ease, and with the most complete success. The section of the house shows a series of hot-water gutters, as originally invented by Mr Corbett, covered with common tiles, in such a manner as will permit a portion of the steam to escape amongst the mass of loose stones which supports the soil destined for the growth of the plants. The stones themselves will constitute perfect drainage to the conservatory bed; at the same time the moisture which ascends in the shape of steam amongst the stones, and that also which filtrates through the earth in which the plants are growing, will readily escape, and cannot in either case injuriously influence the health of the plants; but the very contrary will be the result, as when the heat in the gutters is increased under such circumstances, so also will be the moisture—thus securing the soil from becoming exhausted or desiccated by the constant application of heat to the roots, which is the defect in all common contrivances of this kind that supply bottom heat."

*Fleming's mode of tank-heating.*—The annexed figs., 263 and 264, represent a pine-pit invented by Mr Fleming, the intelligent superintendent of the Trent-ham Gardens. We had the satisfaction of seeing this pit shortly after its ereo-

tion, and find that since that time Mr F. has published a description of it in "The Gardeners' Chronicle," from which source our figures are taken. "Under the bed are four tanks *a a a a*, into which the water is delivered from the boiler by a 4-inch pipe *b b*, (fig. 263,)

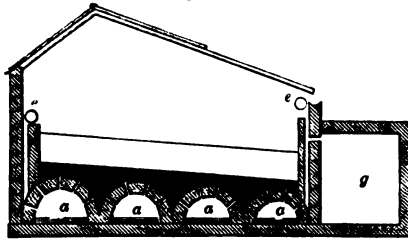
Fig. 263.



and, after pursuing the course indicated by the arrows, is again received by another pipe, the end of which is shown at *c*. The advantage of two deliveries is, that the water, not having so far to go, does not get so cold before it is returned to the boiler, and the heat is more regular in all parts of the house. The depth of water in the tanks is about 3 inches. The tanks are made of brickwork, coated with Roman cement. They are arched over with brickwork also, which we find cheaper than covering with slates; and, by leaving interstices between the bricks of which the arch is composed, the steam is allowed to escape, and, penetrating the stratum of rubble above, keeps the tan in a proper state of moisture. The same boiler also supplies a range of 4-inch pipes, which goes round the pit, as shown

at *e* in the section. There are cavities in the wall to permit the steam from below

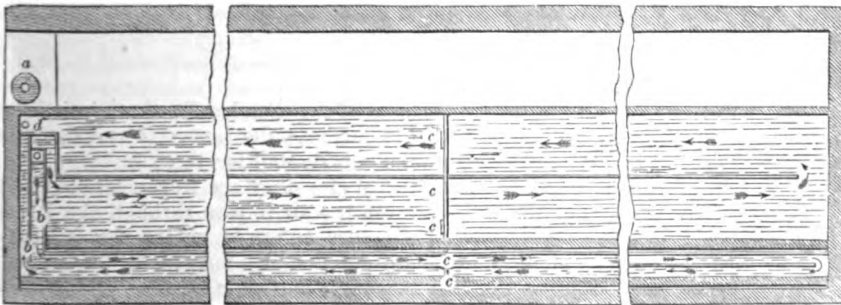
Fig. 264.



to pass to the top of the pit. The aperture to these can be closed at pleasure, thus insuring a perfect command over the moisture of the atmosphere. *g*, fig. 264, is a chamber which formerly contained a flue belonging to the house that occupied the place of the one I am now describing. This chamber has been left with the view of its being useful for filling with hot dung, either for the purpose of assisting to maintain the heat of the house, or for destroying insects. The tanks and pipes cannot both be wrought at the same time," on account of the difference of level, "but they are fitted with stopcocks, as that either can be wrought at pleasure; and a few hours in the middle of the day, when the pipes are not wanted, is found amply sufficient to keep up the bottom heat, as the mass of material, when once heated, retains its heat for a considerable time." The use of dung lining at *g* is, we think, quite superfluous; nor can we see how four brick arches can be constructed cheaper than a covering of slate or pavement.

*Haycroft's mode of tank-heating.*—The fol-

Fig. 265.



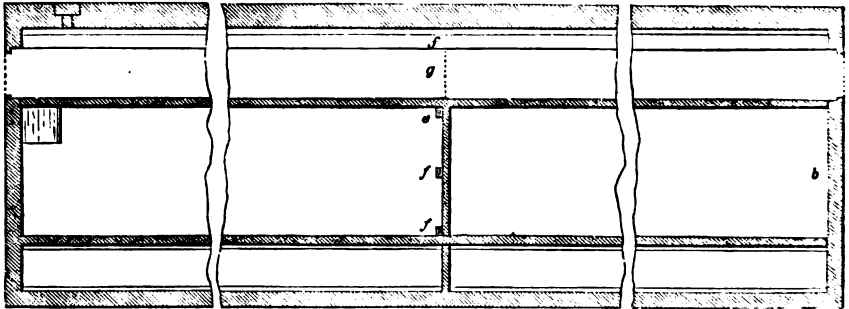
lowing diagrams (figs. 265, 266, 267) of a pine-stove were communicated by Mr

Haycroft as the details of a house he erected for Lord Doneraile: *a*, in fig. 265,

represents the boiler; *b* flow and return gutters; *c* sluices made of zinc, 3 by 9 inches; *d* return-pipe; *e* (fig. 266) covers

over the sluices with boxes the depth of the bed. "The smoke is carried off in a flue *f*, in ground-plan, fig. 266, which

Fig. 266.

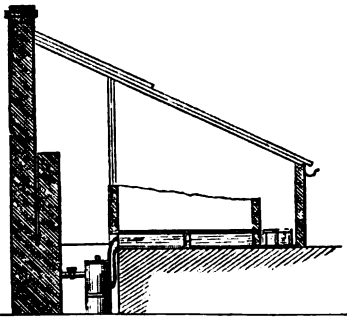


passes along the back of the house, by which a great saving of fuel is effected; and when the extra heat is not required, it is allowed to pass off in a chimney connected with the boiler and regulated by a damper. *g* is the walk or passage along the back of the house, in the usual way. The boiler employed is one of Stephenson's third size, and is placed within the house, as may be seen by the section, fig. 267. The tanks are formed of pave-

mented altogether or separately at pleasure. The length of one division is 30 feet 6 inches, and of the other 25 feet 6 inches. The width is 12 feet 4 inches within, of which the flue at the back occupies 12 inches, the footpath 2 feet 2 inches, the tank 8 feet, and the gutters 1 foot two inches.

A sensible and practical mode of heating and ventilating combined is given by D. T. F. in "Gardeners' Journal," of which the annexed diagram and description will give a sufficient idea. Fig. 268 is the section, and fig. 269 ground-plan: "a" spaces where bricks are left out of the

Fig. 267.

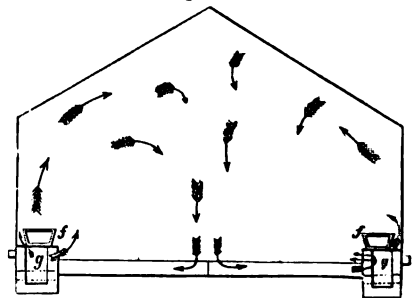


ment for their bottoms; the sides and divisions of bricks, three courses on bed. The whole is wrought in cement and well plastered. The covering of the tanks is slate 1½-inch thick. A double gutter passes along the front and the end nearest the fire, and has very properly a circulation of its own independent of the tank." —See *Gardeners' Chronicle*.

We consider this a very well arranged house, and highly creditable to the inventor. We may observe that it is divided into two compartments, which may, by means of the various sluices, be

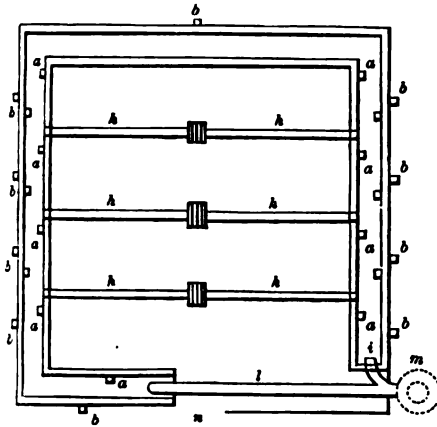
sides of the chamber for the admission of hot air into the house; *b* ventilators in the outside wall for the admission of external air—they are so constructed as to cause the air to pass through the hot-air chamber before it enters the house; *f* hot-water tank, formed of brick and cement, stone, slate, or tiles, and covered with slate—it rests on each side on 9-inch walls; *g* hot-air chambers, rendered so by the heat evolved from the bottom of

Fig. 268.



the tank ; *A* underground cold-air drains, in which the air from the interior of the

Fig. 269.



house is conveyed to the chamber *g*, where it is again rendered buoyant, and diffuses itself in all directions through the openings *a*, as indicated by the arrows ; *i* flow-pipe ; *l* return-pipe ; *m* boiler ; *n* doorway."

This house, which is 32 feet long, 9 feet wide, and  $7\frac{1}{2}$  feet high, was heated, exclusive of the tanks, for the small sum of £2, 16s. 6d. The tank is of wood with slate covering, calculated, including labour for fixing, at £5, making the whole expense somewhat under £8. This house is divided into two equal parts, one of which is kept at a temperature of from  $50^{\circ}$  to  $55^{\circ}$  in winter, and from  $70^{\circ}$  to  $90^{\circ}$  in summer ; the other at from  $40^{\circ}$  to  $45^{\circ}$  in winter, and from  $50^{\circ}$  to  $65^{\circ}$  during summer, at a total expense per annum of £4, 10s. in a locality where coal is 20s. per ton.

The advocates for the Polmaise system of heating claim for themselves the merits of having introduced economy in the apparatus, abundance of heat, and a perfect circulation in the atmosphere of the house. Now, we consider that D. T. F. has shown above all these conditions completely complied with, and certainly with an atmosphere far more pure and congenial to the vegetation into the bargain.

*Toy's mode of tank or gutter heating* is described by him as an apparatus constructed on a plan which will insure a temperature of  $70^{\circ}$  when a thermometer in the external air indicates  $20^{\circ}$ , and the

expense of such a structure as he purposes, not including the boiler, will not be more than about £10. Any description of boiler may be used provided it has two arms, the upper one of which must be connected with the flow, and the lower with the return pipe. The flow-pipe should rise at least 2 feet before it enters the gutter, and the return-pipe should be placed as closely as possible to the bottom of the boiler, so that the water may pass out freely. The bottom and sides of the tank are formed of wood ; it rests on pavement supported on brick piers, and slates are used for a covering or top, some of which are movable for admitting vapour into the house. The tank is not divided, as is usually the case ; and Mr Toy calculates that the circulation is carried on by the hot water flowing along the top, and the colder water returning along the bottom of the tank. This is a most unsatisfactory mode of circulation, and, to say the least of it, has no advantage whatever. That circulation will take place upon this principle is to a certain extent true, but not so well as if the tank were divided into two distinct spaces.

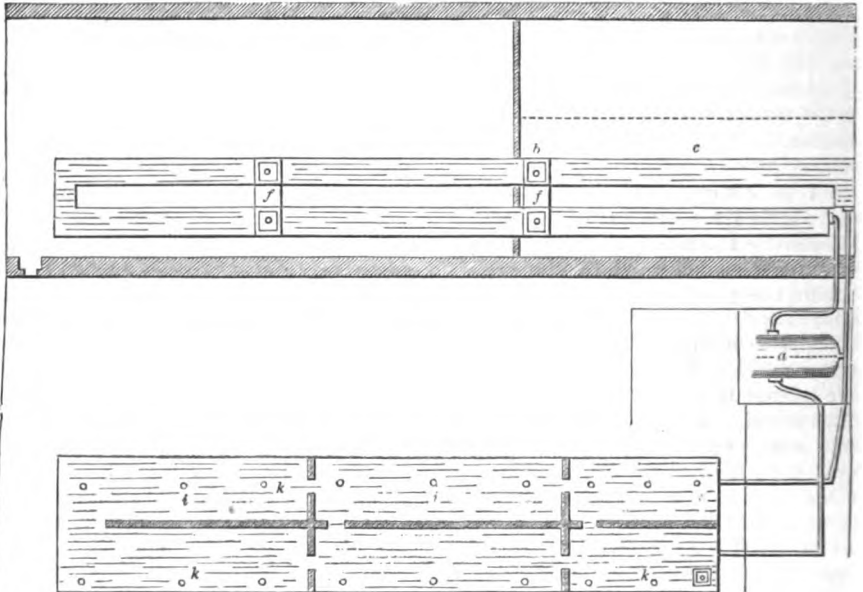
Our chief objection to this plan is the use of wood, which is a bad conductor or reflector of heat ; and its application here is quite unnecessary, as, if the pavement were properly jointed and coated with cement, and the sides done with brick on edge, it would be more durable and less expensive. Mr Toy appears to have fallen into the mistake long generally entertained, and by ourselves also, of placing the boiler under the level of the circulation. Hood has proved the fallacy of this theory, and we have also had practical proofs of its inutility, not only in respect of its not increasing the rapidity of the circulation, as it was long thought to do, but also of its causing an unnecessary degree of pressure on the boiler. Where water is carried along the front of a house, as in this case, and has to return in the same line, it is best to divide the tank ; but where it makes the circuit of the house this is unnecessary, as the terminating end serves for a return, the water being by that time so reduced in temperature that it enters into the boiler freely. We may here observe, that many have been deterred from carrying the tanks, gutters, or pipes, round

their houses, on account of the interruption of the doorways. This is easily got over by connecting them on each side of the door, by means of a leaden pipe bent so as to pass under the level of the floor, and rising again to the tank or gutter on the opposite side. This dip must only be made once, for reasons hereafter given.—(Vide section ON CAUSES OF CIRCULATION, and also fig. 246.) Wooden tanks are excellent when they have to be placed in an elevated position. In such cases they

are better than brick, as being less expensive; but in a case like the present, where the tank rests on a solid foundation, we think brick or stone preferable.

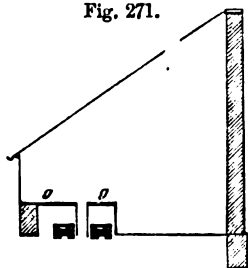
*Lawrence's system of tank-heating.*—As an instance of employing earthenware tanks, we may notice one described in "The Gardeners' Chronicle," which was erected at Cirencester, and with complete success, although upon a larger scale than ordinary. The diagram, fig. 270, will show its operation: *a* is the boiler upon

Fig. 270.



the double cylindrical principle, placed about midway between the hothouse and pits heated by it. The hothouse is divided at *b* in the ground-plan, the smallest division being that nearest the boiler, and used as a stove, while the other is used as a vinery. They can be heated together

Fig. 271.



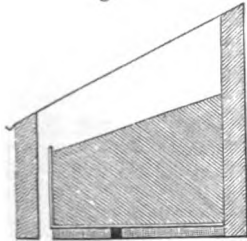
or separately, as required. Under the footpath at *c* is a brick tank for holding the rain water that falls on the roof. The gutters are of earthenware, and shown in section, fig. 271. They

are 15 inches

broad and 5 inches deep, and in lengths of 15 inches each. The tiles at the angles or turns are of a different mould, and are in three pieces, one for each angle, there being no joint at the angle. The tiles at the boiler end are also different, having projecting collars for the more readily joining them with the pipes from the boiler *a* in ground-plan. The flow and return gutters are connected at two points in ground-plan, *f f*, so that the circulation may be confined between either and the boiler: "at these points the gutters are covered by a wooden frame instead of a tile, in which is fixed a movable cover which exposes the plugs, by means of which the circulation is diverted across the house, or extended at pleasure along the entire range." As the ground

under the gutters had not been disturbed, they are set on a floor of concrete, and elevated the thickness of a brick, two bricks being placed at every 15 inches immediately under the joints. This is intended to obtain heat by radiation from the bottoms, as well as from the top and sides, giving a radiating surface of 40 inches to every lineal foot of gutter. This, when the gutters are placed so near the ground, we think of small importance, as the radiating power from the under surface must be nearly all absorbed by the floor. The gutters are covered with tiles  $1\frac{1}{4}$  inches in thickness; and over them, level with the top of the front parapet wall, are laid slate tables, as seen in the section *g g*, fig. 271;—these are supported upon iron rods and the top of the front wall, and are about 1 foot apart, and are intended for setting plants on. The hot water is conveyed from the boiler to the tanks, by a pipe from its top extending to both hothouse and pits, having a brass union-joint on each side at the bottom, to receive the return-pipes. The flow-pipes are regulated by cocks, so that the water may be made to flow to both house and pits at the same time, or to either separately. The pits are heated by a tank laid on a concrete and cemented floor, and covered with tiles as above. An aperture is left between the front wall

Fig. 272.



and the bed—*vide* section, fig. 272; the latter is formed of slates set on edge, which take up much less room than brick walls, however narrow they might be made. The chief peculiarity in the tanks in the pits is their being divided into three compartments, which may be heated either together or separately. This is effected by sluices having a handle, fig. 273, long enough to pass up through the bed of mould, so that they can be opened or shut without trouble. Circular earthenware tubes, *i i*, are set on the top of the tile covers, and pass up through the bed

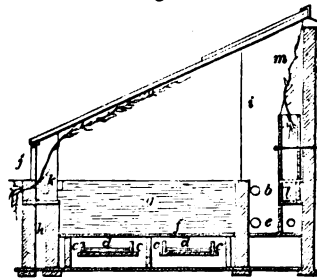
Fig. 273.



of mould to admit dry heat into the atmosphere of the pit, while at the same time similar tubes, *k k*, are placed with one end through the tile covering, and also up through the bed, to admit moist heat—and these are opened or shut at pleasure by wooden plugs. The owner of these tanks concludes his description of them by saying, "I see nothing to prevent these gutters and tanks lasting sound for ever, and they undoubtedly heat a considerable area at a very small first cost."

*Tinker's method of tank-heating.*—The annexed woodcuts, figs. 274, 275, exhibit

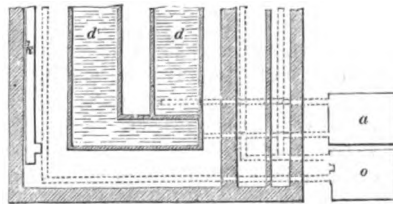
Fig. 274.



a very excellent mode of heating by means, and one well adapted for the cultivation of cucumbers and

piners. The gutters or tanks are formed of Yorkshire pavement, in long lengths  $2\frac{1}{2}$  inches thick. They are grooved and joined

Fig. 275.



together with white lead, with a coat of Roman cement over the joint. The gutters are 2 feet 3 inches broad, and 5 inches in depth; the bottom is laid on brick piers, and the sides and middle division are of brick set in cement, and are carried up 2 inches above the level of the sides, to support the iron bearers which are laid across them for sustaining the slate covering. The water is 4 inches deep, the flow-pipe entering near the top, while the return one is placed close to the bottom of the gutters, by which means Mr Tinker thinks every drop of the water is made to circulate, and which he considers of great importance, as it keeps the

water sweet and healthy. The boiler used is of copper, with a supply-cistern and ball-cock to keep the boiler always full. Over the covering of the tanks  $2\frac{1}{2}$  feet of tan is placed as plunging material, which of itself gives out a considerable supply of heat; when that declines the fire is employed for a day or two, which brings up the necessary temperature in the tan, and which will last, he asserts, for two or three weeks or more. A secondary boiler is employed for top heat, as he finds it much cheaper not to give one boiler too much to do.

Reference to figs.—*a* gutter boiler; *b* flow-pipes; *c* return-pipes under the floor; *d* tanks—the tanks at the end are level with and attached to the flow-pipe; *e* spaces between and at sides of gutter; *f* bearers and slates; *g* bark bed; *h* space to prevent cold and damp from acting on the bed; *i* small iron rods to support the roof; *j* glass lights hung to admit air, the top ones also movable; *k* open gutter attached to front iron flow-pipe at each end—may be used or stopped off by two small plugs, when necessary; *l* gutter covered with blue slate, for the bottom of cucumber-trough, which is kept in its place by bolts through the wall—this trough is kept 1 inch off the wall, to allow the warm air to circulate round it; *m* trellis for cucumbers, which cover the whole length of the back path—a vine is introduced at each end; *n* boiler for top heat, the flue of which runs into the back of an adjoining house, which is worked by it also with pipes in front.

Mr Lyons of Mullingar has, in a communication in "The Gardeners' Chronicle," proposed the following system of heating a considerable extent of pits upon the tank principle. His system has certain advantages, and at the same time is no doubt capable of considerable improvement. "I propose," he says, "to construct twelve pits, each 7 feet in length, and 4 feet in width, separate from each other, but all worked by the same apparatus, in such number as may be required. This enables the gardener to have a succession of either melons or cucumbers, or both; and, from each pit containing a distinct species of fruit, he will find no difficulty in preventing the seed from becoming hybridised. Some of the pits intended for a succession, may

in the interim be used for forcing strawberries, French beans," &c. Mr Lyons prefers Burbidge and Healy's ribbed boiler, and proposes "to set it in the centre, with a flow and return pipe right and left from it, extending to the required length of the range—each pit to be supplied with a tank connected by means of a stopcock, with the main flow-pipe, and a return-pipe from that tank to the main return-pipe. The stopcocks admit or turn off the flow of hot water, to or from whatever number of pits it is intended should be heated, the boiler being of sufficient capacity to work the entire pits at once. The quantum of heat to be admitted can be regulated by means of the stopcock of each pit. I would," he continues, "insert ventilators in the front and rear walls, under the stone coping, covered with perforated zinc, for the two-fold purpose of keeping out bees and preventing a too sudden rush of cold air." The references to the figs. 276, 277, and 278, here given, will show the working of

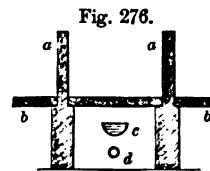


Fig. 276. The whole: *a a* partition walls; *b b* bearers; *c* tank; *d* return-pipe; *e* stopcock; *f* main flow-pipe; *g* return-pipe; *h* ventilators. "The main flow and return pipes are shown in the ground-plan fig. 278,

Fig. 277.

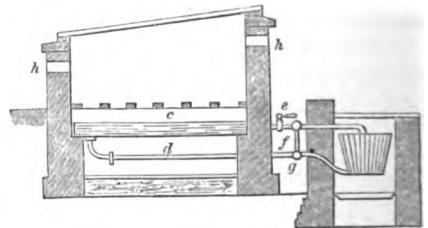
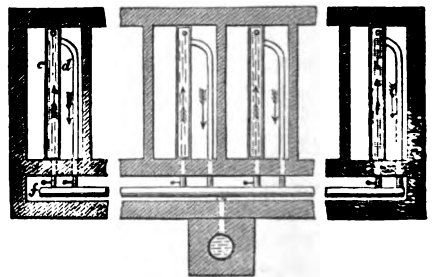


Fig. 278.

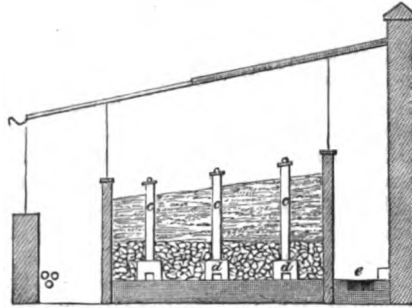


by the dotted lines, as also the connection between them and the tanks. In general this arrangement is good, and it may be extended or curtailed to suit existing circumstances. There are, however, some objections to it. For example, the partitions *aa*, instead of being of brick, should be of wood, and portable—that is, capable of being taken out and put in, as may be required. The ventilators in front are placed too high: they should be brought in close to the ground-level, and discharge the cold air immediately over the tanks, provision being made for the air thus heated to ascend into the pit. The boiler also should be placed within the pit for the economy of heat; and the space over it, instead of being covered with a glass sash, should be covered with slate or boarding. The pits are also too narrow; instead of being only 4 feet wide, they should at the least be 6. The boiler is very properly placed in the centre; and the idea of covering the ventilators with zinc, if perforated, is also good. The adoption of Messrs Burbidge and Healy's metallic tanks is also good, as they may be made to act either as close water-pipes or open gutters, according to the degree of humidity required. The main for conducting the heated water to the extremities of the pits, as well as the returning main under it, for the return to the cold water of the boiler—it will be seen in section—is laid in a chamber without the pits, and is neither covered over, nor in any way prevented from giving out the heat by radiation. This should have been guarded against, by enclosing them in a perfectly dry drain, and surrounding them with sawdust, charcoal, or some other non-conducting material. These are all omissions, the rectifying of which will be readily understood by those practised in pit-building and heating.

It should be remarked that Mr Lyons is an amateur, and of course wishes to have various degrees of heat, to suit the different purposes for which his pits are intended. In this he has succeeded very completely; and, upon the whole, has produced a set of pits highly creditable to

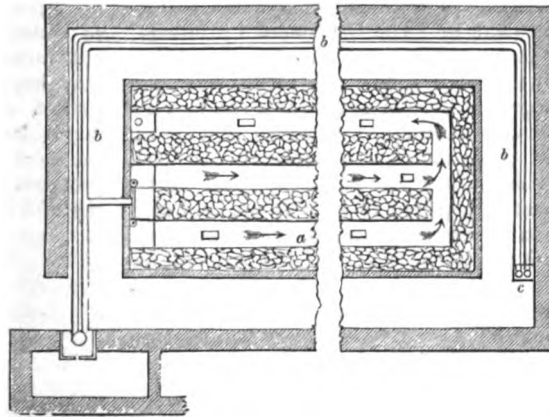
his inventive genius. We have had the pleasure of being in correspondence with Mr Lyons for some years, and know him to be a gentleman of great worth, and ardently devoted to horticulture; and we are certain that these remarks will be taken by him in the same spirit in which they are given.

The annexed fig., 279, is a section of a  
Fig. 279.



pine-house heated upon the tank principle, in the garden of Colonel Baker at Salisbury. The tanks *a* are of wood, covered with slate, as will be seen by the plan, fig. 280. Two of them are flow-troughs, and the third the return. Around

Fig. 280.



and above these tanks is a stratum of rough rubble stones, and on this the mould for the plants is laid, (for they are planted out.) To economise heat, the flue, after passing round the boiler, is made to run along the whole length of the back foot-path *e*, and to return again under it to the point from which it started; and the smoke, accompanied of course with very little heat, ascends the chimney above the



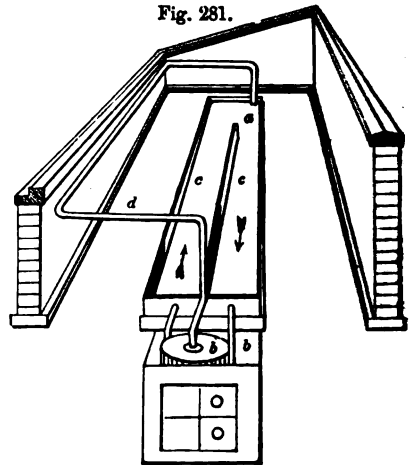
boiler. Hot-water pipes from the same boiler pass along the ends and front of the house *b*, in the front and end passages. These pipes are very properly laid level with the tanks, which prevents the latter from overflowing. Tubes—*c* in section—pass up through the bed from the tanks, to admit steam into the house when required. The pipes are open at the extreme ends, and the water makes its return through the cistern *c* in plan, instead of by an elbow turn, as is usually the case. This is done so that the orifices of the pipes may be easily stopped, to prevent circulation in summer, when little atmospheric heat is required. We would have preferred stop-cocks such as are used in the Frogmore gardens, placed at the ends nearest the boiler. The tanks are also furnished with sluices, *d*, at the ends of the flow-tanks, by which the heat is regulated.

*General remarks on tank-heating.*—The principal objections to the tank mode of heating, (unless the necessary provisions are made,) are an excess of bottom with a deficiency of atmospheric heat, and an excess of humidity when the heat from the tank is admitted freely into the house or pit. On this subject, we find the following very sensible remark, in a communication from an anonymous correspondent in "The Gardeners' Chronicle." "It is well known," he observes, "that by means of a flow and return tank, the degree of bottom heat in pits can be very steadily maintained. Once the mass of soil, or other materials composing the bed, is heated to the required pitch, very little heat is required to keep it up, and sudden changes of extreme temperature do not greatly affect it. If the temperature outside be one night at 55°, and the next at 25°, this difference of 30° will only occasion a few degrees lower temperature in the soil of the bed. But the case is very different as regards the air of the pit; for under the above conditions it would certainly be affected to a much greater extent, perhaps as much as 20°.

"Presuming that the temperature of the bed is exactly what it ought to be, any attempt to counteract the coldness of the air in the pit, in a cold night, will cause an excess of bottom heat, which by repetition must prove highly injurious. If the communication of heat from the tanks to the surface is only through the mass

of soil, the conduction of heat is exceedingly slow, whilst its escape by the glass is rapid. To raise the temperature of the whole mass of soil 10° in as many hours, would require an extraordinary force of fire; notwithstanding which, should a fall of external temperature take place to the extent of 30°, not an unusual circumstance, the top heat will lose 30°, less 10° counteracted by increase of bottom heat;—or, in other words, the air in the pit will be 20° lower than it ought to be; and in attempting to prevent this, the bottom heat will be raised 10° too high. If the tanks are in a chamber communicating with cavities between the walls and soil, the external cold will be much more readily counteracted by the increased heat of the tanks; but if, as presumed, the bottom heat was previously high enough, an excess must be communicated to the soil by any extra heating of the tanks immediately under it. It is evident that, whilst the requisite supply of heat for the bottom is almost uniform, and that for the top is exceedingly variable, both cannot be duly heated by combination. A separate command of heat is necessary for each. A boiler with tanks for bottom heat, and another with tanks for top heat, and the whole so constructed as to admit of giving out moist or dry heat, according as may be required, is doubtless the most perfect arrangement; and perhaps it might be found ultimately not to be the most expensive." This correspondent proposes to introduce a small steam-pipe, say of 2 inches bore, to rise from the top

Fig. 281.



of the boiler, as will be seen by the accompanying sketch, fig. 281, to be carried along the front of the pit immediately under the glass, and to terminate at the extreme end of the return-tank *a*; *b b* is the boiler; *c c* the tanks; *d* the steam-pipe. When the steam-pipe is to be used, the flow-pipe from the boiler into the tank is intended to be stopped.

Our objection to the use of steam in this case is, that the water in the boiler must be kept at such a temperature as to supply the steam-pipe at 212°; for below that point steam would condense, or rather would not be generated. Such a temperature as this is seldom desirable wherever hot water is employed in heating. It would be much better to use a 3-inch hot-water pipe, furnished with a cock, so that the water could be allowed to flow through it when required. One pipe, in this case, would do, as it could empty itself into the return-tank; and this pipe must be on a level with the water in the tank, or be upon the siphon principle. The former, where it can be conveniently adopted, is the simplest and best. Wherever the tank system is used, unless for the purpose of heating borders or pits for particular purposes, we would recommend, as an absolute condition in insuring complete success, to employ a hot-water pipe in conjunction with the tank, for supplying atmospheric heat, and that unaccompanied with so much humidity as would be given out by the tank alone.

Tanks, as we have seen, are usually divided, thus forming a flow and return circulation. An instance, amongst some others, has been shown by F. Harrold Fenn, where this mode is departed from. He employs a brick-cemented gutter, which passes directly round the house from the boiler to it again. Another rather unusual feature in this case is, that the water, in passing from the boiler to the tank or gutter, has to fall under the level of the doorway, and rise again, through a leaden pipe, to the level of the gutter. This might have been avoided by placing the boiler below the floor-level. We state this instance, to render the system practicable where it might be either impossible or inconvenient to set the boiler so low. The scale upon which this experiment was tried was not a very

small one; for we find the house was 45 feet long and 14 feet high, and that the method answered the purpose completely. Mr H. states that his greenhouse (the house in question) is sufficiently free from damp to enable him to keep his plants in safety through the winter, although the tank is only covered with slates one-fourth of an inch thick, but cemented at the joints. Mr H. is the first person whose observation we have met with in a published form, as to the crisp ice-like scum appearing on the surface of the water in recently-constructed tanks. This is a very common case, and arises from the lime which is contained in the cement; the carbonic acid contained in the atmosphere of the house acts on the calcareous matter dissolved by the water, and converts it into carbonate of lime. This is only injurious in as far as a portion of it may find its way into the boiler and form a calcareous incrustation on the sides or bottom; but it may easily be removed.—*Vide* section BOILERS AND PIPES.

As connected with tanks, we may observe that Burbidge and Healey, in connection with their patent boiler and furnace, have constructed a cast-iron tank, which combines the advantages of the round pipes and open trough. These troughs are of an oblong shape, with steam-tight covers, and with valves also steam-tight, to open and shut at pleasure. The advantage of this is, that it admits of ready means of saturating the atmosphere of the house, so that a moist or dry heat can be obtained to any desirable degree.

Cast-iron gutters, of the shape as shown in figs. 282 and 283, are excellent substi-

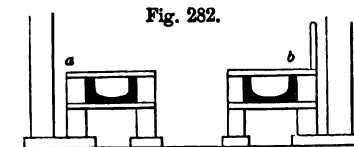
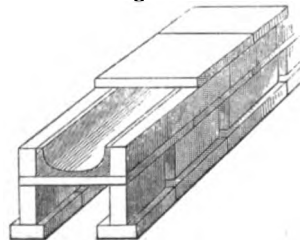


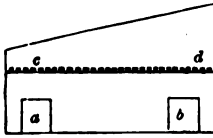
Fig. 283.



tutes for tanks; but they should always be elevated from the ground, as here shown, and fitted with portable covers, so that the amount of evaporation from them may be regulated. The flow passes along one side of the house or pit, and returns by the other, as shown at *a* and *b*, fig. 282.

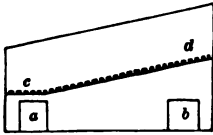
A curious discovery has been made in the garden of the London Horticultural Society with regard to the correction of dampness during winter in pits heated by gutters; it is noticed by Dr Lindley in "Gardeners' Chronicle."

Fig. 284.



tion, water will lodge on the foliage, and death will result with all soft and tender plants;—this, of course, arising from condensation;—"but the moment the line

Fig. 285.



raising the covering materials gradually to *d*, a motion of the colder air takes place from *d* to *c*, while at *c* the hotter air rises up to the sashes, follows them, and, when cooled, falls again to *d*; and this kind of circulation going on incessantly, all dampness is effectually prevented."

It does not appear to have been much noticed how far heating by tanks, if much steam be allowed to escape from them, may tend to lower the temperature of a house or pit instead of raising it; yet such may be the case in consequence of an excess of *spontaneous evaporation*. "The process of boiling," Tomlinson observes, "is by no means indispensable to the formation and escape of steam or vapour; for at all temperatures below the boiling point, vapour is formed at the surface of liquids, and escapes therefrom by a process called spontaneous evaporation. During the spontaneous evaporation of wet surfaces, a considerable degree

of cold is produced by the quantity of heat rendered latent by the formation of the vapour, and the heat is mostly derived from the liquid itself, or the surface containing it. By proper contrivances, water may be frozen in consequence of the abstraction of heat during the rapid formation of vapour. When a person takes cold from wearing wet clothes, the vapour from the wet clothes obtains its heat from his body, and the chilling sensation is often the greater the warmer the air."

We have already noticed that heat is given off from bodies by the two processes of radiation and conduction. These are very different processes in the propagation of heat. By conduction the heat travels through or among the particles of *solid* matter, and is gradually communicated by one particle to another, until the temperature of the body in contact with the source of heat is elevated more or less above that of the air. "When heat is communicated to a *fluid* body, the process is different. In consequence of the great mobility of its particles, those which first come under the action of the source of heat, being raised in temperature, escape from its influence, and ascend through the fluid mass, distributing a portion of their acquired heat among other particles on their way; other particles immediately take their place, and being heated, ascend in like manner, and distribute their heat. By this process of convection, as it is called, the whole of the particles in a confined mass of fluid come under the action of the heating body; those first heated escape as far as possible from the source of heat, and becoming cooled, descend again to be heated, again to ascend and descend. In this way a circulation is maintained in the whole mass of fluid. It is only by this process of convection that air may be said to be a conducting body; for if a mass of air be confined in such a way as to prevent the free motion of its particles, it ceases almost entirely to conduct heat, and may be usefully employed to retain it; as, in the case of double windows, the enclosed mass of air prevents the heat from escaping from the apartment, and shields the glass which is in contact with the warm air of the room from the cooling action of the external air. Glass is a very bad conductor of heat, and the cool-

ing effects of wind upon it are not so great as is generally supposed. Solids differ greatly in their heat-conducting powers. The slow conducting power of such bodies as porcelain, brick, and glass, may be contrasted with the rapid conducting power of some of the metals, by holding one end of a piece of each substance in a flame; the metal will soon become too hot for the hand, while the porcelain may be heated to redness in the flame without its being felt to be much warmer at the other end.

“When a heated body cools under ordinary circumstances, it is by the united effects of radiation and conduction, and the rate of cooling increases considerably, in proportion as the temperature of the heated body is greater than that of the surrounding medium. We have seen that the cooling effect of radiation depends greatly on the nature of the surface; but it is a remarkable fact, that the cooling effect of the air by conduction has no reference to the nature of the surface. It is the same on all substances, and in all states of the surface of those substances. The air in contact with such surfaces robs them of a portion of heat, and immediately ascends to make way for other portions of air, which repeat the process. By these two processes, the body cools down to the temperature of the surrounding air, the conductive power of which varies with its elasticity or barometric pressure;—the greater the pressure the greater the cooling power. It has also been shown by Dulong and Petit, that the ratio of heat lost by contact of the air alone is constant at all temperatures; that is, whatever is the ratio between 40° and 80°, is also the ratio between 80° and 160°, or between 100° and 200°.

“It was long supposed that a certain relation existed between the radiating and conducting powers of heated bodies; that the variation between them was exactly proportional to the simple ratio of the excess of heat; that is, supposing any quantity of heat to be given off in a certain time at a specified difference of temperature, at double that difference twice the quantity of heat would be given off in the same time. This law does, to a certain extent, apply where low temperatures are concerned, but does not hold at high temperatures. Thus, in a set of

experiments by Dulong and Petit, the total cooling at 60°, and 120°, (Centigrade,) was found to be about as 3 to 7; at 60° and 180°, as 3 to 13; and at 60° and 240°, as 3 to 21: whereas, according to the old theory, these numbers would have been as 3 to 6, 3 to 9, and 3 to 12. When the excess of temperature of the heated body above the surrounding air is as high as 240° Cent., or 432° Fahr., the real velocity of cooling is nearly double what it would have been by the old theory—varying, however, with the surface. Since the heat lost by contact of the air is the same for all bodies, while those which radiate most, or are the worst conductors, give out more heat in the same time than those bodies which radiate least, or are good conductors, it might be supposed that those metals which are the worst conductors would be the best adapted for vessels or pipes for warming by radiation.”—TOMLINSON.

“Such would be the case,” says Hood, “if the vessels were *infinitely* thin; but as this is not possible, the slow conducting power of the metal (iron) opposes an insuperable obstacle to the rapid cooling of any liquid contained within it, by preventing the exterior surface from reaching so high a temperature as would that of a more perfectly conducting metal under similar circumstances;—thus preventing the loss of heat both by contact of the air and by radiation; the effect of both being proportional to the excess of heat of the *exterior* surface of the heated body. If a leaden vessel were *infinitely* thin, the liquid contained in it would cool sooner than in a similar vessel of copper, brass, or iron; but the greater the thickness of the metal, the more apparent becomes the deviation from this rule; and as the vessels for containing water must always have some considerable thickness, those metals which are the worst conductors will oppose the greatest resistance to the cooling of the contained liquid.”

#### § 5.—HEATING BY HOT-AIR STOVES.

It is now upwards of forty years since we first heard the sentence of condemnation pronounced on hot-air stoves as applied to hothouse-heating; and many will recollect the mild but expressive

opinion of them given by Nicol, who had experimented more than any man of his day upon them, and declared them "to be worse than useless."

All stoves are, in their respective degrees, open to the fatal objection of heating to so high a temperature as to deteriorate the quality of the air passing over them. "The temperature of boiling water or steam is the highest degree to which considerations of health and purity of atmosphere should permit us to heat the surfaces of air-warming apparatuses; but often as this has been impressed on the public mind in multitudes of scientific works, and by numerous medical authorities,—from the time when Tredgold wrote, nearly twenty years ago, to this day, only one kind of stove has been produced, in which a contrivance for keeping the heat within this assigned limit has been the leading feature; which contrivance, from its requiring some nicety of adjustment, was soon abandoned by most of the manufacturers: the consequence of which is, that nine-tenths at least of the stoves now known and used as 'Dr Arnott's stoves,' though they retain the name of the philanthropic projector, and something of the outward form of his contrivance, have lost every other distinctive feature of his invention, and have no claim to any merits beyond such as may be claimed by stoves in general. In the work which Dr Arnott published at the time when he produced this stove, he insisted strongly on the boiling point of water as the limit of its temperature; and he adopted means well calculated to insure that limit not being exceeded. But in few of the stoves now imposed on the credulity of the public as veritable 'Arnott's stoves,' are his self-controlling regulators (whether the mercurial, or those acting by the expansion of bars of metal) applied; and therefore the miscalled 'Arnott's stove' of the present day may be, and is, constantly worked at as high a temperature as was used in most of those cheap health-destroying contrivances which it was his aim to subvert. The impossibility of raising," by the true Arnott's stove, "the temperature of steam and hot-water apparatus many degrees beyond the mild water-boiling limit of 212°, stamps those modes of superiority, in a sanitary point of view, which few

stoves can ever attain to." — WALKER'S *Useful Hints on Ventilation*.

Notwithstanding the soundness of the above reasoning, and also of all that has been said and written on the subject, still some foolish people will persist in using and recommending such stoves for the purpose of heating plant-houses, than which, scarcely a more unfitting mode could be thought of.

It would be vain to enumerate even the names of half the manufacturers and patentees of hot-air stoves, much less to give the most condensed description of their parts and powers. We consider the man who admits one of them into his dwelling as on the borders of insanity, and running not only the risk of burning his house about his ears, but of shortening the span of human existence to all who dwell in it. If the archives of the various fire insurance offices could be examined, they would present a fearful catalogue of burnings occasioned by the use of hot-air stoves. Many of the finest buildings in Britain, both public and private, have fallen a prey to fire proved to have been caused by their use. Again, were hot-air stoves all that their advocates have endeavoured to represent them, there would not be a house in the kingdom without one; and long ere now they would have been very generally introduced into hothouses and conservatories. Such, we know, is not the case; and we may safely answer the question Why? by stating the positive fact—they have been tried, and found wanting. And we will go farther, and predict that, notwithstanding the immense mass of learning and argument lately brought forward in favour of a stove of this kind, in a couple of years it will be only talked of with all the others that have gone before.

The most popular of these stoves, so far as hothouse-heating is concerned, are Dr Arnott's, Chunk, Nott's, Vesta, White's, Lawe's, Boyce's, Juck's, Forsyth's, Harper and Joyce's, Deane's, Cundy's, Hazard's, and the Polmaise.

Of all these, when brought out, it was predicted they would work wonders. They are now, with the exception of Mr Rivers' improved Arnott's, all but exploded; and perhaps before this page pass through the press, that also may be numbered with the rest.

It is, however, with them as applied to horticultural purposes that we have at present to deal; and here we may observe, that it appears to us to be a retrograde movement, rather than one of advancement in horticultural science, to endeavour to reintroduce a system so long ago abandoned, and so justly condemned. It is now upwards of a century since the original hot-air stoves were expelled from the gardens of Britain, as being both dangerous and inefficient. That they have existed more or less on the Continent is easily accounted for; but even there, smoke-flues, hot water, and steam are rapidly banishing them from the gardens of our neighbours; and it is not too much to prophecy that, in a very few years, hot-air stoves for heating hothouses will be talked of abroad also as things that have been.

Dr Anderson, the inventor of a patent hothouse, so early as 1803, experimented largely upon a mode of heating by hot air; but he endeavoured to derive his heat from the sun, and to store it up till required. Mr Stewart, about the same time, patented a method he endeavoured to carry into effect at Blackheath Park: both were equally unsuccessful. The highly respectable family of the Strutts of Derby has for years been applying heated air to forcing-houses, brought from some of their neighbouring manufactories, with more or less success, but in all cases attended with the evils arising from too much dry air, until Mr Jedediah Strutt heated his houses at Belper by causing the heated air to pass over water, which so far remedied the previous defects. Mr Penn's mode of heating and ventilating, elsewhere noticed, was, as is well known, a decided failure in the art of heating, as well as of ventilating, and is no more heard of. Dr Arnott's stove, as now made, the Chunk stove, the Vesta stove, &c., have all been so generally and justly condemned, that we think them unworthy of particular notice as regards horticultural purposes.

*Rivers' improved Arnott's stove.*—One of the great objections to metallic hot-air stoves has been partially got over by Mr Rivers, the well-known rose cultivator. His method is detailed by him in "The Gardeners' Chronicle." After stating that he has for several years used Arnott's

stoves for forcing roses, and finding that the period of their duration extended only to three years, he had constructed a stove, of which the annexed figs. 286, 287, 288, and 289, are a representation, and the

following a description:—"Fig. 287, front elevation; fig. 289, ground plan; fig. 288, horizontal section through *a b* in fig. 287, showing the fire bars or grating; fig. 286, vertical section through *c d* in fig. 287, showing the front and back fire-lumps, the former reduced to 9 inches in depth; *e* iron pipe leading to chimney; *f* fire-lump, placed  $1\frac{1}{2}$  inches from the mouth of the pipe leading to the chimney, and about the same distance from each end;—this causes the smoke to pass round, thus preventing a too rapid consumption of the fuel. The first five courses of bricks, in height, are laid flat; the remaining three courses are set on edge." The following, in Mr Rivers' own words, will further explain this stove:—"One of these stoves is placed in a forcing-house for roses, 20 feet long by 11 feet;—this it is more than sufficient for; its

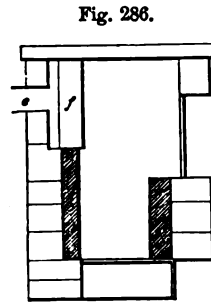


Fig. 286.

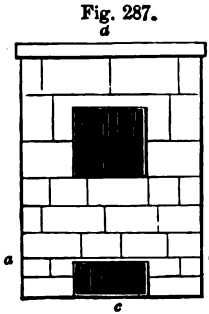


Fig. 287.

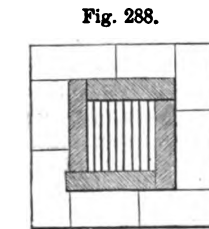


Fig. 288.

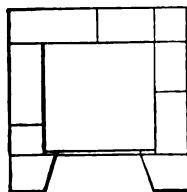


Fig. 289.

height is 2 feet 8 inches, and exactly 2 feet square; foundation, common bricks and mortar; the part surrounding the fire-box, which is formed of four lumps, is built with fire-bricks and fire-clay. On

the top of the stove is placed a Welsh tile, 2 feet square and 3 inches thick; the feeding door is about the centre, and a small sliding draught and ash-pit door at the bottom—the whole forming a neat and unobtrusive structure. A pipe about 18 inches long leads from the stove to a small chimney outside. A stove of this kind requires feeding but once in eight or ten hours." The advantages of this stove are thus stated: the total expenditure of material and labour is £2, 5s.; it is calculated to last for twenty years, with occasionally renewing the bars at the bottom of the fire-box, which can be done without disturbing any part of the structure; the heat is efficient and uniform, its dryness being counteracted by placing a pan of water upon the top of the stove; the draught is regular; there is no danger of bursting by over-heating; little soot is formed, as coke is used; the consumption of fuel is trifling. This stove is placed within the house or pit; but in consequence of the regularity of the draught, and the shortness of the pipe leading to the chimney, no fear is entertained by Mr Rivers of noxious gases escaping; and the dust so much complained of in ordinary stoves when so situated, is got rid of by saturating the half-consumed coke and dust with water before the fire is kindled in the morning. "For heating large and lofty houses," Mr Rivers, however, "presumes, at present, hot water must have the preference;" and only offers this mode to those "who wish to have the pleasure of a greenhouse and forcing-house at the smallest possible expense—in short, for economists in gardening, to whom the expense of heating has been, and is, a great bar to the erection of small greenhouses."

*Allen's Archimedean stove.*—Our attention was directed to this stove last year in the Royal Polytechnic Institution. We notice it as being a very ingenious apparatus, and one which may be useful to those who think more highly of hot-air stoves than we do. "It is called the Archimedean or screw stove, from the flame or heat from the furnace, or place containing the fire, being made to revolve in its ascent through a spiral funnel, so that it passes through a considerable length of space, and in so doing conveys and emits a vast degree of caloric influ-

ence on the surrounding atmosphere. There is no vapour, dust, or disagreeable smell, no generation of unpleasant gases, and no danger incurred. The mode of feeding the furnace"—for which we principally notice it—"or fire-place, is by a tube, round which the screw or worm revolves, the coke or coal being put in at the top, and falling into the fire-place as the fuel is burnt out or consumed."—*Patentee's description.* The arrangements for carrying away the smoke, and receiving the debris of the fire, are simple and complete.

*White's patent hot-air stove.*—With this stove we were early acquainted, being consulted by Mr White upon its principles some time before it was brought before the public. The following description of this stove is from Mr White's own prospectus:—

"Iron is well known to be a rapid conductor of heat, and, when much heated, to have a great affinity for oxygen. The fire-box of the Cockle stove, being of iron, at times is liable to be red hot with a strong fire; and, on these occasions, the heated air comes from it in a highly offensive state. The object of Mr White's patent air stove is to produce the heated air free from these objections. Fig. 290 is an elevation of this stove complete; fig. 291 a transverse section on the line *a b* of fig. 290; and fig. 292 a section on the line *c d* of fig. 291. In fig. 292, *a* represents the fire-box; *b*, aperture for supplying fuel; *c*, strong brick dampers to prevent the too rapid escape of the heat, and direct the flame round the internal surface of the fire-box; *d* smoke flue; *e* a regulating aperture for supplying the fire with cold air; *f f* apertures for supplying cold air to the stove; *g g* zig-zag flues for heating the cold air in its ascent; and *h* the hot-air chamber, from whence it may be taken as required. The top of the fire-box is enclosed with an iron plate covered with a layer of sand about 3 inches deep, which prevents the escape of smoke, or carbonic-acid gas, in that direction. In the transverse section, fig. 291, the tops of the zig-zag flues, *g*, are distinctly seen, and also the position of the brick dampers for impeding the escape of the heat by way of the smoke flue. In the management of this stove but little attention is required. As a

matter of course, when the weather is cold, it should be supplied with more fuel than if the cold were less intense; and to make the fire burn freely, or arrest its

combustion, the regulating aperture *e*, by which it is supplied with cold air, must be opened and shut for those purposes. By a little attention to this instrument

Fig. 290.

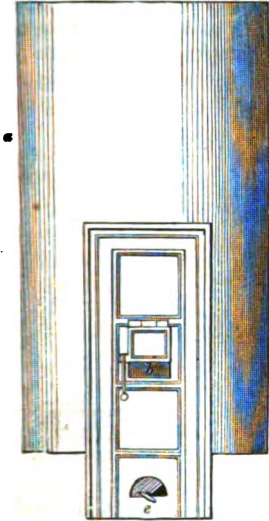


Fig. 291.

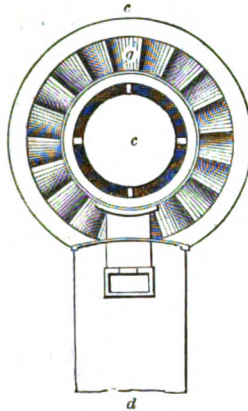
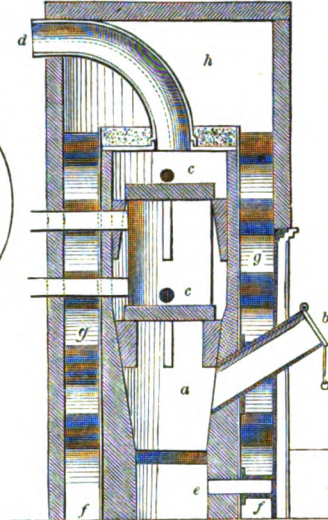


Fig. 292.



on the part of the individual who attends the stove, both fuel and labour can be greatly economised. For example, when left quite open, (which it ought to be when the stove is first lighted,) the fuel would be consumed in two or three hours' time; whereas, if nearly closed, it will burn without a fresh supply for twelve or fifteen hours. An index being placed round the circle, the time it will last is readily ascertained.

The purity of the air produced by the patent air-stove proceeds from the construction of the fire-box. It is formed of a circular tube of burned fire-clay, a material which is a slow conductor of heat, consequently not liable to overheat the air like fire-boxes made of metal. It is also more durable than iron, if exposed to a constant great heat. To give the tube strength at a moderate thickness, and perfect safety against the escape of carbonic-acid gas mixing with the heated air, it is girt round with a casing of iron, which is brought into close contact with the whole of its external surface, on a principle entirely new. To this casing of iron the zigzag flues are attached; and their being of this formation gives to the

stove an extensive heating surface; and the heated air, having to zigzag in its ascent, is discharged uniformly, not being subject to accelerations by concussions from the wind.

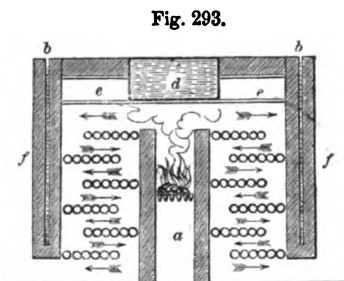
When a humid atmosphere is required, a dish containing water is placed on the sand which encloses the fire-box.

These stoves have the cold air generally supplied to them in the apartments where they are situated; but in some cases it is brought from the external atmosphere, and introduced below them, as represented by fig. 292 at *f f*.

*Lawé's hot-air furnace.*—This is another example of heating by hot air, accompanied with a considerable circulation. It was first communicated to "The Gardeners' Chronicle," from which our diagram is taken, by Mrs Tysson of Foulden, in Norfolk, in whose establishment it is said to have given satisfaction. Contrary to what might be expected, the air heated by this furnace loses less of its humidity than we were prepared to expect: this is stated to be owing to the rapidity with which the cold air is made to pass through the pipes, so that it is said to be totally unaltered except in temperature. Mrs

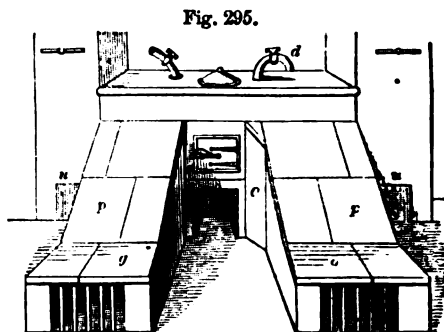


Tyson states, that "the great advantage of this stove is the extreme purity of the air conveyed by it, either to a conservatory or dwelling-house. By experiments tried by a hygrometer, it appears, when heated, to retain the same degree of moisture as the outer air; at least, the hygrometer varies in the house according to the outer damp, and the steam has never been required in the conservatory from any dryness proceeding from the warm air." This we can only say, if correct, is rather extraordinary; for air made to pass over dry heated bodies must and does part with a greater or less amount of humidity—depending, however, no doubt, on the slowness or quickness of the transit. The cross section, fig. 293, of the



furnace, shows the fire-grate over the ash-pit *a*. The furnace oven is surrounded by a chamber, the outer walls of which, *b b*, are built double, to retain the heat. This chamber is furnished with six rows of earthenware pipes, 20 inches long, and 1½ inch in diameter, their orifices being all kept open. As will be seen in the section, these pipes are placed in a position to allow the flame and smoke to pass freely through the chambers, and to escape at the flues *f f*. "The tubes, thus heated, are made the channels through which all the fresh air is admitted into the house; and it is easy to imagine that there is a cold-air chamber externally, and a warm-air chamber within, together with valves and gratings to facilitate and control the passage of the air, and to regulate the temperature. The double walls, *b*, are filled with pounded coke, and there are air spaces, *e e*, all well adapted to prevent the loss of heat at improper places. There is also a boiler, *d*, with steam and other pipes, to command any

required supply of moisture. The ends of the pipes are separated by fire-bricks cut into the form represented in fig. 294. The apertures in the inside of the house, through which the warm air is admitted, are as at *b b*. The external appearance of the stoke-hole, is as below, fig. 295: *u u* are doors for clearing out



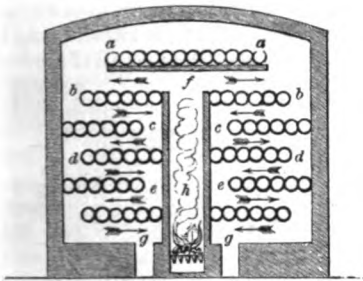
the soot; *p p* flag-stones covering over the air-flues; *g g* the sides of the air-flues; *o o* a space left in order to enable the furnace-door to open; and *d* a pipe from the boiler, by means of which steam is admitted into the interior when necessary."—*Gardeners' Chronicle*. We have no doubt this is a powerful heating furnace; but we suspect that the humidity maintained within is derived from the frequent use of the boiler. We also approve of this furnace, in so far as earthenware tubes are used, and so small a portion of metallic matter is employed in its construction.

It may be remarked, that one of the principal recommendations held out by the inventors of, or advocates for, most kinds of heating apparatus, is the extraordinary economy in fuel. Mrs Tyson, in a later communication to the same journal, asserts that a bushel of cinders per week—not more—kept her stove going day and night through the winter;—an amount of fuel so exceedingly small, that we apprehend this good lady either measures with a pretty large bushel, or has intrusted the management of the dust-hole to a very inefficient factor.

A stove very similar to the last is described in Ure's "Dictionary of Arts,"

&c., p. 1187. Fig. 296 is a transverse vertical section of it. "The products of combustion of the fire, *h*, rise up between two brick walls, so as to play upon the bed of tiles *f*, where, after communicating a moderate heat to the series of slanting pipes, whose areas are represented by the small circles *a a*, they turn to the right and left, and circulate round the successive rows of pipes *b b*, *c c*, *d d*, *e e*, and finally escape at the bottom by the flues *g g*, pursuing a somewhat similar path to that of the burned air among a bench of gas retorts. It is known that two-thirds of the fuel have been saved in the gas-works by this distribution of the furnace. For the purpose of heating

Fig. 296.

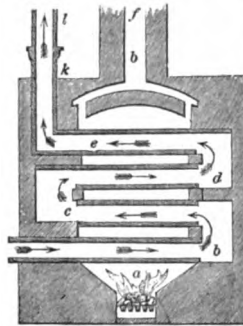


hothouses, the great object is to supply a vast body of genial air; and therefore, merely such a moderate fire should be kept up in *h* as will suffice to warm all the pipes pretty equally to the temperature of 220° Fahrenheit; and, indeed, as they are laid with a slight slope, are open to the air at their under ends, and terminate at the upper in a common main pipe or tunnel, they can hardly be rendered very hot by any intemperance of firing. If the tubes are made of earthenware, the construction of this stove will cost very little; and they may be made of any size, and multiplied so as to carry off the whole effective heat of the fuel, leaving merely so much of it in the burned air as to waft it fairly up the chimney."

A very powerful stove is described by Dr Ure in "The Dictionary of Arts and Manufactures," p. 1187. Fig. 297 "exhibits a vertical section of a stove, which has been recommended for power and economy; but," says the learned Doctor, "it is highly objectionable, as being apt

to scorch the air. The flame of the fire *a* circulates round the horizontal pipes of cast-iron, *b c d e*, which receive the external air at the orifice, and conduct it up through the series, till it issues highly heated at *k l*, and may thence be conducted wherever it is wanted. The smoke escapes through the chimney *f*. This stove," he observes,

Fig. 297.

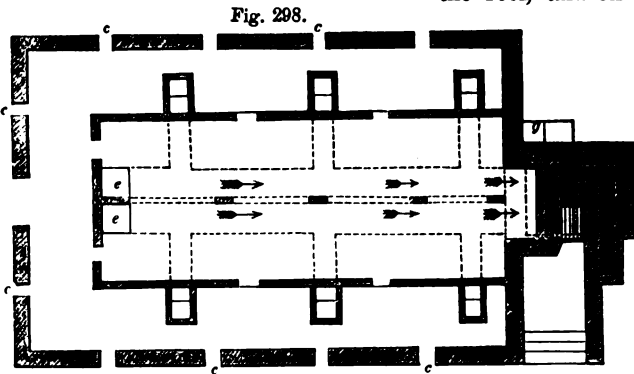


"has evidently two obvious faults: first, It heats the air-pipes very unequally, and the undermost far too much; secondly, The air, by the time it has ascended through the zigzag range to the pipe *e*, will be nearly of the same temperature with it, and will therefore abstract none of its heat." Such are the faults of most of the air-stoves now in use.

*Polmaise hot-air stove.*—This mode of heating has pretty generally been set down as the invention of the late Mr Murray of Polmaise, near Stirling. That gentleman, it appears, only revived, and probably unknown to him, a mode of heating invented by Dr Desaguliers, and described by Bradley so early as 1719. It appears to have lain nearly dormant from that period, till Mr Sylvester employed it some years ago to heat the Derby Infirmary, as well as several hothouses in the same county. Mr Murray's revival of Desaguliers' method in 1841, created at the time a considerable degree of interest, more especially as the editors of the two leading horticultural newspapers of the day took opposite positions in the matter, and each brought forward an array of evidence, conjecture, and opinion, to bear for or against the utility of this system.

We shall briefly detail the objections that present themselves to it. But first let us describe the stove in its most perfect form; and we conceive we cannot do this better than in Mr Meek's own words, accompanied with his diagrams as published in "The Journal of the Horticul-

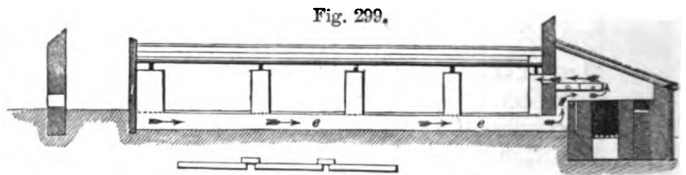
tural Society," vol. ii. p. 57. "The outer line of the ground-plan," fig. 298, "re-



presents the walls of a hothouse. The openings *c* are external ventilators, for the purpose of admitting fresh air. These are exactly such as might be employed for any other system of heating; they have no necessary connection with Polmaise, and the heating principle acts, whether they are closed or whether they are open. It is evident that, when open, they admit fresh air into the house; and however cold the weather, any air admitted by them, instead of cutting the plants, as is the case when side sashes are open, will immediately, from its great specific gravity, descend at once into the cold-air drain, and become warm before coming in contact with the vegetation within the house. The number left open will, of course, be dependent on external circumstances; and when they are all closed, the hothouse resembles any other hothouse that is closed; and thus heating and ventilation are kept apart, the requirements of the two necessarily being different. Within the external walls is a walk round three sides of the house, in which are openings, *e*, leading into drains;—these drains converging into a main drain, as shown by the arrows. These drains are formed of brick on edge sides, and duchess slates for roof, the soil forming their floor. The main drain is 4 feet wide and 1 foot deep, so that by laying a brick flat and four courses high in the

centre, and bricks on edge at the sides, two common duchess slates reach to form the roof, and on these is spread some sifted soil to make the drain air-tight. The centre brick-work forms a support on which, in several places, to build up single brick piers to support the iron rafters which carry the slates on which rests the plunging-bed, as shown in longitudinal section," fig. 299. "This main drain,

which should be slightly on the descent towards the chamber, pierces the end wall of the hothouse, the foundation being left out at that point—the end wall of the house



being there carried by York flagging, with a centre support—and thus the means are provided for allowing the cold air to travel from the house to the chamber. The openings at *e*," fig. 298, in Mr Meek's house, "are regulated by sliding lids made of slate, for the purpose of experiment. This, for practical purposes, is unnecessary; and in many cases it will be found very convenient to make the cold-air openings in the centre of the house concealed by some ornamental stage, the floor of the walk forming the roof of the cold-air main drain; or handsome ventilators may be inserted at once in the roof of the main drain, to take down the cold air." These are points of minor detail, "the great and essential point being to provide a means for the cold air at the extreme end of the house to pass to the hot chamber. The outer wall of the hot chamber is  $4\frac{1}{2}$ -inch work,—is air-tight as far as regards the external air, having two openings on the side next the house on different levels, the lower one to admit the cold air, the upper one to allow its return when heated. The stove occupies

the chief portion of the chamber, standing isolated within it, except at the points where the fuel is supplied and the ashes removed, and where the return-flue passes into the chimney. The area left between the wall of the stove and the wall of the chamber is 2 inches, except on the side next the hothouse, where there is a larger area to allow the cold air to rise and flow over the plate; but it will probably," Mr Meek thinks, "be found desirable to sink the top of the stove to a level with the cold-air drain. The stove is formed of four walls of 9-inch brickwork; the outside measure is 5 feet 5 inches long, 4 feet 4 inches wide; the internal measure, therefore, 3 feet 10 inches long, and 2 feet 10 inches wide. Another wall of the same substance is carried up between the two ends, but not in the centre; it is 16 inches from the wall of the stove next the hothouse, leaving a space of 9 inches between itself and the farther wall. It will be seen by the plan, that this wall, and the one next the hothouse, form the actual furnace or fuel-box. In part of their length, where such is the case, they are built of fire-bricks, as are also the flues; and wherever the walls are likely to be much heated, they are Stourbridge fire-bricks, set in the same clay, being," in Mr Meek's opinion, "more durable than Welsh lumps. It will be well to parge the outside of the walls of the stove. The stove is 3 feet high, which allows 3 inches for paving of ash-pit  $\times$  1 foot for depth of ash-pit  $\times$  3 inches for depth of bars  $\times$  1 foot 6 inches for depth of furnace from bars to plating = 3 feet. The iron top is formed of three plates, with a view to allow for expansion. Two of these plates have extended rebates. They are 1 foot 6 inches one way, by 3 feet 6 inches the other; so that, when laid in their place, and the space for expansion between each allowed, they form a surface of 4 feet 7 inches by 3 feet 6 inches. This, by calculation, will be found to give them a 4-inch bearing on the four outside walls of the stove. Along the wall of the stove next the hothouse, a course of thin brick is laid, not close to the edge of the plating, but half an inch from it. The two end walls are carried up three courses higher in 4 $\frac{1}{2}$ -inch work; and so is also the outer wall; and between all these and the edge of plating there is a  $\frac{1}{2}$ -inch space. The purpose of this groove

is to fill it with sand, so that the plates can expand and squeeze up the sand, while, when they contract, this will fall back and keep the joint air-tight. I am assured, however," says Mr Meek, "by practical men of great experience, that it will be found quite unnecessary to have the plates cast in three pieces; that it will suffice if cast in one piece, provided it were cast with a loop round the edge, which should fall into a groove of sand, and that the plate would then expand in the loops: this will greatly lessen the danger of exhalation. The situation, as shown in

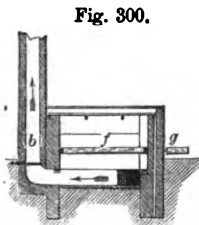


Fig. 300.

of the section fig. 300, the damper *b*, is bad. It should be placed exactly at the junction of the flue with the chimney; and it will be found to economise fuel, by preventing the loss of heat, if between the

brickwork forming the end of the chamber and the stove some non-conducting material, such as hair felt, be placed, and also if double doors be used for the furnace. I find the only loss of heat that takes place in the apparatus is from the furnace doors and the brick around them, and this might be prevented by the above plan. The doors employed are Sylvester's patent, which, for all purposes where the regulation of draught is required, seem to be the best that can be imagined. There are no hinges to rust, or machinery to get out of order, or screws to untwist: they simply hang on a frame, in which they slide, the edges of the door and frame being ground to fit. And another advantage which they possess is, that if any explosion should take place within the stove from a collection of gases, (and all economic stoves, where, of course, the combustion is slow, are liable to such occasionally,) instead of the boiler or plates being blown out of their place, these doors would be lifted outwards, and the evil consequences avoided. Within the chamber extending between the two end walls of the stove, and bearing slightly on the end wall of the hothouse, is a tank of water, *f*, divided longitudinally, 4 inches deep, as shown in the section, also by dotted lines in the ground-plan, supplied by a check-cistern from the outside *g*,

also, of course, divided. This may be furnished with a tap by which to empty it, or at which the gardener may always obtain water with the chill taken off. The roof of the hot-air chamber is formed of double slating, with a layer of M'Neil's hair felt, and 2 or 3 inches of sawdust between, and the upper surface is never warm. From these arrangements it is evident that the entire air of the hothouse must flow over the plating through the chamber, and back over the tank of water, (as shown by the direction of the arrows in plan and section,) and be returned back into the hothouse in a heated form through the upper opening. Here it is received into a large brick pit, (as shown by inner lines in plan,) and it is allowed to escape through slate ventilators from the sides and ends of the pit. Iron bars extend across this pit, and on these slates (thick duchesses) are laid: upon these some pebbles and a few inches of tan as plunging material. Those who have been accustomed to hot water," Mr Meek says, "may regard the cold-air main drain as the return-pipe, the chamber as an air boiler, the brick pit as a hot-air tank. They can be at no loss to understand either the arrangement or the principle, and to perceive that there is no difficulty whatever in reducing those principles to practice."

Such was Mr Meek's description of his Polmaise stove, considered to have been the perfection of the principle. Its advantages are stated by him to be—economy in erection and maintenance. "Compared with hot water," he is assured "that the first cost does not exceed one-half what the cost of the latter would be, to secure the same amount of bottom and atmospheric heat in the same house and in the same locality; that a healthy atmosphere will be produced by it; an equal distribution of heat secured, entirely independent of external circumstances; and that constant motion of atmosphere within the house maintained, which is so much wished for by cultivators in general."

In regard to the economy in the first erection, when compared with hot water, he is perfectly correct; but then a hot-water apparatus will last for probably a century; the bars in the grate will burn out in the one case in about the same time as in the other; a boiler will last

for twenty years, in which time as many Polmaise plates will be cracked and burnt out as will replace half-a-dozen boilers. The wear and tear of fire-bricks, be they Stourbridge lumps or any other, will be the same in both cases. The hot-water pipes, as we have already stated, will not be worn out in a century. How many cold-air drains, and hot-air drains, and duchess slates for covers will be broken or worn out in the same space of time? As many, we confidently assert, as will very nearly reverse Mr Meek's hasty calculation. Nor do we take into this calculation the many losses of crops of fruit, or collections of plants, which will fall a sacrifice to the economy of a Polmaise system of heating. In regard to the expense of maintenance—we mean fuel as well as hot plates and cold drains—a very slight knowledge of the properties and operations of heat must lead to the fullest conviction that double the amount of fuel requisite to heat a given space by a well-appointed hot-water apparatus, will not heat the same space if burnt under the most perfect Polmaise apparatus that has hitherto been constructed. Thus much for the economy of the principle, without taking into calculation the sleepless nights of the unfortunate wight who has to watch the hot and cold drains and cracked plates of a Polmaise stove, when the thermometer is travelling towards zero. It is rather singular that Mr Meek should enumerate, amongst the catalogue of previous errors in heating, that of placing the "stove in a separate building," and yet have fallen into the same error himself, as will be seen by the plan of his stove previously given. We think it scarcely possible for Mr Meek, or any one else, to heat a house of the same size for less money than has been done by both Mr Toy and D. T. F., as shown in their respective plans given in this work. As for the healthy atmosphere to be produced by this mode of heating, there is something anomalous in the very idea. Air is first passed over very highly heated metallic plates—this rendering it not only unfit for, but actually fatal to, vegetable life; and when, by this means, its utility has been destroyed, the attempt is made to restore it, to a certain extent, by causing it to pass over a cistern of water. Mr Meek says, in a foot-note,

p. 62, vol. ii. "Journal of the Horticultural Society,"—"My present tank, which is 5 feet long, by 3 feet 6 inches wide, and 4 inches deep," and placed over the hot-plate of his stove, "will evaporate fifty gallons per week." But how much of this vapour enters the hothouse he does not say; nor could he suppose that any very great proportion of it would do so, considering that his tank was placed over a stoke-hole without the house, and that aqueous vapour naturally ascends perpendicularly upwards, and not horizontally, as it would require to do, in order to gain admission within the walls of his house. How a healthy atmosphere is to be produced by these means, is, we confess, beyond our comprehension. Besides, fifty gallons per week is no very abundant supply of humidity to the atmosphere of a house 28 feet by 17 in surface area, and heated by a stove pre-eminently adapted for a manufacturer's drying-house.

As regards an "equal distribution of heat entirely independent of external circumstances," this is still more extraordinary, as it appears to us that "external circumstances" have most essentially to do with whatever distribution may take place in the matter; else why depend on the external supplies of air admitted by the openings *c c c* in the ground-plan, and from no other source whatever?

That a pretty constant motion of atmosphere within the house will be produced so long as the stove is kept warm, it is quite possible to believe; because, the air becoming highly rarefied over and around the stove, in consequence of its great heat, it naturally follows that the heavier and cold air entering at the numerous openings will rush in and be diffused through the house, so long as the air around the stove is kept warmer than the external atmosphere without; and this circulation will be increased as the heat about the stove is augmented, and *vice versa*.

However sanguine Mr Meek may have been as to the perfection of the Polmaise stove, he was not entirely blind to its imperfections. "Having noticed the advantages," he says, "of the Polmaise heating, I have no wish to conceal its dangers. Man may take the principles of nature, and when he reduces them to practice, he finds that he has introduced some human

imperfection; and so it is with Polmaise. A boiler may burst, or a pipe choke up with a hot-water apparatus, and a gaseous exhalation may escape from the stove of Polmaise. The compounds of sulphur and oxygen appear, even when much diluted, most prejudicial to vegetable life, and the effects of the bursting of a flue are well known; and this is the point of danger. I prophesy," he says, "that no winter, however severe, will affect the operation of Polmaise." But he at the same time candidly says—"But all the beauty of this principle of heating must be sacrificed, unless we can secure the chamber from gaseous exhalations. With this view, let me urge upon all those who may employ the Polmaise principle, to be extremely particular in the manner in which the stove is built. Let the outside be parged; let it be constructed of at least 9-inch brickwork; and if the iron plate can be cast in one, with a projecting rebate on its under surface, and this rebate dropped into a sand groove, fig. 301, it appears that all possibility of ex-

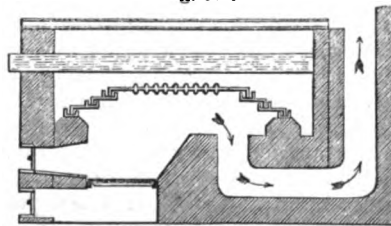
Fig. 301.



halation must be precluded. Indeed, if even this were insufficient, it is hardly probable that a sound principle of heating should be lost for want of some ingenious mechanical contrivance to prevent exhalation." Why employ metallic plates at all for covering, when fire-clay tiles, either in one piece or in several, would answer the purpose of heating, not only much better, but without half of the disadvantages the present stove possesses?

The annexed sections, figs. 302 and

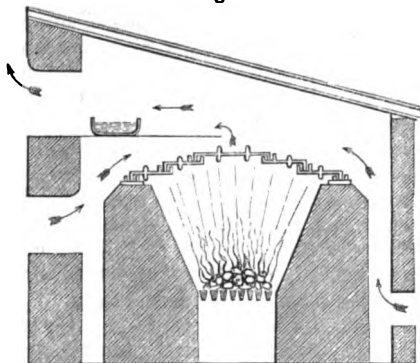
Fig. 302.



303, exhibit a modification of the Polmaise stove proposed by Messrs Burbidge

and Healy. Here, again, the roof of the stove is objectionable, being formed of

Fig. 303.



plates of metal made into compartments, with grooves to be filled with sand to prevent gaseous exhalations. It is constructed in separate pieces, to prevent fracture by unequal expansion. A fire-brick arch would have answered the purpose better, so far as the purchaser at least is concerned.

There can be no doubt of the purity of intention of both Mr Murray and Mr Meek—both since deceased; the one the imaginary inventor, and the other the staunch advocate, of this mode of heating. It is, however, to be regretted that, in canvassing the merits of the principle, so much ill feeling has prevailed,—and consequently error and prejudice have been promulgated, truths have been perverted, and assertions made which had not even the appearance of probability to support them. As a useful mode of heating, our own opinion is unfavourable to it; and we think, had it been designated the Polmaise mode of ventilating, rather than of heating, the title would have been more appropriate. What success may have attended its adoption in the south, we know only by report;—this much, however, we do know, that its utility in the north has not been very great; and, so far as we are aware, there are very few exemplifications of it even up to this time in Scotland. Even with regard to its success at Polmaise—in the neighbourhood of which, by-the-by, a few years ago, grapes ripened in the open air—we know that the grapes sent to Edinburgh for competition in September were scarcely

ripe, although otherwise good-sized fruit, such as might be expected from vines producing from *one to three* bunches each, and that for the sole purpose of exhibition. Its applications in England, so far as we are aware, have been upon so small a scale, that we can attach but little importance to the published results.

*Hazard's plan of heating* is thus described by him in a communication to "The Gardeners' Chronicle":—"I send a sketch of a range of garden houses—fig. 304 section, and fig. 305

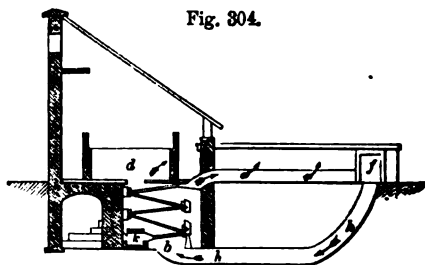
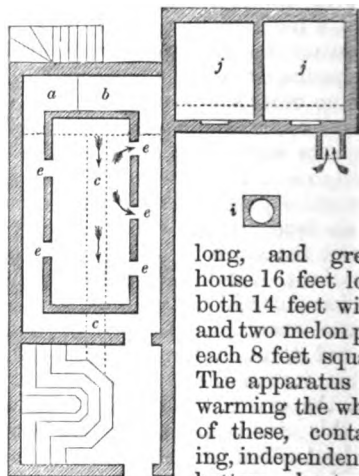


Fig. 304.

ground-plan—heated under my directions, comprising a forcing-house 30 feet

Fig. 305.



area of upwards of 8000 cubic feet, consists of a fire-box *k*, 18 inches by 16 inches, connected with the smoke-flue by a series of five rows of tubes, five tubes in each row. The heated gases produced by the combustion of the fuel traverse the whole of these pipes, affording a radiating surface of 200 superficial feet. The supply of fresh air is brought from *j*, and

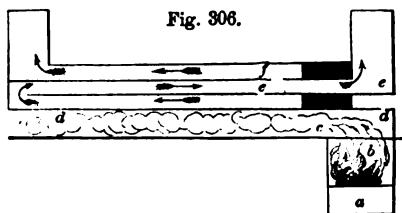
long, and greenhouse 16 feet long, both 14 feet wide; and two melon pits, each 8 feet square. The apparatus for warming the whole of these, containing, independent of bottom heat, an

after being warmed by contact with the tubes, is distributed over the different portions of the house, being first compelled, under the striking-pit *d*, to form a bottom heat. By this extended radiating surface, which has also the advantage of being throughout its whole extent in immediate contact with the source of heat, the gardener has been enabled to obtain an invariable temperature with only two attendances daily. I have," he says, "the satisfaction of adding, that this ventilating system of heating has proved uniformly favourable for plants in all stages, particularly when fruit is setting; and I have witnessed this process going on most successfully under the management above described, when the old plan of hot-water warming has not been able to produce the same result. The vapour appendage only now remains to be described: it is made of copper pipe, attached to the water-cistern, and resembles a fork with perforated prongs, through which water is made to drop at will upon the heated tubes, and may be so regulated as to continue imperceptibly saturating the atmosphere with moisture; or, by allowing a greater flow of water through the perforations, a steam is raised sufficiently dense to cloud the entire house in the course of a few minutes. Thus we have an unlimited power of producing artificial dew, which a consideration of the economy of nature shows to be largely required in hot climates, (else why so largely provided?) and while we strenuously endeavour to make an artificial tropic in our colder clime, we must not omit to imitate its inseparable concomitant—refreshing dew." References to figs. — *a* stoke-hole; *b* the chamber for the apparatus; *k* fire-box; *cc* hot-air drains; *d* striking pit, with bottom heat; *ee* ventilators; *f* mouth of drain, *h h* for supplying fresh air; *i* the chimney; *jj* melon pits. This mode of heating is almost identical with that of Polmaise; indeed Mr Garaway, of the Bristol nurseries, says in "Gardeners' Chronicle," in addressing the talented editor of that excellent paper, "With you it is known as Polmaise, but here as Hazard's system of heating."

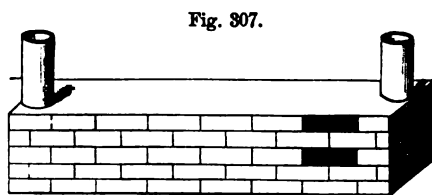
Here is another instance of two individuals, three hundred miles apart, and in all probability entirely unknown to

each other, inventing almost identically the same mode of heating at precisely the same period.

*Kendall's hot-air stove.*—Mr Kendall has taken considerable interest in the subject of heating by hot air; and as we think him one of the most reasonable and sensible advocates of the principle, we shall transcribe the following communication by him to the editor of "The Gardeners' Chronicle":—"In fig. 306 "*a* is the ash-



pit; *b* the furnace, with doors to shut up close when the fire is made up for the night, or when but little fuel is wanted—the furnace door is 12 inches square, and the bars 18 inches long; *c* is the brick box or flue, two courses high above the level of the furnace, supporting the bottom plate *d d*, which is of wrought-iron, 6 feet long and 22 inches wide, and about  $\frac{1}{4}$  of an inch thick, and which rests about 1 inch all round upon the brickwork. This forms a hollow chamber, in



which the fire has free play. On the top of this is built one course of brickwork, upon which is placed another iron plate *e*, similar to the first, leaving an opening at one end, (as shown by the arrows,) for the heated air to flow into the second chamber; again, on the top of this is built another course of bricks, upon which is placed a third iron plate *f*, forming a second chamber, through which the air passes rapidly to the raised opening formed by the chimney-pot *h h*, on fig. 309, where it escapes into the house just above the shelf upon which the plants are



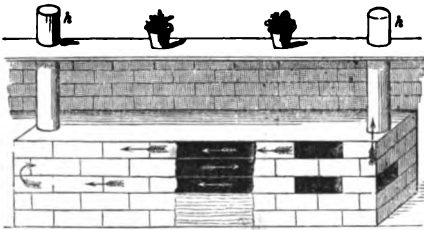
set." Again, on the top of this is built one more course of brickwork similar to the others. This is closed in with slates, and forms a third chamber unconnected with the others, having a distinct opening for the cold air of the house to flow into, as shown by the black

Fig. 308.



square, and also a distinct outlet into the house, thereby dispersing the hot air, which would otherwise be only radiated from the uppermost plate of the chamber. The whole of the apparatus, except the furnace doors, is placed within the house, and occupies a space of only 7 feet by 2½ feet, exhibiting the appearance represented by figs. 307 and 309.

Fig. 309.



"I am aware," says Mr Kendall, "that by applying so high a heating power I am laying myself open to criticism; but to all who feel disposed to apply the lash, my answer is, 'It is well to have a giant's strength,' but yet we need not 'use it like a giant.'"

*General remarks on hot-air stoves.*—Among the many objections we have to such stoves, are their being constructed of iron,—and that so thin in body that they cannot retain sufficient heat in cases where the fire is accidentally allowed to get too low; and also that the heat given out by them is much too great when the fire, from accident or carelessness, is allowed to become too great. They are also soon worn out in consequence of being exposed to damp without and the vapours from the coal within, and will therefore become expensive in

the end in consequence of requiring frequent renewal. And lastly, and worst of all, we may mention the deleterious effects they have upon the air passing through them, or heated by them, which will be noticed more at length hereafter. If hot-air stoves are to be used at all, they should be built of brick, and on the principle long ago laid down by Count Rumford, with probably the addition, as suggested by Dr Arnott, of giving greater depth for the reception of the fuel, so that a fire may be maintained within them for eight or ten hours. Count Rumford, as we have elsewhere remarked, introduced into use double doors to his furnaces and stoves, with ash-pit doors fitting close to the frame, and regulating the admission of fresh air, for the purpose of carrying on slow and progressive combustion through a well-appointed register in the centre of the ash-pit door. Dr Arnott carried his improvements still farther, by adding greater depth to the receptacle for the fuel, as well as perfecting the admission of air to support a slow and steady combustion. The Chunk stove varies the application of this principle, but not conveniently for hot or green-houses, because it is not calculated for a perpetual fire. An anonymous correspondent in "The Chronicle," on this subject remarks: "The Vesta stove offers greater advantages for the purpose; and, where the fire-place is required large enough to become necessary to place it outside the house, I think," he says, "it may, with some variation, be adapted to the purpose. Under these considerations, and having a fire-door and ash-pit register that had belonged to a Rumford roaster, I fitted up a small greenhouse on the plan here suggested. The cubic dimensions of the greenhouse inside are about 1260 feet; the area of the glass 220 feet; the back and end walls have an area of about 260 feet. The fire-place, with the door inside the house, is 8 inches by 9 inches within; the flues, passing backward and forward over each other," a very bad plan, "are nearly 30 feet long before entering the chimney. As to its effects, we have kept the fire in for three weeks or more without re-lighting,—and have had rather more than sufficient heat at times, from the want of experience in the early part of the experiment. I had coals weighed at the most severe period of the

season, when the thermometer was little, if anything, above zero, when we found the cost of the anthracite or Welsh coals was within threepence for the twenty-four hours."

The opinion of Thomas Sabine Pasley, Esq., on hot-air heating, taken from the same authority as the last, accords in many respects with our own. Although advocating this system of heating as applied to churches and dwelling-houses, having had ten years' experience of it, he says, "The principle of my apparatus is to *heat a large quantity moderately, and not a smaller quantity to a high temperature*; and for this reason, that the air may not be burned, as it is called, *by a too hot iron surface*. Nevertheless, *the close dry feel* which we sometimes experience when the same air is circulating, would be insupportable if we could not remedy it by the admission of fresh air. My heating surface, and that of our church, are iron. I am inclined to think *brick would be a better material*. First, because the air could not be burned by passing over it, since *the brick would hardly ever, if ever, become so hot as iron does*; and secondly, because *the temperature would be more equable*. For I consider it a very great objection to my furnace and heating apparatus, that, *unless it has constant attention, the fire burns low and goes out. The metal then rapidly cools, and we find a stream of cold air rushing into the house, instead of hot*;—and this although the hot-air chamber is in the cellar, where, by theory, nothing but warm air can ascend; but we do find cold air blow in." He further observes, "that he has no objection to this mode of heating on the score of salubrity, provided a sufficient quantity of air be admitted from the outside, and that the heating surface be not too hot." But he continues, "It is certainly dry, and subjects all unseasoned wood, whether in stairs, doors, floors, or furniture, to a severe test. *We find much dust carried about the house when the slightest defect occurs in the heating apparatus; then, of course, noxious gases must escape, and danger is incurred of setting fire to the house.*" Such is the opinion of one very competent to form a correct estimate, and of one who is unprejudiced. We have put those parts in italics which accord most with our own views.

The following critique upon the work-

ing of the Polmaise hot-air stove as existing in the pine-house of Mr Meek, the well-known advocate of the system, and whose arrangements, as the most complete, we have already fully detailed, is by Mr W. P. Ayres, one of the most intelligent gardeners of the day. "At the time of my visit," says Mr Ayres, "December 5th, I was suffering from a very severe cold; but, notwithstanding this, I could recognise the old enemy of over-heated masonry, and its concomitant effects of scorched leaves, mildew, and the usual accompaniments of the old flue system. The heat was perfectly dry; the water, for some reason which did not transpire, having been drawn off from the evaporating tank,—probably because Mr Meek found that, when throwing in heat at 194°, charged with moisture, into an atmosphere of 57°, he obtained more moisture than was altogether consonant to vegetation in mid-winter. Hence, then, to avoid Scylla, he was obliged to run upon Charybdis. I have little doubt that to maintain a temperature of 70°, with the external thermometer at 10°, and a tolerably sharp wind, Mr Meek would be obliged to throw in his heat at 300°; and as the whole air of the house must pass over this plate scores of times every hour, I will leave practical men to judge what kind of an oven these plants would be in, and what drains there would be upon them for moisture under such circumstances; or, even supposing moisture was supplied by the tank, the plants would then be in a Scotch mist. These things, it is true, might be avoided by extending the radiating surface, or by cooling the air in an intermediate chamber before it was supplied with moisture or admitted into the house;—*but where, then, would be the economy?*" Mr Meek's present arrangement is calculated by Mr Ayres to have cost not less than £20, and, with hard forcing, would require new plates every second or third year; while £30 expended upon a hot-water apparatus would give any required temperature, and last a lifetime. "As for economy in the consumption of fuel," Mr Ayres proceeds, "the thing is absurd, and I have no hesitation in asserting that Mr Meek loses more heat up the chimney of his stove than I do from a hot-water apparatus which has six times the work to do." In regard to

the heating of the bark bed by hot air being admitted under it, Mr Ayres found, instead of a uniform heat, that at "one end the temperature was little more than 70°, while, where the heat entered, the bottoms of the pits were so hot, I could scarcely bear my hands upon them. The grand fundamental error of the system is that of radiating heat at a high temperature; and it may be laid down as an incontrovertible and established fact, that no system which does that, whether it be hot air or hot water, is capable of generating a fine, genial, and healthy atmosphere either for plants or man."

Regarding the unwholesomeness of atmospheres heated by iron hot-air stoves, Dr Ure remarks—"When coke is burned very slowly in an iron box, the carbonic acid gas which is generated, being half as heavy again as the atmospherical air, cannot ascend in the chimney at the temperature of 300°, but regurgitates into the apartment through every pore in the stove, and poisons the atmosphere. I have recently," says Dr Ure, "performed some careful experiments upon this subject, and find that, when the fuel is burning so slowly in the stove as not to heat the iron surface above the 250th or 300th degree of Fahr., there is a constant deflux of carbonic-acid gas from the ash-pit into the apartment. This noxious emanation is most easily evinced by applying the beak of a mattress, containing a little Goulard's extract, (solution of subacetate of lead,) to a round hole in the door of the ash-pit of a stove in this languid state of combustion. In a few seconds the liquid will become milky by the reception of carbonic-acid gas."—*DR URE'S Dict. of Arts, &c.*

The same authority also observes, as to the unwholesomeness of hot-air stoves, particularly such as are wholly or in part constructed of iron, that "as cast-iron always contains, besides the metal itself, more or less carbon, sulphur, phosphorus, or even arsenic, it is possible that the smell of air passed over it in an incandescent state, may be owing to some of these impregnations; for a quantity of noxious effluvia, imperceptibly small, is capable of affecting not only the olfactory nerves, but the pulmonary organs. He also states a case at great length of the dangerous effects of heating air by mak-

ing it pass over highly-heated iron plates, as having occurred to the persons employed in the long-room in the custom-house of London, nearly all of whom were attacked with severe illness." Not only is the air rendered unhealthy by being brought into contact with heated iron plates, but even were it otherwise, the equal diffusion of air, and still more, conducting it to a distance from the fire, appear to be so little under the control of man, that we are really surprised to see so many otherwise intelligent men, and men for whose general opinions we have so much respect, advocating a system so void of utility, and pregnant with evil. Steam and hot water may be, and have been, carried for hundreds, nay, thousands of feet from the boiler; hot air, even at Polmaise, scarcely thirty.

#### § 6.—HEATING BY STEAM.

Heating by steam, so far as hothouses, &c., are concerned, is now so completely superseded by hot water that our observations on it need only be brief.

It appears pretty certain that the celebrated lawyer, Sir Hugh Platt, was the first to suggest steam as a heating medium for horticultural purposes. In his curious work, "The Garden of Eden," p. 19, an account of his method is given. Colonel William Cook, in 1745, improved on Sir H. Platt's plan; and in 1755, we find that it was suggested as a method for forcing fruits. The celebrated Watt reduced these hints to practice; and the philosophy of the method was first explained by the no less eminent Leslie. In or about 1789, Mr Boulton heated a room in his house by it, and soon afterwards a bath also.

The first successful application of steam for heating a hothouse was made by Wakefield of Liverpool, in 1788; and patents were first granted to Hoyle of Halifax, and soon afterwards to Green of London.—*Vide Rep. of Arts, vol. ii. p. 304, and vol. i. p. 304.* The principle of the former was to convey the condensed steam back to the cistern that supplied the boiler; that of the latter consisted in carrying a worm-pipe through the boiler containing hot water or steam, with a view to moderate the heat, and keep the

air in a fit state for respiration. Another improvement of Green's was to place the pipes conveying the steam from the boiler within other ones of larger calibre, admitting external air into the space between them to become heated; which air he conveyed to where the heat was most wanted. The same gentleman also heated a vinery and plant-house by steam at Hammersmith, where it gave great satisfaction. In 1793, Mr Butler, then gardener to the Earl of Derby, heated melon and pine pits by steam, by conveying it under the bark or dung-beds, and allowing it to escape amongst the pots—and hence was the first of the profession to apply it to forcing purposes. In the same year, Mr Mawer, who had seen and approved of these experiments, heated a large range, consisting of seven hothouses, by steam at Dalry, near Edinburgh, which had formerly been heated by smoke-flues in the ordinary way. Considering how little was then known of the principle of steam, it is not a little singular that Mawer's plan, although simple, was practically so perfect.

"The extension of the principle," says Bernal in "History of Heating," &c., "was much promoted by Mr Buchanan of Glasgow, particularly by a pamphlet that he printed on steam-heating, in 1807, and which he enlarged a few years afterwards with a description of his apparatus. Nothing of value to a practical man, or in which he should have the least confidence, has since been printed."

Hay of Edinburgh, the eminent garden architect, employed steam in and after 1807, in many places in that county where he was employed. Descriptions of his methods have appeared in the "Memoirs of the Caledonian Horticultural Society." Various plans and descriptions of steam-heating will be found in "The Gardeners' Magazine," "Horticultural Society's Transactions," &c.; and it may be seen exemplified in the most perfect way in the nursery of the Messrs Loddige at Hackney, and the plant-houses in the garden of the Duke of Northumberland, at Sion House, Middlesex, both upon a very large scale, and in various other places upon a more limited one.

The advantages of heating by steam are thus given by Mr Loudon in "Ency-

clopædia of Gardening," p. 592:—"It is not, however, the genial nature of steam heat which is its chief recommendation for plant habitations, but the equality of its distribution, and the distance to which it may be carried. Steam can never heat the tubes, even close to the boiler, above 212°; and it will heat them to the same degree, or nearly so, at the distance of 1000, 2000, or an indefinite number of feet. Hence results the convenience of heating any range or assemblage of hot-houses, however great, from one boiler, and the lessened risk of over or insufficient heating at whatever distance the house may be from the fire-place. The secondary advantages of heating by steam are the saving of fuel and labour, and the neatness and compactness of the whole apparatus. Instead of a gardener having to attend to a dozen or more fires, he has only to attend to one; instead of ashes and coal, and unsightly objects, at a dozen or more places, they are limited to one place; and instead of twelve paltry chimney-tops, there is only one, which, being necessarily large and high, may be finished as a pillar, so as to have effect as an object. Instead of twelve vomiters of smoke and flakes of soot, the smoke may be burned by using" one of the now many smoke-consuming furnaces. "The steam-pipes occupy much less space in the house than flues, and require no cleaning. They may often pass under paths where flues would extend too deep. There is no danger of steam not drawing or circulating freely, as is often the case with flues, and always when they are too narrow or too wide, or do not ascend from the furnace to the chimney. Steam is impelled from the boiler, and will proceed with equal rapidity along small tubes or large ones, and descending or ascending."

Such are the advantages of heating by steam, stated by one of its greatest advocates. The following are the disadvantages also given by the same authority:—

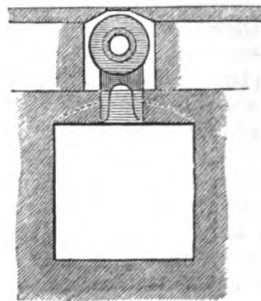
"On a small scale, it is more expensive than smoke flues, and more trouble is required to attend to one boiler, than to one or even two or three furnaces. It is also somewhat more expensive than heating by hot water."

Steam, as a medium of heating by itself, is far too volatile. It travels with great rapidity, and gives out its heat

rapidly. It is therefore by no means the best mode of heating plant-houses where a uniform or steady heat is required, unless it is made the medium of heating other bodies, such as water or masses of loose stones, either of which, when once heated, gives out its heat regularly and slowly. Mr Hay of Edinburgh employed steam to heat masses of loose stones which formed the bed on which the plants grew. Roundish, hard, water-worn stones, or broken granite, are preferred, as being less liable to crumble away than soft sand-stones. The steam-pipe is introduced at one end of such a bed, near to the bottom, and carried right through it. It is finely perforated with holes along both its sides for the free escape of the steam amongst the stones. "The steam only requires to be introduced once in twenty-four hours in the most severe weather; and in mild weather, once in two or three days is found sufficient. After the steam is turned on, it is kept in that state till it has ceased to condense among the stones, and consequently has heated them to its own temperature. This is known by the steam escaping either through the soil over the stones, or through the sides of the pit; or where a mass of stones is enclosed within a case of masonry, as in the stone flues in the Bristol nursery, the point of saturation is known by the safety-valve of the boiler being raised."—*Encyclopædia of Gardening*, p. 593. Such being, therefore, the case, might not the waste steam of manufactories, or other works using steam-engines, be brought to a useful purpose in the forcing of fruits or flowers for the proprietor's own use, or even for supplying the public markets? We recollect to have seen steam employed to heat cisterns and pipes of water some years ago in the Bristol nurseries, and also to heat masses of stones enclosed within walls of masonry. The former of these plans had been even before that period exemplified by Count Zubow, at St Petersburg. Mr Stothert of Bath carried heating by steam, by heating cisterns of water, and also beds of stones, to a very considerable extent. Steam was applied in the garden of Mr Sturge, near Bath, to heat the atmosphere of a hothouse, making it the agent for conveying the heat to pipes of water, and carrying the small steam-pipes through

the larger containing the water. This we think an excellent adaptation of steam, and one which may be of advantage in

Fig. 310.



large places, more especially when the hothouses are detached from each other. The following figs., 310, 311, and 312, and description, from the "Encyclopædia of Gardening," p. 595, will explain its operation:—"The water-pipes are 8 inches in diameter, and about 28 feet long,"

Fig. 311.



Fig. 312.



which we presume to be the length of the house to be heated; but if not, there can be no reason why it should not. "The steam-pipe, of 1 inch in diameter, entering at the centre of one end, and proceeding in rather an inclined direction to the other, is then returned still inclining, and passed out at the bottom of the bore immediately under the place where it entered. It is then formed into a siphon, *b*, about 3 feet deep, whence the condensed water is conveyed away. A smaller pipe is also connected with the top of the large one, to receive the increase of water by expansion when heated, which, as the large pipe cools, returns into it again. Fig. 310 shows the arrangement of the front pipe under the floor. The air being admitted from the air-chamber underneath, through an opening extending the whole length of the pipes, and passing through the upper chamber on each side of the pipes, is discharged through the grating into the house. The arrangement of the back

pipes is similar. Shallow cisterns are connected with the upper part of the pipes, fig. 311, about 18 feet from each other, by means of hollow screws, shown at *a*, fig. 312, which admit the water to pass to and fro reciprocally. The capacity of the cistern is more than sufficient to receive the increased bulk of the water, which expands when heated, and returns again to the pipes as the water cools. The external diameter of the front pipes in this instance is 13 inches, and of the back pipes 10½ inches. Each set of pipes is divided in the middle of their lengths, except that the nearest division of the front pipe returns about half way round, the end being in length rather more than 60 feet. These water-pipes have inch-and-quarter steam-pipes extending in them their whole length, and returning again, preserving a regular inclination throughout. The back pipes have steam-pipes 1 inch in diameter passing through them in a similar way; and the feeding-pipes are so arranged that either division of the pipes may be heated separately or in conjunction with the rest. Another advantage of applying this mode of heating is, that as no returning-pipes are necessary, as in the common hot-water apparatus, the bulk of water is doubled, with the same extent of heating surface, and the retaining power of the apparatus is doubled accordingly. The cisterns are farther serviceable for regulating the humidity of the house, which can be done with the greatest accuracy by attending to the covers."

We have stated that, in extensive ranges like that at Sion House, steam may be most advantageously applied; still, on the other hand, we find far larger spaces heated by hot water, as those of the large conservatories at Chatsworth, and the new palm stoves at Kew.

In drawing a comparison between the advantages of heating by hot water and heating by steam, it may be observed that, in the former case, it is not desirable to raise the water to the boiling point, (212°,) because, in such a case, steam would be formed, and, escaping by the top of the boiler or otherwise, would abstract much useful heat from the apparatus. In the latter, on the other hand, the water must be maintained at 212°, because, at a lower temperature, the

steam would condense, and also absorb much useful heat. And to effect this temperature, a much greater consumption of fuel must take place. From the necessity of maintaining the temperature of 212° in steam-pipes, it is evident that a given length of steam-pipe will afford more heat than the same quantity of hot-water pipe; but remarks by Hood on the relative permanence of temperature of the two methods quoted at p. 191, will show an advantage in favour of the hot-water system.

### § 7.—BOILERS AND PIPES.

Of boilers, there is now a great variety, as the illustrations in this work will show. As it is in form that these principally differ from each other, we may here observe that that form must be the most perfect which presents the greatest extent of surface to the action of the fire, either at bottom, through the centre, or over the sides; but, at the same time, complicated forms should be avoided. The rage for improvement in this department has led to an endless number of odd shapes, as if it was supposed that the contriver who hit upon the most out-of-the-way form had achieved the greatest feat; while a large portion of the public, ever on the scent for novelty, have from time to time been severely bitten. The more whimsical and unphilosophical the form, the greater the expense; the more intricate and complicated, the more likely it is to get out of order; while such forms are not calculated to stand the wear and tear which those of more simple construction do. Copper, zinc, wrought and cast iron, and latterly lead and earthenware boilers, have been recommended. Of these, we prefer cast-iron, as being the strongest, and as less liable to corrosion than wrought-iron. The metal requires to be of excellent quality, and carefully cast, so as to be of equal thickness throughout, else they are liable to crack upon fire being applied to them for the first time, on account of the inequality of expansion; and for this purpose they should be gradually heated when first subjected to the fire.

Copper is expensive, and zinc can only be safely used upon a very small scale, and, like copper and lead, it is incapable

of resisting great pressure, unless very thick or supported with iron hoops. This latter is, however, not a safe precaution, on account of the unequal expansion of the different metals. We have in use, in the Dalkeith gardens, leaden boilers which have stood the test of six years' constant firing: they are of lead, weighing 16 lb. to the square foot, and have the merit of heating rapidly, and are of course not liable to oxidation, which all iron boilers are.

Malleable iron, being somewhat thinner than cast-iron, heats sooner. Boilers made of it are, however, much more expensive, and, in consequence of their natural tendency to oxidize, soon wear out. Water impregnated with lime is very destructive to malleable-iron boilers; and there are other matters often contained in water equally pernicious to them. The very best steam-boiler plates we could procure have been used by us; and in no case has any malleable iron boiler in general use lasted seven years; while we have cast-iron ones, exposed to the same tests, which have lasted fourteen years. Our preference has long been in favour of the latter.

For ordinary purposes, malleable-iron boilers, where the pipes are laid level, or little elevated above the boiler, may be of  $\frac{1}{8}$  of an inch in thickness; but such boilers as are placed much below the level of the pipes should not be less than  $\frac{1}{4}$  of an inch, as the pressure upon them is very considerable. This is the usual thickness for steam-boilers of the greatest power.

Earthenware boilers are longer in heating than metallic ones, but they have the property of retaining the heat much longer. As regards strength, they are fit for the horizontal mode of circulation, as the pressure in that case is very trifling;—we would not recommend them when great pressure is apprehended. As to their durability, so far as experience has shown, they will last probably as long as any of the metallic ones; but this entirely depends on the clay of which they are formed.

As regards the size of boilers, the extremes of too large and too small ones should be alike avoided. The advocates for large boilers say they will keep their heat much longer after the fire is extin-

guished; but it should also be kept in mind that they take an equally greater length of time to become heated; nor will the circulation be so rapid as in one of smaller dimensions. The opposite extreme is sometimes fallen into by having them too small; hence repulsion takes place between the iron and the water, the latter not receiving a sufficiency of heat; and the higher the temperature of the iron becomes, the greater is the repulsion;—so that, when it becomes red hot, water is completely repelled, and the iron will scarcely communicate heat to it unless under great pressure.

The surface which a boiler ought to expose to the fire should bear a proper proportion to the length of pipe that is to be heated by it. The following table of proportions of surface which a hot-water boiler ought to bear to the length of pipe is given by Hood, assuming the difference in temperature between the pipes and the atmosphere to be heated to be 140°—that is, the pipe being 200°, and the air to be heated 60°:—

Surface of boiler exposed to the fire.	4-inch pipe.	3-inch pipe.	2-inch pipe.
3½ square feet will heat	200 feet.	266 feet.	400 feet.
5¼	300	400	600
7	400	533	800
8½	500	666	1000
12	700	933	1400
17	1000	1333	2000

There are causes, however, which alter these proportions,—such as the construction of the furnace, the height of the chimney, fuel, draught of flue, smaller degree of temperature to be communicated to the atmosphere than that assumed above, &c. If the difference of temperature between the hot water and the air to be warmed be 120° or 100°, instead of 140°, then the boiler in the former case will heat one-sixth, and in the latter one-third more pipe than is stated in the table. That table affords, however, the best data we have at present for forming a correct estimate of the proportion that should exist between the boilers and pipes.

On this subject Mr Ainger, in "Gardeners' Chronicle," makes the following remarks:—"The proper size of the boiler and fire-grate have been made the sub-

ject of elaborate calculation, which the imperfections and uncertainties of the practical details render of little value. The following, as a general rule, will be found, perhaps, as good if it were demonstrated by algebraic formulæ:—Take the cubic contents of the house, and for half-hardy plants give to every 100 feet 10 square inches of boiler surface, and 1 square inch of fire grate. For tropical plants, double these proportions; and for forcing-houses, take intermediate proportions according to the temperature required." 2000 feet of pipe-surface is found sufficient to heat the large conservatory at Chiswick, containing 100,000 cubic feet of capacity, and 11,000 square feet of glass. This, with ease, commands a degree of heat 30° above the external temperature.

Much depends upon the distance that the pipes are apart from each other at their junction with the boiler, as regards the insuring a proper circulation. That distance should not be less than 16 inches from centre to centre of 4-inch pipes of ordinary length, where they have not to dip under the level of the top of the boiler. For general purposes, where the boiler is not more than 18 inches deep, it will be better to take the flow-pipe off from the top, and insert the return-pipe as near to the bottom of the boiler as the joining can be safely made. Where the pipes are less than 4 inches, and extend 50 or 60 feet from the boiler, with only one turn, the above precaution is of less consequence, as the water will be considerably cooled before its return to the boiler.

The proper size of pipes requires some consideration; for, at first sight, we might be led to suppose that the main feeding-pipe, which proceeds from the boiler, and has to supply several circulating ones, ought to be of area equal to that of all the circulating pipes together. This, however, is not the case. A 4-inch pipe will serve a supply to four pipes of like diameter; but beyond this number it will be prudent to increase the size of the feeding-pipe, more especially if the circulating ones extend to a length exceeding 50 or 60 feet; but this increase of size need not exceed the above proportion, as the velocity in the main pipe is increased, in proportion to the num-

ber of branches, to the limits above stated.

Small pipes should be employed, say of 4-inch diameter at most, when the water is to be conveyed to a distance from the boiler, as in the case of two or more houses being heated at the same time, and at some distance from each other; as a pipe of the above dimensions, while it is sufficient to afford the supply, loses only one-half the heat which a pipe double the size would do, the water flowing four times as fast in the former as in the latter case, and the loss of heat in the water being not in proportion to the velocity, but to the length of circuit. Pipes so circumstanced should be laid in an air-tight drain, as air in a stationary state is a powerful non-conductor; or they may be embedded in charcoal, or some other equally non-conducting material. Indeed, smaller connecting or feeding pipes than the above have been successfully employed—even 2-inch pipes to supply 4-inch radiating ones.

It is not easy to say how far hot water may be carried in pipes enclosed in air-tight drains, but certainly much farther than has yet been attempted. The most proper drain for this purpose is the double-walled barrel, (fig. 313,) or one with upright sides and circular top, (fig. 314;) as

Fig. 313.

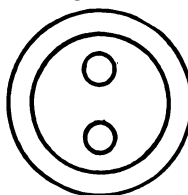
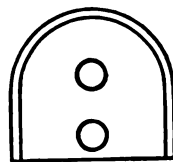
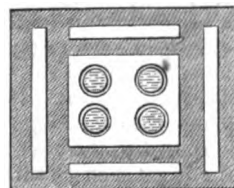


Fig. 314.



these, together with the elliptical or egg-shaped, are the strongest of all drains, and have, at same time, the property of throwing off the water from above

Fig. 315.



them. Mr Ainger, in "Gardeners' Chronicle," has proposed a square drain or tunnel, with double sides, as in fig. 315; and recommends that both ends be open, "the

one opening into the atmosphere of



the house, and the other into the external air. The supply of cold air entering at one end will take up and propel the heat given out by the pipes, and carry it into the house, with a portion of pure air highly beneficial to the plants." This would be all very well where the distance between the boiler and the house to be heated is not great; but if that distance exceed 30 or 40 feet, it will be more advisable to carry the pipes in drains as completely air-tight as possible.

Larger pipes can only be advantageously employed when it is desirable to keep up a certain temperature without keeping up at the same time a constant fire. This is seldom necessary, nor does it appear that there is any advantage in it as regards the economy of fuel. 4-inch pipes are, therefore, the most proper size to use for hothouses in general, although 3-inch ones may be employed in heating greenhouses and pits.

The form of pipes in general use is very properly round, not only on account of their more convenient manufacture, but also because in that form they are better adapted for giving out heat by radiation. Flat pipes have been recommended as presenting a greater upper surface; but this is rather a defect than a merit, as the greater part of the heat given out by them ascends perpendicularly upwards, and will, therefore, produce less beneficial effects to the surrounding atmosphere. Moreover, the warmer such pipes are made, the loss of heat is the greater; for it is well known that the relative proportion which radiation bears to conduction increases with the temperature.

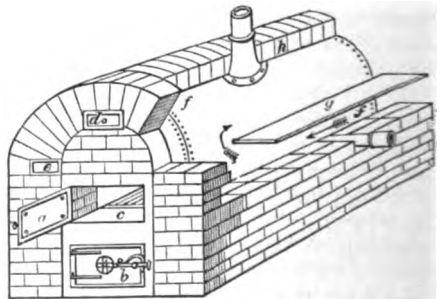
One of the most important points to be understood and acted upon, in the arrangement of a hot-water apparatus, is the proper setting of the boiler. Every bricklayer professes to have a plan of his own, when, indeed, very few of them understand the first principles of the matter. Boilers are, in general, set as if the object of the setter had been to try how much fuel could be consumed so as to produce the least possible effect. It is reasonable to suppose, that the larger the surface of boiler exposed to the direct action of the fire, the greater effect will the fire have on it, the sooner will the water become heated in it, and the less

amount of fuel will be required to produce that effect. The earliest constructed boilers were ill adapted for abstracting the amount of heat contained in the fuel burning under them; and the directions laid down by the earlier advocates for hot-water heating were far from being founded upon correct principles; for, in most of them, fully nine-tenths of the available surface was not exposed to the action of the fire at all. The force of the fire was made to act upon only a small portion of their surface, and the boiler in general was set much too close to it—thereby preventing the radiant heat from acting beneficially upon them.

On the subject of setting boilers, Mr Glendinning, in "Journal of the London Horticultural Society," remarks: "Badly designed boilers, when well set, often answer beyond expectation, and even to the astonishment of the contriver; whereas, boilers constructed upon the best principles, when improperly set, have failed. In the latter case the heat is not advantageously applied." The intelligent authority just quoted says, in continuation: "Mr Hood's method of setting the arch-boiler cannot fail to answer when properly carried out, as I have amply proved. It appears to me, however, that, for large houses, a greater increase of the piers of the arch would be an improvement, as thereby affording more room for fuel. Beyond this, as far as my own experience goes, it seems to be the best source of warming yet devised, combining, as it unquestionably does, both efficiency and economy."

The following illustrations, figs. 316,

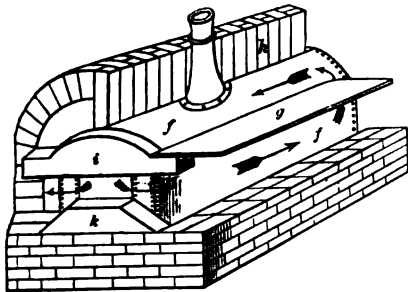
Fig. 316.



317, and 318, from the work quoted above, appended to Mr Glendinning's

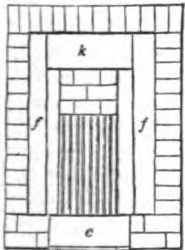
excellent article, will show Mr Hood's method of setting his arched boilers. *a* is the furnace door; *b*, ash-pit; *c*, the

Fig. 317.



dumb or carbonising plate; *d* and *e*, small iron doors, for the purpose of extracting the soot from around the boiler;—a corresponding one on the opposite side is not shown, as the brick-work is supposed to be removed, to show the side of the boiler; *ff* are the upper and lower flues which pass round the boiler, separated

Fig. 318.

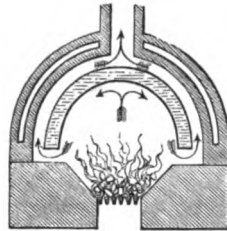


by an iron flue-plate marked *g*; *h*, a brick separation of the flue on top of the boiler; *i* and *k*, two fire-clay lumps, placed close to the back of the boiler. The space between them is from  $3\frac{1}{2}$  to  $4\frac{1}{2}$  inches, according to the size of the boiler and height of the chimney. This opening is the only passage for the flame and smoke to pass through from the furnace into the flues. We have no doubt this latter contraction has a tendency to retain the heat longer in the oven of the furnace before it escapes into the chimney, and is consequently lost.

On the same subject we have the following remarks from Mr Ainger, in his *Essays On the Production, Distribution, and Preservation of Heat, &c.*, published in "The Gardeners' Chronicle:"—"In the examples of boiler-setting usually published, not more than one-half or a third"—this is estimated much above the truth—"of the lower surface is exposed to the direct radiation from the fire, everything being sacrificed to the close contact of the fire with the water, and to the

supposed efficacy of the air-carried heat in the circuitous flues. In this respect the conical boiler of Mr Rogers is a decided improvement, as it exposes the whole of its inner surface to the direct action of the fire, while it retains the error, as I deem it, of burning its

Fig. 319.



fuel within cold walls." In the accompanying fig. 319, Mr Ainger explains his idea of efficient boiler-setting:—"The boiler in the figure may be considered either as a hemisphere or as a semi-cylinder with

the ends closed, presenting to the fire in either case an inverted chamber, from which no gaseous matter escapes but by descending to the lower edge, which, being supported only at intervals, leaves an almost uninterrupted channel for the flame and smoke to play round the whole upper surface. The fire is contained in a brick case, so situated that every part may radiate freely to every part of the under surface of the boiler; and this free radiation, to so large and so favourable a surface of heat, reduced by distance to that degree of intensity which is favourable to its absorption by the water, will exhaust, I believe, a very large portion of the effective power of the fuel, which, under such circumstances, may be of any description, and may be burned subject to the most perfect control. The dotted arrows show the probable course of the flame and gaseous products, the heating powers of which must be sufficiently exhausted by the whole upper surface of the boiler, and of the arched vault in which it is contained: their escape would of course be limited, as usual, by a valve in the flue."

"I feel confident," he continues, "however, that the heat obtained from the smoke flues is very trifling compared with that obtained from the radiation of the fuel itself, provided that radiation has fair play. Bad combustion not only produces less heat, but it interposes between the fuel and the boiler a cloud sufficient to intercept we know not how much of the already impaired heating power; and

when the fire, after wasting a prodigious quantity of fuel in the shape of soot, becomes cleared, the heating power which results for a short time is too great for the small quantity of boiler surface exposed to it, and a repellent action ensues between the over-heated iron and the water, similar to that in the well-known experiment of the drop of water in the red-hot capsule. Thus, in a boiler-surrounded furnace, every part of the process is bad. There is, first, imperfect combustion, and consequently a small portion of heat, rendered effectually still smaller by the screen of smoke between the fuel and the boiler; and there is, next, good combustion—too good, indeed, for the distance and quantity of the surface upon which it is to act.”

“It seems rather paradoxical to assert that the boiler can be too close to the fire; and when I have quoted,” he continues “the brassfounders’ furnace as an example of good combustion, the reply has been, that the founder closely surrounds his crucible with the fuel. And he does rightly, because the melting point of brass is something like 3800°, being fully four times greater than the red heat which is sufficient to excite the repellent action between metal and water, and to stop the farther transference of heat from the one to the other.”

Mr Rogers’ conical boiler, which is, in many respects, of a good form, would be, nevertheless, Mr Ainger thinks, “more effective if set upon principles more resembling that in the annexed fig. 320. The simplicity of the circulation in this and the former case will be no recommendation to many persons; but I have,” he says, “little fear in appealing to



experience on this point.”

“With all the care that can be taken, much heat will unavoidably be lost from the exposed surface of the boiler and

furnace. Where practicable, the boiler should be wholly enclosed with brick-work, built hollow, and the spaces filled with some imperfectly-conducting material; or it should be cased in a wrought-iron jacket, and the space between filled with clay or charcoal; and it is a good practice, where otherwise convenient, to enclose the boiler and furnace within a small chamber, with its fire-door only on the outside.”—BERNAN, in *Hist. of Heating, &c.*

In regard to setting boilers, the same excellent authority remarks: “Small boilers are often formed with flues conducting the hot smoke round them before it enters the chimney. That portion of boiler surface exposed to the smoke can seldom, in favourable circumstances, be estimated to have an effect equal to one-half of the same extent of fire surface; in common cases it is much less. Count Rumford found the evaporation nearly as great when the circulation of the smoke in the flue was totally obstructed, as when it was rapid; and side flues he considered, in most cases, useful only in preventing the radiation of heat from the boiler. They are less effective in small than in large boilers. Indeed, flues are seldom introduced into the former; their economy of heat is doubtful, but their effect certain, in increasing the chances of accidents, and hastening the wear of the boiler. The perpendicular smoke-flue, after it leaves the boiler, may have an area double that of the sum of the air-spaces between the bars, and be fitted with a regulating damper. The area for the smoke, when the furnace is in action, will seldom be more than the sum of the air-spaces. Where it can be had, a deep ash-pit is very desirable; but whether deep or shallow, it should in all cases be carefully enclosed by a door, as nearly air-tight as neat workmanship in fitting will make it. The air-valve, which should extend nearly the whole width of the door, or rather the width of the air-spaces, should be formed to have an area, when fully open, equal to the sum of the spaces between the grate bars, and placed as low down, or as near the hearth as possible. The furnace door should be carefully fitted with a similar valved opening to that in the ash-pit door.”

In regard to the water used to fill

boilers, &c., care should be taken that it be rain water, if possible, for all spring or hard waters are impregnated with matter which will soon form sediment or incrustations in the boiler, and ultimately in the pipes also; which will not only impede the operation of their working, but be attended with dangerous consequences. The incrustations which form on the bottoms of boilers prevent the water in them from acting on the surface of the metal while the fire is acting on the other side; consequently, the bottom is soon burnt out, and the whole apparatus rendered for a time entirely useless. These incrustations usually consist of carbonate and sulphate of lime, together with sulphate of soda and magnesia, with other salts, according to the nature of the water used.

A patent has recently been taken out by Dr Babington of London, for preventing incrustation in boilers, by voltaic agency. For iron boilers, he recommends a plate of zinc, 16 oz. to the superficial foot, to be attached at one of its edges by solder to the interior of the boiler; and both sides of the plates being left exposed to the action of the iron and water, the voltaic agency thus excited is said to have the desired effect.

If, in first filling a new boiler, a pint of tar be poured in, and the boiler then filled up with the water, the thin film of tar which floats on the surface attaches itself to the metal. The lime deposits, adhering to the tar instead of to the iron, fall to the bottom, and can be cleaned out by occasionally emptying the boiler. A teacupful of tar thrown into the boiler once a fortnight will in this way entirely prevent calcareous incrustations.

A compound of coal-tar, linseed water, plumbago, or black lead and soap mixed together, has a similar effect.

To clean boilers of incrustations, Hood recommends "a weak solution of muriatic acid (one part of acid by measure to twenty or thirty parts of water.) This," he says, "will reduce the concreted sediment, and render it of easy extraction." One ounce of sal-ammoniac to every ninety gallons of water, occasionally applied, is said to keep them clear of incrustations. And it has been asserted that mahogany sawdust put into the boiler will completely answer the same

purpose; but of this we have had no practical proof.

Dr Ritterbandt's invention for preventing crust in steam-boilers has been highly spoken of. The principle on which it is based is the chemical action which the muriate of ammonia exerts upon the carbonate of lime, the incrusting material. Dr Ritterbandt discovered that, by introducing muriate of ammonia into a boiler containing water holding lime in solution, the carbonate of lime, instead of depositing when the carbonic acid by which it was held in solution was expelled at a high temperature, became converted into muriate of lime—a substance eminently soluble—while the carbonate of ammonia, likewise formed by the double decomposition, passed off with the steam, so that the boiler could not foul. The process is equally applicable to fresh and salt water. The inventor has proved, that when sea water is boiled, the incrustation produced is not formed of salt, but of calcareous matter—the salt not depositing until the water has attained a density far beyond that at which the boilers of marine engines are worked. The object of the frequent blowing off which obtains in practice, is to prevent the accumulation of the deposited calcareous matter. By preventing the formation of carbonate, by the addition of muriate of ammonia, the necessity of blowing off is, to a great extent, dispensed with; for while with the best-contrived apparatus it is found impossible to continue working at a density above 20° marine hydrometer, with the plan of Dr Ritterbandt a density of 60° may be safely employed. Three-fourths of the quantity of water usually blown out is thus economised, and consequently that proportion of the loss of fuel saved. The soundness of Dr Ritterbandt's principle has stood the test of time and experience. Twelve months have elapsed since his discovery was brought under the notice of the public, and in that time its operation has been tried in every variety of way with eminent success—in large and small steamboats, in stationary and locomotive engines, working with water from all localities—and in every instance has it been found perfectly effective, not merely in keeping the boilers, wherever it has been applied, clear of deposit, but in dis-

integrating that which had formed previously to its application. And we should be wanting in justice to the ingenious inventor, were we not to state that the invention has been tried for nearly twelve months upon the boilers of the engines printing the *Times*, working on an average of seventeen hours per diem throughout the year. Not only have the boilers been kept perfectly free from deposit, but an incrustation which had formed previously to the application of the invention has been entirely removed. We can further state, that neither the boilers nor any part of the machinery has been in any, even in the slightest degree, acted upon or injured by the action of the remedy in question.

Pure water is usually employed wherewith to charge the boiler and pipes; there are, however, other liquids that may,

under certain circumstances, be employed, as for example, where a very high temperature is required. The advantage of using fluids which will bear a high temperature without boiling, consists in reducing the quantity of surface necessary to produce a given effect. Thus oil requires only one-third of the surface necessary for water, and sulphuric acid somewhat less. Oil is, however, dangerous, on account of its inflammability; and sulphuric acid objectionable, as it is so very corrosive.

The following table, drawn up by Tredgold, shows the boiling point and temperature of the heating surface of different liquids, when confined by iron or glass; also their specific heat, or that quantity of heat they can convey, that conveyed by an equal volume of water being taken as 1 :-

KIND OF LIQUID.	Specific Heat.	Boiling Point.	Greatest Temperature of Surface.	Average Temperature.
Water, . . . . .	1°	212°	190°	180°
Sea Water, . . . . .	--	214	192	182
Brine, . . . . .	--	226	205	192
Water 48, alum 52, . . . . .	--	220	200	188
Water 55, sulphate of lime 45, . . . . .	--	220	200	188
Petroleum, . . . . .	.415	316	285	245
Linseed oil, . . . . .	.496	600	540	510
Sulphuric acid, . . . . .	.35	605	544	514

Excellent rules have been laid down by both Tredgold and Hood to find out the quantity of pipe necessary to heat a given cubic amount of air. "If the cubic content of air to be heated per minute," says the first of these authorities, "be multiplied by the number of degrees it is to be warmed, and the result be divided by twice the difference between the temperature of the house and that of the surface of the pipes, the result will be the feet of surface of iron pipe required. Thus, if 1000 cubic feet per minute are to be warmed, and the extreme case is supposed to be that when the external air is 20°, the house should be 50°; and therefore the air is to be warmed 30°;— and with water the surface will be 190° when the water boils, but only 180° in the average state: therefore

$$\frac{1000 \times 30}{2(180 - 50)} = \frac{30000}{260} = 116 \text{ feet of surface.}$$

If we employ brine for the same case, then

$$\frac{1000 \times 30}{2(192 - 50)} = 106 \text{ feet.}$$

And with oil,

$$\frac{1000 \times 30}{2(510 - 50)} = 32\frac{1}{2} \text{ feet}$$

would answer the purpose."

"When bright-tinned iron, earthenware, &c., are employed for pipes, much more surface is necessary."

"It is known from experience that the heat which raises the temperature of 1 cubic foot of water 1°, will heat 2850 cubic feet of air 1°; consequently if A be the quantity of air to be heated per minute to  $t$  degrees, and  $x$  be the difference of the temperature of water in the apparatus, then

$$\frac{A t}{2850} = w x; \text{ or, } \frac{A t}{2850 x} = w =$$

the quantity of water in cubic feet that must flow along the pipe per minute to supply the heat; and the quantity being equal to the velocity per minute multiplied by the area of the pipe, the means of knowing whether the pipes be capable of allowing the proper quantity to flow along or not becomes easy; as well as fixing the proper diameter. If any other liquid be used, the number 2850 should be multiplied by the specific heat of that liquid; and then proceed as before.

"The least quantity of liquid the apparatus could contain is double the quantity cooled during the time of making one circuit in the pipes, which is found by dividing the quantity  $w$ , as found above by the number of circuits, or parts of a circuit, made in a minute, and comparing the velocity with the length of the pipes. Whatever the quantity is in excess above this is to be considered a reserve of hot fluid to afford heat after the fire is out; and the fire must be so much earlier lighted as to heat this excess of water, as it must be hot before the surface can afford its effective supply of heat." Small boilers, it appears from the above reasoning, are better for green-houses, and such structures as require to be speedily heated, than large ones; and moderately large boilers may be the best for pine and other stoves, where a constant and high temperature is required—as the larger quantity of water, when once heated, retains its heat longer, and at a comparatively small addition of fuel. It is entirely owing to the excess of fluid that hot water has this advantage over steam heat; and the knowledge we now have of the heat which water contains, in proportion to its temperature, enables us to calculate the time the cooling of the fluid will maintain the heat of a house.

Hood, who is excellent authority upon heating, has made the following calculation as to the quantity of pipe required to heat a given space, founding his estimate upon computation of the specific heat of gases compared with water. Every substance, it is well known, has its peculiar specific heat. "Now, 1 cubic foot of water, by losing 1° of its heat, will raise the temperature of 2990 cubic feet of dry air the like extent of 1°; and

by losing 10° of its heat, it will raise the temperature of 2990 cubic feet of air 10°, or 29,900 cubic feet 1°, and so on." He calculates the quantity of heat lost by radiation, and imperfect fitting of doors and sashes, but makes no allowance for the supposed loss of heat by the laps of the glass in houses, such as plant and pine stoves, where a great degree of humidity is maintained, as the condensed steam running down the inside of the roof fills the spaces between the laps, and prevents the escape of the heated air. The calculation in the quotation above refers only to dry air, such as that of rooms and airy plant-houses, where only a limited quantity of water is employed; but in such as are much saturated with moisture, the case is somewhat different. Taking the temperature of the latter at 60°, the same amount of heat that would have heated 2990 cubic feet of dry air will only raise the temperature of 2967 cubic feet of saturated air to the same degree; because the latter number of feet of saturated air will contain 67 cubic inches of water, which will absorb as much heat before being converted into vapour as would raise the temperature of 115.922 cubic feet of air 1°. This Mr Hood estimates to be equal to the entire heat that 46 feet of 4-inch pipe will give off in ten minutes, when its temperature is 140 degrees above that of the air. "The glass will, however, cool much less of this saturated air, than of dry air, for the mixture of air and vapour has greater specific heat than dry air." In conservatories and forcing-houses, the quantity of air to be warmed per minute must be 1½ cubic feet for each square foot of glass which the building contains. The quantity of air to be heated being ascertained, the requisite length of pipe may be found by the following rule:—

"Multiply 125 by the *difference* between the temperature at which the [house or] room is proposed to be kept when at its maximum, and the temperature of the external air, and divide this product by the *difference* between the temperature of the pipes, and the proposed temperature of the room [or house]: then, the quotient thus obtained, when multiplied by the number of cubic feet of air to be warmed *per minute*, and this pro-

duct divided by 222, will give the number of feet in length, of pipe 4 inches diameter, which will produce the desired effect." If 3-inch pipes be used, then the number of feet of 4-inch pipe must be multiplied by 1.33; and in regard to 2-inch pipes, the number of feet of 4-inch pipe is to be multiplied by 2;—the length of 3-inch pipe being one-third, and the length of 2-inch pipes being double that of 4-inch, the temperature being all the same.

Mr Neeve, long principal assistant to the late Mr Tredgold, asserts that he proved by calculation that a boiler  $3\frac{1}{2}$  feet long, 1 foot 2 inches deep,  $1\frac{1}{2}$  feet wide, and 178 feet lineal of 4-inch pipe, would be quite sufficient to heat a peach-house

containing 7600 cubic feet of air to 55°, supposing the external temperature to be as low as 20° Fahrenheit scale.

The following table has been drawn up by Mr Hood, and cannot fail of being acceptable to all those interested in heating. 200° Fahrenheit is the assumed heat of the pipes in this table, that being the temperature at which they can most easily be maintained. "When the quantity of air to be warmed *per minute* is greater or less than 1000 cubic feet, the proper quantity of pipe will be found," Mr Hood observes, "by multiplying the length given in the table, by the number of cubic feet of air to be warmed *per minute*, and dividing that product by 1000."

TABLE of the QUANTITY of PIPE, 4 inches diameter, which will heat 1000 cubic feet of air per minute any required number of degrees, the temperature of the pipe being 200° Fahrenheit.

TEMPERATURE OF EXTERNAL AIR.	TEMPERATURE AT WHICH THE ROOM IS REQUIRED TO BE KEPT.									
	45°	50°	55°	60°	65°	70°	75°	80°	85°	90°
	<i>Feet of Pipe required for One Thousand feet of Air.</i>									
10°	126	150	174	200	229	259	292	328	367	409
12°	119	142	166	192	220	251	283	318	357	399
14°	112	135	159	184	212	242	274	309	347	388
16°	105	127	151	176	204	233	265	300	337	378
18°	98	120	143	168	195	225	256	290	328	368
20°	91	112	135	160	187	216	247	281	318	358
22°	83	105	128	152	179	207	238	271	308	347
24°	76	97	120	144	170	199	229	262	298	337
26°	69	90	112	136	162	190	220	253	288	327
28°	61	82	104	128	154	181	211	243	279	317
30°	54	75	97	120	145	173	202	234	269	307
32°	47	67	89	112	137	164	193	225	259	296
34°	40	60	81	104	129	155	184	215	249	286
36°	32	52	73	96	120	147	175	206	239	276
38°	25	45	66	88	112	138	166	196	230	266
40°	18	37	58	80	104	129	157	187	220	255
42°	10	30	50	72	95	121	148	178	210	245
44°	8	22	42	64	87	112	139	168	200	235
46°		15	34	56	79	103	130	159	190	225
48°		7	27	48	70	95	121	150	181	214
50°			19	40	62	86	112	140	171	204
52°			11	32	54	77	103	131	161	194

\*.\* To ascertain by the above table the quantity of pipe which will heat 1000 cubic feet of air per minute, find, in the first column, the temperature corresponding to that of the external air, and, in one of the other columns, find the temperature of the room; then, in this latter column, and on the line which corresponds with the external temperature, the required number of feet of pipe will be found.

There are other rules laid down for calculating the length of pipe required for heating any extent of hothouses; but although, perhaps, sufficiently correct for ordinary purposes, they are far less scientific than those already noticed. Thus, for example, for a hothouse to be heated to about 60°, divide the cubic contents of the space to be heated by 30; when 70° to 75° of heat is required, divide by 20; and when 75° to 80°, by 18—the quotient will give the length of 4-inch pipe required. If 3-inch pipes are used, add one-third; if 2-inch pipes, double the length of the 4-inch pipe.

The foregoing calculations, &c., have been made, presuming the buildings are of the ordinary construction, and neither buried underground nor subject to excessive damp. If buried much under the surface, unless great precautions have been taken to keep the walls dry, much heat will be lost by abstraction; and, if the walls are damp, a great deal of the heat is lost in evaporating the moisture; for it has been ascertained that it will take as much heat to vaporise one gallon of water from the walls of a building as would raise the temperature of 47,840 cubic feet of air 1°. Pits and hothouses, which may be seldom heated, and then, perhaps, only in the time of frost or wet weather, will take a much longer time to heat than those that are constantly in operation.

The following calculations have been made by Mr Forsyth as to the proportions the surface of pipe should bear to the cubic contents of air to be heated. He says, "I consider 1 square foot of pipe" to 10 cubic feet of air to be heated "necessary for pines; 1 foot in 12 for grapes; 1 foot in 15 for peaches; and 1 foot in 24 to keep the frost from greenhouse plants, when the thermometer in the open air falls to zero."

The following are the calculations of Mr Scott, the intelligent superintendent of the gardens at Leigh Park, Hants, regarding the proportion of hot-water piping to heat certain capacities: "In stoves of considerable dimensions, containing from 50,000 to 60,000 cubic feet of air, having a surface of glass (including rafters and sash bars) in the proportion of 1 square foot of glass to 10 cubic feet of air, the proportion of 1 foot of 4-inch pipe to 5.33

feet of glass will be ample heating surface to maintain a minimum temperature of 60° during severe weather. But in a house containing from 10,000 to 15,000 cubic feet of air, with a surface of glass in the proportion of 1 foot of glass to 6.75 feet of air, the proportion of 1 foot of pipe to 3 feet of glass will be required to maintain a minimum temperature of 60° or 65°, provided covering be not used. In vineries and peach-houses the quantity of heating surface required will very much depend on circumstances, as whether they are detached or connected in a range, also whether the crop is wanted early or late; but 1 foot of pipe to 4 feet of glass will be a fair average for vineries, and 1 foot of pipe to 5 feet of glass for peach-houses. Conservatories and greenhouses, according to size and other circumstances, will require 1 foot of 4-inch pipe to 5 or 6 feet of glass. If flues be preferred, I should consider 1 foot of an ordinary flue equal to 2 feet of a 4-inch pipe. In pits or small forcing-houses, where covering can be easily applied at night, the proportion of 1 foot of pipe to 4 or 5 feet of glass will maintain a minimum temperature of 60°."—*Journal of Horticultural Society.*

Pipes used for hothouse purposes should be made of what is called hard cast-iron, as it resists oxidation nearly three times as long as soft or common cast-iron, and fully as long as wrought iron does. The latter is seldom or never used for pipes, but for boilers it frequently is. Galvanised hard cast-iron pipes would be a great improvement.

To prevent oxidation is a most important matter, as it not only in time destroys the pipes, but it prevents the radiation of heat from them. Many experiments have been tried with a view to this, but with no very satisfactory result. It is probably the best way to keep the surface of the pipes always clean by a free use of pumice stone. To paint pipes with lead paint, although it is often done, appears to be injurious, as it prevents the free radiation of heat; and Hood conjectures this to arise "from the total change of state which the lead undergoes by its chemical combination with the carbonic acid in the process of making it into white lead. Practically," he continues, "it is found to have an injurious tendency on



the free radiation of heat from most bodies, varying, however, with their radiating powers. On a good radiator its effects are the most injurious; on a bad one, less so; but its use should be avoided as much as possible in all cases where the free radiation of heat is the object in view." Ainger, also an excellent authority on such matters, treats this subject lightly, however, and observes, "The colour and texture of the pipe surfaces, with reference to radiating powers, have been sometimes insisted on; but these are refinements of little value. The differences in radiating power are very trifling till we arrive at polished metallic surfaces, and these are not likely to be adopted. Pipes are usually covered with black paint; but almost any material, and any colour, will do equally well." Our own practice is to use anti-corrosive paint, which is prepared without any white lead whatever, and has decidedly the advantage over all other paints of resisting the effects of oxidation. The late Mr Lymburn observes, on the radiating power of pipes, "When the radiating power of lamp-black is 100, polished iron is estimated at 15; and though rough cast-iron, and oxidised on the surface, will be much more, still it would add greatly to the effect to have them coated with lamp-black."

Sir Joseph Paxton appeared to be at one time in favour of elliptical pipes cast as thin as possible, and also observes, ("Magazine of Botany," vol. ii. p. 253,) "that thin sheet-copper ones are far superior, and in the end the most economical." He also says, "Zinc, though otherwise an excellent material, is not well suited for elliptical pipes; it becomes so soft at the temperature of boiling water that they soon, the lower ones especially, change their shape and become nearly round." This, however, we think, is caused in a great degree by the expansive force, or pressure of the water in them. Zinc pipes we cannot recommend, as they are so liable to accidents and decay.

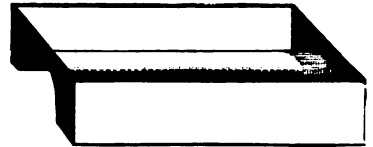
Leaden pipes may be very advantageously employed for heating pits, &c.; but they should not exceed  $2\frac{1}{4}$  inches in diameter; and where a considerable temperature is required, two or more courses of them may be used. Their advantages are, a total absence of oxidation and rapidity in heating; and, from being

in long lengths, fewer joints will be required.

*Earthenware Pipes* have been employed in many cases as a substitute for cast-iron ones, and even earthenware boilers have been used. An instance of the former occurs in the gardens of J. Greenall, Esq., employed to heat a pit between 30 and 40 feet in length. A portion of these pipes, which are of large dimensions, is introduced into a vault below, for affording moist bottom heat. These have openings in their upper surface for the escape of a moderate quantity of steam; the others are conveyed round the pit in the usual manner, and supply dry heat. In connecting earthenware pipes with metallic boilers, it is advisable to connect the pipe with a block of stone, perforated at one side to the size of the pipe, and at the other, to the size of the nozzle-pipe of the boiler. This last joint should be put together upon the union-screw principle, to prevent leakage from a difference in the expansion of the materials. Where earthenware boilers are used, this precaution is unnecessary.

Earthenware evaporating pans are very frequently used. The annexed diagram, fig. 321, will explain their merits. They

Fig. 321.



are manufactured of common pottery-ware, and are each about 15 inches long, and 5 inches wide, with a concave bottom to fit upon 4-inch water-pipes; they are placed in various parts of the houses. When filled with water, they continue to give out a genial and uniform vapour, and of course are not liable to rust, or any of the objections raised against the metallic pans usually employed for this purpose. The only fault we have to those above noted is, that they are rather too small; but this is a fault readily remedied, or a greater number of them may be employed. Supplying humidity to the atmosphere of a hothouse is much better effected by the use of

evaporating pans, than by the direct admission of steam from the boiler, and much more gradually and permanently than by pouring water on the pipes, or indiscriminately syringing the house all over. The idea of increasing the humidity of hothouses is almost coeval with the application of steam as a heating power. With some this practice of admitting steam took its origin from an idea that, if a portion of vapour was thrown into the house direct from the boiler or pipes, an additional degree of heat would be diffused through the structure; others applied it with the view of destroying insects on the plants; while a few only saw the necessity of employing it to increase the humidity by counteracting the drying effects of the heat in the house. "The device proved, at least, that gardeners began to be conscious of the unnatural dryness of the atmosphere of these houses, and, anxious for any expedient, however unnatural, to counteract it, and considering the state of many plant-houses, it is not surprising that its effects, as occasionally employed, should, for a while at least, be apparently beneficial. Food, though scalding hot, and rather unwholesome, is better than absolute starvation to plants as well as men; but, nevertheless, it is my firm conviction that steam is invariably injurious in a greater or less degree, and will speedily be found so even by those who at first had every reason to be satisfied with its effects. I have repeatedly tried it myself, under divers modifications, and have never failed, sooner or later, to perceive its injurious effects. Indeed, its injuries are for the most part not long in manifesting themselves. The only case in which it is not evidently injurious is in large houses, where the volume of air is great, and the steam is converted into vapour long before it reaches the plants—for it must ever be borne in mind that steam from close boilers, and water heated in open vessels, are essentially different things. Both are alike liquids, and both aeriform, and there the resemblance ends. Caloric in a sixfold proportion has entered into the composition of steam, in the form of latent heat, which is discharged amongst the plants, when the steam is reconverted into vapour."—ROGERS, in *Gard. Mag.*

The same excellent authority farther remarks, that, under certain modifications, steam may be employed by causing it to be discharged into a space between the real and the false bottom of a water-cistern 6 inches deep, and having not less than 4 superficial feet of surface. The false bottom of this cistern is to be of wire or zinc, pierced with very fine holes, and 2 inches above the real bottom. The cistern is to be filled with water, and the steam introduced into the space between these bottoms, when, by heating the water, it will induce the giving off an abundance of vapour, in a state very beneficial to the plants. It is in this modified way that the admission of steam is recommended by Mr Rogers in the case of his conical boiler.

Mr Beaton has suggested the application of steam highly impregnated with tobacco or sulphur, for the destruction of insects; and we have found the beneficial effects of mixing sulphur, and also the unrolled leaves of tobacco, in evaporating pans, placed on the top of the pipes—as well as the fertilising effects of guano, pigeon-dung, and urine, used in the same way. The ammoniacal fumes given out by the use of these latter bring the atmosphere of a hothouse or pit to about the same state as did the old-fashioned dung-beds, known, notwithstanding their dirty appearance, and great waste both of labour and manure, to be so pre-eminently valuable for the restoration of sickly plants, the vigorous growth of healthy ones, and the total destruction of insects.

We have already stated that earthenware boilers and pipes have been recommended; and indeed there are instances of their being in use, and fully answering the expectations of those who have recommended them. We have also, in another part of this work, spoken of the cements used for joining metallic boilers and pipes. The following is used in forming connections between earthenware boilers and pipes of the same material:—red or white lead, painting over the parts to be brought together two or three times with oil, so that the parts to be joined may be well saturated. Cotton wool has been recommended to be mixed with the lead, which has the effect of preventing it from cracking. This latter preparation

has been used to stop leaks both in iron and earthenware pipes, securing it well with twine or cord. Water should not be put into them for a few days after the joints are made, nor indeed until the lead has become quite dry and hard.

Cement of the best quality, *without* any mixture of sand, will stand any heat communicated by hot-water apparatus. It is of consequence to have it applied as quickly after it is made as possible.

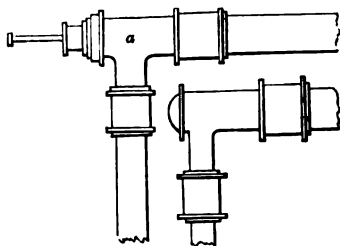
Another cement for earthenware pipes is thus prepared:—Mix one pint of sweet milk with two pints of butter milk; set them on the fire till they are curdled; strain them, and save the curd; pound some lime very fine, and, after passing it through a fine sieve, mix it and the curd till they become a dough; dry the pipes, and afterwards apply the cement.

In the case of garden walls heated by hot-water pipes, and indeed in pits that may be for a time during winter not in use, it will be well to draw off the water from them, to prevent their bursting by the expansion of frost. This precaution is, however, unnecessary where the pipes are in houses, and where the temperature is not likely to fall below 32°. For greater safety, all boilers should be furnished with a waste-pipe inserted in their bottom, so that the water may be withdrawn when required. Should obstructions arise that might be difficult to overcome, recourse may be had to a siphon formed of a flexible tube—a gas-pipe, for example. The former is, however, the simplest and most effectual means.

*Stopcocks* are of various constructions, and are usefully employed in changing the course of circulation from one pipe to another. They are seldom used, however, for graduating the temperature, as, by diminishing the internal capacity of the pipe, the velocity of the fluid is increased. Hood gives the following data: "In most cases, a cock of 2 inches diameter will be sufficiently large to use with pipes 4 inches in diameter, and a cock of 1½ inches diameter with pipes of 3 inches; but for very small pipes, the relative proportions should perhaps be more nearly equal, on account of the increased friction." One of the best of these is that of Mr Rogers, fig. 322, which has the merit of not impeding the circulation, as all cocks must be liable

to do when, on being turned, they diminish the opening through which the water

Fig. 322.



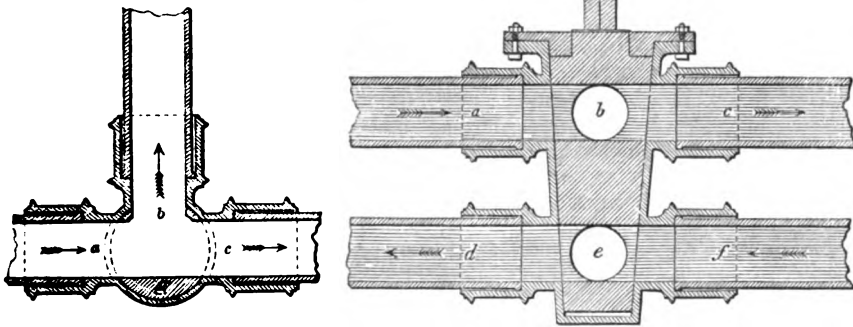
flows. To the box or hollow plug *a* is fitted a valve perfectly water-tight, and which is opened or shut by the handle sliding through a stuffing-box in the end of the plug. It appears, however, to require to be placed at the elbows or turns of the pipes;—this, unless in certain cases, can be no great objection. One of the most economical, and, at the same time, one of the simplest modes of shutting off circulation in pipes, is to have a small cistern cast, to which the pipes are to be attached. This cistern is to have a movable cover, with a half-inch flange bent downwards, so as to fit into a groove running round the top of the cistern; and this cover, when placed on the cistern, and the groove filled with water, will form a tight steam-joint. When it is desirable to shut off one or all of the pipes, a wooden or cork stopper is to be put in their orifices. These, being non-conductors, will prevent the heat from passing from the cistern to the pipes by conduction, and will completely cut off circulation. Where these can be conveniently attached, no other stopper is equal to them. For single pipes, sometimes an oblong cistern, 1 foot in length and 6 inches wide, is cast on them, with a cover as above; and this is found to answer all useful purposes as well as methods of greater complexity and expense. In no department is the apparatus for heating by hot water more defective than in that of stopcocks;—many expensive and inefficient illustrations of them might be given.

Fig. 323 gives a section and cross section of the stopcocks we had constructed especially for, and used at, Poltalloch, and which are very complete, having six waterways each—that is, three flows and three returns. They are placed

at the junction of three sets of double pipes—one on each side of a high-pressure boiler; and they allow the water to flow, or check it, as may be required. When

the part of the stopper marked *g* on the cross section is in the position shown in the fig., the cock is open in every direction, allowing the water to flow freely

Fig. 323.



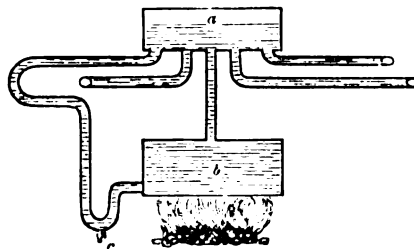
from the boiler along the pipe *a*, and through the cock into *b* and *c*, returning again by *e* and *f* in the under part of the cock, and into the under part of the boiler by the main return *d*. When *g* is turned round in front of pipe *b*, no circulation takes place in that direction; the whole water then flows along the pipe *c*, and returns by the under part of the cock *f*, and into the boiler by *d*. When *g* is placed in front of *c*, the flow and return is there stopped, and the water flows and returns by *b* and *e* into the cock, and into the under part of the boiler by *d*, as indicated by the arrows shown on section. And again, when *g* is placed in front of *a*, all connection with the cock is cut off, and the water from the boiler flows along the other set of pipes situated on the left hand of the boiler, which can, in this case, be more quickly heated if required. These cocks are made for 4-inch pipes, and are bored, turned, and ground very exactly, to prevent any heating from the different branches. They are solid in the bottom, which prevents leaking, and have a close cover ground into the outer case, and on to the top of the movable stopper.

Some of these stopcocks are made to circulate along *a*, and return down through the stopper to the boiler by *d*, without going into any of the other branches. These latter have not the branches *b* or *c*.

Stopcocks are both an expensive, and often an unsatisfactory part of a heating apparatus. One of the simplest substitutes is thus described by Tomlinson, and

may be made applicable where two or more hothouses are to be heated by the same boiler, or where bottom and atmospheric heat is supplied from the same source: "To effect this, a small open cistern, *a*, should be placed on top of the boiler *b*, as shown at fig. 324, and from the bottom of this cistern the various

Fig. 324.



flow-pipes are made to branch off. By this means," he says, "the expense of stopcocks or valves is avoided; for by driving a wooden plug into one or more of the pipes which open into the cistern, the circulation will be stopped until the apparatus is heated;—but in that case, water will flow back through the return-pipe. This, however, may be prevented, by bending a lower portion of the return-pipe into the form of an inverted siphon, as shown in the figure. This will not prevent the circulation when the flow-pipe is open; but if that be closed by a plug in the cistern, the hot water will not return back through the lower pipe. Any sediment that may accumulate in the

siphon may be removed from time to time, by taking off the cap *c* at the lower part of the bend."

Pipes are connected in various ways; the following, however, are the principal,

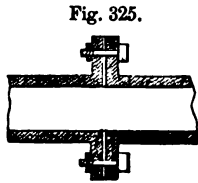


Fig. 325.



Fig. 326.



Fig. 327.



Fig. 328.

is valuable when pipes are laid down for temporary purposes.

The spigot-and-faucet, or socket-joint, is the neatest and strongest, but can scarcely be separated when once made, unless joined with lead instead of rust, which is found to make a secure and permanent joining.

The composition generally used to pack this joint with is called rust or borings by tradesmen, and is a mixture of iron borings with sulphur and sal-ammoniac. The following are the proportions given by Buchanan in "Essays," p. 177:—"To make iron cement, 40 parts by weight of iron borings are to be added to 1 part of sal-ammoniac and  $\frac{1}{2}$  part of flowers of sulphur, well mixed together, and beaten up like putty. Much sulphur renders the composition brittle. When a considerable time can be allowed for the cement to dry in the joint, before steam" or hot water "is admitted into the pipe, a smaller proportion of sulphur may be used."

—viz., the flange-joint, fig. 325; the spigot-and-faucet, or socket-joint, fig. 326; the thimble-joint, fig. 327; and the saddle-joint, fig. 328. The flange-joint is made by placing some elastic substance, such as felt, pasteboard, rope-yarn, caoutchouc, well-saturated with white-lead and drying oil, between the flanges, and bringing them firmly together by means of three or four screw-bolts and nuts. This joint presents a clumsy appearance; but it has the advantage of being easily taken asunder, and hence

Mr Peckstone has given slightly different proportions in "Practical Treatise on Gas-Lighting," p. 340. "The iron borings are to be pounded in a mortar until they are fine enough to pass through a fine sieve; then, with 1 lb. of these borings, so prepared, mix 2 ounces of sal-ammoniac in powder, and 1 ounce of flowers of sulphur, by rubbing them well together in a mortar; afterwards keep the mixture dry till it is wanted for use. When it is to be used, for every part, by measure, take 20 parts of iron borings, prepared as prescribed, and mix the whole well together in a mortar, and bring the compound to a proper consistence by pouring water gently over it as it is mixing. It is then to be applied between the flanges by a blunted caulking-iron, where it is to be well set up; and after the joints are screwed up very tight, the loose cement is to be scraped off." Of course the same mixture is to be used for the other varieties of joinings in the usual manner, and as elsewhere described in this work.

In joining hot-water pipes, rope-yarn has often been used; but this, if much saturated with tar, is objectionable, as the tar melts with the heat, and consequently the stuffing becomes loose and imperfect. New or untarred yarn, or soft-spun rope, is much better. In the case of flange-joints, the same material was used, and formed in shape of a collar; now, thick mill-board is preferred for this purpose. Lead was used in the case of socket-joints, and perhaps it is not much to be objected to; and when pipes are put up for experiment or for temporary purposes, it is certainly the best, as, when it is necessary to take them to pieces, a fire lighted under the joints melts the lead, when the pipes may be disengaged without much trouble; whereas, if permanent joints be made of rust, almost no power can take them asunder.

Some engineers make the joints of their pipes with iron filings, gold size, and litharge. This, however, is not a good compound, and has been said to split the sockets when the pipes become heated,—perhaps from expansion in the two latter materials being greater than in the first; whereas the expansion must always be only equal to that of the pipes themselves.

Messrs Cottam and Hallen make

their joints with what is called a "loose collar," namely, hemp, white lead, brown paper, Dorking lime, and boiled oil. This mode of joining has the advantage of being readily taken to pieces when alterations are required; and also that the pipes can be jointed by any handy labourer.

"The thimble-joint is not only a strong, but also a neat connection. It has the advantage over the flange-joint of being much neater; while, like it, it may be taken to pieces for repairs or otherwise without disturbing the other joints. It has been recommended to make the thimble of thin wrought iron, leaving but a small space for the cement, that the expansion may be equalised, and the risk of an unsound joint avoided.

"The saddle-joint is composed of two pieces, forming a thimble, which are embraced by two hoops, the ends of which are secured and tightened by screws. This is a convenient joining when a branch has to be made from the main pipe. The branch ought, however, always to be cast upon the main, with its proper flange or faucet. When the pipes are vertical, the ends are ground to fit each other; and the iron cement being placed between them, the weight is sufficient to unite the joint. Where the exterior of the pipes must be flush at the joint, the projection is made inside of the pipe.

"In small wrought-iron pipes used in some hot-water apparatuses, the joint is formed by placing the ends of the tubes within a socket, forming a right and left hand screw: the edge of the one pipe being flattened, and the other sharpened, they are screwed so tight that the edge of the one is indented into the flattened surface of the other. The wrought-iron pipes of small diameter that are occasionally used as branch-pipes, or to carry off the water of condensation, are screwed into the cast-iron pipe. By whatever method the joints are made, the space between the joined ends should be as small as possible, to prevent the lodgment of water in the lower part."—BERNAN'S *Hist. of the Art of Warming and Ventilating*.

All metallic bodies expand by heat; and hence pipes heated by hot water or steam expand and contract by change of

temperature. This has been noticed in another part of this work. Engineers, to provide against danger from this expansion, have adopted rollers placed under the pipes, which latter, being kept clear of the building, admit of the pipes stretching out, when heated, to their full expansion, and also of returning to their original length when contracted. In ordinary cases, such as in hothouse-heating, unless upon a very extensive scale, this provision is unimportant; but where the pipes are carried to a great length horizontally, it is useful.

Expansion-joints are also used to correct expansion and contraction; as, for example, in the case of the flange-joint, fig. 329, where Count Rumford's expansion-drum, *b*, is made of thin copper: as the pipes *a* *i* elongate, they press on the thin sides, *b*, of the drum, inwards; and as they cool, they draw the sides out.

The thimble-joint, fig. 330, is often formed to admit of this expansion, by having the adjoining ends of the pipes *a* *b* turned true on the outside, and having a thimble, as in the common joint: a piece of tin, *c*, or inner thimble, is interposed, and made to fit nicely to the turned parts of the pipes, which works backwards and forwards like a piston in a cylinder, as expansion and contraction goes on.

Spigot-and-faucet joints are similarly made, and, in a range of pipes 120 feet in length, permit a movement of three-quarters of an inch upon the whole length.

The cone-joint, fig. 331, is employed by Mr Parkins in his high-pressure mode of circulation: it is a strong joint, and easily made. The cone is inserted into the ends of the pipes, in the same way as connecting gas-pipes, and is made tight by two screw-

Fig. 329.

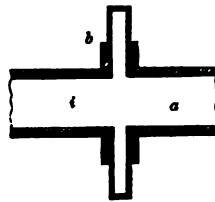


Fig. 330.

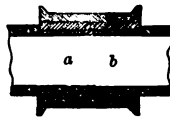
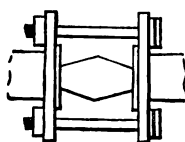


Fig. 331.



bolts, as will be seen by a glance at our diagram.

"The allowance made for the expansion in cast-iron pipes is, in practice, 1-8th inch in 10 feet, or 1-960th of their length. When heated from 32° to 212°, cast-iron expands 1-900th of its length, bar iron 1-819, copper 1-581, brass 1-535, tin 1-462, lead 1-351, zinc 1-933."—BERNAN, in *Hist. of Heating, &c.*

M'Intosh's (of Glasgow) patent elastic washer may be used with much advantage for packing hot-water pipes; it is about a quarter of an inch thick, is much cleaner than ordinary plugging, and forms a much more certain and durable joint.

Most excellent and minute directions are given in "Buchanan on the Economy of Fuel," for the various modes of connecting cast-iron pipes—a work which should be consulted by all who are interested in the subject.

"Care must be taken, in joining cast-iron pipes, to allow room for expansion. This is sometimes done in the thimble-joint, fig 330, in which the adjoining ends of the pipes *a b* are turned true on the outside, and have a thimble, or short cylinder of wrought iron, to enclose them, leaving only a small place for the current. A piece of tin, *c*, or inner thimble, is interposed, and made to fit well to the turned parts of the pipes, which, under the influence of heat or cold, work forwards or backwards, like a piston in a cylinder. A similar expansion-joint, applied to spigot-and-faucet connection, fig. 326, answers very well. Lead cannot be substituted for tin or iron cements in joints, for, by frequent heating, it becomes permanently expanded; while the iron pipes, always contracting in cooling, and the lead not participating in the contraction, the joints soon get loose. Count Rumford introduced an expansion-drum, *b* in fig. 329, of thin copper, between the extremities of two pipes, *a i*, which, in elongating, pressed the sides of the drum inwards, and, in cooling, drew them outwards. The pipes should not be connected with any part of the building, but be quite independent thereof: all the horizontal branches should be supported on rollers, and nothing done to interfere with the expansion

of the different parts."—TOMLINSON, on *Warming and Ventilating*.

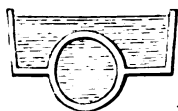
However excellent these *internal* provisions may be for making a secure joint, and they are no doubt well fitted for steam-pipes—for those in which hot water is to circulate—the impediment caused in the circulation by the obstruction must have its objections. Lead has, no doubt, the fault imputed to it above; but when used in the case of pipes having a bead cast on the end of the spigot, we think it one of the best materials for joinings, as, when it contracts, it leaves the beaded part of the spigot, and thus forms an internal cavity, in which the spigot end of the pipe works backwards and forwards, as it becomes heated or cooled—providing, by this property of contraction, a joint such as the art of man could scarcely, if ever, imitate.

Perkins's improved hot-water pipes—of which we have lately seen some excellent examples in the new Commercial Bank, Edinburgh—are fitted together with screw-joints and couplings of a peculiar kind, which renders stuffing and cement wholly unnecessary. To this we may add, that these pipes may be taken to pieces, for the purpose of cleaning or removal, with very little trouble—a circumstance which is not the case with others, and which, it must be admitted, is a serious deficiency. The joints to which we have alluded are also more elegant in appearance. For a detail of the principle, *vide* "Repertory of Patent Inventions, 1841," p. 216.

The heat given out by hot-water pipes is just as dry as that from smoke flues: it has the advantage, however, of being much purer, and free from the smoke or deleterious gases which accompany flues, unless they are built with great care, and kept in good order. To obviate this, or rather to supply the air in the house with an amount of humidity equal to that it has been robbed of by the heat from the pipes, various contrivances—some of which we have already noticed—have been recommended. The most sensible of these is that proposed by Mr Ainger, in his valuable essays on "The Production, Distribution, and Preservation of Heat," published in "The Gardeners' Chronicle." After alluding to

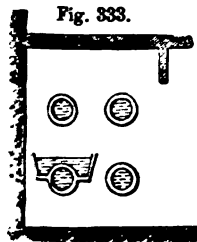
the practice of raising vapour from water sprinkled on the soil, &c., which he very properly condemns, and lays it down as a rule, that wherever artificial heat is employed, all the requisite moisture should be vaporised by the heating apparatus, and by it only, he goes on to observe: "Various schemes have been devised for this purpose, amongst which may be mentioned the plan of making a part of the water circulate in open troughs, instead of closed pipes. This plan, however, and all the modifications of it, are open to the objection, that all the impurities which by accident fall into these troughs or gutters may be carried by the circulation into the boilers, and, depositing themselves there, give rise to numerous unpleasant consequences. A much better plan is to cast a trough upon the circulating pipes, which has frequently been done upon a small scale, and attempted on a larger. It failed, however, for some time, in consequence of the tendency of any large excrescence on the pipe to bend it in the act of cooling."

Fig. 332.



At his suggestion, pipes with large troughs of this form, fig. 332, have been recently made, where the troughs contain 10 gallons of water in each length of pipe, so that one or more placed in a hothouse would furnish an abundant source of moisture, without abstracting it from the soil, and without affecting the purity of the circulating water. These troughs have the farther advantage of being entirely inoperative when left dry; whereas the open gutters depend on the perfectly close fitting of their covers.—*Vide* Rogers's opinion on the same subject, sect. VARIOUS MODES OF HEATING, &c.

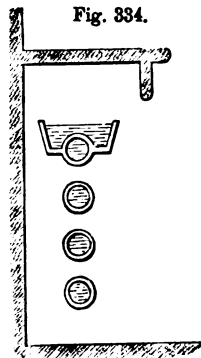
Fig. 333.



to the air than is unavoidable, it would

be better, perhaps, to expose all the pipes to the plants by placing them thus, (fig.

Fig. 334.



334,) provided the height of the shelves and other circumstances permitted this mode of arrangement. In this way a larger portion of the heat would arrive at the plants in a radiant form, because on the other plan the opposing surfaces of the adjacent pipes maintain a mutual interchange of radiation, and become cooler

principally by the contact of the air. This objection applies in some degree to the inner sides of all pipes which are presented to the wall, and from which, therefore, the heat is conveyed to a large extent by the atmosphere. Economy would, doubtless, be consulted by closing up all those portions of surface which are not adapted to radiate directly upon the plants or upon the soil. The same effect would be produced by clothing the inner semi-circumferences of wall pipes with non-conducting materials, or, if practicable, by giving to those portions a bright metallic lustre."

Glass tubes were used in the Royal Gardens at Vienna so early as 1836, the tubes being about 3 inches in diameter, and in 3-feet lengths. The glass was quite transparent, and about a quarter of an inch in thickness, jointed by bands of brass and cement.

Iron pipes enamelled with glass, both inside and out, are now common for conveying water for domestic purposes. Were we certain that the expansion of the metal when heated would not throw off this glass coating, then we would say that perfection had at last been reached in the construction of hot-water pipes. The recent invention of covering iron with other metals not subject to corrosion, by chemical means, may also open up a new era in this department of hothouse architecture.

It appears to be the fate of all newly-invented improvements to meet with opposition by that class of individuals who are content to remain stationary, and



who will not progress with the times. Hot water, as a heating medium, has had that opposition to contend with, and every little accident, to which all improvements are for a time liable, has been taken hold of. A boiler will not heat so soon as expected. How many common flues will not draw, let us ask, because the furnaces have been improperly built? The boiler may heat, but the water refuses to circulate. What is the cause of this? Only two can be stated—namely, the pipes being laid lower in one part than in another—that is, out of a direct line as regards their level. But this seldom occurs. By far the most frequent cause of a want of circulation is air getting in—as, when water is boiled for the first time, the air it contains is expelled; and this goes on accumulating, until the pipes at some particular part become fully charged with it instead of water. The very process of filling the apparatus tends to produce this effect; for as water is poured into the boiler, which, being always the lowest point, will of course be filled first—and as the lower pipe will next receive the water, and afterwards the top one—it follows that the air which is in the pipes, unable to find its way out through the water in the boiler, is forced into some part of the pipe generally at the highest point, and there remains compressed between the two bodies of water, and consequently separating them. Till this air be extracted, no circulation can take place. In the case of close-topped boilers, accidents might occur attended with danger. To remedy this, a small perforation should be made in the pipe at the highest point, about the size of a quill; “for,” as Hood remarks, “the rapidity of motion in fluids being inversely proportional to their specific gravities, as water is 827 times more dense than air, an aperture which is sufficiently large to empty a pipe in fourteen minutes if it contained water, would, if it contained air, empty it in about one second.”

Some have recommended a self-acting valve, others a cock, and some square openings fitted with corresponding stoppers. The usual plan adopted by ourselves is a simple aperture about one quarter of an inch in diameter, having a wooden peg loosely fitted into it, so that

if the pressure of the air be considerable, it will force the peg out. Where it can be applied conveniently, we insert into the upper part of the flow-pipe a small tube of several feet in length, and fix it to the wall, leaving the orifice always open.

“The velocity with which the water circulates has been attempted to be given by calculating from the difference of temperature indicated at opposite points of the apparatus. But many circumstances in practice affect the motion;—varying temperature of the air, and consequently of the pipe surface—the flexures, and inclinations, and length of the pipes—the varying rate of combustion in the furnace, and heat of the water in the boiler—the thickness, material, and surface of the pipe—its irregular or uniform calibre—the greater or less skill with which the air-valves are placed, and many mechanical niceties of detail and finish. Most of the data must be assumed, so that, to practical men, the few rules that have been given are not only useless, but often delusive; and hence the uncertainty and varying practice of those who have erected this sort of apparatus. Some general maxims are, however, recognised in these arrangements. As the effect of the circulating-pipe depends on the temperature of its surface, that will be higher or lower as the velocity of the internal fluid is rapid or slow. All bends or flexures in the pipe should be avoided; and, where unavoidable, they should have as flat a curve as possible. Angular elbows or knees are most faulty. The ascending and descending pipes should throughout have the same, or nearly the same, internal diameter, without contractions or enlargements; and where cocks are introduced, their water-way should be as near that of the pipe as possible. It is obvious that, in a series of tubes in which the circulation depends on a minute difference of level, this should be carefully preserved by proper fixing, more particularly where the direction is nearly horizontal. A slight accidental depression in a series of pipes will mar the action of an otherwise effective apparatus; and more failures have arisen from this than by all other causes united.”—*BERNAN'S History of Heating, &c.*

## § 8.—HOTHOUSE FURNACES.

The hothouse furnace described by Nicol about the beginning of the present century, is still very generally in use, and may be understood by the following description of it in his own words: "It is simply an oven, capable of containing less or more fuel, according to the kind of hothouse to which it may be attached, and the kind of fuel to be used." His medium size is of the following dimensions:—"The oven is 30 inches long and 20 inches wide; the grate 18 inches long and 10 inches broad; the furnace-door 10 inches square, with a circular valve in the centre of it 3 inches in diameter; the ash-pit door is of the same construction and width, but 15 inches deep. These valves turn with a handle, and are capable of admitting any quantity of air to the extent of half their diameters, which is deemed sufficient. The sole of the oven is placed 12 inches below the level of the flue, and is paved with firebrick. The walls are also formed of firebrick to the height of 12 or 15 inches, and the arch is turned with the same material. Fire-clay is used instead of lime."

Little improvement has taken place on this furnace up to the present time, if we except the introduction of larger bricks in its construction, thereby lessening the number of joints, and the lengthening out the floor by introducing dead-plates between the fire-bars and furnace door. The first improvement made on Nicol's furnace was by the late Mr Loudon in 1803, who added a double door, upon Count Rumford's principle. Hay, Steuart, Atkinson, and others, about the same time turned their attention to the subject; but we observe little alteration of consequence made by any of them, excepting by the latter, who introduced brass registers in ash-pit doors, instead of the iron ones used by Nicol, as being less liable to corrosion, and of course much easier opened and shut. He also added the dumb or dead plate, which is either a plate of thick cast-iron, or a strong fire-clay tile, placed between the opening of the door and the front end of the bars or grate, laid in a slanting direction, having an inclination of from 3 to 4 inches from the door towards the grating, and from 1 foot to 18 inches in length, according to the

size of the furnace. A similar dumb-plate was placed between the inner end of the grating and the throat of the furnace, laid slanting upwards in the direction of the floor of the flue. Upon the front dead-plate the fresh supplies of fuel are laid, and become pretty well carbonised, being ignited by the fire on the grate. While it burns slowly there, the smoke is given out, and, having to pass over the fire on the grate, becomes to a certain extent consumed.

It may here be remarked that this was the first attempt to consume smoke, at least in garden structures; and fires managed as directed by him, and detailed in the latter end of this article, are found to answer the purpose very satisfactorily. The great advantage of double doors and ash-pit registers—the latter first suggested by Dr Black, and afterwards put in practice by Count Rumford—is the command they give the fireman over the state of the fire. By shutting them closely up, the process of combustion is lessened from the want of air, and the fire may be kept in a state of suspension, as it were, for many hours; while on opening the register either in the door or the ash-pit, air is admitted, and combustion goes on. Indeed it is impossible to regulate the temperature of any house without these necessary appendages and their proper application. As regards the size of furnaces, we may remark that, where the best Newcastle coal is used, a furnace will be amply sufficient of half the size of that required where inferior or Scottish coal is alone to be got.

To understand the defects of the furnaces in common use, we should consider that the greatest part of the floor—often the whole of it—is taken up with the grate, which is also, in many cases, too wide in the bars. They frequently have two ill-fitted doors, one to supply the fuel, and the other to remove the ashes. This unnecessary extent of grate and doors admits too much air, by which the fire is not only kept below the temperature sufficient to consume the smoke, but also, as soon as the door is opened, a vast quantity of cold air sweeps over the fire and through the flues, carrying along with it three-fourths of the heat in them out at the chimney-top. Then the cold damp coal is thrown into the centre of

the fire, which reduces the temperature—destroying in one instant all the effect required; liberating the products of the coal in an imperfect state at a low temperature—and thus giving rise to volumes of thick smoke, which, when once formed, it becomes impossible to burn with all the heat such a furnace is capable of producing.

The construction of furnaces, whether for smoke-flues or hot-water boilers, deserves particular attention; for on the perfection of their principle much depends, as regards both their power of producing the greatest amount of heat from the smallest quantity of fuel, and of continuing to give out heat for the greatest length of time. One of the greatest faults to be found in hothouse furnaces generally, is their having too great a draught, whereby an unnecessary waste of fuel takes place, and the heat is driven past the boiler, or through the flue and out at the chimney-top, without having time either to heat the water or to communicate with the air of the house through the brickwork. Hood's description of a furnace for this purpose is good, and, in fact, contains the essential conditions required. "The heat," he observes, "should be confined within the furnace as much as possible, by contracting the farther end of it, at the part called the throat, so as to allow only a small space for the smoke and inflamed gases to pass out. The only entrance for the air should be through the bars of the grate, and the heated gaseous matter will then pass directly upward to the bottom of the boiler, which will act as a reverberatory, and cause a more perfect combustion of the fuel than would otherwise take place. The lightness of the heated gaseous matter causes it to ascend the flue, forcing its passage through the throat of the furnace with a velocity proportioned to the smallness of the passage, the vertical height of the chimney, and the levity of the gases, arising from their expansion by the heat of the furnace."

Amongst the advantages of nearly airtight furnace-doors, we may state that combustion cannot be supported until the temperature of the air reaches from 900° to 1000°—points to which it cannot arrive before it comes in contact with the fuel, by merely passing through the

chinks of an imperfectly-constructed furnace-door. The cause is very different when made to pass through the ash-pit and the bars of the grate, as it becomes heated nearly to that degree before coming in contact with the fire.

According to Tredgold, in a furnace for burning a bushel of coals per hour, the area of the fire-grate should not be less than 8, or more than 16 square feet, and the surface of the boiler should be four times the area of the grate, with 32 feet of side flue. This, however, we think considerably more than necessary. A large proportion of grate and bottom surface was considered by that eminent engineer as greatly tending to lessen the labour of the attendant.

The following table has been drawn up by Hood for determining the proper area of the bars for furnace grates: "Supposing the ordinary kind of furnace-bars afford about 30 inches of opening for the air, in each square foot of surface measured, as the bars are placed in the furnace, and allowing half-inch openings between the bars, when the bars themselves are about 1½ inches wide, then the relative proportions between the area of the bars and the length of the pipe should be as follows:—

Area of bars.	4-inch pipe.	3-inch pipe.	2-inch pipe.
75 square inches } will supply	150 feet,	200 feet,	300 feet.
100 --- ---	200 ---	266 ---	400 ---
150 --- ---	300 ---	400 ---	600 ---
200 --- ---	400 ---	533 ---	800 ---
250 --- ---	500 ---	666 ---	1000 ---

This table is carried to the extent of 500 square inches of bars; but the above may be considered sufficient for our purpose, as the proportions upwards are in the same ratio.

Nicol, Atkinson, and others, used dead-plates both behind and in front of their furnace bars, as already stated; and some have very judiciously introduced them along the sides also. Dead, or more properly carbonising plates, should be made of strong fire-clay tiles laid round the grating, and with it forming the floor of the furnace. Strong iron plates have also been used, but they are objectionable as being less durable, and as having so great an affinity for oxygen, which all heated metals possess;—indeed, the less iron em-

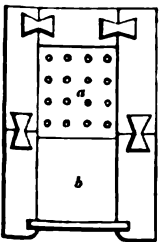
ployed in a furnace the better. The use of these plates is for diminishing the area of the grating without lessening the size of the furnace; and as the fuel upon them consumes very slowly, in consequence of receiving no air from below, it continues to burn on them, when that which was immediately above the grating has burnt away.

In building furnaces, strength and durability ought to be considered; therefore, common bricks should never be used. Fire-clay bricks—a sort containing a large proportion of sand, which renders them exceedingly hard, and capable of resisting for a long time the action of heat—should be invariably employed; and those of a large size, known in England by the names of Welsh lumps or Stourbridge lumpers, are to be preferred to bricks of the usual dimensions. Fire-clay should also be used instead of mortar.

We are at present getting manufactured by the Garnkirk Company, near Glasgow, a complete set of fire-clay bricks for furnaces, as well as a hot-water boiler and flue of the same material, so as to construct either a hot-water apparatus or smoke-flue system of heating, in which not a particle of iron is to be used. The very injurious effects that heated metallic bodies have upon the air is so well known, and has been so satisfactorily proved by chemical experiments, that any farther allusion to it here would be superfluous. The following are plans

and descriptions of our furnaces. Fig. 335 is the ground-plan, and, like all the other parts of the apparatus, is made of a peculiarly excellent kind of fire-clay bricks and tiles, for which the Garnkirk Company is celebrated, having on their property a species of clay con-

Fig. 335.



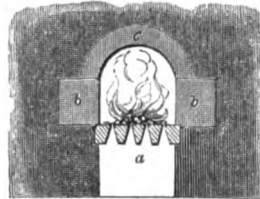
taining, by chemical analysis, above twice as much alumina as Stourbridge, considered the best in England, and nearly as much silica; and as alumina and silica are the only materials that ought to enter into the composition of fire-bricks or crucibles, which are exposed to the most intense temperatures, that clay which contains these in greatest abundance,

without the presence of lime, peroxide of iron, peroxide of manganese, or phosphate of lime, as the Garnkirk clay does, must be admitted to be the best. The floor of the fire-oven is formed of two fire-clay tiles, 18 inches broad and 2 feet long. The perforated tile *a* forms the grate upon which the fire burns, and the other the carbonising plate *b*, upon which fresh supplies of fuel are to be laid. These perforations, as shown in cross and longitudinal sections, figs. 336 and 337, are 1 inch in diameter upon the top surface, and 2 inches in diameter on the under surface, for the admission of air to cause combustion. These tiles are each 4 inches thick.

The sides of the oven are formed of four bricks, two on each side, 2 feet 3 inches long, 6 inches thick, and 12 inches broad. These are laid on their edge, and dovetailed together, as well as to the brick at the back of the furnace, which is of the same width and thickness as the side ones, but only 18 inches long;—they are rounded at the front edge, to ease the draught. The dovetailed bricks, which tie the others together, are 12 inches long, passing quite through the side bricks, 12 inches broad, and 16 inches thick at the tail end. The utility of these in binding the furnace together must be apparent.

Fig. 336 is a cross section, showing the

Fig. 336.



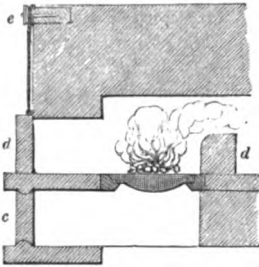
perforations in the grate *a*, the ends of the side brick *b*, and the roof or covering *c*. The roof is formed of one semi-circular tile, 4 inches thick and 2

feet long, covering that part of the furnace which is over the grate, and also the throat of the flue, which are the parts most exposed to intense heat: it is bevelled off at the ends, so as to rest square on the side bricks. The roof over the carbonising plate is a flat tile 6 inches thick, 18 inches broad, and 2 feet long, contracting this part of the furnace to 12 inches by 18.

Fig. 337 is a longitudinal section, showing the ash-pit door *c*, which is also of fire-clay, 3 inches thick and 15 inches

square, hollowed out at the top and bottom sides, so as to move on the rounded

Fig. 337.



projections on the tiles above and below it: *d* is the door of the furnace, also of fire-tile, and suspended from the pulley *e* by means of a round vulcanised India-rubber belt. The arrangement will be better seen in fig. 339. This door slides in two grooves in the side bricks, as seen in the elevation.

Fig. 338.

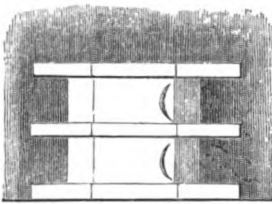
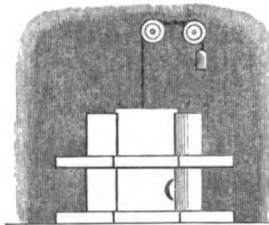


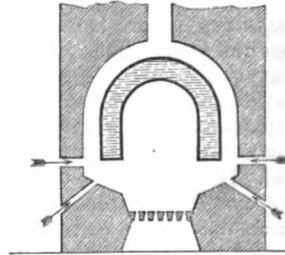
Fig. 339.



*Williams's improved or Argand furnace.*—This furnace is founded upon the principle of the Argand lamp; and although sufficiently ingenious and creditable to the inventor, has not been found to act very satisfactorily in practice. In "The Gardeners' Chronicle," an anonymous correspondent, in criticising this furnace, makes the following remarks in regard to its effects:—"In the annexed diagram we have shown how simply and easily the benefits, real or supposed, of the contrivance in question may be obtained in furnaces resembling those generally used for horticultural purposes. The aperture in the brickwork marked by four arrows, which indicate the course of the entering

current of air, are the only novelties; and they are new only in this peculiar arrangement; because, as we have already stated, air has been admitted behind the fire for the same purpose for very many years. In this arrangement, the air which enters by the four channels meeting the current of gas at right angles, or rather, indeed, opposed to it, would tend to produce that forced intermixture

Fig. 340.



which is secured in the turpentine lamps by the peculiarly formed chimney, and the deflecting button placed over the flame." The four arrows show the direction of the air. Fig. 340 will more fully explain its principle.

In the "Transactions of the Society of Arts" will be found several kinds of furnaces described; and amongst them one in which all the bars of the grate are tubes, for the purpose of admitting a current of air to pass into a long narrow chamber, formed in the bridge behind the fire, which has a communication with the hollow bars, and from them, through a thin aperture, into the flue at the throat. This, with many others that could be named, shows how various are the opinions regarding the admission of air into furnaces—whether it should be admitted in large or small quantities—whether in a cold or heated state—whether directly upon the fuel through the doorway, or only through the ash-pit bars, &c. It is somewhat surprising that the hot-blast has not been tried upon hothouse furnaces. The theory appears practicable enough, and it would certainly be worth a trial.

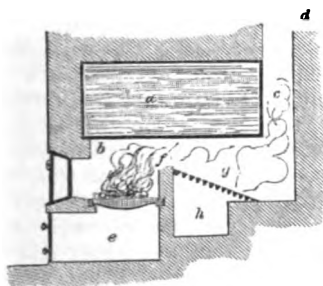
Amongst the various kinds of furnaces that have been projected, there are none so valuable as those constructed upon the principle of consuming smoke. Of these there are now somewhere above forty, for which patents have been taken out.

So early as 1680, a stove was exhibited at the fair of St Germain, near Paris, in which the smoke not only descended, but

was also consumed. And a simple but highly ingenious grate, in which the burning fuel was made to consume its own smoke, was one of the many original contrivances of Dr Franklin. Soot is very inflammable; and when we reflect that one pound weight of it gives as much, if not more heat, than a pound of coal, we need not be surprised at the increasing anxiety for the construction of fire-flues and furnaces that will consume their own smoke.

One of the simplest and most successful appears to be one mentioned in a report to the "Liverpool Health of Towns Advocate," the invention of Mr Wye Williams, and kindly furnished to us by John Sutherland, Esq., M.D., of that town. "It consists in placing a perforated iron plate, several feet square," but of course proportioned to the size of the furnace, "immediately behind the fire-bridge in the bed of the flue. The air is admitted into a space below this plate, and is diffused by passing through the apertures. The gases and carbonaceous vapours become immediately ignited when the air is admitted, and no smoke is produced. The annexed sketch, fig. 341, will show the plan: *a* the boiler,

Fig. 341.



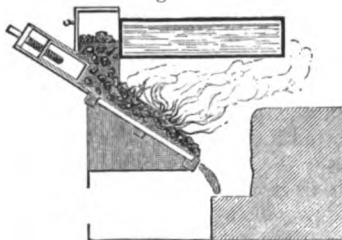
*b* the fire-place, *c* the flue, *d* the chimney, *e* the ash-pit, *f* the fire-bridge, *g* the diffusion-plate, through which the air passes before it plays upon the hot gases; *h* a space into which the air is introduced from without, the quantity being regulated by a valve. This plan requires no other management than to keep the fire-bars always covered with fuel; and the size of the diffusion-plate must be ascertained by trial, and also the quantity of air to be admitted. Of course this should be no more than sufficient to

effect the combustion, otherwise the boiler is cooled down." Mr Joseph Williams of Liverpool has effected an important improvement on this plan, by introducing hot-air into the space *h*, by making it pass through hollow bars or tubes placed near the fire, instead of admitting it directly from the atmosphere. The waste in fuel alone in furnaces where the smoke is not consumed is enormous—amounting to nearly one-third of all the coal used. The experiments of Mr Henry Holdsworth of Manchester have shown that, in the front flue of a furnace of common construction, the thermometer seldom rose above 1100°, and often fell below 900°, the mean being 975°; while in the same furnace, while consuming its smoke, the mean temperature was 1160°, ranging between 1400° and 1000°. The quantity of water evaporated by a pound of coal was one-half greater than when the smoke was not consumed.

The perfect combustion of coal in a furnace fire requires that the gases generated during the process of burning should be brought in contact with an adequate supply of fresh air, so as to furnish oxygen for the conversion of the whole of the carbon into carbonic acid gas, which is invisible. If from any cause the supply of air be inadequate to effect this object, the carbon is disposed of in the form of smoke; and every atom thrown in this state into the atmosphere is not only a source of nuisance, but is also the cause of a direct pecuniary loss to the proprietor of the furnace.

*Witty's or Chanter's smoke-consuming furnace*, of which the annexed fig. 342 is a sketch, has been hitherto more extensively used in gardens than any other; and, when proper attention is paid to its working, it answers extremely well. Exclusion

Fig. 342.



of air, excepting when made to pass directly through the fire from the ash-pit, is

its leading feature. No furnace, however constructed, can consume its own smoke upon first kindling the fire, nor until the fire has attained the temperature necessary for the consumption of smoke, which appears to be never less than 1000° of Fahr. scale.

To understand the principle of this furnace we may observe, that there is a carbonising plate, on which the coal is submitted to two processes—namely, carbonisation and combustion. Over this plate is formed an arch of fire-brick, or large Stourbridge lumps, either of which radiates sufficient heat to produce a powerful effect upon the coal, which instantly gives out plentiful streams of carburetted hydrogen gas. The gas, being thus formed at a high temperature, is immediately inflamed by a due proportion of atmospheric air rushing through the heated coke at the bottom of the furnace, which, meeting the gas, produces a brilliant and lasting fire, and, from its purity of flame, prevents soot from lodging in the flues, if common attention be given to the first lighting; and it can be kept in for months together without relighting if required.

In this furnace a third, or thereby, only of the floor consists of a grate, and that placed close to the throat. The inclined plane on which the coal is placed is set at an angle of about 35° or 40°, and occupies the whole space from the grate to the feeding-door. This door is smaller and differently formed from those in common use. It has merely sufficient opening to admit of the supply of the fresh coal, and is very completely closed with a flanged lid to exclude air. The fuel is pushed forward upon the inclined plane by means of a square piston, wrought by a handle from without; and by reversing the motion, the piston is brought back to its original place, to admit of fresh supplies of coal. The first arrangements being completed, the fire being kindled, and the door completely closed, the plane and the arch are thus converted into a retort. The heat of the fire and the hot air rising through it, which is strongly reverberated from the arch, promotes the distillation of the nearer portions of the coal. The gases as they rise are whirled into the current towards the flue, and, meeting with the

rush of heated air through the fire, are inflamed and completely consumed. This process continues till the coal is perfectly coked;—which is then pushed forward by the screw, to make place for fresh supplies of coal. If properly attended to, these furnaces work well; but it is difficult to get men to attend to them, as the feeding of furnaces has hitherto been carried on without system or regard to correct principles.

A scientific remedy is noticed in "The Pharmaceutical Times" for the consumption of smoke, which consists in introducing a cast-iron tube from a boiler to convey a column of steam above, and to be dispersed by a rose nozzle over the surface of the coking coal. "Decompositions and new combinations thus take place, which effect the entire combustion of the inflammable gases, and the immediate disappearance of a column of black smoke, which, till the turning on of the steam, had hovered in the shaft of the chimney." Where steam is employed, this is easily effected, and at little waste of power. A more simple and almost as efficacious a method may be applied in any hothouse furnace, even of the most common construction, by leading a metallic tube, finely perforated at the end, to terminate over the fire, the other end being connected with a cistern of water. The jet of water, about as fine as a small needle, being thrown upon the fire whilst burning briskly, will generate sufficient steam in the furnace to secure the combustion of all smoke. The accidental leaking of a boiler over a fire-place kept constantly at work led to the discovery of this simple remedy.

The majority of smoke-consuming furnaces, although in form and minor details differing from each other, nearly all rest on one general principle—namely, the admission of an adequate supply of air behind the fire-bridge, and just at the point where the supply afforded by the ordinary draught ceases to be effective. The carbonaceous vapour, being still heated to a high degree, becomes instantly ignited on being brought in contact with the air, so that a sheet of flame may be seen to sweep along the bottom of the boiler, and no smoke is produced. If the extra supply be cut off, the flame immediately ceases, and its place is occupied with a dense volume of black smoke,

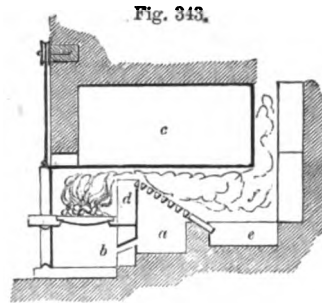
which escapes by the chimney. The restoration of the current of air causes the smoke to cease and the flame to reappear.

In these essentials the smoke-consuming furnaces differ widely from those in common use, because, in the latter, no air can possibly reach the back part of the furnace at the bridge, but is admitted at the front of the fire close by the door, and, in consequence, passing rapidly over the fire, enters the throat of the furnace at the bridge in an improperly heated form, and not only carries along with it a large quantity of smoke, but also a great portion of cold air, which, instead of heating the flues, tends rather to reduce their temperature. In regard to that part of the furnace called the bridge, Mr Ainger, in "Gardeners' Chronicle," makes the following remarks:—"In ordinary boiler-setting, what is called the bridge, which is intended to direct the rising flame and gases into close contact with the boiler, but which, at the same time, shuts out a large space from its radiation, is, I believe, a totally injurious contrivance. By diminishing the primary radiation of the boiler, we, of necessity, give a larger portion of heat to the gases which it is sufficiently difficult to reclaim during their rapid passage through the thereby overheated flues, and which escape with an unnecessary large share of heat into the chimney."

Our own opinion of the exclusion or admission of atmospheric air is, that a very limited quantity is all that is necessary, both for the support of combustion and also for the consumption of smoke; but that this air, whatever its amount may be, should be directed to the warmest part of the furnace;—and the warmer it is before it is so applied, the better. Airtight furnaces should be first constructed; and, if provided with proper registers in their frames and ash-pit doors, the necessary quantity of air can be most readily supplied.

Fig. 343 is a longitudinal section of a smoke-consuming furnace upon Mr Joseph Williams' principle, and approved of by the Committee of the Health of Towns, &c. The cross section is the same as that formerly given in fig. 90. The furnace door and ash-pit are upon the same principle as those there detailed, as is also the fire-clay grate with its per-

forations. The leading feature in this furnace is the perforated fire-clay tile *a*, placed in the throat of the furnace, and sunk 3 inches into the groove in the tile *d* at the back of the grate, and also into the



tile *e* in the evolving-chamber *f*. Air is admitted, after passing through the ash-pit to become heated, by the aperture *b*, so as to act with force on the half-inflamed gases and smoke after passing through the perforations in the tile *a*; for on the quantity and force of this body of air, consumption of the smoke depends. *c* is a boiler over the fire, but it has no direct connection with the principle of this furnace.

*Jucke's patent smoke-consuming furnace* is a very ingenious piece of mechanism, but by far too complicated to be used for ordinary purposes. A set of drawings of it in detail, with description, will be found in the *Repertory of Patent Inventions*.

A patent has recently been taken out by Mr G. Ansty of Brighton, which we think worth the attention of furnace-builders. The principles, so far as published, are in the right direction. His method for more effectually securing the combustion of the smoke is by causing the products of combustion to pass through apertures in plates and cones, and thereby to be retained longer than usual in contact with the flues and heat. And his invention also embraces the means of regulating draught in chimneys, so as to maintain an equable degree of temperature at the upper end of the chimney, by preventing any sudden influx of cold air.

*Messrs W. and J. Galloway's patent boilers*.—These boilers consist of a cylindrical shell or outer case containing two cylindrical tubes forming the furnaces. These two tubes unite behind the fire-bars in a single chamber, and it is in this union that their virtue as smoke-consumers consists. The ordinary double-



furnaced boilers in use are defective as smoke-consumers, inasmuch as the two furnace tubes extend the whole length of the boiler, so that the products of combustion do not meet until their temperature has been reduced below the point of ignition. Extended experience proves that, as economic evaporators, Messrs Galloway's boilers hold a high rank. They are, however, better adapted for large steam-boilers than for ordinary hot-water ones; but, as we yet hope to see one large hot-water boiler made to supply heat to a large establishment of hothouses, such boilers may yet find a place in gardens of importance.

Various other mechanical contrivances have been tried, both for the purpose of consuming smoke and also for feeding the fire without manual attendance; but, from their complication, they are found not to work so satisfactorily as could be wished. Still their respective inventors are entitled to praise for their ingenuity. The examples we have given of smoke-consuming furnaces may be deemed sufficient.

The causes of opaque smoke being so copiously produced by furnace fires are thus detailed by W. Keld Whytehead, C.E., in "Suggestions on Smoke-consuming Furnaces," &c.—"The escape of carbon, the presence of which causes the opacity of smoke, arises from imperfect combustion of the fuel, which may be occasioned by any of the following causes. *Over-rapidity of combustion.*—This is the most common cause of opaque smoke, and defies the most careful stoker. In other words, it is forcing a furnace—*i. e.*, compelling it to burn a larger quantity of coals in a given time than it is fitted to do. That is to say, a certain proportion ought to exist between the area of the furnace and the quantity of fuel necessary to be consumed to evaporate the required quantity of water; or, as engineers say, "a square foot of fire-grate will only burn to advantage 10 lb. of coal per hour." The reason of this limitation is easy to be understood. Each lb. of coal requires 2 lb. of oxygen for its perfect combustion, to supply which 150 cubic feet of atmospheric air must be passed through the fire. Now, all this air has to pass through the spaces between the fire-bars, and sufficient space

can only be obtained by having a proportionate area of fire-grate. Thus, supposing the fire-bars are  $1\frac{1}{2}$ -inch wide at top, and the spaces between them  $\frac{3}{8}$ ths of an inch, it is obvious that out of the  $1\frac{1}{2}$ -inch space in the width of the grate, only  $\frac{3}{8}$  inch, or one-fifth of the whole, is available for an air-passage. But, even if there be sufficient area of fire-grate, and the fire-bars of proper proportions, there may be *want of draught in the chimney*. The passage of air through the fire is entirely dependent upon the action of the chimney, which is a species of pump; and a chimney of insufficient diameter or height will no more discharge a disproportionate quantity of gas than a pump would of water under similar circumstances. It is desirable that the chimney should stand as near to the boiler as possible, because every foot of horizontal flue causes additional obstruction to the passage of the air, and diminishes the useful effect of the chimney. It often happens that the action of a good chimney is neutralised by the malformation of the flues surrounding the boiler. In this case the remedy is easy, or the fault may rest partially or entirely with the *ignorant fireman*." We are afraid this defect will be more difficult to remedy than "*irregular firing and too much stoking*, which are the ordinary faults of the inexperienced fireman. And the extreme of firing too thick is as bad as too thin—the former preventing the proper admission of air through the bars, and the latter allowing the air to pass through in excess, which has the effect of cooling down the furnace and preventing the perfect combustion of the fuel. The effect of regular hand-firing may be expressed in figures as follows:—Suppose a furnace, the bars of which are so proportioned as to admit sufficient air for the proper combustion of 60 lb. of coal per hour; now, if once every minute we could throw evenly over the fire 1 lb. of coal, it is obvious that the quantity of coal on the bars would be nearly invariable, because it would be supplied just as fast as it was consumed, and the demand for air would be constant. In hand-firing a different operation takes place: the coal is thrown on, say 15 lb. of coal every fifteen minutes, and the consequence is, that for one-half of the time too little air passes through the bars, and for the

other half, too much. And here another evil ensues—

*"The temperature of the furnace is lowered below the smoke-burning point.—*The water, of which all coal contains more or less, and the bituminous particles, are evaporated, and carry off the heat very rapidly; the fire thus cooled down, and deprived of a due supply of air, is incapable of raising the bituminous particles to a sufficiently high temperature to cause them to inflame, and a densely black smoke escapes from the chimney-top. It may suggest itself to the reader, that a more regular combustion may be obtained, and a better effect produced, if the fireman were to divide the charge of coal, and throw on 5 lb. of coal every five minutes. This is true in theory; but in practice another evil is induced—the more frequent opening of the furnace door, which admits a volume of cold air, the cooling effect of which on the boiler and flues would more than counteract any saving that could be effected by the greater regularity of the combustion.

*"Stoking is an infallible receipt for making smoke. When an idle fireman wishes to save his trouble, he fires heavily, and stokes or breaks up his fire when the fresh coal is just warmed, which disengages a large body of the gases which escape unconsumed. The secret of economical hand-firing consists in disturbing the fire as little as possible; and regularity of combustion is one effectual means of preventing the production of smoke."*

In regard to the effects of smoke on vegetation, we may here observe, that it is perhaps less objectionable as being injurious than on account of the unsightly appearance it produces, and, still more, the enormous waste of fuel which passes off in an unconsumed state where no means are used for its combustion.

Some propositions have been made for economising the fuel in furnaces attached to hothouses; and, strange enough to say, the old and long ago disused plan of attaching a small lime-kiln to them has been revived of late, and by more than one individual. Speechly published a plan and description of one so long ago as 1796, (*vide* his "Treatise on the Pine,") and informs us that Mr Thompson at Billing, in Northamptonshire, had them in

use upon rather an extensive scale; and, on the authority of Lord John Cavendish, we are also informed that such kilns were in use at Bishop's Court in Ireland prior to 1794. Admitting, however, that some economy in fuel could be attained, the dust and filth attending the operation will, we think, prevent their being used in gardens of high keeping.

The opinions given in favour of nearly air-tight furnaces, and hence stove combustion, are far from being in accordance with those of Sir H. Davy and Dr Ure, both of whom have shown that fuel may be consumed by an obscure species of combustion, but at the same time give out little heat. The former says, in "Researches on Flame,"—"The facts detailed on insensible combustion explain why so much more heat is obtained from fuel when it is burned quickly than slowly; and they show that, in all cases, the temperature of the acting bodies should be kept as high as possible;—not only because the general increment of heat is greater, but likewise because those combinations are prevented which, at lower temperatures, take place without any considerable production of heat. These facts likewise indicate the source of the great error into which experimenters have fallen, in estimating the heat given out in the combustion of charcoal; and they indicate methods by which the temperature may be increased, and the limits to which it may be carried."

It has been proved by satisfactory experiments, that 1 lb. of charcoal is capable of converting 13 lb. of water at 60° into steam at 212°, if burned to the greatest advantage; but on account of our hitherto imperfectly constructed furnaces, this heating power is very seldom obtained, even after making allowance for the waste of heat, which, in the best of furnaces, is inevitable. Dr Muller, in his inaugural lecture at King's College, says: "The first and most obvious loss arises from the escape of the heated air from the chimney before it has surrendered to the boiler or flue the full amount of heat which it is capable of relinquishing. It is manifest that the best method of obviating this consists in so arranging the chimney and passages for the products

of combustion that they shall circulate thoroughly around the boiler, and that sufficient time may be allowed them to part with their high temperature before escaping into the external air." This is mainly occasioned by the admission of too great a supply of air. "There is, however, a very important, but more unsuspected mode in which loss is sustained, and one which is intimately connected with the chemistry of combustion. It depends upon an insufficient supply of air. It is a fact, not less singular than important, that charcoal, or coke, may be dissipated in vapour, and may be apparently wholly consumed, by one-half of the amount of air which is usually required in an open fire, under circumstances where the full quantity of heat is given out; and it is to be observed, that in this case, 1 lb. of charcoal, instead of emitting heat enough to convert 13 lb. of water into steam, will only give out one-fifth of the heat, and will therefore raise little more than  $2\frac{1}{2}$  lb. of water into steam. This important fact depends upon the property which charcoal has of forming two compounds with oxygen. In the first case, where the most heat is emitted, twice the amount of oxygen is taken up, and carbonic acid gas, or fixed air, is produced: in the second case, a gas is obtained also, called carbonic oxide;—it is colourless, and therefore escapes notice; but it is combustible, which carbonic acid is not; and in burning, it gives out a large amount of heat—in short, the other four-fifths of the heat which are deficient when charcoal is burned into this gas.

"This gas is not formed, in the first instance, by the direct union of the coke or charcoal with the oxygen of the air; for carbonic acid is the compound which is invariably obtained; but when this carbonic acid is made to pass over red-hot coals, it dissolves a portion of the coal, becomes dilated to twice the bulk it occupied, and actually, instead of increasing the heat of the furnace by the quantity of coal with which it thus unites, it most materially diminishes it, and carries it off in sheer waste. Now, let us consider what is actually going on in many of our furnaces: these are usually open to the air at bottom by the bars of the fire-grate;

brisk combustion takes place, and the body of coke above becomes of a bright red heat; but the air is quickly deprived of its oxygen by the lowest layer of coal, the draught carries up the exhausted air, and with it the carbonic acid that has been formed;—this gas, as it passes over the intensely ignited coal, dissolves a fresh portion, cools the fire, and ascends the chimney: when it reaches the top of the chimney, it has become too much cooled down to take fire as it comes into the air, and passes off unsuspected, and to waste, actually carrying with it four-fifths of the heat that it ought to give out, if the coal that it takes off had been burned with a due supply of air. I do not mean to say that the whole of the carbonic acid is ever entirely converted into carbonic oxide: the gas is not in contact with the heated coal for a sufficient length of time to produce this effect; but this I do say, that in all furnaces of the common construction, a large loss is sustained in this insidious and unsuspected manner. In the case where coal, and not coke, is employed, still greater loss is sustained;—all the visible smoke is wasted, a good deal of carbonic oxide in addition passes off in the invisible form, and still more coal gas escapes unnoticed; the coal in the upper part of the furnace becomes coked by the heat of the lower portion, and nearly all that the gas-works obtain by distillation of coal in retorts, here passes unheated into the air. The question, therefore, for the consumption of smoke resolves itself, not merely into a question of public health and convenience—to which too often a deaf ear is turned by those who are deriving profit at the expense of the sufferers—but it is also a question of economy on the widest scale; it is a question on which common sense and common humanity are alike agreed; and it is therefore a point which eventually will demand, from self-interest, that attention which mere good feeling would long solicit in vain."—*Pharmaceutical Times*.

In reference to combustion and the management of fuel, we find the following sensible remarks by Mr Rogers, the inventor of the conical boiler with which his name is associated, given by him in a communication to the "Gardeners'

Magazine," vol. xvi. p. 136: "When the fire is first lighted, it should be allowed to burn brisk and clear, till the fuel in the bottom is well ignited; it may then be filled up to the throat of the furnace, when it will last through the night. In filling, care, of course, must be taken that the fuel is not so small and dusty as to stop the draught. As fuel cannot be consumed without air, if a furnace be constructed of considerable depth," (the form of Mr Rogers' boiler being conical, it follows that his furnaces are deeper than those under boilers in a horizontal direction—still the philosophy of combustion is pretty much the same in both cases.) "and filled with fuel, and air be admitted only at the bottom, that fuel alone is consumed which lies immediately on the bars, and first receives the draught of air. The fuel above, providing it transmits the air, becomes red hot, or nearly so, but does not consume, until that below it is destroyed. In this manner, one of these conical furnaces being lighted and filled with fuel, that portion in the upper part of the furnace which cannot burn, absorbs the heat of the burning fuel below, and radiates or transmits it to the water on every side. So perfect is this absorption of heat, that for several hours after the furnace has been filled up with cinders, though there may be a fierce fire below, little or no heat escapes by the chimney, the whole being taken up by the surrounding water. The economy, therefore, of fuel in such an apparatus is very great; and it is also evident that excess of draught must be guarded against, so much only being allowed as will consume the fuel steadily, which is easily learned by experience. The necessity also of keeping the aperture in the front close, so that air enters the furnace only through the ash-pit, is hence evident."

Besides the proper construction of furnaces, much of the success of their operation depends on the manner in which they are attended to. This is a matter sadly neglected, not only in gardens, but in all large establishments, even where regular engineers are employed in superintending them. Nor is it a subject much treated on, in works of horticulture at least. The first, and almost the only

useful instructions we know of in a published form, are given in a paper "On the Management of Hothouse Furnaces," by the late W. Atkinson, Esq., in the "Horticultural Society's Transactions," vol. v. p. 467. They are to this effect: "When the fire is first lighted, the ash-pit door may be left open till the fuel be properly kindled. The door should then be shut close, leaving the brass register so far open as to allow sufficient air to blow the fire, but not more than is absolutely necessary to make it burn well—not violently, nor with a strong draught; for if more air be admitted than is required for a moderate brisk fire, it occasions a great waste of fuel without increasing the heat. The fire-place door must at all times be kept shut, and the sloping part of the iron frame of the door must be kept clear of coals, so as not to prevent the door from latching. No air must be let in at the door at any time, except when it cannot be avoided, in feeding the fire. Any cold air that may get in at the fire-place door is apt to rush over the fire into the flue without being heated, and that air tends to cool the flue instead of heating it. Therefore, all the air that is necessary for blowing the fire must be admitted at the ash-pit register, in order that it may get heated in passing through the fire to the flue.

"It is impossible to determine the exact opening necessary to be left in the ash-pit register to admit sufficient air, as that greatly depends upon the goodness and length of the flue, and the height of the chimney.

"When a flue is once properly heated, the draught becomes stronger, and then a smaller opening in the register is sufficient to supply the fire with air. In this state, about  $\frac{1}{4}$  an inch opening in the register is generally sufficient, and it should be shut quite close, if it will be found that the fire will burn in that position, as a considerable quantity of air will get in through the joints of the ash-pit door. The best fuel for hothouse fire-places is cinders or braise. This is cheaper than using coals only, and keeps up a steadier fire with less smoke. At all times when fresh fuel is added to the fire, the hot fuel unconsumed must be pushed with an iron rake towards the further end of the bars, and fresh fuel applied

immediately in the front of it, so as to fill up the space between the bars and the lower part of the frame of the double door. This fuel being dead between the bars and the door, protects the door from the heat of the fire, and prevents the iron from warping. In supplying the fire with fresh fuel, great care must be taken not to throw it over to the farther end of the fire, or into the throat of the flue, for this is often the cause of flues bursting. When coals are thrown beyond the fire, after it has burnt low, and the flue is hot, the heat of the brickwork generates gas from the coals; this gas gets into the flue; and when the fuel over the fire becomes inflamed, if the flame be drawn into the flue, it ignites the gas that has been there generated, and causes an explosion. This ought to be particularly attended to, as an explosion of gas in the flue may destroy a valuable collection of plants in a moment.

“There is also another circumstance which renders it desirable to attend to the manner of supplying the fire with fuel. If the fresh fuel be thrown over the whole surface of the hot fire, it will produce an immense volume of smoke and black; but, on the contrary, when the fuel is added carefully to the front of the fire, in the manner before described, then much of the smoke given out by it is consumed in passing over the hot part of the fire. Besides the management of the ash-pit register, the damper of the flue ought particularly to be attended to, by not opening it farther than is absolutely necessary for the combustion of the fuel. The more the damper can be closed, provided the fire will burn moderately well, the more will be retained in the flue, without escaping up the chimney, and the less will be consumed. And when the fire is made up for the last time in the evening, the damper should be put in as far as it can be, so as only to keep the fire just alive, and, in general, the fire may be allowed to burn bright against the last attendance in an evening; and then, instead of putting on fresh fuel, close the ash-pit and damper completely. This will prevent any draught of cold air through the flues carrying the heat out at the chimney; and the body of heat that is then in the mass of brickwork of the flues, having no other means of escape

than into the house, will frequently be found sufficient for the night.

“The ash-pit register should be properly attended to, and never suffered to get injured with rust—not even in the summer time, when not in use. The door should then be taken off the hooks and properly cleaned, and rubbed with oil to prevent rust. The shovel used for the fire-place should have a short handle, which is as convenient for use as a long one; and, with a short-handled shovel, the fuel cannot so easily be thrown over the fire. The person who attends the fires should be directed to use his hands in opening and shutting the doors by their proper handles, and not be suffered to do it with a spade or shovel; for, however strong they may be made, they may soon be destroyed by improper usage.

“It is of the greatest importance to preserve the doors and ash-pits perfect, for if they be injured, it is difficult to repair them without taking them out of the brickwork, which is attended with considerable expense, and cannot be done when the fire is in constant use.”

It would be superfluous to make any comment on the merits of this excellent paper. Many young gardeners, by reading it carefully, will see how very few of the conditions laid down are attended to in everyday practice; and although many of them may console themselves with the thought that they have not blown up a hothouse flue, how many tons of coals, and how many furnace doors, have they wasted or burnt out!

In the construction of furnace stoke-holes, it sometimes happens, in low situations, that drains cannot be got to the bottom of the excavation. In such cases, recourse must be had to caissons of iron-work, or brick and cement, so constructed that the water may be kept out of the space where the furnace, &c., is to be set. This is frequently done in Holland, when dwelling-houses, which are often below the levels of rivers and canals, are thus secured against the inroads of water from them.

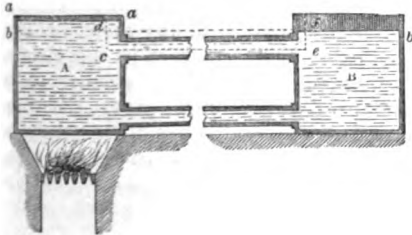
In regard to furnace-doors, we may here observe that, of all others, Sylvester's patent doors are the best for regulating the draught in flues, as well as for lasting long. They hang on a frame in which they slide, the edges of the door and

frame being grooved to fit exactly; and they are therefore nearly air-tight. They also possess this advantage, that, should explosion take place in consequence of an accumulation of gases within the furnace—and all furnaces and stoves upon the principle of slow combustion are liable to such accidents—instead of the furnace being shaken by such explosion, the doors would be lifted outwards, and the evil avoided.

§ 9.—CAUSE OF CIRCULATION OF HOT WATER.

The inventors of heating with hot water, and most of the writers on the subject, appear to have held erroneous notions on its principle of action. Atkinson, Bacon, Barrow, Tredgold, and others, believed that circulation was caused by the water in the boiler expanding when heat was applied to it; and in the appendix to Tredgold's work on heating, we find the following reasoning:—"If the vessels A B, fig. 344, and pipes,

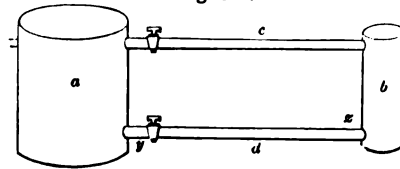
Fig. 344.



be filled with water, and heat be applied to the vessel A, the effect of heat will expand the water in the vessel A, and the surface will, in consequence, rise to a higher level *a a*, the former general level surface being *b b*. The density of the fluid in the vessel A will also decrease in consequence of its expansion; but as soon as the column *d e*, above the centre of the upper pipe, is of a greater weight than the column *f e*, motion will commence along the upper pipe from A to B; and the change this motion produces in the equilibrium of the fluid will cause a corresponding motion in the lower pipe from B to A." This reasoning coincides exactly with the opinions held by the authorities above named. Mr Hood,

however, dissents from these opinions; and after pronouncing them erroneous, gives his theory in the following words:—"Let us suppose heat to be applied to the boiler *a*, fig. 345, a dilatation of the

Fig. 345.



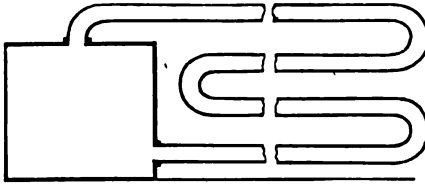
volume of the water takes place, and it becomes lighter—the heated particles rising upwards through the colder ones, that sink to the bottom by their greater specific gravity; and they in their turn become heated and expanded like the others. This intestine motion continues until all the particles become equally heated, and have received as much heat as the fuel can impart to them. But as soon as the water in the boiler begins to acquire heat, and to become lighter than that which is in the opposite vessel *b*, the water in the lower horizontal pipe *d* is pressed by a greater weight at *z* than at *y*, and it therefore moves towards *a* with a velocity and force equal to the difference in pressure at the two points *y* and *z*. The water in the upper part of the vessel *b* would now assume a lower level, were it not that the pipe *c* furnishes a fresh supply of water from the boiler to replenish the deficiency. By means of this unequal pressure on the lower pipe, the water is forced to circulate through the apparatus, and it continues to do so as long as the water in *b* is colder, and therefore heavier, than that which is in the boiler; and as the water in the pipes is constantly parting with its heat, both by radiation and conduction, while that in the boiler is as continually receiving additional heat from the fire, an equality of temperature never can occur; or else, if it did, the circulation would cease.

"We see, then, that the cause of circulation is the unequal pressure on the lower pipe of the apparatus; and that it is not the result of an alteration which takes place in the level of the water, as has been erroneously supposed."

From this it appears that circulation is really owing to the water in the lower

or returning pipe being of greater specific gravity than that in the boiler ; and that motion takes place in the lower pipe first, instead of in the higher one, as was formerly supposed. The colder the water is in the lower pipe when it enters into the boiler, the more rapid will the circulation be ; and as it is desirable to have, in most cases, a rapid circulation, it follows that the greater length of pipe employed, the more likely is this to be effected ; because the greater the length of pipe, the more surface is produced for radiation and conduction. Hence four courses of pipes, as in the annexed cut, fig. 346, will give out more heat than two ; and the specific

Fig. 346.



gravity of the fourth, on entering the boiler, will be much greater than at the same end of the second pipe. The water, having given out nearly all its heat in the course of a long circuit, must naturally absorb more heat from the fire than if it had made a shorter circuit, and entered the boiler in a much less cold state — consequently economising fuel. We have often been struck in practice by finding the same quantity of fuel used in heating the atmosphere of a hothouse, by the pipes running parallel to the front wall, as is usually the case, as was requisite when the water was turned into pipes or tanks under the beds to supply bottom heat also,—a consequence arising from an insufficiency in the extent of pipes, and a circumstance too little attended to.

It appears by Hood's experiments, that another erroneous opinion has been entertained regarding an increased circulation being caused by giving the return-pipe a considerable fall towards the boiler. This, so far as regards boilers that are open at the top, and adapted to the original or horizontal circulation, is found, he says, to be erroneous ; and although advocated by Tredgold and other scientific men, who founded their theory upon consideration of the subject as a simple question of

hydraulics, instead of a compound result of hydrodynamics, has been proved by Hood and others to be attended with a loss on the effective pressure rather than a gain, as the height between the highest part of the pipe and the boiler is exactly the same whether the pipes be laid vertically or inclined.

In the arrangement made by Rogers as to the position of his pipes to that of the boiler, he recommends that, when 2 or 3-inch pipes are used, a uniform rise of about 1 inch in 20 feet should be given them ; but when 4-inch pipes are employed, it is better that the pipes should fall from the boiler in exactly the same proportion, if local circumstances will admit of the arrangement ; for, he says, "the moving force, and consequently the velocity of the circulation, depend upon the difference in weight between the ascending and descending columns : now, the greater the height of these columns, the greater the difference in their weight, and consequently the greater the velocity of circulation, and the higher the mean temperature of the pipes. With 4-inch pipes this is unimportant, for the volume of water contained in them is large as compared with their radiating surface ; so that, with any given velocity, the water loses less heat in one circulation than it would in smaller pipes. Moreover, in 4-inch pipes the friction is small, and offers little resistance to circulation, so that in 4-inch pipes there is little need of very rapid circulation, and less resistance to such circulation ; but with smaller pipes there is need of more rapid motion, or the water in the return-pipe will be much colder than in the delivery-pipe. To take the instance of 2-inch pipes, and suppose the circuit of equal length, and the velocity equal in both cases, the difference of temperature between the flow and return pipes will be four times as great as it would be with a 4-inch pipe, because the volume of water conveying heat is only one-fourth of that contained in the larger pipes. It is true, this difference of temperature increases the difference of weight in the column,—that is, the moving force—and the supposition of equal velocities does not hold good in practice. But with increased velocity comes increased friction ; and, moreover, with diminished

diameter comes increased friction also ; so that, with the boiler of the same height, it is impossible to heat a given length of 2-inch pipe to the same mean temperature with an equal length of 4-inch pipe. But there is yet another disadvantage to be taken into account on the score of the 2-inch pipe, which is this : that as a given boiler is calculated to supply, say 100 feet of radiating surface—if this 100 feet of surface is exhibited in the form of 200 feet of 2-inch pipe, instead of 100 feet of 4-inch pipe, you have not only the increased friction due to the diminished bore to contend with, but also the increased friction due to a double length of pipe ; so that, in order to bring the radiating surface of 200 feet of 2-inch pipe to the same mean temperature as 100 feet of 4-inch pipe, you require a greater increase of moving power—that is, a great elevation of the pipes above the boiler." One foot of rise, Mr Rogers says, is sufficient in all ordinary cases, "even with 2-inch pipes, but the higher the better ; for the higher the pipes are above the boiler, the greater will be the economy of fuel, inasmuch as the heat will be carried off more rapidly from the boiler. It is a possible condition that small pipes might be properly placed, and perfectly free from air or other impediment, and yet that the water in the boiler should boil to waste in steam, although the mean temperature of the pipes fall far short of 200°—simply because in a very long length of pipe, if it be laid level with, or only just above, the top of the boiler, the moving force would not be sufficient to overcome the friction."

It was some time after the application of hot water in heating hothouses, before close-topped boilers, and carrying the pipes to any extent of altitude, were practised. The advantages of departing from the original plan are many, such as an increase of circulation, adapting this mode of heating to situation and circumstances where the horizontal method could not be applied, &c. It is not easy to say to what altitude water may be raised by this means, but certain it is that it can be elevated to any extent directly connected with horticultural buildings, provided the boiler be made sufficiently strong to resist the pressure.

According to the calculations of Hood,

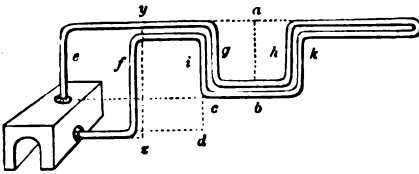
"the pressure of water on each square inch of surface increases at the rate of about  $\frac{1}{4}$  lb. for every foot of perpendicular height : if the height from the bottom of the boiler to the top of the pipe be 6 feet, the pressure on the bottom will be 3 lb. on every square inch of surface ; but, if the boiler be 2 feet high, the pressure on the top—which will be a pressure upwards—will be only 2 lb. on every square inch of surface, because it will only have 4 perpendicular feet of water above it. If the height of the pipe be increased to 28 feet, and the depth of the boiler be 2 feet as before, making 30 feet together, the pressure will be 15 lb. on each square inch of the bottom, and 14 lb. on each square inch of the top, and an average pressure of  $14\frac{1}{2}$  lb. on each square inch of the sides of the boiler. Suppose, now, a boiler to be 3 feet long, 2 feet wide, and 2 feet deep, with a pipe 28 feet high from the top of the boiler, when the apparatus is filled with water there will be a pressure on the boiler of 66,816 lb., or very nearly 30 tons."

It is seldom such a pressure as this will be applied to garden purposes, if we except cases where hot water may be supplied from a boiler to heat baths, &c., in higher parts of attached buildings, or in the case of a whole garden being covered with glass, (a thing by no means in the future improbable,) and where part of the columns which would be required for the support of the roof might be used as pipes for radiating heat. The expansive force of water is so trifling, that under no circumstance could it burst an ordinary well-constructed boiler ; the only effect would be a slight leakage : but the pressure upon the boiler is quite a different thing. The amount of the friction of water passing through pipes has never been accurately determined ; but it must, of course, be greater in pipes of a rough or uneven inner surface than in such as are smooth and even. Hence glass pipes would have less friction than any others. Difficulties frequently present themselves when it becomes necessary, from local circumstances, to carry hot-water pipes to a higher or lower level than that of the horizontal line of the main pipes and boiler ; but this latter should be avoided as much as possible. If 16 inches be taken as the minimum distance at which



4-inch pipes should be placed centre from centre to effect a perfect circulation under ordinary circumstances—that is, where the pipes are placed so as not to fall below the horizontal level—then, in such cases, the ascending pipe should in general be just as much greater than the above dimension as the depth which the circulating pipe is required to be below the horizontal level, taking into account the length and diameter of the pipe through which the water passes, as on this depends the motive power, on account of the difference of temperature between the ascending and descending columns of water. If the pipe be of considerable length, a less extent of vertical pipe will be required; but if the pipe be shorter, a greater height must be allowed, taking into consideration, at the same time, the temperature that surrounds the pipes—for on this depends the amount of heat given out, which also affects the temperature of the descending pipe. Thus, suppose the depth of the dip, shown by the dotted line *a b*, as in the diagram annexed, fig. 347, “to be 24 inches, then

Fig. 347.

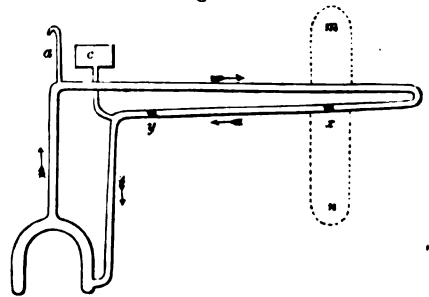


the distance *y z* ought to be 40 inches, if the pipes be 4 inches diameter—that is, 36 inches from centre to centre, or 40 inches from the top of the pipe *y* to the bottom of the pipe *z*; and, with these dimensions, as good a circulation will be obtained as when the distance between the top and bottom pipes is 16 inches from centre to centre in the common form of the apparatus. It will be observed that by this arrangement the distance *c d*, from the under side of the flow-pipe to the upper side of the return-pipe, is just 12 inches, which is the same height that was stated (*vide BOILERS AND PIPES*) to be necessary to secure a good circulation on the ordinary plan without a vertical dip. The reason why this height is sufficient in the present case, notwithstanding the increased friction of the

angles, is because there must always be a greater difference between the temperature of *e* and *f* than between *g* and *h*, or between *i* and *k*, or even more than between these together; therefore the tendency to direct motion is greater than towards retrograde motion in proportion to this difference, and is sufficient to overcome the increased friction caused by the vertical declination, while the additional height of 12 inches beyond the height of the dip, possessed by the descending pipe *f*, is sufficient to produce circulation of the water. If *g* and *h*, and also *i* and *k*, were very wide apart—say 40 or 50 feet—instead of being, as usual, only about 3 or 4 feet, the balance of effect, though still in favour of direct motion, would not be so great as in the last supposed case, because there would be a greater difference in temperature between *g* and *h*, (that is, *h* would be heavier than *g* in a greater degree,) which would give a greater tendency to retrograde motion. In extreme cases, therefore, it will be advisable to make the ascending pipe somewhat higher in proportion to the dip than is here stated, probably when there are several such alterations required in the level of the pipes; and, in all cases, as has been before observed, the higher the ascending pipe is made, the more rapid will be the circulation.”—HOOD.

On the subject of carrying hot water to heights above the level of the boiler, as well as depressing it to a lower level, Mr Ainger gives the following statements in “Gardeners’ Chronicle.” “If,” says he, “it be required to discontinue the line of pipes in order to pass a doorway or other obstacle, it is best done by an ascent, as

Fig. 348.



shown by the dotted lines *m*, in fig. 348, which, if the pipes be kept close at the

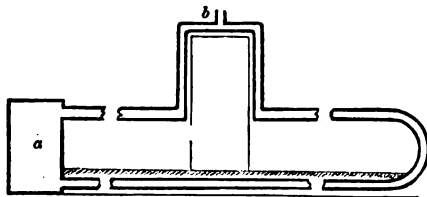
bend, so as to form a siphon, may rise higher than the feeding cistern *c* and air-pipe *a*; but this construction is dangerous, inasmuch as air may accumulate in the bend and stop the circulation. It is better, therefore, to make the cistern *c* and air-pipe *a* higher than any required elevation in the water-pipes, as *m*, and furnish the latter with a small pipe to carry off the air. Every such ascent and descent evidently creates a force of some amount in favour of the movement, not, perhaps, more than enough to balance the increased friction produced by the bends, because the temperature of the ascending and descending columns cannot differ much. When it is, however, necessary to make a descent, as *n*, the difference of temperature in the two columns is adverse to the movement; and as this acts in addition to the retardation produced by the changes of direction, such descents should be cautiously made, and only when there is an obvious preponderance of power to carry the water through them.

"In such a system as that described in the figure, where the vertical pipes may be called from 5 to 10 feet, and where there are no descending bends like *n*, it is surprising through what an immense length of nearly horizontal pipes the circulation may be carried. I believe," he says, "that the limits are not known; and, as the friction of many hundred feet of pipe must be considerable, though it is less than is generally supposed, the effect seems to require some more powerful cause than the different weights of the two columns. Various speculations have been made with the view of accounting for this, but I am not," he says, "aware of any that is quite satisfactory, and the following may be as little conclusive. It appears to me, however, that the continual cooling of the water furnishes a material facility towards its movement. Referring to the last fig., (348,) if *x* be supposed to represent the bulk of a certain portion of water at that place, and *y* the smaller bulk that it would afterwards occupy in consequence of its loss of heat in the interval, it is clear that there must be a rush to fill up the void thus created; and as this rush would take place with the greatest facility in the direction of the moving mass, there would exist at

every part of the circulation an impelling force dependent on the constant diminution of the volume of the water, and perfectly independent of the different weights of the two vertical columns. The effect would, indeed, be very similar to what might be produced by a constant but slight increase in the diameter of the pipes, where the water would be continually moving into a larger and larger space, and where of consequence it must move much more freely than where the space was constant in reference to the bulk of the fluid."

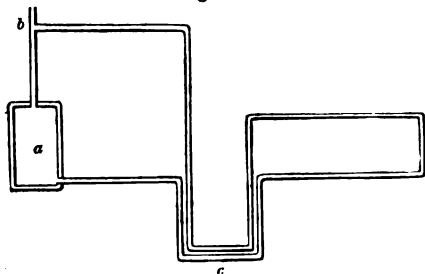
To circulate water to levels either above or below the boiler, it is necessary, in the first case, (fig. 349,) to have the

Fig. 349.



top of the boiler *a* fixed, from which a pipe may be taken to any height and made to descend again; but it must not rise nor fall twice after leaving the boiler. That part of the pipe *b* that is highest above the boiler should have a small air-tube inserted in it at the bend; for, should air accumulate there, no circulation can take place till the air is extracted. In the next case, fig. 350—namely, circu-

Fig. 350.

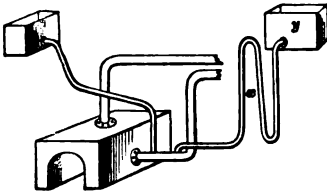


lating water below the boiler (*a*) level—it is necessary to raise the water as it is heated to as great a height (*b*) above the boiler as it is intended to carry it below it (*c*).

Much has been said on the necessity of supply-cisterns for feeding the boilers,

particularly such as are close-topped. This we consider a very minor affair, and prefer such as have a gauge-pipe and supply-pipe communicating with some convenient spot near the stoke-holes, the former furnished with a cock, the latter left open to serve as an expansion tube. Two or three times a-week these are examined, the cock of the gauge-pipe turned, and water poured into the other till it runs out at the cock, which indicates that the boiler and pipes are fully charged, when the cock is again closed. As water expands 1-24th part of its bulk when heated to 212°, it follows that neither boiler nor pipes should, when cold, be filled to their utmost extent; and should they by accident be so charged, the utility of an open expansion-tube is obvious. It is seldom, however, that the water attains a temperature of 212°, and hence the expansion is much less, perhaps not often more than 1-30th part of the volume, exclusive of the increased capacity afforded it by the expansion of the boiler and pipes. The usual mode of attaching supply-cisterns is to place them in any convenient place near to and above the level of the boiler, and to connect them by a small pipe, say of half-inch bore, to almost any part of the apparatus; but if to the return-pipe, so much the better, as shown in fig. 351. Hood has suggested

Fig. 351.



a still better plan, namely, "to bend the pipe attached to the cistern into the form shown by *xy*, which is a preventative to the escape of any heat or vapour at that part, as the legs of the inverted siphon *x* generally remain quite cold."

The cause of circulation is thus described by Ainger in "The Gardeners' Chronicle":—"The basis of the whole system is this—that whenever a vessel of any form, containing an elastic or non-elastic fluid, is partially heated, motion will immediately take place in the fluid;

and so far from its being difficult to produce this motion, the only difficulty is to prevent the movement. It occurs under the slightest difference of temperature; and the result is, that in nature no fluid matter is quiet. Warm water in an exposed vessel is in constant motion down the cooling sides, and up the protected centre; while liquids cooling and evaporating, under the microscope, are seen to describe the most extraordinary evolutions. In short, the whole fluid world, whether heating or cooling, maintains a perpetual motion, which requires a few simple considerations to direct to our own

Fig. 352.



purposes. In illustration of the simplest form of circulation, let fig. 352 represent a section of any enclosed space containing air, the opposite sides of which have temperatures differing in any sensible degree, there will infallibly occur in the air a continuous movement up the warmer and down the cooler sides, as shown by the arrows; while, in the centre of the space, the conflict of the ascending and descending currents will create numerous little whirlwinds, which will, to a certain extent, interfere with and check the main currents. For this reason, it is found that a diaphragm, fig. 353, to separate the two currents, promotes the freedom and increases the rapidity of the circulation, by confining the two streams within their proper limits.

Fig. 353.



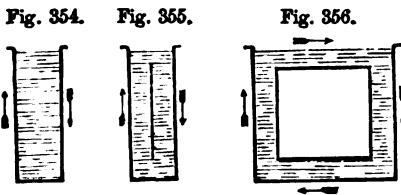
"By this diaphragm, the vessel has become converted into an ascending and descending pipe; the more rapid circulation in which, spite of the increased surface exposed to friction with the circulating matter, leads to the inquiry, What is the nature and amount of that friction of fluids in pipes, about which so much is said, and so little generally understood? In the first place, it appears to be forgotten that the friction of the fluid against the pipe cannot be greater than that of the fluid against itself, because, if it were so, the moving fluid has only to leave an

indefinitely thin film of its own substance against the surface of the pipe, and the resulting friction would then be fluid against fluid." After proving, by examples and arguments of sufficient force, that the friction of water against water is greater than against foreign bodies, he proceeds to say—"The inference deducible from these facts in relation to our present purpose is this, that in every hot-water circulation, there should be the least possible liability to produce intestinal currents or eddies, that the water, as much as may be, move in a mass. With this view, sharp and numerous bends in the pipes should be avoided; and, above all, we should guard against *strictures*, which *souredraw* the water, and create a quantity of inter-friction, infinitely more prejudicial than that against the sides of the pipes. With well-arranged pipes, then, the friction is doubtless very small, but the inertia of the water is an obstacle of considerable amount, which, like the friction, will increase with every change of direction, with bends, and with strictures."

It is difficult to calculate the amount of resistance caused by friction and inertia, either in rapid or sluggish circulation; for both are affected by a variety of circumstances, neither easily understood nor computed. "We are obliged, therefore," says Ainger, "to estimate the quantity of resistance, by knowing that it is certainly below that of the force which overcomes it, and which is more easily estimated. In any system of pipes, however complicated or numerous, if the sum of the products of the specific gravities of the ascending columns, multiplied by their several lengths, measured vertically, be less than the corresponding sum of the descending columns, motion will result, which will be more rapid as this difference is greater." Ainger's theory of circulation will be readily understood by a

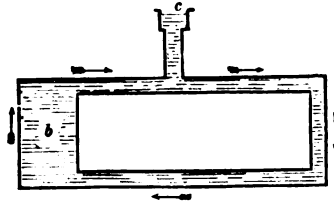
containing water, which simply illustrate the principle of the movement. In all of them, the left-hand side, or that having an ascending arrow, is supposed, from some cause, to be the warmest. In fig. 354, the ascending and descending currents would interfere with each other, as before mentioned, creating whirls and eddies which would check each other's movement. In fig. 355, the diaphragm, by preventing this intermixture, and by preventing also the exchange of temperature otherwise than by circulation, would greatly increase its velocity. And in fig. 356, the velocity will be still farther increased by the horizontal distance between the ascending and descending columns, which would cause them to exhibit greater differences of specific gravity.

"Here, then, we see gradually produced the three elements of power. 1. Freedom from intestinal movements. 2. Substituting the friction of water against some other substance, for that of water against water. 3. Difference of specific gravity, by causing the water to become much cooler in the descending than in the ascending chamber. We have now only to imagine this last chamber to be closed, fig. 357, and unequally divided, forming



glance at the annexed diagram, figs. 354, 355, and 356, "representing three vessels

Fig. 357.



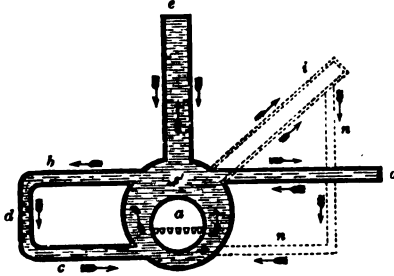
what may be called a boiler at *b*, with a cistern at *c*, and we have a hot-water apparatus of the simplest form."

The clear and lucid explanations given by Mr Ainger in his various papers in "The Gardeners' Chronicle," from which the above, with the diagrams, is taken, show a thorough practical, as well as theoretical, acquaintance with this subject, and a general agreement in principle with the views of Hood and others.

On the operation of circulation, Bernan observes, ("Hist. of Heating," &c.)—"In all the apparatus which have been described, the circulation of the water is

promoted by what is technically called a return or descending pipe. But in many cases in which the difference of level is small, the effect does not seem to have been impaired by this arrangement. In the diagram, fig. 358, *a* is a furnace

Fig. 358.



in the inside of the boiler *s*, with various pipes proceeding from it. If we suppose the pipe *e* only to be attached to it, and to be filled with water, as that in the boiler was heated, a circulation would commence and continue by the hottest water rising to the upper part of the pipe, and the water cooled by contact with the surface falling into the boiler. It is clear the same effect will be produced if the pipe *i* were substituted for the pipe *e*; and it is also clear that the circulation would be less impeded than if the hottest water rose to *i*, and descended, when cooled, through the pipe *n n* to the bottom of the boiler *s*—supposing in both cases an equal quantity of heat to be dissipated. If the heating pipe *o* was nearly horizontal, the same effect would take place from the molecular action: the water in the pipe would be somewhat warmer than if it flowed along *b* and descended by *d*, and returned by *c* into the boiler, as less of the velocity due to the temperature would be lost from friction in the straight pipe than in the return-pipe. In most cases the return-pipe might be altogether omitted, with manifest advantage to the simplification, and consequent certainty, of the circulating process. The lightest water will always find the highest level; and the less it is impeded, the circulation

will be the more perfect, and the heating effect will be greater."

The following is Mr Tomlinson's theory of circulation :—"When heat is applied to a vessel containing water, the principle of conduction altogether fails; for water is so imperfect a conductor of heat, that if the fire be applied at the top, the water may be made to boil there without greatly affecting the temperature below. But when the fire is applied below, the particles in contact with the bottom of the boiler, being first affected by the heat, expand, and thus, becoming specifically lighter than the surrounding particles, ascend; and other particles take their place, which, in like manner becoming heated, ascend also;—and the process goes on in this way until the whole contents of the boiler have received an accession of temperature. If the process be continued long enough, the water will boil and pass off in steam; if the boiler be closed in on all sides, so as to prevent the escape of steam, it will burst with a fearful explosion. If a tube full of water rise from the top of the boiler in a vertical line to any required height, and then by a series of gentle curves descend, and enter near the bottom of the boiler, the process of heating is still the same. The particles of water first heated will rise, and, in doing so, distribute their heat to other particles, which will also rise; these in their turn will lose a portion of their heat to other particles, which rise in their turn, until at length an equilibrium is established. But as the source of heat is permanent, other particles are rapidly brought under its action, and, being heated, ascend. By continuing the process a short time, the particles in the vertical tube become heated, and, by their expansion, exert a pressure on the water contained in the lateral branches;—this, together with the increasing levity of the water in the boiler, establishes a current, and the water from the branches begins to set in in the direction of the boiler; the water in the lowest branch, where it enters the boiler, supplying colder and heavier particles every moment, to take the place of the warmer and lighter particles which are being urged upwards along the vertical pipe."

## CHAPTER V.

### VENTILATION.

VENTILATION, as applied to dwelling-houses as well as to hothouses in this country, has, till lately, been both much neglected and little understood. This is the more extraordinary, as it is historically known that, in other countries, it was well understood and much attended to, even centuries ago. In the famous palace of the Alhambra, for example, begun to be built in the reign of Mahomet the Second, we are informed by Power, in his "History of the Moors in Spain," that "in every apartment two currents of air were continually in motion, apertures being formed near the ceiling to discharge the warm and unwholesome air, which the pure inferior current forced upwards. So well directed were these currents of air, as to come refreshed every instant with that delicious coolness, breathed only in this edifice." How few dwelling-houses at the present day have provision made near the ceilings for the escape of impure air; and yet it is at those parts, and by such means as those described above, that we are to get rid of those pestilential elements with which the air of even our best-regulated houses is so often contaminated.

All ventilation is founded upon the simple principle that cold air is heavier, and has a tendency to sink downwards, whilst hot air is light, and rises to the top. At first sight it may appear that, for the purpose of ventilating any building, it is only necessary that holes should be supplied at the bottom of the apartment for the air to enter, and other holes be placed at the upper part, for the hot air to escape. Practically, however, ventilation is far from being so simple an

affair; and if there is anything more difficult than another for a scientific man to accomplish, it is that of causing currents of air to obey his will, and take that course through any building, and with any velocity, which he may desire.

"Ventilation is necessary, not to enable plants to exercise their respiratory functions, provided the atmosphere is unmixed with accidental impurities, but to carry off noxious vapours generated in the artificial atmosphere of a glazed house, and to produce dryness, or cold, or both. If ventilation is merely employed for the purpose of purifying the air, as is often the case in hothouses and in dung-pits, it should be effected by the introduction of fresh air, damp and heated. If it is only for the purpose of lowering the temperature, as in greenhouses, or in the midst of summer, the external air may be admitted without any precautions."—LINDLEY'S *Theory of Hort.*

"Vertical openings in upright walls, if they communicate immediately with the external atmosphere, are objectionable, because they are liable to be acted on by the prevailing wind, which, blowing sometimes in one direction, sometimes in another, and sometimes not at all, renders their action uncertain, and not to be depended on. Generally speaking, the exterior terminations of all ventilating openings, whether for ingress or egress, should be in a horizontal, rather than in a vertical plane."—WALKER'S *Useful Hints on Ventilation.*

The earlier constructed hothouses in this country, being copied from those of the Dutch, had fixed roofs: how they were ventilated, we have scarcely any record left us. As soon, however, as

houses began to be constructed of separate sashes and rafters, means were contrived by which ventilation was effected, chiefly by mounting the sashes on rollers, so that they could readily slide over each other. On the Continent, where the fixed roofs were, and still are, common, portions of them near the top are made to open, by being hinged to the wall-plate, and propped up by a long wooden handle, reaching nearly to the ground, inside of the house. We have seen the same principle adopted even in this country, and in very modern houses, only substituting an iron rod for a thick wooden pole.

Ventilation, for a long time after the invention of hothouses, was considered necessary only with reference to preventing the atmosphere of the structure from becoming too much heated. Still, too often it is the temperature, and not the actual change of pure air for that which has become vitiated and impure, that is thought of.

New and more rational views have arisen, and improvements followed. Still we must confess much yet remains to be done; but as the natural properties of air are now better understood, we have hopes that, ere long, ventilation may be effected upon true and correct principles.

In a leading article, some time ago, in "The Gardeners' Chronicle," written, we presume, by the talented editor, Dr Lindley, we have the following piquant observations: "When a man builds a forcing-house, he settles carefully the slope of the roof, the nature and direction of the heating apparatus, the material for his shelves and floors, the quality of his glass, the size of the squares, and the depth of their laps. Whether the door shall be at the end or side, and the whereabouts of the stoke-hole, are other points of grave deliberation. How, then, are we to account for the almost universal neglect of the most important part of all—THE VENTILATION?"

"But no: we wrong the builders of forcing-houses;—they do not neglect ventilation; on the contrary, they provide for it copiously. They make the roof-sashes slide, and the side-windows unfold, and the door-way alone administers no inconsiderable doses of wind. In fact, the ventilation—if by that term is

meant the *letting in of wind*—is in no ways deficient. But unfortunately this is not precisely what plants require. They want in-draughts neither of hot dry air in the dog-days, nor of ice-cold breezes in the winter. Both hot and cold air act like water; the one scalds, the other freezes. It is because of the danger of such ventilation as this that gardeners have concluded that a close moist atmosphere is indispensable to vines when in flower—a singular mistake, which the author of this article has disposed of some years ago.

"If we did not hate new words," says the same high authority, "we should be half inclined to expunge ventilation from the language of gardening, and to substitute zephyration, or some such gentle epithet. We shall, however, content ourselves with distinguishing ventilation from *aération*—the latter a legitimate word in actual use—defining *ventilation* as the process of letting the external air at once into a forcing-house, and *aération* as the act of keeping the atmosphere of a forcing-house in motion by currents of warmed fresh air. The importance of *aération* cannot be over-estimated. It is the one thing which now requires to be secured, in order to render our artificial climates natural. A man's reason, indeed, must tell him, that a plant condemned to pass its life in a still atmosphere, is like nothing so much as a criminal set fast in an everlasting pillory. In order to secure motion in the vegetable kingdom, currents of air are made to do the work of the muscles, limbs, and volition of animals. It is not at all improbable that, in addition to the mechanical effects of motion in assisting the propulsion of the sap, it may be important that the stratum of air in contact with the leaves of plants should be incessantly shifted, in order to enable them to procure an adequate supply of food; for we find that water in motion feeds them better than that which is stagnant. Leaves are continually abstracting from the air the very minute quantity of carbonic acid which it contains. When the air moves quickly over their surface, fresh supplies of that food are incessantly presented to it, and the operation of abstraction may be facilitated; while, on the contrary, if the

air is stagnant, the absorption of carbonic acid may be much slower."

"Perspiration is another vegetable function which must be maintained in healthy action. The quantity of water that flies off from the surface of a plant will, *cæteris paribus*, be determined by the rapidity of the motion of air passing over its surface. In an absolutely still air, perspiration will be reduced to its minimum, and it will increase within certain limits, in proportion to the quickness with which the air sweeps over it." "If the motion of air is thus favourable to the two great operations of feeding and perspiration, we shall find that it is equally needed day and night; for perspiration goes on principally during daylight, and feeding in the hours of darkness. A good system of aëration *must then be constantly in action*. How to secure that is the great horticultural problem which now remains to be solved."

Mechanical inventions of considerable ingenuity have been applied for the purpose of ventilating hothouses, in some of which the motive power employed to put them in action has been derived from increase of temperature within the houses. This regulates temperature only; but it has little power over the purification of the air, the escape of impure air, or admission of fresh supplies of this indispensable element. It is true that whilst the temperature within is high, these machines operate, and, in doing so, allow a considerable quantity of vitiated air to escape from the top of the house, and a corresponding supply of fresh air to be taken in at front to make up the loss; but when the internal temperature is low, they cease to act, and all change of air is arrested. So it is too often, even where this is accomplished by manual labour, the operator being almost invariably guided by the state of the thermometer, and not by the state of the air in which the plants breathe, and from which they derive so much of their health and vigour. Again, ventilation, as usually applied, is confined to the daytime only, and can only be serviceable to the plants so far as perspiration is concerned, which goes on principally during the day; while feeding, the other of the two great operations in plants, goes on during the night, when the house is shut up as close as if the ad-

VOL. I.

mission of air were to be instantly fatal to them. Were it not that hothouses are not so well jointed as a cabinetmaker would joint a piece of furniture, or a cooper a tub, and that glass is fortunately liable to be broken, plants could not exist in these structures; but, fortunately for them, a constant process of ventilation or aëration is going on night and day almost unknown to man, through the various chinks in the framework and fractures in the glass. Under the old system of ventilation, plants prospered better in houses glazed with the overlaps left open, than in those that were cross-puttied—and still more so where the glass was small than where it was of the largest size, because there were many more openings for the admission of air from without, these openings being small, and very equally distributed over the roof. There is, however, no possible necessity for returning to that mode of glazing, which is so destructive to the glass during frosts, as the same means may be attained by a proper and equally diffused mode of ventilation.

Calculations have been made as to the amount of ventilation necessary for public buildings, and where many people are congregated together; but we are not aware if such have been made regarding plant or hot houses. The calculation for these would be much more difficult, as every plant or tree would require a supply of air in proportion to its size, the number of its leaves, &c. 800 cubic inches of air per minute is a sufficient pulmonary supply for a man, exclusive of that required to carry off the insensible perspiration, which is calculated to be about ten grains per minute, when no particular muscular exertion is making.

Having such data before us, it is not difficult to calculate the size of the openings necessary to ventilate these public buildings; but having no such guide in regard to hothouses, the difficulty is obviously great. Were it possible to calculate accurately the quantity of air required to be changed per minute in a hothouse, the next thing would be to estimate the proper size and position of the openings for the escape of the foul or exhausted air, and also for the entrance of fresh air to supply its place.

Hood, in "Remarks on Ventilation as ap-

2 M



plied to Rooms," lays down the following rules; and as they, to a certain extent, apply also to forcing-houses, at least so far as the velocity and circulation are concerned, they may not be out of place here. "When an opening is made in the ceiling, or upper part of a room, the force which produces motion in the air is the same universal law which regulates the falling of bodies, and is precisely similar to the motion of water in a siphon. The total height from the floor to the point of final escape of the heated air is the height of the siphon. The force of motion is the difference of weight between this column of heated air and that of a column of external air of the same height. Now, air expands, when heated, 1-480th of its bulk for each degree of Fahrenheit; and the velocity of motion is equal to the additional height which a given weight of heated air must have in order to balance the same weight of cold air. Thus, suppose a room 12 feet in height, and the air 20° higher in the room than the external temperature, the air will expand 1-24th of its bulk by the excess of temperature; therefore 12½ feet of heated air will balance 12 feet of air which is 20° lower in temperature. The motion of fluids is equal to the velocity which a solid body would acquire by falling through a space equal to the excess of height which the lighter body must have in order to balance the heavier. This velocity is *as the square root of 16 feet is to 16 feet per second, so is the square root of the given height to the velocity sought*. This resolves itself simply into multiplying the square root of 16 feet by the square root of the given height. But as the acquired velocity of a gravitating body is equal to twice the space it falls through in a given time, the number thus found must be doubled. In the case of the room we have before supposed—as the additional height of the heated column of air is 6 inches, so the square root of 6 inches reduced to the decimal of a foot, multiplied by the square root of 16 feet, and that product multiplied by 2, will give 5.6 feet per second as the velocity of the air. An opening in the ceiling 1 foot square will therefore discharge 336 cubic feet of air per minute.

"It will be perceived that here also, as well as in the case of the circulation of

water, if either the vertical height or the excess of temperature be increased four-fold, the velocity will, in either case, be twice as rapid as before. But whatever be the calculated velocity, the real discharge will not be so great as this theoretical quantity, not only in consequence of friction, but also because the air will be cooled in its passage through the ventilating tubes, particularly if they extend beyond the roof of the building. This will considerably lessen the discharge; and we ought, therefore, to deduct a certain amount from the calculation, which, on an average, should be about one-fourth of the whole quantity."

"As the discharge through any given height and size of ventilator is less in proportion as the difference between the external and internal temperature is smaller, it follows that it will be most difficult to obtain ventilation in hot weather. In summer, either the number or dimensions of the ventilator should be increased," otherwise ventilation that would be sufficient in winter would be quite inadequate in summer. "The openings for the admission of air," Hood observes, "should always be placed as near to the floor as possible. In size they should be larger than the area of the ventilators," that is, the discharging ones, "in order that the influx of cold air may not proceed with too great velocity and cause a draught. In fact, the size of these openings is a matter of indifference, provided only that they be sufficiently large; for the quantity of air that enters through them depends entirely on the quantity that passes off through the 'top' ventilators, and not *vice versa*; for if the passages for the cold air were double the size of the ventilators 'for its escape,' no more cold air could enter than a quantity equivalent to that of the heated air which escapes at the 'top;' and none of the heated air can escape at the cold-air channels, because heated air cannot descend.

"The more numerous and divided are the openings for the admission of cold air, the less inconvenience will be experienced by currents; but unless a sufficient quantity of cold air be admitted in this manner, there will be a counter current of cold air forced through the ventilators, which will descend and produce a very disagreeable draught."

Acting upon the theory here laid down, Mr Williams of Pitmaston ventilated his melon frames by keeping the south side of them open day and night—this opening

Fig. 358.\*



being merely covered with a fine screen of fly-wire, painted black (fig. 358.\*) The air passing through the wire-screen is divided much in the way that water is divided in passing through the rose of a watering-pot; and, according to Mr Williams' views, it receives a degree of heat from coming in contact with the black-coloured wire. One peculiarity in this mode of ventilating is, that the wire-screen is set to the exact angle of the roof. "This screen receives the rays of the sun from 10 A.M. to 3 P.M. all summer long; it becomes heated to 80° or 100°, and consequently heats the air that passes between its interstices. By raising the sashes at the back, a very powerful current of air is established. The thermometer ranges from 80° to 90° below the leaves in a sunny day; and, in short, the atmosphere is as hot as is experienced in the southern parts of Italy, with almost as much ventilation as if growing in the open air."—*Gardeners' Chronicle, and Journal of Horticultural Society.*

The admission of cold air, either in large or small quantities, into forcing frames or houses is extremely dangerous, and the dread of its bad effects often prevents sufficient air being given. If air could be brought to nearly the same temperature as that within the house, it might be applied in larger quantities, and be of great service to the plants. This is not easily done without depriving it of too much of its natural humidity, an evil to be guarded against. The primitive mode of suspending a thin bass mat over the opening of a frame in early spring is good—it causes a regular dispersion of the air without absorbing much of its humidity; so also is a plan often adopted by ourselves—namely, covering the front openings of hothouses with thin canvass, and leaving the lights or ventilators open, or partially so, in the coldest weather. Fine fly-wire would be more lasting; and it may be painted black, were it only for appearance' sake. Whatever means may yet be employed for producing ventilation upon correct principles, it is evident

that the present mode is extremely faulty. We have elsewhere observed that ventilation has hitherto been considered more as a matter relating to the regulation of the temperature than to the admission of a regular and well-diffused supply of air, so necessary to the existence of vegetable as well as of animal life.

"Ventilation in hothouses is required to serve a double purpose—to renew the atmosphere, or exchange a portion of the external for the internal air, and thus to give a gentle motion or current amongst the plants. If this be done judiciously, it may be practised at all times or seasons with but little waste of fuel. Motion, and consequently change, exist in every natural climate, and cannot be entirely withheld from plant-houses without a corresponding loss of vigour and compact growth. The other purpose of ventilation is to prevent an injurious increase of temperature during hot weather, or sudden bursts of sunshine. Although the principles of ventilation are simple enough to be understood by all gardeners, I may mention there should always be one set of ventilators, or sliding sashes, at the top or upper part of the house, and another near the floor, where the newly-admitted air may, by passing over a part of the heating surface, have its temperature gradually raised to that of the house. By giving more air by the lower than by the upper ventilators, it will be gradually discharged at the top of the house, with but little cold draught amongst the plants. If the upper ventilators only are opened, we shall experience counter currents and draughts of cold air. The lower should be comparatively numerous, in order that small quantities may be admitted by each, thus preventing sudden gusts of cold air at one place. It is apparent that all our contrivances for warming and regulating temperature and humidity in confined atmospheres will have no effect in deteriorating the air, and that its original constitution will remain unchanged. As the most important functions of vegetable life are the decomposition of carbonic acid gas, and the assimilation of carbon under solar influences, the source of the latter, and other elements which plants derive from the air, will be present in the usual proportions. Nevertheless, the plants may not be able to assimilate

their due proportion of these elements, for the sluggish motion of the air in a hothouse is so different from the natural atmosphere, which is always in motion, more or less rapid, both horizontally and vertically, that the plants may not be able to appropriate their due share of atmospheric food, the air not coming fast enough in contact with the leaves and other surfaces of absorption. The advantages to vegetation of brisk motion in the air, therefore, will be obvious."—Mr Scott in *Jour. of the Hort. Soc.*

Every cultivator who has studied the subject now admits the necessity of warming the external air by some means or other before it is admitted to come in contact with the plants. The late excellent president of the Horticultural Society, Thos. A. Knight, was amongst the first to direct attention to this subject, (*vide* section PITS,) but few followed his example till of late years. One of the most rational plans to effect this desirable object, without sacrificing the natural humidity of the air, is detailed by Mr Thomas Moore, (author of a useful treatise on the cucumber,) in a paper in "The Journal of the Horticultural Society." "I recommend warming the external air," he says, "before admitting it to the plants, by a plan which will be explained by the annexed diagram, fig. 359.

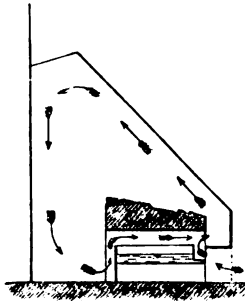


Fig. 359.

The main point which this plan was intended to secure was this, that the cold air should pass directly over the surface of the heated water in a tank provided for supplying bottom heat to the cucumber pits; and by passing over this surface, it was supposed that it would not only be warmed, but so far charged with moisture as not to abstract any from the succulent foliage and stems of the plants, but rather to furnish them with a source whence they themselves might draw part of their supply. This plan was entirely unconnected with any scheme for securing motion without admitting the external air; but it is obvious that both

might be combined, as in the following diagram, fig. 360, which also represents an improvement on the original plan. In this arrangement it will be seen that the cold external air is supposed to pass through a heated chamber separate from the tank, but admitting of communication for the purpose of supplying moisture if necessary. Thus the external air may be warmed either with or without being moistened before it reaches the plants inside the houses, or the moisture may be directly admitted from the tanks by other means, in the exact quantity required at any particular stage of growth. The advantage gained by this plan is a greater command over the moisture of the atmosphere, though, in a forcing-house, such a power would seldom be required to be put in practice."

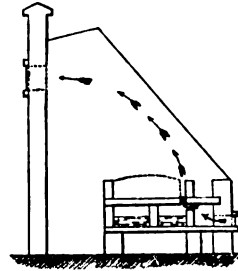


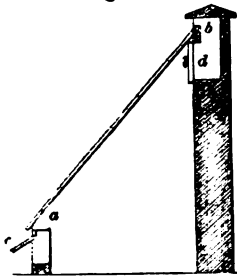
Fig. 360.

Mr Moore, in the same communication, mentions a plan invented by Mr Leaf's gardener, which "consists in passing a zinc pipe, thickly perforated with small holes, from end to end of the vinery, and exactly beneath the range of hot-water pipes which heat the structure. In the outer wall, communicating with this perforated pipe by means of a kind of broad funnel, a register-valve is fixed, by which the admission of air can be regulated with the utmost nicety, or the supply be shut off altogether. This valve is fixed a little below the level of the perforated pipe. The action of this contrivance was evident enough from the motion communicated to the foliage of the vines; and its effects were apparent in the unusually healthy and vigorous appearance they bore until their period of ripening. In this case, sufficient moisture was kept up by syringing the walls and pipes, wetting the pathway, and by the use of evaporating troughs placed over the metal pipes, and kept constantly filled with water."

The first great reform in ventilating forcing-houses was brought about by the late Mr Atkinson, and will be understood by a glance at the section, fig. 361, which shows one of the houses in the Horticultural

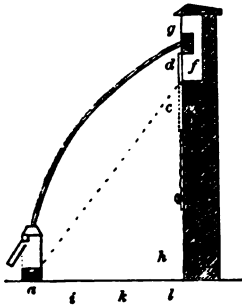
tural Society's Garden ventilated by that

Fig. 361.



gentleman. Our section and description are taken from the Transactions of that Society. The principle, however, to be understood, requires that we should state that the roofs are fixed, and may

Fig. 362.

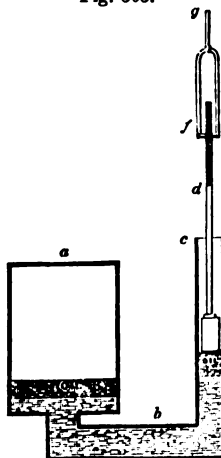


either be all in one piece, or divided by rafters into many sashes, as in ordinary houses. The object was to provide ample ventilation, without the danger of breaking the glass by pulling the sashes up and down; and also to ventilate curvilinear houses, as in our diagram, fig. 362, or straight-roofed houses in the usual way, as fig. 361. This was Mr Atkinson's favourite form—the sashes being fixed, and the usual front or perpendicular sashes entirely dispensed with, the roof resting on the front parapet wall *a*, and at back upon the face of the back wall at *b*. "In the front wall are built a number of wooden frames, into which shutters, opening externally on hinges, are accurately fitted, *c*. In the back wall, within the house, and next the glass at top, are also fitted a corresponding number of wooden frames *d*, furnished with a wooden slider, running up and down by means of pulleys with cords and weights, after the manner of a window sash. These sliders are interposed between a hollow in the wall *f*, which communicates with the external air in front, above the glass roof of the house *g*. When it is wished that no air be admitted, the front shutters and back sliders are closed; and in proportion as it is desired to ventilate the house, they are opened to a greater or less degree. By these means a current of air is maintained from front to back; and as fast as

the admitted air becomes heated and rises in the house, it escapes through the ventilators at the top of the back wall. When it is expedient to admit fresh air without loss of much heat, the front ventilators alone are opened. The ventilation of the houses being thus effected with facility and accuracy, renders the moving of the lights for that purpose unnecessary. By aid of these ventilators, the temperature of iron houses is capable of being lowered in the hottest days of summer to a degree even inferior to that of the external air." To this latter opinion we, however, by no means subscribe; nor do we think that metallic houses can be reduced, in very hot weather, to so low a temperature by any means of ventilation at present in use.

A glance at our diagram will show the extent of ventilation effected by this, as well as by all the other modes in houses of the ordinary construction, namely, the space between the dotted line and inner surface of the roof, leaving almost half of the internal space unprovided for—that is, the triangle formed by the dotted line, back wall, and floor. To displace the air which must occupy this space, and which, from its position, is the coldest and most impure in the house—fresh supplies, and consequently motion, must be obtained by an opening at *h*, or by several in the floor, as at *i k l*—the former by perforating the back wall, and the latter

Fig. 363.



by bringing an air-drain under the ground level, with openings in the floor to admit the air into the house.

The mechanical contrivances employed in ventilating hothouses are various; of these the self-acting ventilators are the most ingenious. Fig. 363 represents one of this kind invented by John Williams, Esq. of Pitmaston, and described in the

"Transactions of the Horticultural Society." The object in this, as in all

others, is to guard against excess of heat in the absence of the gardener. It is thus described in the "Gardeners' Magazine," vol. i. p. 419 :—The movement "is effected by the expansion and contraction of air in an air-tight vessel *a*, communicating with a cylinder and piston *b c d*, which, by means of a rod *g*, operates on the ventilator, or sash, to be opened. The use of the water, or other fluid, is to confine the air; and by that means, when the air expands or contracts, it operates upon the piston. By means of an adjusting screw *f*, the register may be made to open at any required degree of heat. The air vessel *a* should contain several gallons, according to the size of the valve, or register, to be opened. When first used, the vessel must be heated sufficiently to expand the internal air; water is then to be poured in at the top of the cylinder *c*, so as to give the required motion to the float; and about half-inch of fine oil must be laid on the top of the water to prevent evaporation." The proper situation for the vessel to be placed in is in front of the upper part of the top wall, where it may be fully exposed to the greatest heat of the house. "If the apparatus," Mr Williams says, "is of proper size, nicely constructed, and filled with a proper quantity of water, the registers—one being placed in the upper part of the back wall for the escape of heated air, and the other near the floor of the house for the admission of cold air—will open and close again several times during the course of the day."

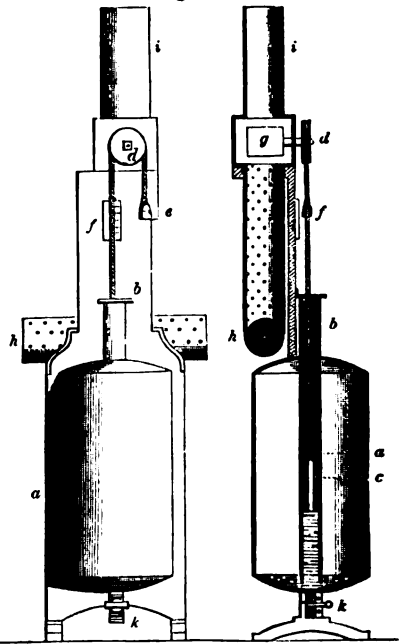
Mr George Mugliston of Repton about the same period invented a self-acting ventilator, but upon a smaller scale. Mr Sylvester and Dr Ure also applied themselves to the same task. Mr Kewley, so well known for his successful modes of heating by hot water, invented a self-acting machine for this purpose, of which an excellent figure and clear description will be found in the "Encyclopædia of Gardening," p. 557.

Of other mechanical ventilating machines, we may mention that of Mr J. Lindley, (not the Professor,) which in some respects resembled Kewley's; but was so far inferior to it, that the apparatus of the latter acted so as to regulate the temperature of a room or hothouse to nearly one quarter of a degree; while that of the former would only act when the change had taken place to the extent

of 15°. In the "Repertory of Patent Inventions," Dr Ure has described a self-acting apparatus for regulating the safety-valves of steam-boilers, founded on the principle of the unequal expansion of different metals. This instrument might be fitted with the necessary apparatus to cause it to operate upon the sashes, ventilators, &c., of hothouses, the windows of public buildings, and even the dampers in chimneys for the regulation of their draught.

Mr Mugliston's apparatus was founded upon the principle of the expansion of heated air. The following is his description and illustration, (fig. 364,) taken

Fig. 364.



from his paper in "The Horticultural Society's Transactions," vol. v. p. 502 :— "The cylinder or air-vessel *a* is made of thin copper, tinned on the inside, and coated on the outside with flatted varnish or black paint, to assist in the absorption of the heat of the surrounding atmosphere. The tube *b* is also of thin copper, descending nearly to the bottom of the cylinder, into which water is poured, varying in quantity according to the size of the machine; *c* is a corked phial, or other float, suspended by a cord passing over a wheel *d*, at the end of which is a

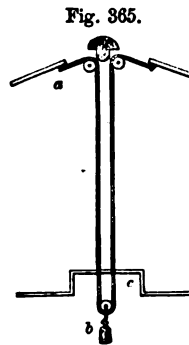
balance-weight *e*; an index, *f*, shows the elevation and depression of the float. When the temperature of the house is increased, the air in the cylinder will immediately expand, and, pressing upon the water in the bottom, will elevate that which is in the tube, and with it, of course, the float will be elevated. The movement of the wheel *d*, whose axis runs through the valve *g*, immediately opens the valve in proportion to the extent of the revolution. The heated air which collects in the perforated air-tube *h* is thus suffered to escape. The length and shape of these tubes may be varied according to circumstances. If the communication with the external air is to be made at the top of the house, it will be necessary to put a conical cap on the top of the air-tube *i*, acting upon a spindle so as to turn with the changes of the wind; and if the communication is to be made through the end of the house, a transverse tube will be necessary. A drain-cock, *k*, is inserted in the bottom of the cylinder, in order that the water may be drawn out and replaced if air should get in by the machine being shaken."

The celebrated Dr Anderson, the inventor of the patent hothouse, &c., and J. Williams, Esq., "made use of oblong bladders, made fast at one end, and with the other attached by means of a cord to a movable pane or small sash. The bladder being filled with air at the common temperature allowed for the house, and hermetically sealed, the window remains at rest; but as the air of the house becomes heated, so does that of the bladder, which consequently swells, and assumes the globular form;—its peripheries are brought nearer together, and, of course, the sash or pane is pulled inwards. In a small house this scheme may answer perfectly well for the prevention of extreme heat. Another mode is by using a rod of metal, such as lead, of the whole length of the house; and, one end being fixed to the wall, on the other is attached a series of multiplying wheels, the last of which works into one, which in various ways may open valves or sashes. As the expansion of lead is considerable, the effect of twenty degrees of increase, with proper machinery, might perhaps guard against extremes, as in the other case. A column

of mercury, with a piston-rod and machinery attached, has also been used, and a ring on a barometrical principle is suggested by Sylvester."—*Ency. of Gard.*, p. 604.

Deacon's Eolian machine, Dr Reid's chimney, Dr Ure's fan, and various other contrivances, have been suggested for performing self-acting ventilation. However creditable to the inventors, these machines have not been found to work satisfactorily in practice. Probably the great nicety required in their manufacture renders them liable to accidents through the carelessness of operatives; or the damp and heat they are subjected to may prevent them from working freely.

We shall now proceed to record the various modes of ventilation which we deem worthy of especial notice, without regard to their priority of invention. We find the following mode described, with an illustration, in the "Gardeners' Magazine," vol. ii. p. 369, and exemplified in the conservatory of Mr Latour at Craven



Hill: "It is on the principle of a self-balancing chandelier. A cord from each sash passes over a pulley *a*, fig. 365, and is joined under the stage *c*, where a weight, *b*, is attached to them by another pulley, and may either be limited in its descent by the ground, or by the length of the line.

By this arrangement, easily understood, either or both sashes may be opened to any extent by a very slight motion of the line, and without the least derangement to the plants, or unsightly fastenings of the cord."

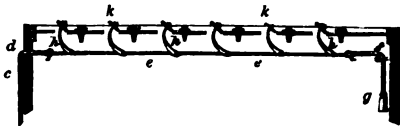
The Messrs Booth of Hamburg employ a similar mode of ventilating span-roofed houses in their extensive establishment, but carry down the chains and weights within tubular metallic columns, intended to support the ridge of the roof.

In such cases, flexible copper chains should be substituted for cords, as they are less liable to decay. By such chains the roof of the large circular conservatory at Dalkeith is ventilated, an ornamental column rising in the centre, enclosing the chimney, round which balance-

weights are suspended by copper flexible chains, by which the top ventilation goes on simply, and without being seen; while the front ventilation, or supply of air, is obtained by pulling down or raising up the casement-windows forming the sides of the house.

Where new houses are erecting, advantage will undoubtedly be taken of the most approved modes, of which we have given several examples; and in the case of houses already up, and imperfectly ventilated, perhaps the simplest and most effectual will be that recommended by Mr Tweedie, and described in the "Memoirs of the Caledonian Horticultural Society." Fig. 366 shows a longi-

Fig. 366.



tudinal section of a roof to be ventilated in this way, on which, by sympathetic movement, small tin, copper, or zinc frames are lifted, with one or more panes of glass in each, according to the opening desired. In the diagram, *l* shows the ventilators half open, and *e* the cord or jack-line, to which the lever *l* is attached, balanced at one end by a weight *g*, and made fast at the other by a movable hand-pin. In one of the door-posts, or other permanent piece of the end framework, are several sockets, 6 inches asunder. Into these sockets an iron hand-pin is "introduced, regulating the whole apparatus, by being moved upwards and downwards, from socket to socket, by the hand, according to the various degrees of air-vent wanted. This iron pin is fixed to a cord or chain *c* passing through the stile or door-frame *a*, over a pulley *d*, which cord or chain is fixed to a rod or chain *e*, having an axle-joint at the junction of each lever. The rod or chain, when the hand-pin is moved up or down, moves horizontally between a pulley *d*, and another pulley *f*, fixed to the corresponding stile or door-frame at the other end of the house, by the action of a weight *g* attached to the end of the rod by a cord or chain passing over the second pulley *f*. This horizontal rod or chain *e*, in its motion thus pro-

duced by the weight *g*, operates at every joint, as already mentioned, on bent levers *l*, which, being attached to hatches"—that is, the openings for ventilation—" *l*, lift or lower them so as to admit or exclude the air, as circumstances may require. The upper end of the lever is fastened to the hatches by screw-nuts, in order that, by unscrewing them, the sashes may be freed from the levers, and removed at pleasure for repair."

The whole of the top sashes of a house may be easily drawn up or down by means of an endless screw applied to a rack fixed on a circular rod of iron extending the whole length of the house, to which each sash is secured by a double chain passing over a pulley fixed in the wall. By turning the screw in one direction, the sashes are pulled down, and by reversing the motion they are pulled up again. They may also be kept stationary at any point desired. The same machine, slightly modified, will apply to the front sashes or ventilators. The handle in both cases should be acted upon at the middle of the house.

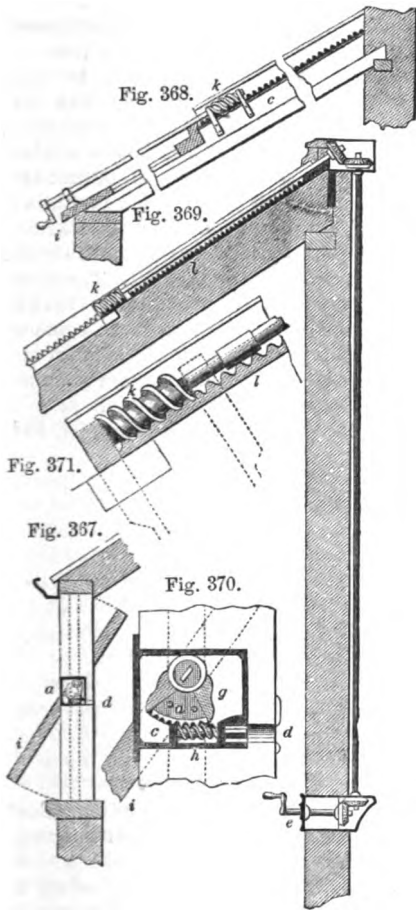
Mr G. Hurwood, of St Peter's Foundry, Ipswich, has lately taken out a patent for various mechanical modes of ventilating both dwelling-houses and plant structures. We consider his mode to possess considerable merit; and, indeed, so far as ventilating hothouses is concerned, we see no difficulty in applying Mr Hurwood's principle to those already built, and also to houses of almost all forms. The roof-lights are opened or closed by turning the handle *e*, fig. 369, working, by means of a vertical cog-wheel, in another horizontal wheel placed in the back wall, and attached to the lower end of a perpendicular rod or axle, which is also furnished at top with a similar cog-wheel, working in another set obliquely, so as to suit the angle of the roof—the latter wheel being attached to the spiral screws, *k* in figs. 368 and 369, working in a toothed rack or plate of iron, *l* in figs. 369 and 371, which is attached to the side-rail of the sash to be acted upon. From this it will readily be seen that, by turning the handle *e*, fig. 369, the spiral screw, *k*, lets down or draws up the sash to any extent of ventilation required, and keeps it steadily in its place. In fig. 369 part of the wall is broken away, to show the arrangement of

the small wheels, &c. The apparatus is shown more in detail in figs. 368, 370, and 371. *e* is the crank, fig. 369; *l* the rack; *k* the screw that works into and gives motion to the rack and the lights which are attached to it. When it is not a matter of convenience or choice to move the lights within the house, then the wheelwork in

upon pivots, and two are moved simultaneously by an apparatus shown in figs. 367 and 370, where *a* is a box containing the quadrant *c* and screw *h*; *d* is the socket for the key to move the windows." *i*, *i*, in both figs., show the front sashes thrown outwards at bottom and inwards at top.

The opening of the front sashes is conducted upon very correct principles; but as they are so much above the floor-level, it will be necessary to have another system of ventilation through the parapet wall close to the ground, so that the stagnant air occupying the space between the floor and the level of the top of the parapet may be displaced.

Mr Fortune, the celebrated Chinese traveller, offers the following practical remarks on ventilation as applied to curvilinear houses, in a paper published in "The Gardeners' Chronicle:"—"Curvilinear iron-roofed hothouses have been erected in various parts of the country of late years, but they have not proved to be so generally useful as was at first expected. Those in common use are modifications of forms recommended by Sir G. Mackenzie and the late President of the Horticultural Society, (T. A. Knight, Esq.,) with the view of having the sun's rays perpendicular to some part of them at all seasons of the year. The principle is certainly good; but in making an artificial climate, there are other things to be attended to besides light; and one of these, if it has not been overlooked, has at least not been provided in many of these houses—I mean a sufficient ventilation. Everywhere we hear gardeners complain that they admit too much light, and consequently burn the leaves, and otherwise injure the plants. There can be no question about such

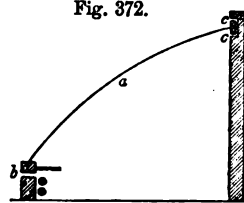


the back wall may be dispensed with—the object of which is simply to give motion to the apparatus from the place that is most convenient. The lights can equally well be worked direct from the front of the house without, by the crank *i*, fig. 368.

"The working of the patent apparatus for the roof-sliding lights is extremely simple, durable, and effective. The lights can be moved in any direction with ease and certainty, and without danger.

"The front vertical lights are suspended

effects being produced, although the cause is not generally what it is supposed to be; for we are not likely to have too much light in England for greenhouse plants or vines, even if the photometer would indicate a higher degree in the house than out of doors. The accompanying transverse section, fig. 372, of one of these houses in common use, will enable me better to explain its defects. *a* is the



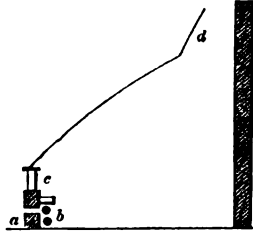


fixed roof, reaching from the front wall to the back; *b* represents one of the small ventilators in the front wall; *c c* one of the small ventilators at the top of the back wall, to allow the heated air to escape. These small openings, with the addition, sometimes, of one or two in the ends, are all the means available for reducing the temperature in a hot summer day. If such houses had been heavy wooden ones, affording ten times as much shade, they would doubtless have had ten times more space for ventilation. Supposing, then, that the house is built and filled with plants, if this happens to be late in autumn, they will look remarkably well in winter and early spring; but as soon as the sun's rays become more perpendicular, shining in a clear sky for a few days, the worst effects are produced. The change is easily explained. These structures are so light, that they admit nearly all the sun's rays. The atmosphere is thus subjected to sudden variations of temperature, although every ventilating space be open; and the moisture is drawn from the leaves of the plants much faster than their roots can supply them; consequently the leaves flag, curl at their edges, and ultimately become sick and unhealthy. That this is a correct explanation, is proved by the fact that succulent plants, such as cacti, having leaves with fine evaporating pores, will thrive in a house of this description. The front ventilators in such houses are placed in a very good situation for the admission of air; but those in the back wall are in a very bad one for allowing it to escape when it is overheated. Some persons lately had rather an expensive example of the truth of this principle in the working of a new method of heating, when it was supposed that, if the pipes were placed in a chamber below the level of the floor of the house, and communicating with it by a few holes or trunks made along the front or back, the heat generated by the pipes in the chamber would all ascend through these places and keep up a sufficient temperature. Such, however, was not the case; a great quantity of heat remained where it was, and the plants were in some instances frozen. So in like manner the heated air passes out very slowly at these back ventilators, and the plants are burned.

"A house, of which the following is a

section, fig. 373, would have all the advantages of the other with regard to light, and, at the same time, the means of sufficient ventilation would be provided. *a* represents the ventilating boards in the front wall, as shown in the last section:

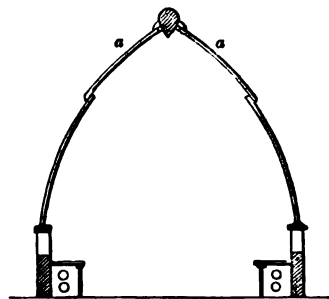
Fig. 373.



these could be used in mid-winter, when the air thus admitted would have to pass over the hot-water pipes, *b*, before it came in contact with the plants; *c* is

a glazed ventilator, as seen in common wooden houses; and *d* are ventilators in the roof, which move on hinges. The span-roofed curvilinear house is not liable to such sudden variations of temperature, because, having glass on both sides, many of the rays pass through, and therefore they are much cooler than those which have a back wall. The annexed sketch, fig. 374,

Fig. 374.



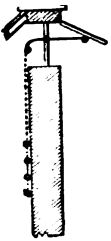
shows a house of this description, which is ventilated at the base in the same manner as the preceding, and at the top, by either having part of the roof of an inclined plane with movable sashes, *a a*, or by leaving a considerable space below the coping, and fixing wooden ventilators on it. Having pointed out what I consider to be defective in the construction of many of these houses, other, and perhaps better, methods of remedying these defects may be suggested. The inclined plane and sliding sashes might be used in the first section, instead of the hinged ventilators, if it is thought desirable. It would be rather advantageous than otherwise with regard to light, being of course

more perpendicular to the sun's rays in winter and spring; and although it would be less so in the months of June and July, yet this would be rather beneficial."

Ventilating the upper part of fixed roofs, by having the openings hinged, as proposed by Mr Fortune in fig. 373, is extremely objectionable on account of the liability of the hinges to break or get out of order, and also because the wind has great power upon those parts of the roof so opened. Where sufficient ventilation cannot be obtained by openings in the front and back walls of lean-to houses, and in the ridge of span-roofed ones, or at the top of dome-shaped ones—and we see no reason why this should not be completely accomplished, particularly for the greater part of the year—then it would be better to adopt sliding sashes, to be used only in extreme cases.

Fig. 375 exhibits a mode of opening and shutting ventilators placed at the top of the back wall of houses.

Fig. 375.



A lever is attached to an upright bar of iron, which, when pulled down at one end by a cord or small chain, throws the ventilator out, by the other end becoming elevated, and keeps it at any point of elevation, by the cord or chain being fastened to studs in the wall within. When the cord or chain is loosened, the lid of the ventilator falls back into its place, being loaded with a sufficient weight of metal fixed to the lower part of its external surface.

Fig. 376.

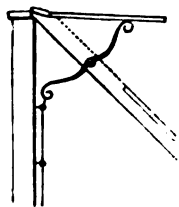


Fig. 376 acts much in the same way, the opening being effected by pulling down one cord or chain, and the shutting of it by

pulling another.

M. Noiset, in *Manuel du Jardinier*, describes a mode of ventilation very common on the Continent.

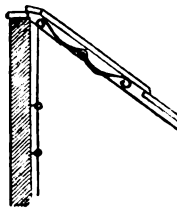
Fig. 377.



It consists of a bar of iron made to swing upon a pivot fixed in the rafter, as shown in the annexed cuts. Fig. 377 shows the sash ele-

vated; fig. 378 the same when it is shut. There are many objections, however, to

Fig. 378.



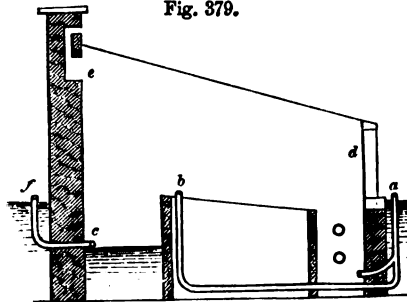
this mode, of which the chance of the wind blowing the sash to pieces is not the least. It is, at the same time, a much more ingenious mode of ventilating than many we have seen in use on the

Continent. We publish it with the view of its being improved upon.

A very excellent mode of admitting cold external air into a heated vault in which water tanks are placed, and allowing it to enter the atmosphere of the house or pit, is shown in section *TANK HEATING*, fig. 259, as exemplified in the garden of the Hon. Robert Clive. By this method a pipe, the orifice of which is level with the ground surface, is made to pass under the front wall, and to discharge its air into a vault heated by hot-water troughs. The air thus heated, and consequently taking with it a large portion of humidity, after passing over the whole vault, is admitted into the house through chimneys at the back of the bark bed. These chimneys, as well as the mouth of the air-pipe, are furnished with stoppers, so that air can be admitted or excluded at pleasure.

We have tried the following mode of ventilation, which will be understood by a glance at the annexed diagram, fig. 379.

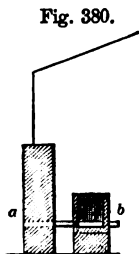
Fig. 379.



a is the orifice of a 4-inch cast-iron pipe, fitted with a stopper to be used as occasion may require. This pipe passes down outside the parapet wall, discharges its air into an open chamber in which the hot-water pipes are placed, and which is

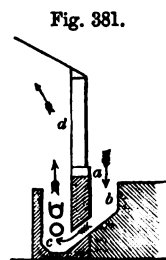
itself rendered water-tight at bottom, and kept filled with water as high as half the diameter of the return-pipe. The water is, in consequence, kept warm, and gives out a genial vapour to the house all along its front. The air discharged by the pipe into this chamber becomes considerably heated, and, in its ascent into the house, carries with it more vapour than it brought in, because it naturally takes some with it from the water over which it passes. One of these air-tubes is placed under the middle of each alternate sash, the remaining sashes having a similar air-pipe, which, instead of discharging itself into the shallow tank, passes through it and under the pit, rising at *b* by the side of the footpath, and discharging its supply of air through a perforated covering. The houses where this mode of aëration is practised have a range of cellars behind well lighted and ventilated. From these an orifice is cut through the back wall, as shown at *c*, through which a supply of air, far from cold, enters the house close to the footpath; and, where no cellars exist, the pipe may be supplied with air from the surface, as shown at *f*. By these contrivances, abundance of ventilation is produced during winter and spring; and during summer, when more may be desirable, especially for lowering the temperature, the front sashes *d*, and the usual top ventilators *e*, are opened in addition.

On a somewhat similar principle, in houses heated by smoke flues, which in general run parallel with the front of the house, and not far distant from it, fire-clay tubes may be brought through the parapet wall, extending through the flue close to its bottom, having one end open to the atmosphere, as shown at *a*, in fig. 380, and the other to the atmosphere of the house within, at *b*. A circulation would take place, and a supply of genially heated air be thus drawn in, which could be regulated to any extent by a revolving ventilator being placed on the orifice of each tube within the house. The quantity of air obtained by this means would be very considerable, and, of course, greater as



the number of tubes was increased, which latter we would prefer to having them fewer in number and of larger calibre. As a homely illustration of this, we may observe, that any one may satisfy himself of the operation by putting his hand to the key-hole of his sitting-room door. If the passage without be cold, and the room within warm, the draught of air rushing in, even at that small aperture, will be found very considerable; and this the more so, as the temperature in the room and that of the passage happen to differ. Were it not for the pressure of the cold air from without, even with our best fitted doors and windows, our warm rooms would be unbearable to human beings; and even our fires would cease to burn.

There is also another mode of ventilation upon the same principle which may be adopted with great advantage. The annexed diagram, fig.



381, represents part of the front of a forcing-house, the parapet of which, under the ground level, is built of piers, and lintelled over with stones, which form the plinth (*a*) on which the superstructure rests. Between these piers cast-iron boxes (*b*) are placed, 2 feet long and 3 inches in diameter, the one end open to the external air just below the plinth, and fitted with a lid to regulate the admission of the cold air. The lower end is open, and through these boxes the air is partly forced down by its own gravity from *b*, and partly drawn down by the heated air at *c* rising into the house and creating a sort of vacuum, which the cold air rushes in to fill up. The hot-water pipes are, as in the former case, laid in an open flue, the bottom of which, at *c*, is meant to contain water, supplied by a small pipe from the cistern over the furnace. The lower pipe is partially sunk in this water, which gives out a genial steam, and increases both the temperature and the moisture of the cold air as it passes over it, rendering it fit for coming into immediate contact with the plants. The arrows at *d* show the direction of the current of air. By a very

simple mechanical contrivance, all these boxes may be opened or shut at once, or less or more, as is desired.

Upon the same principle as the last, but on a much larger scale, we have applied a mode of front ventilation to a range of vineries 100 feet in length, with a view to obviate opening the front sashes, as well as treading on the border during the operation. These vineries are on the lean-to principle; but, as will readily be imagined, the same mode of ventilating may be applied to span-roofed houses also. The stone plinth upon which the front rests is supported upon 10-inch brick piers, one being placed under each rafter—that is, about 3 feet 8 inches centre from centre. Along the front of these piers an area, opening 9 inches broad in the clear, is carried along the whole length, but divided into spaces of 18 inches in length, one-half of which are as deep as the bottom of the return hot-water pipe within, which is 23 inches, and the other half are only 9 inches—that is, level with the top pipe, also within. On top of this area is fixed down an open framework of cast-iron, having in it openings 2 feet long by 9 inches in width. The margin of this frame is 3 inches broad, with cross bars between the openings an inch and a half broad, placed at every 10 feet, the whole frame being 1 inch in thickness. Over this metallic frame are placed movable covers or plates, also of cast-iron, and flanged at the edges. These are connected together along the top by means of a malleable-iron rod, three-eighths of an inch in diameter, extending the whole length, and connected at the end of the range, close to the wall, with a wheel. This wheel is fixed on a shaft placed across the frame. In the middle of this shaft is also placed a pinion 4 inches in diameter, which hooks into a rack cast on the back of the first cover. This wheel is acted upon by a lever, which, when depressed, has the power of drawing every alternate cover on the top of the one next to it, to any extent not exceeding its own length. By elevating the same lever, the lids or covers are pushed back to their original place. This is for winter and spring ventilation. For summer ventilation, the covers which we have stated as fixed are attached to

the metallic rod, by running it through eyes cast on *all* the covers, by which means these fixed ones are capable of being moved as well as the others. It should be remarked that all the alternate covers are their own thickness above the others. It will readily be understood, that, for winter ventilation, none of the covers are required to be withdrawn to their whole extent—3 or 4 inches being the average of the opening. We state this, because it may seem to some that, from the construction of the apparatus, as much air would be admitted by one set when opened to their full extent—namely, 18 inches—as by both sets when opened to their half extent—namely, 9 inches each. This would not be the case, however; for more air will be admitted by two openings of 9 inches square during summer, than would be through one of double the size, as the velocity of its passage inwards will be increased, although the individual openings be smaller, because they are increased in number, and also on account of the greater difference in temperature between the internal and external air. Indeed, the openings can never almost, during winter, be used to their full extent. Besides, by increasing the number of openings, the distribution of the air is more completely accomplished. Another reason for using only the alternate openings during winter is, that as more fire-heat is then employed, there is the greater necessity for throwing in fresh supplies of air to the interior atmosphere; and as these alternate openings, by which air is thrown in, are also the deepest, they take with them a certain amount of humidity from the water under the lower pipe, and carry it into the upper parts of the house. By this mode of ventilating, all treading on the border is obviated; and even should it be necessary to pass along the front of the houses, the cast-iron plate forms a clean footpath. The same mode might be applied at the front of the border next to the walk, and the air carried through the border in drains, and admitted into the house. It may be found advantageous to bring down cold air from the roof, on a somewhat similar principle, in tubes, so that it may fall perpendicularly on the hot-water pipes or flues, or even be made to fall

under them; and, when slightly heated, it will ascend again through the house.

Referring, again, to the mode of opening and shutting our front ventilators, noticed above, we ought to observe, that any number of the sliding covers can, by a very simple contrivance, be thrown out of gear, and so remain stationary while the others are movable. This range consists of three vineries, any one of which can be left unventilated while the others are open. In consequence of the area air-drain being placed along the front of the house, and occupying 22 inches of space, the vines have, of course, to be planted beyond this area, and their stems brought through apertures formed in the brick-work, and under the plinth, and then up within the house.

However front air be admitted, it is evident that it should be let in at as low a point as possible, as there is no difficulty in getting cold air to descend to the extent required in hothouse arrangements; and that it should be warmed to as near the temperature of the house as possible, is equally clear. But this heating of the air should not be secured at the expense of its purity, nor by lessening the degree of humidity natural to it. When cold air has to pass over highly heated flues, unless humidity be added to it at the same time, it loses much of its real value; but heated air may be brought over hot-water tanks or gutters, as in the two cases last alluded to, with great advantage. It will readily be understood that aëration produced by these means may go on night and day, as the temperature of the house is not affected by it. This, if not a new, is at least a very important feature in hothouse management, and could not be effected by the modes hitherto in use.

Fig. 382 represents a mode of mechanical ventilation very good in warm weather, when the external temperature is little below that in the house. The front sashes are hung upon pivots at their centres, and are opened and

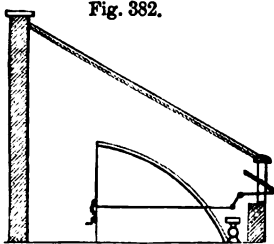
shut by means of a long handle with a compound joint, reaching from the front to the back passage, or other convenient place. Again, front sashes may be hung by hinging their upper stile to the bottom of the upper wall-plate, and opened and shut by the same means as those above described. Or an iron axle or cylinder may extend the whole length of the house, and each light be attached to it by an iron crank; and by a lever handle made fast to either end—or, better still, to the middle of the cylinder—the whole may be opened or shut at once.

The same contrivances may be employed for opening and shutting the top ventilators, which are usually of wood, and, being lighter, are much more easily operated on.

Where the walls of hothouses are built hollow, a very good mode of aëration may be adopted without the danger of cold draughts of air injuring the plants, or greatly reducing the temperature. This consists in opening holes in the walls, close to the floor, in the inside of the house, and corresponding openings on the outside, and near the top of the walls. The cold air will enter at these top openings, and descend through the vacuities, and enter the house close to the floor. This method we have adopted in the two orchid-houses at Dalkeith, and with the best results. One of the many evils of the former methods of ventilating hothouses was having the front openings too high—generally several feet from the floor—leaving the lower part of the house, where the roots and part of the stems and foliage are, entirely without change of air, excepting the occasional supplies admitted when the door was opened,—a supply entirely inadequate for their health and welfare.

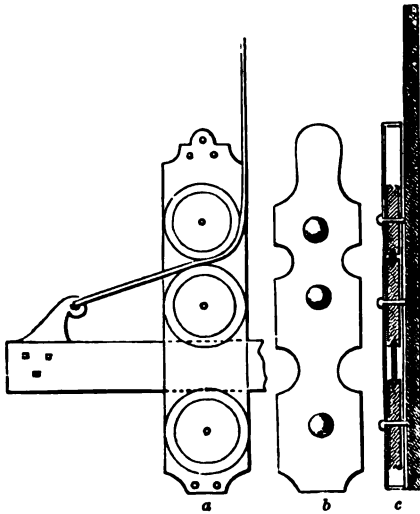
A very simple and efficient plan of ventilation has been adopted by Mr Fleming in the case of the houses at Trentham, of which figs. 383 and 384 are illustrations. One peculiar advantage of this method is its being simple, and little liable to derangement,—a very important consideration in garden architecture.

When last at Trentham, we had not time to make a detailed drawing of this mode of ventilation, as there is so much to see and to admire in the improvements that have taken place there of late years.



We, however, were informed by Mr Fleming, that the whole was made by the village blacksmith, and that he executed his work so well that the apparatus wrought to perfection upon the first trial.

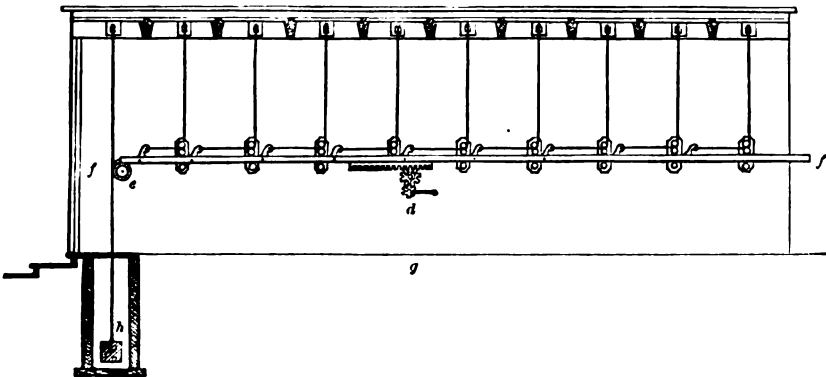
Fig. 383.



The drawings, and reference to them, we copy from "The Gardeners' Chronicle." Fig. 383—*a* front section of pulley and rollers; *b* front plate lifted off to show the working of the pulleys and rollers;

*c* end section of pulley and rollers. Fig. 384—*d* toothed wheel and wrench; *e* iron rope and pulley for the sinker under ground; *f f* horizontal bar, with annealed iron ropes attached. By this contrivance, (the invention of Mr Fleming,) the whole extent of a large house may be ventilated to the greatest nicety, by merely turning a wrench, which we found no difficulty in doing with one hand. The movement, instead of being vertical, is horizontal—the sashes being attached to an iron bar by annealed iron ropes moving in that direction. The movement is effected by means of a toothed wheel and wrench, the horizontal bar having about 4 feet of its lower edge toothed to suit the wheel. Small rollers are fixed about 6 feet asunder, and in pairs—one under and another above the bar, to lessen friction. The iron wire ropes that move the sashes up and down are, by means of a pulley, made to turn from the inclined plane to the perpendicular of the back wall; and, by another pulley, to turn again to the horizontal line of the sliding horizontal bar. The ropes are attached to studs, 3 inches long, fixed in the iron bar. Provision is made for lessening the strain on the machinery by having a sinker (*h*) under ground, (*g* being the level of the floor,) made fast to the lower edge of the horizontal bar by means of an iron rope and

Fig. 384.



pulley. We imagine that the sashes are furnished with brass or iron rollers, to facilitate their moving up and down the rafters. These, however, we should observe, are built at a pretty high angle of elevation, which renders the movement

of the sashes much easier than if they were more flat.

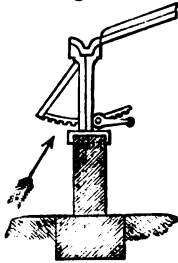
In most of the hothouses in the gardens at Dalkeith, every alternate top sash is made to slide down the rafters—being furnished with brass castors or

rollers. They are kept in their place when shut, or at any point of ventilation, by a spring catch fixed to the side of the rafter.

One great objection to ventilation being effected by sliding one sash down over the other is, that there is a double portion of glass over a considerable part of the roof—therefore a double portion of light must be excluded: as light so transmitted will be doubly decomposed by passing through two surfaces of glass, a considerable loss of light must ensue. But the greatest objection of all is the breakage of glass.

In the Royal Gardens at Frogmore a very efficient and simple mode of ventilation is adopted; and we believe the merit of its construction is due to Mr Jones, the eminent hothouse builder of Birmingham, who executed the whole of the extensive range there. Front ventilation is effected by the whole of the upright lights being opened simultaneously, either to their whole extent, or otherwise. These lights are provided each with a brass pinion, fixed to their centre, and working into a toothed quadrant, which is attached

Fig. 385.

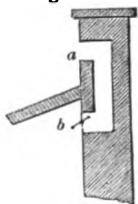


to an iron shaft extending the whole length of each house.

This shaft being turned round by means of a handle at one end, the quadrants are either thrown out or drawn in, according as the handle is moved backwards or forwards, and can be kept in any position required.—*Vide* fig. 385.

The ventilation at the top of the back wall is effected by having openings, from 3 to 4 feet long and 6 inches deep, as shown in fig. 386, left under every alternate sash, and opening above the roof at *a*. These upper openings are provided with iron gratings, to prevent birds, &c., from entering the house; and communi-

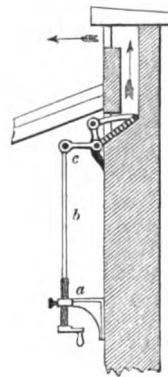
Fig. 386.



cate with similar openings within the roof, which are provided with shutters moving on pivots, as shown at *b*. These are opened or shut simultaneously by turning the screw *a*, fig. 387, connected by

the iron rod *b* to the lever *c*, which is fixed to the rod of wrought-iron extending the whole length of the roof.

Fig. 387.



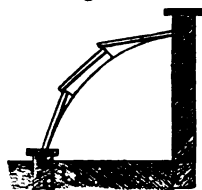
To this shaft are fixed the small levers *c*, one of which is attached by a wrought-iron link to each ventilating door or shutter—so that, by raising or lowering the lever by means of the screw, the shaft is turned more or less round; and this, acting on the levers, opens and shuts the ventilating doors simultaneously the whole length of the house. The top sashes of the roof of

these houses slide down, and this movement is regulated by a semi-circular contrivance of iron, resembling half a cog-wheel, and a catch. A movable handle turns this wheel to any extent, by which means the lights are let down as far as may be requisite, and are there kept stationary. To close them it is requisite only to reverse the operation.

The previous remarks on ventilation have reference for the most part to lean-to houses—that is, glass structures built against a wall. Houses on the curvilinear and span-roofed principle are ventilated at top somewhat differently. Ridge-and-furrow roofs may be ventilated at top, by having the ends of each bay made so that they can be opened to their full extent.—*Vide* RIDGE-AND-FURROW PIT. The polyprosopic roof—which is a species of curvilinear roof—admits of the greatest facility in ventilation, being composed of many faces, hinged at their upper angles. Rods being connected with the lower “outside corners of these faces, and terminating in chains which go over pulleys in the top or above the back wall, the whole roof, including the ends, may be opened or raised simultaneously, like Venetian blinds, either so as each sash or face may be placed in the plane of the angle of the sun’s rays at the time, or to the perpendicular, to admit a shower of rain. In consequence of this arrangement, the plants in a polyprosopic house may, at any time, and in a few minutes, be placed in effect, or as far as respects light, air, wind, rain, dew, &c., in the

open air; and being so placed, may, whenever desired, be as speedily restored again to their former climate."—*Ency. of Gard.* p. 585. All curvilinear roofs are difficult to ventilate, the safest plan being to let the sashes slide down over each other in Niven's manner, elsewhere noticed. But the most efficient is to hinge the sashes at their upper angles, and cause them to open outwards by means of iron

Fig. 388.

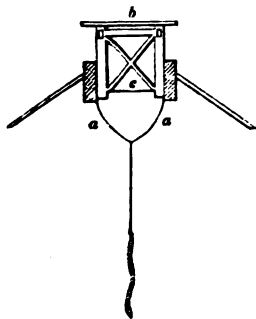


levers at their lower extremities, fig. 388, where such arrangement would not interrupt the plants growing within, such, for instance, as vines or peaches trained near to the glass. The whole

sides and roof of metallic houses in particular may be made to open upon the polyprosopic principle; but instead of hinging them at the top of the opening parts, these parts may be hung on pivots at their centres, one-half opening outwards, and the other inwards—the casements being half-checked into each other, so as to overlap when closed, for the exclusion of rain. The difficulty which presents itself in obtaining sufficient ventilation, is one of the greatest objections to this form of roof.

Span-roofed houses are now becoming popular—and very justly, as they combine many of the perfections, and few of the imperfections, of all other kinds of glass structures. We have shown (fig. 366) one mode of top-ventilating such houses, and will instance a plan adopted by ourselves. The ridge, instead of being composed of one

Fig. 389.



thick beam of timber, is formed of two 2-inch planks, *a a*, fig. 389, 9 inches broad, and extending the whole length of the roof. These are kept apart to any required distance—say from 3 inches to 1 foot, or more, according to the amount of ven-

tilation desired. Fig. 389 is a section of the

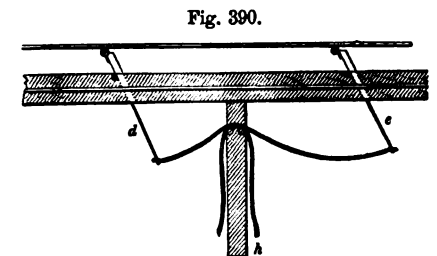
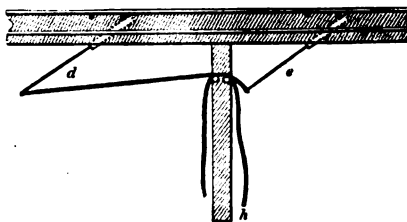


Fig. 390.

*a a* forming the ridge are kept in their place by iron bolts. The capping *b* is

Fig. 391.



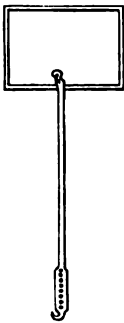
lifted and shut, by being attached by hinges to the tumbler *c*. This is acted upon by the levers *d e*. To each of these again is attached a line passing over a pulley in the upright *h h*, (which also supports the roof.) By pulling the right-hand line in fig. 391, the lever *d* is drawn towards the perpendicular, more or less according to the amount of ventilation required, and kept at the desired point by fastening the line to a stud in the upright. The levers, *d e*, as well as all the tumblers, *c* in fig. 389, are acted upon at the same instant. By pulling the left-hand line, the whole action is reversed, and the capping or top of the ridge *b* falls close down, and ventilation is suspended. A house 60 or 80 feet long may be ventilated by this means; but, of course, if the house is longer, it will be better to divide the ventilation into two pieces. Back and front air may be given to lean-to houses on the same principle, it requiring but a very slight modification to adapt it to such circumstances. The houses ventilated upon this principle have fixed roofs, glazed with sheet-glass 9 inches by 21, and nearly air-tight. Front ventilation is obtained in one case by means of openings in the

ventilation desired. Fig. 389 is a section of the



side wall 2 feet by 10 inches, placed close to the floor, and furnished with box ventilators in Atkinson's manner. In the other case, the same kind of ventilators are built in the front wall. The cold air admitted by them has to pass up the side of a hot-water tank, and becomes thereby warmed before coming in contact with the plants. The back wall is built hollow, and openings 4 inches square are made on the outside, near the top, by which cold air enters, and, descending the wall, enters the house by similar openings close to the floor. This latter ventilation is left open day and night.

Fig. 392.



Ventilators in the back walls of houses may also be opened and shut very conveniently, even when at a considerable height, by hanging them at top with hinges, or by pivots at their centres, and attaching them to a long rod of iron, perforated with holes at the lower end, to fix on pins or iron studs driven into the wall. Fig. 392 will show the principle.

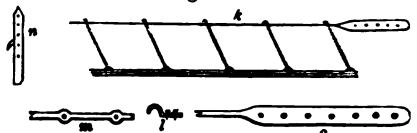
And front ones, if hung so as to open inwards, may be opened and shut without treading upon the border, by attaching a line to their lower edge, to be brought over a small brass pulley, fixed to the inner edge of the wall-plate, carried upwards under the roof, and made to pass over another pulley, fixed to the under side of the top-rail of the bottom sash, leaving a sufficient length of line to hang down to be within the convenient reach of a person standing in the footpath. A slight pull of this line will open the lid of the ventilator to any extent; and if the end of the line be furnished with a small iron or brass eye, it may be fastened to hooks in the back wall, so as to give sufficient head-room over the passage. To secure the shutting of the ventilator, it should be loaded at the bottom by having a plate of lead or iron screwed to its outer side, sufficiently weighty not only to cause it to shut, but to keep it so.

A very ingenious mode of ventilation is described in the "Gardeners' Journal," as practised at Beau-Manor Park. It is to the following effect:—"Along the top

of the back wall of the houses, below the centre of each light, there is a square cast-iron frame built into the wall. In this frame is placed a ventilator of thin iron, having a wire spring and ball attached to its lower end. Beneath the pits in the centre of the houses are a number of air-drains, brought into the interior of the house from the sheds containing the fires and boilers. The air coming through these drains causes a circulation of air within the houses, and this, acting upon the ventilators, (which are nicely balanced by means of the ball,) causes them to open for the escape of the heated air; but the moment that the cold air rushes down the shaft towards the ventilator, it immediately closes—thus preventing the admission of cold air. All the ventilators do not open at the same time, but, as it were, in rotation." Of course, the operation of these ventilators goes on day and night, and therefore that perpetual change of air so necessary to plants must be also perpetually going on. The mechanical contrivance is so simple and devoid of complication, that a diagram of it would be superfluous.

Another useful mode of ventilating pits is described by an anonymous writer in the "Gardeners' Magazine," and is upon the principle of opening the roof-lights all at once to any extent; and also, instead of elevating them at the back, as is usually done, they are elevated at the sides, which causes a more equal degree of ventilation—a practice long in use, but, so far as we know, effected only by lifting each sash individually, and propping them up with a flower-pot or wedge-shaped piece of timber. In this case mechanical power is applied, which performs the operation quicker and with more security. "For this purpose," he says, "I would have a hook (l, fig. 393)

Fig. 393.

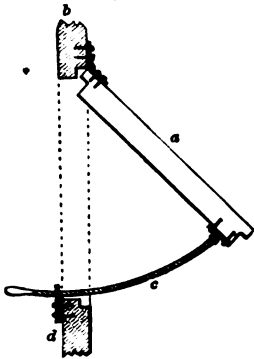


fixed to the middle of both sides of the frame, and holes in the flat part of the iron rod *m*, to catch on these—the ends of the rod having a series of holes to graduate the height—and, when drawn

along, to be fixed with a staple to an upright staucheon, *n*, placed at each end of the pit. When the lights are to be raised the reverse way, it would be only hooking on the rod to the opposite sides of the frames. By this simple contrivance, the frames may be all raised at once, and to a pitch that the glass may receive the rays of the morning and evening sun perpendicularly, while it catches that of the mid-day sun at an angle of incidence."

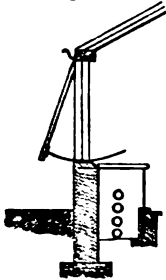
The front upright sashes of lean-to houses, and also the side sashes of span-roofed ones, are often opened and shut

Fig. 394.



This handle is attached to the sash by a universal joint, so that, when the handle is drawn in on

Fig. 395.



shutting the sash, the handle, instead of lying amongst the plants, is turned aside, and laid upon the wall-plate, if found to be more convenient.

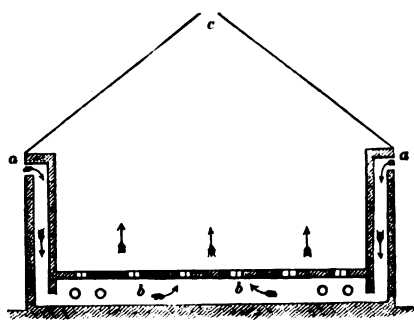
Another modification of this method is shown by fig. 395, where the handle is curved upwards, but which acts

upon the same principle.

Span-roofed houses might be advantageously ventilated as in the annexed diagram, fig. 396. Let the side walls be built hollow, whatever may be their height; and 4-inch square ventilators be placed along both sides of the house immediately under the wall-plate *a a*, and 2 feet apart from each other. The hot-water pipes, flues, or heated air-chamber, are to be under the floor within a hollow-walled

cavity *b b*, and covered with an iron-grating footpath. The ridge is to be open

Fig. 396.



and arranged as in fig. 389. The cold air will, by entering at *a*, descend, or rather be drawn down, the hollows in the wall, and, entering the heated cavities *b b*, will become genially warmed, and ascend into the house through the gratings, not in currents, but in a uniform and diffused manner, and escape through the ridge at *c*. In winter, this, or a similar mode of ventilation, is of paramount importance; as nothing is so hurtful to plants placed in a warm climate as to be exposed to sudden draughts of cold air, which in the majority of houses is the case. In summer, when greater ventilation is required, the side sashes may be opened, or ventilators in the wall of a larger size may be employed; as at that season the atmospheric air is sufficiently heated to be rather beneficial than the reverse to plants. Were the apertures for the admission of cold air on a level with the pipe or flue chamber, this might be found neither advantageous to plants, nor sufficient for the exclusion of vermin.

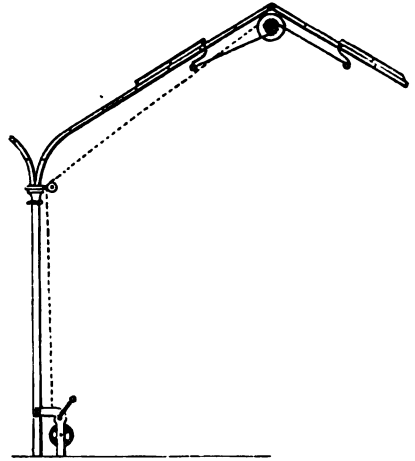
Nicol—whose ideas in horticultural architecture were in general original—says of ventilators that they are useful at those times when it may be imprudent to open the roof or front sashes, and that they may be constructed in various ways, and placed in different situations. "If," says he, "the hothouse have a shed behind it, they might be made to open in the manner of a common window, near to the top of the back wall; and three in an ordinary sized house would be enough. I lately made," he continues, "four ventilators in a house that had no sheds behind it in this manner. When the wall

was raised to within a yard of its full height, apertures were formed in the manner of a common chimney or fire-place, 18 inches wide and 2 feet high, from which a small vent was carried through the coping. On the top was fixed a horizontal tube, 3 inches square and 2 feet long, with a centre pipe fixed in the vent. The aperture or chimney was filled in front with two movable panels or boards, hung in the manner of common sashes, the one to move up and the other down, for the admission of air through the tube at the top—thus diverting or breaking a strong current, which might be prejudicial to the grapes. Ventilators in front, at the distance of 6 or 8 feet from one another, may be made thus:—Pierce a hole, an inch in diameter, through the bottom rail of the under sash, if the house has no upright glass; or through the upper rail of the upright sash, if it have one. In this hole insert a tin tube to fit, having a funnel mouth outwards, and a fine rose, like that of a watering-pot, to fit to it inside. The tube should be made in lengths of 2 feet each, that the air may be either diffused as it enters through the front, or be carried to the centre of the house, or further if thought necessary. When not in use, it ought to be stopped with a cork or plug. When a full stream is wished, the rose need not be put on; but it should if the air is keen. In order the better to collect the air, the funnel should be pretty large—that is, about 7 or 8 inches in diameter. With these, and with the ventilators at or near the top of the back wall, as mentioned above, any hothouse may be safely aired or ventilated even in the severest weather; and also when it may be improper to open the glasses, as during rain." This appears to have been the earliest idea of ventilating otherwise than by movable sashes.

The annexed cut, fig. 397, exhibits a mode of ventilating the roofs of large houses, which has been most successfully employed by Mr Turner of Dublin in the case of the large conservatory at the gardens of the Royal Botanic Society in the Regent's Park. As will be seen by a glance at our figure, the roof sashes are furnished, on the under sides of their side rails, with brass castors, which run on the rafters, and are suspended by a flexible chain, made to pass over and under a cylinder

placed immediately under the ridge. This chain is thence brought down under the

Fig. 397.



roof, and passed over a pulley at the springing of the roof, and from thence to the bottom of the supporting column, where it is wound up by a simple cog-wheel, which, when acted upon, draws up the sashes of each side of the ridge, more or less, or to their full extent, according to the will of the operator. From the construction of the roof in this conservatory, it became necessary that top ventilation should be effected from within; and probably few better modes of accomplishing this could have been adopted.

*Weel's improved mode of ventilating* consists of a sloping roof sash, which may be of any size, and applicable to any sloping-roofed hothouse. It is worked upon the principle of a parallel ruler placed edge-ways. It is thus described by Dr Lindley, who says "it has all the appearance of being a contrivance of much practical value. Let the rafter be represented by the lower half of such a ruler, and the sash itself by the upper half; it is evident that if any movement of elevation is communicated to the sash, the immediate result will be the withdrawal of the sash from the top or wall plate, and the opening of a space all round, while at the same time the sash itself remains pretty nearly over its own bed. The elevating and depressing movement is produced by a crank, a wheel, and a horizontal bar, so that any number of sashes can be elevated or depressed at the same instant."

Amongst the many advantages resulting from the repeal of the duty on glass, may be mentioned that of glass ventilators, somewhat upon the principle of Venetian blinds. These have been employed in many of the first mansions in London and elsewhere; and we see no reason why they should not also be applied to the ventilation of hot-houses and conservatories. The following description of these ventilators, for which a patent has been taken out, is from "The Mechanics' Magazine:"—"It consists, firstly, of a series of louvres"—the technical name of the laths in ordinary blinds—"which are permanently fixed at a certain inclination, so that the currents of air may be deflected upwards in one uniform direction; and, secondly, of a sliding valve, likewise of glass, by which the quantity of air admitted may be regulated at pleasure, and which, when closed, renders the openings perfectly air-tight. The whole is contained in a neat frame, which may readily be adapted, by a common glazier, to any of the panes of a window. Other advantages arise from having the louvres stationary, instead of being movable. For example: First, the draught of cold air is avoided, which, in the case of movable louvres, enters through the intervals that are required to be left between their ends and the sides of the frames. Secondly, the apparatus has no joints, nor other working parts, where the dust can accumulate and become hardened, so as to obstruct their action. It may be closed in a perfectly air-tight manner, even in the most dusty situations. Thirdly, its construction is so simple that nothing but rough usage can injure it; and, if out of order, it may be repaired by any ordinary workman. And, fourthly, a cord or line, by which the sliding valve is opened and shut, (when such is used,) may be carried to any part of a room, in the same manner as a bell-rope."

Mr Henderson, of the Oxton Hill Nurseries, Birkenhead, also a garden architect of great practical experience, has recently exhibited a very complete mode of mechanical ventilation in an extensive range of hothouses, built under his directions, near Liverpool. It is effected as follows: "Each alternate upright front sash is fitted on a brass rail and rollers; the

whole working by connecting-rods, rack, and pinion-wheel. Thus the person giving air, by turning a crank handle, can give from an inch to three or four feet of air in each alternate sash in front of each house, without moving from the spot. Each alternate back sash is hinged to the first ridge, or piece, and worked by lever and pulley; and each alternate top sash in front of the roof also works on brass rail and rollers—thus producing a thorough ventilation adapted to all seasons."

A peculiar mode of ventilation, somewhat on the foregoing principle, has long been in use in the gardens at Pitmaston, near Worcester, and is thus described by Mr Thompson in "Journal of the Horticultural Society:"—"The back wall" of the vinery "forms a partition between the vinery and coach-room. This room is 10 feet wide, and of the same length as the vinery, and has a warm ceiled roof; but the wall between it and the vinery has openings at top, and also near the ground, for the intercommunication of air between the two compartments. By this arrangement, superfluous heat, which must otherwise be dissipated in the open air, is economised to a considerable amount. When the temperature of the vinery rises above that of the room at back, the heated air flows into the latter by the apertures at top; whilst at the same time the colder air is withdrawn at bottom to an equal extent. Enclosed by non-conducting materials, as regards heat, the air in the room would long retain its warmth if entirely shut up; but its store is gradually transferred to the vinery, by the communication existing between them, whenever the temperature of the vinery falls below that of the room. A very simple experiment, the principle of which, I believe, has been often familiarly explained, may be referred to as affording the easiest possible illustration of the mode of action resulting from the above arrangements. Let two close rooms be unequally heated. Partially open a door between them, and in the opening place a lighted candle on the ground, whilst another is held near the top. Their flames will be deflected in contrary directions. The lower one will indicate the direction of the current of colder, and consequently heavier, air, from the cold into the hot room; and the one at top will be

seen urged in the opposite direction by the egress of warm air from the hot into the cold, the action continuing until an equilibrium is established in the air of both rooms, which can only be the case when both acquire an equal temperature.

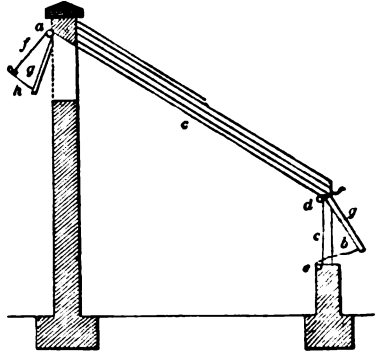
"The benefit to be derived from the above principle may be approximately calculated in the case of a vinery, or rather forcing-house. Supposing the room to contain as many cubic feet of air as is contained in the vinery with which it is in communication—say 6000 cubic feet; supposing, also, that by sun heat the air in the vinery rises as much above 70° as will be sufficient to render the whole of the air in both compartments of that temperature, and that the cold at night would reduce the 6000 feet of air under glass from 70° to 40°;—it follows that 12,000 cubic feet, the quantity of air in both compartments, will only be reduced half as much—that is, to 55°. Again, if the air in a greenhouse were liable to be cooled down from 50° to 30°, then in communication with a quantity of air equal to that contained in the greenhouse alone, and to be also reduced from 50°, the minimum of the greenhouse would be 40° instead of 30°; and thus, without fire heat, the plants would be in a comfortable medium. In practice, however, it will be doubtless found that the minimum will be somewhat lower than is indicated by the above calculations, because the inertia of the air interferes with the otherwise free circulation between the respective compartments."

The above illustrates a very good mode of ventilation, founded upon correct principles, and leads us to the conclusion that ventilation might be most efficiently effected by constructing chambers behind hothouses for the express purpose.

Another mode of mechanically ventilating hothouses is described by Mr Walton, in "Gardeners' Journal," and is to the following effect, the chief object being to get rid of the unsightly appearance of ropes, &c. hanging from the roof. Fig. 398—"By this plan, both front and back ventilators may be opened with the tenth part of the trouble usually incurred," and at the same time. "The plan is very simple, consisting of a rod *a*, which extends along the front of the house, and is turned by a small windlass

outside, at one end. This rod, or axle, is attached to each of the front sashes by

Fig. 398.



the arm *b*, having a joint at its centre—so that when the axle is turned in one direction, this arm *b* opens towards the straight, pushing the bottom of the sash outwards; a contrary turn causes the arm to collapse or fold up, and in so doing draws in the sash to its original position. To the extremity of the front rod *a*, where the windlass is attached to it, is fixed a cord or chain *c*, running up from the front and along a groove in the end rafter, to the top of the back wall, where it passes over a pulley attached to the rod or axle *a*, extending along the back. To this axle, *a*, are attached small rods *f*, one to each ventilator, the rod and ventilator being connected by a cord *h*. When the windlass turns the rod *a*, it will, by the action exerted upon the chain *c*, also turn the rod *a*, which will open all the back ventilators simultaneously with the front ones. To secure the proper acting of the apparatus, due attention should be paid to the length of the joints *b* and *f*, which must be so determined, that one quarter of a revolution of the rod will open the ventilators to their full extent. To gain mechanical power, cog-wheels should be used along with the windlass." This is an ingenious mode of ventilation, though rather complicated. The use of ropes acting in conjunction with iron rods is very objectionable, on account of their liability to elongate or contract in certain states of the atmosphere. There is no reason why iron rods may not be used altogether.

Amongst ventilating contrivances prin-

cipally adapted to dwelling-houses, but which might be applied, we think, with much advantage to hothouses also, may be noticed Sheringham's ventilator, Dr Arnot's ventilating valve, and Moor's patent lever ventilator. The first of these is so arranged that any requisite quantity of air may be admitted without the slightest draught being felt; and as the apparatus is placed in the external wall, its action is not impeded when the house is closed for the evening, at which time a constant supply of air is most required. Dr Arnot's ventilating valve is too well known to require any remark from us, farther than that it, as well as the last, may be built in the front parapet, and also in the back walls of lean-to houses, with great advantage.

Moor's patent lever ventilator is simple and effective, and consists of louvres of glass fitted into brass frames. Its action is produced by a line, which, on being pulled, opens the louvres, and when loosed, again closes them with the greatest nicety; or they may be kept at any degree of elevation, according to the amount of air required. To adapt them to hothouse ventilation, the louvres should be connected at their centres with a metallic rod, having a curved arm to each louvre; so that, when the upright rod is elevated by means of a spiral screw near its bottom, the louvres will be thrown outwards to any extent not exceeding half their own square, or to any angle under that, and kept in that position until the upright rod is depressed by a counter motion of the spiral screw, when the whole will shut down quite air-tight.

Such a contrivance could be attached to either roof or upright sashes, and also to houses already in existence, by taking out every alternate sash, and substituting louvres instead, of a size say 12 inches in breadth, and of a length equal to the space between the rafters. Or, in the case of a new erection, the whole glass thereof might be put in on the louvre principle, and by a very simple application of machinery the whole roof might be moved at once, and the perpendicular sides by a separate movement.

*General remarks on ventilation.*—A series of very excellent practical papers on ven-

tilation and heating, by Mr Glendinning of the Chiswick Nursery, has been published in the columns of "The Gardeners' Chronicle." This excellent cultivator very properly begins his remarks on large houses, which the remission of the duty on glass is likely to multiply, as well as magnify. Small houses are easily managed in this respect, particularly those constructed of wood, and glazed with small glass. With those of great magnitude, of metallic construction, and glazed with large sheets of glass, the case is very different. According to the present defective mode of ventilation, plants seldom succeed so well in such houses as in those of more humble pretensions. The bad effects of such houses are soonest manifested, as Mr Glendinning very justly remarks, "in houses constructed of metallic roofs, and glazed with sheet-glass, thus rendering what is considered elegant and beautiful in these ornamental structures fatal in the application; as vegetation thrives ten times more luxuriantly under the huge wooden beams and rafters, with green glass and leaden laps. Shading of different kinds has been extensively adopted to counteract the scorching influences of a warm sun; but this, at best, is a nuisance; and in some cases it is impossible to remove it with sufficient ease and rapidity to reap the advantages resulting from lightly constructed edifices with clear and spotless glass. Take, for example, a conservatory similarly built to the large building in the Horticultural Society's Garden at Chiswick, and it will be found, in all such erections, utterly impossible to produce or maintain luxuriant foliage in a general collection of plants, even although considerable command may be had in blinding the sun's rays. The spring leaves being so excessively tender, with every care they are almost sure to get scorched. Plants growing in tropical countries do not suffer in this way, because the heat of the sun, although great, is not increased by artificial means, as in glass-houses, where the tension of the atmosphere becomes immense; the young juicy foliage is in consequence compelled to part with its moisture, and it withers in an hour. The admission of air to lower the temperature, or rather to prevent the temperature from rising so very rapidly, is a point too often over-

looked, because it has not been so clearly understood by those who build houses for plants, as by those who grow plants in them. Almost all the great plant structures with which I am acquainted are notoriously deficient in this respect. Plate-glass and metallic sash-bars offer little obstruction to the admission of light and heat transmitted from the sun; and on this account, anomalous as it may appear, their value in horticulture is estimated; and so it should be, because the watery juices of plants are elaborated just in proportion to the presence of them; but then they should be present naturally and relatively."

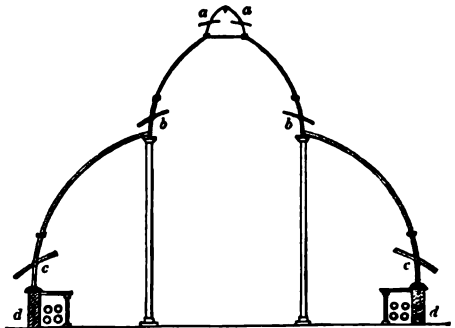
Much of the want of success in growing plants in large houses, the intelligent authority above quoted attributes to the great difference of temperature between the soil in which they are planted and the air in which they breathe—the want of heat in the former, and the excess of it in the latter.

"It is an easy matter to design elegant-looking hothouses and conservatories, and of any conceivable dimensions; but it most assuredly does not follow that their usefulness depends upon their architectural proportions or embellishments, or on the number of roods or acres they may cover. The contrary is always the case, because the larger the house, so in proportion does ventilation become of greater consequence; in fact, its necessity and importance are exclusively governed by this circumstance. The ventilation afforded to small houses is generally sufficient, as the space enclosed is so small, and the movable sashes so numerous, that complete command is obtained over the temperature; not so, however, in those immense glass balloons, or rather, as they may be well termed, mausoleums in horticulture, as their occupants commonly show them to be."

The following diagram, fig. 399, will show sufficient and insufficient ventilation as relates to large houses. "Take, for example," says Mr Glendinning, "a conservatory similar to that represented by the woodcut, and only imagine the sashes *a a* to open, with small ventilators in the wall at *d d*, and with a clear summer sun striking fervidly upon it. The heat in a house of this kind, it will be readily admitted, would be quite insuf-

ferable; neither animal nor vegetable life could long withstand it. Now, if provision had been made in this conservatory

Fig. 399.

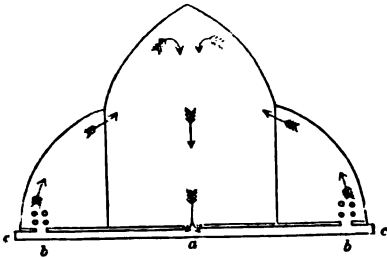


for the sashes to open at *b b* and *c c*, which undoubtedly ought to have been the case, the temperature would instantly and easily be reduced to any desirable extent consistent with the kind of culture in progress."

The theory of artificial motion being communicated to the atmosphere and plants in large houses, has been advocated by Knight, Dr Lindley, and various writers on vegetable physiology and pathology; and to effect this has been the study of several horticultural architects, Mr Glendinning amongst the number. We shall not stop to inquire into this theory at present, satisfied as we are that the means employed to produce that effect will be exceedingly favourable to the production of ample ventilation. "The interchange of atmosphere constantly going on" to effect this, "and the motion in which it is continually kept," says Mr Glendinning, "from being thus circumstanced, is a tolerably clear proof of the immediate cause of the healthiness of plants in" small "houses; and there is one other reason, also equally clear, that the inequality of temperature in such buildings is manifestly inconsiderable compared with buildings of large dimensions. In houses constructed like that which the accompanying woodcut represents, fig. 400, the pipes are usually carried immediately round the inside of the front wall. The heat, therefore, passes up under the glass, until it reaches the highest part of the building—that part generally being intolerably hot. The great body of air in the centre of the house remains stationary, and does not

participate in the heat thus given off from the pipes to the extent intended or sup-

Fig. 400.



posed. This is accounted for by the greater density of the air; and from this fact, also, it is likely to remain stationary, because the means usually employed to heat or cool the house cannot, from the arrangement in most cases adopted, drive it from its position. Nothing can be more certain than that plants, in such buildings where the heating and cooling powers are so applied, must suffer considerably. Now, the point we have arrived at is to change the position of the cold air, constantly and rapidly, either by the admission of external air in hot weather, or by some other contrivances, so as to mingle with promptitude and certainty the cold and hot air within the building. This can certainly be accomplished, because of the unequal gravity of the enclosed atmosphere in different parts of the house, provided means are introduced by which one of the simplest laws of nature will come into full and active operation.

"In the annexed woodcut (fig. 400) the coldest part of the house is at *a*, and, of course, the air is heaviest at that place. A drain, therefore, communicating with *b b*, will at once set the atmosphere in motion in the direction indicated by the arrows, provided an artificial temperature be kept up by means of the heating apparatus. During summer, when artificial heat is unnecessary, I would open valves having communications to them from these air-tunnels at *cc*, to admit the external air, which would invert the direction of the current, as is now shown. An impulse would thus be given, not only in winter, but in summer also, by the colder air to the hotter, thus keeping the atmosphere constantly excited and in motion, besides equalising the temperature throughout the entire building."

The following remarks on ventilation,

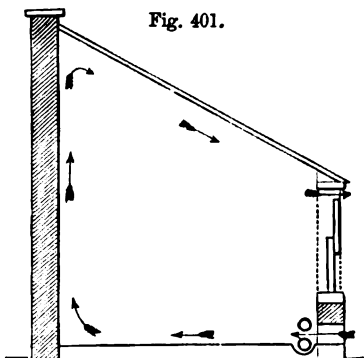
VOL. I.

by Mr Errington, a very sensible writer in "The Gardeners' Chronicle," and a man of great practical information, are so different from the usual practices and opinions, that we gladly avail ourselves of his communication in that excellent paper, and have added a diagram, which we think will elucidate his views. Mr Errington, like ourselves, thinks that far too little attention has been paid to ventilation, and also that, in the way it is often practised, a very great waste of heat has been occasioned. "There seems," he says, "to have hitherto prevailed but one general notion on the subject—viz., the throwing open the back and front sashes the moment the sun shines; and this happens to be precisely the moment, in many cases, when an accumulation of heat would be beneficial, provided sudden scorchings could be avoided. I must set out with declaring my opinion, that before many years have passed away, no mode of heating will be considered complete which does not provide for a system of ventilation, or rather purification, both day and night. What I would, in the first place, object to is the necessity that exists, in the majority of cases, for permitting the accumulated heat to escape at the highest level at the back of hothouses. If nothing, however, but the mere escape of heat was involved in the question, I would forbear to argue further; but, with the heat, the moisture also escapes, and this is not at all times desirable." After protesting against the doctrine held by some, that sufficient fresh air gains admittance through the laps of the glass, and arguing strongly for the absolute necessity of purifying the air of all glass houses, as well as making up for the deterioration the air sustains by passing over many hundred feet of heated iron, he proceeds to say, that, from observation, he is persuaded "that it would be better, in the great majority of cases, to make moisture-loaded air traverse the whole interior area of the houses, without permitting it to escape at the back, allowing it to enter at a low level, and departing by a high one, both at front, by means of a copious provision at the front of the house for that purpose. To put a case: Suppose a house, a lean-to," as in our fig. 401, "7 feet high at the front above the interior floor-level, and that floor-level 1 foot above the ordinary ground line outside.

2 P



Supposing also that sliding ventilators are placed in the front wall at the very



lowest point—say at the floor-level—and that these ventilators lengthways occupied nearly one-half of the frontage of the house. So much for ingress—now for the egress. Suppose, again, that the front sashes (which meet the wall-plate where the roof terminates in front) were made to drop 6 inches—what, then, would be the motion, or rather direction, of the air through the body of the house? This I have long since proved; and, according to my thinking, it throws some light on ventilation matters. The cold air coming in at the lowest level,” as shown by the direction of the arrows, “proceeds at once along, or just over, the interior floor-line, passes up the back wall, and returns down the roof, passing out at the front apertures at the top of the sashes; and, as to speed, in a corresponding ratio to the discrepancy between the outer and inner temperatures. Now, if this air be duly charged with moisture and warmth on entering the house, it is obvious that it will deliver more of these two in thus returning over the surface of the plants, than it would if hurried out at the back lights or ventilators. True, it will not drive so keenly through in one given line; it will, however, do more in the way of purification: it will traverse in an equal way the whole interior extreme outline, causing all extraneous or stagnant air to fall into a sort of whirlpool, from which it cannot escape without purification.

“If the principle of a special ventilation night and day be admitted, it only follows that enough of interior heating be furnished, in order to be enabled to carry out such plans; for, be it remem-

bered, that although ventilation be desirable, warmth is equally so. Some iron piping should by all means be placed tolerably close to the lower front ventilators, and the air should in most cases enter below such piping. With such, and a copious supply of moisture to temper the air at its entrance, I am of opinion that a slight amount of ventilation should be kept up day and night, both winter and summer, provided, as before observed, sufficient warmth can be guaranteed through a liberal amount of piping or otherwise.”

Mr Errington at the same time purposes to retain back ventilators also, as they may be used in extreme cases during very hot weather. He merely contends that such a mode of ventilation as has been described above will be found more beneficial than the back ventilators in ordinary use, which he says “are robbers during three parts of the year,” and that his plan will economise “both heat and moisture, and keep the air constantly in motion.”

The coldest part of every hothouse is close to the floor, and it is there also that the greatest amount of foul and stagnated gases accumulate. To get rid of the latter, and to change the former, led us lately to adopt the following plan. The stoke-hole behind the house experimented upon is a close chamber 12 feet by 8, and closely fitted with a door, which is kept shut, unless when the fires are examined with a view to regulate combustion in the furnace. In this chamber the heat is very considerable—often 20° above that of the house within, taken close to the floor. This heat, as will readily be understood, proceeds from the furnace front and ash-pit. An opening, just over the boiler, a foot square, provided with one of Dr Arnott’s valves, was made; the cold air from the floor of the house rushed out, carrying with it, no doubt, the noxious gases amalgamated with it, and would escape into the atmosphere every time the door was opened. The deficiency of air within the house is speedily made up by the ordinary means employed for giving front air, as well as through the laps of the glass, and all other openings so favourable for the admission of cold air, on account of its pressure from without.

For other methods of ventilation, *vide* VINERIES, PITS, &c.

## CHAPTER VI.

### FRUIT-HOUSES.

#### § 1.—VINERIES.

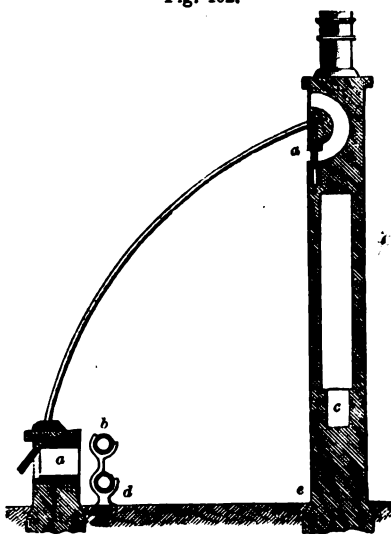
IN the construction of vineries, there is greater scope for indulging in variety of form, size, and circumstances, than in any other fruit-tree structure. That there is, however, a right and a wrong mode of construction, is undeniable. The vine, from its proverbial docility, submits to a greater degree of ill-usage, and often with apparent impunity, than any other fruit-bearing tree in artificial cultivation. It admits of being forced into fruit at the earliest period of the year; and it may be retarded to the latest. Under these circumstances, structure has a good deal to do in insuring success in either case.

The narrow and steep-roofed houses used generally on the Continent are, no doubt, the type of proper structures for early forcing, because they are easily managed, particularly as regards heating; and from the high angle of their roofs, the vines derive all the benefits, both of light and solar heat, that our northern latitude affords during the short days of winter. The vinery in use very generally on the Continent varies from 25 to 30 feet in length, and from 10 to 12 feet high, placed at an angle of  $15^{\circ}$  to the perpendicular, or about 5 feet wide at the bottom, and 3 feet at the top. They are almost universally heated by smoke flues, although frequently with hot dung, or both combined. The vines are planted inside, and trained to the back wall, but not very close to it, and sometimes parallel to the glass, and also at a little distance from it, to avoid danger from frost. The upper portion of the roof falling towards the back wall is often of boarding, and projects a little over at

front—a precaution necessary to protect the glass from hail-storms, which are more frequent abroad than with us.

As an improvement on the above, when intended for early forcing, we would suggest (fig. 402) a curvilinear-roofed house,

Fig. 402.



ventilated in front and back by ventilators *a a*, and heated by hot-water pipes *b*, placed near to the front, as well as by carrying the smoke and heat which pass the boiler along a flue in the back wall *c*, which, being built hollow, will allow the heat to diffuse itself from bottom to top. The vines may either be planted along the front at *d*, or at the back at *e*. The foundations being carried up solid, the roots would be prevented from reaching the cold border without, which is of vast importance to vines early excited, and

does away with the necessity for concreting the surface, heating by vaulting underneath, forming hotbeds on the surface outside, and all the other means hitherto tried with so little advantage. The advocates for a great range for the roots will be alarmed at the limits of our space; but if such sized borders are well made of rich strong loam, and afterwards supplied with liquid manure, the vines will have as much food presented to their roots as they can digest: more would be useless, and extent of border only an inducement to the roots to wander far in quest of that food which they have in abundance nearer home. If planted in front, the vines should be trained to a trellis 18 inches from the glass, and allowed to descend a part of the back wall. Or, if planted at the back, they should be trained 2 feet from the wall, and partially down the glass roof also; but, in both these cases, they should not be left so thick as to cause shade or obstruct the light; and hence, in such cases, the spur system of pruning should be adopted. The width of such a house may be 6 or 7 feet, and the height 9 or 10. This form of vinery may be modified by having the roof in two parts, a lower and larger, and an upper and smaller sash—the rafters being metre-jointed at the angle of junction, and each kept in its proper place by an iron stretcher bar placed between them. Ventilation and planting, the same as in the last example; and a smoke flue may be substituted for hot-water pipes. Such houses are well adapted for early forcing either vines or peaches.

*Speechly's early vinery.*—This great authority on the vine, after pointing out what his ideas were in favour of upright front sashes for an early vinery, instead of a dead dark wall, says: "Supposing a flued wall 12 feet high, the breadth of the border 10 feet, and the height of the upright glass frame, or front, 3 feet, the roof will then form an angle of 43°. Experience shows this to be a proper pitch for vines forced after the vernal equinox. I mention this circumstance," he says, "because some persons who give designs for buildings of this kind, lay so great a stress on this point as to pronounce a vinery or peach-house incapable of answering the intended purpose, should the pitch of the

roof happen only to vary a degree or two from their favourite angle. Indeed, if we suppose the sun's meridian altitude always the same, such an objection would rest on a solid foundation; but we know that it not only varies daily, but many degrees in a short space of time, so that if the pitch of the roof depended on so nice a point, what might be deemed right in the early part of the spring would certainly be wrong in the latter part of the summer.

"Hence it follows that the construction of the different frames or buildings, for the purpose of producing grapes, should not only vary according to the quantity required, but also according to the season in which that fruit is intended to be produced. The roof should be *steep for early forcing, and flatter for the summer.*"—*Treatise on the Vine*, p. 98.

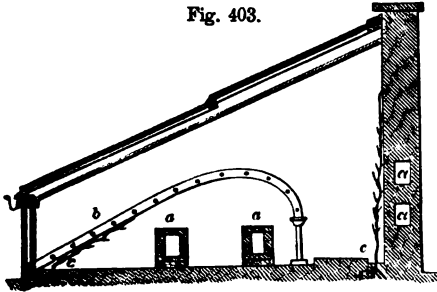
The early vinery of Nicol is described as being 30 feet long; for, he remarks, if it were 40 or 45 feet long, two fires would be necessary. The height proposed by him is 13 or 14 feet for the back, the front not to exceed 4 feet, including glass lights and parapet, the width 10 or 11 feet. "But if the roof were made to rest on the parapet, without having any upright glass, and if the parapet were about 18 inches high, it would have a much better pitch, and there would be a longer run for the vines. The front flue should be 2 feet clear of the parapet, should return in the middle of the border, and double by the back wall, being separated from it by a 3-inch cavity—that is, in case of there being but one furnace for the house. But if the house is much above 30 feet in length, and requires two furnaces, one should be placed at each end, and the power of both should be brought to the front, the flue of the one to be placed within 2 feet of the parapet, and of the other, close behind the first, being separated by a 2-inch cavity only, both to stand on a common foundation. The one may return in the middle of the house, and the other by the back wall; but it will be unnecessary to have a double return in either of them."

The directions here laid down for flues are equally applicable to hot-water pipes, the latter being much superior to the former, but unknown in Nicol's time.

The general opinion, it will be seen, is in favour of steep roofs for early vinerias.

We have, however, an exception to this rule in the case of the late Mr Acon, who superintended the once splendid gardens at Worksop Manor, now a heap of ruins. Fig. 403 exhibits a section of what Mr

Fig. 403.



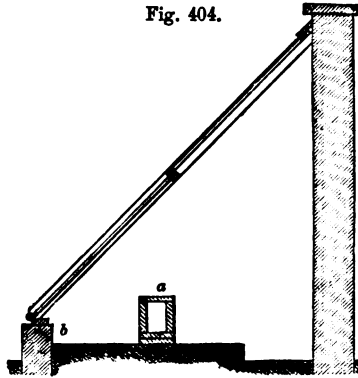
Acon considered a perfect early vinery. *a a*, flues; *b*, trellis with wires 12 inches apart; *c c*, places where the vines were planted. "The method usually adopted," says Mr Acon, (in "Transactions of the Horticultural Society," vol. vii. p. 2,) "for early grapes, is to train the vines under the roof near the glass, or on small frames against flued walls. Both these methods are," in his opinion, "objectionable. By the former the house is rendered much too dark, and the young branches are liable to suffer from the currents of cold air that blow through the interstices of the glass in stormy weather; and, by the latter, the plants are frequently scorched from the intense heat of the flue. For early forcing, a great command of heat is essentially necessary, to secure which the house here described was constructed with two flues, which first pass along the middle of the house, and then return in the back wall; the fires are placed at each end behind; thus the house was equalised to a great nicety. The vines are trained horizontally on the trellis, and on the back wall of the house. Some are also trained on the rafters; but these last are introduced six weeks after the forcing of the first has commenced, and they yield a succession crop. The form of this house gives it a peculiar advantage over most others, in presenting a greater surface for the growth of the vines than could be derived from any other plan. The trellis which covers the flues is equal to the whole roof, without being in the least detrimental to the plants at the back of the

house. To prove the superiority of this trellis, some branches were brought from the vines growing on the rafters and trained on the trellis; these ripened their clusters a fortnight sooner than those above, and were exceedingly large and fine. The vines are planted in the earth within the house; for I consider it," he says, "of the utmost importance to have their roots secure from external exposure; but I do not, by any means, desire to have the mould in which they grow heated by the fire. Few plants will thrive well if the earth in which their roots are placed is warmed by other means than that of the atmosphere."

The principal objection we have to this vinery is, that the vines are too far from the glass, not that the fruit is more shaded than it would be if they were trained all over the roof, as is so often done. We think, also, that the heat of the flues would be injurious to the tender foliage so close to it.

*Acon's late vinery*—fig. 404—is more in the manner of the early vineries in ordi-

Fig. 404.



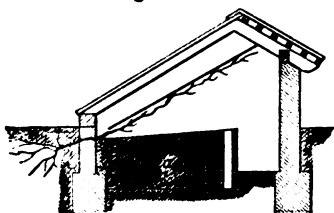
nary use. As a late house, it has one advantage—namely, a rather steep roof, which will be beneficial for throwing off the rain-water that falls on its surface. *a* is the flue, on arches 18 inches above the level of the floor; *b* the place where the vines are planted. The vines are trained to a trellis under the glass.

*Nicol's late vinery* is from 30 to 50 feet in length, 14 feet wide, and 15 or 16 feet high, with or without front glass as may be desired. In the former case, the parapet and glass should not exceed 5 feet in height, as it is but seldom that any fruit

grows below the angle of the rafter. The flues may be constructed as directed above for the early vinery of the same authority. "The number of furnaces must be regulated by its length. If under 35 feet, one furnace will do. The parapet and front flue of both houses should stand on pillars  $3\frac{1}{2}$  feet deep under the ground-level, in order that the roots of the plants may have free scope to run to the border without the house, as the intention is to plant them inside, and train them under the roof to a trellis fixed to the rafters."

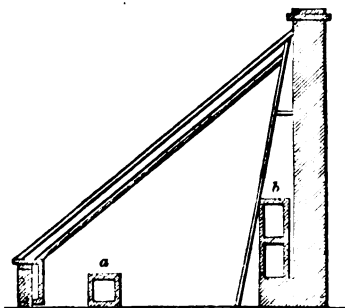
*Continental vineries* are, as with ourselves, of great variety and form. Portable houses are erected against walls already covered with vines, and sometimes depending entirely on solar heat; while at others, fermenting materials are employed, as in fig. 405—the part at *a* being

Fig. 405.



a bed of stable-yard manure, constantly kept refreshed in temperature by the addition of fresh, and the subtraction of decayed, dung. "The most perfect form of vinery on the Continent in general use may be understood by a reference to fig. 406. It is a house of variable dimensions,

Fig. 406.

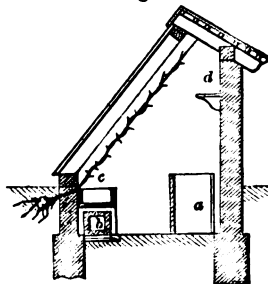


calculated according to the circumstances of the owner, and in general is heated by a smoke flue in front (*a*), which, in every

case which came under our observation, is faulty in not being elevated clear of the ground. These flues usually make one or more turns (*b*) close to the back wall. Vines are planted within, and trained to the back wall against a trellis, and also in the front, sometimes within, and at other times without, the house; and these are trained up the roof."—*Pract. Gard.* p. 520.

Fig. 407 is a variety of the same kind

Fig. 407.

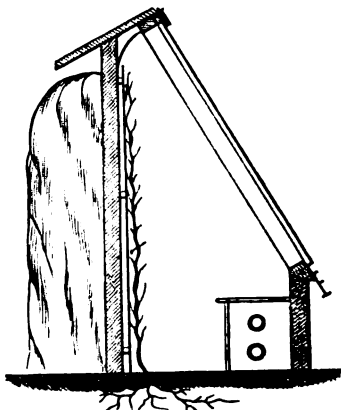


of structure, heated by the dung-bed *a*, in conjunction with a flue (*b*) in front. Over this flue are placed boxes (*c*) in

which lettuces, mustard, cress, &c., are grown; and strawberries or French beans on the shelf *d*, upon the back wall.

The *Danish vinery*, fig. 408, is an early forcing vinery in very general use in

Fig. 408.



Denmark and in the north of Germany. It is 10 feet high at the back, and 3 feet high in front, and usually 6 or 7 feet wide within. The back and front walls are from 6 to 9 inches thick; and the length of the house from 30 to 40 feet. Strong linings of dung are placed against the back wall, and hot-water pipes are laid parallel to the front wall, over which is

placed a shelf for French beans and strawberries. The vines are trained against the back wall only, the time of forcing beginning about the first of November. The application of fermenting dung in this manner is both useless and wasteful; and hence, in cold countries, it would be better to build the walls not only of greater thickness, but also to construct them hollow.

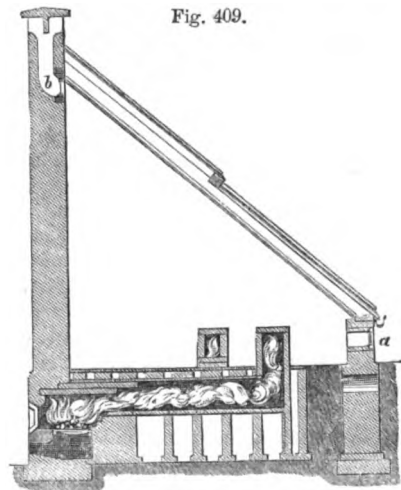
In the Royal Gardens at Copenhagen, portable frames are used to ripen grapes already established on walls. These frames may be placed over an entire vine, over part of a vine, or over part of two vines. The branches chosen for forcing are introduced through the boarded ends, and heat is supplied by filling a pit within with hot dung, or dung and leaves, or with a mixture of these and tanner's bark. The same branches are not forced the following season. The ends of the structure are formed of boarding, fastened to wooden uprights. Such simple contrivances might be worth the attention of amateurs in the south of England, where vines are grown upon the open walls; but as forcing-pits or houses in any other part of a country abounding in fuel, we think them below mediocrity. Branches of vines are also often taken inside the windows of dwelling-houses in many parts of the Continent, where the fruit ripens much earlier than on the open wall, affording at the same time an agreeable shade, and a certain amount of enjoyment in watching their approaching maturity.

*French's vinery.*—Mr French cultivated grapes for several years with great success by the following process:—The heat was derived from a ridge of stable dung laid along the floor of the house, and repeatedly turned over and renewed with fresh material as the former became decayed. To moderate the steam arising from fermentation, after the buds were fairly broke, the fresh supplies were laid at the bottom, and the more decayed laid on the top. The ventilation was secured by a very simple method applied at the top of the back wall. It may be remarked that Mr French was an extensive farmer, and his vinery was in connection with his farmyard;—the waste of manure, therefore, in this case, was not great; nor

was the labour of taking it in and out serious.

*Atkinson's vineries.*—Vineries continued long to be erected upon the principle laid down by Speechly, Nicol, Hay, and others; nor was it till the late Mr Atkinson, about 1809, turned his attention to the subject, that much alteration was effected, either in their form or the mode of heating. Mr Atkinson was not a speculative hothouse architect, nor did he experimentalise at the expense of others; for he had, prior to this date, erected vineries in his own garden at Grove End, that he might with greater convenience and certainty watch the working of them. The object this eminent architect had in view was economy combined with utility; hence he adopted the solid brick wall in front, alluded to by Nicol, and thus saved the expense of the front upright sashes—nearly one-third of the gross expense of the whole roof. He substituted wooden ventilators in these walls—a great improvement on the tin tubes suggested by Nicol. He also adopted small glass 6" × 4"—a vast saving as regarded the excise duty, and still more so in the wear and tear; and greatly improved the furnace of Nicol, and ultimately applied hot water as the heating medium. Amongst the earliest examples of Atkinson's improvements were those at Scone Palace, Kinfauns, and elsewhere.

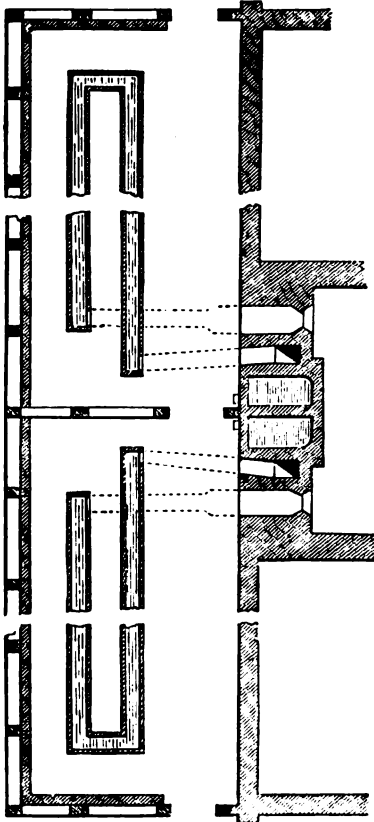
The accompanying cross section, fig.



409, and ground-plan, fig. 410, exhibit his principles clearly. The roof sashes

are fixed, or every alternate top one, at most, made movable; and ventilation is

Fig. 410.



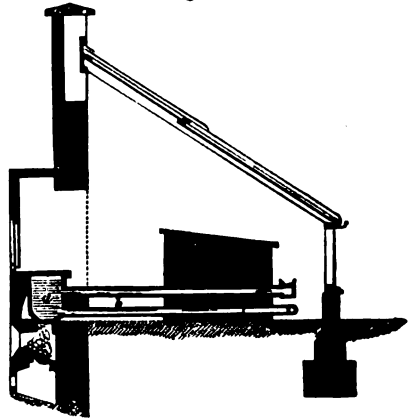
effected by openings in the front wall *a*, and near the top of the back wall *b*. The furnace is placed in the shed behind, and the flues enter the house under the floor-level, and proceed to within two feet of the front wall, to admit of the vines being planted inside the house, so as to sustain no injury by the heat. They then rise above the surface, and pass to the farther end of the house, whence they return to where they entered, and the smoke is discharged by a chimney just over the furnace. To economise building, two furnaces are placed in each stoke-hole, the flues of which diverge to the right hand and to the left, as seen in fig. 410. The front wall is built on arches or on piers, lintelled over, the tops of either rising to within a few inches of the surface of the

border, so that the roots of the vines when planted within may find a free passage out to the external border. This artist in general planted his vines within the house, so that the stems might be protected from frost. There is no upright glass in these houses, as seen by fig. 409. The parapet is carried up 2 feet, and in it wooden ventilators are placed at regular distances. The end sashes open upon hinges. These houses varied in length from 28 to 39 feet, according as they were for early or late crops; the smallest being, of course, that intended for being first ripe. Their height at back was 10 feet from footpath level to top of rafter; 12 feet wide in the clear; and the front 2 feet high above the level of the border.

*Atkinson's vineries heated by hot water.*—

We cannot illustrate this kind of house better than by giving a cross section, fig. 411, of one of those erected at Woburn Abbey from designs by that gentleman, from which it will be seen it differs in some important respects from the last, as well as from most of those erected by him. The length, width, and back height are the same as in the last figure. The front wall consists principally of piers placed  $3\frac{1}{4}$  feet apart, and brought up to the ground-level, where they are lintelled over with pavement, as affording more space for the

Fig. 411.



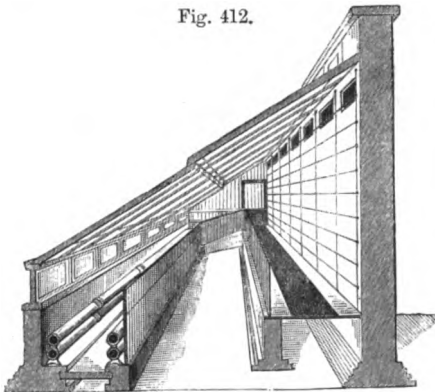
roots than if they were arched over in brick. Above the pavement are 15 inches of a solid wall, on which the wall-plate is laid to receive the front sashes, which, in this case, are substituted for the wooden

ventilators, raising the front about 3 feet 9 inches above the ground-level of the border. "There are also piers built in the interior," says Mr Forbes, (in "Hortus Woburnensis," p. 350,) "for the support of the hot-water pipes, which are arranged parallel to the front wall, and about 20 inches distant from it; this space being reserved for planting the vines in, which are placed close to the wall, their roots extending under the pipes, and also through the openings to the exterior borders. The interior width of the house is 12 feet in the clear. A pit is formed in it for forming a bed of leaves or dung, to produce a moist heat, for the assistance of the breaking of the vine buds. The roof of this range is also constructed with cast-iron, copper, and wood"—the first instance, we believe, of Mr Atkinson's deviating from wooden roofs. "The rafters, wall-plates, and spouting, are all cast-iron. The frames of the lights are composed of wood, and the astragals of small bars of copper; which combination of materials forms a very durable, light, and elegant roof. The front sashes are all made to open outwards, which is done by means of a pivot, and fastened on the outside by a key, so as to prevent their being blown open by the wind. The lower tier of roof sashes are all fixtures, and only every alternate sash in the upper range is made to run, in order to admit air. There is also a ventilator placed under every alternate or fixed sash of the top tier, which communicates with the openings in the top of the wall, whereby a free current of air may be admitted into the house in wet weather, without sliding down any of the sashes. In short, a free circulation of this element may be at all times admitted by opening these ventilators and the front lights, which, except in very sultry weather, will be found sufficient to keep the temperature of the vinery as low as it may be required.

"Each of the movable lights is furnished with a chain and small *wind*, which draws them up with the greatest facility. The trellising is of wrought-iron bar, about  $\frac{1}{4}$  of an inch in diameter, and is placed within 9 inches of the glass at the front, or lower end of the rafter, and about 12 inches from it at top." *a* is the boiler, *b* the hot-water pipes.

*Crosskill's vinery.*—The vineries, both at Everingham Park, and also at Sunderlandwick, with many others in the north of England, and also on the Continent, were erected and designed by Mr Crosskill of the Beverley Iron-Works; and in both these cases they form part of a very neat and elegant range. We were very much struck, on visiting both the places named, to find the workmanship so complete in even the most minute detail. The annexed perspective view, fig. 412, of

Fig. 412.



the interior, will explain the principle upon which they are constructed. They are all of iron, excepting the sashes, which, Mr Crosskill justly observes, are better to be of wood, being lighter, and more readily fitted into the rafters; and also, that if the rafters expand a little during the heat of summer, the sashes contract a little from the same cause. The rafters are of cast-iron, and cast with a gentle bend or knee at the middle, where the bottom of the upper sash covers or overlaps the top of the under one. The front is furnished with upright lights, which are made to open and shut by a very simple mechanical movement, as are the ventilators in the back wall also. They are heated by hot water upon the horizontal principle, and have a double course of pipes placed along the front. The interior of the house contains a pit, in which pines may be grown, of the usual size and description; but instead of being constructed of brick walls, it is formed of plates of iron, which gives it a very neat appearance, and affords more room. The passage along the back is covered with a very elegant iron grating of an orna-



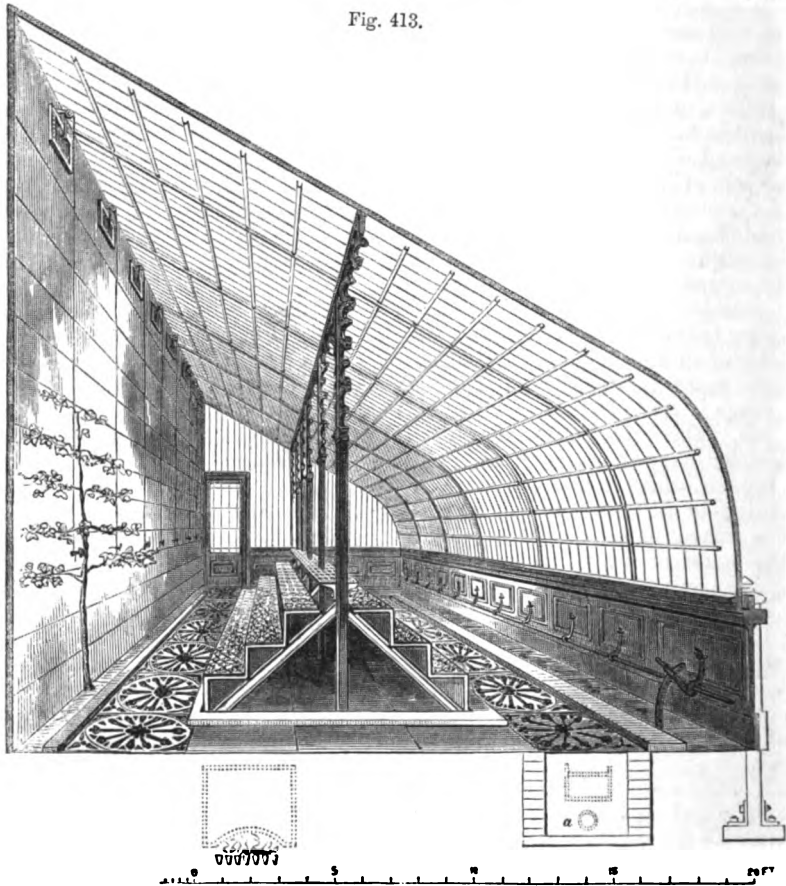
mental pattern, admitting air and water to the border, and at the same time being much more comfortable to walk on than the longitudinal strips of wood constituting the generality of footpaths of such houses. The roof, as well as the back wall, is trellised with wire in a neat and substantial manner. A passage runs along the front, between the two courses of pipes, and rises by steps at the ends to the level of the passage behind. The boiler is in the sheds behind, and so arranged that two houses may be heated from the same point. We may here remark that, from our conversations with Mr Crosskill, we find that when he forms curvilinear roofs he makes them of

wrought-iron, and, dispensing with rafters, makes his roofs fixtures, or a continuation of astragals, with ventilators upon Atkinson's principle.

Our own opinion of metallic hothouses is, that they should have no upright sashes in front if lean-to ones, nor upright side sashes if span-roofed, but that the roofs should be formed of a continuous series of astragals, curved at the lower ends, as in the following fig. It is one of the few advantages that metallic houses have over wooden ones, that the astragals can be so curved without loss of material.

The elevation, Plate XVIII., and internal perspective view, fig. 413, show a vinery erected and designed by George

Fig. 413.



Mushet, Esq., Dalkeith, for his own use. Mr Mushet is an extensive iron-founder, and has spared neither expense nor ingenuity to produce one of

the most beautiful and most complete houses of the kind that we have seen. The whole structure, excepting the back wall and the hot-air chamber *a*, for the

hot-water pipes, is of cast and wrought iron. A prepared border runs along the front, in which vines are planted, their roots being allowed to pass into the external border, as the front of the house is supported upon cast-iron pillars set on large blocks of stone, to which the parapet is fastened by screw bolts. These pillars above ground are highly ornamented, as will be seen by a glance at Plate XVIII.; nor are they ornamental alone—they are useful also, being made conductors of the rain-water collected in the shoots or hollowed part of the parapet at the bottom of the astragals, which also forms a neat moulding the whole length of the house, and conveying it to a drain which communicates with a large reservoir for the supply of the house. The parapet is composed of plates of iron, and in them the front ventilators are placed, which are made to open and shut simultaneously, by being attached to a common axle extending the whole length of the house. The hot-water pipes are placed in a chamber, and covered with an elegant cast-iron grating floor, which admits of a free ascent of heat, while it forms a comfortable and clean floor to walk on. A border is also formed along the back wall, also planted with vines; and a low stage for a few plants occupies the centre. Very small zinc gutters are placed along the roof longitudinally, with a view to collect the condensed steam, or any drip from leakage in the roof. These communicate with others placed under the astragals at equal distances, and deliver the water into the hollow of the parapet outside. This, and all other similar contrivances for a like purpose, we consider to be quite useless, while they take considerably from the light and elegant appearance of the roof when viewed from within. The top ventilation is effected by metallic ventilators let into the back wall, which, passing upwards, terminate in ornamental openings along the top of the wall—a feature quite new in this department of hothouse building. The wall itself is finished with a massive stone coping. These ventilators are opened and shut by a chain and pulley, as shown in the perspective view. This house being wide, the roof is supported by cast-iron columns rather crowded with ornament, as well as by a bar of iron extending from

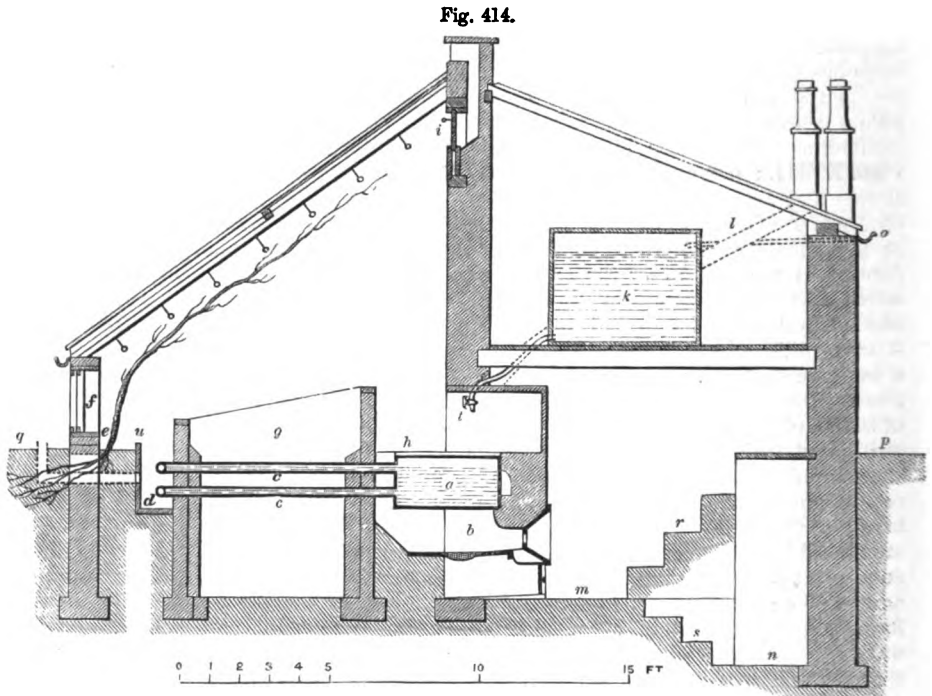
end to end, to which these columns are attached. This bar ties the house together, and tends to keep the astragals from shifting their places. The back wall is trellised with wire, as is also the roof.

The whole front of the house is supported upon cast-iron pillars securely set in blocks of stone, and lintelled over with bars of the same material. The heating is by flat upper pipes, with flanges along the sides of the upper surface for securing evaporation. The return-pipes under them are 4-inch circular ones. The large cavity they are placed in greatly lessens the loss of heat by abstraction at the sides, and the grating above allows it to ascend freely into the house.

The ventilation, it will be seen from the internal view, is copious, the whole of the front opening excepting the pilasters which support it, and a small margin round the ventilators. The back ventilators are sufficient, and, as will be seen, exceedingly ornamental. The interior view also shows the only defect of this house—namely, the zinc gutters running longitudinally and vertically, as shown by the stronger lines in the roof.

*Dalkeith vineries.*—The annexed cross section (fig. 414) through the boiler will show the principle of these houses, which differs in many respects from those already described. To avoid a lengthened letterpress description, we shall first direct attention to the following references to the plan:—*a* is the boiler; *b* the furnace; *c c* are hot-water pipes which extend along one end and front in an open chamber *d*; *e* is the border in which the vines are planted, their roots extending through the openings in the front wall, which is built of piers lintelled over with pavement level with the border, and on which is placed a stone plinth or base 9 inches thick, supporting the front sashes, set between stone mullions or pilasters, *f*; *g* is a pit for pines, or in general used for keeping tall plants when the forcing operations admit of it; *h* is a footpath of Arbroath pavement; *i* are top ventilators suspended by weights, and moving up and down in the manner of a window sash; *k* cistern of water over the stoke-hole, by which it is kept moderately warm, and fit at all times for use, fed by a pipe from the collecting shoot *o*, and

brought into the house by a pipe and boiler; *l* is the flue for conveying the smoke from the furnace through the party wall behind to the chimney tops, which



are placed over the walls of the apartments behind, instead of over the back wall of the house, to prevent the smoke and soot from discolouring the glass and woodwork, as well as for warming and keeping dry the rooms behind; *m* is the floor of stoke-hole; *n* the floor of cellars which are placed under all the rooms behind; *o* shoot for collecting the rain-water from the roofs; *p* level of broad gravel walk; *q* level of border; *r* stair leading to furnace; *s* stair continued to cellars; *t* water-cock for supply; *u* 4-inch wall upon which the front sashes are set when the vines are pruned and laid down to rest. The roof is trellised with wire for training the vines to. The front upright sashes move in the usual way for ventilation, but we are at present introducing ventilating tubes in the direction of the dotted line, to be used in cold weather, when it would be injurious to open the

front sashes on account of the current of cold air coming in immediate contact with the stems and foliage of the vines. By the latter expedient, now adopting, the cold air is drawn into the pipe cavity, and becomes warmed before rising to the plants.

*Malguyn Castle vinery.*—The following description (section, fig. 415, and plan,

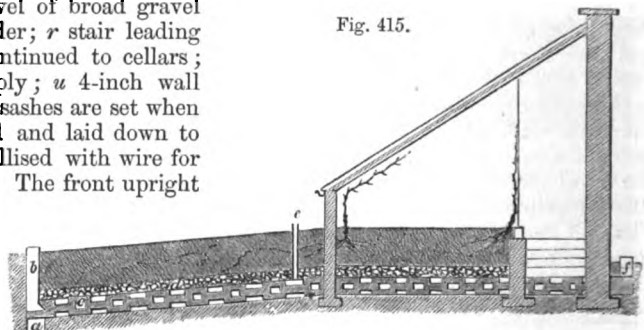
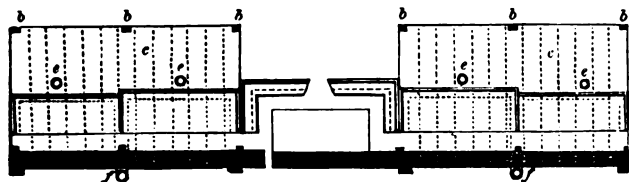


fig. 416) of a vinery, and thoroughly drained and ventilated vine border, as

exemplified in the gardens of A. L. Gower, Esq. of Castle Malgwyn, are given in the "Journal of the London

Fig. 416.

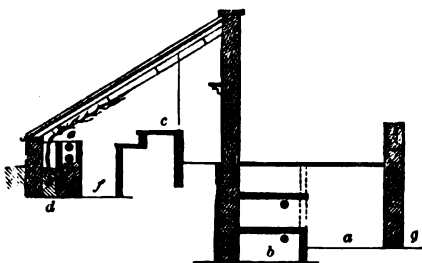


Horticultural Society":—"The bottom of the border is gently sloped from the houses to the extreme edge, where is built a box-drain (*a* on fig. 415) extending the whole length of the border, as shown in the section. This drain is 1 foot square, the top of it being level with the bottom of the border. When this was completed, dwarf walls, marked *c*, were built across the border,  $3\frac{1}{2}$  feet apart, in the pigeon-hole manner. On the top of these walls were laid rough flags. These in reality form the bottom of the border; and upon these is placed about 6 inches of broken stones and bricks, marked *d*, covered with turf, with the grassy side down, to prevent the soil mixing with the stones. There are flues or chimneys at each end of the border and centre, communicating with the drains in the bottom, as shown in the section, marked *b*. The tops of these flues are nicely made of stone, 10 inches square, through which is cut a hole of 6 inches square, into which is inserted a plug, of a wedge-like form, so as to fit tightly, but removable at pleasure. These flues are about an inch above the ground. At the back of the border are placed cast-iron pipes (marked *e*) perpendicularly, and also communicating with the drains underneath. Those, being higher than the flues in front, cause a motion in the air beneath the border. *ff* are the boilers. After a long continuance of rain, the plugs in the flues in front are taken out, thereby creating a great circulation of air, and thus to a vast extent accelerating the proper drying of the borders, which is deemed of much importance." The object of the inventor of this border, no doubt, was to get rid of superfluous water, and at the same time to admit a sufficiency of air naturally warmed by the sun; and by the same

judicious arrangement, he has it in his power, during cold or damp weather, to exclude the air altogether. By a reference to the section, it will be seen that we have carried the drainage and ventilation under the border within the house, and shown the means of supplying it with air from behind the back wall. By placing hot-water pipes in the front or back drain, the whole border might be warmed when deemed necessary.

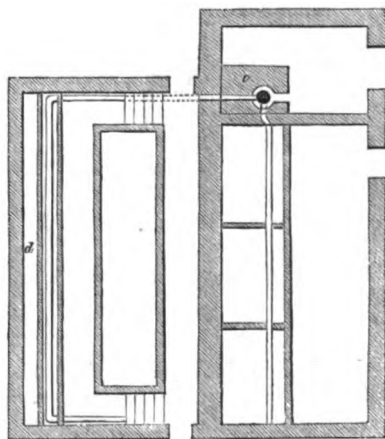
*Henderson's vineries.*—Fig. 417 is a

Fig. 417.



section, and fig. 418 ground-plan of a house designed by Mr Henderson, nurseryman, Oxton Hill, near Birkenhead,

Fig. 418.



intended for a villa residence, and to combine the culture of grapes with that of greenhouse plants, to supply a conservatory. In some cases, such a combination as this is necessary. We therefore take it

as an example, because the general details are good. The dimensions are 40 feet long, and 15 feet 3 inches wide.

Reference to plan and section: "a, floor line of mushroom house; b, surface of sunk bed; c, iron grating, forming a platform for plants; d, area in which the vines are laid when at rest; e, hot-water pipes; f, front path; g, sunk area; o, boiler in ground plan."—*United Gard. Jour.*

The same intelligent artist is the designer of figs. 419 and 420, which repre-

Fig. 419.

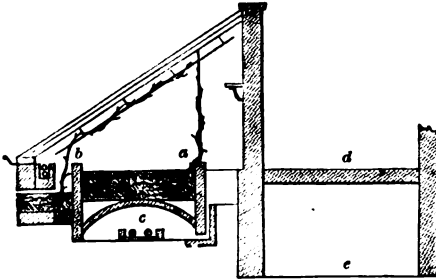
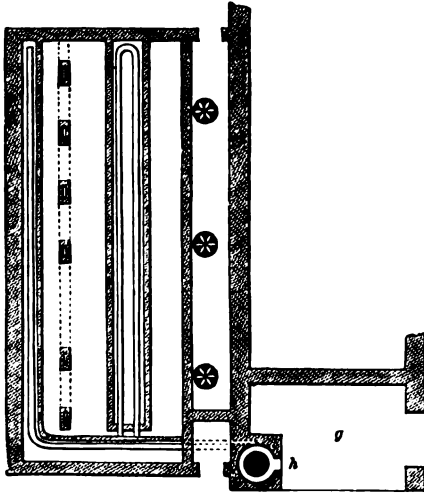


Fig. 420.



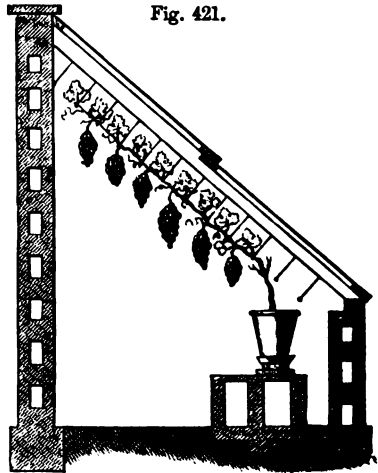
sent a vinery calculated to yield a succession in the ripening of grapes, and therefore well adapted for an amateur, or for a villa residence.

"The vines planted at a may be stimulated to action at a considerably earlier period than those planted at b; and the latter may be much retarded if untied from the wires and laid down,

and secured from the action of the heated atmosphere by a slight covering." We presume that the tanks in the heated chamber are to be used only while the vines in the border a are in a growing state, and that the late crops are to be brought forward by the heat from the pipes in front of the house, which will also counteract the effects of damp, and prolong their keeping. Were it not that the culture of vines in pots requires considerable skill and labour, we would have thought it a more judicious mode to have grown the early crops in that way, than planted out over a heated vault. In the case of pot-culture, the vines could be removed entirely from the house while the late ones were brought to perfection. The dimensions of this house are precisely the same as the last. c, heated chamber; d, floor line of back sheds; e, floor line of cellars; g, stoke-hole in ground-plan; h, boiler. The pipes in the chamber c are laid in a trough of water, or left dry, as moist or dry heat is required.

The annexed section (fig. 421) of a vinery for growing vines in pots, was designed for a gentleman in Scotland, who wished an economical house for this purpose. The section shows the position of the vines in pots placed over the flues, but elevated from them by a brick or two, according to the heat kept up in them. The vines are trained in the

Fig. 421.

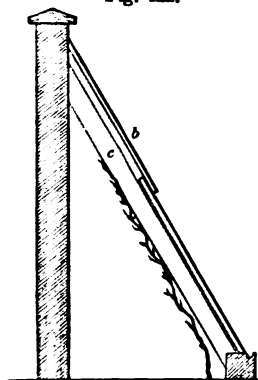


usual manner under the glass roof; and some are also set on the floor, to be

trained up the back wall. The angle of the roof is  $43^{\circ}$ . It is in two sashes, the top ones being 4 feet 6 inches, and the lower ones 4 feet 4 inches in length. The top ones slide down in the usual manner, and ventilators are built in the front wall. The walls are 9 inches thick, and built hollow, the bricks being laid on edge, not on bed. The height of the back wall is 8 feet 6 inches; the breadth of the house within, 5 feet 6 inches; and the whole length, 33 feet. It is heated by a smoke flue, which, entering at one end, passes along to a tank of water, supplied from the roof, and returns again, the smoke escaping close by the furnace end. The door enters at the furnace end.

*Saul's vinery*—fig. 422.—“The accompanying section of a vinery,” says Mr

Fig. 422.



Saul, is, in his opinion, “best suited for keeping late grapes. The great superiority a house of this construction has over the old form is, first, that by the nearly upright position of the glass, scarcely any of the rays of the sun are lost; while, for the

same reason, scarcely a drop of wet can find its way into the house. Another recommendation of this plan is, the small space to be heated; consequently the temperature can more readily be raised to any degree required. This kind of house would also be the very best for early forcing, as, from the small space to be heated, one boiler placed in the centre would be quite sufficient for heating a house of 150 feet in length. This kind of structure differs very little from that recommended by the late Mr Atkinson, except in the more upright position of the sashes; and probably the method of ventilation adopted by Mr Atkinson would be found the best. *b* is the rafter; *c* the trellis.”—*Gard. Chron.*

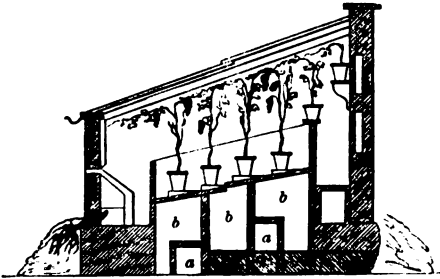
The vines in this house are very properly planted inside, so that the roots

may be beyond the reach of frost; as they are either safe within, or those that pass through the arches of the front wall, and get into the border without, can be effectually secured by coverings of leaves or litter. There is also another advantage attending this mode of planting, namely, securing the collar of the plant—that is, that part which connects the roots with the stem, and which is known to be more sensible of cold than any other part, from the changes of temperature, particularly in early or very late forcing. The vine is also here placed in a much better position for the free ascent of the sap, than if planted outside and bent, so as to pass through either above or below the wall-plate; for it should be borne in mind that every facility should be afforded for the free flow of the sap in the vine;—and hence an intelligent cultivator has suggested placing the upright sashes of his vinery in a sloping direction, instead of a perpendicular one, so that the stem of the vines may be as little bent as possible. For this purpose the front of the house is supported by mullions in the usual manner; but instead of these being of an equal thickness from top to bottom, they are made wedge-shaped, the broad end being undermost, and resting on the stone plinth or coping, which projects 6 or 8 inches over the outside of the wall, having a semi-circular notch cut out of the outer edge of the stone sufficiently large to enclose the stem of the vines. The vines are planted under the centre of the sash, and not close to the mullions, as is generally the case. The stem is enclosed by the front sloping sash, and reaches the trellis under the roof in a better position for the free ascent of the sap, than if it were bent horizontally over the coping, and immediately brought to the perpendicular of the inside of the mullion, and again bent to the angle of the roof. The sashes are suspended from the top wall-plate, and fit closely into a rebate formed for them in the sides of the mullions. The border is made up close to the coping, so that no part of the stem is exposed to the weather. Another advantage arises in some degree from this practice: the sloping position of the front sashes leaves them at a better angle for the admission of light than if they

were perpendicular. And again, by having the mullions portable, the vines, with care, may be laid down horizontally along the front of the house, on the top of the outer half of the coping, and mullions of the ordinary form substituted—the sashes, unscrewed from the outer edge of the wall-plate, and suspended from the inner side, shutting out the stems of the vines entirely.

*Stafford's vinery for pot-culture*—fig. 423.  
—The practice of cultivating vines in

Fig. 423.

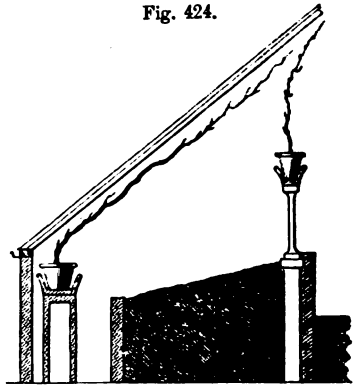


large pots has now become somewhat popular. Amongst the first and most successful operators in this way was Mr Stafford, who describes his practice and structure in "The Horticultural Register" as follows:—"The plan itself will require little explanation, being of very simple construction. The flues (a) under the pit will heat the air-chamber (b) to a very high degree. This heat should always be applied so as to act as a reserve, and be admitted into the house occasionally, as may be required, through apertures in the back and front walls of the pit. The same flues return under the back walk, and likewise in the back wall; and, from having such a quantity of heated masonry, you may calculate upon a certainty with regard to the heat of the house, let the external air be what it may. I have," he says, "so economised the heat of a house here, that I have often, in the winter months, had no fire for three weeks together, and have always had pine plants at the same time in the house." We think Mr Stafford's retention of heat might be improved by filling the chamber b over and around the flues with small stones, which, when heated, would retain it longer than the air, as at present. "It will be unnecessary," he says, (and what

I should by no means recommend) "to fill the pit with bark during the time the vine pots stand in it, but they should be placed in rows in the pit, on the back curb and shelf, putting a feeder (or pan) under each pot—as the success will greatly depend on the proper application of water at the different periods of the season. In the front it is intended to have vines to supply the rafters, which might be brought to vegetate some time before the pots were ready to remove; and by planting them in the border in front of the house, and with apertures to allow the outer air to enter under the partition, the vines will, without difficulty, remain torpid till May."

*Burn's vinery for pot-culture*—fig. 424.  
—Both Mr Burn of Tottenham Park, and his pupil Mr Sanders of Tedworth, author of a very excellent treatise on the vine, have done wonders in the cultivation of vines in pots; indeed, in all our experience we never saw such muscats, in particular,

Fig. 424.



as we have seen at both places. The transverse section above shows how the pots are arranged at Tottenham Park. The pots are set in wooden troughs, one of which is placed near the front of the house, and the vines growing in it extend up the roof till they come opposite those placed in the other trough, which is elevated above the stone curb. These troughs are 16 inches wide at top, and 10 inches deep. The vines in the latter reach the top of the house. The bed in the middle of the house is filled with tree leaves, to ferment and give out heat and moisture. In the construction of the houses, there is nothing particular in

either case; but the number of vines in a portable state is extraordinary—Mr Burn fruiting no less than from one hundred to one hundred and twenty annually.

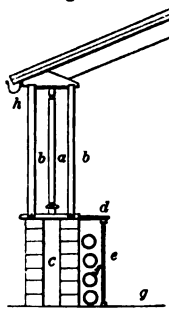
The intention of pot-culture is to extend the season of ripe grapes throughout the year; and this has been very satisfactorily accomplished, particularly by the two cultivators last named. It must, however, be admitted, that pot-culture is precarious, and requires great skill and attention, as well as an annual propagation of the plants; for the received opinion at present is, that the vines should only produce one crop. We should also state that, beyond a certain degree of northern latitude, the practice is not likely to be attended with satisfactory results.

Attempts have long ago been made to ripen two crops of grapes in the same house, one early and the other late. Some have tried to accomplish this by planting one set of vines within, either along the back wall or in the middle of the house: these were forced early, so as to be ripe in April and May. The other set were planted outside in the usual manner, and brought into the house at the period their buds were breaking—thus producing a late crop, which, of necessity, must be ripened off by the month of November, and then withdrawn, to allow the others to be put in order for forcing again. Another mode of attempting this has been by planting two sets of vines in front, outside of the house—half of which are early sorts, and taken in in December, while the other set, being later kinds, remain out till April. Thus we have the spring season of the one and the autumn season of the other coming in conjunction in the same house.

The vinery at Tedworth differs in construction, in some respects, from any others we have figured. Mr Sanders, in his excellent "Treatise on the Culture of the Vine," introduces his account of these deviations from the usual practice by observing, "Every grape-grower is fully aware of the difficulty in protecting the stems of vines planted in outside borders from the frost during the progress of early forcing; and even at a later period of the spring, they often receive injury from the same cause." With a view to remedy this, Mr Sanders has constructed his vinery with double

walls in front, as will be understood by fig. 425, which is a portion of the section forming the front of the house,—the house of

Fig. 425.



itself differing nothing from vineries in common use, excepting in having a flow and return hot-water pipe placed close to the bottom of the back wall, the utility of which is clear and obvious, that part being always the coldest and worst ventilated. The front wall of the house is formed of

two 4-inch walls having a cavity between them of 5 inches, the whole being set upon an arched foundation, and covered at top with a wooden wall-plate, upon which the mullions *a* are set to support the top wall-plate on which the ends of the rafters rest. These wall-plates are provided each with two grooves at top, and also at bottom, to receive the upright lights, which are made to slide instead of being opened by hinges. In planting the vines, which is done in autumn, (Mr Sanders thinking that the best season,) they "are placed 2 feet apart, or as nearly so as may be practicable; but the distance must in some degree be regulated by the under-ground arches, for the following reason: the stems of the vines are intended to be introduced through them, and to be carried up between the two walls—thus affording them that protection from the effects of frost which is so desirable during the process of forcing; and if each vine, at planting, be sufficiently long to reach the top of the front sash, so much the better. In training them, let the one be brought immediately under the rafter, and the next under the centre of the light, and so on throughout." In autumn, when the wood is perfectly ripened, the vines are pruned; and now comes the second advantage of the double walls, in the withdrawal of the vines. "The only thing required is to slide out the upright sashes from the outer wall, which must be done from the end of the house, then disengage the vines from the wires to which they have been trained, and dispose of them by securing them to the pillars (mullions) or any other con-

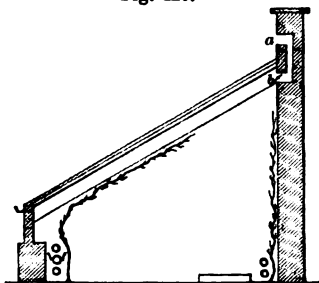


venient plan that may suggest itself. This can readily be done without the vines undergoing that twisting and distortion which is so liable to bruise and injure them, when taking them out of the houses as they are usually built. In the present case all that difficulty is removed without any danger of checking a free circulation of the sap; and when the vines are thus disposed of, and the front sashes slid into the groove of the inner wall, the house is not only enclosed and in a fit state to apply to other purposes, but the whole top lights, by projecting over the outer wall, will be a great advantage to the dormant vines by the protection thus afforded them from heavy rains, and also by preventing icicles from hanging about them, whereby they receive more injury than from any other cause. A free circulation of dry and cold air is highly beneficial to them; at the same time, a protection from too much moisture is necessary—and by adopting the above plan, they will have the advantage of both."

Reference to fig.—"*a* pillar or pilaster; *b b* front lights; *c* hollow space for vine stems; *d* shelf for plants; *e* small pillar for support of do.; *f* hot-water pipes; *g* front path; *h* gutter to carry off rain water."

The two principal vineries in the royal garden at Frogmore, of which the annexed fig. 426 is a section, are each 102 feet

Fig. 426.



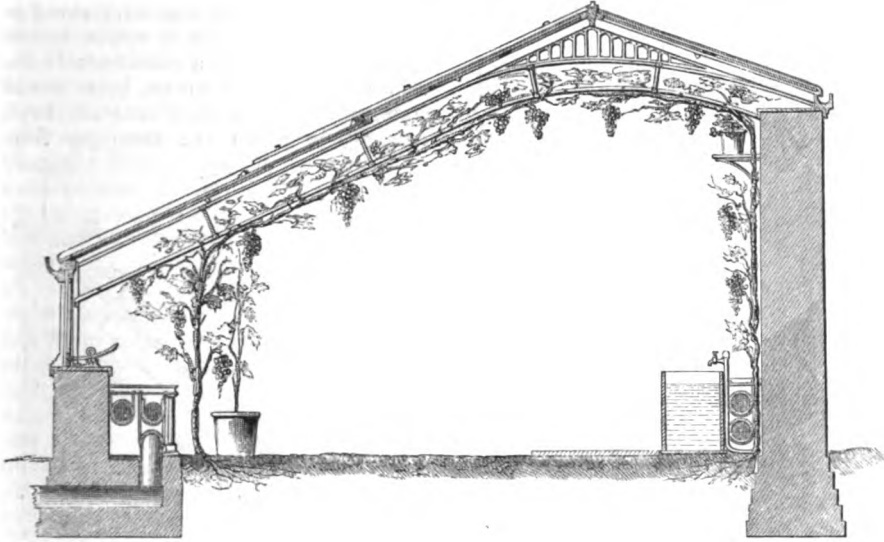
in length, 16 feet 6 inches wide, and 13 feet 6 inches high. They, like the rest of the range, are constructed of metal, the rafters being coped with wood to lessen conduction, the wall-plates, &c., being of cast-iron, the frame of the sashes of rolled or wrought iron, and the astragals of copper. They are glazed with British

sheet glass in lengths from 24 to 30 inches each pane. They are heated by hot-water pipes placed along the back and front, the latter being furnished with evaporating pans cast on them. The mechanical contrivances for ventilating, steaming, and regulating the temperature are very complete. The front sashes are opened and shut by a screw turned by a removable handle, (*vide* fig. 385,) and the top sashes slide down and are drawn up by means of a half cog-wheel and catch, and are kept in their places by flexible copper wire chains. The ventilators in the back wall are openings between 3 and 4 feet long each, and 6 inches deep, and are placed at equal and convenient distances apart.—*Vide* fig. 387. The outside of these openings, *a*, is protected by open grating; while the inner side, *b*, is furnished with a shutter moving on a pivot which extends the whole length of the house, and is turned by a handle, by which means all these shutters are opened or shut in an instant. Over the top pipe in front is an open metallic trough, communicating by a siphon with the pipe below it, so that an open circulation of warm water may be produced at the will of the operator. Over these open troughs, again, is placed a small perforated pipe containing cold water, so that when it is necessary to produce steam, a flange is turned, and the cold water falling in the troughs produces this effect. By means of very simple and efficient stopcocks, the whole of the hot-water pipes may be wrought at once, or part only, as is required.

Fig. 427 shows the cross section of one of the vineries recently erected in the royal gardens at Frogmore, 80 feet in length and 15 feet in width within the walls. This house is on the half-span principle, a form greatly superior to the common lean-to vineries. The vines are planted both along the back wall and along the front of the house inside; and, as will be seen by our fig., are trained in such a manner as to obtain the greatest possible surface under the extent of roof. Vines are also grown in pots—a department in vine-culture in which Mr Ingram has greatly distinguished himself. Ventilation is effected by the front sashes being made to open outwards, they being attached to a rack-and-pinion movement,

acted upon at one end, by which the whole are opened or shut simultaneously. Top ventilation is effected by the upper tier of roof sashes being made to slide up and down. A flow and return hot-water pipe runs along the back wall, suspended from strong iron brackets placed at equal distances along the whole length of the

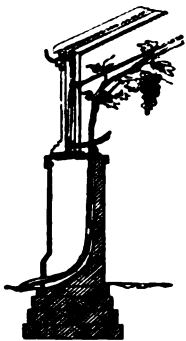
Fig. 427.



house. The hot-water pipes in front are suspended from a very ornamental set of brackets, which also serve for supporting a table on which strawberries, French beans, &c., may be advantageously forced. Neat slate cisterns are placed close to the back wall, and supplied abundantly with water from the general main of the garden.

Fig. 428 shows a very ingenious mode of taking the vines out of one of the vineries in the same establishment. A niche

Fig. 428.

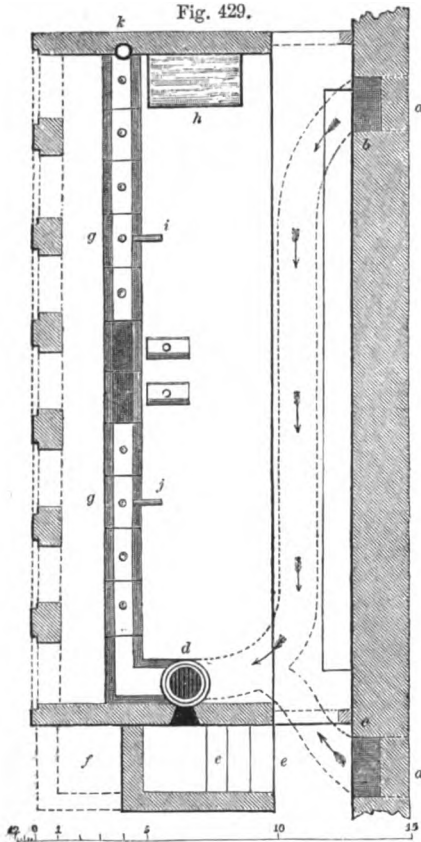


so that when the vines are to be withdrawn from the house, these pieces are

removed, and the whole vine taken out with the greatest ease and safety. The pieces are then restored to their former places, and remain so until the vines are to be again replaced in the house.

*White's vinery.*—This vinery was designed and executed by Mr White for his own use in 1839; and, shortly afterwards, one upon the same principle was erected by him for the Marquis of Tweeddale. Both are heated by his patent hot-air stove—(vide section, HOT-AIR STOVES.) They are thus described by him in his prospectus: “ Fig. 429, plan of the vinery, and fig. 430, a view, with the ends of the house removed in order to show its internal construction. *aa* is the back wall; *bc* are the mouths of cold-air drains, and the dotted lines their continuation to the hot-air stove *d*; *ee*, a few descending steps by which it is supplied from the outside with fuel through an opening in the wall, as shown in the plan. On the same level there is a place, *f*, for containing coke, as represented by the dotted lines; *gg* is a fire-brick casing formed in lengths of 2 feet each, and neatly jointed together—they are open at top, and have movable covers. Into this casing the heated air from the

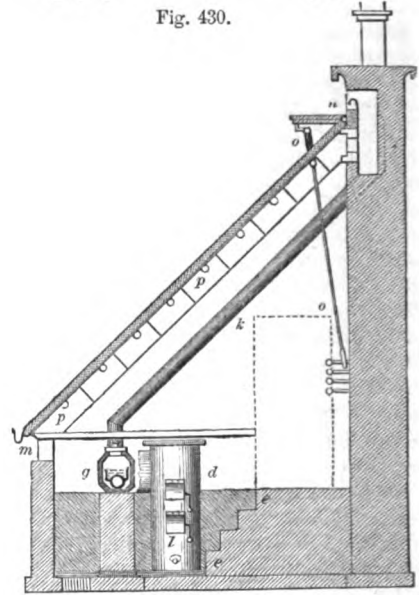
stove is first received, and afterwards distributed at pleasure. In addition to the heat given off in this way, the brick casing, from retaining the hot air, together with the flue-pipe passing through it, becomes so hot as to give off a large quantity in a radiating form. In fig. 429, two



of the flue covers are removed to show the surface of the iron water-troughs fitted on the flue-pipe, and resting on the bottom of the brick casing, better seen in sectional view, fig. 430. The troughs are only filled when the heated air is wanted in a humid condition: in other cases, the humidity from the cistern *h*, which supplies water for the ordinary purposes of the house, will be sufficient. *i* and *j* are wood wedges inserted on one side of the covers to raise them more or less, in proportion to the quantity of heat required; *k* is the termination of the flue-pipe, where it ascends, crossing the house above

the door, and entering the back wall into the chimney. When the house is to be heated, it is only necessary to light the fire in the stove *d*, and open one of the cold-air drains *b c*, as in the present instance the internal one *b* is open; the arrows represent the cold air flowing towards the stove where it enters below; and after traversing a numerous formation of winding channels in a heated state, it discharges itself into the brick casing *g g*, above the flue-pipe, from

Fig. 430.



which it escapes as heretofore mentioned. When the cold air is taken from the external drain *c*, the internal one *b* is closed—a regulation, however, which is entirely at the discretion of the superintendent of the house. *l* is the regulator in the ash-pit of stove, the handle of which is turned so as to admit a greater or less quantity of air, by which the combustion of fuel in the stove is regulated; *m* and *n* are ventilating grates; *o o* rods of iron suspended to the frames of the top windows to open and shut them; *p p* a system of small roans for conveying the drip from the inside of the roof to the cistern *h*. The appearance of the front is light and elegant: the main rafters are formed of malleable iron, and the intervening sashes of zinc, with an opaque edge, so extremely small as to give the house, at a short distance, the appear-

ance of having a roof composed of one sheet of glass;—at the same time the panes are only 6 inches by  $3\frac{1}{2}$ , thereby securing to them great strength in resisting hail-storms and other casual misfortunes to which hothouses are exposed.”

We have frequently seen both these houses. For metallic lean-to houses, they are finished in a style superior to any we have ever seen. We may, however, observe, that the system of roans or small gutters, *p*, is in our opinion superfluous: the only drip we ever observed in either house was that from the condensed steam, the glazing being very perfect. The mode of ventilation is inferior to that of openings in the back wall, as exemplified at Frogmore, Dalkeith, and elsewhere. It is a return to the mode generally in use over most of the Continent. The pipe for conveying away the smoke forms a great objection, from its unsightly appearance; and it is quite unnecessary, as the smoke could be carried away in another way. It will be observed that Mr White, in speaking of the power of his heating apparatus, is quite conscious of the limits of its action. Although sufficient to heat a vinery for ordinary purposes of 25 feet in length, for a larger house hot-water pipes are recommended to make up the deficiency.

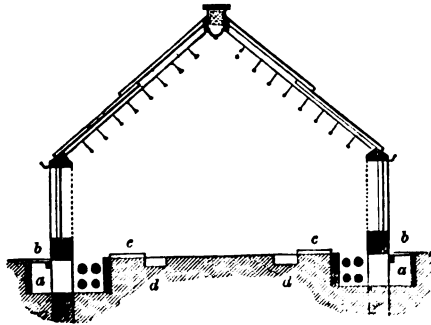
The rafters are of malleable iron half an inch broad and 3 inches deep; the astragals are of zinc.

*Span-roofed vineries.*—These are by no means so common as they ought to be; although, perhaps, of all sorts of lean-to houses, the vinery is the least objectionable, as the vines are trained near to the glass, and consequently their foliage is placed in a proper position to enjoy the full influence of the sun's rays. Instances occur where the span-roofed form has been long adopted—as, for example, at Gunnersbury House, Baron Rothschild's. This vinery we have occasionally seen for the last thirty years, and have ever found in it abundant crops and healthy trees.

The section annexed, fig. 431, is a span-roofed vinery, 60 feet in length and 25 feet wide, forming the centre of a range of span-roofed houses. Ventilation is effected by areas sunk under the level of the borders at both sides *a a*, and covered at the top *b*, when the air is to be excluded. The top ventilation is effected

through the ridge, as explained at fig. 389 in section VENTILATION. As this house

Fig. 431.

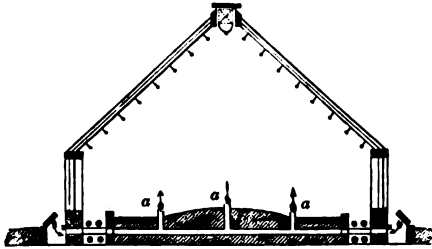


is large, the roof is composed of two sashes, each alternate top one being made to slide down over the lower in the usual manner. The vines are planted outside, and just behind the ventilating area, (this being for a general crop), and are brought in under the front lower wall-plate, immediately above the ventilation, and trained under the glass as indicated by the trellis studs. The sides are of upright glass sashes, and may be opened and shut in any of the ways already detailed. A set of vines is planted at each side of the house. Heating is effected by hot-water pipes, four courses of which are placed at each side—the boiler being placed in the centre of the north end, and the door in the centre of the south end. To obviate treading on the borders without, should the house be so placed, the whole of the covers to the area ventilators on each side may be opened and shut from one end, by having an iron rod extending the whole length of the house, to which the covers (of iron) are to be attached—the rod having a lever handle, as described in section VENTILATION, by turning which, the lids of the ventilators may be opened or shut less or more as is required. Open metallic grating footpaths, *c c*, are placed parallel to the sides and ends; or the whole floor may be paved with flags, tiles, gravel, or composition flooring. Four or more air-drains may be carried under the floor, as at *d d*, communicating with the external air at both ends, and having gratings placed over them every 6 or 8 feet. Additional ventilation may thus be secured, and equally diffused throughout the house. These drains are to be pro-

vided with air-tight doors at each end externally.

Fig. 432 is a section of a span-roofed vinery, which differs from the last inas-

Fig. 432.

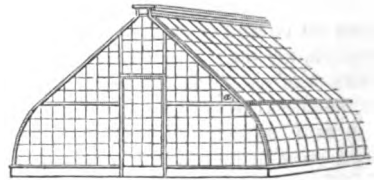


much as the roof is a fixture, without rafters or sashes. Ventilation is effected by opening the side sashes, and no other part of the roof is movable—the top ventilation being in the ridge, as in the last example. The vines, also, are planted within the house, to preserve their roots from cold in spring, and too much damp in winter. The hot-water pipes are placed in an open flue, the sides next the border, within the house, being built in the open, or pigeon-hole, manner, to enable a portion of the heat to find its way to their roots. A species of underground ventilation is here also exhibited: drains laid without mortar, or large drain tiles, are carried through the internal border, communicating at both ends with the open flues in which the pipes are laid, and opening into the house at *a a a*. These are placed at every six feet. Between them the vines are planted, and the border rises slightly towards the centre. The advantage of this mode of ventilation must be apparent, as it is seldom that the side sashes will require to be opened, therefore cold air will be prevented from reaching the early vines; while the late crops will remain longer in perfection, as a constant current of air is passing through the house, deprived of extra humidity by passing through the underground pipes, which will absorb it in its passage through them. Again, when the vines are in a state of growth, and a humid atmosphere is required, this also can be produced by placing evaporating pans on the upper pipes, or, better still, by rendering the bottom of the open flue in which they are placed waterproof

as high as half the diameter of the lower pipe; into which water can be led by a small pipe connected with the cistern. The trellis shown is 15 inches from the glass. The vines are planted under the footpaths, which are portable cast-iron gratings, through the openings of which the air, light, and water will find their way to the border in which the roots are. The stems of the vines may be tied to iron rods, at least until they attain a sufficient size to secure themselves from accident. The ventilating tubes, where they pass between the hot-water pipes, have openings on their upper sides to allow the air to rise directly to the bottom part of the roof. Any or all of these may be stopped, if desired, by having stoppers provided for them. Here, as in the last example, there is an open area with a hinged cover passing along both sides of the house without, and close to the parapet wall—the intention of which is to admit air to the air-drains within the house. These covers may be of wood or iron, laid on a basement of ashlar, or on a frame of cast-iron. As the situation of the house is, like the last, on a gravel space, free access can be got all round to open or shut the covers of these open areas, when required.

Fig. 433 is the elevation of a curvilinear house adapted to the same use and

Fig. 433.



situation as the last. We have endeavoured here to show what in practice is quite attainable, although, so far as we are aware, it has not been exhibited before, namely, a curvilinear house partly of wood and partly of iron. From the plinth or base, which is presumed to be of stone, the metallic astragals rise in a curved direction, and are united to the iron bar *a*, which extends the whole length of the house, and is itself supported by cast or wrought iron pillars rising from the floor. To this iron bar the wooden astragals, which form the upper

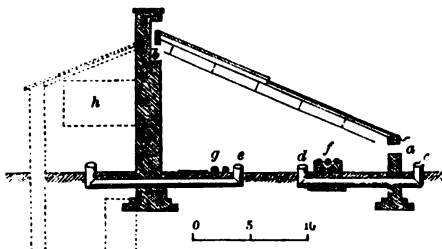
or straight portion of the roof, are attached, (the roof being all in one piece, not divided by rafters and sashes,) as well as to the ridge-board, as in ordinary span-roofed houses. Here we think some important objects are gained—namely, the curved metallic part is so low down that the conduction of heat by it can do little or no injury to the plants within; the expense of front lights and top wall-plate is dispensed with; the upper part, on which the sun has most effect, being of wood, we have all the advantages given to curvilinear roofs, without the bad effects attending them when of iron. The ends may be all of metallic astragals and framework, which will give to the structure a lighter appearance; and as the house is intended to run from north to south, the conducting powers of the iron there will scarcely be perceptible. Ventilation is to be effected as in the last example.

The majority of vineries built of late years have been made too narrow. These are undoubtedly adapted for early forcing; but for general crops, houses of much greater breadth will be found superior. We may here remark that, as regards the size of vineries, singular changes have taken place. The earliest erections in this country, copied from the Dutch, were narrow; then came houses of much greater breadth, as may still be seen in the few examples left of those built about the latter end of the last century. The beginning of the present century brought into vogue narrow vineries again, no doubt arising in a great degree from the examples furnished by Mr Atkinson. Of late, broader houses have been recommended; and for general crops in large establishments, this principle is undoubtedly correct. In this particular, the vineries at Frogmore afford excellent examples.

The annexed example, fig. 434, is what we would call a very excellent house for this purpose: it has some peculiarities about it differing from the structures in ordinary use. The houses are each 50 feet in length, and 20 in breadth: they may either be on the ridge-and-furrow principle, or constructed with two top sashes in the ordinary way, and as shown in section. The front wall should be of brick or stone ashlar, with venti-

lators 3 feet long and 9 inches broad in the opening, distributed equally along

Fig. 434.



lators 3 feet long and 9 inches broad in the opening, distributed equally along the front. This wall is to be 3 feet high, and built upon stone or brick pillars, arched or lintelled over with pavement, stone, or bars of cast-iron, to permit the roots of the vines to pass out to the external border.

The back wall is to be 14 feet high from the ground line to top of coping, and 12 feet high from border level to inside of glass roof. Ventilators, *b*, of the same size as in front, are to be placed along the top of the back wall, which should reach within 6 inches of the glass.

Ample though this extent of ventilation may appear, still we would provide means for increasing it, and therefore would bring air-drains, by means of tubular tiles 10 inches in diameter, *c*, from the front, through under the parapet wall, as shown in section, and lead them under the hot-water pipes, having their opening, *d*, close to the floor, and 8 feet within the house. Similar tubular drains should be brought through under the back wall, having their openings at *e*, close to the trellised footpaths: these tubular ventilators to be placed under the front ventilators, and in the same proportion to numbers. This underground ventilation should be regulated from within the house by proper covers or stoppers being fitted to the mouths of the tiles; and for this purpose nothing, perhaps, would look neater, or answer the end better, than brass revolving ventilators; or the whole may be opened and shut by machinery of a very simple form. The vines are to be trained all over the roof and also against the back wall. As vineries of this size are too large for early forcing, the roof may be fixed,

which will be more economical in the first erection, and save much breakage of glass afterwards. The heating is to be by hot-water pipes, the boiler being placed in the centre of the house, and within it, but under the level of the footpath. The pipes are to rise from thence and cross towards the front to within 4 feet of the parapet wall, where they will discharge themselves into a cast-iron cistern, to which all the pipes, both flow and return, are to be attached, and from whence they will branch off to the right hand and to the left—three upper or flow pipes, and two under or return ones, as at *f*. The cistern is to be cast with a broad margin, having a quarter of an inch groove all round, to receive the flange of the cover, which, if let in, and the groove filled with water, will make a good tight joint, and prevent steam from entering the house. Another object in using this cistern is, that any of the pipes may be stopped at pleasure, by introducing a wooden or cork plug, which will stop the circulation, and also the heat by conduction, which no metallic stopper completely effects.

The top ventilation, instead of escaping by the opening of the ventilation at the side, as is generally done, may be made to do so above the top of the wall, in the way shown in Mushet's vinery, fig. 413. This latter would, perhaps, have a better appearance.

The pipes, *g*, shown along the footpath are auxiliary ones, to be used in very cold weather, or when a greater degree of heat is required. They are laid side by side, instead of being placed the one over the other. They may also be wrought at the same time with those in front; for it is found to be better to have a great heating surface of pipe heated moderately, than a lesser quantity heated more. To regulate the flow in these latter pipes, it will be expedient to have a smaller cistern attached to them on the same principle as that in front, by which they can be stopped when desired.

A cistern, *h*, of rain water, collected from the roof behind, is placed behind the back wall, at the height shown in section, to be supplied from that source alone; or it may be placed sufficiently low to be supplied not only by that, but by the rain which falls on the roof of the

vinery also. This cistern will supply the boiler and pipes, and, if made sufficiently capacious, most of the water for the use of the house also.

*The formation of vinery borders.*—Many opinions have been offered upon this subject. The majority of gardeners, up to a very recent period, advocated deep, rich, or highly manured borders: some insisted on the bottom being rendered dry, while others disregarded this recommendation; some concreted the foundation, while others paved it with tiles, bricks, or pavement, all sufficiently jointed and secured to form excellent bottoms for tanks, and this often in soils quite impervious to water. Modern cultivators have adopted different views, and, instead of deep and narrow borders, have made them shallow, and increased their width—instead of sinking them under the natural surface, have elevated them above it. A thoroughly drained border is now considered "the first condition requisite for success;" but there is more than thorough draining the superfluous moisture to be considered in this case. "It is the air that takes the place of water," says the editor of *The Gardeners' Chronicle*, in a recent leading article in that paper, "in a well drained soil, which proves so beneficial to plants: it is because air cannot reach the roots of plants, when a border is water-logged, that trees suffer. Roots require air as well as leaves; and no mistake can be greater than to suppose the contrary. It is evident that if the cavities between the particles of soil in a garden be filled with water, air must be thence excluded: they cannot both be present; for the quantity of air dissolved in stagnant water is too inconsiderable to deserve attention. It may be enough for the maintenance of a rush or a horse-tail, but not for a healthy garden plant, and least of all for a vine, whose air-vessels are perhaps the largest and most abundant of any European tree.

"When a vine border is drained it is improved, not so much by the removal of water as by the admission of air. But the removal of superfluous water, and the free access of air, have the additional and very important effect of raising the temperature of the soil. Air is a bad conductor of heat, water a good one. A

border composed of porous materials not water-logged is an apparatus of non-conducting cavities, from which any heat that may be gained escapes with difficulty, and slowly: once warmed, it remains so, not for a few hours, but for weeks. Water, on the contrary, carries off heat with such rapidity that a water-logged border is always cold. Warm rain falling on a water-logged soil cannot sink into it, but remains near the surface, and speedily cools again; but warm rain falling on a thoroughly drained border sinks quickly through it, parts with its heat as it descends—and that heat is detained in the air cavities of the soil, to be very gradually parted with again. We may therefore say that a thoroughly drained border is advantageous to a vine, not because it has less water, but because it has more air and warmth."

Than this no better reasoning can be given; and if we even extend our views in the same direction, and upon a much larger scale, we will readily understand why not only whole farms, but also whole countries, become not only more fertile, producing their crops earlier, but even sensibly warmed and improved in climate, by thorough and complete drainage. This also confirms the doctrine laid down by the most enlightened improvers of the land. "Drain your land well," they say, "whether you have water-pools in it or not; drain, that you may not only supply the roots of your corn crops with air, but with warmth also."

We believe that it is now very generally admitted by most reflecting persons, that ventilating vine borders, and indeed all others, is of the greatest utility; and few new ones will now be formed without this operation being attended to. The process, we apprehend, most likely to succeed will be to carry a drain built on the sides, but leaving the top open, along the front of the border, and from it to lead air-drains of drain-tiles, or bricks laid without mortar, and not very closely placed together, across the border, in parallel and direct lines towards the front of the house, and 3 or 4 feet asunder.

It has been proposed, and with good reason, to allow some or all of these air-drains to join the area in which the hot-water pipes are laid, or where flues are

used to bring them in near contact with them. The heat from the flues, or hot-water pipes, will so rarefy the air near them that the draught through the air-drains will be considerably increased. Some also have proposed this as a mode of admitting general ventilation to the front of the house; while others have suggested—and in one instance to our own knowledge, at Ingestrie, in Staffordshire, adopted—the plan of keeping the area or open drain in front filled with fermenting manure, with the view of throwing in heated air and fertilising gases at the same time to the roots through these air-drains.

As earth is a bad conductor of heat and air, we think that the air-drains should be laid in a stratum of broken brickbats, flints or broken stones, or the bottom of the border furnished with pigeon-hole walls a foot or 18 inches high, and covered over with flags, and these covered with broken stones or brickbats, as already noticed.—(Vide *Malguyn Castle vinery*, page 308.)

The admission of air at its natural temperature is, we think, much better than throwing in heated air from flues or hot-water pipes, unless these are applied only to the extent of promoting circulation.

To regulate the admission of air, or to suspend it altogether, perhaps, in frosty weather, the whole operation may be stopped by covering the area or open drain in front, or by stopping up the mouths of the air-drains themselves.

*Chambered borders.*—There is another matter connected with vine borders, so nearly allied to that of ventilating them that we may briefly notice it here, and that is, dividing the border by walls into compartments, or, as it was denominated by Mr Mearns—a great advocate, if not the originator, of the plan—"chambering them in." This practice consisted in carrying solid walls across the borders, so that each vine might have its own separate compartment to grow in. Although this plan was much ridiculed at the time of its proposal, still we believe that there is something good in it. It keeps the strong-growing kinds from robbing the weaker of their just supply of food—a result which frequently ensues when vines are planted promiscuously in the



same border. There appears to be something so congenial in the presence of brick or stone walls to the roots of the vine, that they are in general found thickly matted upon them wherever the roots come in immediate contact with them.

*Concrete borders.*—A new feature in the construction of vine borders has been now for some years most satisfactorily exemplified at Trentham, and, as a deviation so great from formerly established rules, it created at the time no little speculation. The borders being formed to the desired depth, 20 inches, and in breadth 14 feet, the surface was rendered smooth, and on it was laid a covering of concrete, consisting of eight parts of gravel to one of lime, to the thickness of 2½ inches. The border has a fall of 24 inches from the house to the walk, and is drained with stones and brickbats at the bottom to the thickness of about 10 inches.

All this is exactly agreeable to the usual routine: the concrete covering is the deviation from that rule. In attempting to describe the philosophy of this novel and startling practice, Mr Marnock, in "The United Gardeners' Journal," thus remarks: "A host of arguments rise up before the mind, approving and disapproving of the general scheme. Probably the first apparently important objection that will present itself is the impossibility of watering, manuring, or otherwise affording any of those artificial helps which, in ordinary cases, cultivators deem it to be both their duty and their privilege to supply; for it ought to be understood that the concrete becomes as hard as a shell of solid stone, neither admitting, upwards nor downwards, perceptible moisture of any kind. At first glance this would seem to be an insuperable objection, rendering it utterly impossible that fruit-bearing plants especially could continue to live, far less to flourish. This is, however, but one instance of the many, which shows how little is really known of the true principles of vegetable physiology, and of the laws by which vegetable life is regulated; for these vines do not only live, but are in the most vigorous health, and bearing better crops of better coloured and better flavoured fruit than those in the other half of the border which is treated in the

usual way." To this we can confidently subscribe, having seen them two years ago. "Nor have these vines had the least artificial watering of any kind applied to them since the day the concrete was first laid upon the border. Looking at the other side of the question, there are points which might be referred to, as likely to prove advantageous in the case of this concrete; and the first to which we allude we deem a very important one, arising from the fact that the concrete acts as a complete preventive of a common evil—we mean the all but irresistible temptation to dig and crop vine borders. In the next place—and it is this wherein consists its chief recommendation—namely, the preservation of the whole of the roots near the surface, and within the influence of warmth from sun and air. The indurated smooth shell of concrete, spread over the surface of the border, would absorb a greater quantity of heat than the ordinary surface of dug and loose earth—just as a smooth flagstone feels, and really is, hotter under the influence of sun heat than the less smooth surface of ordinary earth. Presuming on what is a common result, that wherever the roots of plants, no matter of what kind, meet with the sides of walls—the brick or stone work of drains where there are partial cavities, filled, of course, in such situations, with moist air—there the roots of all plants become more vigorous than in any other situation whatever; and this is just the nature of the situation in which the roots of the vines are placed immediately under the concrete, and between the latter and the earth forming the border; and we have no doubt that, were the concrete removed, the roots of the vines would be found to be thickly matted. The concrete being almost impervious, necessarily prevents rapid exhalation, by which the border earth cannot be deprived of its moisture. The moisture by which the border is kept constantly supplied, is dependent upon a principle which is neither sufficiently known nor so fully valued as it deserves—we mean capillary attraction, and the tendency of moisture to rise to the earth. Upon this principle, it is not difficult to understand why there should be no inconvenience arising from the impossibility of giving water at the surface of the

border. The situation of the garden at this particular point is low and damp, and hence the desirableness of protecting the border from the effects of heavy rains, and also the certainty of sufficient moisture rising upwards to supply the roots of the vines. We especially mention this, because it is an illustration very much to the point, showing the necessity of practical knowledge: here, owing to the situation of the garden and the vine border, the concrete is most advantageous;—first, by protecting the border, which is naturally damp, from heavy rains; and, secondly, by communicating increased warmth to the border earth, by the smooth hard surface of the concrete absorbing a greater amount of heat from the rays of the sun than the rough and loose surface of a common border would do. Thus, at Trentham, the practice is obviously advantageous, and in very dry situations it might probably be questionable; hence practical knowledge can alone prove the safe guide in all such matters.”

We have made this long quotation because it entirely coincides with our own views on the subject; and we shall add, as a proof of the theory, the condition of the large vine at Hampton Court, which is in circumstances exactly analagous to those of vines in concreted borders. This celebrated vine has no prepared border, and if the roots penetrate within the house, they are securely covered with a pavement floor; while, by extending outwards, they come into immediate contact with the walls of a large drain and the remains of old foundations. When that drain was opened a few years ago, the sides were completely covered with the roots of the vine. The same may be said of vines planted in hothouses whose roots have penetrated under the paved floors of tan-pits, as was the case at one time at Claremont; and the finest Muscat grapes we ever had were from these. The advocates for admitting air to the roots of vines may do so, in the case of concreted borders, by carrying air-drains through them; and those who will insist on supplying the roots with liquid manure, may do so, also, by introducing drain-tiles to act as distributors. But neither of these cases will materially alter the conditions of a concreted border, if the drainage is

complete beneath. The great merits of these borders in cold damp situations appear to us to come under three heads—namely, the supply of solar heat to the roots, by conduction through the concrete; the prevention of cropping, and consequent preservation of the roots; and the uniformity of temperature and humidity in the border.

Something of the same kind was done some years ago by Mr Barron at Elvaston Castle, in the case of peach and apricot trees on the open walls. With a view to accelerate the ripening of the fruit by radiation, foot-tiles, 3 or 4 feet in width, were laid along the bottom of the walls;—this had its effect upon the fruit, and no doubt also upon the roots, tending to produce the effect intended.

As substitutes for concreting vine borders, they might be covered with Bangor slates, say 2 feet by 3; or with slabs of coarse glass, half an inch thick, laid on a bed of finely-sifted coal-ashes or sand. Both are great conductors of heat, and, if laid in an imbricated manner, would throw off the rain completely. They need not be jointed at the edges, so that they might be taken up and relaid whenever it was found necessary. In Scotland, where the slates, although of much less size, are much stronger, and admit of being walked over, vine borders might be covered with them, laying them down as on a common roof, and, if deemed necessary, pegging them to the border with wooden pegs. Plain tiles might also be used; and thin plates of cast-iron may yet be found an excellent substitute. But the best of all protections to vine borders would be a roofing of glass, slates, or tiles, laid on rafters a few inches clear of the surface of the border.

The aëration of vineries has now assumed a very tangible form; and therefore we find the most intelligent and enterprising cultivators adopting the system, and with the most satisfactory results. Amongst the various modes by which this subterranean ventilation has been effected, we may notice that adopted by Mr Spencer, the very intelligent director of the gardens at Bowood, Wiltshire, and communicated by him to the Council of the London Horticultural Society. “By a reference to the plan, fig. 435, it will be seen that the house in

question is one of the common lean-to description. The chamber containing the heating apparatus runs the length of the house, (see *f*.) and into this chamber, and immediately below the hot-water

with the external air by two drains *h h*, which are protected by a wire grating. Both sets of drains are furnished with sliding valves made of slate, working in a groove, *m n* ; to each valve is fixed an

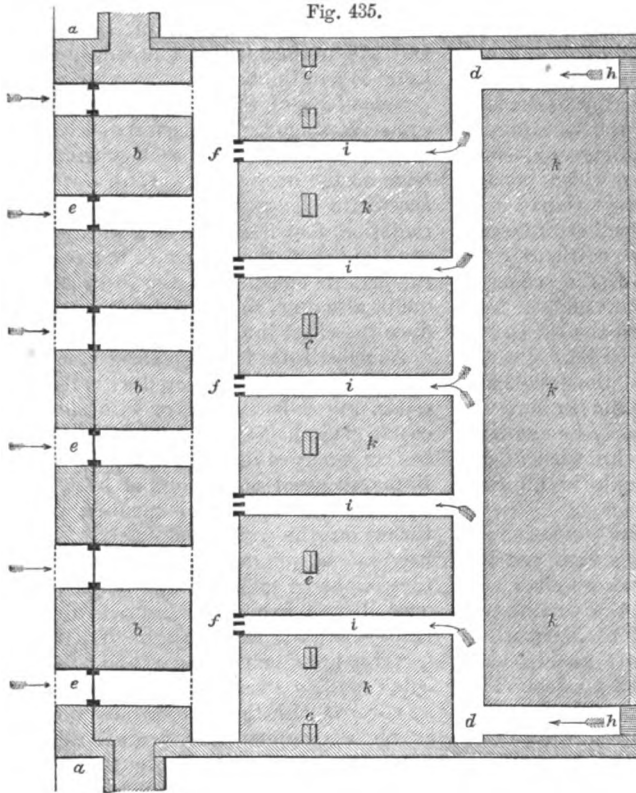


Fig. 435.

upright wooden bar, furnished with holes, and by means of a pin the admission of air can be regulated as wished. In addition to these drains, there are five ventilators, *g*, in the back wall of the house. These are made to slide in a frame, and are connected together by an iron rod, having at each end a weight attached, by moving which the whole of the ventilators are acted on simultaneously.

"It will be seen, by the above description, that when the valves *m* and *n* are raised, and the back ventilators opened, a current of air is immediately admitted beneath the heating medium, and thus gets warmed before coming in contact with the foliage of the vines. The general

direction of the warmed air is naturally towards the back ventilators. During the winter months, and in dull weather, these valves require only to be slightly raised, keeping a continuous current through the house without lowering the temperature. During bright sunny days I open the whole of them, when, of course, a more rapid circulation takes place ; but I do not find it necessary to open the top sashes until the weather becomes sufficiently warm that air may be admitted without any fear of its injuring the foliage by direct exposure to its influence, which often occurs to vines in leaf when the sashes are lowered in cold though bright weather during winter and early spring."

direction of the warmed air is naturally towards the back ventilators. During the winter months, and in dull weather, these valves require only to be slightly raised, keeping a continuous current through the house without lowering the temperature. During bright sunny days I open the whole of them, when, of course, a more rapid circulation takes place ; but I do not find it necessary to open the top sashes until the weather becomes sufficiently warm that air may be admitted without any fear of its injuring the foliage by direct exposure to its influence, which often occurs to vines in leaf when the sashes are lowered in cold though bright weather during winter and early spring."

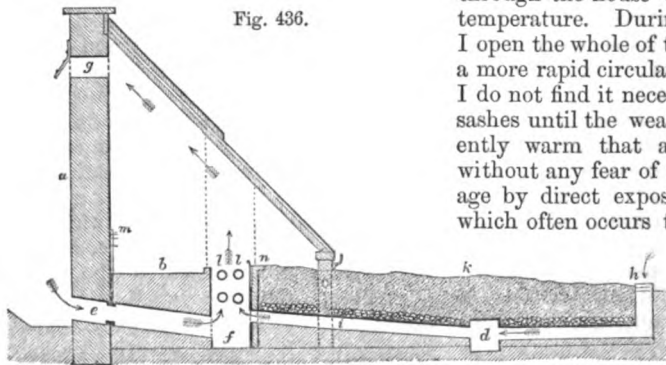


Fig. 436.

the sashes are lowered in cold though bright weather during winter and early spring."

Mr Spencer observes, that had he "had the entire building of the house in the first place," he would "have preferred building the back wall sufficiently high to have left room for the back ventilators to have opened above the wall-plate, and immediately under the coping, to remedy the evil, in the present case, of a direct current of cold air passing through." He has "attached to the north side a frame which prevents the air entering the house directly from the outside."—*Jour. of Hort. Soc.*

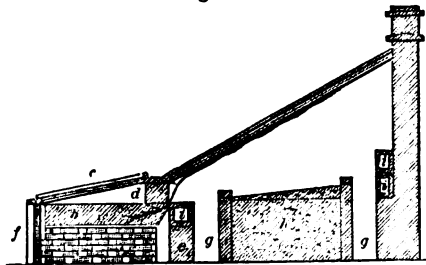
Reference to section and ground-plan : *a* back wall of house ; *b* floor of house ; *c* supports to front plate ; *d* large air-drain running parallel with the house ; *e* air-drains entering from behind ; *f* open chamber for hot-water pipes or flue ; *g* ventilators in back wall ; *h* drains for admitting external air to *d* ; *i* air-drains communicating with *d*, and opening into *f* ; *k* border for vines ; *ll* hot-water pipes ; *m* sliding valves for regulating admission of air through drain *e* ; *n* valves for admitting air from main drain *d*.

*Subterranean chambering vine borders at Welbeck.*—In the gardens of the Duke of Portland, at Welbeck, has been exemplified a mode of rendering the bottoms of vine borders dry by chambering them underneath, and their surfaces dry by covering them with rafters and glass sashes. Glass is now cheap, and a very inferior quality will do as well for this purpose as any other ; nay, even a covering of common roof-tiles, such as has been used in other places, will answer the same end, excepting in so far as the transmission of light is concerned. That the bottoms of vine borders, as well as their tops, should be kept free from excess of damp, is admitted by all ; but it seems questionable whether all this expense should be incurred in such a case as that of Welbeck, where the annual fall of rain does not exceed that of several of the adjoining counties ;—because, though the garden lies low, and only a few feet above the level of an adjoining rivulet, the common drainage of that part of the park, yet, by adding 3 feet to the height of the back and front wall, and raising the roof to that height, 3 feet of drainage of broken stones, brickbats, flints, or other similar matter, would have been secured, which would produce as dry a bottom, and at little more expense, than

that of either chambering the border, or covering it with rafters and sashes.

Were all the houses at Welbeck elevated upon a terrace 3 feet above the present level of the garden, and the front of that terrace finished with a dwarf retaining-wall, as formerly recommended, the fine ranges there would have a far more imposing appearance than they have at present, and the borders would be completely exempted from the evils of stagnation and damp at their bottoms. We have too high an opinion of Mr Tillery, the present gardener at Welbeck, to think for a moment that he entertains different views from what we have here expressed ; but we know the difficulty of persuading even liberal and intelligent proprietors to alter or correct evils which have long existed. We would not have alluded to this matter here, had it not been that Welbeck has been celebrated for its vine-culture for more than a century—having been the field upon which Speechly operated, as well as succeeding gardeners of great worth in their profession, of whom Mr Tillery, although last, is not the least. We were also prompted to notice this matter, from seeing a section of one of these houses published in the "Gardeners' Journal," of which the annexed fig. 437 is a copy ; and after the

Fig. 437.



following explanatory remarks, we shall give the references to the diagram : "As it is a very heavy wet soil about there (Welbeck) and the neighbourhood, the vines are found, without the precaution of borders being well chambered (as in the annexed plan) or extremely well drained, to make but little progress ; and the grapes are not found to be of that superior quality they should be, without the borders being peculiarly adapted to the locality. As it will be seen, by refer-

ence to the plans, the border *b* is well chambered underneath. The rafters *c*, over the border, are portable, and so constructed as to be removed when the weather is found to be sufficiently congenial. While the lights are over the roof, the front of the house at *d* is thrown open so as to admit the warm atmosphere of the house over the border; the heat is also admitted under the border at *e*. There is also a vacuum all round the wall at *f*, to allow the heated air to circulate round the roots."

*a* ground line; *b* border; *c* portable rafters; *d* opening in front wall; *e* entrance under the chambered border; *f* vacuum round the wall; *g* pathway; *h* pine-pit; *i* flue.

At Trentham, there is a reason given for concreting the surface of the border, which is, the amount of rain which falls there, combined also with extra humidity below. At Welbeck, the same amount of rain does not fall; and if it did, a covering of roof-tiles would correct the evil. One of the advantages resulting from a chambered border, in such cases, is, that a little heat may be introduced into it at the expense of the temperature of the house, where flues only are used. Would this not be better effected if hot-water pipes, heated by the same fire, were conducted through drain-tiles laid under or amongst a sufficiency of draining material?

*Heating vine borders.*—The following original plan of warming vine borders has been employed by Mr Fleming at Trentham, who, with most gardeners of equal experience, is well aware of the great importance of stimulating the roots

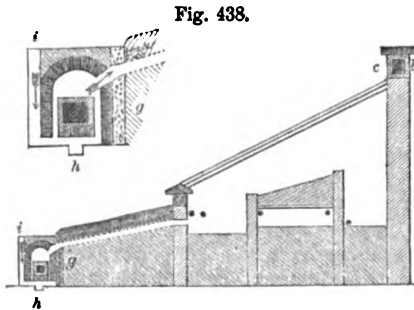
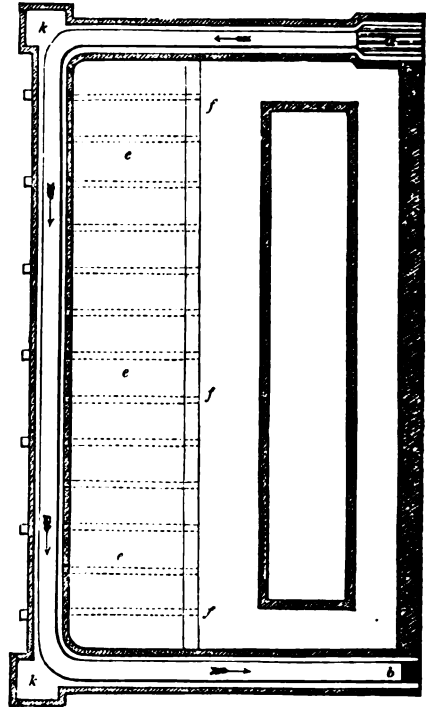


Fig. 438.

of vines into growth as soon as, or rather before, the buds are excited by early forcing. An account of this process is given

in "The Gardeners' Chronicle," from which our woodcuts are taken. Fig. 438, transverse section; 439, ground-plan;

Fig. 439.



and 440, longitudinal section. "I propose," he says, "to carry the smoke from

Fig. 440.



the furnace *a*, round the border, as indicated by arrows, to the wall at *b*, when it will rise to a horizontal flue under the coping, and pass along it to the chimney over the boiler. The flue will be enclosed in an arched chamber *e*, from which will proceed perforated earthen pipes, passing through the drainage of the border, which will be formed in ridges, as shown in longitudinal section. These ridges will be composed of bones, broken bricks, lime, stone, and pieces of charcoal, to afford nourishment to the roots, as well as to act as drainage. The warm-air pipes will terminate inside the front walls of the house at *ffff*, and

there be fitted with zinc ventilators. By means of these ventilators, the warm air can be made to act equally on every part of the border. For instance, the ventilation of the warm-air ducts nearest to the origin of the flue being shut, the air would pass on to the next open ones. The floor of the border should be formed of concrete, and at *g*, in the transverse section, is a rubble drain to carry off the water from the concrete to a drain, *h*. At *i* are apertures for the purpose of admitting cold air to the bottom of the arched chamber to displace the heated air, which, being lighter, will rise into the perforated air-ducts, and, partly diffusing itself through the draining material into the soil, the remainder will pass into the house. From this will arise the collateral advantages of being able, at any time, to cause a circulation of air in the interior of the house, which will be found congenial to the health of the vines, and whatever other plants it may contain. I may here remark," he continues, "that the warm air in its passage to the border cannot be otherwise than moist, as the rains that usually fall during winter, spring, and autumn, will always cause a sufficient moisture about the sides of the chamber, which, being converted into vapour by the heat from the flue, will pass with it into the border. From the outside of the stoke-hole should be brought a current of air to the end of the chamber next the boiler, to drive the heated air from that part in the direction of the warm-air ducts. The smoke, by passing along the flue, will lose a great part of its blackness, and will appear more like steam when it leaves the chimney. This of itself will be almost equivalent to the expense incurred; while the soot can be easily collected at *k k* in the ground plan."

The advantage of such an arrangement as this cannot be doubted; and the colder the locality, and the more uncongenial the soil to the culture of the vine, the more important this or a similar arrangement will be. Our own opinion of the matter is, that hot water would be a better medium for diffusing heat under such circumstances than hot-air or smoke flues, as the former could be propelled through the various ramifications with greater certainty and equal effect. Entire

earthenware tubes, however, would have to be substituted for perforated ones; and the ends of the tubes entering through the front wall of the house, would require to be moulded with a bend presenting their orifices upwards instead of sideways.

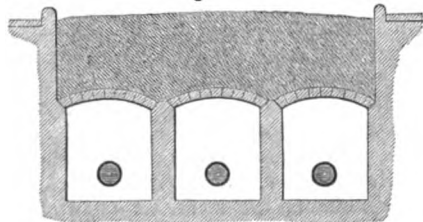
In a leading article in "The Gardeners' Chronicle," (1847, p. 555,) the talented editor remarks, in speaking of vine borders: "In general, vines are treated as a man would be, if exposed to a steam bath with his feet in ice. The necessity of providing some means for warming the borders of vines to be forced (we will even say grown) in a climate like this, will be obvious when we compare the temperature of the earth in the south of France and Great Britain. The mean temperature of the earth near London, in the three first months of the year, may be taken at 38°; that of Marseilles or Bordeaux will be at least 65°. The mean temperature of the earth near London in July and August is 62°; that of Marseilles about 78°; and of Bordeaux 77°. We will ask whether it is probable that such differences in the soil can be unimportant to the plants which grow in it?" After stating the temperatures of the soil in various places, he proceeds—"It is therefore interesting to inquire whether the temperature of the earth in which plants grow may not be inferred from that of the air which rests upon the surface. It has been shown, in the 'Theory of Horticulture,' p. 95, that in October, near London, the mean temperature of the earth has been found 3° or 4° above that of the air, although, in general, the difference is not more than a degree, or a degree and a half, in favour of the earth. The permanent heat of the earth may therefore be regarded as being always higher than the mean of the air; but the amount of difference will be regulated by the temperature to which the earth is exposed, and by its own conducting qualities. It seems to us, however, that for gardening purposes the temperature of the earth may be taken, on an average, 5° above the mean temperature of summer in warm countries—very often more, seldom less; so that if the mean temperature of Rome in the hottest month be 77°, it is probable that that of the soil, at the same time, will not be less than 82°.

As we advance to the northward, the difference diminishes; so that in London it is not more than  $2^{\circ}$  in favour of the earth."

If we compare these data with the circumstances of vines growing in earth nearly at the freezing point, while their stems are exposed to a temperature of  $60^{\circ}$  or  $65^{\circ}$ , we will then surely see the advantage, if not the absolute necessity, of warming vine borders by some means or other.

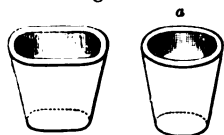
The plan recommended by Mr Ainger, in his "Essays on the Production, Distribution, and Preservation of Heat," &c., published in "The Gardeners' Chronicle," would be well adapted for heating vine borders. He says: "The application of bottom heat to an exposed border is one of the experiments that remain to be tried; and whether or not it shall appear that glass buildings may be to some extent dispensed with, the increasing conviction of the value of soil heat leads me to suggest the following mode of supporting the earth over the cavity containing the water-pipes or other source of temperature. Let the annexed fig. (441) re-

Fig. 441.



present a bed of earth sustained upon arches springing from low walls or piers, between which are placed the heating-pipes. If these arches be formed of bricks, they would obstruct the passage of the heat to the soil; but if turned with hollow earthen *voussoirs*, as occasionally practised for the sake of lightness in ancient and modern vaultings, we should have, perhaps, as perfect and as cheap

Fig. 442.

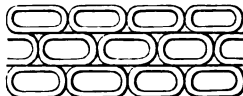


(a in fig. 442,) and with or without

an arrangement as could be devised. The earthen *voussoirs* would be first formed something like a garden pot

a hole in the bottom, as might seem best: this vessel should then be flattened on two sides at the top, *b*, retaining the circular bottom so as to render its sides parallel in one direction, and of course in-

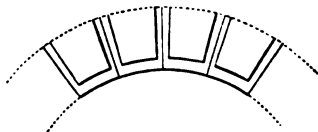
Fig. 443.



creasing the angle of the sides in the other, fig. 443. These vessels, baked in the usual way,

and set in a small quantity of cement, would form arches, fig. 444, of great strength: they would offer a large

Fig. 444.

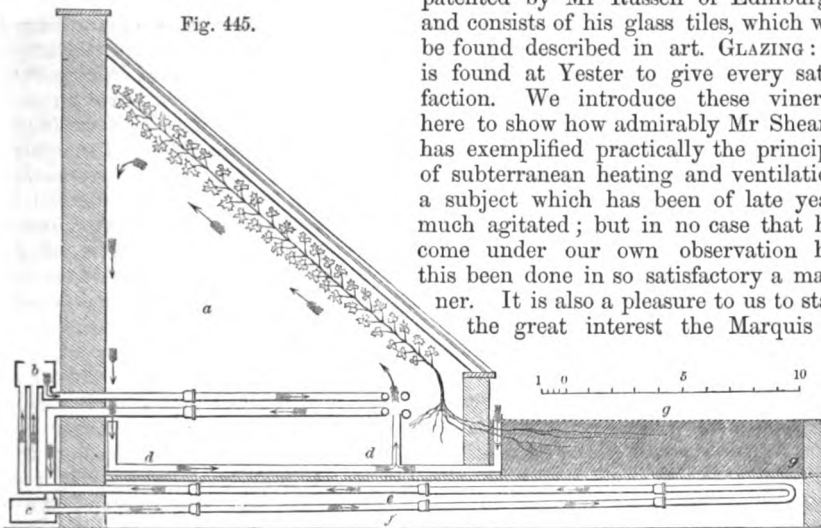


quantity of surface to the warm air or vapour rising from below: that warm air or vapour might, indeed, penetrate the soil through the numerous interstices presented to it, and, by filling the *voussoirs* with stones and potsherds, the drainage of the soil might be commanded in the most perfect manner. The objection made by Sir John Herschel to the ordinary modes of producing soil heat—that it is greatest below, while in warm countries it is greatest near the surface—shows, at least, that we have the highest scientific authority for attending to the most minute points of resemblance to, or departure from, nature. And though this is perhaps an extreme refinement, when compared with such practices as purposely heating the air which nature keeps cool, and leaving to chance the soil, which in the tropics sometimes reaches a temperature of  $150^{\circ}$ , it may be remarked that the arrangement just proposed, in which the heat is in some measure imparted to the soil by warm air and vapour insinuating itself through innumerable interstices, and having a tendency to ascend, would probably approach as nearly as is practicable to the required conditions."

Fig. 445 shows a section of the new vineries at Yester; while fig. 446 gives a section of the chambered or heated borders for the roots of vines, of which

fig. 447 is the ground-plan, the whole arranged under the direction of Mr Shearer, the intelligent gardener there.

The chief novelties in the general construction of these houses are the mode of glazing, which is upon the principle patented by Mr Russell of Edinburgh, and consists of his glass tiles, which will be found described in art. GLAZING: it is found at Yester to give every satisfaction. We introduce these vineries here to show how admirably Mr Shearer has exemplified practically the principle of subterranean heating and ventilation, a subject which has been of late years much agitated; but in no case that has come under our own observation has this been done in so satisfactory a manner. It is also a pleasure to us to state the great interest the Marquis of



Tweeddale takes in every improvement connected with rural affairs, and his great liberality in bringing them into

are placed much in the usual manner, while others show the flow and return of the water after circulating through the vaulted chambers below the borders, which also is shown in the ground-plan. The whole of the vine borders within and without are vaulted—that is, covered with Caithness pavement supported upon brick piers 2 feet in height; and in this vault hot-water pipes are laid close to the pavement, thereby preventing the loss of heat by absorption in the soil below and side walls. Over the pavement a drainage is placed, and on that the soil for the vines to grow in, extending from the back wall of the house to the walk in front of the border, a breadth of 32 feet. Mr Shearer estimates highly the value of vaulted borders, and considers them, even without the aid of fire heat, as being equal to 9° of temperature over similar borders not vaulted. Air is admitted into these vaults from the neighbourhood of the stoke-holes, and from the front of the border—a very necessary precaution for the better diffusion of the heat within them.

Fig. 447.

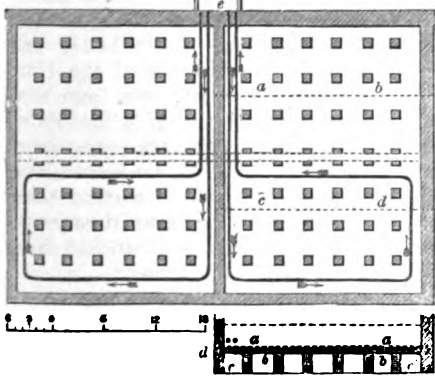


Fig. 446.

operation. The figures are so detailed as to require little description. We may, however, remark that the boiler which heats both the vinery internally and the borders externally, has a cistern very properly placed over it, and somewhat higher than the hot-water pipes within the house. The arrows denote the course of the flow of hot water both in the pipes within the house, which

References to section, fig. 445: *a* shows the vinery, hot-water pipes, chamber, &c.; *b* the cistern; *c* the boiler; *d* the air-circulating pipes; *e* the flow-pipe into the chamber; *f* the return-pipe



from the chamber ; *g* the surface of the border.

References to cross section, fig. 446 : *a a* shows the drainage ; *b b* the pavement covering over the chambering ; *c c*, &c., the chambers.

References to ground-plan, fig. 447 : *a b c d* shows the vault, with the square piers for supporting the pavement ; *e* the stoke-hole furnace, the direction, of the hot-water pipes proceeding from the boiler across the house and border to the front, and, after making the circuit of the border, returning again to the boiler.

Another ingenious mode of bringing in air, and causing it to circulate through the interior of the house, is, as will be seen by a glance at the section of the vinery, the employment of air-tubes placed immediately in front and close to the parapet wall, down which a supply of fresh air rushes, and is carried along till immediately under the hot-water pipes in front of the house, where it rises under the lower pipe and so becomes warmed before it comes in contact with the plants. Another pipe descends at the bottom of the back wall, which is the coldest part of the house, and conducts the cold air from thence, to become also warmed by the pipes in front. Three vineries, with two chambered borders, a mushroom-house, and a liquid-manure tank, are all heated by one boiler.

*Trellises for vineries.*—These are, in general, of the simplest form—namely, wrought-iron eyed studs driven, or, much better, screwed, into the lower part of the rafter, through which wires are drawn and tightened by screws at the ends of the house. These studs should be not less than from 15 to 18 inches long, to allow sufficient space for the foliage under the glass. The horizontal wires for vines may be from 12 to 15 inches apart, and extend from bottom to top of the rafter, forming means for training the shoots under the whole of the roof. When this mode is adopted, no other trellis is required. The back walls of vineries are often, and not improperly, trellised in a way similar to the roof, for the purpose of training figs to, which succeed better under the partial shade of other trees than any other of our forced fruits.

Rafter-training is, perhaps, more gene-

rally adopted than any other mode. It causes less shade in the lower part of the house than any other ; and the fruit, having more light and sun, is considered better. In this mode of training, the wires to which the shoots are attached run parallel with the rafter from bottom to top, and are fastened to it by means of branched wrought-iron eyed studs placed at distances of from 3 to 4 feet apart.

“The movable rafter trellis consists of a rod bent parallel to the roof, with horizontal studs or rods, extending from 6 to 10 inches on each side, containing two collateral wires, the rod itself forming the third. This rod is hinged, or moves in an eye or loop, fixed either immediately above the plate of the parapet, or near the top of the front glass. It terminates within 1 or 2 feet of the back wall, and is suspended from the roof by two or more pieces of chain attached to the studs, the links of which are put on hooks fixed to proper parts of the roof. Their advantage is chiefly in the case of very early forcing, when they can be let down 2 or 3 feet from the glass ; and this is to lessen the risk of injury from frost. A whole sheet or segment of trellis, if desirable, may be lowered or raised on the same general plan.”—*Encyc. of Gard.*

Hanging or gable trellises were first brought into notice about 1817, and exemplified in the vineries of the Hon. Robert Lindsay at Balcarras, and soon afterwards adopted by Mr Hay the garden architect. Some of them are occasionally still met with ; but, as they are less adapted for vines than for peaches, we find them almost confined to the latter description of hothouses, in which they had been used at a much earlier period.

## § 2.—PINERIES.

In construction, externally, the pinery differs little from the vinery, and the two are very frequently combined. In the former, provision is made for having beds in the middle heated by the fermentation of vegetable substances—such as tanners' bark, leaves, flax refuse, stable manure, moss, &c., or by tanks of water heated by steam, or from a hot-water boiler connected with them, or by admitting steam into masses of broken stones

or open brickwork; and sometimes by hot-water pipes passing through a hollow chamber beneath the bed on which the plants are plunged, planted out, or set, and occasionally on a stage or platform, in the manner of greenhouse plants, as recommended by the late T. A. Knight, Esq.

The best constructed pineries are either low in the roof, or the beds are elevated so far that the plants may be near the glass. The necessity of this led to the adoption of pits, a plan generally followed on the Continent, and also frequently in this country.

Speechly and Nicol were amongst the first who improved this kind of structure; and were a section of a fruiting-house, given by the former of these authors, consulted, it would be seen to differ little, except in the discontinuance of the smoke-flues, from most of those in present use. He also, in 1792, heated the bed of a pine-stove by steam, perhaps as successfully,

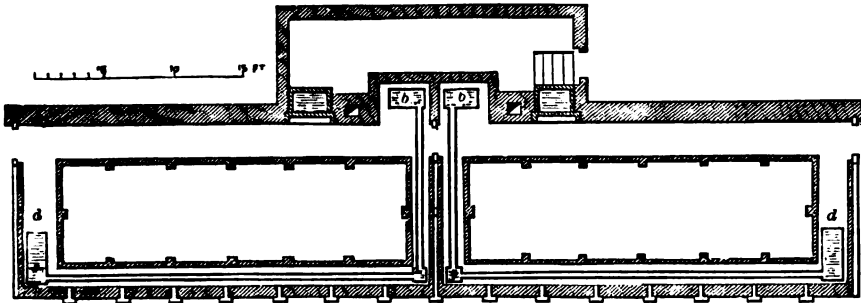
and certainly at infinitely less expense, than many of our modern applications of it.

The large, double-pitted pine-stove erected by Speechly at Welbeck, must have been the wonder of its day, and was probably the first large fruit hot-house erected in Britain. It was intended for the growth of grapes as well as of pines. That house does not now exist, nor does that built upon the same plan in the Royal Gardens at Kew; but one of the same dimensions we saw lately at Harewood House, in which both pines and grapes were exceedingly well grown.

Nicol's pine-houses were almost similar to Speechly's. He, however, ultimately preferred growing pines in pits, and arranged them in three divisions—one for fruiting-plants in the centre, one at one end for succession-plants, and the other for crowns and suckers.

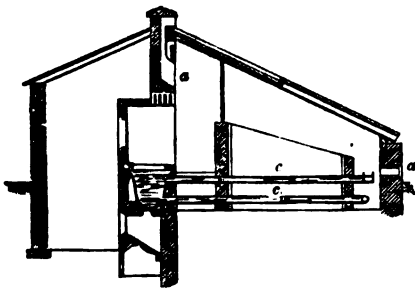
*Atkinson's pinery.*—The accompanying plan, fig. 448, and section, fig. 449, will

Fig. 448.



show the principle of this structure. Our long and intimate acquaintance with this eminent architect has put us in posses-

Fig. 449.



sion of copies of many of his horticultural designs. We prefer, however, so far as practicable, to give specimens of houses

actually existing; and with this view we now transcribe, from the "Hortus Woburnensis," Mr Forbes's lucid description of the pineries erected for the Duke of Bedford, from Mr Atkinson's designs:

"This house is 65 feet long, and 13 feet wide in the clear, and is divided into two divisions. The sashes and rafters are of wood, and fixtures; consequently air is admitted by the ventilators *a a* in section. They are placed in the back wall, and along the centre of the front wall, which, together with opening the doors, will admit a sufficiency of air in the summer season for the pine apple. The houses are heated by hot water, with separate boilers and pipes for each division. The boilers, *b b*, are placed in a recess, about the centre of the back wall—(vide fig. 449)

—the dimensions of which are 2 feet 6 inches long, 1 foot 6 inches wide, and 1 foot 8 inches deep, of an oblong square form. There are two pipes, *c c*, attached to each boiler—one near the top, and the other at the bottom. The upper pipe is round until it reaches the front of the house, when it forms a square of 12 inches broad by 4 inches in depth. The lower pipe is circular, and 4 inches in diameter. The pipes convey the water from the boiler across the ends, and along the front of the house, to the reservoirs, *d d*, which are of the same dimensions as the boilers, and are filled with water, flowing from the boiler, as the pipes, reservoirs, and boilers are placed all on the same level, and filled about equally, within half an inch of the top, so as to allow room for circulating the heat regularly from one end of the house to the other.

“These houses, or compartments, are capable of containing seventy fruiting pine plants each. The atmosphere of the house may be kept regularly from 60° to 65°, in the severest weather, without consuming more than three-fourths of a bushel of coals to each division, or a bushel and a half to the two compartments.” Mr Forbes has heated these houses from 75° to 80°, when the external temperature fell to 28° of frost. “The fermenting leaves in the pits also assist in keeping up the temperature. The pipes, boilers, and reservoirs in each contain about 140 gallons of water. When the fires are first lighted, the furnace and water being then cold, it takes about an hour to heat the water to 130°; but when it is once heated, after the first night, it may be raised to the same temperature in twenty minutes; as, from the volume contained in the apparatus, it will retain its heat for nearly twenty-four hours, consequently the water is about milk-warm when the fires are lighted in the afternoon. In the winter of 1829, the self-registrating thermometer indicated 28° of frost two different nights that season, which afforded ample means of ascertaining the power of the hot water; and as both divisions of the pinery were then at work, the fires were made up both nights at five o'clock in the evening. One of the compartments was regulated at eight o'clock, at 70°, and the other at 60°. The dampers were then shut close,

so as to confine the heat about the boilers, and prevent it from escaping out of the chimney, but no fresh fuel was added after five in the evening. The next morning, at eight o'clock, the division that was left at 70° the previous night had lost 10°, and the other that was regulated at 60°, only 5°, during the night. This lapse of fifteen hours, without any fresh fuel being added, and that when we had 28° of frost, is a sufficient proof that the hot water has adequate power to answer all horticultural purposes in the most inclement season, when the apparatus is properly constructed, and is of a sufficient magnitude for giving out caloric, according to the size or area of the house which it is intended to heat. The furnaces are attended from the shed behind, in which are also placed cisterns for supplying the houses with water.”

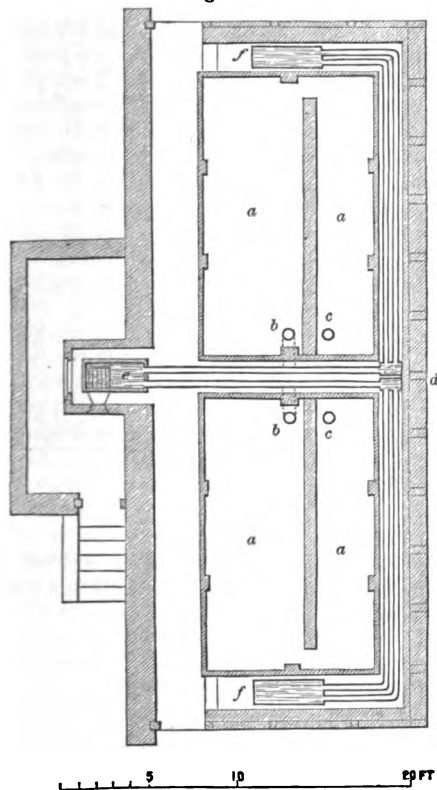
These houses are very complete in their general details. We would, however, increase the number and size of both back and front ventilators, and place the latter lower down, so as to be opposite the hot-water pipes, for reasons given in section VENTILATION, to obviate the necessity of opening the doors in warm weather. We would also dispense with the bed of leaves, and employ a tank, to be heated by merely taking a branch pipe, a few inches in length, from the end ones, both at bottom and top; and as we have shown, in section BOILERS AND PIPES, the inutility of square pipes, we would, were a house to be built upon this principle, substitute round ones. The reservoirs may also be dispensed with, and a simple bend substituted, as occupying less room, and being furnished at less cost.

It has been objected to this style of house, that the front or parapet wall, being of brick, looks heavy, and that upright glass frames should be substituted. There is undoubtedly some truth in this; but it should be taken into consideration that Mr Atkinson had in view only an economical structure, and one at the same time sufficient for the object in view,—and in this he succeeded most completely. Glass fronts would no doubt look lighter, but they would at the same time entail a very considerable expense, and, except for appearance, would be of no use whatever, as any one

acquainted with the effects of the rays of light or solar heat is well aware. The absence of front sashes is one of the essential points in Mr Atkinson's improvements in hothouse-building, so far as economical fruit-houses are concerned.

The annexed ground-plan, fig. 450, shows a pinery upon the same principle

Fig. 450.



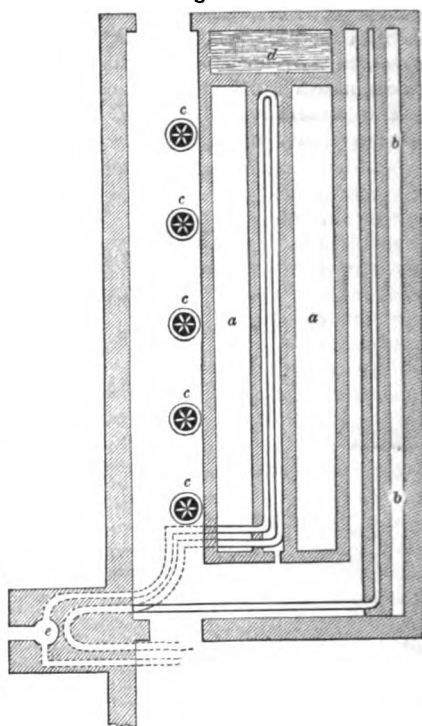
as the last, only so far altered as to show the boiler in the centre of the house instead of at one of the ends, as is the usual practice. This plan is sometimes adopted when the pinery is large, the pipes extending towards the front, and circulating both to the right hand and to the left, with reservoirs at each end. A single pipe takes the water to the front, and delivers it into a square box, from whence two upper pipes flow, and the colder water returns again to the boiler in a single pipe placed under them, which cannot be shown in the plan. The intention of the two upper pipes is to increase the radiating surface. From

the end pipes nozzle ones, *b b*, branch off, and deliver the hot water into the tanks *a a*; and after circulating round these, it returns to the boiler through the lower pipe, entering it at *c c*. In this way the tan or leaf bed is dispensed with altogether. This modification of Mr Atkinson's plan we have exemplified in several pineries built under our direction, both in England and Scotland. As the orifices of the upper pipes open into the square box at *d*, one or all of them may be closed at pleasure, by merely inserting a wooden stopper—by which means the heat can be regulated to the greatest nicety, and, with stopcocks on the nozzle-pipes, top or bottom heat may be had as may be desired. When the bottom heat is to be dispensed with, these stopcocks are to be shut; and when the top heat is to be reduced, the stopper is put into the flow and return pipes. The tanks are formed of brick and cement, and covered over, at the height of the breadth of a brick, with Welsh slate or thin pavement,—and on this the plants are set, or planted out in a prepared bed, according to the mode of culture adopted. We may here also remark, that this house may be divided by a glass partition in the middle, and one or both divisions may be wrought at the same temperature, or at different temperatures; or, indeed, one of them may be kept quite cold, if desired. These houses may be extended to a greater length than that shown in the plan. If it be desired to have a passage round the ends and front of the pits, the boiler and pipes may be set lower, and the passage over them covered with iron grating. By increasing the size of the boiler one-third or one-half, 100 feet of pine stove may be completely heated, both as regards atmospheric and bottom heat—that is to say, leaving the present arrangement as it is, only carrying out the two ends to the above extent. Thus two pine-stoves, by placing a glass partition from back to front between the two pipes, might be readily constructed.

*Burn's pine-house.*—The pine-stove at Tottenham Park, Wiltshire, is the invention of Mr Henry Burn, one of the most successful cultivators of both pines and grapes in the kingdom. The internal pit is filled with leaves, into which the plants

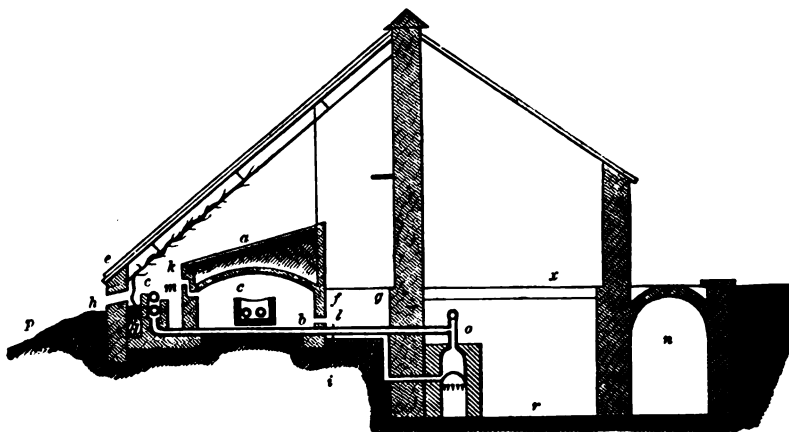
in pots are plunged. The front and ends are pigeon-holed walls 9 inches thick, and round them linings of hot dung, 4 feet wide, are kept in operation. These linings are enclosed within a pit, and covered over with oak boarding, which prevents the waste of the dung, as well as gives the whole a neat and orderly appearance. This house is 38 feet long, and 12 feet wide, having a narrow passage along the back; and alongside of it is placed the smoke-flue, which goes and returns upon itself. The front of the roof is formed of iron rafters and sashes; the back part of it is opaque. This is altogether an excellent house, or rather pit, for pines; but we think it would be much improved if the smoke-flues were removed, and hot water in pipes made to circulate round the front and ends, the leaf-bed within converted into a hot-water tank, the walls built solid, and the external linings discontinued altogether. These alterations would no doubt lessen the labour of management, and give the pit a neater appearance, as well as economise a great deal of dung, which could be turned to an account equal to the extra fuel required; but notwithstanding all this, we question if, even under Mr Burn's excellent management, better pines would be grown than there are at present.

*Henderson's pinery.*—Fig. 451 the ground-  
Fig. 451.



plan, and fig. 452 the cross section.  
The following plan and description of a

Fig. 452.



pine-stove, by Mr W. Henderson, nurseryman, Oxton, near Birkenhead, were published in "The United Gardeners' Journal." Mr Henderson has had great experience as a garden architect; and

being himself not only an excellent practical gardener, but a man of general intelligence and observation, his productions are entitled to all respect. The woodcut given in the above paper is upon

so small a scale as to be scarcely intelligible; we have therefore re-drawn it to a scale double the size:—

“I have been long impressed, indeed convinced,” says Mr Henderson, “that however successful has been the result, in many cases, in connection with the tank and open-gutter system, no mode of heating can be considered complete unless so arranged as that either a moist or dry heat may be obtained or modified at pleasure. To effect this, then, you will see that the open gutter and hot-water apparatus are combined in the accompanying plan. The pipes being laid in the gutter *c c*, will readily suggest the facility with which the atmosphere may be charged with moisture: or, on the contrary, when a dry heat is desired, the water has only to be withdrawn from one or either of the gutters, just as may be deemed proper. The bottom heat to the plunging or planting-out bed *a*, is communicated through the brick arch from chamber *b*. Brickwork is found to be by far the best medium—the porous material being a good conductor, as well as a guarantee that no accident can happen from overheating the roots; while no difficulty will be found in raising the temperature of the tan or soil in the bed to 75° or even 80°. The pipes laid in gutter *c*, in front, are for supplying the necessary heat to the atmosphere of the house, and of course can be wrought from the same boiler, with, or independent of, the pipes in the chamber *b*. A rotatory motion is given to the air in the house—a siphon action being formed by admitting the heavier, viz., the cooled air, at the register gratings (*c c c* in ground-plan,) through the aperture *l*, which, displacing the heated air in the chamber, escapes through the higher cavity *m*. Thus a constant circulation is kept up—an object so desirable and so well understood by all practical men, but which has hitherto been very much neglected. As it is intended to have an early crop of grapes in the stove, and that the vines may not be deprived of their due period of rest, but at the same time to avoid the necessity of turning them outside of the house, an area is formed, as at *d*, where the vines are planted, their roots having free access to the border through the arches of the front wall. At the proper season the vines are detached

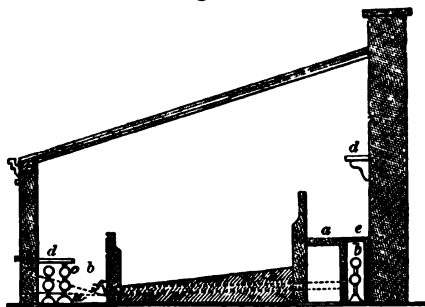
from the training wires, and carefully laid down in the area—a shutter being nicely fitted over them at *e*. The front ventilators at *h* being opened, a circulation of cold air is admitted, and they remain in this state till the forcing season comes round again.”

Reference to section: “*a* bed to plunge or plant out in; *b* hot-air chamber; *c* gutter, with pipes, supplying heat to the atmosphere; *d* area, where vines are planted and laid down during the season of rest; *e* a closely fitted shutter is fixed here while the vines are laid down; *f* and *g* show an offset in brickwork, which carries the back footpath; *h* ventilators in front wall, regulated to admit or shut out air from the area *d*; *i* descending air cavity; *k* ascending air cavity; *x* floor of potting shed; *r* cellar or root store; *n* passage to ditto, which is an open area, except where an arch crosses, forming entrance to potting shed *x*; *o* boiler; *p* surface of the border.”

References to ground-plan: *a a* hot-air chamber; *b b* area for vines; *c c c c c* register gratings, to regulate air to hot-air chamber; *d* tank for water from the roof; *e* stoke-hole.

*Bicton pine-stove*—fig. 453. This structure, erected by Mr Glendinning, of the

Fig. 453.



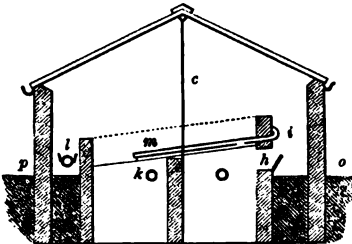
Chiswick nursery, is complete of its kind. In some particulars it differs from those in general use; and those, we hesitate not to say, are improvements—viz., the perforated tube *e*, which is of copper, and nearly parallel with, and immediately over, the hot-water pipes in front. “This pipe is attached to other pipes connected with a main, which supplies some fountains. There is a considerable pressure on this perforated pipe, which is movable, the

whole length of the house, with the hand, by means of a union joint; and thus the greatest facility is afforded of throwing water like rain over the plants, pathways, or pipes, to produce steam at pleasure. I ought to observe," Mr Glendinning remarks, "that there is a coil of pipe in the boiler, through which the water passes on to the perforated pipe, and thus becomes warmed in its passage. There is another pipe, with a cock, connected with this coil of pipe in the boiler, from whence warm water can be drawn during the winter months, to water the plants." —GLENDINNING'S *Practical Hints on the Culture of the Pine*.

Another peculiarity in this house is the opening at *f* for the admission of cold air from the front passage, through under the back bed, to the area under the back footpath: this air becomes heated from passing over the hot-water pipes at *b*, and rises through the iron grating *e*. *d d* are stone shelves for strawberries, French beans, &c. We think it would be an improvement on this otherwise excellent pine-house, were cold air admitted through the front wall in the direction of the dotted line by means of iron or earthenware pipes, whose orifices should be level with the ground surface, or slightly elevated above it. Atmospheric air would thus be drawn down the pipes by reason of the difference of temperature at both ends. A similar arrangement might be made in the back wall, and carried to such an extent as to render ventilation by moving the glass sashes unnecessary.

*Hamilton's improved pine-stove*, of which fig. 454 is a section, and fig. 455 a ground-plan.—Mr Hamilton's success in pine

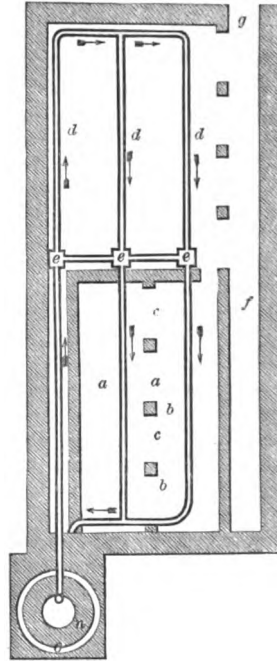
Fig. 454.



culture has created a considerable degree of interest, and we believe with a great degree of justice. After a few preliminary remarks as to the advantage of

span-roofed houses for pines, &c.—in which opinion we most cordially agree with him—he proceeds to describe his stove as follows:

Fig. 455.



—“The improved stove, as shown in the engraving, is according to my views, excepting the lights, which ought to be of equal lengths. The front lights having been previously made for another purpose, the roof was therefore made to accord with them.” In our figure we have represented them all of the same length. “The front lights incline

nearly 6 inches to the foot: this angle causes the condensed moisture to run down the glass. More light is generated by the span-roof, provided there be a sharp angle, by catching more of the sun's rays, which is an important advantage in favour of this roof, particularly in autumn, winter, and spring; and in summer the sun's rays may be moderated by a slight shade, in the middle of very bright days. Half the house next the boiler is occupied with twenty-six pine plants: they are planted out in a compost, which consists of the refuse of the garden, such as cabbage, tree, pine, and vine leaves, sweepings of walks, &c., to which is added a little old mortar and a few broken sticks, to add to its porosity, with some old peawood at the bottom as drainage. This constitutes the compost for the pines, in which they appear to delight; and they are intended to remain for years undisturbed, and perfect a succession of fruit. The cultivation of the pine upon the planting-out system is comparatively of

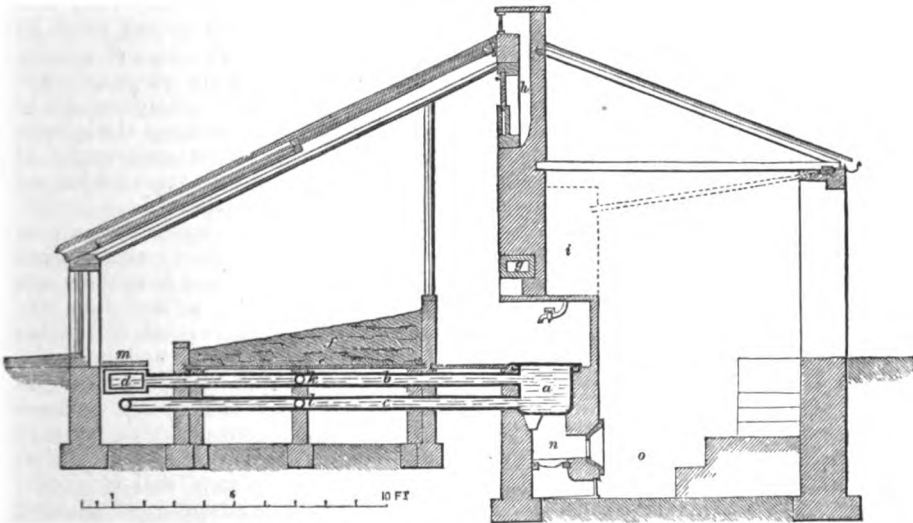
modern date in this country. We believe the first who successfully established this practice was M. Lang, gardener to the King of Bavaria, a notice of which will be found in the fifth volume of the "Gardeners' Magazine." Underneath the pines are planted rhubarb and sea-kale; the other compartment is well adapted for cucumbers and melons. The compost is laid on slates supported on timber, which lie across the pipes. The slates are 2 feet wide; between each is a vacuity, for tying and earthing up the plants. Underneath the slates is grown asparagus, which answers admirably. In the summer, when no top heat is wanted, the pipes at *e*, on fig. 455, are plugged up, and the hot water all passes under the chamber, to supply the bottom heat for the pines. The flow-pipe from the boiler to *e* is to be covered with a slab, (see *l* on section,) or it may be covered with sand in the summer; and if kept moist it will give out a fine humidity to the plants. The water is heated by a common round, open-top, 35-gallon boiler: the price is from sixpence to sevenpence per gallon.

The flue is surrounded with a cavity, (see *o*,) into which cold air is admitted through an aperture above the furnace door: it passes over the boiler, and enters the house above the flow-pipe; thus a current of external air is passing into the house continually, quite moist and warm when it enters the house. So great is the command of moisture, that both bottom and top heat may be kept saturated if required. So economically may such a stove be erected, that a tolerable house might be completed for £30, sufficiently large for an amateur."—*Culture of the Pine Apple.*

References to plan and section: *a* chamber; *b* pillars to support iron bars; *c* pillars to support the roof; *d* pipes; *e* reservoirs; *f* path; *g* door; *h* apertures to let heat out of the chamber when required; *i* lead pipes, with three perforations, to water over the slates; *k* strong slates, supported on iron bars; *l* pipes cast with dishes; *m* soil; *n* flue; *o* cavity; *p* ground-level.

*The Dalkeith pine-stoves*, of which fig. 456 is a cross section taken through the

Fig. 456.



boiler, are four in number, dedicated to fruiting pines, and in which the larger plants are placed—the smaller being fruited in pits. These are all of the same size—namely, 40 feet in length and 13½ in width within, and 9 feet high from the

VOL. I.

floor to the bottom of the rafter. They are ventilated by the front sashes opening by sliding past each other, and by wooden ventilators near the top of the back wall. These houses are constructed entirely of wood, with upright glass sashes

2 U



in front, which are removable ; and every alternate top sash slides down for ventilation.

Both atmospheric and bottom heat is obtained from hot-water pipes ;—the former from pipes which pass from the boiler direct to the front, and extend the whole length of the house, the upper one being flat, and the return one round ; the latter from pipes joined to the cross ones, passing along the middle of a vault, under the pine beds, to the farthest end, where they empty themselves into a large reservoir or tank left uncovered, from which a copious steam is perpetually given out, keeping the vault in a very humid state. The cold water returns to the boiler from this tank by another pipe, placed under the flow-pipe in the usual manner. Stop-cocks are placed on the pipes under the vault, by which the quantity of water flowing in them, and consequently the quantity of heat, can be regulated. Circular holes, 4 inches in diameter, are cut in the pavement forming the roof of the vault ; and to these are fitted upright earthenware tubes of the same dimensions, for the purpose of allowing the superabundant heat from the vault below to rise into the atmosphere of the house. These tubes are provided with large cork stoppers, and are placed along the back and front of the bed, so as to be easily reached.

This vault is covered with Caithness pavement in large pieces, and this forms the floor, on which the plants stand in pots ; and to prevent them drying too rapidly, they are plunged in half-decayed leaves. It has been asked by some, if the plants did not suffer from dry heat when set upon this pavement ?—but this can never be the case, as much of the heat which rises from the vaults passes through the joints of the pavement, which, for this very purpose, is laid dry ; besides, much vapour rises through the tubes used for regulating the bottom heat, while the pines are frequently syringed overhead : and even if all this were not sufficient, the bed of half-rotten leaves in which the pots are plunged can be watered if required.

We formerly grew all the plants in beds formed on this pavement in the planting-out manner ; but have of late abandoned this to a certain extent,

and use large pots plunged as above stated.

Each house had a separate boiler until lately, when we were induced to try the experiment of heating two houses, as they stand connected, with one boiler about one-third larger than either of the two removed—that is, 3 feet 6 inches long by 2 feet in breadth, and the same in depth, and with one fire instead of two, which reduced both the quantity of fuel and of smoke to nearly one-half.

So far as our experience goes, this is an admirable improvement. The heat which passes the boiler—and this is no small quantity—in every case is made with the smoke to pass along a flue in the back wall, (*g* in section,) which gives us an additional amount of heat, not only in the pine-houses, but also in the houses behind. Since the substitution of one boiler in the place of two, we have placed a damper at each side of the furnace, so that we can turn the heated air and smoke either to the right hand or the left, often changing them once in twenty-four hours.

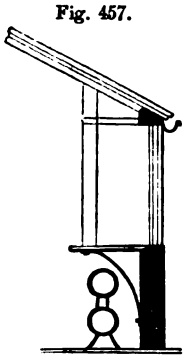
A footpath passes round the bed on which the plants are set, excepting at the end where the pipes cross the house. This is a convenience which should never be neglected, even at the expense of making the house wider, or the plant bed narrower, as it facilitates the operations of watering and of examining the plants, while it also gives an opportunity of using the space over the pipes for forcing French beans, strawberries, &c.

As these houses occupy rather a prominent position in the gardens, front glass sashes are used, and form the whole height of the houses, as seen from the walks in front—a stone plinth of 6 inches in thickness being placed under them—and then the vine border is finished off to that level ; for it is to be observed that vines are grown and trained up to the rafters. The border slopes so, that all the rest of the front wall is hidden, which has also the advantage of allowing the vines to be planted, so that no part of their stems is above the ground—a cavity being cut in the stone plinth for their reception.

The pilasters or mullions between the front sashes are of wood and stone alternately—the former being movable, and

the latter fixed. The intention of this is, that while the vines were young, the wooden mullions were taken out, and consequently the space of two front sashes was opened for the greater facility of taking out the vines when their wood was ripened. This was done for several years at first. As the vine stems grew stronger, and more likely to sustain injury by being disturbed, the following plan has since been adopted:—

Iron brackets, fig. 457, are placed in the front wall, and remain there permanently: upon these is laid an open trellis, upon which French beans and strawberries are forced during winter, and chilies grown during summer. When the season arrives for wintering the vines, a plank 3 inches thick and 10 inches wide is laid over this trellis. Into this plank uprights are mortised and screwed to the



under side of the rafter: a board of the same width is half checked into the uprights, and fastened to the wall-plate by thin plates of iron 1 inch broad. The vines are then pruned and taken down, and fastened to the mullions in a horizontal direction. The front sashes are then taken out of their places, and set into the spaces thus prepared for them within, leaving a clear space of 10 inches along the whole front for the vines to lie horizontally in. The 3-inch plank over the pipes prevents the heat from injuring the vines. When the season for bringing in the vines returns, the front sashes are replaced in their proper position, and felt is now substituted for them within—thus placing the vines in sufficient light and heat for causing them to break their buds regularly and strongly; which they do better in a horizontal position than in a vertical one. Additional heat is given to the vines when necessary, while in this state, by partially opening the felt shutters which separate them from the heat of the house.

The vines remain in this position until every bud has broken, and extended in length from 2 to 3 inches. The whole

of the framework is then removed, and the vines are suspended from the rafters in a slanting direction, where they remain a week or ten days, according to the season, or the progress they make in growth. The intention of this is to moderate the ascent of the sap, so that the buds and embryo fruit near the bottom may not be robbed of their share of food by the buds towards the top of the vine.

During eight years, we have found abundance of bottom heat from the two 4-inch pipes under the bed; and the heat from them is at all times moist, as a constant evaporation is going on from the large reservoir at the end; and this can be increased by pouring water through the tubes by which the bottom heat is regulated, into the chamber below.

For several years we grew pines planted out in beds formed on the top of the pavement which covers the pipes and vault they occupy. We however abandoned that plan, not from any want of bottom heat, but because of the untidy appearance of the pit, when plants here and there had had their fruit cut, (for we do not adopt the Hamiltonian system,) while others were only in bloom, and the great difficulty of getting out the old and exhausted plants, and filling up their places with others, without breaking the leaves of those that were already in the pit. We now grow the plants in rather large pots, and set these on the pavement, filling up the spaces around the pots with half-decayed leaves.

The annexed cross section shows these pine-stoves as described above: *a* the boiler; *b* the flow-pipe; *c* the return-pipe; *d* square flow-pipe in front, having a circular return-pipe under it; *e* floor, of Caithness pavement; *f* bed for plunging or planting out pines; *g* smoke-flue in the back wall; *h* top ventilators, suspended by weights, and moved up and down in a frame; *i* cistern of water, supplied from the roofs behind, and discharging its water by a cock over the boiler; *k* flow-pipe under the bed; *l* return-pipe; *m* shelf for French beans, strawberries, &c.; *n* furnace; *o* stoke-hole.

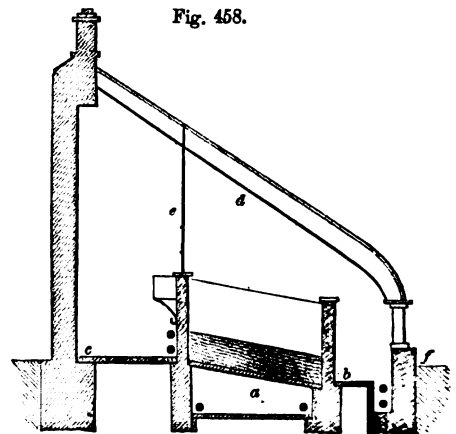
Several plans very similar have been adopted for wintering vines grown in pine-stoves. The following method is one adapted to houses where the vines are planted low:—a 4-inch wall is car-

ried up within, parallel to the front wall of the house, and about 12 inches from it, and a little higher, in order that the front sashes, when taken out of their proper place and set upon it, may fill up the increased space caused by the upward slope of the roof. The vines being taken from the rafters, are laid horizontally along the front, and exposed to the open air, but not fully, as they have the protection of part of the roof above, as well as a slight heat from the pipes—all of which is an advantage to them. Another modification was long exemplified in the pine-stoves in the kitchen garden at Kensington Palace, now no longer existing. The vines planted in the back passage, and trained to the back wall, and over the passage along the roof, were completely wintered by drawing down the top sashes about 3 feet—that is, the breadth of the walk—and setting hot-bed sashes, not otherwise in use, and boards on the top of the back wall of the pit, and so forming a partition between the pine plants in it and the passage behind.

*The Bamford Hall pine-stove* is upon the span-roofed principle. This is not, however, the only peculiarity in its construction. It is 25 feet in length and 15 feet wide, having a 3-foot walk or passage round the interior. The other details will be better understood by quoting Mr Cherry's description, as given by him in "The Gardeners' Chronicle." We should, however, premise by stating, that the sides of the roof are unequal—the front rafters being 11 feet long, and the back ones 6 feet; by which we understand that the longer side of the front faces the south. "It is fitted up with a shelf at the back, 3 feet from the glass, and with another in the front, five feet from the glass. The front of the house is 6 feet high above the walk, and the upper portion is glazed to the depth of 4 feet. At both ends of the house, there is a flight of six steps from the front walk to the back one, which is on a level with the front of the pit. The latter stands in the centre of the house, its slope corresponding with that of the roof; but instead of being heated with bark in the ordinary manner, the roots of the plants are warmed by means of hot-water pipes passing beneath them. For this purpose, the pit is surmounted by a boarded stage,

containing four shelves, with openings in them, to receive the pine pots up to the rims. Each shelf is 2 feet in width, and capable of containing nine plants. The hot-water pipes in the pit, and those which warm the house, are on the same level, and communicate with each other, so that only one fire is required. These pipes are all dished, for the purpose of holding water to create steam. The dishes in the pit are filled by means of 1-inch leaden pipes, one end of which comes through the stage; and these are filled twice every day with hot water. There are also six small 1-inch iron pipes, about 18 inches long, which stand upright, and are screwed into the main-pipes under the stage. The tops of these you can open or close, according as more or less moisture is required." The pots used for fruiting plants "are 11 inches wide inside at top, 6 inches wide at the bottom, and 16 inches deep, with a good strong rim 1 inch wide, made quite flat (on the under side we presume) to fit close to the stage." The pipes are provided with throttle-valves, by which means the circulation may be stopped, and the atmospheric heat thrown into the bottom heat—at least, such is Mr Cherry's opinion. We, however, question if more heat is in reality thrown into the bottom-heat pipes by this means. The bottom heat is said to be easily kept up, by these means, to 90° or 95°. We learn, also, by this communication, that young pine plants are grown upon the same principle.

*Niven's pinery and vinery combined.*—This structure is the design of N. Niven,

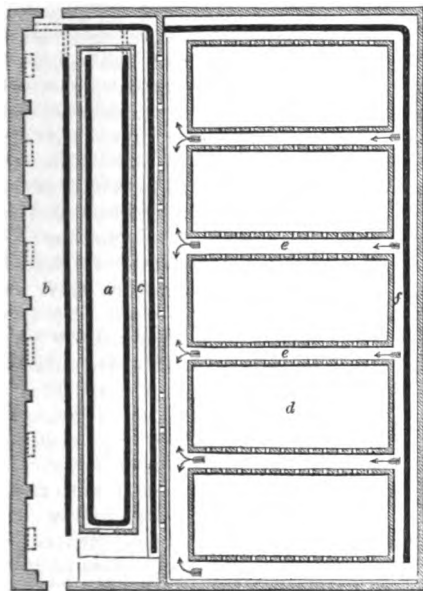


Esq., of Dublin. It is upon a principle different from most others, and has had its share of criticism, and in some respects has been unfairly dealt with.

Fig. 458 is a section of this house. *a* is the hot-air chamber; *b* front walk, alongside of which run hot-water pipes; *c* back walk, also with hot-water pipes, and brackets over them, on which the melon and cucumber boxes are placed. Along the other side of this path, but in niches cut in the wall, stand tubs or boxes with dwarf *Musa* plants, the foliage of which canopies over the passage. *d* roof trellis for vines; *e* upright supports to which melon and cucumbers are trained; *f* external front pathway, to prevent the border from being trodden upon, and to protect the stems of the vines, as will be hereafter noticed.

Fig. 459 is a ground-plan of the same house on a smaller scale, and also of the

Fig. 459.



heated vine border in front. *a* is pit for pines; *b* back passage showing the niches for the *Musas*; *c* front passage; *d* vine border; *e* air-flues; *f* hot-water-pipe chamber for heating the border.

This house is 60 feet in length, 14½ feet in breadth, and the same in height, from the floor-level to the glass. The roof is slightly curvilinear, and of metal.

Bottom heat is produced by introducing hot-water pipes into the chamber usually filled with tan or leaves; the floor of which, being made quite level, is rendered capable of holding a shallow body of water to produce evaporation, and to counteract the drying heat of the hot-water pipes—a judicious arrangement. This chamber is roofed over with Kyanised timber, 3 inches broad and 2 inches deep, leaving spaces of 1 inch between them. Over this is laid about 8 inches of heat-absorbing materials—as brickbats, stones, &c.—with a covering of fresh turf, the green side undermost, and over all 2 feet of half-decayed leaves, into which the pine plants are plunged. Mr Niven, like most hothouse builders, till of late, used timber as a covering for the heated chamber, which of all coverings is decidedly the very worst, not only on account of its non-conducting properties, but also from its liability to decay—against which Kyan's preparation is no safeguard. In such cases decay goes on much more rapidly than when the timber is exposed to the air, and placed in a dry atmosphere: and, which is worse, this decay is going on unperceived; and while the mind of the owner is trusting to the infallibility of his prepared beams, down the whole mass comes, carrying with it his whole stock of "the king of fruits."

We have repeatedly stated in the various sections of this work the danger of employing wood for such purposes, while slate and pavement are so much preferable as to durability, and less expensive in the first instance. Mr Niven found that it took four days to heat this vault, and the plunging material above it, to the temperature of 100°. This is not at all strange, considering the obstruction the heat met with in the timber covering. It would have taken two days to have heated the whole, even had slate or pavement been used; but this is no objection to the principle, as, when once heated, it will retain its heat, and be maintained for a long time with a very gentle fire.

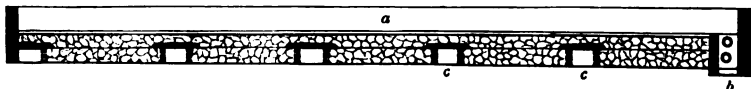
The hot-water pipes are so arranged that the atmosphere of the house and the pit may be wrought either separately or together. Ventilation is effected by ventilators in the front wall and also in the back, which admits of the roof being unbroken—a very important matter when

metallic roofs are employed. The vines are planted in the border without, and are introduced through the front in rather a novel manner. "At each side of each ventilator," says Mr Niven, "there is an opening for the reception of each vine, which vine is planted, not close to the front parapet as usual, but 4 feet from the house, and then taken to it under a front pathway, (*f* in section,) in narrow boxes which are made with lids, and open at the ends, and through the opening under the ventilator to the trellis within." This part of the arrangement deserves particular attention, as it provides against two evils often attended with the most serious consequences—

namely, the twisting or breaking of the stems while taking them out or putting them into the house, and also the injury done by frost to the exposed parts of the stem when the sap is rising in winter or spring in the case of early forcing, and before it ceases to flow in autumn, in the case of late crops. Both these evils are completely obviated by this plan, as no part of the vine stem is at all exposed to the air; and the radius thus obtained, of something like 4 feet, besides the width of the ventilator itself, another 4 feet, renders the removal out or in of the vines a matter of ease and safety.

Fig. 460 is a longitudinal section of the external borders of this house, show-

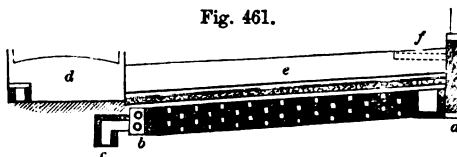
Fig. 460.



ing how they are heated by hot water, that heat being derived from the boiler employed for heating the interior. *a* prepared border in which the vines are planted; *b* hot-water-pipe chamber; *c c* air-drains.

Fig. 461 is a section of the same border, and walk in front. *a* air-drain; *b* hot-

Fig. 461.



water-pipe chamber; *c* drain; *d* walk in front of border; *e* border; *f* pathway along the exterior front of the house, and under which the boxes are placed, for the stems of the vines to lie in, as before described.

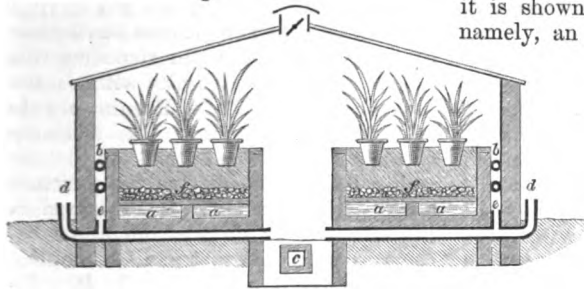
Mr Niven was amongst the first to carry into practice the theory, long ago laid down, of the advantage of heating vine borders; and he appears to lay great stress upon its application, and describes the operation of the plan as follows:—"The chamber containing the pipes is formed along the one end and front only of the vine border, having small minor chambers or drains, 1 foot square, crossing it at regular distances, with open side walls, which may be covered over either with

short pieces of charred timber, long-shaped bricks, or large slates; the spaces between these minor air-conducting chambers to be filled up with broken stones or brickbats. The whole is to be covered over with a stratum of limestone broken very small, and then by a firm thick turf with the grass side down, over which the compost is to be laid to the depth of  $2\frac{1}{2}$  feet next the house, and 2 feet at the walk or chamber. Thus, whenever the branches of the vines are introduced inside the house, the valves may be turned on the outside pipes, and the requisite temperature obtained for the roots. Calculating according to the ordinary principles of circulation," Mr Niven "considers that a regular current through the inner chamber will be the result of heating the air in the pipe chambers in front, and also that the heat will find ready access through the open side walls of the cross chambers amongst the stones and brickbats forming the bottom of the border between. At the same time," Mr Niven "proposes having a small plug-hole opening opposite the end of each minor chamber through the front parapet into the house, so that at any time, if found requisite, the heat derived from the outside chambers may be admitted into the body of the house." As a retainer of heat in the border so heated, Mr Niven very wisely proposes to have

the surface covered with a few inches in thickness of rotten dung or leaves, which will not only resist the cold during winter, but will also tend to keep the roots of the vines dry.

*Span-roofed pinery.*—Fig. 462 shows the section of a span-roofed pinery, the

Fig. 462.



ends being placed north and south. To be under the command of one fire, it may be 35 feet in length and 17 feet wide within, and 8 feet from the floor to the ridge. With two fires, one at each end, it may be double this size, or 70 feet long. Heat is applied by the tanks *a a a*, hot-water pipes *b b*, and smoke-flue *c* under the passage. Ventilation is obtained by introducing cold air through the side walls, and close to the ground-level, through earthenware tubes *d d*, 3 inches in diameter, and 3 feet apart. These tubes have an opening equal to half their diameter on their upper sides at *e*, to allow a portion of the air to ascend in the space between the walls and tanks, and disperse itself into the house under the hot-water pipes. The air-tubes also pass under the tanks, and terminate flush with the walls of the tanks and level with the floor, their orifices being furnished with a revolving brass ventilator to regulate the admission of air from without. The openings at the external ends, being in a line close to and parallel with the side walls, are opened and shut more or less by metallic stoppers attached to the lower side of an iron bar extending the whole length of the house, and placed immediately over the openings, and elevated or lowered by means of a rack and pinion attached to it at the middle, by which all can be opened or shut at once. The cold air admitted through these tubes becomes genially heated before it comes in contact with

the plants—a very important feature in all kinds of ventilation. Top ventilation is accomplished by an opening in the ridge 8 inches wide, and extending the whole length of the house. There are various ways of opening and shutting this part of the ventilation—(vide section VENTILATION.) In the house in question it is shown upon a simple principle—namely, an iron rod extends along the

ridge, which is open, as shown above. To this rod is fixed a board 8 inches in breadth, which, as the iron rod or axle is turned by a handle at one of the ends, revolves with it;—and when the full ventilation is on, it stands perpendicular; when half on, obliquely; and when

entirely shut, quite flat. To prevent the rain from entering, a fixed coping is placed a little above the opening of the ridge, of a semicircular or angular form, either of wood or cast or wrought iron, leaving a space of 6 inches clear along both sides of the ridge; or it may be covered close at top, the openings of the sides being opened and shut upon the Venetian principle.

The heated air and smoke, after passing the boiler, are carried along the flue *c*, placed in an air-chamber under the passage. A ventilator, graduated by a revolving plate 12 inches in diameter, and opening to nearly half that size, is placed at the end of the air-chamber nearest to where the flue enters it, through which a current of atmospheric air enters, and, passing along above and by the sides of the flue, becomes moderately heated, and is admitted into the house through gratings placed in the floor for the purpose.

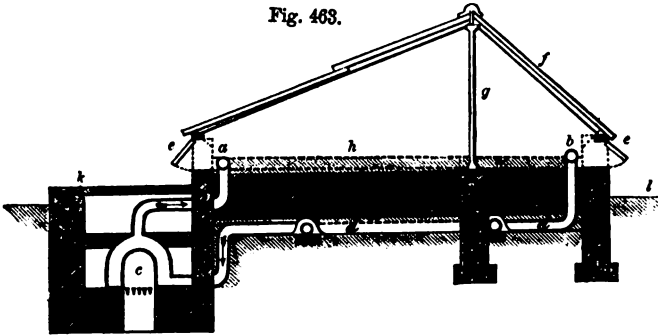
The pipes extend the whole length of the house, and return by the same route to the boiler. The tanks are of brick and cement, covered with pavement; over this is the drainage *f f* on which the pots are set, or bed formed if the plants are to be planted out. The passage is 3 feet wide, the beds 7 feet each, including the hot-water pipes, and a clear space of not less than 2 or 3 inches is left between the pipes and the wall.

Of all forms the span roof is best adapted for the culture of the pine, as every part of the plant requires the full-

est exposure to the light and air, except during the hottest and brightest sunshine, at which times slight shading may be applied.

The span roof is approved of by Mr Fleming of Trentham, one of our most successful pine cultivators. He, however, constructs his roofs slightly different from those in ordinary use, and thus reasons on the subject in a communication in *The Gardeners' Chronicle*:—"The span-shaped roof is the best for obtaining an abundant supply of light, which is so essential to success; but instead of having the ridge over the centre of the pit according to the general construction, I prefer placing it about one-third of the pit's breadth from the back wall, as, by this arrangement, it forms no obstruction to the direct rays of the sun falling upon all the plants. With respect to the width of pits, ours," says Mr Fleming, "are like that shown in the section, fig. 463 ;

Fig. 463.



but it would be no disadvantage to construct them a few feet wider, as the amount of light which enters the pit is so much greater in proportion to the distance between the side walls." His pits are 12 feet wide in the clear. Mr Fleming also prefers the circulation of the heated water to be carried on in pipes instead of tanks, considering this both more efficient and economical. "It is not necessary," he says, "to go any length into the arguments on the subject, but it will be sufficient to state that the water flows more freely in pipes than in tanks or gutters, and consequently the heat is kept up with less labour and a much smaller expenditure of fuel. In addition to this, tanks are much more expensive in their first construction, and are objectionable from the irregularity of the heat

they produce; for while the soil immediately over where the water enters the tanks is too hot for the health of the plants, that over the part where the water re-enters the boiler is as much too cold." This, however, we have not found to be the case. "It has been suggested," he continues, "by some, that the heat from the close pipes would be too drying. This, however, is not the case—as a proof of which we find, when removing the soil, roots in perfect health within a few inches of the pipes." Mr Fleming objects to tanks and gutters on the following grounds, and finds them an injury rather than a benefit, "as the moisture arising from the tanks is condensed in the soil, and by degrees the latter becomes so saturated that in a few months' time it is totally unfit for the healthy development of the roots." The pipes at Trentham, (*vide* section,) "are laid on a bed of ashes or gravel about 18 inches

below the surface of the soil; and over the pipes is a ridge of gravel, the crown of which is 12 inches from the surface. The intervals between should be filled with oak leaves to the same level, thus leaving 12 inches of soil." It will be seen by the section that Mr Fleming

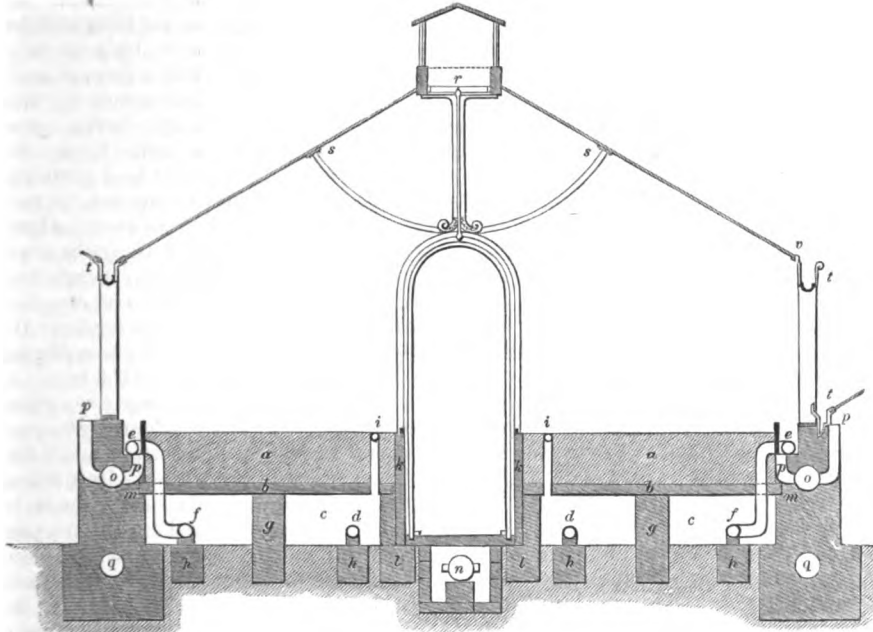
grows his plants very close to the glass, the surface of the soil being only 18 inches below the level of the wall-plates. He depends greatly on ventilation, and gives it as his opinion that this is one of the most important points to be attended to. "By allowing a constant and free circulation of air to traverse through the pits, and taking due care to make it pass over the surface of the hot-water pipes immediately on its entering, the plants will not grow nearly so large as they are generally seen under the ordinary modes of cultivation; but, as the sap is more highly concentrated, the strength and vigour of these small plants is very superior to the large rambling ones which are grown in a closer atmosphere, and whose leaves can scarcely support their own weight."

*a* flow-pipe, for top heat; *b* return do. do.; *c* boiler; *d* bottom-heat pipes; *e e* ventilators; *f* back sashes, fastened to the ridge with hinges; *g* light cast-iron columns, 12 feet asunder, to support ridge; *h* sur-

face line of soil; *i* oak leaves; *k* raised path, paved; *l* ground line.

Fig. 464 represents the fruiting pine-stove at Pottaloch, which is, in all its details, exactly similar to the melon and

Fig. 464.



cucumber houses described in their proper place, as existing in the same establishment; only, in this case, the width and height are increased. The following reference to the figures in our section will more fully explain the principle: *a a* bed in which the fruiting plants are either planted out in the soil or grown in pots and plunged in gravel or other porous material; *b b* Caithness pavement, forming the bottom of the bed, supported on the 10-inch brick piers *g* and *l*, and also let into the side walls at *m*; *c c* the vaults under the beds; *d d* the flow hot-water pipes; *e e* the flow surface-pipe for heating the atmosphere; *f f* the return pipes; *g g* 10-inch piers for supporting the centre of the beds; *h h h h* 10-inch piers for supporting the hot-water pipes; *i i* upright tubes set in pavement to regulate the bottom heat, by allowing it to ascend into the house when too strong below; *k k* polished Caithness pavement, 3 inches thick, set on edge, forming the sides of the passages, vaults, and beds; *n* tubular

air-drains showing the nozzles through which the air escapes into the air-chamber under the passage, and is admitted into the house by ornamental iron gratings set in the floor pavement at equal distances; *o o* tubular air-drains in centre of cross partition walls, giving out air through the bent pipes *p p*. The section shows the mode of bottom ventilation employed not only in the fruiting pine-house, but in those for succession and younger pines, and for melons and cucumbers also. The internal arrangements of all are the same, excepting that in the latter they are not so lofty; the rise of the roof will be seen at *t*. *q q* show the position of the air-tubes in passing under the doorways, after which they rise up to the level of the beds. Two ventilators, each 2 feet square, are placed in the front or end of each house, and have been already noticed; rain-water tanks, supplied from the roof, and brought down from the gutters at the end next the back wall in 3-inch leaden



pipes fixed in the angle formed by the partitions and back wall, are placed under the pine beds. The waste water from the cisterns is conveyed through under the back wall, and discharged into the main drain under the floor of the cellars. The ornamental cast-iron arches, of which there are three in each house, are intended to support the ridge ventilators *r*, and the inverted arch ties the roof together, and supports it where connected with the straining-bars *s s*, and to these bars the astragals are also secured; *!!!* show the cast-iron gutters and the way the houses are connected together. Atmospheric air is admitted into the vaults under the beds, by which a constant air motion is maintained day and night. The cisterns are 6 feet long by 3 feet deep, and 4 feet in breadth; and should at any time the rain water be found insufficient, provision is made to bring it in pipes from the reservoir marked 31 in ground-plan of garden; ornamental cast-iron gratings extend across the floor, and are each 6 inches wide, to admit the air into the house from the air-drain pipes *o o*; *o* a neat ornamental iron grating extending the whole length of the roof, as a security against snow falling upon the lower part of the adjoining house, which is much lower, and in which succession plants are grown.

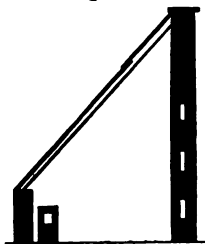
### § 3.—PEACH-HOUSES.

In general construction the peach-house differs little from the vinery, save in the mode of arranging the trellises for training the trees to. If we except the application of the span-roofed and curvilinear forms, the peach-house has undergone much less alteration than any other plant structure.

Kyle, of Moredun, the earliest authority in Scotland as a cultivator of this fruit, and also Speechly, of Welbeck, who may be regarded as the father of English forcing, both adopted the Dutch mode of building houses for this purpose. The houses built by Speechly do not now exist, but those of Kyle still remain. The annexed diagram, fig. 465, will show their principle. The trees are trained against the back wall *only*, as a security against frost, or cold draughts blowing upon them through the laps of the glass; they are heated by smoke-flues along the

front, and making two or more turns in the back wall. Where the houses are not

Fig. 465.



carried to too great a length, say not more than 30 or 40 feet, these back-wall flues are useful; and as the trees are usually trained to a trellis from 6 to 12 inches from the wall, they derive great benefit from the mild heat given out

by them, and cannot be injured, as they might be, if planted in front over the front flue, which, of course, will always be much the warmest. The great fault of these houses is imperfect ventilation, as no other means are employed but that of drawing down the top lights, or by having a few panes of glass made to open and shut near the top.

Such houses are extremely economical in erection, and well fitted for early forcing, being 6 feet wide at the bottom, and 9 feet high; and were they heated and ventilated upon modern principles, they would be all that could be desired for the purpose of early forcing. Were it not that some cultivators insist on stripping the early peach-house of the glass sashes, after the crop is gathered, and some also while it is ripening, the whole of the roof might be in one piece, dispensing with the expense of rafters and framed sashes altogether. On this subject we find that the opinion of Knight was quite in accordance with those of many of the most eminent peach forcers of the early part of the present century, who removed the top lights in fine days, to colour and improve the flavour of the fruit; and again, in autumn, took them away altogether, for the purpose of exposing the wood to the full action of the weather. The imperfect state of ventilation, and the dark houses crowded with large rafters, and often glazed with bad glass, perhaps inclined them to adopt this plan. With all these defects remedied, we do not now find this practice much attended to. We know that this system is still followed on the Continent; but we should consider the difference between a Continental autumn and those of our own country. Admitting that the practice is good, the lights may be made movable, without altering the

principle of the house. Our own opinion, however, is, that uncovering peaches, whether early or late forced, is of little advantage to them in England, and certainly much less so in Scotland, where we require all the sun we have to mature the wood and buds properly.

The Dutch, who are great economists in most things, have adopted the most temporary of all structures for forcing the peach. A triangular heap of warm dung is formed, against the south side of which a wooden frame, about 15 inches deep, and of a length and breadth sufficient to cover the tree intended to be introduced, is placed. A tree is selected from the walls of the garden, taken up, and planted at the base of this hotbed, the branches being trained to a trellis fastened within the frame. Sometimes this frame has a partition of thin boarding placed between the tree and the dung heap; at other times a partition of thick coarse paper, supported on a frame made of laths. The object, in either case, is to prevent the steam from the dung injuring the blossom. A glass roof is put on, and all is left to the effects of the sun and the warmth from behind, which is kept up by constantly turning and renewing the mass of fermenting matter. When the fruit is gathered, the tree is again removed to the wall from whence it was taken, and in two or three years it is again in a condition to undergo a similar process. And, in the same country, peaches are forced so as to ripen by the middle of May, in deep frames. The tree is taken from the wall when in a bearing state, and planted in a box; the branches are trained to a trellis, close on the bed, which is formed of tan, and brought to within 18 inches of the glass. When the heat of this bed declines, it is revived by exterior linings of dung. Sometimes dung is used instead of tan; but, in the latter case, the surface of the bed is covered with earth or tan during the time the trees are in flower, to keep down the steam.

Fig. 466 is a peach-house heated by solar heat, and by the fermentation of tan, or stable manure placed in the pit, *a*, upon which lettuce or strawberry plants are set in pots, and often planted in soil laid over the fermenting material. Raspberries or currants are usually planted on the wall behind, outside, and the

peach trees, which are permanent, are

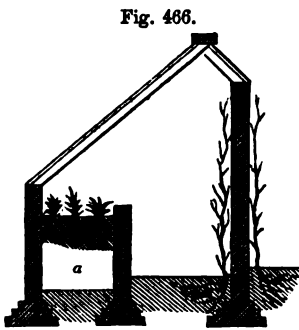
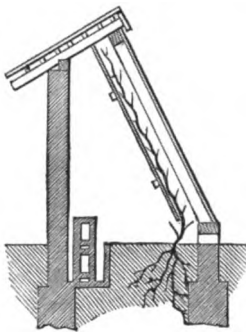


Fig. 467 exhibits the section of an early forcing peach-house very much used in Denmark. This is an improvement on the two preceding ones, and is heated by smoke-flues, the undermost sunk into a chamber, the depth of which is equal to the height of the flue. This is, no doubt, intended to warm the border in



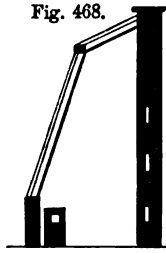
which the roots are, as the trees are planted within the house—a very necessary precaution in a climate so intensely cold during winter. These flues are very properly built detached from the walls and soil, as well as from each other. The part of the roof sloping towards the north is opaque, being either slated, or more frequently thatched, to keep out the cold, and also to give head room within, and greater space for the foliage, neither of which could be effected were the roof to rest on the top of the wall. The trees are, in this case, trained to a trellis near to the glass—an improvement also on the last example. Another mode of peach-forcing practised in Denmark is described by the late Mr Lindegaard in "Horticultural Society's Transactions," vol. v. p. 320. In this mode the forcing is by dung heat, the trees being planted against the back wall, which is heated by a lining of dung, and the roots being stimulated by similar means in the area of the house.

Fig. 468 is a section of peach-houses

trained on the inside. Ventilation is sparingly admitted—and that only on warm days, by opening the doors, or by drawing down a part of the roof sashes.

Denmark. This is an improvement on the two preceding ones, and is heated by smoke-flues, the undermost sunk into a chamber, the depth of which is equal to the height of the flue. This is, no doubt, intended to warm the border in

very much used in Scotland about fifty years ago; and certainly, if heated by hot water, and ventilated upon modern principles, it is one which would be found useful for early forcing, and where small houses are required. These houses were, however, badly ventilated, the toplights being never moved unless at the season of

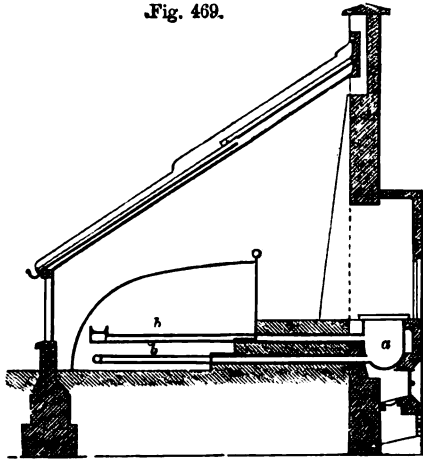


stripping the glass off the house, already alluded to. The only means, therefore, of giving air was by allowing the front lights to slide down either to the ground, or less, as desired, by suspending them upon iron pins passing through an eyed screw in the side rail of the sash, and into holes pierced 2 or 3 inches apart in the rafter. The air, therefore, came in at about a foot from the top of the house; but no thorough ventilation could take place, as there was no other opening for the exit of the heated or impure air. In such houses we have, however, seen splendid crops of fruit.

Mr John Hay, and others, projected and carried into effect peach-houses of quite a different character. They carried the fronts perpendicularly up to 4 or 5, and, in some cases, 6 feet of parapet and glass, and the back walls to the height of 15 or 18 feet. Such houses were, and still are, very excellent for late crops; but for early forcing they are far inferior to some of those noticed above.

The late Mr Atkinson adopted an intermediate size, and succeeded in construct-

Fig. 469.



ing very useful houses. Fig. 469 is an example of his style, which was executed for the Duke of Bedford, at Woburn Abbey. It is thus described by Mr Forbes, in "Hortus Woburnensis,"—"The range of peach-houses here is placed at an angle of 30°, and is 102 feet long, and divided into three different lengths; the middle division, intended for the earliest forcing, is 28 feet long; the end compartments are 35 and 39 feet long; the width of the house is 12 feet in the clear; and the height of the back wall is 10 feet from the floor-level to the top of the rafter. The front sashes and parapet wall are 3 feet 9 inches from the ground-level to the top of the spout, or water-gutter. The spout serves both as a plate for the support of the rafters, and also for conveying the water that falls on the roof." We should here observe that these houses are metallic, so far as plates and rafters are concerned. "There are also small piers of brickwork carried up from the foundation of the front wall, for the support of the table trellising, which springs from within 12 inches of the wall: this space is reserved for the planting of the trees within the houses. Their roots extend under the arches of the parapet wall, to the exterior border, which is raised about 1 foot above the level of the adjoining ground. The hot-water pipes, *b b*, are also supported on pillars, and run parallel to the front wall, at 2 feet distance, under the table trellising, to the extremity of the compartment. The boiler *a* is placed in a niche in the back wall, and is attended from the sheds behind, where the furnace is supplied with fuel. The back trellising springs from within 9 inches of the back wall, and goes up in a sloping position, as shown in the section—the whole trellis being composed of iron rods, and the meshes left about 6 inches wide. The roof, ends, and front lights of these houses are all constructed with cast-iron rafters and wall-plates; the sashes with wooden frames and copper bars, and glazed with crown glass—by which, in a roof of this kind, more sun and light are admitted in March, when they are so essential to early forcing, than one composed of wood will admit in April." Such is Mr Forbes's opinion.

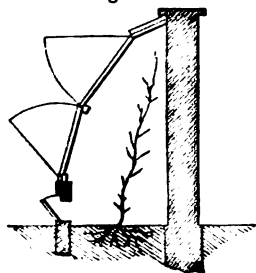
"A peach-house for the earliest forcing," Nicol says, "to be heated by one fire, acting either by smoke-flues, or by

hot water or steam, may be of any length between 30 and 40 feet, 8 or 9 feet wide, and 12 feet high. It should have no upright glass. The parapet may be about 18 inches in height, and the rafters should rest immediately upon it. The intention here is to train the peaches and nectarines up the roof in the same manner as vines, only a little nearer to the glass, and none against the back wall. The front flue, steam, or hot-water pipes, may run within 2 feet of the parapet, and should return by the back wall, being separated from it by a 3-inch cavity. The parapet and front flues or pipes must stand on pillars 3 feet deep under the ground-level, in order to give full scope to the roots of the plants."

The original early peach-house of Atkinson was much such a house as that just described—with this addition, that ventilation was effected by openings in the front parapet, and also in the back wall near its top, both provided with the means of opening and shutting.

The late peach-house of Nicol he proposes to heat by one fire; and no peach-house should be larger than one fire will heat—as the fruit, unlike the grape, must be used when ripe; for the present state of our horticultural knowledge does not extend so far as to enable us to keep it longer. Such a house, therefore, should not exceed "40 or 45 feet in length, 13 or 14 feet wide, and 14 or 15 feet high. It may either have or not have upright glass in front, which should not, however, exceed 4 or 4½ feet in height, including the parapet. The flues" (or hot-water pipes) "may be conducted as above specified for the early houses. The intention here is to train the trees on trellises against the back wall, and likewise half-way up the roof, in the manner of vines, so that it may be termed a double peach-house;" or the trees in front may be trained as standards.

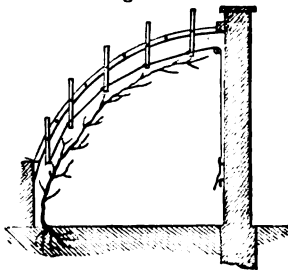
Fig. 470.



in two planes, each plane forming an angle with the perpendicular of 15°, and formed into sashes, fig. 470, hinged at their upper angles, and opening outwards."

And for a house for a principal crop, the same ingenious authority also suggested

Fig. 471.



a polyprosopic roof, with the sashes opening on the principle of Venetian blinds, fig. 471.

That these forms of roofs have advantages is quite clear

—but whether these advantages are equal to the extra expense of construction, and liability to derangement afterwards, may be questioned.

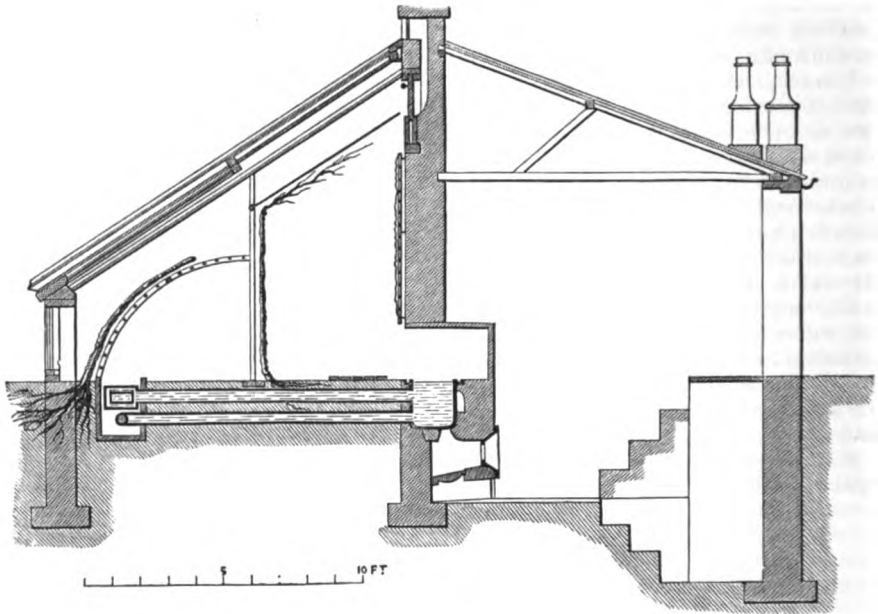
The peach-houses at Dalkeith, of which a section is given, fig. 472, are all 12 feet in width within, varying in length from 30 to 32 feet, and 10 feet high at the back. They are heated by hot-water pipes placed in a chamber under the level of the floor, and open at top. Into these chambers cold air is admitted from the outside in front, as shown at *a*, fig. 373, and further explained in article VENTILATION, fig. 381; and these openings serve the purpose of front ventilation, thereby avoiding the necessity of opening the front sashes, unless during the heat of summer, when the external air is sufficiently warm to be admitted with safety to the foliage—an improvement, we think, which will appear sufficiently obvious to practical men, over the general mode of opening the front lights whenever ventilation is required, and whatever may be the state of the weather; for we all know that nothing is so bad as allowing currents of cold, frosty, keen air to come in immediate contact with the young and tender shoots and foliage of plants enclosed within a high temperature. Nor is this the only advantage of this mode of ventilation. By reason of the difference of gravity between cold and heated air, the cold or heavier air descends through the openings, and, displacing the heated and lighter air in the chamber, drives it upwards with considerable force, creating

The late Mr Loudon suggested (but we are not aware if the plan has been carried into effect) a house for early forcing of 40 feet in length, 8 feet wide, and 12 feet high—"the glass to be

a circulation throughout the whole house, and, at the same time, equalising the temperature; which, without this agitation, would remain in a sluggish state about

the lower and front part only, and consequently heat those parts more than the others. The pipes being placed so low, heat the borders slightly by conduction;

Fig. 472.

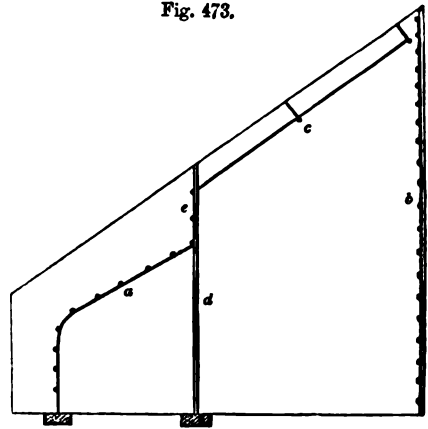


and this might be carried to a considerable extent by leading flues or air-drains through them. The pipes are also out of the way, and a useful bottom heat is always at command, as plants in pots or boxes may be set over them. The lower part of these chambers being water-tight, could be supplied by a small pipe from the cistern, so as to cover a portion of the lower pipe. A genial steam would at all required times be thus obtained, and vapour would thus be given out more equally, and much less heated, than by evaporating troughs on the upper pipes, or by throwing water on them. The impure air escapes by the ventilators in the top of the back wall. The trees are planted along the back wall, which is completely covered to within  $2\frac{1}{2}$  feet of the floor; others are planted in the narrow border between the air-chamber and the front parapet wall, which is supported on piers, and lintelled over with stone; and under which stone, and between the piers, the roots extend themselves to the external border. The trees planted in front are trained to a curved trellis rising from

the ground and falling backwards; and branches both of them, and also of those in the back, are trained to the gable trellises suspended under each alternate rafter—thus giving the greatest possible extent of surface, and the least possible extent of shade.

In other houses, the gable trellises are omitted, as in fig. 473; but the front

Fig. 473.

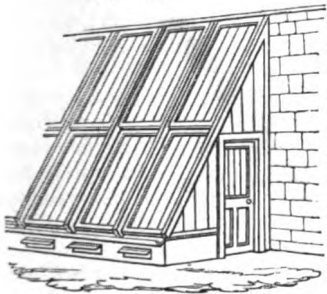


curved trellis *a* is retained, as well as the back wall *b*; and under each rafter three courses of wire *c* are attached, extending from the top end of the rafter to the iron upright *d*, to which branches are trained. In addition to this, three courses of wire, *e*, extend from end to end of the house, to which also branches are trained.

The old, and now almost obsolete, method of training peaches over the entire roof is no doubt to a certain extent favourable for ripening, colouring, and flavouring the fruit, but not to any greater degree than the last two methods mentioned, where air, light, and sunshine can reach every part; nor will it be found by calculation, that in either of the above examples given is there a loss of surface, but rather a very considerable gain. In fitting up trellises for peaches, they should invariably be made of iron or copper wire, and kept as near to the glass as shown in the above examples.

Fig. 474 shows the end and part of the front elevation of a very economical and

Fig. 474.



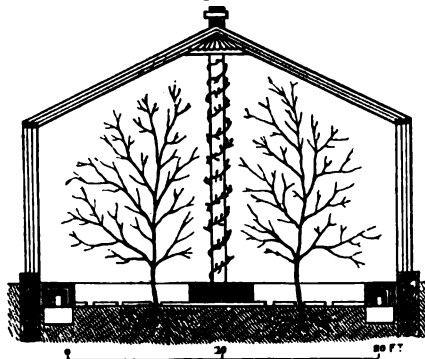
full range of peach-houses recently erected by O. Tyndal Bruce, Esq. of Falkland, Fifeshire. They have been placed against an exist-

ing wall, well covered with peach and nectarine trees; but, as is the case in most parts of Scotland, frequent disappointments arose from the late spring frosts cutting off the blossom, as well as by the ungenial autumns to which we are exposed preventing the full maturation of the buds and young wood at that season. Since their erection, excellent crops have been secured, and accommodation found upon a table trellis in front, for wintering a large stock of planting-out things to furnish the splendid Italian flower-garden at Nuthill, in the immediate vicinity, belonging also to Mr Bruce, and of which our Plate XXIX. is an illustration. These peach-houses are of wood, 13 feet high at the back, and 6 feet wide

at the bottom. The sashes of the roof are in two parts, placed on a parapet wall 18 inches in height, and resting on the face of the wall behind. Ventilators are placed in the parapet wall, one under every sash, the whole being connected with an iron axle which extends the length of each division, and made to open and shut simultaneously by means of a crank-handle at the end of each section. Top ventilation is effected by letting down the top course of sashes in the usual manner. The walls were originally heated by smoke-flues, which still exist, and afford all the artificial heat required, as the crop is not required to be early ripened. Had this range been constructed without rafters and framed sashes, and made to consist of one entire roof of glass and astragals, with ventilators in the back wall as shown at fig. 414, it would not have cost half the money, and would have answered the purpose as efficiently. As it is, we think it an excellent and useful range, and worth the attention of those who wish either early or late fruit at little expense. Of course, in the former case, a range of hot-water pipes in front would be a necessary improvement.

*Span-roofed peach-houses* are by no means a new feature in horticulture. So early as 1805, Loudon has figured and described one that existed prior to that date in the gardens at Dalry, in his work on "Improvements in Hothouses." Of his illustration the annexed, fig. 475, is a copy.

Fig. 475.



After remarking how well the peach is adapted for being grown as a standard under glass—in which opinion we most cordially agree with him—he proceeds to state the form best suited for this purpose.

His remarks on this we are here induced to transcribe, were it for no other purpose than to show how completely the span-roofed peach-house of 1800 accords with that of 1851. We shall use his own words. The first thing requisite is, that the house shall be glass on all sides, in order to admit light to every side of the trees.

"That this may be best effected, it follows that the house should be made of an oblong form, and placed south and north, and that the trees should be planted along the middle of the house."

"The next thing is, that the side or upright glasses should be made as high as possible, in order that the trees may not be cramped or compressed."

"This naturally reminds us that the house should be of a considerable height—at least 12 or 14 feet."

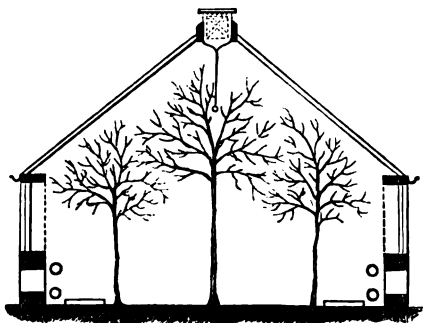
This, of course, is to be understood under the ridge.

"In order that no ground in the house may be lost, it seems preferable to plant dwarf trees, that they may fill the house with branches regularly from the ground to the roof."

All that is wanted in the house above figured is the use of hot-water pipes instead of flues, and our mode of ventilation at the ridge.

Fig. 476 is a section of another span-roofed peach-house. This house is 60 feet

Fig. 476.



long and 15 feet in width. It is intended for a principal summer crop, and is ventilated by openings in the side wall 2 feet long and 10 inches wide in the clear. These openings are placed opposite the hot-water pipes, but the side sashes may be opened also in mild weather. The top ventilation is as already described in section VENTILATION. The trees are

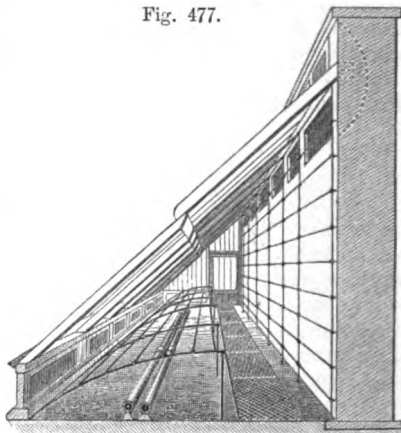
planted as usual inside, and may be trained as standards, or to a trellis over the whole roof. The roof is fixed.

Of the advantages of span-roofed houses for peaches, there can be but one opinion. Prejudice has, however, to be got rid of; and this, as in all other cases, must ultimately give way to reason. In such houses peaches might be advantageously grown in large pots or boxes, and thus a long season of fruit might be obtained at little extra trouble or expense.

The best mode of training in a span-roofed house is unquestionably that of standards—one row of taller trees along the middle, and a row of dwarfer ones along both sides.

The annexed, fig. 477, is an internal perspective view of Crosskill's (of Beverley)

Fig. 477.



peach-house, as exemplified at Everingham Hall, Sunderlandwick, and elsewhere. The trees are trained over the whole of the back wall, and another set to a curved trellis occupying the front of the house. Gable trellises might be introduced into this house, under each alternate rafter, with advantage, or a branch might be trained under each rafter in the manner of vines, and upright shoots might be trained to iron rods rising from the back of the front trellis, and attached to the rafters. In either of the two last ways a considerable addition of training space would be secured, and the fruit produced on either would be superior to any in the house, being better exposed to light and air.

The front parapet of these houses is of

cast-iron, as are also the ventilators, both at front and back. The principal fault we have to this house is, that the front trellis is too far from the glass; and this mistake has been fallen into to avoid shading the bottom part of the back wall, the least important part of the whole house. The back part of the front trellis ought to have been much higher than is represented in the figure.

The accompanying diagrams, figs. 478 to 492, show the details of a range of glass recently erected in the splendid gardens of the Duke of Sutherland at Trentham. The conception of this novel and ingenious design, as well as the execution of the same, is entirely due to Mr Fleming, who has so long and so creditably superintended the horticultural department at this princely establishment. It is difficult to determine under what denomination these elegant structures should be classed—whether they should be called hothouses, glass corridors, &c. Their object, however, is to secure abundant crops of peaches, cherries, plums, apricots, and grapes, or similar fruits, at a much less cost than the huge and expensive glass houses in general use. They possess, besides utility, other merits, of which elegance in appearance is not the least. Fig. 478 shows a portion of the ground-plan; fig. 479 the elevation, showing alternate sashes open. Figs. 480 and 481 show the rack and pinion at the centre of the structure, by which the opening and shutting of the front sashes is effected—by turning which at the centre, without moving from the spot, the whole of the movable front sashes are acted upon simultaneously, while, as will be seen by the transverse section, fig. 483, the operator has only to turn himself round, and by a turn or two of the handle, *d*, elevate or depress the whole of the sashes along one side of the roof;—thus admitting ventilation to any extent, with the least possible amount of trouble, and with the greatest degree of accuracy. Fig.

VOL. I.

Fig. 478.

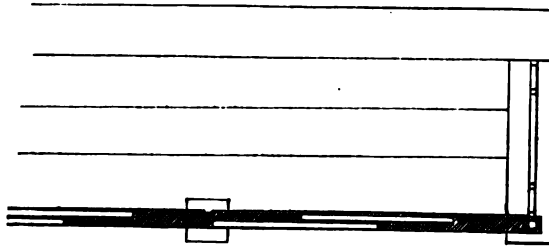
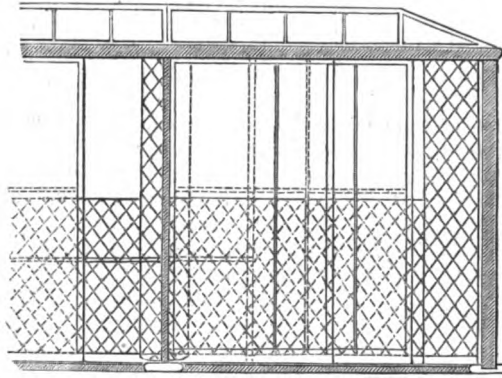


Fig. 479.



482 is the end elevation, showing door-way, and also the end rafter connecting the upright hollow columns with the brick wall behind. Fig. 483 is

Fig. 480.

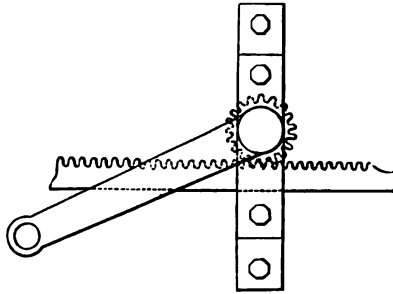
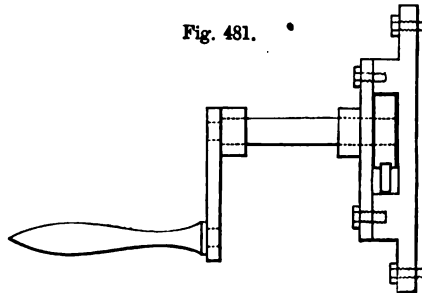


Fig. 481.



2 Y



transverse section, showing the founda-

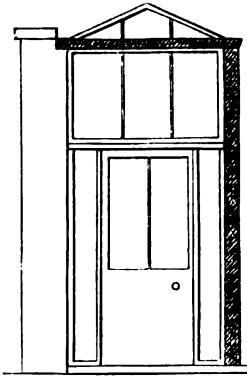
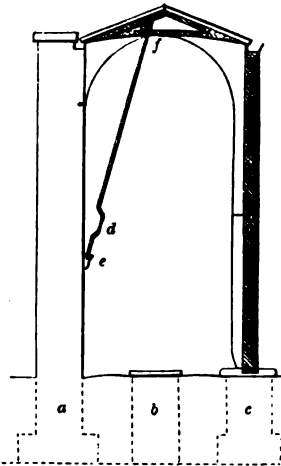


Fig. 482.

tions of back wall *a*, piers for supporting the slate pavement forming the passage *b*, as well as that of the piers *c*, upon which the iron plate or plinth *a*, fig. 484, reposes. These latter piers are placed at equal distances, each

space being equal to the breadth of two of the front sashes, one of which is a fixture *d*, while the other is movable, as shown at *e*, fig. 484.

Fig. 483.



The moving sashes, working on two iron wheels, one of which is shown at *b*, fig. 484, screwed to the side rails of the sash *e*, and running upon the semicircular bead *f*, forming part of the iron plate or plinth. In the transverse section, fig. 483, *d* shows

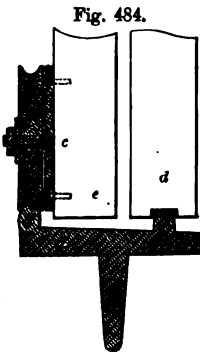


Fig. 484.

the handle of a lever placed in the centre of each compartment, which, working in an iron socket, fixed in the back wall, throws up the back half of the roof, for the purpose of top ventilation. This is, however, better seen in fig. 485, where the spiral screw is shown at *a*, working in a cog-wheel, *b*, which gives

the required movement; and in fig. 486, the toothed quadrant *a* is shown, which regulates the amount of ventilation, as well as maintains it in its

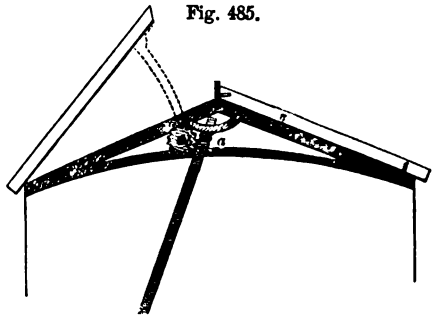
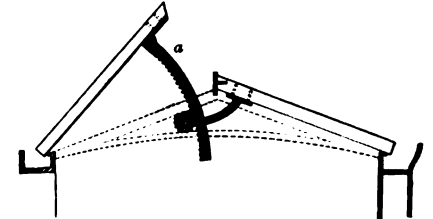


Fig. 485.

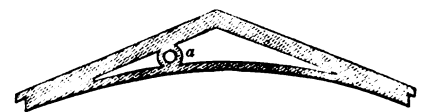
proper place. These cog-wheels, which are acted upon by the spiral screws at the centre, are all fixed to a longitudinal axle of iron bar, extending the

Fig. 486.



whole length of each compartment: one of each is attached to the centre of each movable roof-sash, so that, by the operator turning the lever handle at the

Fig. 487.



centre of the structure, each of the movable roof-sashes is acted upon either for depression or elevation, thus ventilating the whole in about the space of a minute. Fig. 487 shows the

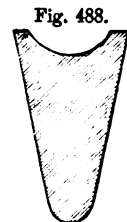
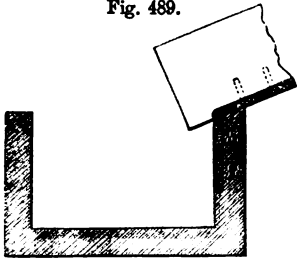


Fig. 488.

rafter, with the orifice *a* for the longitudinal axle to work into. Fig. 488 is a section of the rafter, half size. Fig. 489 shows the back gutter, with the movable sash attached to it by a hinge at *a*. This gutter receives the water of the back part of the roof, as seen in the end elevation and transverse

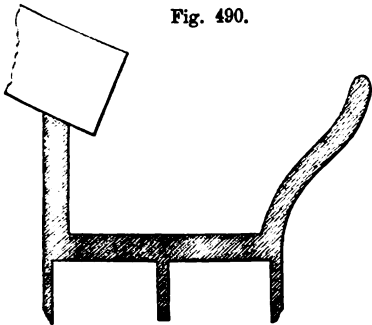
section. Fig. 490 shows the front gutter, with the fixed roof-sash attached, for receiving the water that falls on the front

Fig. 489.



half of the roof, and which water is carried along that gutter, which forms a plain cornice, until it is carried down

Fig. 490.



one or other of the hollow upright columns, into tanks underground. Fig.

Fig. 491.



491 is a section of one of those hollow upright columns, with the necessary stops for keeping each sash in its proper place. Fig. 492 is a section of the corner columns, with similar provisions, but of a large size. Figs. 480 and 481 show the mechanical appliances for front ventilation. In

Fig. 492.

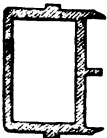


fig. 481 is shown how this is secured to the side-rail of an upright sash, and fig. 480 the rack and pinion, which, when turned round, either draws forward or pushes back the front sashes into their places again. In fig. 482 is shown, by the line behind the front uprights, and continued under the roof, one of the conductors to which vines are trained; and as these are placed at 10 feet

distance from each other, their shadows, or the amount of light intercepted, is quite immaterial to the trees trained on the back wall. This trellis is also shown in the elevation, fig. 479. The hollow uprights in front, and the rafters, are all of iron. The glass used is 16 oz. British sheet, and is fixed in the astragals in the usual manner, with the exception that, instead of overlaps, the squares meet in Snow's manner, which gives the structure a much lighter and more agreeable appearance.

From this it will be seen that, by the movement in the centre of the house, top ventilation is given or taken away; while that of the front is given, reduced, or totally shut off, by a turn or two of the handle of the rack and pinion placed opposite. As an economical and efficient mode of ventilation, we consider this the very best we have seen; while the whole structure, for simplicity, efficiency, and economy, meets our fullest approbation.

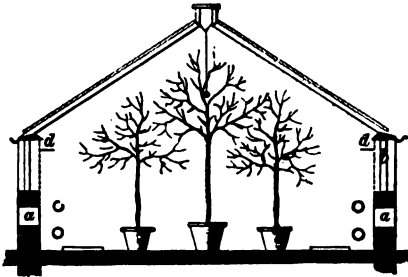
#### § 4.—CHERRY, FIG, PLUM, AND APRICOT HOUSES.

The forcing of cherries, figs, plums, and apricots, has only been attempted upon a limited scale in this country, even in the gardens of royalty. For the most part, the houses in which the culture of these fruits has been attempted have hitherto been constructed upon the same principle as vineries and peach-houses; the success, therefore, has been various, and seldom satisfactory. That all of them, with the probable exception of the fig, require abundance of light and ventilation is certain; therefore the kind of buildings best adapted to them must possess these requisites to the fullest extent. As curvilinear or span-roofed houses possess these merits more than lean-to houses do, they are no doubt best adapted to the end in view.

The structure represented in the annexed diagram, fig. 493, we consider well adapted for this purpose. The house is 62½ feet long, and 15 feet wide. It is heated by hot-water pipes, the boiler and stoke-hole being placed in the middle of one end, the boiler being within the house, and the pipes branching from it to the right hand and to the left. The pipes are

carried parallel to the side walls, and return when they approach the door, which is placed in the centre of the

Fig. 493.



opposite end. Ventilation is effected in cold weather by opening the ventilators *a a* in the side walls, and the ridge, which is constructed upon the principle laid down in the section VENTILATION.

The side ventilators *a a* are 3 feet by 12 inches in the clear opening, and are furnished with malleable-iron frames, fixed on the face of the inner side of the side walls, and forming a margin round them. These frames are forged with a groove three-eighths of an inch in breadth, and three-quarters of an inch in depth all round their inner edges—the lower grooves being furnished with two small iron rollers each, upon which rest thin plates of sheet iron equal in size to the ventilators, including the depth of the grooves. These plates are neatly fitted to the frames, and made to slide along the rollers by being attached to an iron rod, 1 inch in diameter, extending the whole length of the house. This is acted upon at one end by a screw or worm, which, on turning in one direction, draws each of the sliding plates more or less forward, according to the quantity of air that may be required. A counter movement shuts them up again simultaneously. Thin plates of iron are used for this purpose, as being more durable, and not liable to swell when damp, as well as not liable to warp. To stiffen them, however, without much increasing their weight, two ledgers, or cross-bars of iron plate, three-eighths of an inch thick and an inch in breadth, should be fastened to their inner surface, of such a length as will clear them of the top and bottom edges of the frame. This ventilation, it is obvious, may be increased, from an

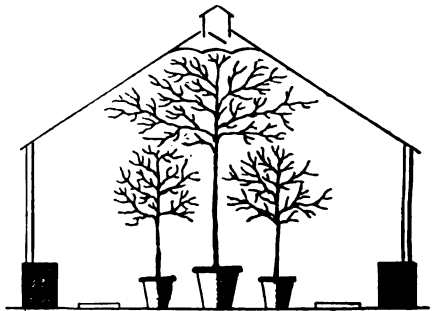
opening of half an inch, to the whole extent of the ventilator.

In warm weather, the side-lights *b* may be partially or wholly opened, and may be made to slide past each other as in ordinary cases, or hinged on the north side, as exemplified in the cherry-house at Frogmore, or hung on pivots at their centres, or hinged at top and pushed outwards. As the roof is intended to be fixed, the opening in the ridge must be sufficiently large to admit of a free current; and as by this mode of ventilating the opening extends the whole length of the roof, the width need not, even in this the very extreme case, be more than 10 inches. The tumblers should be capable of throwing the capping to the height of 15 inches.

A shelf for strawberries may be placed at *d d*; but it should not be close over the pipes, as is often done, for this would interrupt the radiation of heat upwards. The trees, we would propose, should be kept in large pots or boxes, so that they may be removed when the fruit is ripe, and be replaced by others. In such a house figs might be grown throughout the year.

Fig. 494 is a section of the span-roofed house for cherries in the royal

Fig. 494.



gardens at Frogmore. It differs little from the preceding, except in so far as it wants the lower ventilation, which we hold to be of very great importance, especially during the early part of the season, when the winds are often cold and frosty, and not in a fit state to blow in upon the tender blossoms, foliage, or shoots. The ridge ventilation in this house is just as it ought to be—the opening and shutting lid of the ventilation being hung upon a centre, by which

means its motion is easily acted upon by a screw, turning the axle to which it is attached; and as this axle extends the whole length of the house, the movement is effected from end to end.

The windows, which form the sides of this house, are moved simultaneously, being hung on pivots at top and bottom, opening outwards, but all from the northern side, so as to prevent the entrance of cold winds. This movement is effected by means of levers, acted upon by a screw at one end of the house, which is on the termination of a square bar of iron extending the whole length of the structure, and working through brass rollers fixed upon the sill. Iron levers, working on pivots at their junction with the bar, are attached to it, as well as by joints to the bottom rail of the windows.

By turning the screw in one direction, the square bar slides forward and opens the windows, which turn on a ball-and-socket joint at the same time, to such an extent as may be desired.

To render the top ventilation more convenient, an upright rod of iron is attached to the one which extends along the ridge, and brought down by the side of the door at the end of the house, so as to be easily reached. This is furnished with a crank handle, which, acting on a worm at the lower end of this rod, moves a curved lever at top attached to the lid, and opens and shuts the latter instantaneously, either to its full extent or otherwise. A set screw, as in the side windows, keeps it at any elevation required.

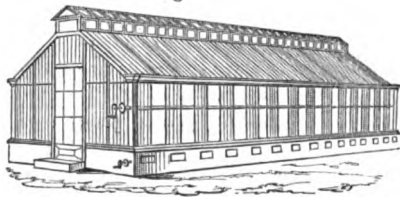
This house is 50 feet in length, 16 feet wide, and 10½ feet in height. The front windows are 4 feet high, and a stone pavement passage runs through the middle from end to end, in which the doors are placed; on each side of this passage the trees in large pots are arranged. We have shown the passage running round the sides of the house to admit of trees of larger size being placed in the centre.

A house of the same form and dimensions stands at some distance from this, for later crops, (*vide* ground-plan of Frogmore gardens, Plate X.)

Fig. 495 is an external view of this very elegant structure, to which we have taken the liberty of adding a system of

ventilation along the middle of the side walls, and which, we would propose,

Fig. 495.



should be constructed and made to move upon the principle laid down in our last subject, for the reasons there given.

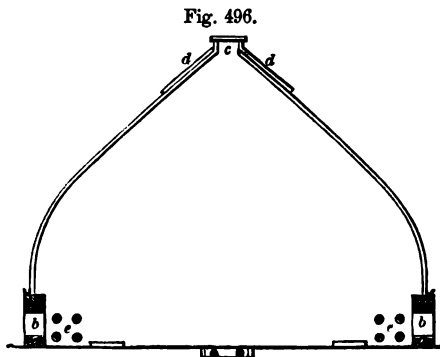
Regarding the position of the trees in such houses, our own opinion is, that they ought all to be in a portable state, so that they may be taken out or in at pleasure. Every practical man knows, from repeated experience, how uncertain a *set* of these fruits is—therefore, if the trees be planted out permanently, the whole season may be lost; whereas, if a stock be kept in tubs, boxes, or large pots, in the quarters of the reserve garden, trees that may fail to set their fruit in the house can be taken out, and their places supplied with others. Such is the practice of many of those who force these fruits for the London market; and from no better source can we gather correct information.

Many have succeeded in forcing these kinds of fruits by merely covering established trees on the garden walls with portable wooden frames covered with glass sashes, which are removed when the crop was gathered. Such walls, when the fruit was required early, were flued; when fruit was wanted only a week or two before the natural season, the solar heat was found sufficient. Portable span-roofed houses for cherries and plums, when these are not required to be early forced, may be erected in any well exposed part of a garden, and the trees planted permanently out in them, because the wood of these will ripen sufficiently without artificial heat. Such, however, is not the case with apricots and figs grown as standards, especially in Scotland and the north of England—hence it follows that they must be always trained to walls; and whatever covering may be placed over them, when so circumstanced, must be of the lean-to form. In both cases,

the structure, excepting that of the parapet wall, should be portable, and removed when no longer required; or the parapet walls, hot-water pipes, &c., as well as the superstructure, may remain, the sashes only being removed, and that principally for the purpose of their being employed in covering late peaches, or ripening the finer kinds of pears by the agency of solar heat only.

### § 5.—TROPICAL FRUIT HOUSE.

In a first-rate garden a house for raising tropical fruits should exist; few, however, have been dedicated to this purpose in this country. As glass is now cheap—the price of which hitherto prevented even the most opulent from enjoying many of the most delicious fruits of the tropics—we see no difficulty now in having the guava, custard apple, banana, bread-fruit, coffee, jack-fruit, lee-chee, loquat, mango, mangosteen, plantain, tamarind, &c., cultivated to greater perfection (as is the case with the pine) than they are to be found in their native countries. The ginger, sugar-cane, and similar herbaceous plants might also be cultivated; and the valuable spices, the clove, cinnamon, camphor, allspice, and nutmeg, brought to useful perfection. We do not mean to say, that the latter five spices can be cultivated artificially, even in sufficient quantity to supply the wants of the owner; but that the others may be, is beyond a doubt. Such a structure as is exhibited in the sec-



tion, fig. 496, (which is designed for the ground-plan *h*, in fig. 21,) may be

considered sufficient for a garden and family of the first order. This house is 62½ feet long, and 20½ wide. It is here shown as a curvilinear structure, rising from the parapets *a a*, and ventilated by openings, *b b*, along the sides for the admission of air, and by an opening along the whole length of the roof at *c*, upon the principle exhibited, fig. 389, in section VENTILATION. As all lofty hothouses hitherto built have been defective in top ventilation, we have shown that portions of the roof are to be made to slide down, as at *d d*; and these are to be drawn up and down by a double-line roller and pulleys fixed to the ridge-boards, upon the principle shown in article VENTILATION, as adopted in the conservatory of the Botanical Society of London. We would propose that all the trees and plants in such a house should be grown in large pots and boxes, being, with most practical men, convinced that planting out trees of difficult culture—as most of those in question are—in borders, however carefully prepared, leaves them subject to accidents at the roots, which are in no way so easily detected and remedied than when the trees are treated as we have recommended. That a degree of genial bottom heat is of great advantage to such trees and plants, we know from long experience; and to supply this in the most convenient way, and in the least objectionable manner, we would heat the floor they stand upon as shown by Mr Glendinning in section TANK-HEATING, fig. 262. The radiation of heat from the eight courses of pipes, as shown at *e e*, will be sufficient for excluding cold from the glass surface; but that it would be sufficiently powerful to heat the large volume of air towards the centre of the house, particularly during winter, we very greatly doubt. A flow and return pipe, to be used in cold weather, is placed along the centre of the house in an air-chamber covered with cast-iron gratings. Hot-water gutters, as shown in the example alluded to, should therefore be employed; and as these of necessity should be placed under the floor level, a separate boiler should be devoted to heating them. The stoke-holes and boilers should, in the case before us, be set at the end next the back wall, and the return of the pipes

should be near to the door of entrance. And, still further to economise fuel and to give additional heat, the spaces under the footpaths may be (although this is not shown in the section) made into chambers extending the whole length of the house, and their sides built on the hollow-wall principle, to prevent loss of heat by absorption. In these a double set of smoke-flues could be built, through which the smoke and heat which passes the boiler could be made to travel, instead of being carried up at once into the walls as elsewhere suggested. The smoke would pass up one of these flues and return by the other, and be finally let into the wall-flues. Indeed, throughout the summer, it might all pass off in that manner. As the furnace is placed at the end of this house, and in the centre of the end, by means of a damper being placed at each side of the furnace, the smoke and heated air could be directed into the flues under the footpath on one side of the house through the day, and into those of the other side at night; and, as the flues and brickwork around would be charged with a very considerable amount

of heat, that heat would continue to be given out long after the direction of the smoke and heated air had been changed.

The footpaths should be of iron grating, to allow the heated air to rise into the house; and, to facilitate this, a *small* supply of cold air might be admitted from over the furnace, to aid in driving out that which is heated in the chambers under the floors.

Tropical fruits, for their cultivation to perfection in this country, for the most part require a greater degree of light and sun than those we have been in the habit of growing hitherto. Therefore, a house upon the curvilinear principle, as exemplified in our figure, we consider the most eligible for the purpose.

Attempts have been made in various places in England to cultivate certain of these fruits, and considerable success has attended the experiment. The only house of any size we have seen entirely appropriated to this purpose is that built a few years ago by the late Duke of Northumberland at Sion, and in which many of these fruits have attained the greatest perfection.

---

## CHAPTER VII.

### PLANT-HOUSES.

#### § 1.—CONSERVATORIES.

THE erection of conservatories may be considered the highest grade in horticultural architecture; in them elegance of design must be blended with cultural utility—architecture becomes the associate of horticulture. It is difficult to draw the line between the conservatory and the greenhouse—both are conservative in their principles. We must be content to take them according to the usual acceptation, and consider the former as differing from the latter in being larger in size, and having the plants or trees planted in prepared borders, instead of their being grown in pots and set upon stages as they are in the latter. Conservatories are either tropical or extra-tropical. In the former, the plants of India and the tropics are cultivated; while, in the latter, those brought from more temperate countries are kept. The situation of the conservatory may be on the lawn or in the flower garden, but not in the kitchen or fruit garden; and in such situations it should be a detached building, and glass on all sides. It is often also attached to the mansion, and forming part of it, as at the Deepdene in Surrey, and the Grange in Hampshire, to both of which highly architectural residences the conservatory forms a useful and appropriate appendage. They are often detached, as at Alton Towers, Sion House, the large one at Chatsworth, that at Dalkeith, and others. In style they vary like other buildings; but they should always be, particularly if attached to the mansion, of the same style of architecture. This rule is, however, not always attended to; for that at Sion House,

designed by Fowler, is in the Italian style, that at Alton Towers in the Grecian or Roman, and that at Chatsworth of no particular style whatever. There is, however, attached to that princely residence a large and excellent conservatory, quite in accordance with our views, as forming part, as it were, of the house.

Architecturally speaking, there is no impropriety in this; but, horticulturally speaking, a very great deal. In such cases it were better to place the conservatory at the very extremity of the buildings, and to connect it with the mansion by a glass corridor of a height and in a corresponding style with the conservatory's elevation. This would produce the architectural effect wished for; and the conservatory, extending beyond the line of front elevation, and placed rather in rear of it, would not mar the effect, as it would be considered an independent building. This corridor should have its roof fixed, and the front windows movable, so that they might be taken away during summer if desirable. The wall of the corridor should be covered with camellias, oranges, and similar hardy evergreen plants, planted in the soil under the floor, which should be covered with polished pavement or encaustic tiles. This corridor would form, as it were, a long narrow conservatory when viewed from the living room with which it should be connected, and doubtless would, even when seen in perspective, have a less grand and imposing effect than a broader and more spacious structure; but it would be calculated to afford a great amount of enjoyment to the lover of plants, as well as great variety in passing along it towards the conservatory. It would also offer an

excellent means for taking exercise in bad weather, and also become an interesting promenade at all times. There is no necessity that such a corridor should be carried its whole length in a direct line—it may recede and project according to

the breaks in the building; and from the conservatory it may be continued to the stables, or to any other place of usual resort.

The conservatory at the Grange, of which fig. 497 is an internal view, and

Fig. 497.

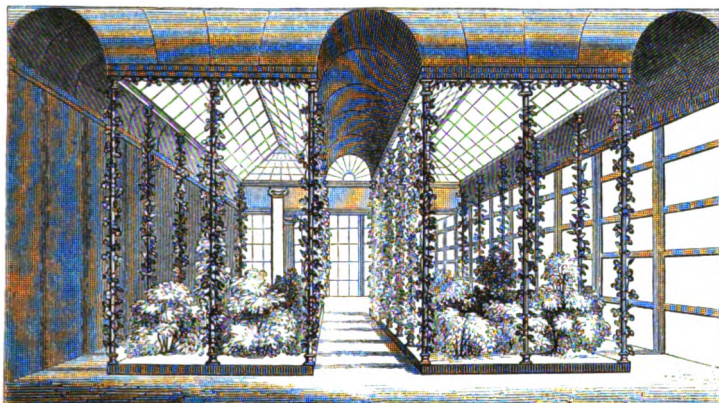
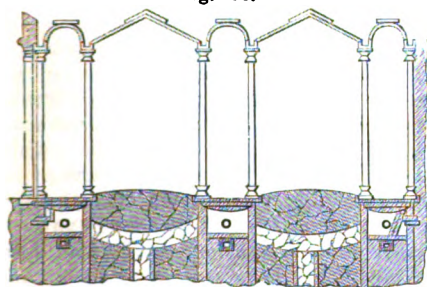


fig. 498 a cross section, was built from the designs of C. R. Cockerell, Esq., who, at the same time, greatly improved the mansion. It is in the Grecian style, and

Fig. 498.



is 70 feet in length by 46 feet in breadth, and 21 feet high. We do not introduce this house as a novelty, but as being one of the best conservatories we have seen. Its proportions are good, its connection with the mansion enjoyable, its details faultless, and, either as a conservatory attached to a mansion, or as standing detached on the lawn, we consider it a model;—of course we would, in the latter case, substitute glass for the opaque wall that connects it with the mansion. Two beds of prepared soil, each  $15\frac{1}{2}$  feet wide, are planted with suitable plants; a walk

VOL. I.

6 feet 6 inches broad passes down the centre, and one of 4 feet 9 inches passes along the back and front sides. Along the back wall is a border 18 inches broad, in which climbing plants are grown and trained to a wire trellis to cover the back wall. At each pilaster in the front and ends, also, there is a prepared border, in which the choicer kinds of climbing plants are planted and trained up the iron columns (fig. 449) which face the pilasters. A glass door opens into the conservatory from Lady Ashburton's private apartments; and the principal entrance, from the spacious terrace without, leads through a vestibule in which large specimen plants in ornamental tubs, boxes, and pots stand.

Fig. 499.

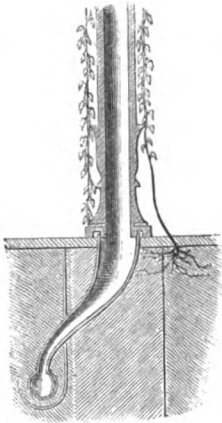


In the recesses of the windows, between the pilasters, stands 7 inches high are placed, upon which small plants while in bloom are set. "Under these stands are the ventilators, which admit the heated air and steam together or separately, as may be desired, into the house. The water which falls from the roof is conducted through iron columns,



fig. 500, which support the roof, into a large tank under the portico, and brought up again by a forcing-pump for the supply of the house."

Fig. 500.



Those parts of the roof immediately over the walks are covered with double plates of iron enclosing a body of air, to prevent the escape of heat; and over these are neat iron gratings, so that any one may walk along to repair the glass, paint, &c. Ventilation is effected by opening the windows in front or at the ends, and by letting down the top roof sashes. It is heated by a combination of Sylvester's hot-air stove and steam placed in chambers under the floors. From the manner in which the roof of this house is constructed, it will readily be understood that any extent of area may be enclosed; and, in this respect, it approaches very closely to the more recently invented ridge-and-furrow roof. In the latter, no doubt, half the number of columns would suffice, both for supporting the roof, and also for taking away the rain water; but the number of these is no disadvantage, as climbing plants constitute so large a portion of conservatory decoration, and as, for want of such conveniences to train them to, they are much less cultivated than they deserve; for amongst them some of the most beautiful and profuse bloomers are to be found. A further use to which these might be put, in the case of a tropical conservatory, might be to use each alternate column for taking away the rain water, and to make the others the means of heating the atmosphere, the hot water ascending up the centre of the column, and descending down the sides. The heat, by this means, would be radiated to all parts of the house. The conducting pipes, both for the flow of the hot water and its return towards the boiler, should be placed under the walks, in a detached chamber, and, from these pipes, branch ones might be carried under

the beds to afford bottom heat when required. These could easily be regulated by proper stopcocks placed on the mains, and could be reached by having ornamental brass ventilators fixed in the floor, and made to open sufficiently to admit a turncock key for the purpose of turning off or on the circulation to the beds under the plants. The branch pipes should be laid amongst the drainage, and not in the soil of the border. Such beds might also be very efficiently heated by forming brick-and-cement tanks under them, and supplying them either by branch nozzles from the mains that supply the columns, or by a separate set of main pipes, which would be better, as the pressure of the water in the columns would be liable to burst the tanks, unless these were made exceedingly strong. Indeed, it is always better to have separate boilers where two objects are to be served, as in such a case as this. In ornamental conservatories such as this is, when intended for tropical plants, it will be found exceedingly useful to have elegant vases distributed through it: at times these may be occupied with single specimen plants, but their legitimate use is to act as reservoirs of hot water, to be supplied by small pipes passing up through them, and not only to give out heat by radiation from their sides, but vapour from their tops. Vases, however, for this purpose, should be metallic, as giving off heat more rapidly than stone, composition, or earthenware; and care should be taken that they associate with the style of architecture of the house.

In defining wherein the conservatory differs from the greenhouse, we have said above that, in the former, the plants or trees are planted out in a border of prepared soil. This, however, is not absolutely necessary, nor at all times expedient. The trees or plants may be grown in large tubs, boxes, or pots; but as these are in general unsightly, they may be set in a floor sunk under the level of the walks, and elevated or lowered according to the depth of the tub, box, or pot—the space above being covered with portable panels of cast-iron grating of ornamental pattern, so as to form, when arranged, a very complete flooring. Or the boxes may be plunged, or covered with stones, flints, brickbats, coarse gravel, &c., to within a few inches of the floor level, and finished

off with a covering of clean gravel, moss frequently renewed, or any other similar contrivance, to hide the cases in which the trees are planted—leaving, however, the surface of the soil exposed to view, for the purpose of watering and for the admission of air to their roots. By these latter means they will appear as if planted out in the general effect, but, at the same time, be capable of removal when fresh arrangements are deemed expedient, or of being taken to some other house in the event of sickness, or totally removed to give room to others more valuable. When the stronger and more robust growing plants are planted in a bed of prepared soil, which is in general, in conservatories, made too rich and too deep, they outgrow all bounds; even the house itself is not sufficient to contain them. They injure or destroy their less vigorous, and, very often, more valuable neighbours, and, after a year or two, they themselves have to be cut out and thrown away, after having destroyed all around them, by overshadowing them, and robbing them of their share of nourishment at the roots. By confining them to large tubs, boxes, or pots, the latter of these evils is completely remedied, their extra luxuriance is checked, a disposition to produce more flowers, in proportion to their size, is brought on; and often, in summer, some of the more hardy may be set out of doors, to give breathing room, as it were, to the others; and when the house becomes too much crowded, the duplicates, or those least interesting to the proprietor, may be removed altogether, and disposed of in a variety of ways. It is quite absurd in this country to attempt to grow the trees of the tropics, or even of extra-tropical countries, to anything like their natural size. Who would be so bold, let us only ask, as to construct a house in which a single plant of *Araucaria excelsa* could develop itself to *even half its* natural size?—or who would find accommodation for a full-grown tree of *Adansonia digitata*, the very trunk of which, if we are to believe travellers, is equal to the diameter of almost the largest glass-house built in Europe? As it is, therefore, quite impossible for us to exhibit the trees, and, indeed, many even of the herbaceous plants of distant countries, of their full natural size, let us be content to raise them as it were by

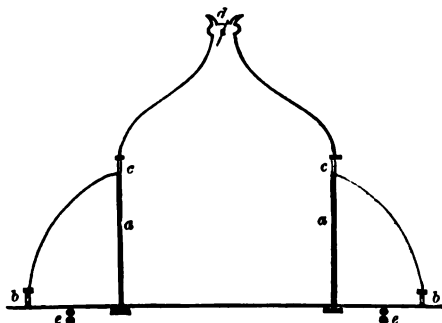
scale, and, by good cultivation and proper accommodation, cause them to develop their natural character somewhat diminished from the original in dimensions.

Regarding the dimensions of conservatories, we quote the following remarks, as offered by the late Mr. Loudon, on this subject: "The laws of vegetation render it utterly impossible that a small conservatory can ever look well. A conservatory is for the growth of trees and shrubs, not like a greenhouse for mere pelargoniums and other small plants in pots; and trees and shrubs, to look well, must have room, and especially breadth, to expand themselves. As every conservatory, however narrow, must be at least of the height of the apartments with which it is connected, the width, if not considerably greater than the height, will always occasion the plants to have an etiolated appearance. Supposing the height of a conservatory to be 12 feet, the width should never be less than 18 feet; it being understood to be essential that the whole of the roof is to be of glass." The same authority goes on to observe, that "provided the whole of the roof be of glass, and the walks broad, so as to allow of a free circulation of air round the trees, it signifies much less than is generally imagined what may be either the aspect or the position of the conservatory." Perpendicular light is of so much importance to plants, that without it they will not thrive, nor even long continue to exist. Were it not for the shadow of opaque side walls, it would signify little to some plants—camellias and oranges for example—whether they were composed of bricks or glass, provided a sufficiency of ventilation was admitted. It is want of ventilation, more than of horizontal light, that causes plants at the back of conservatories with opaque walls to suffer as they in general do. However, we believe that glass sides all round may be now constructed as cheap, if not cheaper, than they can be formed of brick or stone. Such being the case, and as transparent sides must be admitted to look best, we see no reason why they should not be adopted.

The large conservatory erected for the late Mrs Col. Beaumont, at Bretton Hall, although no longer existing, having been dismantled by her successor, may be given as a specimen of a dome-shaped house of

the largest size hitherto erected. It was designed and executed by the Messrs Bailey, of Holborn, the well-known hot-house builders; it was entirely formed of curvilinear sash bars of wrought iron, without rafters or principal ribs. These sash bars were nearly two inches deep, and half an inch thick in the thickest part, and weighed only about one pound per lineal foot. The house consisted of two domes—(*vide* fig. 501)—the upper and

Fig. 501.



lower, the former being supported by a series of cast-iron tubular columns, *a a*, covered with climbing plants. This immense structure was 100 feet in diameter, and 60 feet high. It was heated by steam, brought from a boiler at some distance, so as not to be seen from the house; the pipes, *e e*, being laid under the floor, as in similar cases. The ventilation was effected by a series of ventilators in the plinth *b*, by opening sashes between the two domes *c c*, and by an opening in the crown *d*, all of which were opened and shut by very simple and effective means. The entrance was by a porch attached to it, a mode always necessary in such forms of houses.

The original model of this house was lately pointed out to us in the royal gardens at Frogmore, having been presented to the Princess Royal by the Messrs Bailey, with a view to its being converted into a Wardian case. For objections to dome-shaped houses, *vide* HOTHOUSE-BUILDING, &c.

The circular architectural conservatory at Dalkeith Park, of which Plate XV. is an elevation, is a detached building placed in a small flower-garden, intended to have been very much enlarged. Other arrangements, however, having since been made,

this intention is not likely, at least for the present, to be carried into effect. This is a highly enriched architectural building, and reflects great credit on the taste of the Duchess of Buccleuch, at whose suggestions it was erected; and also on William Burn, Esq., the eminent architect, under whose directions it was built. It is the most elaborate, and, probably, the best specimen of a truly architectural conservatory in the kingdom. The situation has been unhappily chosen, being too low, lying in a valley by the river side, instead of being upon rising ground. Such a house should have stood on high ground, surrounded by an architectural flower-garden, approached by three or more distinct flights of steps, and encompassed by highly ornamental mural parapets and pavement terraces, with richly laid out parterres, in a style corresponding with the architecture of the building. One flight of steps, and one terrace, about 3 feet in height, surrounds the house; but, from the low level of the ground, a sufficiently grand effect has not been produced.

The present terrace and richly carved balustrade are in excellent keeping; beyond this, however, should have been an architectural garden, and, descending from that level, another in the same style, of greater diameter, also enclosed by a parapet, the descent from it leading to the natural ground-level. Within this latter garden should be placed fountains, statues, and vases, the two latter arranged by the sides of the four principal walks, which should have approached the house from the four cardinal points. Had the situation otherwise been good, all this could have been effected artificially, namely, by elevating the floor of the house 20 feet or more above its present level, and forming the first terrace round it on arches, and the receding ones solid, falling to the natural level of the grounds.

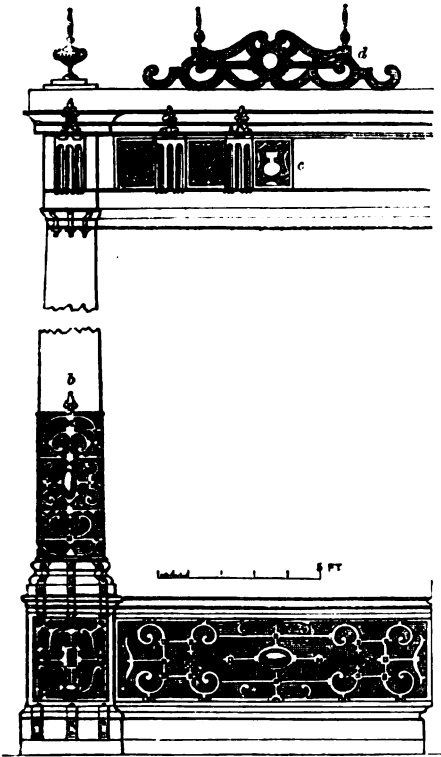
The whole of the building is of beautiful white sandstone, the best in Scotland, but, unfortunately, as is the case with all soft stones of this kind, very subject to become discoloured from the growth of lichens and other minute mosses, which require much labour in removal.

The lower parapet, of which fig. 502 *a* is a portion of one of the divisions or panels, is richly carved.

The circular pilasters, *b*, rise from a

square base, and are richly carved about one-third of their height. These support

Fig. 502.



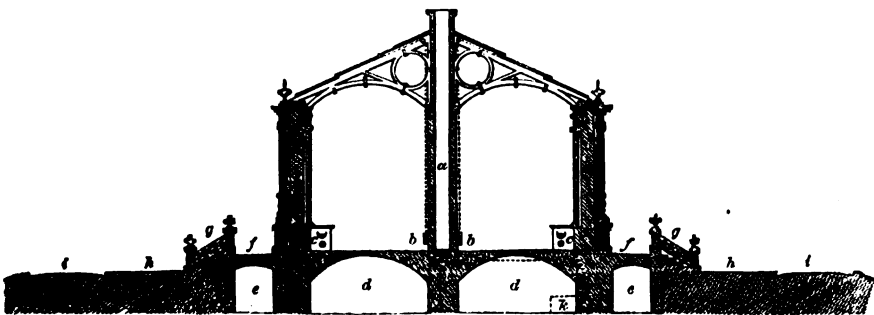
the roof and also the entablature *c*, and the richly-cut open parapet *d* over it. Behind this parapet is the gutter for taking away the rain water, which is conveyed in pipes set in the centre of two of the pilasters, perforated on purpose, into two large stone cisterns in the cellar underneath. The stone carving all over the interior of

the house is equally rich with that without.

The roof is of wood, in angular sashes, supported by unnecessarily heavy girders, giving the interior a heavy and confused appearance; and this, together with the chimney rising from the centre of the floor, although equally rich in stone carving with the rest of the building, destroys the internal effect. This will be seen by a glance at fig. 503, which is a cross section of the house.

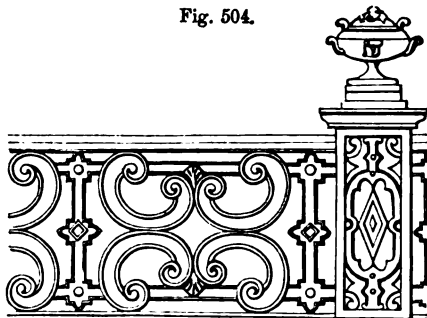
Had the roof been a simple dome, without the apparently unnecessary trussing, and the chimney omitted, the house would have looked lighter, and in imagination would have been larger. Architecturally reasoning, however, the trussing and chimney are in correct keeping with the rest of the building. In the cross section *a* is the chimney flue; *b b* the balance weights by which the top lights are drawn up and down; *c c* the position of the hot-water pipes under the stone table, for plants, which surrounds the house—(these pipes are partially hidden by a very elaborate cast-iron trellis, in exactly the same architectural style as the house;) *d d* is the cellar under the floor of the house, in which are placed two furnaces and boilers, as well as two large cisterns for holding rain water. This cellar, although in reality intended for the furnaces, and for giving height to the building, is found valuable for potting the plants, and keeping all material, such as coal, ashes, mould, &c., out of sight, and it is also used as a mushroom house; *e e* is a vaulted passage which goes round the house, and communicates at both ends with the cellar; *f f* a broad polished pavement walk which surrounds the house, and is approached by flights of steps, provided with highly cut hand-rails,

Fig. 503.



marked *g g*—this pavement walk forms a narrow terrace, with a rich open parapet, fig. 504, divided into panels by square

Fig. 504.



pilasters, finished at top with elaborately carved vases; *h h* is the grass lawn; *i i* a broad gravel walk, leading from other walks to the steps of the pavement terrace; *k* the position of the furnaces; *l* the direction of the smoke-flues from the furnace to the chimney.

The whole floor is paved with polished Arbroath pavement. Formerly a cast-iron stage occupied the centre of the house, leaving a passage of four feet between it and the stone table. This was removed some years ago, and as the plants which occupy the house are large, they stand upon the floor.

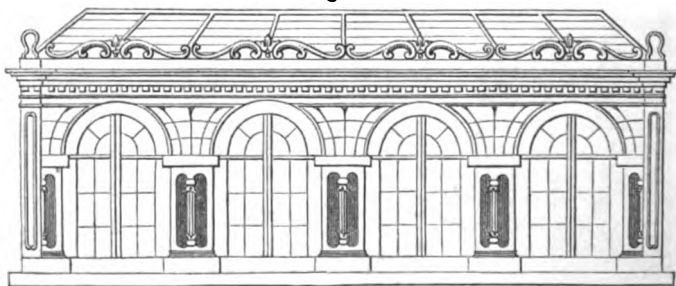
For elaborate workmanship and elegance of design, this house, as an architectural conservatory, is not equalled by any we have seen, nor is there perhaps in Britain a finer specimen. The arrangements for heating are very properly under the house, as has been already mentioned, and are therefore quite out of sight. Two hot-water boilers are employed, though one would have been sufficient; and the pipes surround the house under the side platform. We may here observe, that the general error has been

fallen into of connecting the stone platform with the external wall of the house, thus completely shutting off the plants on it from participating in the least in the heat arising from the pipes. We may also state that this house was one of the first, if not actually the very first, heated in Scotland upon the hot-water principle. Although it was glazed with double thick glass, it has suffered much from bad glazing, the laps being much too broad.

Many rather severe criticisms were passed upon this house after it was finished; and it was very generally predicted that plants would not grow in it. Such, however, is not the case; for we find that plants thrive as well in it as in any of the other nine plant-houses erected in the new garden by ourselves. The ventilation is copious, and is effected by the top lights sliding down over those below them, and being suspended by balance weights and copper chains, as seen in the cross section, which hang down round the central column; while the whole of the side windows of the house, which are in two lengths, open upwards and downwards. This, although very well during the heat of summer, is by no means adapted for winter ventilation; for, as in all cases of high side ventilation, the cold air blows at once on the tender plants within, before it becomes at all warmed by the temperature of the house. This might have been readily remedied by bringing in air under the pavement walk, and terminating these air-pipes close to the floor under the hot-water ones.

As another example of a detached architectural conservatory, fig. 505, we shall give one of those at Alton Towers, the princely although extraordinary residence of the Earl of Shrewsbury. This

Fig. 505.

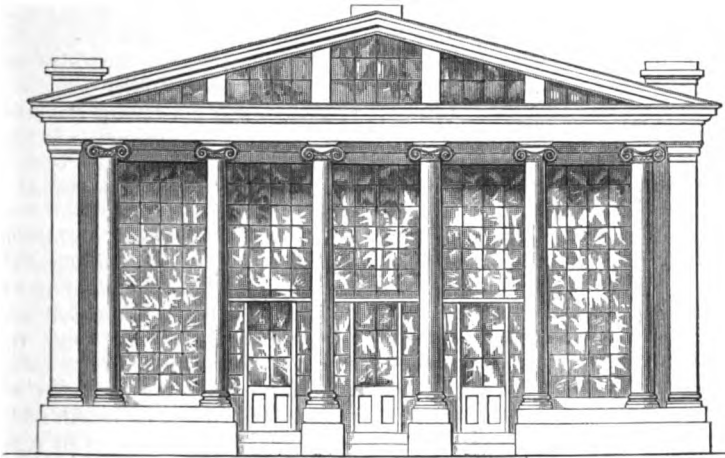


house, which is from the designs of Mr Abraham, resident architect to that nobleman, has been condemned by some writers as being heavy, dark, and unfitted for the end in view. We, however, think differently; and although it is not altogether what we think the *beau ideal* of a first-rate architectural conservatory, still

there is something so original in it altogether, that we deem it a fit subject for republishing. Though not to be entirely copied, it may give ideas in the composition of one of a greater merit.

The detached architectural conservatory at Kew, of which fig. 506 is an end elevation, and 507 a cross section, now

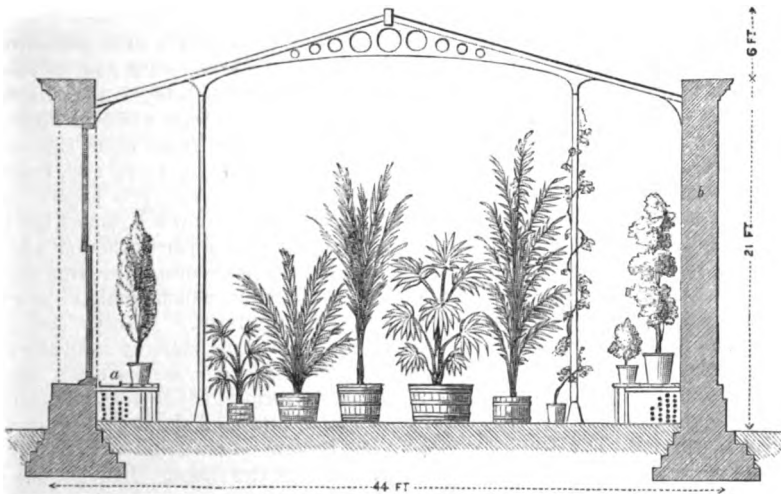
Fig. 506.



occupied with specimens of New Holland plants, is in a different style, and, although much more massive than necessary, is in itself a house of considerable merit, and one in which plants may be cultivated to very great perfection. This house is 87 feet in length, 44 feet broad and 26 feet

high—proportions we think exceedingly well fitted for the object in view. Ventilation is effected by the windows along one side letting down. The back wall *b* is solid brickwork, with the exception of three windows, all of which let down. By this it will be seen that the ventilation is by

Fig. 507.



no means perfect, nor sufficient. The roof is of iron, with metallic supports, but the side windows are of wood—the panes of glass in them being 14 inches by 10. The larger plants are in tubs and large boxes set on the pavement floor; the smaller ones are set on stages along the sides—the front one having an evaporating trough *a*, 18 inches wide, along the side next the glass, and immediately above the hot-water pipes, for the purpose of keeping up a humid atmosphere. The heating is by Perkins's coil-pipe boiler, of which there are two. The command of heat is found to be sufficient. The columns between the front and end sashes, as will be seen by the elevation, as well as the base and entablature, are of stone. This house, to be complete, should have the solid back wall removed, and glass substituted, similar to the front and ends.

In connection with this house, it may not be uninteresting to state that three conservatories exactly alike were erected in the grounds at Buckingham Palace, from designs by the late Sir Jeffrey Wyattville, of which this is one—it having been removed to Kew by William IV. The second was converted into a royal chapel; and the third still remains in the private grounds attached to Her Majesty's town residence.

The detached conservatory at Sion House, shown on Plate XVI., is elegant in design, and of superior workmanship. It has, however, the fault of being too narrow for its length and height, and also of having the back walls of masonry instead of glass. This splendid structure is in the Italian style, and was designed by Mr Charles Fowler, an architect of great taste. It is surrounded in front and at the ends by a chaste architectural terrace, and connected at the centre and ends by spacious flights of steps, with an architectural flower-garden, better designed than originally planted. The ground-plan will show the arrangement, which consists of a parallelogram centre, the dome of which is 60 feet high, and glass on all sides, adapted to the culture of stove-trees and large plants. The two wings form each a crescent, terminating in two parallelograms chiefly used for greenhouse plants, oranges, &c. The front elevation consists of stone piers and cast-iron lights:

the whole of the roof is composed of the same material, and partly glazed with plate glass. The whole is heated by two steam-boilers placed in a building at a considerable distance, and well shut out of sight. Ventilation we have always considered as imperfectly effected in this range, and to this may be attributed in a great degree that want of success which, for years after its erection, was found to exist—a result which was experienced in the cultivation of many plants, not only in this conservatory, but also in others constructed upon similar principles. The crescent wings connecting the centre with the terminating divisions are much too narrow, which, with the opaque back wall, gives them the appearance of ordinary greenhouses.

The Royal Botanical Society of London's conservatory in the Regent's Park, of which only one-fourth of the original design has as yet been finished, is a structure very much to our mind, the more especially as it is not carried to too great a height. That portion of it which is finished is 175 feet in length and 75 feet in breadth. "It consists of a series of curvilinear span-roofs, the centre one being 40 feet in height and 50 feet in width, and the two others on each side of it being about 25 feet in height and the same in width. They are supported on rows of iron pillars, which are tubular, for the purpose of conducting rain water from the roof to the cisterns, to be made available for watering the plants. The centre span has a semicircular end standing out about 25 feet from the front line of the building, forming the principal entrance, in which the broad walk leading from the south gate terminates. A span-roof of the same height and width as the others (25 feet) starts from each side of the principal or centre arch, and, extending along the front at right angles to the other roofs, presents a fine-looking frontage resting on a perpendicular elevation of about 10 feet—thus improving its general appearance, which would otherwise be of a zigzag form. At each end of the building a curve, starting from the spring of the upper one, comes down near the ground, forming, as it were, a lean-to curvilinear house of about 12 feet in width, but having no partition to divide it from the rest of the house. In regard to heat-

ing, this is effected by hot water, which, entering at one corner, is made to travel in six coils of 4-inch iron pipe round the whole area, within a short space of the boundary, and in four pipes up and down the middle of the house. The pipes are enclosed in drains about 3 feet deep, which are connected with each other at right angles by hollow chambers or drains, for the purpose of conducting the heated air across the space intervening between one row of pipes and the other—the warm air rising through shafts closed in with iron gratings, and placed at distances varying from 15 to 25 feet square throughout the entire area.

“In addition to the pipes, an iron tank, 2 feet in width, and 6 inches in depth, passes all round the inside, close to the glass, which comes down to the ground all the way round. This tank is furnished with openings for the escape of vapour, which can be closed when required, and an aperture, covered with a grating, is left along each side of the tank, to allow the heat radiated from the sides to escape into the atmosphere of the house. The whole is warmed by two of Burbidge and Healy’s ribbed boilers, each measuring 29 inches in width. Each boiler is presumed to heat 2500 feet of 4-inch pipe. The chimney and boiler are at some distance from the house, to which the pipes are led through a covered drain.”—*Gard. Chron.* For the mode of ventilation, which is, of the kind, very complete, *vide* section VENTILATION. The internal arrangements are quite a departure from the stiff and formal style generally followed in structures of the kind. Here, so far as the space enclosed will admit of it, the plants are grouped in clumps, while specimens of extra merit stand singly, the majority of them being in a portable state, so that the arrangement can be varied or changed to suit existing circumstances; and ample space is afforded between them, so that visitors may ramble amongst them with as much freedom as in a shrubbery in the open air. A portion of this fine structure is separated from the main body by a glass screen, and is kept at a much higher temperature, to accommodate the tropical plants growing in it—exemplifying what we have elsewhere noticed, that glass structures, however large, may be partitioned off by

glass screens, to suit any circumstances of temperature or culture. In this part, a very successful attempt has been made to give additional interest to the interior, by elevating the surface considerably, and giving it the character of rock-work, adding to the extent of promenade, as well as placing many of the low-growing plants much nearer to the light, and enabling the visitor to extend the range of vision over the greater part of the interior. The whole structure is composed of iron rafters and sashes, part of which are movable, for the purpose of ventilation. Were this structure finished according to the original plan, it would be one of the best specimens of hothouse architecture in existence, exceeding even that at Kew in the correctness of its proportions—if not architectural, at least cultural.

On the subject of conservatory-building we have the following very sensible remarks by Mr Marnock, in a leading article in “*The Gardener’s Journal*”: “In the arrangement and construction of horticultural erections of all kinds, and especially such as are of large dimensions, LIGHT is decidedly the first and most important question to be considered. An architect is by education taught to study and apply principles which, when carried into effect, as we sometimes see them in the construction of conservatories and plant-houses, are too often in direct opposition to those laws which nature has determined as essential to the development of vegetable life. The architect, guided by the principles of his own art, must of necessity, if the erection be one of importance, introduce opaque pilasters or columns of due proportion, with frieze, cornice, and blocking course of the same material: add to this, what is a common accompaniment of ordinary conservatories, the back and end walls of masonry. Such conservatories may be suitable asylums for the blind, but they are ill adapted for the growth of plants. If, therefore, our experience be worth anything, nothing can compensate for the want of light, nor can anything justify the adoption of a single square inch of opaque material in any part of the roof or sides, from the level of the floor upwards, except so far as the strength and durability of the structure



itself may require. This is unquestionably essential to the growth and perfect culture of what we are in the habit of designating stove and greenhouse plants; and we do not at all understand why the same principles should not be alike applicable to forcing-houses, no matter for what purpose they may be required.

"It has often occurred to us that the usual arrangement of such structures greatly disfigured and injured the effect which garden establishments would otherwise produce. Instead of the customary mode of placing a lofty sloping roof of glass against the south side of an equally lofty brick wall, with lean-to sheds on the north, for the most part slovenly, and always unpleasant as objects seen within the garden—instead of arrangements of this kind, why not construct some of the various forms of span-roofed houses, or a series of spans running north and south along the centre of the garden, with glass on all sides to within a foot or so of the ground, and surrounded with well-kept gravel walks? We believe the time is not far distant when gardeners will no more tolerate the existence, and far less attempt to defend the necessity, that any portion of a hothouse should consist of opaque walls, than they would attempt to eulogise the superior advantages of a permanently clouded sky for imparting high flavour to their fruit, or ripeness and firmness of woody texture to the buds and bearing wood of the future year."

The same authority is particularly anxious to direct the attention of gardeners to endeavour to "show their employers the impropriety of spending large sums of money in the erection of architectural conservatories for the growth of plants: such structures are proper places for the display of sculpture and works of art, but they have no other utility. A shell of glass of the lightest and slightest description, consistent with due regard to strength, will afford the greatest enjoyment to the family, because in such the plants will thrive. A conservatory is essentially a place of amusement for females, and ought no more to be detached from the mansion than the music-room or the billiard-room. We should, of course, equally with the architect, object to join a mere shell of glass imme-

diately upon the massive masonry of the mansion, and would connect the one with the other by means of a corridor or covered-way of greater or less length, according to the circumstances. Then, instead of spending £5000 or £10,000 to cover a few square yards of ground with a mass of expensive but useless masonry, we would say, spend it in a manner adapted only to the growth of plants; and on this principle £10,000 would cover an acre of ground, or any quantity in the same proportion."

We do not, however, go so far as entirely to exclude architectural conservatories: in many cases we prefer them, the more especially when forming part of the mansion; but we would, in all such cases, adapt them as nearly as possible to the style of architecture in which the house is built; and we would furnish them with trees or plants that would prosper in them. The conservatory we hold to be as much a place for showing off plants already grown, or in bloom, as a structure for their growth; and we would have houses for bringing them to that state adapted to the purpose. We also hold the conservatory to be a part and portion of the mansion, and as necessary an appendage to it as the picture gallery, music-room, or billiard-room. It may with great propriety be attached to a lady's boudoir, and opening into it, as is the case with Lord Ashburton's at the Grange, where the conservatory forms no small feature in the general elevation of that splendid mansion, a chaste Grecian building—while it is a house in which plants have long been known to thrive to admiration.

Unfortunately, in writing upon any subject, man is apt to be led away, to a certain extent, by the train of thought passing in his own mind at the moment, without waiting to see whether all the world is following in the same path. Now, it appears to us that conservatories ought to be looked upon in more lights than one. No doubt a conservatory, expressly got up for the cultivation of plants alone, without regard to any other object, should have all the light possible; and such, we would say, should be the conservatories in botanical establishments. But a private conservatory may, without any breach of good taste,

or good sense either, be attached to the owner's dwelling, so that it can be visited at all times without inconvenience, and indeed, upon fitting occasions, thrown open so as to form part of his house. Again, a conservatory may be erected in some part of the grounds as an object to be seen from some particular point, or it may be attached to a flower garden, in the Italian or similar decorative style. In either of the latter cases, the conservatory should accord with the architecture of the mansion: it should be an object consisting of something more than a mere sheet of glass, and ought to be in strict keeping with the garden of which it is to form no unimportant part.

In the first case, we hold it to be a house to show off plants already grown, and brought into it for the enjoyment of the owner, and to be kept always gay with flowers supplied from other sources. There may, indeed, be permanent trees in it—such as oranges, camellias, and some creeping plants also. Such a house, therefore, if nearly all glass, and much exposed to the

sun, would be the very worst possible place for the purpose of retaining the flowers in perfection for any length of time;—too warm to be enjoyed during the day, and, if not exceedingly well fitted and kept in repair, too cold and draughty during the night, when evening parties might wish to promenade in it.

An effective and imposing conservatory was once attached to the Regency Cottage in Windsor Park; but, like most of the gardening works of that period, it is now talked of as a thing that was. We allude to the house because it was *actually* in the *cottage style*, in form a parallelogram terminating in a circular saloon, which latter was thatched without, and the ceiling

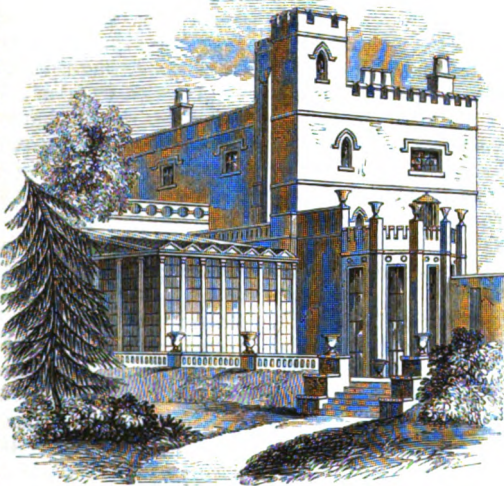
covered with the bark of trees and cornices formed of pine cones. This house formed the termination of the principal suite of apartments, which all opened, by means of movable partitions and very wide doors, into one grand promenade.

At Pain's Hill, Clarence Lodge, &c., the conservatories form good adjuncts to the mansions, and the one attached to Chatsworth, even with a bad exposure, is an additional luxury even in the palace of the Peak; and the same may be said of that at the Deepdene. Of those that are incongruous and completely out of place, we may mention that at Trent-ham, at the entrance to the house, those at Tottenham Park, Welbeck, &c., as being amongst the

worst. That at the Deepdene, fig. 508, forms not only part of the elevation, but of the general design of an Italian residence considered as a model. How far a conservatory attached to a castellated mansion would be in good taste, we are not prepared to say, not having had an opportunity of seeing one, although we know that such do exist; and, as an instance, we

may mention that at Swinton Park, where the conservatory is built to correspond with the adjoining castellated mansion, plants have been grown in it to a very high state of perfection. We have, however, ventured to attach one to a strictly Norman-Gothic residence at Dunnemarle near Culross, fig. 509, which, we are told, has met with commendation. The conservatories at Alton Towers we consider objectionable, as there was no positive necessity for their being so strictly architectural to the extent they are, they being disconnected with the house, and not even in the same style. They partake too much of house, and too little of garden architecture—two entirely different branches of

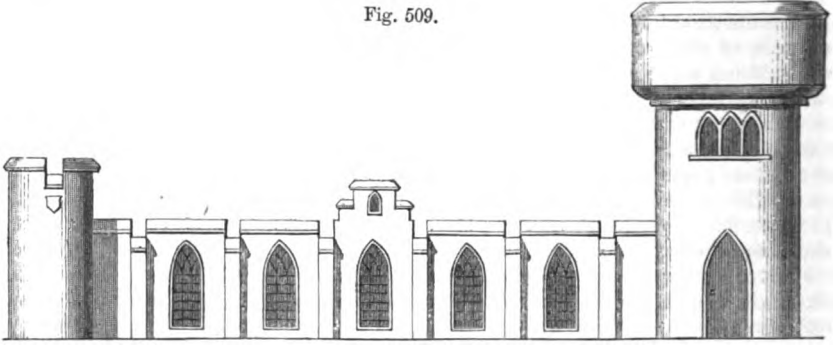
Fig. 508.



the same art; but everything at Alton Towers is done in a way peculiar to itself. The architectural conservatory at Dalkeith has been much criticised, and

although we disapprove of it in some respects, and in none more than in the enormous cost, which would have built an excellent house ten times the size, still we

Fig. 509.



find it a good house for large specimens of plants to grow in.

There are two aspects, we think, in which conservatory-building should be regarded—namely, external effect and internal convenience and fitness for the end in view. If external effect is desired, it can scarcely be looked for in a mere sheet of glass, whatever the form or however transparent it may be; but if the cultivation of plants be the object, then let us have light, and as little architectural display as possible.

For the following designs, Plate XVII., we are indebted to Messrs Mackenzie and Matthews, eminent architects at Elgin, who have recently executed this building for a gentleman in the north of Scotland. As a plant-structure in connection with the mansion, it is very complete, both in regard to convenience and effect. It is evident, however, from its size, that it is intended to be kept supplied from another greenhouse, where the plants are to be brought into a flowering state. The details are so complete that further description is unnecessary.

This may be called a town conservatory, the upper part of which might appropriately enough be placed over some of the offices, and entered from the drawing-room or breakfast-room. As an agreeable adjunct to a villa residence, it will recommend itself; and even, upon a larger scale, it might be happily enough connected with a house of considerable magnitude. Indeed, it were well if ladies would adopt such plant-structures in

connection with their rooms, instead of continuing the unhealthy and plant-destroying system of having them placed in their sitting-rooms. The communication with such a conservatory, to be complete, should have a double door—that is, one of glass and another of wood, the former to be all in one piece, of plate glass, and, like the other, made to run back into a recess in the wall. When privacy is wished, the wooden door may be used; and when the plants are wished to be seen, the glass door is to be substituted; or both may be slid into the recess, and the conservatory thrown open to the room. Besides the enjoyment arising from the mere sight of the plants, or their odoriferous aroma, such an arrangement would incite even a valetudinarian to quit his couch and take a stroll amongst them. Such structures should be glazed with a slightly obscured glass, so that the sun's rays during summer may be partially modified, by which means the plants would remain longer in flower, and greater privacy would be enjoyed by the owner. In certain cases it will be desirable to have a private mode of entrance for the person who attends to the watering, &c., to avoid his having to pass through the rooms. This may be effected in a variety of ways. For example, if a flower-stage occupies the centre of the house, a trap-door may be placed under it; or a spiral metallic stair may be placed on the outside where least seen, and where the most ready means of entering by a small window in the side of the

structure may be effected. The door of communication should be placed opposite to the centre of the conservatory; and, like the subject of our illustration, the building should be heated by hot water.

The conservatory at Dunnemarle (fig. 509, already given) will be objected to by the advocates for mere glass coverings, on account of the massive elevation. This, however, was necessary, as it constituted part of the mansion; and, as it is intended to form a pleasant promenade to the owner, who is unable to take exercise at all times in the open air, more than a structure for the cultivation of plants. It also forms a connection between the house and the garden, the walls of which are built in the same style, (*vide* section GARDEN WALLS,) and join the conservatory at the end farthest from the house. A mere glass case in such a situation would have been in as bad taste as the lean-to conservatory existing upon the same spot prior to the architectural improvements being commenced. We have elsewhere stated that light, to be beneficial to plants, must fall upon them perpendicularly, and that horizontal light is of very little moment. Here, adapting the plants to the circumstances of the case produces, as it always will do, a happy result. The proprietor is fond of camellias and orange trees, and certainly possesses not only the best collection of the latter to be found in Scotland, but the best grown specimens also. This house is span-roofed, that roof being, however, hidden from the terrace in front by the parapet, which is carried sufficiently high only to effect that end, and to shut out as little sunshine as possible—it is found sufficiently light, not only for the two genera above named, but also for many other conservatory plants, as well as creepers up the walls and over the roof. The roof is carried up to a considerable pitch, because, on account of the ground falling immediately beyond the terrace to the depth of 80 or 90 feet, it cannot be seen, nor is there any part of the grounds from which it can. The level of the floor is the same as that of the ground-floor apartments and entrance hall; and, at the height of 12 feet, a balcony occupies the whole end of the house, from which the proprietor can view the whole of the plants by stepping out of

her private sitting-room upon the balcony; and, as this room is only separated from the conservatory by large folding doors, almost the same enjoyment may be had by sitting in any part of it. This conservatory is heated by hot water, the boiler being placed in one of the offices behind; and arrangements are made for a bath joining the conservatory being also heated from the same fire. The water from the roof is conveyed to a tank under the floor, so that a supply is always at hand without the necessity of carrying it from a distance.

Indeed the conservatory may be considered as a covered or exotic garden, in which the owner may take recreation and exercise when the weather prevents him from enjoying himself in the open air, and at times, also, when business or sickness confines him to the locality of the mansion. Architecturally speaking, there are some mansions to which it would be bad taste to attach a conservatory, and there are others where situation also steps in; but, generally speaking, these cases are few compared with the many where such structures may not only be added with effect, but also with comfort. The Italian style, for example, can scarcely be said to be complete without such an appendage—as is sufficiently illustrated both at the Deepdene in Surrey, and at Biel in East Lothian. For the effect of the former, *vide* fig. 508. We do not at this moment recollect the details of the former, so as to say how the opaque wall behind could be removed; but the latter we have visited lately, and we would decidedly recommend the removal of the back wall, and the substitution of glass for it. This would greatly lighten the north or entrance front of this fine mansion, and be most advantageous to the plants. No one of taste, or at all acquainted with the Italian style of architecture, would wish this house removed. It forms the termination of the south or garden front, and is on a level with the principal suite of apartments, communicating with them. From it we look down upon terraces, and exceedingly well-planted banks of evergreens and ornamental trees, to the gardens, some 60 or 80 feet below—the eye ranging up and down a very interesting valley, with a pellucid stream of water, which, by the

by, might be greatly improved by showing more breadth and depth of stream. That such conservatories as the two we have instanced—and we could point out many more—are ill adapted to the growth of plants, is not the fault of the principle, but of the execution. And here we quite agree with our excellent friend Mr Mar-nock, that architects have not sufficiently studied the subject, so as to make these buildings plant-habitations, and at the same time mural decorations to the mansion. The reason is obvious: the architect has in too many cases treated the gardener with contempt, and has acted in many cases unjustly towards his employers, by not making himself perfectly acquainted with those natural laws which regulate the growth of plants, or calling in the aid of those who do. That there are some amongst that honourable profession who have done so, there can be no doubt; and it would be an act of great injustice in us were we not to declare that, in one case in particular, that of the late William Atkinson, Esq., the most celebrated garden architect of his day, we know from many years' intimate acquaintance with him, he would not send the plan of a common vinery, nay, even of a common cucumber frame, from his office, without consulting professionally the most eminent garden authorities within his reach. Mr Atkinson's guiding principles in garden architecture were economy and the raising structures fitted for the end in view. Of course he met with the opposition which all reformers encounter; but, strange to say, scarcely one of his principles has been controverted or abjured. It is a want of co-operation in the two professions, and a total ignorance of the subject on the one side or the other, that has led to such incongruous and unsatisfactory erections as we so often see in this style of building; and until either an amalgamation of judgment takes place, or a very great improvement in the information of both the parties concerned, we need not look for much improvement.

With the view of rendering the conservatory useful as a place of exercise or recreation to invalids, and enjoyable at all seasons, we may add, that in these days of tunnelling we see no reason why a conservatory, at a considerable distance

from the mansion, may not be very comfortably reached by this means; and in that case it may be, by all means, a sheet of glass. The tunnel need not be so hideous as the Box one, or those near Sheffield: it may be sufficiently lighted from above, or laterally, and made interesting by containing a collection of geological or fossil specimens.

The large conservatory at Chatsworth—the mammoth of its kind—is, internally viewed, a splendid sight. The external elevation is wanting in effect, and only surprises by its magnitude, even when contrasted with the natural scenery around it, which is upon a scale of no ordinary size. The sensation, on entering the massive portal, is not only one of surprise, but of pleasure, and one feels as if entering a new world. The length is about 282 feet, and the breadth 120 feet—consequently it contains 33,840 square feet. It is about 60 feet high. At the height of 25 feet from the ground, a balcony is carried round the centre part of the house, to which access is gained by an easy and rather grotesque stair, built within a mass of rock-work, of which, however, we rather question the taste in a glass-house. A broad walk surrounds the whole, leaving, however, space for a substantial stone table between it and the glass, for the smaller plants in pots to stand upon. A spacious straight walk passes through the centre from end to end, while another intersects it at the middle of the house. The entrance is at the ends,—the whole having the appearance of a cathedral, with a large aisle in the centre, and two smaller ones forming the sides. This immense structure is entirely of wood, and glazed with sheet glass of a large size. The smoke is carried away in a tunnel to such a distance that the nuisance, which would otherwise be very offensive, is completely got rid of. The roof is curvilinear, and in the ridge-and-furrow manner. The astragals are not in the usual rebated form, but a groove is cut out in them, for the reception of the glass, by machinery of Sir Joseph Paxton's invention; thus saving an immense amount of labour, and producing a much more efficient roof, as the small quantity of putty requisite to fill in round the glass cannot be acted on by the weather, as in ordi-

nary cases, where it is constantly falling off, and admitting the wet into the astragals, and consequently hastening their decay. From the nature of the roof, it follows that it is a fixture; but ventilation is effected by various openings, mostly acted upon by machinery. This is the only part of this extraordinary structure that we think defective, as an immense quantity of heated air must accumulate towards the top, for the escape of which we think effective means are not sufficiently provided.

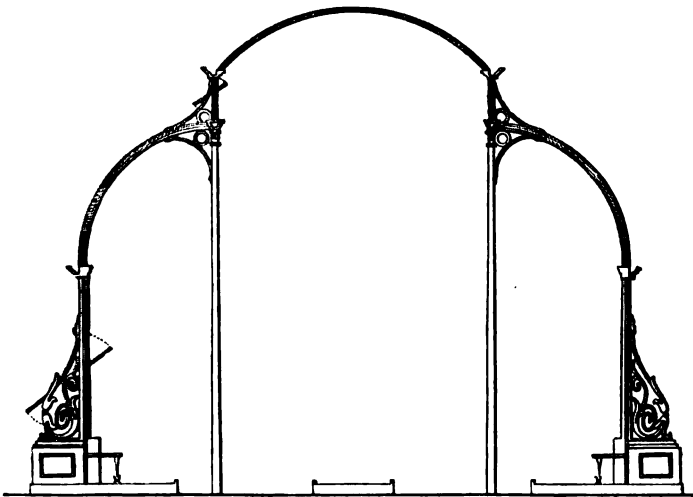
This immense house is heated by hot water in a very complete manner—which is sufficient proof of the efficiency of water, and the absurdity of employing steam. The pipes surround the house just within the side walls, and run parallel to each other, in two chambers under the floor level. The whole of the furnace department is in a vault under the house, and completely hid from sight; the entrance to which, and for supplying the furnace with fuel, is by a tunnel ingeniously contrived. This stupendous structure reflects great credit on Sir Joseph Paxton, who designed and superintended the erection of it; and also on his Grace the Duke of Devonshire, for his liberality in affording the means.

Plate XIX. shows the elevation and ground-plan of a conservatory designed by Richard Turner, Esq., of Dublin, one of the first hothouse architects of the day. Fig. 510 is a cross section of the

same. The whole structure is metallic—the ribs, gutters, and larger members being of cast-iron, while the astragals and smaller members are of malleable iron, fabricated in that superior style of workmanship for which the Hammersmith works have been long and justly celebrated. The base or parapet is also of iron, divided into panels, resting on a polished ashlar plinth. The panelling between the piers is all made to open and shut by mechanical arrangement, admitting, when opened, a most abundant supply of fresh air, close to the floor, around the whole structure. The heated and impure air is made to escape by the perpendicular sashes, which connect the main body of the house with the top part, in the central division, which sashes are pivot-hung at their centres, and moved simultaneously by the action of a spiral screw and rod, which is brought down in connection with one of the columns, on each side, that support the upper part of the roof. The ridge in the two wings opens throughout its whole length for ventilating purposes also. Those parts of the sides shown with darker lines are opened during the heat of summer, so that the temperature of this capacious structure may be lowered nearly to that of the open air. The elegant bracket-like projections in front of the exterior columns add greatly to the strength, as well as to the appearance, of the whole. The entrances are by well-proportioned doors placed at both ends, and

also at the two opposite sides of the centre division. The interior arrangement will be seen by the ground-plan, the centre part being divided into four beds, while the two wings contain a longitudinal bed each. The floor around and between these beds is laid with polished pavement; and a very elegant

Fig. 510.



cast-iron plant-table, supported on ornamental iron brackets, surrounds the whole house, and which is capable of accommodating a large number of plants in pots, whose constitutions unfit them for being planted out in the beds, and which require to be placed near to the glass. The hot-water pipes, of which there are two flows and two returns all round, are placed under this table, the heat from which is diffused upwards through the many openings in it. The surface of the beds of soil is 2 inches below the level of the floor, to prevent the soil from being at any time washed over. They are also margined with very neat cast-iron edgings, which gives a finished appearance to the whole. The beds of soil are thoroughly drained below, and drain tiles are laid amongst the drainage, supplied with air from the vault below;—for it should be understood that, as this very elegant structure is intended to stand upon the open lawn, the whole paraphernalia of furnaces, cisterns, potting-room, &c., is placed under the floor of the centre part, which is lighted by narrow area windows close to the plinth on which the house stands, and by bull's-eyes let into the pavement of the floors, and kept flush with them. The entrance to this vault is by a well stair, covered with a neat iron grating, opening to the surface of the lawn, in the angle formed where the centre part joins one of the wings, as shown on the ground-plan. The smoke is carried off through a tunnel, which terminates in an ornamental chimney-shaft at a considerable distance, and rising from amongst shrubs. The present design has been prepared for a nobleman who wishes the whole structure to be in one temperate conservatory. But to those who may wish for a greater variety of temperature, &c., it will be readily seen that the wings can be separated from the centre part by throwing a glass partition across at the points of junction,—thus giving the proprietor an opportunity of cultivating tropical or extra-tropical plants, according to his taste. By referring to what has been said, (section GREEN-HOUSES,) in connection with the low-roofed greenhouse, of a cruciform shape, in the Royal Gardens at Kew, as to its capability of affording complete accommodation for a general collection suited to a private

establishment, it will be seen that, in the present case, the same may be accomplished, but upon a much larger and more important scale.

It sometimes happens, as in the case of the splendid gardens of Lady Rolle, at Bicton, that the conservatory, for private reasons, is placed in connection with the forcing or fruit-houses. Of this arrangement we have another instance in Plate XX., the drawings of which have been kindly placed at our disposal by Richard Turner, Esq., of Dublin. It represents a beautiful curvilinear range, having a conservatory, with straight sides and circular front, forming the centre, which he has erected at Kilikee, the seat of Colonel White, in Ireland. This range is placed upon an open lawn, and has a fine effect. The wings, which are dedicated to the growth of peaches, grapes, &c., are on the lean-to curvilinear principle, only so far improved from the generality of houses of the same description as to have their ends carried round so as completely to shut out the offices behind from being seen from the entrances, which are placed at each end. Indeed, on this excellent arrangement the principal merits of this range, in our estimation, rests. We have given this plate to illustrate this, as well as to show how a proprietor of more limited means, or having a less taste for plants, may combine his conservatory and fruit-houses together, so as to produce effect by bringing all his glass into one point of view. This structure is of metallic material—the rafters, gutters, wall-plates, &c., being of cast-iron, while the astragals and lighter parts are of malleable iron. Ventilation, as shown by the two ventilators being partly open, is in the usual manner placed in the front parapet: they are opened or shut simultaneously by a very simple mechanical operation, which throws them out at bottom, while they are hinged to the upper wall-plate above. Top ventilation is effected by means of openings near the top of the back wall, the fresh air being admitted, or the foul air allowed to escape through the ornamental iron grating which rises above the glass, and forms a part of the ornamental finish on the top of the wall. The chimney-tops are placed on the ends, more for ornament than for use. The smoke from the furnaces, as well as that

from the rooms behind, should be carried up over the front wall of the offices behind, as exemplified in the gardens at Dalkeith, Poltalloch, &c. The vestibule, or lobby entrances at the two ends, as well as that in the centre of the conservatory, are well designed, and more effective than had they been curvilinear, as is frequently seen in houses with similar roofs. This would make a very neat range of houses, and be equally well adapted either for plant-houses or for the purpose for which they are at present intended, were the back offices removed, and the whole space roofed in by a roof similar to that of the front. The conservatory could then be extended, forming nearly a square, with two semicircular ends. Of course such an alteration of form could only be justified, if fruit was to be grown, by having the ends facing the north and south, instead of, as at present, facing the east and west. For plant-houses this would be immaterial, as many plants thrive better in a northern exposure than in the opposite.

In remarking on the defects of domical houses, p. 129, it will be seen that one of our objections was the disproportion between their height and diameter—the former being too much for the latter, and the latter too small to allow of a sufficient extent of the circumference being seen at one time. We speak of the plants as arranged within them. In Plate XXI. we think this defect is greatly modified, because with increased diameter we have a decrease in height. Our present subject also of itself has much more of architectural effect than the majority of domical houses we have met with. The design is by Richard Turner, Esq. We have, however, taken the liberty to alter it in some few respects. This plate may be taken as an excellent model for a conservatory for a residence of the first order, and should, like all similar structures, stand isolated, as it can have no connection with other buildings. We have placed it on a platform 15 feet broad and 3 feet above the level of the ground around, to give apparent height to the elevation when viewed externally, without adding to the actual height within, and also that the bottom may be secured against excess of damp. The structure is entirely metallic: the internal columns for the support of the centre

dome, the pilasters forming the upright part of the elevation, the ribs of the dome, the entablature above the pilasters forming also the gutter behind them, the balustrading at base of the upper dome, &c., being all of cast-iron, the astragals and smaller members of the structure being of malleable iron.

The pilasters are cast open, to lighten their effect by the introduction of a narrow frame of glass, without lessening their strength. Ventilation is effected by bringing tubular air-drains, 6 feet asunder, through the platform or terrace on which the house stands: these deliver the fresh air into the area in which the hot-water pipes are placed, and which surrounds the whole house, and is covered with an ornamental grating fitted into the pavement and level with it. Besides this, the shaded part under the upright glass is composed of a series of metallic ventilators around the whole of the structure, which, when open, deliver the air passing through them close to the floor. Thus it will be seen that, from the number and distribution of these in-draughts of air, an amazing volume of that element will be brought within the house. This, however, on account of its buoyancy on becoming heated, would naturally ascend upwards instead of passing onward to the centre of the house. To supply this part also, four 12-inch tubular air-drains are brought from without the terrace parapet, and meet at the centre in a 3 feet square chamber; from thence the air is admitted as required into the body of the house. As with all domical houses, difficulties present themselves here in ventilating the roof. The ribs of the roof, in the present case, are not united together at the very apex, but are connected to a strong bar of iron bent in form of a hoop, and of the internal diameter of 4 feet: the inner edge of this is formed into a small gutter 1 inch in width, having two 1-inch openings to deliver any rain water that may fall on the movable ornament above the glass roof without. Across the iron hoop which ties the top of the ribs together is welded an arm, to which an upright one is attached, passing upwards within the movable top, and fashioned like a common sliding-pencil. The top of the sliding part is secured to the mov-

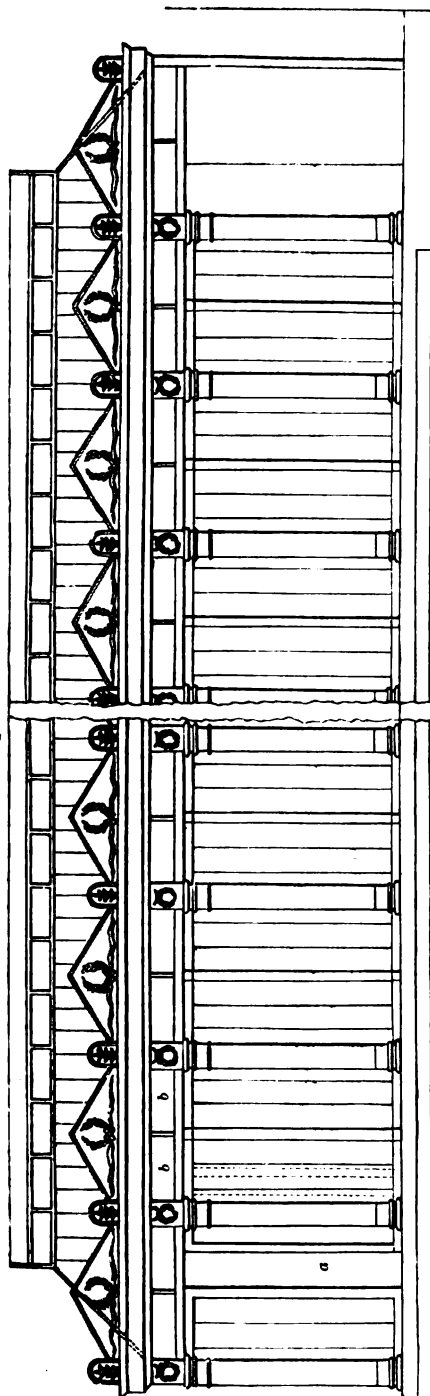


able top, while the other, or stationary part, is attached to the cross arm by means of two pulleys, and a double line of chain attached to the sliding part, and brought perpendicularly downwards to the ground: the pulling down of the one chain would draw up the sliding part of the upright arm, and so elevate the movable top to the height of 18 inches or more, according to the length of the slide; pulling the other chain would reverse the action, and draw it down again to its original position. Thus we would have the means of opening the apex of the roof to the extent of 4 feet in diameter. It would be possible, by another appliance, to bring the chains down under one of the ribs of the top dome, and from thence down one of the upright columns that support it; but the liability of this to become deranged would be a much greater inconvenience than having the double chain suspended in the centre of the house. A structure of this form and size would require to have the means of ventilation at the top of the under dome also. Here the difficulty is much more easily got over, as ventilators can be placed along the top of the under dome, by uniting two, or even three, astragals together at their top ends, and filling in the opening thus made with movable glass ventilators; and here they could be acted upon by small chains or iron rods being attached to them, and brought to within reach of the floor, by the sides of the upright iron columns of support. The internal arrangement of such a house should be to have a circular bed of equal diameter with the upper dome, and in this the tallest growing plants should be set. This may be divided through the centre by a pavement passage opposite the doors, or it may be divided into four quarters with equal propriety. This bed should be encompassed with a pavement or encaustic tile passage, not less than 4 feet in breadth. Another passage of equal breadth, and of the same material, should be carried round the house parallel to the upright sides, and be connected with the inner one, either at two or four points. There is no loss of space in having broad passages in conservatories, as the plants, when they become fully developed, will require all the head-room

that can be afforded them; while a more limited range to their roots will be an advantage. As a matter of course, the heating apparatus, &c., should be in a vault under the house, so that no litter or confusion may appear around or near such a structure. The smoke in like manner should be carried away at a considerable distance.

As an exemplification of a conservatory with glass sides, we may refer to the following figures, being a design prepared by us lately for J. P. W. Butt, Esq., of Grovefield, Gloucestershire, and intended to form a wing to the mansion, which is in the same style as our conservatory. The conservatory is 93 feet long, 16 feet high at the ridge, and 25½ feet in breadth. The whole stands on a plinth of ashlar, ascended by three steps of 8 inches each, as shown in the cross section *a a*, fig. 514, rising from a gravel terrace walk, 10 feet broad, which surrounds the house on three sides. The floor within is of polished Yorkshire pavement, and is 4½ feet broad around the sides and ends of the house; while the pavement around the centre or circular bed is 2 feet 10 inches broad. As the whole of the upright lights are movable, each forms, when required, a means of entrance; but the principal entrance is through a vestibule or corridor, which leads from one of the drawing-rooms. This mode of entrance became necessary, as it was deemed inexpedient to run the conservatory in a straight line from that room—as, by so doing, a great part of the elevation of the mansion would have been hidden; while, again, no other entrance could have been got leading immediately into the conservatory, as certain offices, which could not have been well dispensed with, come in immediate connection with its end. We therefore designed the corridor, which encloses the drawing-room window without depriving the room of light. This may be kept decorated with a stand of plants in flower, which will at all times be seen from the drawing-room, and, when the glass door is open, will form, as it were, a part of it. In passing from the drawing-room through the corridor, we enter the conservatory at a sliding door of glass, hung on the suspension principle in two parts—the one running back into the wall, and the other behind the half

Fig. 511.



sash. The end abutting against the offices, as already noticed, is, for uniformity's sake, constructed the same internally as the other ends and sides of the structure, but is filled in with ground glass, so that nothing can be seen through it : behind it is an open area 15 inches wide, to admit air and light to the offices behind.

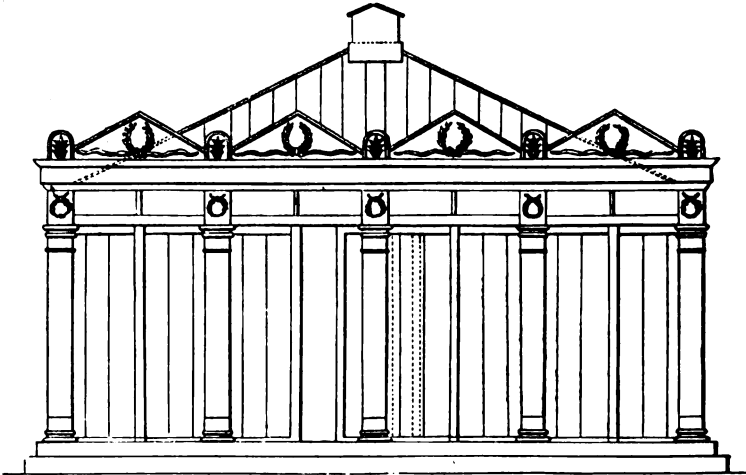
We have avoided curved lines as much as possible in the figures of the beds in the flower garden connected with this conservatory, as we propose them to be of 1½-inch slate set on edge, and the walks gravelled. The circles being too small to border with other than box edgings, we propose to occupy them with vases, of Grecian patterns, to be kept full of flowering plants, and to give elevation, as it were, to the monotony of the ground-plan. In the centre is a fountain and basin of water.

Fig. 511 is the front elevation : at *a* is shown the end upright sash partially opened, and run back behind the next to it. The fan-lights *b b*, all round the house, are filled in with violet-coloured glass in single panes. The columns are tubular, and convey the water from the gutter behind the pediment to a cistern below the house, from whence water is procured for the plants. The whole roof is fixed, and without rafters or framed sashes. The top ventilation is placed in the lantern at the top, every alternate glass panel of which is moved by machinery, as seen at fig. 31, art. PRINCIPLES OF HOTHOUSE-BUILDING. The roof of the lantern is also fixed, and of glass.

Fig. 512 is the end elevation, while fig. 513 is the elevation of the corridor. Fig. 514 is a cross section, showing at *d d d* the drainage below the bed for the plants, as well as for admitting air to their roots at the same time ; the earthenware pipes used for the purpose being closely fitted to retain any water that may find its way into them, until it is discharged at their extreme ends, where they terminate in sunk areas covered with grating. From these, air enters them,

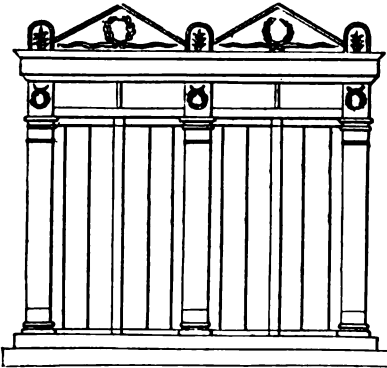
and is discharged upwards into the stone, flint, or rubble drainage *b b*, placed under the bed, through upright metallic tubes

Fig. 512.



fue under the floor pavement, the heat from which ascends into the house through highly ornamental brass gratings, and is

Fig. 513.



forced upwards by the admittance of cold air, brought in in small pipes from without; *e* is the stone plinth for supporting the cast-iron column which sustains the ridge, and the arms *f f* which curve from it, and are attached to the straining bar, extending the whole length of the house, to which the astragals are individually fastened. The lantern above the ridge shows the mode of top ventilation, every alternate panel on each side being made to open while the others are shut.

Besides the subterranean ventilation

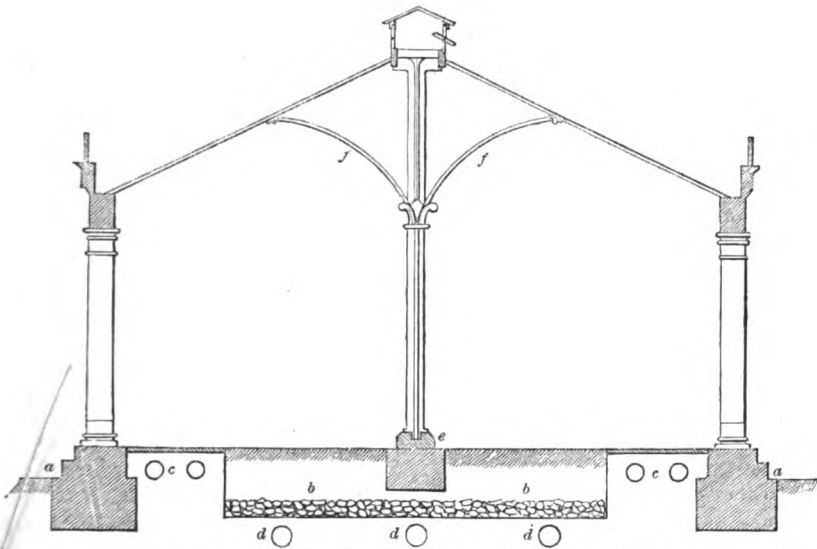
fitted to them, and dispersed regularly through the whole mass; *c c* are the hot-water pipes, placed side by side in an air-

flue under the floor pavement, the heat from which ascends into the house through highly ornamental brass gratings, and is introduced into the bed for the plants, another and more copious supply for the atmosphere is brought in through brass ventilators placed at a level with the gravel walk which surrounds three sides of the conservatory, passing through the lowermost step, and communicating with the air-flue in which the hot water pipes are placed.

It would appear, judging from the monotonous arrangement of the plants in our conservatories, &c., in general, that the whole attention of those concerned in these constructions was concentrated on the building itself, and that, however elegant it may be in form, or even however well suited to the culture of plants when finished, the internal arrangements, as far as regards the disposal of the plants, are left uncared for, beyond following up the old and absurd practice of crowding them together so that their surface of foliage may appear as much like that of a newly-clipped hedge as possible. In nature we see no such arrangements—every plant there occupies the space and situation most suitable for its existence. Why should not this arrangement be carried out in the disposal of them in our glass-houses? The thing is practicable, and, if acted upon, our houses would present a much more interesting appearance than they do as at present managed.

We are aware that this has been some with the happiest effects. The difficulty of combining horticultural conve-

Fig. 514.



niences and graceful arrangement has been happily overcome, even where the houses were upon no very extensive scale.

As plant structures may now be expected to become more numerous, as well as more capacious, we hope that attention will be directed to this matter. Our Continental neighbours have attempted something, here and there, in the way of giving pictorial effect to the interior of their conservatories, while they tacitly adhere to a very formal style of laying out the grounds around them. We, on the other hand, continue to adopt quite an opposite practice. All, with us, is grace, freedom, and expansion without; while within, as was remarked by an observing Frenchman, "we huddle our plants together upon a stage or shelf, just as if our greenhouse was a shop, and the plants were objects placed for sale upon the counters."

At Chatsworth, Sion, Kew, Leigh Park, and some other places, both the useful and the beautiful have been carried out to a considerable extent—and upon a smaller scale at Poles, in a house designed by Mr Glendinning, at Mr Dillwyn Llewellyn's in Wales, and more recently at Mr C. Walner's at Haddesdon.

Mr Llewellyn's stove conservatory is

internally arranged so as to represent a tropical forest scene on a small scale—the idea having been suggested to him on reading the graphic description given by Schomburg of the falls of the Berbice and Essequibo. In this house rockwork is introduced; a fall of water heated to a proper temperature is made to dash over the rocks and to fall into a pool which occupies the middle of the stove, forming a tiny aquarium and small island of rockwork, which, like that forming the cascade, is covered with ferns, orchids, lycopodiums, &c. Innumerable seedling ferns spring up, amongst which many species of orchids grow in all their native luxuriance. Many species are cultivated on the rocks, attached to blocks of wood or placed in baskets suspended from the roof; and all are growing in that wild yet beautiful confusion in which they are found in their native habitats. Nor is this picturesque effect all that is gained by this mode of arrangement—the plants are individually placed in the conditions the most natural to them in a strange land, and under the control of man.

Conservatory and greenhouse floors should always be laid with polished Arbroath, Caithness, Yorkshire, or Portland pavement, in large pieces, and

neatly jointed. As substitutes, we may recommend Welsh and Irish slate, manufactured by Mr Beck of Isleworth and others; or ornamental tiles, of which the Staffordshire potteries afford great variety. For small greenhouses, tile quarries 6 inches on the side, in blue, red, drab, and black, properly arranged as to colour, will make a good and lasting floor. Wright's quarries may also be used: these on a pale yellow ground have dark brown figures in pigment let in; or for houses of the first order, Minton's encaustic tiles, which can be procured in great variety of design, and, if laid, will produce a very splendid effect. Black and white marble may also be employed; but Minton's tiles look better, and have a much warmer appearance. The recent improvements in the manufacture of slate by inlaying—as shown by Mr Magnus in the Great Exhibition—are worth the inspection of those constructing houses of this description. In no department of horticultural buildings is there more ample room for still further improvement, both in respect to elegance in form and adaptation to the purpose for which they are intended, than in the department to which we are at present alluding.

At page 114 we incidentally alluded to the practicability of roofs of glass being constructed upon the suspension principle, with a view to enclose large spaces without the necessity of using internal supports;—we are now in a position to prove the practicability of such a system, and offer the following diagrams in support of our opinion. Before, however, launching a principle so diametrically opposed to present practice and opinions, it may be necessary to preface our statements with a few brief remarks. Suspension bridges—and those especially upon Drench's principle—gave us the first idea of a suspension glass roof. Bridges, in principle of construction, may be considered a species of roofing, as each arch, whatever be its form, is a roof over the area it spans. For ages they were founded upon the principle of compression, although suspension ones may be traced to a very remote date. Roofs, like bridges, were founded nearly on the same data, the compression at the ridge being counteracted by tying the points of support together, or, as is said in practical phrase-

ology, guarding against the lateral thrust which the base of all roofs has upon the walls that support them. The difference between compression and suspension—where the material employed (as must always be the case in hothouse roofs) is of the lightest and least bulky form possible—is so great, that the following data may be considered sufficient to prove the correctness of the principle:—It has been satisfactorily proved that a bar of iron, of 2 tons weight, and 1000 feet in length, will sustain in a perpendicular position, when suspended, 10 tons. A tower, for example, upon the principle of compression, of 1000 feet in height, capable of sustaining the same weight, would require in its construction more than one hundred thousand times the amount of iron. On the other hand, a bar of best iron, of an inch area at the base, would sustain itself on suspension nearly 60,000 feet in length. Now, the same bar of iron would not sustain *itself* in a perpendicular position above 40 feet in length, apart from any compressive weight being placed upon it. The greatest power in nature is the tension or lifting power, and upon this all suspension power is founded.

Very lucid explanations and calculations, as to the stability of suspension bridges upon Drench's principle, will be found detailed in the "Surveyor's, Engineer's, and Architect's Journal;" and those who study the papers therein contained will at once see the practicability of suspending hothouse roofs in a similar manner. Vibration and pendulous motion will be a different thing in roofs constructed upon the ridge-and-furrow principle from what it is in bridges, which are long, narrow structures, as well as subject at times to be loaded with very great weights, which latter is the principal cause of that motion. Hothouses, on the other hand—at least such as we would apply the principle to—would be of a different form altogether, their great breadth constituting one of the causes of the absence of vibration. Supposing a hothouse to be 100 feet square, or 100 feet in length and 100 feet in width, the vibration caused by the wind, which would be the only power acting upon it to cause a vibratory motion, would no more be felt upon it than if the roof was supported upon the compression principle—that is,

supported upon columns, walls, &c. Its only force would be in an oblique or pendulous direction upon the surface of the roof—but that roof could be so tied together externally by tension-rods, that the force of the wind would meet with resistance from them from whatever point it might blow; and when we consider that an inch bar of best iron is capable of sustaining a weight, when suspended, of nearly 30 tons, we need not fear the force of the wind upon a ridge-and-furrow roof, be its extent ever so great.

Fig. 515 shows part of the elevation of such a structure, the front or perpendicular lights being made to open by running past each other, as elsewhere explained. Cast-iron tubular columns,

10 inches in diameter, are planted in a sufficient bed of concrete to enable them

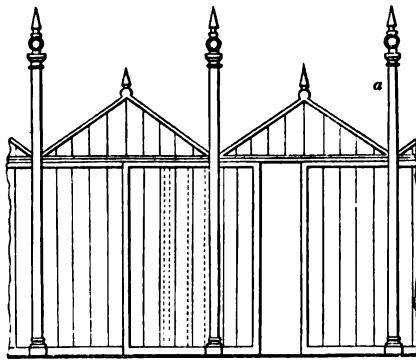
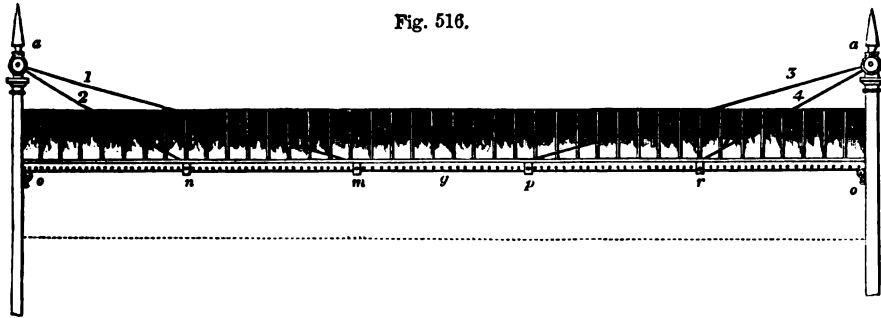


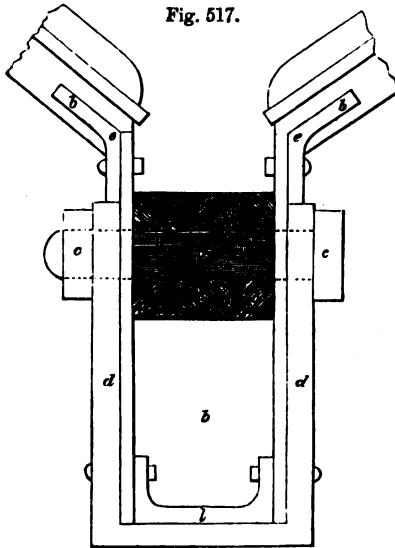
Fig. 516.



to resist the strain of the tension-rods, which are fixed to their upper end, as seen in fig. 516, *a a*. These columns may be architectural or not, according to taste, and may be finished at top with any appropriate ornament. Both sides of the structure are the same, and the columns are carried up opposite the valleys, to give the necessary fulcrum to the suspension-rods. Fig. 517 is a section of the gutters, while fig. 516 is that of the longitudinal line. The following description will more clearly explain the construction:—The gutter, as above, is formed of malleable iron boiler-plates a quarter of an inch thick, having a sole, *l*, of malleable iron rolled to the shape shown. To this bottom plate the sides are joined by rivets  $\frac{3}{8}$ -inch diameter, and 3 inches apart, as shown by the dotted line in longitudinal section. In the upper edge of the gutter are fixed by  $\frac{3}{8}$  rivets, 4 inches apart, two pieces of angle iron, *e b*, made to suit any angle which the roof may require. This gutter is made all in one length, and

divided into five equal distances, *n m p r*, on fig. 516. At each of these divisions is fixed a strap *d*, 3 inches broad,  $\frac{3}{4}$  thick,

Fig. 517.

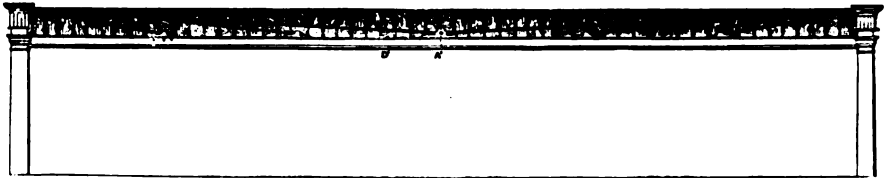


made to go round the sides and bottom of the gutter. This strap, which is made of L.M. iron, is pierced at the upper end for the bolt to pass through. These gutters are placed between two upright columns *a a*, fig. 516, having a bracket cast on them at *o o* for the gutter to rest on, 6 feet from the top. The tops of these pillars are cored out to allow the double joints of the suspension-bars, 1 2 3 4, to be inserted, a bolt of the best iron or soft steel passing through the jaws of the cast-iron pillars and joints of the suspension-bars. These bars are  $1\frac{1}{2}$ -inch diameter, of best iron, made with double joints on both ends, as shown in section of gutter,

the bolt *f* passing through the strap *d* and the sides of the gutter, and also through the double joints of the suspension-rods. The strap *d* is to support the weight, and to prevent the sides of the gutters from being torn out by the strain of the suspension-rods. This gutter may be made from 50 to 100 feet of span, and requires transverse bars of round iron crossing the gutter to keep it in a straight line. The upright pillars may be made of any pattern to suit the design of the house, and should be, for an 80 feet span, at least 8 inches diameter, and  $1\frac{1}{2}$  metal.

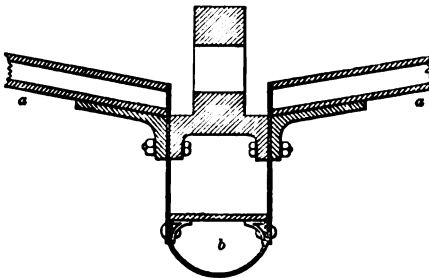
Fig. 518 shows another mode of suspending the gutters—for upon them the

Fig. 518.



whole of the ridge-roof rests. Fig. 519, section on A B, shows, upon an enlarged

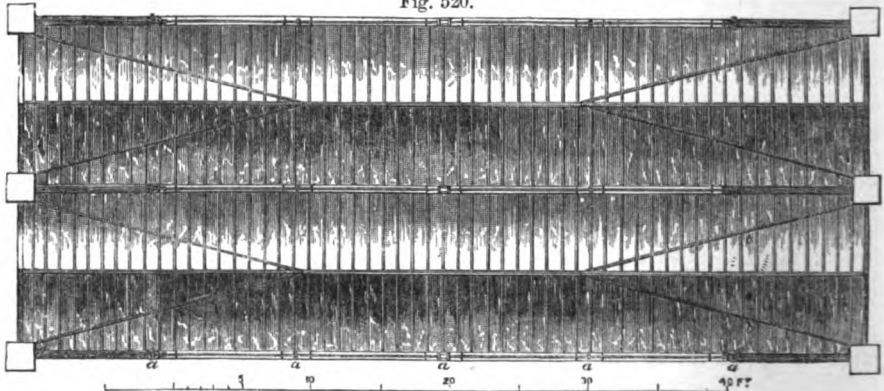
Fig. 519.



scale, a section of the gutter and its connection with the roof astragals *a a*, as

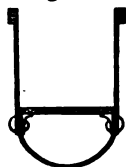
well as an open passage, formed by a perforated plate of iron or open grating, to prevent the snow from choking up the gutter, and leaving a clear passage for the melted snow-water passing off at *b*. In fig. 520, the plan of the roof, are seen the tension-rods connected with the gutter at *a a a*, while others are placed diagonally, *b b*, from the upright columns, and secured to the apex of the ridges, their use being to tie the roof together, and prevent vibration and pendulous motion. The upright columns, gutters, tension, and diagonals, are of iron, the ridges and astragals of wood. Top ventilation is to be effected by openings in the ridge, which may, for this purpose, be in two

Fig. 520.



parts, the opening being 6 inches wide, and extending the whole length of each ridge. Fig. 521 is a section on C D.

Fig. 521.



The front elevations—for all the sides are alike—of such a structure would present a straight line of columns in any style of architecture suitable to the situation and surrounding objects: their capitals and friezes would form a parapet not much exceeding the top of the ridges, which would give a finished appearance to the whole, and hide the roof, which, in most conservatories upon architectural principles, is very objectionable. The panelling or frieze between the capitals should be of glass, giving greater apparent height to the elevation, and casting less shade than if it were constructed of opaque substances, such as wood or iron.

We have submitted this style of roof to a high engineering authority, who states that there would be no difficulty in constructing such roofs to any extent in length, and from 100 to 150 feet in width, and probably even more. Those we have consulted have now prepared more detailed drawings and calculations than is necessary for our present purpose, and are ready to construct such roofs upon the shortest notice.

## § 2.—GREENHOUSES.

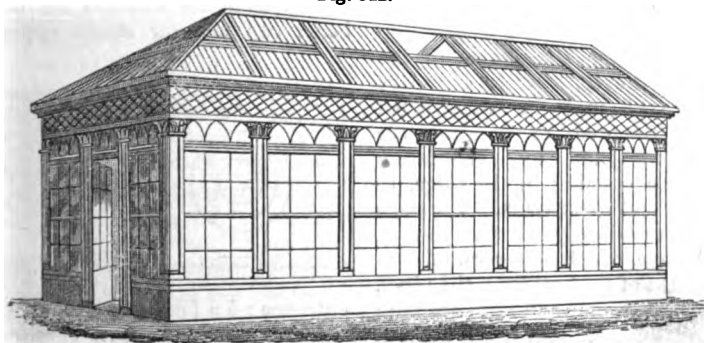
The greenhouse differs from the conservatory, principally in containing smaller plants, and these for the most part being in a portable state; and also in being a

house of smaller dimensions, and without architectural pretensions. Of all forms for a greenhouse, that of a lean-to is decidedly the worst, and that of the span or curvilinear the best. Peaches and vines may be grown to the greatest degree of perfection in lean-to houses; but greenhouse plants seldom can, as the merits of the latter greatly depend on the symmetry of form—and this cannot be attained unless every part of the plant is equally exposed to light, air, and sunshine. It is true, there are many plants that will thrive with much less light than others; but they are few in number compared with the thousands in cultivation. This we learn from the great book of nature, where we see how profusely she has clothed the mountain, the valley, and the open country; while the forest and the shady dingle are comparatively barren—at least so far as number of species is concerned. The orange, the myrtle, and the camellia, will thrive where the extensive generas *Erica*, *Pelargonium*, &c., will not long exist.

It seems now almost universally admitted that the span or curvilinear form of roof is best adapted for this purpose, and that the ends of the houses should front the north and south, although, under peculiar circumstances, they may be usefully constructed to face the east and west; the more so if they are glass on all sides to within a foot or so of the ground, as in most of the annexed illustrations.

In regard to elevation, fig. 522 is supposed to be of wood, standing on a plinth or basement 18 inches high, the better to secure the framework from decay. The pilasters are hollow, as is usual in

Fig. 522.





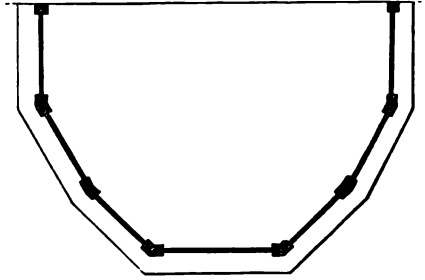
such cases, for the purpose of containing the weights by which the sashes are suspended. The sashes all round are in two parts, for the purpose of being drawn up or down for ventilation, the doors being at each end. The roof is also composed of two sashes on each side, the top ones movable for ventilation; and to take off the appearance of the eaves, a latticed parapet is carried up to hide the gutter, and shorten the apparent length of the roof, as well as to give height to the elevation. The water from the roof is conveyed to a cistern at each end under the floor, through a pipe enclosed in each corner pilaster. Such a house should stand clear of all other buildings, say on a lawn, or in the shrubbery, and consequently no chimney should be seen—the smoke being conveyed to a distance in a flue surrounded with a water-tight drain, and terminating in an ornamental vase, or in a hidden chimney amongst the shrubs. As little fire heat is required for a greenhouse, and that only in winter, the smoke will cause little or no inconvenience. The stoke-hole, boiler, and furnace should be in a small vault underneath the floor, and reached by means of a movable grating, close to the plinth on which the structure stands. The hot-water pipes are placed under the stage, making one turn only round the area of the stage; or they may be placed under the side tables, which ought to be of iron grating. The floor should be paved with polished

pavement or ornamental tiles, excepting under the stage, which should be 2 or 3 feet deep of broken stones, and finished at top with clean river or sea gravel, for the absorption of the spilt water from the pots. The roof may be constructed either as represented, or in one piece without rafters, and top ventilation attained by an opening in the ridge, as shown in section VENTILATION. The stage should be of cast-iron grating, or timber, but not of stone, which latter would prevent the ascent of the heat from the pipes. Besides, although stone and slate are both elegant and durable, still they prevent

a due admission of air to the bottom of the pots, unless the latter are made different from those in ordinary use.—(For improved flower-pots, *vide* section FLOWER-POTS, vol. ii.)

The ends of all span-roofed houses, if wide, should not be less than three-sided—that is, half a hexagon: if more, so much the better. The square end and

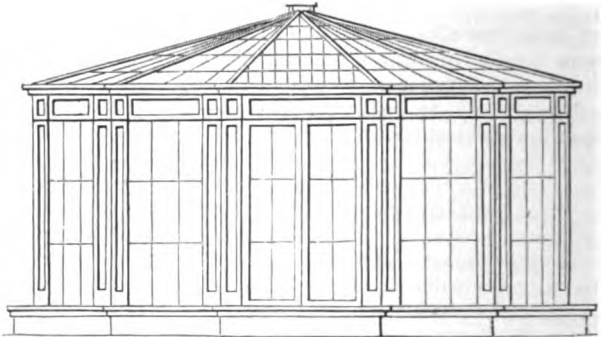
Fig. 523.



pavilion roof look too heavy, and will be much relieved in appearance if constructed as in ground-plan, fig. 523, of which fig. 524 is the elevation.

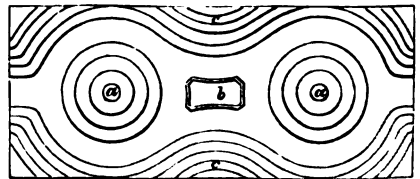
When the entrance is from the centre

Fig. 524.



of the ends, the plant stages may be arranged as in the annexed fig. 525,—*a a* being two circular stages opposite the

Fig. 525.



entrance; *b* a fountain or plant table, on which some of the finer specimens may

be set; *c c* the sides, fitted up with a serpentine table on each side. By such an arrangement a greater surface of foliage will be exposed to the sun and light, and the plants brought not only into better view, but they will be within reach from the passage, both on the centre and side tables. Such an arrangement will be found exceedingly well adapted for a greenhouse or heathery, where the plants are kept small.

In regard to elevation, fig. 526, the

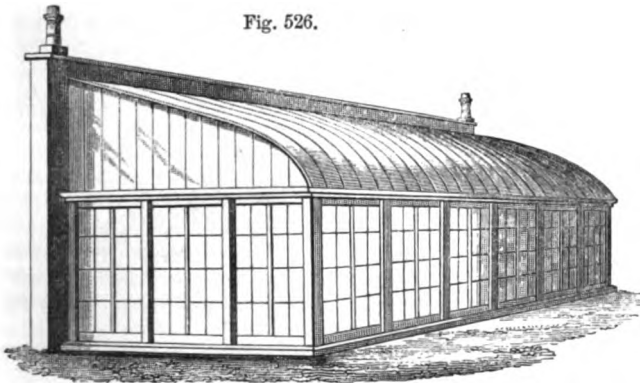


Fig. 526.

superstructure stands on a plinth or basement of ashlar stone, 6 or 8 inches high. From the curvilinear shape of the roof, such a house should be metallic; the pilasters and wall-plates (the latter also serving for a gutter) should be of cast-iron; the frames of the doors (for the ends and front are a continuation of folding doors, or what is in general called French windows) may be of wrought iron, the astragals of copper, and those of the roof at least of wrought iron. Although the roof of such a house must be of metallic material, on account of the curvature at the lower ends of the astragals, there would be no objection to the front doors being entirely of wood, as they would be lighter, and open and shut with greater ease; or the top and bottom rails and side stiles may be of wood, and the astragals of hollow copper sash-bar. It may be held as a pretty general rule, that all doors and movable sashes should be of wood, or at least wood and copper, as iron ones are too heavy to be safely or conveniently moved. The pilasters, however, in the case before us, between the doors, should be 6 inches square, of cast-iron, with neat mouldings

on both faces, and may be cast hollow, with equal strength and considerable economy, if the sashes are to open by running past each other upon a rail fixed to the plinth, and a groove in the lintel, which is of all plans the best; but if they are to be hung by hinges at their sides, some difficulty will arise in giving the screws a proper hold, if the pilasters are hollow. Perhaps the simplest way will be, to let the screws pass right through the pilaster, and to counter-sink the nuts on the opposite side. If the doors are of wood, or wood and copper bars, and run on a rail, they may be all in one piece, namely 4 feet wide; but if of metal, they should be in two pieces of half that size.

The astragals of the roof should be kept in their places by two straining-rods of iron, to which each astragal should be screwed. The roof water may be conveyed down as in the last example, and the heating be upon the same principle;—only, in so far as this house has a back wall of brick or stone, the furnace may be of the usual form and in the usual position, and the smoke may be carried off as shown in the figure. Ventilation is effected by opening any or all of the front or end doors, and by openings in the back wall near the top, which will require to be large, say 4 feet in length by 1 foot in depth of a clear opening.

An improvement on such a house as this would be the removal of the back wall, and the construction of a similar roof behind, bringing the tops of the two roofs to within 9 inches of each other, and securing ventilation as shown in the case of wooden houses in section VENTILATION.

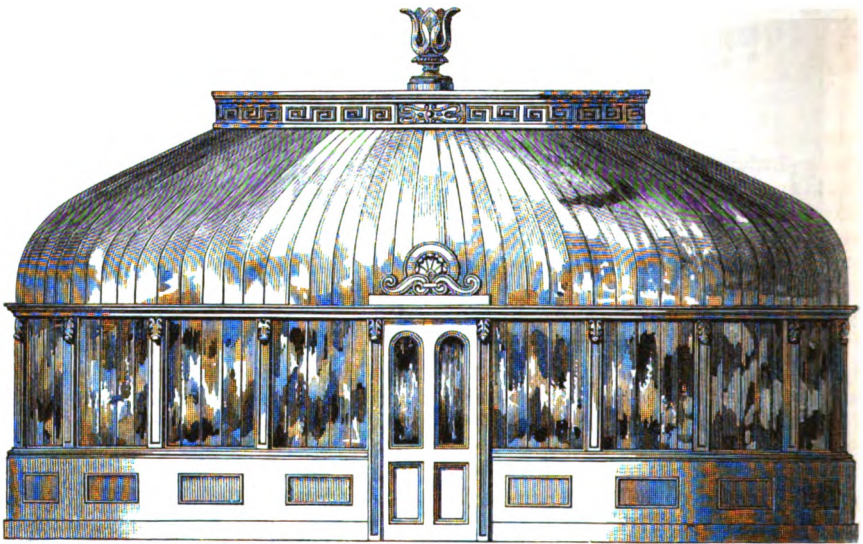
The roof of such a house is without rafters or framed sashes, and simply consists of a continuation of astragals placed at equal distances, that distance being governed by the breadth of the glass intended to be used. We think 9 inches a good breadth for the glass of such roofs; and for the flatter part, towards

the top, the panes may be 2 feet in length. Towards the front, where the curvature is much greater, the glass should be cut much shorter, so that it may fit properly into the rebate; or it may be bent in making, to suit the exact curve—which, of course, would have a more elegant appearance, and not add much to the cost. The two end astragals will require to be made four times the thickness of the others, as the upright ones in the gables have to be fastened to

them: their outer edges also should be plain. The front and end windows should all be made to open; and the best way of hanging them is upon a pivot at top and bottom—or, better, to run on rails fixed to the plinth, and made to pass behind or in front of each other. By this latter plan they are in less danger of being broken by the wind while open.

As an example of a greenhouse to stand clear of all other buildings, we may offer the annexed fig., 527, which shows an

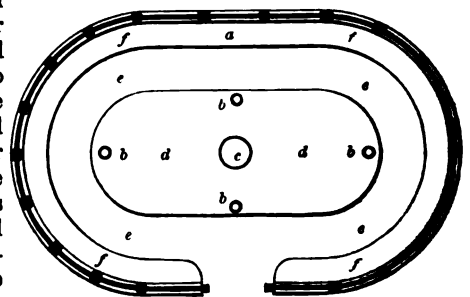
Fig. 527.



elliptical structure, set on a parapet of polished ashlar stone, with ventilators all round. The whole roof is a fixture, and of metallic material. The elliptical part of the roof at top is hid by an ornamental entablature or parapet of thin and open cast-iron, within which is an inner roof of glass rising from the girder which supports the entablature (and which itself also forms a water gutter) to the top of the base on which the urn-like chimney-top is placed, and so constructed that half of its whole area opens for ventilation, and is acted upon by a simple mechanical process. The entablature is supported by four cast-iron ornamental columns *b*, &c., as shown on the ground-plan, fig. 528; while the smoke is made to pass up the circular metallic column, *c*, in the centre, the furnace being placed in a vault beneath the floor, and the

hot-water pipes running round the sides of the house, rising above the floor level at *a*, branching to the right hand and to the left, and returning when they approach the door entrance.

Fig. 528.



In the ground-plan, *a* is the point at which the hot-water pipes enter the

house; *b b b b* are the columns supporting the entablature; *c* is the circular column for the smoke; *d d* is a central platform of slate; *e e*, &c., passage; and *f f*, &c., slate shelf running round the house.

Fig. 529 is an elevation in projection of a curvilinear greenhouse of the same

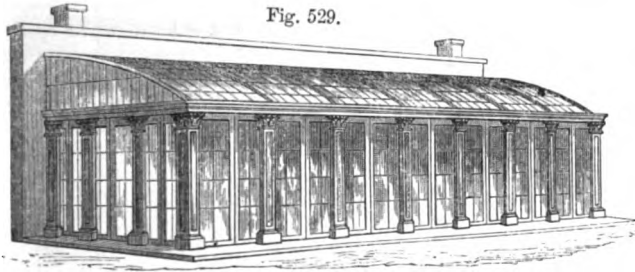


Fig. 529.

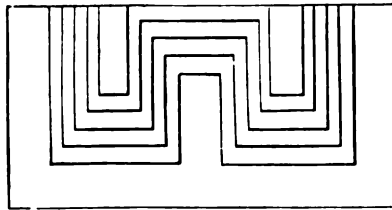
dimensions as fig. 526, but fitted up within in rather a different manner. There are also the following points of difference—namely, the roof in the present case, although in one piece, is divided into apparent sashes, by the introduction of light rafters placed over the pilasters. These rafters are, however, cast with a rebate on each side to receive the glass, as if they were astragals. They are intended to stiffen the roof, and give greater strength, as well as to take off that strain which must of necessity be upon the ends of a house having straining-rods extending from gable to gable, for the regulation of the astragals, as in fig. 526. In the present case, the astragals of each span are secured by rods fastened from rafter to rafter. The wall-plate or architrave over the front, as in fig. 526, is of cast-iron, serving also as the gutter for receiving the water from the roof, which, in this case, will require to be carried to the two opposite ends, taken through the back wall, and conveyed to tanks formed there for its reception. For this purpose, a slight inclination must be made in the gutter from the centre, both ways; but this inclination must be made in the bottom of the gutter, so that the front may be of equal depth throughout its whole length. The reason why, in this case, the water is taken to the ends, is, that the pilasters in front are not of sufficient size to admit of its being carried down them, as they are cast open, having their openings fitted with plate glass, in one piece, from top to bottom, which

may either be plain or coloured, violet colour being preferred. The doors are double, opening outwards, and hung on pivots at top and bottom. The coping over the pilasters may be either Doric, Ionic, or Corinthian, according to taste; but if such a house be erected near the

mansion, of course this should be governed by the style of architecture in which the house is constructed. Instead of the uniformity presented by having the stage as in the last example, showing the plants in an unbroken outline, it would be better

to substitute a stage, as in fig. 530, which would present the sections of three pyramids, and offer ample oppor-

Fig. 530.

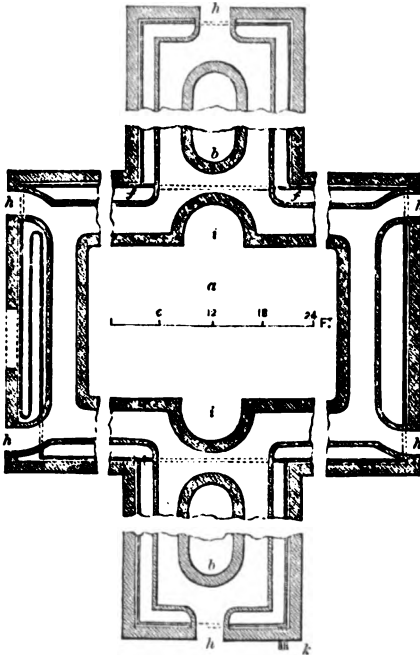


tunity, not only for watering and examining them, but also for showing off their forms and flowers to much greater advantage.

The annexed ground-plan, fig. 531, and sections, figs. 532, 533, exhibit one of the greenhouses built within these last few years in the Royal Botanic Gardens at Kew. We had an opportunity of inspecting this house while building, and frequently also since it has been completed; and we consider it altogether one of the most useful houses we have seen. The great merit of this house is, that it is capacious and convenient, holding an immense number of plants, of which all equally enjoy the benefits of light and air, and without the prevailing error in most large houses, of its being too lofty. The arrangements are very complete, and the heating satisfactory. There are two faults, however, we have to find with this house; and as we deem them to be important—and, strange to say, of

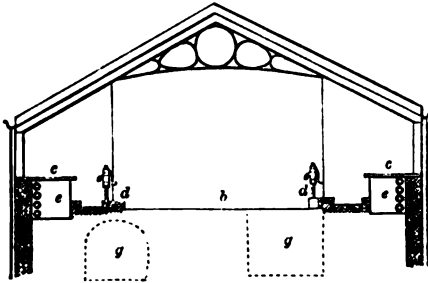
very general occurrence—we shall point them out. First, the hot-water pipes are

Fig. 531.



placed under the side tables or shelves—of course, the proper position for them; but then the shelves, which are of stone, are let into the side walls, preventing the

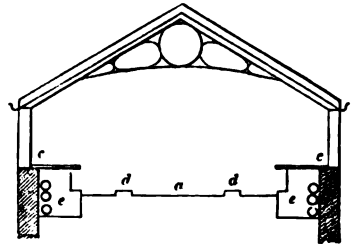
Fig. 532.



heat from ascending and diffusing itself over the inner surface of the glass, losing considerably its effect, and placing the plants on the side tables (in general the most valuable) in danger of being frozen to death during winter. Secondly, when stone shelves are used, (and these, or slate, are the most proper for such purposes, so far as durability is concerned,) the

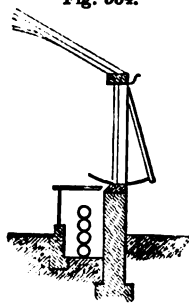
conduction of cold through the side walls is such as often to freeze the roots of the plants set upon them. Now, both these evils could have been avoided by merely leaving a space of 3 or 4 inches between these shelves and the side walls. From both the sections it will readily be seen

Fig. 533.



that, had that precaution been taken, the heat from the pipes would have radiated upwards, and completely cut off the connection between the cold air on the surface of the glass and the warmer air of the house within. The system of ventilation shown in fig. 534, more especially during winter, and always in windy weather, would have been improved if ventilators had been placed in the side walls opposite the pipes, as shown in various examples in this work. By this means nocturnal ventilation could have been indulged in, and air admitted during the day, even in

Fig. 534.



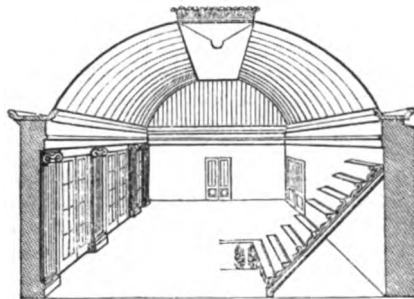
the severest cold or most stormy weather—times when, every sensible cultivator is well aware, the side sashes cannot be opened without great injury to the plants. The rafters are of good size and proportion for the weight they have to carry: we would, however, have preferred them had they exhibited less of the moulding-plane. Mouldings of all kinds should be discarded from houses of this description, as they tend to no good, but much evil—harbouring dust, filth, and damp, and reducing the strength without diminishing the bulk of opaque surface. We do not say, however, that highly-finished conservatories or elegant plant-houses may not be ornamented by

appropriate carvings and mouldings; but for houses dedicated merely to culture, as this and the generality of greenhouses in ordinary gardens are, all mouldings and carvings should be dispensed with. All rafters and astragals should present a smooth and uniform surface, by merely being chamfered off from the shoulder of the rebate towards the lower point—always, however, leaving a sufficient thickness there in proportion to their depth. We see no reason why this roof, dispensing with rafters and framed sashes entirely, and consequently reducing the expense of the roof more than one-half, and at the same time producing a much more light and elegant structure, might not have been all in one piece. The following references will explain our figs. : *a* and *b* spaces for large plants, *c* benches for small do., *d* curb-stones, *e* hot-water pipes, *f* stopcocks to turn the course of hot water into division *b*, when not required in division *a* of ground-plan; *g g* cisterns for rain water under ground-level; *h h*, &c., doors; *i* semicircular stage to fill up the lobby, as it were, that connects the two parts of this house together; *k* stoke-hole under ground, (but in the case of the house at Kew this is the point of entrance of the hot-water pipes, which are heated by a boiler placed at some distance.) The roof, as will be seen, is of the span form, and placed at an angle of 30°—perhaps the pitch best suited for houses of this form, and for such purposes. It is glazed with sheet glass, in lengths of only two panes to each side; and the upright side-lights have only one pane, which gives the whole a light and cheerful appearance. Such a house as this may be imitated by any country gentleman, as it is, perhaps, the most economical, in proportion to the area which it covers, of any house possessing the same accommodation. For plant cultivators upon a limited scale, we may remark that, by throwing a glass partition across the junction of the broader and narrower divisions, a very complete plant establishment might be formed by converting the broader part into a store or conservatory; and by dividing the narrower compartments by glass screens and doors, each wing into two, four sections of plants—say *Ericas*, *Pelargoniums*, *Orchids*, &c.—may be cultivated. As a

model, few better can be offered, as its arrangements admit of contraction or extension by merely cutting off or adding to the ends, and this without much trouble or expense; or either part may be adopted and put into operation, to remain as a whole, or to be added to afterwards. It is needless to say how easily one or more parts of such a structure may be heated—that division intended to be kept the hottest to have the stoke-hole and boiler attached to it. Much has been said of late years about winter gardens; here we have a very excellent model, either as a whole for greenhouse plants, or subdivided by glass partitions, portable, or made to slide in panels behind each other as high as the square of the roof, or rather so high as to give sufficient head-room. The principal object in making these divisions portable is to secure the power of throwing the whole into one during summer, as well as to enable the proprietor to cultivate as great a variety of plants as possible. Such a house, in a large establishment, would be far more imposing than half-a-dozen detached houses equal in extent, and, we hesitate not to say, could be erected at less than half the expense. As regards the rain-water tanks, we can see no necessity for placing them under ground. As the water is supplied from a level sufficiently high, these might have been better situated—namely, under the plant tables, and above the floor surface. With the exception of this, and the objections already stated, we think this house, as a whole, very complete.

The annexed fig. 535, is a perspective view of the interior of a greenhouse built

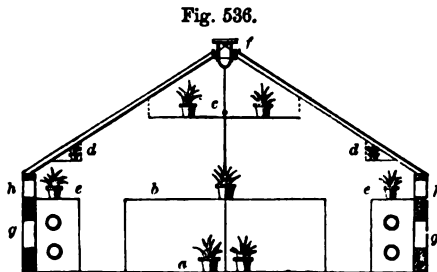
Fig. 535.



by Mr W. Crosskill of Beverley, at Everingham Hall, and also at Sunderland-

wick, both in Yorkshire. We have had opportunities of seeing both, and consider them well adapted to the object in view. We only regret that in both cases the north or back wall exists: had that side presented the same elevation as the front, these houses would have been quite a different thing. Local difficulties, however, occurred in both cases, as they form the centre to very neat ranges of forcing-houses. The roofs are of wrought iron sash-bar, but being erected before the repeal of the duty on glass, they have rather a crowded appearance, being made close together, with a view to economise glass. The entablature over the front windows is unnecessarily deep, creating shade, and giving a heavy appearance; but these are matters easily rectified, as well as removing the back wall and substituting glass instead, exactly similar to that in front. The internal arrangement would then become a curvilinear or triangular stage, instead of the present lean-to one.

The annexed diagram, fig. 536, exhibits a most economical and commodious struc-



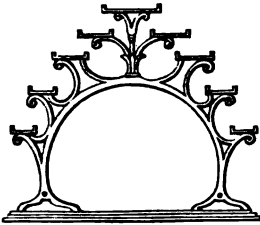
ture, deserving the attention both of nurserymen and those having many small plants to winter, for bedding-out in summer, &c. On the floor *a*, fuchsias, hydrangias, and other deciduous plants, may be wintered, as well as bulbs in a dormant state laid on their sides to keep them dry. On the principal platform *b*, camellias, oranges, magnolias, and such plants as do not require a direct light, may be grown. On *c*, which is a broad shelf suspended from the roof, geraniums, petunias, heaths, verbenas, &c., may be placed, as well as on the two side-shelves *d d*, and other plants on the side-tables *e e*, under which the flues or hot-water pipes are to be placed. Ventilation is to be effected by openings in the ridge *f*, and also at the

sides *g g*, by wooden box ventilators built in the side walls, opening immediately upon the pipes or flues, so that the air may be warmed before reaching the plants during winter and cold weather; and in summer, when an increase of ventilation is required, by opening the upper ventilators *h h*, also built in the wall. No side-lights being required, the whole might be erected at little cost. One of the advantages of span-roofed greenhouses is, that the plants present a greater surface of leaves and branches to the light, whether they are arranged on a triangular stage in the centre, or set on tables along both sides of the house. In the former of these cases, one side of each plant is, however, less favourably situated in regard to light and air than the other; the whole mass also presents a formal appearance. To obviate this, an alteration of the stages may be made, which will give a much larger surface of foliage, admit the air more freely around them, and increase the means of both viewing and reaching them considerably. The following method may be adopted to secure this: triangular stages, or flat tables, occupy the centre of the house, separated from each other by a 3-foot walk; between, and in front of these, smaller triangular stages or tables are placed on both sides, on which single extra fine specimens may be set, or groups of plants in flower. The entrance, as it should be in all span-roofed houses, is placed at the end—and as each side of the arrangement is complete, it matters not to which hand the visitor turns. The ridge is supported by iron columns, set on stone blocks in the middle of the floor, and passing up through the centre of the larger stages, and to which an inverted arch of rod-iron is attached at its apex, the ends extending towards the roof, and completely tying it together, as well as giving support to it at or near the middle of each side. These stages should be of cast-iron or wood. The latter is the best, although not in this case the most durable, on account of the drainage from the pots keeping it damp; but, on the other hand, it is not so cold in winter, nor so hot in summer. A free circulation of air, provided the ventilators are properly placed, will pass round the plants upon such stages, which would not be if they were solid. Lean-to houses may be

arranged upon this principle, but, of course, with only one-half of the advantage.

The annexed, fig. 537, represents a very neat cast-iron stage, suited for a curvilinear, circular, or span-roofed house.

Fig. 537.

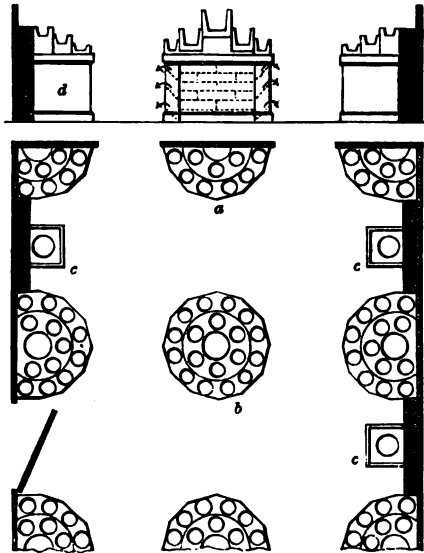


The shelves for the plants are solid, with flange edges, intended to retain the water that may drain through the pots, and prevent it from falling on the floor. It is calculated that this water will be partly taken up again by the plants, by capillary attraction, and partly dissipated by evaporation during hot sunshine: the latter we think extremely beneficial, particularly in metallic houses. Were it necessary, as we think it is not, it would not be difficult to cast the supports hollow, and so convey the water to a cistern or drain under the house.

An anonymous contributor in "The Gardeners' Chronicle" offers the following very judicious remarks on the subject of stages. "The first object," he says, "in the construction of stages, should be to have them so constructed and situated as to afford facilities for grouping the plants; the second should be, to give the plants more the appearance of growing in borders than upon artificial structures; and the third, to keep the pots out of sight. This is requisite for two reasons: first, because they are no ornament; and, secondly, that it is always desirable to protect the plant from being scorched by exposure to the sun. It is also desirable to adopt another mode of construction, for the purpose of giving plants that aspect most suited to their habits; and, therefore, instead of placing the stages from the front to the back of the house, as is generally the case, I would place them in groups of stages, thus producing an effect similar to the borders of a well-arranged flower garden." The annexed diagram, fig. 538, exhibits the arrangement. "The ground-plan represents part of the floor of a house, 19 feet by 13, on which are placed 12 stages," (9 only, however, are shown,) "and 3 vases, *c c c*, basins, or any

other suitable ornamental article, with a footpath between them 3 feet wide,"—that

Fig. 538.



is, of course, at the narrowest parts. "The plan also shows sections of three different modes of constructing the stages, and the position of the pots in each: all the stages stand upon stone tables, resting upon brick piers, the top of each table being 2 feet 2 inches above the level of the floor. In the stage *a* there are no shelves, the pots being plunged into cylinders (made of the same material as flower-pots) standing upon the tables—the space all round them being filled with compost level to the rims of each series of pots. The object of this plan is to afford opportunities of planting various creepers and small bulbs betwixt each of the potted plants, for which there will be plenty of room when they stand 12 inches apart stem from stem. The pots are supposed to rest by their rims upon the edge of the cylinder, and may, of course, be removed with the greatest facility.

"In the centre stage *b*, the supporters stand directly upon the table, and are cemented to it, the space between each being made water-tight, and filled up solid to within half an inch of the bottom of the pot. If an inch deep of water is poured into this space, the pot will be immersed half an inch; a small hole in the side will regulate the height of the

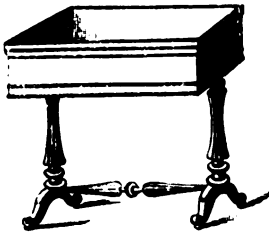


water line, and another in the bottom will draw off the water when it requires changing. This mode of construction may be adopted for such plants as need large supplies of water.

"The stage *d* is supposed to have shelves pierced with holes to receive the pots, which rest upon their rims. The fronts of the stone tables may be variously ornamented: those in one house having trellised panels, another may have rusticated courses of brick or stone; while a third may be in imitation of rustic basket-work, and a fourth with rough courses, like small rockeries, with spaces between for creepers, orchidaceous, or any other plants best suited to the purpose."

The general plan of this arrangement is good, but many of the details are too trifling for adoption. It is a movement, however, in the right direction, and may afford hints to be improved upon. Our own opinion is, that the plunging is bad, and that a better plan would be to have strong tables constructed of cast-iron, slate, or wood, quite flat on the surface, as the taller plants would occupy the centre of each, and perforated with holes, graduated to the sizes of pots in common use—each perforation to hold a pot, to be suspended by the rim, and the tables under the top part, as far *at least* as the bottom of the deepest pot, to be covered

Fig. 539.



in, so as to hide them entirely. Such tables might be made very ornamental, as fig. 539, and lined with copper or zinc, in order to prevent the spilt water from dropping on the floor: by having at one of the corners a small pipe with a cock the water could be drawn off when necessary. The plants should be plunged in moss; and by having the tables mounted on castors, they could be moved about at pleasure. For small greenhouses we know of no mode of arranging the plants that would produce a better effect than this; and as the tables should be of different forms, the groups can be altered to suit convenience and taste.

In small greenhouses, particularly those attached to or near the proprietor's house, where elegance of design and neatness in keeping are attended to, we see not why stages of the ordinary clumsy description should not be entirely dispensed with, and the plants set in elegant vases or flower-stands, having the surface of the

Fig. 540.

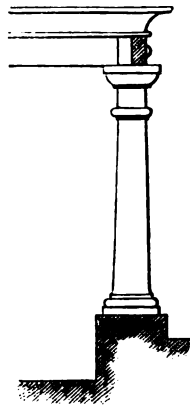


pots covered with clean green moss. The subjoined cut, fig. 540, represents a flower-stand suited to this purpose, and much used in France. They are of cast-iron or bronze, and not only are the plants tastefully arranged in them, but often little jets are introduced, as shown in our cut. Wherever such an arrangement is

intended, we would suggest to have all the tables portable, so that the arrangement may be altered at pleasure.

In ordinary cases, where side tables or platforms are introduced along the sides of span-roofed houses, whether they be of wood, stone, iron grating, or slate, supports are necessary.

Fig. 541.



The bracket support can only, in a few cases, be introduced, therefore perpendicular ones, having a horizontal arm reaching to, and fastened into, the side wall, are had recourse to. The annexed, fig. 541, exemplifies one of these in use in the Kew Gardens, but faulty on account of the stone covering being let into the wall. Fig. 542 is another form equally massive with the last: the uprights and cross bearers in both

are intended to be of cast-iron, and the top of polished pavement. The bearers only in both cases should be let into the wall, and the pavement be kept at least 3 inches distant from it. A much more simple and economical form of support is an upright rod of malleable iron 1 inch in diameter, and a flat wrought-iron arm or cross bearer 3 inches broad and 1 inch thick welded to it: these cross bearers to be let into the wall and the pavement laid upon them, making the joints meet exactly over the support.

Fig. 542.



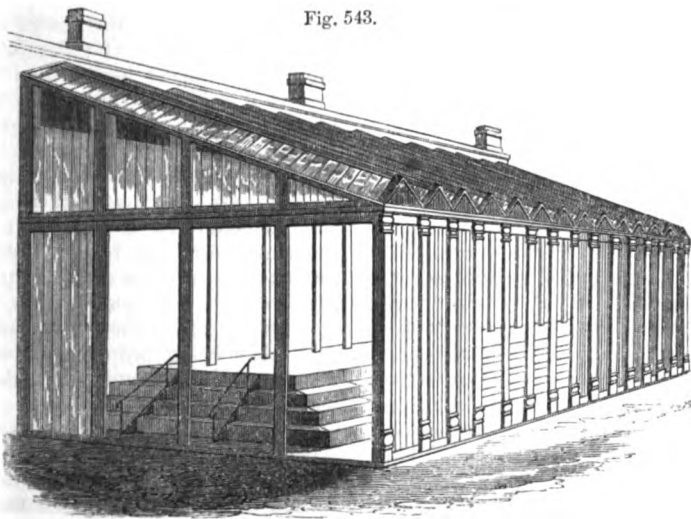
Ridge-and-furrow roofs for greenhouses possess many of the merits of span-roofed ones—such as admitting more light than lean-to ones, and also from the position of the astragals breaking the force of the mid-day sun. One disadvantage pertains even to ridge-and-furrow roofs, while constructed on the lean-to principle, with opaque back walls—namely, that little more than one side of the plant is exposed to the sun and air, just as occurs under lean-to roofs of the ordinary construction. It is better, therefore, in adopting this form of roof, to have all the sides of the structure of glass, to within a few inches of the ground, and the roof carried through of equal height from side

to side. This was meant for Mr Duncan's house, which has not been figured. Such structures, admitting the maximum of light to all sides of the plants alike, and if not carried to too great a height, will be found of all forms that best adapted for growing fine specimens in. Having stated this much, the reader will at once see the necessity of abandoning the old and absurd practice of placing plant-houses against the face of solid walls, let the aspect of that wall be to what point it may. Hence it follows, that all plant-houses should stand detached from all other buildings, and form of themselves entire and complete structures, having the sides and ends in all cases uniform. Conservatories attached to the house or mansion should, as far as the nature of the situation will admit of, be of glass on all sides, except that end at which they are joined together.

One of the first and most extensive houses of this description was erected by Sir Joseph Paxton at Chatsworth, of which the annexed figures and letterpress description, taken from his "Magazine of Botany," vol. ii. p. 81, will give a clear idea. This house "is so constructed that scarcely any more light is obstructed than in a metal-roofed house; but it possesses, at the same time, all the advantages of wood.

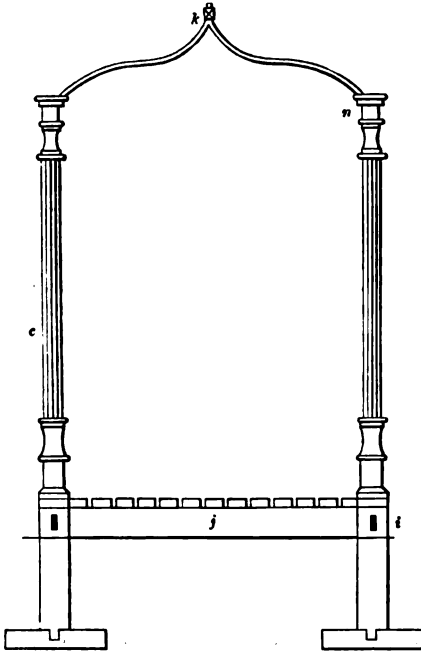
"Its whole length is 97½ feet, and its breadth, from the back wall to the front lights, 26 feet." Fig. 543 is a perspective

Fig. 543.



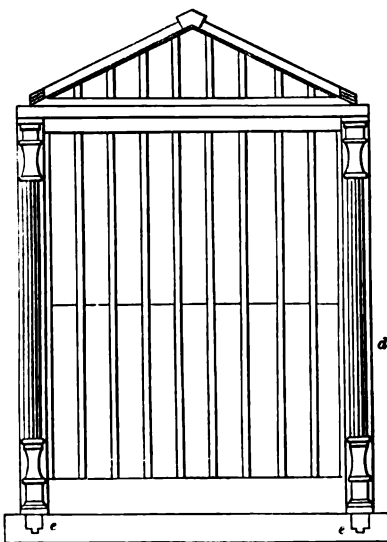
view of this house. "The roof is supported by two rows of cast-iron pillars," fig. 544, "one row along the front and

Fig. 544.



end, as *d*, fig. 545, and the other along the centre of the house, as *c*, fig. 544.

Fig. 545.



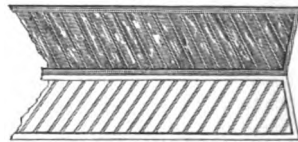
These pillars are placed  $6\frac{1}{2}$  feet apart

in the rows, and are each 3 inches in diameter. The front ones are made hollow, so as to admit a leaden pipe which carries off the water from the roof into a drain laid in the gravel walk on the outside of the house: this entirely does away with the appearance of a spout. At the bottom of the iron pillars there are sockets *e*, fig. 545, which are let into the stone, and give the pillars firmness; and through this socket the pipe descends into the drains." Instead of allowing the water to run into the drains, we would convey it into a tank or reservoir under the house, or elsewhere, as we hold that not a drop of rain water should be lost.

Fig. 545 is the elevation of part of the front or movable doors, and above it, the end of one of the pediments and bays of the roof.

"The elevation of the back wall is 13 feet 6 inches at the lowest part, and 15 feet at the highest part or ridge of the angle: the height in front is 8 feet 6 inches to the valley, and 10 feet to the ridge of the angle. The lights of the

Fig. 546.



roof," fig. 546, "are made fast, and fixed on angle fashion;— each light is 25 feet

6 inches long. All the front and end lights slide in a double groove, so that, although there is no door, a person may enter at any part of the house.

"The centre row of pillars *c*, fig. 544, are 2 feet 6 inches longer than the front and end pillars; about 2 feet from the bottom of each a small hole is left, *i*, through which a screw passes, to fasten the bearer which supports the centre walk *j*. On the top of these pillars is also fixed another iron support *k*, which is formed to rise up to the ridge of each angle: each of these arched supports has at its ends small square parts which fix in a hollow left at the top of each pillar; and, after being properly adjusted, they are fastened by running a little melted lead into the interstices.

"In each valley of the angles two large screws are inserted into the stiles of the lights to fasten them firm. Air is admitted by sliding the front sashes, and

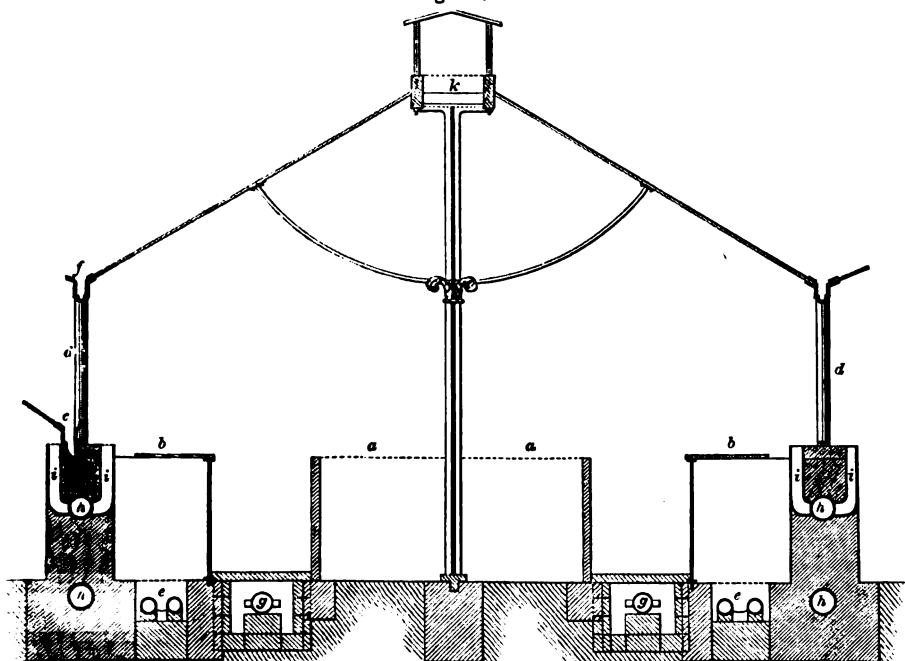
by ventilators in the back wall, which are made to swing on pivots, and open by means of long iron rods having holes to fix on pins driven in the wall, so as to regulate the proportion of air at pleasure. To prevent these ventilators from being unsightly, a square piece of trellis-work is placed over the opening inside the house."

This is altogether a very splendid greenhouse—such, indeed, as few can boast of. We would, however, have preferred hav-

ing the walks of pavement, instead of the bars of wood, and the back wall removed and substituted by glass; and as such a house is more fit for well-grown specimens than for a general collection, we would have dispensed with the stage altogether, and placed the plants on the floor in groups or singly, as circumstances might direct.

Fig. 547 is a section of the greenhouse at Poltalloch, forming part of the series of span-roofed houses recently erected there. *aa* is a raised platform covered

Fig. 547.



with polished Bangor slates, for the larger specimen of plants, supported by polished Caithness pavement in 6-foot lengths, and 3 inches thick, set on edge, and forming one side of the passages, which pass all round; *bb* polished slate tables, for smaller plants, supported on ornamental cast-iron brackets let into the pavement in the passage, and into the side walls. This slate tabling is 6 inches clear of the side walls, to permit the heat from the hot-water pipes *ee* to rise freely; *c* is the half gutter already noticed, employed where the height of one house is much lower than that adjoining it; *dd* the tubular cast-iron columns which support the bottom parts of the roofs, and also

take down the water from the valleys or gutters above them; *f* ornamental cast-iron parapet, 6 inches high, planted on the edge of the cast-iron gutter, but having spaces under it 1 inch in the clear, to allow the melted snow to pass freely into the gutter below it, while it prevents the slipping down of a body of snow upon the glass roof of the lower house next to it; *gg* the ventilating tubes under the floors of the passages; *hh* the same in the centre of the partition walls; *iiii* the 3-inch tubes connected with the last, discharging fresh air at their orifices, on each side of the partitions, between the compartments. Ventilators are placed in the front wall, as seen in the general

elevation, and in several ground-plans of portions of this range. The top or ridge ventilation *k* is the same as in all the other houses. A capacious rain-water tank is placed under the centre plant-table, supplied from the roof, and, in the event of an insufficiency of this, from the general supply which is laid over the garden.

The merits of span-roofed greenhouses are not entirely confined to the admission of more light and air than lean-to houses; they possess other and very important advantages, "for," says Mr James M'Nab, (in a communication in the "Edinburgh Advertiser,") "in such a greenhouse fire-heat is scarcely at all required; for if there be a free circulation of air during the autumn and winter months, and if the tables and shelves be carefully kept dry and clean, and water be sparingly given to such plants only as require it, cold, even should it extend to the occasional freezing of the surface-soil of the pots, will do less injury to most plants than the application of fire-heat." We have seen, under this judicious cultivator's management, in the garden of the Caledonian Horticultural Society, while he presided over that establishment, his experiments testing between the plants in a lean-to house and those in a span-roofed one. In the former, soft and hard wooded plants almost alike became drawn up, soft, and spongy towards autumn, from want of the bracing breezes that those of the same species enjoyed in a span-roofed house within a few yards' distance. A severe frost came on: the plants in both houses, early in the morning, had much the same frozen appearance; "by ten o'clock the sun shone forth. The plants in the lean-to house were subjected to the full influence of the mid-day's rays; and although air was given, they blackened and perished. In the span-roofed house, extending north and south, the effects of the sun were much less felt; for as he proceeded towards the meridian, the intercepting astragals and rafters necessarily formed a screen or shade; and air being given, the plants survived, and soon recovered." Experiments since made have shown the following curious results:—"The self-marking thermometer in the open air, during several nights, indicated 20°, 15°, and even 10°

Fahr. During these frosts no heat whatever was applied to the span-roofed house, which contained a general collection of soft and hard wooded plants." On the mornings of these frosts, "the mercury in the thermometer within the house stood at 25°, or 7° below freezing; yet only two or three plants, which were standing near the upright glass of the south end of the house, and were thus exposed to the mid-day sun, suffered from the intense cold to which they had been subjected. The temperature in the span-roofed house always remained much more equable than in the lean-to house. This was signally remarkable at one P.M. of the 14th of February, when the thermometer in the open air indicated 56°, in the lean-to house 70°, and in the span-roofed house 43°. In the lean-to house, therefore, where the whole glass-roof was fully exposed to the sun's meridian rays, the temperature thus became 14° higher than the open air, and 27° higher than in the span-roofed house."

Nor is it only in resisting the effects of cold during winter that the merits of span-roofed houses consist; they act also beneficially during the heat of summer in keeping down the temperature, and from the very same causes, namely, "the freest possible circulation of air, by means of upright sliding sashes on both sides of the house; while the rafters and astragals of the roof break and intercept the sun's rays, and help to shade the plants from their direct influence." Both these effects, it quite clearly appears, would be considerably lost, if large, and particularly broad, squares of glass were employed in the construction, as there would be fewer astragals to break the force of the sun's rays; and this defect would be increased were rafters entirely dispensed with. It follows, therefore, that after all that has been said about large squares of glass and mere glass cases, to have the advantages above stated, we must keep to the small glass and many astragals. Notwithstanding all this, we are still anxious to see rafters and framed sashes entirely superseded by roofs all in one piece, and the glass, where these results are wished to be carried out, retained at the usual size of from 6 to 8 inches in breadth. Their length is of less importance, although a certain loss in the above result

will be occasioned by the number of overlaps being lessened.

Where large glass is insisted on, recourse must be had to shading in summer and covering in winter. Whether the expense and trouble attending these operations are not more than an equivalent for the gain in appearance, it is not easy to determine.

### § 3.—ORANGERIES.

Houses dedicated to the culture of the orange and its allies are by no means common in Britain, although some instances exist, as at St Margaret's, Kew, Stratton Park, Hampton Court, Welbeck, and some other establishments. On the Continent it is far otherwise, as few country seats are without their orangery, and, indeed, it may be considered their principal plant-house. It is difficult to account for this taste, otherwise than by attributing it to the nearly complete want of evergreen trees and shrubs in the open air over the greater part of the northern European continent.

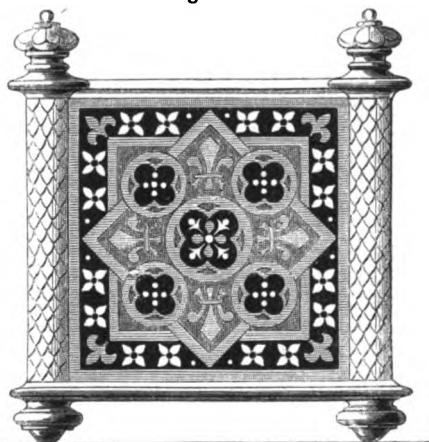
The style of house in general use for the protection of the orange during winter—for they are arranged in the open air during summer—is often partially architectural, having the front consisting of Doric, Ionic, or Corinthian columns, though also often plain, with glass casements filling up the space between. The roof is slated, and the back, and often the ends, are solid walls. The trees are grown in large pots, vases, or boxes, in general entire cubes: sometimes they are slightly tapering towards the bottom, and occasionally they are ornamental. For very large trees, they are of oak planking, two inches thick, and are all very properly elevated upon feet, which keeps them clear of the ground, and admits of drainage and free circulation of air around them. Large tubs are also frequently used, and these are elevated on stone, brick, or wooden stands.

Some years ago, finding a difficulty in examining the state of the roots of trees under our care, we constructed boxes with two of the sides made so as to open, being hinged at the bottom, and, when in their place, being kept firm by an iron bar, which fits into a socket in the

opposite sides. When this bar is lifted up, the hinged sides fall down, and the other two lift out, leaving the ball quite entire. The roots can be in this way examined, old soil be removed, and fresh added, the tree standing all the while upon its bottom.

Although the orange ranks amongst our oldest cultivated exotic trees—and orangeries had a recognition in this country before greenhouses or conservatories—it is singular that so little attention has been paid to the cases in which they are grown, for, with few exceptions, we meet with little elegance in their design, or even fitness in the purpose for which they are intended. Our own orange-box possesses the latter merits more than most others; and next to it are the slate boxes, made to take conveniently to pieces, by Mr Beck, of Isleworth. They are, however, much less ornamental than the subject of our woodcut, kindly supplied us by Messrs Minton, the eminent manufacturers of encaustic ware, of Stoke-upon-Trent. Fig. 548 is from a design of

Fig. 548.

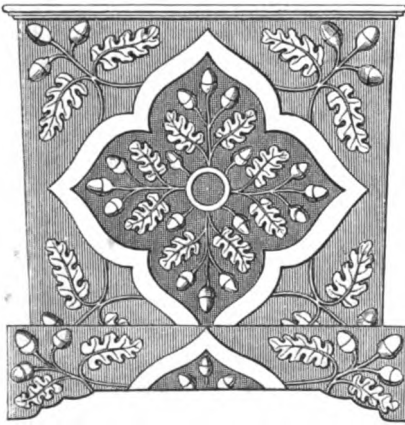


Mr Pugin, and is manufactured by Messrs Minton in their usual excellent style. The framework is composed of iron, and may be gilt or otherwise, according to taste; and the sides or panels are fitted in with their beautiful and imperishable encaustic tiles, in various colours, arranged upon the best principles of artistic taste. As will be seen by our illustration, these boxes stand clear of the ground or floor on which they may be set, and hence air

is admitted to the roots, and complete drainage secured by perforations in their bottoms. The four sides are so constructed that they may be removed, leaving the four corner columns, and the top and bottom rails, which connect them together, to form the skeleton of the case, so that a free examination of the roots may take place when required. Such orange cases as these may be made of any required size, and the sides may be filled in with encaustic tiles of any pattern, according to taste, from those portraying the armorial bearings of the most ancient family to the simplest and plainest tiles used for ordinary purposes.

Fig. 549 is a design from the same

Fig. 549.



respectable firm, but intended for trees or plants of a much smaller size, and, therefore, comes more directly under the denomination of an ornamental square flower-pot or vase, but elevated upon a plinth supported at the four corners by feet, which clear the bottom from the ground or platform they are placed upon, and thereby secure drainage and admit air to the roots. The specimen sent us, from which our figure is taken, is coloured, the ground of the whole being green, the foliation and band around the shield (represented in our illustration as white,) is yellow, while the shield itself is a dark red. Our taste in this arrangement would be to make the ground blue, the foliation and belt yellow, and the shield bright red, which would, according to Mr Owen Jones' arrangement of colours, place the three

primary ones in very nearly their proper proportions to each other. Many other elegant specimens have been sent us by this firm: the two we have given may be taken as a fair example of the whole. We may here, however, remark that the prejudice existing amongst a portion of the horticultural world against vases, tubs, cases, or pots made of encaustic tiles or *hard* burned pottery ware, is perfectly unfounded, so long as there is ample drainage provided underneath them.

Cast-iron boxes have been recommended for their durability; but they are objected to on account of their tendency to rust in the inside. Slate boxes are a more recent invention; and, as they last as long, nay longer, than iron ones, and are not liable to be affected by rust, they are much to be preferred. In Italy, very handsome earthenware vases are made for the smaller trees; and these, being often of classic forms, are better adapted for placing on parapet walls, sides of steps, in the front of balconies, &c., as they harmonise better with the architectural forms that surround them, and of which they are made to constitute a part.

The majority of the orangeries we have seen on the Continent have opaque roofs, and the older ones in England are also so constructed, as that at Kew, and the two at Hampton Court—which, by the way, were originally designed as guard-rooms. That at Windsor has one of the principal terraces passing over it; those at Stratton Park, Tottenham Park, and Welbeck, have glass roofs, as in ordinary conservatories. That glass-roofed orangeries are better fitted for the climate of Britain there can be no doubt, the more especially as the trees have to remain much longer in them than in some other countries where the season is sufficiently warm and long for the young wood to become maturely ripened, and, consequently, it remains in a state of repose during most of the period they are confined to their gloomy abode. With us, on the contrary, the four months during which they can be safely trusted in the open air, form a period much too short to enable them to make their wood and ripen it sufficiently; consequently, when they are transferred from light and air into a dark opaque-roofed building, the transition is so great that the energies of vegetation are checked;

much of the young wood damps off; and the trees, being thus treated year after year, become completely exhausted, and at length perish.

Culture, we ought here to observe, has also something to do with all this. When the Continental gardener has gathered his supply of orange flowers—which is very often a part of his salary—and he thinks his trees have made sufficient young wood, instead of allowing this wood to continue growing, and increasing rapidly the size of his trees, he sets about clipping them all round into as perfect globes as he can with the hedge shears—a species of pruning not exactly in accordance with the modern improvements in plant culture. Were he to use his knife, rather than his shears, his progress would be slower, but the end would be better attained. Still, however, rude as his system of pruning is, it is founded upon correct enough principles; for by this means he foreshortens the young wood, much as we do vines, rids the trees of superfluous matters, and insures the maturation of the buds on the short stubby branches left. The sap, which would otherwise be expended in producing extension of shoots which would not ripen, is thrown back into the buds left, and in them elaborated into full and perfect flower buds for the ensuing season. The trees also, being eased of so much wood, have less occasion to provide so large a supply of food; and this may probably in some degree account for the great age some of them attain—often three or four hundred years. Trees so treated, and kept pretty dry during winter—that is, from the beginning of November till the end of April—remain perfectly safe under these opaque roofs; and ages have proved the truth of this assertion. With us, admitting that we were to foreshorten the young wood, still our growing season is neither so long nor so favourable as would suffice to ripen the remainder without the aid of covering; and that, of course, in order to insure perfect health and abundance of bloom, (the only thing to be sought for,) must be of a transparent nature. Hence, we conceive, should originate an entirely different construction of an orangery on the Continent and with us. We may here also remark, that on the Continent the trees are all in a portable

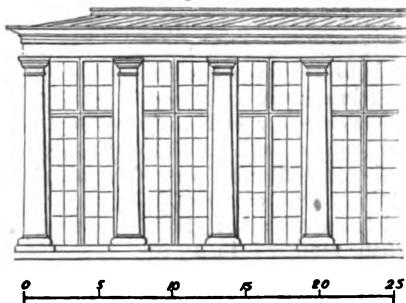
VOL. I.

state, to suit them for being moved out and in. They never think of planting them out; while with us many fine trees have been sacrificed from planting them out in conservatory borders.

Of all glass structures, none more readily admits of being constructed upon architectural principles than the orangery; while, moreover, from the trees being always in foliage, often with their golden fruit hanging on them, and at the proper season perfuming the surrounding air with their blossom, they are of all other exotics the best to bring into connection with the mansion; and to its style the elevation of the orangery may be assimilated, and the structure made to form, as it were, a part of it.

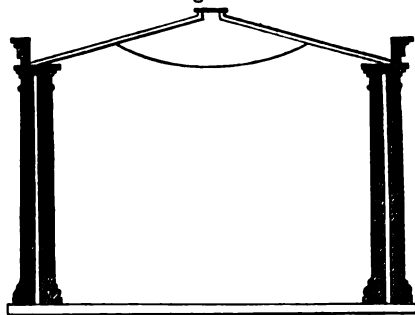
The annexed design, fig. 550, is the

Fig. 550.



elevation, and fig. 551 the cross section, of what we consider to be a good example of this kind of structure, calculated for a

Fig. 551.



lawn, or other exposed situation. The style of architecture may be varied to suit existing circumstances. The sides and ends are composed of double doors between the columns, all made to open. The fan-lights over them should be fixtures, as ventilation is to be effected by



opening the doors, and also the ridge, as shown in the cross section. The whole glass part of the roof is fixed, and composed of a continuous range of astragals, without rafters or framed sashes. The ends are half hexagons. The heating may either be by flues or hot-water pipes; in either case to be under the floor, but enclosed in an air-chamber—the heat being admitted into the house through brass registers sunk in the stone pavement, the whole floor being covered with that material, and the plants arranged in lines or in groups, so that a free promenade may be left between the rows or groups. Very little heat is required for the orangery—merely the exclusion of frost. The general entrances should be at the two ends. The stoke-hole and furnace are to be in a vault under ground, and placed near the centre of the house. The smoke is to be carried away through a flue enclosed within a larger one, and made to discharge itself where it will be as little seen as possible.

The orangery at Nuneham Courtenay, laid out, as well as the original flower garden, by Mason, was of humble pretensions, and consisted of a roof, front, and two ends, all of which were portable. When removed in spring, the ground between the trees (for they were planted in the soil) was turfed over, the whole then appearing as a group of orange trees growing on the lawn. These trees, as well as the protecting frame, have long ceased to exist.

The first orange trees seen in England were those at Beddington in Surrey; and according to Bray, (*vide* "Memoirs," vol. i. p. 432.) "they were planted in the open ground, and secured in winter only by a tabernacle of boards and staves." They are said by the same authority to have been large and goodly trees, bearing abundance of fruit, and to have stood one hundred and twenty years.

The most perfect form of an orangery would be that of a highly architectural conservatory, glass on all sides, from the plinth at the ground to the roof glazed with plate glass in large pieces. The whole of the sides should be made so that they can be removed during summer, like the conservatory at Grovefield, fig. 511—the house standing isolated upon an open lawn. The roof we would glaze

with obscured glass—not Hartley's patent, which, however good for pits and houses of culture, would be ill adapted for houses of the highest pretensions, on account of the rough and coarse appearance of that glass. In regard to heating, little more is required except the exclusion of frost; but, for greater elegance, we would carry the hot-water pipes under the floor, imbedded in non-conducting material, and place highly ornamental vases through the house, into which the heated water would flow, and give out its heat by radiation. These would associate well with the ornamental tubs or boxes in which the trees should be grown; and during summer, when not required for affording heat, a small tree growing in a pot may be placed in each.

The orangery, like the conservatory, is to be regarded more as a structure for the display of plants already grown than as one for mere culture; it follows that, in its details, it should be rendered as perfect, and as well fitted at all times for a lounge or promenade, as the saloon or gallery in the mansion. Hence the propriety of having the trees grown in cases of a very different character, as regards artistic taste, from the monstrous tubs and cubical boxes which we see in houses of this kind, and also that something better than a mud or tile floor should be provided. There is, for this purpose, nothing better than polished Portland pavement kept perfectly white, like the passages in the Royal Gardens at Frogmore. Polished Caithness pavement, in large slabs, oiled after being laid down, would form no bad substitute for black marble,—and next, and best of all, are the encaustic tiles of Minton laid in ornamental patterns.

#### § 4.—HEATH-HOUSES.

As no section of cultivated exotics requires a greater degree of both sun, light, and air, than the heaths, so no structure is so well adapted for them as a span-roofed house having the ends pointing towards the north and south. There are details also in the construction of a span-roofed house that require especial notice in order that it may be completely fitted for this purpose. That ventilation may be the more complete, it is advisable

to have the roof portable—that is, composed of rafters and sashes—so that part, or all of them, may be removed during summer, to admit of soft genial rains and dews falling directly upon the plants;—cold and heavy continued rains should, however, be excluded by replacing the roof sashes. The temperature also will be lowered by this means, as the conduction of heat by the glass will be avoided; and, to break the full force of the meridian sun, thin canvass awnings should be used, mounted on rollers at the ridge, and ready at all times to let down upon the rafters. The side or upright lights should also be made to open freely, and so constructed as to be capable of removal during summer. All this may be considered ventilation enough,—and so it is during summer; but during winter, when the side lights cannot be opened with safety, on account of the cutting draughts of wind, other and more judicious means must be employed; and no plan is so simple, and at the same time so effectual, as ventilators in the side walls opening into the house close to the floor, by which atmospheric air, fully charged with moisture, will enter, and, becoming diffused through the house and amongst the plants, will find an escape through the openings in the ridge-board, as shown in several figures in section VENTILATION. The air thus admitted does not come into contact with the plants, but enters below them, and, ascending upwards, parts with its cold, and imbibes the temperature of the internal atmosphere nearly, before it reaches a single branch or leaf. In the coldest weather this operation goes on, as, when the atmospheric air is too cold to be admitted into the house, it indicates that the hot-water pipes should be put in operation. And, as all kinds of heating should be placed along the sides of such houses, it follows that the cold air, in entering as above, will have to pass under and over the hot pipes or flues, and thus abstract sufficient heat from them to render it fit for being admitted amongst the plants.

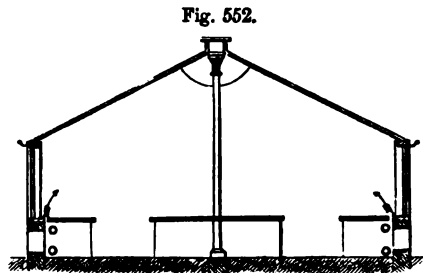
Again, a constant stream of air should be kept going on, we would almost say night as well as day, to counteract the effects of damp, or rather the effects of those gases formed in air in a stagnant and damp state, which are found to gene-

rate on the floor and near the bottom of all hothouses not sufficiently ventilated, at or under the floor level; and few houses are exempt from this defect. A rapid circulation of air is absolutely necessary to the welfare of heaths; and this circulation, to be beneficial to the fullest extent, must be frequently charged with moisture, but not uniformly so. Whoever has studied the habitats of our mountain heaths, or had the good fortune to see this genus luxuriating in all the pride of exotic splendour on the Table Mountain at the Cape of Good Hope, must have experienced the buoyancy of the rarefied air they breathe, the sweeping currents of wind, the drizzling showers, the misty dews, and, at times, the low temperature they are exposed to.

To imitate all these conditions artificially should be our endeavour. This is to be effected by judicious and ample ventilation, and by placing the plants upon open stages, so that the air may circulate freely around them, and not upon close stages or platforms, as is too usually done; by keeping the temperature low, and the atmosphere humid, during summer; by placing evaporating pans in various parts of the house, or by watering the floor copiously, particularly in warm weather; and by currents of air let in on all sides when a drier atmosphere may be deemed expedient.

A complete heath-house should be furnished with hot-water pipes of 3 inches bore—that being found sufficient to exclude frost, the utmost degree of artificial temperature required. Indeed, where arrangements can be made to exclude frost by neat and portable coverings, it is better to use them, as the heath is, of all other plants, the most impatient of fireheat.

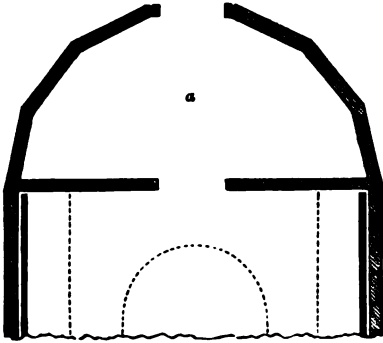
The accompanying section, fig. 552,



and plan, fig. 553, represent what we

consider a model house for this purpose. We may here also observe that lean-to

Fig. 553.

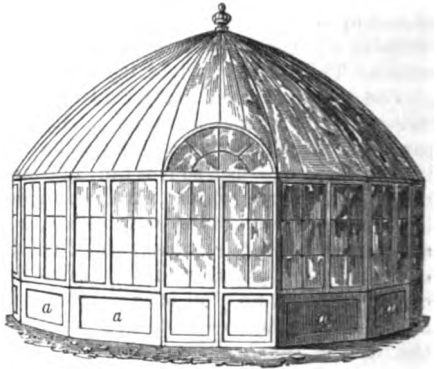


houses are, of all others, the worst adapted for heaths, as the plants draw towards the light in front, while the opposite side becomes naked and deformed from want of it. Turning the plants frequently will not remedy this defect; besides, vegetable physiologists can assign reasons why this is injurious to them. In building a complete heath-house, cisterns should be provided for collecting all the rain water that falls upon the roof, and even for containing a greater quantity if convenient, as no plants suffer more from water impregnated with mineral substances than the heaths. For this purpose a cistern should be placed under the stage, and covered over to prevent too much evaporation in winter; but, in summer, it may be left uncovered with advantage.

In the section above is shown top and bottom ventilation, to be used during winter, when opening the side or roof sashes would be inexpedient. The plants are arranged on the centre and side tables in the usual manner—the largest, of

course, occupying the centre platform. As all span-roofed houses present angular gable-ends, and as these are the points of entrance, we have here shown what we consider to be an improvement—namely, a lobby or porch, (a on ground-plan,) which is separated from the body of the house by a glass partition, and may be furnished with seats, or occupied with large specimen plants. Fig. 554 shows

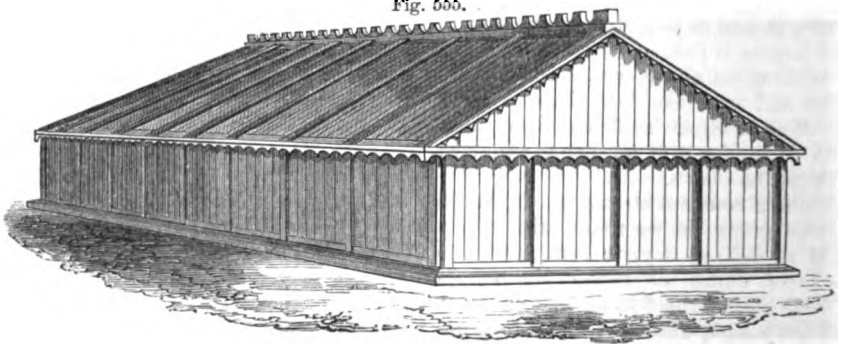
Fig. 554.



the elevation of one of the ends, which, on account of the form, has a fixed roof. The ventilators in the parapet wall are also shown, a a a a, as well as the door opening as high as the sides of the house.

Fig. 555 shows the elevation of another span-roofed heath-house, the sides of which are glass sashes running on rollers, and fixed rails set on top of the stone plinth, the sashes being made to pass each other, as shown in several figures in this work. The ridge should also be made to open for ventilation. As the whole of the sides and ends may be removed during summer, sufficient venti-

Fig. 555.



lation will be attained, although the whole roof is fixed, which will give the house a lighter appearance, and considerably lessen the expense of erection. The internal arrangements of this house may be similar to those of the last; for although the whole of the ends and side-sashes open, there can seldom be a necessity for entrances at other than the two ends. This house is better adapted for exhibiting large or full-grown specimens than the last, on account of its width and height. The length of such a house is 36 feet, and breadth 17 feet, 6 feet high in the sides, and 12 feet from floor to ridge.

Long, narrow, span-roofed houses are also very suitable for growing heaths, provided large specimens are not an object. Thus, for instance, the heathery at Woburn Abbey is of this kind: it is, however, curved, instead of being in a straight line, by which much of the perspective effect is lost. A very complete heath-house might be constructed of the following dimensions: 100 feet long, 15 feet wide, and 12 in height from the floor to the ridge; the sides may be 6 feet from the ground-level to the top of the side-sashes, which latter should be 3 feet, set upon a parapet of the same height. The plants should be arranged on cast-iron grating tables along both sides, 2 feet in breadth, having a flat table along the centre 6 feet in breadth, with a passage all round of the breadth of  $2\frac{1}{2}$  feet. Ventilation may be effected as recommended above, only the whole roof may be fixed, with an opening in the ridge 12 inches wide extending the whole length, the side-sashes opening by sliding past each other—not opening outwards or inwards, as is usually done—and numerous ventilators being placed at the bottom of the side walls, for admitting humid and fresh air during night, as also in cold stormy weather.

### § 5.—ORCHID-HOUSES.

The taste for orchids, of late years, has formed quite a new feature in the management of plants; indeed, at the present time, their cultivation may be ranked as the most popular of all the departments of exotic culture.

Within our own recollection, the whole exotic orchids in cultivation embraced less than twenty species; now there are

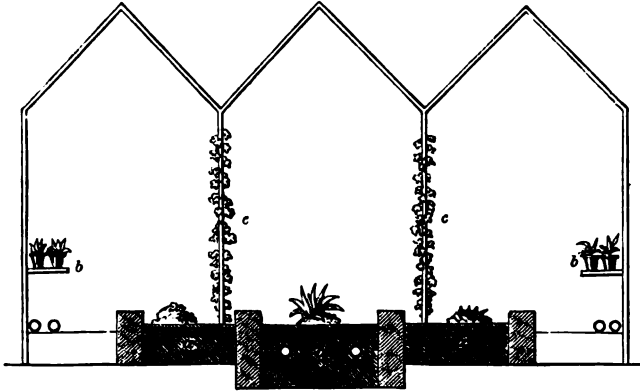
considerably above two thousand. Within a very few years they were considered as of difficult culture; now, their management is as well understood as that of any other family whatever. The late Mr Cattley, Mr Cooper of Wentworth, and the Messrs Loddiges, were the first who attained eminence in their cultivation. These shortly afterwards were followed by Harrison of Liverpool, Clowes of Manchester, Barker of Birmingham, the Duke of Bedford, &c., as pre-eminent in collecting and cultivating; but these excellent individuals have been removed by death, and their collections dispersed or transferred to other hands. The Dukes of Devonshire and Buccleuch, Mrs Lawrence, Mrs Wray, Mr Rucker, Mr Lyons, Mr Bateman, and others, have followed in succession as amateurs; while Low, Knight and Perry, Rollison, Veitch, Lucombe, and Pince, &c., as nurserymen, excel in the same line; and the botanic gardens of Kew, Glasnevin, Belfast, Glasgow, and Edinburgh, possess highly creditable collections, the first having been enriched by being presented with the collections of Woburn, and that of the late Mr Clowes of Manchester, and the last greatly increased of late by the munificent presentation made by Mrs Haig, of Viewfield, of her rich collection.

As this interesting section of plants became popular, houses were erected for the express purpose of doing justice to their cultivation, as the following illustrations will abundantly show.

The orchid-house of Mrs Lawrence, fig. 556, is not, however, dedicated entirely to these plants, but combines also an aquarium, and accommodation for climbing plants besides—the latter a very necessary appendage, as affording shade during summer, which can be reduced during winter by a judicious use of the pruning-knife. This house is thus described in "The Gardeners' Chronicle":—"The roof consists of three spans, which cover a breadth of something more than 50 feet, and is supported by columns *c c* in the section, to which creepers are trained. In the centre is an irregular piece of water, (*a* on section 556 and ground-plan 557,) called the lake, surrounded by a rock-work edging, heated by pipes passing through it from the boiler *e*, and containing aquatic plants. The flooring

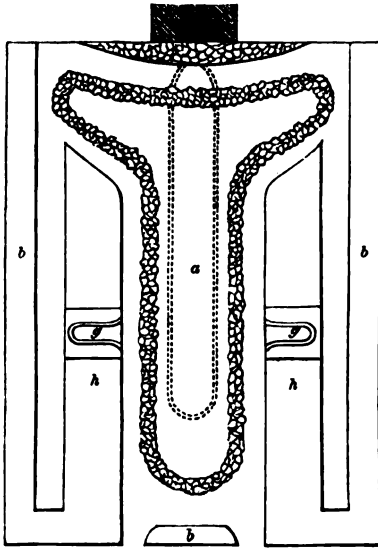
of the house and the shelves (*b b*, &c.) are of slate. Parallel with the shelves, and

Fig. 556.



separating them from the narrow part of the lake, are beds, (*h h* in ground-plan,) raised  $2\frac{1}{2}$  feet above the level of the floor, and each furnished in the middle with a tank, *g g*, the water in which is heated

Fig. 557.



by a turn of the pipe passing through it. At the north end, the house is closed with a solid wall, covered with bark and rough projections, for ferns and such plants; at the other end it opens into what is called the plant-house, by two doors. The heating apparatus consists of a boiler, *e*, at the close end, and of pipes running through the water and under the slate

shelves." The boiler is one by Weeks, junior, formed of cylindrical pipes placed in rows alternately above each other, and heated by one or two fires, as occasion may require. The pipes passing through the tank or lake give out a genial evaporation, and also keep the water in a fit state for syringing over the plants. "From the roof, as well as from trees placed in the centre of the lake, orchidaceous plants are suspended in bas-

kets and on logs of wood," and on the pits and shelves are placed plants in pots.

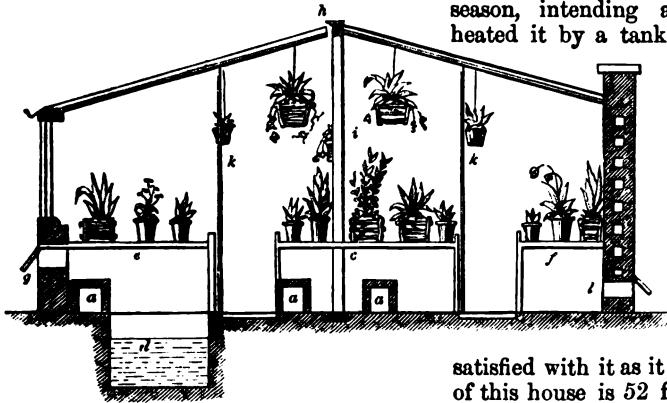
The orchid-house of S. Rucker, Esq., we learn from the same authority, is 55 feet long, and 15 feet wide: the sides are 5 feet 6 inches high. It is heated by hot-water pipes, which pass along two sides and one of the ends, the entrance being at the other. The plants are set upon a pit in the centre of the house, and on stone shelves over the hot-water pipes. The pit is 4 feet wide, and the passages 2 feet. The water from the roof is very properly collected and led by pipes into a cistern under the centre group of plants. The success of Mr Rucker as a cultivator has been sufficiently shown at the various exhibitions of the London Horticultural Society.

The accommodation for orchidaceous plants in the gardens at Dalkeith consists at present of two houses, of which the annexed section will give a pretty good idea. The house first erected is heated by smoke-flues, a furnace being placed at each end, these being capable of being wrought together or separately. The flue of the one passes across one end, along the front, and, turning at the extreme end, dips under the doorway, and ascends the chimney at the opposite end. The other flue enters the house at the opposite end, and, making two turns under the centre platform, dips also under the doorway, and joins the other flue. A cistern or tank of water extends the whole length of the house, 4 feet broad and 3 feet deep, supplied with water by the rain that falls

on the roof; and, when that is insufficient, by a pipe from the general reservoir. This house joins the camellia-house on one end, and the second orchid-house on the other.

In the section fig. 558 the arrangement will be seen more clearly: *aaa* are the

Fig. 558.



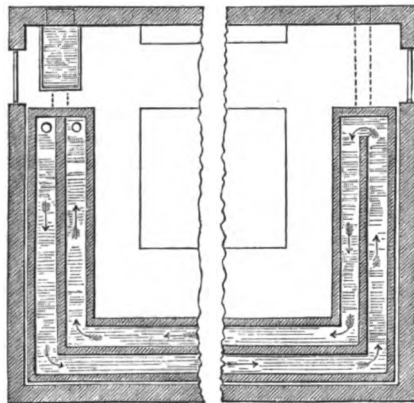
flues; *d* the cistern of water; *c* the centre or principal plant-table; *e* the front table; *f* the back table; *g* front ventilators; *h* ridge ventilator; *i* support of ridge; *k k* iron rods supporting the rafters, to enable them to sustain the weight of plants suspended from them; *l* back ventilation,—the cold air entering the house close to the floor level. This house is roofed with rafters and sashes, placed here as being the most trying situation as regards the decay of material. These rafters, considerably reduced in size, and the sashes re-glazed, are the same which formed the vineries in the old garden at Dalkeith; they were made in London about the year 1762, and brought to Scotland in a vessel freighted on purpose; and such is the state of the wood-work at the present day, that we predict they will last longer than any of the houses built by ourselves of new material within the last ten years. The plants are set on platforms of open wood-work, to admit of the free circulation of both heat and air around them, as well as to keep the roots moderately dry; for we are not of those who cultivate plants, the majority of which grow naturally suspended from the stems and branches

of trees, on shelves of stone flooded with water. The front ventilators *g* are built in the front parapet wall in the usual manner; the ridge ones are lids which lift up and down, and are operated upon by means of a rod to push them up, and a line to pull them down. We introduced smoke-flues into this house, having built it in haste towards the end of the season, intending afterwards to have heated it by a tank in the centre, and hot-water pipes round the sides. It, however, works so well, that we see no reason for altering it; and were it not that there is the usual trouble and dirt attending the cleaning of the flues, we would be quite

satisfied with it as it stands. The length of this house is 52 feet, breadth 22 feet, and height 11 feet from the floor to the ridge.

Fig. 559 is the ground-plan of another orchid-house in the same establishment

Fig. 559.

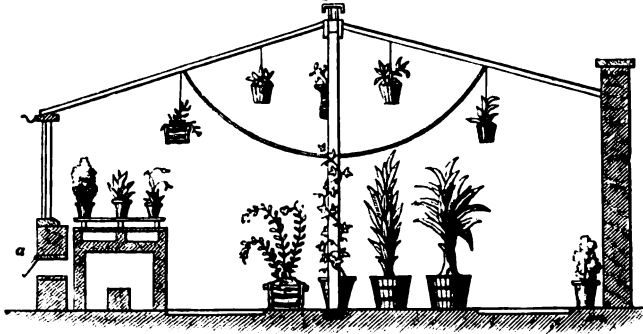


as it was till very recently arranged. As will be seen, it is heated by hot-water tanks, which have already been described, (*vide* section FLUES.) Over the tanks, which were covered with Welsh slates, were arranged the plants, but elevated 4 inches above the slates on wooden trellises, as shown in section, fig. 560. Ventilation is effected by wooden box-ventila-

tors built in the front wall *a*. The cold air, on entering, comes in immediate contact with the side of the tank, and also passes through under it, in openings 4 inches

The length is 30 feet, breadth 22 feet, and the height 11 feet from the floor to the ridge.

Fig. 560.



From the roof were suspended many species, both attached to blocks of wood, and also having their roots enveloped in balls of moss, &c. Many of the orchids, ferns, &c., were so treated, some of which require a greater degree of humidity than others, particularly the latter. To afford them this supply in a gradual and constant

square left on purpose, thereby becoming warmed before reaching the plants. The back wall is built hollow, (as all our brick walls are :) the cold air entering near the top by openings, 4 inches square, made in the north side of the wall, descends through the wall, and enters the house close to the floor by similar openings inside—these remain open night and day. The top ventilation is accomplished by the ridge opening along its whole length, as described and exemplified in section VENTILATION. The roof is a span without rafters or framed sashes, the astragals being dovetailed into the side-wall plates and ridge-boards. They are kept in their proper places by means of an iron bar 1 inch square, extending the whole length of the house, and perforated under each astragal, to admit of the latter being screwed down upon the bars. The ridge is supported by upright wooden columns, 5 inches square—their bottoms being set *on*, not *in*, stone blocks a foot in height. An inverted arch of iron circular rod is attached to these uprights, and, curving upwards, is screwed into the iron bars above alluded to. This is done more with a view of suspending plants from, in rustic baskets or ornamental earthenware pots, than for supporting the roof, which would be strong enough without such aid. It is glazed with sheet glass 2 feet long and 9 inches wide, 16 ounces to the foot. There is no iron in this house excepting the inverted arches and the bar for regulating the astragals—the boiler employed being of lead.

manner, just over them was attached to the edge of the astragal a small piece of putty, which intercepted the stream of descending condensed steam, and caused it to fall upon the moss, block of wood, or whatever else the plant was attached to; and this supply of water could be directed to their roots, if it was judged inexpedient for it to fall on the stems or foliage, by attaching a small wire to the putty, and fixing the other end at that point where it was wished the water should be discharged.

The centre part of this house was two years ago transformed into an aquarium, in which the *Victoria Regia* and other aquatics are growing luxuriantly. The water-tanks in front have also been removed, to afford space, and a smoke-flue substituted; while the large tank in which the *Victoria* is planted is heated by a system of leaden pipes supplied from the original leaden boiler, agitation being given to the water by mechanical power, and a constant supply of fresh water heated, by causing it to pass through a pipe coiled in the furnace, before it is discharged into the tank. A waste-pipe leads the overflow water into a tank in the adjoining house.

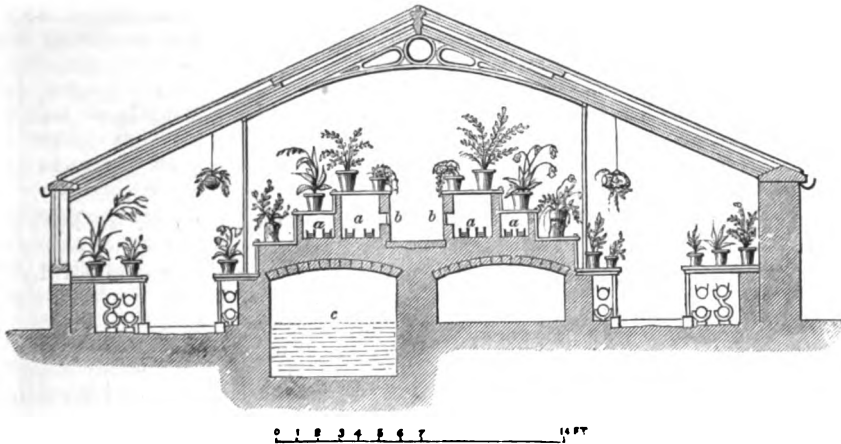
Orchids are, however, still cultivated in this house, and are set upon a trellis placed over the flues, and suspended from such parts of the roof as will not make them shade the plants in the tank; and the back wall is also covered with them.

The orchid-house at Kew is also of the span-roofed form, heated by hot-water

pipes placed under the side tables, as seen in section, fig. 561. In the centre is a stage formed of pavement, hollowed out

so that each shelf holds water, with the view, as Mr Smith, the excellent curator, informed us, of giving off humidity by

Fig. 561.



evaporation for the benefit of the plants. On the top of this stage is a walk, which is ascended to by steps at the end. This house appears to have been erected upon similar principles to that of the late Mr Clowes at Manchester. As an instance of the mutability of human affairs, this house now contains the rich collection formed by that excellent gentleman, it having been presented by him to the Royal Gardens, as well as that of the late Duke of Bedford.

Some peculiarities, and indeed improvements, exist in this house, which did not in the other. Under the two top shelves on each side of the passage are placed a system of tanks, *aaa*, 9 inches deep, and open at the top, the water rising in the centre of the house from a pipe, which goes across below the path, to supply them. These top shelves are in the form of chambers, having openings, *bb*, in them along the centre passage; these can be opened or shut at pleasure, according as the state of the atmosphere renders necessary. The shelving in the centre is made of Welsh slate, and furnished at the edges with a little bead let in, by which means they may be covered with water when desired. This house is 80 feet long and 34 broad. It is heated by two boilers, one or both being used at the same time. There is a capacious tank for water at *c* under the plant stage, —a very proper and necessary appendage.

VOL. I.

The hot-water pipes are placed directly under the slate shelving in front and back—the worst possible place in which they could be placed, as the radiated heat, ascending upwards and to one side, has no means of ascending into the house at the very part it is most required, namely, between the plants on the side tables and the glass. The only heat which can be beneficial to the atmosphere of the house is that which is admitted on one side next to the passage, some 3 feet from the inner surface of the glass, leaving that space on both sides of the house little benefited by the operation of the pipes.

The orchid-house of the Messrs Booth, nurserymen, &c., at Hamburg, of which the accompanying, fig. 562, is the section,

Fig. 562.



is not only one of the largest, but also one of the best contrived houses, for this purpose, of any we are aware of in commercial establishments. In length it is 103 feet, in breadth 21, and in height 11 feet. In form

3 F

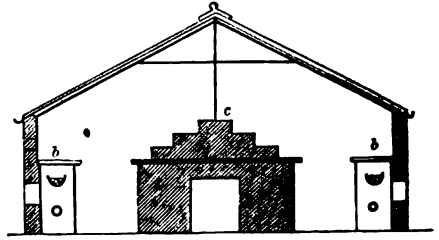


it is span-roofed, the ends pointing north and south. Tables of blue slate,  $2\frac{1}{2}$  feet broad and  $3\frac{1}{2}$  feet in height, run all round the sides, and in the middle is a covered pit, in 3 divisions, upon which the larger specimens of plants stand. The boiler is placed at the north end, and the entrance, which consists of five Gothic arches, enriched with stained glass at the top, occupies the south end. The roof is supported by iron columns *e*. Ventilation is effected by openings in the side walls *a a*. The heating is by hot-water pipes *b b*, running parallel with the passage *c*, and returning again under the top ones. Under the front platforms are placed flues *d d*, to be used in addition to the pipes when required. In the centre pit are placed two cisterns to receive the water which falls on the roof; also a tan-pit, and another division of it covered with gravel, upon which the plants are set. The foot passages are 4 feet broad, and pass all round the house. The side platforms are laid with a slight inclination towards the front walls, by means of which water spilt on them, while watering, runs off in that direction, instead of towards the foot passage, which is by this means kept quite dry. Climbers of the choicest kinds are planted in small beds in the middle platform, and are trained over the roof both for ornament and shade. The roof is of double sashes, a plan not unfrequent on the Continent, where glass is cheap, and the winters are so much colder than with us. Experience has satisfied Mr Booth that such a mode of roofing has many advantages; it economises fuel, an article expensive at Hamburg; and it also affords a moderate degree of shade during summer, where the sun's power is much greater than with us, and where, without shading of some kind or other, few plants, orchideous ones in particular, would prosper under its direct rays.

The orchid house of Mr Lyon, of Ladiston, Mullingar, is exhibited in the annexed diagrams, figs. 563, 564. This gentleman, who is possessed of the best private collection of Epiphytes in Ireland, has published a work on their culture, and given a plan of his house, a copy of which he has kindly presented us with. From it we learn that the house is of the span-roofed form, 45 feet long, and 16 feet wide. The end at which the entrance is placed is five-sided, *a*, and forms a lobby

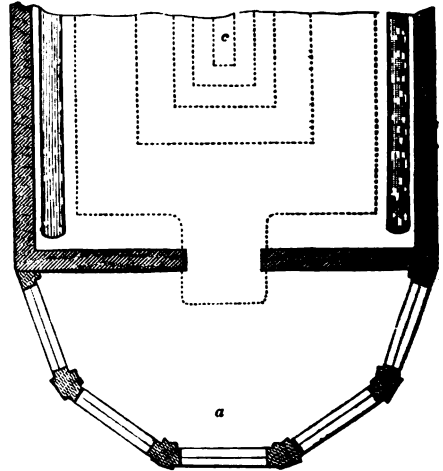
or ante-room, intended for visitors to remain in till sufficiently cooled to prevent

Fig. 563.



danger by catching cold in leaving a heated atmosphere and going out into a colder one. From this, and Mr Lyon's directions for culture, we learn that he con-

Fig. 564.

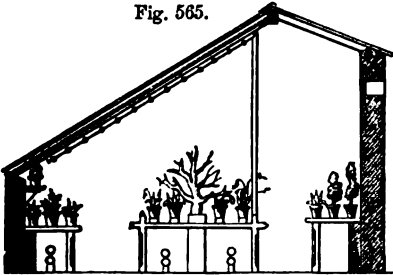


tinues to maintain a degree of temperature much higher than most good cultivators now approve of. The side walls are  $5\frac{1}{2}$  feet high, without side lights; and in them are placed ventilators, eleven in number in each side, and one also in each gable. The sashes are fixed, and of the whole length of the side of the roof. The plants are arranged on stone shelves along the sides *b b*, and also on a stage *c*, occupying the middle, formed of pavement, and three shelves on each side in height, as well as at the ends; the centre one being hollowed an inch deep. Mr Lyon, approving of the system followed by the late Mr Clowes of Broughton Hall—namely, of keeping his house at nearly the point of saturation during the period of the plants' growth—has arranged it so that

the whole stage and floor can be overflowed with water at pleasure. The sunk shelves are filled up with small pebbles, and on these the pots are placed. A Grecian fountain is placed in the centre of the house, the water from which falls into a basin in which aquatic plants are cultivated. The waste water is conveyed into a large tank holding 2000 gallons, which is used for the plants, pipes, &c., and is all rain water collected from the roof of this and other buildings adjoining. The space under the stage is used for forcing sea-kale, mushrooms, and rhubarb, during winter. The house is heated by hot-water tanks, and pipes underneath them to return the water to the boiler. The tanks are metal, and the boiler used is one of Burbidge and Healy's ribbed ones, which, Mr Lyon thinks, is a decided improvement, as it exposes a much larger surface to the action of the fire, and thereby derives a much greater benefit from the same quantity of fuel than could be obtained by a plain boiler.

The orchid-house in the Belfast Botanic Gardens, fig. 565, differs from the fore-

Fig. 565.



going examples, inasmuch as it is of the lean-to form, whereas all the others are span-roofed. The same error has been fallen into here as in other houses we have noticed—namely, the carrying the stone shelves in front into the parapet wall, thereby preventing the ascent of heat from the pipes. We observe also, that Mr Ferguson, the highly respectable curator, has his plants set on stone tables, the centre one especially, so arranged at the edges as to hold water, upon which the plants are set; but they are elevated a few inches above it, being set on stones or otherwise raised. There are two principal reasons given by cultivators for adopting this practice—namely, to secure

the plants from the attacks of wood lice, cockroaches, &c., and also to give out humidity to the atmosphere. Cleanliness prevents the attacks of the former, and copious syringing provides for the other. Here we observe a provision made for collecting the condensed steam and the rain-water that finds its way through the roof, by introducing copper or zinc gutters to prevent its falling on the plants. If the glazing be in proper repair, and the necessary ventilation provided, all this is unnecessary, and only gives the appearance of imperfection and decay to the structure. For a lean-to house its arrangement is as good as can be, and the plants under Mr Ferguson's care are well grown. We would, however, have placed the upright supports perpendicularly under the ridge, by adding to the main table and dispensing with the back one altogether. At present they do not give that appearance of support which they are intended to do; but, even as it is, they are much better than similar supports we lately saw in a pine-stove erected for a Scottish nobleman, where the same kind of supports are nearly a foot out of the perpendicular. The back part of the roof is opaque, a circumstance rendered unnecessary since this house was built, as such structures can now be covered with glass cheaper than with boarding and slates.

In the construction of an orchid-house, a full command of heat, and means of applying moisture, should be secured. In regard to capacity, a medium-sized house should be preferred; for if too lofty, it is difficult to keep either moisture or temperature at their proper points, both during hot dry weather in summer, and severe frosts in winter, when strong fires are required. Small houses have also their faults, although in a less degree, as they are unfit for showing to advantage large specimen plants, and are liable to sudden changes of temperature and moisture, being easily acted upon by external causes. The form should be span-roofed, having the ends in any direction excepting due east and west, or the nearest points thereto. In width it should not exceed 14 or 15 feet, and presenting an angle not exceeding 30°. In glazing, rough plate-glass should be used, as rendering artificial shading unnecessary; the laps should be closely puttied; wide

squares of glass should be avoided, particularly if transparent glass is used. In regard to ventilation, a very small amount of fresh air admitted near the floor of the house will be safest; but ample means must be provided near the top for the escape of impure air, and also for regulating the temperature during the heat of summer. Where the collection is large, and of a mixed character, two houses are indispensable, one for the natives of the Western hemisphere, which grow in rather a low temperature and drier atmosphere; the other for those that are natives of the East, as they require both more heat and moisture, particularly during their growing season. The interior should be fitted up with open cast-iron stages or platforms, to keep the roots dry, and admit of a free circulation of air to pass all round the plants.

#### § 6.—THE AQUARIUM.

Notwithstanding the beauty of aquatic plants, and the interesting circumstances connected with them, and despite their cultivation being attended with no difficulty, it is singular that, while expensive structures are erected for almost every other description of plants, this country can scarcely, at the present day, boast of a dozen dedicated to the cultivation of aquatics. True it is, that since the introduction of the *Victoria Regia*, the queen of all known aquatics, several structures have been remodelled to suit its cultivation, and some few entirely built for it.

Of the aquariums at present existing in this country, we may mention those at Chatsworth, Kew, Sion House, that of the Royal Botanical Society in the Regent's Park, Messrs Veitch's at Exeter, Messrs Knight and Perry's, that of the Sheffield Botanic Garden, and that of Dalkeith Park, as the principal, all of which date their origin to a desire on the part of their owners to cultivate the *Victoria*. A new aquarium, upon improved principles, is now in course of erection in the royal gardens at Kew. The following paragraph upon this subject appeared recently in the "Liverpool Chronicle," from its style, it has been written by one highly competent to the task:—"Few, perhaps, are aware of the great beauty which the tropical aquatic tribes present under good

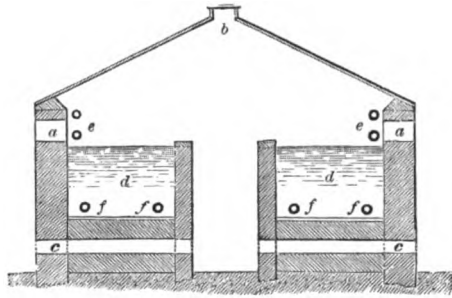
cultivation. They are not well adapted for small houses, but look best in houses having a vestibule, or circular centre. They may be made in various forms, according to the taste of the proprietor: if in a square or oblong vestibule, the aquarium should be of the same shape; if in a circular house, or part of the house, the form may be varied and much ornamented—a vase-shaped basin, circular cistern, or any other form suitable to the style of the building: a jet-d'eau in the centre is a great improvement. The interior must be of various depths, to suit the plants of various sizes, for which reason steps are usually formed from the circumference to the centre—the water being thus made shallower at the edge, to suit the smaller plants. Upon these steps or shelves pebbles and soil are laid, in which the roots are planted; and gold and silver fishes may be made to add to the interest of this group." As an inducement to amateurs to turn their attention this way, we cannot resist the temptation of completing this excellent paragraph: "And what, we fancy some one inquiring, can you grow in water, that is so beautiful? We will give a selection of plants for a stove, and also for a greenhouse aquarium. In the former we would not forget to have the *Papyrus antiquorum*, so interesting from its having furnished the writing paper of the ancients: the very name conjures up a museum of mummies, scrolls, sarcophagi, and manuscripts of the classics of ancient Greece and Rome: the beauty of the plant, independent of other points of interest, renders it worthy of a place in the stove aquarium. The other species adapted to this place are *P. odorata* and *P. laxiflorus*, which are also elegant gramineous plants. We have also seen the rice plant growing in the same way: it is very pretty, being more graceful than the common oat, and much taller. Then there is the magnificent *Nelumbium speciosum*, with its large emerald green, round, floating leaves, fine large rose-coloured flowers, and its Pythagorean associations, the seed being supposed to be the sacred bean of the Egyptians and Pythagoreans. *N. Tamara* is a fine species, with azure blue flowers; also *N. jamaicense*, and *N. luteum*, with bright yellow ones. The beautiful genus *Nymphaea*, or water-lily, also furnishes some lovely ornaments for the aquarium:

there is *N. cærulea*, with its cups of intense blue; *N. scutifolia*, *N. stellata*, and *N. cyanea*, are also beautiful blue species. *N. pubescens* is pink; *N. rubra*, red; and *N. rubra*, var. *rosea*, rose-coloured. Then there is the Egyptian Lotus, *N. Lotus*; the Hungarian, *N. thermalis*, with white flowers; *N. versicolor*, the variegated water-lily; and the pure white one, *N. blanda*. Besides these, the pretty yellow flowers of *Villarsia indica*, the red blossoms of *Euryale ferox*, the yellow flowery *Jussieua natans*, and the white *Alisma cordifolia*, make a group of great beauty. The leaves alone of the *Nymphæas* make them well worthy of cultivation. For the greenhouse aquarium we have an equally extensive selection. Two species of water-lilies, *Nymphæa reniformis*, and *odorata*, both with white flowers; *Limnocharis Plumieri*, and *L. Humboldtii*, with pretty pale yellow blossoms. The remarkable genus *Sarracenia*, with their pitcher-shaped leaves, grow best with their roots in shallow water. *Jussieua grandiflora*, *Alisma parnassifolia*, *Frontium aquaticum*, *Hypoxis aquatica*, *Byblis liniflora*, (blue,) *Drosera binata*, *Menyanthes americana*, *Villarsia lacunosa*, and *ovata*, cum multis aliis, are all beautiful ornaments to the greenhouse aquarium. Few who have not seen a well-arranged aquarium can imagine anything so beautiful as one when in perfection."

In regard to the structures best adapted for this purpose, we may observe that, as aquatics require the greatest possible degree of light, a house that presents the largest surface of glass must be looked upon as the most proper; nor must they, for the above reason, be placed too far from the glass. A house of the span-roofed form is the most suitable, so far as economy is concerned, as it admits of various heights, which is a positive condition to be observed; but, unfortunately, in such houses the walk is in the middle, and, consequently, the tallest-growing plants would of necessity be placed along both sides of it, to attain head room for them, leaving the smaller, and, indeed, the most interesting, to be placed at too great a distance from the eye. Were low-growing aquatics only to be cultivated, then such a house as fig. 566 would be all that could be desired, and might be constructed as follows:—The length and breadth may be at the disposal of the pro-

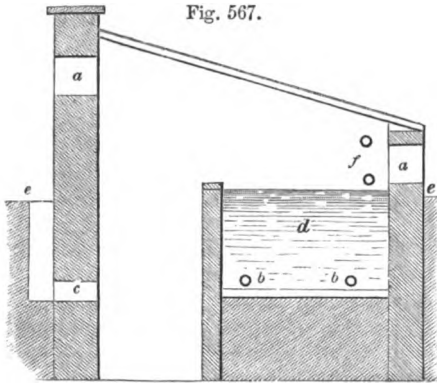
prietor, but the height should never exceed that which will enable him to walk

Fig. 566.



freely along the passage. A tank or cistern of water should occupy each side, from 1 to 2 feet in depth, which will be sufficient for the most robust growing kinds. Others, that do not require such a depth, may be elevated in a variety of ways to the depth suitable to their respective habits; whilst those which grow only in a swampy soil can be accommodated by partitioning off a space for their accommodation. That the water in which tropical aquatics grow is warmed by the sun is well known; it follows that in cultivation an approach to this effect should be attempted, and, with this view, hot-water pipes should be placed along the bottom of the water in the tanks, as shown at *f f f f*, and pipes of the same kind along the sides at *e e*, to warm the atmosphere of the structure. It would be unsafe to connect the water in the cisterns with the boiler directly, as in the case of ordinary tank-heating, because earthy and other matter would find its way into the boiler, and be productive of bad effects. The same rule is applicable to a greenhouse aquarium in every respect. The roofs of such houses may be of the fixed kind, which will admit more light, lessen the expense, and have a much better appearance. Ventilation is to be effected as so frequently exemplified in this work, and as shown in our woodcut, which, however, is slightly varied from former examples. *a a* represents the ventilation to the foliage; *c c* the ventilation to the passage; *b* the ventilation in the ridge. The tanks *d d* should be built of brick, and cemented, which is not only the cheapest, but also the most durable construction. The roof should be very flat, say from 12° to 15°, in order that the plants may be near the glass.

Those who object to the expense of a regular aquarium may grow many of the low-growing kinds in a pit, as exemplified in fig. 567, with very good success.



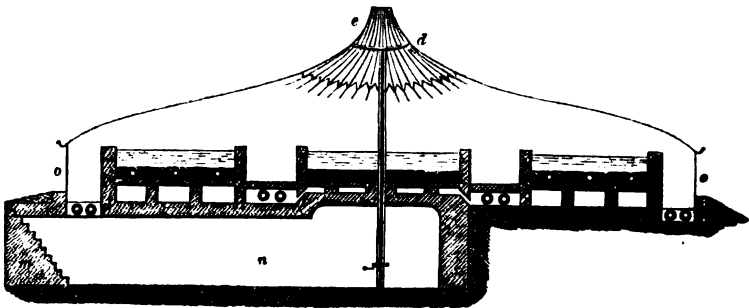
This was the practice of the late Mr Kent of Clapton, one of the best cultivators of aquatics of his day; but as Kent had not the advantages we possess of hot-water pipes and tanks, he was compelled to use fermenting material aided by smoke flues. *a a* is the ventilation in the back and front walls; *b b* hot-water pipes for warming the water in the tank; *c* ventilation to the passage, by admitting the cold air from the surface, down a tube and through the back wall, the orifice of this opening to be regulated by a brass ventilator; *e e* ground-level; *f f* hot-water pipes for warming the atmosphere, connected with the same boiler as those which warm the water in the tanks. As in most collections aquatics are not cultivated to a very great extent, such a pit as this might be attached to a cucum-

ber or melon pit, and be of limited length. The tanks of all aquatic pits or houses should have a waste-pipe, so that they may not only be emptied occasionally, but the water may be changed frequently, by letting off a part and replacing it with a fresh supply. Without this precaution it would become offensive, as well as muddy.

Much as we dislike circular houses in general, we admit that, for an aquarium of the first order, they are superior to all others, particularly such as have curvilinear roofs. In the earlier editions of "The Encyclopædia of Gardening," a figure is given of a house of this kind, and for this purpose, which appears to us to be the most perfect idea of a house for the purpose we have met with. The editor therein proposes a set of mechanical arrangements for producing motion in imitation of a river, a principle of late held to be of much importance in the cultivation of aquatics, and variously effected—in the aquarium at Dalkeith being by a horizontal wheel, kept in constant motion by a small jet of the supply water made to play on the wheel, which as it revolves agitates the surface of the water, and tends to drive it to the point of escape.

The annexed fig. 568 is that of an aquarium of the highest order. It will show the principle—altered, however, from the original, and adapted to modern modes of heating and ventilating, as well as giving a ground-plan to render the description more complete. The ground-plan, fig. 569, should consist of a cistern or tank *a* in the centre, 10 feet in diameter, with a small jet-d'eau supplied from

Fig. 568.



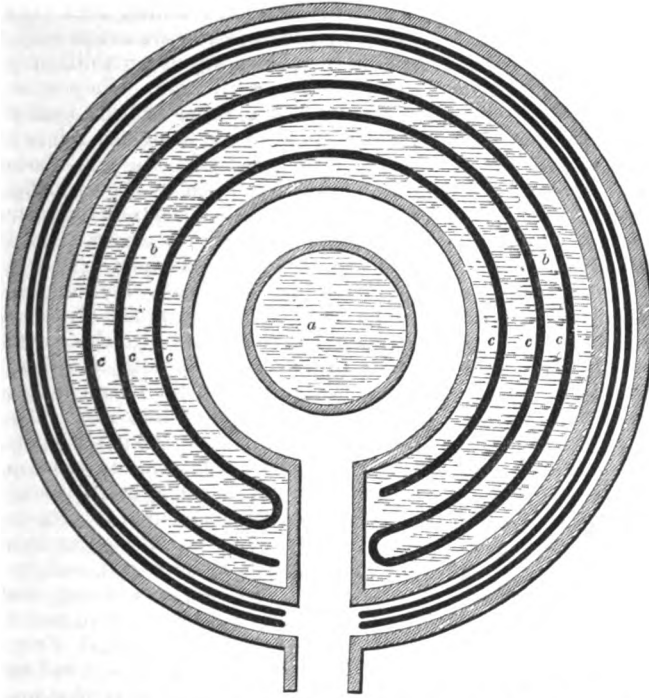
a reservoir, so elevated and constructed that the water in it during winter might be kept at or about the summer tempera-

ture of river water; a thing easily done by bringing up a flow and return half-inch leaden pipe, and forming a coil of

them within the reservoir. This supply would be sufficient to make up for the loss sustained by evaporation and

floors and sides of the passages should be laid with polished Bangor slate, Caithness pavement, Minton's patent tiles, or covered with patent Antonica, in imitation of polished Aberdeen granite, or any of the various coloured marbles, which can all be imitated to the greatest perfection by this excellent material, and at little more cost than that of Roman cement. The tops and inner sides of the tanks, as far as they are not covered with water, may be covered with the same material.

Fig. 569.



In regard to heating, hot-water pipes should be laid in the bottom of each tank, as shown at *c c c c c* in ground plan, and atmospheric heat obtained by the same means, the pipes being laid under the foot-paths in chambers disconnected from the side walls, to prevent

leakage, as well as to secure constant change of the water, to prevent it from becoming stagnant and unwholesome, the highest point of level being provided with a waste or overflow pipe. In this centre cistern, being the highest part of the house, the taller species of aquatics are to be grown. We have thought it unnecessary to show the hot-water pipes in the centre tank *a*, or passage round it, as they are shown so clearly in the section, fig. 568. We may remark that all these pipes, being laid in a circular direction, should be  $2\frac{1}{2}$ -inch leaden pipes, by which means few joints will be required. The side tanks *bb* are to be appropriated to the cultivation of the lower-growing and floating kinds. These latter tanks should be divided by partitions, so that various depths of water can be secured to suit the different habits of the plants, and one division should be set apart for bog plants, or such as merely require a damp surface, as the genera *Sarracenia*, *Drosera*, &c. The

the abstraction of heat; in fact, they should be placed in what may be called a well-built flue without covers. To admit this heat into the body of the house, an elegant pattern of brass grating should be laid in the floor, flush with the surface, and directly above the pipes, so that perpendicular radiation may not be obstructed. Should Minton's tiles be used—and they are, of all other floors, not only the most elegant, but also the most durable—a different mode of admitting the heat may be adopted—namely, by plain, square, circular, or angular brass ventilators, cut to the same pattern with the figures on the tiles, which should be introduced at least every 3 feet. The principal objection to placing flues or hot-water pipes under the floors of hothouses, is, that provision is not made for preventing the heat being absorbed by the surrounding walls, soil, &c., and also that no supply of fresh air is admitted to cause a circulation and drive the heat upwards. Air in a state

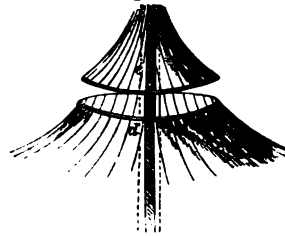
of quiescence is a bad conductor of heat, but in a state of motion it is a good one. To provide this circulation, an air-drain should communicate between the stoke-hole and the open flues in which the pipes are laid. It need not communicate with the external air, as it would thus draw in too much cold air, particularly in frosty weather, and lower the temperature in the house instead of raising it.

The furnace, stoke-hole, &c., in section, should be placed in a vault beneath the centre of the house, access being obtained to it by a well stair, *m*, covered with a neat iron grating set level with the surface of the walk or ground around the house, and sufficiently large to allow a man to enter freely. The vault should also be sufficiently capacious to hold a supply of coals and the refuse ashes, so that a supply and clearing-out once a month may be sufficient. The air admitted by the grating over the stair will be sufficient to insure a well-regulated combustion in the furnace, and also a supply of moderately-heated air to cause circulation of the heat from the pipes within. In summer, in the case of the greenhouse aquarium, a species of ventilation will take place when the ventilators in the floor are kept open, which will lower the temperature in hot weather very considerably, and much to the benefit of the plants; while, in regard to the tropical aquarium, the same means will produce a circulation of air through the structure, which will not only cause a regular diffusion of heat through every part of the house, from the floor upwards, but will carry in much of those natural elements so necessary to plants, and with which an allwise Power has furnished the atmosphere in which we live. The smoke from the furnace may be carried away in a flue built within an outer covering or drain, and laid upon an incline rising from the furnace to the chimney-top, which may be concealed behind shrubs; or it may be discharged through a vase on an elevated pedestal, the smoke being consumed to a great extent by some of the plans recommended in Section FURNACES.

Ventilation is to be effected by openings in the side-walls *o o*, and regulated by brass registers placed level with the floor of the passages next the front of the

house, 6 feet apart, and 12 inches in diameter, every alternate one communicating with the principal passage by passing under the two outer tanks. Thus bottom ventilation is amply provided for; but in all circular-roofed houses with fixed roofs, which such a structure as this necessarily is, there has always been a difficulty in effecting top ventilation. We propose in this case that the roof be tied together at *d*, all the astragals being fixed into a circular girder, and that the part above that (*e*) be in one piece, as shown in fig. 570, and attached to an upright circular iron column 3 inches in diameter, formed upon the telescope principle, or like a common sliding pencil-case. This column is to be attached to the circular girder at top, and made to pass through the centre tank to the stoke-hole beneath, and there secured to the roof of the chamber, but extending 2 feet below that roof. The movable column within the outer one is to be attached by four arms to the top piece of the roof above *d*, and, passing upwards to its apex, is secured to it there also. A simple lever is attached to this movable column at its lower end, and, by elevating or depressing this lever, the movable column is acted upon, and moves upwards or downwards as required. From

Fig. 570.



this it will be seen that, upon depressing the lever (whose fulcrum is suspended from the roof of the stoke-hole) the movable column

will be elevated, and consequently lift up that piece of the roof *e* above *d* to any height—say 6 inches—which will give as much ventilation as if it were removed altogether. A counter action of the lever will lower this part of the roof to its original place, and, being made fast to the movable column, it is kept in its place as securely as if it were part of the roof. A common rack and pinion would effect the same thing, but we think the lever the simplest of the two. There are various ways by which the top part of such a house could be elevated; we may state a very simple

one, illustrated by a common sliding cedar pencil, the moving part of which slides up and down the other in a dove-tailed groove: the motive power in such a case could be given by the lever, or rack and pinion, above alluded to.

The only aquarium of any extent, dedicated entirely to the culture of aquatic plants, that existed in Britain until within these few years, was that of the Duke of Marlborough at White Knights, dismantled many years ago. It is thus described by Todd in "Plans for Green-houses," who was builder of it: "It is constructed with a span roof of glass"—(by the way, one of the earliest specimens of this kind of roof constructed;) "the sides and ends are also of glass, as low down as the top of the flue. A cistern occupies the interior of the house, having a walk round it: it is lined with lead, and filled with a mixture of mud and water proper for the reception and growth of such plants as require aqueous nourishment. A flue goes round directly under the bottom of the cistern, for the purpose of keeping the water of a certain temperature. Another flue goes round the house above ground, and terminates in a chimney at the north-west corner. The bottom of the cistern, to receive the lead, is formed with slates, supported with bars of cast-iron: a bottom of wood would have been more convenient for laying the lead upon, but as the flues are so near the bottom of the cistern, danger of fire was apprehended." From our recollection of the house above described, it was far too lofty for the majority of plants of this description. We notice it here more to show that such houses have existed, than as a specimen of what they ought to be. To grow tropical aquatics in full perfection, they require a greater degree of bottom heat than is generally afforded them when cultivated in tubs or cisterns, and placed, as they are, too often in out-of-the-way parts of the stove; the want of success following so bad a practice has probably been the principal cause of banishing those beautiful plants from general collections. They require a bottom temperature of at least from 75° to 80°, and will bear more with impunity. Such pits as we have shown above will readily afford that temperature, as well as at the same time bring the foliage near to

the glass, by which the success of the cultivator will be the more complete, as it is well known that these plants will not long survive if kept far from the light.

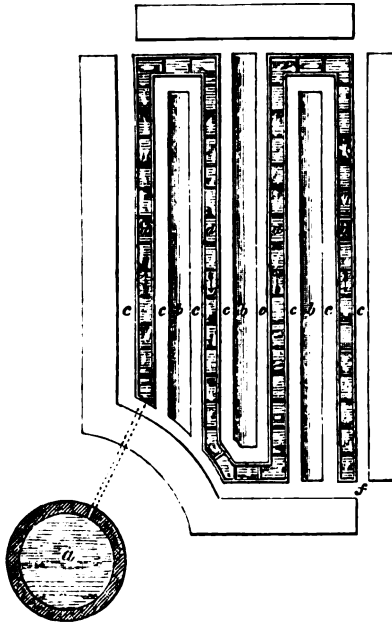
An attempt has been made by Mrs Laurence of Ealing Park to combine an aquarium and orchid-house together; and no doubt, under the excellent cultivation practised in that well-known establishment, aquatic plants are cultivated with considerable success along with orchids, and other somewhat similar plants. We must, however, remark that, upon visiting that splendid collection, we were struck with the circumstance of the aquatic plants being placed so far from the glass, that we were led to consider them as being a secondary object. For plan and description of this house, *vide* section ORCHID-HOUSE.

Aquariums for hardy plants are seldom met with out of gardens strictly botanical, and even in them we have never seen one that was so perfect as it ought to be. On the Continent, far greater attention is paid to the cultivation of aquatic plants, many of which are not only extremely curious, but also beautiful while in flower; and in addition, they are of easy cultivation, requiring little attention after planting, being scarcely susceptible of injury from neglect while a supply of water is kept around them. The aquarium, fig. 571, designed by the celebrated German garden-architect, F. L. Seckell, for the botanic garden at Munich, will be understood by the annexed diagrams. The circular basin or tank *a*, which supplies the aquarium, is 1 foot higher than any part to be supplied, for reasons quite obvious. The section, fig. 572, and also the plan at *b b*, show a division for bog plants not requiring to float in water: this division is prepared by laying a secure foundation of well-prepared puddle, and over it the proper soil for the plants to grow in; *c c*, &c., in both section and plan, are gravel walks 18 inches broad; *d d*, &c., are the water cisterns for true aquatic plants; and as some of these require a greater depth of water to grow in than others, provision is made to accommodate them by having the tanks subdivided by wooden sluices or partitions, so that some may be deeper than others, and also that the strong-



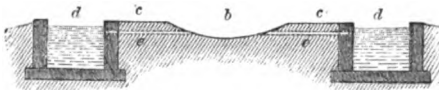
growing kinds may not overrun or mix with their more diminutive neighbours.

Fig. 571.



These tanks are so arranged in regard to level, that they have a fall from the highest

Fig. 572.

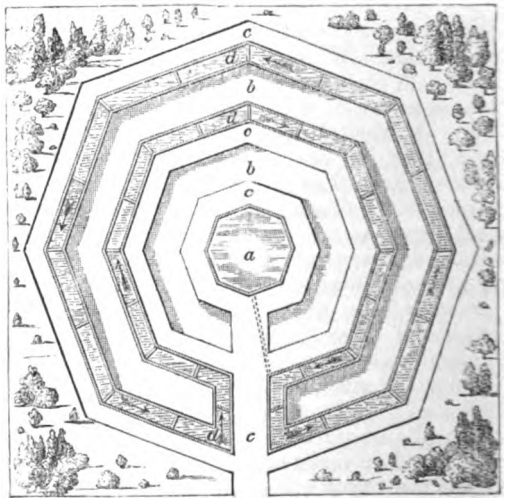


to the lowest point of 1½ inches in the 100 feet, so that a change of water takes place, but so slowly as to be scarcely perceptible. *e e* shows leaden pipes leading water from the tanks to the bog department *b b*, which can be kept drier or moister by this means, as may be deemed expedient. M. Skell has constructed his aquarium of oak posts and planks, a precaution rendered necessary to resist the severe frost to which the climate of Munich is liable. We have, however, substituted pavement sides and bottoms for the tanks in our figure, as suiting our climate, and being more economical and durable. The bottom is well puddled before the pavement floor is laid upon it. The sides are formed of pavement set on edge, resting on the pavement

floor, and thoroughly jointed. At the termination at *f* a waste-pipe is placed in the bottom of the tanks, and connected with an underground drain, so that the tanks may be dried when deemed necessary.

From the section it will be seen that all these tanks are under the ground-level, a plan adopted to render them stronger, and more easily made water-tight. There is, however, an objection to this plan—viz., the plants are too far from the eye, particularly those of smaller growth, which do not rise much above the surface of the water. This might be easily remedied by forming the tanks upon the surface instead of under it; by this means the walks would be 2 feet under the level of the surface of the tanks and bogs, and the plants brought into a better position to be examined. In this case, the sides would require to be made of pavement 3 inches thick, and securely jointed at their edges, both for strength and for retaining the water. The form also might be improved by forming the tanks and bogs in concentric octagons round the basin *a* as a centre, leaving an open passage from the outer circle to the basin at any point of the circumference most convenient, as shown by fig. 573. The centre basin might be furnished with the tallest of all aquatic plants, and the lower growing ones kept in the outer circle. To protect the whole from frost during winter, as most of the plants would be down, the

Fig. 573.



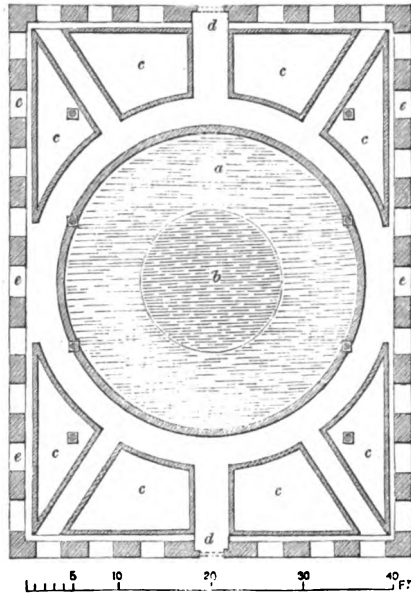
whole might be covered with straw hurdles, and by this precaution many exotic aquatics might be preserved. Circular forms would be equally elegant, but there would be greater difficulty attending their erection, as the joints could not be so well formed, unless the tanks were constructed of plates of iron, which in some instances would be perhaps the cheapest, but might not be equally durable, in consequence of the oxidation that would take place. This, however, painting with anti-corrosion paint would in a great measure prevent. Sckell's aquarium was intended to form one quarter of a small botanic collection of aquatics, the cisterns forming the centre.

The divisions towards the end from which the waste water is intended to flow, being securely separated from the others by being set at a little lower level, might be filled with salt water kept to a proper state of saltness by adding salt to it occasionally; and in them marine aquatics, many of which are exceedingly curious as well as beautiful, might be kept in good preservation.

The tropical aquarium at Chatsworth, at once the most elegant and extensive re-

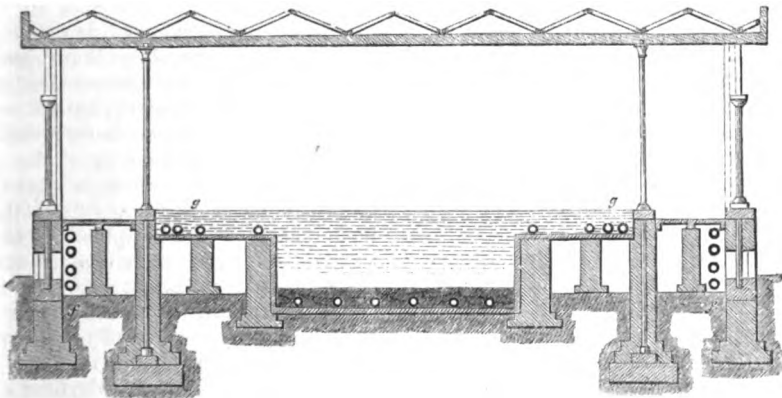
cently constructed in this country, will be understood by a reference to fig. 574, which

Fig. 574.



is a ground-plan, and fig. 575, which is a section through the centre of the tank.

Fig. 575.



The dimensions of this house are  $61\frac{1}{2}$  feet in length and  $46\frac{1}{2}$  feet broad. The tank *a* is circular, and occupies the centre; it is 33 feet in diameter, with a smaller tank, *b*, within it, in which the *Victoria* is planted, of 16 feet across. The angles cut off in forming the circular tank and passage round it, within the rectangular figure of the house, are divided into eight compartments, *c c*, and dedicated to the growth of various species

of aquatics. The entrances *d* are from the two opposite ends, and are ascended by flights of steps—the floor of the house being 3 feet 6 inches above the ground-level. This is a most judicious arrangement, as aquariums should not be lofty houses; and this rising of the floor gives a proper proportion to the elevation of the structure—the whole height, including the parapet wall, being 27 feet 4 inches, and the internal height 23 feet—

a height sufficient to secure architectural proportions when compared with the size of the building; but we question much whether a house of much less altitude would not have suited the purpose of culture better. We think the height of the aquariums at Kew, Sion, the Regent's Park, Messrs Knight and Perry's, and our own, none of which exceed half of that at Chatsworth, are nearer the true height so far as culture is concerned. Ventilation is secured by having openings *e* in the parapet walls all round, fitted with rebated wooden frames with pivot-hung flaps for opening and shutting. The top ventilation is by means of small glazed and framed sashes hinged to the ridges, and made to open and shut by a simple mechanical contrivance. The heating is by means of hot water, 4-inch pipes being carried all round the house parallel to the side and end walls; while similar pipes heat the tanks, as shown in section, *f f*. Besides these, 2-inch leaden pipes, *g*, are also laid immediately under the surface of the water.

The walls of the tanks are of brick-work, and finished with a wooden coping; the tanks are laid with pavement, and covered with lead. The footpaths are of larch boarding, laid on oak sleepers. The circular tank is surrounded by a neat hand-rail. The glass used is sheet, 4 feet long and 10 inches wide. The upright sashes are not overlapped, which gives greater transparency to the house.

It may not be uninteresting, in connection with this house, to state that it formed the type of Sir Joseph Paxton's grand idea for the Crystal Palace, which, in fact, was only an extension of the parts employed in the Chatsworth aquarium.

### § 7.—WINDOW GARDENING.

Under this head we shall include the various little contrivances of our Continental neighbours, who carry the cultivation of plants in rooms, on balconies, and in windows, to a much greater extent than has hitherto been done in this country, more especially in towns and cities, where the enjoyment of greenhouses and conservatories is often denied them. N. Ward, Esq., an amateur cultivator, who lived many years in the heart of the city of

London, carried the cultivation of plants, even rare ones, and those of difficult growth, to an amazing state of perfection, in small portable greenhouses of elegant forms, and which have now become almost an indispensable article of furniture in every drawing-room. These are called Wardian cases, and are found to answer the purpose intended most completely, and are perhaps, upon the whole, much better adapted for the end in view, as they are at the same time far more convenient and elegant, than the window cases so frequently met with on the Continent—the former constituting an elegant article of furniture within the room, while the latter is attached to the outside of the window. They preserve the plants much longer in bloom or in a healthy state than the usual mode of setting them in stands or on tables, and at the same time afford a degree of agreeable enjoyment in their management.

Mr Ward has published a very interesting pamphlet on the growth of plants in such cases, which those interested in the matter should peruse. It contains, as Dr Lindley has justly observed, "all the information that can be given; but it is in few hands, and everybody does not understand the principles on which his cases are constructed. It is imagined by uninformed persons, that complete exclusion of air is the entire object which Mr Ward sought to secure by his contrivance; but we need hardly tell the reader who knows anything of the atmosphere, that such an effect cannot be attained by a Ward's apparatus: the air finds its way into every place not hermetically sealed, and such contrivances as close glazing, puttying, and so forth, cannot exclude it. What Mr Ward sought to gain was uniformity of moisture and an exclusion of soot; and these he effectually secured. It is the dryness of the air that destroys plants in sitting rooms and great towns, and not impurities in the gaseous constitution of the atmosphere, the importance of which has been singularly overrated. By enclosing plants in tightly-glazed cases, light is admitted, soot is excluded, and any desirable amount of moisture is securable. There are, however, some practical difficulties in the way of growing plants in close moist cases, which amateurs unacquainted with

the nature of plants are unable to overcome. Amongst these difficulties, the principal is the adjustment of the amount of moisture to which a plant is exposed in one of these cases, to the surrounding heat, and to its own proper nature. Another is the prevention of dew upon the inside of the glass, by which the interior is often entirely hidden. These are practical difficulties that must exercise the ingenuity of cultivators. Upon the former we can give no information, because each species requires a special consideration. As to the deposit of the dew upon the glasses, we may observe, that as this is owing to the inside of the case being colder than the air that surrounds it, the only course to take is, either to warm the internal air by some means, or to open a door in the case for a short time; and as the latter is the most easy, and is quite efficient, it will be the more generally adopted."

Plants have been kept in Wardian cases for upwards of twelve months in good health and condition without renewal, and all this while but with one supply of water. "This to some may appear strange, but the principles of evaporation and condensation sufficiently explain it. The heat of the sun, or even of the room in which the case stands, naturally produces evaporation through the daytime, and during night the process of condensation takes place, and the moisture which has been evaporated is returned to the soil. These two principles are in active operation alternately day and night. It ought to be noticed, however, that owing to the growth of the plants, as well as other contingent causes, such as apertures in the framework, the quantity of moisture in time becomes lessened; and when this is the case, a fresh supply will be necessary. As monotony and continuity cease in time to afford gratification, and as it may happen, no doubt, that some of the plants will grow beyond their bounds, fresh removals and replacements will be found necessary."—*Gard. Jour.* Add to this, much of the pleasure to be derived from plants growing under one's care and in one's drawing-room, would be lost, were we not allowed to arrange and re-arrange them according to taste and fancy.

M. Victor Paquet, in "Almanach Hor-

ticole," speaking of window gardening as followed in Belgium, says, "The balconies are turned into greenhouses, and you may find, on the fifth or sixth floor, a miniature stove, gay with the brightest flowers and the greenest foliage. In Paris there are many such contrivances, especially two on the fourth floor of a house in the Boulevard de la Madeleine. Here are to be found the rarest plants. Camellias grow in the open ground; passifloras cling to the columns; the creeping fig forms a carpet upon the walls," (*Ficus stipulacea*, we presume,) "and water plants start up from tiny basins, curiously contrived in the solid brickwork. By turning a screw a stream of limpid water flows down a rock, from whose crevices start up ferns and Lycopodiums, and such things. And what is it that adjoins this little paradise but a bedroom!"

Enjoyable as such a window garden must be to the lover of flowers, it is, perhaps, upon a scale beyond the reach of more humble admirers of Flora. The Belgian window-garden, figured and described by M. Paquet, is within the reach of all, and will be understood by a glance at the annexed elevation, fig. 576, and section, fig. 577. In the latter it will be

Fig. 576.

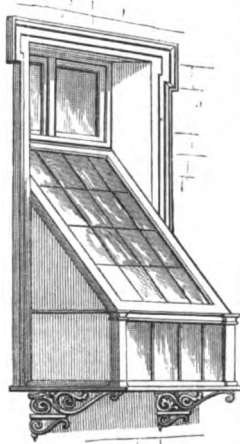
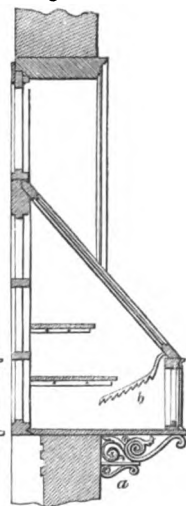


Fig. 577.



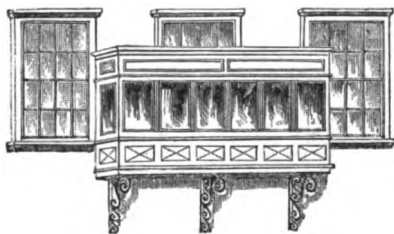
seen that the sill of the window is extended in breadth beyond the face of the wall of the house by brackets *a*, generally highly carved, as in the sketch; two or

more shelves are placed across the window, which, with the sill, are covered with plants in pots. A roof of glass is hinged to the window-frame, at any convenient height; for it should here be remarked that windows on the Continent are, in general, much higher and broader than with us; if, for example, (as shown in the diagram,) the frame extends three parts of the way up, sufficient light is admitted into the room. These sloping roofs fall down upon a stone or wooden front, either solid or filled with glass, as seen in fig. 577, and are opened and shut for ventilation by raising up the bottom part of the roof, and securing it at any point of elevation desired, by the curved handle *b*. The plants are watered and arranged from the room within, as the windows are hung on hinges, in two parts, and do not generally run up and down, as with us.

In cases where the sloping roof extends to the top of the window, as is sometimes the case, the window being thrown open, the owner can enjoy their fragrance and beauty, while the plants are not subjected to the dust, heat, and dry air of the room, and, with the large squares of glass used, they lose little of their effect, even when the window is shut altogether.

Fig. 578 is another example of the same kind of window garden, placed opposite

Fig. 578.

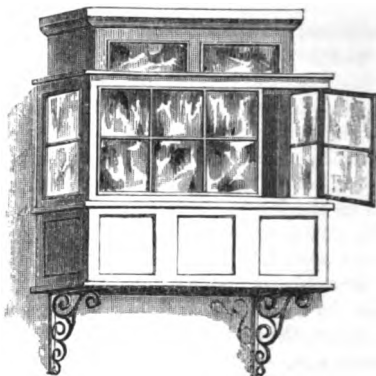


the centre window of a drawing-room, and extending considerably beyond the breadth of the window on both sides. It is supported on highly ornamental metallic brackets, and the bottom part, in which the pots are set, or plants planted in, is of stone, slate, cast-iron, or wood—the three first, of course, the most durable—as this part of the case is kept constantly wet. It should rise to the level of the window-sill, but no higher; indeed, a few inches lower would be no disadvantage. Large panes

of glass are used both for the front, ends, and top—one or more of them may be made to open for ventilation; the wall of the house and the casement of the window serve for the back. The operation of arranging the plants is, of course, to be performed from the room within by opening the window.

Fig. 579 is the same kind of case adapted to a single window; the ventila-

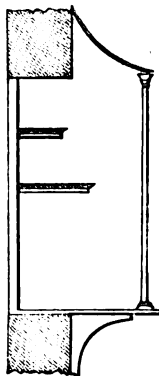
Fig. 579.



tion, although shown in front, may be better if placed in the ends.

Again, where double windows are used, and more especially where the outer window projects beyond the wall of the house, great accommodation is obtained for the keeping of plants. When these window gardens upon the last principle are made to project for 2 or 3 feet beyond the wall, as

Fig. 580.

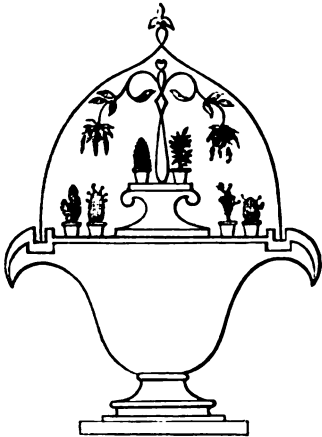


shown in section, fig. 580, the ends should be of glass also, and in them the ventilators should be placed. Windows facing the full sun should, in summer, be provided with an awning, to shade the plants during intense sunshine. This will prolong the season of flowering considerably; while a thicker covering substituted during winter will exclude the cold in ordinary weather; and a tea-urn, or similar vessel, replenished with hot water, or an iron heater dropped into it in the

usual manner, will exclude frost of considerable intensity. Sometimes neat green gauze blinds are fastened to the top of the sloping roof inside, and made to run on wires close to the glass, for the purpose of shading; and again the bottom and shelves are often so contrived, by having wire basketwork round their edges, that the pots are plunged in green moss, which, being kept constantly moist, supplies the plants with moisture, and counteracts the bad effects of a scorching and drying up sun.

The lady's plant-case, fig. 581, is a miniature adaptation of the Wardian case,

Fig. 581.



and is admirably calculated to form an interesting object either in the drawing-room or hall. The vase, as will be seen, is furnished with a groove all round, into which fits a glass shade, which covers the plants. It may be all in one piece, or framed with elegant and light brass, copper, or even silver sash-bar, and glazed with long, narrow, strips of glass, bent to the proper curvature. Indeed, it may be made to represent a conservatory in miniature.

Large crystal bell glasses are now made for the purpose of covering a whole vase of plants; and we question much but ere long every flower table or stand will be fitted with a glass shade, both when cut flowers are used, and for plants in pots. In both cases the duration of the flowers and plants in a perfect state will be prolonged, and their beauty unimpaired. At all events, their use during night must be

obvious, more especially in apartments lighted by gas.

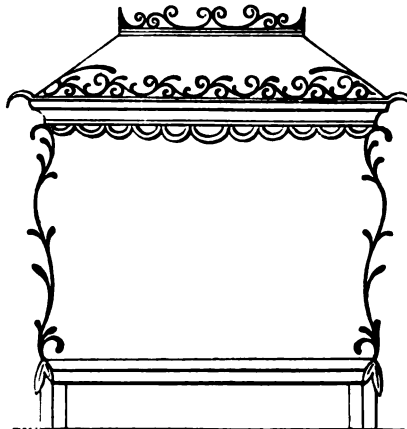
The annexed, figs. 582, 583, represent

Fig. 582.



two very pretty Wardian cases, exhibited at one of the Horticultural Society's fêtes at Chiswick. Fig. 582 is 7 feet high, 4 feet 2 inches wide, and 2 feet 6 inches in

Fig. 583.

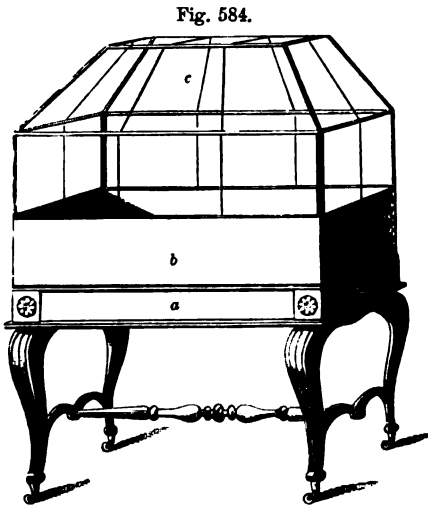


depth. Fig. 583, 4 feet high, 3 feet broad, and 1 foot 11 inches in depth. The workmanship is in the very best manner of

gold-coloured metal, the bases being of polished wood lined with metal, and moving on castors; they are glazed with the best sheet glass, and each has a door at the end. Very fitting ornaments, we would say, for any drawing-room.

When the Wardian case was first brought into notice, an opinion got abroad that they must be constructed so as to be perfectly air-tight, as if plants, more than animals, could exist without that vital element. They are in general fitted pretty close, but by no means air-tight. The principle which governs the health of the plants in them is purely mechanical; the water which is in the soil or medium the plants are set in, is turned into vapour by the heat of the sun or room during the day, and becomes condensed upon the inside of the glass, and is returned again, as soon as the glass becomes so cold as to condense the vapour on its under surface. This process of evaporation and condensation goes on day and night, governed by the temperature of the room the case is placed in; and under these conditions many plants luxuriate in an astonishing degree.

Fig. 584 represents a Wardian case



mounted on a stand, with castors, for the more readily moving it about. The dimensions are as follows. The stand *a* is 22 inches in height, fitted with a groove all round for the reception of the base *b*, which is  $8\frac{1}{2}$  inches deep; the glazed top or cover *c* is  $19\frac{1}{2}$  inches high, making the

whole height of the case 4 feet 2 inches. The sides of the box are of mahogany,  $1\frac{1}{2}$ -inch in thickness, and the bottom of deal,  $1\frac{1}{2}$ -inch thick, well framed and dovetailed together, and strengthened with brass bands, as seen in the sketch, and with two cross bars beneath. The upper edge of the box is furnished with a groove for the reception of the glass roof, and this groove is lined with brass, to prevent the wood from rotting. The roof is composed of brass, and glazed with the very best flattened crown glass. The brass astragals are grooved for the reception of the glass, and not rebated, as in ordinary glazing. The length of the case is  $3\frac{1}{2}$  feet by 2 feet in breadth. Eyed studs are cast on the inner side of the ridge astragal, about half an inch in length, for the purpose of suspending small orchids or ferns from the roof. The inside of the box is lined with copper, and at one of the corners an aperture is formed into which a copper tube, 2 inches long, is inserted, and furnished with a cock for withdrawing any superfluous moisture that may at any time accumulate within the box. One of the panes in the roof is made to draw out, being less firmly set in the groove of the astragals—this provision is necessary for the occasional arrangement of the plants, but the general arrangement is made by lifting the top off entirely. This is, however, seldom necessary, as plants both in pots plunged in moss, and planted out in proper soil, and well drained below, have been kept in a healthy state from four to nine months without removal.

The necessity for adopting window gardens, Wardian cases, or something equivalent, by those who are fond of having plants in their rooms, will, we think, be strengthened by the following remarks by Professor Lindley:—"What, it may be asked, is there in the air of a sitting-room which plants are thus unable to support? Can anything be purer than the atmosphere of an English drawing-room? Perhaps not; but it is this purity which in part inflicts the injury. Plants would thrive better if it were otherwise—but it is more especially its dryness. Let any one measure the moisture of a sitting-room and the open air, and he will see how great a difference prevails. We have," says the learned Professor, "this moment tested it by Simmon's hygrometer: in the open air

this instrument indicates 40°, in a sitting-room 60°. When plants are kept in a dry atmosphere they rapidly lose their water of vegetation; the sides of their pots are robbed at the same time; and it is impossible for plants to suck out of soil thus partially dried the moisture demanded for the sustenance of their exhausted foliage. Such a state of things is inseparable from a sitting-room. To render the latter congenial to plants, it would be uninhabitable by ourselves. The extent to which plants are injured in a common sitting-room is strikingly illustrated by the condition of cut flowers. Let two clusters of fresh-gathered flowers be introduced into a sitting-room: place the one in the mouth of a narrow-necked jar of water, and arrange the other upon such a shallow pan of water as a deep dish will furnish. It will be found that the latter will be perfectly fresh days after the former are faded. The reason is, that in the narrow-necked jar the flowers have no access to water except through the ends of their shoots, and are surrounded with a very dry air; while, in the flat dish, they are able to absorb abundant water, because a large part of their surface is in contact with it, and are, moreover, surrounded by air incessantly moistened by the vapour which continually rises from the dish."

"Of this we may be sure, that darkness, dust, heat, want of ventilation, and all the other calamities to which plants in sitting-rooms are subject, are as nothing compared with the inevitable dryness of the air—which, indeed, acts injuriously not merely by exhausting plants of their water of vegetation, but by lowering the temperature of the pots in which they are grown, in consequence of the evaporation constantly taking place there. What makes the evil greater is, that the plants which are purchased for sitting-rooms are invariably brought into high condition by being grown in a damp atmosphere. They are transferred from the hands of skilful gardeners, armed with the most perfectly constructed forcing-houses, into the care of inexperienced amateurs, whose means of maintaining a plant in health are something considerably less than nothing."

Of Wardian cases, figs. 585 and 586 are elegant examples, calculated for a drawing-room or saloon. In fig. 585 the top

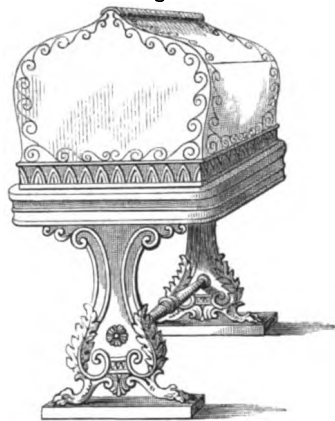
lifts off for ventilation, and is fitted closely into a brass groove, to which all the other bars are attached.

Fig. 585.



The under part also fits into a groove in the raised part of the table, and has entirely to be lifted off when the plants are introduced or arranged. The whole is made of brass highly polished, and plate-glass bent to the necessary curves in making. Fig. 586 lifts off in one piece, and is formed of polished brass, as in the last example.

Fig. 586.



The Hopean apparatus is thus described in "The Gardeners' Chronicle:"—"A flat dish of porcelain had water poured into it. In the water a vase of flowers was set; over the whole a bell-glass was placed, with its rim in the water. This was a Ward's case in principle, although different in its construction. The air that surrounded the flowers, being confined beneath the bell-glass, was constantly moist with the water that rose into it in the form of vapour. As fast as the water is condensed, it runs down the sides of the bell-glass back into the dish; and if means are taken to enclose the water on the outside of the bell-glass," (which can easily be done by having the



bell-glass as large as the porcelain dish,) "so as to prevent its evaporating into the air of the sitting-room, the atmosphere around the flowers would remain continually damp. What is the explanation of this? Do the flowers feed on the viewless vapour that surrounds them? Perhaps they do; but the great cause of their preserving their freshness is to be sought in another fact. When flowers are brought into a sitting-room, they fade because of the dryness of the air. The air of a sitting-room is usually something drier than that of the garden, and always much more so than that of a good greenhouse or stove. Flowers, when gathered, are cut off from the supply of moisture collected for them by their roots, and their mutilated stems are far from having so great a power of sucking up fluids as the roots have. If, then, with diminished powers of feeding, they are exposed to augmented perspiration, as is the case in a dry sitting-room, it is evident that the balance of gain, on the one hand, by the roots, and of the loss, on the other hand, by their whole surface, cannot be maintained. The result can only be their destruction. Now, to place them in a damp atmosphere is to restore this balance, because, if their power of sucking by these wounded ends is diminished, so is their power of perspiring, for a damp atmosphere will rob them of no water: hence they maintain their freshness.

"The only difference between plants in a Ward's case and flowers in the little apparatus just described, consists in this, that the former is intended for plants to grow in for a considerable space of time, while the latter is merely for their preservation for a few days, and that the air which surrounds the flowers is always charged with the same quantity of vapour at all times in the dish and bell-glass, while in a Ward's case the quantity of vapour will vary with circumstances, and at the will of him who has the management of it."

This very excellent quotation comprises all that can be usefully said on the subject of preserving cut flowers in rooms, and ought to be carefully studied by every lady who takes pleasure in having flowers in her room. We have long seen expensive glass shades placed over artificial flowers, and over delicate specimens

of natural history, with a view to keep the dust from them, while no such precaution was taken to preserve natural flowers from the same evil, much less to prolong their existence in a fresh and perfect state.

It would be of little utility for us to attempt giving specimens of such apparatus; the description given shows the principle completely. We may, however, remark that porcelain dishes might be made with a shallow groove within their rim, into which the glass shade might be made to fit, both for the exclusion of air, and also to prevent the evaporation from the water from mixing with the air in the room;—not, however, that the small quantity of aqueous matter discharged by evaporation from such dishes would at all affect the air of a large sitting-room; perhaps it would rather have a beneficial effect, especially in winter, when large fires are maintained, which, it is well known, rob the air of a room of its moisture, and render it unwholesome for the inmates.

Closely connected with Wardian cases is the subject of plant tables for rooms, certainly a department of drawing-room furniture hitherto much neglected. The following specimens may afford ideas for further improvement, should they not be considered sufficiently complete in themselves.

Fig. 587 is a flower-basket of wirework painted green; or, still better, the basketwork part



may be made of brass wire, and left of its natural colour. It is mounted upon a mahogany or oak clawed pedestal set on castors. A shallow zinc tray is placed within, to prevent the water that may pass through the pots from falling on the carpet. This tray, like all others used for the same purpose, as well as in Wardian cases, should have a small waste-pipe attached to the lower part of its bottom, and regulated by a brass

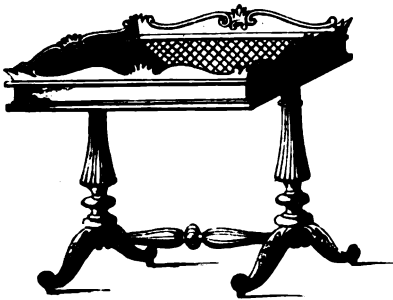
cock, so placed, and of such a size, as not to be seen from any part of the room. This is intended for withdrawing the water that may accumulate in them, and so preventing its overflowing,

Fig. 588.



as it may not be convenient at all times to remove the whole of the plants out of the table. The plants are to be packed in moss, kept perfectly green and fresh on the surface. Figs. 588 and 589 are more adapted for cut flowers than for plants in pots. They are made water-tight within, with the usual provision for drawing it off every day, that fresh water may be supplied. The

Fig. 589.



top is covered with a portable fine brass-wire grating, the meshes being about half an inch square, to support the flowers, and to keep them in an upright position.

Fig. 590.



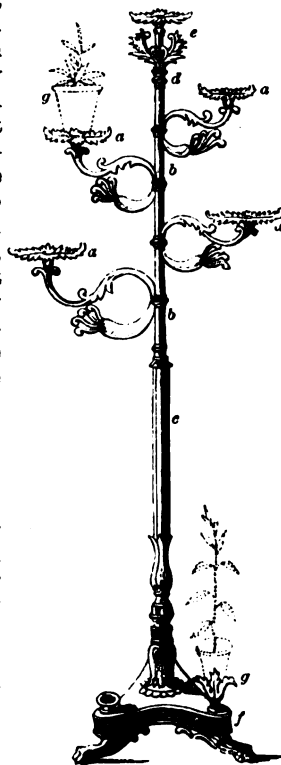
Fig. 590 is an example entirely composed of mahogany, rosewood, satin-wood,

or oak, according to fancy. The interior of the box is lined with thin lead, zinc, or copper, and provided with a waste-pipe. The basketwork round the top, in this case, should be brass, rolling rather outwards at top, and only from 4 to 6 inches in depth, as the framework of the table is presumed to be deep enough to hide the pots: the whole of the basketwork should appear above the surface of the moss. This table may be used for cut flowers of dahlias, pinks, or carnations, half of the box being filled with moss, and filled up with fine white sand, into which the flowers are to be stuck nearly up to their calyx. If tastefully arranged with regard to the harmony of colours, such a table will have a pretty effect, and the flowers will last for several days, if not exposed too much to the action of the air. All stands with cut flowers should be provided with

glass shades, to be put on at night when the company retires, and removed just before breakfast in the morning, to secure them from dust, which must necessarily arise in doing up the rooms in the mornings, and also to protect them from air. The moss and sand being saturated with water when they are put in, the flowers will remain much longer than if placed in water alone.

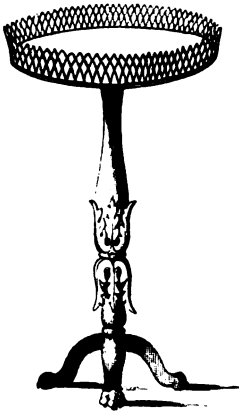
The annexed, fig. 591, exhibits a very elegant flower-stand upon a principle different from those already noticed. It was

Fig. 591.



the invention of Mr Saul of Lancaster—a name well known, from his many and excellent contributions to the horticultural periodicals, extending now over many years. It was published in the second volume of the "Magazine of Botany," and described as follows: "The very high state of perfection to which casting in iron has arrived is taken advantage of for ornamental purposes. The present flower-stand is worthy of notice, and will not be very expensive. There are four movable baskets, *a a a a*, which move round on the rod *b*, and may be placed any height and any figure that may please the possessor, to suit the situation in which it is to be placed. The rod *b* moves up and down in the pillar *c*, till the branch rests at the top of the pillar at *d*. The branch *e* is movable, and may be taken off the rod, so that the brackets may be slipped off at the top, leaving only one or two, according to the number of plants intended to be placed thereon. The stand is bronzed, which gives it an elegant appearance, either fit for a drawing-room or any other place. The bottom *f* is made of different

Fig. 592.

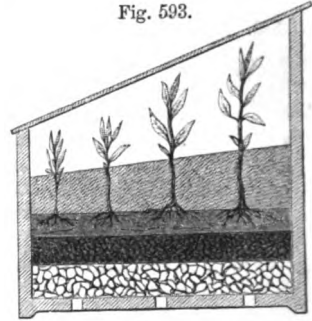


kinds of ornaments, to suit the taste of the purchaser. The pots *g g* are merely placed to show that they rest on the leaves fixed at the ends of the brackets." Fig. 592 is another specimen of a flower-basket upon a stand, with basketwork of brass enclosing a shallow vessel

placed with the top of a circular or elliptical table.

The amateur propagating-box is exemplified by the annexed diagram, fig. 593.

Fig. 593.



They are much used in Denmark by those who have no regular greenhouse, pit, or frame, and are both ornamental and useful, and seem to attract the same attention the Wardian cases do in the drawing-room in this country. The case here represented is 3 feet long, 15 inches wide, 1 foot high in front, and 18 inches high at the back; the sides are formed of boards, and painted. The top is covered with glass, and the whole elevated to a convenient height upon a stand. The bottom is covered with drainage, over which is a stratum of moss, one of sand, and a third of mould. The cuttings are made and planted in the usual manner, for it is for the propagation of cuttings that these cases are intended. The whole is well watered and the glass shut down, and afterwards managed exactly as Wardian cases are with us. With us a species of cultivation of the already formed plant affords the gratification, but the Danish ladies take the subject up a step earlier, and produce the perfect plant from the cutting or slip—each in their way equally gratified with their success, and of course equally annoyed should failure ensue.

The form of this kind of propagating-box may be varied, and elegant and ornamental forms may be indulged in.

## CHAPTER VIII.

### PITS AND FRAMES.

#### § 1.—PITS AND FRAMES HEATED BY FERMENTATION.

OF pits there is now a great variety, adapted both for the cultivation of plants and fruits. The most primitive structure of this kind appears to have been a pit walled round with bricks, sometimes sunk under the ground-level, and at other times raised above it, as the situation was dry or damp. Upon this was placed a wooden frame similar to those still in use, covered with glass lights, leaded or glazed in the casement form, without astragals or overlaps. The heat was obtained by filling the pit with tanner's bark; but there were no means of assisting it by linings, the use of which was the next step in improvement.

At the time to which we have alluded, pits were also heated by smoke flues, both of bricks and earthenware cans.

It is doubtful if, even in these days of improvement, the use of fermenting materials will be entirely abandoned, as there is something so congenial to the growth of plants given out by the fermentation of stable litter—probably ammoniacal gas, accompanied with a suitable degree of humidity in a warm state—which all our other modes of heating, as at present employed, appear to come short of. This is to be regretted; but we doubt not that this defect will ultimately be got over. Suggestions to this effect have been noticed in the section HEATING BY STEAM, TANKS AND HOT WATER.

In order to elucidate the relative merits of pits, we shall begin with those heated by fermentation, and include that section of them denominated hotbed frames,

which are no other than pits without building appendages.

The common hotbed frame requires no description, being merely a bed of well-fermented stable manure neatly put together, rather higher at the back than at the front, upon which is placed the frame and sashes,—the frame also being from 6 to 9 inches higher at the back than at the front, with a view, no doubt, to place the glass roof at a better angle of elevation to the sun's rays, and also to allow the rain water to run freely off.

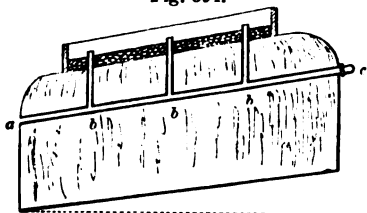
The only improvement of any consequence that took place in hotbeds and frames, from the time of their being first used up to the first quarter of the present century, was that of forming the ground on which they were erected upon an inclined plane, equal to the angle of elevation formerly given to the glass roof. This was recommended by T. A. Knight, with the view of equalising the bottom heat by having the dung-bed of the same depth both at back and front. The elevation being thus given to the bed, the frame was then made of an equal depth both at back and front. The chief improvement next to that just noticed was, constructing the frame with a fixed bottom of deals, perforated so as to admit of the escape of superabundant humidity, but having the disadvantage of preventing the heat from the dung-bed from ascending. This was followed by J. Weeks' patent forcing-frame, which is no other than that suggested by Laurence in his "Kalendar," published exactly a century before. Its improvements consist in putting a bottom of wire to the frames, and covering that with tiles, upon which the soil was laid; the object

of these changes being to enable the cultivator to add to or renew the bed without disturbing the plants in the frame, which could be lifted off or elevated for the time. Some have suggested similar movable frames, making them to slide from the exhausted bed to another prepared for it made up at one of the ends.

Were such an arrangement worth consideration, we would suggest placing a cast-iron rail, supported on pillars, along the back and front of the intended beds, and mounting the frames on iron rollers or wheels, by which means they could be moved backwards and forwards with much greater facility.

It is difficult in all dung-beds to maintain a proper atmospheric heat. To remedy this, Mr Knight proposed admitting air slightly warmed to improve the internal heat, as well as to produce ventilation by admitting air from below instead of by opening the sashes, which at all times is a most inadequate, and often dangerous, mode of ventilating frames or pits—as the pure air admitted at front passes over the foliage and escapes at the back, without dislodging the foul and stagnated air just above the surface of the mould; while, in addition, that air is seldom sufficiently warm to be so admitted with safety to the plants. The following diagram, fig. 594, will explain its

Fig. 594.



principles. A metallic tube, the orifice of which is at *a*, is laid about 1 foot under the top of the bed: from this the three short upright tubes *b b b* proceed, and open into the atmosphere of the frame. The end of the long tube at *c* is furnished with a stopper, by which the draught of the other tubes is regulated. These tubes should be, we think, perforated so as to admit the heat and gaseous moisture from the dung more readily, and the orifice should be in shape of a wide funnel, for more readily admitting the cold

air to become heated. We had also, without previous knowledge of Mr Knight's experiment, practised a somewhat similar plan even at a prior date.

The other principal improvements on pits and dung-frames, but of which it is deemed unnecessary to give illustrations, are the *meridian pits of Neeve*, of which excellent figures are given in "The Encyclopædia of Gardening," "The Gardeners' Magazine," &c.,—the chief merit of which consists in elegance of appearance—and the *revolving frame*, invented and partially described by Mr Gawen of Shirley, near Southampton, and Mr Alexander Bisset, late of Methven Castle, near Perth, much about the same time, and almost on the same principle, and certainly without any communication existing between the parties. These inventions, however, have not been followed up; and, so far as we are aware, were exemplified only by the inventors themselves.

Were revolving frames worth consideration, as we think they are not, far more simple and effective means to produce the movement than the one referred to above may be seen at every railway station—viz., the revolving tables upon which the carriages are placed when a change in their position is desired.

The *German hotbed* is often half sunk under the surface of the ground, and is in very common use in Germany and the north of Europe. It is composed of stable manure, leaves, and tan, mixed or separate according to circumstances. On the Continent it is a very common practice to sink the dung-beds under the surface. The intensity of cold to which they are exposed during winter led, no doubt, to this practice; but we do not think the system is a wise one, because the conduction of heat into the earthy banks that surround the mass is more than would be lost by building them on the surface, and thatching them with faggots and coverings of straw, reeds, or any other non-conducting material.

Probably this fact led to the erection of pits walled all round, and afterwards to the walling in of the linings, as exemplified in most pits built on the best principles. No doubt having the heating materials under the surface prevents the cold winds from driving the heat from one part of the bed to the other, while

beds so situated are much easier got at for the purposes of internal arrangement.

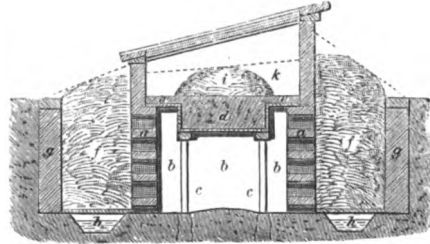
The *Alderstone pit* is a walled pit above ground, according to the material employed, of 4 or 9 inch work, supported on iron pillars 3 feet in height, which is the depth of the sunken part. These pillars are set in blocks of stone, and are tied together at the top by a plate of iron, on which the walls rest. The brick walls forming the sides and ends of the pit are coped with wood or stone, into which the rafters are fixed. Linings are applied in the usual manner within a walled trench, and are covered with strong boarding. The interior of the pit is filled with dung, leaves, or tan, either separately or mixed together. The mode of supporting the brickwork part of this pit is good, as the iron supports occupy much less space than stone or brick piers would do, and are much stronger. This was one of the earliest improvements in pit-building; still it is singular to find so few examples of this excellent pit in present use. These pits are built parallel to each other, as may readily be done: a great saving of heating material will be effected, as well as of labour in attending them, as the back lining of the one heats the front of the other. These linings are 3 feet deep, and the back wall above the covering of the lining is 2 feet 3 inches, while the height of the front wall is 1 foot 6 inches.

*M'Phail's pit*, fig. 595, may be described as consisting of two parts—the frame and lights, which are both of wood, although often and better the frame is dispensed with, and bricks on bed are substituted: the second part is the basement, on which the frame is placed, consisting of flues of brickwork, having the side or outer walls built open, as shown in section. Round these pigeon-hole walls linings of fermenting material are placed, the heat of which enters the flues and

heats the mould in which the plants grow. This pit is objected to upon the same principle as the last—namely, a great waste of heating material, and often an insufficiency of heat.

*Mearn's pit*, fig. 596, is one of the best pits heated by fermenting matter. *a a* are

Fig. 596.



the side walls in open brickwork; *b b b* the hot-air chamber or cavity into which the heat and steam of the linings are admitted; *c c* posts of iron or stone supporting a bed or trough *d*, made of slate, stone, or tiles—the former to be preferred—and extending the whole length of the pit; *c e* slabs of slate employed to close the space between the trough and side walls, which should be closely jointed to prevent the entrance of too much steam into the pit. At an early part of the season the heat is freely admitted into the pit, the slate slabs being at that time only thinly covered with mould: *f f* are dung linings; *g g* retaining walls, to form the space for the linings; *h h* drains to keep the dung dry at bottom; *i* shows the hill on which the plants are first set; and *k* marks the height of the mould when filled up for the season. This otherwise excellent pit would be greatly improved if the space over the linings was covered with portable boarding, as indicated by the dotted lines. Indeed, the linings of all such pits should be covered over, as sufficient air will always find its way in to promote fermentation, without which it would cease altogether. No pit has a finished appearance if the linings are left exposed; and they suffer much in temperature as well as waste of material, in consequence of being often saturated with wet or melting snow. A considerable amount of heat must escape from them in an upright direction, which would be prevented by their being enclosed in the manner we have suggested.

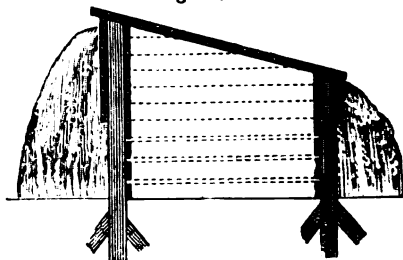
*The arched pit.*—Of pits heated by fermenting material, we may notice the following, as communicated to "The Gardeners' Chronicle" by an anonymous correspondent. This pit has the merit, at least, of originality. It is thus described:—"The length is 33 feet. There are nine arches, separated by piers which are only 9 inches square. The abutments at the ends are only 18 inches by 9." The ends and sides are similarly constructed. "It is divided into three compartments. The end walls and the partitions are 9-inch work up to the level of the springing of the arches; above this line it is only 4½-inch work. It is finished with a wooden coping, upon which the sashes slide. The front arches are about 2 feet 5 inches high; those behind, 2 feet 10 inches. The masonry is carried up about 18 inches above the arches in front, and about 1 foot more behind. It is plastered inside, cow dung being mixed with the mortar as in a chimney. It is probable that the heat from the outer lining of dung will more thoroughly penetrate the mass inside than it would do through the pigeon-holes of the ordinary construction, as the opening is very considerably greater in extent, and it is more easily filled and emptied when required."

This pit is constructed entirely of brick; but the same ends would be accomplished were the piers of cast-iron, or stone pillars used, and lintelled over with pavement or cast-iron bars. Indeed we question in the present day whether cast-iron might not be introduced both for pillars and lintels with greater economy; certain it is that less solid space would be occupied by it. But the superstructure should either be of wood or brickwork, as stone, when exposed to the weather, is so great a conductor of cold and damp; and plates of iron would be liable to objections of another description.

*Baldwin's pine pit*, fig. 597.—This is one of the most economical of all pits. It was at one time held in much repute, and is still used by those who have a command of stable litter, and in localities where coal is expensive. It is thus described in Baldwin's little work, "Culture of Ananas," p. 11:—"Sink your pit 3 feet 3 inches deep, and of such length as you may require," (the usual dimensions

are 7 feet wide and 7 feet 3 inches high at the back, the height of the front de-

Fig. 597.



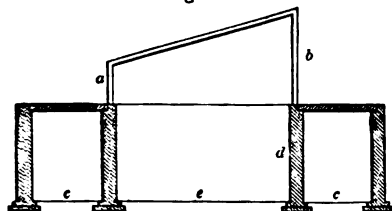
pending on the angle of elevation desired.) "and make it sufficiently broad to admit of linings on each side. There should be a good drain at the bottom of the pit to keep it dry. Then set posts of about 6 inches square in the pit, at convenient distances, (say about the width of the sashes,) and case it round on both sides of the uprights with 1½-inch deal wrought boards above the surface, and below it with any inferior boards or planks." These latter should not be more than 3 inches broad, and 3 inches apart from each other—their use being to keep in the leaves, tan, or dung, and also to admit the heat of the linings with as little obstruction as possible. Such pits are very useful, and may be erected at little cost where timber is plentiful. They are of all others the best adapted for temporary purposes. In damp situations, these and all other pits should be built on the surface, *not under it*; and as an improvement on them, they should be provided with gutters at front to take off the rain water that falls on the sashes, to save the material as well as the heat of the front linings.

One objection to this pit is, that the linings are not enclosed to secure them from the weather, by which a great waste of dung takes place. Another improvement would be to substitute cast-iron uprights for the present wooden ones, and to enclose the bottom part with ¾-inch wrought-iron rods, made to pass through the uprights 3 inches apart, instead of spurs of wood, for the purpose of rendering them more durable, as well as to admit more freely the heat of the linings to the main bed. The upper part of the pit we would prefer to

be of wood, as at present, as being a good non-conductor; and through the linings and boarding we would introduce metal tubes to carry heated air into the interior of the pit, in the way proposed by Knight. *Vide* p. 430. Enclose the linings within stone or brick retaining-walls; cover them with portable boarding; substitute cast-iron uprights, with malleable-iron rods run through them, as suggested above; form the framework above the level of the linings with double boarding, packing the space between with charcoal; and we would have in this form of pit one of the most economical, durable, and useful pits that could be desired.

*The Edmonstone pit*, fig. 598, is one of the best of its kind. It may be of any

Fig. 598.



length, and is 6 feet in breadth, which is the usual width of all pits heated by linings. The height of the back is 5 feet, and that of the front 3 feet 9 inches. The spaces for the linings are 2 feet 3 inches broad, and 3 feet deep. The outside walls of the linings are of 9-inch work, and finished on top, level with the ground, with a course of hewn stone. The linings are covered with boarding, the boards having rings in them for lifting them by, and being of convenient lengths. These boardings rest on a check cut out of the stone plinth or coping, and on the scarcement or projecting part of the side walls. Although shown in our sketch level, which was the original plan, they would be better if laid slightly inclining towards the outer sides, for more readily throwing off the rain water. Such pits may be built upon the pigeon-hole principle, or 9-inch brick piers may be carried up at equal distances, and the spaces lintelled over; or, where pavement is abundant, they may be formed of 3-inch flags set on edge, secured at the base by building between them, and lintelled over as above for the reception of the 4-inch brick

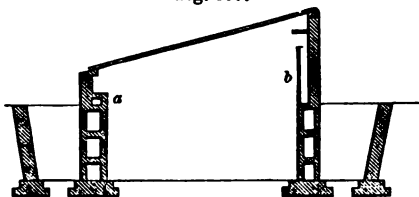
VOL. I.

walls that form the upper or above-ground part of the structure.

*Knight's melon pit* has a peculiarity both novel and useful—namely, at each of the lower corners is a drain or cavity, which extends along the surface of the ground under the linings, and communicates with the cavities in the walls, which are built cellular, into which it admits the external air, to occupy the place of that which has become warm, and passed into the pit. These drains are secured with iron gratings, to exclude vermin. These pits are 4 feet high at the front, and 5 feet 6 inches at the back, and are capped with wooden wall-plates, as in ordinary cases. The interior is filled with leaves or tan, and heated without by dung linings. The linings are exposed to the weather, which occasions great waste of material. It was in such pits that that excellent man and ardent horticulturist grew his melons in pots, training them on a trellis at a proper distance from the glass. We should, however, here observe, that during these experiments he employed no heating material within, but trusted to that afforded by the linings from without.

*The Heckfield melon pit*, fig. 599.—This pit differs from the pigeon-hole pit, and

Fig. 599.



also from M'Phail's, which it nearly resembles, but is, at the same time, an evident improvement on it. The walls are built hollow, forming a hot-air flue from their bottom to the ground-line. The course of bricks used for covering the back and end flues projects 1 inch beyond the face of the wall outside all round, forming a support to the boarding which covers the lining. The front flue is covered also with bricks, but laid lengthways and across; or, as bricklayers would say, a header and stretcher alternately, leaving an opening between each header to admit the heated air of the flue into the pit. Narrow slips of slate are fixed in the joint immediately over the headers at *a* in sec-

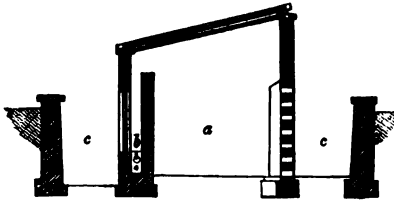
3 I



tion, to prevent dirt falling into the flue, and also to give the heated air a slightly horizontal direction, instead of an upward one. Under the centre of each sash are openings in the back flue about a foot long, and over it is a cavity formed by the erection of slates set parallel to the wall, and 2 or 3 inches from it, as seen at *b* in section, for the purpose of admitting heat to the atmosphere of the pit, and within 6 inches of the glass. This pit is furnished with air-drains running across under the floor level, and these 9-inch drains communicate with the bottoms of the back and front flues, with a view to create a draught or current of air, to supply the place of the warm air that escapes into the pit. The side walls of the linings are very properly battered, which gives them greater strength to resist the pressure of the surrounding soil. This is one of the best pits we know for the purpose intended; still, we think it would be improved by having an aperture through the end retaining-walls, brought up behind them to the surface by an earthenware tube, and covered with a grating; or, where such an arrangement would not be in the way, a small area, say 9 inches square, or more, and covered in the same way, to admit a greater supply of air for the better working of the air-drains and flues already described. Either of these openings, however, should be made so that they could be opened or shut at pleasure.

*Atkinson's early forcing-pit*, fig. 600, is sunk under the ground-level, as shown in

Fig. 600.



cross section. The main part of the pit *a* is filled with tan, leaves, or stable litter, and the heat maintained by means of linings in the spaces *cc*; the back wall is built open, or in the dovecot fashion, to admit the heat from the linings to enter the pit; but, as a provision to prevent rank steam from entering also, Welsh

slates are set on edge in front of this wall, and about 3 inches from it. The vacuity thus formed is closed at top by a movable covering of slate, so that the vapour can be admitted or excluded at pleasure. The front wall is built with piers, the openings between which are filled with large slates set on edge, and fixed in the centre of the wall. This is with a view to admit heat from the front linings unaccompanied by steam, which heat finds its way into the atmosphere of the pit through the vacuity formed between the front wall and an interior 4-inch one, which separates the vacuity from the bed. Any matter that may fall into this cavity during the process of filling is easily extracted by introducing a narrow hoe at the ends, where a provision is made for that purpose by taking out a movable stone or tile.

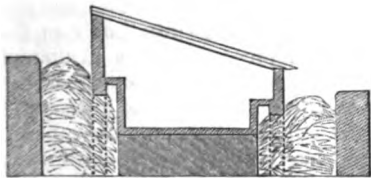
*Atkinson's late forcing-pit* is in many respects similar to the last, only it has open brickwork all round, with a vacuity formed by setting up slates parallel to the walls, and covered at the top like the last. The intention of this pit is to keep up a sufficient degree of heat in autumn with a very limited extent of steam, as a drier heat at that season is more desirable than it would be in spring and during summer. Both pits are formed with gutters in front for taking off the rain water, and the walls are supported by piers. The retaining walls between the linings and the soil are coped with stone coping 3 inches thick, and the whole is neatly covered in with boarded coverings.

*Atkinson's melon pit* in principle does not differ from the early and late forcing pit of the same artist, but it has certain differences of detail. The retaining walls are battered a good deal, which not only enables them to resist the pressure of the soil behind them, but also increases the capacity of the space for the linings at the part where their heat is of most use—namely, at the top. Another feature in this pit is, that the front walls are built 14 inches thick, and hollow, which cavity is open at the top inside, whereas the back and end walls are only 4 inches thick, and constructed in the pigeon-hole manner. The wooden coverings for the linings are kept well up, to allow of a sufficient amount of air, which promotes fermentation, as well as the preservation of the boards themselves. In forming the front

wall of this pit, the external course of bricks is constructed of paving bricks (about half the thickness of common bricks) set on edge in cement: the rationale of this arrangement being to admit moist or humid heat at the back, and dry heat at the front.

*Thompson's pit*, as figured and described in "Encyclopædia of Gardening," p. 573, is different from that of M'Phail, by its substituting "stone lintels instead of pigeon-holes to the outside walls. The suspended insulated position of the pits admits a circulation of warm air, both under and all around the pit of each light, whereby a greater degree of surface temperature is obtained, in the absence of solar rays, in the early forcing season. But air-flues run round and under the bottom of the pit, which are covered with a single tile. When the bottom of the pit is laid, the brick on edge is continued up to a convenient height for the surface hot-air flues, which are also covered with a single tile, laid the reverse way to those at the bottom of the pit. Fig. 601 is the transverse section, showing the pits and the position

Fig. 601.



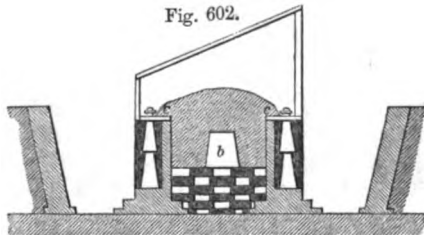
of the lintels, which admit the fermenting body of manure to act under the north and south flues. The internal part of the pits is covered with a thin coat of hair mortar, made rough by finishing with a wooden float and brush; and the tiles are the flat draining tiles, without knobs." These pits are, in general, from 5 feet to 6 feet 10 inches in breadth, and may be considered amongst the best of their kind.

*Kendall's double pit*.—One object Mr Kendall has had in view in the construction of this pit is the economy of fermenting material; for, the pits being parallel to each other, and having the space for the linings placed between the back of the one and the front of the other, and that carefully covered over, no waste can take place. Another novel feature in this pit is carrying up the walls tapering and

hollow, which gives great additional strength to them. The walls are a foot thick at the base, and the outside of the external ones is built perpendicular with common-sized bricks, while the inner sides are built of paving bricks, about half the thickness of the others. That the front pit may not shadow the other, it is sunk about 12 inches below it. The floor upon which the mould is placed is supported by iron bearers, reaching across the pit, and let into the side walls, and is formed of old boards, branches of fir, pea stakes, or turfs, as may be most convenient. This is the only objection we have to this otherwise excellent pit. Why not lay thin pavement, Welsh slates, or plates of cast-iron perforated? which would, in either case, last as long as the walls; whereas the others will be constantly going to decay, besides, from their non-conducting properties, preventing the heat from below from ascending. The vault under this covering or floor is filled with fermenting matter, introduced at doors at each end, and so gives out a humid temperature to the mould above it, while a dry heat is admitted into the atmosphere of the pit by passing up through the hollow walls. To prevent the loss of heat by absorption through the outside of the linings, precautions are taken to fill up behind them with broken brickbats or other porous material. "Immediately above the intended depth of the soil of the pit, a course of bricks on edge is left out, both in the back and front walls, and the walls are then covered from one end to the other by a course of slates or tiles 9 inches wide. Above this the walls are continued hollow to the top, where they are finished with a stone or wooden coping."

*Watson's cucumber pit*, figs. 602, 603, 604, is thus described by Mr Watson in

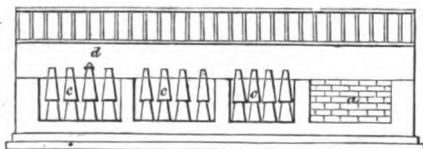
Fig. 602.



"The Gardeners' Chronicle:"—"The plans show the pit I have now in use, the frame

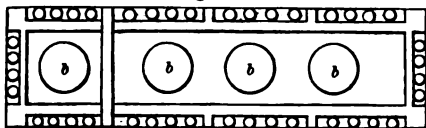
being carried on pillars of brickwork *a*; and in the divisions between these pillars are pipes or tubes of common earthen-

Fig. 603.



ware, *c c c*, 4 inches in diameter, which may be made larger or smaller, as may be required, and on the top of the pipes

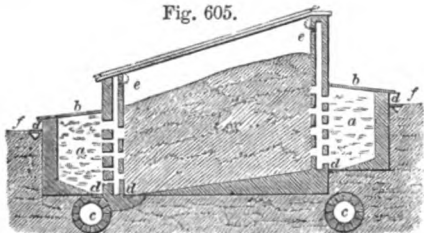
Fig. 604.



I place a small garden-pot *d*, when it is necessary to alter the soil: this prevents the admission of earth into the pipes. I find that the introduction of these pipes causes a considerable increase of heat, and when I uncover the frames now (March) in the morning, the thermometer stands always at 80°, the variations of heat being very slight. The brickwork behind all the pipes should be made open at the end joints for the first four or five courses. I would have made the openings in the brickwork much larger than shown, had it not been that I am troubled with rats. The circles *b* on the ground-plan are sea-kale pots, 18 inches in diameter at bottom, and 9 inches at top, which stand upon open brickwork, as shown by the section; the whole of the bottom part of the frame, to the height shown on the section, being filled with open brickwork for the admission of heat."

*Glendinning's pine pit*, fig. 605.—This

Fig. 605.

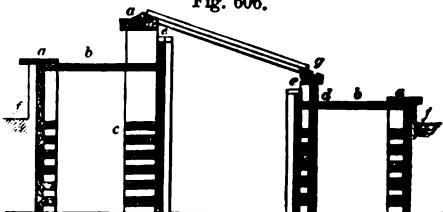


pit was erected at Bicton by Mr Glendinning some years ago, and has been found to answer the purpose intended. The

following description of it is taken from his excellent work, "Practical Hints on the Culture of the Pine-Apple :"—"*a a* spaces for the linings of dung and leaves; *b b* boards hung with hinges to cover the linings; *c c* barrel-drains; *d d d d* gratings with communications conveying the drainage and rain water to the barrel-drains *c c*; *e e* wood plugs, to take out and admit steam from the linings; *f f* level of the surface of the ground."

*Forsyth's early forcing pit*, fig. 606.—In the eleventh volume of "The Garden-

Fig. 606.



ers' Magazine," Mr Forsyth has published the annexed pit with the following description: "*a a* show the stone copings of the walls; *b b* cast-iron pipes, 4 inches in diameter and 6 feet apart, connecting the steam flues; *c c* cavities in the brickwork through which the hot air and steam pass from the linings into the steam flues; *d d* cast-iron pipes, 3 inches in diameter, conducting the water from the gutter into the drain, tending also to strengthen the front wall and support the coping, by being placed under every third rafter; *e e* tile covers to the steam flues, with brass plugs like those used in wooden water-troughs, 2 feet apart; *f f* ground-level; *g* coping of the front wall, which serves also as a gutter. This groove or gutter need not be large, as the column of water cannot be great collected from a light and a half, the receivers being placed under every third rafter. The cast-iron pipes introduced here to connect the steam flues are intended also to support planks 3 inches thick, closely fitted together, which are to be used in summer as a walking way, and to hide the then almost useless lining pits;" but Mr Forsyth would by no means use them in winter, "as it would prove injurious, by causing the condensed steam to drip upon the linings, thereby rendering it too wet for proper fermentation; besides, the linings in winter ought to be made up as

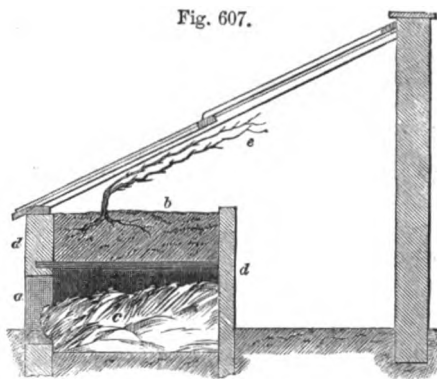
high as the bottom of the coping-stone, to prevent the weather from acting upon any part of the walls of the pits." The authority just quoted highly approves of pits, heated by hot dung or other fermenting matter, being placed parallel and near to each other, so that the back linings of the one may serve for the front linings of that which is immediately behind it.

The following description of a cucumber or melon pit is by an anonymous contributor to "The Gardeners' Magazine," who very properly recommends, where the ground is liable to be flooded, to sink the foundations only to the depth of 12 or 15 inches under the surface, and to lay a drain along the centre of brick on edge, and covered with bricks laid across; but in ordinary high and dry situations they should always be sunk 2 or 3 feet below the surface, and a cavity cut that depth for the linings, for the better retaining the heat, and for convenience in working. This pit is 2 feet 6 inches below the ground-level. "The front and back walls are built in the pigeon-hole manner, and a vacuity is left between them and the brick-on-edge divisions. A stone shelf may be placed over the vacuity at the back part, for holding strawberries in fruit, &c. The lights are at an angle of 12° to the horizon." We think this pit would be much improved by substituting slate for the brick between the bed and vacuity, as in Atkinson's pit, already described.

*Atkinson's succession pine pit.*—These in many respects resemble the early and late forcing pits of the same architect, already noticed. The walls are built in the pigeon-hole fashion, having an inner 4-inch wall carried up to within 2 feet of the top, leaving a space between each which is covered at top with a thin slate, with holes in it to admit the steam from the back linings into the atmosphere of the pit. The steam is regulated by plugs in the slate, and the walls are tied together by 14-inch piers 4 feet apart, intended to strengthen the walls and support the rafters which are placed over the centre of each pier. The front wall is in like manner hollow, and also supported by similar piers, the cavity between the walls in this case being left open. The front wall is divided into panels fitted

with thin tiles set on edge in cement, so that the heat of the linings may freely pass through into the cavity, and ascend through it, and warm the atmosphere of the pit. This precaution of excluding the rank steam from the linings from entering directly into the pit, particularly during winter, has its advantages. The dimensions of these pits are as follows: 6 feet 9 inches in the clear of the interior walls in width, the back wall 8 feet high, the front one 5 feet; the pit is sunk 3 feet under the ground-level, surrounded by trenches for the linings 2½ feet wide. The retaining walls are 9 inches thick, coped with oak kerbs 1 foot in breadth.

*Cooper's pit for forcing grapes by dung heat, fig. 607.*—This plan was communi-



cated to the Horticultural Society by Sir George Staunton, as the practice of the Rev. Blakley Cooper, and has merits to claim some attention even at this day. Mr Cooper states his reason for adopting this plan in the following words: "I have long thought it unnatural to force the branches of a vine in a heated atmosphere, whilst the roots are confined to a soil that, early in the season especially, is, if not frozen, the very reverse of hot; and I have presumed it to be impossible that the roots could keep pace in their growth with the branches, and consequently maintain that supply of sap required of them by the forced and accelerated advance of the shoots. It is well known that a cautious and progressive temperature in the house can alone insure success in bringing out all the eyes; and that in most cases, when early forcing is resorted to, a few eyes only on each shoot can

be made to break, and that all except one or two of the leading shoots will be weak and dwindling. The remedy for this is, I apprehend, so to accelerate the growth of the roots as to enable them to keep pace with the branches, when the supply of sap will be adequate to all the demands of nature. The bearing wood may also by these means be trained to any reasonable length, for every eye will receive a due supply of nutriment: each, therefore, will break regularly, and each make strong and vigorous shoots, and consequently be capable of bearing fruit. By this system, too, grapes may be brought to a ripe state in much less time; for, instead of the slow and cautious proceeding required for bringing out the eyes at the commencement, a high degree of temperature may be kept up in the house; for, as the roots are taking up, in consequence of their rapid growth, a larger quantity of nutriment, the supply of sap is more rapid; and therefore a more rapid growth of the branches may be permitted."

*a* doors for introducing the dung *c*;  
*b* the border in which the vines are planted;  
*d d* iron joists supporting a covering of slates;  
*e* trellis to which the vines are trained.

## § 2.—PITS HEATED BY SMOKE FLUES, TANKS, HOT-WATER PIPES, AND STEAM.

The idea of abandoning tan and other fermenting matter for the production of bottom heat is no new feature in horticulture, for we find substitutes employed towards the latter end of the last century, (*vide* section VARIOUS MODES OF HEATING, &c.); and we find, so far back as 1823, Mr Stewart, at that time gardener at Valleyfield, near Culross, growing pines in a pit heated with flues. This pit was provided with a hot-air chamber, from which tubes conducted the heated air into the pits, not only for keeping up a proper atmospheric heat, but for regulating the bottom heat also. These tubes had stoppers that were taken out or not according to circumstances. They were placed along the back and also the front of the pit, and were 4 feet asunder. It appears, also, that prior to the above date, both Mr Kent and Mr T. A. Knight had

pits heated upon much the same principle.

It has been stated in objection to pits heated in this manner, that a dry and uncongenial heat is produced. Such is, however, not the case; for, by watering the sand upon which the plants are placed, the atmosphere of the house might be kept at the point of saturation, if desired.

To render this pit perfect, we would suggest the following improvements,—namely, the carrying one flue through it along the centre instead of two, and over it placing a hot-water tank, extending the whole length and breadth of the pit, or the making the water to circulate round in a wooden tank or gutter along the front, and returning in the same manner along the back. A small boiler should be placed over the furnace, and in fact forming its roof and sides. By this means a greater length could be heated by one fire; and, to prevent loss of heat by its being absorbed by the surrounding side walls, we would suggest that these be built double, having a vacuity between to be filled with air in a quiescent state. The smaller also the pit or air-chamber is, the better; and air should be admitted to it from without, under proper regulation. This supply of atmospheric air is to be admitted through tubes, placed through and up the outer sides of the back and front walls, as shown in many instances in this work. This would produce a regular circulation; and instead of the same air being made to pass down from the interior of the pit—which it would do if at any time colder than the air in the vault—and thus circulate only the same air over and over again, we would have a constant supply of pure air from without, which would be beneficial to the plants, while the foul and heated air would escape through the roof whenever the sashes are opened. To lessen the capacity of pits already built and to be heated upon this principle, they may be nearly filled with hard water-worn stones or very rough gravel.

In the case of this pit we have hot dry air and hot moist air combined, which, working together, will make a good healthy atmosphere for ordinary purposes; indeed, there will always be a sufficiency of humid air. To counteract this when a drier air is required, cut off

the circulation of the water by stopcocks near the boiler. The water in the tanks will cool down, and give off little vapour; while, the flue heat being increased, a sufficient supply of dry air will ascend into the pit. An opening, with a door, should be placed at one end of this pit, to admit a man entering to clean the flue, as all flues extending to a great length in a horizontal position very soon become choked with soot, unless coke or very superior coals be used. The flue is not intended to heat the tank, but to throw dry warm air into the atmosphere of the structure above.

Fig. 608 is the section of a plant pit, which may also be used for many other purposes. It is 18 inches under the ground-level, and

filled with suitable material to the desired level, on which the pots are to be set. It is heated by hot water, the pipes being supported on 4½-inch brick piers. The roof is at an angle of 18° to the horizon.

*Niven's pine pit*, fig. 609.—These pits are substantially built, and well adapted

Fig. 608.

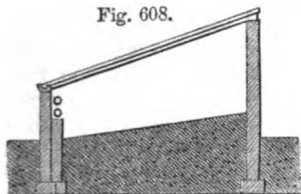
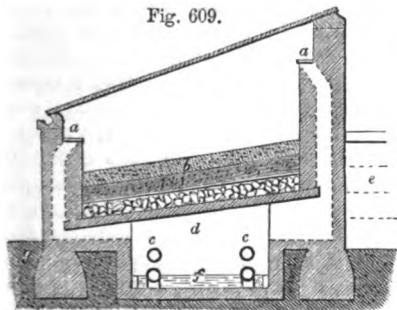


Fig. 609.



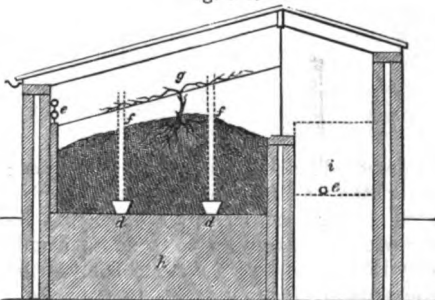
for general purposes, as well as for that of growing pines. The figure will fully explain their principle without any lengthened description: *a a* are hot-air tubes, or open pilasters, which can be opened or shut at pleasure; *b* is the bed of compost, &c.; *c c* are hot-water pipes; *d* is the hot-air chamber; *e* the steps and platform; *f* the line of water; and *g* the ground line.

It will be seen that bottom heat is supplied by means of hot-water pipes in the vault below the bed, and that surface

heat is supplied by the same means through the tubes or open pilasters; and that humidity may be commanded by admitting water into the tank to be heated by the under course of pipe to cause evaporation, to modify the heat of the pipes in the vault, as well as to find its way into the atmosphere of the pit through the tubes or hollow pilasters. The vault is covered with pavement, upon which is placed the necessary drainage of broken brickbats to the thickness of 6 or 8 inches. Thin turf is laid on the drainage, and on that the bed is formed for the reception of the plants.

*Glendinning's melon pit*, fig. 610.—The

Fig. 610.

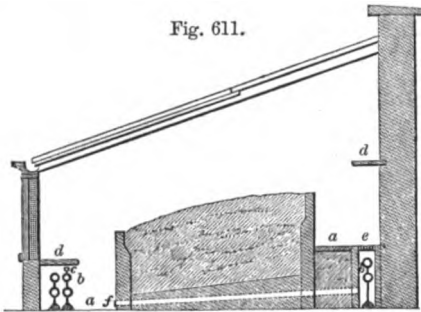


annexed section and description will explain the merits of this pit, the invention of Mr Glendinning of the Chiswick nursery, one of the most intelligent horticulturists of the present day. "It is heated by Burbidge and Healy's boiler. *d d*, in section, iron troughs; *e e* hot-water pipes; *f f* copper tubes fastened to the troughs to admit steam when required; *g* wire trellis on which to train the plants; *h* a convenient place for the growth of sea-kale, rhubarb, or asparagus, or keeping tubers of any kind during winter; *i* cistern."—*Gard. Chron.*

This pit may be used either for the growth of melons, or, without any material alteration, for young pines, as the hot-water apparatus is so arranged that bottom and surface heat may be had together or separately, as required. A layer of flints or broken stones is placed over the bottom of the bed, to prevent the roots of the plants from coming in contact with the iron troughs; and on this the soil is laid. A cistern is placed at one end, into which the rain water from the roof is received, so as to be at all times in a fit state for the plants.

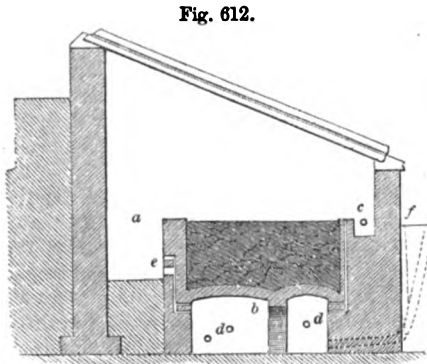
In principle, if we except the iron troughs, this pit does not differ from those in use in the gardens at Dalkeith, erected in 1841; and, from our experience during that period, we can speak in the highest terms of their utility. Our pits are used for cucumbers, with the vaults below the tanks, &c.

Fig. 611 shows a fruiting pine-pit by the same author, which will be at once



understood from the following references: *a a* paths; *b b* hot-water pipes; *c* perforated copper pipe, by which water may be thrown over the pipes, to promote humidity in the house; *d d* stone shelves for the growth of strawberries in pots, &c.; *e* iron grating over hot-water pipes; *f* opening for the admission of cold air, to cause the heated air to ascend at the grating *e* from the pipes at *b*.

The *Worsley pit*, fig. 612. We had an opportunity of examining this pit shortly



after its erection, the details being kindly pointed out to us by Mr Mitchell, who stated his principle to be, obtaining a full supply of fresh air without the danger of a cold draught; securing circulation without loss of heat; obtaining sufficient

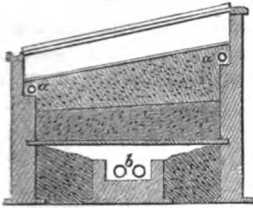
bottom heat; and, lastly, a supply of humidity in proportion to the internal temperature. The first is attained by opening the upper sash for admitting cold air, which he concludes falls into the passage *a*, and which, having to pass through the heated vault *b*, is in a proper state and temperature to come in contact with the plants. The way of securing the second will be seen by referring to the diagram, in which *c* is the flow-pipe, *d d* the return pipes placed in the vault *b*. As the air in this vault gets heated, it rises through the aperture *e* into the pit or house. This deficiency is made good by a constant supply of cold air from the passage *a*. Mr Mitchell calculates that upon the heated air coming in contact with the glass of the roof it gets cooled, and sinks to the passage *a*, and from thence again into the vault, thus keeping up a constant circulation of air,—of course increasing or decreasing in velocity according as the temperature in the vault rises or falls, and thus without much loss of heat, as the same volume of air performs the revolution. We apprehend that a very considerable improvement might be made here by admitting fresh air from without the house into the vault, regulating this supply by valves or otherwise to suit existing circumstances. No doubt all plants are benefited by motion, however produced, for we find such going on in nature; and motion produced by mechanical power, or, as in this case, by a current of unequal heated air, must, to a certain extent be beneficial; but the same air revolving over and over again in a plant-house is quite analogous to man inhaling the same air over and over again in a closely shut up, ill-ventilated room. Plants derive no small share of their sustenance from pure air; and why should it be denied in cases where it can be so readily afforded them? for it is not always convenient to open the top of the lights, in rainy weather for instance, or when snow is falling. We believe that no one will deny that the best point to admit pure air for ventilation, either in the dwelling of plants or men, is at the lowest possible point, and the best for the exit of heated and impure air at the highest part of the building. We would suggest, as an improvement in this otherwise excellent pit, the admission of cold air by a

sufficient number of tubes, as represented by the dotted lines in front of section at *f*.

Heat in abundance is produced by the pipes in the vault; while the requisite degree of humidity is obtained effectively and simply, by having the flow-pipe laid in a channel or gutter which may be filled less or more with water; thus combining, to a certain extent, the tank and pipe systems.

*Weeks and Day's pit for hot-water bottom heat*, fig. 613.—This is a well-contrived

Fig. 613.



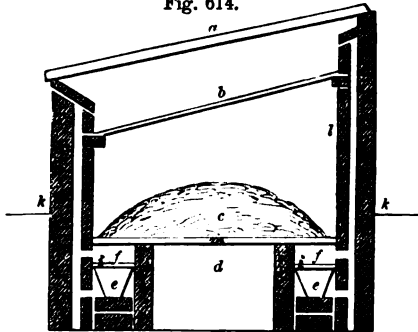
pit. Hot-water pipes are carried along the front, ends, and back (*a a*) of the pine-bed to give surface-heat, while others are carried under the bed in a gutter *b*, for affording bottom heat. The latter may be wrought at all times, unless a diminution should arise in the temperature of the atmosphere of the pit, when they may either be stopped by stopcocks, or even allowed to work altogether, as may be deemed most expedient. We need hardly say that, wherever tanks or gutters are used, abundance of atmospheric moisture can be commanded, by merely having a few openings through the bottom of the bed.

As the covering over the gutters is let into the walls at both sides, tubular openings should be brought up through the floor and soil to admit the heat, accompanied with moisture, into the atmosphere of the pit.

*Mill's cucumber pit*, fig. 614.—This very excellent cultivator has published in the "Gardeners' Journal" the annexed plan of a pit of his invention, of which the following is his description: "*a*, glass sashes; *b*, trellis for plants; *c*, bed for soil; *d*, hot-air chamber; *e e*, gutters for hot water; *f*, chamber for top heat; *g*, 4-inch wall; *h h*, brick on edge wall; *i i*, 9-inch tiles, covering 8-inch gutter; *k k*, ground-level; *l*, 4-inch wall; *m*, old ship timber." This is a very excellent pit, though we object to the use of timber between the soil and hot-air chamber, when slate or pavement would have been so much better, as either would be more durable, transmit the heat better, and be provided at very

little additional expense. Even though the timber is perforated with holes, or

Fig. 614.

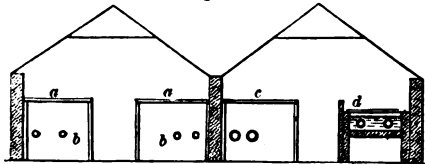


the joints are left pretty open, the non-conducting property of the wood will retard the ascent of the heat to the roots of the plants, which neither slate nor pavement would do. The hot-air cavities at back and front, formed by carrying up the two 4-inch walls, are, we think, quite superfluous, as iron or earthenware tubes placed along the back and front would have answered the purpose better, and saved 8 inches of space within the pit; while they could have been furnished, with stoppers complete, for half what the two 4-inch walls cost.

To render this pit complete for the purpose of winter culture, for which it is principally intended—and without these it cannot be perfect—hot-water pipes of 3 inches diameter should be placed along the front in the usual manner.

*Reid's propagating and protecting pit, with tank and hot water combined*.—Fig. 615 shows an arrangement of this kind, which

Fig. 615.



will be found useful in nurseries, and in garden establishments where many plants are required for planting out during summer, where it will be valuable for preserving them during winter. The following references will explain its principle. The platforms *a a* are formed of pavement supported on iron columns; 2-inch hot-water pipes *b b* are employed, being



found sufficient to exclude frost and damp. In the other division, one side is provided with a pavement platform *c*, under which is placed a flow and return 4-inch pipe; the opposite side has a tank *d*, in which a continuation of the 4-inch pipes is laid, which warms the water around them; the tank is "covered with two layers of pan-tiles, the upper tiles covering the joints of the lower, which are laid on pieces of iron placed 9 inches apart. The tiles are not laid in mortar, so that there is always a nice moisture in the plunging material. In the event of too much moisture occurring, the water is drawn off the tank, and the heat arising from the pipes soon dries it up; in fact, the regulation of the moisture is under perfect control, as the pipe may be only half covered, or more or less, as may seem advisable, and the moisture will be in proportion. The boiler is at the centre of one end, and works one or both pits as may be required."—*Gard. Chron.*

One essential fault occurs in this pit, namely, having the pavement shelves let into the side walls. This should not be, as we have already more than once observed both in regard to pits and green-houses. The heat of the pipes or flues placed under such shelves is prevented from rising upwards at those very parts where it is most required, namely, close to the side walls. Such an arrangement also conducts the cold in winter from the side walls along the pavement, and not unfrequently destroys the plants. All shelving like the above should be kept clear of the walls from two to three inches; yet, strange to say, this is an error almost invariably fallen into by builders.

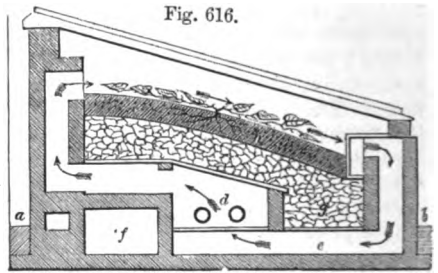
*Rogers' pit.*—The following plan has been suggested by Mr Rogers, of Seven-oaks, Kent, for a pit combining in itself both top and bottom heat, accompanied with the requisite degree of humidity necessary for such structures.

Fig. 616 is a section of the pit, supposed to be built entirely above the ground-level. The walls are hollow, and formed of brick on edge, with a view to economise material.

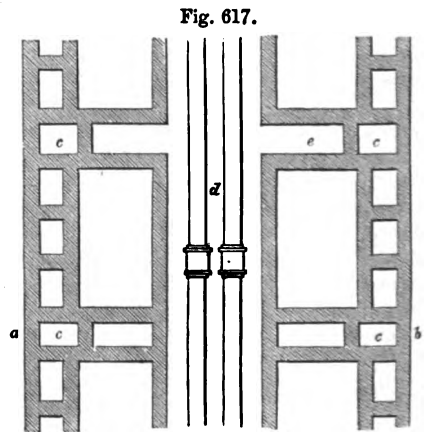
Fig. 617 is the ground-plan, *a b* marking the sectional line.

The details are as follows:—Under each rafter is carried up a hollow pillar, *c c c*,

projecting only 4 inches within the pit, and having no communication with the



general cavities in the side walls: in these a cavity is left both at top and bottom. Along the centre of the pit a flue of brick



on bed, *d*, is carried, 2 feet broad, and  $1\frac{1}{2}$  feet in depth, with openings at its bottom, *e*, corresponding with those in the pillars along the front of the pit, and also with those in the back, the openings in the latter being just below the level of the top of those in the front. These openings are to be all connected by flues or tile-drains. The hot-water pipes are to be laid along the centre, as shown in plan and section, but somewhat elevated above the floor on which they are placed, and covered over, about 9 inches above their upper surface, with slate slabs three quarters of an inch in thickness. The communicating openings between the flue in which the pipes are laid and the hollow pillars of the back wall should be 3 inches below the top of the said flue, to act as chambers to retain heated air. The boiler is to be placed at one end of the pit, unless so situated as to be

heated from a boiler adjoining. The spaces *f*, between the hot-water-pipe flue and the back wall, are to be made solid with earth and rubbish, so as to form a good foundation to the connecting openings or flues to be laid on top of them. Those between the said flue and the front wall, *g*, should be filled with hard, dry, open materials.

In fitting this pit for the reception of plants, the space between the hot-water-pipe, flue, and the front wall of the pit, as well as the whole surface of the pit over the flue, and the space between it and the back wall, should be covered, as shown in the section, with stones, brick-bats, or coarse gravel, to the depth of not less than 12 inches. Over this, if for melons or cucumbers, is to be placed a layer of turf, with the green side undermost, and over it the necessary compost, *h*. If the pit is intended for pines in pots, or other plants, then gravel or coal ashes may be substituted.

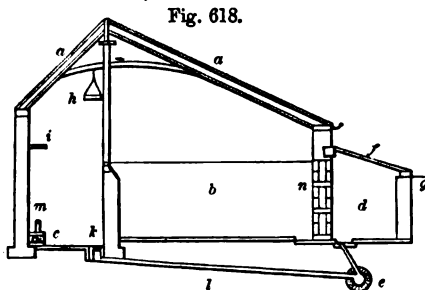
“By this arrangement it will be perceived,” says Mr Rogers, (in his communication on the subject to the “Gardeners’ Magazine,”) “three things are attained—bottom heat, top heat, with an atmosphere constantly moist, and finally, a constant circulation of air. Unless I am much mistaken, supposing the pit to be 6 feet wide, and 3 feet high at back, and 1 foot 3 inches in front above the mould, the whole atmosphere of such a pit would pass through the flue once in every two minutes when the apparatus was in full work, thus producing a constant and vigorous circulation. Farther, if it be desired to change a portion of the air continually, small apertures to the outward air may be made in the front descending flues: a small portion of fresh air will then pour in, continually mingling with the descending air, and ascending heated into the pit, supplying the place of that which will escape through unputted laps and various crevices. The internal areas of the pilaster flues should not be less than 6 inches square, which they may be according to the proposed plan; and the cross flues and apertures into the pit must have the same area. If it be found that, with this area or apertures, the heat produced by the pipes is brought up too rapidly, not having sufficient bottom heat, and over-

heating the top, these apertures may be diminished. If they be too small, an inequality will arise between the temperature of the back and front of the pit, caused by an excessive difference of the ascending and descending air. The total heat brought up will be the same; for as the heat increases, the velocity with which the air will ascend will increase also; but if apertures of the size above recommended be employed, there will not be 2° difference between the front and back of the pit. In order the better to disperse the ascending currents, it may be well that the aperture, instead of opening directly into the pit, should have a semi-cylindrical draining-tile placed in front of it, to throw its draught right and left; but this is an unnecessary refinement; a pair of 4-inch pipes will be found sufficient for cucumbers and melons, or pines, in a 6-foot pit.” Regarding the temperature thus secured by two pipes, Mr Rogers candidly observes that it may be insufficient “for early forcing,” and consequently for hot pits during the winter. He very properly suggests the employment of four instead of two pipes; but we apprehend that if a nozzle-pipe were attached to the boiler, and if the flue in which the pipes are placed was rendered water-tight, so as to constitute a tank, temperature enough would be attained without going to the expense of the extra set of pipes; and such an arrangement would give out a far more genial and humid heat.

In this pit, as well as in most others heated by hot water, it quite clearly appears that much of the heat of the furnace must be lost by escaping at the chimney-top. We see no reason why this heat, after passing the boiler, should not be turned to advantage, by being made to pass along in a smoke-flue, under the heated air-flue, in the chamber *f*. To effect a complete command of heat in this otherwise excellently contrived pit, we think it would be requisite to carry a tank along the flue *d*, and also the smoke-flue in space *f*, as already alluded to. With such an alteration, we think this would be one of the best pits which has come under our notice. At all events, as constituted by its intelligent author, it is at present deficient in the command of heating power.

The inventor of this pit remarks, that objections may be made to his plan, as, "that the ascending flues should be at the front rather than at the back, lest the upper part of the pit should be warmer than the front. The extreme rapidity of the circulation already alluded to is a complete answer to this objection; but further, any other arrangement of the circulation than that above suggested would be prejudicial, and lead to precisely the opposite results to those intended. In the first place, instead of a great, there should be but a small difference between the ascending and descending columns, and consequently a much slower circulation. In the next place, if the descending flues were at the bottom of the back instead of at the front, and the heated air entered at the front, it would immediately rise to the upper part of the pit, and there accumulate its heat, while the whole surface occupied by the plants would be covered by the coldest air. Moreover, the earth at the back being always higher than the front, the coldest air would not flow away to be repeated, but would lie all along the front of the pit, and scarcely circulate at all; whereas, by the arrangement proposed, the coldest air will always descend to be heated, while the influx of warm air, constantly encountering the warmest air, which has risen to the top, will beat it down, and mingle it with that below. This is perhaps theory, but it is theory based on experience; and I have no hesitation," he says, "in saying that such would be the effects."

*Glendinning's pit, heated according to Mr Corbett's system.*—The pit of which fig. 618 is a cross section was designed



by Mr Glendinning, of Chiswick, to whose taste and judgment in all that relates to

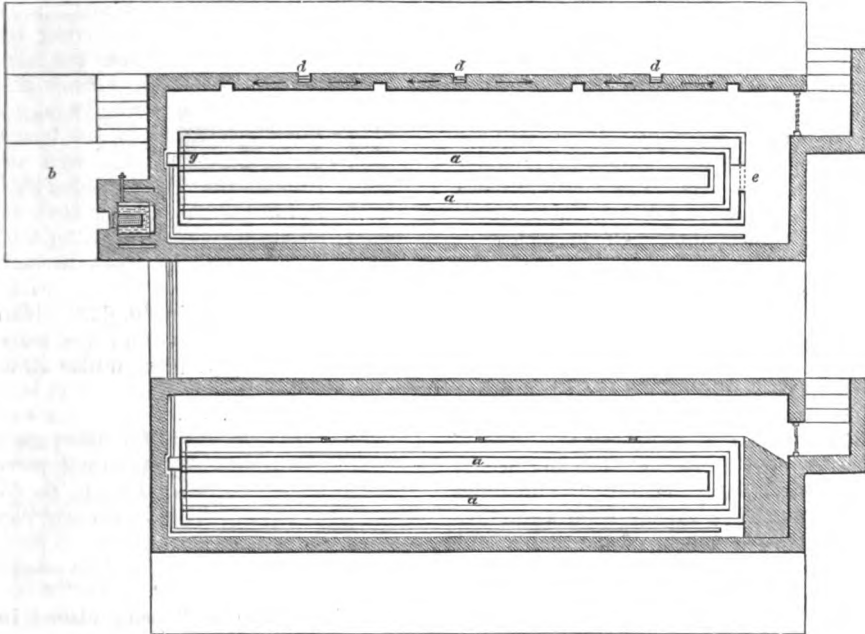
garden architecture we have more than once alluded in the foregoing pages. The plan of this pit was, we are informed by Mr Glendinning, in "Gardeners' Magazine," vol. xvii. p. 58, made out for His Grace the Duke of Somerset. The plan is so clear that we need not attempt its description, farther than by giving the note of reference accompanying the original plan. "a a, glass roof; b, bark pit; c, back path; d, pit for dung lining; e, drain; f, hinged cover of ledgered boards to protect the dung from the rain and wind; g, ground-line; h, suspended shelf for strawberries in pots; i, slate shelf for pots; k, stink-trap communicating with the cross-drain, l, which leads to main drain; m, Corbett's hot-water apparatus; n, hollow wall of bricks on edge." This will be seen at a glance to be a pit of great merit and utility. The linings of dung in front will not only throw in heat, but also that genial and invigorating kind of atmosphere in which the inmates of all pits seem to delight; and much as we could wish to see dung applied to the enrichment of the soil—its real and legitimate use—still we are not blind to its great utility in its application to forcing purposes. As the back part of the roof is glazed, we think the introduction of shelves under it good, as they in no way interfere with the plants in the main bed. The hot-water gutter behind gives out heat in the part generally coldest, and equalises the degree of humidity in all parts of the house. The drainage is efficient; and we may here remark, that this very important accompaniment is more fully attended to in the designs of Mr Glendinning than in those of any other garden architect—a convincing proof of his practical acquaintance with the subject.

*Mitchell's forcing-pit, figs. 619, 620.*—The annexed cuts represent two ranges of pits of a very economic character, erected at Somerton Erleigh by Mr Josiah Mitchell, from his own designs, with which he has kindly favoured us, accompanied by the following description: "They are heated by hot water, one boiler serving the two pits, and supplying them with both bottom and atmospheric heat. The heat in each pit is regulated to suit circumstances, by slides contained in the stopping-off boxes, marked g in the

ground-plan. I am of opinion that these slides are superior to the valves commonly used, for they are more simple in construction, easy to manage, and less

liable to get out of order. The boiler has a flue passing through its centre, and round the two sides. It is very powerful, and requires but little fuel to heat it.

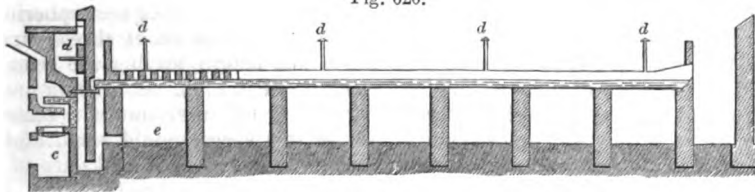
Fig. 619.



“ In the longitudinal section, fig. 620, you will see how I have attempted to make use of the ‘Polmaise’ for the purpose of economising heat, and causing a

circulation of air in the pit upon which it acts. The bottom of the pit has a fall of 6 inches towards the end at which the boiler is placed. From this lowest part

Fig. 620.



an air-drain is taken, first downwards, then up the back of the boiler, into an air-chamber above it, and is then connected with the hollow in the back wall. When the fire is lighted, and the air in contact with the boiler, &c. becomes heated, in obedience to a natural law by which it is governed, the heated air ascends, and the cold air presses up to take its place, and so, in its turn, becomes heated, and is again thrown into the pit, at the openings in the back wall.

“ This circulation of air tends to keep up a constant movement in the atmosphere of the pit, and, at the same time, conveys the heat, which would otherwise be absorbed by the bricks and mortar which surround the furnace and boiler, into it. It is the common practice, when tanks are used, to place the covers *close* down on the top of the tanks. In these pits the tanks are of  $\frac{1}{4}$ -inch cast-iron, 15 inches across at the top, and 9 inches at the bottom, with 3 inches of a bevel

on each side: the covers are of slate, cemented so as to prevent the vapour from rising up through the soil, and raised 3 inches from the top of the tank, so that the vapour of the hot water comes in contact with the whole of the under surface of the bed; and the bottom heat from one end of the bed to the other is nearly equal; whereas, when the covers are close down on the tanks, the heat is very unequal. Into the vapour-chambers four pipes were introduced for the purpose of admitting vapour when required in the pits. The covers of these pipes are a piece of 1-inch thick wood, made to project about half an inch over the pipe all round: two holes are bored through the wood, *even* with the *inside* of the pipe, and opposite one another; then a piece of strong wire, a foot long, is doubled, and an end pushed through each hole, until the double of it forms a handle, and the two legs below a spring which presses against the sides of the pipe, and keeps the lid at any height to which it may be raised, and thus prevents the hot vapour from ascending directly to the foliage of the plants and scorching them.

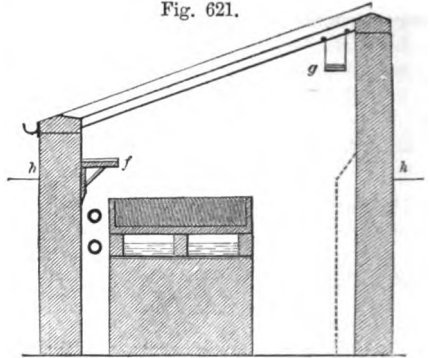
"The ventilation of the back pit is the only other thing to which I will direct your attention. The back wall is hollow, 1 foot 8 inches deep, with the bricks thrown across it to keep the wall strong. The ventilators for the admission of air on the outside are placed on the bottom of the hollow wall; and where the air is to enter the pit, the holes are at the top of the hollow. Now, the cold air, when admitted below, is obliged to travel to the right and left, as shown by the arrows in the wall, and at the same time rises a little before it can enter the pit; and in consequence of this hollow wall being connected with the hot-air chamber, it is always full of warm air, so that the fresh cold air gets the chill taken off it before entering the pit."

References to the letters marked on the plan: *a a a a* tanks, *b* stoke-hole, *c* ash-pit, *d* hot-air chamber, *e* cold-air drain.

*Dalkeith propagating-pit.*—The annexed section, fig. 621, and ground-plan, fig. 622, exhibit this pit. It is connected with a bulb-pit at *a*, ground-plan, which shows the flow and return hot-water pipe taking the water to the tanks *b b* from the

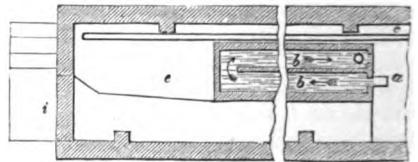
boiler, which is placed in the division between both pits, as seen in the follow-

Fig. 621.



ing fig. 623, and at *c* in fig. 622, which represents the flow-pipe from the same boiler, the return-pipe being under it, as

Fig. 622.

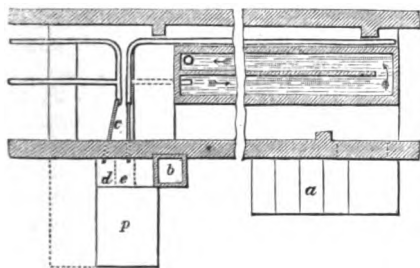


seen in the section, both being placed in a space separating the tank from the front wall. The intention of the tanks is to supply bottom heat to a bed of sand in which cuttings are planted, or pots set or plunged, when bottom heat is required. The other pipes extend the whole length of the pit, for producing atmospheric heat. The tank extends about three-fourths of the whole length, leaving the remainder at *e* without bottom heat, being used for hardening off newly-potted plants, &c. Under this space, mould, sand, and pots are kept for use. The tanks are of brick and cement, covered with Welsh slates, and having a frame of wood 10 inches deep all round to keep in the sand or plunging material. A shelf, *f*, is placed along the front, which, being somewhat shaded, is used to set newly-potted-off plants upon; while another is suspended from the roof *g*, and runs along the back for those pretty well established in the pots. These pits are sunk, as will be seen by the ground-lines *k k*. They are 6 feet wide within, and seven feet high at the back, and are entered at the end at *i*.

The water re-enters the boiler from the tank by descending through a pipe, the orifice of which is level with the floor of the tank at *k*.

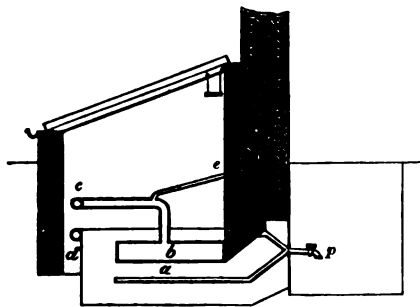
*Dalkeith bulb-pit*, figs. 623 and 624, is in size and arrangement similar to the last,

Fig. 623.



only, instead of a bed of sand, the pots stand on the slates which cover the tanks. *a* shows the stair leading down to the passage from the back, *b* the chimney, *c* stoke-hole, *d* pipe for supplying the boiler and pipes with fresh water, *e* the gauge-pipe, the external orifice of which is level with the full height of the water within, so that, when the water flows from it in charging, it is certain that boiler, pipes, and tanks are full. This pipe is left open, so that, should the water expand from being over-heated or too full, it finds a ready escape. Fig. 624 is a

Fig. 624.



section across the furnace *a* and boiler *b*, showing also the flow and return pipes *c d* in front, and also the supply-pipe *e*. In the first instance, the slate covering extended from the passage across the pit over the tanks and hot-water pipes, and was let 3 inches into the front wall. This was found not to answer the purpose, as the pipes, being covered, gave little heat

to the atmosphere. We have since had them altered, laying the pipes bare, and the top of the cavity in which they are being left open, which gives us sufficient top heat, and at same time counteracts the effects of too much damp.

The stoke-hole *p* is behind, and wholly sunk under the ground-level; it is covered with a door, and descended to by steps. There is a space also arched over for keeping the supply of coal. The chimney, being carried up 10 feet, is not shown at full height in section, and is finished with a cannon-shaped chimney-pot.

*Dalkeith cucumber-pit* is nearly upon the same principle as the propagating-pit. In it we also found that covering the hot-water pipes in front induced an insufficiency of atmospheric heat; we therefore have removed the pavement on top of the tank, and replaced it with other stones 9 inches narrower, which we find of great advantage. Under the bed of soil is the tank covered with Caithness pavement. Along the back of the bed are placed, 4 feet apart, small tubes, through which water is occasionally poured to reach the roots, instead of applying it on the surface of the bed. Under the soil is placed, immediately above the pavement, a drainage of broken pots 3 inches in depth. The cucumbers are trained under the glass to a trellis of small cord, so that it may be cut to pieces when any of the larger branches of the plants are to be removed. The fruit, when set, are placed in glass tubes, which are suspended from the roof. Under the tanks, which are supported upon flat brick arches, are forced, during winter, sea-kale, rhubarb, &c. These openings are furnished with doors which exclude the light, and the sea-kale is thus blanched without trouble.

*Dalkeith nursing pine-pit*.—This pit is heated by hot water in the usual manner, with a bed of leaves, into which the plants are plunged. It forms a continuation of the cucumber pit last described. We may here observe that the four pits last noticed are 6 feet wide in the clear—a width we would not have adopted, had it not been that the sashes were at first made for another purpose; and had it not been for local circumstances, we would have ranged them from north to south, instead of from east to west, and made

them in the span-roofed form. A glance at the ground-plan of this garden (*vide* Plate V.,) will show the propriety of this arrangement.

*Dalkeith succession pine-pits.*—These pits are exactly similar to the last, only that they are 10 feet wide within, and about 10 feet deep at the back, and are filled more than half-way up with leaves, into which the plants are plunged. They are sunk under ground like the former. The walls are of 9-inch brickwork, wrought solid, and coped with wood on the back walls, and with stone on the front, as the latter, being more liable to be affected by damp, either from rain without or condensation within, would be liable to decay, if of the former material. They are provided with water-gutters in front, as are all the buildings in the garden, for the collection of rain-water, and keeping the buildings dry. They are heated by 4-inch hot-water pipes placed along the front, the boilers being placed in the centre of the ranges, the water flowing from them to the right hand and to the left. They are thoroughly free from damp within, as the ground they are sunk in is a sharp alluvial gravel.

We would no doubt have tanked all these pits, to save the time and expense of collecting leaves for them; but in that case the pits would have been of a permanent depth; and as the plants extended in height, they would get broken by coming against the glass. This is avoided by their being plunged in leaves, as, when the plants touch the glass, they are taken out, and the depth of leaves reduced, which could not very readily be done by the tank mode of heating, unless the floor they stood on, or the roof above them, could be elevated and depressed by machinery—both of which, although quite possible, would render them complicated, and liable to derangement.

*Pelvilain's pine-pits.*—M. Pelvilain was one of the gardeners to the late King of the French at Meudon near Paris, and his success in the cultivation of pines, of late years, has been reported as being extraordinary. When we knew something of French gardening, and were in the habit of seeing it practised, we used to consider a French-grown queen pine of 2 or 3 pounds' weight extra good. However, it is not with the culture, but the means

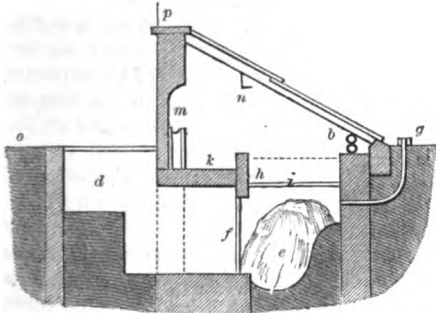
employed, so far as structures are concerned, that we have at present to deal.

We have not been in Paris since the *pine revolution* took place, therefore we must take the description and illustration of the Meudon pits from those who have been there. We are informed by "Mirabile Dictu," a correspondent in "The Gardeners' Chronicle," that M. Pelvilain's pits for young plants are frames or wooden boxes. "These boxes," he says, "are supported by piers of wood about 2½ feet above the ground. The under portion of the boxes is lined with old ship-timber, laid as close as possible to prevent the ingress of steam, and also to keep the soil in which the pines are planted from mixing with the stable litter which is employed in heating them." The heat is applied in shape of linings of hot dung round the sides of the pits, and the same material placed in a vault under the beds, but from which it is also carefully separated by a flooring of boards, upon which the soil is laid in which the pines are planted, M. Pelvilain making it a principle to exclude ammonia and all other gases from entering his pits. Now, we have here to confess our ignorance how heat, in degree to be at all useful to the plants within, can penetrate through the closely-boarded sides and bottoms of these pits. With the principle of these pits we do not quarrel, but with the material used. For why not use slate, thin pavement, or even plates of thin iron, all of which are conductors of heat, while timber is quite the reverse? Or why not use Baldwin's pits, page 432, which are all also of wood, that portion, however, which separates the dung lining from the dung-bed being of open timber-work, for the purpose of more readily admitting the heat? To separate the mould-bed from the heated dung underneath with thick boarding is the height of folly; and no man having the slightest knowledge of the properties of heat, or of the non-conducting power of timber, would do so. If the exclusion of ammonia and other gases is the only object in view, surely slate, tiles, pavement, or metallic plates, would answer as well. Taking these pits as a whole, we consider them as the very worst that could possibly be conceived.

The fruiting pits are thus described in "The Gardeners' Chronicle:"—"M. Pelvi-

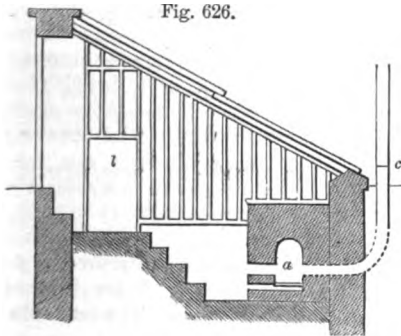
lain has four fruiting pits, which are heated with hot water and stable litter combined—the stable litter for bottom heat, and the hot water for surface heat." Eleven lights (each light is 4 feet 4 inches wide) form the largest fruiting pit, of which figs. 625 and 626 are sections. In fig. 625 is shown the manner in which

Fig. 625.



access is had to the hotbed. Fig. 626 shows the entrance and the furnace, with a side view of the pit. a furnace, b hot-

Fig. 626.



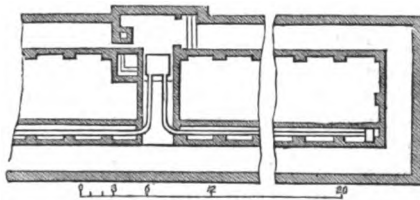
water pipes, c chimney, d concealed pit to get at the hotbed, e hotbed, f door, which is shut up after the stable litter has been removed; g air-holes, furnished with a cover to regulate the bottom heat; h bed filled with peat soil, in which the pines are planted; i iron bar, supporting boards to hold the peat soil; k footpath, l door, m water-cistern, n shelf for straw-berries, o ground line, p iron railings for hanging the straw mattings upon, which serve to cover the pits. Ventilation is given in the usual way, by lifting up the lights.

M. Pelvilain's pits are narrow, admitting only of three rows of plants. Their depth must be regulated by the height of the plants to be grown in them; and to

that add 18 or 20 inches for the depth of the soil, which consists entirely of pure peat, with abundance of white, sharp, sparkling sand—such, for example, as would be preferred for heaths. The bottom heat is regulated by the drains g, which are opened when the heat is too strong, and shut when it is too low.

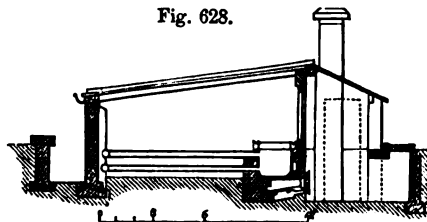
*Atkinson's succession pine-pits with hot water and dung linings combined.*—Figs. 627 and 628 represent an excellent range of pits upon this principle. This pit is

Fig. 627.



70 feet long, and divided into two compartments. It is heated by means of dung linings placed all round, and also by hot water, as well as by the tan or leaf bed in which the plants are plunged. Although somewhat more complicated and expensive in erection and working than a tank pit of the same size would be, still it has advantages that few pits of its day had; and where stable litter is abundant, it may be advantageously used, as the pit and linings will be often sufficient to keep up the necessary temperature, and the hot water can be applied when these decline. When the linings are covered over, the whole has a neat and compact appearance. The section fig. 628 is drawn to a larger scale

Fig. 628.



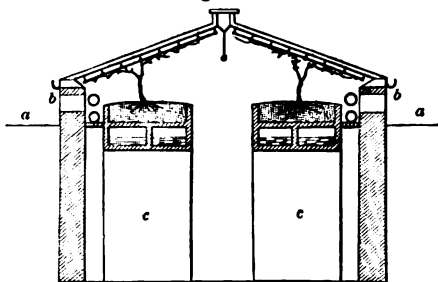
than the ground-plan and elevation; but as a scale is attached to each, the dimensions may be accurately enough taken.

Fig. 629 is a section of melon or cucumber pits, adapted to those shown in ground-plan of kitchen gardens, marked m m m, fig. 21. They are 8 feet



wide, which will afford a scale for the other parts. They are heated by hot-

Fig. 629.



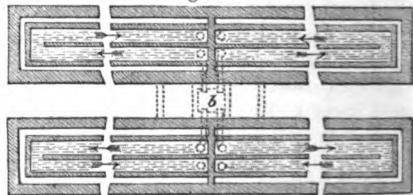
water pipes to afford atmospheric heat. These are placed in a space between the side of the tank and the front wall, the lower or return pipe resting on the pavement or slate covering of the tank. The sides of the front wall and tank being watertight as well as the bottom, water may be let in, so that the lower pipe may be partly or wholly covered, to give greater humidity to the pits. If dry heat is desired, the water is to be withdrawn. The ventilators *b b* are placed along both sides of these pits, so that the atmospheric air may be warmed before reaching the plants. Bottom heat is obtained by tanks of hot water placed under the beds in which the plants are set. The shoots are trained to a trellis under the glass. Top ventilation is effected by the ridge opening from end to end, upon the principle explained in section VENTILATION. The spaces under the tanks *c c* are to be used for forcing sea-kale and rhubarb during winter, and mushrooms during summer. The passage along the middle may be entered at both ends, which, in summer, will give abundance of ventilation. These pits are sunk to the line marked *a*, presuming the ground be dry. If it is not, they should be kept higher up; but these are arrangements which must be ruled by local circumstances. The roof of this pit may be fixed, and rafters and sashes dispensed with altogether. This pit may also be wrought by fermentation as a bottom heat, and by hot-water pipes for atmospheric. In this case the tanks would be dispensed with, and the roof constructed of rafters and sashes, as it is necessary to remove them for the purpose of making up the beds and removing the decayed material. The hot-water

pipes are kept clear of the fermenting material, and they are placed in a space formed by laying in a course of pavement or Welsh slate into the wall, allowing it to project 8 inches within the face of the wall. Upon this is set on edge, in a groove, a slip of pavement or slate 12 inches broad, which will form a trough for the pipes to lie in. If this is well jointed, as it ought to be, water may be let in when desired, by a small pipe, and steam will be generated to keep up the genial humidity so essential for the growth of these plants. Ventilation is effected, as in the last example, both at the side walls and also at the ridge.

Such a pit as that last described is peculiarly suitable for young pines, for which tank-heated pits are inconvenient, as the plants require to be arranged in the pits according to their heights, and the beds of leaves or tan can be lowered or elevated according to the height of the plants, which beds heated by tanks could not.

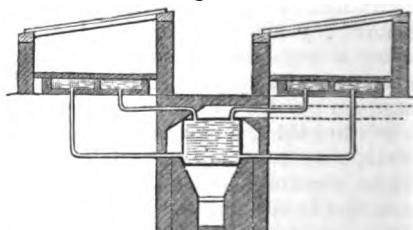
Pits to a very considerable extent might be heated upon the tank system at little expense, if arranged as in fig. 630. The

Fig. 630.



ground-plan is intended to represent four distinct pits, each 50 feet in length, and 6 feet wide in the clear. The boiler is to be placed in the middle as at *b*, or, as is better seen in section fig. 631, with the

Fig. 631.



stoke-hole under the level of the walk or passage between them. The floors are to be rendered perfectly level and firm with a coating of concrete, and afterwards covered with cement over their whole

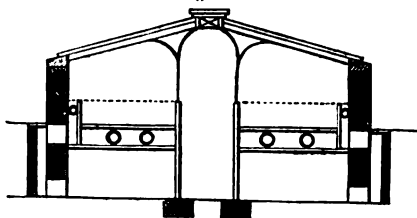
breadth, as are also the side walls to the height of 6 or 7 inches. Down the middle of each pit let a line of bricks set on edge be placed, leaving the one nearest the extreme ends out: this will give a flow and return current; the line of bricks forming the outer edge of each tank being kept 3 inches clear of the side walls, to prevent the loss of heat by absorption or otherwise. Over the tanks thus formed, thick slate or thin pavement is to be laid, and closely jointed with cement, extending from back to front of the pit. Apertures at every 5 or 6 feet may be cut in them, to which iron or earthenware tubes should be attached, of 4 inches in diameter, and furnished with stoppers, to be taken out for the admission of moist heated air into the atmosphere of the pit, and replaced when that is not required. Similar provision should be made over the apertures between the outer edges of the tanks and the side walls, to allow the heated air in them free access into the pit; and as the air from such sources is not over moist, the openings may be left uncovered. The back walls may be  $3\frac{1}{2}$  feet high above the ground-line; that is, allowing 8 inches for the depth of water and thickness of the top covering, and 2 feet 10 inches from the top of the covering to the glass. The front wall above ground-line should be 2 feet 6 inches. Circumstances will always direct this, as the height of pits must be suited to the purpose for which they are intended. The boiler will supply all, or part, as may be required; and this can be regulated by stopcocks placed in the pipes which connect the boiler with the tanks; and these again can be subdivided by sluices, as in fig. 251. By this means we would have 1200 square feet of surface heated by one fire; and for the purpose of growing young plants in pots, forcing French beans, strawberries, asparagus, potatoes, salads, &c., such pits would be invaluable. The walls should be 9 inches thick, for durability, and also for retaining the heat, or for the exclusion of cold; and if they are built hollow, so much the better. The rafters and wall-plates should be of iron, and the sashes of the best Baltic or sound yellow pine timber. The glazing should be with crown glass, in sizes 6 inches by 10. To use larger glass in such structures is unnecessary. The roof may be on the ridge-and-furrow prin-

ciple, without much difference in the cost. The range should extend from east to west, so as to present the frontage to the meridian, or nearly so.

To heat the greatest possible space, at the least possible expenditure of fuel and cost of erection, we think this and the following the best of all methods.

Fig. 632 represents a span-roofed pit extending to the length of 100 feet from

Fig. 632.



north to south, and 12 feet in breadth within the walls, of which the footpath occupies 2 feet 6 inches. The boiler is placed in the middle, at one side of the pit, its top being level with the floor of the passage, and placed under the side tank. The stoke-hole is to be sunk by the side of the pit, so that the fire can be managed from without. One flow-pipe is to rise perpendicularly from the top of the boiler to the surface heating pipe, and another from the end of the boiler passing under the footpath and opposite tank, and rising with a gentle bend to the flow-pipe. These pipes branch out to the right hand and to the left, and are carried to the two extreme ends of the pit, where they are bent down and made to return towards the boiler in the hot-air tank, formed of pavement for top and bottom. The bottom is supported by cast-iron brackets set in stone plinths by the side of the footpath—these plinths rising perpendicularly to the height of the beds, and serving the purpose of supports, to which the long narrow strips of Welsh slate are secured which form the sides of the beds, to the depth of 12 inches. To these, at every 25 feet, the arched supports of the ridge are fixed. Bottom ventilation is obtained by 4-inch openings in the side walls, opening into a 9-inch area extending the whole length of both sides of the pit. This area is provided with a cast-iron covering, the frame-work of which is fixed to the top of the area wall, as well as to the sides of the pit, having its upper part

in 2-foot lengths, one half of which is fixed to the frame, while the other half moves on a rail, so that when acted upon at one end of the pit by a wheel and lever handle, they may be drawn forward from one inch to their whole length, as the extent of ventilation may be less or more. A similar movement at the other end shuts them up again. By these means the 4-inch openings along both sides of the pit may remain always open. Top ventilation is secured through the ridge, as exemplified in various ways—*vide* section VENTILATION.

It is of great advantage to have free access to pits of this kind during all seasons. Here it is amply provided for along the centre, and by having a door at both ends.

Cold air is admitted at the sides close to the ground-level, and also close to the floor-level, by openings 4 inches square, and at distances 4 feet apart. We prefer small openings to large ones, as admitting a more equal distribution of air; and also that they should be brought in at the lowest part of the pit, to cause circulation. The cold air admitted by them is received into the space under the tanks, from whence it is allowed to ascend upwards between the tank and side walls to the top, as well as through under them, and ascending in the passage. The same operation going on on the other side causes an equal distribution of air in all parts of the pits.

Although the external openings for the admission of cold air are placed 4 feet asunder, it does not follow, nor is it requisite, particularly in winter, that many of them be opened. All that is necessary is, that an adequate supply be admitted, and warmed sufficiently according to the season. In summer these precautions are wholly unnecessary; for the whole of the external, as well as the internal, openings may be used at once. The spaces under the tanks may be left solid ground, and the tanks formed upon it, the passage only being excavated, and the sides supported by 9-inch walls.

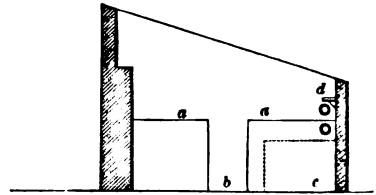
To render this pit still more efficient, the whole interior should be excavated, as shown in the figure, to the level of the passage, and the tanks supported as we have described. The spaces under the tanks will be found exceedingly useful for forcing rhubarb, sea-kale, chicory, mushrooms, asparagus, &c., and for keeping

bulbs and other plants in during their season of rest.

This pit may be divided into four compartments of 25 feet each, the division nearest the boiler being occupied with French beans in winter and spring, and cucumbers or melons during summer; the next with plants for flowering during winter; the third with strawberries, asparagus, &c.; and the fourth with bedding out plants.

*Fortune's plant-pit*, fig. 633.—The transverse section, as shown by the figure, will

Fig. 633.

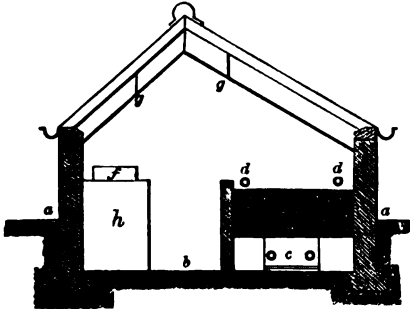


fully explain the principle of this pit: *a* back and front shelves or stages; *b* passage along the middle; *c* proposed tank. The width is 9 feet, and will form a scale to the other parts. The stages are of narrow boards, laid on cross bearers, having one end let into the walls, and the other supported by upright posts set along both sides of the walk. A narrow shelf *d*, supported on iron brackets, runs along the front, for small plants. These brackets, Mr Fortune proposes, should support the hot-water pipes; but we would suggest their being supported from below, as being much less liable to strain the front wall, which is only 9 inches thick. Under the front stage a large water tank is proposed at *c*, to contain the rain water that falls on the roof. In regard to the angle of elevation which plant-pits of this description should have, Mr Fortune quite agrees with our own experience on the subject. "Any experience which I have," he says, "goes to prove, that houses with high angles—that is, from 30° upwards—having a wall behind, are apt to draw the plants too much to the front, and to make them one-sided; and for this reason I prefer houses of this description with rather flat roofs." The angle Mr Fortune, therefore, prefers for such houses, should range from 20° to 28°. The section of the pit above given is rather below the minimum of these.

Mr Fortune considers a hot-water apparatus the best of all modes of heating; and estimates the expense for such a pit as the above at—a 10-inch Rogers conical boiler, about £5, 10s.; the fittings, £1, 18s.; and 2-inch leaden pipe at about 3s. per yard.

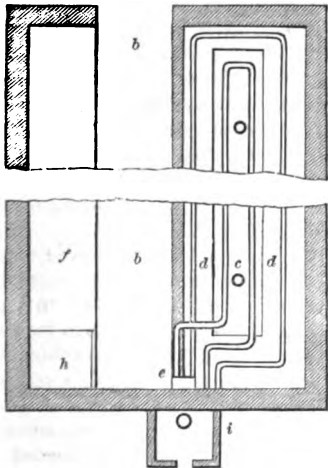
*Dawson's cucumber-pit*, figs. 634 and 635.—This pit has considerable merits.

Fig. 634.



We would, however, have preferred had the tank been immediately under the bed, and occupying its whole breadth. As

Fig. 635.



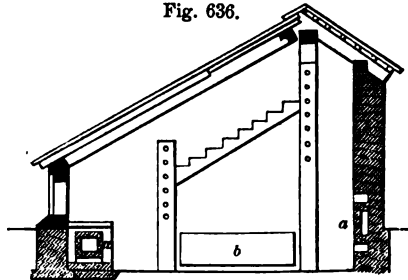
it is, we doubt if sufficient bottom heat can be commanded during winter. We approve greatly of the hot-water pipes for atmospheric heat being laid above—if laid on it, heat would be lost by absorption—the surface of the bed, and also of the tank for rain water being under the back table. Mr Dawson is quite correct in stating his doubts as to the sufficiency of heat to be obtained from tanks placed under the bed alone. This we have

found out by experience. By having his tank heated by hot-water pipes passing through it, he has the choice of moist or dry heat as he pleases; as, when dry heat is wanted, the water can be withdrawn from the tank. The pipes he employs, however, are too small, if of cast-iron, and will soon choke up by corrosion. It is not stated whether the tank is covered with pavement, slates, or timber; we trust not the latter.

The following reference to the section and plan is from the "Gardeners' Journal," in which paper it has been published:—"Interior dimensions—length 28 feet, by 9 feet wide; height over passage, 7 feet: *a* ground-level; *b* door and passage; *c* tank and 2-inch pipe, with three apertures for the moisture to rise by, for surface-moisture; *d* 4-inch pipe for surface-heat; *e* a small tank, higher than the bed into which the water flows from the boiler, to allow of expansion—from this the flow-pipes carry the water, and in it either of them can be stopped at pleasure; *f* a platform for cucumber boxes or pots, &c. &c.; *g* trellis for cucumbers, raised or lowered at pleasure by an iron rod from the rafters; *h* cistern to hold rain water collected on the roof; *i* fire-place and boiler."

*German pit for forcing French beans, strawberries, &c.*—Fig. 636 exhibits a pit

Fig. 636.

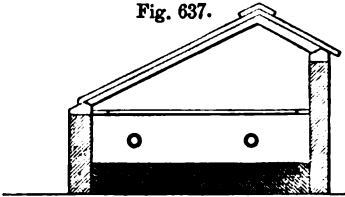


well contrived for these purposes. It is 12 feet wide and 10 feet high. The stage on which the pots are set is arranged so that it can be elevated or lowered at pleasure, as will be sufficiently understood by a glance at the section: *a a* are smoke-flues, (hot-water pipes would be better.) Over the front flue is a trellis, on which pots are set; and under the stage at *b* is a mushroom bed; or sea-kale, rhubarb, &c., may be forced in it during winter. Ventilation is effected by sliding

the front upright lights, and by letting down the top roof ones. Ventilation through the front parapet, with corresponding openings in the opaque part of the roof at top, is also an improvement to be recommended.

Fig. 637 is a section of a pit for similar purposes, heated by a flow and return

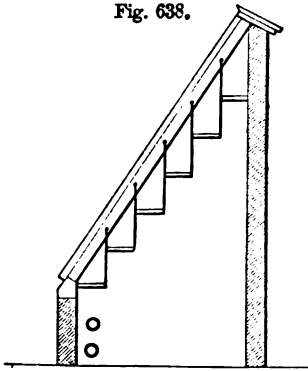
Fig. 637.



hot-water pipe, under the trellis on which the plants in pots are to be set. The back part of the roof is covered with imbricated thick boarding, and in it ventilators are placed. The front is glass sashes, in a portable state—this being necessary, as all operations connected with the plants are carried on from without. The trellis on which the plants stand is of wood, and sufficiently open to admit the heat to pass readily upwards.

Fig. 638 is a strawberry house or pit, heated by hot water—the shelves for the

Fig. 638.

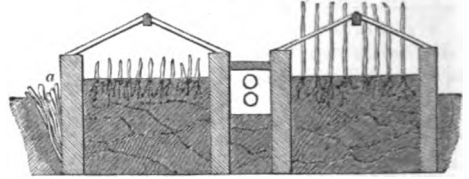


pots being suspended from the rafters by wire brackets, hooked on so that they can be entirely removed. The operations of culture are chiefly carried on within, which is a great advantage over the last example; as is also the angle of elevation being higher, and better adapted to the season when strawberry forcing is carried on. During summer this pit may be advantageously used for ripening tomatos, Chilies, cucumbers, and melons, in pots,

&c. The ventilation is not shown in the section. It may, however, be understood as being effected through the front parapet and top of the back wall.

*Asparagus pits.*—In the royal gardens at Frogmore, asparagus is cultivated during winter in pits constructed as in the annexed wood-cut, fig. 639. This, al-

Fig. 639.



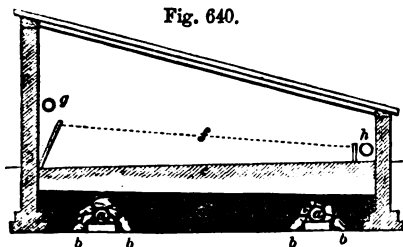
though not exactly a new system, has merits deserving of imitation, and may be much improved by a very slight alteration. In the royal gardens, permanent beds are formed within pigeon-holed side walls. Between the pits are placed hot-water pipes, in an open chamber, covered with thick boarding to walk upon and keep down the heat. The heat is thrown into the atmosphere of the pits through the openings in the brick-work, and slightly into the bed by the same means. The pits are covered with a ridged roofing of boards, which are opened in mild weather to give colour to the grass, and are removed when the crop is being cut. Sea-kale roots are taken from the quarters and planted close by the sides of the pits *a* without, where no hot-water pipes are.

*Improved asparagus-pit.*—We do not think the Frogmore pits by any means the best calculated for the end in view, as the heat applied must be both ineffective and attended with considerable waste. We would suggest, as an improvement on these, chambering the bottoms of the pits, and placing hot-water pipes in them, resting on piers of bricks 12 inches high, laying the floor of the chamber over the depth of 9 inches with charred sawdust, as a non-conductor of heat, to prevent its waste by absorption in the soil beneath. To prevent the loss of heat by the side walls of the chamber, we would also cut off conduction by building the walls, which support the pavement on which the soil beds are formed, 6 inches distant from the side walls of the pit. Earthenware or metallic pipes should be set ver-

tically, communicating with the chamber below, and provided with proper stoppers to allow heat to ascend into the atmosphere of the pits. These may be placed in two rows along the pit, at the distance of 6 feet apart, as the heat passing through their sides, even when their orifices are stopped, would greatly tend to heat the soil in the beds, and not materially interfere with the roots of the plants.

The pits should be provided with portable rafters and glazed sashes, on the span-roofed principle, leaving the wall-plates, which should be of cast-iron, to remain permanently on the walls for their protection. Wooden shutters are nearly now as expensive as glass sashes. The advantages of the latter over the former are very great; and it is the more advisable that these should be used, as they would only be required for that set of pits which was to be forced during the current season; and as that season is of short duration, they could be usefully employed for other purposes. We think that, by such a mode of heating, a more certain result might be expected; and as the water, after the forcing season had passed, could be withdrawn, by allowing the boiler to discharge itself into a drain, the pipes would last for years in a working state. The depth of soil we would allow for the roots of the asparagus would be 2 feet; but that should be of the most fertile description possible, aided, during the growing season, by copious waterings of highly enriched liquid manure.

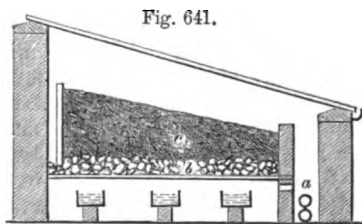
*Trentham melon and pine pits, fig. 640.*—Pits upon the principle here exhibited



exist to a large extent in the gardens at Trentham, and, under the very judicious management of their inventor, Mr Fleming, have been found admirably suited to the culture of both melons and pines. Atmospheric heat is secured by a 4-inch hot-water pipe, which traverses the whole

length at the level *g*, returning along the front at *h*, when it descends below the level of the soil, and makes a second circuit through the pipes *a a*. These latter pipes are embedded in a mass of stones *b b*, and rough gravel, which abstract the heat from the pipes, and diffuse it through a bed of leaves *d*, over which the soil *e* for the plants to grow in is placed. When melons are grown, the trellis *f* is used; when pines are planted out, this trellis is dispensed with. Mr Fleming prefers hot-water pipes for bottom heat to either tanks or open gutters: the latter, he thinks, tends to render the soil much too damp for healthy vegetation; and he depends upon surface-watering for keeping the mould in a proper state of humidity. These pits recommend themselves on account of their simplicity and economy, not only in their first erection, but in working them afterwards; and if we are to measure their fitness for the purpose intended by the extraordinary success which has been exemplified at Trentham as regards the culture of both pines and melons in them, then would we say that such pits rank amongst the very best of their kind. By the use of such pits we at once get rid of the greatest nuisance that can exist in a garden, as well as prevent an unnecessary waste of fertilising material in the shape of stable manure.

*Glendinning's melon-pit, fig. 641.* The intelligent designer of this pit was im-



pressed with the idea that melon culture was long defective, in so far as there were difficulties in supplying moisture to the bottom of the beds, particularly those heated by hot water, whether in close pipes or open tanks. In the annexed sketch, "the gutters of water are confined in the chamber beneath; and when steam is required in the pit, valves are provided at *a*, by which it is allowed to escape into the pit amongst the plants. The soil

in which the melons are planted is supported in its position by strong slate, which completely shuts out all moisture escaping from the gutters, unless when the valves are intentionally opened. Immediately on the slates is laid a layer of brick-bats or flints, at *b*, and over this some turfy loam. Communicating with the rubble are small tubes, through which the water can be poured when any doubt arises as to the roots of the melons suffering from dryness. The water thus applied spreads itself over the surface of the slate, producing that

moisture so congenial to the roots, and which forms in this mode of culture so desirable an attainment, particularly as the roots are only supplied with the proper amount of moisture to maintain the plants in luxuriance and health; and that this moisture can be withheld, when the period arrives that a cessation of the supply of all fluids is desirable, to promote the ripening of the fruit."—*Gard. Chron.*

Fig. 642 is a section of one of several very excellent pits, or rather low greenhouses, in the royal gardens at Frogmore. Each divi-

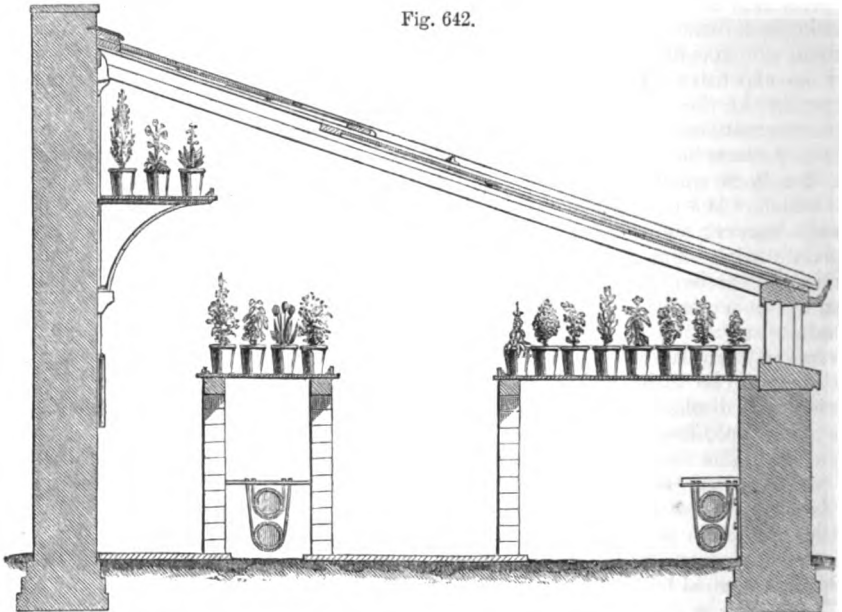


Fig. 642.

sion is 8 feet in height, and 13½ feet wide. The plants are arranged on slate tables, laid over brick chambers, in which the hot-water pipes are placed, by which arrangement a fine genial heat is afforded to the roots of the plants. These houses are intended for the culture, propagation, and flowering of plants. The advantage of their construction and arrangement will therefore be obvious.

A passage runs along the centre, and another of narrower dimensions along the back wall, over which is placed a broad slate shelf supported on iron brackets, and on which are placed the smaller plants, and such as require to be placed nearest to the glass. This shelf, as well as the slate tables, is furnished at the side with a very neat beading of slate, which

prevents the water spilt in watering from dropping on the footpaths. They also answer another important end, namely, being capable of holding water. The cultivator has it in his power to command any degree of humidity in the atmosphere he chooses, or of allowing the plants to supply themselves with water at their roots. Provision is also made by which this water may be withdrawn when a drier atmosphere is deemed necessary. The plants are arranged as will be seen by our fig., so that they all equally enjoy the full influence of the light, and are nowhere too far from the glass. Ventilation is effected by the top lights sliding down, and graduated to any extent of opening by weights and pulleys suspended along the back wall. The front upright sashes are also

made to open. The hot-water pipes are supported upon suspended brackets, a mode very generally adopted at Frogmore, which has the advantage of their being less likely to get out of level than if laid upon piers, which, on soft foundations, are apt to sink. Being suspended as here shown, the pipes lose none of their heat by abstraction, but give it out from all parts of their surface by radiation. The floors are laid with polished pavement. For cultural purposes no houses on the lean-to principle are better adapted, and the healthy condition of the plants gives efficient evidence of this.

Ridge-and-furrow roofs were first employed by Sir Joseph Paxton for roofing pits.

Of the correctness of the idea there can be no doubt. The annexed diagrams will explain his views, which are given in answer to a correspondent in "The Gardeners' Chronicle." He says, "The best method of building pits is to construct them of 9-inch brick on bed; and the best

mode of heating them is by Roger's conical boiler." In the case of a pit 78 feet long and 7 feet wide, he advises as follows:—"Cover the pit with a ridge-and-furrow roof, making the space from the ground in front of the pit to the valley-rafter 3 feet 6 inches, and the back

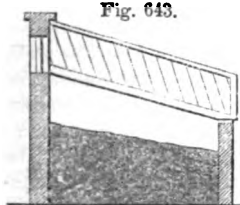


Fig. 643.

growing the different sorts of plants, by 4½-inch brick-on-bed walls. Divide the whole length of the ridge-and-furrow roof into 12 bays, having a ventilation in the angle of each pediment, as at *d d d*, fig. 644. Now, to get to the plants, each light is hinged at the valley-rafter, and fastened with a thumb button at the

ridge-rafter. By referring to fig. 644, it will be seen that the light or frame

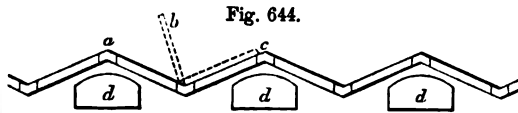
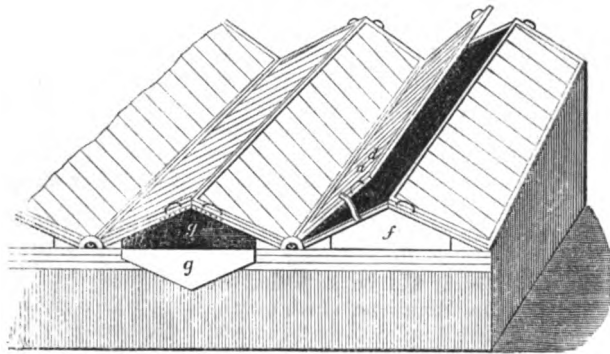


Fig. 644.

leaves the ridge rafter at *a*, in the direction of *b*, and lies flat upon the next light at *c*. Each light may be opened in this way, so that a workman may get to any part of the pit."

A pit upon this construction was erected in 1842 by John Allcard, Esq., of Stratford Green, well known for his enthusiastic love of plants. A description of it, with the annexed illustrations, is

Fig. 645.



wall below the rafter 5 feet 6 inches. See section across the pit," fig. 643.—

"Divide the whole length into four compartments for

published in "The Gardeners' Chronicle." "Each ridge is formed of two lights resting on the top sides, where they open against each other, and secured on the lower sides by hinges; so that when it is necessary to give air, or to work in the interior of the pit, they can be tilted to any required height, or be thrown back like the leaves of a book, against the ridges on either side. In wet weather these top lights can be kept quite closed, as abundance of air can be admitted both at the back and front of the pit by means of triangular ventilators situated immediately under each ridge. All the water which falls on the pit is carried off in gutters formed in the rafters, upon which the lower sides of the ridges rest." The dimensions of Mr Allcard's pit are 40 feet long, 9½ wide, and 5¼ feet deep at the back, and 4 feet in front. The following description refers to the figures annexed: "Fig. 645, *a*, represents a light open, with the iron stay pierced with holes to regu-



late the opening, and to which the lights are secured by a bolt, which can easily be removed; *f* wooden ventilator, closed;

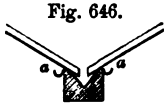


Fig. 646.

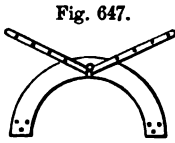
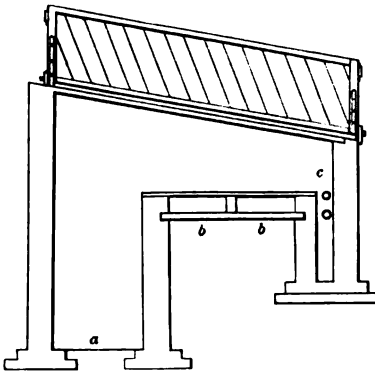


Fig. 647.

*g* the same, open. Fig. 646 is plan of rafter, under each pair of lights, with a concave centre to carry off the water, and small gutters, *a a*, on each side of the rafter, to carry off water caused by condensation. Fig. 647, plan of hinge."

Behind Mr Allcard's pit is a small pit for alpine plants, which we think rather an objection, and have, therefore, omitted it in our figure, because, as his pit is arranged, many of the operations of culture are performed from without; consequently the pit behind must be in the way of the operator, and must prevent his reaching the plants standing at the back part of the pit. In Mr Allcard's pit, melons and cucumbers are cultivated during summer upon beds of fermenting material; and in winter a boarded flooring is placed in it, upon which are set plants to be preserved till spring. By referring to our section, fig. 648, it will be seen that we have made some alterations, which may be perhaps considered improvements; at least they represent such an arrangement as we would adopt for ourselves. We have provided head room along the back of the pit by sinking a narrow passage, (*a* in fig. 648;) and instead of employing fermenting

Fig. 648.

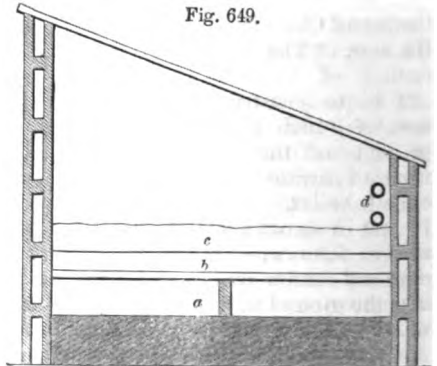


materials, we have introduced a tank, *b b*, for bottom heat, and two 3-inch hot-water pipes, *c*, between the tank and the front

wall for atmospheric heat, to be used together with the tank or not according to circumstances—that is, according as a dry or moist heat is required. Under the tank, sea-kale or rhubarb may be forced, or mushrooms grown, as in the Dalkeith pits. Such pits, upon the whole, we consider excellent; but with the ample provision which can be made in the back and front walls for ventilation, we would prefer to have the whole roof fixed, excepting the openings in the pediments, as being more economical in the erection, and less liable to accidents and leakage. With the convenience of having a passage within, we would increase the breadth by the extent of the width of the passage, which could be done at very little additional expense, and would afford much more accommodation. However, where there is no access required to the interior, the breadth of Mr Allcard's pit is quite sufficient, and the movable roof may also be retained.

*Pine or melon pit.*—Fig. 649—a very useful pine or melon pit may be constructed

Fig. 649.



upon the following principle:—The walls are built hollow, to prevent the escape of heat; and may be either partly underground or above it, according to circumstances and the dryness of the soil. The bottom is to be heated by a tank *a*, extending under the whole floor of the bed, over which a stratum of drainage *b* should be placed; and over that the bed of earth *c*, if for melons, or gravel if for plunging pines in. For admitting moist heat from the tank into the pit above, iron or earthenware tubes should be set upright, communicating with the tank below and the pit above. These tubes are to be

provided with stoppers for the regulation of the heat. Similar tubes should communicate between the drainage and the surface, for the purpose of applying water to the roots of the plants.

This pit, although all that is required where bottom heat only is needed, is deficient as regards the providing sufficient atmospheric heat—as all pits are where dependence is placed on the tanks alone. Sufficiency of heat may indeed be obtained from these, if they are allowed freely to communicate with the air in the pit; but this heat is so charged with humidity, that plants would soon be destroyed by an excess of it.

To render this pit, therefore, efficient during winter, and to counteract the effects of damp even in summer, a flow and return pipe of 2 inches in diameter *d*, should be placed along the front, and its ends connected with the boiler, but not with the tank; so that it can be wrought when the circulation in the tank is shut off by a stopcock, or by plugging up the pipes near to the boiler.

### § 3.—CUCUMBER AND MELON HOUSES.

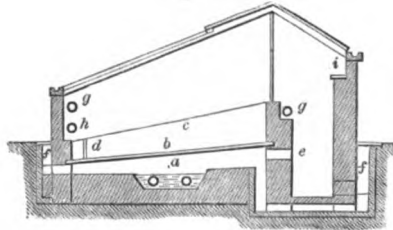
The melon and the cucumber have for ages been cultivated upon the primitive principle of dung-beds, and within the narrow compass of a three-light frame. Some have extended their accommodation to a pit of somewhat greater length, but in few cases increased in breadth. If economy can be attributed to this mode of production, it must certainly be limited to the original expense in the construction, and not to the annual waste of manure, labour, and the anxiety that always attends precarious and uncertain results. The fruit also has been grown in a medium the least likely to improve flavour, or secure a crop of long duration. Indeed, during the winter the production of cucumbers has been looked upon as one of the greatest feats in gardening, and he who could produce a brace of this fruit on Christmas-day was looked upon as no ordinary being, or as one deeply skilled in garden craft.

That both of these fruits can be produced in greater abundance, with greater certainty, and of better quality, in well-ventilated houses, and where the fruit

can be grown suspended from the roof, and on all sides exposed to the sun and air, has been of late years abundantly proved. The first attempt at producing cucumbers in houses dedicated to their sole production, we believe, occurred at Knowlesly, near Liverpool, so early as the beginning of the present century. Few followed the example till of late years, notwithstanding the results shown by the late T. A. Knight and others. Times, however, are so far changed that cucumber-houses are not unfrequently met with; and we see no reason why the lovers of melons should not have their melon-houses as well as their vinerias and peach-houses.

Fig. 650 may be offered as a very useful structure for this purpose. The gut-

Fig. 650.



ter *a* is heated by a flow and return pipe, and the water in the gutter supplied by a small leaden pipe from the cistern placed at one end of the house, in the corner of the bed next the door. The water is withdrawn when a drier atmosphere is required, by a similar pipe leading into an underground tank without the house. Bottom heat is supplied by the gutter and lower pipes passing up through the pavement *b*, into the bed *c*, in which the plants are grown. Tubes are let through the pavement along the front *d*, to admit heated air, or rather to produce a circulation of air in conjunction with the openings *e* in the parapet-wall behind. Fresh supplies of air are admitted into the vault, in which the gutter *a* is placed, by the air-drains *f, f*, at back and front. The orifices of all these tubes and openings are to be furnished with proper revolving brass ventilators, for the complete exclusion of air at any one or all of them, as may be deemed necessary. With such a command of lower ventilation, a constant agitation

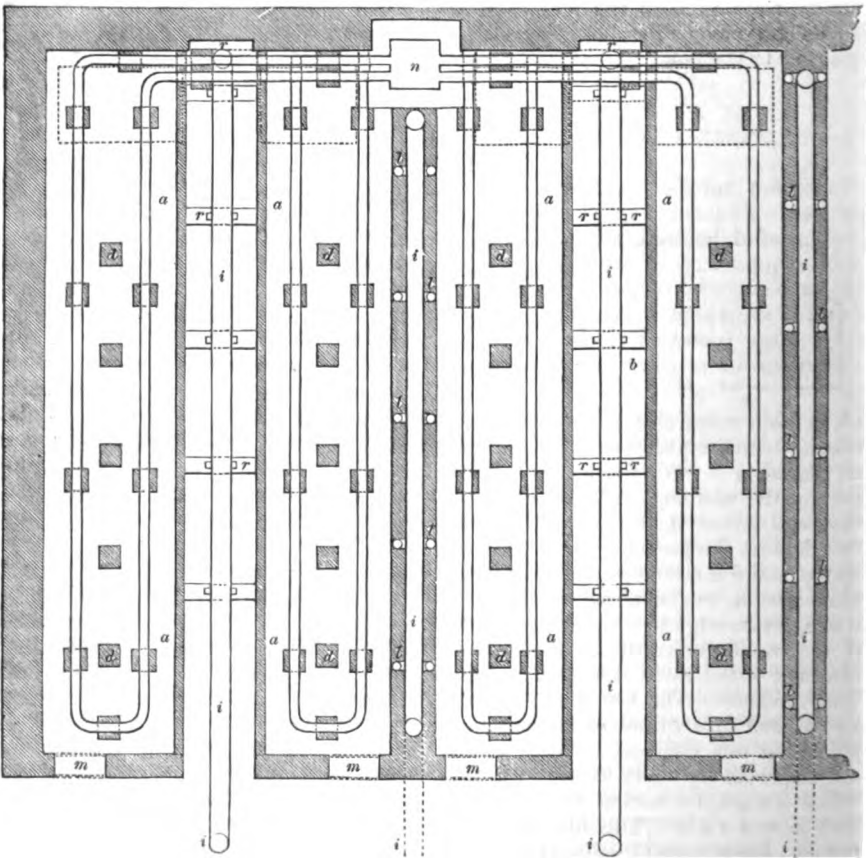
would be kept up within the pit in every part, and that motion would be increased as the temperature is elevated, and the supply of cold air increased. Atmospheric heat is obtained by the two flow-pipes *g g*, and single return-pipe *h*, connected together by a square box placed at any convenient part of the end of the house farthest from the boiler. The openings of these three pipes being in the box, any of them may be plugged to stop the circulation in it when required. With such an internal circulation, little top ventilation, beyond that of the escape of the impure air through the laps of the glass, will be required. As the top sashes along the front are movable, these may be opened, or those over the passage, whichever is most convenient. A shelf, *i*, is placed along the back wall, on which French beans may be cultivated. The bottom of the

roof, both at back and front, is provided with cast-iron gutters for collecting the rain water for the use of the house, as well as for keeping the walls dry. The rain water should be conducted to the cistern already noticed, and an overflow-pipe led from it to an underground tank either under the floor of the vault, or outside the house, as may be most convenient; or the water, as it is collected at some height above the ground-level, may be led into a tank above the surface, or otherwise disposed of; but by no means should it be wasted by being carried into a drain.

For a very excellent cucumber-house, *vide* Mr Moore's, fig. 359, in chapter VENTILATION.

In such a house as that described above, the cucumber vines are to be trained to a trellis covering the whole roof,

Fig. 651.

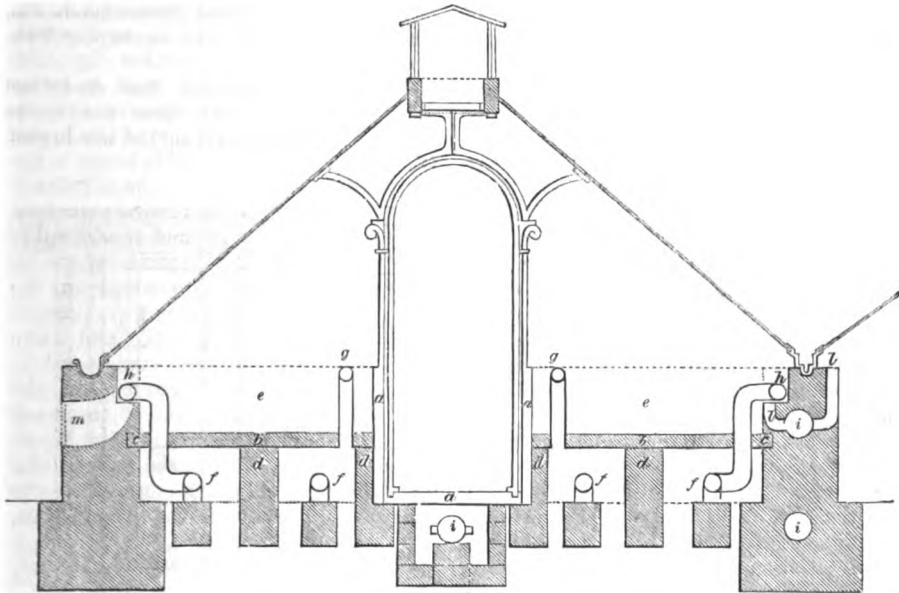


and 12 inches distant from it. By a slight alteration in admitting the cold air at front, and by narrowing the bed in which the plants grow, which could well be afforded, a passage 2½ feet wide might be made along the front and ends, which would greatly facilitate the operations of culture. Again, the whole of the surface under the bed might be formed into a tank 4 inches deep, and thus a much greater amount of heat be secured than is given out by the two pipes and water gutter. In this case, however, a separate

boiler would be required for the tank, it being so much lower than the hot-water pipes.

The cucumber and melon houses erected by us at Poltalloch will be understood by a glance at the annexed ground-plan and section, figs. 651 and 652. These houses are identical in size and arrangements. They are both heated by one boiler, *n*, placed at the end of the wall which separates them, and supplying both top and bottom heat. The pipes branch off from the boiler to the right hand and to the

Fig. 652.



left, in both cases circulating under the beds in which the plants are grown. They are placed in a vault formed, as will be seen by the section, of Caithness pavement, *a*, 2 inches thick, and polished on the side next the passage, as well as along the top, and 6 inches down the inner side, which is as far as the surface of the stone is seen, set on edge to form the two sides of the passage, and resting on the polished pavement of the same description which forms the floor. The top of the vault is also formed of Caithness pavement, *b b*, jointed but not polished, in large pieces, and supported by being let into the side walls at *c c*, and by resting on the 10-inch brick piers *d d d d*. This also forms the bottom of the beds of soil *e e*, in which

the melons and cucumbers are planted. The hot-water pipes flow and return under the vaults, and are set clear of the floor by being placed on cast-iron chairs set upon brick piers, as shown at *ffff*: these afford bottom heat, which is regulated by allowing it, when too great, to pass upwards into the house through the 3-inch pipes *g g*. Atmospheric heat is obtained by a single flow-pipe, brought up at the ends nearest the boiler, and made to flow along the top of the side walls, as at *h h*: this pipe is connected with the pipes below, as shown by the bends in section.

The plants are trained under the glass to a wire trellis, as well as over the iron arches which support the ventilators at

the top. These ventilators have been already described. The front wall, as well as the external side one, which terminates the range, is provided with ventilators, *m m m*, 2 feet square, furnished with an ornamental iron grating externally, and internally with an opening and shutting one, upon the louvre principle already described. The subterranean ventilation is brought from the front of the terrace wall in 9-inch fire-clay tubular pipes, as shown at *i i i i*, one-half of which enter under the door sills, and pass along under the pavement passage to the farther end of the house, where their orifices come in contact with the hot-water pipes a short distance from the boiler; while the other alternate pipes, after passing through the front wall under the 20-inch hollow partition-wall, proceed in a like direction. It will readily be seen that the pipes, being made to terminate at the hottest part of the house, will produce a draft in them which will require a constant supply of fresh air from without to keep up the circulation, and that fresh supply of colder and heavier air will cause a diffusion at the warmer parts, equalising the temperature, replenishing the internal atmosphere, and keeping up a constant motion in the air of the house—a matter of great importance to all plants.

The air, as it travels along the tubes under the pavement footpaths, has means of escape at equal distances, through nozzles cast on the sides of the conducting pipes. From these it passes upwards through ornamental cast-iron gratings let into the pavement at *r r*, &c. These gratings extend the whole breadth of the passage, and are 6 inches broad.

The other air-tubes, which are laid in the hollow partition walls, have also 3-inch fire-clay tubes attached to them, *l l l*, &c., and bent so that their orifice forms a plane with the top of the partition walls, rising up on each side of the glass divisions, securing altogether as uniform a distribution of air as can well be imagined.

These pipes are opened or shut at pleasure by sliding lids, that cover them more or less, according to circumstances; and so arranged that the whole can be moved simultaneously, as already noticed.

Rain-water tanks are placed under each bed, as shown by the dotted lines on fig.

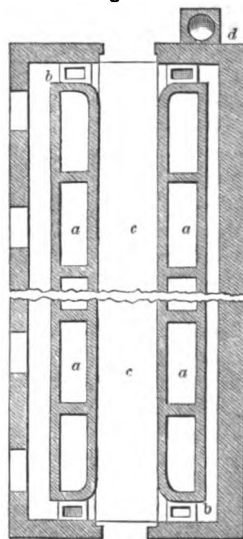
651. These are supplied from the roof, the tanks being placed level at top with the floor of the passages.

For cucumber pits, *vide* section PITS OF VARIOUS CONSTRUCTIONS, &c.

The succession and nursing pine-houses in the same establishment are in all respects the same as the above.

The melon-house at Chatsworth is thus described by Sir Joseph Paxton, in

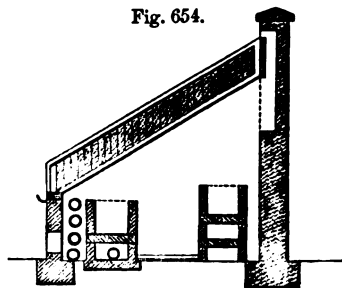
Fig. 653.



“Paxton’s Magazine of Gardening and Botany,” accompanied with cuts showing the ground-plan, fig. 653, and cross-section, fig. 654, as well as by an elevation and section of the tanks. This house is upon the ridge-and-furrow principle, and is admirably ventilated by openings in the front parapet wall, and also by corresponding openings in the top of the back wall; the front ones being under

the pediments, and the top ones above the valleys or gutters. In the ground-plan,

Fig. 654.



the different pits over the tanks are shown, *a a*, with two small cisterns at each end for cold water, as also to give access to the tanks *b b*. The footpath *c c* is a wooden trellis footpath; a form of footpath Sir Joseph appears to prefer to what we would judge to be preferable—namely, a neat cast-iron open one. The

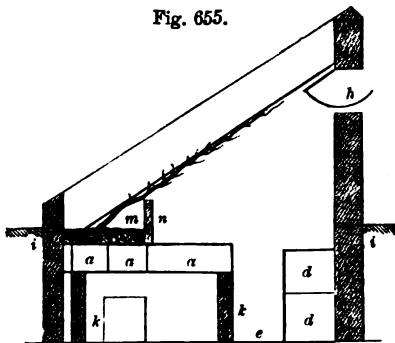
boiler *d* is placed at one end. Between the back range of tanks and the back walls, a space is left, of 4 or 5 inches, for the free circulation of air; and between the front tanks and front wall there is a space of 12 inches, to admit of the free circulation of air from the ventilators, shown by the openings in the front wall, and to make room for the hot-water pipes shown in the section. The width of the house inside in the clear is 10 feet: the length may be regulated by the supply required. The foot-paths are constructed of larch boards  $4\frac{1}{2}$  inches wide by 2 inches thick, a quarter of an inch apart, resting on sleepers 4 by 5 inches, supported by brick piers. The house is built against a garden wall, and the front and end walls are 9 inches brickwork; while the walls of the pit within are  $4\frac{1}{2}$  inches, or brick on bed, plastered, with a wooden coping on top. The transverse section shows the tanks, pipes, pathways, pits, and the space for ventilation in the back wall. The angle of the rafter is  $32^\circ$  to the plating. The platings are 6 inches by 3 inches; the rafters—*i. e.*, ridges and valleys—are  $5\frac{1}{2}$  by 3 inches; and the bars or astragals are  $1\frac{1}{2}$  deep. The ventilation is thus described:—"In each bay of the roof there is a ventilator, raking at the top parallel to the pediments, and about 2 feet 9 inches wide, and 3 feet in length. These ventilators inside communicate with the vacuity in the back wall, as shown in the section; they are made to slide up and down a wooden frame fixed to the wall, and are balanced by a line, pulley, and weight, so that they may be set to any point required. A wooden trellis is fixed to the back wall, to which the plants are trained. It will be seen by the section that the back tank at the back part of the house is at a higher level than that in front: this is in order that the flow-pipes from the top of the boiler may descend from the back tank, pass under the pathway, and proceed along the front tank as a return-pipe to the boiler. The four pipes shown in front are the flow and return pipes from and to the boiler.

This is, upon the whole, one of the best melon-houses we have seen, and is, of course, especially well adapted to the forcing of cucumbers also. The whole

is glazed with sheet-glass, and has a very elegant appearance.

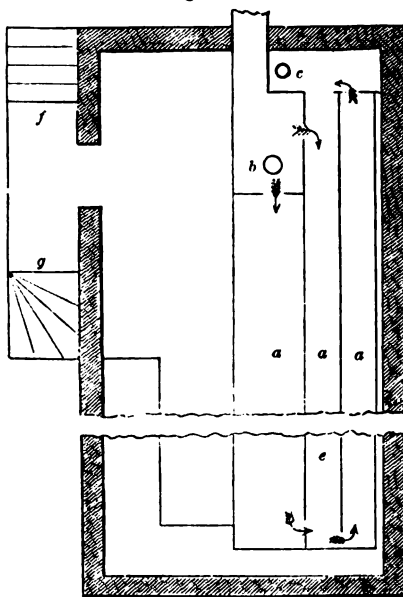
*Davidson's cucumber-house.*—Of the cucumber-house erected by Mr Davidson at Stackpool Court, the annexed diagrams, figs. 655 and 656, section, are illustrations;

Fig. 655.



and although erected by him without any previous knowledge of the tank-

Fig. 656.



heating system, it possesses merits not in all cases excelled even at the present day.

Reference to the plans:—*a*, hot-water tanks; *b*, flow-pipe; *c*, return-pipe, which cannot be seen in the section; *d*, flue; *e*, pathway; *f*, steps to house; *g*, steps to stoke-hole; *k*, ventilators; *t*, level of

ground outside; *k*, brick supports on which the flag tanks rest; *l*, drainage and soil for plants; *m*, brick wall, forming outer edge of bed.

In this case the bottoms of the tanks are made of pavement, the sides of bricks in cement, and the covering slate cemented down. The boiler is placed under the end of the tank, and is 2 feet deep, and 1 foot in diameter. The smoke-flue is carried along under the tanks, and makes two turns along the back wall. One peculiarity in this house is, that parallel with the flow and return tank is a third and broader one, uncovered with soil, for the purpose of giving atmospheric heat, in conjunction with, or independent of, the other two—the regulation being effected by a slider in the end of the third tank. The brick-on-edge wall, to keep up the soil at the front of the bed, is built so that 1-inch spaces are left between the bricks for the better draining of the bed.

Cucumber-houses and pits have in general had their roofs placed at much too low an angle. The first, we believe, who directed attention to this matter was Mr W. P. Ayres, in his excellent treatise on the cultivation of this plant. "Cucumber pits and frames," he observes, "have the sashes generally placed at an angle of  $15^{\circ}$  or  $16^{\circ}$ , too low to obtain the full solar power in June, when the sun is at his highest altitude;  $60^{\circ}$ , too low for December; and  $36^{\circ}$ , too low for March and September." Alive to these defects, this intelligent cultivator constructed his house to obtain a maximum of solar influence in mid-winter, at the very period at which, for this purpose, it is most required. "To obtain the perpendicular rays of the sun in December, it would be necessary, in latitude  $53^{\circ}$ , to place the glass at an angle of  $75^{\circ} 28'$ ; in January,  $71^{\circ} 52'$ ; in February,  $62^{\circ} 29'$ ; and in March,  $51^{\circ} 41'$ ." As the influence of the sun is very slight from the autumnal to the vernal equinox, Mr Ayres prefers securing the perpendicular rays in March and September, and therefore constructs his roof to an angle of  $51^{\circ}$ . The following diagram, fig. 657, will show the construction of his house:—"a is the tan-bed in which the pots containing the plants are placed; *b* is the trellis to which the plants are trained; *c* is the pathway,

under which is a flue, with the pipe of an Arnott stove passing through it; and *d* is

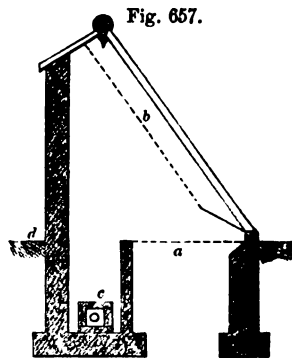


Fig. 657.

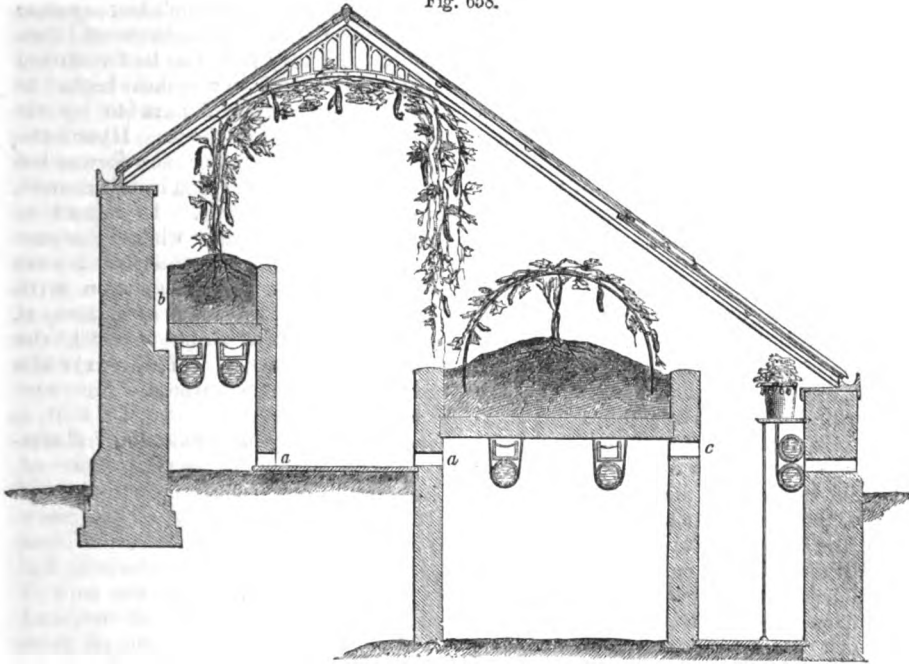
the ground-line." With the exception of Arnott's stove, of which, together with all other hot-air stoves, we have a perfect horror, this is an excellent house for the purpose, and if

heated with hot water, would be perfection itself. The fig. is taken from Mr Ayres's book, of which every cucumber-grower should be possessed.

Fig. 658 shows the cross section of the cucumber-house in the royal gardens at Frogmore. In external appearance, if we except the front upright sashes, they somewhat resemble the vinerias last erected in the same establishment, fig. 427. The internal arrangements, as will be seen by our figure, are different, and exceedingly well adapted for the purpose for which they are intended. The beds of compost in which the plants are set are placed over chambers most efficiently heated by hot-water pipes, having open gutters or troughs cast on their upper sides, by means of which dry or moist heat can be employed when either is thought most desirable. One peculiarity in the manner of arranging the pipes seems to prevail very generally in these gardens—namely, suspending them from above, instead of supporting them from below, as is usually done. This, no doubt, admits of a freer radiation of heat from their whole surfaces, than if they were supported as in ordinary cases. A passage divides the house into two ranges of borders; the plants set in the one next the back wall are trained up to about the middle of the back part of the semi-span roof, and thence upwards over the very tasteful iron trussing which ties the front and back parts of the roof together. The plants in the front or principal bed are trained over a semi-circular trellis, and shoots from it may be carried up the iron supports which

strengthen the roof. Both borders are supported on brick walls, which also form the sides of the beds, while the bottom is supported on pavement, in which provision is made for the necessary drainage of the compost. Along the

Fig. 658.

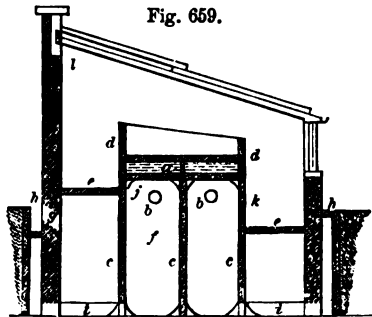


front is placed a neat stone shelf, supported on iron columns, under which a flow and return pipe is placed; and upon this shelf, strawberries, French beans, &c. are grown. The floors of the passages, like all those in these gardens, are paved with stone pavement. Ventilation is carefully provided for by opening the roof sashes at top, the cold air descending to the back passage at *b*, entering through apertures formed, by using air-bricks, in the side walls of the pits at *a a*, and circulating completely through, under, and around them, and escaping at *c*. Ventilators are placed in the front wall at regular distances opposite the two front hot-water pipes. These houses are 72 feet 6 inches in length, 17 feet in breadth, and 8 feet 3 inches in height from passage to under side of ridge. These dimensions will serve as a scale to the other parts. Upon the whole, these are the most complete cucumber-houses we have seen.

In all hothouses there is a want of ventilation near the floor; and until means are devised to remedy this, purity of

atmosphere within cannot be looked for. This defect is most obvious in melon and cucumber houses, pine-stoves, &c., where a great portion of the floor is occupied with tan or other beds, below and around which no circulation of air takes place. The annexed figure, 659, will show how

Fig. 659.



the circulation throughout all parts of a house or pit may be effected. The tank *a* is elevated upon cast-iron pillars, and is, with the sides and ends of the bed *d d*, all formed of plates of cast-iron. The



division of the tank, it will be observed, is placed just above the centre line of the columns of support, and takes the bearing of the top of the tank, which is also the bottom of the bed, and thus affords stability and strength. The iron columns *c c c* are placed 3 feet apart. Both divisions of the tank act as flows; the return of the water is made through the pipes *b b*. *e e* is a grating footpath extending all round the pit; and through it, as well as from between the supporting pillars at *k*, light and air are admitted into the vault *f* below, as also through the openings at *g* and *h h*. The two latter are shown as shut by a contrivance for regulating the admission of atmospheric air from without. These openings, which extend all along the front and back, acting as blind areas, are 9 inches wide, thus keeping the walls under the surface dry, and admitting air into the bottom of the vault through the drains *i i*. Atmospheric ventilation is effected by the usual opening of the front lights and wall ventilators near the top of the back wall.

With such a command of ventilation from below, the front lights need never be opened. We are not aware that such a house has ever been constructed, but we are preparing plans at present for a house of this kind, for the purpose of growing melons, the plants to be planted in the bed over the tanks, and trained over the roof in the manner of vines. The great degree of humidity, accompanied with a high temperature, required in melon and cucumber houses, calls loudly for a principle of ventilation for the maintenance of a healthy atmosphere, which, we doubt not, will be secured by following out the principle here explained.

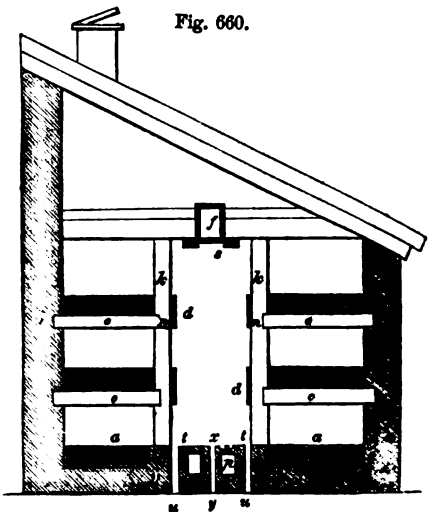
#### § 4.—MUSHROOM-HOUSES.

Although the cultivation of the mushroom has long been practised in Britain, it must be acknowledged that, up to the year 1815, when Oldacre introduced the German mushroom-house and mode of cultivation, it was carried on in a very slovenly, if not a very uncertain manner.

In construction, the mushroom-house should be made sufficiently large, as it

will be found the most suitable place for forcing rhubarb, sea-kale, chicory, &c., in winter, not only securing a constant succession of these invaluable winter vegetables, but doing so at much less expense and trouble than the modes in general use. Lily of the Valley may also be forwarded in it until the flower spikes begin to appear, when they will have to be removed to a lighter abode. Hyacinths and all other bulbs may be also forwarded by being plunged overhead in leaf mould, or other light covering. In regard to situation, it matters little what the aspect be; and hence it is generally made part of the arrangement in connection with the offices behind the range of hothouses, or in cellars under them. Indeed, the latter, if not too damp, is of all others the best situation for the purpose.

The German mushroom-house, fig. 660, is thus described by Mr Oldacre in "Horti-



cultural Society's Transactions," vol. ii. :—  
 "The outside walls should be  $8\frac{1}{2}$  feet high for four heights of beds, and  $6\frac{1}{2}$  feet for three heights, and 10 feet wide inside the walls. This is the most convenient width, as it admits of a set of shelves  $3\frac{1}{2}$  feet wide on each side, and affords a space through the middle of the house 3 feet wide for a double flue and a walk upon it." Hot-water pipes were not in use when this house was erected. "The walls should be 9 inches thick, and the length of the house as may be judged necessary. When the outside of the house is built,

place a ceiling over it (as high as the top of the walls) of boards 1 inch thick, and plaster it on the upper side with road sand, well wrought together, 1 inch thick, (this will be found superior to lime,) leaving square trunks, *f*, in the ceiling 9 inches in width, up the middle of the house, at 6 feet distance from each other, with slides *s* under them, to admit and take off air when necessary. This being done, erect two single-brick walls, *v v*, each five bricks high, at the distance of  $5\frac{1}{2}$  feet from the outside walls, to hold up the sides of the lower beds *a a*, and form one side of the air-flue *t u t u*, leaving 3 feet up the middle, *t x t*, of the house for the floor. Upon these walls, *v v*, lay planks, *t u*,  $4\frac{1}{2}$  inches wide and 3 inches thick, in which to mortise the standards *t k* which support the shelves. These standards should be  $3\frac{1}{2}$  inches square, and placed 4 feet 6 inches asunder, and fastened at the top through the ceiling. When the standards are set up, fix the cross-bearers, *i n i n*, that are to support the shelves *o o*, mortising one end of each into the standards *n*, the other into the walls *i*. The first set of bearers should be 2 feet from the floor, and each succeeding set 2 feet from that below it. Having thus fixed the uprights, *t k*, and bearers, *i n*, at such a height as the building will admit, proceed to form the shelves, *o o*, with boards  $1\frac{1}{2}$  inches thick, observing to place a board, *d d*, 8 inches broad and 1 inch thick, in the front of each shelf, to support the front of the beds. Fasten this board on the outside of the standards, that the width of the beds may not be diminished. The shelves being complete, the next thing to be done is the construction of the flue, (*p* in section) which should commence at the end of the house next to the door, run parallel to the shelves all the length of the house, and return back to the fireplace, where the chimney should be built, the sides of the flue inside to be of the height of 4 bricks laid flatways, and 6 inches wide, which will make the width of the flues 15 inches from outside to outside, and leave a cavity (*t u*) on each side betwixt the flue and the walls that are under the shelves, and one (*x y*) up the middle, betwixt the flues, 2 inches wide, to admit the heat into the house from the sides of the flues."

A humid atmosphere appears, from all

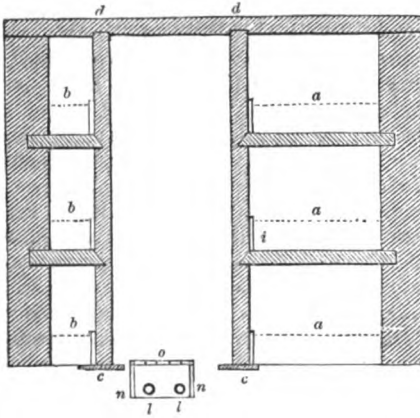
we see in nature, as well as from experience in artificial culture, to be exceedingly favourable to the production of mushroom-rooms. The flues, therefore, of such a house as we have been describing, should be covered with hollowed tiles, and these frequently supplied with water, that a genial and warm steam may be produced, or evaporating pans may be set upon them.

We give this lengthened description because the principle of the house is good. Modern improvements have, however, been added, of which the heating by hot water is not the least important. Slate and stone shelves have also been substituted for the wooden ones, answering the same purpose, with the advantage of being more durable. Iron uprights and cross-bearers have also taken the place of wooden ones, and more durable ceilings have been adopted, some of which are arched over in brick—as that of Patrick's, afterwards to be described. Asphalt, slate, and even pavement, have also been used for the ceiling. From the humidity, and want of free circulation of air, mushroom houses are more liable to decay than any other horticultural building; hence the necessity for using material less perishable than wood. In the Royal Gardens at Frogmore, that of Trentham, and elsewhere, slate shelving is used: it is not only more durable, but more elegant, and occupies less space. Indeed, there is no reason why iron shelves should not be used altogether; but in either case the bottoms should be perforated with abundance of holes, to prevent the beds becoming at any time too damp. Mushroom shelves of pavement supported on brick piers, and arches of brick thrown very flat, and levelled on the top, are now common: the only objection to these is the space taken up with the material. On the whole there is nothing better, cheaper, or more durable than iron uprights and bearers, with either thin pavement or thick slate for shelving.

*Sellers' mushroom-house.*—This house is thus described in "The Gardeners' Chronicle," 1841, p. 277. Fig. 661 "represents a section of the interior of the house, with three beds of mushrooms, *a a a*, 18 feet long, and 3 feet wide; and three shelves for forcing rhubarb, *b b b*, 1 foot 3 inches wide: if circumstances permit, these

shelves may be made wider, and used for mushrooms. Stones are placed on each side of the passage, at *c c*, for the standards

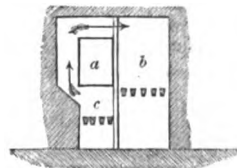
Fig. 661.



to be placed on that support the bearers of the shelves, and which are mortised at *d d*. The stones should be about 6 inches square on the surface, and 3 inches thick, and the standards about  $3\frac{1}{2}$  inches square." The standards and cross-bearers are fitted up in the usual manner, as will be seen by a glance at the diagram. "When the standards and cross-bearers are fixed, the shelves may be formed by laying along the latter boards  $1\frac{1}{4}$ -inch thick; and it will be convenient, when removing or putting fresh dung in, if a board 8 inches broad and 1 inch thick is placed behind the standard at *i*, or cut so as to come flush with it. When the shelves are fixed, a trench 9 inches deep is made in the passage *l l*, for the reception of the hot-water pipes; on each side this trench a brick wall, *n n*, is built, to prevent rubbish from falling in. The bottom of the trench must be puddled with clay, so that the water thrown on the pipes may not escape. The pipes used are inch-and-half bore, and they are laid in the trench 3 inches apart. A wooden trellis, *o*, is placed over them, resting on the brick walls *n n*, and forming a path. Fig 662 shows the section of the furnace for heating the pinery"—as the same fuel used for the latter heats the mushroom-house also—"and it is so constructed that the same quantity of fuel is found sufficient to keep up the temperature in both houses. When a strong fire is required

in the furnace *b*, which heats the flues in the pine-stove, it is sufficient for the

Fig. 662.



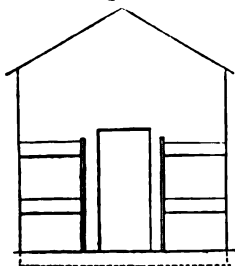
boiler *a*, which is placed on one side of it. When the weather is mild, the fire in the furnace *c* is sufficient for both purposes; but when cold weather sets in, another fire is then made *under* the boiler at *c*, which is sufficient to keep the water in the pipes in circulation. The heat from the furnace *c* passes over the left side of the boiler, and enters the flue heated by the furnace, as shown by the arrows in the sketch. A flange is placed on the flow-pipe, by which it is fixed over the top hole in the boiler *a*. This pipe runs horizontally, and is attached by an elbow to the pipes laid in the trench of the mushroom-house. The return-pipe is fixed in the boiler below the flow-pipe, and on it is screwed a tap to let out foul air when required. When the mushrooms want steaming, take a fine rose watering-pot, and sprinkle the pipes with it till the steam arises so thick that objects cannot be seen at the farther end of the house. Steaming is better than watering over-head for mushrooms, as much water destroys the spawn."

The system of heating and steaming recommended here is excellent. We think, however, that 3-inch pipes would in the end have been found better, as those of so small a calibre will soon be choked by the formation of rust and mineral deposits. The whole framework we would here, as we recommended for Oldacre's mushroom-house, have of iron; the shelving of slate or thin pavement; and were the shelves perforated thickly with holes, perhaps it would be an advantage—at least it would tend to guard against damp at the bottoms of the beds. The shelves *b b b*, which are only 1 foot 3 inches broad, are rather too narrow for holding rhubarb roots; perhaps it would be better to force the rhubarb on the ground floor. The idea of puddling under the pipes is also good, as a slight vapour will arise from it, and so keep the atmosphere of the house moderately humid.

*Hankin's mushroom-house.*—Before describing this house, it may be necessary to mention that Mr Hankin differs in his mode of culture considerably from cultivators of the mushroom in general. Instead of excluding light, and almost excluding air, he admits both to the extent of rendering his house as interesting to the visitor as any plant-house under his care, concluding, and we think with good reason, that *light* and *air*, where an equal temperature can be kept up, are as essential to the successful culture of this plant as to many others; "and that a confined atmosphere will never produce healthy and full-grown mushrooms." Another part of his management is also different from the common routine—namely, covering his beds with fresh green turf about 1½ inches in thickness, having the green side uppermost, through which the mushrooms force themselves, and assume quite their natural appearance. The grassy turf is kept in a healthy growing state, and in the mornings has all the appearance of being covered with a copious dew.

The annexed section, fig. 663, and ground-plan, fig. 664, are taken from a communication by the inventor, and published in "The Gardeners' Chronicle," 1845, p. 99:—

Fig. 663.

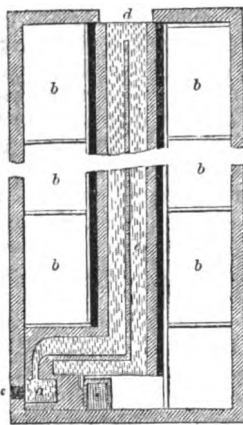


References: *a* boiler, 2 feet 1½ inches by 1 foot 9 inches; *b* boxes, 6 feet 5 inches by 3 feet 6 inches; *c* chimney; *d* door, 3 feet." This house is heated by an open brick-and-cement tank *e*, placed under the passage, and covered with an open trellis. The boiler is also open, and placed within the house. The beds on the ground-floor are sunk 9 inches under the floor-level, and are used for forcing rhubarb and sea-kale. The roof is tiled, and in it are three glazed sashes on each side for transmitting light. This house is 26 feet in length and 13 feet wide; but of course the length may be extended to any required degree. When the beds are

made up and covered with green turf,

the house must have a much more inviting appearance than those in common use. We think, however, from the height of the side walls, that another course of boxes might be placed along each side. The advantage of the boxes we do not quite clearly see. Why not use shelving, as in the

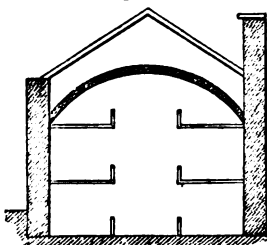
Fig. 664.



cases already noticed?

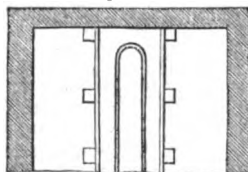
*Patrick's mushroom-house.*—The annexed diagrams, figs. 665 and 666, exhibit the mushroom-houses used at Stoke Place,

Fig. 665.



both for summer and winter use. Of course the former is not heated;—the latter is, by 4-inch hot-water pipes, which are brought from a boiler constructed to

Fig. 666.



heat, at the same time, a range of pits for pines, melons, &c., 89 feet long and 7 feet wide. The shelves are close-bottomed, to prevent the beds from drying too rapidly, and also to require less watering,

which Mr Patrick thinks a very important precaution in mushroom culture. Ventilation is effected by a slide in the door, and a wooden trunk up through the arch and roof, with a slide in it also. We do not exactly see the motive of Mr Patrick, whom we have long known and esteemed as one of the best gardeners in England, in adopting the span-roof over this house, as, from its situation behind

the garden wall, a lean-to roof would have been cheaper, and would have carried off the rain-water better. It is rather a novel, but still a good plan, to have the inner roof constructed of a brick arch, as it will of course save the outer one from decay, to which all mushroom-house roofs are liable more than any other kind of garden building. This house struck us at first sight as very complete, excepting in breadth, which we would increase to 9 feet—that is, 3 feet for the breadth of the beds on each side, and the same for the footpath, which at present is inconveniently narrow.

The mushroom-house of the Baron Joseph D'Hoogvorst, of Limmel, near Brussels, in which we have seen abundant crops, is confined to very neatly fitted up wooden cases arranged in his extensive stables, and covered in with canvass curtains, which at first sight induces one to believe them repositories of stable-furniture, rather than mushroom cases. The annexed fig., 667, will give a perfect

the creation of an unhealthy atmosphere for their horses, that such is not the result in his case. A French or Belgian stable of the first class is, however, a very different affair from most of those in this country, which are, when compared with the others, little better than close-boxes.

*Forsyth's mushroom-house.*—This intelligent cultivator has described, in the "Gardeners' Magazine," the following structure, which, he very justly remarks, has durability as one of its objects. After pointing out the false economy of growing mushrooms in beds in the open air, which requires great labour in covering and uncovering, to say nothing of the value of the materials, and showing also that mushroom beds made on wooden shelves hasten their decay, as well as that of all the wooden materials of the house, he proposes a house of the following description :—Fig. 668 "represents the ground-

Fig. 667.

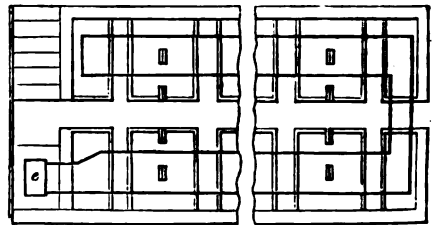
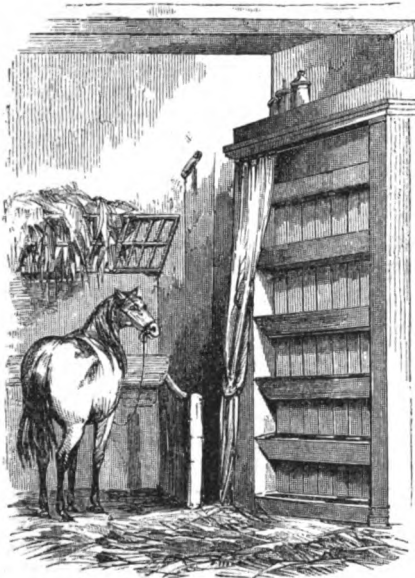
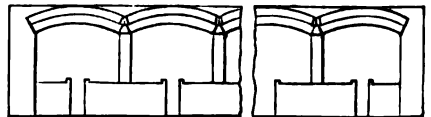


Fig. 668.

plan, which shows the size and shape of the beds and alleys, the piers for the arches, the boiler *e*, and the direction of the pipes."

Fig. 669 is a longitudinal section, showing the kirbs of the beds, and the form of the stalls and arches.

Fig. 669.



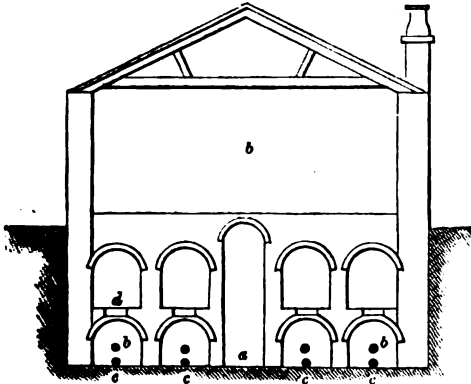
idea of their form and arrangement. Some peculiarity in the Baron's mode of culture, as will be seen by a reference to his published treatise—"Méthode nouvelle, facile, et peu couteuse, de cultiver la Champignon," will satisfy those who would dread

Fig. 670 is a transverse section, showing the arches under and over the beds, the thoroughfare *a* in the middle, and the position of the hot-water pipes *c*. *b* is an open shed and general workshop, the receptacle of everything requiring protection, too clumsy to be otherwise housed.

A shed of this description is an indispensable adjunct to every well-ordered garden, and in the present case it serves as a roof to the mushroom-house. In the centre of each vault, shown in fig. 670, a

in finely-sifted coal ashes, to preserve their roots from being frozen; that material being also, at the same time, an excellent corrector of damp, which is the greatest enemy to plants during their

Fig. 670.

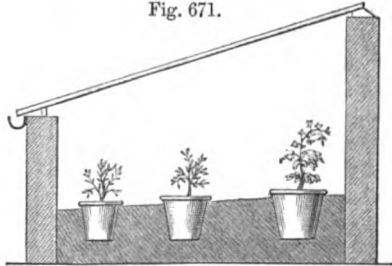


circular ventilator, *d*, 9 inches in diameter, will be made, having a stone or cast-iron stopper, with a folding ring. The boiler is placed at *e* on ground-plan; the direction of the hot-water pipes is indicated by the lines, and the whole roof of the mushroom-house is covered over with pavement, which at the same time forms the floor of the shed above. Mr Forsyth objects to cast-iron shelves "on account of the rust—and to slate shelves, as being generally cold and damp, and therefore not suitable to the purpose; but he knows of no objection to shelves built of bricks and mortar, and kirbed with hewn stone 3 inches wide, and battled together with lead." We presume, upon the same ground, that he would also object to stone shelves. For ourselves, we do not see how such could be colder or damper than bricks, in a structure kept at a moderate temperature by fire heat. The plan altogether deserves attention.

§ 5.—CONSERVATIVE PITS.

*Conservative pit with solid walls*, fig. 671. —The protection afforded by this pit during winter will be found sufficient for preserving many of what are called half-hardy plants, such as ericas, many New Holland plants, fuchsias, myrtles, and many others. The pots should be plunged

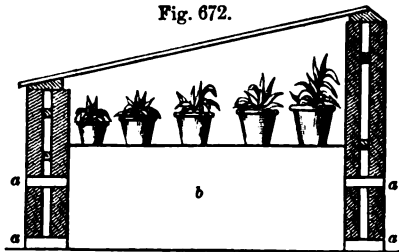
Fig. 671.



state of rest. Frost may be excluded by covering the sashes with felt or canvass shutters, and ventilation effected by tilting up the bottom and top ends of the sashes alternately. Such pits should be 6 feet wide, 3 feet 6 inches high at back, and 2 feet 6 inches in front, and the walls 9 inches in thickness.

*Conservative pit with hollow walls*, fig. 672.—This is a modification of the last,

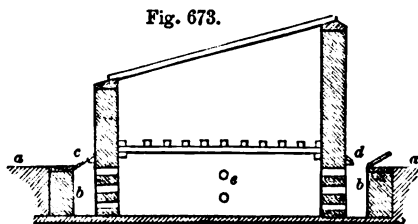
Fig. 672.



adapted for smaller plants. The walls are all above the surface, and are built hollow the more effectually to exclude the frost. The plants are set on a level trellis stage, with openings at least an inch between the bars. This stage is movable, to admit of its being lowered or elevated to suit the height of the plants. Ventilation is secured by openings along the back and front of the pit at *a a*. These are furnished with revolving brass registers, so that more or less air may be admitted according to the state of the weather. The air passes into the space *b*, and, rising through the trellis, circulates through amongst the plants, without coming directly upon them, as it would

do if admitted higher up the sides. The bottom of the pit is to be rendered perfectly dry, by having a drain run along its whole length; and the floor should be composed of 10 or 12 inches of coarse gravel or coal-ashes, to absorb the spilt water that falls from the pots while watering. The circulation of air passing over the surface of the floor will also greatly tend to keep it dry. With sufficient coverings to the glass, many plants may be wintered in such a pit, which will give room in the greenhouse for the larger and more delicate species. In section RAFTERS will be shown the kind of rafter we use in the gardens at Dalkeith for such pits—as, from their construction, we can cover the glass roofs most conveniently with asphalt felt, or wooden shutters, made exactly of the same size as the glass sashes. With such covering, we require no fire heat; and were it no other than the saving of the breakage in glass, such coverings are well worth the expense of making and of putting on. Such pits as these are invaluable to amateurs.

*Conservative pit, with bottom ventilation.*—The annexed cut, fig. 673, represents

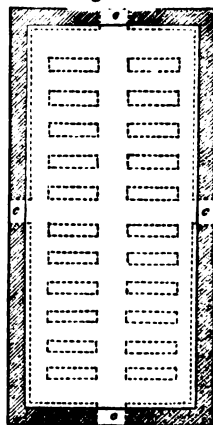


what we think would be an excellent pit for wintering bedding-out plants, young heaths, or other young greenhouse stock. Build the pit upon the pigeon-hole principle, as high as the ground-level *a a*, and above that in 9-inch brick-work. Build retaining-walls *b b*, 9 inches distant only from the side walls of the pit, similar to those where dung linings are used. Cover the spaces thus formed with thick boarding, to be shut down in cold weather to exclude the frost, as shown at *c*, and opened in mild weather, to promote a free circulation of air through the pit, as shown at *d*. The plants being set upon open trellis-work, the spilt water in the process of watering would fall down into

the bottom of the pit, which ought to be well drained and covered with coal-ashes. To render such a pit as useful and complete as possible, hot-water pipes 3 inches in diameter may be laid, as shown at *e*, to be used only in severe frosts, and when the boarded coverings are also laid down. Indeed, if sufficient covering be laid over the roof, fire heat will be seldom required. A pure and dry atmosphere should be kept up in such pits, which will secure the plants against both cold and damp. Such a pit may, with every propriety, be constructed under the surface of the ground, when the soil is quite dry and gravelly; otherwise it should stand above the ground-level, with a view to secure perfect dryness within. Wherever the soil is damp, or the situation liable to inundation, conservative pits should be elevated above the surface rather than sunk under it: that elevation may extend to the height of 2 feet, thus securing freedom from damp, and bringing the plants, particularly if small, nearer to the eye.

*Span-roofed cold pit.*—The annexed fig. 674 shows the section, and fig. 675 the

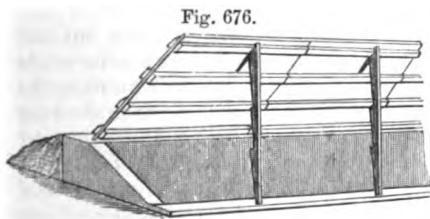
ground-plan, of a conservative pit for protecting half-hardy plants during winter. The side walls are of 9-inch brick-work, both for strength and for resisting the cold. The roof is in the span form, for convenience and light. The floor should be of paving tiles, but laid open in the joints for admitting the air from the flues below to ascend amongst the plants. The floor is supported on brick walls 9 inches thick, and from 6 to 9 inches high. Their position is shown in the ground-plan, as



ings *cccc* in the side walls for the admission

of air. These openings should be 6 feet apart, and about 18 inches by 9 inches in the clear, and be furnished with doors to open and shut for the admission of air. The sashes are to run on rafters for the purpose of being taken off to facilitate the putting in and taking out the plants. During winter, such pits ought to be carefully covered with waterproof canvass. If this is mounted on long rollers, it can be let down and drawn up with little trouble or loss of time; and if fixed to the ridge along one side, and to the roller on the other, it will require little further fastening down, as the weight of the roller will keep it in its place.

*Cold pits for preserving vegetables during winter.*—These are of great use in every garden, and, indeed, in most nurseries. They were brought into notice some years ago by the late Mr Stewart of Valleyfield, and an account of them published in "The Transactions of the Horticultural Society," from which our next figure is taken. They may be built of turf, bricks, or stone; if of the first material, where much turf is used for potting, and where exposure to the weather for a while is deemed necessary, the fresh turf taken early in autumn may be employed for the walls, and used during the following summer for potting or other purposes. On the walls, of whatever material, wall-plates rough from the saw should be used, and rafters dividing the whole into spaces 4 or 5 feet wide. Mr Stewart's pit was without these, as will be seen by fig. 676, which shows the pit opened up



and covered with thin boarding in such lengths as to be conveniently lifted and propped up. From this it will be seen that the rain or snow is thrown to the back, keeping the interior of the pit dry—a most important point in wintering tender vegetables.

The span-roofed vegetable pit, fig. 677, is an improvement on the last. It consists

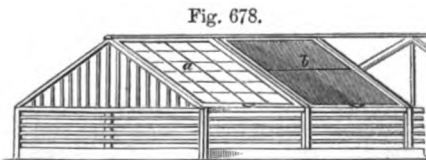
VOL. I.

of a permanent roof of straw, heath, or reeds, supported on larch posts 2 feet



high from the ground and 6 feet asunder. To the wall-plate that supports the roof the sides of boarding are hinged, and let down to exclude the frost, and opened both at back and front when ventilation is required, and when the weather is mild. The advantages of such a pit consist in the vegetables being kept perfectly dry, from the roof never being opened, and also in the freedom by which air and light can at all times be admitted by opening the sides. Such pits may be 12 feet wide, with a passage up the centre, and a bed of dry earth or sand made along both sides, into which the vegetables, when full grown in autumn, are to be planted. The entrance being at the two ends, free access can be got to the pit for the purpose of filling it, clearing away any decayed leaves, and also for gathering and examining the state of the contents. The situation for such a pit may be in any out of the way place, provided it is perfectly dry, and not under the shade of trees. During summer it may be used as a mushroom-house, and also for retarding crops of cauliflower, &c., that may be coming on too fast. We scarcely know of a more useful appendage to a garden than such a house would be. If carried to a greater height than here represented, one or more courses of strong shelving might be erected, and thus afford greater accommodation at little extra expense.

The span-roofed conservative pit, fig. 678, is for protecting small plants from heavy rains during summer, and will be found



of great use in extensive nursery establishments. The framework is permanent, the sides being formed of long narrow



slips of wood nailed to the upright posts, and kept 2 or 3 inches apart for the admission of a free circulation of air at all times. Glass sashes are fitted on (a) to keep the plants dry, and they are shaded from the bright sun by canvass awnings, b. Ventilation being so abundantly supplied by the openings in the sides and ends, the sashes may remain unmoved, unless for the purpose of watering. Such a pit might be rendered valuable also during winter, if the sides and ends, instead of having the slips of wood fixed to the uprights, were made to open and shut upon the principle of Venetian blinds or louvre boarding. The frost would be thus excluded from half-hardy plants, and abundance of air can be admitted, which is one of the principal considerations to be kept in view in all arrangements for protecting plants during winter, as by that means damps are corrected.

All cold pits should face the north. If they do not, the air in them gets heated by the sun, and instead of the plants being allowed to remain in a dormant state during winter, they are first kept growing to too late a period in autumn, and afterwards stimulated into temporary growth too early in the spring, which renders them much more liable to destruction from frost than if they were otherwise circumstanced. They should also be kept as dry as possible; and no better medium

can be found in which to plunge them than coal ashes. The floor of the pits, unless the subsoil is gravel, should be elevated a foot or 18 inches above the ground-level; and the walls should be 9 inches thick, to exclude the frost. Where the subsoil is dry gravel, there is no impropriety in keeping them on the surface; but by no means should they be sunk under it. The necessity of keeping both the soil, walls, and plants dry during winter, is thus stated in the first volume of the "Gardeners' Chronicle," p. 659—"This necessarily seems to arise out of the nature of vegetation, which, being entirely passive, cannot resist the influence of surrounding media. If the air or soil is damp, plants exposed to them must absorb the moisture; but from the lowness of the temperature of a winter house—or pit—"their powers of digestion and assimilation are torpid, and therefore the water they receive, instead of becoming incorporated with their system, stagnates in their cells and cavities, where it becomes putrid; and as soon as that takes place, the evil extends with rapidity, causing both branches and stems to become rotten; for decay in plants is always contagious, and will spread through all the parts with which it is in contact, until the renovated forces of vegetation restore the equilibrium of chemical constituents, and thus arrest contagion."

## CHAPTER IX.

### MISCELLANEOUS GARDEN STRUCTURES.

#### § 1.—GARDENERS' HOUSES.

THESE should form an adjunct corresponding in style and consequence with the garden, of which they may be said to form a part. This is, however, we regret to say, by no means a general case; and hence we often find, even in gardens of high pretensions, and where great expense has been gone to in minor details, the accommodation afforded the head gardener inferior to that which ought to be provided for his assistants; while the latter are lodged in damp and ill-ventilated dens, in general forming part of the back-sheds, and wholly unfit for human habitations. The house for the head gardener should be in keeping with the garden itself, and in all cases closely attached to it, and, if possible, placed near the entrance, having the principal windows looking towards the garden. Hence the south-west or south-east corners of a walled garden are appropriate sites; and next to these the north-east or north-west, as being in general nearer to the hothouses. The latter is the position of the garden house at Woburn Abbey. In some cases the house is placed immediately without the garden, as at Tottenham Park; in some within, as at Eaton Hall; in some, in the centre of the principal range of glass, as at Frogmore; while others are placed on elevations from which the whole of the gardens may be seen at one glance. Such is the case at Drumlanrig Castle, where one of the best specimens of such houses in Britain may be seen. In respect to style, they should be in harmony with the mansion and the other buildings in the park. In respect to accommodation, none should have less

than two sitting-rooms, exclusive of the kitchen, nor less than four sleeping apartments, with corresponding minor conveniences; and all bedrooms should be up-stairs. If the intended occupant be only a man and his wife, less accommodation might be sufficient; but if there be a family, common decency and morality demand separate sleeping apartments; and in places of consequence, a spare bedroom should always be provided. Water should be laid on, for the use of the family, the supply of a water-closet and bath; and abundant drainage and ventilation should be secured even to the most humble of these dwellings. The examples we have given in the following pages are neither extravagant nor out of character with the gardens to which they are attached. Most of them have been built, or are in course of erection, from our own designs. A fashion of very questionable propriety appears to exist very generally in Britain, of placing the dwellings of *all* domestics in the most out of the way places imaginable; and if circumstances force the site into view, the building is immediately surrounded with plantations, or covered with scandent growing plants, as if unworthy of being seen;—thus rendering the air around it unhealthy and impure, the rooms dark and damp, and forcing an impression on the mind that the occupant is an inferior being.

If such houses are so unsightly—and many of them are so, having been built without any regard either to taste or comfort—then it were better to raze them to the ground, and to build others in their stead that would accord with the buildings or objects around them.

Another palpable evil is of almost universal occurrence—namely, having the floors level with, and in some cases even below, the surrounding ground; while, in addition, the rooms are much too low to be habitable, the windows too small, and ventilation uncared for; and in most cases the sleeping apartments are on the ground floor also. Greater errors than these cannot possibly be fallen into; yet these, and others we could name, arise from a fear of carrying the roof so high as to render it difficult to plant it out. Here comfort, health, and elegance of expression in a good design, are all sacrificed to a vitiated taste—a taste unknown in any other country in the world. An elegant and well-designed gardener's house, in connection with a well laid out garden, is as much an appendage of ornament as the walls, hothouses, or conservatories themselves: it is a part of a perfect whole; and if that part be wanting, that whole must be imperfect and incomplete.

In regard to the interior arrangements of such houses, we may observe, that all fixtures and principal articles of furniture should be the property of the proprietor of the garden, and valued to the occupant on his entering on the situation, and again valued on his leaving it—he paying any difference in value which may have been occasioned by use. This is not the usual practice, although we know it to be so in several places, much to the credit of the employer and comfort of the employed. Indeed, some proprietors furnish the house entirely, even to bed and table linen. A small library of the most useful and popular works on horticulture, botany, arboriculture, rural economy, and natural history, one of the best encyclopædias, &c., should be furnished by the proprietor—as well as some of the best periodicals, as books of reference, and also that the gardener may be enabled to keep pace with the times in which he lives.

A very sagacious writer has remarked that a gardener, when he enters upon the charge of a garden, should not only be at the head of his profession, but keep himself at the head of it, by taking care to be informed of all improvements and inventions in his line as they are discovered and made public. "He must not only know all that is in books, but must be in advance in knowledge; not only ready to apply all the best practices, but fertile in expedients on extraordinary occasions, and in cases of novelty, difficulty, or emergency." No doubt such is expected of him; and therefore, as he is in most cases far removed from towns, without the advantages of public libraries, or intercourse with men of intelligence and learning, the necessity becomes the more apparent that the proprietor, who is to benefit from the acquirements of his servant, should assist him in procuring that information which is of so much importance to both.

Figs. 679, 680, are offered as a design suitable for the residence of a gardener

Fig. 679.



in an establishment of the first order. Architectural embellishments are avoided, and the form is adopted which affords most convenience within the least extent of space. The situation should be near to or attached to the garden, so that some of the windows may command a view of the greater part of it.

The following will show the arrangement:—

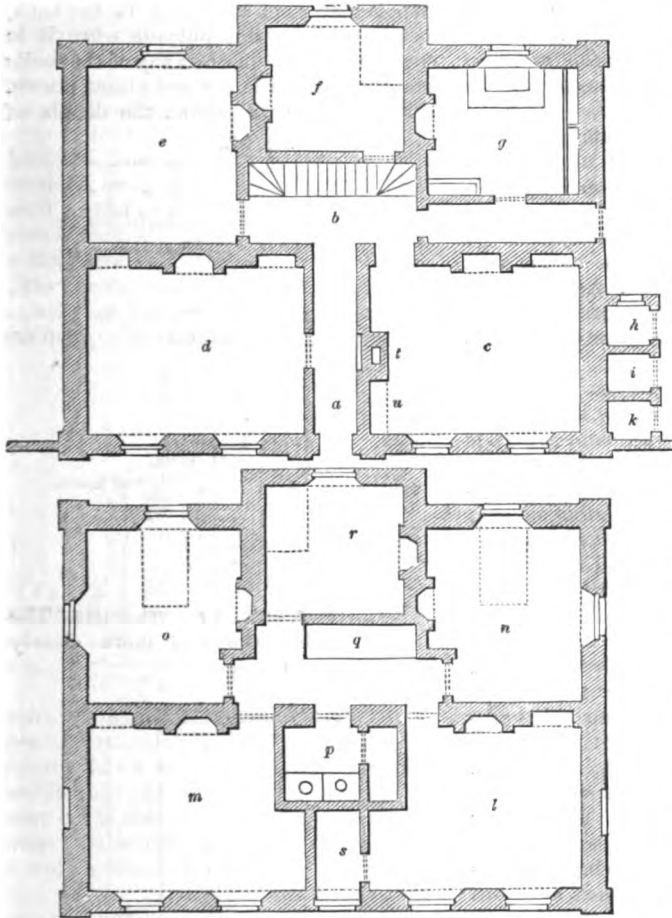
Ground floor—*a* entrance lobby; *b* passage and staircase; *c* kitchen, 18 feet by 14 feet, with one wall closet, fore-pump *t*, and sink *u*; *d* parlour, 18 feet by 14 feet, with two wall closets; *e* family room, 13 feet by 15 feet; *f* servants' bedroom, 12 feet by 11 feet; *g* office, 13 feet by 11 feet, fitted up with writing-

desk, presses, drawers, &c.; *h* ground-floor water-closet; *i* fuel store; *k* ash-hole. The entrance to the servants' bedroom is placed under the stairs, from whence, also, a stair descends to the cellars under the family room and parlour.

Chamber-floor — *l* best bedroom, 18 feet by 14 feet, with one wall-closet; *m*

house will readily be understood by our figure. It is necessary, however, to show how the bath and closet are supplied with water, &c. In the space between the roof of the house and the ceiling of the upstairs rooms, and immediately over the bath, two cisterns, 3 feet square, and the same in depth, should be placed close together, and a communication formed

Fig. 680.



up-stairs sitting-room, 18 feet by 14 feet, with one wall-closet; *n* bedroom for the female branches of the family, 12 feet by 13 feet; *o* family bedroom, 12 feet by 13 feet; *p* chamber-floor water-closet and bath; *q* linen-closet; *r* bedroom for the male branches of the family, 12 feet by 11 feet; *s* closet off best bed-room.

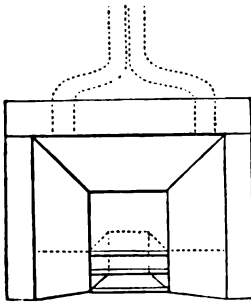
The general arrangement of such a

place of an adjoining bedroom, such as *l* in our figure, and forming the back and sides of the grate. From the top of this a three-quarter inch leaden pipe rises and passes up the chimney till it reaches the height of the floor of the garret, where it passes through the wall, and extends to the cistern. The pipe is wound round with hay-bands, to prevent the escape of heat.

between them by a 2-inch pipe, with stopcock. These are to be supplied with cold water by a force-pump *t* in the kitchen, which also supplies the boiler behind and forming the back of the kitchen range, which boiler, if close-topped, will supply one of the cisterns above the bath with hot water, by means of a flow-and-return leaden pipe, 2 inches in diameter, proceeding from it up the chimney, and brought along the ceiling joists to the cistern. Stopcocks should be placed on these pipes close to the boiler, so that the circulation may be shut off when the hot water is not required for the bath. We have exemplified a still more simple method of procuring a supply of hot water, by placing a small cast-iron boiler, fig. 681, behind the fire-

The return-pipe from the cistern is exactly similar, and returns alongside the other,

Fig. 681.

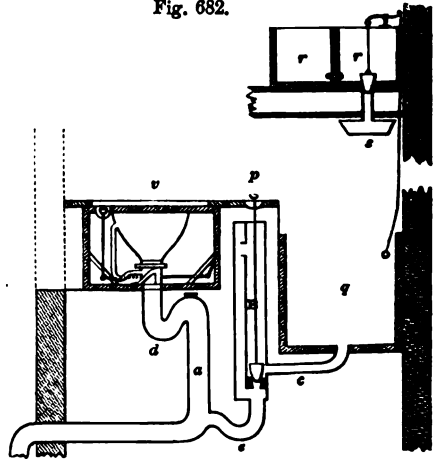


and enters the boiler near its bottom. Thus we have a rapid circulation. A waste pipe empties the boiler, passing under the floor to the outside of the house. Stop-cocks are also placed on the pipes close to the cistern, so that all communication between it and the boiler may be cut off when the hot water is no longer required. Folding wooden doors enclose the bath when in use, and at other times are folded back into a recess in the wall formed for their reception. A cold, tepid, or warm plunge bath may also be taken, as pipes communicate between the cisterns above and the bath beneath, and are regulated by stopcocks, so that any quantity of hot or cold water may be admitted at pleasure. The washhand-stand is placed at the left-hand side of the closet, or it may be placed in the opposite corner of the bath-room, and supplied with water from the cistern above; and the *chaise percée* on the right. The soil-pipe, passing between the floor of the bedroom adjoining and the ceiling of the parlour beneath, is carried through the external wall, and terminates in an air-tight drain, which conveys the contents to a liquid-manure tank at some distance. To provide against a back draught of air, this drain enters the tank close to its bottom, and, besides, has two traps set in it at 10 feet distance apart. The proper position for a bath should be in connection with the passages which communicate with the various bedrooms, as shown in our figure. Light is admitted through a flat window in the roof of the bath, 2½ feet by 18 inches, which is made to move in a groove. By pulling a cord attached to one end, it opens by running back between the ceiling and floor of the garret, and is shut by pulling another cord in an opposite direction. In the roof over this sliding window is placed a large skylight, by means of which

abundance of light is thrown in through the day; and as all the house is lighted with gas, a jet is placed in the bath also. This is a much better way of lighting a bath than having openings in the sides, because it renders the place more private, and completely provides ventilation at the same time. This opening of the window in the roof also answers the purpose of opening a communication with the garret above by means of a jointed step ladder, kept folded up in the bath, and is used for this purpose when it is necessary to turn off or on any of the cocks connected with the cisterns placed above.

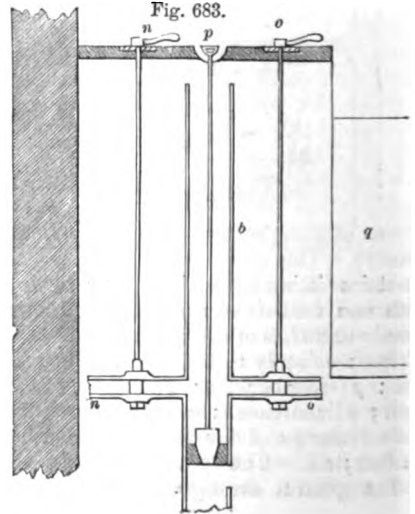
Figs. 682 to 685 shows the details of

Fig. 682.



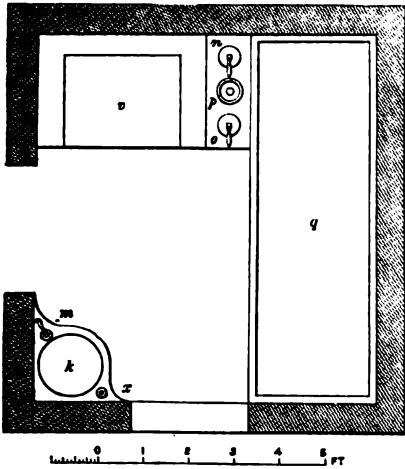
the bath-room and its conveniences. The following references will more clearly

Fig. 683.



explain the figure :—*a* lead soil-pipe of water-closet ; *b* lead standing waste-and-overflow pipe for plunge-bath ; *c* supply-

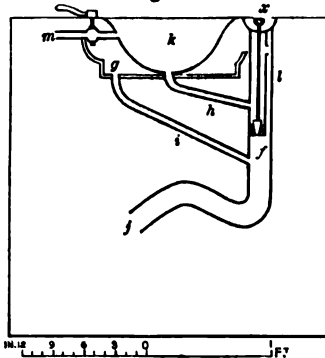
Fig. 684.



and-waste pipe of bath, to join the standing waste-and-overflow pipe ; *d* cesspool of water-closet ; *e* cesspool of plunge-bath ; *f* standing waste-and-overflow pipe of

washhand basin, on same principle as plunge-bath, but smaller ; *g* lead safe of washhand basin ; *h* waste pipe from basin

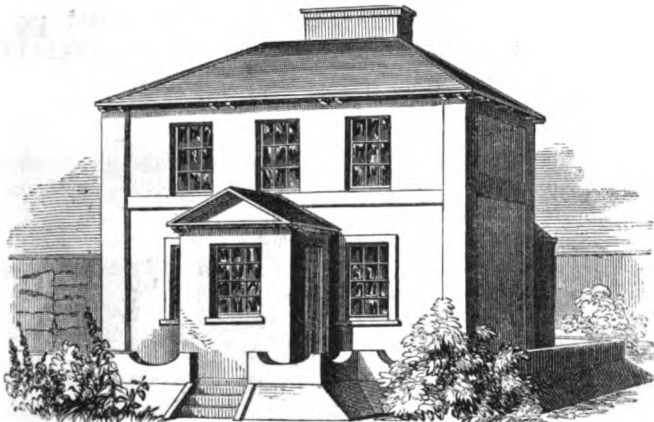
Fig. 685.



into standing waste overflow pipe ; *i* waste-pipe from safe ; *r r* the hot and cold cistern in garret ; *s* shower bath ; *q* bath ; *n* hot water ; *o* cold water ; *v* *chaise percée* ; *p* waste valve of bath ; *r* washhand basin ; *m* stop-cock for supplying basin ; *x* waste valve of basin.

Fig. 686 is a design for a gardener's

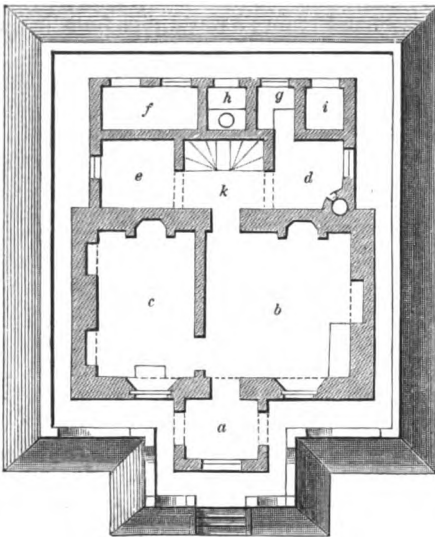
Fig. 686.



house of four rooms and other conveniences. The situation is to be in the corner of a walled garden, or it may be detached if more desirable. In the ground-plan, fig. 687, there is a porch *a* ; kitchen *b* ; parlour *c* ; back kitchen *d* ; closet *e* ; cellar *f* ; pantry *g* ; water-closet *h* ; coal-house *i* ; staircase *k*, leading to two bedrooms over *b c*, and downwards to a cellar underneath. The smaller apartments are attached to the back of the principal

part of the house by a lean-to. The walls are to be of brick, built hollow, and the flues brought into one chimney. The roof to project over the walls, and be covered with Grecian tiles. The ground-floor to be elevated above the ground-level, and surrounded with a terrace having not less than four steps leading up to it. The parlour to be 11 feet by 12 ; the kitchen 12 feet by 12 ; which dimensions will serve as a scale for the rest.

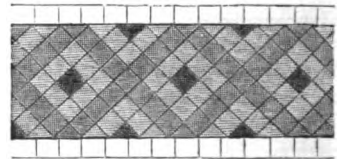
Fig. 687.



Figs. 688 and 689 represent a gardener's cottage with considerable accommodation on one floor. *a* entrance lobby; *b* kitchen; *c* back kitchen; *d* parlour; *e* bedroom; *f* closet; *g* bedroom closet; *h* water-closet; *i* store-house; *k* open shed; *l* pantry; *m* wash-house.

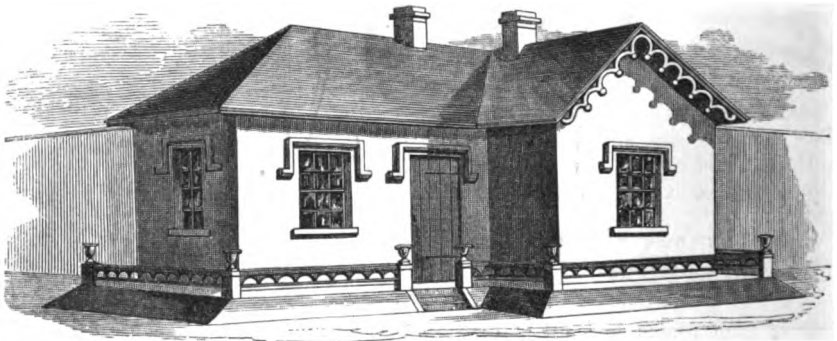
The accommodation behind is, of course, under a lean-to roof. This cottage is elevated  $2\frac{1}{2}$  feet above the surrounding grounds, and finished off with a grass terrace, and parapet wall formed of a base of foot tiles, on which are placed 9-inch drain tiles in form of open balustrading, and coped with tiles similar to those of the base. 9-inch brick piers or pedestals are carried up to divide and strengthen the parapet, and on them neat earthenware vases are set. The walk round the house should be neatly gravelled, or, still better, as it will be both dryer and cleaner, paved with bricks of the common sizes, but of three different colours. 6-inch paving tiles will make a neater and more even floor; and if in three colours, and arranged as in the annexed diagram, fig. 690, will be a good

Fig. 690.



imitation of tessellated pavement. A few of these will require to be cut angu-

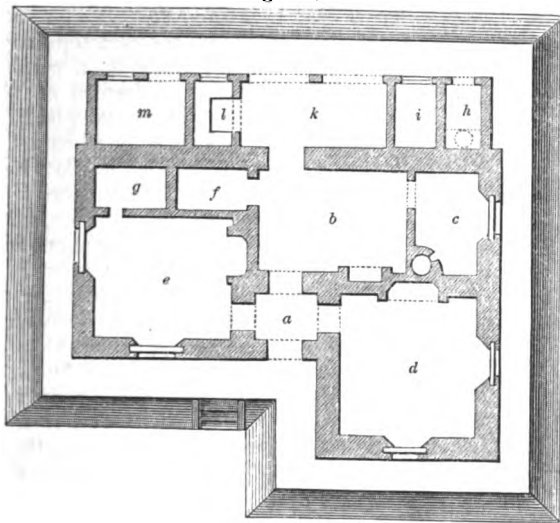
Fig. 688.



lar, and this can be done before they are put in the kiln. They must also be cut to a scale to suit the width of the walk. We will suppose the colours to be blue or hard-burnt tiles, common red colour, and black or yellow—all colours easily given them in making. A walk of this kind, pitched with small pebbles of various colours, and laid in pattern, has a good

effect, and is consistent with the situation and use. Still more elegant parapets than that above shown may be formed, in imitation both of the Italian and Gothic styles, by the use of curved and plain tiles, and bricks for piers to divide the parapet into panels, as well as for the corners and terminations. These tiles may be made at any tile or brick work in

Fig. 689.

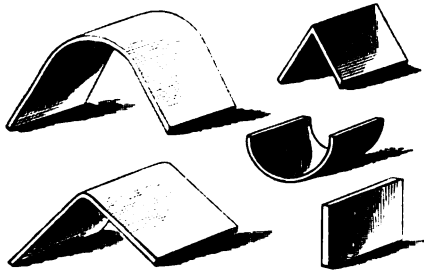


above the ground-level, to render the floors dry and add height to the elevation. A rustic or other simple parapet should be carried all round, leaving sufficient breadth for a walk and a narrow flower border round the house. References to the ground-plan fig. 697:—*a* entrance; *b* bedroom; *c* kitchen; *d* back kitchen and wash-house; *e* parlour and wash-house; *f* sitting-room; *g* closet; *h* water-closet; *i* dust-hole; *k* wood and coal house; *l* passage.

Fig. 698 is in the cottage style, and contains, fig. 699—*a* entrance; *b* sitting-room; *c* parlour; *d* kitchen; *e* larder or pantry; *f* store-closet, fitted up with shelving, &c.; *g* fuel-house; *h* back entrance to kitchen; *i* water-closet, with four bedrooms over, and sundry closets. The roof is to be covered with ornamental tiles, the walls trellised with wire 6 inches

forms as represented at fig. 691; and these, set upon each other upon a plain

Fig. 691.



tile base, and coped with the same, will produce parapets similar to figs. 692 to 695. They should be jointed with cement, and the whole washed over a good stone colour.

The house represented by fig. 696 stands on a platform elevated three feet

up with shelving, &c.; *g* fuel-house; *h* back entrance to kitchen; *i* water-closet, with four bedrooms over, and sundry closets. The roof is to be covered with ornamental tiles, the walls trellised with wire 6 inches



Fig. 692.

Fig. 693.

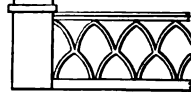


Fig. 694.

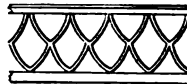


Fig. 695.

from the walls, and covered with creepers. The whole to be enclosed by a rustic fence 3 feet high, with a walk and flower borders.

Fig. 696.

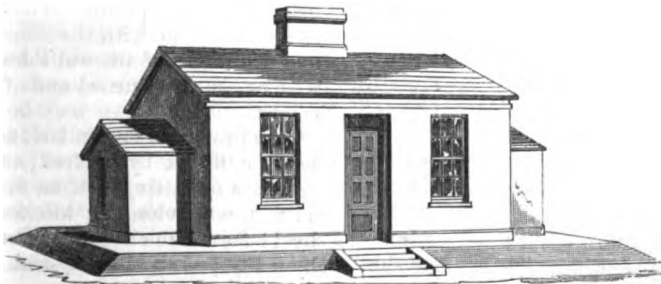




Fig. 697.

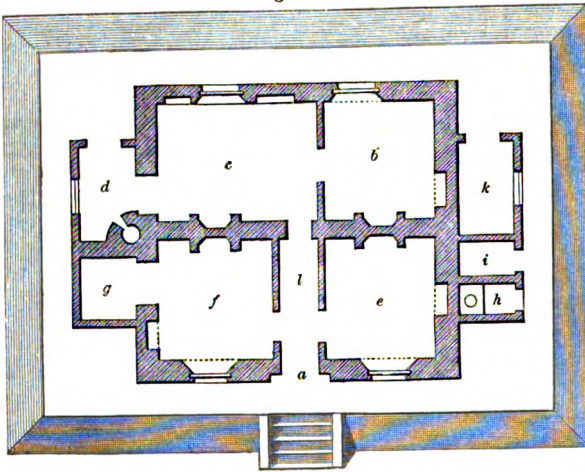


Fig. 700, of which figs. 701 and 702 are ground-plan, was designed by us for a gentleman in Argyllshire. The old English style appears to be that most suitable in order to accord with the mansion and situation. The structure is set on an elevated terrace of  $2\frac{1}{2}$  feet above the ground-level, to secure dryness in the ground floor, and to give greater apparent elevation to the building. The oriel or projecting windows at the ends are intended to give expression to the style; they may however be dispensed with,

Fig. 698.

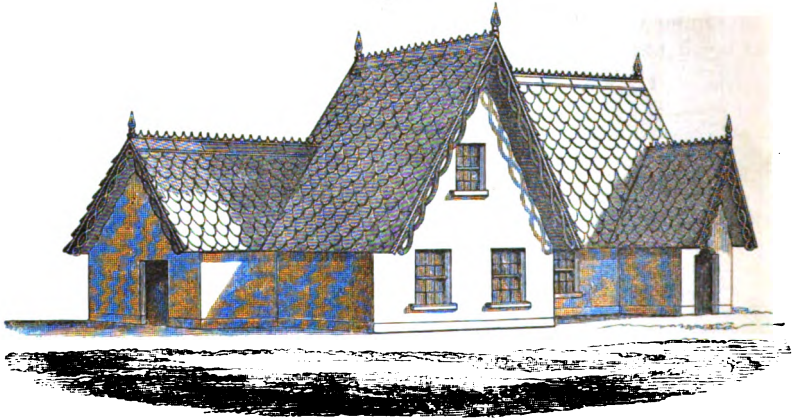
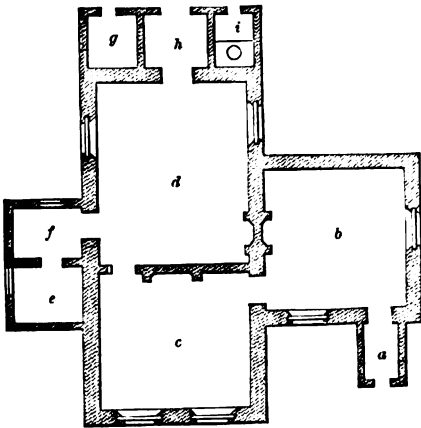


Fig. 699.



and ordinary ones substituted. The roof projects 2 feet over the walls, to keep them dry. White firebricks are used for the door porch, the rebates, sills, and lintels of the windows. The first 12 inches above the ground-line project 3 inches beyond the plumb of the walls, and are also of firebrick, to form a plinth. The corners are to be carried up with the same material, and the whole of the walls built hollow, with bricks well burned and of a subdued colour.

The ground floor, fig. 701, consists of a porch *a*, 6 feet by  $4\frac{1}{2}$  feet; passage and staircase *b*; sitting parlour *c*, 12 feet by 11 feet, with closet *d*; kitchen *e*, 12 feet by 11 feet, with closet *f*; pantry *g*, 5 feet by 5 feet; back kitchen, wash-house, and

scullery *h*, 12 feet by 11 feet, with boiler *i*; sink *j*; fixed washing-troughs *k k*, the waste water of which is to fall into the tank under water-closet *l*. This apartment also answers for a back or common entrance, the door of which is at *m*. A closet is placed under the stairs.

Fig. 702.—The upper floor consists of

stair landing *n*; family bedroom *o*, 10 feet by 8 feet, with two useful closets at each side—a portion of the width of most houses cut off as being deficient in head room, and in few cases turned to any useful account. The convenience of such places to a family is great, and the only expense to the proprietor is merely the

Fig. 700.

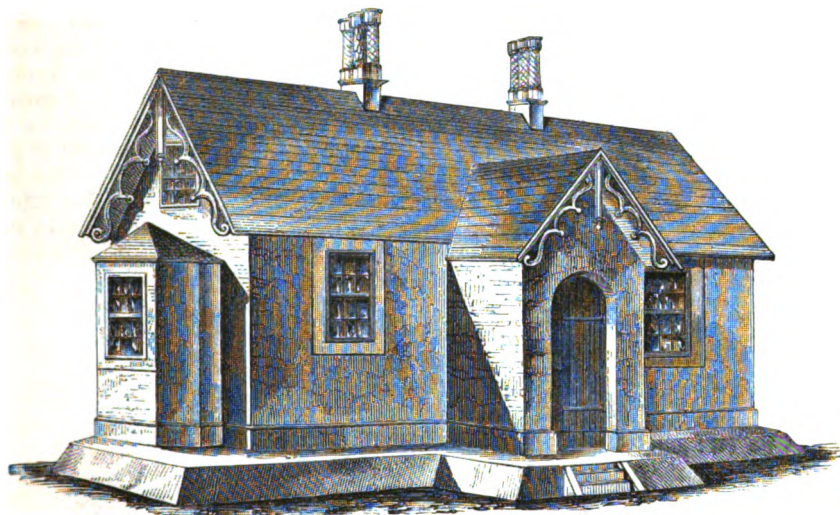


Fig. 701.

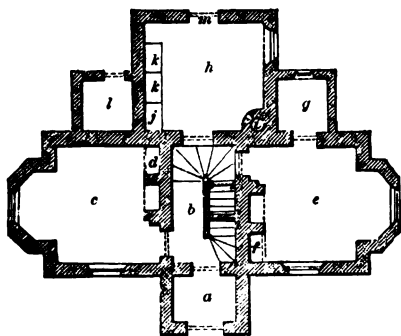
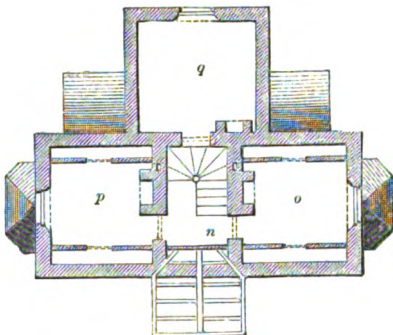


Fig. 702.



little extra flooring and a couple of plain doors. The bedroom *p*, 10 feet by 8 feet, may be for the female part of the family, and has the same convenience of store closets as the last. Bedroom *q* is for the male part of the family. Each of the bedrooms has an open fireplace. The staircase is lighted by a skylight 3 feet by 4 feet, set in the roof immediately under the ridge on the north side, which will be

found better than a storm window, and less expensive.

Fig. 703 represents a cottage in which the style is simple, yet ornamental. The roof projects 2 feet over the walls, showing the ends of the rafters as brackets.

Ground floor, fig. 704, shows front entrance porch *a*, 7 feet by 6 feet; family room *b*, 16 feet by 16 feet; parlour *c*, 16 feet by 16 feet; kitchen *d*, 15 feet by 11

feet. As, in houses of this description, the kitchen is usually the room most constantly occupied by the family, there is no objection to the entrance to the stairs being placed within it. There is a closet under the stairs. All the flues, excepting one bedroom, are placed in one stack, which is in the centre of the house, so that no heat is lost. Back entrance *e*, enclosed for warmth; *f* water-closet; *g*

fuel place: both of these are 4 feet by 5, and have a lean-to roof.

The upper floor, fig. 705, contains a family bedroom *h*, 16 feet by 12 feet; a bedroom for females, *i*, 16 feet by 12 feet, each of which has three closets; a bedroom for males, *j*, 12½ feet by 9 feet, with open fireplace and a closet on each side; *k* is a closet over front door porch, 7 feet by 6 feet.

Fig. 703.

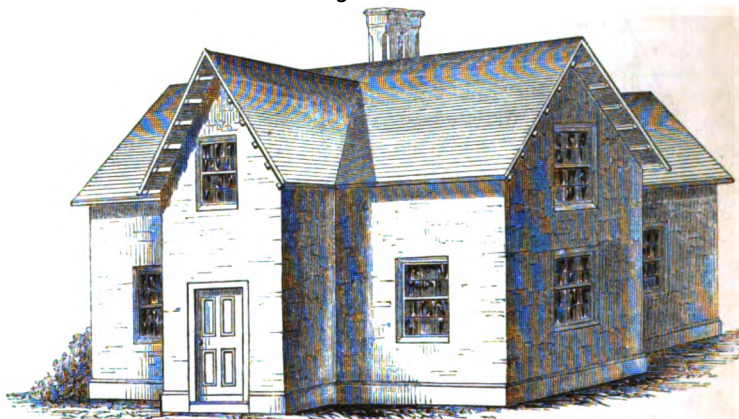


Fig. 704.

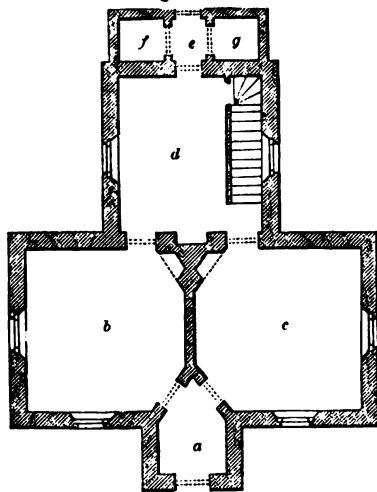


Fig. 705.

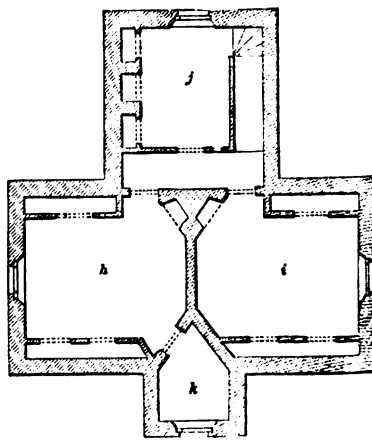


Fig. 706 represents a house in the old English style, and gives a view of the south and east fronts.

The ground-plan, fig. 707, shows the entrance porch *a*, from which we pass to the lobby and staircase *b*, by a Venetian door, the upper part of which is to be of

ground glass; parlour *c*, 14 feet by 12 feet; family room, *d*, 14 feet by 12 feet, with oriel window, commanding a view over the garden and back offices; kitchen, *e*, 12½ feet by 12 feet, with a dry closet on each side of the fireplace; back kitchen, scullery, or wash-house, *f*, with

boiler, 12½ feet by 9 feet; pantry, *g*; *h* and *i* two closets; water-closet *j*.

Fig. 706.



Fig. 707.

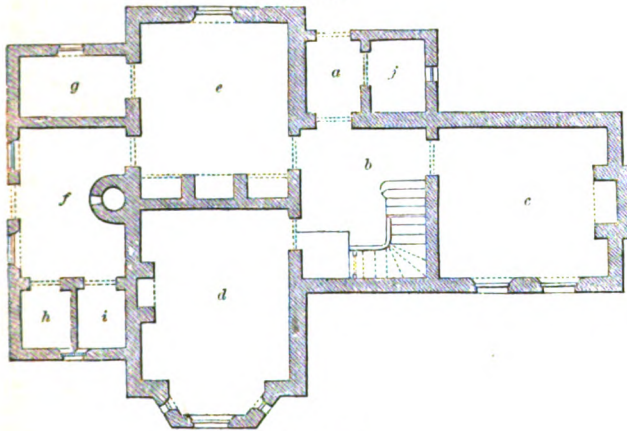
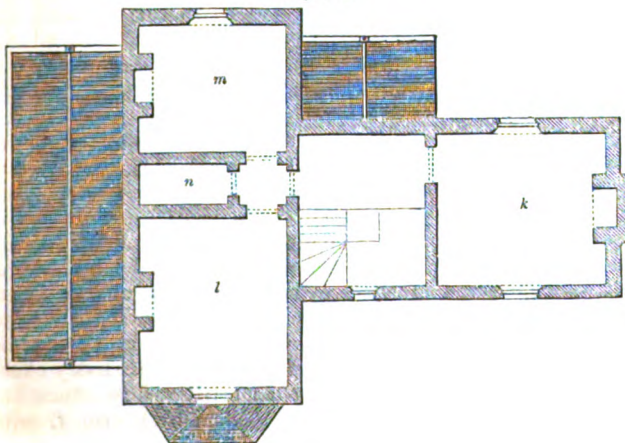


Fig. 708.



Chamber floor, fig. 708, contains family bedroom, *k*, 12½ feet by 12 feet, with two wall-closets; females' bedroom, *l*, 14 feet by 11 feet, with two closets; males' bedroom, *m*, 12 feet by 9½ feet; linen closet *n*.

*Assistant gardeners' apartments.*—Intimately connected with the accommodation provided for the head gardener is that of his assistants. A number of these, in proportion to the size and duty required, should have accommodation found for them within the garden. Such is the case more generally in Scotland than in England, although in the latter the practice is more frequent now than formerly. The advantages both to the employer and the employed are much greater than may be generally supposed. Without going into the reasons for this assertion, we shall briefly state what that accommodation should be. The sitting and eating room should be decidedly separated from the sleeping apartments. Each person should have a bed to himself, and if not a separate room, not more than two beds should be in each. The beds should be of iron, mounted on castors, and completely furnished with bedding and curtains. Each man should have a small table with a drawer, to serve for dressing and writing, with looking-glass,

washhand-stand, water jug, basin, and towel. Both bed and table linen should be changed once a-week, and the bedding cleaned twice a-year. It is extremely desirable that an apartment should be set apart for cooking and cleaning; and into it a supply of water should be brought, as well as a sink for the escape of slops. In this apartment should be a set of cupboards, one at least for each person, in which to keep his provisions, and these should be provided with different locks. A clean jack, or round towel, should be hung up in this apartment every day; and the washing, cooking, and bed-making should be attended to by an elderly female. The men should be provided with fuel and light; and if the employer studies the moral condition of his servants, the most useful practical books on their profession should be at their service. The rooms should be dry, and well lighted and ventilated, the floor standing 2 feet above the ground-level, and boarded. If a cellar be underneath, so much the better; and in a portion of this the cooking apartment may be placed. In time of sickness, medical and nursing attendance (if the latter is required,) should be found them; and in the case of death, they should be buried respectably. Some may think these indulgences great; we do not envy the minds of such;—and for precedents we have only to name Dalkeith and Drumlanrig Castle, where even more than these reasonable comforts are provided. As these pages may be perused by the younger members of our profession, we shall state some of the duties required of young men enjoying those privileges; for privileges they assuredly are, compared with the dreadful dens to which many are driven, and more dreadful influence which an opposite mode of treatment has on many youthful minds. The master has a right to expect constant attendance to duty night and day; he is entitled to insist on no outings at night to public houses, or otherwise, without leave asked and given, and to prohibit all Sunday visiting. He has a right to require that those who are not needed on Sunday for the works of necessity, which in extensive gardens are many, be recommended to attend some place of worship at least once a-day, without using any coercion as to what church; and that orderly conduct, clean-

liness in person, and polite demeanour to superiors, be insisted on.

That great advantages arise from young men visiting other gardens is unquestionable; and therefore, to enable them to do so, we have long made it a rule that they shall have any reasonable time, at convenient seasons, and be furnished with letters of introduction to other head gardeners, to see the gardens under their charge. The bothy system we wish to see completely swept away; nay, the very name obliterated from our national vocabulary.

## § 2.—THE FRUIT-ROOM.

It is somewhat surprising, after all the expense gone to in the formation of gardens and orchards, the building of walls hot and cold, the erection of fruit-houses of all descriptions, which we see going on from one end of the land to the other, that after all these are completed, and the fruit produced, there is not one garden in ten, nay, perhaps less, where any reasonable provision is made for its proper reception and preservation. Why this should be so is not easy to account for, as the fruit-room in itself is certainly as interesting a part of a garden structure as any of those we have named.

Upon this subject we find a great diversity of opinions, some of them diametrically opposed to each other, and not a few scarcely consistent with sound sense. To the sounder views on the subject we shall confine ourselves, as being of the greater importance. We shall only premise by observing that these things are done differently on the Continent, where great care is taken of their winter fruit—pears and apples in particular—and where a species of accelerating and retarding, ripening and colouring, goes on constantly, in itself an important branch of horticultural science. The results are, that in France and Germany apples and pears are brought to the table in higher perfection, and for a longer period of the year, than with us; and by this art of retarding and ripening them at will, we find certain popular kinds daily on the table for several months in succession. Nor is it altogether to the climate that all this is to be attributed; nor is it to be attributed to their better constructed

fruit-rooms, for these, in general, are only dry cellars; the greater care taken in their management is the principal cause of it all. No doubt, however, the climate of France, Belgium, and the south of Germany, is better adapted for the production of fine fruit of certain kinds than ours, on account of the greater warmth of their summers, and the greater amount of solar influence they enjoy.

Little information has been given us by horticultural writers upon the construction of fruit-rooms, or the preservation of fruit: although most of them have given us their practice, but few of them have detailed the reasons for it. The late Thomas Andrew Knight was amongst the first who took up this matter; and his valuable papers in the "Transactions of the Horticultural Society" undoubtedly laid the foundation of all hitherto attained on the subject. The most valuable information that has as yet been published on the subject will be found in the early numbers of "The Gardeners' Chronicle," and is based upon the experiments made by Mr Thompson in the gardens of the Horticultural Society of London. Although we differ from that high authority in some minor points, yet, as a whole, his experience is far too valuable not to find a place in a work of this kind. The following excellent remarks on the principles that ought to guide the designer, in the building and arrangement of a fruit-room, are from the work mentioned above: "Darkness, a low steady temperature, dryness, and exclusion of atmospheric air, are the great points to secure." The term dryness here, we think, should be taken with some qualification, as apples are found to keep in a rather damp atmosphere. Regarding the exclusion of light, the above authority very sensibly remarks: "If the light of the sun strikes upon a plant, the latter immediately parts with its moisture by perspiration; and it does so in proportion to the force exercised upon it by the sun, and independent of temperature. The greatest amount of perspiration takes place beneath the direct rays of the sun, and the smallest in those places which daylight reaches with most difficulty. Now the surface of a fruit perspires like that of a leaf, although not to the same amount. When a leaf perspires while

growing on a tree, it is immediately supplied with more water by the stem, and thus is enabled to bear the loss produced by light striking on its surface; but when a leaf is plucked it withers, because there is no longer a source of supply for it. So it is with a fruit: while growing on the tree, it is perpetually supplied by the stem with water enough to replace that which is all day long flying off from its surface; but as soon as it is gathered, that source of supply is removed, and then, if the light strikes it ever so feebly, it loses weight without being able to replace its loss. It is thus that fruit becomes shrivelled and withered prematurely. Light should, then, have no access to a good fruit-room." Some qualification, however, is necessary on this point, for it is well known that, if fruit be gathered before it is fully matured, it will shrivel, let it be placed in whatever position as regards light it may; and hence gathering fruit too early should be avoided. We grant, however, that light brings about this shrivelling sooner, in immaturity ripened fruit, than darkness would do; but, nevertheless, unripened fruit cannot be prevented from shrivelling, place it where we may.

Regarding temperature, "it should be low and uniform. If it is high—that is to say, much above 40°—the juices of the fruit will have a tendency to decompose, and thus decay will be accelerated; if, on the contrary, it is below 32°, decomposition of another kind is produced in consequence of the chemical action of freezing." Here, we think, the statement is slightly defective, for it is quite well known that apples, in Canada and other cold countries—nay, not unfrequently in our own—are often frozen quite hard; but in consequence of that process taking place in the dark, and the counter process of thawing also, without the influence of light, that chemical change does not take place which otherwise would if the freezing and thawing went on in the light, or even if frozen apples were brought out of the dark into the light to thaw. The potato is another example of this fact. Potatoes planted in autumn, as well as those left in the ground, and so far covered as to be beyond the range of light, are not injured by frost, although they may have been several times as hard

as a stone during the winter. Plants frozen in a pit, if left covered and in the dark, are seldom injured; but if exposed to light before being fully thawed, they almost invariably perish. With these practical facts before our eyes, we are rather surprised at the above opinion being given without some qualification, considering the intelligence and physiological attainments of the source from which it emanated. The chemical action here meant may only apply to the deterioration of the quality of the fruit, which would assuredly be the result, but certainly not to its decomposition—that is to say, if it is continued to be kept in darkness. To resume our quotation, however: “In any case, fluctuations of temperature are productive of decay. A steady temperature of 35° to 40°, with a dry atmosphere, will be found the best for most kinds of fruit.” A dry atmosphere has the effect of shrivelling up the skins of apples and pears upon a principle somewhat analogous to that stated in the paragraph above on Light. “Some pears of the late kinds are, however, better to be kept in a temperature as high as 60°, for this ripens them, deprives them of their grittiness, and improves their quality very essentially. We do not, however, conceive that the general construction of the fruit-room ought to be altered on their account; we would rather make some especial arrangement for such cases.”

Our practical experience in this matter, and the lessons we got from some of the most eminent Continental fruit-growers, lead us to the conclusion that several apartments are requisite in every fruit-room; and if we may make so free with the “three degrees of comparison,” we would have them in this way—cool, cooler, coolest. The longest-keeping sorts—that is, those that are longest in ripening—should lodge in No. 3, where they would remain, as it were, in a state of suspended animation; for at a low temperature they would neither very speedily rot nor change their state;—ripen they would not. The medium-keeping sorts should occupy No. 2, and the autumnal kinds No. 1. As the emptying of the last proceeds, it should be filled up from No. 2, and so on until April, May, and June, when all No. 3’s inhabitants would,

after passing through No. 2, at last find themselves in No. 1, in a state almost fit for the table. The ripening process must take place gradually, when upon a large scale; but circumstances will often occur, making it necessary to accelerate that process, and then recourse must be had to warm closets or the like, as a pear that might be kept till June in a low temperature may, by being gradually brought into warmer ones, be fit to eat in November. It is warmth that ripens, and cold that prevents that process from going on. Mr Beaton, a highly intelligent man, says in “The Gardeners’ Chronicle:”—“I have sometimes had apples as hard as cannon-balls with frost; and by keeping the room quite close for a time after the return of fresh weather, they did not seem much affected by it.” The late Thomas Andrew Knight recommended exclusion of air, as he packed his choice fruit in air-tight vessels, and placed them “in a dry and cold situation.”

Mr Thompson goes on to say regarding ventilation—“All authors and all practical men are agreed in recommending the air of the fruit-room to be dry. Dampness produces mouldiness, encourages the growth of minute fungi, and accelerates the progress of decay, the moment that commences, from whatever cause. It is, however, to be understood that we do not mean by dryness what is chemically so called, but merely that condition of the air to which the term is commonly applied. It is for the sake of preserving this state of the air of the fruit-room that constant ventilation is recommended by many persons; but in that recommendation we by no means concur. A power of thorough ventilation must, no doubt, be possessed by the gardener, to be used in case of necessity, for the purpose of removing offensive smells arising from the putrefaction of the fruit. But the power should be rarely exercised; and if the commencement of decay is watched with vigilance—if no substances liable to decay are introduced—if fruit is removed as soon as it begins to spot—and, finally, if perfect cleanliness is maintained, there will seldom be any occasion for ventilation.

“One reason why ventilation by continual currents of air is objectionable, is, that they incessantly carry off from fruit

the moisture it contains, and thus act in the same way as light, producing shrivelling, and destroying that plump appearance which gives beauty to the fruit. Another reason is, that an equable temperature is scarcely to be maintained when the air is constantly changed. It may be said, indeed, that the sweating of the fruit throws into the air so much fresh moisture that constant ventilation becomes indispensable, in order to remove this excessive humidity. But we answer, that no fruit should be allowed to sweat in the fruit-room." The means of ventilation should certainly be provided, but it should be had recourse to as seldom as possible.

"The house," says Duro, in the work last quoted, "in the first place should be ventilated in the ceiling—as, from the moment of storing until the apple is absolutely decayed, an organic transposition of its parts is constantly going on; therefore it is important to allow the confined air of the room, which becomes highly impregnated with the effluvia, to pass off. Any animal or vegetable substance in a sound state is more liable to become diseased when placed in an atmosphere impregnated with effluvia; but again, on the other hand, it is well known that apples and pears shrivel and lose their flavour when exposed, particularly in spring, to the free admission of external air. This may be attributed not so much to the free admission of air, as to the increased temperature which the air in spring has attained. The increased heat of the atmosphere then dries up the juices of the apple, and destroys its flavour: in fact, fruit so exposed becomes tasteless and tough. Now it appears," he says, "quite necessary to admit air, or rather to allow the impure air to pass off quickly at the ceiling, without creating a complete current in the house, and to exclude the admission of external air at the doors and windows as much as possible, to keep down the temperature of the room, for on this a great deal depends. Could the same kind of temperature be maintained in spring as during winter, there can be no doubt but fruit would keep much better, and be better flavoured."

On the construction of a fruit-room according to the foregoing principles, the following directions are given: "It should

be near the gardener's residence, and sufficiently large to enable him to store away the whole winter produce of his trees without heaping or confusion. The walls should be thick enough to prevent the entrance of frost, which may be effected either by building them hollow, or by guarding them externally by a casing of earth. It would be better without windows; but if they are considered necessary, they ought to be made with double sashes, and wadded shutters to fix on the inside. If the room is covered by a roof, its ceiling should be 'pugged,' or rendered frost-proof by some other means, such as effective thatch. It would, however, be better if the fruit-room had a chamber over it, in which the gardener can arrange his summer fruit, sweat his winter store before laying it by, and prepare his dessert as required. In that case the fruit-room itself might be communicated with by a trap-door, and the ordinary entrance to it in the outer wall would seldom require to be used."

Ventilation is only to be applied so far as may be necessary for getting rid of the foul air that would of course accumulate in a place shut closely up, and containing a quantity of vegetable matter. This ventilation might be effected by having wooden chimneys 6 or 8 inches square, passing from the roof of the room into the air above, and these secured against rain by a coping in the usual manner, and provided with a sliding or flap door or lid below, to prevent circulation when not required. Everything tending to damp or decomposition should be carefully kept out of the fruit-room. "In all cases the fruit-room should be built on a dry bottom. If the situation is low, the foundations must be raised in proportion, so as to elevate it completely above the damp of the earth; and if it is floored with concrete, or some substance impervious to moisture, and in which mice cannot burrow, so much the better.

"Supposing that space enough can be afforded, the fruit-room would be improved by being divided into two or three compartments, to separate the ripening fruit from that which will be later. In such a case the door should be at the end of the room, and the fruit which ripens first should be next the door, while that which is latest should be stored up in the



farthest compartment. The reason for such an arrangement is, that the compartment next the door may be ventilated without opening the other divisions; and as ripening fruit requires more ventilation than such as is still immature, this is an important provision. Then, when the first division is empty, the second may be opened and ventilated without interfering with the third. In such a case, however, when a chamber is over the room, the second and third compartments must have chimneys carried through the floor, and ceiling also, of the chamber.

"In situations where the fruit-room can be built adjoining a hothouse, it would be advantageous to construct an additional closet, which may be warmed by the flue of the hothouse, in order to receive winter pears. These are all exceedingly improved if gradually introduced to a temperature of 60° or thereabouts, in which to ripen."

The interior fitting up is slightly treated on in this excellent paper: "There must be shelves, composed of parallel rails, on which to store away the fruit, and a table, on which to place it occasionally, and wooden boxes and earthen jars, in which to pack particular varieties. The only thing that is material to observe is, the quality of the wood, which must not be such as to communicate an unpleasant taste to the fruit that touches it. Good, clean pine wood, or white deal, is probably the best material that can be employed."

Every variety of pine timber communicates more or less a terebinthous or turpentine flavour to fruit, at least for several years after it has been first used. Beech, although not a very durable wood, is better; and, from all our experience, we would say poplar is the best, not only as communicating no bad flavour, but also on account of its durability, and the beautiful, clean, white appearance it has—a merit which has led to its introduction as a flooring boarding in houses of the first class.

An anonymous correspondent in the work last quoted offers the following judicious remarks on this subject, which we are induced to give nearly at length; for, as we have already remarked, the very important subject of fruit-rooms has hitherto been very superficially noticed in works on horticulture. This being the

case, we are the more disposed to avail ourselves of as much information as we can command, that the various opinions may be brought together, so as to enable the reader to judge for himself, and to adopt that plan most suitable to existing circumstances, and, at the same time, most adapted to carrying out the end in view. "When a room is wanted to preserve apples and pears to as great a length of time as it is possible for these fruits to keep, it ought always to be fixed in as cool a place as possible,—even a cellar keeps apples well: though I do not advise a fruit-room to be entirely underground, I yet think it ought to be partially so. The reason why I recommend a humid atmosphere is, from frequently having found apples in the spring months amongst strawberry leaves, long grass, &c., under the trees: thus fallen off, they were in a better state of preservation than those stored in the usual manner." This writer lays the usual stress on the necessity of careful gathering, recommends placing the fruit singly on the shelves with the crown up, as decay generally takes place first near the crown: it is then much easier perceived. He also, like ourselves, prefers laying the fruit on the shelves at once, and dispenses altogether with the ceremony of sweating them, and very properly advises as little handling of the fruit as possible, as that not only bruises them, but also removes that "greasy substance which all apples, more or less, exhale, and which I consider is one of the most essential requisites to their keeping well,—as it forms a sort of natural varnish or coating of paint sufficient to exclude all moisture, and instead of being hurtful is congenial, by checking the too rapid perspiration of the fruit." By this authority we find that frost is not so injurious to the keeping of apples as some suppose, else those found by him, as well as hundreds of times by ourselves, under the circumstances above stated, would not have been sound in spring, when merely covered with a few strawberry leaves or long grass under the trees.

Regarding ventilation he says: "Too much ventilation is apt to cause the fruit to shrivel, or wither rather, prematurely, long before they ought to do so; it is, therefore, for that reason that I recom-

mend fruit being stored away in a cool, damp place ; certainly it ought to be free from all noxious smell or disagreeable vapour." He also approves of the room being kept dark, and ventilation only given in cool windy days, "when occasionally all the doors and windows may be opened for a short time, merely to sweeten the air inside the house, by carrying the rank or stagnant air out of it—an operation only required occasionally."

By microscopic examination it will be found that the decay of fruit is often caused, and rapidly increased, by minute fungi, and that when the spawn of these fungi is once generated in a fruit-room, it spreads over the whole contents like a contagious disease. The seed, or spores, like those of all cryptogamic plants, are far too minute to be distinguished by the naked eye ; they, however, float in the atmosphere in innumerable quantities, and, in places congenial to their existence, their presence is more readily discovered by the sense of smell than by that of sight. They appear to float about like the motes in the sun's beams, until they find a favourable place of settlement, or they may possibly be attracted to it by some cause entirely beyond our conception. The nidus on which they establish themselves is those parts of fruits which have been torn, cut, or scratched ; there they insinuate themselves, and fructify amazingly. They are doubtless able also to introduce their microscopical spawn through the pores of even entire skinned fruits, and although with less activity, yet with equal certainty, they will soon cause their decay. This shows us the great necessity of removing every separate fruit the moment it exhibits symptoms of decay ; for, as soon as that is apparent, the seeds or spores of the fungus are perfected, and ready to be wafted in the air of the house to every part of it, and so increase the contamination ; for every speck of decay, however small it may appear to our vision, contains myriads of seeds, each capable of producing the very same effect when placed on a proper nidus, and under those circumstances most favourable for its reproduction.

No doubt there is a period of existence to which every kind of fruit, as well as every living thing, is limited. Natural decay, therefore, will at the end of these

periods take place without the agency of fungi ; and beyond this period all the art of man cannot extend it, so long as it is kept in its natural state and form. But, as Dr Lindley has observed, "it is one thing for the texture of a fruit to be destroyed by the ordinary agencies of decomposition at its natural period, and another for the action of those agencies to be brought on long before the necessary term of existence has been run out—by the ravages of parasites, the removal of which is to a considerable extent within our power." Hot lime is a great enemy to all the fungus tribe ; and hence it may be used in fruit-rooms, not only for the purpose of preventing their appearance, but also, to a certain extent, destroying those that may have already taken possession of it. Its known properties of abstracting moisture are so great that a bushel of unslacked lime has been calculated to absorb five gallons of water. The best mode of applying it is to place pieces of it in an unslacked state in shallow pans distributed about the house.

The method of preserving fruits practised by M. Deslongchamps, and announced in the "*Mémorial Encyclopédique*," consists in having recourse to artificial cold to retard their ripening, and so placing them in a stationary condition until he wished them to be brought to maturity at a late period of the season. The principle of his plan is to keep them free from moisture, and in a low temperature, as little above the freezing-point as possible. With this view he had zinc boxes made, 1 foot deep and 6 inches broad, with a detached lid of the same material, with a projecting rim. In these boxes he packed his finer pears, each enveloped in fine paper, and over that another covering of coarser paper. When the boxes were filled, he sealed them hermetically by pasting thick paper round the edge of the box and lid, packed them in wooden cases, and set these on the top of the ice in his ice-house. A dry medium around the fruit and a low temperature was thus obtained. A somewhat similar mode was practised by Columella for preserving grapes : they were packed in earthenware jars covered with lids, which were luted round with clay ; they were next coated with pitch and sunk in deep wells, where they were kept down by

weights, so that no part of them should rise above the surface of the water. Here, again, we have a low and uniform temperature.

The garrets of houses are too often converted into fruit-rooms. It would be difficult to find a worse situation than these, as they are more influenced by change of temperature than any other part of a house. Dry cellars, where a regular fruit-room is not deemed necessary, are the best part of a dwelling for this purpose; and in such the Continental fruit-growers and dealers preserve theirs.

With the exception of the quotations we have made in the beginning of this article from "The Gardeners' Chronicle," there has, in reality, been little written upon the subject of preserving fruit and the construction of fruit-rooms of much utility. The papers by the late Mr Knight in "The Horticultural Society's Transactions" are valuable; but they relate to practice only, excepting the following rationale, which merits attention: "A dry, warm atmosphere operates very favourably to the preservation of fruits under certain circumstances, but under other circumstances very injuriously; for the action of those electric attractions which occasion the decay and decomposition of fruits, is suspended by the operation of different causes in different fruits, and even in the same fruit in different states of maturity. When a grape is growing upon the vine, and till it has attained perfect maturity, it is obviously a living body, and its preservation is depending upon the powers of life; but when the same fruit has some time passed its state of perfect maturity, and has begun to shrivel, the powers of life are probably no longer, or at most very feebly, in action; and the fruit appears to be then preserved by the combined operation of its cellular texture, the antiseptic powers of the saccharine matter it contains, and by the exclusion of air by its external skin; but if that be destroyed, it immediately perishes. If longer retained in a dry and warm temperature, the grape becomes gradually converted into a raisin, and its component parts are then only held in combination by the ordinary laws of chemistry.

"A Nonpareil apple, or a Catillac or d'Auch pear, exhibits all the character-

istics of a living vegetable body long after it has been taken from the tree, and appears to possess all the powers of other similar vegetable bodies, except that of growing, or vitally uniting to itself other matter; and the experiments which I shall proceed to state prove that the pear is operated upon by external causes, nearly in the same manner after it has been detached from the tree, as when it remains vitally united to it.

"Most of the fine French pears, particularly the pear d'Auch, are much subject, particularly when cultivated in a cold and unfavourable climate, to crack upon the trees before they become full grown, and consequently to decay before their proper season, or state of maturity; and those which present these defects in my garden are therefore always taken from the trees to a vinery, in which a small fire is constantly kept in winter, and they are there placed at a small distance over the flue. Thus circumstanced, a part of my crop of d'Auch pears ripen, and will perish if not used in November, when the remainder continue sound and firm till March or April, or later; and the same warm temperature which preserves the grape in a slightly shrivelled state till January, rapidly accelerates the maturity and consequent decay of the pear. By gathering a part of my swan's-egg pears early in the season, (selecting such as are most advanced towards maturity,) and subjecting them, in the manner above mentioned, to artificial heat, and by retarding the maturity of the later part of the produce of the same trees, I have often had that fruit upon my table, nearly in an equal state of perfection, from the end of October to the beginning of February; but the most perfect in every respect have been those that have been exposed in the vinery to light and artificial heat as soon as gathered."

On the construction of a fruit-room, Maher, in the work last quoted, says: "The room may be of any form, but one long and narrow is generally best adapted for ventilation, and heating and drying when necessary by a flue. The system of shelves may be placed along one side, and may be raised to the height of 6 feet or more, according to the number wanted. The shelves are formed of open work, on which to place square sieves of fruit, each

of which should be numbered, and a table or slate containing the corresponding numbers may be hung up in the room; and opposite each number should be a space for noting down daily the number taken out of each sieve for use."

The fruit-room in the Horticultural Society's garden at Chiswick is a long, narrow apartment, having a northern exposure. The floors are formed of concrete, to prevent rats or mice from getting in; a counter-like table occupies the centre, and the sides are fitted up with shelves of open trellis-work, on which the fruit is laid. Such, we may here observe, is the general form and arrangement of what may be called the better sorts of fruit-rooms. The fruit-room at Dalkeith is almost a fac-simile of this one, being furnished with shutters to the windows inside, and box-ventilators *a* through to the ceilings, and extended to an opening in the top of the back wall, as will be seen by fig. 709. In this fig. we have shown

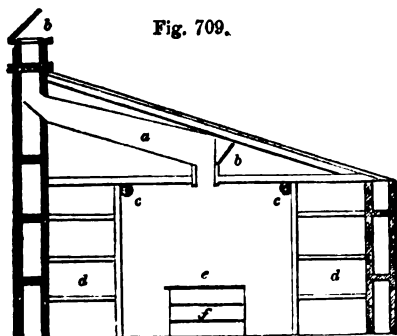


Fig. 709.

what we consider to be the best kind of building for this purpose. The walls are built hollow, to resist external damp, heat, and cold. Ventilation is carried on by an opening in the ceiling, and the damp or foul air made to escape through the box *a*, and out at the top of the wall. Both ends of this ventilating tube are to be shut, when necessary, by letting down the flap lids *b b*, to which a line and pulleys are applied for the purpose. The ceiling is triple-coated with plaster, and deafened with nogging above. The slates are laid in mortar, also to exclude air, and double-thick sarking is laid under them, tongued and grooved. Thin canvass curtains, hung on rollers *c c*, are let up and down in front of the shelves, to exclude air and light when it may be necessary to open

the door. The fruit is laid upon the side shelves *d d*, on both sides, and the operation of sorting is carried on on the counter-like table *c* in the centre. Under this table are drawers, *f*, for the finer specimens of both apples and pears. The whole of this apartment is darkened by keeping the window-shutters shut; and as the decomposition of fruit appears not to be so much affected by candle light as by solar light, the necessary operations are carried on by that light entirely. We have deemed it unnecessary to give a ground-plan of this erection, as it will appear sufficiently obvious and clear that a vestibule or entrance apartment may be made, in which specimens of the various fruits may be exhibited, and where the necessary operations of packing and arranging the dessert may go on. The side shelves may be enclosed by having folding-doors in front of them, and they may also be divided into compartments of from 6 to 10 feet in length each. If it be found inconvenient to have a fruit-cellar under such a room, it may, if of sufficient size, be divided into two apartments, one of which may be dedicated to the preservation of the later kinds, and therefore may be kept darkened and shut up; while the other department is set apart for cleaning, packing, exhibiting the fruit, and ripening it off for use.

Justice, Hitt, Forsyth, Smith, Stewart, Knight, and others, recommended and used earthenware jars, in which they packed their best fruit—the two former packed them in layers of moss, and sinking them to the depth of a foot in dry sand in a cellar, in preference to keeping them spread on tables or shelves in a fruit-room: the moss should be dispensed with. With this omission, there is little difference between their practice and that of Mr Knight, who also packed his in glazed earthenware vessels, each fruit being wrapped up in paper by itself. Prior to his using paper he used oat-chaff and dry moss; but eventually he abandoned both, as communicating a musty flavour to the fruit. The vessels used were perfect cylinders, about a foot in height—this being found a convenient form for packing them closely together to economise space. Stewart of Pinkie also used glazed earthenware vessels, provided with tops or covers, for his best fruit. In

the bottom of the jars, and between each layer of fruit, he put some pure pit-sand, which had been thoroughly dried on a fire. These jars were kept in a dry, airy situation, as cool as possible, but secure from frost. A label on the jar indicates the kind of fruit; and when this is wanted, or ought to be used, it is taken from the jars and placed for some time on the shelves of the fruit-room. The less ripe fruit is sometimes restored to the jars, but with newly dried sand. In this way he preserved Colmars, and other fine French pears, till April, the Terling till June, and many kinds of apples till July, the skin continuing smooth and plump. Although Mr Stewart's jars were placed in an airy situation, the air could not affect the fruit, as they were packed in fine sand, and carefully covered at top—in fact, as completely excluded from air as Knight's were in similar vessels, and having the spaces between the top of one and the bottom of another filled with a cement composed of two parts of the curd of milk and one of lime.

To those who have no proper fruit-room beyond a dry, airy, cool apartment, nothing can be better than packing their best fruit at least in earthenware vessels, either embedding the fruit in perfectly dry sand or dry fern, or not, and then packing the jars in dry casks, or in presses fitted up on purpose—the use of these latter being as much a safeguard against petty pilfering as against the natural decay of the fruit. An immense quantity of fruit may thus be kept in little space; while the commoner kinds used for kitchen purposes may safely be kept packed in dry fern in boxes, and piled up on top of each other. In such cases the name of each fruit should be affixed to the outside of the box, and, so far as possible, only one kind should be placed in each; or if two sorts or more are included, they should be assorted so that the contents of each box shall be fit for use at the same time. The best of all media for packing fruit intended to be kept to the latest period, is to place each in a small canvass bag, tied tightly at the mouth, and to embed them in dry casks or earthenware jars, amongst charcoal, not rendered too fine, or in well-dried peat earth—both of these being powerful antiseptics.

Some have furnished their fruit-rooms with shallow drawers, fitted into cases—each drawer only deep enough to hold one layer of large apples or pears, or two of the smaller kinds. Such an arrangement excludes air completely, as well as light, and of course secures great uniformity of temperature. The drawers are numbered on the front, and a list according with those numbers is hung up in the room. For the finer kinds of fruit this is an excellent plan; but it could hardly be carried out so as to contain the whole produce of a large garden, and is attended with very considerable expense. In an article in the "Edinburgh Encyclopædia" it is recommended that the fruit-room should consist of two apartments—a colder and a warmer; but the former, though cold, must be free from damp. From this the fruit is brought into the warmer room as it is wanted; and by means of increased temperature maturation is promoted, and the fruit rendered delicious and mellow. Chaumontelles, for example, are placed in close drawers so near to a stove that the temperature may be constantly between 60° and 70° Fahr. For most kinds of fruit, however, a temperature equal to 55° is found sufficient. The drawers are about 6 inches deep, 3 feet long, and 2 broad. They are made of hard wood, fir being apt to spoil the flavour of the fruit.

Fruit-rooms fitted up with shelves, if not less than 18 inches apart, may have fixed wires running longitudinally, to which the finer specimens of pears may be tied, so that they will hang in their natural position, and very much economise space. Those apples which retain their stalks may also be suspended in the same manner. It is also an excellent mode for hanging up late grapes, which, when laid on their sides, soon mould and decay. For preserving grapes, imperatrice, or Coe's golden-drop plums, a much drier atmosphere is required; therefore fruit-rooms are not the best place for the purpose, but a closet or room considerably elevated, which at the same time may be rendered dark and pretty airtight.

From all the foregoing opinions, it would appear that the conditions requisite for the preservation of fruit—we mean especially apples and pears—are,

*exclusion from air, a cool and uniform temperature, an atmosphere neither too dry nor too moist, and total darkness.* Is it, then, in fruit-rooms, as usually constructed, that fruit is to be expected to keep best, where they are exposed to the opposites of these conditions, and where even stoves and flues are recommended to be considered as necessary appendages? The subject appears to have been hitherto misunderstood. The whole operations have been carried on in one apartment, which ought to have been distributed among two or three—the first for arranging, the second for ripening, and the other for retarding. Two apartments, at least, are absolutely necessary—the one complying with all the conditions above stated for prolonging, and the other for ripening them off. This latter is in itself indispensable; and such a form as that exhibited in our diagram is of a very proper and fitting construction. In it the summer fruit should be placed as gathered from the trees; and the daily dessert fruit, and peaches, pines, apricots, plums, cherries, melons, &c., as they ripen, should be also deposited in it until disposed of. It should be at all times kept neat and clean, furnished with chairs and writing materials, paper, &c., for packing, and be in such a state that the owner may visit it with his friends. The means for admitting ventilation and light should be abundant when either is required; but as a moderately cool temperature should exist in it, it ought to face the north.

As regards the other department, we think it should be in a cellar under the former; but this cellar should be constructed with hollow walls, and even the floor of it laid over a vault, so as to cut off all chances of conduction of heat from the soil surrounding it. It should be so constructed as to be in all respects capable of fulfilling the conditions above stated. There may be an entrance to it through the floor of the former; and the necessary top ventilation may be carried up through the side walls, and the lower ventilation by tubes passing down the sides of the walls externally, and through them quite on a line with the floor. This mode of ventilation will exclude vermin as well as heated air. In regard to its internal arrangements, there can be no harm in having it fitted up with trellised

shelves, upon which to lay the fruit. A great portion, however, of the best should be packed in jars, upon Stewart's principle; the coarser kinds in casks or boxes, in dry fern; and the medium sorts in boxes mixed with dry sand. Each kind should be kept separate, as they will require to be examined, and, when necessary, removed to the ripening chamber above. For this purpose, they should be correctly named or numbered, to prevent mistakes. It is in cellars that the majority of the fruit on the Continent is kept. The construction of the houses is favourable for this purpose—they being in general cellared under nearly their whole extent. In these—at least those of them that we have visited—very little arrangement has apparently been made: the fruit often being laid in large heaps, sometimes buried in dry sand, packed in boxes or barrels, or indeed arranged in any way that will occupy as little space as possible. Notwithstanding all this apparent want of care, the fruit keeps well, and is from time to time carefully turned over, and the decaying ones removed. Indeed, in this particular they take great pains, and do not leave one that has the slightest incipient symptoms of decay. By this means they prevent the spread of the minute fungi alluded to in this section. Now, what is the cause of fruit so treated keeping so well? Can it be attributed to any other cause than that the conditions we have stated are complied with to the fullest extent? With them we see or hear of no expensive erection for keeping fruit, although the quantity over most of Europe is far greater than even with us. With them orchards and hedgerows of fruit-trees abound; and there is scarcely a meal we sit down to anywhere, from the palace to the cottage, without fruit in some shape or other making its appearance.

These general principles we have laid down are also in exact accordance with the method of keeping apples and pears, particularly the former, in pits underground, as is done with potatoes. We have kept apples till April and May in this manner; and once, on the 20th October 1838, had several bushels of apples of the growth of 1837 in excellent preservation. Apples, however, kept in this manner, soon decay when brought into the light and air; but if kept in

earthenware jars or similar cases, and buried, they may be taken up in quantities as they are required.

The great success attending the method of preserving fruit practised by Mr Moorman, Clapham Road, London, led that indefatigable pomologist, Mr Thompson, of the London Horticultural Society, to visit his fruit-room, and to draw up an account of it, which has recently been published in the *Journal of that Society*. This room, Mr Thompson observes, was not originally constructed for a fruit-room, but is a partitioned-off portion of a loft, which extends over a coach-house and stables, and was originally fitted up for a harness-room. The walls, as is usual in such places, are lined with wood; the roof is slated; the building is detached, and faces the south-west. There is "a cavity between the boarding and the walls," which Mr Thompson believes is an important circumstance, "and so is the wooden lining, because air and wood are known to be slow conductors of heat. The ceiling on the north side is double, and the floor is wood above a ceiling. We may therefore conclude," that authority says, "that a uniformity of temperature in the interior of the room is insured to a considerable extent." There is in this room a small stove; "but it is seldom used, and never with the view of warming the air of the room, unless the temperature is actually below freezing. The fruit is therefore kept cool." The window is occasionally opened, "but is at all times covered with a roller-blind, so that the fruit is kept in the dark. A little fire in the stove (air being freely admitted by the windows at the same time in a dry day) is useful for speedily removing any damp which may arise from the fruit. The shelves have a layer of clean drawn straw laid across them, and on this the fruit is placed singly."

From a consideration of all the above details, it may be inferred that, if a fruit-room be built over a place where there is a free circulation of air, its roof double ceiled, the walls lined with wood, a cavity being left between these two, it will possess the essential properties of a fitting house for the purpose.

Mr Thompson observes, "The more important principles necessary to attend to, with regard to the long keeping of

fruit, are, uniformity of temperature, coolness, and darkness. If the temperature is uniform, there can be little or no deposition of moisture on the surface of the fruit; but if the air of the room should be, say  $10^{\circ}$  warmer than the fruit, then the relative coldness of the latter will cause a condensation of the moisture contained in the air in contact with the fruit, just as a cold glass becomes dewed over when brought into a warm atmosphere. If the air is indeed very dry, then a proportionably greater difference of temperature is necessary to produce the above effect; but in winter the hygrometer seldom requires to be cooled more than a few degrees before it indicates a deposition of moisture. Fruits with smooth glossy skins, in close contact with the cold substance beneath them, are those most profusely covered with moisture"—the Nonsuch apple may be given as an example—"from the above cause. In russeted varieties, their dry rough coats serve as non-conductors of heat, and hence less moisture is deposited on them. When the air becomes colder than the fruit, a contrary action—that of evaporation—takes place, and the surface of the fruit becomes dry. But this wetting and drying must prove very injurious; whilst its cause—alternations of temperature—must likewise affect the specific gravity of the juices of the fruit."

The fruit kept in such a room as is described above "is not exposed to such vicissitudes; for when the weather becomes frosty, it is several days before the thermometer" in such a room "is affected as much as one degree."

In regard to ventilation, Mr Thompson remarks that air should only be given at a period of the day "when the thermometer outside indicates the same temperature as that in the room. No deposition of moisture can then take place in consequence."

In reference to a low temperature he says, "It is well known that this condition is favourable to the long keeping of fruit; for we act on the contrary principle when we wish to render any variety fit for use before its usual time." An elevated fruit-room, constructed like that described, is cooler on an average than one on the ground floor, and also more so than one sunk under the surface, more especially

during winter, the season when its advantages are most required.

Again, extreme cold is equally to be guarded against; for although apples and pears have been known to have kept long after being frozen quite hard, their flavour has in consequence been completely destroyed. This was exemplified a few years ago in the case of the specimens of the famous Boston nectarine, sent from the United States to London packed in ice. They arrived in apparently excellent condition, and, so far as plumpness and colour were concerned, they appeared as if fresh gathered from the trees; but, as regards flavour, they were found to be perfectly worthless.

It is difficult to lay down a rule as to the temperature at which a fruit-room should be kept; but somewhere between 40° and 50° may be taken as the extremes of heat and cold.

Darkness, as we have elsewhere remarked, is also considered by Mr Thompson as an essential in keeping fruit, because light accelerates its maturity, and consequently its ultimate decay. Therefore the darker the fruit-room is kept, even when air is admitted, the better; and this is effected in Mr Moorman's fruit-room by the blinds over the windows.

For the general management of the fruit-room, *vide* vol. ii.

### § 3.—ICE-HOUSES.

The history of ice, as applied medicinally, or for domestic purposes, although somewhat vague, may still be traced to a very remote period amongst civilised nations. The first notice of it used as a luxury and a medicine is that in the 51st aphorism of the second section of Hippocrates, or about 460 years B.C.; and so much was it then used that that learned physician, after detailing a long catalogue of ills attending its immoderate use, concludes by saying—"But for all this, people will not take warning; and most men would rather run the hazard of their lives or health than be deprived of the pleasure of drinking out of ice." In the history of one of the Ptolemies we find an account given of an entertainment to his nobles, served in double vessels lined with ice; and the Romans, during the Empire,

VOL. I.

regarded ice and snow as essential both to luxury and health—as may be drawn from the expression *Nivatae potiones*, which shows that cool drinks were in much esteem. Some of the practices still recommended for preserving ice are of very ancient date,—one of which is, pouring boiling water on the ice while in progress of packing in the ice well. This has, no doubt, the effect of expelling the air from the water, and causing it much sooner to congeal. Mixing common salt or saltpetre with ice or snow was well known to Lord Bacon as increasing the amount of cold. Even common salt, mixed with ice or snow, will reduce the temperature to 0° of Fahrenheit; "and this at one time," says Masters in his "Ice Book," "was imagined to be the utmost intensity of cold that could be produced." But, says the same authority, "by similar admixtures of salts in various proportions and diluted acids, a much greater reduction of temperature can be produced."

Till of late years little improvement has been made in buildings for the storing of ice, or in the means of preserving it. Recent discoveries almost lead us to conclude that ice and snow can be preserved throughout the year without their aid altogether.

Some very interesting information on the subject of keeping ice will be found in the "Supplement to the Encyclopædia Britannica" (art. *Horticulture*), "Pharmaceutical Times," "Prospectus of the Wenham Lake Ice Company," "The Ice Book," by Masters, "Nouveau Cours d'Agriculture," (art. *Glazier*), Rozier's "Diet of Agriculture," and the "Prospectus of the Rockland Lake Ice Company." From the latter of these the following extract is taken, to show the importance of ice as an article of commerce, and also as an estimate of its value in different States: "There are in Boston, United States, sixteen companies engaged in transporting thousands of tons of this arctic crystal ice to the East and West Indies, to South America, and even to this country. In 1830 the quantity of ice shipped from Boston to distant parts amounted to 50,000 tons; from Charlestown it was equal to 30,000." The following may be of practical utility in guiding to the selection of ice in this country: "Ice frozen upon very deep water is much more com-

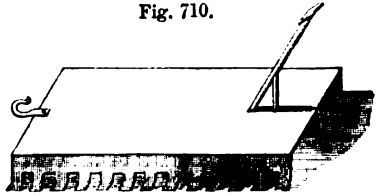


compact and solid than that which is procured from the surface of shallow lakes and streams; and, therefore, even when an equal surface is exposed to the atmosphere, the former melts more slowly than the latter. Now, the ice in America is derived from lakes of great depth, sometimes as much as 200 feet; and the severity of the cold, which in winter falls several degrees below zero, combined with this fact, renders the ice from the American lakes famous, not only for its solidity, but for its magnitude likewise—it being allowed to *grow* till it attains 12 inches in thickness. Thus, the ice being much thicker than any that is usually procurable in this country, it exposes a less amount of surface to the deliquescent action of the air." When the ice is taken from the lake for filling the ice-houses, which are usually wooden shed-like structures entirely *above the ground surface*, it is cut up into blocks 21 inches square, and, as stated above, a foot or more in thickness. These blocks are piled together whole, being cut with instruments for the purpose. It is often transported as ballast for ships, and, in such cases, is cut into blocks of such shapes as may best pack in the hold of the vessel. It is merely covered with sawdust, straw, or charcoal, all non-conductors of heat, and in this state is frequently carried to distant countries. When shipped as regular cargo, the blocks are packed in thin, airtight timber boxes, with straw and hay. In this state the ice is sent to the East Indies, and in one case is known to have been exchanged for cotton, weight for weight, and the cotton brought to England and sold at a handsome profit. Figs. 710 to 714 will show the implements used in preparing the ice.

"From the time when the ice first forms it is carefully kept free from snow until it is thick enough to be cut. A surface of some 2 acres is then selected, which at that thickness,"—1 foot,—“will furnish about 2000 tons:” a straight line is then drawn through its centre from side to side each way. A small hand-plough is pushed along one of these lines until the groove is about 3 inches deep and a quarter of an inch in breadth, when the marker, fig. 710, is introduced. This implement is drawn by two horses, and makes two new grooves parallel with the

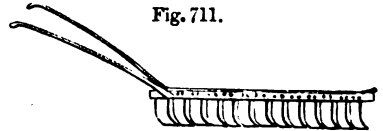
first, 21 inches apart, the gauge remaining in the original groove. The marker

Fig. 710.



is then shifted to the outside groove, and makes two more. Having drawn these lines over the whole surface in one direction, the same process is repeated in a transverse direction, marking all the ice out into squares of 21 inches. In the mean time the plough, fig. 711, drawn by

Fig. 711.



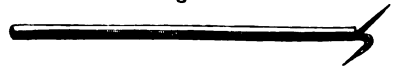
a single horse, is following in these grooves, cutting the ice to a depth of 6 inches. One entire range of blocks is then sawn out with the ice-saw, fig. 712,

Fig. 712.



and the remainder are split off, toward the opening thus made, with an iron bar. This bar is shaped like a spade, and is of a wedge form: it is called the splitting-bar. When it is dropped into the groove the block splits off, a very slight blow being sufficient to produce that effect, especially in very cold weather. Platforms or low tables of framework are placed near the opening made in the ice, with iron slides extending into the water, and a man stands on each side of this slide armed with an ice-hook, fig. 713.

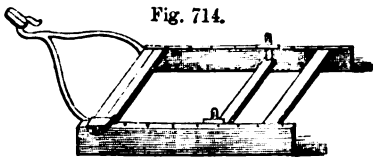
Fig. 713.



With this hook the ice is caught, and, by a sudden jerk, thrown up the slide on to the platform. In a cold day everything is speedily covered with ice by the freezing of the water on the platforms and slides, and the enormous blocks of ice, weighing some of them more than 2 cwt.,

are hurled along these slippery surfaces as if they were without weight. Beside this platform stands a sledge of the same height, capable of containing about 3 tons, which, when laden, is drawn upon the ice to the front of the storehouse, where a large stationary platform of exactly the same height is ready to receive its load, which, as soon as discharged, is hoisted, block by block, into the house by horse power. This process of hoisting is so judiciously managed that both the taking up of the ice and the throwing it into the building are performed solely by the horse. The frame which receives the block of ice to be hoisted is sunk into a square opening cut in the stationary platform, the block of ice is pushed on to it, the horse starts, and the frame rises with the ice until it reaches the opening in the side of the storehouse ready for its reception, when, by an ingenious piece of mechanism, it discharges itself into the building, and the horse is led back to repeat the process.

When a thaw or fall of rain occurs, it entirely unfits the ice for market, by rendering it opaque and porous; and occasionally snow is immediately followed by rain, and that again by frost, forming *snow-ice*, which is valueless, and must be removed by the ice-plane, fig. 714. The



operation of planing is somewhat similar to that of cutting. A plane, made to run in the grooves made by the marker, which shaves the ice to the depth of 3 inches, is drawn by a horse until the whole surface of the ice is planed. The chips thus produced are then scraped off, and if the clear ice is not reached the process is repeated. If this makes the ice too thin for cutting, it is left *in statu quo*, and a few nights of hard frost will add *below* as much as was taken from *above*.

The various applications of ice, as well as the best modes of keeping it, have never been fully appreciated or understood in this country. The very careless mode of collecting it from stagnant pools and filthy

ditches is a convincing proof of the statement just made. Its extreme impurity renders it unfit for any other purpose save that of merely cooling wine or other viands enclosed in bottles or well-covered dishes. The very circumstance of laying fish, game, pastry, fruit, &c., upon pounded ice, as we in general have it in the ice-bins or refrigerators in use in every gentleman's house, is little short of disgusting. Nor can we enjoy those cooling draughts so much prized by the French, Italians, and Americans, obtained from melted ice, or pieces of it thrown into their water decanters; or have fresh butter eatable in the dog-days comparable to what it would be if served up in iced water, and surrounded by pieces of the same pellucid material. The perfect purity of the American ice fits it for table use; and, accordingly, it is the constant practice in America to mix it with water or milk for drinking, to dilute wines and spirits with it, and to place it on the table in direct contact with butter and jellies.

From these facts, briefly quoted from American practice, we learn, first, That ice, to be valuable, ought to be pure, and that pure ice cannot be obtained but from clear and wholesome water; secondly, That ice should be transparent, unmixed with snow, and still more with decaying vegetable and often animal matter; thirdly, That it should be thick, and, instead of being pounded to almost a powder, should be stored by in pieces 21 inches square, or thereby, and, if it can be procured, 12 inches thick. But as we seldom in Britain have it so thick, we calculate that, if it be half that thickness, which it often is, it will answer every purpose completely; or if we extend the surface area to make up for the difference in thickness, it may be found to keep nearly as well, although we are quite aware that a cube or sphere of ice will keep longer than the same amount spread over any figure presenting a greater surface. Ice in its natural state must be more solid than when broken up even to powder, and packed as tightly as man can do it, and consequently must be less liable to the melting process. And here the question arises, Would it not be better to pack our ice in as large pieces as we can, and fill up the spaces between these with pounded ice prepared on purpose? Fourthly, The

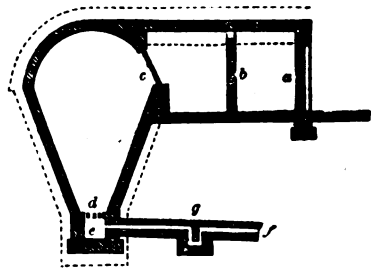
Americans use no salt—nor should we do so. They store their ice in wooden buildings on the surface, and thus save the expense of costly wells, excavated to a great depth. For covering they use sawdust, straw, and charcoal, the best of all non-conductors of heat. Their houses being upon the surface, damp cannot injure them. Fifthly, snow, being produced at a much higher temperature than ice, does not keep so well; and ice being in the best state for packing when quite dry, applying water to it must be injurious. Finally, considerable allowance must be made for climate, we having never such depressions of temperature in Britain as the Americans have. We have, however, plenty of ice from 6 to 8 inches in thickness—sometimes more—in most seasons, and in many situations, particularly on lakes in districts high above the sea. Why, therefore, should not proprietors having such lakes form ice-stores on their margin, and procure a supply of pure and clean ice for their own use, and even for the supply of the London, Liverpool, Manchester, and other markets? Railroads intersect the very districts to which we allude, or will ultimately do so, within short distances of beautiful and pellucid lakes. Artificial ones could easily be formed by throwing embankments across valleys, the ends of which might in many cases be within a few yards of a railway line. As much ice could be taken from the lake near Carnwath, within 20 or 30 feet of the Caledonian Railway, as would supply London and Edinburgh, or all the intermediate towns, abundantly, and afford employment to the poor at the most needful season, as well as yield a handsome return to the proprietor.

Whether any enterprising individual or company will attempt such a scheme, we know not; this we must however admit, that the Americans have shown us the example, and have not only converted a material, with which our country also abounds, into money, but have reduced the traffic in ice to such a system or order as to render it an article of very considerable commercial importance. A pond or lake of 2 acres extent, at 1 foot thick of ice, will yield 2000 tons, which, at 1d. per lb., would give £9, 6s. 8d. per ton, or £18,666, 13s. 4d. for 2 acres.

The annexed plan, fig. 715, is very per-

fect of its kind, on the principle upon which ice-houses have hitherto been built.

Fig. 715.



It will be understood by the following description: Three-fourths of the building is under the ground-level, the remainder being covered with soil, and rendered perfectly waterproof over the top. The situation is on the side of a hill or sloping ground, perfectly dry, and, if possible, facing the north. The principal advantage in choosing sloping ground is, that the drain *f*, for taking away the waste or melted ice, may be more conveniently constructed. This drain should terminate in a pond or river, so that the end of it may be under water, to prevent the entrance of air. Still further to effect this end, air-traps should be introduced as at *g*, and more than one is requisite if it be a built drain; if a pipe, one or two swan-necked bends will answer equally well. Under the bottom of the ice-chamber should be a well or cistern *e*, into which the melted ice may drain through a grating, or plate of iron perforated with holes, *d*. The side walls are to be carried up in 2-foot work, if of rubble stone, or 14-inch work, if of brick, puddling a space of not less than 2 feet in width between the back of the wall and the sides of the excavation. This puddling is to be carried up along with the building; and after the roof is domed over, the puddle should be increased to 3 feet, the more effectually to keep out the wet. The space between the wall and dotted line shows the puddle. It is probable that a stratum of stones, laid loosely in, should intervene between the puddle and the wall of the house, as a means of keeping the walls dry, and also cutting off, to a certain extent, the conduction of heat from the earth to the wall. A still more efficacious way of securing this would be to introduce a

layer of charcoal 18 inches or 2 feet thick instead of the stones. The best plan of all would be to build the walls hollow, or to build two walls with an interval between them, and to pack the space between with some non-conducting material. The only advantage of having ice-houses sunk under the ground-surface is the facility with which they can be filled from the top; but it is questionable if this convenience is not more than balanced by the difficulty of keeping such underground walls dry—and upon this much of the keeping properties of ice depends. The entrance should be from the ground-level, and the passage furnished with three doors, *a b c*, fitted into the door-frames as closely as possible, the better to exclude the air. The innermost of these, *c*, need not be a full-sized door, as shown in the figure; and instead of its opening by hinges in the ordinary manner, it should consist of separate oaken planks made to fit into a groove at both sides, and so be lifted out and in when the ice is being taken out. A better construction for it still would be to form it of two plates of iron made to run on a small rail, and carried into a slit in the wall at both sides, fitted with a cast-iron frame to receive them—the iron plates to be flanged at the ends, so that, when shut, they may fit the frame so closely as to exclude the air. It will be seen also, from our figure, that it is filled through the passage, a case often rendered necessary from local circumstances, and where the more speedy mode of filling from the top may either be impossible or inconvenient. We may here remark that cast or wrought iron doors would be more desirable than wood in such situations, but they are more difficult to render air-tight.

In regard to size, every ice-house should be made large, even for a small family; as, if all is properly done, ice may be kept for two or three years. This is a point of much consequence in parts where ice is difficult to procure—as at Dalkeith, for example, where, from the absence of ponds and the mildness of the seasons, and probably from the North and South Esks being chiefly supplied by springs and the drainage of the deep coal-mines in the neighbourhood, they are seldom so reduced in temperature as to form into ice. Be this as it may, during the

last ten years we have only had a full supply of ice twice wherewith to fill our ice-house, and in both cases very little of it has been from the rivers. We have therefore been constrained to use snow as a substitute, and last year to import ice from Norway. Mr Loudon has sadly miscalculated as regards the dimensions given in his "Encyclopædia of Gardening" regarding the size of ice-houses; for after stating the advantages of having a two or three years' supply of ice laid in, he says, "Where the quantity wanted is not great, a well of 6 feet diameter and 8 feet deep will be large enough; but for a large consumption, it should not be less than 9 or 10 feet diameter, and as many deep." In the first instance, we do not think such a well would afford a bushel of ice in July; and in the latter, it would be exhausted by September, even were very little taken out for use. The larger the bulk, we have always found the ice to keep in proportion longest.

Figs. 716, 717, exhibit another example of an ice-house somewhat different in

Fig. 716.

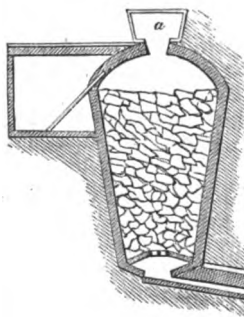


Fig. 717.



construction from that just described. The waste-water drain, with air-traps, &c., as well as the cavity under for receiving the melted ice or snow, and the puddling around the sides and over the top, are all much the same as in the last example. The difference in this case consists in the ice being thrown in from the top *a*; and the passage, instead of being straight, is zig-zag, as shown in the ground-plan, fig. 717—all of which are improvements. Although we have recommended that ice-houses should be built air-tight, it does not follow that ventilation is not of advantage at times, as will be noticed hereafter.

The ice-house is in general placed in some obscure and out of the way sort of place, and often, to get it completely hidden, is situated at a most inconvenient distance from the mansion, entailing great and unnecessary waste of time in supplying the ice for domestic purposes. Why this is so, it is difficult to say; and why the ice-house itself has not been made ornamental as well as useful, is equally strange. The section and elevation, figs. 718, 719, will show how this could be

Fig. 718.

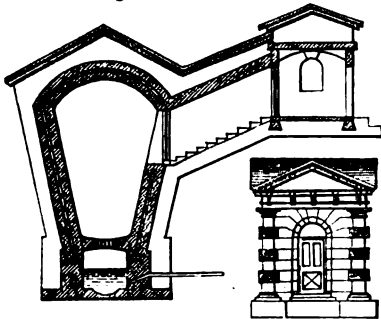


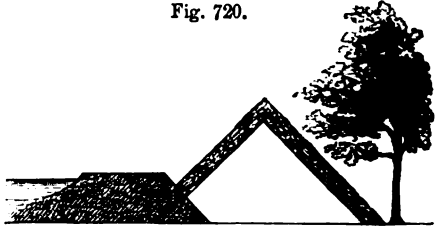
Fig. 719.

effected, and also how it may, in many instances, be brought within a convenient distance of the house, by having the entrance constructed as in fig. 719, and which may be used as an alcove or resting-place, rendered sufficiently ornamental by giving it a slight expression of architectural character.

Preserving ice in stacks on the surface has been for years more or less practised, and with various degrees of success—this success of course depending greatly on the situation chosen, and the care with which the operation was performed. Mr Pearson of Kinlet, in the first number of "The United Gardeners' Journal," brought the subject prominently forward in a way which at the time attracted considerable attention, as, even in regard to what were considered well-constructed ice-houses, complaints had often arisen that the ice did not keep in them. In addition to this, the expense of building an ice-house fit for the supply of an ordinary family runs, in general, from £70 to £100—of course depending a good deal on the expense of the material in the locality. By the method now proposed this expense is saved, and a supply of ice produced at little more than the cost of annually filling an ordinary ice-house.

In the third number of the paper last quoted, Mr Pearson has republished his mode of proceeding, accompanied with a section of the ice-stack when finished, fig. 720. The ice is collected and broken

Fig. 720.



small much in the usual manner. "After the work has got a fair start, thirteen or fourteen men are employed in breaking the ice as small as possible with wooden mallets, while five or six are taking it off the pool and casting it to the mound;" for, as will be seen by the diagram, the stack is formed close to the pond, so that no carting is required. "Thus the work proceeds till the mass is 1 or 2 feet thick, when two of the beaters lay down their malls and take up large paving rammers and commence ramming the ice down into a compact body. The ramming, being, if well kept up, the hardest work in the process, is done in turn by the men. The accompanying sketch represents the mound of ice we made early in December 1844, 15 feet high, with a base of 27 feet, and a covering of fern, as there indicated, about 3 feet thick; and though the cattle frequently trample round it during the summer, and almost expose the sides of the heap to the atmosphere, yet we have a considerable stack of ice left," (January 1846.) As some doubts have been expressed as to the keeping of ice by this means—although we have no doubt of it ourselves, considering the great respectability of the author of this paper—we will, in justice to him and our readers, continue our extracts from his paper:—

"Ice being scarce in the winter of 1843-4, we embraced the first opportunity of making a mound of snow. We made it at the head of the pool, so that if ice could be got at any future time during the winter, it might be easily added to the snow. In the morning of the second day we found ice an inch thick on the pool, and the second day's work was, therefore, a mixture of snow and ice, the

whole of which was watered as the work proceeded. This mound of snow and ice afforded a regular supply till May 1845, notwithstanding the mound was exposed to the broiling sun of 1844.

"No doubt but the situation of the mound has considerable influence over the preservation of the ice, and in some situations it may be necessary to form the ground where the ice is to be laid into an *ogee*, that the water may drain from the ice as it melts into the hollow or ditch which surrounds the mass: the same ditch will also prevent any water from foreign sources finding its way to the bottom of the ice. The spot where we generally make our ice-mound is shaded by a large oak tree, which has been considered by some persons to act as a preservative to the ice; but it is probable that the same shade which prevents any given amount of heat from being directed against the mound by day, also prevents radiation both by day and by night—and this tends to make the situation of about the same average temperature as would be experienced in an exposed situation of the same altitude.

"Where fern cannot be got to cover with, any non-conductor may be used, such as dry refuse hay, straw, dead leaves, &c., afterwards thatched to prevent the rain-water from running through the covering to the ice, which would melt it away rapidly." Mr Pearson says, "We never thatched our ice-mounds but in one instance; and I do not remember," he adds, "that the ice either kept better or worse for it. But then it must be borne in mind that the fern we cover with is always dry, and when placed 3 feet thick over the ice, in the form of a cone, does not in some summers get wet through; though this was the case last season—and the ice was wasted more than usual from that cause alone." At least such is Mr Pearson's opinion, and there can be no doubt it is correct. In forming ice-stacks, the first thing to be considered is choosing a dry situation, and one not much shaded with trees. Most people agree in the necessity of breaking the ice into as small pieces as possible, and some recommend introducing alternate layers of snow; which we think a good practice so far as ice for ordinary purposes is required, but not when it is wanted quite pure for mixing with water, wine, &c., as it fills up the

spaces between the pieces of ice, and thereby tends to exclude the air. Some use the snow dry, and others in a melting state: in the latter state, particularly if a sharp frost follows before the thatch or covering is put on, the consolidation will take place sooner and more effectually. This is, however, at variance with American practice.

"To keep ice in stacks or heaps in the open air, an elevated circular platform is raised of earth: on this the ice is piled up in a conic form during a severe frost, and the addition of water enables the builder to form the cone very steep. On this some wheat-straw is laid a foot in thickness; over this a stratum of faggots, wood, or spray; and, finally, another thick stratum of thatch or long litter of any sort. In this way ice will keep a year, care being taken to expose it to the air as short a time as possible in taking supplies."—*Encyclopædia of Gardening*.

In regard to situation for ice-houses or ice-stacks, the prevailing opinion now is that it should be dry, elevated, and fully exposed, and by no means under the shade or drip of trees, as formerly erroneously recommended.

Still there are others who advocate "the good old plan;" and amongst them the most scientific reasons for this system are given by Mr Corbett of Pencarrow, in a communication to "The Gardeners' Chronicle." After expressing his opinion in favour of situations shaded by trees, &c., he says, "As the earth is warmest in summer, being heated in a great measure by radiant heat proceeding from the sun, it is at that period that the heat is transmitted from the surrounding earth to the ice-house with the greatest velocity; and the melting of the ice takes place in proportion to the difference in temperature between the stored ice and the surrounding medium. This difference is increased either by the earth which surrounds the ice-house becoming heated by the rays of the sun, or by the freezing point of the ice becoming lowered by a mixture of salt. It is, therefore, a desirable object to keep the surrounding earth as cool as possible. If the ice-house is surrounded and overtopped with large trees, their effects will be—first, To shield off the rays of the sun from the earth below; and secondly, The great surface of

foliage exposed to the light and air will be continually giving off water in the form of vapour, which, in its transformation from water to vapour, will have taken up 950° of heat in a latent state more than the water contained, and expanded into about 1.690 times its former volume, having in effect destroyed 950° of sensible heat for all the water given off, (the quantity of which is known to be very great in hot and very dry weather.) A coolness is therefore produced under the shade of large trees, which is not to be found in exposed situations, produced, it may be presumed, not only from the shade of their foliage, but from the evaporation of water from their surfaces; but the still air beneath being an excellent non-conductor, the earth below will be found several degrees colder than that which is exposed. Again, the drip of trees from accumulated dew, &c., instead of being injurious, must be beneficial; because the surface of the soil will be partially wet when that of exposed ground will be quite dry. The evaporation from the surface will produce a coldness below. But it may be said, that though the mere surface of the earth under large trees is often damp when exposed surfaces are dry, yet the earth below is much drier under and about the roots of large trees than anywhere else. This I consider a great advantage: dry earth is a much better non-conductor of heat than wet; and I contend that the rain which falls where large trees are is evaporated in a larger proportion from that surface than if it fell in an exposed situation. It appears to me that the best of all places for an ice-house is the side of a hill covered with large trees, three-fourths of the house being sunk beneath the surface of the ground, and the top being covered over with earth and planted with ivy."

The Chinese, who differ widely from Europeans in many of their operations and artifices, even when the same end is in view, do so conspicuously as regards the subject at present under consideration. We learn, from "The Chinese Repository," that the ice-houses around Ning-po are numerous, and in general on the banks of the river. They are not built underground, but above the surface, and generally upon a platform of earth so elevated as to be out of the reach of the

freshes or "floods," whether of the river or of the surrounding swamps. Upon this mound a bamboo frame is thrown, which is well and closely thatched with paddy straw. The ice is collected from the surrounding fields, or from tanks and ponds, which the proprietors of the ice-stores fill with water during the winter season. When it is of a sufficient thickness it is collected; and, as it is brought in, each layer is covered with dry straw, which preserves it during the whole summer. Each ice-house has its drain to carry off the meltings. This article is not used at Ning-po but as an antiseptic for flesh and fish during the heat of summer. The people know nothing of cooling their liquids, except as they have observed foreigners use it for that purpose, and they are quite content to retail it at a very low rate."

Mr Fortune, who resided some time in China, describes a Chinese ice-house, of which he has given drawings, one of which we have copied, fig. 721, from the

Fig. 721.



"Gardeners' Chronicle," 1845, p. 576, as well as the following account of the building: "The bottom of the ice-house is nearly on a level with the surrounding fields, and is generally about 20 yards long by 14 broad. The walls, which are built of mud and stone, are very thick, 12 feet in height, and are, in fact, a kind of embankment rather than walls, having a door through them on one side, and a kind of sloping terrace on the other, by which the ice can be thrown into the house. On the top of the walls or embankment a tall span-roof is raised, constructed of bamboos, thickly thatched with straw, giving the whole an appearance exactly like an English haystack. And this is the simple structure which keeps ice so well during the summer months under the burning sun of China. The Chinaman, with his characteristic ingenuity, manages also to fill his ice-

house in a most simple way, and at a very trifling expense. Around the house he has a small flat level field, which he takes care to overflow in winter before the cold weather comes. It then freezes, and furnishes the necessary supply at the door."

From the circumstance of the ice-house being shut up as soon as it is filled, and seldom examined until a supply is required, we can know little of the operations going on, or of the changes the snow or ice may be subjected to, in the very best constructed houses that we can with our present knowledge build. Heat and moisture, we are well aware, tend to the melting of the ice; and it is probable that vapour, formed and confined in a closely shut up place, may also have its bad effects. Should it be ascertained that the latter is the case, then recourse must be had to moderate ventilation for its escape. This is a matter which deserves our serious consideration, as well also as the propriety or impropriety of sinking our ice-houses under the ground surface. A great deal of the success of keeping ice depends on the temperature at which it has been frozen. The ice of the Polar seas, that of the lakes in Canada, and such as is formed in equally low temperatures, keeps much better than that formed in Britain. Even with ourselves, indeed, that formed in severe winters keeps much better than that of mild ones. In some years it keeps till the return of the icy season, while in others it is all melted by the beginning of September, although kept in the same house, and managed in the very same manner.

Ice-houses, we believe, will no longer be built under ground, but on the surface; and we question much whether wooden structures will not be found the best. The sides may be built on the principle of hollow walls, the uprights being of 9-inch battens set edgewise, and boarded up on both sides, leaving a vacuum of 9 inches between; or this space may be filled up with dry straw or sawdust, finely sifted coal-ashes, or any other non-conducting material. The roof should be thatched with straw, reeds, or heather, at least 2 feet in thickness, and the sides covered with the rugged bark of trees or with moss, or panelled off in ornamental patterns with straight rods of hazel, larch,

or otherwise, in imitation of rustic work. The late Mr Cobbett, thirty years ago, stated plainly, in his "Cottage Economy," the cause why ice will not keep in underground wells. "In England," he says, "these receptacles of frozen water are generally under ground, and always, if possible, under the shade of trees,—the opinion being that the main thing, if not the only thing, is to keep away the heat. The heat is to be kept away, certainly; but moisture is the great enemy of ice; and how is this to be kept away under ground, or under the shade of trees? Abundant experience has proved that no thickness of wall, that no cement of any kind, will effectually resist moisture. Drops will, at all times, be seen hanging on the under side of an arch of any thickness, and made of any materials, if it have earth over it, and even when it has the floor of a house over it; and whenever the moisture enters, the ice will speedily melt." This may arise from two causes—filtration or condensation. "Ice-houses should, therefore, be in all their parts as dry as possible; and they should be so constructed as to insure the running away of the meltings as quickly as possible. The ice-house should stand on a place quite open to the sun and air. The next thing is to protect the ice against damp from beneath. It should, therefore, stand on some spot from which water would run in every direction; and if the natural ground present no such spot, it is no very great job to make it. Then comes the materials of which the house is to consist. These, for the reasons before mentioned, must not be bricks, stone, mortar, or earth, for these are all affected by the atmosphere; they will become damp at certain times, and dampness is the great destroyer of ice. The materials are wood and straw. Wood will not do; for, though not liable to become damp, it imbibes heat fast enough; and, besides, it cannot be put together so as to shut out air sufficiently. Straw is wholly free from the quality of becoming damp, except from water actually put upon it; and it can, at the same time, be placed on a roof, and on sides, to such a degree of thickness as to exclude the air in a manner the most perfect. The ice-house, therefore, ought to be made of posts, plates, rafters, lathes, and straw. The best form



is the circular ; and the house, when made, appears as I have endeavoured to describe

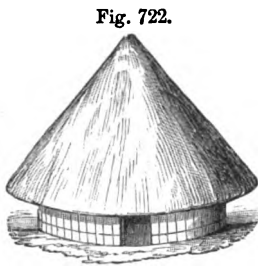


Fig. 722.

post ought to be about 9 inches through at the bottom, and not a great deal smaller at the top.

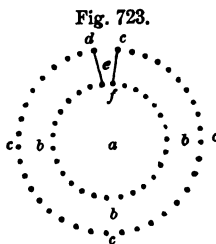


Fig. 723.

Great care must be taken that this post be perfectly perpendicular, for if it be not, the whole building will be awry. *b b b* are 28 posts, 9 feet high, and 6 inches through at the bottom, without much tapering towards the top. These posts stand about 2 feet apart, reckoning from centre to centre—which leaves between each two a space of 18 inches ; *c c c c* are 38 posts, 5 feet high and 5 inches through at the bottom, without much tapering towards the top. These posts stand about 2 feet apart, from centre to centre, which leaves between each two a space of 19 inches. The space between these two rows of posts is 4 feet in width, and, as will be presently seen, is to contain a wall of straw ; *e* is a passage through this wall ; *d* is the outside door of the passage ; *f* is the inside door ; and the inner circle, of which *a* is the centre, is the place in which the ice is to be deposited.”

The walls are to be formed between the posts, of clean wheat or rye straw, laid closely and smoothly. Plates of wood are to be laid on the top of the two rows of posts for receiving the rafters of the roof. The roof should not be at a lower angle than 45°, and should be covered with strong laths, to which the roof thatch is to be secured. This thatch is to be of wheat or rye straw, and 4 feet thick. The bed for the ice to be laid upon is recom-

mended to be formed by laying round logs, about 8 inches in diameter, across the area, leaving spaces between them of about a foot. Over these, poles, about half the size of the last, are to be laid across in an opposite direction, and 6 inches apart ; over these a third course, 2 inches diameter, and 3 inches apart ; upon these, again, a course of still smaller rods 1 inch apart ; and, finally, upon these 2 inches of dry twigs and branches, or strong heath free of moss or grass. Upon this bed the ice is put, broken and pummelled and beaten down together in the usual manner. When the house is filled it is shut up in the usual way.

Such a house would, undoubtedly, keep ice well ; but for a family, of even moderate consumption, such a scale would be far too small, for, according to the calculations made by Mr Cobbett, such a house would only contain 375 cubic feet of ice ; not much more than a cubic foot per day throughout the year, admitting that no waste takes place by melting. A difficulty presents itself as regards filling such a house, at least the filling it quite to the top. We are not a little surprised at this omission, particularly in one who was in general so diffuse in his descriptions, and who professed, at least, to study economy in everything.

An anonymous contributor to “The Gardeners’ Chronicle,” 1844, p. 572,

offers the following plan, fig. 724, of a cheap ice-house, and proposes to have several such, instead of one large one—as, by frequently opening the house to take out the supply, “the air,” he says, “gets in, and causes the ice to dissolve before a third of it is consumed.” From the small size of such a house we would be apprehensive that the ice would not keep three months.

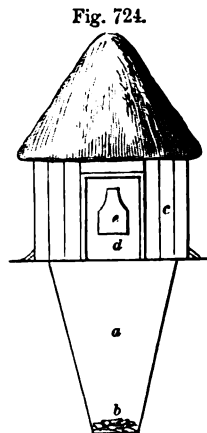


Fig. 724.

The drainage below we consider perfectly inadequate, unless the stratum in which it is sunk is of porous gravel. One new, and we think good, feature in

this plan, is the ventilation in dry arid weather.

“Reference to plan—*a*, a conical hole in the ground; *b*, stones or rubble to act as a drain, 18 inches; *c*, slabs 4 feet high above the surface; *d*, door; *e*, trap-door, to answer a similar one on the opposite side, to be opened in a dry air, and care-

fully closed when the circumambient atmosphere is damp.”

“The Gardeners’ Chronicle” has, during the last few years, been, and very properly, filled with plans and descriptions of ice-houses. We say very properly, because, with very few exceptions, there have neither been drawings nor descrip-

Fig. 725.

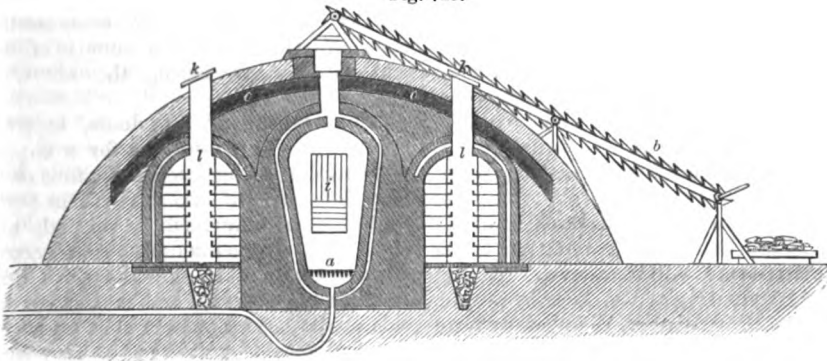
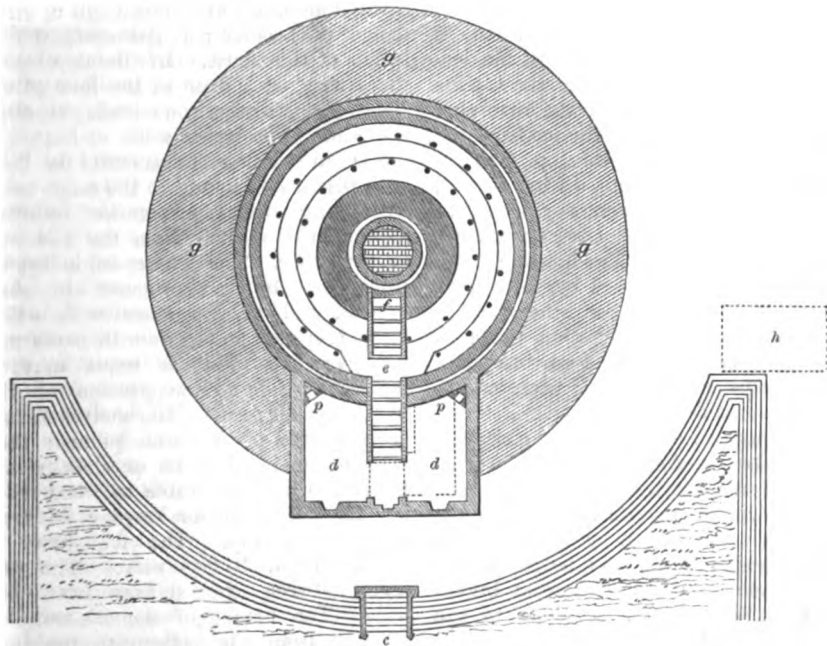


Fig. 726.



tions of this kind of building published in works on gardening in general. The ice-house and fruit-room combined, represented in the annexed ground-plan and

section, figs. 725 and 726, are very complete, although we do not approve of combining the two together; nor can we sanction the complicated mode of filling

in the ice by an endless canvass, as it is both inconvenient and expensive. The idea of placing the ice-house at the end of a bowling-green, from whence the supply of ice is to be procured by flooding the latter upon the approach of frost, is all very well, and perfectly practicable, and invaluable in situations where ice is difficult to be got; but to render the bottom of the bowling-green so impervious to water as to retain it till it becomes frozen, must of necessity render it at all other times very unfit for its legitimate purpose—as bowling-greens, like lawns, can hardly be made too dry. Do away with the term bowling-green, and substitute curling or skating pond, and our objection is removed. Building the walls hollow, and with brick, is excellent, as well as that of keeping the house nearly above the ground-level. Taking this example as a whole, it is by far the most complete house of the kind we have ever seen drawings of. We do not suppose, however, that it will keep ice better than Cobbett's, already described, if both were of an equal size.

The following is a brief description, as given by the inventor:—"a is the ice-house, with a circular hole in the top for filling; b an endless canvass, revolving on rollers, for conveying the ice from the ground to the hole at the top; c is one end of the bowling-green; d d two rooms; e entrance to fruit-rooms; f ice-house door; g part of the circular mound covering the whole. The bowling-green is intended to be flooded by water from a *jet-d'eau* or fountain, or otherwise, to the depth of 2 feet, and thus made to serve for a curling-pond, ice-house pond, or skating-pond during winter, and a bowling-green during summer.

"The method of filling the house may be as follows:—An opening is made in the ice at the corner adjoining the stone flooring h, and increased in a diagonal line to the far corner on the opposite side, in which forms may be placed for the workmen to stand upon when breaking and spearing the ice along to the corner. Two men stand at the corner and drag the ice on the flooring; two others with mallets break it into small pieces, and two shovel it on to the canvass," by which it is wound up to the top, and thrown into the house. The

rest is routine. "The door i being shut, and a layer of reeds, wheat-straw, or laths laid against it, to prevent the ice adhering to it," the usual process of packing and filling goes on. Strips of lath are preferred to straw for placing between the ice and the walls; and doors nearly air-tight, by having their edges covered with soft leather, are preferred to filling the passages with straw, as is usually done, both for economising time in taking out the supply of ice, and also for preventing the air from getting in.

"By means of air-tight doors," says the inventor, "the person sent for a supply of ice, after having opened the first door, may shut himself and his pail in; the second door may then be opened, and should fold in the middle, so as to occupy little space in opening; the third door may open outwards, and to the reverse side of the second, and be shut on entering the house: by this means very little air will be admitted on entering, and far less on returning; and every sort of litter being done away with, there will be little danger of carbonic acid gas accumulating inside of the house. In the above plan there may be a door at the foot of the stairs, and two others on entering through the wall. The inner walls of both ice-house and fruit-room should be built with brick, and bound to the outer walls with long bricks or stones reaching through the vacuity from the one wall to the other. The fruit-room is lighted from above by circular vents with glass tops k, and wooden shutters l, which may be opened and shut with cords and pulleys: five of these vents may be sufficient to light the passage of the fruit-room all round. The shelves should be supported on cast-iron pillars: they may be made of stone or slate, either material being preferable to wood, both for durability and for keeping the fruit cool and plump. The fruit-room is 12 feet high, 8 feet wide. The passage between the shelves is 3 feet wide. The height of the ice-house is 20 feet from the bottom to top, and 11 feet diameter at the springing of the arched roof. o is a layer of coal or gas tar mixed up with sand, to prevent the wet from getting down to the building. The swan-necked pipe will exclude the

air from below, as it will always stand full of water. The drain below the passage of the fruit-room will prevent any over dampness in the flooring. Heated air may be conducted from the back of the fire-places *p* into the vacuity in the fruit-room wall, and may be admitted into the interior of the room by turning valves in the inner wall. Cold air may have ingress by a pipe or pipes from outside the bank into the vacuity, and from thence through the valves into the interior; and the ingress may be through the vents at top. However, I am of opinion," he says, "as far as my experience of keeping fruit goes, that little air, heat, or light is necessary, and that an atmosphere inclining to a damp state rather than a dry is essential. The air-pipes, of course, will be useful in extraordinary cases. The room *d*, on the left-hand side, is intended for the accommodation of bowlers, and, as a dessert and sitting room, should contain chairs, a table, and a strong press for the bowls, curling-stones, &c. The room on the right hand is for preparing the dessert in, and for keeping and ripening some of the finer sorts of French and Flemish pears, &c., and should be fitted up with shelves and drawers for seeds."

"Ice-houses are frequently built in a very obscure corner, and sunk in the side of a north sloping bank, under the shade of forest trees, and often at a considerable distance from the house and garden, and, when passed at any time, present no peculiar attraction; whereas, if built on the plan here described, they may occupy a place at one side, or even in the middle of the flower garden, and being of such magnitude, would contain ice and fruit for the constant supply of a large family. If the elevation of the rooms *d d* was built in the form of a Grecian temple, the bank of earth covering the ice-house, &c., planted with dwarf ornamental flowering shrubs, and partially shaded with trees on the south side, or studded over with rock-work, it would be not only an object of peculiar attraction and elegance, but would afford the means of recreation, and combine economy with utility."

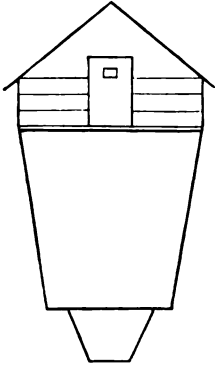
*The ice-house at the Hirsal* is constructed as follows;—it has been found by Mr

Smith to answer the purpose completely. A high, dry, airy situation, having a northern exposure, and partially shaded with large trees, has been selected. A pit, 14 feet square and the same in depth, was excavated and lined round with coarse boarding; a well, 5 or 6 feet deep, dug under this for the melted ice to drain into; and from this well a leaden pipe is carried up to a convenient part, to which a pump is attached, so that any water accumulating in the well may be pumped up. In gravelly soils this precaution is unnecessary. This well is covered by laying some strong planks across it; and these, covered with faggots, form the base for the ice to rest on, and, as will be seen, act as a drain to keep the bottom always dry. In each corner of the pit a strong post is fixed, upon which a roof is placed 4 feet above the surface of the ground. The space from the ground to the springing of the roof is boarded with slabs, having a door in the north side, in which a sliding ventilator is fixed, and another ventilator is placed in the opposite side—Mr Smith having found this ventilation useful, a subject which of late years has occupied the attention of several, and a result which is curious as being directly at variance with former practices. Ventilation is attended to particularly in windy weather, when the ventilators are opened frequently, by which, Mr Smith says, any water that may have accumulated on the top of the ice will become frozen again. Of this there may be doubts; but of the advantage of ventilation there can be none, were it only to allow the heated air, with which all under ground ice-houses abound, to escape, and so lower the internal temperature; and also to remove the damp, which always accompanies confined heated air in such places.

The ice is broken and put in in the usual way, using reeds instead of straw—which amounts to the same thing—as a non-conducting body between the ice and the sides of the pit. Much stress appears to be laid in this case, as well as in many others, on a plentiful supply of boiling water during the process of filling. This is a practice we never have adopted, nor can we see the rationale of it. The roof is thatched from 18 inches to 2 feet in thickness: the eaves project above 2 feet,

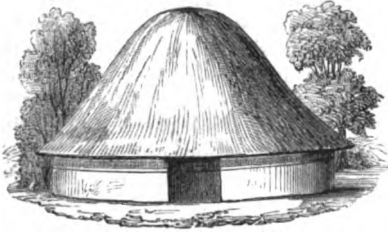
to prevent the sun from acting on the sides. The annexed diagrams, figs. 727 and 728, show the section and elevation. The building was erected, Mr Smith assures us, for under £20, and the timber used, although the Earl of Home's own, was included in the estimate at the current price. The sides under ground are not quite perpendicular, al-

Fig. 727.



though the house is described as being square,—the slight batter being found, of

Fig. 728.



course, better resisted by the boarding by which the sides are covered.

A very economical ice-house has been in use at Erskine House, the seat of Lord Blantyre, near Renfrew. It consists of a pit sunk in a gravel hill, 16 feet in diameter at the top, 10 feet at the bottom, and 8 feet deep. No drain is here used, as the melted ice finds free precolation through the gravelly soil. Previous to putting in the ice, branches of trees are laid across the bottom, and over them some smaller spray, which acts as a filter for the melted ice escaping. When this pit is filled to about 3 feet above the surface-level, the ice is covered with from a foot to 15 inches of peat earth, over which a temporary roofing of spars is put, and slightly thatched. When the ice is wanted for use, an opening is made in the peat earth covering, and left open during the season, the ice protruding through the stratum of peat earth, like a block of marble. Several ice-pits upon the same principle exist in different parts of Scotland.

In this case we think the peat earth will have the effect of discolouring the ice very much—which, however, for the ordinary purposes for which ice is used, can be of little consequence; but when required pure, to mix with water, wine, or for being put into vessels containing butter, &c., it must lessen its value very much—nay, indeed, render it entirely unfit for the purpose. In Britain we have yet to learn the value of pure ice, and the great necessity of collecting it from clean sources.

The oldest form of ice-house with which we are acquainted is that of an obovate shape—the shape which approaches the nearest to the spherical—which of all other forms is the one best suited to the purpose in view, because it presents the least surface in proportion to the cubic contents of the mass, and is therefore much less acted upon by the dissolving agents. And next to this is a cube, amongst regular straight-sided prisms. “If, however, a ball of ice—say of 2 inches diameter—containing little more than 4 cubic inches, be thrown into tepid water along with a cube of 2 inches on the side, the latter, though containing 8 cubic inches, will be melted as soon as the spheric, which contained but little more than one-half that quantity of ice. But although nearly double the quantity is thus wasted by the cube, as compared with the sphere, yet this is little to what will be found to take place in a figure bounded by lines still less concentric than the cube. Thus, from a flat piece of ice 6 inches square by 2 inches thick, containing 72 cubic inches, no fewer than 60 cubic inches will be dissolved in the same time and by the same temperature that are required to dissolve only 4 cubic inches, when these are in the form of a sphere. Although from this it is evident that the most spherical form is that which is best adapted for preserving a body of ice, there are various circumstances, notwithstanding, which render it necessary to deviate from such in the construction of ice-houses. The mass of ice, by solidifying, and by partly melting at bottom and top, when also a portion may be supposed to be taken away for use, would reduce the sphere to a flattened oblate spheroid; whereas the form of an oblong spheroid, or that of an egg, the widest

part being uppermost, would approach the form of a sphere as the reduction of its length, from the above-mentioned causes, was being effected; and by the time that the heat of the summer becomes most trying, the ice would be in a form more nearly spherical than if it had been perfectly so when first stored in. Another advantage may be mentioned as belonging to a circular building—and that is its strength, compared with one of which the walls are straight, and liable to be forced in by the external pressure of the surrounding soil.”—*Gard. Chron.* 1841.

The fact of ice-houses built upon the very same plan as to form, and of the same size, and filled in the same manner, keeping ice for two years and upwards, while others do not preserve it nine months, is sufficiently well known. We must therefore look to something more than form and size to account for this difference. And first, let us observe, that heat and moisture are the two principal causes of dissolution, and that air, apparently the principal thing hitherto guarded against, has not the same effect. Indeed it has been suggested to ventilate the ice-house at top, occasionally, to let off the accumulated vapour supposed by some to accumulate over the surface of the ice in the house; while others have recommended leaving the doors frequently open during the night, for a somewhat similar reason. If air, says a third party, can be admitted under and around the body of ice at a low temperature, and that body of air kept in a quiescent state, it will be the best medium to secure its preservation. That the ice should be completely separated from the earth, by walls of great thickness, or, still better, by hollow built ones, is quite clear, were it for no other purpose than to prevent the conduction of heat; while, at the same time, this provision would counteract the effect of damp also, so far as its entrance through the roof and sides is concerned.

In accordance with these views we find a clever article in “The Gardeners’ Chronicle,” from which we extract as follows:—“The temperature of the earth in Britain, so far as the excavation of an ice-house is concerned, may be stated to average from between 48° and 52° Fahr., and the atmospheric temperature about

50°. The earth parts with its heat, and communicates the same to bodies in contact with it, much quicker than the air. Hence it becomes desirable to prevent the immediate contact of the ice with other substances, by interposing some slower conductors of heat. On observing the comparative effects of water and air, both of the same temperature, in lowering a thermometer as much as 50°, it was found that the depression was accomplished by the water in one-twentieth of the time required by the air. Hence the contact of ice with water should be prevented by proper drainage. Indeed, too much attention cannot be paid to this most essential operation. That the rain should be excluded directly from the roof, it is scarcely necessary to mention; but its approach to the sides by percolation through the earth should also be guarded against, otherwise it will occasionally introduce a temperature of more than 60°.

“As air is a very much slower conductor of heat than either earth or water, it might be concluded that if the ice were surrounded by air at the sides, and partially at the bottom, by resting on a wooden grating, it would be in the most favourable situation for preservation. A cavity is gradually formed at the sides in consequence of the melting of the ice; and if the air in the cavity as formed were to remain perfectly at rest, it is probable that no substance would occasion less thawing—taking into consideration the fact, that substances possessing non-conducting properties in a higher degree than air, when they are dry, lose less to a considerable extent when exposed to wet or damp. It must, however, be observed, that in a clear cavity between the ice and wall, a constant though slow circulation of air will take place from the following causes: The portion of air next the ice is affected by a temperature of 32°; that next the earth or wall is heated by being in contact with substances communicating a temperature of about 50°: such portion consequently ascends, whilst that next the ice descends in consequence of its greater density; but as it sinks, a supply from the warmer side must be drawn to occupy its place. It is therefore evident, that if the continuity of this circulation would be intercepted, the free interchange of particles would be

retarded, and the action of the warmer current upon the body of ice diminished."

We believe the practice of throwing salt on the ice, during the process of filling the house, is not only useless but injurious. No doubt the practice owes its origin to the well-known experiment of producing an intense degree of cold by mixing salt with either snow or ice—a practice still continued by confectioners in preparing ices for the table.

On this subject we find the following reasoning by Mr Corbett, a very intelligent gentleman, in the work last quoted: "In a temperature of 40° Fahr., a certain weight of ice takes ten hours to become fluid: in the same time, and with the same source of heat, 140 times the weight of water would be raised 1° in temperature; therefore 140 times the quantity of heat is required to convert ice into water, as to raise the same weight of water 1°. Allowing the air and ice, when filling the ice-house, to be 32°, if salt be thrown upon the ice, a part of it immediately melts; and all that which melts, having no time to draw upon the atmosphere for its source of heat, (viz. 140°, which is immediately destroyed in the act of melting,) becomes in the water latent. Thus melted water and ice, being suddenly reduced in temperature, will lower the thermometer from 32° to zero. If only a small quantity of salt is used, the surrounding ice, which has not been reduced in temperature by melting with salt, will gradually give out some of its sensible heat, and will soon become equalised with that in immediate contact with the melting water; but the latter, having partly disseminated itself through the whole mass, becomes partially saline, and its freezing-point will be lowered in proportion to the quantity of salt used. After these sudden changes have taken place, therefore, the difference between the salted and unsalted ice-house will be, that the latter is filled with ice at the temperature of 32°, and whose freezing-point will remain 32°, while every grain of ice melted by transmitted heat will give the protection of 1° of cold to 140° grains of ice surrounding it; whereas the former will also be filled with ice exactly at its freezing-point, which may perhaps be 30°, and every grain of such ice, when melted by transmitted heat, will also give 1° of protection to 140

grains of the unsalted ice, or will counteract the transmitted and continually transmitting heat to that extent. But with what velocity will that heat be transmitted? Exactly in proportion to the difference in temperature between the stored ice and the medium which surrounds it. If we allow the surrounding medium to be 34°, then the velocity of the transmitted heat from that medium to the ice will be twice as much in the salted house—viz. from 34 to 30°—the difference being 4°, as in the other, which would only be from 34° to 32°, the difference being only 2°; consequently the ice would keep twice as long in the one as in the other." Mr Corbett observes that he does not pretend to say "that these presumed temperatures are such as really occur, but they must of necessity approach it; and if so, the argument remains the same."

Before filling the ice-house, every means should be taken to dry the walls as thoroughly as possible. For this purpose the doors should be kept open in dry windy days, to admit of the fullest amount of ventilation; and that this may be the more completely accomplished, a ventilator or chimney should be built on the highest part of the roof of such houses as are so constructed as to be filled from the doors only. A bushel or two of unslaked lime may be with great advantage employed, by being placed within the ice-well, as it is an absorber of water to the extent of 5 gallons to every bushel.

The production of ice by artificial means, from what has already been stated, is not a modern invention, although the most convenient mode of bringing about that process is so. Those who wish to manufacture their own ice should study the principles laid down by Mr Masters in "Treatise on the Production of Ice and Artificial Cold," from which the following extract and table are taken: "The cooling power of different substances undergoing solution may be represented by various relative quantities, according to their power of absorbing heat; and, from a long series of experiments, I have at length prepared a compound capable of accomplishing this effect to a much greater degree than any hitherto known mixture. Still, however, let it be understood, I do not pronounce it specific against any uncommon positions. Let the cooling

influence of my salts be represented by 100°: in this condition they are capable of reducing water from a temperature 132° to the point of congelation; but the same charge of salt would not reduce boiling water to a like condition, unless the charge be again repeated. Thus the same quantity of salt (represented by 100°) would reduce boiling water to a temperature of 112°; and a second charge being placed in the room of that now exhausted, would infallibly convert the previous boiling water into ice;—therefore it is a desideratum in all cooling processes to have the liquids to be congealed as cool as possible, in order to facilitate the operation of congelation; still, by repeated quantities of freezing mixture, any substance may be reduced from any point down to 32°, the freezing-point of water, the point of its conversion into ice, and even much beyond that.”

FREEZING MIXTURES WITHOUT ICE.

	Mixtures.	Parts.	
1.	{ Muriate of ammonia, . . . . .	5	Lowers thermometer from + 50° to + 10°.
	{ Nitrate of potash, . . . . .	5	
	{ Water, . . . . .	16	
2.	{ Muriate of ammonia, . . . . .	5	From + 50° to + 4°.
	{ Nitrate of potash, . . . . .	5	
	{ Sulphate of soda, . . . . .	3	
	{ Water, . . . . .	16	
3.	{ Nitrate of ammonia, . . . . .	1	From + 50° to - 7°.
	{ Carbonate of soda, . . . . .	1	
	{ Water, . . . . .	1	
4.	{ Water, . . . . .	1	From + 50° to + 4°.
	{ Nitrate of ammonia, . . . . .	1	
5.	{ Sulphate of soda, . . . . .	3	From + 50° to + 3°.
	{ Diluted nitric acid, . . . . .	2	
6.	{ Sulphate of soda, . . . . .	6	From + 50° to - 10°.
	{ Muriate of ammonia, . . . . .	4	
	{ Nitrate of potash, . . . . .	2	
	{ Diluted nitric acid, . . . . .	4	
7.	{ Sulphate of soda, . . . . .	6	From + 50° to - 14°.
	{ Nitrate of ammonia, . . . . .	5	
	{ Diluted nitric acid, . . . . .	4	
8.	{ Phosphate of soda, . . . . .	9	From + 50° to - 12°.
	{ Diluted nitric acid, . . . . .	4	
9.	{ Phosphate of soda, . . . . .	9	From + 50° to - 21°.
	{ Nitrate of ammonia, . . . . .	6	
	{ Diluted nitric acid, . . . . .	4	

- 10. { Sulphate of soda, . . . . . 8  
 { Muriatic acid, . . . . . 5  
 Lowers thermometer from + 50° to 0°.
- 11. { Sulphate of soda, . . . . . 5  
 { Diluted sulphuric acid, . . . . . 4  
 From + 50° to + 3°.
- 12. { Pulverised muriate of ammonia, 5  
 { Nitrate of potash, . . . . . 5  
 Water, . . . . . 16  
 From + 50° to - 10°.
- 13. { Sulphate of soda, . . . . . 6  
 { Muriate of ammonia, . . . . . 4  
 { Nitrate of potash, . . . . . 2  
 { Diluted nitric acid, . . . . . 4  
 From + 50° to - 10°.

§ 4.—TANKS AND CISTERNS.

The great utility of tanks and cisterns has hitherto been much overlooked in gardens: indeed, a sufficient supply of water has been seldom thought of; and this is the more extraordinary, as so much depends on its presence; for, as old Switzer remarked, “water is the soul of a garden;”—without it all the other elements of nature are useless and unavailable.—*Vide* article WATER.

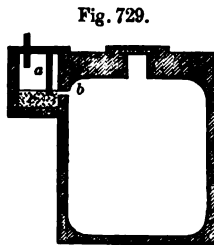
Tanks are of various constructions, and for various purposes: viz. filtering-tanks, liquid-manure tanks, rain-water tanks, and general reservoir tanks, &c. Smaller water vessels are called cisterns, and are usually set in or attached to hothouses, &c.

Filtering water is a simple process, employed to purify or sift out earthy or other heterogeneous matter out of river, rain, or other water, that may not be considered sufficiently pure to be used for culinary or other domestic purposes.

Waistell, in “Designs for Farm-Buildings,” thus describes a filtering tank used

by him, of which the annexed diagram, fig. 729, will show the principle: “The bottom should be in the form of a flat dome reversed, and the top also domical, with an opening left in the centre of sufficient

size to admit a man to clean it out occasionally: the top of this opening should be a little above the surface of the ground, and should be covered with an oak flap,





with several holes bored in it for ventilation; or the cover may be an iron grating, horizontal and a little elevated, or conical. These tanks may be constructed of various dimensions; the depth and width should be nearly equal; a hole should also be left for the service-pipe, or that which conveys the water into the tank, and also for the pipe for the pump, if the water be drawn out by that means. The water may be filtered previously to its entering the tank; the hole for the service-pipe ought, therefore, to be near the top, and on that side most convenient for the filtering chamber: this may be about 4 feet in diameter, and 3 feet deep. Across this, about 12 inches from the side next the tank, as at *b*, fig. 729, a slate partition, *a*, reaching from the top to within about 6 inches from the bottom, should be fixed; at the bottom of the box should be put clean coarse sand or powdered charcoal, *c*, about a foot in thickness. The pipe or opening, *b*, from the filter to the reservoir, should be of ample dimensions, and be made at about 18 or 20 inches from the bottom, in the small division or space behind the slate. Above this opening, and in any part most convenient in the large division of the filter, should be an opening or drain to carry off the water when the tank is full. This filter should also have a cover, that it may be cleaned out, and fresh sand or some other purifier put in as often as may be found requisite. Of course the water, as it comes from the roof, is to be first conveyed into the large division of the filtering chamber, on the opposite side to the slate partition, and, passing through the sand, it rises in the small division purified, when it is fit to pass into the tank by the tube *b*. If there are two or more of these filtering chambers, or if they are of greater depth, the water may be passed through the greater quantity of sand in them, and be still more purified." If water be brought from any other source than from the roof, it must be admitted into the filtering chambers. Both the tanks and filtering chambers should be water-tight: if constructed of brick, the inner course should be laid in Roman cement, and afterwards the whole of the inside covered with a coat about  $\frac{3}{4}$ -inch thick, of the same material. Water from drains formed in the ground, for the purpose of collecting

it for domestic purposes, may be purified by passing it through a sand filter previous to its entering the tank. Sponge and flannel may also be used as filters. In constructing tanks of the above description, care must be taken to have the earth closely filled in around the brickwork, and to allow sufficient time for the work to get properly settled previously to admitting any great weight of water."

In regard to the size of tanks, more especially where much depends on the quantity of rain water, we may here observe that Waistell's calculation is to the effect that 126 gallons fall annually on every square yard in Britain, or 2722 $\frac{1}{2}$  tons to the imperial acre. Another authority says that, taking the annual fall of rain at 31 inches, it would give 3100 tons per acre. To show how much we are independent of wells or water companies, let us take for example a cottage roof, 50 feet in length and 10 feet in width of slating on each side of the ridge, which will give 1000 square feet of surface, equal to 111 $\frac{1}{2}$  square yards. This, taking the fall of rain at Waistell's calculation of 126 gallons per square yard, will give us nearly 14,000 gallons of water per annum, all to be secured by merely building a water-tank, and placing shoots—or rones, as they are called in Scotland—round the eaves of the house;—a precaution which, when it is taken, (though this is far too seldom,) is more frequently with a view to carry away the water to waste in the nearest drain, than to turn it to any useful account. Rain water for vegetation, and for most domestic purposes, is by far the most valuable, and, when properly filtered, is the purest of all for the use of the table. This is one of the many instances where man spurns the blessings his Creator has amply provided for him, and put within his reach, while he will not avail himself of them, but will dig wells, and bring water for miles, by the force of his own ingenuity.

We have paid some attention to this subject for a number of years, and in various localities; and we have, from calculations made, arrived at the conclusion that a supply of rain water falls annually upon the roof of most dwellings—if we exclude those of densely peopled parts of towns and cities, where people live in story above story—sufficient to supply the in-

mates with this indispensable element throughout the year. A cottage has a limited surface of roofing, but it contains also a limited number of inmates; a mansion contains more inmates, and thus requires a larger supply, but it also presents a proportionate extent of roofing surface.

A very simple and effective filter may be constructed according to the annexed section, fig. 730, which should be built

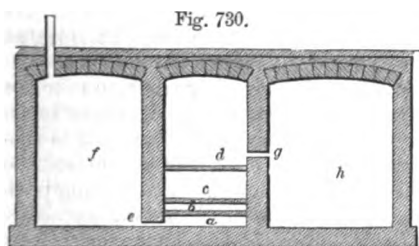


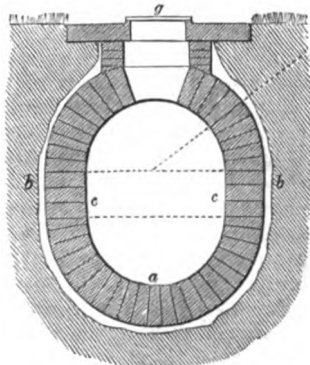
Fig. 730.

with brick and cement, or, if upon a small scale, of pavement sides, well jointed and puddled behind and at bottom. *a* is a space of about 3 or 4 inches, covered with a perforated tile, slate, or stone at *b*; the filtering material—say small gravel, charcoal, or coarse gravel—is placed at *c*; a filtering-stone of some porous kind—or, in default of that, a plate of lead, cast-iron, or, best of all, a thick plate of glass, perforated with numerous very small holes, not more than one-twentieth part of an inch in diameter—is placed at *d*. The water from the receiving-tank *f* passes through the small opening *e*, and is forced up by its own pressure through *a b c* and *d*, and enters into the reserve-tank *h* through the opening *g*. From the above diagram it will readily be seen that, when the water in the receiving-tank rises above the level of the opening *g*, it will force itself into the receiving-tank *h*, and this force will be increased if the tank *f* be carried higher than *h*; and we think it should be so, to the extent of 1 foot, or perhaps 2. A man-hole should be left in the top of the filtering space, so that it may be cleaned out occasionally. This is, however, not shown in the diagram, but may be supposed. This filter may even be considerably simplified by placing in it 6 or 8 inches of small round stones; above these a corresponding layer of sand and charcoal mixed; and over that a flat piece of sponge, or several thicknesses of coarse drugget or carpeting, kept in its place by

a wire grating fixed to the sides. The filtered water must be drawn up for use from the reserve-tank by means of a pump, unless the apparatus is placed so high above the points of distribution that the water may flow to them through a pipe by its own gravity.

*Mallet's tank* is thus described in the "Encyclopædia of Cottage, Farm, and Villa Architecture," to the talented editor of which work it was communicated by Mr Mallet, along with the annexed figs. 731, 732, and 733. This tank is calculated to save expense—first, by using a figure of maximum capacity and minimum surface; and next, by being able to dispense entirely with the centering, which, according to the present practice, is used for arching over tanks. Mr Mallet proposes, for very large tanks, to adopt a spherical form; but for any of less than 5 or 6 feet in diameter, a short cylinder with hemispherical ends, as shown in fig. 731. "The excavation being made,

Fig. 731.



the building is commenced, either with a single brick at the bottom *a*, or, better, with a circular piece of stone laid on a layer of tenacious clay, tempered as dry as possible, well beaten together, and previously mixed with some salt to prevent the worms from working through it"—a precaution we think almost superfluous. "This layer of clay, *b*, completely surrounds the brickwork in every part, to make it retain the water. The bottom part is now built all with common mortar, in the form of an inverted dome, 9 inches thick; then the perpendicular part *c*; and, lastly, the upper dome. Now,

any common arch may be built without centering as far up as where the courses lie at an angle of about  $32^\circ$ , or what is called the angle of repose for masonry—that is, where the bricks will first begin to slip off; but a brick dome may be built of any size entirely without centering, for the following reason:—Referring to fig. 732, *dd* are two bricks supposed to belong to part of the course of bricks

Fig. 732.

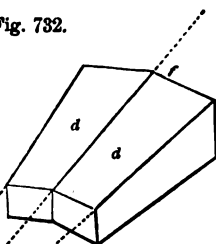


Fig. 732\*.



next above that of the angle of repose. Each of these is to be considered, with the mortar in which they are embedded, as a quadrangular prismatic frustum, whose sides all incline towards the centre of the hemisphere at *c*. Now, the upper surfaces of these two bricks form an internal or retaining angle with one another, from the position they lie in on the preceding courses: that is, they lean against each other as if they lay on opposite inclined planes, as shown in fig. 732\*. If, then, these bricks slip, they must do so in the line *ef*; but, in doing so, they must approach each other. But they are already in contact, therefore they cannot slip. This demonstration applies to any greater number of bricks until the whole course is finished, when the bricks are sustained by their lateral thrust. There is a limit to the weight of the *vousoir*, (the overhanging part of an arch looking up from under it,) which will support itself in this way, as must be obvious to every one from the common principles of gravitation. It is also obvious that a dome may thus either be left open or closed at top. To make the tank per-

fectly water-tight, it is finally coated over two or three times with coal-tar inside. A man-hole is shown at *g*, fig. 731, for getting in to clean it out occasionally." A great deal of the success of all tanks depends on the external resistance being equal at all points, for the pressure of fluids is great; and if one part of the resisting soil or embankment yield, the building, however strong, is apt to follow. Hence spherical or circular forms are better than those with straight sides, at least so far as strength is concerned.

In forming tanks or reservoirs for the propulsion of water, it is necessary to ascertain the pressure the tank has to sustain, the more especially if the tank be above ground, and have no resisting pressure from without. The rule for ascertaining this is laid down in the "Pharmaceutical Times," as follows:—"The pressure on the bottom of the tank is equal to the whole weight of the fluid it contains, as none of the weight is supported by the vertical sides. The amount is found by multiplying the area of the base in feet by the altitude in feet, and the product, which is the number of cubic feet it contains, by 62.23, which is the number of pounds weight of a cubic foot of water, giving the total weight in pounds. The entire lateral pressure, or that on the sides in a cylinder, is to the weight of the fluid as the altitude is to the radius of the base. The pressure increases with the depth in the proportion of the numbers 1, 3, 5, 7, 9, &c.—*e. g.*, at 2 feet deep there will be three times the pressure on the sides as at 1 foot, and at 3 feet deep there will be five times the pressure, and so on. From the preceding remarks it is obvious that, as the lower plates," or parts, "of the tank have to sustain so much more pressure than the upper ones, these parts should be correspondingly stronger.

"When a mass of fluid contained in a vessel is in a quiescent state, every particle is pressed in every direction with a force equal to the weight of a column of the fluid, whose base is the particle pressed, and whose altitude is equal to the depth of the particle below the surface: hence the pressure on any particle varies directly as its perpendicular depth beneath the upper surface of the fluid. The lowest parts of a fluid, therefore, sustain the greatest pressure, and they exert perpendicularly

a force equal to the intensity of the superincumbent mass. Therefore, the lowest parts of a vessel," tank, or cistern, "containing large masses of water, ought to be stronger than the upper.

"If we take a cistern whose sides are equal in area to the bottom, the pressure on the four upright sides is equal to twice the pressure on the bottom; but the pressure on the bottom is equal to the weight of the fluid contained in the cistern, (supposing it to be full;) therefore, the pressure on the upright surface is equal to twice the weight of the contained fluid: hence, in a cubical vessel, whose bottom is horizontal, the whole pressure on the bottom and the four sides is equal to three times the weight of the fluid which the vessel contains.

"Let the box be a cube of 1 foot; then, since a cubic foot of fresh water weighs  $62\frac{1}{2}$  pounds, the whole pressure on the bottom and three sides is equal to  $62.5 \times 3 = 187.5$  lb. If the vessel be cylindrical, its base horizontal, and its upright surface perpendicular, the pressure on the base is to the pressure on the upright surface as the radius of the base is to its altitude.

"Let the diameter of the base be 3 feet; then, since the solidity of the vessel is  $32 \times .7954 \times 6 = 42.9516$  feet, the whole weight will be  $42.9516 \times 62.5 = 2684.465$  lb., being exactly the fifth part of the weight which measures the entire pressure—which is, therefore, equal to  $13422.475$  lb., or to  $5.992$ , or nearly 6 tons.

"The pressure exerted by a fluid in a quiescent state, on any portion of a vessel, is equal to the weight of a column of the fluid, having for its base the surface pressed, and for its altitude the mean depth of the incumbent fluid. This mean depth is the same as the distance of the centre of gravity of that portion below the surface of the fluid.

"But in vessels resembling truncated cones, the pressure on the base may be greater or less than the weight of the contained fluid, in any proportion whatever, according as the sides of the vessel converge or diverge with respect to the bottom. Hence the pressure on the bottom depends solely upon its perpendicular altitude, and not on the quantity of the fluid; and on this principle any portion

of the fluid, however small, balances any other portion, however great."—*Loudon's Self Instruction, &c.*

Hence it follows that, in forming heads of water, cisterns, or tanks, to propel the water through close pipes to a distance, depth is of far more consequence than superficial area. "In considering," says Mr Loudon, in the work last quoted, "the velocity of water flowing through close pipes, of a given diameter and length, with a given head of water, Eytelwein conceives the whole head of water above the point of discharge to be separated into two portions, one of which he supposes to be employed in overcoming the friction and other resistances in the pipe; and the other portion in producing the velocity, and forcing the water through the orifice.

"The height which is employed in counterbalancing the resistances he considers to be directly proportioned to the diameter of the pipe compounded with its length, and inversely as the area of the transverse section, or the square of the diameter, and, consequently, on the whole, it varies inversely as the diameter. But the friction varies as the square of the velocity; hence the height equivalent to the friction must vary also as the square of the velocity.

"The effect of atmospheric pressure on running liquids is, that in a tube of considerable length, descending from a reservoir, it quickens greatly the discharge; in fact, it much resembles the operation of a piston. Hence we see in a vessel of water, discharging itself by means of a tube in its bottom, a depression of the water surface in the vessel over the tube; and as the volume of water lessens, this hollow extends itself like a large funnel." This will readily be seen by withdrawing the waste-pipe out of a cistern of water, and watching the effect. "In fact, the force of the effluent water diminishes the pressure beneath; on which account the incumbent air, following the stream, finds, as it were, an easier passage, the velocity of the effluent water being always greater in the middle than towards the sides of the aperture, where it is retarded by tenacity and friction.

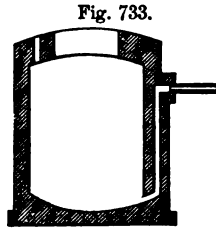
"As regards the friction or resistance of fluids in pipes, an inch tube, 200 feet long, placed horizontally, discharges only

one-fourth part of the water which escapes by a simple aperture of the same diameter. The cohesion of the fluid particles is diminished by heat, which, when increased 100°, nearly doubles, in certain cases, the discharge."

The quantity of water discharged by pipes of different diameters, and under different heads of water, may be found by multiplying the area of the pipe in inches by the square root of the head of water, or the vertical height in feet, and that product by 1117.25. The friction in small pipes is proportionably greater than in larger ones; but this is not very generally regarded in practice. The quantities of water discharged in a given time, from different sized pipes, the head of water being the same, are to each other nearly as the area of the outlets.

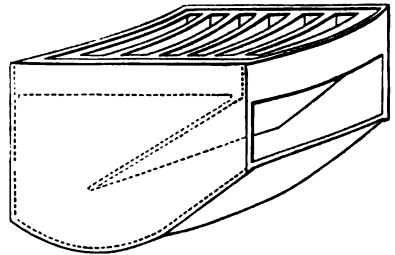
*Liquid manure tanks* are of such great importance to all gardens that no one should be without them; and their situation, as well as that of all other tanks or cisterns, should be sufficiently elevated, that the water may flow from them throughout all the garden by its own gravity, in pipes laid for the purpose. By this arrangement the expense of pumping will be saved. The advantage of liquid manure applied for irrigation has been exemplified in a most complete manner in the gardens of the Marquis of Tweeddale, at Yester House. The tank from which the supply is obtained is placed in the farm-yard, somewhat elevated above the garden. This tank contains 5000 gallons. The liquid manure is from thence conveyed to the garden, a distance of 900 yards, in earthenware pipes. In the centre of each quarter of the garden is placed a tank capable of holding 500 gallons; and from these, during the last year, no less than 32,000 gallons have been used, with the most marked effects. We should also mention that liquid manure tanks are attached to the hothouses, and heated by hot-water pipes running through them, so as to be at all times ready for use. The crops produced by Mr Shearer give evident proofs of the utility of applying this "nectar of vegetation." As regards the construction of such tanks, we may, so far as strength goes, refer to Mallet's, already noticed; but as disagreeable effluvia are apt to arise from those intended for liquid manure, we would propose the following

arrangements to obviate this result. The drains or pipes which supply them should be carried down through the side walls, as shown in fig. 733,

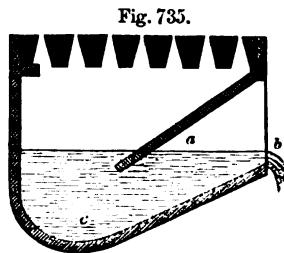


so that the lower end may be constantly under the surface of the water, to prevent what is called a back draught—that is, the air and gases formed in the tank rising up through the drains, and escaping at the surface of the ground, or wherever the feeding-pipes may be taken from,—or the drains may be furnished with traps, so constructed as to remedy this evil, as well as to prevent sand and litter getting in. Of such traps there is a great variety; and many different kinds are to be procured from every ironmonger. The best, perhaps, is that of Cottam and Hallen, of London, of which fig. 734 is a perspective view, and

Fig. 734.



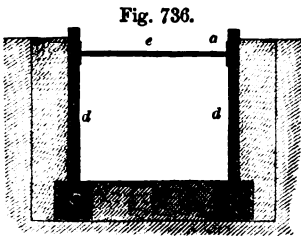
735 a section. In the latter, *a* is the level of the water, *b* the opening by which it escapes, and



*c* the space where the sand or other sediment is deposited. When this is to be removed the grating is lifted off. In the construction of such tanks it is important that they be water-tight; this is effected by carrying up the walls in 9-inch brickwork, set in cement, taking care that the bottom and sides are well puddled as the operation progresses. Whatever their form be, the roof should be that of a dome, if they are constructed

of brick or rubble stone; and in it a man-hole should be left, for the purpose of cleaning out the tank at seasons when it may be dry;—or the walls may be built with good mortar, and the surface covered with cement a quarter of an inch thick, or the whole may be covered with two or three coats of coal-tar, as a cheaper substitute. In some cases tanks formed of plates of cast or malleable iron, strongly riveted together, may be found more economical: these, if properly put together, will require no puddling, and they are certainly the best if placed on an inclined plane, or where much of their surface is above the ground-level. Timber is sometimes used; but, from its liability to decay, it is undoubtedly the dearest material in the end.

In counties like some parts of Caithness and other parts of Scotland, and Yorkshire, where pavement abounds of almost any size, it will be found an excellent and cheap material for tank-making. We have several so constructed, one of which we have already alluded to in sect. WATER. It is constructed as follows:—The space being dug out 18 inches longer and broader than the intended internal size of the tank, and the same proportion in regard to depth, a bed or floor of well-prepared clay is laid all over the bottom *b*, fig. 736, 16 inches in thickness. Along the sides



and ends are laid square blocks of stone *c c*, 4 or 5 feet apart centre from centre—(this distance depends on the lengths of the pavement to be used.) These blocks are firmly set on, or rather in, the puddle, and kept exactly level along these tops. On these the pavement *d d*, forming the sides of the tank, is set on edge, and close-jointed at the ends: puddle to the thickness of 7 inches is rammed between their back surface and the sides of the excavation, so as to make

it solid, and impervious to water. The same operation is carried on all round, and up to the top of the tank—the pavement being kept in its place during the process by pieces of wood wedged tightly across the tank, but not placed opposite the joints, which should stand directly opposite to each other, for the following reason: As soon as the bottom and sides of the tank are finished, and the puddle fairly set and dried, iron stretchers *e* are fixed, of a size and strength proportionate to the width of the tank, palmed at each end, the heels of the palms being let into each piece of pavement about an inch, and run in with lead. The flat part of the palm comes exactly opposite the joints, thus keeping the sides from ever moving inwards; and as they meet with a corresponding resistance from the puddle and soil on the opposite side, they cannot be displaced. As no such security could be given the end pavements, they are selected as long as possible—say from 6 to 8 feet—which will suffice for a large-sized tank, as its length may be extended to any amount. These end pavements are half-checked into the end side ones, or they may be secured by iron bats. It is not desirable to make such tanks too broad, on account of the great size of the pavement required to cover them. The covering stones are laid in puddle, as they are thus easily removed for the purpose of cleaning the tank: if closely laid, and the surface over them covered with gravel, no disagreeable effluvia will escape. In the case of the one alluded to, we have earthenware shoulder-jointed tubular drain-pipes, 3 inches in diameter, laid from within a few inches of its bottom, provided with a stopcock, by which the contents are made to flow to another pavement-tank: from thence they are carried to any distance by means of flexible pipes, which can be shortened or lengthened at pleasure.

In the case of the above tank we have not divided it as yet, although we are aware of the utility of having two compartments—one to receive the drainage of a town, farmyard, or even a dwelling-house, which, as soon as the compartment is full, is allowed to undergo fermentation while the other is filling, and so on alternately. With such care do the Bel-

gians and Dutch attend to this matter, (who, by the way, are better managers of manure than we are,) that in many cases they have a tank to contain each day's supply; and, beginning on Monday, for example, they use that collected the Monday previous, and so on in regular rotation throughout the year.

One way in which great loss of manure ensues in most gardens, is by an almost total disregard of nightsoil, and, we may add, a want of common decency in having so few water-closets. In the gardens at Dalkeith they are placed over watertight tanks, supplied with water from the roofs, from which the contents are pumped up and applied either immediately to the ground, or upon dung-hills formed of leaves and the refuse of the garden.

Tanks for holding rain or river water are often made by excavating the ground to somewhat more than the capacity required. If the soil is naturally sufficiently retentive to hold water, the whole is a simple affair—as, after the excavation is made, and the surface rendered smooth, it may be covered with bricks set in cement, or lime mortar such as the Dorking, or any lime mixed with oxide of iron, and which stands under water; or it may be covered with rubble stone, pavement, or slate. In lifting such tanks—if they are, for example, of the circular or basin form—the regularity of the work will be secured by placing a large stone or pier of brickwork in the centre of the bottom, and a beam of timber from side to side of the surface, exactly in the line of the true diameter of the circle. A quadrant-shaped gauge of boarding is to be formed, the ends of the perpendicular side of which are to be furnished with a pivot each, to play in a hole sunk in the centre of the block in the bottom, and a corresponding one in the beam at top: the circular part of the gauge is to be so formed, that, in turning it round, it will describe exactly the circle required for the bottom and sides of the tank. The operation of building or paving is to commence at the centre of the bottom, and to be continued in concentric circles till the whole is finished—the operators, as they proceed, drawing the gauge after them, and making their work correspond to it.

If the soil is gravelly or porous, of course the excavation must be made larger in proportion, to allow for the pavement or building, as well as 2 feet of thoroughly prepared puddle behind it, which should be put in and consolidated as the work goes on.

With such a foundation as this, if of 9 or 14 inch brickwork, or 18 or 20 inch rubble, well grouted, the walls may be carried above the ground-level several feet, and finished with a coping of pavement or ashlar.

Brick will be, in most cases, found the cheapest material; stones dressed and laid in courses, or even ashlar-work, perhaps the most durable, but at the same time the most expensive.

Very useful tanks are made, where appearance is not a primary object, by forming them of well-tempered clay, as above, and covering that over with a foot of clean river gravel.

Upon a well-prepared foundation of well-tempered clay puddle, excellent tanks may be formed by paving them all over with cheap undressed pavement, the sides and ends only being straightened and squared so as to fit pretty closely together. The sides of such pavement may be brought close together in the usual manner, or they may overlap each other if this is deemed better. No regard need be paid to making the joints watertight, as the puddle under them will effect this—the use of the pavement being to preserve the puddle, and to keep the water more pure.

*Cisterns* for garden purposes were long made of lead, sometimes enclosed in wooden cases, and often not. In the latter case, they are, if large, liable to become deformed, in consequence of the pressure of the water in them, and oftener from their expanding, particularly when placed within a hothouse, and not contracting equally again when cooled. Lead is in all cases expensive; and when the water to be kept in these cisterns contains calcareous matter, the metal soon decays, and the cistern becomes leaky. Milled lead of 6 or 7 lb. per superficial foot is quite heavy enough for lining wooden cisterns for garden purposes.

All cisterns should be supplied with a waste-pipe, to prevent the water from

overflowing when they are full : for this purpose the discharging orifice in their bottoms should be furnished with a brass bush, into which the gauge-pipe ought to be inserted.

Wooden cisterns are objectionable, from their facility of decay ; but they may be preserved for years by being kept thoroughly pitched within.

Of late years slate cisterns have become much used, and of their great utility there can be no doubt. They are not expensive, are very neat, of great durability, and communicate no deleterious qualities or taste to the water. Stone cisterns are, where pavement abounds, an excellent substitute for slate ; but on account of the extra labour upon them in most places, they become more expensive.

We have recently erected thirty water-tanks in a new garden in the course of formation. Those in the hothouses are placed under the floor-level, to save room. They are of Caithness pavement, squared and half-checked at the joints, and are 6 feet long, 4 feet broad, and the same in depth : they are formed of one stone of the above dimensions for a bottom, each side and end being also formed of one stone, with another of the same size as the bottom for a cover. The joints are put together with the best white lead ; and they are firmly packed all round with the soil of which the borders are composed. They are batted together at the upper corners with lead instead of iron bats, the former being not liable to oxidise. Those which are placed above the surface are polished on all sides, and batted together at both top and bottom corners : each is furnished with a brass valve at the bottom, into which the waste-water pipe is fixed : to the bottom of the valve another leaden pipe is attached, conveying the water to the main sewer, which carries off all the drainage and waste water, first to similar tanks in the garden, and from them to a drain beyond the boundary of the enclosed ground. These are, of all tanks, the cheapest and the best.

Cast or wrought iron in plates is, of all materials for this purpose, the cheapest and most durable, next to slate or Caithness pavement. Such cisterns are formed in five parts, the bottom in one piece, and each of the sides and ends also in

one piece, flanged at the edges, so as to fit exactly together, and kept so by means of screw bolts and nuts. If the castings are not very fair, the joints are easily made good with rust, white lead, or any of the means used in fitting together hot-water pipes. The pieces are cast barely one quarter of an inch in thickness, and malleable ones may be had even thinner. Of course, when we say that the sides may be cast in one piece, we mean cisterns not exceeding 3 feet by 5 ; but larger ones may be made by joining several pieces together, of which many beautiful examples may be seen on every railway in the kingdom.

Rain or soft water tanks may be made of any form fancy may suggest. We may however observe that, if of brick, oval, circular, or oblong forms are the best ; and if of courses of hewn stone or pavement, or slate set on edge, square or oblong ones should be preferred. Such a cistern may be constructed as follows :—The bottom is well puddled and covered with pavement, jointed with Mulgrave cement. The puddle of the bottom must be continuous with that of the sides, for obvious reasons. The side walls are carried up 9 inches thick in front, with a space of 4 inches, for puddle, between them and another 4-inch brick wall on the other side. If this 4-inch puddle is of good material, well wrought, and not used too soft, the bricks may be set in common mortar, the face of the walls all round being well grouted with cement when finished, and allowed to become perfectly dry before the water is let in.

We have also made perfectly water-tight tanks, by forming the bottom of paving bricks set in concrete, and the sides of two 4-inch walls, with a space of 2 inches between them, which, as the side walls rise, is filled in with Mulgrave cement, and slates set edge-ways in it. The whole speedily sets into one solid mass, and retains the water completely. These tanks are, however, under ground, and are finished at top with a course of 3-inch stone coping. The cement ties the walls together : if headers were used, they might not keep in the water so well. Were it not for the pressure of the water within, and their having no counter resistance from without, we do not doubt but that such

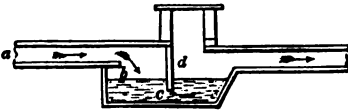


tanks might be built upon the surface with safety and advantage.

A very important precaution ought to be taken as regards tanks and cisterns exposed to the weather—namely, to break the ice that forms in them once or twice a-day during frosty weather. Inattention to this has been the cause of many tanks and cisterns being destroyed by the expansive effects of frost.

Of *air and vermin traps for cisterns*, there is a great variety; and they are so valuable that we are surprised they are not more generally used. Fig. 737 repre-

Fig. 737.



sents one of these, which, as will be seen, is simple and efficacious. The drain *a* may be of any form; the trap *d* is a sunk area as it were in its bottom, in which the water will stand as high as represented at *c*, provided this area be made water-tight, which should be the case. From the bottom of the drain at *d*, a piece of pavement, if the drain is large, or a tile if it is small, should project about 5 or 6 inches over the sunk part, which will prevent vermin passing that way. The drain should drop in level 5 or 6 inches at the other end of the trap, which will keep the water sufficiently low. Another piece of pavement or iron plate may be suspended from the roof of the drain, and of sufficient length to dip 3 or 4 inches into the water, which will not only act also as a barrier to vermin, but, at the same time, will prevent the ascent of noxious effluvia. An eye or opening should be placed immediately over the trap, with a movable stone or cast-iron cover, closely fitted into a stone or wooden plinth, to admit of the trap being cleaned out or examined

Fig. 738.



occasionally. Fig. 738 is nearly on the same principle.

## § 5.—APIARIES.

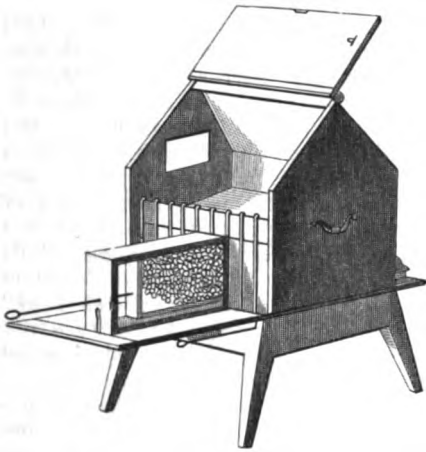
The keeping of bees is of very ancient date—almost coeval with the cultivation of fruits and culinary vegetables. They have, in all ages and in all civilised countries, been protected and placed near the habitations of man—most generally in his garden—and, by their industry, have amply repaid him for the small share of assistance they receive at his hand. The humble straw-thatched hive in the little garden of the cottager may be taken as an indication of the moral habits of the owner; and in the gardens of the great, the variously contrived structures provided for the protection of these insects add not a little to the decorative embellishments of the domain.

Great diversity of opinion exists both as regards the management of bees, and also as to the form and material of which their habitations should be constructed. Such, therefore, being the case, we need not be surprised at the number of treatises which have been published on the subject,\* nor at the variety of structures recommended for the use of the insects. The desire, also, to know something of their internal government has led modern apiarians to adopt such forms and means as might enable them to watch their progress without disturbing the economy of the hive. Amongst those, the "Patent Bar and Frame Hive" of A. Munn, Esq., deserves notice, while his little work on their management will well repay a careful perusal. The annexed sketch, fig. 739, will show its principle. This hive contains eleven frames, one of which is shown in the sketch, partly withdrawn, to show the progress of the bees in the glass case in front. One peculiarity in Mr Munn's management is moving the hives from place to place, for the purpose of affording the bees a larger field for feeding. This, although condemned by some, is by no means either an unnatural or useless practice. In Scotland, it is quite common to take the hives from the low country, when the season of flowering of the plants most sought after by the bees is over, and to carry them to the hills, where the prevalent flowers, particularly

\* Cotton, in a work entitled "My Bee-Book," gives a list of one hundred and twenty-four works on bees, from 1639 to 1842.

the native heath, wild thyme, &c., are later in coming into bloom. To under-

Fig. 739.

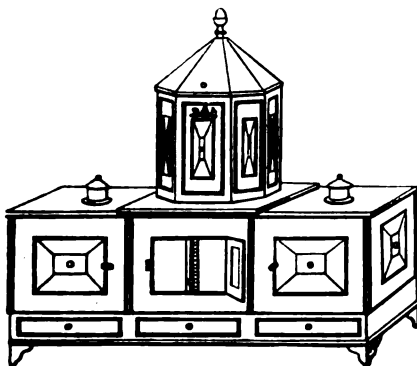


stand Mr Munn's theory, it will be necessary to peruse his very sensible and unprejudiced book.

The hive in common use is too well known to need any description. It is, perhaps, as ill adapted to the wants and habits of the insects as it is unpicturesque and devoid of ornament as a garden appendage. How such a form came to be adopted it is not easy to say, but that it has existed long is quite clear; for we find it in an improved form described by Hartlib in 1655. This improvement consists of the addition of a cap or smaller hive set on the top, with a view to deprive the swarm of the honey which they may make in it without disturbing the whole.

*Nutt's hives* are represented in fig. 740.—These hives consist of a series of three

Fig. 740.



boxes placed together collaterally, with an entrance from the centre box to the side ones, which entrance can be opened or shut by means of a sheet of tin which can be pushed backwards or drawn forwards. The centre box is the place of residence and breeding of the queen, and is never disturbed. As the bees require more room, one or both of the sliding sheets of tin are withdrawn, and the bees take possession of one or both of the side boxes. In general one is occupied first, and, when full, they are admitted into the other. The honey is also taken from these side boxes one after the other. Underneath are drawers for feeding; and on the top is an octagon cover, under which bell glasses are often placed; and the bees having access to them through holes in the top of the centre box, a supply from time to time of honey is thus also obtained.

"This bee-hive obviates the necessity of destroying the bees to obtain their honey; and the facts stated by the inventor, as to the success of numerous experiments made of his plan, tend to show that, besides the recommendation of humanity, it has in its favour also that of practical utility—the produce of honey being considerably increased, as well as the quality most essentially improved.

"A conspicuous feature in the management of bees, according to this system, consists of judiciously regulating the heat of the hive, by means of ventilation, so as to avoid to the bees the necessity of swarming, at the same time obliging these industrious creatures to exchange a store-room filled with honey for an empty one immediately connected with it."

*Taylor's improved collateral ventilating hive.*  
—Without departing from the essentials of Nutt's system, Taylor "has altered the form and arrangement of the boxes, and made a set complete as a whole, without the usual necessity for an additional shed to cover over it, which detracts altogether from any picturesque appearance it might otherwise possess."

In regard to size, Mr Taylor observes— "Circumstances must determine it according to locality; for what is suitable in one place will not do in all. The dimensions I like," he continues, "for the largest sized pavilion, are 13 inches in front, 14 inches backwards, and 10 or 11 inches deep. The side boxes should be

13 by 9 inches, and 9 inches deep. Or a set may be thus made—13 inches square for the pavilion, and 10 inches deep; the side boxes 12 by 9 inches, and 8 or 9 inches deep. A still smaller set of boxes may be thus proportioned—12 inches square and 10 inches deep, with side boxes 11 by  $8\frac{1}{2}$  inches, and 8 inches deep," all inside measure.

"The pavilion is made of  $\frac{3}{4}$ -inch deal in the back, front, and top, and  $\frac{1}{2}$ -inch at the sides. At each end is a good-sized window. Over the windows slide down movable  $\frac{1}{2}$ -inch panels into grooves made in the pilasters. To the panel in front is attached a covered porch projecting 4 inches, as a shelter from wet, wind, and too much sun—all evils at the mouth of the hive. To make this more effectual, a movable piece, cut in the form of an arch, slides within the porch. The top of the side boxes is made with a projection of half an inch at each end, for the convenience of lifting. They have each two windows, and are protected by cases covering the three sides, and fitting at the extremity into the grooves of the centre pilasters. In this way are formed on the outside panels to correspond, and of equal size with those of the pavilion. Thus every part of the boxes is doubled, excluding all light and wet." The boxes being double, enables them to resist the effects of heat and cold better than if they were single, and much thicker boarding was used. The side boxes are attached to the pavilion by hooks and eyes, and to the floor boards at the ends.

"A weather boarding roof fits over the whole, resting on the tops of the pilasters, which are cut down rather more than an inch to receive it, allowing ample ventilation, with perfect protection from sun and wet." Height is left under the roof for bell glasses, and holes are cut in the top of the pavilion for the bees to ascend into them. These holes, however, should not be cut in the centre, according to Mr Taylor, but towards the sides. "Here they are accessible to the bees without the usual necessity of passing through the centre of the hive, which is the seat of breeding, and where the brood would be endangered by a direct current of air, which ought to be avoided." Ventilation tubes are placed in all the boxes, near the back windows, and are there much less in

the way of the combs, as well as in emptying the box of the honey.

"The communication between the pavilion and the side boxes is made in each by two lateral openings, one being on a level with the inside top of the side box, and extending nearly the whole distance. The bottom opening is on the ground-level, and ought to extend almost the length of the pavilion, and be half an inch high. The openings are stopped, when required, by separate narrow slides of strong tin inserted from behind, let into the pavilion their own thickness. This part of the boxes differs from Nutt's, which have numerous apertures between them." These, Mr Taylor has found, "are not only useless, but practically injurious, as the bees will frequently unite the combs through them. At the entrance of the pavilion are two slides of perforated zinc about 1 inch wide, moving at the back of the panel, and behind the pilasters right and left, so as to contract the mouth at pleasure."

*Huish's hive*, figs. 741 and 742, is placed on its narrow end, differing from all others

Fig. 741.



in this respect excepting the Grecian hive, of which it appears only to be a modification. Like it, it has a convex cover. It is so constructed within that each comb may be extracted individual-

Fig. 742.



ly without disturbing the others, the combs being attached to slips of wood, as shown in fig. 742, and not to cross sticks as in ordinary cases. Each may thus be lifted up, which the unusual form of the hive favours.

Bees are very liable to attach the sides of the combs together; but the inventor thinks he has provided for the prevention of this by admitting air through perforated plates of tinned iron—a mode of prevention of the efficacy of which we have very great doubts, while, at the same time, we cannot but consider it injurious to the animals. Were it possible to prevent the bees from attaching the combs together, we would consider

this an excellent hive, as, by removing the lid or top, the state of the whole can be minutely examined, and any portion of honey removed at pleasure, either for use or for making room for the further operations of the bees.

*The Grecian hive* so closely resembles the last that further description would be needless.

*The Polish hive.*—This primitive bee habitation is formed out of the trunk of a tree, usually from 12 to 14 inches in diameter, and 9 or 10 feet in length. The inside is hollowed or bored out so as to leave a cylindrical opening of about 6 or 8 inches in diameter; a portion of the side of the tree, say 4 or 6 inches in breadth, is removed to facilitate the hollowing out of the space, and is afterwards fitted to answer the purpose of a door. It appears, by the experiments of Huber, and Huish also, that bees will thrive in any space if not too wide, the height or length being, it appears, of no consequence. Hence, were a tree of greater diameter used, they would not prosper so well in it. Very rustic and highly picturesque hives could be made upon this principle, sufficient space being given to them longitudinally.

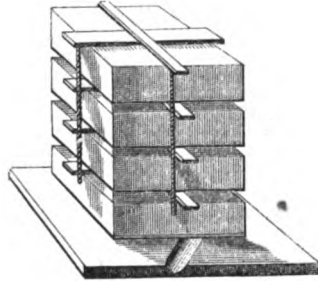
From the above, and from other experiments made, it seems pretty clear that a great error is committed in using too large hives. This is accounted for by the circumstance of our climate being of short duration for the purpose of honey-making; and also because the time of the bees is wasted in making comb which they have not time to fill with honey; for, like all wise house builders, these sagacious creatures complete their habitation before they begin to furnish it with honey.—*Vide* BAOSTER'S *Hive, Improved* by J. D.

*American hive.*—This hive we have had no opportunity of seeing. It is, however, described in MILTON'S "Practical Bee-Keeper," to which interesting work the reader is referred.

*The hive of Pulteau*, fig. 743, is thus described in the "Encyclopædia of Gardening:"—"It is composed of three or four frames, each 1 foot square by 3 inches in height. These square frames are placed the one on the other, and the first and last can always be lifted without deranging the work of the others. Each

square is strengthened from every side by a cross piece of eight or ten lines in width"—

Fig. 743.



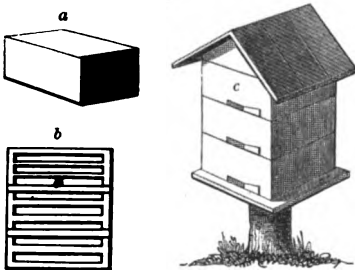
(it is a French invention, which accounts for the dimensions being so given)—"and two lines in thickness, which serve to sustain the combs of the bees. All the frames are tied together by means of these cross pieces—a board is placed on the top, and a general cover is placed over the whole, to guard it from the effects of the seasons. In autumn, when the honey is to be taken from the hive, the cross pieces are untied, and one or two of the upper frames are removed, passing the long blade of a knife or a wire between. This done, an empty frame is placed above, and another under all the rest, which make up for the two removed."

The communications of two correspondents to the editor of "The Gardeners' Chronicle," published in the same article, p. 764, each describe a hive upon nearly the same principle as the above. The one describes his as being about a cubic foot in contents outside measurement, the boards being about three quarters of an inch thick: "They are painted black," which, by the by, is not a bad idea, "and their tops have four or five holes, which are stopped with corks. When the bees require more room to work in, these corks are taken out and another box *half* the depth, and the same breadth and length, is placed over the holes, and, if necessary, a second or even a third box on top of this."

The other communication is accompanied by the annexed drawing, fig. 744, which only differs from the last in the boxes being all of the same size—in this respect approaching very near to the hive of Pulteau above noticed. "a represents

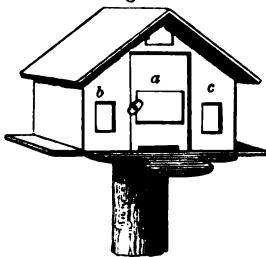
the box ; *b* the framework which fits on top of the hive before the sliding lid is put on ; *c* the whole three boxes in use."

Fig. 744.



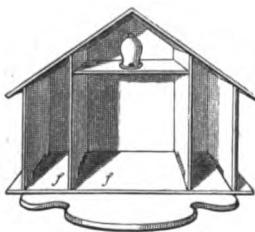
*Bagster's hive as improved by J. D.*, figs. 745, 746, is thus described in the work last quoted : "It is 13 inches square inside ; but this J. D. has improved by having

Fig. 745.



the sides *b c* divided into four compartments instead of eight : the centre for the swarm in the original hive being too large, it occupies too much of the bees' time to

Fig. 746.



make comb ; but this can be arranged to any scale. In the sides *b c* he proposes having thin deal boxes made to fit in the apartments, communicating at *f f*, fig. 746, with the colony, and also to afford a way out and in. The advantage of these boxes sliding out and in the divisions, would be that the bees and comb might be taken all away at once, instead of having to cut or break the comb in pieces in the hive. Fig. 746 shows the interior : the upper part may be used for glasses ; but " he " is not sure with regard to this, for the larger the hive the less the honey ; and, by leaving so many openings, instead of making plenty of honey, the bees loiter about and are idle. If, then, the sides *b c*, fig. 745,

be divided in the middle, there would be four places to give room when required ; but by no means leaving more than two in operation at once, and these must not be used till the centre *a* is quite full. The dimensions of these boxes are 12 inches square outside measure, and they are made of  $\frac{3}{4}$ -inch deal."

*Dr Howison's hive.*—An account of this hive was published in the "Mem. of the Cal. Hort. Soc.," and is described by the Doctor as being in form "two distinct hexagons, one placed above the other. The under is formed of six panes of  $\frac{1}{2}$ -inch deal, measuring 10 inches in width and 8 in depth, and covered with a thin board at top. This is intended for the breeding as well as winter habitation of the bees. The upper is of the same dimensions and form as the under at bottom ; but, in order to give it a conical shape, the panes at top are only 5 inches wide, which is also covered with a piece of board. The upper box has a moulding fixed to its under part, which projects about a quarter of an inch, and so exactly embraces the upper part of the lower box as to join these two firmly together. In the deal which forms the top of the lower box are cut four oval holes, each 1 inch wide and 2 inches long, through which the bees pass into the upper. This communication, when not wanted, is shut by a board which moves on a nail in its centre. The small pane of glass in the top of the upper box admits of seeing the progress the bees have made in it without separating it from the lower one. This pane is covered to exclude light and cold or heat, by a small shutter. When the swarm is first put into the lower box the communication is shut with the upper until the bees have completely filled the lower one with combs. The communication is then to be opened, when the bees will ascend, and, if the season is favourable and the swarm numerous, they will fill it also, but not till they have completely stocked the lower."

*Kashmir hive.*—We learn from "Moorcroft's Travels," vol. ii. p. 155, that the farmers in the eastern districts of Kashmir, in building their houses, make provision for their bees by leaving cylindrical cavities in the walls which extend quite through. These cylinders are plastered within with clay, and are about

14 inches in diameter and about 20 or 22 inches in length—this depending, of course, on the thickness of the walls. The end of these cylindrical hives next the apartment is closed by a round platter of pottery ware, a little convex in the middle, but the edges are made flush with the wall, and jointed with a luting of clay mortar. The external end is also closed with a similar covering, only having a hole about the third of an inch in diameter for the entrance of the bees. When the season arrives for taking the honey, the farmer, provided with a pan of charcoal and a wisp of dry straw, enters the apartment, opens the end of the hive, and burns the straw in small quantities at a time so as to produce a smoke, which he blows into the hive, taking care not to allow the straw to ignite for fear of burning the bees. This process he continues until the bees escape into the open air. He then, with a sickle, cuts away as much of the comb from the inner end as he wishes, shuts up the orifice again, and in a short time the affrighted bees return, repair the damage done to the combs, and proceed as usual. Such a plan might be adopted with us in building garden walls—or, indeed, a bee wall upon this principle might be built on purpose. Upon the principle before laid down regarding the size of hives, we would suggest for this climate cylinders of 8 or 9 inches in diameter only; and earthenware cans might be used, and built into the wall, so that their removal could be effected without trouble.

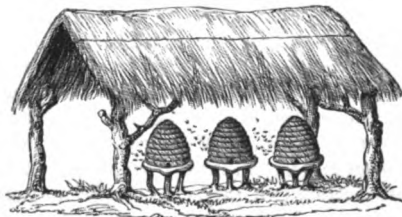
*Wighton's improved Polish hive.*—"The distinguishing feature in this hive," says Mr Wighton, in his excellent "Treatise on the History and Management of Bees," "is its simplicity; its approach, in fact, to the habitations which the bees instinctively choose for themselves. It consists of the root end of a spruce fir, 9 feet long and 3 feet 9 inches in circumference, from which the centre wood is hollowed out, and the planks removed for that purpose are sawn off to within 3 feet of the bottom. One of these is nailed on again at the back; the other, being divided, fits into its place again as an upper and lower door. The interior, 7 inches square, is separated by a slide into two compartments, the roof of each being provided with four slips of wood, nailed north and

south, for the bees to fix their combs upon. By reducing the cavity, the heat is increased within, which enables the bees to get on faster with their cells; also, in winter, they can be kept in one division, and they always choose the upper. In taking away the honey, if the operator be afraid of the bees, he can force them with a little smoke from brown paper into one division; then, putting in the slide, he will have it all his own way.

"In the lower division there are two entrances, one at the bottom and the other at the top, made with an auger, having a slip of wood on the inside to keep out the mice: in the upper part there is but one, which is in the centre. They are of course made on the opposite side of the doors: the space out of which these last were sawed being first filled up through its whole length by two glasses fixed in a movable frame, gives the apiarian ample means of observing the proceedings of his bees; while, when the doors are closed over it, the bees are shielded from the light, and from changes of temperature. The block end of the hive is sunk  $2\frac{1}{2}$  feet into the earth to keep it firmly upright, and the top is closed with zinc, and surmounted by a block of wood."

The authority last quoted says, regarding crowding hives in close bee-houses, that it is an erroneous practice—"not that the bees mistake their own home, but, when bent on robbery, they get too easily to each other's tenements; it also tends to hinder their egress and ingress, by causing them to come in contact with their neighbours. Close bee-houses," he continues, "are always objectionable; for in summer they harbour insects injurious to bees; in winter they are often damp. An open house, similar to fig. 747,

Fig. 747.



affords sufficient protection from the weather, and shades the hives in summer, except about the doorways." With all due

deference to Mr Wighton, who, we know, has studied the history and management of the bee with great assiduity, we think that a bee-shed or shelter in the rustic style would be better for them if formed as in fig. 748, (taken from "Illustrations

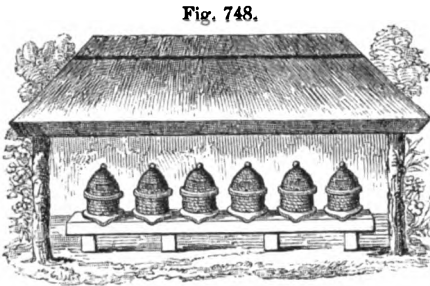


Fig. 748.

of the Hives referred to in the Practical Bee-Keeper," by J. Milton.) In Mr Wighton's shed there must be a perpetual draught blowing through it; while in the latter, this cannot take place, as the back or north side of the shed is closed in. Almost all bee managers disapprove of placing the hives in a draught, or where currents of air blow upon them, which must be the case in a shed whose sides are open all round.

These hives are of the kind called revolving hives, shown upon a larger scale in fig. 749, from the same source. The glasses are removed when full of honey, and empty ones substituted. They are also covered with a top, or bonnet, as shown by those in the shed.

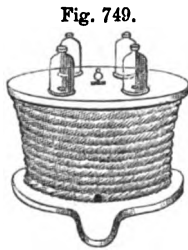


Fig. 749.

In fig. 750 we have attempted to show a variety of the Polish hive, internally on the same principle as those before alluded to, but externally exhibiting more of the grotesque or pictorial character, which we think such bee-hives undeniably should have, more especially when admitted as objects of ornament in picturesque gardens. Of course, in such as profess to be of a different character, other forms should be preferred. In situations where an old and picturesque tree exists, little harm will be done to it by converting it into a Polish bee-hive, the openings being made all on one side, as exhibited

above. Indeed the tree may exist for ages after being converted into a habita-

Fig. 750.



tion for these industrious and profitable creatures.

For this purpose any tree is more suitable than a fir; for the exteriors of the trunks of all that species are far too regular and column-like for the purpose.

*Young's bee-hive.*—This picturesque and ingenious bee-hive is the invention of Mr W. Young, late of Florence Court, Ireland, but now of the Cape of Good Hope. It was sent as a communication to "The Gardeners' Magazine," vol. viii. p. 665, from which the description and sketch, fig. 751, are taken.

It is in external appearance somewhat like the Polish hive, and admits of the honey being taken out without injuring the bees.

"A door opens in the rear, and inside is a glass door, which you can open to take out as many combs as you wish. The bees do not swarm, nor are they any trouble after being once put into the hive, which is done in the same way as with any other hive, by scenting the inside. The ends are two round boards; and



Fig. 751.

rails of wood are nailed to these, and strong canvass nailed round, leaving only the door. Two slight iron hoops are

nailed over the canvass, in order to strengthen the rails—one going round at the top of the door, and the other at the bottom, so that the door is between the hoops. Another piece of canvass is put over the first, and nailed all round as before, which makes the frame quite firm and strong. Now brush the canvass all over with thin paste made of flour and water, in order to fill the canvass and make it stiff, to keep the paint from going through the first canvass next the honey; and, when dry, give two coats of white paint. When the paint is dry, lay the whole surface over with strong putty, in imitation of the back of the elm, ash, or any tree to your fancy. When dry, paint it as like the colour as you can, and stick pieces of moss or lichen from the trees in the putty. There may be some fixture on the top, to throw off the rain. This one has a large cone of the stone pine for the bees to light upon. The sticks are fixed cross-wise, proceeding from the three entrance-holes to each side of the door in the rear. Currant bushes are growing up the two sides, and a few plants of thyme in front. The bee-holes in the bark look like key-holes, and they, being the same colour as in a door, and painted like bark, are not noticed. They have brass outside shuts in cold weather."

The same correspondent contributed, at the same time, the following description of another bee-hive, from which the honey may be taken without destroying the bees. The preservation of these industrious insects demands of us much more attention than has hitherto been bestowed upon the subject. The practice of destroying them is a species of unnecessary cruelty, and in an economical point of view like "killing the goose that laid the golden eggs."

The following is Mr Young's description:—"Make a square hive of straw: when at the height of 5 inches, work a floor of the same all over, leaving three round holes in the middle, about half an inch wide, in this way, ° ° °. Get a bee-hive, and fix a few thin willow sticks up the sides and top inside. Line the inside with canvass fixed to the sticks, and fastened outside the hive. Fix a thin board in the mouth of the hive, making it fit quite close and tight. Then make three holes in the middle, the same as

before noticed, which lay over the holes in the division or floor. Then continue making the outside hive until high enough to permit the passage of the other; and leave a door to open, to take it out and put another in. Three sticks are to be placed from the bottom to the holes in the floor, for the bees to creep up into the upper hive, where it is likely they will first begin. When the upper hive is full of honey, take it out, and put in another, leaving always what honey is in the under one for their support. When you wish to take the honey, set the hive on a dish, cut the fastening of the canvass and sticks, and shake the hive until the combs slip out on the dish; then remove the canvass, and the honey will be clean and the combs whole. If any bees remain in the combs, brush them off with a feather, and they will fly back into the hive again."

*Pillans' hive.*—Mr Pillans—rather dissatisfied with Nutt's hives, as being by

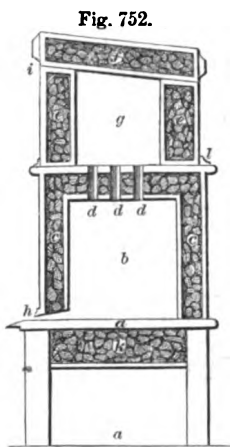


Fig. 752.

him considered too hot for the bees during summer, and also too cold in winter—says, "This spring I have had some boxes made," as shown in fig. 752, "but with hipped roofs, which look much neater, and are made to turn round on an iron pin fixed in a block of wood, so that when the sun shines upon the front of the box

in winter, it can be turned round to face the north, which prevents the bees from coming out and perishing from cold."

Reference: *a a* height of the frame; *b* the hive; *c c* space between outer and inner box, filled with charcoal; *d d d* spaces made with zinc tubing, to admit the bees from the lower to the upper hive; *e e* spaces filled with charcoal; *f* ditto, with the lid; *g* space for placing the glasses; *h* the alighting board, and aperture for ingress and egress; *i* the hinges of the lid; *k* space between frame, filled with charcoal; *l*



the upper box, made to take off and on, for placing the glasses within the upper hive.

Fig. 753.

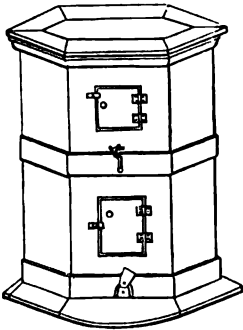
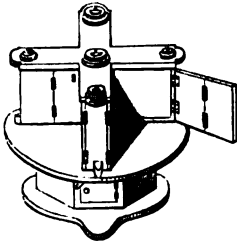
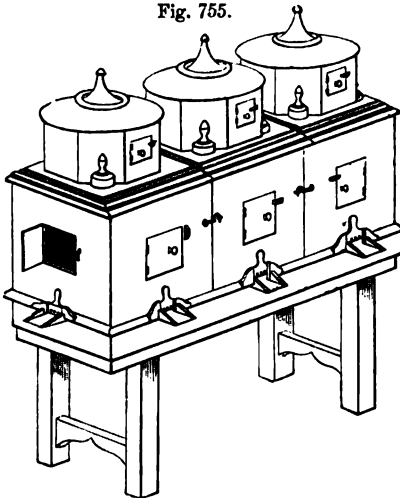


Fig. 754.



flower-garden or lawn, we present fig. 757, which was erected some years ago

Fig. 755.



at Pishobury, and is described in MILTON'S "Practical Bee-Keeper," a work which all those interested in bee management should consult.

This section is made square, but it may be extended to any length."—*Gard. Chron.*

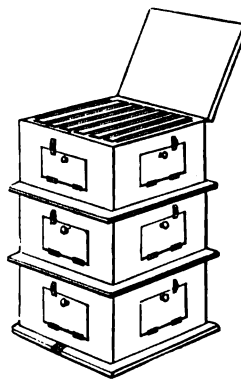
Fig. 753 represents the hexagon box-hive; fig. 754, Unicombe observatory hive; fig. 755, a stand with three hexagon tops, for separate swarms; fig. 756, Dr Bevan's storified hive. For ample descriptions of these, *vide* MILTON'S "Practical Bee-Keeper," 1st edition.

As an example of an apiary suitable for a

The following very judicious remarks appeared lately in a leading article in

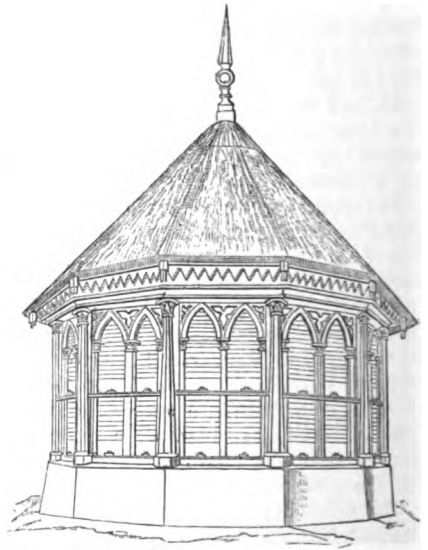
"The Gardeners' Chronicle," in connection with a critique upon the bee-hives from America which were exhibited in the Crystal Palace. After pointing out their defects, the writer proceeds to indicate what he conceives to be the fundamental principle by which bee-keepers ought to be guided, as follows:—"Any shed or other building will answer the

Fig. 756.



Any shed or other building will answer the

Fig. 757.



purpose of an apiary, in which the following conditions can be secured: 1st, Perfect shelter to the hives from the sun and wet; 2d, A firm place in the ground, and so low in height as to be as much as possible under the wind, and yet to admit of the hives being placed from 15 to 20 inches from the ground; 3d, Free access to the back of the hives, with an aspect avoiding the morning and mid-day

sun, but placed towards its setting ; 4th, The sides and back, if enclosed, not to be fitted so close as to prevent a free circulation of air at all times around the outside of the hives—the door or shutters to be so contrived that they can be opened or shut without the least disturbance to the bees by jarring or grating ; 5th, Freedom from all rustic or other ornament that can harbour spiders or other enemies ; 6th, A place where the bees are as little exposed as possible to disturbance of any kind, more especially in front of the hives ; 7th, Not to be placed on grass, but to have sand or fine gravel beneath it, extending at least a yard in front.”

---

## CHAPTER X.

### DETAILS OF CONSTRUCTION.

#### § 1.—GLASS AND GLAZING.

UNTIL the repeal of the duty on glass we had few varieties, and, if we except crown glass, still fewer fit for horticultural purposes. Now we have many, of which the following may be considered the best,—viz., British plate, patent plate, rough plate, patent rolled rough plate, crown in various qualities, British sheet, Belgian sheet, &c. &c.

In regard to the respective merits of these glasses, opinions are still as much at variance as they have long been; and they are likely so to continue. Crown, British sheet, and Hartley's patent rough plate are amongst the principal now in use. Inferior sorts of crown and sheet glass are manufactured, and find their way into the market under the denomination of cheap horticultural glass. As an instance of this we may state, that there are no less than five qualities of ordinary crown glass, varying in price from £2, 6s. to £6, 15s. per crate of eighteen tables; and in the case of sheet glass, 16 oz. to the foot, even when taken in crates, the difference in price is from 1s. to 3¼d. per foot; of 21 oz., from 1s. 3d. to 5d.; of 26 oz., from 1s. 6d. to 6¼d.; and of 32 oz., from 1s. 9d. to 9d. per superficial foot. We presume the quality in each class differs in a like proportion. This requires to be guarded against. Opinions regarding the merits of British sheet, and other modern improved kinds, have been, and still are, very conflicting. Notwithstanding all their presumed evils we would be sorry to lose them, both on account of their elegance in appearance and their economy in use. There can be little doubt that insufficient ventilation

is the principal cause of the accidents that have arisen from the use of these when of a large size; for we believe the same effects have occurred in glass of all descriptions when used beyond the old dimensions; and this opinion is confirmed by the circumstance, that where they have been used of small dimensions, the scorching and burning complained of have been scarcely recognisable—at least to a greater degree than in the glass formerly used. The best quality of crown or sheet glass will produce disastrous effects where ventilation is neglected; and of course this will be more evident when glass of inferior quality is used—arising chiefly from unequal thickness, undulated surface, and specks and nebules existing in it. These defects are daily disappearing as the manufacture is improved—the more so as cultivators are now aware of the necessity of a more abundant ventilation. It should be borne in mind, that for a hot-house roof, glazed with glass of whatever quality, in pieces 1 foot in breadth, and possibly 3 or 4 feet in length—more especially if the laps be cross-puttied—a much greater amount of artificial ventilation will be required, than in the case of another roof glazed with the same quality of glass 6 inches by 4 inches;—as in the latter, however thoroughly it may be kept in repair, air is admitted through the laps to an extent greater than is generally supposed. The same cause produces another effect, namely, condensation—and this often to excess—from the same amount of evaporation from within. In roofs glazed with small glass, and with innumerable laps, this condensation is allowed to escape to the exterior surface; whereas, in the case of large panes being used, the

means of escape are greatly lessened. Early morning ventilation is of great importance, whatever mode of glazing be adopted; and it is probably the lesson taught us by the scorching and burning complained of that has directed that attention to ventilation, not only during the day, but during the night also, which has led of late years to a more perfect study of that important subject. In all such houses as are built upon the best principles, and glazed with large-sized panes, let the glass be what it may, a constant system of ventilation must be maintained during both day and night; and where this is duly attended to, we doubt not all the evils of burning and scorching will disappear.

Notwithstanding all this, it behoves us to be upon our guard against an inferior quality of glass; and this object is first secured by dealing with respectable (*not cheap*) firms in our purchases: and, secondly, to exercise our own judgment by applying some of the many tests by which the quality of glass may be determined, and of which the following may be given as one both simple and certain: Take a square of glass and hold it up to the sun, so that the light passing through it may fall on a white surface—a sheet of paper, for example—carrying the glass from a distance of a few inches to 8 or 10 feet. If any bright or luminous spots or stripes are shown on the white surface, it is unsafe to use, and should be rejected. This test should be made by presenting both sides of the glass to the sun alternately. Although to inadequate ventilation may be chiefly traced the evils complained of, it may not be uninteresting to glance at some of the other causes to which these evils have been attributed; and, first, because we think there is a good deal in the argument, we may state that Dr Lindley was of opinion that the angle the roof may be placed at has a good deal to do with the evils discovered in the use of sheet glass, as at first manufactured, as well also as of its variability in quality. Regarding the first of these he says, in "The Gardeners' Chronicle:"—"If, for instance, the roof forms such an angle that the sun can strike it perpendicularly near the middle of the day, at the season when the leaves are young and tender, an effect may be produced by the rays of

light, however imperfectly concentrated by the irregular lenses, which effect would not be produced by the same glass placed at another angle of elevation, as plants may be entirely out of the foci of the lenses. Hence it will follow that in one case its use will be condemned, while in another it may be found satisfactory."

The same authority last quoted thus explains part of the process of manufacture: "From the way in which sheet glass is made, it must necessarily have numerous concavities and convexities, some of which, or many, as the case may be, have the power of concentrating the rays of light enough to burn the leaves of plants. The process of splitting and flattening cylinders, whose exterior circumference is  $\frac{1}{4}$  of an inch greater than the inner, must cause such irregularities to occur, with whatever degree of care the flattening is conducted. If sheet glass were simply irregular, or wavy, or uneven, its thickness being uniform, this concentration would not take place; but its thickness is so variable, from the effects of 'cockling,' that it may be compared to a layer of meniscus lenses or spectral glasses fused together; and these, from their large size, and the small difference between the diameter of their inner and outer curves, will have long foci. When the cylinder is spread open into a flat sheet, the two surfaces become of equal width, the glass adjusting itself by the expansion of the inner or smaller surface, and by the contraction of the outer or larger surface. In this operation is formed what the manufacturers call 'cockles,' producing that uneven puckering appearance which is the peculiar characteristic of sheet glass. Of these cockles some are circular, and form lenses of considerable power. It is said, indeed, that the effect of burning is observed far beyond the focus of any possible lens in the glass; but this is a mistake, as will be readily seen by watching the luminous spots formed on leaves beneath sheet glass in a bright sun."

The process of flattening, as carried on a number of years ago, was thus performed: The cylindrical glass or "muff" being cut longitudinally down the middle, was then placed in a heated oven, the bottom of which was as nearly level and smooth as possible, as upon this, we

think, very much depended the equality of one of its surfaces at least. When the glass was sufficiently heated, the edges were gradually separated until it lay flat on the floor of the oven; the workman then flattened the upper surface by passing a wooden block attached to a long handle over it backwards and forwards, until it was flattened to his mind. From this it will readily be seen how very liable the glass was to be of an uneven surface; and if the glass got heated so much as to become softened, it came out of the oven in very considerable ridges. The least unevenness in the floor of the oven would cause either concave or convex undulations, which is the groundwork of one species of lenses; while the ridges produce those which run in parallel lines, on account of their greater thickness, in a way somewhat analogous to that described by Mr Spencer of Bowood, who had recourse to painting his overlaps on the outside, as he found the leaves under the laps to be burnt in continuous lines exactly corresponding with the laps. This also agrees with the observations of Mr Worall in "Gardeners' Chronicle," who says—"I have four more or less distinctly scorched parallel lines running horizontally from west to east (action P. M.) and separated by distances of 3 to 5 inches, and these all the effects of one square, and nothing more than slight transverse undulation, in conjunction with latitudinal cuniformity, appears. This line begins at the side, and runs the whole length of the square." All this is now changed, and in place of the bottom of the kiln being used for the purpose of flattening, polished sandstone, and latterly polished plates of glass, have been used for that purpose; and for the purpose of diminishing the chance of injury to the glass in removing it from the flattening plate to the annealing pit, these plates are placed on frames mounted on wheels, and travelling on iron rails to the place where they are piled on edge to be annealed; and "cockling" has in consequence almost disappeared. Although it still takes place sometimes from minute particles of dust getting under the glass, that fault, for all practical purposes, may be considered extinct; but the radical defect of sheet glass—the want of parallel-

ism in the two surfaces, which gives it a blurred appearance even in very good qualities—still remains, and, we are afraid, never can be remedied, because it is a necessary consequence of the method of manufacture.

Hartley's patent rough-plate glass, one-eighth of an inch in thickness, and weighing nearly 30 ounces to the superficial foot, has been recommended for conservatory and hothouse roofs, and is said to be exempt from the bad effects complained of in the common sheet glass. This glass is strongly recommended by Dr Lindley, who says—"This glass is prepared by rolling, which *destroys transparency without diminishing translucency*. It is slightly rough on the surface, which has the important effect of dispersing the sun's rays instead of concentrating them. The roughness, however, renders it less agreeable to the eye, and would make it objectionable for the perpendicular sides of glass houses. It renders a shade superfluous in summer; and we do not expect that it will intercept any material amount of light in winter. We believe, indeed, that light passes through it as freely, though not so directly, as through transparent glass. The mere fact of its rendering a 'shade'—one of the worst of the gardener's nuisances—unnecessary, gives the 'patent rough-plate glass' a great value in our eyes."

As to its fitness for houses to be early forced, its utility is not as yet fully confirmed; and it is even probable that of it there may also be good and bad qualities, as well as of the various kinds of sheet glass. How far it may be beneficial for the roofs of glass houses and pits during winter, when all the light we can possibly obtain in a dark and cloudy climate is required, is also as yet not quite fully determined; but during the heat of summer, in consequence of the subdued light passing through it, we have always found plants thrive under it better than under that which is more transparent. It may be procured not only in large pieces, but also of great thickness and strength, and has been used in plates  $5\frac{1}{2}$  feet long by 4 feet in breadth, and  $\frac{3}{8}$ ths of an inch in thickness, in the garden of Josiah Wilson, Esq., Stamford Hill, where it has given the greatest satisfaction. The roof upon which it is used

is curvilinear, and these immense plates of glass are bent to the necessary curve. There is very little interruption to the light, as none of the framework, which is very slight, is nearer than 4 feet. The light within is as clear as in the open air, while the glare of the sun's rays is intercepted so that no bad effects are experienced by scorching.

At the time the large tropical conservatory at Kew was building, the glass question was then engrossing the attention of all concerned in hothouse building, and scientific men began to turn their attention so much to the subject that the glass for this very structure formed the text of a very interesting paper read by R. Hunt, Esq., before the British Association. And soon afterwards we find that the Commissioners of Woods and Forests, at the suggestion of Sir William Jackson Hooker and Dr Lindley, applied to that gentleman to ascertain "if it would be possible to cut off these scorching rays by the use of a tinted glass which would not be objectionable in its appearance." After an elaborate series of experiments, Mr Hunt determined that a glass, coloured of a pale yellow-green, by means of oxide of copper, gave the most satisfactory results. The absence of the oxide of manganese, commonly employed in the manufacture of sheet glass, is insisted on—it having been found that glass, into the composition of which manganese enters, will, after exposure for some time to intense sunlight, assume a pinky hue, and any tint of this character would completely destroy the peculiar properties for which the glass is chosen. In fact, the experiments of Mr Hunt do little more than lead us back to the days when good crown glass of a greenish hue was in high repute for hothouse roofs. In the experiments made on radiant heat, some years ago, by Melloni, he discovered that the colorific rays were nearly all obstructed by the green Italian glass used in his country, for almost all ordinary purposes. From all this, it would appear that glass having a greenish tinge is the most suitable for hothouse purposes, so far as mere colour is concerned. On a subject of so much importance as this—and we hold the colour of glass to be so—other opinions should be brought to bear on

the matter also. The theory laid down by Dr Daubeny, in the "Philosophical Transactions" for 1836, and corroborated by M. Decaisne, is worthy of attentive perusal—as are the experiments made by Dr Horner of Hull, who recommends violet-coloured glass, as not only affording a partial shade, but as transmitting a light which possesses a subtle action in exciting vegetation, and proving, as he says, in all respects an admirable auxiliary to the artificial heat and moisture necessarily employed in culture. The best paper, however, we have read on this subject is that by R. Hunt, Esq., already referred to, and published at length in "The Gardeners' Chronicle," to which we refer our readers.

From this paper it appears that, by the use of red, blue, and yellow glasses, of peculiar kinds, we may so far alter the natural condition of the plants as to free them from one or more influences, whilst the third is brought more decidedly into action. Mr Hunt's experiments have led him to conclude, that "red, blue, and yellow media are suitable to all the conditions necessary for producing the following results:" First, "light which has permeated yellow media" was found, in almost all cases, to have the effect of preventing the germination of seeds; and in the few cases forming this exception, the young plants soon perished. Mr Hunt concludes that this is owing more to the action of the heat rays than to the light. He conjectures, however, that although the luminous rays may be injurious to vegetation, (which, no doubt, they are,) and the early stages of vegetation, they are essential in after growth, particularly in forming woody fibre. Secondly, "light which had permeated red media" is not unfavourable to germination, if the seeds be kept sufficiently moist, to make up for the increased evaporation. The plants, however, assume a sickly appearance, and become partially etiolated, showing that the production of chlorophyl is prevented." And another important fact has been proved—namely, that plants bend themselves as much from red light as they bend towards white light in ordinary houses. To this another interesting circumstance may be added, that plants in a flowering state continue much longer in bloom under

the influence of red light than under any other. Thirdly, "light which has permeated blue media." The rays thus separated from the heat and the light rays, which are regarded by Mr Hunt as a distinct principle, for which he has "proposed the name of *Actinism*, have a power of accelerating, in a remarkable degree, the germination of seeds, and the growth of the young plant. After a certain period, varying with nearly every plant upon which experiments have been made, these rays became too stimulating, and growth proceeds rapidly, without the necessary strength. When this is perceived, the removal of the plant into the yellow rays, or, which is better, into light which has permeated an emerald green glass, accelerated the deposition of carbon, and the consequent formation of woody fibre proceeds in a very perfect manner."

Such, says Mr Hunt, are the conditions and results of his experiments. So much for the colour of glass.

In regard to the charges brought against British sheet glass, on account of inequality in thickness, undulation of surface, &c., we must admit that, for a time after its being first brought into use, there was great cause for complaint. This is, however, now much less the case, as the article is of a superior manufacture. The evils here referred to arose from the convex parts forming lenses, by which the rays of the sun became concentrated at a distance from the under surface of the glass, proportioned to the convexity and diameter of the part. These defects were found to exist, to a very serious extent, in the large conservatory of the Botanical Society of London, although great care was taken by the curator, Mr Marnock, who states the following interesting particulars; and, coming from such authority, they merit especial attention:—

"In many instances," he says, "the concentration of the rays only occurs at the floor of the house; and making allowance for the oblique direction of these rays, the distance from the glass is in many cases not short of 40 feet. Many others, again, are the products of much smaller convexities, and the rays from these concentrate, of course, at various distances in the neighbourhood of the under surface of the glass. Thus, it will

be readily understood, must the whole interior of the glass house, glazed with inferior sheet glass, consist of an atmosphere filled with a multitude of concentrated rays, proportioned in number to the undulations on the surface of the glass, meeting and crossing one another in every possible direction, from within a few inches of the glass to the distance which we have already stated of feet, or more. It is also worthy of remark, and it is important in a practical point of view, that the larger—that is, the broader the convex parts, the less injury do they commit—for the two following reasons: First, that when the convex part or lens in the glass is several inches in diameter, and not much raised, the rays of the sun cannot meet through this form but at a considerable distance from the glass; and, secondly, in proportion as the concentration of the rays is distant from the glass, so in like manner does the focus, or point at which they meet, acquire motion. Hence, except upon broad-leaved plants—such as camellias, orange trees, vines, pines, peaches, and similar plants, upon which injury is inflicted, owing to the breadth of the leaves and the time required for the concentrating point to travel over their surface—the evil is seldom much felt; and if the leaves are small, these distant rays do no damage whatever—that is, unless the glass be of the very worst possible quality.

"It will, however, be very properly inferred from what we have stated, that the matter is very different with the smaller undulations, when the house is used for forcing, and the leaves are necessarily near the glass. In such cases it is impossible that mischief should not occur; and this will be the case in defiance of skill or care, however applied, unless the best glass has been employed. When horticultural erections are raised for early forcing, and the British sheet glass is used, it would seem prudent to construct the trellis upon which the plants are trained at a greater distance from the glass than that at which it is usually placed. It is also well to bear in mind that wavy glass, with its surface much undulated, refracts a portion of the light, which, by smooth and superior glass, would be transmitted into the house for the benefit of the plants."

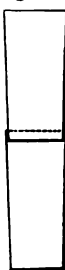
*Corroborated glass.*—This glass was brought into notice a few years ago by Mr Apsley Pellatt, who describes it to be both stronger and better calculated to prevent the drip by reason of the rain entering between the laps, and, at the same time, lessen, if not wholly remedy, the formation of globules from condensed steam on the under side of the roof, which is known to form lenses, and to cause serious injury to the leaves of the plants. This glass is of an arched form, 7 inches broad and 20 inches long. A roof glazed with this arched or corroborated glass would have a very novel appearance, somewhat resembling a roof of corrugated iron. This glass being of moderate and uniform thickness, and being periscopic, has no tendency to burn the plants placed under it, nor to reject the sun's rays at any angle of impingement. A roof glazed with it to a certain extent becomes a modification of a ridge-and-furrow one. This form of glass requires the sashes to be made expressly on purpose, at least the astragals must be of a different form from those in ordinary use.

*Polished thick plate glass,* we apprehend, will be found inapplicable to the roofs, at least of horticultural erections, for reasons apart from the enormous expense. It is an established law that light is transmitted through glass in exact proportion to the angle at which it falls on the surface. At  $45^\circ$  it is found that exactly half the light passes through, and the other half is reflected off at the same angle into the air. We apprehend that heat follows the same law; and when we come to very acute angles, total reflection takes place, and this occurs with thick glass at a larger angle than it does with the glass commonly used.

*Russell's patent glass tile.*—The following description and illustration will explain this invention. About half an inch of the opposite sides of a flat sheet of glass, of any dimension that may be desired, are bent upwards until they form a flange nearly at right angles to the plane of the glass, and about half an inch deep of the section. The ends are made of unequal breadths between the flanges, so that the narrow end of one tile may go easily within the flanges of the broad end of another, as shown in

fig. 758. The tiles are placed in rows along the roof, the narrow end downwards, the wide end upwards, resting on a purlin of small dimensions, between the principal rafters: the lower ends of the second row of tiles are placed within and above the upper and wide ends of the first row, with a lap of half an inch: the adjacent flanges of each pair of tiles, which are from a quarter to half an inch apart,

Fig. 758.



are then covered with a metal hollow bead, screwed down at one end to the purlin below, the crown of the bead being filled with putty before it is put on.

The saving effected in the first construction of the roofs of hothouses or conservatories, by using this tile in place of the usual sashes, is from 10 to 15 per cent, taking glass of similar strength in both cases. The sashes, as in ordinary construction, are entirely dispensed with, and the rafters need not be placed nearer each other than 6 feet, rendering the roof more open and light.

The purlin or small cross-rafter, upon which the ends of the tiles rest, affords an excellent means of catching the moisture, condensed upon the inner surface of the glass, into a rone or groove cut out of the upper side of the rafter, and lined with thin marine metal, and which falls into a pipe trained down one of the rafters. Dripping of moisture from the roof is thus prevented.

Keeping out of view the saving effected in the first cost of roofs for horticultural purposes by using these tiles, the following very desirable objects are attained:—

First, No timber on the roof, with the exception of part of the cope of the ridge beam, is exposed to the weather.

Second, No putty is exposed: the putty used is covered by the metal bead.

Third, No paint is required, and consequently the continually recurring repairs or renewal which putty and paint need every second or third year are altogether avoided.

Fourth, The roof is nearly air-tight, and must therefore render the heating more effective, and consequently economical, as no part of it is wasted by escape.



Ventilation at will is insured by simple and effective openings at the ridge.

This very elegant mode of glazing we have seen exemplified in various places, and are glad to find that Mr Russell, who is at the head of the glass trade in Scotland, is very actively employed in erecting hothouses upon this principle. We believe the idea to be quite original to its inventor, although it very closely approaches the mode of roofing with tiles practised by the Romans, and described by Borgnis in "*Traité de Construction*," specimens of which are still to be seen in Rome. The hothouses at Alva and at Yester are good specimens of Mr Russell's principle, and we believe he has covered several public buildings in the same way.

*Various modes of glazing.*—Glazing without overlaps was, we believe, first brought into notice by Mr Snow of Swinton. The advantages of this plan are "greater neatness, durability, economy, and cleanliness, as well as a freer admission of light." For this purpose the glass is cut with perfectly straight edges, which are brought together, edge to edge, instead of being overlapped, as in ordinary glazing. This plan appears to be a great improvement, when large squares of strong thick glass are used. The loss sustained by breakage, in consequence of the expansion of water by frost, which is so general, unless the laps are carefully puttied and kept in the best state of repair, is avoided. Again, whether the laps be puttied or not, a considerable amount of light is obstructed, which is completely obviated by this mode of glazing. Should any individual pane get broken, it does not affect the others, as each is independent of the next. There appears, however, to us a difficulty in the great nicety required in cutting the pane to be inserted, so that it shall fit exactly with those above and below it; for on the correctness of this joining the principal merits of the plan depend. We have tried this mode of glazing, and think highly of it, on account of its more elegant appearance, and, strange as it may appear, its almost total absence of drip.

As it has been calculated that 10 out of every 60 feet of glazing are taken up with laps, choked with dirt or green muscous matter, and from 18 to 20

feet with unnecessarily large rafters and astragals, glazing upon Snow's principle, and using astragals of moderate breadth and increased depth in fixed roofs, will greatly remove this evil. It is useless to talk of rendering the house air-tight by close glazing, whether by this means or by using large squares, and fixing them with leaden laps, as in the Royal Garden at Frogmore. Ventilation, properly applied, will overcome all this, let the glazing be as tight as possible.

Glazing, without fore putty—that is, dispensing with the covering of putty usually laid over the edges of the glass in the rebate—has been found an improvement in some cases. When the glass is laid in the bed of putty in the rebate, and firmly pressed down, leaving the laps one-eighth of an inch broad, instead of covering with putty in the usual manner, lay on two coats of good stiff white-lead paint, about a quarter of an inch in breadth, along both sides of the squares, which, when dry, will keep the glass as firmly in its place as the usual mass of putty applied to the upper sides of the squares. This mode is of use in glazing metallic roofs more than wooden ones, as the absence of putty allows expansion to go on more freely, and thereby saves the breakage of glass from that cause. The paint should be renewed annually; and if attended to in this respect, the roof will be more free of drip than in the ordinary method of glazing.

Much too little attention has hitherto been paid to glazing, and we fear the reduction in cost will not amend this defect. Glass should never be cut too large—that is, fit tightly between the astragals, because the latter are apt to swell when wet, and the glass, being non-elastic, is sure to be broken. If too hard glazed, (as the phrase is,) any violent concussion, such as carelessly pulling down or drawing up the sash, will produce the same effect. Each square should have nearly one-eighth of an inch play between the sash-bars. Another evil is in bedding the squares so that both surfaces do not touch each other at the overlaps; this is often done through want of skill, and often intentionally, to allow a greater depth of putty in the lap. Now, it were better they were not cross-

puttied at all than to have too much placed between the laps, as, after a time, it falls out, and the thicker the body is the more likely is this to happen. The putty cannot be too thin for this purpose, and indeed it is questionable whether a little paint would not be a good substitute.

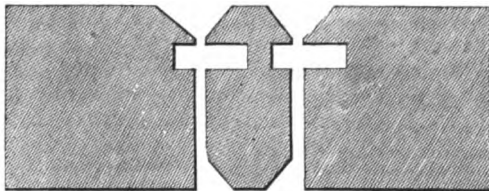
We are not advocates for large squares of glass unless for conservatories and houses of the first order; and in large establishments several sizes should be used. For vineries, peach-houses, &c., moderately sized squares should be employed; and for pits and less pretending structures, panes of one-half that size, as the fractured squares of the former will cut down to repair the latter. The glass should be chosen flat, so that each pane may fit close to the other; and previous to glazing a new sash, they should be first fitted in to see that they are of a proper size, and that they range in straight lines, not only across each sash, but along the whole length of the roof. When this is arranged, the rebates should be bedded with putty, and the glass pressed firmly down upon it, and the sashes laid down flat until the bedding has partially dried, when the process of fore puttying should be gone on with, or the system of painting above described; but in either case the sashes should be kept quite flat, and not set on edge, as is too frequently the case; as by the latter practice the glass is apt to be shifted out of its proper place.

The method described above of fixing the glass by means of a narrow strip of paint, instead of putty, may be adopted with great advantage even when putty is to be used. The paint will cause the fore putty to adhere more closely to the glass; and in the event of the putty coming away, the above precaution will prevent the entrance of wet both into the house and also from lodging in the rebate of the astragal.

*Read's mode of glazing.*—The late Mr John Read, the inventor of Read's patent syringe and other useful garden implements, proposed a mode of glazing in which the glass is let into rebates or grooves cut into the astragals and side rails of the sashes. The annexed cut, fig. 759, will explain the principle. It will, however, be necessary to observe that the

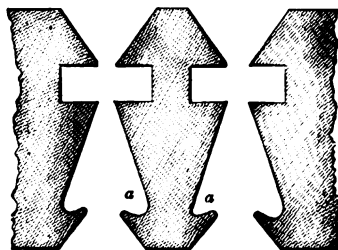
grooves on the right hand sides are deeper than those on the left, which facilitates

Fig. 759.



the introduction of the glass. When the squares are properly arranged, the space between the glass and the top of the groove is filled with putty, which, although in a very small body, is perfectly sufficient to answer the purpose of keeping the squares in their proper places, and also for excluding the wet. This mode of glazing, and at the same time of puttying the laps, is no doubt both the strongest and most effectual for keeping out wet, and, in regard to expense, does not exceed that in ordinary use. The grooves cut in the astragals should barely exceed in breadth double the thickness of the glass. We use this mode of glazing very extensively, considering it preferable to most others. A somewhat similar plan has been recommended by Mr Stevenson in "Gardeners' Chronicle," with the view of curing the damp "caused by the drip from the astragals and side bars of the lights, in consequence of bad glazing, together with the vapour rising from within, and condensing on the under side of the lights. To obviate this evil," he says, "I had a frame made and fitted up with astragals and side bars, as shown in

Fig. 760.

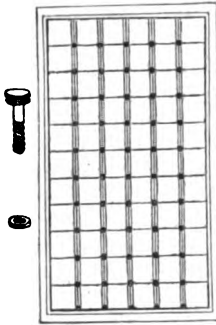


the above section, (fig. 760) which requires no farther explanation than that *a a* are grooves which catch the rain water which finds its way inside, as well as the condensed vapour, carrying it to the bot-

tom of the lights, instead of dropping on the surface of the bed." The grooves, it will be observed, are upon Read's principle, but not so well contrived for the insertion of the glass, as they are all of the same depth.

*Curtis and Harrison's mode.*—Fig. 761 shows the principle.

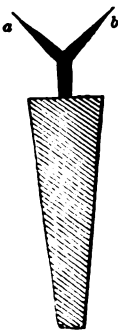
Fig. 761.



The frame of the sash is constructed in the usual manner, and rebated on the inside all round, for the reception of the glass; the astragals or bars are flat on their upper sides, and exactly level with the rebate in the frame. The glass is cut into squares and laid on the bars upon a very thin coat of putty, and fastened down by means of a metallic screw and flat collar, which are placed at each angle—the lower side of the collar holding the glass in its place. The advantages of this mode appears to consist in presenting a plain surface of glass over the whole roof—thus saving the expense of repairing, putty, painting, and securing the durability of the astragals, which are covered with the glass. The objections to it are the difficulty of removing the screws in case of repairs, and the trouble in cutting the glass to the exact size required.

Saul's method is intended to protect

Fig. 762.



the rafters and sash-bars from exposure to the weather, and to give the outside of the roof a smooth and even appearance. Fig. 762 is a section of the rafter. *a b* is a thin piece of metal, lead or zinc, which runs between every joint of the sash-bar, with the upper part divided as shown, so as to turn over each joint about a quarter of an inch. The glass is bedded on putty on the top of the sash-bars; and a little white lead is put under

*a b*; and when turned down it is completely waterproof.

*Barratt's method.*—The glass here is laid upon a wooden sash-bar, (not in rebates,) and the joints are covered where the sides of the glass meet, with strips of thin lead, so that the roof appears at a distance to be one sheet of glass, and has been found to be completely water-tight.

Glazing with leaden laps was formerly more practised than at present, although instances occur of this being, under various modifications, still met with. In the Royal Gardens at Frogmore, where the houses are glazed with panes from 24 to 30 inches in length, and cut curvilinear at the ends, a very ingeniously contrived leaden lap is employed, with a view to render the roofs dry, and to exclude the air by a more permanent material than putty. In fig. 763, *a*, a lap, is shown as

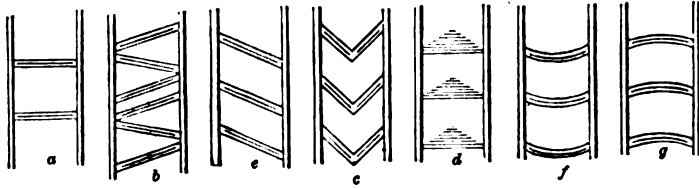
Fig. 763.



inserted in a groove; *b* an improved lap, and consists in using thin slips of lead in connection with putty; *c* Stewart's lap; *d* slip of thin lead bent in form of the letter S, used by glaziers to keep the glass in its proper place on steep roofs or perpendicular frames until the putty is thoroughly set, when they are entirely removed. Metallic laps add greatly to the strength of glazing by giving each pane a firm bearing on the upper and lower edges, and by preventing water from lodging between the laps of the glass; and has the advantage over putty that it cannot be displaced. The most common forms of glazing are shown in fig. 764—namely, the rectangular, *a*; the fragment, *b*; the perforated shield, *c*; the entire shield, *d*; the rhomboidal, *e*; the curvilinear *f*; the reversed curvilinear *g*; and the long pane of from 12 inches to 3 or 4 feet, introduced since the repeal of the glass duty. Of all these methods, we greatly prefer the curvilinear, because the rain water is in it attracted to the middle of the panes, and consequently drawn from the sides, where it might find its way under the putty, and thence into the house; and if a small opening be left in the putty at the centre

of the curve, the condensed steam will tied laps are objected to by those who to a great extent pass off outwards. Put- advocate that too much light cannot be

Fig. 764.



admitted into a house under any circumstance, and that the laps rendered opaque by the putty tend to the exclusion of light. This we admit; but were the laps left unputtied, we maintain that in a very short time the same effect would take place, as the dust and filth, finding their way between them, would exclude quite as much light as the puttied laps do. Others object on the ground that the house would be too close; but ventilation, properly conducted, will remedy this. And some are afraid of the condensation which takes place within; but ventilation is again the cure; and openings in the middle of each lap about a quarter of an inch in length will allow the condensed steam to escape to the outer surface of the roof. The great advantage of laps is to strengthen the glass, to exclude wet, and to prevent breakage by the expansion of frozen water.

However effective any or all of the methods hitherto proposed for getting rid of paint and putty as a means for fastening the glass to the wood or metallic parts of hothouses have been, certainly there is room for improvement and hope for success. The methods proposed by Curtis and Harrison, Saul, Kent, Barratt, &c., are all in the right direction; and we have no doubt that rebated astragals will be soon entirely dispensed with, and others, with their upper sides quite level, substituted. We have constructed some of this form, and bedded the glass on strips of vulcanised india-rubber above one-eighth of an inch thick. On this the glass is laid; and over the joinings of the panes another similar strip of the same material, half an inch in breadth. Over this is laid a bead of glass, rounded slightly at top, and perforated with holes 12 inches asunder and one-eighth of an

inch in diameter, passing through the glass bead and astragal. Into this perforation Jeffrey's marine glue, or vulcanised india-rubber, is poured in a liquid state, and received at the lower side of the astragal into a small capsule, which, when removed after the material has cooled down and hardened, leaves it similar to the head of an ordinary screw. The top part is moulded in the same manner—the little funnel through which the liquidised india-rubber is poured being about a quarter of an inch in diameter, and of circular form. When the liquid is poured in and beginning to solidify, this funnel is removed, and the portion which is above the glass beading is moulded by the finger and thumb, while yet soft, in form of a button. Glass so secured is much more firmly attached to the framework than by any other method, and will remain for years in the same state. When repairs become necessary, or new glass is put in, the head of *either* end of this tie, of india-rubber is cut or filed off; and with a pair of nippers applied to the other end, the whole is withdrawn, both out of the astragal and glass bead, with perfect ease. The glass beading is lifted off, the square of new glass laid in its place, and again secured as already explained. The elasticity of the vulcanised india-rubber is such that no ordinary concussion, vibration, or pendulous motion can break or disturb the glass resting upon it, and kept down by it, under the glass beading. The coping formed by the glass bead covers the india-rubber so completely as to keep it dry, and also to prevent the entrance of wet to the astragal; and the whole surface of the roof is one continuous sheet of imperishable glass, without paint or putty, wood or metal.

Mr Spencer's mode of glazing has been

noticed in connection with his glass walls, *vide* page 91, and fig. 80. By subsequent information received from the intelligent inventor, we find that strips of india-rubber are placed on *top* of the sash-bars for the glass to lie upon, as well as over it, on which the beading rests. Securing the glass in all hothouse roofs by means of portable beading, as here recommended, will shortly, we have no doubt, become the general practice in all new erections, because it has reason in its favour; the only difficulty at present being in the construction of the screws, which are apt to become difficult of extraction. This, however, could be remedied by forging their heads like square nuts, sufficiently thick to admit of a turn-screw wrench, instead of a screw-driver being applied. Another improvement would be making the beading of glass, instead of wood or metal. By this means we would have the entire surface composed of two imperishable materials, viz. glass and copper. In the manufacture of glass beading there would be no difficulty in forming perforations for the screws at 12 inches apart. The greatest improvement that can take place in glazing is the total disuse of putty and paint, which such a mode as this would completely realise.

*Jeffrey's marine glue* has been recommended as a substitute for putty, and when laid on the astragal to the thickness of a quarter of an inch, and over the glass about 3-eighths of an inch, has been found to stand both frost and heat. Its elasticity prevents the breaking of the glass when the sash is shaken or carelessly let fall, which is no slight recommendation to its adoption. It is more expensive than common putty; but as it is almost imperishable, and requires no paint, this is a matter of less consequence. It should be thoroughly melted in a common glue-pot, using oil instead of water in the outer vessel, and applied quickly by using an iron spoon. Any of the glue that runs over the glass may be easily removed with a knife or chisel.

One of the principal causes of the breakage of glass is too tight glazing, more especially in metallic roofs, when expansion and contraction are going on upon all sudden changes of the temperature, and the evil practice adopted by some tradesmen of sprigging down—that

is, putting small sprig nails into the astragals of wooden roofs, at the corners of the panes, when they happen to be a little crooked or of uneven surface; for on a sudden blow being given to the sash, the glass is sure to crack, beginning at the point where it comes in contact with the resistance of the sprigs. But the greatest of all causes of breakage is open overlaps, and this is increased in proportion to their breadth. The water that finds its way between the laps, whether from capillary attraction, the dashing of rain against the roof, or otherwise, becomes frozen unless the temperature within be kept sufficiently high to prevent it; and as water, when converted into ice, becomes much enlarged in volume, the breakage of the glass by expansion naturally follows. All roofs should be cross puttied—that is, the overlaps filled in with some material that will exclude water, if the preservation of the glass be a consideration. The lap need not be more than one quarter of an inch in breadth, even where the panes are large; and where they are small, (say 6 inches by 4,) one-eighth of an inch is quite sufficient.

The best system of glazing sashes of the ordinary construction, in our opinion, is to cut the lower ends of the panes on the curvilinear principle;—to bed them evenly on a putty bed; bring the two surfaces as close together as possible at the overlaps, and, keeping these about two-eighths of an inch in breadth, putting them, or introducing a copper or lead lap between them—leaving, however, always an open space in the centre of the lap, of about a quarter of an inch, to allow the condensed steam from within a free passage to the outer side of the roof;—to draw the paint-brush along the sides of the squares to the breadth of the shoulder of the rebate, and, when this is dry, to put on the fore putty;—then, when sufficiently dry and quite hard, but not till then, give the whole three coats of white-lead colour reduced to a stone shade.

A very great deal of the durability of glazing depends on old putty of the best quality being used, and that it gets perfectly dry before painting. It is needless to observe that the sashes should be quite dry before the glazing commences, and that they should be primed and knotted also. In repairing glass roofs, which

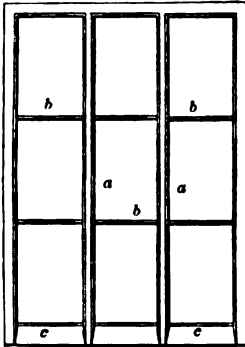
often has to be done during winter when accidents occur, the rebate should be thoroughly dried by searing it with a hot iron before the square is put in.

*Reversing the position of the sash-bar.*—About six years ago we observed an experiment being tried in the gardens at Hungerton Hall, by reversing the sash-bar, and so placing the rebate under the sash instead of above it. The intention was to preserve the putty from the action of the atmosphere. The glass, of course, was put in from below instead of from above—a process attended with much trouble to the glazier. The success of the plan we have not since been able to learn; we anticipate, however, no advantage from the principle.

*Rishton's registered sash*, for conservatories, vineries, greenhouses, and hotbeds, &c., will be understood by a glance at our figures and the following description:—

Fig. 765 is a complete frame in plan; fig. 766 a longitudinal section of the

Fig. 765.



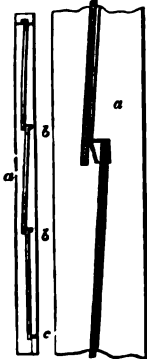
same; and fig. 767 a longitudinal section of part of a frame, constructed according to this design. *aa* are the styles and astragals of the frame; *bb* cross bars of thin metal, which receive the upper ends of the squares of glass, and form a receptacle for putty round the glass at that part, while at the same time they give additional strength to the frame itself. The super-incumbent square of glass *a* is kept a very short distance clear of the bar *b*, which arrangement prevents the collection of water and discoloured matter at

the laps, and also the breaking of the glass by frost, while at the same time ventilation is facilitated, and any square of glass may be removed without disturbing the others. *c* is a strip of angle-shaped metal, to carry the water outside when it arrives at the bottom square.

*Alfred Kent's new mode of glazing hot-houses*, exhibited in the Crystal Palace, and provisionally registered, is thus described by the editor of "The Gardeners' Chronicle":—"This method of glazing may be thus described: Suppose two squares of glass, each 2 feet long, are laid flat, edge to edge, on the grooved sash-bars; then, about 3 inches from each end of the square, a small copper bolt is driven through the bar from the under side; the edges of the squares are brought up to the sides of the bolts, and a strip of vulcanised india-rubber, about three-quarters of an inch wide, and the length of the square, is carried along the joint so as to cover it; on the top of this india-rubber is placed a strip of thin iron the same length as the square; and finally, the whole is secured by screwing a copper nut upon the copper bolt. It is to be observed that this nut is necessarily made of copper, otherwise, being on the outside, in four or five years' time, when such a house would want painting, there would be no getting the nuts unscrewed, as must be done, it being necessary to remove all the glass previous to painting the bars." The principal objection to it, the authority above quoted states—and to this we would add, the liability of the iron capping to corrode—"is its cost, which must at first be higher than ordinary glazing. On the other hand, it certainly possesses some advantages, especially in repairs, the whole process of unputtying and puttying being done away with. It will, however, be indispensable that due provision be made for the expansion and contraction of the iron straps which are placed in the glass joints, otherwise the straps will cockle, or the copper bolts break, and the roof become leaky, or be blown away."

As to the peculiar merit of the grooved bar above alluded to, and on which Mr Kent rests that portion of his invention which guards against leakage, the escape of evaporation, and a more complete system of ventilation, it has, we think, been so completely exemplified before, as to

Fig. 766. 767.



claim on our part little attention either for novelty or advantage. The means, however, for removing the glass, either for washing it, or for admitting the sash-bars to be painted, as well as for rendering a glass house so constructed a movable and not a fixed structure, and thereby enabling tenants or others to remove such houses, are not without their advantages, as well as the doing away with rebated astragals, and fixing in the glass with putty—two principles in hothouse building which should be avoided as much as possible.

*Removing glass without breakage.*—In repairing glass it is often found difficult to remove the old putty, particularly if it has been of long standing, and compounded with white or red lead in its formation. A little nitric or muriatic acid, or a little strong vinegar spread over it, will soften it so that it will remove easily. The same means will remove paint. Rub the putty with soft soap, and in a few hours it will be sufficiently soft to part with the astragals and glass freely. When whole sashes are to be re-glazed, the putty may be softened so as to admit of the glass being taken out without breakage, by placing the sashes over a pit filled with stable dung in a high state of fermentation.

*Putty.*—Much of the success of glazing depends on the quality of the putty used, and this depends on the materials used, and the mode of manufacture. New putty should never be used, as the older it is the better. Indeed, putty-making has now become a considerable trade of itself, and steam-power is employed in preparing it. Whoever, therefore, wishes to procure a good article, should purchase it direct from the manufacturer, as, if kept in close barrels, it will keep for years, and only requires to be beat up with a little linseed oil as it is required for use. Glaziers employ four kinds, which may be considered as being of relative strengths.

*Soft putty* is well-wrought paste of flour of whitening and raw linseed oil. This is the worst kind, and is that often procured from village glaziers. A better kind is common whitening powdered very fine, and thoroughly dried, and mixed with linseed oil till of the consistency of dough.

*Hard putty*, composed of whitening and boiled linseed oil.

*Harder putty* is that in which a portion

of turpentine, or what is called drying oil, is introduced. These are the usual kinds, and should be well dried before painting.

*Hardest putty.*—This is used chiefly for metallic roofs, or where the rebates are small. The body of putty, therefore, being small, it requires to be stronger in proportion. This is composed of oil, red or white lead, and sand. Another kind of hard putty is often used for metallic roofs, viz., mix as much red lead with good old common putty as will make the whole of a salmon colour. It is necessary to paint the astragals with red lead mixed with boiled linseed oil before glazing. It may be painted any colour afterwards, but we prefer stone to all other colours.

Various means have been devised for collecting the condensed steam as well as the rain water that finds its way through hothouse roofs, one of which will be understood by fig. 768,

the invention of Mr Neeves. It consists in attaching small copper gutters to the astragals. These gutters are fastened to the bars with copper nails, and extend the whole length of the sash, delivering the water into the gutter usually fixed to the front of the house outside. Mr Rogers has recommended his own practice of

attaching small pieces of cobblers' wax to the apex or sides of his astragals, to intercept the streams of condensed steam, and to cause it to fall into pots or baskets in which plants are growing, and suspended from the roof, that require this species of watering.

The annexed fig., 769, shows a sash-bar, full size, used by Sir Joseph Paxton to prevent the drip in one of his orchid-houses. The late Mr White of Haddington used metallic gutters for collecting condensed evaporation, as will be seen noticed in article VINERIES, &c. Mr Saul

Fig. 768.

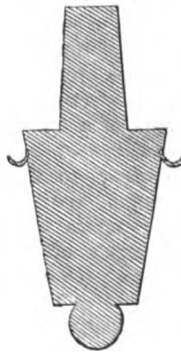
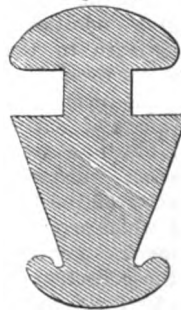
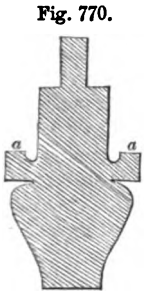


Fig. 769.



proposes a gutter formed in the rafter as at *a a* in the cut annexed, fig. 770. Many other contrivances might be shown, but these are sufficient for our purpose; while we may take this opportunity of stating that condensed vapour, if not in very great excess, is more useful than baneful, and also that, in hothouses properly constructed and judiciously managed, contrivances of this kind can seldom be wanted. Wherever they do appear, they give us, as it were, to understand that something is exceedingly defective in the roof, and give the whole house a patchy and unfinished appearance.



## § 2.—LIGHTS OR SASHES.

These are compartments of the roofs, and often of the sides of hothouses, which have hitherto been deemed indispensable in hothouse-building. They are not now so considered, fixed roofs having become more common; and we believe that, ere long, excepting for pits and small houses requiring to be annually uncovered, they will be entirely disused. They consist of two side pieces called styles, and two end pieces, called the top and bottom rails, the internal space being divided by rebated bars called astragals, in the rebates of which the glass is laid. Astragals are also formed by having a groove cut out of each side, into which the glass is let in with a very small quantity of putty: the one groove being cut deeper than the other opposite to it, is to facilitate the insertion of the glass. (*Vide* ASTRAGALS and GLAZING.) The material employed in their construction was for long wood; but, since the beginning of the present century, cast and wrought iron, zinc and copper, have been used. Cast-iron sashes are too ponderous, and, when fractured, are not easily repaired. Wrought-iron ones are also liable to the first objection, and, in addition, are subject to corrosion. Copper is less liable to these objections; but its price must ever render it rare in gardens, at least if the sashes are entirely constructed of that metal. Zinc,

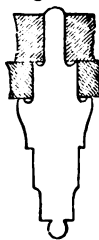
although less expensive, is not well fitted to the purpose. A combination of wood and copper is perhaps at present the most popular, the frame being of the former and the astragals of the latter. Wrought-iron frames and copper astragals are also frequently used; those of the houses in the Royal Garden at Frogmore are thus constructed.

Mr Crosskill, an extensive ironmaster and hothouse-builder at Beverley, never makes his sashes of iron, but of wood—knowing from experience that wood is lighter, and slides with greater ease, and can be fitted more accurately to the rafters, so as effectually to exclude the weather. Another advantage arising from using iron rafters and wooden sashes is, that the former expand a little by the excessive heat of summer, while from the same cause the latter contract in a slight degree, which prevents friction, and renders the sashes more easily moved up and down.

## § 3.—RAFTERS AND ASTRAGALS.

Rafters are constructed of wood, and of cast and wrought iron. Astragals were long formed of wood; but of late years they have been made sometimes of copper, zinc, and cast and wrought iron also. As may be supposed, there is a great variety of these, both in regard to form and size.

Fig. 771.

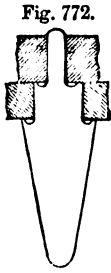


The annexed example of a rafter, fig. 771, is to a scale of 1 inch to 6, and has been exemplified in the Royal Gardens at Kew, in one of the recent erections there. We give it as an example of one we do not by any means approve of, on account of the unnecessary mouldings, which to us are no ornament, and certainly lessen the strength without diminishing the substance. We have elsewhere stated our objections to mouldings in hothouse roofs: we consider them as so many receptacles for harbouring dirt and the accumulation of damp. We know well, from long experience, the difficulty of getting joiners to abandon mouldings—so pertinaciously do many of them adhere to “use and wont” habits. As an



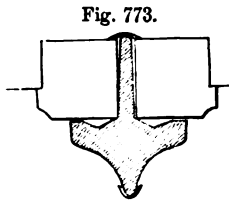
instance which happened to ourselves very lately, in getting an estimate from a highly respectable tradesman, for the construction of a fixed roof consisting of astragals only, he positively offered to mould the whole at the same expense he would charge for a simple chamfer—that is, dressing them plain.

Fig. 772 is that of a rafter of the same size and strength, divested of the mould-



ings, engraved to the same scale. In this rafter there is a groove shown under the corner of each sash. We have shown it to afford an opportunity of stating how entirely useless it is. The original intention was good, as it was meant to allow the condensed steam from within, or the rain water from without, which might find its way down by the sides of the sashes, to escape at the bottom ends of the rafters, and thus tend to their preservation. Unfortunately in practice—that trying test of theory—this groove is found to be worse than useless, as, instead of carrying off the water that may find its way to these parts, it becomes soon choked up by dust, and instead of acting as a drain to carry off the water, it keeps it penned up till it is absorbed by the timber—thus laying the foundation of rot and decay.

Fig. 773 represents the cast-iron rafters used in the gardens at Woburn Abbey, on the scale of 1 inch to 4; and as they were manufactured by that highly respectable firm, Messrs Jones of Birmingham, we conclude that



there are many such in the kingdom. They are also, in their details, somewhat novel, having over them a wooden coping, to lessen the effects of contraction and expansion, as well as conduction of heat and cold—a precaution, we think, for the small surface, quite superfluous; while under them is screwed on a water gutter, composed of wood, and lined with lead—another superfluity, tending only to increase the expense, and render what

ought to be simple and plain, complicated and useless. Here, again, we have an instance of a groove or channel under the side rails of the sashes for the escape of rain or condensed steam water; but in this case it is sufficiently large, and of good form, to effect the purpose intended. We do not see why the feather, or upper part of the rafter, should taper towards the top, unless it be to admit water that might be blown in under the wooden coping in times of high winds and rain. Again, the friction of the wooden rails of the sashes upon the very small points of bearing must have a tendency, in time, to hollow out the under side of the sash rails, and render them difficult to move upwards or downwards. We are aware that, at the time of the erection of these houses, two conflicting systems were brought into contact, and each party giving way so far, led to the erection of houses of the most complicated kind. In them the three principal materials are combined—namely, wood, iron, and copper—the wall-plates and rafters being of iron, the frames of the sashes of wood, and the astragals of copper. The rafters and wall-plates in the Royal Gardens at Frogmore are all of cast-iron.

In the three examples last shown it will be observed that the side styles of the sashes project more or less over the sides of the rafters. This should be avoided as much as possible; as it produces shade, in some cases equal to fully that of half the rafter.

It is better to give depth to the styles of the sashes than breadth, as by that means strength is gained, and shade, or obstruction of the rays of light, lessened. *Vide* figs. 774 and 775, where the sides of the rafters and sash-styles run in a direct line.

Fig. 776 represents a section of rafters used in the gardens at Dalkeith for pita. *a* shows the shoulder of the rafter on which the glass sash rests; *b* a fillet 1 inch square, nailed to the rafter, on which asphalt shutters rest, for the exclusion of cold during winter, and thin canvas-framed screens, for shade during the heat of summer. These latter are kept

Fig. 774.



Fig. 775.

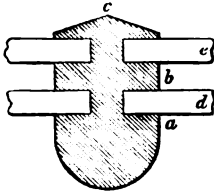


down by a button, *c*, screwed to the top and bottom ends of each rafter; *d* is the glass sash, *e* the felt shutter. By such simple protection we keep heaths, New Holland plants, &c., through the winter, without the aid of fire-heat or any other covering whatever.

It will readily be seen that, when the asphalt shutters are placed over the glass roof, a space of about two inches is left between them; and as this space is filled with air, which is one of the best non-conductors of cold, the keenest frosts we have are resisted, as well as the glass preserved.

The cast-iron astragals we have in use at Dalkeith are upon two small houses, having a *northern aspect*—the one span-roofed, and the other in the lean-to form.

Fig. 776.



They are both without rafters, and are represented of full size by the annexed sketch, fig. 777. We had them cast some years ago for a different purpose. They are very well cast—having been cast vertically instead of horizontally, as all such castings should be: the cost, however, was nearly ten times that of the wooden ones we had made for the purpose the others were intended for.

Most of the wooden astragals in the houses here, having framed lights and rafters, are of the same pattern, only a quarter of an inch deeper.

Figs. 778 and 779 are sections of astragals used by us in various houses, erected in different parts of Britain, without rafters. Fig. 778 is grooved on both sides—the one groove being deeper than the other, for reasons already given; while 779 is rebated in the usual manner—the dotted lines showing the surface of the putty.

The copper sash-bar or astragal in common use is represented by fig. 780,

of full size. It will be observed that, from its construction, it is one of the strongest that can be made, with the least amount of metal. Indeed, we question whether it is not as strong as if cast solid.

Croskill, of Beverley Ironworks, who has erected a considerable number of hothouses in various parts of England and on the Continent, always uses wrought-iron for the astragals for his curvilinear roofs; and, as

has been already noticed, for lean-to houses he uses invariably wooden sashes.

Fig. 780.

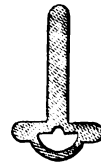
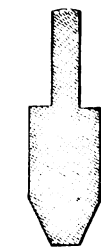


Fig. 781.



The sash-bar of Waldron, published in the second volume of "The Horticultural Register," is of the annexed form, fig. 782. In point of size and strength it is estimated at 1 lb. in weight to a lineal foot. We see no advantage in hollowing out this box at the sides, unless it be to reduce its weight, because the shade thrown by it at the shoulder of the rebate is just the same as if the sides were bevelled off straight. Indeed, we think they would look better if so formed.

Fig. 782.



The sash-bar used by Sir Joseph Paxton in his ridge-and-furrow houses, prior to the building of the great conservatory, are excellent.

Fig. 783.

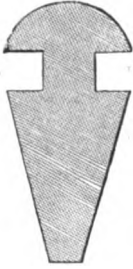


Fig. 783 is a section, full size, of those used in the roof—those for the upright or front sashes being simply a little thicker. From the way in which they are bevelled off below, it will clearly appear how little light they intercept. The grooves in which the glass is set prevent the wet from getting in, and dispense with the use of putty as an external covering, none being used except the least possible quantity, to bed the glass in the grooves. Similar astragals, but of a larger size, have been used by Sir Joseph Paxton in the Crystal Palace roof.

The astragal we use, fig. 778, is very similar; only one groove in each bar is about one-third deeper than in the other, to facilitate the introduction of the glass in cases of repairs, which could not so easily be effected if both grooves were of the same depth. In fitting in the square, it is introduced into the deep groove first, and then slightly drawn back until it has an equal bearing on each astragal. By this mode of glazing, no putty is exposed to the weather, which is a vast improvement. Since the use of large glass has become so general, and rafters and framed sashes have been almost dispensed with, we use much larger astragals, and place them also much farther apart.

Within these few years, considerable improvements have been made in hot-house-building, so far as astragals and rafters are concerned. The repeal of the duties on glass and timber has so much lowered their price, that now, in fact, labour is the chief item of serious expense; and we hope the day is not far distant when that will be considerably abridged, by the discontinuance of ponderous and expensive rafters, and costly framed sashes, the manual labour upon which has been in many cases equal to, if not more than, the whole value of the material.

As roofs are now so generally made fixtures, we have little more to do than to calculate the expense of astragals, wall-plates, and ridges, which are estimated for

by the lineal foot or yard. These are all the details necessary for well constructed roofs, except in the case of houses of very extraordinary dimensions, where rafters or purlins, either of wood or metal, must be introduced to give greater strength to the roof. We can only look to mechanical aid in this respect; and, as a first and excellent beginning, we have for some years had a beautiful and efficient machine for making astragals, the invention of Sir Joseph Paxton of Chatsworth, figured and described by him in "The Transactions of the Society of Arts," vol. liii., part 1. Instead of describing this invention, we may remark that it has, with some improvements, been for some years in use in the extensive establishment of Messrs Montgomery of Brentford, and, with various modifications, in other places about London, where astragals of all sizes and qualities can be purchased by the lineal foot or yard. Such, therefore, as intend to build hothouses, in whatever part of the kingdom, have only to send the dimensions, and they will be supplied with them ready to fit up.

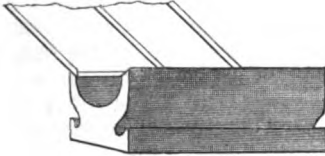
Mr Birch, of the Phoenix Sawmills, Regent's Park, has further improved the *sash-bar cutting machine*, and furnished with it the whole of the bars used in the Crystal Palace. His improvement consists in the addition of a second set of cutters, whereby the sash-bars, instead of passing *twice*, pass *only once* under the formidable claws which give to them their proper form; thus doubling the amount of work performed in a given time, or at ordinary work producing 2½ miles of finished bars per day, with only the manual labour of one man and a boy. Mr Birch has also another machine in operation for cutting ridge-bars, which are finished in 24-foot lengths, and cut out of deal 3 inches square, producing 2400 lineal feet in ten hours. Nor are these important adaptations of very simple machinery confined to the cutting off the astragals to their proper lengths; they embrace also the giving them the required bevel at one end, and the shoulder at the other: even the nail-holes are perforated at each end, for fixing to the gutter and ridge.

As ridges and gutters have now taken the place of rafters, it may be as well to allude to the "Paxton gutter" here. The original gutters used by that intelligent

gentleman were of wood, and cut out by hand ; but recent improvements have been made, whereby they are now cut out by machinery.

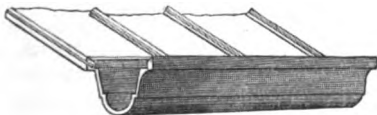
Fig. 784 will show the Paxton gutter, as used in the Crystal Palace.

Fig. 784.



Whether gutters, or valleys for conducting off water, should be made out of one solid piece of timber, or by the combination of three pieces, seems to us in no degree doubtful. Join the separate pieces as you may—nay, even cover them with copper, zinc, or lead—still they cannot be rendered waterproof, and, as a consequence, they will soon rot ; and as the whole roof is supported by them, the durability of such roofs is shortened. Nor can wooden valleys of the same dimensions be considered as strong as iron ones. The gutters which we use are of the latter material ; and we find that, with less bulk, and consequently less shade, we not only have a much stronger roof, but one which may be rendered perfectly dry. Our gutters are also cast with dove-tailed mortices along their sides, into which the lower ends of the astragals fit, imbedded in white-lead, and sometimes fixed in with boiling pitch.—*Vide* fig. 785. For an illustration of our metallic gutter, *vide* Plate VIII., and full description, *vide* p. 59.

Fig. 785.



To show the economy of mechanical power in the Chatsworth conservatory alone, Sir Joseph Paxton informs us that, even in its original form, the sash-bar machine performed the labour of twenty men for one year, and consequently saved £1200. The length of bars made by it for that conservatory would extend upwards of forty miles in a direct line, making at the rate of 2000 lineal feet of bars per day, and at an expense for

attendance of only 5s. per diem ; and its first cost was only £20.

The annexed woodcut, fig. 786, shows the form of sash-bar, half size. The glass, being let into the grooves, requires little putty, and, when once in, is more impervious to rain than by the usual modes of glazing. In this case it will also be seen that the astragals taper both upwards and downwards from the shoulder

Fig. 786.



to the groove, thus requiring very little putty. The astragal, although thin, has its strength retained by giving additional depth, upon which the principle of strength is well known chiefly to depend.

The first cost of this machine is so trifling, that any one intending to build anything beyond an ordinary range of hothouses would economise the expense by the saving of manual labour. The machine could easily be attached to a saw-mill, thrashing-machine, corn-mill, or indeed wherever there is motive power on the premises.

We have seen, in the establishment of A. L. Wallace, Esq. of Edinburgh, a very simple and effective machine for cutting out mortices. It was wrought by a lever acted upon by the foot, somewhat like a turning-lathe, and is, for framed doors and sashes, an improvement which materially reduces the expense of their construction.

An amazing amount of prejudice has to be got rid of before either of these machines can be brought into general use ; and before the second Crystal Palace is finished, we shall see mechanical power applied to such purposes to a much greater extent than has as yet even been anticipated.

For Read's, Stevenson's, Saul's, Paxton's, &c., sash-bars to prevent drip, *vide* article GLASS AND GLAZING.

#### § 4.—WALL-PLATES.

These are of wood, cast-iron, or stone : the two latter are much to be preferred, on account of their greater durability. The former has hitherto been most generally used, no doubt from the circumstance of hothouses being for long constructed entirely of this material. From their position, wall-plates are much

exposed to damp, and therefore they not only speedily become decayed, but the ends of the rafters, mullions, or astragals reposing or set in them, are also liable to share the same fate. Stone is well adapted for the purpose when the superstructure is to be metallic, and cast-iron whether it is of that material or of wood. Stone wall-plates are best when they rest on solid masonry or brickwork, and cast-iron, when used in a similar manner, or when the roof is to be supported on columns—in which case they may be used both for upper and lower plates with equal advantage. The first consideration regarding either is, that they be sufficiently thick, so as to be strong and capable of sustaining any weight that may be laid upon them, as well as incapable of becoming twisted or cast, or of being easily displaced; and this is also necessary in order to admit of the rafters, gutters, astragals, &c., being securely fixed to them. With regard to wooden wall-plates, their form deserves consideration, for on this much of their durability and usefulness depends. Their under surface must always present a plane similar to that of the top of the wall, or the supports they are to rest upon: their sides should be perpendicular to that wall, whether they exceed its thickness or not. The outer half of the top surface should present an angle or slope exactly equal to that of the roof; the inner half should have a greater bevel, to allow the condensed steam, conducted by the roof to that point, to run freely off. All this, it will be clearly seen, is with a view to keep the wall-plates as dry as possible. They should never, unless in the case of cast-iron ones, have the water-gutters cut out in them: these ought always to be attached. The best gutter is of cast-iron; and these should be cast, with the edge which comes in contact with the wall-plate, quite straight, so that it may fit closely to it. The lighter the castings are, the better: they should certainly not exceed an eighth of an inch in thickness, and should be so formed that the end of the one may lie within the end of the other,—or in what may be called the *half* spigot-and-faucet form, set in rust, and secured by a bolt and screw-nut. Lead was long used for this purpose; but it is apt to get bent, and often to crack from

expansion and contraction. Zinc has more recently been employed; but it is neither durable nor sufficiently strong, and scarcely worth the expense of fitting up. Whatever kind of gutters is used, it is of great importance that they be of sufficient size to carry off freely all the water that may fall into them from the roof, and also that they be laid at a sufficient incline, so that the water may flow to the points of discharge, which should not exceed 25 or 30 feet from each other. These dischargers should be cast-iron pipes, laid to carry the water to the nearest tank or cistern; for rain water is an element too precious in a garden to be wilfully wasted. Where iron wall-plates are to be used, it will be better to have the gutters cast on them, as making both the cheapest, best, and most elegant finish. Both stone and iron wall-plates should be so formed that no water may rest on their upper surfaces: they should therefore be bevelled on both sides, so that it may run freely off. In forming the connections between the rafters, valleys, or astragals, and wall-plates, all mortice joints should be carefully avoided; as, however well they may be finished off by the tradesmen, they in time, from one cause or another, become so open as to admit damp, and damp will cause decay. In the case of wooden rafters and wall-plates, the former should be cut with a shoulder to abut against the wall-plate on its inner side, while the point of the rafter should be so fashioned as to rest on the wall-plate, but not be mortised into it. To secure it in this position, a hard wood bolt or dowel should be driven through it, and three parts through the wall-plate. We prefer a wooden to an iron dowel for this purpose, as rust affects the one and not the other. The wood may slightly shrink from the iron in dry weather; while the iron, not expanding in proportion, opens a way for wet getting in, which, when once in, cannot get out again; whereas the wooden bolt will expand somewhat, perhaps to the whole extent required—as, from being driven in with force, its diameter is a little reduced, and it will have a natural tendency to assume its original size. All wall-plates resting on solid masonry or brickwork should be securely battled or bolted down—a precaution seldom

thought of by self-styled hothouse-builders, who, in too many cases, show as slight an acquaintance with the rules of carpentry as they do of the principles upon which hothouse-building should be based. Indeed, looking at many specimens of their handiwork, one would think their ideas were stereotyped to error. When the parapet walls are built of brick or rubble stone, inch-iron dowels should be built in them, at 10 feet distances, let into the wall not less than 12 inches, and upwards into the wall-plate at least to the extent of half their thickness: by this means the superstructure and the walls will be firmly knit together. If the parapets are of ashlar, the dowels should be sunk 6 inches into the top course. Top wall-plates in lean-to houses have hitherto been little attended to; they have in general been merely a 4 or 6 inch square batten, built into the solid wall at top, and surrounded with bricks or stones and mortar. To these the top ends of the rafters have been nailed or otherwise fastened.

The ridge beams of span-roofed houses may be regarded as wall-plates, as they answer a similar purpose. Fig. 787

Fig. 787.



shows an improved form, with its coping, and the manner in which the top ends of the rafters are secured to it. Such ridge beams are only to be used where the roof is composed of rafters and sashes, the top ones of which are to slide up and down for ventilation. Their form is, however, different when ventilation is effected at that part, and has been elsewhere explained.

#### § 5.—COVERING THE ROOFS OF GLASS HOUSES AND PITS, FOR THE EXCLUSION OF COLD OR THE RETENTION OF HEAT.

The advantages arising from covering glass roofs appear to have been to a certain extent known, and partially acted upon, perhaps as early as the beginning

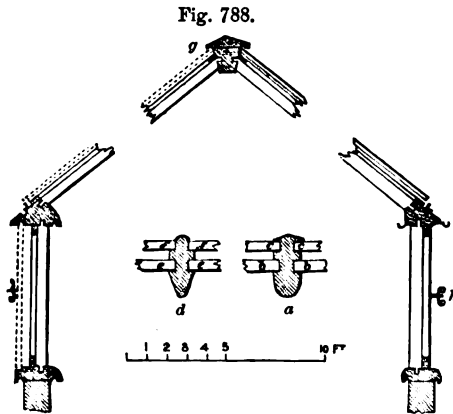
of the last century. At all events, speaking from our own personal knowledge, we have seen hothouses covered during winter fifty years ago; and, judging from the very complete manner in which the operation was performed, the arrangements preconcerted to carry this into effect leave no doubt on our mind that hothouses were furnished with shutters almost from the period of their introduction into Scotland. This fact is not, we presume, unknown to reading gardeners, even although much younger than ourselves, as the case has been published long ago, and not only described and detailed, but also figured in a very copious manner—for example, in "Treatise on several Improvements recently made in Hothouses," by the late J. C. Loudon, published in Edinburgh in 1805.

We are led to these remarks, as we find, within this year or two, coverings recommended as if quite a new feature in horticulture, while scarcely one of the plans recommended is half so good, efficient, and businesslike as those we have alluded to as being in full operation more than half a century ago. Modern writers recommend covering the exterior of the house with canvass screens, not one of whom, that we have met with, appearing to have thought how much more effectually frost could be excluded and heat retained by internal coverings or screens. Undoubtedly there are cases—such as low pits, &c.—where this mode could not very conveniently be adopted, but in many others internal coverings could be employed with perfect ease. Night covering on the outside of hothouses is very desirable during winter, and, if judiciously applied, prevents the excessive dryness in the atmosphere which is so injurious to plants, and can scarcely be avoided when strong fires are applied to resist the cold from without. The temperature of the glass in the roof of a hothouse at night, when fully exposed, is exactly the mean of the external and internal air; and consequently, in very cold weather, and when there is moisture floating in the internal atmosphere, it becomes a great condenser, and dries the air of the house much faster than it would otherwise be. This an outer covering prevents in a great measure, as well as economises fuel, and lessens the evil of too much fire heat.

Continental cultivators calculate that

external coverings, if properly applied, effect a saving of nearly nine-tenths of the fuel, and that a better and more certain temperature is maintained even when the thermometer sinks to from  $15^{\circ}$  to  $24^{\circ}$  of frost, Reaumer—that is, below zero by Fahrenheit's scale. All coverings, to be most effective, should be impervious to water, and of non-conducting materials.

The following description and illustration, fig. 788, will explain a method of



covering span-roofed hothouses much used throughout the north of Europe; nor is it span-roofed houses alone that are thus covered, but lean-to houses also, as well as pits of every description. The coverings formerly used were wooden shutters and straw mats set in frames; but felt is now common, making not only a much more economical, but, at the same time, more convenient kind of covering. *a* is a section of a rafter constructed for this purpose, in which *b b* are the glass sashes; *c c* the felt or other covering made into frames the exact size of the sashes, and put on every evening during winter, and removed again in the morning, unless the weather is exceedingly cold, and much snow has fallen; *d* another section of a rafter for the same purpose, the fastenings of the shutters being rather different; *e e* the sashes as before, and *f f* the covering, which in this case is not kept down by the coping as in *a*, but the top ends of the shutters run under the coping of the ridge at *g*, and the bottom part is secured by a button on top of the rafter in a variety of ways, which will suggest themselves to the intelligent gardener. A provision is made for closing in the space

between the bottom rail of the shutter and the top of the bottom rail of the sash, by a piece of wood suited to the purpose. This is intended to prevent too much cold air entering between the shutters and the lights, or rather to keep such air in a quiescent state—a precaution very necessary in cold climates, and not to be disregarded in our own. The side sashes are also covered, as shown by the dotted lines, and are secured to the mullions by means of wooden or iron buttons, or screw, as shown at *h*. These side shutters are let into a groove in the top wall-plate, and into a rebate in the lower one. In the extensive nurseries of the Messrs Booths of Hamburg, both top and side shutters are so arranged, but a circulation of air is allowed to flow between the shutters and sashes from the parapet wall to the ridge—which should not, however, be the case. Such contrivances have been occasionally used in this country for years, and may be employed to great advantage in excluding frost from heath-houses, greenhouses, &c., so as to dispense with fire heat entirely; and in forcing-houses their use will lessen the consumption of fuel, as well as the perilous effects of too much artificial heat during the night.

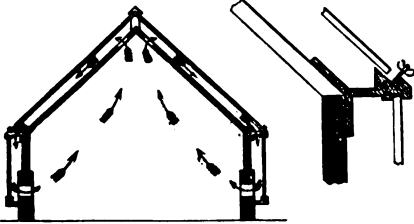
*Patent felt shutters* are used extensively in the gardens at Dalkeith; and we believe that heaths, camellias, azaleas, and many Japan, Chinese, and New Holland plants, would succeed much better if the glass roofs were so covered, than by the application of fire heat. Should the frost at any time get in, the covering should be left on until it has thawed, and the plants will be found to have sustained little or no injury. The most expeditious method of covering and uncovering the roofs of houses and pits would be, to have thick canvass rendered waterproof, and mounted on rollers, so that it could be run up or down when required.

We have stated at the commencement of this article that coverings were used many years ago: we may instance those in the garden at Abercainey so early as 1800. Amongst the hothouses was a pine-stove, with rafters constructed exactly like those shown at fig. 788, *a*. The shutters used were wooden frames of the exact size of the sashes, and these were covered with strong canvass or sailcloth, and painted with oil-colour, notwithstanding

oil has been said to destroy such fabrics, every third or fourth year. They lasted for many years. They were put on every evening, from the beginning of November till the beginning of March, and taken off every morning, the whole operation taking one man about five minutes, the house being 50 feet long, with two sets of shutters—one for the lower range of roof sashes, and another for the upper. A pine-pit adjoining, 40 feet long and 12 feet broad, was also covered in the same manner, only the shutters in this case were as long as the width of the roof, and in one piece. Fuel was expensive, which led to this precaution, and the saving was considerable; besides, the plants were not subjected to the unnatural excitement they would have been exposed to, if strong fires had been kept up during the night. In fact, these shutters were made upon far more correct principles than any we have since seen. The framework fitted close to the styles, and the top and bottom rails of the sashes, so that little or no air could find its way between them and the glass; and hence their great utility. The volume of air thus enclosed, being in a quiescent state, became a most powerful non-conductor, which would not be the case were the air allowed to circulate between them and the glass, as is the case with the houses at Hamburg alluded to above.

The woodcut annexed, fig. 789, exhibits a mode of covering and ventilating pro-

Fig. 789.



posed by Mr Moore, in the "Journal of the Horticultural Society," vol. ii. p. 28:—"I am aware," he says, "that night covering is a generally acknowledged benefit, and that it is in some cases acted on; but it should be more universally and more systematically followed up. To assist in bringing the principle of night covering into more

universal application, is the purpose of the following suggestion. I need not stop to show how night coverings prove beneficial. It is sufficient to state, that whatever prevents the radiation of heat from the interior to the exterior atmosphere, through the conducting agency of the glass, decreases in the same ratio the amount required of *applied* heat, and hence saves the plants from being exposed to unnecessary excitement. The principle upon which a covering acts most effectually is that of enclosing a complete body or stratum of air exterior to the glass—this body of air being entirely shut away from the surrounding outer atmosphere; and as air is a bad conductor of heat, the warmth of the interior is by this means prevented from passing to the exterior atmosphere; or, in other words, the exterior atmosphere being prevented from coming in contact with the glass, cannot absorb from the interior any sensible proportion of its heat. To secure this advantage, however, the coverings must be kept from contact with the glass; and they should extend on every side where the structure is formed of materials which readily conduct heat, such as glass and iron." An improvement connected with this subject, and which is probably seldom acted upon, is to have the covering to fit so accurately as to exclude the external air, "and then to have a series of ventilators provided, to stand open during the night. The stagnation of the internal atmosphere would thus be prevented, in consequence of the interior air, and the air between the glass and the covering, being of different degrees of density, owing to their being differently charged with heat. It will be understood that, as here shown, the side and end shutters (the latter not indicated) fit into grooves, the upper groove being attached to iron pins, and thus fixed at a proper distance from the building, without obstructing the passage of air along the enclosed space, and that on the lower side being so fixed as to exclude the external air in that direction. The top or roof shutters also run into a groove along the ridge of the roof, and at the lower end are fixed close down to the top of the side shutters, fastening with a button. Each of the shutters should have a projecting fillet fixed on one side,



so as to shut close over the adjoining one. The shutters themselves should of course be made of light framework, strengthened, where necessary, with small iron rods. The material used for covering them may be the asphalt felt, or strong brown paper coated with tar."

Of all protecting materials for covering pits and bothouses, mats are undoubtedly the worst, and are expensive both to provide and apply. Patent asphalt, upon Crogan's or M'Niell's principle, is probably the best, when fitted up as shutters of the same size as the sashes—being both a non-conductor, and almost waterproof at the same time; or it may be rendered perfectly so by coating it over with asphalt and pitch in a hot state, and dusting it over with fine sharp sand before it becomes hard. Its weight, however, is liable to break the glass, unless provision be made, as above, for preventing it coming in too close contact with it; nor is it adapted for rolling up in the manner of canvass, being liable to break on account of its stiffness.

A lighter and more flexible material may be found in thin canvass, such as is used for covering ricks, and purchased for from 8½d. to 1s. per yard. It may be rendered quite waterproof by being covered with resin and melted fat in about equal quantities, adding about one-fourth of bees'-wax, the whole laid on when quite hot. The bees'-wax, being antiseptic, preserves the canvass, and gives consistency to the other ingredients, and prevents their becoming soft by heat, as well as keeps them pliant. Mineral pitch has been tried, but not with successful results.

The best materials for excluding cold and retaining heat must be non-conductors of both heat and cold. Hence the wooden shutters used in Russia over their double glass roofs, and the straw or reed mats employed by the Dutch and Germans, are well fitted for the purpose, so far as non-conduction is concerned. They are, however, both rather unwieldy to handle, but, from natural circumstances, absolutely necessary in those countries. Woollen cloth, or felt, if rendered waterproof, appears to us the most suitable for our climate; and the mode of applying it must be regulated by circumstances, as our roofs are

of so great a variety of form. Where rafters are used, we would recommend framed shutters, to fit into them over the sashes; and where rafters are dispensed with, coverings in large pieces, mounted on rollers, would be the best, as requiring little time to put on or take off; for much of the success of covering will depend on this matter. Waterproof canvass is the next best material to woollen cloth.

That much heat is saved by covering glass roofs is very clear; but what that amount is, is not easy to calculate. Dr Wells, in his experiments on dew, found that a cambric handkerchief, supported 6 inches above the ground, caused the ground at that spot to be 8° warmer in a clear frosty night than the surrounding ground that was not so protected. Following this fact, many cultivators place the covering at some distance from the glass, so as to admit a body of air to intervene; while others lay the covering close upon it, calculating that, by this means, both radiation and conduction will be very much prevented,—as with glass the cooling process arises from these two causes, the former being increased by a clear sky, and the latter being much affected by the force of the wind. Thick coverings have been much used in cold countries—thickly formed straw mats, and even boarding, being often had recourse to, and, with such protection, they estimate a saving of two-thirds of the ordinary loss of heat. In accordance with these views, Mr Percival, in "Gardeners' Chronicle," says: "By a good covering of wood or thick straw, I have no doubt fully two-thirds of the ordinary loss of heat may be prevented; and I think it may be fairly assumed in practice, that the saving will be quite equal to one half—that is to say, that the loss of heat from glass so covered will only be one half what it would otherwise be, provided such covering fits tolerably close to the frames, without allowing any circulation of air between the glass and the covering. Of course, also, if the top only of a pit or house be so covered, the saving must only be calculated for the portion so treated, and not for the whole house."

Impermeable or waterproof canvass may be prepared in any of the following manners:—

1. Vegetable or mineral pitch, applied hot with a brush, the canvass being spread evenly on a level floor.

2. Linseed oil, boiled with litharge or sugar of lead, or what is called drying oil.

3. The same oil, holding in solution a small quantity of caoutchouc.

4. A solution of glue or isinglass, introduced into a stuff, and then acted upon by a clear infusion of galls: the fibres get thus impregnated with an insoluble, impermeable, pulverulent lather.

5. A solution of soap, worked into cloth, and decomposed in it by the action of a solution of alum: whence results a mixture of acid, fats, and alumina, which insinuates itself among all the woolly filaments, fills their interstices, and prevents the passage of water.

6. A varnish made by dissolving caoutchouc in rectified petroleum or naphtha, applied between two surfaces of cloth, as described under Mackintosh's patent.—*Ure's Dict. of Arts, &c.*

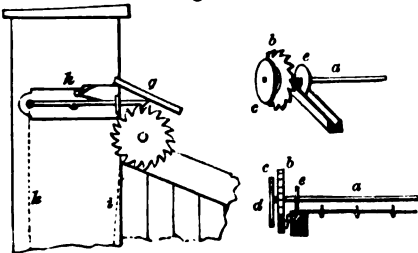
Burnettised canvass—that is, canvass prepared by being saturated with a dilute solution of chloride of zinc—is flexible, and being in pieces of any size, is convenient for covering both pits and houses. The high character given of its durability by many of the most scientific men of the day—(*vide* Prospectus and Testimonials, published by Sir William Burnett, the patentee, King William Street, London)—has induced us to use it pretty largely. Our experience of it has not extended over a sufficient period to enable us to speak to its durability; but so far as regards the convenience of using it, we think it the very best material we know of for covering glass roofs upon the rolling-up principle.

The following mode of applying canvass coverings to the roofs of either lean-to or span-roofed hothouses, as a protection during winter, is the same as that proposed for shading during summer. The covering material in the former case should be strong waterproof canvass; while in the latter it should be thin canvass of a semi-transparent fabric. Fig. 790 represents a

simple apparatus, used at one period in the gardens at Sion House for the latter purposes. It was the invention, we believe, of Mr Forrest. Our figure and description are from "The Suburban Horticulturist:" "The canvass is fixed to a roller of wood 50 or 60 feet in length—the length depending on the diameter of the pole or rod *a*, and the toughness of the timber employed, as well as the dimensions and strength of all the other parts. On one end of this rod, and not on both, as is usual, a ratchet-wheel, *b*, is fixed, with a plate against it, *c*, so as to form a pulley groove, *d*, between, to which a cord is fastened; and about three inches farther on the rod is fixed a third iron wheel, about 6 inches in diameter and half an inch thick, *e*. This last wheel runs in an iron groove, *f*, which extends along the end rafter, or end wall of the roof to be covered. The canvass being sewed together of a sufficient size to cover the roof, one side of it is nailed to a slip of wood placed against the back wall—that is, along the upper end of the sashes. The other side is nailed to the rod *a*. When the canvass is rolled up, it is held in its place, under a coping *g*, by a ratchet *h*; and when it is to be let down, the cord *i* of the roller is loosened with one hand, and the ratchet-cord *k* pulled with the other, when the canvass unrolls with its own weight. The process of pulling it up again need not be described. The most valuable part of the plan is, that the roll of canvass, throughout its whole length, winds up and lets down without a single wrinkle, notwithstanding the pulley-wheel is only at one end. This is owing to the weight of the rod, and its equal diameter throughout."

A more simple plan is that adopted for orchid-houses, one of which we have in operation here. It consists of a pole 70 feet in length and 3 inches in diameter, having fixed to one end a wooden wheel 18 inches in diameter, and hollowed out in the periphery—over which a double line is wound, being fixed at one end to the wheel; the other is brought down and made fast to the front of the house. When loosened, the pole runs down, bringing with it the thin canvass shading which is fastened to it, along its whole length, by one of its sides; while the other side of the canvass is

Fig. 790.



fastened to the ridge of the house. The other double of the line, when pulled down, winds up the pole, which takes along with it the canvass, rolling itself round the pole in its progress upwards—the whole operation of shading or unshading being performed in less than a minute. A double line of saddle-girth is fastened to the ridge of the house, and also to the end of the pole, which gives the revolving motion to the latter. For lean-to houses, one sheet of shading is sufficient; but for span-roofs, a separate sheet and pole is necessary for each side. For houses with the old-fashioned rafters, no precaution will be required for preserving the glass from being broken by the weight of the canvass, even should it be used of thick sailcloth for resisting cold, as the rollers will move upon the upper sides of the rafters, and so run clear of the glass. But for houses, as now often constructed, without deep rafters, it will be necessary to place from top to bottom of the roof, and at distances of 6 or 8 feet apart, temporary pieces of wood, upon which the roller may run.

#### § 6.—ESPALIER RAILINGS.

In former times every garden had its espalier rails, which were considered appendages as necessary as the walls themselves, for the production of various kinds of fruit, deemed rather too delicate to ripen properly on standards, and excluded from the walls for want of room. Opinions have been at variance for some years as to the advantages or disadvantages of such a mode of training; and the older mode has been returned to, in many instances, after having been condemned and exploded for more than half a century—namely, dwarf standards or buzzelars.

Espalier rails, when well covered with trees, no doubt produce abundant crops of fruit; and they have also another advantage in places where general order and high keeping are not fully carried out. They form blinds or screens, by which the quarters of the garden are hidden; and if the walks, edgings, and border between them and the espalier be kept in trim order, the superficial visitor

concludes that the whole place is in excellent keeping.

Of authors on gardening who have pronounced opinions on their merits, we may mention that M'Phail condemns them, while Nicol, Marshall, Neill, Abercrombie, Loudon, Rogers, &c., approve of them. "Besides the value of their fruit," says Loudon, "they form a sort of counterpart to the trees on the walls, and add much to the general effect of the garden, by increasing the appearance of design, and much to its beauty in detail, by the variety of their blossoms in spring and their fruit in autumn." Our own opinion is, that they are valuable in cold and exposed situations, preventing the fruit from being blown off by winds, presenting one surface at least as well to the sun as if the trees were grown against a wall, but without the advantage of radiated or reflected heat, occupying, when placed vertically, much less space than standards; while they both form blinds to hide the coarser kitchen garden crops, and afford shelter to those of a more delicate nature.

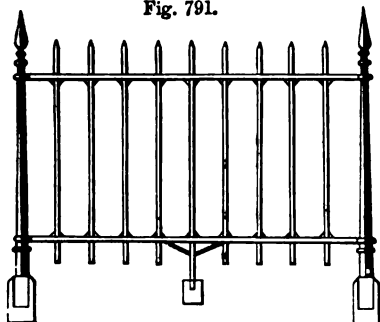
The almost total disregard of elegance in design in the construction of espalier railings, has no doubt tended to their disrepute. Why this should be it is hard to conjecture, seeing we have so many specimens constantly before us in the elegant and architectural railings with which every town and city abounds; for, in fact, an iron espalier rail can be considered as differing but little from these. The specimen books of wire-workers and ironmongers supply abundant examples, and the cost can be ascertained from them either by the ton or by the extent in feet.

Formerly espalier railings were constructed of timber. If they were made of the mere thinnings of the young plantations, they had almost yearly to be replaced; while if made of better material, and well finished off, they became an expensive affair. Cast-iron superseded wood; and malleable-iron uprights and strong wire have in turn been introduced to set aside this.

Of cast-iron rails, the annexed, figs. 791 and 792, may be given as examples. The uprights in both are set in blocks of stone, are 9 feet apart, and are  $1\frac{3}{8}$  inches square at the bottom, slightly tapering upwards, and finishing, in the one case, in a

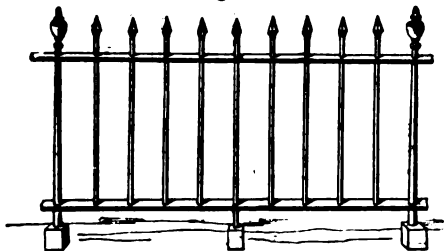
small urn at the top, which, as the tapering form prevents its being so readily fitted up

Fig. 791.



as the uprights, is screwed on when the latter are fixed in their places. In the other, the standards must be cast in the same

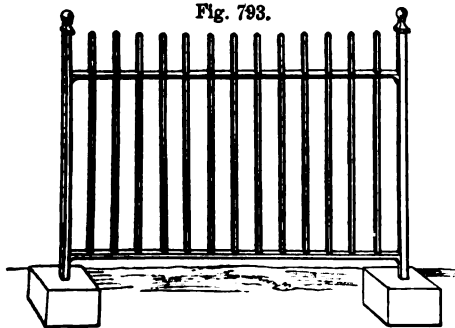
Fig. 792.



manner. The horizontal bars are  $2\frac{1}{2}$  inches broad, and three-quarters of an inch thick. The small upright bars are three-eighths of an inch square,  $8\frac{1}{2}$  inches apart, and rise with a spear point 5 inches above the upper rail. Every 100 feet in length of such a rail weighs about 1 ton, and may be purchased at from £10 to £12 per ton, according to the price of iron at the time and place.

Fig. 793 is another example, in which

Fig. 793.



the standards and horizontal bars may be of the same dimensions, while the uprights are well seasoned timber instead of iron. The former, being a non-conductor of cold, would be less apt to induce the injurious effects which ensue from the action of frost on the parts of the branches that come into immediate contact with metallic substances. The upright wooden rails should be fitted loosely into the horizontal rails at the top and bottom, to prevent the lodgment of damp; and small fillets attached to them, immediately above the lower rail, will keep them sufficiently firm in their places.

In the erection of espaliers, the bottom horizontal rail should be placed at least 12 inches above the surface of the soil, as under that no fruit would be produced; and by the leaves and branches being kept clear of the ground, a free and healthy circulation would be promoted under them.

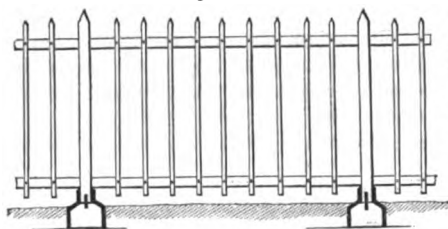
Notions of economy have led some to fix their iron espaliers in blocks of wood instead of in stone. This is a great mistake, because, as the blocks they are set in begin to decay round their outer circumferences, a vacancy is thus formed between them and the ground, which daily increases by the shaking of the rail by wind or other causes; and, in consequence, the rails soon get twisted, so that in a few years they become very unsightly and unsteady.

Wooden espaliers were, and still are, in use; and, except as regards durability, they are better than iron ones. If the uprights be set on, *not in*, blocks of stone standing 12 inches above the ground, they will last for many years. All fanciful trellis-work should be avoided, as being less strong than more simple forms, and infinitely more expensive in the erection. Whatever may be said to the contrary, we know from experience that iron railings have been productive of considerable injury to the branches of trees and plants trained upon them; and as these injurious effects have followed severe frosts, we need hardly say that the cause arises from the rapid conduction of heat from the branches—an effect that never can take place where wood is employed.

The subjoined fig. 794 will show the principle of a wooden rail of this kind. The uprights should be of oak,  $3\frac{1}{2}$  inches square at the bottom, and tapering to  $2\frac{1}{2}$

inches at top. They should be set on stone plinths at least 12 inches above the surface

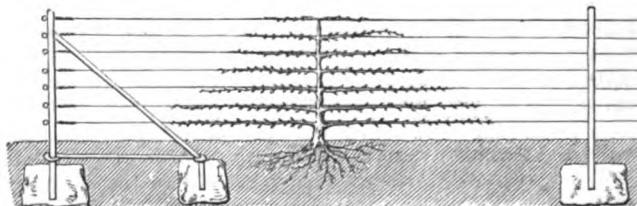
Fig. 794.



of the ground, the tops of which plinths should be bevelled off to throw off the rain, as shown in the diagram. An iron dowel, 1 inch in diameter, should be sunk 6 inches into the stone plinth, and also 6 inches into the base of the wooden upright, to give stability to the whole; and, still farther to insure strength, iron straps should be brought up from the stone plinths, and screwed to the uprights, as shown in our figure.

Fig. 795 exhibits a specimen of a cheap, durable, and elegant espalier railing, consisting of wrought-iron uprights  $1\frac{1}{2}$  inches square, and 6 feet in height. They are set into large blocks of unhewn stone, sunk in the ground so as not to be seen. The horizontal wires are nearly a quarter of an inch in diameter; and after being very firmly secured at one end, are made

Fig. 795.

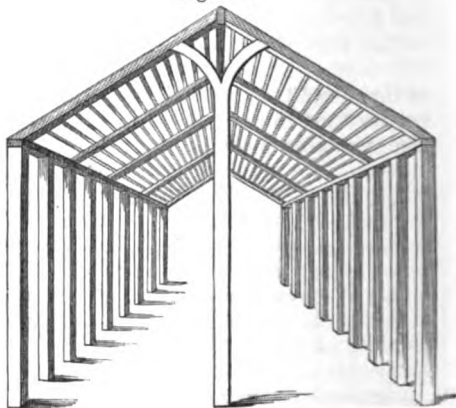


to pass through the uprights at about 6 or 7 inches apart from each other. They are then tightened up with a nut and screw at the other end.

Fig. 796 represents a method of training fruit trees, more especially pears, which we first saw in use thirty years ago, in the garden of Bellenden Ker, Esq., St John's Wood. The sides are formed of larch uprights, 7 feet high, and 6 feet apart. A wall-plate of 2-inch deal

plank, 6 inches in breadth, is laid along their tops, and nailed down to them, which keeps them in their place, and at the same time supports the roof. The latter is also formed of larch rafters, 6 feet apart, along which tile laths, 2 inches square, are laid longitudinally. The width of the structure within may be from 6 to 10 feet; in the latter case the roof may be supported by uprights, as shown in the sketch. The great advantage of such an espalier is the check the ascending sap

Fig. 796.



sustains when the branches are trained out of the perpendicular, and also the facility with which both the roof and sides can be protected by double nets or

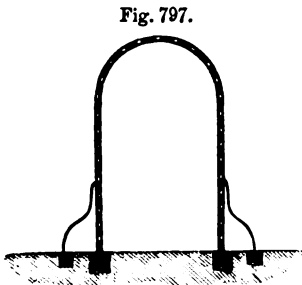
canvass during spring, and the fruit preserved from birds by netting during summer and autumn. If standard pears be planted at each alternate upright, and the roof only covered by their branches, the sides may be planted

with apples or pears trained horizontally, which will fill the whole space sooner than if dwarfs only were planted. This is certainly by far the best mode of training pears, both as regards bringing them into an early state of bearing, and also for the preservation of their blossoms during the frosts of spring. Upon a smaller scale, it is also a good method of growing currants, double-bearing raspberries, and the later ripening kinds of gooseberries—as they can be so

completely secured from the attacks of birds, and at the same time so conveniently gathered from the inside. Nor are these the only advantages such an espalier possesses. It forms a cool shaded promenade during summer; and, if so required, might be a good mode of communication between one part of the garden or grounds and another, the surrounding objects being shut out whenever the sides of the espalier are covered. The whole floor within should be gravelled over, and rendered perfectly dry by drainage. Such an espalier, however, should always be well exposed to the sun; and, for the same reason as that given for span-roofed hothouses, it should run from north to south, and be sufficiently removed from tall trees or buildings, to prevent their shadow falling on the trees, at least from the first of March till the end of October. It may be suggested by some to construct this espalier of iron: we prefer timber, as being a non-conductor of cold, as well as for economy in erection. If the uprights be, say 6 inches in diameter at bottom, and set on not in blocks of squared stone, standing 12 inches above the surface, the whole will last for many years.

Curvilinear espalier railing has of late years become very general; and, for certain purposes, and under certain circumstances, has its advantages. Could we satisfy ourselves that no bad consequences arise from the conduction of cold, we would give it our unqualified approbation.

The annexed fig. 797 represents one of these. The uprights should be at least 8 feet in height, set in blocks of stone, and strengthened with spurs or struts, as shown in the figure. If perforated with holes 8 or

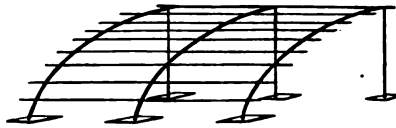


10 inches apart, according to the kind of trees to be trained over them, then wires drawn through, tightened, and secured at the ends, will make a durable and strong trellis. Their breadth within need

not be great—say 4 feet for the minimum. They afford shady walks in summer, and, with a very simple contrivance, may be covered in spring, to protect the blossoms—an advantage standard trees are seldom capable of having afforded them. This mode of training trees has been adopted at Trentham and elsewhere extensively.

Many years ago our attention was directed to pears trained on inclined wooden trellises, both on the Continent and in various parts of Britain. We thought them inferior to perpendicular ones, as they covered so much ground, and because we observed many of the pears hanging from their under sides, and hence shaded from the sun. The same objection, but of course to a somewhat more limited extent, may be urged against curvilinear ones, and also against such as are represented in fig. 798.

Fig. 798.



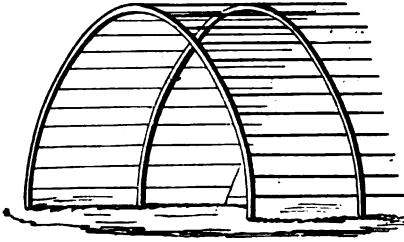
It would, no doubt, be a great improvement upon horizontal and inclined espaliers, and such as are not intended to have walking space underneath, and would bring them nearer in utility to a wall—between which and the open standard they may be said to form the connecting link—if the spaces below them were filled up with dry material, and covered over within 6 inches of the bars either with paving bricks, tiles, or slates. The solar heat that would pass through between the branches in spring, and the leaves in summer, would, instead of passing downwards and being absorbed by the soil, be arrested in its progress during the day by any of these materials, and be given out again, by reflection or radiation, to the trees. A small volume of atmospheric air, enclosed as it were between the trees and the covering under them, would become considerably heated—a circumstance that never can take place if the rays of heat are allowed to pass directly downwards.

In the case of fig. 798, the trees should be planted at the back part, and trained

to a single stem as high as the upright part of the espalier, and then trained downwards all over the curved part of the trellis, which, of course, should face the south.

In the Royal Gardens at Frogmore, fruit trees are trained to a curvilinear iron espalier, as shown in the annexed sketch, fig. 799. The trees are planted

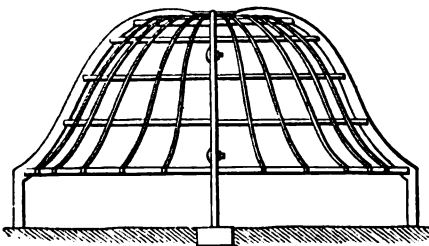
Fig. 799.



in the centre of the space covered, and are trained to one stem until they gain the apex of the trellis, when they are allowed to branch out, and are trained over its outer surface, chiefly in a horizontal and pendant form.

Fig. 800 represents what may be called a dome-shaped espalier. It is in-

Fig. 800.



tended for training a single tree to each. The material used is malleable iron. The espalier is constructed in four pieces, which are screwed together as shown in the sketch. The tree is planted in the centre, with a height of stem equal to that of the dome: the branches are trained downwards over the outer surface of the trellis. After the tree has been fully modelled, and the branches have become large, the trellis may be taken away altogether, as the tree will continue, under proper management, to retain its habit; while the espalier may be used to model another young tree.

The horizontal mode of training trees to espaliers elevated 1 foot or 18 inches from the surface of the ground, and also that of having them placed at different degrees of inclination, were introduced many years ago from the Continent, where this method is frequently employed even at this day. They have the disadvantages of covering an unnecessarily large surface of ground, and of exposing the blossom to the injurious effects of spring frosts.

No doubt cast-iron espaliers, such as are represented in figs. 791 and 792, or wrought-iron uprights, and longitudinal wire running either horizontally or vertically, as in fig. 795, are lighter and more elegant in appearance than those of wood;—but, as we have observed of the former, they are liable to injure the trees during intense frosts; while the latter, being too flexible, become crooked and misshapen by the unequal pressure of the branches which are trained upon them.

There is one advantage which should not be overlooked, in training trees upon the principle shown from figs. 796 to 800,—and that is, the trees being planted under the espalier, the roots are secured from the injury occasioned by digging amongst them. To counteract the effect of the abstraction of heat from the branches which come in contact with the metallic substance, (and it is only at the points of contact that injury is sustained,) chips of wood might readily be placed between the branch and the iron, as the process of training goes on.

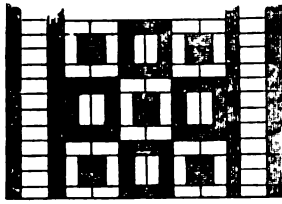
#### § 7.—FOOTPATHS.

Greenhouses, conservatories, and all plant-houses of the highest order, should be paved with the best polished stone pavement, in considerable lengths and breadths, or any of the highly ornamental floorings of terra-cotta, encaustic or other tiles manufactured by Minton, Copeland, and others—these being not only the most elegant, but at the same time the most durable.

For pine-stoves and ordinary plant-houses, Arbroath or Caithness pavement, or earthenware tiles, are certainly the best; and next to them, paving bricks laid in imitation of tessellated pavement,

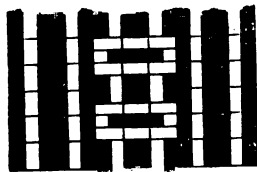
by using bricks of various colours. Thus red bricks and grey stocks, properly disposed, will produce patterns in the manner shown

Fig. 801.



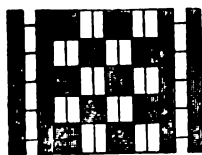
Very excellent paving tiles, called quarries, are manufactured in various parts of Staffordshire, and are formed of small squares 6 inches on the side, coloured blue, red, drab, and black. These, if properly arranged, make beautiful floors. There is a very superior kind called Wright's quarries, which, on a pale yellow ground, have dark brown figures in pigment let in; and although rather expensive, they make footpaths and floors of great beauty.

Fig. 802.



Footpaths for vineries, peach-houses, and all such as have borders requiring renewal or examination, should be of cast-iron grating in convenient lengths, and resting at the joinings of the pieces upon cast-iron plates, and these supported on rails of the same material. The pattern of the footpath may be simply a multiplication of octagons, hexagons, &c., or they may, with very little additional expense, be of highly elegant and elaborate patterns. These are not only cheap, but clean, durable, and admit of both air and water reaching to the roots of the trees.

Fig. 803.



In few things has garden architecture more improved than in footpaths in forcing-houses. Formerly these consisted of mere planks laid along, not always of the same breadth, and with little regard to level; next followed wooden trellised paths, both expensive and of no long duration, and at the same time the most uncomfortable of all floors to walk upon.

The improved cast-iron footpaths, resting on longitudinal rails, which are themselves supported on stone or brick piers, and having a raised margin, within which the footpath rests, are of all others the best. They should be from 2 to 3 feet in breadth, and in length of from 4 to 5 feet. At such sizes, including the rails, they can be furnished at the foundry at 1s. 6d. per superficial foot. Some still prefer polished stone pavement for this purpose, as is illustrated in the Royal Gardens at Frogmore, where an almost pure white pavement is used, and certainly with the best effect. These pavements are in long lengths, and are supported underneath upon brick piers, so that, in the event of renewing or of examining the borders, they can be readily taken up and again relaid. A darker colour would be more economical, as it would require less cleaning, and, for this purpose, 3-inch Welsh slate, Caithness, Arbroath, or Yorkshire pavement, polished on the upper side, would be suitable.

*Chimney tops.*—Well proportioned chimney stalks, whether ornamental or plain, as well as elegant forms of cans or chimney-pots, add very considerably to the effect of all garden buildings. This is, however, a matter in general very much neglected, and why, it is hard to say, seeing that cans of even the most classic forms can be purchased at the cost of a few shillings each. The annexed figs. 804, 805, 806, 807, will serve as examples. Their heights are as follows:—804, 4 feet 1 inch; 805, 5 feet 4 inches; 806, 6 feet; 807, 6 feet 3 inches. In material they consist of common pottery ware, fire-clay, artificial stone, cast-iron, stone, and various compositions. Chimneys, if properly arranged, and the designs in accordance with the building they form a part of, give character and expression. The study, however, of these has hitherto been a sort of stumbling-block to modern architects; and, as if seemingly

Fig. 804.



Fig. 805.



and, as if seemingly

and, as if seemingly



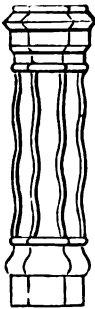
aware of this fact, many of them have endeavoured to place them so as to be completely unseen. With the exception of the chimneyshafts in some of our old English houses, which form certainly the most prominent and agreeable features of the style, we have no other examples of antiquity left us.

Fig. 806.



One general fault in chimney shafts and cans is, that they are too short and diminutive, and scarcely indicate the purpose for which they are intended. They should in all cases rise boldly into the air above the roof, and so form conspicuous features in the outlines of all buildings against the sky. Like all architectural or sculptural objects, the pots should be always set upon a proportionable plinth or base; and all grotesque and fantastic forms should be avoided.

Fig. 807.



### § 8.—PAINTING.

*Carson's original anti-corrosion paint* is a very durable out-door paint for the preservation of iron, wood, stone, brick, and cement. For such purposes it has been used for upwards of sixty years, but generally in large establishments, dock-yards, &c., and is by far too little known or employed in country places. Painters have also a prejudice against this paint, because it is more difficult to use—that is to say, it takes a little more time, and wears out their brushes. We use it extensively for the iron work of hot-houses, iron gates, fences, &c.

*Todd's patent protoxide paint* is used for the same purposes as the last. It neither cracks nor blisters by the hottest sun, and is excellent on that account for painting the insides of hot-water tanks, as well as hot-water pipes. Its adhesion is so great to iron and wood that the

hardest friction will hardly remove it. It is said also to prevent vegetation on stuccoed buildings and soft sandstone, and is not affected by sea-water. Its concealing properties, according to the patentee's estimation, are as compared with white-lead paint as 75 to 50; therefore 1 cwt is equal to 1½ cwt. of white-lead. It may be used in houses without inconvenience, as it is perfectly innoxious. We have used it, as well as the former mentioned, and can speak most favourably of both.

*Gas liquor, coal tar, &c.*, considered as paints, are found to accelerate rather than prevent oxidation, both in damp and dry situations. They are often recommended for painting rough wood-work, such as pailings, gates, &c.: our own experience is, that they are rather injurious than useful in this case also.

*Spirit of tar*, being a vegetable extract, is no doubt valuable for preserving timber; but both its colour and smell are highly objectionable. It may, however, be advantageously employed for saturating the ends of posts or poles, as far as they are to be inserted in the ground. If laid on with a brush, it will require four or five coats, according to the size of the timber operated upon.

*Mulgrave cement*, made into the consistence of paint, by being mixed with sour milk, sweet wort, or, indeed, clear rain water, is a much better paint for such purposes, as well as for walls, and is not only as cheap, but gives a much more cheerful colour—that of a soft stone colour—which may be darkened by a little lamp-black to the tone or shade required.

*Smith's economical paint, for outside work.*—This paint is described by Mr Smith, in "Art of House-Painting," as formed of "three parts of unslacked lime, two of wood ashes, and one of fine sand, or of finely-sifted coal-ashes. These are to be mixed with linseed oil, or the whole ground together, which would be better, till they become of the consistency of paint, so as to be laid on with a brush. Lay on the first coat pretty thin, and the next considerably thicker; it will last for years, and become harder as it gets older."

*Common anti-corrosion paint.*—We have used this article extensively, and with the greatest success, both on iron, timber,

and brickwork: we believe that it is composed of burnt oyster-shells, ground glass, scoria from the lead works, and a little colouring matter, according to the shade desired. These, when very finely pounded and sifted, may be kept for years in a dry state, and when to be used, they are mixed with raw linseed oil in the usual manner; but the mixture should stand a day or two before being laid on. This is an excellent paint for the inside of watering-pots, preventing rust, and tending to their durability. Some waters contain mineral matters in solution, which, if not counteracted by paint, eat the iron into innumerable holes, as also the lead lining of cisterns.

*M. Zeno's anti-corrosion paint.*—Eighty parts of finely pounded and sifted brick-dust, mixed with twenty parts of litharge, ground together upon a slab with linseed oil to a thick paste, and diluted with oil of turpentine, make a paint which has been found to resist oxidation in iron, both when exposed to the weather and the sea. Before proceeding to use this paint, the iron, even if new, should be rubbed quite clear. Indeed, this latter precaution should be attended to in all cases where iron is painted; for, if neglected, the process of rusting will go on under the paint somewhat as the rot in wood does, if not properly seasoned and dry before the usual paints are laid on.

*Black paint.*—The sombre appearance of this colour in general does, and always should, exclude it from gardens and garden scenery. For this reason, as well as for those shown below, coal-tar ought never to be employed. There is a decaying property in black, depending on colour alone, which has been described in "The Transactions of the Society of Arts," and in "The Civil Engineer," as well as in other periodicals. The writer says—"I have heard many men of considerable experience say, that black is good for nothing on wood, as it possesses no body to exclude the weather. This is indeed partly the case; but a far greater evil than this attends the use of black paint, which ought entirely to exclude its use on any work out of doors—viz., its property of absorbing heat. A black unpollished surface is the greatest absorber and radiator of heat known, while a white

surface, on the other hand, is a bad absorber and radiator of the same;—consequently black paint is more pernicious to the wood than white. Wood having a black surface will imbibe considerably more heat in the same temperature than if that surface were white; from which circumstance we may easily conclude that the pores of wood of any nature will have a tendency to expand and rend in all directions, when exposed under such circumstances: the water, being admitted, causes a gradual and progressive decay, which must be imperceptibly increasing from every change of weather." In following up his argument as to the absurdity of painting ships black, he says—"I am fully persuaded that a piece of wood painted white will be preserved from perishing as long again, if exposed to the weather, as a similar piece painted black, especially in a tropical climate." The extent of the heat-absorbing properties of a black colour have been variously estimated by chemists. So far as paint is concerned, we think its want of popularity depends more on its appearance and want of body than on its direct absorbent power. The best black paint is oxide of manganese. Lamp-black and oil, so frequently used, has little body in it, and consequently does not last long. For hinges of gates, and iron-work employed to brace up timber-work, when colour is an object of contrast, it may be used as a finishing coat over three coats of anti-corrosion.

*Green paint* is the most expensive of all colours, and has little body to protect the timber. For hothouse-work it should never be used, unless to paint, as a finishing-coat, plant-boxes for oranges and similar large plants—and then the hoops and handles should have two coats of anti-corrosion; and if of a light stone colour, it will contrast with the green of the other parts: but, even for this purpose, we prefer painting the hoops and handles black.

*White-lead paint.*—This is the most generally used of all paints; it has sufficient body to preserve the timber, and may be compounded of different shades. Pure white, as a colour, may be used for the interiors of hothouses, as being the best reflector of light, but not for the exteriors, as it becomes so soon stained with smoke

and other heterogeneous matter. A soft stone-colour is the best, as it wears well, and retains its colour better than any other. We use it invariably, both for outside and inside work.

*New white paint.*—Mr Forrest, the inventor, in a paper read before the Liverpool Polytechnic Society, describes this paint to consist of white oxide of antimony. Its advantages are stated by him to be, its superiority as a body paint to white lead, and its being much cheaper and more permanent as to colour, and its capability of being spread over a greater surface than the same weight of white-lead.

*Graining* is a term used by painters when wood is painted in imitation, as of oak. This is the best colour for the doors of gardens, and although expensive in the first application, and requiring renewal every two or three years, it gives an appearance of solidity and finish to the parts covered with it.

Much of the durability of hothouses depends on the state in which they are kept as regards paint, and also on the way in which it is used. Wood, iron, putty, and all bodies to which it is applied, should be perfectly dry and seasoned before it is put on. Three coats are required on all new erections, and once every two years it should be renewed with two coats at least. One of the advantages of movable sashes in hothouse roofs is, that there is some chance of getting them under cover some time during summer, to be well cleaned, the glass repaired, and the old paint well rubbed down with pumice-stone, to remove all that which is loose, and to bring the whole to a uniform smooth surface. When this can be effected, the paint should be thoroughly set and dry before they are put on again. Advantage must be taken of dry weather to clean and afterwards paint the fixed parts, such as rafters, wall-plates, ventilators, &c. Houses with fixed roofs require to be carefully examined during dry weather, to get the glass repaired, the putty carefully examined, and the whole painted when *perfectly dry*. We endeavour to go over all our fixed roofs every year; and if only one coat of paint be given, it is better than to delay it longer, and give two. In painting roofs, the colour should be brought down so as to

cover the edge of the glass next the putty one-eighth of an inch: this prevents the putty from becoming loose, and also the water from getting in under it and saturating the rebates, which, being prevented from drying, soon causes their decay. Turpentine is often used, particularly in the finishing coat, with a view to make the colour dry quickly. This has, however, a tendency to cause the skin of the paint to crack; it is, therefore, better to use the colours without it, for although longer in drying, when once dried it will last much longer. In applying paint, it should never be put on too thick, nor should more than three coats be at any one time given.

In painting upon metallic surfaces, the oil-paints in common use are found objectionable, because the galvanic action prevents the union of the two metals.

*Spelter or white zinc paint.*—Mr Lancaster Scott has lately brought into notice a valuable paint under this name. It is not only cheaper than the common white lead used, but goes farther, three cwt. covering as much surface as four of white-lead paint. We have had some experience of its use, and can speak of its merits. It has the advantage of not blistering by heat, the colour remaining unchanged by light, and exposure to gas or sea water. In using it, care should be taken that knots in the wood be twice covered, and then rubbed flat. Prime in unboiled linseed oil, and give three coats. No boiled oil should be used, nor any drier, except that supplied along with the colour. Red lead, vermilion, or chrome are to be avoided in giving tints to the colour; but amber, stone-ochre, terra di Sienna, Prussian blue, or any stainer that is not based on or precipitated from white lead, may be used with safety.

*Fleming's economical paint.*—An economical and durable paint has been most extensively used at Trentham for painting iron fences; it consists of one-third Stockholm tar and two-thirds gas tar, laid on when quite hot with a brush, and spread as thinly as possible. The cost of this per yard, when applied to common iron hurdles, is about three-eighths of a penny, and it is calculated that it will last for nine years.

*Metallic paint.*—The following materials make an excellent durable paint for

iron-work in the open air—namely,  $\frac{1}{2}$  oz. of aquafortis, 1 gallon of gas-tar, and  $\frac{1}{2}$  pint of spirits of turpentine, gradually and well mixed together in an iron vessel, and over a slow fire. The colour of the gas-tar predominating, renders this paint more fit for field fences than for garden buildings.

### § 9.—CEMENTS.

The most useful cement, and consequently the one in general use, is *the Roman cement*, of which there are two kinds—*Parker's*, and *Atkinson's* or *Mulgrave's*, which is the same thing. Parker's is the oldest, and is said to have been accidentally discovered by a person of that name. Parker's cement is made of the nodules of indurated and slightly ferruginous marl, called by mineralogists septaria, and also of some other kinds of argillaceous limestone. These are burnt in conical kilns, in a similar manner to other limestone; great care is, however, taken not to use too much fire, as, if the slightest degree of fusion takes place, it will be rendered useless. When properly roasted, it is then ground to fine powder, and packed in air-tight barrels, and kept quite dry.

*Atkinson's* or *Mulgrave's* is next in priority, and has long been manufactured on the Mulgrave estate near Whitby. It became known as Atkinson's cement in consequence of that eminent architect, the personal friend of the late Lord Mulgrave, introducing it into more general use. He also superintended the sale of it in London for many years, and had a depot near Blackfriars' Bridge—"*Atkinson's Cement Wharf*." At Lord Mulgrave's death he gave up all connection with it, and since that time it has been generally known as Mulgrave's cement. There is a considerable difference in the quality of these two varieties, Mulgrave's being of a lighter colour and more ochrey than Parker's, much higher in price, and proportionably superior in strength and durability. Both, however, are easily destroyed by being kept in damp places and exposed to the air, in which cases neither are much better than good lime; and hence the disrepute they often fall into from improper keeping. Mulgrave's is manufactured in the

same way as Parker's cement, noticed above.

*Bailey's cement*.—This is a hard and durable material, and is formed of stone-lime recently burnt, and, immediately after being slacked, mixed with clean sharp sand. The usual proportions are three of sand to one of lime.

*Frost's cement* is better calculated to indurate with lime than Roman cement, because it does not set so fast. The inventor has stated in "The Repertory of Arts" that lime, even chalk lime, burned in a close kiln, and cooled without coming in the slightest degree in contact with the atmosphere, will, when afterwards slacked and mixed with sharp sand, set as rapidly as Roman cement, and this even under water.

*Frost's cement* is made by grinding chalk very finely in a mill, water being mixed with it during the process, which carries off its lightest particles to a reservoir. The same machinery is employed at the same time grinding clay, which is also washed with water, and the lighter particles also conveyed to the same reservoir. This combination of chalk and thirty per cent of clay is evaporated till quite dry, then burnt in a kiln and ground to powder, when it is fit for packing by in air-tight casks to keep, or for immediate use. It is much cheaper than Roman cement, and requires no sand to set it.

*Puzzolano earth cement*, and *tarras cement*, like Frost's, indurate freely with lime, and do not set so quickly as Roman cement does.

*Gypsum*, like Roman cement, sets almost instantaneously, whether mixed with sand or not.

*Mastic* is a calcareous cement, consisting of earth and other substances almost insoluble in water, to which, when pulverised, are added any of the oxides of lead, and also a quantity of glass or pounded flints; the whole, when finely pounded, is mixed with any cheap vegetable oil. This cement, when made, may be kept in casks for years without injury, and is of all others the best for producing an imitation of stone, but it is much too expensive to be brought into general use.

*Metallic cement* is formed of scoriæ from the copper-works and stone-lime, both finely pounded. It sets rapidly, and takes a fine polish.

*Dr Ure's asphalt* consists of boiled coal-tar mixed with powdered chalk or bricks, and is said to be nearly equal to the French.

*Asphalt* is found natural in some parts of France, and has been long used in that country for a variety of purposes. It is now made artificially in England, and equally good. The following is the process: "Eighteen parts of mineral pitch, and eighteen of resin, are put into an iron pot and boiled for a little; after which sixty parts of sand, thirty of small gravel, and six of slacked lime, are to be added. For walks, ordinary floors, or the bottoms of tanks, when the surface is dry and made level, the mixture is laid on in a boiling state to about the thickness of 2 inches. For barn-floors or flat roofs it is laid about one-third thicker. This is a cheap and durable covering for the bottoms of tanks, but it is unfit for the sides, as it can hardly be laid on perpendicular surfaces, from its tendency to run. The objection to asphalt for roofs is, that it is apt to turn soft by the sun, and hence becomes unfit to walk upon. This pliancy when heated, however, renders it useful for other purposes. That kind known as *Seyssel's asphalt*, for example, although made in straight pieces, and in that state often used for edgings in flower gardens, when slightly heated can be bent to suit the curves of the walks, and the turns at their angles.

In using any of the varieties of Roman cement, it is of the very first importance that it be fresh from the manufactory, or that it has been kept in a dry cellar or storehouse closely packed in casks, so that the air may not reach it. Hence it is best, when small quantities are only to be used at a time, to purchase half or quarter casks; for after a cask is once opened, the air soon spoils the contents. The work to which it is to be applied should be sound, and secure against settlements. Before laying it on, the wall should be well wetted with water. One-third clean-washed river sand is to be mixed with the cement in small quantities at a time; hence it is proper to have a person mixing the cement while another is laying it on. Cement should in all cases be finished in one coat, and not in two or three, as plasterers do theirs; for all additions to the first coat are certain to come off with

the weather. For tanks or cisterns the cement should be allowed to become quite dry, and then get three coats of boiled linseed oil and turpentine, which should also be allowed to dry, after which the water may be let in. It is of importance that the work be done during summer, if possible—never during frosty weather.

*The Portland cement* is an excellent material for lining tanks and cisterns, and for other hydraulic purposes.

*Lusor's cement*.—Under this signature a correspondent in "The Gardeners' Chronicle" recommends the following cement as excellent in the formation of aqueducts for conveying water. Flooring-tiles are set in the following—viz., 1 cwt. whiting, 2 quarters 18 lb. rosin, 18½ lb. of brimstone, 9 lb. tar.

*Austin's stone-coloured cement* is excellent for covering old defaced walls, brick-built parapets to imitate stone, and also for tanks and water-cisterns. One bushel will, if laid on at the usual thickness, cover 40 superficial feet: it requires the same quantity of sand and water as Roman cement, and is laid on with as great facility.

*Francis Anson's Parian cement*, used as a stucco, cannot easily be distinguished from statuary or Parian marble. It is fit for all the purposes of that beautiful material, and does not crack, warp, or effloresce in any degree. It is adapted to encaustic work, fresco, imitation of marble, &c. It sets readily, so that even when applied to new or damp walls, they may almost immediately be polished, painted, or papered. It is altogether an excellent cement for in-door work. We have no certain knowledge of its properties to withstand the weather.

*Water cement* is of three kinds. The first is made by calcining and reducing to a state of powder four parts good grey clay, six parts black oxide of manganese, and ninety parts limestone reduced to powder by sprinkling water on it. The whole being well mixed is fit for use. The second consists of 1 cwt. of fine clean sand, 1 qr. quicklime in powder, 14 lb. bone ashes. When to be used, beat the mixture up quickly, using water to bring it to the desired consistency. The third is composed of fifteen parts of white iron ore, (manganese iron ore,) eighty-five parts lime.

These, when calcined and reduced to powder, and mixed with fine sharp sand, are fit for use. These three cements harden speedily under water, and are very durable. "The art of mixing earths so as to form mortars which will set or solidify, either by themselves or in conjunction with stones and bricks, can only be scientifically understood through some knowledge of chemistry. All lime mortars depend for their strength on their quality of absorbing carbonic acid gas and water, and solidifying them. All cements are rapidly solidifying mortars, though they depend for their strength on the same qualities as lime mortar, owe their power of rapid solidification to the presence of some metallic oxide, the value of which principally results from its capacity of absorbing oxygen."—*Villa Architecture*. Much of the value of all mortars and cements depends on the purity and quality of the sand used; indeed, for such purposes it should almost invariably be washed, to free it from earthy matter.

*Water cement of Dihl*.—Pure clay, dried by a gentle heat, and powdered, mixed up to the consistence of a paste with *boiled* linseed oil, may be used with advantage for covering the walls of houses, the roofs of verandahs, &c. It may be coloured to fancy by the use of any of the ochres, and may be thinned by turpentine.

*Patent antonica*, an invention of Mrs Marshall, and lately brought into notice by her, is a valuable discovery. Of its component parts we are of course ignorant, as well as of the mode of manufacturing it. That the first is of cheap materials, and the latter easily accomplished, may be concluded from the extremely low price at which very beautiful articles of it are sold. It can be moulded into any form, however elaborate, and made very closely to resemble all kinds of marbles, granites, &c.

*Oropholite cement* has been pretty extensively used as a substitute for lead, zinc, slates, tiles, &c., for covering roofs, and also for lining cisterns and tanks. When employed for the former purposes, it is spread on thick canvass, and either laid on the rafters in webs, or cut into smaller pieces, and laid on in the form of tiles. It has been recommended as being both

cheap and durable,—a non-conductor of electricity, resisting oxidation, perfectly waterproof, and preventing damp from passing through walls. When laid on large surfaces, the joining should be covered with the cement of which it is made, so forming the roof entirely in one piece, preventing alike the entrance of water and the displacement of any part of it by the wind. We have seen it employed as a cement laid on walls in the ordinary manner, like plaster, and also for covering the sides and bottoms of tanks, where it appears to stand well; but we doubt its durability as a roofing material when laid on canvass, as the latter is so liable to decay. To our enumeration of building cements, we may add the following as being much used in Scotland, and manufactured there—viz., Calderwood cement, Borrowstownness cement, Broxburn cement. This latter is of inferior quality.

Cements are valuable for garden purposes, such as building pits where the walls are necessarily narrow, yet requiring strength, building or pointing garden walls, making tanks and cisterns, and various purposes in connection with the imitations employed in ornamental gardening.

#### § 10.—ON THE PRESERVATION OF TIMBER USED IN HOTHOUSE-BUILDING, AND ON THE DURABILITY OF MATERIALS.

Unseasoned timber, and that of trees cut before they have arrived at full maturity, are equally liable to premature decay. The alburnum or immaturely formed portion of the wood undergoes, in consequence of the moisture or sap contained in it, a process of fermentation, which affords food highly relished by a certain class of microscopic insects, whose keen perception leads them to find out its presence. These insects perforate the wood in all directions, and in so doing make innumerable cavities, into which the air and moisture enter. A combination takes place with these and the nitrogen existing in the fermenting alburnum, producing ammonia and its compounds, highly favourable to the growth of the various species of minute

fungi, the seeds of which are continually floating in the atmosphere, requiring only a proper nidus upon which to settle and commence their vegetable existence. These minute plants spread with vast rapidity, and, in their endeavour to reach the light, force their way through the fibres of the wood, until at last, by the combined agency of animal and vegetable life, the timber rots, and speedily becomes perfectly useless,—and this is increased in proportion to the amount of albumen of which the log or plank may be composed.

Various methods have been devised for arresting this process, of which we shall briefly mention the most important.

*Kyan's patent preparation*, which consisted in steeping the timber in a strong solution of corrosive sublimate, was for some years looked upon by many as a complete remedy against decay. Experience has not, however, proved this to be the case. For ourselves, we never had much faith in this nostrum; and in every experiment we tried, we found the timber subjected to the process decay at least as soon as that of equal quality, and exposed to the same action, that was not prepared at all. The very conclusive report drawn up of the experiments made by the Duke of Portland at Welbeck, as well as of those made by Earl Manvers at Thorsby Hall, go far to confirm us in our opinion. In the latter case, the effects produced on plants set in houses, the timber of which had been Kyanised, were such as led to its disuse in that establishment.

In the extensive establishment of the Messrs Loddige at Hackney, Kyanising was carried to a very considerable extent; and although these gentlemen appeared to be of opinion that the process tended to increase the durability of the timber, yet the destruction caused to their plants was such as might well deter any one from using it for such purposes.

It is but an act of justice, however, to state that other opinions have been published as to its effects on the roots of plants. In the gardens of the Duke of Northumberland at Sion, for example, cucumber boxes prepared in this way had no bad effect upon the plants; and Mr Parsons, late clerk of the works there, speaks of it in the highest terms as a

preservative of the timber, though he says nothing as to its effects on vegetation.

Our own observations on it during the last twelve years at Dalkeith, where it has been tried in the Park and in buildings to the fullest extent, have led us to the conclusion that it does not tend to the preservation of the timber at all. Large piles of it, taken from the Chain Pier at Newhaven, pieces of which are now in our possession, are much decayed after four years' exposure to the sea-water;—but those parts which were Kyanised are completely free from the sea-worm; nor have shell-fish or marine plants attached themselves to these portions, while that which was not Kyanised is completely covered with them.

A series of experiments was made so long ago as 1842 in the gardens of the London Horticultural Society, to test the merits of Kyan's patent. The following were the results: "In one experiment, a small portable greenhouse was prepared with Kyanised wood, and, thus pickled, was introduced into the atmosphere of plants under hand-glasses, but without injurious effects in such cases. But when Kyanised wood, or shavings moistened with corrosive sublimate, or crude mercury, or salts of that metal, were introduced into vessels containing plants exposed to the dampness and high temperature of a hothouse, in every such case the plants became sickly, recovered when removed from the influence of the mercurial vapour, and sickened again when again exposed to it."—*Proceedings of the Horticultural Society*, 1841, No. 14. Subsequent experiments also prove that "any timber steeped in corrosive sublimate gives out a vapour highly injurious to all plants which it comes in contact with."

By the "Agri-horticultural Society of India's Transactions," we learn that fences of bamboo which had been Kyanised had stood for three seasons; whilst parts of the same fence, that had not been subjected to that process, had to be repeatedly renewed during the same period. "The proportion of oxymuriate of mercury used was about 1 lb. to 15 gallons of water, and the bamboos remained in steep from ten to twelve days."

In our own experience, which has ex-

tended over a period of forty years, we have seen almost every plan for the preservation of timber, to a greater or lesser extent, reduced to practice, but with no very satisfactory result. We allude more especially to timber employed in garden buildings. That the timber used many years ago for such purposes lasted longer than it now does, is quite evident, and not difficult to account for; as in those days the demand was not anything so great, and the purchasers chose the very best in quality for importation. The case changed as the demand increased, and anything in the shape of timber was imported and readily sold. Again, our timber merchants, and more especially those who were to use it, formerly allowed it sufficient time to season before it was wrought up; but competition and low prices for carpenter work have now induced both the wood-merchant and carpenter to work up their material as soon as possible, being unable to lose the interest on their stock; while the former, to supply the latter with a cheap article, bought also cheap, and took the timber most convenient to be procured, and in many cases even such as had been rejected by former importers. We have been told by those engaged in the Baltic wood trade that formerly every tree felled that appeared of inferior quality was left upon the ground, the good only being squared and shipped. Such is certainly not the case now; and this accounts in a very great measure for the prevalence of what is called *dry rot* in buildings.

*Sir William Burnett's preparation.*—Amongst the many preventatives for this evil, Burnettising has been recommended. This invention has been patented by Sir William Burnett, and consists in injecting a solution of chloride of zinc into the timber by the application of mechanical force; whereas Kyan's patent was simply steeping the timber in a solution of corrosive sublimate or bichloride of mercury, acting, so far as our observation has extended, upon the outer surface only, without penetrating to the centre of the logs, blocks, or planks; and thus probably locking up the natural sap or imbibed moisture, much in the same way as paint does when applied to the surface before the body is thoroughly dry, and so producing the effect it was

intended to counteract or prevent. Hydraulic power of great pressure is employed to inject the chloride of zinc through the section, and consequently through the pores of the wood from one end of the tree to the other; and according to the opinion of A. M. Mangin, Inspector of the French Navy, the operation ought to be performed when the trees have been recently felled, "for then all its pores are open, and the sap is more easily drawn from it and replaced by another fluid. A very dry wood, of which the pores are so close that in a manner they disappear, would offer great difficulties to such a preparation; and there are other hard woods" (we presume box to be one) "with which it would be impossible."

Testimonials as to the merits of this invention have been obtained from many of the most scientific men of the age. We deem it sufficient, however, for our present purpose, to make the following extract from the testimonial of Professor Graham, of University College, London. "The wood appears to be fully and deeply penetrated by the metallic salt. The salt, although very soluble, does not leave the wood easily when exposed to the weather, or buried in dry or damp earth. It does not come to the surface of the wood by efflorescence, like crystallisable salts. I have no doubt, from repeated observations made during several years, of the valuable preservative qualities of the solution of chloride of zinc; and would refer its beneficial action chiefly to the small quantity of the *metallic salt which is permanently retained by the ligneous fibre in all circumstances of exposure.* The oxide of zinc appears to alter and harden the fibre of wood, and destroy the solubility, and prevent the tendency to decomposition, of the azotised principles it contains, by entering into chemical combinations with them."

The preparation is formed by adding 1 lb. of the chloride to 10 gallons of water.

*Sulphate of copper* has been recommended by a writer in the "Mechanics' Magazine," vol. xxxviii. p. 568, as a preservative of timber, who instances the effects in the mines in Cornwall and Anglesea, where this salt abounds in the mineral waters, the timber immersed in which has been found very durable. This composition is prepared as follows: 24



lb. of sulphate of zinc, 15 lb. sulphate of iron, 12 lb. sulphate of copper, are to be pounded and dissolved in hot water, and then one quart of sulphuric acid is to be added to the mixture. The above, added to 36 gallons of water, is ready for use. The timber is steeped in a tank for the following periods: 1-inch deal, three days; 3-inch plank, seven days; 5 to 7 inch plank, twelve to fourteen days; and 12 to 14 inch square timber, twenty-one days.

*Bethell's preparation* for preserving timber, consists of creosote, along with coal tar or other bituminous matter. 40 gallons are required for a load of timber of the pine kinds; a less quantity is required for the closer-grained woods. Creosote is rapidly absorbed by the timber, even to the centre of the plank or log. Wood saturated with creosote is not only said to be more durable, but to become almost waterproof, and is fit for use a few days after the process is completed, about which time it loses its disagreeable smell.

*Dr Boucherie's method* consists in employing impure pyrolignite of iron, in spring, when the ascent of the natural sap begins. The process is as follows: Near the bottom of the trunk a hole is bored through its diameter, into which a thick-toothed narrow saw is introduced, and with it the trunk is cut through to within about an inch of the outside, working the saw first to the right-hand side, and then towards the left, so as to cut through the greater part of the sap vessels. The opening thus made is then carefully covered with pitch-cloth, leaving only a small hole, through which a pipe is placed, communicating between the trunk of the tree and a reservoir containing the pyrolignite of iron. During summer or autumn a large tree will by this operation become completely saturated with the mineral fluid in the course of a few days, as at these seasons the vital forces of the tree are in full activity. When smaller trees, or ordinary-sized branches, are to be operated upon, their lower ends are immersed in the fluid. In winter the operation is thus performed: The timber being cut into convenient lengths, a waterproof funnel is secured to the top end of each, containing the liquid; and the solution is said not only to force its way down through the

wood, but at the same time to drive out of it all the sap and air it contains. The operation is deemed complete when the preparation begins to issue from the lower end of the log. The quantity of mineral liquid used is stated to be one-fifteenth part of the weight of the green wood.

The most certain way of preserving timber is to procure it of proper age and maturity, and to place it so in buildings that it may have sufficient ventilation.

Other methods besides those above stated have been adopted, such as steeping the wood, previous to use, in water, and afterwards drying it in the sun and air; subjecting it to the action of steam, and then drying it; boiling it in water in long troughs heated by steam or flues; removing the atmospheric pressure, and at the same time applying artificial heat, so as to promote evaporation. The object of all these operations is to remove, by extraction and evaporation, what is called the sap, or the watery part of the alburnum, or last formed layers of the wood, which are found to decay sooner than the interior and firmer, or less porous layers. The immaturely formed timber decays first, and no painting whatever will prevent it; nay, painting timber in this state only hastens its decay by preventing the natural sap from finding its way out. Charring is a remedy, but that can only be applied to timber used for the roughest of all purposes; and yet, although the advantage of charring posts to be set in the ground has been known for ages, how seldom do we see it reduced to practice!

Boyd and Miller's antiseptic mineral black paint has been recommended by architects for saturating the ends of beams let into walls, posts set in the ground, &c., as a remedy against decay; and also for iron work, to prevent rust; and for cordage and canvass, to render them durable, as well as to correct the dampness in walls.

The principal cause of decay in timber, we believe, is pretty generally admitted to be the felling it at an improper season. This season appears to be the spring, when the sap is in a peculiar state, and highly disposed to ferment, when it can no longer flow through the tissues. Over timber cut in our own country we have complete

control. Not so with such as is imported either from America or the Baltic; nor is it ever likely that we will have the felling of it in either place regulated by the rules we would wish to lay down.

Of the various remedies recommended for the preservation of this useful article, may be noticed that of M. de Gemini, recently detailed in a Memoir laid by the Minister of Marine before the Academy of Sciences of Paris. The report upon this subject, drawn up by MM. Boussingault, de Gasparin, and Decaisne, states that M. Gemini was of opinion that metallic salts introduced into the wood had the effect only of impregnating it with substances more or less soluble, or even volatile, which consequently could not remain long in the wood; and that by introducing it by force of machinery, the fibres became separated, and the wood rendered even more liable to decay than if left in its natural state.

The three gentlemen above mentioned differ from M. Gemini in this matter, and declare that the salts have not the effect of disorganising the woody fibre, and also that the combination of metallic salts with wood is not so fugacious as M. Gemini asserts.

M. de Gemini's process is thus described in the *Gard. Chron.*—"He operates on dry wood, or on what has been dried in his apparatus, which consists—1. Of a cast-iron hollow cylinder, destined to hold the pieces of wood, and sufficiently strong to resist the effects of a vacuum within. One of the ends of the cylinder has a close cover, secured by screws after the wood has been introduced; the other is furnished with a valve, opening progressively by means of a screw, and serving to reintroduce the air to the cylinder. 2. Three reservoirs for the solutions. These are placed in the ground under the cylinder, with which each is in communication by a pipe having a stop-cock. 3. An air-pump for producing a vacuum in the cylinder. 4. A force-pump for injecting the liquids with great pressure into the cylinder. 5. A generator, intended merely to fill the cylinder with steam by a communication pipe." This apparatus resembles, in some degree, that of Breant, afterwards improved by Payne, and employed in England, for several years, for impregnating timber with bituminous substances. The injection used by M. Gemini is tar, or tar and

pitch, for some purposes, while he uses solutions for others. We apprehend that the former is used for timber of a soft nature, and having large pores, while the latter is used for more matured material, and the harder or closer-grained woods. He appears to have fallen into the same mistake as M. Boucherie did many years ago—namely, endeavouring to inject two solutions, the one after the other, without considering that, if his first solution was injected to the extent of filling all the pores of the wood, the effect of the second would be to drive that out to make room for itself.

So far, however, as M. Gemini's theory goes, we believe that it is useful so far as charging the alburnum or sap-wood with pitchy matter is concerned. How much farther his invention is useful does not so clearly appear.

In regard to the qualities of timber used in hothouse architecture, they stand as follows:—Memel, brought from Prussia, in the Baltic; Riga, from Russia; Dantzic, from Western Prussia; redstone pine, from Miramichi, in North America; and yellow pine, from Quebec.

#### § 11.—ON THE DURABILITY OF MATERIALS.

The durability of materials depends on their natural fitness, or the degree of perfection to which they are brought artificially.

Thus bricks can never almost be over-burnt; and, at the same time, there are certain kinds of clay or brick-earth much better for the purpose of making them than others, and which will stand for ages, even if not burnt to a blue or slate colour. The principal fault of bricks used in Scotland is, that they are neither well formed nor well burnt—a circumstance arising naturally out of the fact that Scotland abounds in stone of first-rate quality; and indeed, till lately, very few bricks were made, and those chiefly for furnace-work, inside walls, and lofty chimneys. We have the satisfaction to know that, through the liberality of the Duke of Buccleuch, we introduced the making of bricks upon the London principle, about fourteen years ago, into Scotland. The demand since, for railway purposes, has much improved their manufacture.

"The most durable of all walls are

those built of bricks, with good mortar, because they attain a degree of homogeneity which no construction of mortar and stone has ever yet equalled. The proof of this is found in the ancient brick buildings of Italy. The walls next in durability are those formed of fragments of porous stone, compactly bedded in good mortar or cement," as exhibited in the oldest stone buildings we have in Scotland, "and in that of the old Roman castles throughout Britain and Germany. The third in order are those (commonly reckoned the first) which are composed of very large blocks of squared stones, and the strength of which does not at all depend on mortar or cements of any kind."—*Cott., Farm, and Villa Arch.* Of this an excellent example may be seen on entering Lincoln by the northern road.

Stone, in general, is the first part of our buildings to decay. Care, therefore, should be taken in its selection. On this subject Brand has laid down the following rule: "Boil two 1-inch cubes of the stone to be tried in a solution of sulphate of soda, saturated at a common temperature, for half an hour; then expose the cubes to the air for evaporation; the salt crystallises, and has the effect of freezing on the stone; then dip the stone in the cold solution until the crystals fall; after this expose the stones to the air. This experiment, repeated during five days, will produce the same effect on the stone which exposure in the open air would do in many years."

In stone building, the stones should be invariably set on their natural bed, so that they may lie in a position precisely similar to that which they occupied in the quarry. This caution specially needs to be observed in the case of sandstone, which is of comparatively modern formation, and is not of such intensity as granites and mountain limestone, and is more easily acted upon in the direction of its bed by the weather. Micaceous slates require the same precaution, and are, from their want of solidity, and their abounding in fissures, the worst sort of stone that can be employed, as they admit readily the rain-water to pass through between the various laminæ of which they are composed.

Of *Slates*, the best are from North Wales, and are of fine texture and blue

colour. The next are the Westmoreland, of a light green colour, harmonising well with buildings surrounded by trees. The Devon and Cornwall slates are much inferior as to durability. Their colour, however, is good, being that of a purple grey. The Dennybole quarry, in Cornwall, produces the largest, finest, and most durable of the south-western formation. Those of Eisdale and Ballahulish are the best in Scotland—very durable, but very heavy. The thin drab-stone of Dorsetshire, the Kentish rag-stone, and the red and grey slate-stone of various parts of Scotland, make picturesque roofs, but load the roofs by far too much. The light-blue Welsh slate is much less penetrable by water than the dark blue sorts. Good slates will not imbibe above  $\frac{1}{10}$  of their weight of water. Indeed, their wetting is merely superficial, and in summer they will dry in half an hour. The Valentia slates, from Ireland, are of excellent quality, and may be had of any reasonable size or thickness.

*Tiles*, whether plain or pan-tiles, constitute a very heavy roofing. They tend to render a house damp, from the quantity of moisture they absorb. All unglazed tiles imbibe one-seventh part of their weight of water in the space of ten minutes, and cannot be deprived of this water without a degree of heat equal to 60°, continued for six days. The red coloured tiles in common use are extremely objectionable as a roofing for ornamental buildings; while tiles of other forms and colours produce some of the most beautiful of all roofs. Of these the Grecian, Italian, Moorish, mathematical, and new French, may be specially noticed. These are either made of fire-clay, burning them to a soft stone colour, or are coloured of various tints to harmonise with the objects which surround them.

*Cramps* are often used in tying together the copings of walls, piers, &c. When wrought iron is used, it should be dipped in boiling oil and red lead, boiling pitch, or be embedded in cement (not lime-mortar) as a means to prevent oxidation. Copper cramps are preferable, but are expensive; and cast-iron dove-tailed cramps are the next best, particularly if tinned, or coated by any of the preparations recently invented for the preservation of metals.—(Vide HOTHOUSE-BUILDING, &c.)

## CHAPTER XI.

### LAYING OUT FLOWER-GARDENS.

#### § 1.—PRELIMINARY REMARKS ON THE CLASSIFICATION OF STYLES.

LAYING out flower-gardens, considered as a work of art, may be divided into three general heads or styles—namely, the *geometric style*, the *picturesque style*, and the *gardenesque style*. These are again subdivided—the first into the *tonsole*, the *architectural*, the *sculpturesque*, the *Italian*, the *French*, and the *Dutch*, &c. ; the second into the *refined picturesque*, the *trivial picturesque*, the *rough picturesque*, and some others ; the last into the *pictorial gardenesque* and *geometric gardenesque styles*. A mixed style, or employing more than one of the above, is admissible in the same garden, but not in the same piece.

These may be considered the fundamental rules for laying out flower-gardens upon principles of art ; but there are other considerations to be attended to—namely, the wants and wishes of the owner, and the natural character of the situation. The adaptation, however, of any of these to suit existing circumstances requires great consideration and judgment. It would be as great an outrage against the rules of art to place a rough picturesque flower-garden in front of Chatsworth, Trentham, or Eaton Hall, as it would be to place one in the sculpturesque or architectural style in front of a cottage residence, or of a mansion, however large, having no pretensions to architectural character.

The nature of this work does not require that we should go into the details of landscape-gardening, in the general acceptation of the term, our object being to give examples of that department of it only which is in immediate connection

with the mansion, and properly called the *Flower-garden*.

The leading features, however, of the principal of these styles we shall briefly notice.

*The architectural style* includes the introduction of stone steps, parapets, terraces, basins, edgings to the beds, &c., these being constructed in various cements, artificial stone, slate, fire-clay ware, cast-iron, &c. The architectural flower-garden forms a harmonious appendage to the mansion, because, as we have elsewhere stated, it constitutes a union between the house and the rest of the grounds, and also as presenting from the windows rich green verdure, and the gay colouring of the flowering plants, combining with the more permanent beauty of sculptured forms—the latter heightening the effect of the former by contrast, as well as by the relief they afford the eye in masses of light amid surrounding verdure.

*The sculpturesque style* is characterised by the introduction of vases, statues, fountains, and other sculptural objects. These should always be specimens of the highest style of art.

*The Italian style* is distinguished by stone terraces, terrace gardens, and sculpture combined. The architectural and sculptural styles trace back their origin to the days of Pliny, and their revival to Rome in the zenith of her power, when the fine arts flourished in consequence of the encouragement given by the force of wealth, and a high state of refinement in society. The family of the Medici, early in the sixteenth century, revived the latent taste, and gave munificent encouragement to artists, who laid out their own gardens in the geometric and architectural taste.

To the noble family of Borghese, Italy owes much for her once classic gardens. It is quite evident, therefore, from what we have stated above, as well as from the remarks afterwards to be made, that the geometric style, in its various modifications, must ever be regarded as in close connection with architecture, and therefore need not be looked for in times or amongst people in a state of rudeness or barbarity. When architecture was more studied in Britain than it was for a part of the latter end of the last century and the beginning of the present one, this style of gardening held a conspicuous position, as every mansion of more than ordinary pretensions had also its geometric garden attached to it. When architecture languished, and fell nearly into obscurity, gardening, associating with it, also did so. Architecture (we speak of that art, however, as employed in the constructing of mansions for the wealthy) has of late revived in this country; and wherever that art has been employed on correct principles of taste, geometrical gardens also formed its concomitant. The Italian flower-garden at Chatsworth is placed opposite the library windows, and is exceedingly rich in coloured parterres, and abounding in pedestals supporting busts and statues, producing rather a whimsical effect from their great height. This is, however, so far relieved by their being partially covered with climbing plants.

*The French style*, if it merits such an appellation, is a sub-variety of the Italian, imitating it in some instances pretty correctly, but in general inferior to the original in the artistic adjuncts, and more especially in fountains. Whoever has visited even the best French gardens, public or private, or consulted the engravings of the most eminent old French architects, who were the designers of gardens in the olden times, must be struck with this, as much as they will be pleased with the majority of their parapets, balustrades, and other mural decorations.

*The Dutch style* is characterised by straight canals, grass terraces, turf mounts, &c. All of these have the best effect upon nearly level surfaces, and in connection with highly-enriched architectural buildings, and upon an extensive scale.

*The tonsile style* is characterised by vegetable sculpture, such as trees and

shrubs cut into various shapes—arcades, pyramids, arbours, &c. This style can never be united with the picturesque or gardenesque styles, because of its violation of principle in not allowing each plant to develop itself naturally.

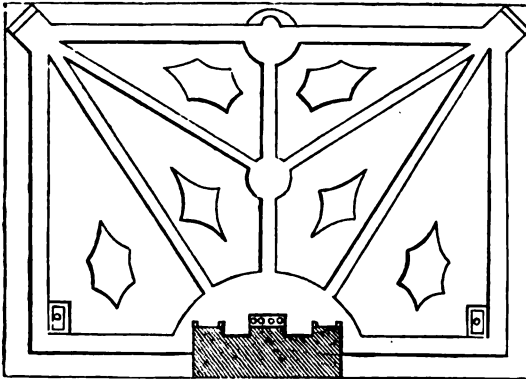
*The geometric gardenesque style*.—Common as well as exotic trees, shrubs, and plants should be introduced, with architecture, sculpture, &c. This is altogether a mixed style. Terraces form a leading feature in the geometric gardenesque style, whether as platforms, as it were, from which to view the rest of the garden from above, or as being placed above the eye, and ascended by steps. In this respect the geometric style furnishes the artist with the means of variations, surprises, and the concealment of bounds, quite as much as the natural manner, and with this advantage, that it can be effected in less space in the one case than in the other. There are many situations where the ground falls considerably, but this inclination should as far as possible be in one direction. For example, if the mansion stands on an eminence, and the ground slopes from it, no matter how great the fall, a terraced garden, in the geometric gardenesque style, may be with the greatest propriety established. The difference in inclination will give scope for terraced walls and parapets, flights of steps, &c., without the aid or appearance of artificial embankments. As in such cases the terraces should run parallel to each other, it follows that the spaces between should be level, both as regards length and breadth. The length, however, may be broken by steps, but these should be at a considerable distance apart. If the ground falls towards both ends of the garden, these steps should be at equal distances on both sides of the centre, which, if possible, should be the highest. This would resolve the side of a hilly piece of ground into parallel terraces, according in number with the scale of the place; but these terraces should be of sufficient breadth to bear a just proportion to their length.

In regard to mixed styles, we have already remarked that they cannot consistently be indiscriminately employed in the same piece. They may, however, be employed in succession, thus: The Italian style may prevail on the lawn nearest the

house, and may be united by grass terraces in the Dutch style, with the gardenesque first, and that followed by the picturesque. To mix, however, indiscriminately the Italian, tonsile, gardenesque, and picturesque styles, would distract attention, and be destructive of that first of all principles in correct composition—the unity of the whole.

As modifications of the foregoing styles, we may notice the following: Fig. 808

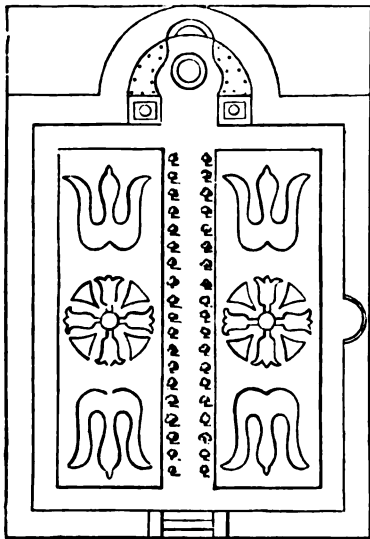
Fig. 808.



represents a Panopticon flower-garden, a style seldom now met with. As will be seen by our cut, it has the walks radiating from the house, cutting the lawn into triangular pieces, on which flower-beds are to be placed as well as basins of water.

Fig. 809 exhibits a specimen of the

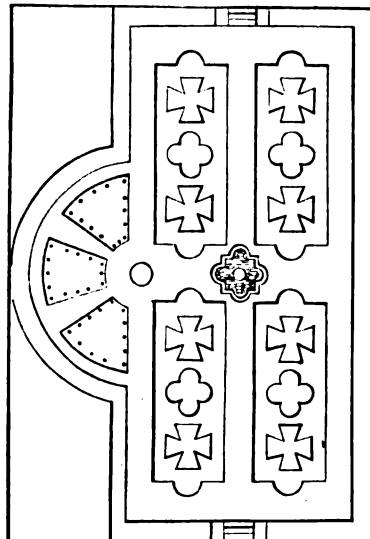
Fig. 809.



Florentine style, 'having a surrounding gravel walk, while the beds are cut out on the grass. It is placed on a raised grass terrace, with an alcove at each side. The spaces are divided into two equal parts by a broad gravel walk, extending from the flight of steps to the basin of water and alcove in the semicircular projection at the farthest end. The Florentine style of architecture was introduced into England about 1544, by John of Padua, who was in that year appointed to the office of deviser of his majesty's buildings. It is probable that the once splendid gardens at Longleat were laid out in this style, and by this artist, as he is known to have built that fine mansion, said to be the earliest specimen of the Italian Florentine style in England. This style prevailed only for a short time, yet many gardens were laid out in it during the period of its existence in England.

Fig. 810 is a design in the Tudor style, and is characterised by its quadrangular form, and by the presence of a foun-

Fig. 810.



tain in the centre, which was deemed indispensable, and associated also with the surrounding buildings, as such gardens were, for the most part, laid out either in the

court-yards or in close proximity with the mansion. The Tudor, or, as it has been called, Henry the Seventh style, from having originated in his reign, had the principal windows looking into the court, both for security, and also because at that period the charms of landscape were little felt. No garden of the Elizabethan age remains; but we have a complete description of one in Sir Francis Bacon's "Essays," written about the end of her reign, from which we learn that the walks and alleys should be spacious, and some set with musk roses, wild thyme, and peppermint, which perfume the air most delightfully when trodden upon. A fountain should occupy the centre. Vases, unless they be turfed and have living plants or bushes set in them, are not to be introduced. The shrubbery is to have a variety of walks finely gravelled, not grass; the borders set with fine flowers, but sparingly; and, at the end, a mound, breast high, from whence to look abroad into the fields.

Flower-gardens in the Stuart style, like the architecture of the same period, differed considerably from the Tudor style, in whimsicality at the least. The terrace in front of the mansion was a novelty at this period, with its stone steps, pedestals, and grotesque balustrades, ascending from the flower-garden to the entrance, and the marble fountain was in the centre of the garden; there were also vases and figures, from the heathen mythology, disposed in different parts. The best example left of this style we know of, is that at Holland House, thus described by Brown as it existed about thirty years ago: "Here is a parterre on the west side of the mansion, beautifully laid out with box edgings, in various scrolls and devices. On the east was once a rosary, of a circular form, now destroyed. A small garden farther west is laid out in the Italian manner: it has a white marble fountain in it, on which water-lilies are floating. Fronting this fountain, on a raised terrace, is a beautiful alcove, and behind it a crescent-formed wall, which has steps at the ends, ornamented with vases, and the wall is overgrown partially with woodbine and China roses." Here the late Lord Holland has written the following distich in honour of Samuel Rogers, the author of

the "Pleasures of Memory," it having been a frequent resort of the poet—

"Here Rogers sat, and here for ever dwell  
To me those pleasures that he sings so well."

Plate XXIV. presents part of this garden as it now exists, which will be understood from the following description: On descending from the broad terrace walk, which bounds the lawn on the south, by the ten-flights of steps at the left-hand corner of the Plate, we enter what is called the embroidered box-garden, which, we should observe, is only a very small portion of the whole flower-garden as now finished at this celebrated place, and which we greatly regret cannot be given upon a scale that would convey an adequate idea of the extent and general arrangement of the whole. In the square recess between these flights of steps, is the small alcove called Rogers' seat, already referred to, where the poet used to spend many happy hours. On each side of the entrance to this alcove are the figures of two foxes in box, cut to the height of about 9 inches. The square they are placed upon is covered with red sand, and margined all round by a narrow border planted with scarlet geraniums kept closely pegged down. The two trees in front are evergreen oaks, clipped into round symmetrical forms; and the two circles beside them are round-headed box shrubs. The octagon figure is a very handsome fountain, and the square figure at the other end of this compartment is a granite pillar, on which is placed a bust of the Emperor Napoleon. This compartment is bounded on three sides by a box hedge 2½ feet in height, within which, on the two opposite sides, is embroidery in dwarf box on a ground of gravel. The narrow borders along the front and semicircular ends of these are planted with scarlet verbenas, as is also the outer border round the figure in the centre, which border is separated from the box embroidery by a narrow border of turf. The circle in the centre of this figure is planted with scarlet geraniums, also margined with turf, while the circle at the end is a basin of water. A yew hedge, 8 feet in height, separates this compartment at the lower end from the shrubs, walks, &c., which constitutes the adjoining parts of the garden.

From the flight of steps to the semi-circular recess at the farther end of the larger compartment, extends a terrace wall, with a border planted with violets, adjoining to which is the larger chain-pattern parterre, the vandykes along the inner side being planted with verbena Tweediana from end to end, while the opposite side is planted with verbena Duke of Cornwall; and the circles, commencing at the end next the flight of steps, with the following verbenas, arranged in the following order—viz., Emperor of China, White Perfection, Robertson's Defiance, Eclipse, Lilac seedling, White Perfection, Heloise, Robertson's Defiance, la Nympe, White Perfection, Morphus, Macrantha, Robertson's Defiance, Lady Holland, St Margaret, White Perfection, Blue Bonnet.

The shorter chain pattern is planted on both sides with verbena Duke of Cornwall, and the circles beginning at the same end as the last with verbenas in the following order—viz., Emperor of China, White Perfection, Robertson's Defiance, Eclipse, Blue Bonnet, White Perfection, St Margaret, Morphus, Robertson's Defiance, Lady Holland, Heloise, White Perfection, St Margaret, Heloise. The diamond borders at the upper corner are planted with Scarlet Geranium Hark-away, Verbena Eclipse, and Geranium Flower of the day.

The small circle marked *a* is planted with yellow calceolarias, the marginal border all round the figure with verbena Melendris superba, this border being separated from the box embroidery within by a narrow border of turf. The circle marked *b* is also planted with yellow calceolarias, having the marginal border of verbena Heloise all round, and a corresponding narrow border of turf as in the last figure. The small circle marked *c* is planted with brown calceolarias, with the narrow marginal border next the diagonal gravel walk with verbena Vulcans superb, while the broader border next to the narrow gravel walk, forming the boundary of this part of the garden, is planted with Calceolaria Amplexicaule. The circle *d* is planted with brown calceolaria, the other arrangement being the same as in the last figure. The elliptical figure *e* is planted with scarlet geraniums, the marginal border all round with verbena Lady of

the Lake. The elliptical figure *f* is planted with scarlet geraniums, and the marginal border all round with verbena White Perfection. The longitudinal border at the right-hand end is margined round with verbena Barleraii, without any grass margin, while the front side of the corresponding one on the opposite side is planted with verbena Duke of Cornwall.

The whole of the groundwork is on gravel, and hence is dry and comfortable to walk on at all seasons. The spaces within the scrolls of box are laid over with sifted coal ashes, while the spaces without the scrolls are laid with red sand. The gravel walks are finished with box edgings.

From these examples it will be seen, that, as architecture improved or altered in style, so to a very great extent did the disposal of the grounds around our best buildings, showing the intimate connection between the two arts, architecture and landscape-gardening.

The following are modifications of the modern style;—

*The trivial picturesque style* should be furnished with the common trees and shrubs of the country on grassy surfaces, neither wild, like the forest glade, nor closely shaven, like the polished lawn.

*The refined picturesque*, shown on Plate XXXIII., should exhibit the rarer of our indigenous trees and shrubs, but chiefly exotic species of both, planted in groups, and occasionally a few solitary ones. The surface should be modelled by art into easy and graceful undulations, slopes, levels, and smooth grass.

*The rough picturesque* is characterised by a surface more or less broken, with as little appearance of artificial arrangement as possible. The vegetable productions should be low shrubs and strong-growing plants interspersed with ferns, the whole having the appearance of the margin of a forest glade, with the shrubs and plants browsed by cattle. Where rocks and rills of water naturally exist, or can be made artificially, they are admissible.

This is a difficult style to execute. The best lesson for the student is to examine closely forest glades, old chalk-pits, sides of unreclaimed declivities, borders of commons in England, and woody highland glens in Scotland.

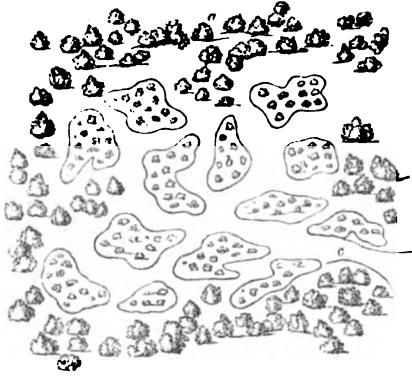
*The pictorial style* consists of moderately



dressed surfaces, either level or undulated, the trees and shrubs being planted and managed so that each may display its natural beauty of outline, whether placed singly or in groups.

And to the modern style we may add the *irregular flower-garden*, fig. 811. This

Fig. 811.



garden is shown as surrounded by an irregular plantation, the front of which should be planted with ornamental trees and masses of shrubs. The beds are of irregular forms, cut out on grass, without much regard to connection with each other. Their centres, when large, are elevated; and when the garden extends over an acre or more space, and the tops of the beds are planted with flowering shrubs, the whole becomes a sort of labyrinth, through which one may wander for hours, seeing only the parts that are within a few yards of the spectator at one and the same time. It should, however, for convenience in damp weather, be surrounded by a gravel walk; and in it no ornaments should appear that are not of the rustic form. This sort of garden is suitable to a residence in the rural Gothic or cottage style; or it may form a termination to some lengthened walk that has already passed through grounds of a very different character. It never should, however, although we often see it do so, be placed near to or within sight of a mansion or villa partaking of architectural character.

*The mingled flower-garden.*—As the name indicates, the plants are disposed in the beds in such a manner, that, while there is no brilliant display of bloom at one

period, there shall be a sprinkling of blossom during the whole season. Instead of the colours being arranged to harmonise or contrast with each other, they are produced promiscuously,—the only order attended to being, arranging the taller plants in the centres or at the back of the beds, while those of more humble growth occupy the margins.

## § 2.—SITUATION OF THE FLOWER-GARDEN.

The flower-garden should always be near to, or adjoining the mansion, that it may be conveniently reached at all times; and, indeed, that it may be seen from the windows of the principal rooms. It is of little consequence on what side of the house it is placed, so long as the carriage entrance front be kept clear. It may, with great propriety, as it often does, surround three parts of the house, (*vide* Plate 31;) and if even on the north front, the advantage will be gained of having the flowers presented to greater advantage to the eye when they are viewed from the windows of the house, the natural tendency of all plants being to have their flowers turned towards the sun. It will, however, be understood that the flower-beds should be sufficiently distant from the house to be beyond the range of its shadow.

The flower-garden should be sheltered from the effects of the wind; yet it should not be shaded by trees. Some authors have recommended that no part of the flower-garden should be exposed, as it offers in itself sufficient to contemplate and admire; and that its character is best preserved and associated with retirement. We, however, think differently, and prefer the garden being placed on one or more sides of the mansion, that it may be seen to advantage from the principal windows and the walks around the house. We here allude to the flower-garden, considered as the finished grounds around the mansion, let the style be what it may; but in retiring from the mansion and entering the shrubbery, flower-gardens of a smaller size and of less pretensions should be found. In such, the lovers of solitude and quiet repose will find those enjoyments associated with

retirement, which can never be sought for in the grand and open garden around the mansion.

In gardening, as well as in other matters, there are often different terms used expressive of the same thing. Hence we have the word pleasure-ground frequently used in common parlance, when a flower-garden, in the gardenesque style, is meant; for such a garden is not confined to the mere plot occupied with flower borders, as would be the case were we speaking of one in the geometrical style. The latter extends not beyond the boundary of its proper enclosure, whereas the other includes the whole ground kept in dressed order, and so far as it extends till united with the park or plantations. The pleasure-ground is thus appropriately enough defined by Mrs Loudon: "A portion of a country residence devoted to ornamental purposes, in contradistinction to those parts which are devoted exclusively to utility or profit, such as the kitchen-garden, the farm, and the park. In modern times, the pleasure-ground consists chiefly of a lawn of smoothly shaven turf, interspersed with beds of flowers, groups of shrubs, scattered trees, and, according to circumstances, with a part of the whole scenes and objects which belong to a pleasure-ground in the ancient style. The main portion of the pleasure-grounds is always placed on that side of the house to which the drawing-room windows open, and it extends in front, and to the right, and to the left more or less, according to the extent of the place; the park, or that part devoted exclusively to pasture and scattered trees, being always on the entrance front. There is no limit either to the pleasure-ground or to the park, and no necessary connection between the size of the house and the size of the pleasure-ground. A small house and a large garden was the wish of the poet Cowley; and the largest parks are sometimes attached to very small houses and pleasure-grounds, and the contrary. A pleasure-ground in the modern time differs from that prevalent at any former period, in including all the scenes and sources of enjoyment and recreation of the ancient style as well as the modern. For example, adjoining the drawing-room front there is a terrace or terraces, with or without an architectural flower garden,

decorated with statues, vases, fountains, and other sculptured and architectural objects. Beyond this, or connected with it to the right and left, there may be a lawn with flowers, shrubs, groups of trees, ponds, lakes, rockwork, summer-houses, or greenhouses, an orangery, and sometimes a botanic garden. Walks may stretch away on either, or on both sides, to a shrubbery which, in the present day, is usually formed into an arboretum, containing all the hardy trees and shrubs which the extent of the scene will admit of; and in the course of the walk through the scene there may be rustic structures, such as wood houses, moss houses, root houses, rock houses, or cyclopean cottages, Swiss cottages, common covered seats, exposed seats of wood or stone, temples, ruins, grottoes, caverns, imitations of ancient buildings; and, in short, there is scarcely an architectural object capable of being rendered ornamental, and a shelter from the sun, the wind, or the rain, which may not find a place."

### § 3.—FLOWER-GARDEN FENCES.

These consist of a variety of materials, all of which should be of the ornamental kind. They are in general intended to be invisible, or, more properly, not acknowledged; as anything like boundary, unless in the architectural style, where terrace walls, parapets, and sometimes hedges, &c., form chief features, should be carefully avoided: hence the introduction of the wire fence, which, according to Sir W. Chambers, has long been used in China. The rustic fence is, in most cases, to be considered as an acknowledged fence, and, when placed in connection with rustic seats, bridges, cottages, &c., forms a part with them in this style of landscape. They, like the architectural walls close to the mansion, should be sparingly clothed with vegetation. They are not placed in either case to serve the purpose of conductors to plants, but to form a part of a whole in connection with surrounding objects, and hence so much taste is required in their construction.

Evergreen hedges are fences of the acknowledged kind, and are indispensable in the tonsile style. They also form a part in most subdivisions of the geometri-

cal style; and when neatly cut, they form, as it were, living walls, and may be panelled so as to resemble those more substantial structures. The piers may be formed by planting a tree of the same evergreen species in front of the line at regular distances; and by allowing it to rise above the determined height, vases or pyramids are thus formed in what may be called vegetable sculpture. For example, a hedge, formed of box or Irish yew, may have its projections formed by planting cypresses, upright junipers, or arbor-vitæ in front, at equal distances. A hedge of dark-green yews may have its projections of golden or silver striped leaved varieties of the same; or a hedge of common holly may have its piers formed by standards of the variegated kinds. For the most massive and lofty description of architectural hedge, no tree is better than the last named.

Where hedges of this description are required to be got speedily up, there is no better plan than to form the ground-work of the wall with strong wire-work, and to cover the whole of the panels with Irish ivy, if upon a large scale; but if in a small garden, with some of the dense-growing and smaller-leaved varieties, and to plant against the piers variegated varieties of corresponding growth. Berceau walks, a remnant of the ancient style, are valuable for shelter, and shutting out objects not wished to be seen. Much, however, of their effect is lost for want of giving them an architectural effect. Instead of the common, round-headed, monotonous, long, uninteresting trellised passages, covered with a heterogeneous mass of climbing plants, few having any relationship with each other, were an architectural character given to the trellis-work, and that divided into panels, with minarets, vases, &c., placed on top of the pilasters, and these planted as we have suggested, a far more striking effect would be produced; and that effect would be heightened, if in accordance with the architectural objects around it.

Such matters were much better understood formerly than at present, when geometrical gardening was more cultivated and appreciated.

In the gardenesque, as well as in the dressed picturesque styles, hedges of various sorts become interesting, if judi-

ciously disposed. Those of Privet, arbor-vitæ, Irish yew, laurustinus, sweet briar, Aucuba japonica, roses, common and Irish whin, Cydonia japonica, &c., are all deserving attention. In the former of these styles, summer hedges may be formed of sweet-peas, nasturtions, hollyhocks, and a variety of similar free-flowing, rapid-growing plants.

#### § 4.—PLANTING WITH A VIEW TO PRODUCE EFFECT.

In regard to planting, it is proper we should say a few words; but these can only be considered as of a very general character, as each style of garden requires a mode of planting almost peculiar to itself. The following, however, apply to all pretty generally, and to some of them in particular.

The highest-growing trees and shrubs should occupy the marginal lines, and the parts next to water and buildings, keeping the lowest nearest to the walks. In detached clumps or beds, plant the highest nearest the centre, so that the mass may assume the pyramid or cone-shape in growing up. Flowering shrubs and plants should be so placed that when the bloom of one is decaying, its adjoining one may be coming into flower, unless in cases where the grouping system is followed, and where the parterre is to be in perfection from the beginning of August till the frost terminates the floral season, which is now a very general desire. Then such plants only should be employed as flower at the same time, and continue in flower till killed by the frost. In regard to shrubs with variegated or coloured foliage, they should not in any case be planted promiscuously, but grouped upon the principles of harmony both as regards form and the tints of their leaves. Bulbs should be planted so as to come into flower in succession, which, from their great variety, if judiciously managed, will keep up a gay display from spring till autumn.

It will be recollected that we have divided flower-gardens into three general heads or classes—namely, geometrical, gardenesque, and pictorial. Each of these requires an order in the disposal of the trees, shrubs, or plants used, peculiar to

itself. In the former, trees disposed in formal lines exhibit as strongly art or design in the contriver, as regular architectural edifices; while, in either of the two latter, they should be disposed in all the variety of groups, masses, thickets, and single trees, in such a manner as to rival the most beautiful scenery of general nature, producing a portion of landscape which will, as it were, unite the comforts and conveniences of civilised life with the superior charm of refined arrangement and natural beauty of expression.

In the geometrical style, trees or shrubs of symmetrical form should be planted in lines, whether straight or curved, at equal distances, not only from each other, but also from those lines that determine the walks, borders, &c. The flowering plants should be grouped according to their kind, form, and colour, each figure in the parterre being filled with the same plant, unless when these parterres are large, when portions of them may be so filled; or in the case of longitudinal ones of considerable size, when three colours may be used in parallel lines, regard being paid, however, to the harmony both of colour and form. It should, however, be borne in mind, that decided colours should be chiefly employed, and that the plants to be used in producing them are limited to few species. In such gardens, variety of plants is to be disregarded; a few well-chosen kinds are all that is required. It is that effect which the harmony or the contrast of colour and form is capable of producing that is here sought to be attained, and that can never be effected by employing a great number of genera and species. The primary colours are three only—red, blue, and yellow; and with these repeated over and over, having the natural colours green in the grass, or white or brown in the gravel used for the walks or ground-work of the design, all small flower-gardens may be completely formed. In the case of larger designs, secondary tints, &c. may be introduced; but these must be so arranged as to harmonise or contrast with the primary colours next to them.

The same rule holds good in the disposal of flowers in the gardenesque style, and it is only in the picturesque, or the sub-varieties of the gardenesque style, that

the indiscriminate mixture of colour and form can be tolerated.

The arrangement of plants, trees, and shrubs in the gardenesque style, as well as in the refined picturesque, is governed by very different laws from those which apply to the symmetrical or geometrical. In the former, it is our aim to produce not only what is called natural beauty, but even higher and more striking beauty of expression than we even see in nature; to create variety and pleasing intricacy by various modes of arrangement; indeed, to give the highest possible degree of elegance and polish to the scene, by introducing rare and exotic species, producing in themselves a character widely different from that which could be produced by any possible arrangement of our own indigenous vegetation.

“As uniformity,” says Downing, an American author on landscape gardening, “and grandeur of single effects, were the aim of the old style of arrangement, so variety and harmony of the whole are the results for which we labour in the modern landscape. And as the avenue or the straight line is the leading form in the geometrical arrangement, so the group is equally the key-note of the modern style. The smallest place, having only three trees, may have them pleasantly connected in a group; and the largest and finest park is only composed of a succession of groups, becoming masses, thickets, woods, &c. If a demesne,” or garden, “with the most beautiful surface and views, has been for some time stiffly and awkwardly planted, it is exceedingly difficult to give it a natural and agreeable air; while some tame level, with scarcely a glimpse of distance, has been rendered lovely by its charming groups of trees. How necessary, therefore, is it in the very outset, that the novice, before he begins to plant, should know how to arrange a tasteful GROUP. Nothing, at first thought, would appear easier than to arrange a few trees or shrubs in the form of a natural and beautiful group; and nothing is easier to the practised hand. Yet experience has taught us that the generality of persons, in commencing their first essays in ornamental planting, almost invariably crowd their trees into a close regular CLUMP, which has a most formal and unsightly appearance, as different as

possible from the easy flowing outline of the group." Clumps are far too stiff, formal, and dense to bear any semblance to nature; and crowded shrubberies, and groups of shrubs in lawns and flower-gardens, are too often liable to the same objection. This often arises from neglect in judicious thinning, even when the original disposal has been the most perfect. Sir Uvedale Price, in his *Essay on the Picturesque*, attacks the clumping system with great vigour, and observes, "Natural groups are full of openings and hollows, of trees advancing before, or retiring behind each other; all productive of intricacy, of variety of deep shadows and brilliant lights. In walking about them, the form changes at every step—new combinations, new lights and shades—new inlets, present themselves in succession. But CLUMPS, like compact bodies of soldiers, resist attacks from all quarters. Examine them in every point of view—walk round them—no opening, no vacancy, no stragglers—but, in the true military character, *ils sont face partout*." In planting, we too often plant too thick, with a view to produce immediate effect; and this is certainly not to be condemned; but too often a total neglect is evinced of timeous thinning, and the whole mass is allowed to grow on, presenting all the while a fair enough exterior appearance so far as verdure is concerned, but completely changed from the light and airy character of the group to the stiff and formal clump. In the formation of groups, care should also be taken so to place them in the garden that they may not stand in too regular or artificial a manner—as one at each corner of a triangle, or other geometrical figure—but so to dispose them as that the whole may exhibit the variety, connection, and pleasing intricacy seen in nature.

In planting, to produce either gardenesque or picturesque effect in their highest order, trees and shrubs of the most graceful habits only should be chosen. Plate XXXII. will illustrate the system of grouping, to produce the beautiful in the gardenesque style; while Plate XXXIII. will show that adapted to the refined picturesque. "It is proper," as is very judiciously remarked by Downing, "that we should here remark, that a distinct species of after-treatment is required for

the two modes. Groups, where the beautiful is aimed at, should be pruned with care, and indeed scarcely at all, except to remedy disease, or to correct a bad form. Above all, the full luxuriance and development of the tree should be encouraged, by good soil and repeated manurings, when necessary; and that most expressively elegant fall and droop of the branches, which so completely denotes the beautiful in trees, should never be warred against by any trimming of the lower branches. In the picturesque style, everything depends on intricacy and irregularity; and grouping, therefore, must often be done in the most irregular manner—rarely, if ever, with single specimens, as every object should seem to connect itself with something else. But most frequently there should be irregular groups, occasionally running into thickets, and always more or less touching each other—trusting to after time for any thinning, should it be necessary."

From what we have thus briefly stated in reference to the two latter styles, it will sufficiently appear that planting, grouping, and culture, to produce the desired effect in the gardenesque style, require much less artistic skill, although much more care and attention, than in producing equally happy effects in the picturesque. The charm produced on the mind on viewing a highly refined and polished garden in the gardenesque style, in which are developed the richness and beauty of high culture, arises from our admiration of the highest perfection, the greatest beauty of form, to which every object in it can be brought.

The kind of trees and shrubs introduced into these three styles of gardens requires consideration, so far as their form and habit is concerned, because they of themselves give expression and character, which, if misplaced, will sadly derange the harmony of effect. Thus trees of fastigate character and symmetry of form are best suited to the geometric style. Hence the cypress, upright or Swedish juniper, Irish yew, &c., in their natural state, are to be employed. In the gardenesque, trees of varied character, but of graceful outlines, are admissible, and amongst them those of drooping or weeping habits; but even those are most effective when planted singly, and on

lawns, or the margins of groups or shrubberies. Their prominent characteristics are gracefulness and elegance suitable to this style of garden, but the reverse when it is desirable to keep up the expression of a wild and highly picturesque character. "When drooping trees are mixed indiscreetly," says Downing, "with other round-headed trees in the composition of groups or masses, much of their individual character is lost, as it depends not so much on the top, as in oblong or spiral trees, as upon the side branches, which are of course concealed by those of the adjoining trees. Drooping trees are, therefore, shown to most advantage on the borders of groups, or the boundaries of plantations. It must not be forgotten, but constantly kept in mind, that all strongly marked trees, like bright colours in pictures, only admit of occasional employment; and that the very object aimed at in introducing them will be defeated, if brought into the lawn in masses, and distributed heedlessly on every side." The forms of trees and shrubs, bearing on the subject before us, are divided into four classes; namely, round-headed (such as the oak and Portugal laurel, &c.) oblong-topped (such as the Lombardy poplar, fastigate oak, Cypress, Irish yew, &c.) spiral-topped (such as many of the pine tribe,) and drooping trees (such as the weeping willow, &c.)

With these for our materials, we should consider the proper method of placing them, so that a harmonious combination of them may be made, so as not to violate the principles of correct taste. On this Downing justly observes: "An indiscriminate mixture of these different forms would, it is evident, produce anything but an agreeable effect. For example, let a person plant together, in a group, three trees of totally opposite forms and expressions—viz., a weeping willow, an oak, and a poplar—and the expression of the whole would be destroyed by the confusion resulting from these discordant forms. On the other hand, the mixture of trees that exactly correspond in these forms—if these forms, as in oblong or drooping trees, are similar—will infallibly create sameness. In order, then, to produce beautiful variety, which shall neither, on the one side, run into confusion, nor,

on the other, verge into monotony, it is requisite to give some little attention to the harmony of form and colour in the composition of trees in artificial plantations. The only rules which we can suggest to govern the planter are these—first, if a certain leading expression is desired in a group of trees, together with as great a variety as possible, such species must be chosen which harmonise with each other in certain leading points. And, secondly, in occasionally intermingling trees of opposite characters, discordance may be prevented, and harmonious expression promoted, by interposing other trees of an intermediate character. In the first case, suppose it is desired to form a group of trees, in which gracefulness must be the leading expression, the willow alone would have the effect; but in groups, willows alone produce sameness. In order, therefore, to give variety, we must choose other trees, which, while they differ from the willow in some particulars, agree in others. The elm has much larger and darker foliage, while it has also a drooping spray; the weeping birch differs in its leaves, but agrees in the pensive flow of its branches; the common birch has few pendant boughs, but resembles in the airy lightness of its leaves; and the three-thorned acacia, though its branches are horizontal, has delicate foliage of nearly the same hue and floating lightness as the willow. Here we have a group of five trees, which are, in the whole, full of gracefulness and variety, while there is nothing in the composition inharmonious to the practised eye. To illustrate the second case, let us suppose a long sweeping outline of maples, birches, and other light mellow-coloured trees, which the improver wishes to vary and break into groups by spiral-topped evergreen trees. It is evident that if these trees were planted in such a manner as to peer abruptly out of the light-coloured foliage of the former trees in dark or almost black masses of tapering verdure, the effect would be by no means so satisfactory and pleasing as if there were a partial transition from the mellow pale green of the maples, &c., to the darker hues of the oak, ash, or beech, and finally, the sombre tint of the evergreens. Thus much for the colouring; and if, in addition to this, oblong-headed trees or

pyramidal trees were also placed near and partly intermingled with the spiral-topped ones, the unity of the whole composition would be still more complete."

From this the gardener will see the propriety of breaking the monotonous appearance of overgrown shrubberies, whose outlines have grown into forms as stiff as if clipped with the garden shears, and whose uniformity of colour is from end to end the same dull green of a huge Portugal laurel. Lightening up such dense and uniform masses by the introduction of trees or shrubs of varied form and diversity of colour will effect much, and he may leave the margins to be dealt with by a judicious use of the pruning-knife.

One fatal mistake has too often been fallen into in planting flower-garden scenery, and even the groups on grass or in dug shrubberies, which is, the desire to possess collections of trees and shrubs more valued for their rarity than for the effect they are capable of producing in landscape. It is vain to expect pictorial beauty by congregating together genera and species, and arranging them upon principles of systematic order. This latter task, laudable as it is, must be developed in an entirely different plan, and that plan is—THE ARBORETUM AND FRUTICETUM.

In laying out flower-gardens so as to produce effect, they ought to be symmetrical—that is, they ought to have a centre, which will appear decided at first sight. All the figures or compartments into which the garden is laid out ought to be so connected with that centre as not to be separable from it, without destroying the general effect of the whole. All the beds ought to have one general character of form and outline. Their size ought also never to differ to such an extent as to give the idea of large and small beds being mixed together; and the general surface ought to be of the same character throughout;—that is, it ought not to be undulated on one side of the centre, and flat on the other. Without uniformity of surface we cannot have symmetry of form in the arrangement; and hence irregular surfaces are the most difficult to manage when the design is to be in any of the modifications of the geometrical style. In the arrangement of the plants in any of these, equal care is

required, so that unity may be preserved throughout.

In planting parterres for general effect, the colours should be so arranged that those which adjoin each other should contrast, and those occupying corresponding parts of the same figure should be the same. If we suppose a bed on one side of the centre to be planted with red flowers, the corresponding bed on the other (the figure being symmetrical) should also be planted with the same kind of red flowers, to insure the preservation of symmetry and contrast.

### § 5.—THE ARBORETUM

Is a comparatively modern designation given to a portion of ornamental planting in parks and pleasure-grounds, and in its general acceptation is understood to be a collection consisting of as many genera, species, and varieties of hardy trees and shrubs as the means or taste of the proprietor leads him to indulge in. The arboretum, as a whole, should contain every tree sufficiently hardy for our climate, and may be planted or arranged according to botanical classification. In this way, however, seldom more than one specimen is allowed to exist in the collection, and all are arranged so that each species with its varieties shall follow immediately next to that to which it is nearest allied. This mode of arrangement, however suitable to the views of the strictly systematic botanist, is exceedingly ill adapted to culture, and much more so to the production of pictorial effect. In the former, each plant must stand in its prescribed place, whether it be a tree of 100 feet or more in altitude—as *Abies excelsa*—or of 3 or 4 feet only, as is the case of one of its twelve varieties—*Abies clanbrasiliana*. The same objection may be urged in other cases, where one species of a genus prefers a light exposed sandy soil, and another of its near allies one of a strong tenacious clay, or probably is by nature a sub-aquatic. One specimen of a species may, from many accidental causes, represent exceedingly ill the true character of its kind; and hence, instead of giving a correct idea of its habit, size, and character, give a very erroneous one. In a pictorial

point of view, trees so arranged never can produce a pleasing effect. In nursery establishments, and strictly botanical gardens, this adherence to systematic arrangement is all very well, as the chief object in the former case is to obtain, at all times, a supply of grafts or cuttings for the purpose of propagation, which could not be so correctly relied upon, did not sufficiently identified specimens exist in the same grounds; and hence, having this object in view, the Messrs Loddige, of Hackney, more than half a century ago, established an arboretum, the first founded upon an extensive scale which appeared in Britain. This laudable example was followed by most of the leading nurserymen in England, and latterly adopted also in Scotland—of which that of Messrs Peter Lawson & Son may be given as a very complete example. In strictly botanical gardens, single specimens of the majority of trees are cultivated for the purpose of botanical study; but the narrow limits to which our gardens of this description are confined, precludes not only the cultivation of a sufficient number of duplicates, but too often does not afford even sufficient space for the true development of individual specimens.

Some of our public gardens have attempted the same thing, with as little effect towards the production of the beautiful as those of more limited space and means: we have only to point to Kensington Gardens for a corroboration of this assertion. There space, diversity of situation, climate, and a nation's purse, were at command; and although now planted many years, few strangers passing through the grounds could recognise the existence of an arboretum, were it not that the eye is so offensively arrested at every step with labels, painted white and lettered in black—giving, it is true, the scientific and English name, native country, and date of introduction of each species, but the labels themselves being of such portentous dimensions as to have no proportion to many of the specimens, and forming in the eye of many the chief attraction. We notice this because of the excellent opportunity which has been thrown away of replanting a noble public garden; which, had it been done upon correct principles, would in after ages have been one of the finest arboretums in

the world. Here there was ample room for displaying good taste, whether the ancient or what is called the modern style were followed; while, at the same time, all that is required or can be expected from the nomenclature of trees and shrubs would have been as completely secured. Of other public arboretums we can speak with as little approbation. It is therefore in private parks, and to the good taste of private individuals, that we are to look for any good exemplification of the kind. A taste for the cultivation of new, rare, or ornamental trees has long existed in this country, as the magnificent grounds of Holkham, Sion, Studley, Woburn, Pains-Hill, &c., bear ample testimony. At one of these places do we find a solitary example *only existing*; nor do they convey to our mind the idea that they were planted in nursery lines, or stuck into the centre of a flower-plot here, or in a snug sheltered corner there; they have been planted in numbers, and in general in situations adapted to them, as may be instanced in the fine weeping willows and deciduous Cypresses by the water's edge at Sion, and the groups of cedars of Lebanon on the elevated knolls at Claremont and Pains-Hill. It is quite evident that no stiff formality or rigid systematic arrangement was thought of by those who planted them, and hence they now form prominent objects in the landscape of the places. But the revival of a taste for the cultivation of new and rare ornamental trees and shrubs has now taken place, for which we are indebted greatly to the late Messrs G. and W. Loddige, as commercial growers, and to the noble encouragement given by the late Duke of Bedford and others, as well as to the energy shown by the London Horticultural Society in procuring seeds from all parts of the world. Many specimens, it is true, were for some years rare and difficult to obtain, and this probably led to the dotting system of planting solitary specimens as they could be procured. The case, however, is now very different; and as abundance of most species can be had in even the majority of provincial nurseries, we see no good reason why they should be so sparingly scattered over the home grounds, and often confined to the precincts of the flower-gar-



den alone. In planting what has in general been denominated arboretums, too much stress has been laid on the term, which properly means a collection of trees and shrubs, without any reference whatever beyond the number of species and varieties of trees it contains, and hence a piece of ground was set apart into which they were congregated together—thus often destroying the amenity of the whole place, forming a patch in the landscape having no connection or harmony with the surrounding parts. In places of less extent the specimens are crowded together, so that before half of them can develop their natural characters, either the other half have to be cut away, or the whole allowed to grow up together, to their universal destruction. An arboretum upon a limited scale can never be ornamental or useful. Upon a grand scale it should be judiciously extended over the whole park, grouping each natural family by themselves, and multiplying the individuals so that each group would not only occupy the situation best adapted to its growth, so far as soil, &c. is concerned, but also the one where it, when completely developed, would fill its proper place in the general features which the situation is capable of producing. There would be no incongruity in planting every exotic oak, hardy enough to stand our climate, in close connection with groves of those indigenous to our own land; and the same may be said of the beech, elm, ash, and indeed every other genus after its kind. From this it will be readily understood that we prefer planting in groups or masses to merely sticking in solitary specimens. These masses should be thinned out as the trees begin to interfere with each other, leaving them at last sufficiently apart that each may have room to show its own natural form and character.

This we consider to be an arboretum of the highest character, as between the larger groups can be placed those families of shrubs which best accord with the larger trees around, forming the natural undergrowth so necessary in pictorial planting. The next mode of arrangement calculated for large places and extensive collections would, in our opinion, be, to group or arrange the natural orders of trees and shrubs along the margins of

already existing plantations, and by the sides of drives, so that the collection would blend with the woods already formed, and at the same time be seen to advantage while riding or driving through them. If these be judiciously placed, and at sufficient distance from the drives, so as at no future time to interfere with them, the surrounding trees can be readily cut away to afford space for their fullest development; and indeed, in cold and exposed situations, this may be advisable, on account of the shelter and protection thus afforded while the trees are young. A third mode of arrangement, where space is more limited, would be to form the arboretum in conjunction with the boundary line of plantation which in general encircles a park or domain; and a fourth, to carry it in a graceful, circuitous manner through the park, as so well exemplified in the grounds at Bicton, near Sidmouth, where Lady Rolle has created one of the most extensive and perfect, if not the most so, of any arboretum existing as yet in Britain. Through this extensive assemblage of trees and shrubs a spacious grass drive passes, from which every tree and shrub can be distinctly seen; and here strict attention has also been paid to scientific arrangement. In this arboretum there are no dug borders crowded with coarse and commonplace annuals and flowering plants, which so much disfigure the grounds in the gardens at Kensington; nor is the eye offended with labels of an unnecessary size, and of a colour of all others the least in association with surrounding objects. The whole rises from a ground surface of well-kept lawn; and the wire-fence, which protects the trees from the ravages of cattle and hares, is so constructed and so arranged as to be scarcely visible—securing protection without the appearance of a boundary line. A fifth method is to dedicate a space on each side of the approach to the mansion of a mile or two in length, and to group the trees and shrubs forming the collection in such a manner that no important objects or views may be shut out, as so well shown in the park at Preston Hall, where the liberality of the proprietor, W. B. Callander, Esq., with the assistance of his intelligent factor, Mr Gorrie, one of our highest authorities in arbori-

cultural science, has shown the first and only example to Scotland how an arboretum under such circumstances can be effectually arranged. Such are the general views we entertain of what arboretums, in the fullest sense of the word, should be.

Such, however, as have not the necessary space at command, or who entertain a partiality for certain natural orders more than for others, we would advise to confine their collections to some of those particular sections, and to render each of them as complete as possible in itself—bearing in mind to choose a section as nearly adapted to the situation and soil as possible. Thus we would have collections of Coniferæ or Pinaceæ, containing the pines, the spruce firs, the silver firs, the larch, the cedars, the arbor-vitææ, the cypresses, the junipers, and their allies; of Corylaceæ or Cupuliferæ, containing the oaks, the beeches, the chestnuts, the hazels, and their allies; of Salicaceæ, containing the willows and the poplars; and so on with other natural groups of trees and shrubs. Each of these might be rendered complete in itself; and if planted in soils and situations adapted to their habits, would in time give us a much better idea of their true characters and value than if planted merely as single specimens, and disposed in systematic order without regard to soil, situation, or association with surrounding objects.

The arboretum, regarded in a utilitarian point of view, is deserving of very serious attention. The taste for its formation has led to the introduction of many trees previously unknown even to botanists; and of these some will, ere many years pass away, supersede in value and national importance many of those upon which we have long placed our whole reliance. It is not, however, in the garden and shrubbery that the relative merits of such trees can be fairly tested; nor is it by the mere cultivation of one or two individual specimens of each, as we have already remarked, that their true characters can be thoroughly determined. Too close an adherence to this rule has retarded rather than advanced our knowledge of their respective value; and it is not until we plant them in numbers, in different soils and situations, more especially as regards exposure and altitude, that we can arrive at any

certain knowledge of their absolute value or utility. It is therefore not in parks of ordinary dimensions, far less in the dressed grounds around the mansion, that these objects are to be attained. A far wider field is necessary; and, combined with this, a greater diversity of circumstances should be taken advantage of. The whole estate offers only the necessary conditions for carrying out this design to its most useful extent. While, however, we throw out these hints to such as have the opportunity of carrying them into execution, we do not wish by any means to deter those possessed of a more limited field from indulging their taste in the cultivation of some of the most curious and interesting of exotic trees. These may be planted through grounds of very limited extent, and with good effect, if planted so as to associate with the trees and plants around them, or to form conspicuous objects of themselves; but under such circumstances, anything like collection, far less systematic arrangement, should be disregarded.

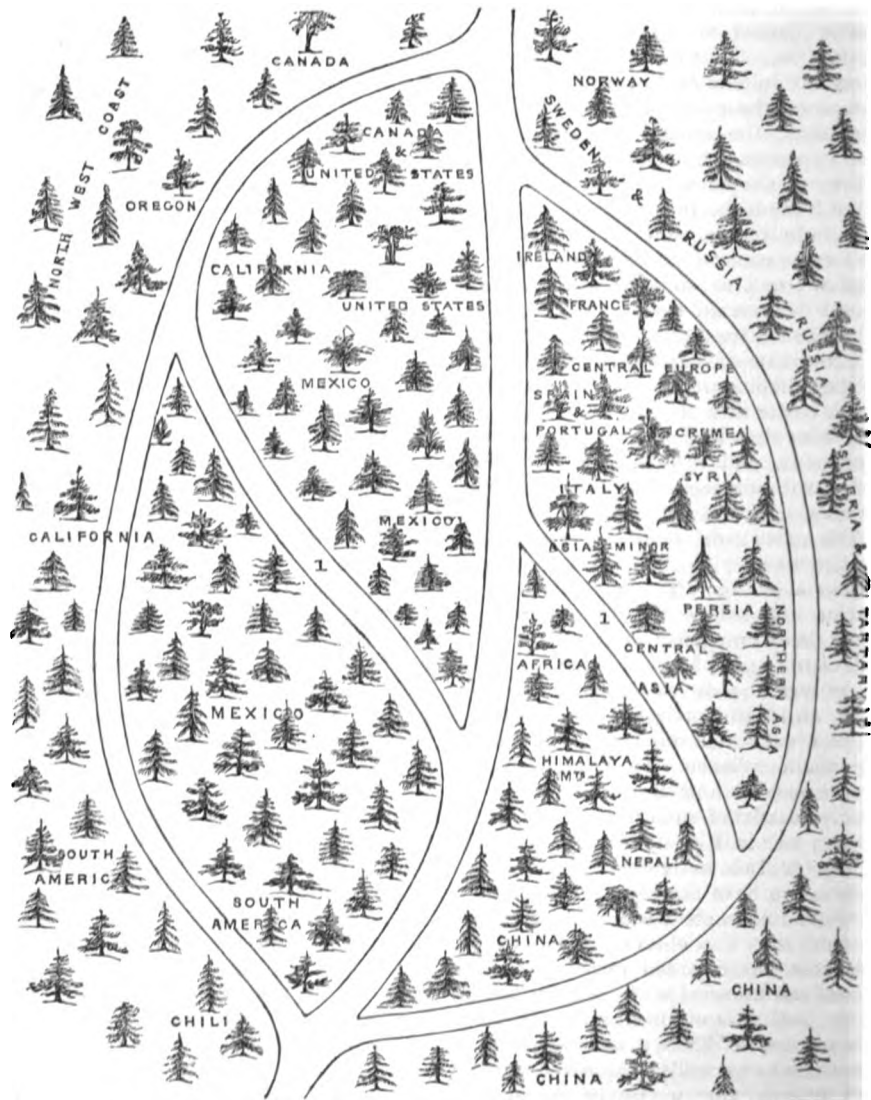
#### § 6.—THE PINETUM.

The pinetum may be considered as a subdivision of the arboretum, which latter is understood to be a collection of all or most of the tree-growing plants sufficiently hardy to withstand the climate of this country. The pinetum, on the other hand, includes only such of those as are arranged in the natural order of coniferæ. Examples of this subdivision are not now uncommon, that at Dropmore being not only the earliest in England, but, we believe, also one of the richest in species; and those of George Patton, Esq., of the Carnies in Perthshire, and Humphrey Graham, Esq., of Belstane, in West Lothian, being the most noted in Scotland. Pinetums, like arboretums, have hitherto chiefly been planted so that the genera and species should follow each other according to the systematic arrangement of botanical science, and almost altogether without regard to the countries from which they come. Indeed this has been too much the rule in regard to the arrangement of all collections of plants. However convenient this mode of classification may be in the compila-

tion of catalogues of plants, or in the arrangement of dried specimens in a herbarium, there is little doubt that it is, of all others, the least fitted for the purposes of cultivation. Geographical arrangement has hitherto been almost disregarded. The only instance we know of was pointed out to us some years ago by the Messrs Vander Mallen, of Brussels, who had then a very extensive collection of hardy plants arranged according to their geographical distribution. The

same thing was hinted at by the indefatigable Loudon, but, so far as we are aware, has not been carried into effect until lately, and that by one of the most enlightened and talented horticulturists of the day, Mr Spencer of Bowood, to whom we are indebted for the annexed illustration, fig. 812, of a pinetum recently formed by him for the Marquis of Lansdowne. We regret that want of space prevents our showing on the cut the surrounding grounds without reducing the

Fig. 812.



pinetum to too small a scale. Mr Spencer's reasons for adopting this mode of arrangement are thus stated by himself:—

"The system generally adopted in planting collections of coniferæ has been either a promiscuous one—i. e., arranged according to their height and habit; such, for example, as at Dropmore, Chatsworth, and other places—or botanically, under the several divisions and subdivisions into which this great natural family of plants has been classed by botanists. To those unacquainted with botanical distinctions, this latter plan is liable to confuse parties wishing to examine the conifera of any particular country, (which I consider by far the most important feature in studying their general character,) who are thus necessarily obliged to examine, perhaps, the greater part of a collection without even then satisfying themselves that all the particular species have been brought under their notice; whilst the former method, though admirable as regards effect, is liable to all the objections I have raised against the latter.

"By the arrangement I have proposed, I flatter myself that the whole of the different species at present introduced may be planted so as to attain their ultimate size and character, and yet show at a glance what plants of this tribe are indigenous to any particular country. Thus, for instance, the plan presents two great divisions, comprising smaller groups. I propose one of these divisions to be appropriated to those species indigenous to Europe and Asia. If we thus commence at one end with the coniferæ of Western Europe, and proceed in the direction of Russia into Asia, we shall comprise the coniferæ of Northern and Central Europe; while a second line, passing through Spain, Italy, and Greece, will embrace those species which are natives of Southern Europe, and carry us to Asia Minor, where several of the European kinds abound, being indigenous to both shores of the Mediterranean.

"It is only in the more temperate parts of Asia that coniferous plants abound, inhabiting chiefly the great mountain ranges intersecting Asia from the shores of the Caspian and Black seas to China. The coniferæ of Europe will thus be succeeded by the Syrian and Caucasian species, and these in their turn by the Himalayan

and varieties from Central Asia, the division ending with the cryptomaria and other coniferæ of Northern China and Japan.

"The African species are unimportant, the principal one being a cedar from Mount Atlas and Barbary. This, with one or two pinuses, &c., might form a small group by themselves.

"The second division I propose to devote entirely to the species from North and South America, beginning with those from Canada, and passing through the States of North America to Mexico; while a second group will comprise those indigenous to Columbia, California, and the north-west coast, ending, as above, with the Mexican coniferæ, and the araucaria of Chili and Peru.

"The Australasian coniferæ, though magnificent, and highly important in an economical point of view, are too tender to bear the winters of this country without protection.

"It will be seen, by the above arrangement, that the hardy coniferæ of the Old World will occupy one side of the centre walk, and those from America the other, and will thus be brought in contrast with each other, and the particular species of any country or countries may be examined and compared with facility.

"One of the central groups I propose devoting to the Himalayan species, and the corresponding one to the principal Mexican species; thus the *Cedrus deodara*, *Pinus excelsa*, the equally large *Cupressus torulosa* and the cedar of Lebanon, with others representing the more characteristic species of the Old World, will be placed in immediate contrast with the gigantic taxodiums, *Pinus Lambertiana*, and the smaller, though more beautiful, long-leaved kinds from Mexico and California. These, with the new *Cupressus macrocarpa*, (which equals the cedars of Asia in size,) will show the difference in the coniferæ of both hemispheres."

The piece of ground now occupied as a pinetum at Bowood was formerly an orchard and nursery-ground, surrounded by an irregular belt of forest trees, with an undergrowth of evergreens. The whole is surrounded by the lawn, and at various points the belt on the side next the lawn contains some fine cedars of Lebanon, red cedars, pinasters, and other ornamental trees. The space enclosed by the wire-fence is about 6 acres.

The trees in the pinetum are shown much thicker on the plan than they are intended ultimately to be. From two to three, and in many cases considerably more, duplicates are planted to produce immediate effect. These may be removed as they grow up. There is room for one of each of the larger growing ones, and more of the smaller, to attain their full size, and these duplicates are planted with a view to such removals at a subsequent time. It is not as yet finally determined whether the clothing of the ground between the trees should be grass, kept close with the scythe, or planted with native heaths, ferns, and very low-growing shrubs, in imitation of wild scenery. Either of these will make a very good finish, particularly the latter; and in the hands of a person of such taste as Mr Spencer, we have no doubt but that the whole will be finished in a most creditable and effective manner.

#### § 7.—EDGINGS.

Much of the beauty of all gardens, whether ornamental or useful, depends on the neatness and high keeping of the edgings; for however well the groups may be laid out, however neat the borders may be formed or kept, and however gay and well arranged the plants in them may be, if the edgings are blanky, uneven, or have a ragged appearance, the garden will at once be felt to be in bad keeping.

Edgings in flower-gardens may be denominated marginal lines, their use being to separate the walks from the flower-borders, and also to define clearly the forms of the beds or subdivisions. They are formed of various materials, of which, in highly-finished and well-kept gardens, dwarf box, thin pavement, or Welsh slate set on edge, hard-burnt fire-clay bricks or tiles, cast-iron, plain or ornamental wirework, and boarding, are of all others the best. Dwarf box has long been in use; and when kept frequently transplanted or neatly clipped, is the best of all living edgings. Its advantages are—harmonising with the plants which it surrounds—its capability of being arranged in lines, however tortuous—and its bearing the operation of clipping, if done judiciously, with impunity. Its disadvantages are—

the exhausting of the soil in the beds—the labour and expense of clipping—and the difficulty of relaying it, in intricate patterns, when it becomes blanky or exhausted by age. Thin pavement, 1 inch in thickness, set on edge, polished on both sides above the ground, and also on the top, if of such a durable and non-absorbing nature as Caithness pavement or Welsh slate, is of all others the best; but neither are easily adapted to circular or acutely-curved lines. These, cut in lengths of from 3 to 6 or 7 feet, and 12 inches broad, if laid so as to rest on bricks placed at their joinings, and the ground made good on both sides, will seldom become displaced. If the walk be narrow—say from 2 to 3 feet—they should only rise 1 inch above the walk-level; if 6 feet broad, 2 inches, and not more than 3 inches for walks of the greatest breadth. Their thickness should be regulated in the same proportion.

Hard-burnt fire-clay bricks and tiles, of various sizes and forms, are also used, and are, on account of their being in short lengths, better adapted for circular and curved lines than the former. The expense of both is much the same, but the durability of the latter is inferior. Very elegant and durable edgings of slate have been manufactured by Mr Edward Beck, of Isleworth, for his own garden. Where curves occur, and circular or elliptical figures are introduced, the slate is cut into narrow pieces, having a dove-tailed groove cut in their edges of connection, into which melted lead is poured, which keeps the whole edging together, and is so strong as scarcely to be pulled asunder. The slate is about  $\frac{1}{2}$ -inch thick, and from 6 to 8 inches in depth.

Cast and malleable iron are of more recent application. Their durability, if kept regularly painted, and the facility with which they can be formed to suit all sorts of lines, together with their light appearance, will no doubt bring them into more general use. They need not be above 3 inches broad, and may be of considerable lengths, having palms wrought upon their under-sides, which, being let a foot or 18 inches into the ground, will keep them firmly in their proper places. In architectural gardens, where the walks may be laid with pavement, metallic edgings must be so formed

as to present a thickness above the surface of the walk of from half an inch to an inch and a half, according to the breadth of the walk and the style of architecture adopted.

Wirework edgings are better fitted to walks in the gardenesque style than to those in the geometrical, as they want the appearance of substance and proportion to associate with the materials around them.

Various kinds of cements and asphalts have been recommended for such purposes; and some of the latter, when slightly heated, become sufficiently flexible to be bent into circular or curved lines. The only evil is their liability to be affected by the weather.

Oak boarding has long been employed for edgings, and for temporary purposes answers as well as any; but its liability to decay renders it unfit for such purposes in gardens of the highest order.

#### § 8.—THE RESERVE FLOWER-GARDEN.

The utility of such a garden in places where flower-gardening is carried out to the fullest extent, is so very great that all acquainted with the management of such establishments will concur with us in urging the formation of such an appendage; for without it the principal flower-garden can never be maintained in proper order. The use of a reserve flower-garden is to contain a supply of plants that can be taken up and planted in the place of those which have ceased to be ornamental or desirable. The reserve ground should, in regard to extent, bear some relation to the extent and the character of the garden it is intended to supply. The smallest residences should have a few square yards of reserve ground; and, for flower-gardening of great extent, there should be a considerable extent of pits, both heated and cold, and the fourth of an acre or more of ground.

In this reserve-ground the various operations of propagating should be carried on; and in it should be kept a sufficient duplicate stock of every plant or shrub that may be required for making up the deficiencies as they occur in the principal garden. For this purpose, unless for heaths, American plants, and the like,

which prefer a peaty soil, but from the multiplicity of their roots are capable of being removed at all times, the soil should be of rather a loamy nature, that it may adhere better to the roots of the plants about to be transferred to the flower borders. It would be well also to grow a large portion of geraniums and similar plants in pots plunged in the ground, as they are found to flower better when so treated than when planted out in the free soil. Many flower-garden plants, such as verbenas, &c., should be rooted in half-decayed moss, refuse flax-dressings, or the like, as they root freely in such media; and, as it is capable of being cut into square pieces with a sharp knife, or of being separated by the hand, their removal will be effected with certainty and with little trouble. Many annuals, perennials, trailing plants, &c., that would not remove easily, might be grown in square or triangular earthenware pans, or sown on pieces of broad or narrow strips of turf, and taken up and plunged when required. We prefer those forms of pans to round ones, because they fit closer together, and are better adapted to fill figures in the geometrical style. No flower-garden can be properly maintained without a reserve-ground, and the nearer it is situated to the principal garden the better; but it should be completely shut out from it. There are many genera of herbaceous plants that, if extensively grown in such a garden, could be taken up and transferred to the borders of the flower-garden just as they are coming into flower. Thus the whole tribe of hepaticas, many of the dwarf-growing campanulas, phloxes, gentians, &c., might be so treated. The great dependence should, however, be placed on plants grown in pots. It is not, however, by growing such things in dozens that all requirements are to be answered—they must be grown by thousands, and even to such an extent that a parterre stripped of its decayed inhabitants in the morning may be again filled up and completed by the afternoon. To such an extent do the Chinese carry this department, that it is no unusual thing to find a garden that is, to all appearance, perfect in the evening, completely changed in its character and contents when seen the next morning.

Ranges of low pits heated by hot water

are valuable for preserving tender plants during winter, as well as for propagating during early spring. Pits without heat, but covered with glass, are indispensable for a similar purpose, and even more so for hardening off those propagated in greater heat; while pits covered with felt or semi-transparent thin canvass, are also indispensable for the purpose of still farther hardening them off and rendering them fit for final transplantation. A great mistake often fallen into, and which is frequently the result of the want of sufficient accommodation, is the practice of planting out flower-garden plants when too small, imperfectly rooted, and also when not sufficiently hardened to stand the cold and evaporating winds of spring. The most satisfactory mode is to bestow sufficient pains on their culture under glass, and to have the plants large previous to turning them out. This is to be effected by frequent shifting and giving abundance of room during their preparatory growth, principles of culture by far too much neglected.

#### § 9.—DISPOSAL OF THE GROUND.

In former times, when the symmetrical style of laying out ground was the prevailing fashion, much expense and great labour were incurred in reducing the ground to the required levels, slopes, &c. In the modern style this is much less regarded; indeed, undulation and variety of surface are elements sought for, and when not found to exist naturally they are created artificially. Around the mansion in the symmetrical style is found the spacious terrace, of a length and breadth proportionate to the building, and forming, as it were, the base line on which the structure stands, furnished with its appropriate accessories, and uniting the house and grounds so as to form a perfect whole, the ground falling in successive terraces, or upon a gentle and uniform incline, until it unites with the park or surrounding plantations. Gardens so arranged cannot fail, viewed from whatever point, to impress us with the idea of finish and a union of parts. "The eye, instead of witnessing the sudden termination of the architecture at the base of the house, where the lawn com-

mences as suddenly, will be at once struck with the increased variety and richness imparted to the whole scene by the addition of the architectural and garden decorations. The mind is led gradually down from the house, with its projecting porch or piazzas, to the surrounding terrace crowned with its beautiful vases, and from thence to the architectural flower-garden, interspersed with similar ornaments. The various play of light afforded by these sculptured forms on the terrace, the projections and recesses of the parapet, with here and there some climbing plants luxuriantly enwreathing it, throwing out the mural objects in greater relief, and connecting them pleasantly with the verdant turf beneath; the still further rambling off of vases, &c., into the brilliant flower-garden, which, through these ornaments, maintains an avowed connection with the architecture of the house—all this, we think cannot be denied, forms a rich setting to the architecture, and unites agreeably the forms of surrounding nature with the more regular and uniform outlines of the building. The effect will not be less pleasing if viewed from another point—viz., the terrace, or from the apartments of the house itself. From either of these points the various objects enumerated will form a rich foreground to the pleasure-grounds or park, a matter which painters well know how to imitate, as a landscape is incomplete and unsatisfactory to them, however beautiful the middle and distant points, unless there are some strongly marked objects in the foreground."—DOWNING.

In fine, the intervention of these elegant accompaniments to our houses prevents us, as the late Mr Hope observes in "Essay on Ornamental Gardening," "from launching at once from the threshold of the symmetrical mansion, in the most abrupt manner, into a scene wholly composed of the most unsymmetrical and desultory forms of mere nature, which are totally out of character with the mansion, whatever may be its style of architecture and finishing."

It is, however, in connection with mansions or villas of a somewhat superior style that the decorated terrace can be brought into this close approximation; but the terrace itself, in so far as it is

confined to a raised dry platform around the house, is a suitable and appropriate appendage to every dwelling, of whatever class.

*Terracing the ground* around a mansion requires great calculation on the part of the designer, so that each part may bear a correct proportion to that immediately adjoining it, and the whole, when finished, may bear the stamp of symmetry as much as the building with which it is associated. This mode of operating also involves a considerable expense, much of which may be saved by judicious arrangements; but this can only be ascertained upon the spot, by taking a correct section through the ground to be operated upon, arranging the breadth and depth of each terrace so as to cause the least removal of soil and the least expenditure in the retaining-walls. Le Blond describes terraces as of three kinds: the first constructed by making the one above the other, separating them, and supporting them by retaining-walls, all of which that are above the ground line should be faced with ashlar and surmounted with ballustrading, &c.; the second supporting themselves without walls, by means of banks and slopes cut at each end of every terrace, or such as we denominate grass terraces; the third having no terraces in straight lines, "but to contrive landing-places or rests at several heights, and easy ascents and flights of steps for communication, with counter-terraces, volutes, rolls, banks, and slopes of grass, placed and disposed with symmetry." These are called amphitheatres, and are by far the most magnificent, the second the most simple and least expensive, while the third hold a medium position between the other two. Terraces, Le Blond observes, should not "be made too frequent, nor too near one another, and, by means of levels or flats, should continue as long as the ground will permit, to avoid the defect of heaping terrace upon terrace,—there being nothing more disagreeable in a garden than to be constantly going up hill and down hill, finding scarcely any resting-place." The breadth of terraces, as of straight walks, should bear a proportion to their lengths. The angle of elevation, or slope of grass terraces, is given from two-thirds of their height to forming the base equal to their

height. The batter given to walls should be in proportion to their height; for very high walls, allow one-fifth or one-sixth part, or say 2 inches in a foot; for walls from 15 to 20 feet high, one-eighth part; from 12 to 15 feet, one-ninth part; and for walls of 6 or 7 feet in height, one-twelfth part. The thickness should be in proportion to their height and the nature of the ground. Stairs should be placed opposite to leading walks, and be of easy ascent, and the steps as few as possible. Their number should be unequal, and should never exceed eleven or thirteen in a flight without a resting step of 6 feet in breadth, and extending the whole length of the stair. Each step should have 15 or 16 inch tread, and a rise of 5 or 6 inches only, including one-fourth of an inch for carrying off the water. Ascents in grass should be as long as convenient, to render them more easy of ascent. Grass steps should never be employed where stone terraces are used; yet stone steps may with propriety be used in grass terraces, but always having their ends enclosed with a stone plinth. Grass steps need not always run square across the ascent, but may be placed in a diagonal direction also.

The disposal of the surface in the gardenesque style requires considerable softening down, if it is naturally irregular and broken. It is not, however, necessary that it be brought to the same degree of evenness and polish as if geometrical figures only were to be drawn upon it: gentle and graceful undulations are one of its characteristics; yet, where beds of uniform outline, such as circles, ovals, &c., are to be employed, the ground should be either level or of uniform inclination.

#### § 9.—HARMONY OF COLOURS.

Great progress has been made of late years in the arrangement of both form and colour in the disposal of our first-rate flower-gardens; the first step to which was, grouping the plants in masses, thereby producing a much grander and more decided effect than the old method of planting them in the promiscuous manner. Grouping also led to a much more judicious taste in the selection of plants; and hence the whole host of weed-like annuals,



of which seldom fewer than a hundred different species were found scattered over even a small garden, gave place to a few, and those of the most decided characters, both as regards form and colour. Indeed, according to the best mode of arrangement now practised, half-a-dozen species are made to produce a far more pleasing effect than half a hundred did in former times. Attempts have even been made, and some progress, it must be admitted, has been effected, in the arrangement of forms and colours, according to what is called scientific or artistic arrangement, with a view to bring out the harmony or contrast of colour in the garden with the same precision as it is exemplified on paper or on canvass. This is a subject much more easily talked of than executed; and this the more so, when we consider that the material at the command of the planter is for ever changing, and that, were it even otherwise, the most perfect picture he could produce to-day is liable to be annihilated to-morrow. A frosty morning, a gale of wind, or a thunder shower, will reduce the labour and conceptions of a season into a chaos of confusion and disappointment. Although in vegetation we have all the shades of colour in the spectrum, still we have not these under our command. The plants which produce them may be of the most opposite characters as to form; they may not flower at precisely the same time, and may not continue in flower for the same period. A colour dies out here; another, intended for a blue, comes up white there. A plant, under ordinary circumstances intended to rise to the height of a foot, from the dryness of the season, or poverty of the soil, may not attain that of 3 inches; while one of the latter height may, in consequence of some favourable circumstance, assume a magnitude of thrice its natural dimensions.

These are a few only of the difficulties that present themselves to even the most judicious planters. There are other circumstances of even a more discouraging aspect which occur in every attempt to produce what is called harmonious colouring in parterres, and that is, the undecided state of taste in different individuals; for what may be looked upon as very beautiful by one, may be considered as diametrically the reverse by another. "Many have fancies and antipa-

thies to peculiar hues. All have their tastes in regard to particular styles of colouring. Some are fond of the gay and lively; some of the rich and powerful; and others of the deep and grave. Some have a partiality for complex arrangements, while others prefer extreme simplicity."—(D. R. HAY, *Laws of Harmonious Colouring*.) Taste is a subject upon which both nations and individuals differ widely; and there are no productions of whatever kind, even should they be somewhat extravagant and absurd, that have not their admirers. Rules, it is true, have been laid down by philosophical writers on chromatics, as to the arrangement of colours, defining, according to their theory, the true principle of harmonious colouring. Of these we may mention Sir Isaac Newton, Field, Buffon, Chevreul, Repton, Owen Jones, D. R. Hay, &c. These gentlemen may be all correct enough as regards the specific subjects to which they have applied their theories; but there is a wide difference, we apprehend, between designing a Manchester print, painting the interior of the Crystal Palace, or the decoration of a saloon or theatre, and the harmonious arrangement of the forms and colours in a garden covering five, ten, or twenty acres of ground. Were there any system of colour harmony authoritatively recognised as of universal application—as applicable equally to the distribution of the tints on the wing of the moth, or the petal of the tulip, and the massing of the colours over great extents of scenery—the case would be different. All that we would have to do then would be to arrange the colours, so far as the thing is practicable with vegetation, conformably to these authoritative and universal laws. But so far from this being the case, even the most limited theories that have been put forth are not authoritative; and the correctness of the principles of some of them are disputed, as regards even the application of them by those who have laid them down. Until, therefore, a greater unity of opinion ensues amongst such authorities as we have named, as to the harmony of colour in our parterres, it would be unwise in us to pin our faith to any of their theories. None of these authorities, so far as we are aware, has practically illustrated his views on the ground; and one of them, who had cer-

tainly by far the greatest experience in the matter, Mr Repton, says—"A beautiful garden is not more defective because it would not look well on canvass, than a didactic poem, because it neither furnishes a subject for the painter or musician."

Were a parterre in form of an arc, or part of a circle, planted with parallel lines of flowers, as near as possible in colour to the seven prismatic colours in the rainbow, its appearance would bear a sorry resemblance to the original. How much more must this harmony be disturbed, when the colours are scattered over a surface of several acres, with large and irregular masses of green lawn, or brown, black, or white gravel intervening! Something approximating this sort of harmony in colours may be effected in one mass, or in the building of a nosegay; but to carry this by repetition over a large surface, would appear extremely monotonous, and would probably afford much less satisfaction than if the whole had been left to the taste of the planter, presuming that he is a person of taste, and of sufficient experience in such matters. Without wishing to depreciate the opinions of others, still we hold that, to arrange the colours in a large flower-garden so that it shall meet the full approbation of the painter, however much it may be desired, is a feat in gardening not likely to be completely realised. That there is room, however, for rendering our gardens more beautiful in respect to the arrangement of colour and forms than they often are, is undeniable; and with such materials as we have at our command, in the shape of plants and flowers, we believe that, in the hands of such men as Mr Beaton, and many others who are actively engaged in this subject, good results will ultimately be brought out. In the present state of our knowledge of the subject, it will be safer to be guided by the practical experience of the intelligent flower-gardener, than to follow the theories laid down by painters, however eminent they may be. The principles inculcated by artists may all be correct enough as regards the specific subject to which they have applied them, but may be of very little importance in planting the flower-garden.

In conformity with the above opinion, we have avoided giving, in our coloured illustrations of flower-gardens, arrange-

ments of colours founded upon any of the theories propounded by the authorities quoted. We have offered those which our own practical experience in such matters suggests to us as at once practicable and agreeable to the generality of tastes, and by such tastes we are willing to be judged.

It may not, however, be uninteresting—nay, we deem it right, to glance briefly at a few of the theories laid down, because this subject is at present engrossing very general attention; but, at the same time, we do not hold ourselves responsible for the correctness of those opinions.

The two first leading authorities on the subject of colour were Sir Isaac Newton and Field. The views of the former were followed by Sir David Brewster and other philosophical writers on chromatics; and their theory was, that there were seven simple or homogeneous colours employed to produce the white solar light. The theory of the latter was, that three only were required—namely, red, yellow, and blue, and that all others resulted from them. To this theory Sir David Brewster eventually became a convert, and it seems now adopted by most writers on colouring connected with the fine arts.

The following experiment, made by M. Buffon, and since illustrated by men of science, is given in confirmation of this theory: "If we look steadily for a considerable time upon a spot of a given colour, placed on a white or black ground, it will appear surrounded by a border of another colour. And this colour will uniformly be found to be that which makes up the triad; for if the spot be red, the border will be green, which is composed of blue and yellow; if blue, the border will be orange, composed of yellow and red; and if yellow, the border will be purple, making, in all cases, a triunity of the three colours, called by artists homogeneous." From these three primary colours, by proper combination, every variety of tint or hue is said to be produced.

"From the combination of the three primary colours," D. R. Hay observes, "the secondary arise. These are, orange, which is composed of yellow and red, in the proportion of three to five; purple, which is composed of red and blue, in the proportion of five to eight; and green,

composed of yellow and blue, in the proportion of three to eight. These are called accidental or contrasting colours to the primaries, with which they produce harmony in opposition, in the same manner in which it is effected in music by accompaniment;—the orange with the blue, the purple with the yellow, and the green with the red. This neutralising or compensating power is the foundation of all agreement and harmony amongst colours, and upon it depends all the brilliancy and force of every conception.

“From the combination of these secondaries arise the tertiaries, which are also three in number, as follows: Olive, from the mixture of the purple and green; citron, from the mixture of the green and orange; and russet, from the mixture of the orange and purple. These three colours, however, like the compounds produced by their admixture, may be reckoned under the general denomination of neutral hues, as they are all formed by a mixture of the same ingredients—the three primaries, which always, less or more, neutralise each other in triunity. These tertiaries, however, stand in the same relation to the secondaries that the secondaries do to the primaries—olive to orange, citron to purple, and russet to green; and their proportions will be found to be in the same accordance, and neutralising each other integrally as 32. Out of the tertiaries arise a series of other colours, such as brown, marone, slate, &c. in an incalculable gradation, until they arrive at a perfect neutrality in black.”

A proper arrangement, according to the principles of harmony, is more easily arrived at than an arrangement by contrast, at least so far as the full effect which it is possible to produce is concerned. An arrangement by contrast is perhaps more striking at first sight, and hence so popular, when the study of the effect is not fully entered into.

As a practical rule in planting parterres, the most intense colours should be placed in the centre, gradually softening down towards the margin of the bed or the sides of the garden. Hence, bright scarlet make the best centres, and whites the best margins.

In a leading article in the *Gardeners' Chronicle*, the following explanation of M. Chevreul's views is given as they apply

to the *contrast* of colours, as laid down in his interesting work, *De la Loi du Contrast simultane des Couleurs* :—

“Every ray of white light is composed of a certain number of red, yellow, and blue rays, combined in certain proportions. Red, yellow, and blue, are called *simple colours*; other colours, being produced by a combination of two or all of these, are called *compound colours*. When white light falls upon any surface, it is either wholly absorbed, wholly reflected, or partly absorbed and partly reflected, by that surface. In the first case, the surface looks black; in the second, white; and in the third, it takes the colour of the reflected ray or rays. In the last case, it is evident that the effect of the absorbed and of the reflected rays, if combined, would be the reproduction of white light. Now, this property, possessed by rays of different colours—or, in other words, by different colours—of producing, when combined in certain proportions, white light, is expressed by saying that such rays or such colours are *complementary* the one to the other.

“Thus, we say that

Red	is complementary to	green,	and	<i>vice versa</i> .
Orange	”	blue	”	”
Greenish yellow	”	violet	”	”
Indigo	”	orange yellow	”	”

Because red and green, orange and blue, greenish yellow and violet, indigo and orange yellow, produce white light by their respective combinations.

“By the *simultaneous contrast of colours* is meant the effect produced on the eye by two different coloured bodies placed side by side. By *contrast of tone* is meant the modification in depth, or intensity of colour; and by *contrast of colour*, the modification in the optical composition of each contrasted colour.

“The first great point to remember with regard to this subject is, that whenever the eye perceives at the same time two substances, differing from each other in appearance, it sees them as dissimilar as possible, both as regards their optical composition, and the depth or tone of their colour.

“With respect to the tone or intensity of colour, it is universally true, that if two colours of different intensities, or if two portions of one and the same colour,

differing only in intensity, be placed side by side, the light colour appears lighter, and the dark one darker by the contrast ; and the difference is greatest where the contrast is strongest, and least where it is weakest ; or, in other words, the difference is greatest about the line of contact, and grows less and less as we recede therefrom.

“ As to contrast of colour, it is found by experiment, and it may also be proved by *a priori* reasoning, that, whenever the eye regards two or more different colours at one and the same time, the colour of each is so modified, that it appears by the contrast to be of that colour which would be produced by the addition of itself to the complementary colours of its neighbours ; and this modification is, as above, greatest where the contrast is strongest, and least where that is the weakest.

“ When colours that are as nearly as possible complementary to each other are contrasted, the colour of each is rendered more intense, or its tone is deepened. This follows immediately from the general principle last laid down, and is fully confirmed by experiment. Colours, when contrasted with white, are deepened in tone, and, at the same time, appear more brilliant, the white itself being tinged very slightly with the complementary of the contrasted colour. Contrasted with black, colours appear of a higher tone or less intense, and the black is feebly tinged with the complementary of the contrasted colour. Grey, being intermediate between black and white, produces an intermediate effect on colours with which it is contrasted. This is seen in the following results, obtained by placing different colours in contact with a grey ground :—

“ *Red and Grey.*—The grey appears greenish, in consequence of its receiving the complementary of red ; the red appears purer—less orange-coloured perhaps.

“ *Orange and Grey.*—The grey appears bluish ; the orange purer—more brilliant, and perhaps a little yellower.

“ *Yellow and Grey.*—The grey is tinged violet ; the yellow appears more brilliant, and, at the same time, less green.

“ *Green and Grey.*—The grey is reddish ; the green is more brilliant, perhaps yellower.

“ *Blue and Grey.*—The grey is tinged with orange ; the blue appears more brilliant, and a little greenish.

“ *Indigo and Grey.*—As the last.

“ *Violet and Grey.*—The grey becomes yellowish ; the violet purer and less dull.

“ When two compound colours, having one and the same simple colour common to them both, are contrasted, the common colour loses its effect in a greater or less degree. For example, take orange (composed of *yellow* and red) and green (composed of *yellow* and blue)—their common colour (*yellow*) being lost by the contrast, the orange appears redder, and the green more blue.

“ When a compound colour is contrasted with one of its own elementary or simple colours, the compound colour loses that which is common to both, and the simple colour is modified by receiving the complementary of the compound colour with which it is contrasted. Thus, with orange, composed of *yellow* and red, and pure red, the orange loses some of its red, and appears yellower ; whilst the red, receiving the complementary of the orange, (namely, blue, as has been already shown,) appears bluish.

“ If two simple colours are contrasted, we find that the general principle before laid down still holds good. If we contrast, for example—first, *red and yellow*, it will be found that the red appears tinged with purple, and the yellow with green, because violet, the complementary of yellow, is added to the red, and green, the complementary of red, to the yellow ; second, *red and blue*—the red has a tendency to become orange, and the blue, green, because orange, the complementary of blue, is added to the red, and green, the complementary of red, to the blue ; third, *yellow and blue*—the yellow has an orange, and the blue a violet tinge, because orange, the complementary of blue, is added to the yellow, and violet, the complementary of yellow, to the blue.

“ Such are the great principles on which the whole art of combining colours in an agreeable manner depends. Any one, with ordinary powers of thought, and a little practice, can, with a knowledge of the above general facts, tell pretty nearly what effect two or more colours, when contrasted, will produce on each other. He has only to remember that each one appears as if its own colour were added to the complementaries of its neighbours ; he has only to recollect what those complementaries are, and then, by his reason alone, he can tell what effect ought to be produced. Whether such

effect will be pleasing or not is another question ; that is a matter of taste, and is governed by the laws of the harmony of colours, which will be afterwards explained."

On the subject of contrast we find the following simple rule laid down by an anonymous contributor to the "Gardeners' Journal":—

*"Contrast of Colour.*—The rule in this case is always to put one of the primitive colours—red, blue, or yellow—next another of these colours, or some other colour formed by compounding the other two. In bedding plants, wherever a handsome plant of the colour required cannot be obtained for any of the particular beds, white, or some neutral tint, should be employed as a substitute. For example—If one bed is planted with red, the adjacent ones may be filled with blue or yellow, or any colour composed of a mixture of these ; but a colour containing red in its combination ought not to be brought into contiguity if it can be avoided. If none of these hues can be employed, green, brown, or white, might be used, but not purple, as it is well perceived that red enters into its composition. So of the other primary colours : where blue occurs, purple must not come in contact, being partly composed of blue ; but yellow, or red, or any combination of these, or any neutral tints, may be used. So of yellow. If contrast be the object, the same rule will hold good with respect to the secondary colours, formed by the admixture of the primary ones. Thus purple should always come next to yellow, but never next blue, red-brown, or red : it may also be contrasted by olive brown or white. Orange does not look well near yellow or red, and black must not approach blue or pink. In this way contrast may be kept up, bearing in mind that a primary colour, and any hues formed by its agency, ought not to come in immediate contact."

Some artists attach a much greater value to the tertiary and secondary colours than to the primary ones ; and so far as the employment of them in the arrangement of flower-gardens is concerned, this may be judicious, because the primary or positive colours are found to exist rather sparingly in nature, while

the softened and subdued tints greatly prevail. "The eye," says Moore, (in "The Principles of Colour applied to Decorative Art,") "is less exerted or fatigued by small than by large masses of positive colour ; consequently, the smaller the object the more positive may be the tint ; and in viewing small objects, it is difficult to shut out of view the surrounding hues which act in support and relief of the positive colours." From this the planter of the parterre should bear in mind not to indulge in the use of any of the three primary or positive colours alone in his largest masses, but to combine them with others of the same class, or substitute some of the more subdued tints ; while, however, he may employ the former in his smallest beds. "We find the general combinations or arrangements of colours in nature beneficially adapted to the requirements of human vision ; and the great painters of the middle ages, having discovered the principals, have applied them in the works which now command the admiration of mankind. It appears, therefore, that if the principles found in nature, and adopted in the works of the greatest colourists, are correct, we should use the tertiary, quaternary, and neutral hues, for the greatest quantities, and reserve the primary and secondary positive colours to heighten the effect, or attract the attention to the points of interest." The reviewer of this work, in "The Gardeners' Journal," very justly remarks : "In gardens we often see a clump of dark sombre-looking evergreens, encircled with a formal bed of scarlet pelargoniums, or some bright yellow or white flowers, which, instead of having the desired effect of making the mass look gay and cheerful, give it a harsh and unnatural appearance ; but if we employ the brightest or yellow flowers sparingly, and with the tertiaries and neutrals, purple, puce, auburn, &c., blend and soften them into the sombre tints of the evergreens, and the surrounding landscapes, they will become part and parcel of the whole, and produce a brighter and more pleasing picture than if they were scattered about at random."

So early as the year 1806 we find that the attention of the late Mr Loudon was directed to the harmony of colours in flower-garden arrangements ; and this was,

we believe, the first attempt made by the landscape-gardener to produce that harmony so very necessary in the disposal of plants. Mr Loudon states, that he "had observed that flower-gardens looked best when the flowers were so arranged as to have a compound colour next the simple one which was not contained in it. Thus, as there are only three simple colours—blue, red, and yellow—he advises that purple flowers, which are composed of blue and red, should have yellow next them; that orange flowers, which are composed of red and yellow, should be contrasted with blue; and that green flowers, which are composed of blue and yellow, should be relieved by red. He accounts for this on the principle that three parts are required to make a perfect whole; and he compares the union of the three primitive colours formed in this manner with the common chord in music—an idea which has since been wrought out by several able writers."

A Mr M'Donald, a London artist, residing in Berners Street, at a somewhat early period purposed an arrangement of flowers according to these colours, either in gardens or bouquets; but whether prior to Mr Loudon or not, we have not the means of ascertaining. Mr Richard Payne Knight, so early as 1794, in "The Principles of Taste," observes that, "when many sorts and varieties of flowers are skilfully arranged and combined, as in the flower-pots of Vanhuysen, they form perhaps the most perfect spectacle of mere sensual beauty that is anywhere to be found." But we do not think he referred to the effects of floral beauty beyond its application to bouquets, as suggested to him by the paintings of that celebrated artist. Vanhuysen, in arranging his flowers, almost invariably placed the brightest colours in the centre of his groups, the tints gradually decreasing in intensity of colour from that centre to the edges. A glance at his lovely productions on canvass will show that he employed one prevailing colour, with a view, no doubt, of preventing his groups appearing patchy or spotty.

The harmonious arrangement of colours is most essential in geometrical gardens, where all is laid down, as it were, with mathematical precision. The least disproportion in size of any of the parts, the

least departure from straight or parallel lines, destroys the harmony of the design; and if harmony in the arrangement of colours be not aimed at, and fully attained, the effect, even to very superficial observers, will be anything but pleasing or satisfactory.

In following out the principles laid down by M. Chevreul regarding the contrast of colours, the editor of "The Gardeners' Chronicle" thus proceeds in regard to their harmony: "We shall point out the results which have been obtained by placing different colours in juxtaposition, and shall notice what combinations are most generally agreeable, and what disagreeable, to the eye. It must, however, be observed that, with respect to the present subject, allowance must be made for differences in taste, and that, of two combinations nearly alike, one may please one person most, and the other another. The following propositions, however, are allowed to be almost universally correct by persons of cultivated taste, and who have made the harmony of colours their special study:—

"1. The complementary arrangement is superior to any other for harmony of contrast. To produce the best effect, the colours should be as nearly as possible of the same tone. White comes in best in the complementary arrangement of blue and orange, and worst in a combination of yellow and violet.

"2. The simple colours, red, yellow, and blue, combined in pairs, go together better than one simple colour and one binary colour containing that simple one. For example—

Red and yellow harmonise better than red and orange.			
Red and blue	"	"	red and violet.
Yellow and red	"	"	yellow and orange.
Yellow and blue	"	"	yellow and green.
Blue and red	"	"	blue and violet.
Blue and yellow	"	"	blue and green.

"3. In an arrangement of one simple colour with a binary colour containing the simple one, the brighter the latter is, when compared with the former, the better the contrast. Or, in other words, in arrangements of this sort, the tone or intensity of the simple colour ought to be lower than that of the binary colour. For example—

Red and violet contrast better than blue and violet.			
Yellow and orange	"	"	red and orange.
Yellow and green	"	"	blue and green.

"4. When two colours harmonise badly, they had better be separated by something white.

"5. Black never produces a bad effect when combined with two bright colours. In such cases, indeed, it is often better than white, especially when separating the one colour from the other. For example, black produces a harmony of contrast with the following binary arrangements—viz., red and orange, red and yellow, orange and yellow, orange and green, yellow and green.

"6. Black associated with dark colours, such as blue and violet, or with bright colours with a deep tone, produces harmonies which often have a good effect. For example, an arrangement of black, blue, and violet is better than one of white, blue, violet, white, &c.,—the latter being too violent.

"7. Black with two colours, one bright and the other dark, is not so good as when the two colours are both bright; and in the first case, the brighter one of the colours, the worse the effect produced.

"Thus, in the following arrangements black is inferior to white:—

Red and blue.	Yellow and blue.
Red and violet.	Green and blue.
Orange and blue.	Green and violet.
Orange and violet.	

"Lastly, with yellow and violet, if not inferior to white, black, at all events, produces but a middling effect.

"8. Grey with two luminous colours, though it perhaps does not produce a decidedly bad effect, makes the arrangement look flat, and is inferior to black or white. With red and orange, perhaps, grey may be better than white, but it is inferior to it, as well as to black, when placed with red and green, red and yellow, orange and yellow, orange and green, or yellow and green; it is also inferior to white with yellow and blue.

"9. Grey associated with dark colours, such as blue and violet, and with bright colours of a deep tone, does not produce so good an effect as black in the same cases. If the colours do not look well when together, it is better to separate them.

"10. Grey and two colours, one bright and the other dark, is better than white, if the latter produces a contrast of too deep

a tone—and better than black, if the latter increases the proportion of dark colours too much. For example, grey is better than black with

Green and violet.  
Green and blue.  
Orange and violet.

"11. When two colours harmonise badly, they had better be separated by white, black, or grey; but, in so doing, attention must be paid to the tone of the colours, and to the proportion of light and dark colours. For example, as to the tone of the colours, the effect of white with red and orange is lessened in proportion as their tones are deepened.

"Black, on the contrary, does very well with the same colours at their normal tone; that is, when, without containing any black, they are as intense as possible.

"Lastly, grey is not so good as black with red and orange, nor does it produce so violent a contrast as white.

"Then, again, with regard to the proportion of light and dark colours, whenever the colours differ too much, either in their tone or by the brilliancy of the black or white associated with them, the arrangement in which each of the two colours is separated by black or by white, is preferable to that in which the black or the white separates each couple of colours.

"Thus the arrangement, white, blue, white, violet, &c., is better than the arrangement, white, blue, violet, white, &c.; so black, red, black, orange, black, &c., is better than black, red, orange, black, &c."

The following diagrams are given by Mrs Merrifield in her excellent essay on "The Harmony of Colours as exemplified in the Exhibition," and may be studied with great advantage by the flower-gardener. The following arrangement, somewhat on the principle of the rainbow or prism, has a happy effect, viz. :—

Deep crimson.	Mixed.	Geranium.	Red.	Orange.	Yellow.	Green.	Blue.	Violet.	Dull red.	Grey.	Mulberry.
---------------	--------	-----------	------	---------	---------	--------	-------	---------	-----------	-------	-----------

"As an instance of defective arrangement, the following may be given:—

Dark blue.
Scarlet.
Green.
Buff.
Violet.
Green.
Pea-green.
Black.
Dark green.
Scarlet.
Blue.
Scarlet.
Violet.
Orange.
Cool green.
Brown.
Salmon.
Sea-green.
Blue.
Black.

“Here,” the talented authoress remarks, “we have black, dark blue, and sea-green in succession, sapphire blue between two scarlets, pea-green between black and blue—all unpleasant combinations of co-

lour. The dark and light colours are arranged indiscriminately, without any regard to effect.”

“The following arrangements of the same colours will be found more agreeable :—

Dark blue.
Orange.
Sapphire blue.
Black.
Green.
Dark brown.
Scarlet.
Pea-green.
Violet.
Salmon.
Black.
Sea-green.
Scarlet.
Dark green.
Buff.
Violet.
Green.
Scarlet.
Dark blue.

“In this arrangement, the dark and the brilliant colours, such as orange and scarlet, occur at regular intervals, all the inharmonious contrasts of the last diagram are avoided, and the colours are arranged, as nearly as the materials will admit, according to the laws of contrast : light and dark blue are opposed to orange, scarlet is contrasted with green, and green with violet.”

“In pictorial arrangement, variety of colour is obtained by the introduction of different hues of the same colour, and of different degrees of brightness. For example, although it is proper to repeat certain colours—as red, for instance—it

is not necessary that all the reds in a picture should be a bright vermilion colour ; on the contrary, the picture will gain in beauty if one should be of a dull earthy red, another bright red, a third crimson, and so on through all the scale of colour.” This rule will be of assistance to gardeners, as it extends the coloured material at their disposal. The principle of repetition is quite in accordance with the laws of harmonious arrangement. The following is an example, the colours used being scarlet, orange, black, white, blue, green, and some of the semi-neutral colours. They may be arranged, with excellent effect, thus :—

Dark blue.
Scarlet.
White.
Black.
Blue.
Brown.
Scarlet.
White.
Black.
Light drab.
Black.
Orange.
Black.
Light drab.
Black.
White.
Black.
Black.
Claret.
Orange.
Grey.
White.
Scarlet.
Dark green.
Crimson.
White.
Dark grey.
Dark red.
Black.

Plate XXVII. is a design for a summer and autumn flower-garden, planted in the grouping manner. Only one-half of the design is shown. In the centre circle a fountain should be placed, with a basin margined with polished ashlar, the sides of which should rise from 9 to 12 inches above the level of the turf. The long, narrow, scarlet scroll-like borders radiating from the centre we would plant with scarlet geraniums, pegged closely down, as also the scarlet middle bed in

those radiating from the corner circles ; and the two triangular ones at the two opposite corners, as well as the large circles forming the base of the radiating figures, we would sow with white candytuft, or any similar white flower. The four small blue circles nearest the centre we would plant with *Salvia patens*—as near the centre of the design the colours should be the most intense. The small yellow beds nearest these small circles should be sown with *Lasthenia Californica*, while the large-



lobed yellow figures should be planted with *Calceolaria amplexicaule*. The outside marginal border, if exceeding 3 feet in breadth, may be planted with any other good light-yellow calceolaria, pegged closely down; but if narrower than that, it may be sown with *Lasthenia Californica*, or, as a marginal line, with *Oxyura chrysanthemoides*, the white eye softening down the colour towards the extremity of the parterre; the centre planted with rose-coloured verbenas; and the outer line of all may be sown with mignonette, or planted with pure white verbenas. The small circles around the margin may be furnished with a vase each, and sown with any pure white plant, such as white rocket candytuft; or, if there are no vases, the beds may be sown with the same. White should occupy the triangular and circular beds of the four corners, as also the angular ones at the base of the lobed yellow beds. Yellow, blue, and red, the three primary colours, will make a good marginal border, and the plants used may be scarlet vervena, *Nemophilla insignis*, and *Lasthenia Californica*, or plants of like dwarf growth and distinctness of colour. The yellow beds in the radiating ones may be *Eschscholtzia Californica*, and the blue beds next them, *Nemophilla insignis*, or any of the medium-growing blue lobelias. The purple beds around the vase-like figure may be sown with purple candytuft, or planted with any of the abundant flowering purple verbenas. The vase-like figure is divided into two parts by a narrow border of grass—the inner portion sown with white rocket candytuft; the outer planted with *Salvia patens*, or sown with *Brachycome iberidifolia*. There are many other flowers of the same colours, and of similar habits, that may be substituted for any or all of these; but with such a collection, and arranged as in our plate, the eye will rest upon the whole with satisfaction.

If this garden be upon a large scale, it will be most effective if cut out entirely on grass; but if of a small size, the borders had better be enclosed with dwarf box-edgings, and the space gravelled between; and if of an intermediate size—that is, when the gravel would too much preponderate—let the borders be margined around with turf verges from 1 to 2 feet in breadth, and the remaining space

be covered with gravel. In either of the latter cases the white in the vase-like figure should be separated from the blue next to it by a margin of grass, and the spaces between the very small yellow beds should be of grass also, as, if the ground be gravel and box-edging only, there would be a deficiency of green in the composition. It will be observed that the most intense colours—namely, scarlet and blue—are here kept towards the centre of the piece; while the more subdued tints—rose, yellow, and lastly, white—form the margin.

There is as much difficulty, and perhaps more, in planting a flower-garden so that the effect shall be pleasing, as there is in painting a landscape upon canvass; not that either the painter or the planter may be deficient in taste, or ignorant of the harmonious arrangement of the materials each has to work with, but the difficulty is in producing a subject that shall be alike pleasing to all. Indeed, this is a point that no man need expect to arrive at until the taste of those who view his performance be exactly assimilated to his own. If there is a rule that can be laid down in regard to the proportions of colour employed in a flower-garden, we think it is that proportion that is pointed out to us by Nature. And the nearer our arrangements in the disposal of those proportions are to hers, so far as regards a garden in the natural or picturesque style, the nearer will we be to perfection. In a geometrical garden, so far as natural arrangement of colour goes, the case is different. The proportions of the colours may be the same as in nature, but their arrangement may be as formal and as striking as the forms of the compartments they occupy themselves are. It is, no doubt, desirable to place the complementary colours as near as can be together; but, in doing this, we have the habit of the plant, its time of flowering, and its duration in flower, to take along with us;—for, to produce anything like a perfect whole, they must flower at the same time, continue in flower for the same period, and all be of consistent habit. The complementary colour of red is green; of orange, blue; of yellow, violet; consequently blue and orange coloured flowers, yellow and violet ones, may be placed together. When the colours do not agree, the interposition of

white flowers or green margins of grass often restores harmony. All that can be attempted in the harmonious arrangement of flowers in a parterre, is an approximation to, and not a perfection of, the principle; for the materials at the disposal of the gardener are much less subservient to his will than the colours in the hands of a painter.

We have given in Plate XXVIII. another specimen showing an arrangement of colours, employing only the three primary ones—red, yellow, and blue—as principals; using the neutral tints, brown and white, only as secondaries where two of the primary colours approximate together. Other neutrals, however, might be substituted for brown and white with equal propriety.

In regard to grouping, small beds should be filled with one colour only, while larger beds may contain three or more;—and these should be arranged in parallel stripes like a ribbon, as shown in the marginal beds; or in concentric circles of unequal breadths, as in the centre bed; or in three or more segments, as in the smaller circles. This latter division into three can only be happily employed when the bed is rather small, say not exceeding 3 or 4 feet in diameter: if larger, it will be better to divide them into six or nine segments or parts, with probably a centre of some neutral colour—as white, brown, &c.

Large circles will always look best when the colours are arranged in concentric lines, as shown in the large circle in the centre of our figure, and two of the smaller ones at the sides, care being taken that the tallest plants occupy the centre of the bed. In the case before us, white might be substituted for brown at the base of the shell-pattern, and either may be extended (providing the figure be not too large) to the full extent of the two lower lobes of the figure shown at present red. The blue in the centre lobe as at present should then be transferred to one of the yellows, and a red colour substituted for it, leaving the figure thus: The three primary colours, yellow, blue, and red, forming the three middle lobes; while

the two under lobes, and the base from which they all proceed, is of a white colour.

In the concentric lines of colour, as well as in longitudinal parallelograms, the breadth of each colour should bear a proportion to the breadth of the bed, the length being immaterial. Thus a circle 20 feet in diameter might have a centre of white, or any other neutral tint, 7 feet across, followed by a yellow zone 6 feet broad, next by a blue 5 feet, and last, by a red 2 feet in width. The same rule applies to ovals or figures of a longitudinal form.

Arrangements of this form are the most striking at first sight, and are probably the best when the parterre is to be seen from a distance above it. It is also the most frequently adopted in what may be called the grouping system. It is also the most easily effected.

The harmonious arrangement of colours in small parterres is a far more intricate and difficult subject, often attempted, but seldom satisfactorily accomplished. This arrangement of colours is best effected in large beds, where the various tints can be blended together in their just proportions, which can seldom be effected in small parterres, particularly if very narrow.

In this example, margins of green grass surround the groups, which, if the garden be upon a large scale, should not be less than 2 feet in breadth, the intermediate space being covered with gravel. If the garden be small, box-edgings should be used instead of verges; but they should not be less than 3 inches in thickness, and cut quite flat on the top, because green is wanted to subdue the colour of the gravel, whatever it may be.

In neither of our coloured Plates have we attempted to exhibit colours exactly according to the formula laid down by painters; for, indeed, this would be a difficult task, seeing how greatly at variance they are with one another; and because we are convinced, also, that had we done so, however well their arrangement might have appeared on paper, they would have produced a very different effect upon the ground.

## CHAPTER XII.

### GEOMETRICAL FLOWER-GARDENS.

#### § 1.—THEIR GENERAL ARRANGEMENT, &c.

THE geometric style is not only the most ancient, but also the most capable of producing, within a given space, far more grand and magnificent effects than any other. It admits of a greater profusion of richly sculptured and highly artistical decorations; and the materials used by the artist in his imitations are different in some medium from those that are presented by nature, by a combination of which he is enabled to produce something which did not before exist. This style commences, in all countries into which it has been introduced, with the civilisation of man; whereas the natural style has only arisen as the whole country became more or less geometrically laid out, by being subdivided by straight lines of fences, hedgerows, canals, and roads, where natural obstructions did not arise to prevent their being carried in straight lines also. While in a country abounding with natural scenery on all sides, the natural style could not possibly occur to the imagination of man—he being, as he is described, an imitative animal—and as it is admitted that all the “productions of the fine arts are arts of imagination, and differ from those of the common arts, or of those which do not address themselves to the imagination, in imitating things in a different medium from that in which they actually exist in nature. Thus the imitation of a landscape by a painter on canvass is a work of imagination, and the production ranks as one of the fine arts; while to imitate it in the actual materials of nature—such as ground, wood, water, rocks, &c.—requires no imagination, but

mere mechanical imitation; and consequently the subject produced has no more claim to be considered as belonging to the fine arts, than an artificial flower made of silk, wax, or paper, and so correctly coloured as to be almost mistaken for nature.”—*Loudon's Review of M. Quatremère de Quincy on the Nature, the End, and the Means of Imitation in the Fine Arts.*

We have elsewhere stated that the Italian style is a species, so to speak, of the geometrical, and, when carried out to its fullest and grandest extent, is perhaps the most imposing of all. The emotions produced on the mind of Sir Uvedale Price, on visiting the gardens of Italy, (although then, as now, greatly fallen into decay,) are thus expressed by him: “Many years have elapsed since I was in Italy, but the impression which the gardens of some of the villas near Rome made upon me is by no means effaced. I remember the rich and magnificent effects of balustrades, fountains, marble basins, and statues, blocks of ancient ruins, with the remains of sculpture, the whole mixed with pines and cypresses. I remember also their effect, both as an accompaniment to the architecture, and as a foreground to the distance. These old gardens were laid out formally—that is, with symmetry and regularity, for they were to accompany what was regular and symmetrical. They were full of decorations, for they were to accompany what was highly ornamental; and their decorations, in order that they might accord with those of the mansion, partook of sculpture and architecture.

“Those who admire undisguised symmetry, when allied with the splendour and magnificence of art, will be most pleased

with such gardens when kept up according to their original design. Those, on the other hand, who may wish for an addition of more varied and picturesque circumstances, will find them in many of those old gardens, wherever they have been neglected; for the same causes which give a picturesque character to buildings, give it also to architectural gardens." It has been the fashion of late years to condemn the ancient or geometrical style, and to laud and hold up the natural or English style as the *beau-ideal* of perfection. The former has been almost rooted out, that the latter might be introduced in its stead; and this too often without due consideration as to local circumstances and situation. If landscape gardening be really an imitative art, the productions of the artist will be most effective where there is a striking contrast between his production and that of the natural scenery which surrounds it. Hence Chatsworth, with its splendid palace and rich Italian and geometric gardens, is well placed, because it has the wildest natural scenery in its vicinity, which acts as a foil or contrast to it; whereas, had the mansion been devoid of architectural pretensions, and the grounds laid out in the natural style, that contrast would have been wanting, and all the power of man would have only produced an imitation, when compared with that of nature around him, truly puerile and ridiculous. For, as Quatremère de Quincy observes, the avowed object of modern landscape-gardening is merely an imitation of nature, in nature's own materials. It attempts nothing more than the repetition of what already exists; whereas, in the ancient or geometric style, nature is not represented in a fac-simile manner; ground, wood, and water, the three natural elements of the art, all undergo a kind of polish or remodelling by the artist's hand, which removes his production farther from nature than those of the modern style, and thus elevates the former above the latter, and ranks it, to a certain extent, as a branch of the fine arts.

Gilpin, one of our best landscape-gardeners, in speaking of the Gothic innovation upon the geometrical style, remarks—"The modern system throws down the walls, terraces, steps, and balustrades at "one fell sweep," and exposes every recess of retirement, every nook of comfort, to

the blast, and to the public gaze; the approach invades the precincts of the garden, which now, in spotty distinctness, is spread over a space cleared of every vestige of intricacy and repose, while a sunk fence excludes the cattle from that lawn which is *apparently* open to them, or the flimsy barrier of an iron hurdle is attached to a building whose ivyed battlements have witnessed the lapse of ages. What compensation, then, does the modern system offer for the destruction of all comfort?" And Sir Uvedale Price, who was himself one of the reformers, and played his part in bringing about the new system, admits his error in having sacrificed an old garden, in his over zeal, and lived to write his own confession of the barbarous act. "I may perhaps," he says, "have spoken more feelingly on this subject, from having done myself what I do condemn in others—destroyed an old-fashioned garden. I have long regretted its destruction. I destroyed it, not from disliking it; on the contrary, it was a sacrifice I made, against my own sensations, to the prevailing opinion."

"No scenery, or object of any kind, can be prized by human nature, without reference to some ideas associated in the mind. Natural scenery, however beautiful, where it is the only scenery of a country, can never be admired by the inhabitants as such, without reference to some ideas already existing in their minds, and which they may have obtained from reading, or from studying the art of sketching landscapes. A country wholly composed of natural scenery, can never exhibit those great contrasts produced by art, which are found in a country where natural scenery prevails, and artificial scenery is only occasionally met with; or in one where artificial scenery abounds, and natural scenery is of rare occurrence. The scenery which is comparatively rare, in either case, whether natural or artificial, will be considered as the most beautiful, and as indicating wealth and refinement in those who possess it. It thus appears that the claim, both of the ancient and modern styles, to be reckoned as fine arts, is entirely relative—not depending on any quality of their own, but on their scarcity or abundance, relatively to the general surface of the country in which they exist.

"It has been observed that, of the two

styles, that which has the greatest claim to be considered a fine art is the geometric manner; but the natural style has also certain claims, which it would be unfair not to notice. The chief of these is the power of selection possessed by the artist, who may imitate scenery of a kind not to be met with in a given locality, and hence, to a certain extent, produce landscapes which could not be confounded with the common landscapes of the country. If he carried this so far as to introduce only exotic trees and shrubs, and at the same time to make every part of the scenes he produced by art in such a manner as that, while they resemble nature, they could never be mistaken for fortuitous productions, he will have gone as far towards rendering landscape-gardening a fine art, as the nature of things renders it possible to do."—LOUDON.

Sir Thomas Dick Lauder, in the introductory observations to his edition of "Price on the Picturesque," remarks—"It was natural that, in the infancy of society, when art was first cultivated, and the attention of mankind was first directed to works of design, such forms would be selected for those arts which were intended to please, as were capable of most strongly expressing the design or skill of the artist." Again, Mr Alison says—"When men first began to consider a garden as a subject capable of beauty, or of bestowing any distinction on its possessor, it was natural that they should render its form as different as possible from that of the country around it; and to mark to the spectator, as strongly as they could, both the design and the labour they had bestowed upon it. Irregular forms, however convenient or agreeable, might still be the production of nature; but forms perfectly regular, and divisions completely uniform, immediately excited the belief of design, and, with this belief, all the admiration which follows the employment of skill, or even of expense. That this principle would naturally lead the first artists in gardening to the production of uniformity, may easily be conceived, as even at present, when so different a system of gardening prevails, the common people universally follow the first system.

"As gardens, however, are both a costly and permanent subject, and are

consequently less liable to the influence of fashion, this taste would not easily be altered, and the principal improvements which they would receive would consist rather in the greater employment of uniformity and expense than in the introduction of any new design. The whole history of antiquity, accordingly, contains not, I believe, a single instance where this character was deviated from in a spot considered solely as a garden; and till within this century, and in this country, it seems not anywhere to have been imagined that a garden was capable of any other beauty than what might arise from utility, and from the display of art and design."

The same authority says—"A garden is a spot surrounding, or contiguous to, a house, and cultivated for the convenience or pleasure of the family. When men first began to ornament such a spot, it was natural that they should do with it as they did with the house to which it was subordinate—viz., by giving it every possible appearance of uniformity, to show that they had bestowed labour and expense on the improvement of it. In the countries that were most proper for gardening, in those distinguished by a fine climate and beautiful scenery, this labour and expense could, in fact, be expressed in no other way than by the production of such uniformity. To imitate the beauty of nature in the small scale of a garden, would have been ridiculous in a country where this beauty was to be found upon the great scale of nature; and for what purpose should they bestow labour or expense, for which every man expects credit, in creating a scene which, as it could be little superior to the general scenery around them, could consequently but partially communicate to the spectator the belief of this labour or this expense having been bestowed. The beauty of landscape nature has sufficiently provided. The beauty, therefore, that was left for man to create, was the beauty of convenience or magnificence, both of them dependent on the employment of art and expense, and both of them best expressed by such forms as immediately signified the employment of such means."

In forming a general comparison between the ancient or geometrical, and the modern or English gardens, Mr Knight

says, "It appears that what constitutes the chief excellence of the old garden, is richness of decoration and effect, and an agreement with the same qualities in architecture as the mansion: its defects are stiffness and formality. The excellences of the modern garden are verdure, undulation of ground, diversity of plants, and a more varied and natural disposition of them than had hitherto been practised; its defects, when considered as accompanying architecture, a uniformity of character too nearly approaching nature; when considered as improved natural scenery, a want of that playful variety of outline, by which beautiful scenes in nature are eminently distinguished."

A departure from the rich and artistic Italian style, which had arrived at great perfection towards the end of the seventeenth century, was forced on this country, strange enough to say, soon afterwards, by a set of political, poetical, and self-interested agitators, who, although vain enough to become partisans in the general demolition, had not sufficient talent of themselves to construct a substitute, but borrowed the ideas of their false conceptions from the Chinese. A love of gardening, as an art of design and taste, must have been at a low ebb about this period; and it is not improbable that the difference in the expense of constructing an Italian garden, and that of one in what has been called the modern, or English style, might have had its share in this crusade, because it suited the poverty and declining taste of the times.

Some, indeed, have gone so far as to assert that we even had not the merit of either borrowing or inventing it. Malacarne, an Italian author of credit, claims the invention of what is now called an English garden for Charles Imanuel, first Duke of Savoy, about the end of the sixteenth century. Warton and Eustace are of opinion that the duke's English garden at Padua gave an idea of an English garden prior to that contained in the description of Paradise by Milton the poet, who, by the way, has also been brought forward as a claimant of this invention. Gabriel Thouin, a name well known in horticultural literature, says that the artist Dufresnoy gave a model of a garden in the natural style so early as the commencement of the last century.

Böttinger even carries us back for the original idea to the description of the grotto of Calypso by Homer, the vale of Tempe by Ælian, and that of Vauclose by Petrarch.

In discussing, however, this subject, we may remark that the advocates, both for the modern, or English, and for the picturesque style, do not confine themselves entirely to the grounds in proximity with the mansion, but include within their range of fancy the whole domain, and much of the surrounding country; so far, indeed, particularly in the latter style, that it is difficult to say where their garden begins, or where it terminates. Sir Uvedale Price, in *Essays on the Picturesque*, remarks—"What appears to me the great defect of modern gardening, in the confined sense, is exactly what has given them their greatest reputation—an affectation of simplicity, of mere nature—a desire of banishing all embellishments of art, where art ought to be employed, and even in some degree displayed." Taking gardening, therefore, in the confined sense above alluded to, we can see no real association between a fine mansion, and even the best imitations of nature artificially created around its very walls. Wherever architecture, even of the simplest kind, is employed in the dwellings of man, art must be manifest; and all artificial objects may certainly admit, and in many instances require, the accompaniments of art. The more magnificent the mansion, and the richer it is in architectural details, the more symmetrical and highly adorned with works of art the garden around it should be.

Every residence of dignity or of architectural pretensions requires accompaniments of a decorative and substantial character, in conformity with the magnitude of the design. Terraces, steps, balustrades, vases, fountains, and other architectural embellishments are a necessary and universal auxiliary to such mansions. Repose and security, as well as every principle of good taste, demand that those should be effectually and distinctly protected by an architectural ornamental parapet wall. The line of demarcation should be unequivocally defined. And Gilpin, on the same subject, says—"I think it agreeable to good taste that a Grecian, Italian, or any other

pile of sufficient character or magnitude, should be separated from the park or pasture by a wall. In cases where this accompaniment is not requisite, or cannot well be applied, I prefer a more solid fence to a flimsy one; and a sunk fence, I hold," he continues, "to be totally irreconcilable to a shadow of taste."

This style of gardening is that in which the shape of the ground, of the beds, of the walks, and even of the shrubs, is regular or symmetrical, such as may be formed on paper by a rule and compass. The ground, if originally flat, is reduced to a general level surface, over which the beds or borders are distributed so as to form figures either simply regular—such as squares and parallelograms—repeated one after another, or squares and parallelograms, and circles and ovals, or other curvilinear figures, so arranged as to be symmetrical; that is to say, that one-half of the figure formed by the whole shall correspond with the other half. When the surface is naturally irregular, or on a slope, it is thrown into different levels, which are joined by steep slopes, called terraces, generally covered with turf, and ascended and descended by stone steps." Here differing from the terrace or architectural style, by the absence of parapet walls, &c. "Each of the levels is laid out either regularly or symmetrically, in the same manner as if the whole were only one bed; but the figures are, of course, smaller. Small trees, or evergreen shrubs, are distributed among the figures, and especially on each side of the main walks; and these trees and shrubs ought, in strict accordance with the style, to be cut or clipped into regular shapes. In modern practice this is generally neglected; and its omission is a defect, for cut trees are as essential to the geometric style, as having the ground cut or shaped into artificial surfaces."—*Ladies' Companion to the Flower-Garden.*

The cutting here meant does not extend to the vagaries of the tonsile style in its extreme points, for vegetable men, monkeys, or peacocks, are not to be thought of; but globose-headed trees, or those of a conical or pyramidal form, only are tolerated; and where the cypress will thrive, and if a little care is taken in training the Irish yew, or Swedish

juniper, the two last will be attained without much artificial effort. As the orange will not stand our climate, Portugal laurels, trained to single stems and globose heads, are very properly used as a substitute; and these are in general planted in lines by the sides of the principal walks, or in the centre of patches of grass, gravel, &c.

The French style of laying out flower-gardens is a modification of the Italian, and was established by Le Notre during the reign of Louis XIV. The great aim of the French artist was to display forms, and lines, and intricate embroidered figures, requiring great skill in transferring them from the plan to the ground. They were originally less intended for growing plants in them, than to show the general design of the figures. Modern improvements in planting flower-gardens, aided by the greater amount of proper materials, arising from the introduction of so many new plants, have nearly overturned that taste, and now we find the most intricate embroidered parterres planted, and the colours of the flowers made to produce the effect which former artists could only imperfectly show, by employing sand, earth, &c., of various shades. The number of plants with which our gardens are now stored supplies us also with those of proper heights and habits. It will readily be understood, that for this style of parterre the plants must be chosen, in height, in proportion to the size of the figure. Plants of the most procumbent habit, and producing the greatest quantity of flowers, are to be preferred. The flatness of the surface is to be relieved by statuary, vases, fastigate growing shrubs, (such as the upright cypress,) or by globose-headed oranges in vases, or their substitute, Portugal laurels, trained to a single stem, and their heads closely pruned.

The French parterre, with its scrolls of box, and its smaller beds covered with various-coloured sand, presented much the same appearance in winter as it did in summer, and was thus more permanent in its effect. This, however, to a great extent, is now considerably modified by planting low-growing flowering plants for a summer covering, having recourse to the sand, in many cases, only before the plants are established in spring, and after

they have ceased to flourish in autumn. The arabesques or scroll-work of box must, however, remain the same. Our present mode of furnishing such parterres is to produce effect during three or four months only, whereas, according to the original design, they remain permanently the same. Notwithstanding the ridicule that has been attempted to be cast on this style of gardening, there is an agreeable association between it, as exemplified in some of our largest and best gardens, and the parterres of summer flowering plants with which it is brought in contrast. This is strikingly exemplified at Drumlanrig Castle, and elsewhere, where both modes are carried out upon an extensive scale. The little flower-garden on the east front of Newbattle Abbey furnishes a good example of embroidered scroll-work brought into contact with beds of flowers.

The French term *parterre* is derived, according to James, in his now rare translation of Le Sieur Alexander le Blond's work, entitled, "The Theory and Practice of Gardening," from the Latin word *partire*; but it seems to have a nearer relation to the Latin compound *par* and *terra*—a level, even piece of ground—and does not even seem to imply any particular decoration or style with which it may be furnished and laid out; in fact, in its most limited sense, it means a division or plot of ground, which with us is in general called the parterre or flower-garden. Parterres are of various kinds, the most simple of all being the bowling-green, and the most elaborate those of curious figures and embroidery; while an intermediate description of them consists in shell and scroll-work, with sand alleys between them.

Sir William Temple has long ago laid down their form and proportions, and observes that an oblong figure is the most proper; and Switzer says the length ought to be "two and a half times greater than the breadth, or something more;" and finds fault with many French designs, (especially those that are in James's work,) as being much too short for their breadth.

The French garden or parterre is described by Mrs Loudon as being formed of "arabesques or scroll-work—or, as the French call it, embroidery of box—with plain spaces of turf or gravel, the turf

prevailing. The box is kept low, and there are but very few parts of the arabesque figures in which flowers or shrubs can be introduced. Those plants that are used are kept in regular shape by cutting or clipping, and little regard is had to flowers—the beauty of these gardens consisting in the figure of the arabesque being kept clear and distinct, and in the pleasing effect produced on the eye by masses of turf, in a country where verdure is rare in the summer season. Those embroidered or arabesque gardens originated in Italy and France, and they are better adapted to warm climates than to England. They are, indeed, chiefly calculated to be seen from the windows of the house, and not for being walked in, like English flower-gardens." Some very good specimens of this style of planting a parterre occur in the flower-gardens at Holland House.—(Vide Plate XXIV.)

These parterres are in general laid out on fine turf—a thing not often met with on the Continent; and in default of that, gravel, sand, or powdered materials of various colours.

We have elsewhere observed that this style became general in France during the luxurious reign of Louis XIV., at which period most of the then known arts of design were much encouraged; at the same time, it is somewhat singular that such a style should have been at all adopted in a country in which turf succeeds so ill, and in which gravel is seldom to be met with. With these two materials it was much better adapted to England; and, therefore, the French gardens laid out in the latter country (few specimens of which now exist) were in their day admitted to be far better kept than those of the country in which the style originated, or rather was in part copied from the Italian, and improved upon by Le Notre. These parterres consisted of turf beds, dug beds edged with box, and embroidered or scroll work, formed chiefly of dwarf box, from a foot or more in breadth, till it gradually tapered to a point at the termination of the scroll—although in some cases it terminated obtusely, according to the figure represented. The broader parts of the dug beds only contained plants, and these were in general of low growth, planted in rows and at equal distances.



Sometimes trees and compact growing shrubs were also admitted; but these, as well as the flowering plants, were subjected to the knife and the shears, so that no plant was allowed to assume its natural character. Even those planted by the sides of the principal walks in lines, or in other places on the grass or gravel, were cut into regular shapes—into balls, cones, or pyramids—but so as never to interfere with the grand object in view—namely, that of showing the entire figure of the parterre at once, as a complete and harmonious whole. Hence all such gardens should be seen from a considerable height above them, and as so completely exemplified, upon a large scale, at such places as Drumlanrig Castle and Holland House.

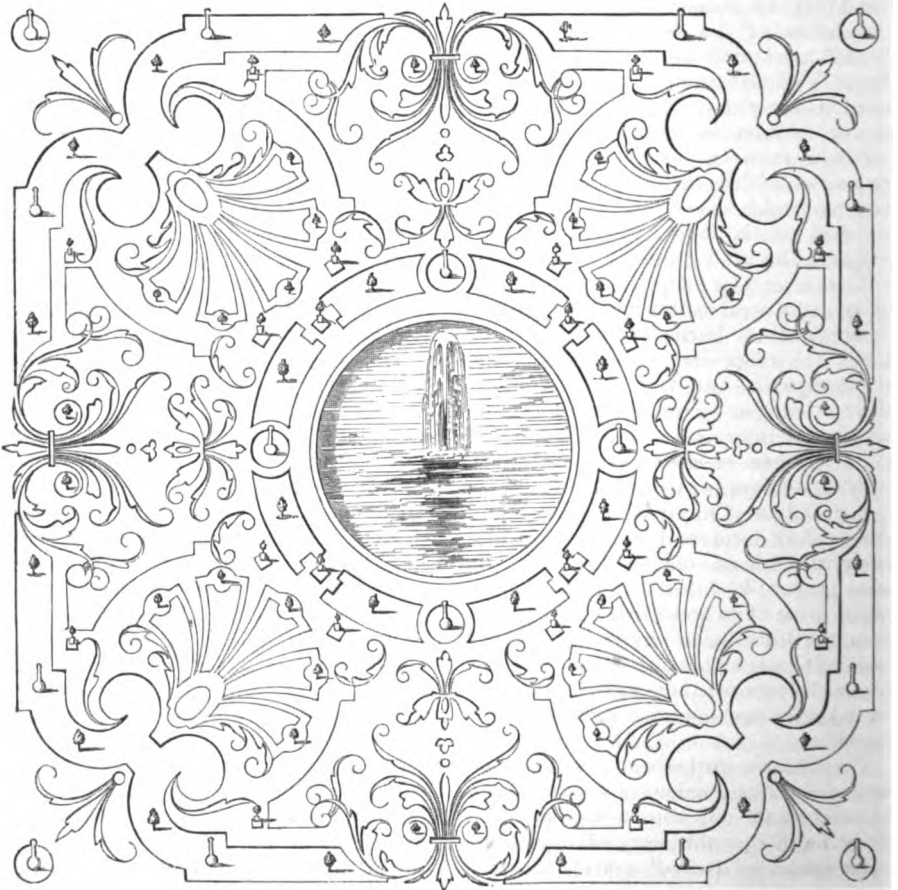
In regard to the boundary of a French garden, it should be, if upon a large scale,

sufficiently enclosed by a phalanx of hedges, which some prefer to architectural walls, gradually rising from front to back, from the height of about 3 feet, to that of 30 or more, according to the space enclosed. These hedges should run parallel to each other, and be graduated in distance from each other by their respective heights, but still so that when viewed from the interior they may not appear as wholly distinct.

In fig. 813, which exemplifies a French garden in the style of Louis XIV., the marginal borders are furnished with upright cypresses and other evergreens, with globose heads, and trained to one stem, and planted alternately. The centre is a basin of water with a fountain.

This garden is laid out in the rich compartment style, and consists, besides the marginal borders and basin, of four

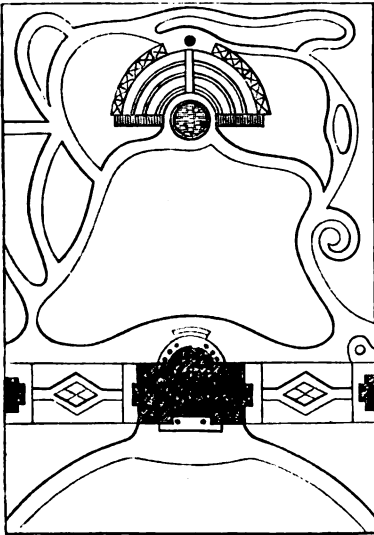
Fig. 813.



rich embroidered scroll patterns in dwarf-box, and shells of grass at the four corners. The whole surface between the beds and embroidery is laid over with gravel or sand of various colours, and edged with lines of box. Around the basin is a border for flowers with yews; and other symmetrical shrubs and vases set on stone plinths are disposed throughout the whole. To adapt this garden somewhat to the prevailing taste, the grass-shell patterns, the outer marginal border, and that around the basin of water, may be transformed into borders for flowers.

Fig. 814 shows a garden in the modern French style, evidently a mixture of the ancient and modern manners.

Fig. 814.



The architectural division of the geometrical style has been more cultivated in England than in France, probably arising from the greater wealth of the former country; though many specimens of great merit existed in the latter towards the close of the reign of its most luxurious monarch, and for some time after his death. Few of these, however, now exist. A taste for architectural gardens is now much cultivated in England, no doubt arising from an increased taste for mansion architecture, which was by no means general in Britain, if we except ecclesiastical buildings, until towards the beginning of the present century.

The architectural style should always adjoin the mansion, and be completely separated from the rest of the grounds, as we have already stated, by an architectural parapet or wall. Its arrangements within should be scrupulously symmetrical, and the walks should be gravel or pavement, not grass, and be margined with stone, earthenware, or metallic edgings.

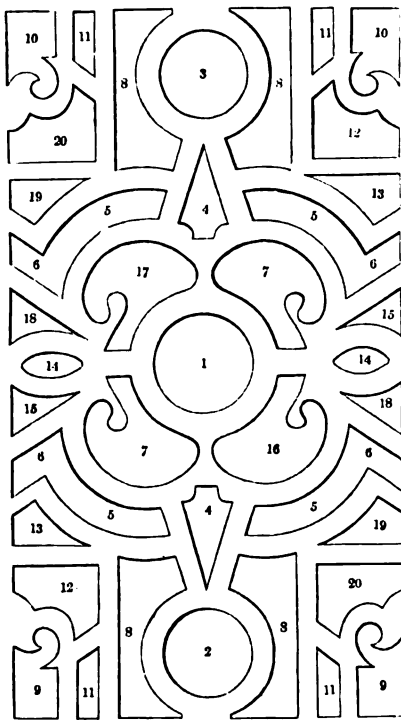
Terrace gardens are merely a species of the architectural style, being formed on one or more levels according to the fall of the ground, and each fall being separated from the other by architectural walls highly enriched with open balustrading, and vases over the piers, &c. They are, perhaps, of all gardens, the most imposing when seen from the highest terrace, or from the balconies or windows of the house. They are also interesting during winter from the abundance of mural decorations, flights of steps, sculpture, and the delineation of the beds, even when denuded of their summer occupants.

We may briefly pass over the Tonsile and Dutch styles, as neither is at all likely to be appreciated in this country; the former on account of the unnatural and grotesque manner of trimming the trees and shrubs in imitation of birds, beasts, and cabinet-work, and the latter for absurdities little inferior. The latter was introduced by King William III., and prevailed in this country for about half a century. It consisted of sloping terraces of grass, regular shapes of land and water formed by art, and quaintly adorned with trees in pots, or planted alternately, and clipped to preserve the most regular symmetry.

Regarding geometrical flower-gardens, we are glad to find Sir Joseph Paxton agreeing with us in opinion, that, "when the disposition of the ground will admit, the French parterre, or geometrical flower-garden, is above all others the most of all to be recommended, because of its readily admitting the greatest variety of flowers throughout the season." The annexed design, fig. 815, was sent to Sir Joseph by Mr Brown, then of the gardens at Stowe, and is calculated for certain situations. "The parterre," Sir Joseph continues, "affords the greatest facilities. Planting in masses produces the most imposing effect; arrangement

of the beds and contrasting of colours is the chief thing to be considered ; succes-

Fig. 815.



sion of plants is also indispensable ; the propagation by cuttings, seeds, &c., and keeping in reserve to turn out when a bed is ready to receive them." The plants

recommended by Mr Brown for this garden are as follows :—

*Plants occupying the beds in spring.*—

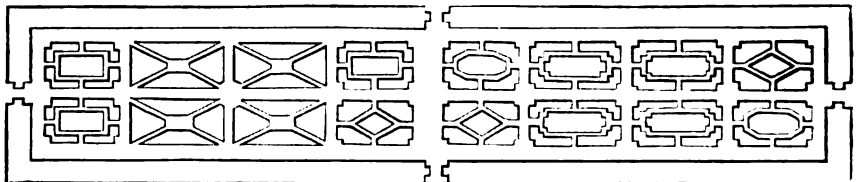
1, Hyacinths, of sorts ; 2 Tulips, of sorts ; 3, Narcissus, of sorts ; 4, Violas, of sorts, standard roses ; 5, Crocuses, of sorts ; 6, Violas, of sorts ; 7, Herbaceous plants and roses ; 8, Hyacinths, of sorts ; 9, Ranunculuses, of sorts ; 10, Anemones, of sorts ; 11, *Mathiola annua*, scarlet and purple, turned out of pots ; 12, Herbaceous plants and annuals ; 13, *Mathiola annua*, scarlet and purple, turned out of pots ; 14, Violas of sorts, standard roses in the centre ; 15, *Oenothera macrocarpa* ; 16, *Ranunculus*, bordered with snowdrops ; 17, Tulips, bordered with snowdrops ; 18, *Mathiola annua*, scarlet and purple, turned out of pots.

*Plants in summer and autumn.*—1, Choice

dahlias, of sorts ; 2, do., do. ; 3, do., do. ; 4, *Verbena melandris*, standard rose ; 5, *Calceolarias*, of sorts ; 6, *Fuchsia gracilis*, and *microphylla* ; 7, Herbaceous plants and roses ; 8, *Heliotropium peruvianum*, and scarlet *pelargoniums* ; 9, *Salvia fulgens* and *splendens* ; 10, *Salvia fulgens* and *involucrata* ; 11, *Lobelia erinus* and *nanus*, standard rose ; 12, Herbaceous plants and annuals ; 13, *Mathiola annua*, sown in spring ; 14, Violas, of sorts, standard rose in the centre ; 15, *Oenothera macrocarpa* ; 16, *Campanula pyramidalis*, and *Lobelia fulgens*, mixed ; 17, *Campanula persicifolia* and *Lobelia splendens* ; 18, *Mathiola annua*, scarlet and purple, sown in spring.

The following design, fig. 816, is by Mr Smith, of Snelston Hall, Derbyshire,

Fig. 816.



and is published with the following remarks in the "Magazine of Botany": "It would agree with any modern building ; but there is something of antiquity about it which corresponds better with a Gothic structure ; and when well enriched with flowers and other curiosities, it renders the parterre exceedingly pleasant to the sight. The one here shown has gravel

walks and box edgings, and would answer well if the beds were planted in masses ; but it is stocked chiefly with about 600 species of herbaceous plants. By this mixture of planting, without farther trouble, there is a successional show of flowers the whole year ; and, in addition, the vacancies are sown in the spring with some of the best annuals, chiefly of a

minor character. The herbaceous plants are chiefly hardy, yet they require some degree of shelter from the north winds, and protection from the mischief of hares and rabbits. Any light wire-fence or trellising answers for protection, and likewise for the support of climbing plants. On the outer side of the guard, a second fence or screen would be useful, and highly ornamental, if composed of evergreen shrubs, and planted alternately with rhododendrons, cypress, and magnolias, &c."

The flower-garden in front of the house at Trentham was laid out from designs of Charles Barry, Esq., who greatly altered and improved the mansion. It is in the Italian-terraced style; but the situation, from being so low, has not been favourable for carrying out this principle. We have seen this garden, and consider it an excellent specimen of a style which we greatly admire, not only in design, but also in the high state of keeping so conspicuously shown in every department under Mr Fleming's management. The following very judicious critique upon it is by an anonymous correspondent of "The Gardeners' Chronicle;" and as it is in accordance with our own ideas, we give it in full:—

"The planting and grouping of the various masses are managed with the utmost skill. Each group contrasted admirably with its neighbour, not only in colour, but in proportion of growth,—a point of quite as much importance as colour in a garden of this kind. Nothing can tend so much to destroy what may be termed unity of expression in a geometrical garden, as the misapplication of plants, causing them to present to the eye the whole thing out of balance. It creates an unsatisfactory feeling, and robs us of that pleasing sensation which proportion, either in architectural or geometrical gardens, always produces. One of the chief ornaments of a garden of this kind is sculpture, which enriches by its classic contrast the entire scene; indeed, no garden in this style, of any pretensions whatever, is worthy of the name without the aid of this kindred art. Mere bald or empty geometrical figures in winter require something to warm them up, something on which the mind can repose with satisfaction. At Trentham these sculpture ornaments are not wanting. Some of them

are figures of pure white Italian marble, bearing the impress of no mean chisel; and the good taste which so abundantly predominates at this fine establishment has distributed them with the very best effect." When the flowering season is past, the beds are not left naked and bare; "the flowers are supplanted by dwarf evergreens, native heaths, &c., which keep up during winter both character and interest, and contrast admirably with the figures, vases, therms, and other ornamental statuary. The fountains in the flower-garden, as may readily be supposed, are of a simple kind. The plain *jets d'eau* will always supersede spinning-wheels, globes, convolvuluses, &c., and are also always in better taste. There are few things so badly managed in this country as fountains. This does not consist so much in their application as in the contrivances which are brought into play to effect the work, which are anything but chaste, natural, and appropriate."

Orange trees, in highly ornamental boxes or vases, are used to embellish the finest Italian gardens; but as these, from the coldness of our climate, are excluded from our gardens, excepting for a few months in summer, and even this only in the most favoured situations, the Portugal laurel is used here as a substitute. These are arranged in lines along the margins of the principal walks; and from being selected with tall straight stems, a character easily given them by their being grown in closely-planted shrubberies and carefully pruned up, their heads are shaped into globular forms, and being closely pruned, not clipped, can scarcely be recognised at a little distance from the orange. The laurel has also an advantage over the orange; for, being hardy, they give a refreshing air to the garden during winter. The boxes in which they are grown may be without bottoms, to allow the roots to extend into the natural soil below, which, by giving them greater vigour, will, at the same time, keep them in a healthy and green state.

This splendid garden extends over a space of between five and six acres. It is laid out in the parallel style, of which figs. 817 and 818 are examples, (but not of any part of the garden in question,) the general surface of the beds at Trentham being from 3 to 4 feet below the

Fig. 817.

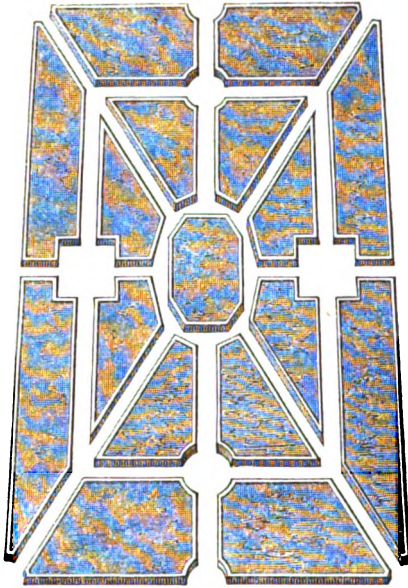
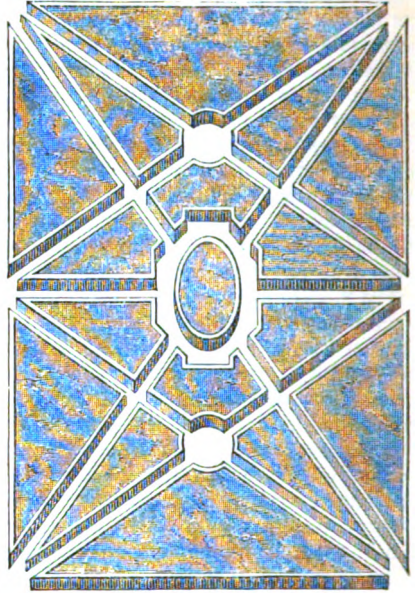


Fig. 818.

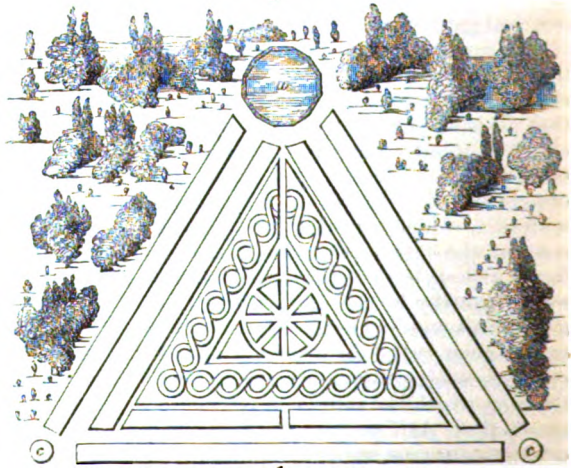


level of the broad and straight gravel walks. The beds in which the flowers and shrubs are planted are elevated in the centre from 9 to 12 inches, in proportion to their respective sizes. The principal walk, of great breadth, extends down the middle, from the centre of the garden front of the mansion, to the extremity towards the lake, where it terminates, and joins another principal walk which surrounds the whole. These elevated walks are in correct keeping with the Italian style; and from them the whole plan of the garden and the rich display of flowering plants are seen as upon a map.

Fig. 819 is an example of a triangular garden, placed either in front of the house or by the side of a broad walk running parallel to its base *b*. The broad walks are grass, to unite with the lawn, which surrounds it on two sides; the narrow walks are of gravel, with box edgings. *a* is a basin of water, with or without a fountain. This basin is multangular, the surface of the water being 1 foot above the surface of the ground, and it is surrounded with a polished

stone plinth or margin, on the top of which small vases may be placed. The pedestals *c c* are for two vases of proportionate size. In planting this garden, harmony of colour will be produced by the small circular beds in the chain-pattern being planted with yellow calceolarias, the scroll with scarlet verbenas, and the margin with *Nemophylla insignis*. The angular divisions in the centre, of which there are eight, are to be planted with blue and yellow alternately, but

Fig. 819.



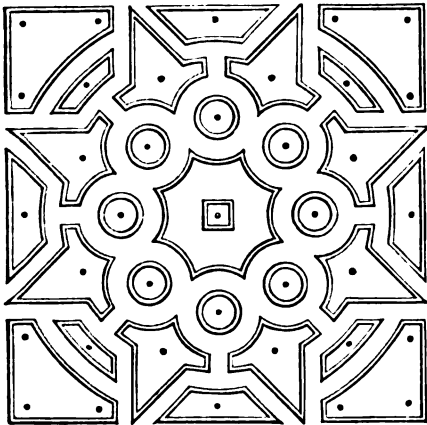
using different plants from those named above,—scarlet geraniums in the two larger angles, and variegated-leaved do. in the two smaller angles.

The long straight borders may have a row of standard roses in the middle, the stems of which will afford support for creeping plants; the ground to be planted, if contrast of colouring be aimed at, with purple, yellow, and white.

Our figure, although complete in itself, may, with every propriety, be extended on the opposite side of the basin of water, or indeed on the two other sides also, this last producing a cruciform garden of great interest and size. A flower-garden very similar to this exists in the beautiful grounds of the Dowager Duchess of Bedford, at Camden Hill.

Fig. 820 is a specimen of a Gothic flower-garden, laid out in 1619 by Solomon

Fig. 820.



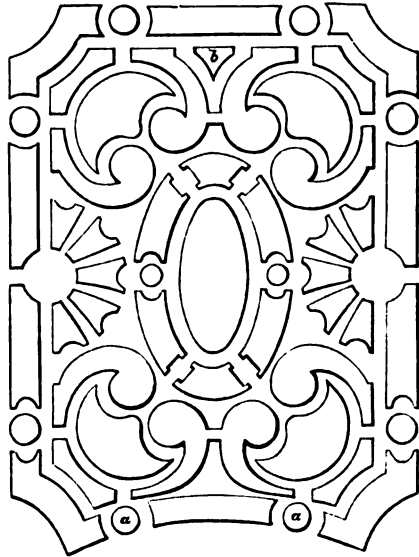
Caus, one of the most eminent architects and engineers of his day, and which long existed in the once celebrated gardens at Heidelberg. This design is so complete that it would be impossible to take out one bed and substitute another for it, without deranging the whole figure. This is a test of the perfection of the figure, as it is also of all architectural ones, of which we have given so many examples. The margins should be of stone, and the borders slightly sunk. The centre may be a basin of water, with a fountain or not; and if so, a Gothic vase should be placed on the pedestal.

This figure has been published in vari-

ous works. We have, however, never seen it executed.

Fig. 821 is a geometrical garden, admitting of a profusion of sculptural deco-

Fig. 821.



rations. The centre may be an elliptical basin, with or without a fountain. The principal entrances to be at *a a*. In the circles in the marginal borders may be placed vases; and also in the two smaller circles in the elliptical border. The surrounding parapet wall should be strictly architectural, with balustrading dividing it into panels, surmounted with vases. A sun-dial may occupy the space *b*.

If upon a large scale, this figure might be cut out on grass, and so, indeed, form in itself a very complete flower-garden for a very considerable place. Instead of being enclosed with an architectural wall, it might be bounded by a grassy terrace bank, backed up with shrubbery. It might also form part of a flower-garden of the first class, either in connection with other figures, or isolated, as is so well exemplified at Drumlanrig, where many gardens of this description are employed in the production of a whole.

The architectural flower-garden, which forms the subject of Plate XXXIV., has recently been designed by us for a residence now in progress of erection on the west coast of Scotland, and is, as will be

seen by our Plate, immediately in front of the mansion, a highly-enriched architectural edifice. The site of the projected garden is on the west front of the mansion, which stands on elevated ground, falling, as will be seen by the section,

considerably towards the park. The principal entrance to the house is on the south front, and indicated in our Plate by the square gravel court, enclosed by a handsome stone balustrading, fig. 822, extending from the south-east corner of

Fig. 822.

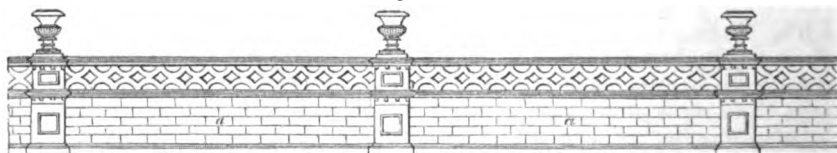


the building to the offices, which form a wing to the house, receding so far back as to leave the entrance front-elevation quite open to view. On the opposite or west front is placed an architectural conservatory, in the same style as the mansion. This conservatory communicates by a private door, as seen in the corner, with the ladies' boudoir. The garden is entered by a private gate in the parapet wall, separating it from the court-yard, by a folding door from the grand corridor near the centre of the building, and by descending a flight of steps from the higher grounds at the extremity of the conservatory, as well as by an ascending

flight of steps from the park in front, near which one of the main approaches to the mansion passes, and is thus arranged so that the family may pass direct through the flower-garden to the park in this direction; or, being set down there, can walk up to the house through the garden, instead of driving round to the front door. The whole garden is enclosed within a substantial parapet ashlar stone wall, with a richly-cut open stone balustrading divided into panels by projecting piers, and these are surmounted with handsome carved stone vases.—(Vide fig. 823.)

The situation, like most in the west of

Fig. 823.



Scotland, being damp, 60 inches being about the average fall of rain per annum, we have adopted stone pavement for not only the smaller walks, but the broad terraces also, which are all edged with the same material. The pavement used is the Caithness flag-stone, in lengths of from 4 to 8 feet each, and of breadths to suit the various parts, the whole being, as well as the edgings, polished and covered with three coats of linseed oil on the top surface, rendering the stone completely impervious to damp, which it naturally is, more so than any other found in Britain. The oil also lessens the disposition to become discoloured by the growth of lichens, for which the dampness of the climate is highly favourable. The whole of this pavement is laid upon brick

piers, leaving a space below of 12 inches clear; and, at convenient distances, cast-iron square gratings, 5 inches on the side, are placed for the escape of the water that falls on the surface, and which is carried away by drains laid under the principal walls.

The soil in the flower-beds is made only 15 inches deep, and laid upon a well-drained bottom, the better to carry off the superfluous water which falls on the surface. The beds are also slightly raised at their centres; and, to prevent the smaller plants from being beaten down, or splashed over with mud, in the time of heavy rains, the surface of the beds, at planting, is covered over with small pebble-stones from the sea-beach, and on those the branches of the plants rest,

instead of on the damp soil. These stones are to be raked off in autumn, when the flowering season is past, and laid by to bleach with the rains of winter till the following planting season arrives. The soil to be used is of a light sandy nature, a strong soil in so damp a climate being the worst adapted for flower-garden borders.

The artistic decorations in this garden are the great extent of parapet-walls, with their vases, balustrading, &c., the flights of steps, enclosed within polished stone margins and with low hand-rails, with vases placed on plinths at top and bottom. A fountain occupies the centre of the square garden, while two colossal vases occupy the pedestals near the two ends of the longitudinal garden, and Canova's Hebe the centre pedestal.

In this Plate we have attempted to give in colours the arrangement of the plants in the various beds; and, so far as we are aware, this is done for the first time. In the longitudinal parterre, on the highest terrace next the mansion, it will be observed that only the three primary colours, red, yellow, and blue, are employed—using, to produce those colours, *Calceolaria amplexicaule*, pegged down, for the yellow centre beds; *Nemophilla insignis*, blue, for the side ones, on one side; and *Verbena melindres*, scarlet, for the opposite side. The whole of this parterre is margined with polished stone edgings; but, on account of the circular figures, box edging is used to separate the narrow walks, laid with white sea-shingle from the earthen borders, thus throwing in the two neutral colours, white and green. In the smaller flower-garden, in front of the conservatory, the sides of all the walks being in straight lines and acute angles, the edging employed is polished stone, and the same material is used for the surface of the walks. The dark-shaded square at each corner is occupied with a vase set on a proportioned plinth; and, as the beds are small, the following dwarf-growing plants are to be employed to produce the requisite colours, viz.—The five scarlet beds are planted with *Verbena Tweediana grandiflora*; the four central yellow ones with *Calceolaria amplexicaule*; and the four side yellow ones are sown with *Lasthenia californica*. The five blue beds are sown with *Brachycome ibiridifolia* var. *cærulea*, pegged down. The three purple beds are

sown with *Campanula Lorei*, and the four green beds with *mignonette*, the nearest approach to green we have fitted for the purpose. The square garden around the fountain is planted with two primary colours, red and yellow—the former produced by *Anagallis grandiflora* and *Saponaria calabrica*, one in each bed; and *Anthemis arabica*, and *Sanvitalia procumbens*, to produce the latter colour, also one in each bed.

The longitudinal garden in the centre or second terrace is to be planted as follows: The four blue beds in the marginal lines to be planted with *Anagallis cærulea*; the remaining sixteen blue beds to be planted alternately with *Convolvulus minor* and *Lupinus nanus*; the four marginal yellow beds to be planted with yellow *calceolarias*, pegged down; while the twenty-one yellow beds towards the centre of the figure are to be sown with *Anthemis arabica*, *Lupinus luteus*, pegged down, and *Lasthenia californica*, planted alternately. The four scarlet beds in the external line to be sown with *Dianthus chinensis*, and *Saponaria calabrica*; and the twenty scarlet beds towards the centre of the figure to be planted with scarlet *verbenas* of different varieties. The eight rose-coloured beds to be sown with *Clarkia pulchella* var. *rosea*, *Anagallis arvensis*, and *Rhodanthe manglesii*. The green beds to be sown with *mignonette*.

The lower garden, or third terrace, is to be filled with plants of larger growth, being farther from the windows. The red beds to be entirely planted with scarlet *pelargoniums*, retained in their pots and plunged, and pegged down. The marginal yellow borders to be sown with *Eschscholtzia californica*; and the three central ones filled with yellow *calceolarias*, planted pretty close, so as to cover the space, and to be allowed to attain their natural height. The four larger blue beds towards the points of the Gothic figure to be planted with *Salvia patens*; the others with *Centaurea cyanus*, *Lupinus elegans*, *Lobelia heterophylla*, *L. ramosa*, and *Gilia capitata*, alternately; the six purple beds with purple *candy-tuft* and *Prismatocarpus Speculum* alternately. The six dark-coloured beds to be filled with *Scabiosa atropurpurea*, or the darkest shades of dahlias, pegged



down close to the ground. The two parapet-walls to be thinly covered with ornamental plants, but not in any way to take from their architectural character. The climate being exceedingly mild, fuchsias, the newer globularias, hydrangeas, ceanothus, and similar half-hardy plants, may be planted, and the borders between the walls and the walks be sown with mignonette, with abundance of tuberous and bulbous spring and autumnal flowering-plants permanently established in it.

The object of the above mode of arrangement is to produce those pleasing effects, which masses of beautiful and decided colours are capable of displaying, and which the same amount of colour, indiscriminately scattered over the surface, must ever fail in producing. Another object to be attained is, that this garden may be in perfection from the first of August until destroyed by the autumn frosts, as at that period only the proprietor occupies this residence.

The geometrical flower-garden and its connection with the mansion are shown on Plate XXIX., which is an isometrical view of Nuthill House, the residence of O. Tyndall Bruce, Esq., Fifeshire. The design for the mansion was given by Messrs Burn and Bryce, and is an excellent specimen of a style in which these eminent architects greatly excel. The design and arrangement of the surrounding grounds and flower-garden were committed to M. Rous, an Italian architect and landscape-gardener of rising eminence. The situation is somewhat elevated, standing in a park of considerable extent, well wooded, and sufficiently undulated, but possessing no features of grandeur or of age, the whole being comparatively of modern creation—the original residence of the family being Falkland Palace, in the immediate vicinity. The antiquarian associations within view are, however, of great interest—namely, the ancient palace of Falkland, often occupied by the Scottish kings up to the time of James VI. as a hunting-seat; and the East Lomond hill, and Mearlsford, near its base, with their ancient British fortifications, supposed, by Colonel Miller and other antiquarians, to have been the site of the celebrated battle of Mons Grampius, the exact site of which has puzzled

antiquarians as much as the birthplace of Homer. The entrance to the mansion is on the north front; the other three, or principal fronts, are surrounded, as will be seen by our Plate, by the flower-garden, arranged in the geometrical style—constituting, as it were, a base upon which the beautiful structure stands, uniting the forms of surrounding nature with the more regular and uniform outlines of the building. On the east front, beyond the boundary of the parterres, the ground falls rapidly; and although enclosed upon this side by a substantial retaining-wall, the parapet, being of very elegant balustrading, divided into compartments by square piers, finished with well-proportioned vases, only rises about 2 feet above the ground-level within—thus securing ample protection, without intercepting the view of the well-arranged park scenery beyond, even when viewed from the ground-floor windows of the house.

The parterre on this side is chaste and unpretending in its arrangement, being surrounded by a broad gravel-walk, and intersected at the centre, where a very elegant fountain of stone is placed. Along the inner margins of this walk are placed longitudinal flower-beds, separated into parts by circular ones, with two larger figures cut out on the grass lawn which forms the centre and greater part of this compartment. These beds are planted in the grouping manner, and have a very good effect, on account of their not being crowded together, and the plants being kept closely pegged down to the ground. On the western front the design is in one compartment, as the space here is only about half the length of the last, an area or sunk garden occupying the remainder of the length of this front, and which is separated from the upper part by a highly ornamental low parapet-wall, in which is placed a flight of steps, to connect the two parts together. This lower garden may be regarded as a private parterre, as it is immediately in front of those apartments occupied chiefly by the family. Against the wall which bounds the northern side of this lower garden it is proposed to erect a handsome conservatory and aviary in connection with Mrs Bruce's boudoir, which, when carried into effect, will render Nuthill a very perfect specimen of a private gentleman's resi-

dence. The parterre on the western side, as we have already observed, is very different from that on the opposite front;—it is more elaborate in its details, and its fountain is more richly carved. Descending from this compartment by flights of stone steps placed in a turf-terrace bank, we reach one terrace already laid out with flower-beds, and afterwards another, now in course of being finished. This latter is separated from the park by a wire-fence, which, commencing at the north-west corner of the dressed grounds, passes, first in a straight line, and afterwards in a circuitous manner, through the grounds, and terminates again at the south-east corner or end of the retaining-wall. On the south or principal front, a very elegant stone fountain—not, however, yet erected—is to occupy the centre. The parterres on each side are planted with scarlet geraniums, verbenas, and similar showy flower-garden plants, while those at the two ends are laid out in sand. Beyond the gravel-walk, which surrounds all the parterres, and also intersects them, the ground at the south side rises gradually, and continues to do so for a great distance back—not, however, in one regular slope, but in a graceful undulating manner, and is at last lost in the woods and plantations which surround it. The whole of this enclosed ground is laid out in the natural style, but without the surface being in any part broken. Groups of rhododendrons, and other flowering and evergreen shrubs, are artfully disposed, and feather down to the grassy sward. Ornamental trees are profusely scattered about, amongst which are many rare coniferæ, which will in time give a new character to the aspect of the place. The three fountains to which we have referred will be found figured in our article FOUNTAINS, the drawings having been kindly put at our disposal by the liberal and excellent proprietor. They are from the designs of M. Rous, and are cut out of stone procured in the neighbourhood, and executed by Mr Howie, we believe a self-taught sculptor, now extensively employed in Edinburgh, and rapidly rising to eminence in his profession. One thing in connection with the fountains at Nuthill deserves notice;—they are not mere jets, but are abundantly supplied with water at all times, and that under a high

degree of pressure, being supplied from an artificial lake more than 100 feet above their own level, the supply-pipes being 4 inches in diameter. This supply also serves the mansion and offices; and ample provision is made, in case of fire, that the whole stream may be brought to bear upon the edifice.

Objection may be made to our giving Nuthill House and flower-garden as a specimen of what such things should be, on account of the garden not extending over a greater amount of surface. We, however, think that a moderately sized garden well kept, as this one is, is much preferable to a larger space kept in a less masterly manner. Our chief object in choosing this as an example is to show the connection of the geometric flower-garden with the mansion, and also its capability of being united with the park on the one hand, and the natural style of dressed ground on the other, without the slightest violation of good taste in either case.

The flower-garden at Drumlanrig Castle may be given as another example, where the geometrical style is carried out on the three sides adjoining the baronial mansion, and extended to a great distance in majestic terraces, in advance of the principal front. The flower-garden here covers an area of upwards of twenty-one acres, the whole of which is seen from the principal windows and spacious terraces which surround the castle. About one half of that space is laid out in the geometric manner, each compartment being different in design, and differently furnished. Beyond this, upon a noble grassy lawn, the gardenesque form begins; and beyond that, the refined picturesque is introduced, which unites the whole with the surrounding scenery.

Plate XXVI. exhibits the beautiful Italian flower-garden of the Duke of Devonshire at Chiswick. It may be interesting to notice that the idea which led to the erection of the original villa and Italian gardens at Chiswick was borrowed from a well-known villa of Palladio's. It was then considered as a model of taste, although not entirely without faults—some of which, Mr Walpole observes, were occasioned by a too strict adherence to rules and symmetry; and Lord Hervey sarcastically remarks

of it, "that it was too small to inhabit, and too large to hang one's watch in." Its courts were then, as now, dignified by its picturesque cedars; and its gardens, so early as 1770, were noted for the purity of the Italian style in which they were laid out. The house was remodelled in 1796, under the direction of Mr Wyatt, afterwards Sir Jeffrey Wyattville, by the addition of two wings. The Italian gardens were at the same time greatly altered, by the removal of "certain puerile conceits" not considered suitable to the taste of the day. The style was, however, strictly retained. A further change took place in 1814-15, under the direction of Lewis Kennedy, Esq., at that period the leading landscape-gardener in England. Slight alterations and improvements have since taken place, and the gardens now exist as shown in our Plate. It is somewhat singular that a place of so much consequence as Chiswick Villa should have withstood the shock of the revolution in style, and that it should remain so perfect a specimen of the Italian school, and be in itself probably the only residence in Britain which has retained that style in anything like its original purity.

The flower-garden is of a semicircular form, placed in front of a splendid conservatory, elevated upon a well-proportioned terrace base. This conservatory is approached in front—at the centre, as well as at the two ends—by flights of steps. It is kept continually gay with flowers, and has long been remarkable for the excellence of cultivation and high keeping which is displayed, even to the minutest points. The greater part of the beds are cut out on grass, and bordered with gravel-walks. The two central or principal parterres are on gravel, with box edgings. The squares along the sides of the outer walk, as well as two within the parterre, are pedestals, on which excellent specimens of sculpture are placed; and behind those, by the side of the semicircular walk, are planted three rows of standard roses.

Plate XXX. shows the ground-plan of the large palm-stove at Kew, and the flower-garden surrounding it, which in part, or as a whole, might, with slight modifications, be adapted to the grounds around a highly architectural mansion. This magnificent structure, of which Plate

XIV. is a view, stands on rather elevated ground, near to the artificial piece of water originally formed by Sir William Chambers,—a portion of which we have shown in front, with its parapet-wall bordering the principal gravel-walk which leads to this conservatory. As will be seen by our Plate, the conservatory stands very properly upon a terrace of gravel, ascended to by flights of stone steps opposite each of the four entrances. The parterres, according to a notice of these gardens which appeared recently in the "Quarterly Review," were laid out by Mr Nesfield, and, as a geometric design, are very much to our mind, but for such a situation extremely faulty, in being almost devoid of artistic ornament. In this respect Mr Nesfield may not be to blame, for we can hardly think that a landscape-gardener of his eminence would have neglected the introduction of vases, fountains, parapets, and appropriate balustrading, and all these of the most classic style. Grass terraces, when substituted for mural ones, bespeak poverty of imagination or of purse. We would have expected to have seen the tops of the pilasters, which form the panelling of the parapet-wall by the water side, furnished with vases—the grass terrace substituted by a polished ashlar wall, and open balustrading on top—two colossal vases, on elevated pedestals, occupying the circular beds of verbenas on each side of the principal entrance walk, as well as corresponding ones at each end of this magnificent structure—two fountains occupying the two larger circles in the angular parterres on the opposite side of the building, with a vase in each of the smaller gravel circles flanking the semicircular part of this garden. The space here dedicated for flower-garden display is by far too limited, either for the size of the building, or the gardens of which it forms a part; for although the collection of plants, botanically speaking, in the Kew Gardens, is richer than in any other establishment in the world, still it ought to be borne in mind that this is almost the only part of the whole dedicated to flower-garden purposes, and, as a royal and public institution, it should have been, in its kind, as perfect as the conservatory to which it is attached is, or the Royal Gardens at Frogmore are in theirs.

Twenty acres of flower-garden here would have given an opportunity of showing what English flower-gardening is, as completely as has been already shown in the case of the culture of botanical plants. These gardens, according to the description given of them by Sir William Chambers, their designer, were more complete in this respect three quarters of a century ago than they are at present,—for he tells us the flower-garden consisted of “a parterre divided by walks into a *great number* of beds, in which all kinds of beautiful flowers are to be seen during the greater part of the year, and in the centre is a basin of water stocked with gold-fish.” Now we have the flower-beds too few in number, and, for the proper display of such plants as are adapted for them, of too large a size. Taking this design as it stands, with the sculptural additions, and with the alterations suggested above, we think it a fair specimen of this style, and suitable for surrounding a large conservatory, or architectural range of conservatories.

In regard to situation, these gardens have no natural advantages,—the ground is almost a dead level, extending over above 120 acres; it is therefore the more important that artistic objects be brought in, to give the mind something more to dwell upon than merely level lawns and full-grown trees. In a climate like Britain, where the cypress thrives so indifferently, and where orange-trees do not abound in sufficient numbers to occupy the spots marked with the lines of dark dots, we would prefer vases, set upon proper bases, to Irish yews, or any other fastigate - growing trees whatever.

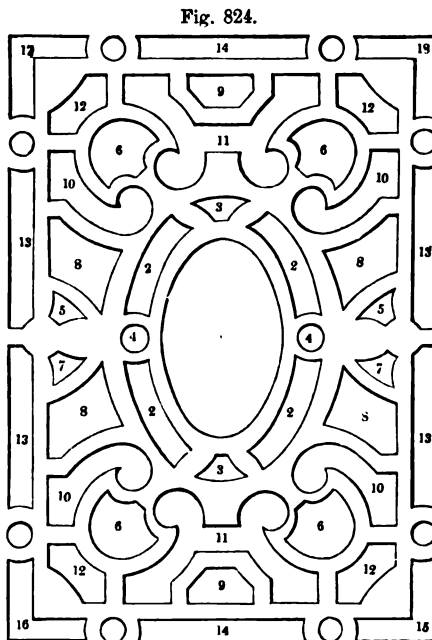
These parterres were planted last year in the grouping manner, the three primary colours forming the majority of the masses. The plants employed were *Calceolaria amplexicaule*—colour, a clear canary yellow; *Frogmore scarlet geranium*—bright scarlet; *ivy-leaved geranium*—pink-coloured variety; *Campanula carpatica*—grey when considered *in toto*, but with bright-blue flowers; *Argeratum mexicanum*—clear lavender colour; *Lobelia erinus*, *var. compacta*—dingy blue when seen in masses, on account of its greyish foliage. The lobelia beds are fringed with *Sanvitalia procumbens*—black and yel-

low—and verbenas of the most brilliant colours.

Plate XXIII. shows the ground-plan of conservatory, fig. 511, and projected flower-garden attached. The conservatory is surrounded by a broad terrace-walk of polished pavement, except at the end where it joins the mansion. The conservatory communicates with an existing range of four plant-houses, with a border for flowers in front. A walk of polished pavement surrounds the parterre flower-garden, beyond which, in the long borders, are cultivated flower-garden plants, disposed of in the mixed manner; and in front of the shrubbery are introduced dahlias, holyhocks, tree and pole roses, and similar tall-growing flowering-plants, while the front borders are dedicated to plants of a much less height. The parterres are planted in the grouping manner; the walks between the borders are laid with Bangor slate, 2 inches in thickness, and polished on the upper surface. The edging is of the same material, only half an inch thick, and scoloped on the upper edge. As it was desirable, for private reasons, that the walks here should be dry, and fit for walking on at all seasons, we have introduced pavement and slate, as being the materials best calculated to secure this desirable object. Another design was originally given, and referred to, p. 379, in which the small circles were omitted, as we presumed there would be a difficulty in bordering them with slate. That difficulty has, however, been overcome by the ingenuity of Mr Edward Beck, of Isleworth, who, by the aid of machinery, cuts slate edging into small pieces, and fixes them together, so that the circles of 18 inches in diameter can readily be margined round. The manner of doing so will be noticed hereafter. There is no doubt but walks and edgings so formed cost considerably more, in the first instance, than gravel-walks and box edgings; but when once done, they require neither repair nor keeping for years afterwards,—so that, in the end, they are very much cheaper than any other form that can be adopted; and added to which, they are, from their property of scarcely absorbing wet, always in a fit state for use, care being taken, in their formation, that sufficient drainage be placed under them, and provision made,

by having small holes drilled in them, to allow the rain water to pass down under them—the dark blue of the slate harmonising well with the colours of the flowers which surround them. The range of plant-houses on the right-hand side are for the purpose of culture alone—for supplying plants in flower for the conservatory, as well as for the rooms in the house. The borders on the opposite side are for affording space for such plants as are too tall for the parterres, as well as for giving a supply of cut flowers, to avoid cutting those in the parterres. The shrubbery around is thickly planted, for shelter and privacy, and the broad walk in front of the hothouses extends onwards towards the offices, home farm, and new kitchen-garden. The principal front of the conservatory faces the park, and commands a varied and extensive view over a large extent of country. The corridor, as has been elsewhere stated, communicates directly with one of the drawing-rooms.

Fig. 824 is a plain geometrical garden, in which no sculptured ornaments are to



be introduced. Upon a small scale it would make a good rose-garden—standard roses being planted in lines parallel

with the walks in the centre of the beds, each series of beds to be of plants of the same height, keeping the tallest in the outer beds, and diminishing the height towards the four beds forming parts of the elliptic figure in the centre. The centre elliptical figure to be of dwarf roses entirely. A pyramidal rose may occupy the centre of each of the four figures marked 6. This figure may be cut on grass, having the walks from 4 to 6 feet in width. Standard roses are much improved, both in strength and appearance, if their stems be neatly enveloped in moss, at same time covering the stakes that support them. Or, if planted in the grouping manner, the following arrangement may be followed:—

1. Standard perpetual roses, the ground covered with mignonette.
  2. Surface, covered with *Nemophila insignis*, blue; with scarlet geraniums, Tom Thumb, planted at equal distances, and so far apart that the outline of each plant may be distinctly seen.
  3. *Lasthenia californica*, yellow.
  4. *Lupinus nanus*, blue and white.
  5. *Verbena melindres major*, scarlet.
  6. Geranium, Punch; bordered round with *verbena perfection*, white.
  7. *Lobelia erinus compacta*.
  8. *Clarkia pulchella* in centre; bordered round with rocket candytuft, white.
  9. Dark-clove carnation.
  10. Dwarf hardy fuchsias.
  11. *Agathæa cælestis* in a row in the centre, blue; *Viscaria oculata* on one side, bright rose with dark eye; *Clarkia pulchella alba* on the other side, white.
  12. *Eucharidium grandiflora* in centre, reddish lilac; *Shortia californica* round the edges, bright yellow.
  13. Variegated-leaved geranium.
  14. *Heliotropes* for covering the ground, intermixed with rocket larkspurs.
  15. *Saponaria calabrica*, brown rose, to cover the ground, with *Salvia patens* planted in centre, bright blue.
  16. *Nemophila insignis* to cover the ground, blue, with *Lobelia cardinalis* in centre, scarlet.
  17. *Rhodanthe manglesii* to cover the ground, pink, with yellow lupin in centre.
  18. *Brachycome ibridifolia* to cover the ground, blue, with purple petunia in centre.
- The small circles round the margin to have a standard rose in the centre of each; the surface of the ground covered with *Nemophila insignis*, *Shortia californica*, *Nemophila atomaria*, *Lasthenia californica*, *Saponaria calabrica*, white candytuft, *Lupinus nanus*, *Nemophila discoidea*—one sort of each.

The garden which forms the subject of Plate XXXI. was designed for a gentle-

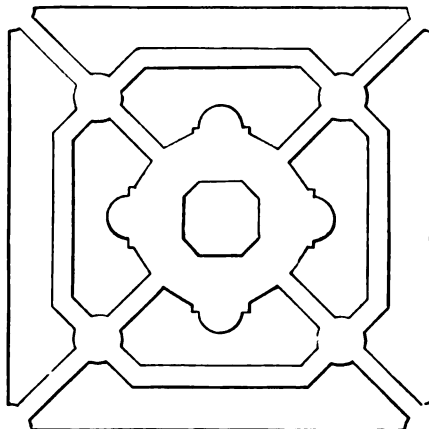
man in Oxfordshire, and surrounds the south and east fronts of a highly-enriched architectural mansion. The garden is enclosed on all sides by a parapet-wall with open balustrading, finished with vases on top; and is descended to by means of four flights of stone steps from the gravel terrace above, from which the *tout ensemble* is seen to much advantage. The walks are of gravel, with broad grass verges, (nowhere narrower than 2 feet,) uniting with the larger pieces of grassy turf which surround the interior beds of flowers. Two colossal vases, set upon 4-feet pedestals, occupy the circles in the centre of the two octagon figures, as well as that within the large circle. The sides of the flight of steps are provided with handsome cut Grecian hand-rails, with vases at top and bottom. The level of the whole garden is 6 feet above that of the surrounding park; and as both mansion and garden stand on elevated ground, a commanding view, not only of the park, but of a large extent of country, is secured from either. This garden is to be regarded as a summer and autumn garden, the proprietor remaining only during that period at this residence. It is therefore proper that it be planted in the grouping manner; and if attention be paid to the arrangement of the plants, as regards harmony of colouring, the effect cannot fail to be pleasing. For these reasons no shrubs or tall-growing plants are admitted, and every border is provided with wire basket-work, to keep the plants from encroaching upon the grass, as well as to define more properly the exact form of each figure.

Plate XXV. exhibits a flower-garden in this style. The situation in which it is placed was the site of an ancient piece of water, which it was deemed desirable to drain off; and sufficient material to fill it up to the level of the surrounding lawn being difficult to procure, we advised its being converted into a sunk flower-garden. The bottom being thoroughly drained, the sides were reduced to straight lines and walled up with rubble, and cemented over to the height of the ground above. This wall was coped with ashlar, set 4 inches higher than the level of a gravel-walk that surrounded the whole. Flights of stone steps were introduced at the centre of the two ends

and sides leading from the walk above to a broad gravel-walk below, which made the circuit of the garden, leaving a border for flowers and the plants which partially cover the face of the wall, as well as a 2-foot verge of turf between it and the walk. Narrower gravel-walks, starting from opposite the flights of steps, intersected the garden, and formed the beds composing the central portion. These walks are margined with turf verges 2 feet in breadth, expanding into grass plots in the centre of all the principal beds, with the exception of two towards the middle. The two lined circles are occupied with two vases, set upon square pedestals 6 feet in height. The scroll patterns, which form the margin of the central parterre, are laid out on grass. The effect of this garden is good, when viewed from the terrace-walk above, because the whole design is seen at once, and to greater advantage than if looked at when on a level with the borders and flowers. Had the associations of the place admitted of it, we would have introduced an open balustrading along the top of the wall, both for effect when seen from beneath, and, as it were, to form an apparent security against falling from the terrace into the garden below.

Figs. 825 to 830 are examples of figures suitable for filling in the larger compart-

Fig. 825.



ments formed by the direction of the principal walks, which in general are made to surround the whole garden, with a border beyond it, separating it from the

outer boundary, whether of shrubs, hedges, or parapet-walls; another of equal breadth

passing down the centre, throwing the interior into two separate compartments; and

Fig. 826.

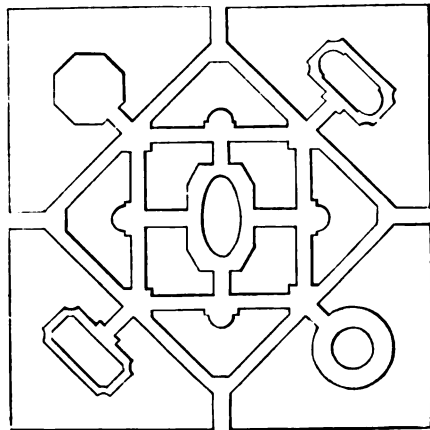


Fig. 829.

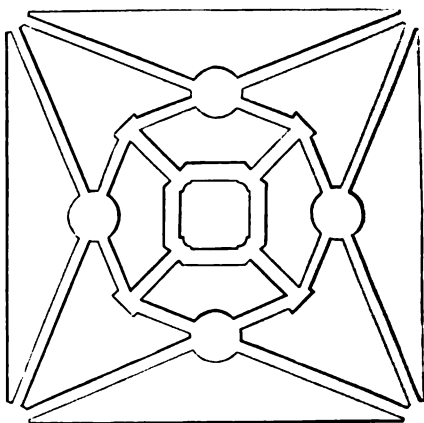
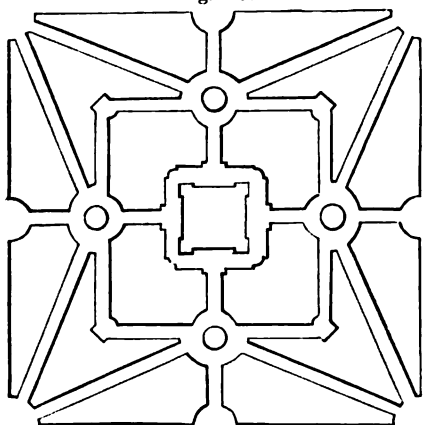


Fig. 827.



where another walk crosses the ground, and intersects the former in the centre, the ground is resolved into four compartments. These may be laid out in four different patterns, or may be all of the

Fig. 830.

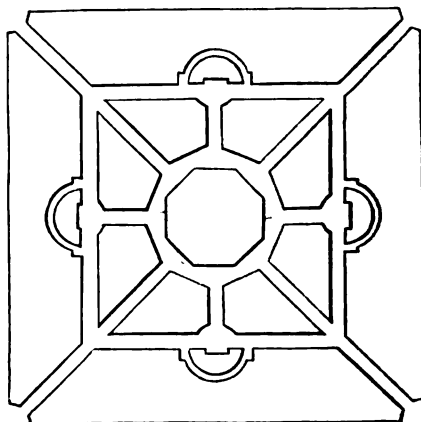
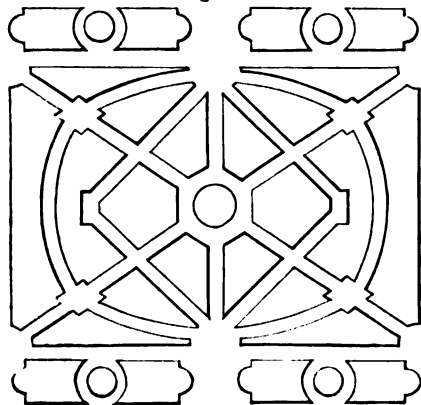


Fig. 828.



same figure—or, indeed, made up of as many, differing in form but agreeing in style, as will cover the entire space.

Figs. 831, 832 are suitable for a style of flower-gardens not very frequently seen. The beds are elevated from 6 inches to 2 feet above the walks, their sides being formed of masonry or brickwork. Where the lines are straight, pavement polished and set on edge, or Welsh slates, are both

economical and of easy construction. To keep them steadily in their places, the bottom should be sunk 6 inches under the

walk-level, and they should also be battled together behind, for greater security ; and, to give greater appearance of solidity and

Fig. 831.

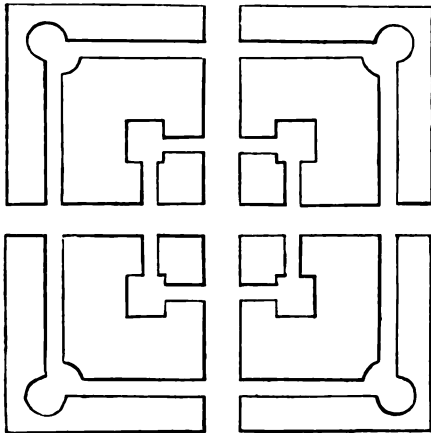
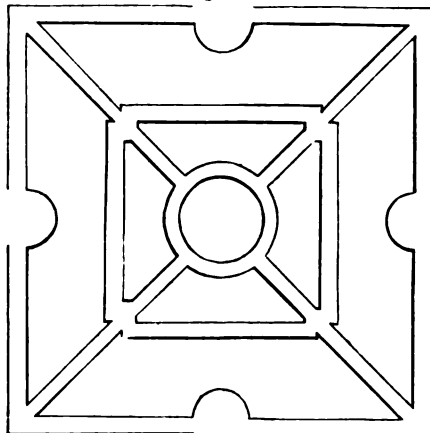


Fig. 832.



importance, they should be capped with the same material not less than 3 inches broad. The walks may be of gravel of uniform colour, but contrasting with the pavement or slate.

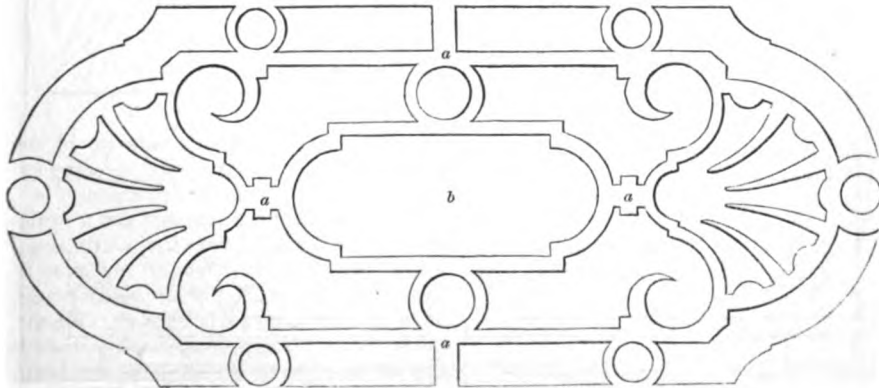
For figures in which curvilinear lines occur, ashlar stone, or bricks covered with cement, should be employed. The former would be the most massive and durable, but would be expensive. A specimen of such a garden, done in brick, exists in the grounds at Elviston Castle, near Derby. When we saw it a few years ago, it appeared crumbling to pieces. A much more durable brick substitute could be got by using composition bricks, and having them made with sufficient radius

to suit the curved lines without cutting.

The principal merit of such gardens is, that they are strictly architectural ; and, to render them still more so, the walks should be paved with the same materials, and the walls finished with a neat coping. In planting them, tall plants, and those of coarse habits, should be rejected, and only dwarf-growing kinds employed. Gardens of this description are, of course, on a small scale.

Fig. 833 exhibits a design different in some respects from any of our other examples. The walks *a a a* are to be of gravel, with edgings of dwarf box ; but if upon a scale sufficiently large to admit of

Fig. 833.



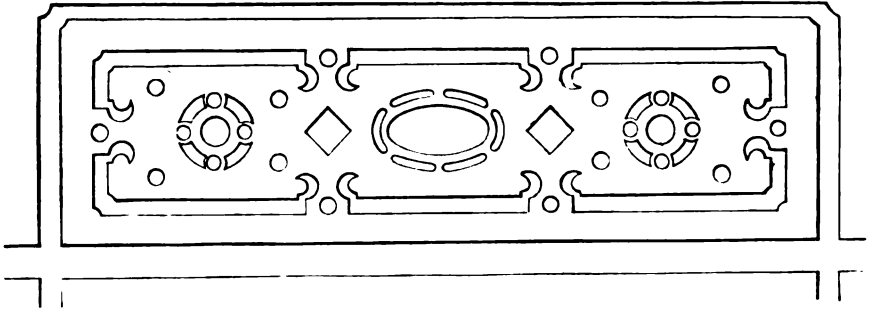


the walks being from 6 to 8 feet in width, the whole may be cut out of grass; and in this case the central bed *b* may be planted with flowering shrubs. Should it be upon a very small scale, say with walks under 3 feet in breadth, they may then be laid with pavement, Welsh slate, asphalt, or very fine coloured gravel; but, in either of these cases, the edges should be of stone, slate, earthenware, or Seyssel asphalt, which is manufactured on purpose, in lengths of about 3 feet, and 2½

inches in thickness, and 6 inches deep. The advantage of using this asphalt is, that the pieces, when slightly heated, may be bent to answer curves or corners. Wyatt and Parker's cream-coloured tiles may also be advantageously used, not only for the edgings, but for the walks also.

In long narrow slips of ground, where it may be difficult to introduce any of our numerous examples, the annexed fig. 834, may be adopted. It will readily

Fig. 834.

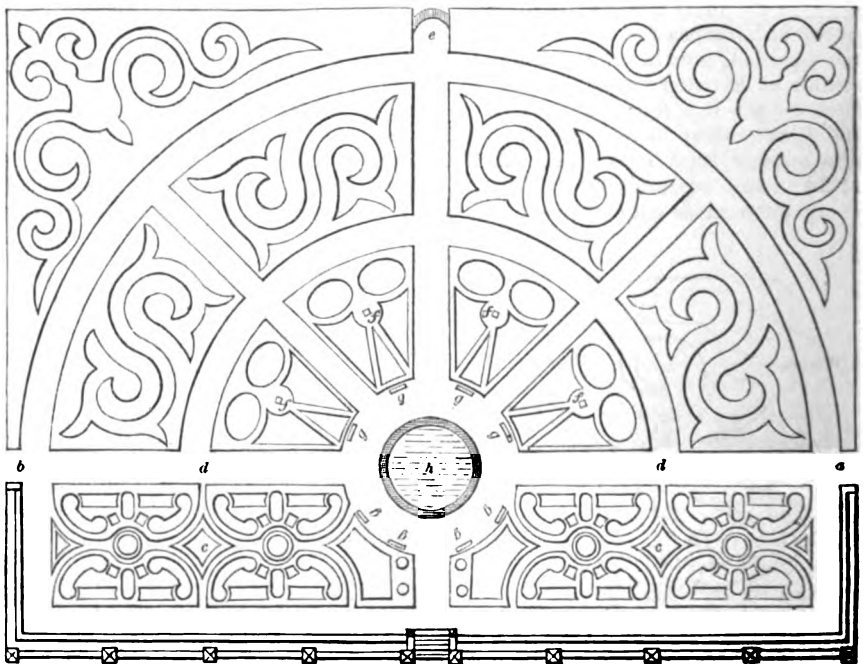


be seen that the figure may be extended to any length by a repetition of its parts. It may be bounded by a gravel-walk, as

shown, or not, according to circumstances.

Fig. 835 is adapted for a garden upon

Fig. 835.

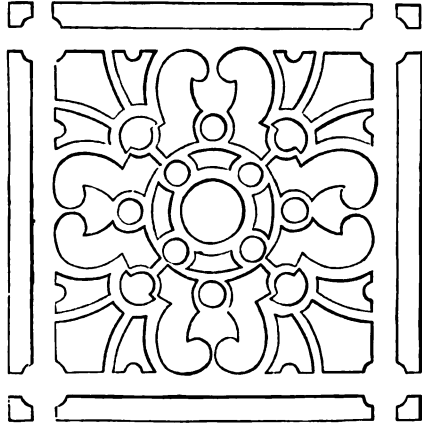


a large scale, and situated in front of a mansion or range of conservatories. It was composed for the lawn on the west front of an Elizabethan residence in the north of England. The mansion is surrounded on the south and west sides by a terrace 50 feet in breadth, bounded by a richly-cut parapet-wall, and the garden is reached by a flight of steps at the centre, and the whole space enclosed within a wire-fence extending from the gates *a* to *b*. The parterre *c c*, next to the mansion, is laid out on gravel with box edgings, while the larger figures beyond the principal walk *d d* are cut out on grass; *e* is an arbour of wire-work covered with roses; *f f*, &c., are vases elevated on square pedestals 4 feet in height; *g g*, &c., are porte-fleurs of artificial stone, standing 3 feet above the surface; *h* basin of water with the fountain fig. 836, a Triton, modelled from a fountain in the Barberini Palace, 7 feet 9 inches in height. The kerb of the foun-

tain is polished stone, rising 15 inches above the gravel.

Figs. 837, 838, 839.—Three examples

Fig. 837.



of geometrical parterres, which, by extension, would each form an interesting garden, or be made parts of a large garden, or disposed over a lawn of considerable size and diversified character, as was at one time so well exemplified at Bagshot Park. They are also adapted for gardens upon a small scale, and, in that case, should be laid down with box or stone edgings and gravel-walks.

Fig. 836.

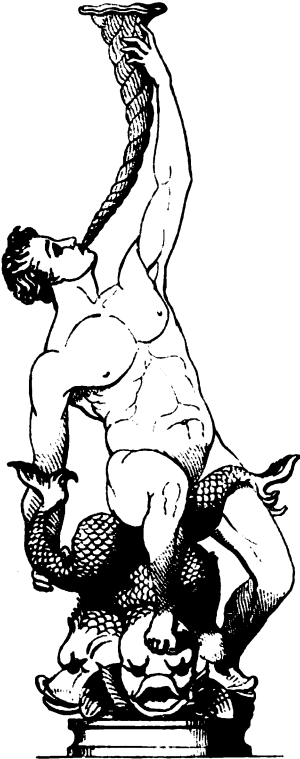


Fig. 838.

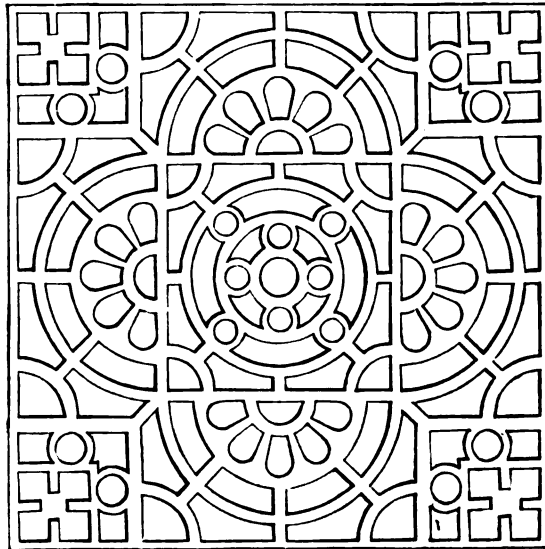


Fig. 839.

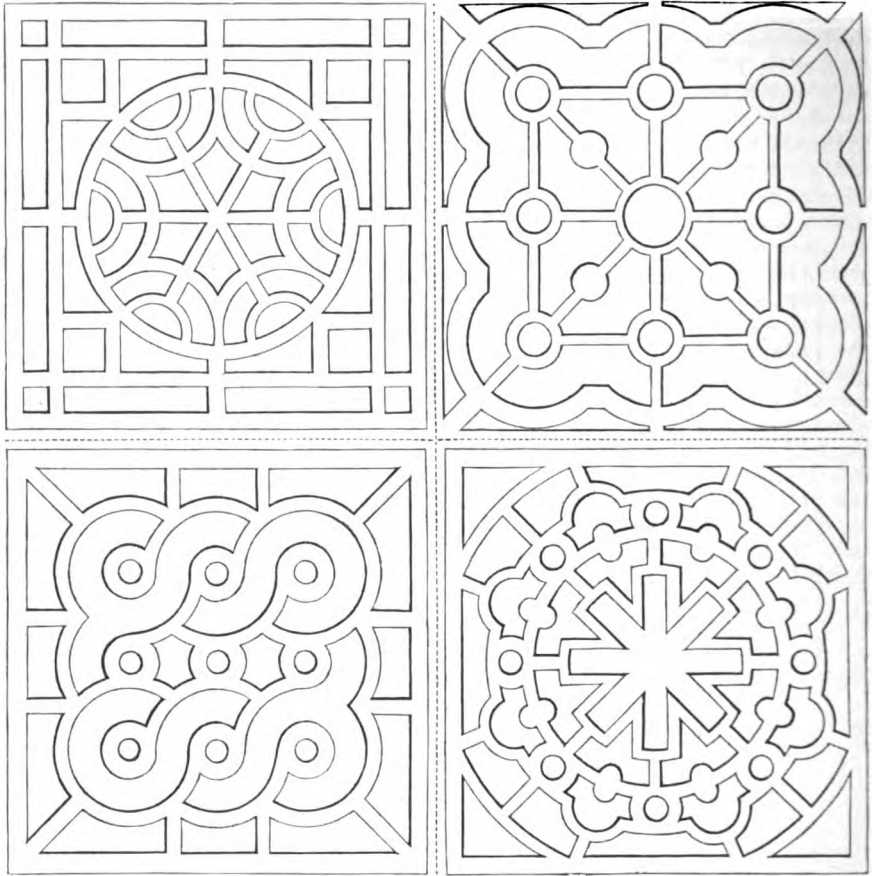
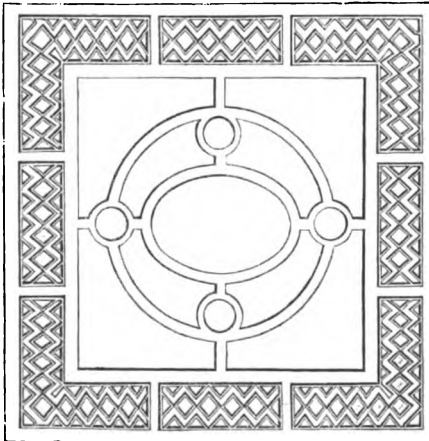


Fig. 840 is a parterre-garden, either entire in itself or forming part of a gar-

Fig. 840.



den upon a large scale. The whole of the beds are intended for low-growing plants. The larger ones are surrounded with gravel-walks and box edgings. The margin is to be edged with stone or slate, the paths covered with white sand, and the borders planted with plants not exceeding 6 inches in height, and of the three primary colours, red, blue, and yellow, the latter occupying the diamond figures along the centre. The same order of arrangement may extend all round, or each division may be varied by transposing the colours, or by employing plants of different species, but of the same colour. It is the taste of some to plant such parterres with dwarf box, heath, or similar plants, setting them so close together as to form compact dense masses in each, and to keep them to an even height by clipping them with the garden shears.

We think this has, however, a very monotonous appearance, and must ever be far inferior in brilliancy of effect compared with such plants as scarlet verbenas, yellow lasthenias, blue Lobelias, &c.

Fig. 841 is a parterre-garden in the same style, but of a different pattern. The principal walks, as in the last ex-

ample, should be of gravel, with dwarf box edgings. The longitudinal figures, with semicircular ends at the two opposite sides, should be margined with a turf edging, and at these sides the entrance and exit walks should be placed. In the case of the marginal borders in this figure, we have given four different pat-

terns, either of which may be continued all round, as in the former example, or each pattern may form a side, their planting and arrangement being similar to fig. 840.

Fig. 842 is a circular garden in the geometrical style. The beds, as will be seen by the sectional line, are considerably elevated in the middle. The figures are cut out on grass, with a boundary walk of gravel. Such a garden as this would make a very complete whole; but, from its figure, it is better adapted for a lawn at some distance from the house, as, having no straight sides, there would be a want of connection between it and the buildings.

Figs. 843, 844, 845, were laid out in the Royal Gardens at Bagshot Park by Mr Toward. They were cut out on a turf surface, and surrounded with grass lawns. The prevailing style at Bagshot was many small gardens of this sort scattered through the grounds, instead of having a combination in one place of greater magnitude. From the circumstances of the place, this was, no doubt, the most judicious system that could have been followed, as there was nothing architectural or upon a grand scale in the grounds. Towards the centre of fig. 843, a portion of grass of irregular form was introduced, and the

Fig. 841.

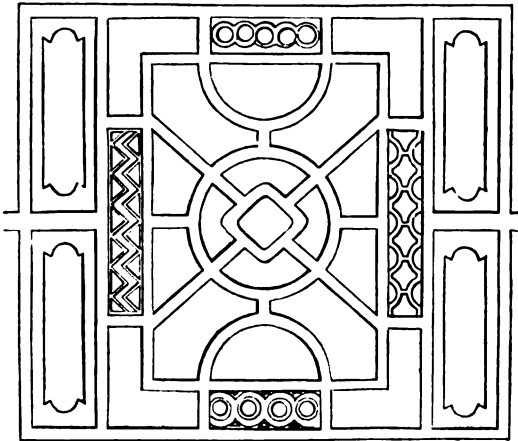
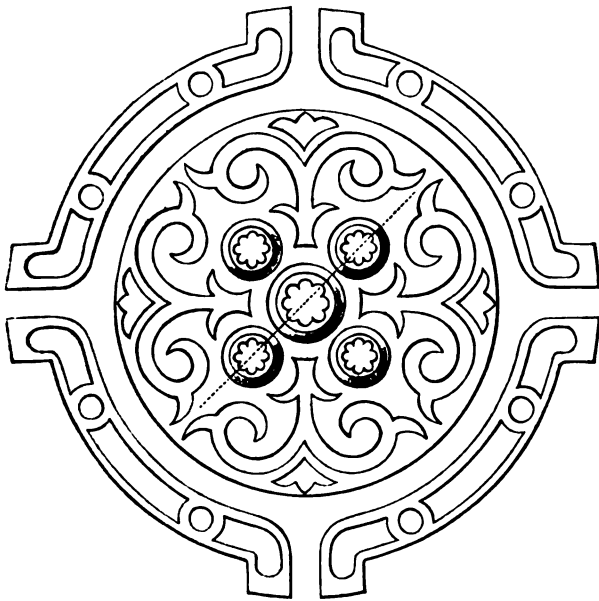
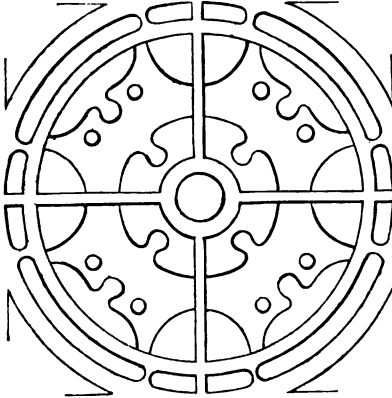


Fig. 842.



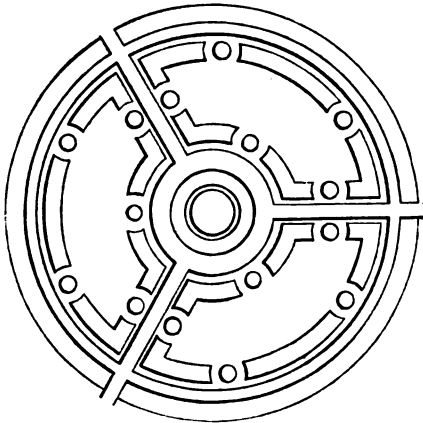
three larger divisions of fig. 844 were the same; the walks otherwise (figs. 844 and 845) were of gravel with box edgings. In fig. 843 a gravel-walk surrounded the whole, enclosing between it and the next a

Fig. 843.



series of flower-beds of the same width as the walks. The interior of the space was divided into four equal parts by gravel walks, but which, instead of intersecting each other at the centre, diverged into a circle, leaving a circular bed for flowers. In fig. 844 a narrow border formed the

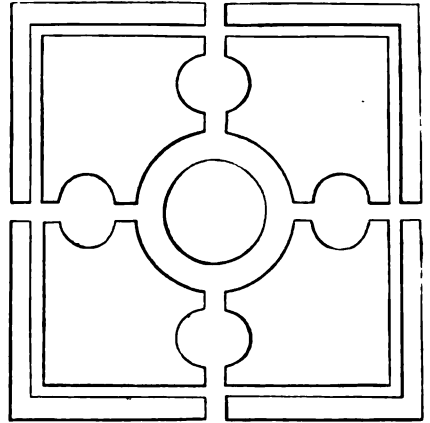
Fig. 844.



circumference, within which was a gravel walk parallel to it and to a series of beds which margined all the walks in the piece, leaving the three larger spaces covered with turf. Gravel walks were disposed of here as in fig. 843, but within the centre circular walk was a circular

border, and within that a circular plot of grass. All the walks in this figure were verged with turf edgings, and the borders in all the three examples planted or sown with low-growing bright-coloured plants. In fig. 845, which is a square form, a marginal flower-border surrounded the whole,

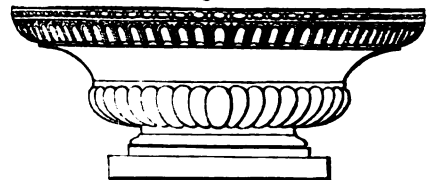
Fig. 845.



within which a gravel-walk, communicating with the other walks which were of grass, resolved the interior into four equal-sized figures.

Amongst the furnishings of a geometrical garden are elevated borders or baskets of flowers, formed of low margins a foot or 18 inches high. These are usually of polished stone, and often richly carved; and, as substitutes, very elegant ones of artificial stone, in Austin and Seeley's manner, are employed. These are called *porte-fleurs*, and are placed on grass and sometimes on gravel, and of themselves form very attractive objects, more especially when filled with plants either planted out in them, or, if grown in pots, plunged in them, and the surface covered with moss. Fig. 846 is the Pantheon

Fig. 846.



basin, which has been used for this purpose for several years in the grounds of

the Royal Botanic Garden, Regent's Park. They are also employed for a similar purpose in conservatories; three of them in the conservatory at Arundel Castle have been much admired. Fig. 847 is one of

Fig. 847.



elliptical form, 7 feet by 5 feet, the cost of which was £30. They stand the weather well, particularly if painted once a-year with boiled linseed oil, which prevents their absorbing moisture. Such subjects should stand properly on gravel; or, if on grass lawns, there should be a gravel walk around them to cut off the connection between them and the lawn.

Marginal borders for the sides of walks require a share of our attention. The following examples may be useful—figs. 848, 849. These borders, being strictly

Fig. 848.

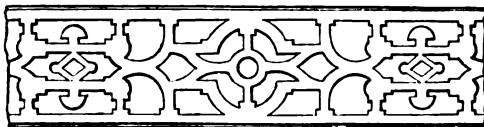
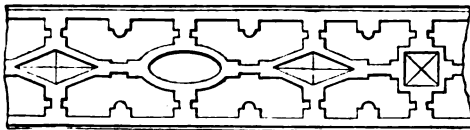


Fig. 849.



architectural, should be done in gravel, with box edgings; or, if in a highly architectural garden, with stone, slate, or earthenware verges, and even pavement or tile walks.

§ 2.—FOUNTAINS.

The proper placing of artistic decorations requires great taste and judgment, and of these none more so than fountains and statues, as being among the most refined of all garden ornaments. "Their effect (especially that of water in motion mixed with sculpture) is of the most brilliant kind; yet, though fountains make the principal ornaments of the old Italian gardens, they are almost entirely banished from ours. Fountains have been objected to as unnatural, as forcing water into an unnatural direction. I must own," says Sir Uvedale Price, "I do not feel the weight of this objection; for natural *jets d'eau*, though rare, do exist, and are among the most surprising exhibitions of nature. Such exhibitions, when imitable, are surely proper objects of imitation; and as art cannot pretend to vie with nature in greatness of style and execution, she must try to compensate her weakness by symmetry, variety, and richness of design. Near a house on a large scale, this mode of introducing water in violent motion, so far from being improper, is of all others the mode in which it may be done with the most exact propriety."

As fountains, for the most part, are to be regarded as strictly artificial objects, it follows that their presence is more in accordance with gardens in the geometric style than in the gardenesque, and more particularly the picturesque styles, in which latter their place should be supplied by cascades, rills, and dripping of rocks. In the gardenesque style, they are, however, perfectly admissible, more especially in near connection with the mansion, conservatory, or plant-houses; but here their simplest forms should be selected. In the geometric and all its sub-varieties, fountains of the most costly and elaborate workmanship should be introduced—choosing, however, those decidedly architectural for gardens of that character; while the more imaginative and fanciful—such as a Triton throwing water from his trumpet, Dolphins and other sea animals spouting water, nymphs wringing their hair or garments, &c.—are more suitable for the

inferior orders of the geometric style, and also for the gardenesque. One of the most elegant of the fanciful forms is that designed by old Solomon Caus, of Heidelberg, in which a female figure is half seated on a rock, holding, as it were, an umbrella of rather scanty dimensions somewhat above her head, from the periphery of which the water is thrown out in such a manner as to form a complete canopy over her. The designs for fountains of this sort are numerous, as a reference to the printed catalogues of the artificial stone manufactures will show. Fountains, sculpture, and mural decorations are now much sought after, and the art of fabricating them in artificial stone, and other materials, places them within the reach of persons of moderate wealth. Another circumstance favourable to the construction of ornamental fountains is the facility with which iron can be cast and zinc fabricated, nay, even glass itself, as was exemplified by Messrs Ostlers in the late Exhibition. Iron fountains are now cast in the most classic forms; and, no doubt, from its nature, this is, of all other materials we possess, the most durable, and best suited to our climate, as well as produced at a very moderate cost. Thus, with the artificial stone of Austin and Seeley, Ransom and Parsons, and others, and the fire-clay of the Garnkirk and Grangemouth Companies—all of which have been proved to be sufficiently durable for our climate—with cast-iron shafts and jets, and with iron or leaden pipes, there is now no difficulty in constructing the most beautiful garden fountains, and of the most diversified forms.

In regard to the mechanical construction of fountains, little information has hitherto been given in horticultural works. As practical rules, the following may be found useful:—As water always will, when uninterrupted, find its own level, it follows that, to produce a jet of any given height, the reservoir or fountainhead of supply must be as high, at least, as the height of the jet. Where a jet-d'eau or dropping fountain only is desired, the level of the water in the source of supply need not be higher than the point at which the water issues from the tazza; but if the water is to be forced to a considerable height, the head must be higher than the height to which the jet is

expected to rise, by at least several inches—but this depends greatly on the diameter of the jet, and the friction the water meets with in its passage from bends or inequalities in the course of the pipe. If the orifice of the jet do not exceed the eighth of an inch in diameter, the head, provided the water be always kept at the same height, need not be more than 6 inches above the height the jet is to rise to. The supply-pipe should always come from the bottom of the head of supply. In laying the pipe from the reservoir, or head, care should be taken to carry it in as direct a line as possible; and, if practicable, there should be a uniform fall throughout its whole length, that the force of the water may not be lessened by unnecessary friction, which every deviation from a straight line and gradual incline will increase. When pipes are laid without regard to uniform inclination, air is apt to lodge in the most elevated parts, while sediment will be deposited in the most depressed. The former may be withdrawn by tapping; but the latter is a more difficult affair, and not unfrequently stops the flow of water altogether. The calcareous matter contained in some waters is very injurious to leaden pipes, and often eats them through in a few years' time. Iron pipes under three inches in diameter are scarcely worth the expense of laying down, as corrosion will choke them up in a few years, unless they are coated both outside and in upon the principle recently registered by Messrs Johns & Co., which has the effect of completely preventing oxidation, and lessening the friction by rendering the internal surface as smooth as glass.

In cases where there is no natural supply of water at a higher level than that to which the jets or fountains are required to play, recourse must be had to mechanical art to force up a supply from other sources. Of these there is an abundant variety. The best and most simple, because it is next to impossible for it to go out of order, is the hydraulic ram, fig. 9. Water may be thrown to a very considerable height by its own gravity, and also by mechanical power. By the latter force a column 6 inches in diameter is thrown in the gardens at Nymphenberg, near Munich, to the height of 90 feet; and by the former, at Chatsworth, by the Emperor

fountain, to the unprecedented height of 267 feet. Single jets of this magnitude have, however, in our estimation, less effect than those of much less force. The jets at Nymphenberg and Chatsworth are interesting, in so far as they show us the maximum power of these means.

In conveying water for the service of jets and fountains, the usual precautions must be taken to place the pipes at a depth beyond the reach of frost or other accidents, which may be taken at 2 feet. Our own practice is to lay them, imbedded in dry soft sand, within drain-tile pipes. The following excellent directions as to the size of pipes, &c., are given in "The Encyclopedia of Villa Architecture:"—"As a general rule, the diameter of the orifice from which the jet of water proceeds—technically called the bore of the quill—ought to be four times less than the bore of the conduit-pipe; that is, the quill and pipe ought to be in a quadruple proportion to each other. The larger the conduit pipes are, the more freely will the jets display their different forms; and the fewer the holes in the quill or jet, the greater certainty there will be of the form continuing the same, because the risk of any of the holes choking up will be less. The diameter of a conduit-pipe ought in no case to be less than an inch;" but for jets of the larger sizes they ought to be 2 inches. "Where the conduit-pipes are of great length—say upwards of 1000 feet—it is found advantageous to begin at the

reservoir or cistern with pipes of a diameter somewhat greater than those which deliver the water to the quills, because the water, in a pipe of uniform diameter of so great a length, is found to lose much of its strength, and become what is technically called sleepy, while the different sizes quicken it, and redouble its force. For example, in a conduit-pipe of 1800 feet in length, the first 600 may be laid with pipes of 8 inches in diameter, the next 600 feet with pipes of 6 inches in diameter, and the last 600 with pipes of 4 inches in diameter. In conduits not exceeding 900 feet in length, the same diameter may be continued throughout. When several jets are to play in several fountains, or in the same, it is not necessary to lay a fresh pipe from each jet to the reservoir, a main of sufficient size, with branch pipes to each jet, being all that is required. Where the conduit-pipe enters the reservoir or cistern, it

Fig. 850.



ought to be of increased diameter, and the grating placed over it to keep out the leaves and other matters which might choke it up, ought to be semi-globular or conical, so that the area of the number of holes in it may exceed the area of the orifice of the conduit-pipe. The object is to prevent any diminution of pressure from the body of water in the cistern, and to facilitate the flow of the water. Where

the conduit-pipe joins the fountain, there ought of course to be a cock for turning the water off and on; and particular care



must be taken that as much water may pass through the oval hole of this cock as passes through the circular hole of the pipe. In conduit-pipes, all elbows, bendings, and right angles should be avoided as much as possible, since they diminish the force of the water. In long conduit-pipes, air-holes, formed by soldering on upright pieces of pipe, terminating in inverted valves or suckers, should be made at convenient distances, and protected by shafts built of stone or brick, and covered with movable gratings, in order to let out the air. Where pipes ascend and descend on very uneven surfaces, the strain on the lowest part of the pipe is always the greatest, unless care is taken to relieve this by the judicious disposition of cocks and air-holes. Without this precaution, pipes conducted over irregular surfaces will not last nearly so long as those conducted over a level."

In fig. 850 we have an excellent specimen of Parisian casting in iron, a material of all others the best adapted for the purpose here exhibited, as being more durable, and less liable to accidents, than stone, however good its quality may be. The fountain here shown is from the establishment of M. Ducler of Paris. We

have been unable to ascertain whether he was the designer as well as executor of this subject, which we consider both novel and unique, never having met with anything like a similar design before. This subject might be cast upon the largest scale admissible into a flower-garden of the largest size, or it might be placed in the centre or at the termination of a terrace, whether in immediate connection with buildings or not.

As a fountain adapted to a flower-garden of the largest size, as possessing far more than ordinary merits as a work of art, apart from the strict rules of architectural design, we cannot present our readers with a more elegant and appropriate specimen than that executed recently for E. L. Betts, Esq. of Preston Hall, designed and erected by Mr Thomas, of London, whose talent and taste in works of art have been brought out so completely under Charles Barry, Esq., in modelling the ornamental details of the new palace of Westminster, and elsewhere. The subject of the fountain by this accomplished artist, and which we have chosen for our illustration, fig. 851, is "Acis and Galatea," surrounded by Tritons. Such a fountain, we should remark, requires

Fig. 851.

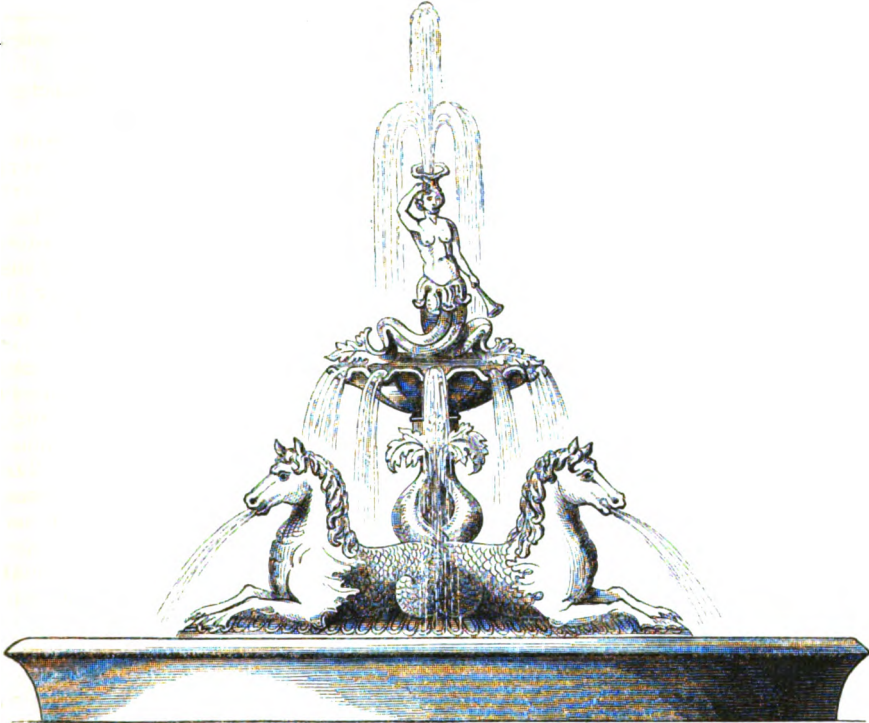


a large supply of water, and can never be applied where that element is scanty.

Fig. 852 is a design by M. de Rous, an artist of considerable celebrity, for a

fountain to be placed in the centre of the flower-garden, in the south front of Nut-hill, (*vide* Plate XXIX.) This fountain has not as yet been executed, but it is

Fig. 852.

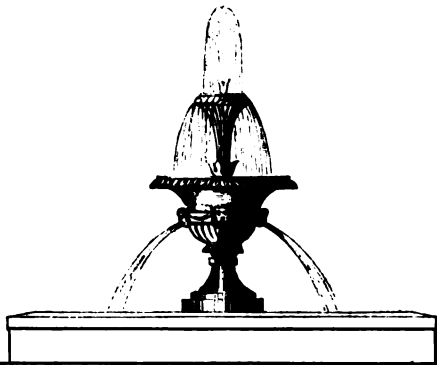


intended to be so. The diameter of the basin is 15 feet, and the height to which the water may be thrown is much greater, on account of the pressure secured by the formation of a capacious reservoir in the woods, at a considerable elevation above the garden. Like the other fountains, figs. 853 and 854, this is to be of stone, of an excellent colour, fine grain, and great capability for standing the weather. The fountains, figs. 853 and 854, have now been in operation several years, and in no part show the least symptoms of decay. The stone is obtained from a quarry in the same county, and the execution of the designs has been intrusted to Mr John Howie, sculptor, Edinburgh, who has performed his part, in the case of those already erected, in a most satisfactory manner. Mr Howie's sculpture establishment is well worth a visit by those interested in

the sculptural department of garden decoration.

Fig. 853 is one of those already erected

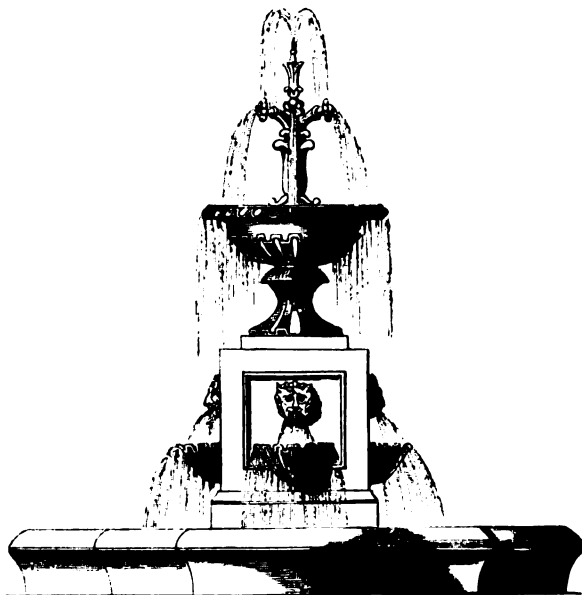
Fig. 853.



in the same garden, and is placed in the centre of the flower-garden on the west front of the mansion. The basin in this

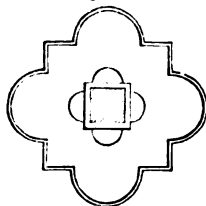
case, as in the last, is of circular form, and rises 18 inches above the ground-level. The principal or vase-shaped portion of this fountain is 4 feet 4 inches above the surface of the water in the basin, and the tazza-shaped top is 2 feet 7 inches high, from the centre of which the water is forced to a considerably greater height. The diameter of the basin is 7 feet 2 inches. Fig. 854 is the third of these

Fig. 854.



fountains. The plan of the basin, as shown by the ground-plan, fig. 855, is a

Fig. 855.



side of which is a head, exceedingly well carved, discharging the water, which here is not, as in many cases, a mere dripping, but a powerful rush, falling into well-formed shells, over whose sinuous margins it falls gracefully into the basin below. The vase and the two tazza parts which surmount this square pedestal are well proportioned, and the whole has a fine effect

from the dining-room windows, opposite which, on the east-front garden, it is placed. The great beauty of the fountains at Nuthill, apart from their artistic merits, is the abundant flow of water by which they are served. In a lower garden, and opposite the private apartments, but separated from the rest of the garden by a retaining-wall, the superfluous water is made to rush through a well-designed

head, falling first into a shell, and from thence into a semicircular basin. It is then carried to the offices, which are abundantly supplied. Taps are placed underground, which, in the case of fire, have only to be attached to flexible tubes which reach to every part of the mansion; and when we consider the pressure and quantity of water rushing through pipes 4 inches in diameter, and from an altitude much higher than any part of this elegant mansion, we can readily imagine the vast power this element, if properly directed, would have in case of fire. The safety here insured, apart from its application to the fountains, is a sufficient remuneration for the outlay of bringing

the water from the fountain-head to the house.

The following are the heights to which water is thrown by the principal fountains in the world: The Emperor, at Chatsworth, 267 feet; Wilhelm, the fountain in Hesse-Cassel, 190 feet; fountain at St Cloud, 160; Peterhoff, Russia, 120; the old fountain at Chatsworth, 94; the fountain at Nymphenberg, Munich, 90; and the highest at Versailles, also 90 feet. The waterworks at Chatsworth were begun in 1690, and executed by M. Grillet, a French artist, when a pipe for what was then called the Great Fountain was laid down; the height of 20 feet, to which it threw water, being at that time considered sufficiently wonderful to justify the hyperbolical language of Cotton—

“Should it break or fall, I doubt we should Begin to reckon from the second flood!”

It was afterwards elevated to 50 feet, and then to 94 ; but it is now elevated to the unique altitude of 267 feet. Such is the velocity with which the water is ejected, that it is calculated to escape at the rate of a hundred miles per minute. It is supplied from an immense artificial reservoir, constructed on the hills above, and covering eight acres ; yet so great is the drainage when the fountain is playing, that a diminution, over that space, of a foot takes place every three hours.

Walpole appears to have had no very high taste for fountains in garden scenery. He says, "Fountains have with great reason been banished from our gardens as unnatural ; but it surprises me that they have not been allotted their proper position in cities, towns, and courtyards, as proper accompaniments to architecture, and as works of beauty in themselves. Their decoration admits of the utmost invention ; and when the water is thrown to different stages, and tumbles over their borders, nothing has a more imposing or a more refreshing sound." "The full effects of fountains can only be displayed on a large scale ; yet I believe," says Sir Uvedale Price, "that in all highly dressed parts, whatever be the scale, water may be introduced with more propriety in the style of an upright fountain than perhaps in any other way. It would, for instance, be extremely difficult, in a flower-garden, to give to a stream of water the appearance of a natural rill, and yet to make it accord with the artificial arrangements and highly embellished appearance of such a spot. Now, the upright fountain seems precisely suited to it, as it is capable of any degree of sculptural decoration which the decoration of the place itself may require ; and likewise as the forms in which water falls, in its return towards the ground, not only are of the most beautiful kind, but have something of regularity and symmetry—two qualities which, nevertheless, are found in all artificial scenes."

No garden in the geometric style can be complete without its fountain ; and in gardens of large size they should be introduced freely, as not only works of art in themselves, but as, by the movement they may be said to produce, giving life and animation to the stillness of the scene.

### § 3.—VASES AND URNS, DIALS AND MURAL DECORATIONS.

The highest class of vases, like statues, &c., are placed in gardens as appropriate ornaments, and as a display of rarity and value, without any idea of placing plants in them.

The beautiful vases in the Castle garden at Windsor, at Chatsworth, at Clumber, and at Trentham, are of this description, and give to those gardens that idea of refinement and artistic decoration which carving and gilding give the saloon or drawing-room.

Their introduction into such gardens has also another effect, not less deserving our regard and attention ; namely, the tendency to create and cultivate a taste for natural beauty in the spectator. "Setting before a person a beautiful vase," Mr Loudon says, "is to familiarise him with beautiful forms, which he cannot help contrasting with ordinary shapes ; and, according to his natural capacity, or the suitability of his organisation for discernment in forms, he will find in the vases a unity of tendency in the lines which constitute their outlines, a symmetry in their general forms, and a richness, an intricacy, and a character of art in their sculptured details, which will induce him to search for those qualities in other objects of art, and to observe every tendency towards them in the works of nature. To such an observer the productions of architecture and sculpture would assume a new interest, and he would gradually, and almost imperceptibly, acquire a knowledge of, and taste for, the beauty of forms and lines in objects generally. He would thus learn to distinguish symmetry, regularity, unity, variety, and other abstract qualities, in works of art, which he would probably never have discovered in the forms of nature without such assistance."

The above remarks have reference more especially to vases of large size, and of the most classic forms, into which plants should never be introduced, as they of themselves are sufficient decoration, and in themselves supply the place, in geometrical gardens, destined to them, as forming a part of the entire design. Of these, the Florence vase, the Borghese vase, the Warwick vase, &c., are examples. Such vases should occupy the

most prominent positions in the garden, and should be of colossal dimensions, and form of themselves an entire subject,

of large size, and set on properly proportioned pedestals, may stand on grass or

Fig. 858.

Fig. 856.



disconnected with buildings, parapets, &c. Secondary vases, or such as are unfitted for smaller gardens, but still not to be filled with plants, are, the Grecian figured vase, (figs. 856 and 857;) large bouquet

gravel, as these pedestals elevate them sufficiently, and cut off, as it were, all connection between the vase and the ground. In regard to the disposal of

Fig. 859.

Fig. 857.



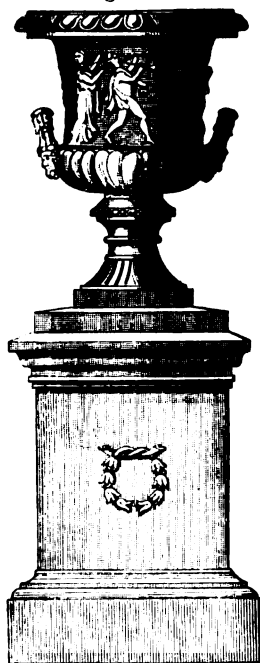
and festooned vase, (fig. 858;) the Grecian vases, with plain pedestals, (figs. 859 and 860,) &c. &c.

Vases such as those we have named, if

vases, we may observe, that they should appear as terminations on the tops of piers, gate-pillars, by the sides of terraced stairs, particularly at the top and bottom of the flights, along parapets broken with piers, or having sufficient depth of coping to form a base for their plinths, where the lines of walls or walks join, meet, or intersect, or at

the angles made at the junction of walks, in niches in buildings, or in gravelled or other recesses by the sides of walks prepared for them.

Fig. 860.



Wherever a vase is placed, it ought not only to have a base formed of one or more plinths, but a pedestal to raise it above the surrounding vegetation, as well as to give it dignity of character. No ornament, of whatever kind, ought to be set in an inconspicuous situation, or in the less important parts of the grounds; and further, no ornament ought to be employed,

the material of which is of less value and durability than the material constituting the objects on or against which it is to be placed. No vase or sculptural ornament should be placed as if it appeared to rise immediately from the ground. Vases are too often converted into substitutes for flower-pots, which, if they are of classic form, is the very essence of bad taste. They are, when on proper pedestals, sufficient ornaments of themselves, and should be considered in no other light. If plants are introduced into them at all, in architectural or geometrical gardens, they should have some connection with architecture also—as the Acanthus, Agave, Euphorbia, &c.

In regard to employing vases of architectural or classic forms, of cast-iron, pottery ware, or artificial stone, as a substitute for borders in small gardens, (town ones in particular,) for the cultivation of flowering plants, while they are ornaments in themselves, they are also admirably adapted for the purposes of culture in such cases. “Nothing, however, ought to

be recommended without assigning reasons for doing so. Now, there are several reasons for recommending elevated vases as receptacles for flowers, in order that they may form ornaments for gardens in confined situations; and there are also reasons for recommending vases not to be filled with flowers for gardens in the country. We shall take these reasons in the order of their importance.”

1st, Town gardens “are generally so confined by walls, that no herbaceous plant will thrive in them more than one season. The cause is to be found in the want of air, of light, and of fresh soil.” The soil soon becomes sodden and useless from want of drainage and a free circulation of air, and the plants suffer from the latter cause as much as from the former. The remedy, therefore, is in elevating the plants in vases set upon pedestals, and filling them annually with fresh soil. The area of such gardens, when small, should always be of gravel, pavement, or some composition which will be clean and comfortable to walk upon, but never of turf, although this latter is persisted in without ever producing a good effect, or lasting one season without renewal. The gravel or stone pavement will always be dry and clean, and avoid the necessity of being dependent on the jobbing gardener, who, in general, is not the most agreeable or reasonable visitor to deal with. One large vase and two smaller ones will be sufficient for the smallest-sized street garden; and these, if fresh filled with good soil in spring, and planted, should be kept the whole season after by the inmates of the house, as occasional watering, weeding, and tying up, will be the principal routine.

“By the plan of having vases instead of beds,” Mr Loudon remarks, “these gardens might be kept neat all the year round, at a trifling expense. In the summer, the vases might be filled with showy flowers; and, in winter, either left empty, or planted with evergreen shrubs and spicy bulbs.”

2d, Vases are interesting and beautiful objects either with or without flowers. “We are pleased to see flowers in them, because, in addition to the natural beauty of the flower, there is the important one of these being presented to us in a new and striking situation. The value, even of

common flowers, thus becomes enhanced; and what would hardly be noticed in a bed, or in a border, has a new interest, and a degree of dignity lent to it, by its being placed in a handsome vase, elevated on a pedestal. The vase is beautiful, as a work of art, whether it be filled with plants or not; but, when it serves as a receptacle for fine flowers, in a situation where such flowers are not seen in beds or borders, its importance is increased by the additional beauty which it confers on them, in presenting them in a distinguished situation."

The satisfaction which any kind of vase or elevated basket containing flowers gives in country gardens, is small compared "to that produced by fixed stone vases in town gardens; because, in the latter situation, flowers of any kind are comparatively rare and cherished; whereas, in extensive pleasure-grounds in the country, where there are beds of pelargoniums, and other flowers without end, it seems almost needless profusion to elevate them in vases. Hence it is that when stone or pottery vases are introduced into gardens in the country, they are very seldom filled with plants of any kind. They are introduced there as beautiful works of art, to give pleasure by their contrast to the beautiful works of nature with which they are surrounded."

3d, Why vases of flowers should be introduced into the little walled gardens of streets is, that they harmonise admirably with the masonry and architectural forms by which they are surrounded. For this reason also, stone vases should be sparingly introduced in pleasure-grounds in the country, except as appendages, or ornaments to architecture—such as on the parapets of terraces near the house, or the stone borders, balustrades, &c. of architectural flower-gardens." — *Gardeners' Magazine*, vol. x. p. 490.

*Vases*, however classic their forms may be, if of small size, and unconnected with buildings, or if in the rustic character, however ingeniously they may be constructed, are meagre ornaments in a flower-garden, if not planted with taste; and the plants they contain should be in keeping with their respective styles. Thus, architectural vases should be planted with agave, acanthus, yucca, &c., of their natural growth; or with orange trees, on single

stems, with globose heads; or with similar plants so trained as to show symmetry of form. Rustic vases, on the contrary, should be filled with plants having much less the appearance of art; and these may be either mixed, or consisting of one species only. It is, however, important to remark, that vases, if intended for flowers *at all*, should never be left entirely empty. Thus, during winter, the various species of yucca will in most places stand the weather; and where they do not, symmetrically trained hollies of various sorts, box-trees, *Aucuba japonica*, upright yews, or junipers, may be substituted. Around these stems may be planted in the soil various shades of crocuses, snowdrops, and winter aconite, to afford colour; and when their flowers fade, *Saxifraga oppositifolia*, *Aubrietia deltoidea*, *Dondia epipactis*, and similar vernal flowering Alpine plants, may be employed; and those again succeeded by others, to carry the season onward until the more showy plants, which are to be their summer inhabitants, can be safely set in them, at which time all the others are to be removed. When orange trees, agaves, or other tender exotics, are planted in vases during summer, they are in general placed in pots plunged under the level of the top of the vase. Around these various plants may be set, unless in cases where the individual plant is sufficient to fill the space. In the first case, elegant and graceful procumbent plants may be set around them, such as various species of *Calandrinia*, *Saponaria ocymoides*, *Saponaria calabrica*, &c., both to produce colour and to cover the surface of the soil. In the latter case, various free-flowering species of *Mesembryanthemum*, or other procumbent abundant-blooming plants of a succulent nature, should be employed. Where brilliancy of colour is a desideratum, then moderate-sized vases may entirely be filled with scarlet geraniums, fuchsias, hydrangeas, cinerarias, &c.; or, if of a large size, one may be furnished with a scarlet geranium in the centre, bordered round with the purple petunia, and again with the white-flowering ivy-leaved geranium, whose slender branches may be allowed to hang partially over the edge in a graceful manner. Another may have a fuchsia of pendant habit for a centre, encircled by a row of

yellow calceolarias, with one of scarlet verbena to complete the group. A good effect is produced in even the best of vases, by employing plants of the three primary colours only, because the just arrangement of colour is as much a work of art as the formation of the vase. In regard to rustic vases, their removal during winter adds greatly to the nakedness of the garden, while their being kept constantly in use tends greatly to their decay. Those who study economy in the durability of such rustic ornaments, will do well, when the flowering season is past, to have the earth taken out of them, and, when thoroughly dried, have them secured in a dry airy shed till spring. In planting for early spring display, select the finer varieties of *Mezereon*, *Rhododendron atrovirens*, *R. dauricum*, with the beautiful scarlet varieties now so common. *Ribes sanguineum* will be found valuable for centres, while the rest of the surface may be covered with *Erica herbacea*, crocuses, snowdrops, &c. These to be succeeded by early flowering azaleas, rhododendrons, and spring-flowering herbaceous plants. The summer inhabitants are of great variety. One may be occupied with a scarlet geranium, surrounded with *Rhodanthe Manglesii*, and bordered with *Lobelia erinus compacta*. Another may have for a centre *Fuchsia fulgens*, *Verbena Robertson's defiance*; while such creepers as *Maurandya Barclayana*, *Lophospermum erubescens*, or *Tropæolum canariense*, may form the marginal line, and be trained in festoons over the sides, or otherwise, even to the almost entire covering of the whole vase. Such plants as we have named will continue flowering during most of the summer; while annuals, for the most part, would last only a short time.

Vases or other architectural ornaments should be always placed as fixed structures. Hence they are in proper keeping when set on the tops of parapet-walls, upon plinths or pedestals, so as to give them a connection with something solid. It is bad, therefore, to set vases, or such architectural ornaments, on grass lawns, gravel-walks, or courts, and still more so on dug borders. "As a general rule," says a writer of taste, "for the gardener in this, and in all similar cases, he may consider it as a fixed principle, that no

work of art should be set down on the ground, in gardens or pleasure-grounds, or any natural scenery, without some kind of artificial preparation or superstructure."

It should be remembered that, in placing vases, and indeed all architectural or sculptural objects, they should stand on a sufficient basement to connect them with the wall or walk on which they stand. For, as the same authority further observes, "without this connection, or something equivalent, they would not be architecturally placed; for, as we have often stated, architectural or sculptural objects ought never to appear but when they are in some way connected with architecture or sculpture. Hence few things are in worse taste than pedestals rising out of turf or dug beds."

"The propriety of introducing any highly artificial decorations, where there is nothing in the character of the mansion which may seem to warrant them, may perhaps," says Sir Uvedale Price, "be questioned. For my own part, I would rather wish that such improprieties should be risked, for the sake of effect, (where the mischief, if such, could be repaired,) than that improvements should be confined to the present timid monotony. What has struck me, in some cases, and in some points of view, as a fault in the general effect of marble statues in gardens, is their whiteness; but it is chiefly where there are no buildings nor architectural ornaments near them; for, like other white objects, they make spots when placed amidst verdure only; whereas the colour and the substance of stone or stucco, by assimilating with that of marble, takes off from a certain crudeness which such statues are apt to give the idea of, when placed alone amongst trees and shrubs. This, however, must rather be considered as a caution than an objection."

Highly enriched or classical vases may be freely introduced in geometrical gardens, elevated on proportionable pedestals, either in marble or artificial stone. Perhaps nothing has tended to exclude statuary and sculpture from even our best gardens, so much as the enormous cost of the former; for, in no garden in this style have we seen the proportion of enrichments of this sort which ought to exist in



them. Even Chatsworth, Windsor, and Trentham are deficient in this respect, while Clumber affords us the only exception.

Cast-iron vases are now brought to great perfection, as well as ornaments of all kinds in the same metal. Sir Francis Chantrey once declared that this could never be the case, as no casting could ever equal the sculptor's chisel. The enterprise of the English ironmasters has completely falsified this assertion, as has been abundantly demonstrated, and while as yet this art, in its highest branches, may be said to be only in its infancy. We have specimens without number of cast-iron vases copied from the most elaborate and chaste sculptural works of antiquity, and of themselves as great a triumph in their respective department of the arts as that of the finest chiselled marble in the world.

Vases of cast-iron are now becoming common, and copies of the celebrated old as well as modern designs can be had little inferior in form, execution, and beauty of outline, to the originals. They are to be had painted in imitation of marble or bronze; and, if care be taken to paint them regularly with thin coats of anti-corrosion paint, the beauty and sharpness of the outline will last for ages; but, if neglected, rust will destroy this; and if carelessly painted, the same effect will be produced. Painting, however, is a dangerous process, unless carefully executed; and, of all imitations, bronze is the best.

In regard to size, great attention ought to be paid to proportion vases, as well as all other sculptural objects, to the size of the garden they are to be placed in. If the garden exceeds one acre, such vases should not be less than 6 feet in height, measuring from the ground; and in gardens of greater extent, they should be even larger, and elevated upon proportionable pedestals. For gardens of one quarter of an acre the dimensions may be reduced to 2 feet in height, and 22 inches in diameter at their top. This is the true proportion of the celebrated Florentine vase. Figs. 859, 860, will show the proportions when set on corresponding pedestals.

URNS differ from vases only in having a covered top. Their situation in a garden should be one of quiet and repose, or by the approach to, or round a cenotaph or mausoleum.

Fig. 861.



Fig. 861, the dove tazza.— We have selected this remarkable chaste and superb specimen of art out of a number of productions kindly put at our disposal by Mr Alderman Copeland, the well-known manufacturer of porcelain and earthenware at Stoke-upon-Trent. For elegance in the design, and beauty in the execution of the workmanship, this tazza reflects great credit on the establishment of the worthy alderman, which has long since attained a high degree of reputation, not only in Europe, but throughout Asia and America, and also displays the correct

taste and judgment of Mr Battam, the intelligent artist who presides over the artistic department of these extensive works. This superb tazza is peculiarly adapted for the decoration of the conservatory, as well as for occupying a conspicuous place on a terrace or other important position in connection with architectural buildings. The material of which it is composed is that superior plastic material for which this establishment has been long and deservedly famed, and is insured to stand even the variable climate of this country in the open air. Conservatories, even of the highest grade, have hitherto been sadly deficient in artistic furnishing, and this has mainly arisen from a want of general taste for the fine arts, and, consequently, a want of patronage to this style of art manufacture—marble sculpture being both expensive and not altogether adapted to the humid atmosphere of a structure dedicated to the culture of plants. With such splendid material as is furnished by Mr Copeland, Messrs Minton, and others, in porcelain, pottery-ware, artificial stone, cast-iron, &c., there can be no reason why our conservatories, particularly such as have any pretension to architectural display, should not have these artistic furnishings as well as the trees and plants with which alone at present they are stored.

Fig. 862.—A garden vase of cast-iron placed on a marble pedestal. One of the most eminent sculptors this country ever produced, as we have already noticed, predicted that cast-iron would never be brought to such perfection as to equal the sculptor's chisel. We think the Coalbrookdale Ironworks have, of themselves, stultified that prediction; and our present subject, selected from that establishment, may be offered in evidence of this assertion. Both the masks and handles are of novel and elegant design, and the sharpness of the angles in the casting is as true as if just received from the studio of Canova. Indeed, it is to cast-iron, porcelain, pottery-ware, and artificial stone, that we have to look for such articles of ornament; and had either or all of these arts been cultivated when the geometrical style of gardening was in fashion in this country, our then finest gardens would not have been disgraced

by monstrosities resembling men and things cast in lead, nor our present ones have been so meagre of sculptured orna-

Fig. 862.



ments, as to give good cause to foreigners to charge us with poverty in design as well as in means. From the imperishable materials of which this very elegant vase is constructed, it is calculated to stand in the open air in this country. Had the pedestal been of polished Peterhead granite, we would have preferred it to any marble whatever, both on account of its colour and its being less liable to become discoloured or covered with minute species of lichens, which all marbles are liable to in our humid climate.

Figs. 863 and 864 are examples of terracotta vases, manufactured by Messrs Dou-

Fig. 863.



cotta vases, manufactured by Messrs Dou-  
ton & Watt  
of Lam-  
beth, suit-  
able for set-  
ting speci-  
men plants  
in, either  
along the  
floor of a  
conserva-  
tory, en-  
trance hall,  
balcony, or  
on the top of low terrace-walls in the  
open air.

Fig. 865.—This very elegant vase is from the manufactory of M. Garnaud,

jun., of Paris, and made of white terra-cotta—a very desirable kind of material,



Fig. 864.

and an exceedingly good imitation of stone. The design of this vase has merits sufficiently obvious to the eye of the connoisseur, and being so far removed in general appearance from those we every day see,

must please even those least acquainted with the principles of true taste.

Fig. 866.—This elegant cast-iron vase is a specimen of the taste and execution of M. Ducl, of Paris. It possesses, in our estimation, merits over the majority of garden vases, as usually met with, which are too often bad copies of the antiques, or, if of modern design, often defective in proportions, or wanting in elegance of form. Vases require to be something more than mere flower-pots; indeed, it is questionable if plants should be placed in those possessing artistic or classic merits. They are sufficient orna-



Fig. 866.

ments of themselves; and our present subject is an illustration of this kind.

Fig. 867 is another garden vase, possessing, with the last, more than ordinary merits. In material it is very different, being fabricated of a rich pale terra-cotta of exceedingly admirable workmanship,

Fig. 865.



and highly creditable to the proprietor and modeller, Mr J. Pulham, of Broxbourne, Hertfordshire. This vase stands

Fig. 867.



on a square granulated pedestal of similar character, which, like the vase, shows great sharpness and delicacy of execution.

Fig. 868.—An urn, selected from many others of various degrees of merit, from the stock of the Grange-

Fig. 868.

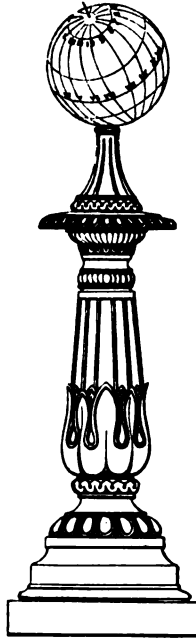


mouthern Coal and Fire-clay Works. We have here a vase evidently intended for its legitimate use in garden decoration, and not to be desecrated into a mere flower-pot. Such vases associate well in connection with Grecian, Roman, or even modern Italian architecture. The material employed in this establishment, like that we have noticed in Section FURNACES, page 253, as used in the Garnkirk Works, contains a large amount of silica and alumina, both of the most essential use in the production of an infusible fire-clay. From the same firm we received, but too late for insertion, drawings of a very ornamental and novel smoke-flue, made of fire-clay, and forming a very neat balustrading.

*Sun-dials.*—Sun-dials are both ornamental and useful. Their position always should be that of full exposure to the sun. A taste for dials appears to have been much greater formerly in this country than at present. No doubt, watches and clocks were not then common; and as men measured time by them, they would be set up as conveniently to their dwellings as possible. These, from being an article of use, would lead to their being introduced in grounds as an article of decoration. Fine specimens of ancient dials exist in the flower-gardens at Drummond Castle, Newbattle Abbey, and elsewhere. Indeed, where they have escaped the frenzy of reform, they seem as faithful chronicles to inform us that a taste for garden decoration existed in ages long gone by.

Fig. 870 represents one of the two ancient dials at the latter place—both being 15 feet in height, and similar in design. They are placed on modern basements, giving them an elevation in excellent keeping with their size and importance. From the initials (in the absence of date)

Fig. 869.



style. Although the dial has now ceased

they must have stood there for two centuries at the least. The panels under those on which the initials and arms of the ancient family of Kerr are cut, form each a separate dial-plate, and are in the highest state of preservation. Those at Drummond Castle are in the form of obelisks of great height and symmetry, and, after the manner of the times in which they were constructed, have many concave dial-plates cut on their sides. Here, as at Newbattle, the dials are placed in gardens, in the formal

Fig. 870.



to be of the same useful importance as formerly, still, if elegant in design, as those to which we have alluded are—or like our example, fig. 869—and if free from such puerilities as are frequently met with, they may, with much propriety, be admitted into flower-gardens of the highest order, either connected with architecture, or placed at the termination of long straight walks, or where these intersect each other. In either case they may be regarded as the silent monitors of the flight of time, and we become, as it were, attached to them.

*Mural decorations.*—The mural decorations of a garden are terraces, parapets, vases, globular, ovate, triangular, and other geometric figures, hewn in stone, moulded in clay or other materials, and burnt; and their principal use is to unite the house with the grounds surrounding it. Rich architectural forms may be indulged in where the mansion is of a high order; indeed, to be in keeping, they must form, as it were, part of it. For architectural villas, terraces and parapets of less costly erection and material may be used. Polished or droved ashlar is usually employed for this purpose, and such should certainly be the case when the mansion is of the same material. Brick, brick covered with various cements, and even fireclay ware—such as that manufactured by the Garnkirk Company, of which the annexed specimens, figs. 871 to 875, are representations—may be

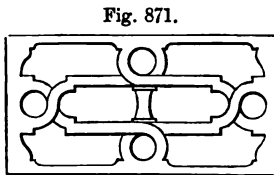


Fig. 871.

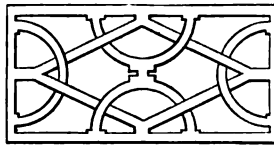


Fig. 872.

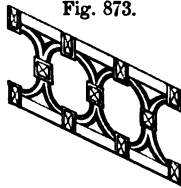


Fig. 873.

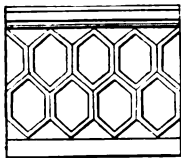


Fig. 874.

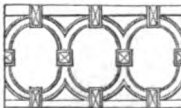


Fig. 875.

with safety and propriety used, especially

for balustrading, which, in any other than a moulded material, becomes so expensive as to preclude the use of this kind of ornament almost entirely from our gardens.

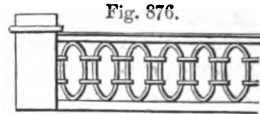


Fig. 876.



Fig. 877.

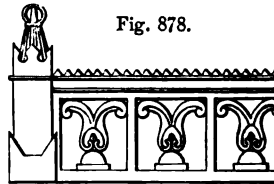


Fig. 878.

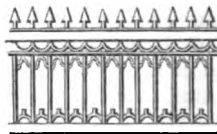


Fig. 879.

and coloured or covered with cement, to suit the colour of the adjoining build-

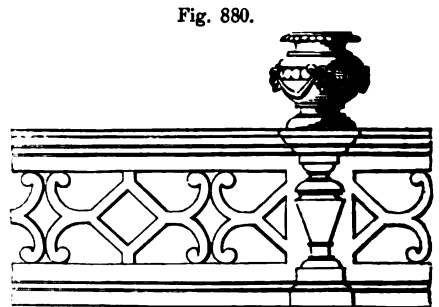


Fig. 880.

ings. This has been employed with good effect in a small Italian flower-garden laid out for Lord Ernest Bruce, in Marlborough Forest. On the top of the wall forming the plinth is set a course of bricks on edge, and on them three courses of 9-inch drain-tiles, forming the open part of the parapet. Over them are two courses of paving-tiles, projecting 2 inches over the face, and 2 inches thick; then a course of brick on bed, the top being finished with another course of

2-inch paving-tiles, such as are used for laying cottage floors. The pilasters are carried up in brick, and capped in the same manner as the rest of the wall. On the top of these pilasters are set vases of appropriate sizes and forms, the whole being set in cement. When we saw this garden, we were much struck with the elegant appearance and economy of the construction. Wherever clay is used for such purposes, it is important that it be of the very best quality, so as to stand the weather; indeed, we think the fire-clay, and clay in various compositions, used by the Garnkirk and Grangemouth Companies, Mr Wauchope of Edmonstone, and Deane of Wishaw, far superior to any we have seen in England, and, for durability and elegance of design, ranking next to the artificial stone of Austin and Seeley, and the still more recently discovered and imperishable material, the Patent stone of Ransome and Parsons of Ipswich. Objections have been made to plastic ornaments, on account of many of the less perfectly manufactured specimens having given way with the weather. Those we have named have been clearly exempted from that defect. The patent artificial stone of Ransome and Parsons has been proved, by experiments made by the Society of Civil Engineers, to be of greater strength than the natural stone of Caen, Bath, York, or Portland; and we have seen vases formed of it, which have stood filled with water all winter, which water was frequently frozen into solid masses of ice. Another advantage this stone, as well as that of Austin and Seeley, has over fireclay imitations, is in colour, which in both cases closely resembles the stone of Bath and Portland, thereby harmonising better with surrounding architectural buildings.

Mr Varden, an architect of great taste, has supplied some excellent designs for economical parapets, &c., in "The Encyclopedia of Villa Architecture," which, for their simplicity, ought to be employed. These designs are evidently the result of much care and study, and are so distinctly given in the cuts that any builder may carry them into execution. Of late years, cast-iron has been employed for most kinds of mural decorations. The only objection, when the design is massive, is its seeming want of importance, if not cast

of the same diameter that a similar subject in stone would be, if used for the same purpose. This, however, may be remedied by casting the pieces, as it is technically called, with a core in them. By this means the external appearance of size may be given without the employment of too much metal, as they would, of course, be hollow. To prevent oxidation, the metal should be coated with glass, on Johns and Co.'s principle, or by some of the other processes mentioned in this work. The great advantage of cast-iron is its durability, admitting it to be kept exposed during winter, which even marble is not found to withstand without injury in our cold and damp climate; and hence, to secure it from harm, it has to be either removed or covered up during that very season when it would constitute almost the only artistic object our gardens present.

Slate has been advantageously employed for steps, coping, terraces, &c., and is found to keep perfectly free of moss or stains, and to require no cleaning. If the natural colour be objected to, the slate should be rubbed down with coarse grit, and painted stone colour, the last coat being flatted—that is, mixed with turpentine instead of oil—which will take off the shiny or glossy appearance, and make the resemblance to stone more complete.

Of all decorations to our gardens, none are so sparingly admitted as specimens of the works of art, and hence the puerile and mean appearance they present, when compared with those laid out in the Italian style. Our modern garden-makers depend too often for effect on the gorgeous display of colour produced by plants, and lose sight entirely of those decorations of a more permanent character, which used of themselves to form the chief feature of our ancient gardens.

In regard to the admission of decorative subjects into garden scenery, Sir Uvedale Price remarks, "that rich and stately architectural and sculptural decorations are only proper when the house itself has something of the same splendid appearance. This is true in a great measure; but though it is only in accompanying grand and magnificent buildings that the Italian garden has its full effect, yet as there are numberless gradations in the style and character of buildings, from

the palace or the ancient castle to the plainest and simplest dwelling-house, so different styles of architectural, or at least of artificial accompaniments, might, though more sparingly, be made use of in those lower degrees, without having our gardens reduced to mere grass and shrubs. Those near decorations, in every different style and degree, and their application, ought certainly to be studied by ornamental gardeners, as well as the more distant pleasure-grounds, and still more distant landscape, of the place."

#### § 4.—STATUES.

Statues, like fountains, and for precisely the same reasons, have long been slightly regarded in this country. Indeed, a taste for sculpture in the decoration of private gardens appears scarcely now to be recognised. Why so important a department of the fine arts should be thus disregarded, whilst others are so ardently cultivated, is passing strange. Statuary and sculpture formed the leading features of those rich and classic gardens of antiquity, of which scarcely even now the remains are left. Both were indicative of a luxurious age and a high state of refinement in society. At no period does it appear that either, in their highest state of perfection, were introduced into our gardens; and this is probably partly owing to the poor imitations of them in lead, with which our older gardens were often stored, the want of native artists, and the cost of procuring genuine specimens from the chisels of Italy—where, notwithstanding the darkness which has long covered that once enlightened land, sculpture, as if it were a genius inseparable from her cloudless sky, lingers. That those castings in lead, which for two centuries were thought graceful ornaments to our gardens, should have given a distaste for their continuance, is natural; but why, now that architectural palaces are rearing up their heads in every corner of the land, and Italian architecture cultivated to a greater extent than heretofore, should those adjuncts, so essential in carrying out the entire design, (the gardens, and their accompaniments—sculpture and statuary,) be so much neglected? Better, indeed, have none, than vile mis-

representations; but although we are not, with all our presumed wealth and refined taste, either rich enough or possessed of sufficient taste to procure, or even attempt to procure, such works of art from the first masters, either of our own or any other country, in sufficient numbers to produce great effects, still the want of encouragement to native talent prevents the genius of Britons from directing its energies to an art to which there is so little encouragement given.

It has been stated that the marbles of Italy are unsuitable to our humid climate. If such be really so, let us take the next alternative, and have recourse to castings in iron, and afterwards to mouldings in the plastic art. Though our gardens may be richer in floral furnishing and in elegance of design, still there is a want to the completion of a perfect whole, and that want is statuary and sculptural ornament.

It has been considered by some pretended connoisseurs to be ridiculous to place imitations of human beings on posts and pedestals, in the open air, and exposed to all weathers; and others, affecting an extreme modesty, object to statuary altogether, unless clothed with more than with a fig-leaf. Our answer to the first objection is, that it would be still more ridiculous to place them only in warm rooms. Statues are to be considered as works of art amongst other works of art, which gardens assuredly are; and there seems no reasonable objection to placing them anywhere, amongst other artistic works of the same kind, such as architecture—an art the productions of which have been in all ages closely associated with sculpture. To the second objection we may answer, "*Honi soit qui mal y pense.*"

Whenever architectural ornaments are introduced in a garden, we see no objection to introduce, in association with them, statues and other sculptural articles, if the subjects are sufficiently good, and in a material capable of standing our climate. There are few things in the way of garden ornaments which we are more desirous of seeing introduced than statues of cast-iron, and those cast in one piece, which now can be coated with several of the more valuable metals, and thereby resist oxidation—one of the former objections to them. We have

seen what has been done on the Continent in the way of casting in iron, and we look to the Coalbrooke Dale and other spirited companies to realise our utmost wishes. The statuary of Austin and Sesley, in artificial stone—that of the Grangemouth Coal Company and the Garnkirk Company, in fire-clay material—and lastly, the patent artificial stone of Ransome and Parsons, all stand our climate without the slightest appearance of decay. The expense of works in any of these, even of the most chaste and classic designs, may be stated at from fifteen to twenty guineas—sums, considering the excellence of the workmanship, exceedingly moderate.

In regard to the disposal of statues in architectural flower-gardens, it may be observed that much taste and feeling is required. The following, as a short general rule, has been laid down in "The Encyclopedia of Villa Architecture:"—"We would suggest that no statue ought ever to be placed where it may not be viewed in connection with some architectural production, such as placed on the piers of a balustrade, on the side-walls of a stair, or simply on pedestals among flowers, but so as to have always a spreading architectural base, and to be seen backed by a wall, or some part of a building. Statues may also be placed where they are seen in connection with each other—though this will not be entirely satisfactory without some mural appendages. Statues placed in woods, in green arbours, verdant alcoves, in the midst of naked grass lawns, or, in short, in any place where they are surrounded only by vegetation, are, from their want of harmony with the scene, decidedly objectionable."

Both the selection and disposal of statues require due consideration, so that the fault of incongruity may be avoided. Thus it would be absurd to place the statue of Pan in a highly-finished flower-garden, while Ceres and Flora are made silent inhabitants of the surrounding woods and groves. Jupiter and Mars should occupy the centres of the largest pieces of lawn. Neptune should possess the centre of the largest body of water; while Venus should be associated along with the Graces, Cupid, &c. in the most refined parts; Apollo, with the Muses and Minerva, amongst the representations of

the liberal sciences. In statuary, the scale of size should be proportioned to that of the garden, and all should be elevated on highly architectural pedestals. Nor should statuary be confined entirely to the tutelary gods of men's imagination. The statues of living as well as of dead heroes, poets, philosophers, and philanthropists, are equally, if not more, fitting for the embellishment of a modern flower-garden. Statues of the class of Eve at the fountain, the Dancing Girl, &c., are also admissible. As sculptural decorations, statuary is undoubtedly the highest in an artistic point of view. Great care is therefore required in their disposal, to avoid the errors fallen into even by the old masters of the art; such, for instance, as those seen by Evelyn in the palace gardens of Hieronymo del Negro, at Genoa, where he says he saw a grove of stately trees, amongst which were sheep, shepherds, and wild beasts, cut very artfully in grey stone. The statues of Adam and Eve, Flora and Pomona, &c., which disgraced many of our older gardens—and very sorry representatives of the originals, we have no doubt, they were—have, in many cases, been substituted by specimens in artificial stone, fire-clay, and other materials of a much higher class, as works of art; and the more recent improvements in castings in iron, zinc, &c., have given us both more durable and artistic substitutes for the marble statues of antiquity. Statuary in these materials is no new invention. James, in his translation of Le Blond's work on gardening, written about the beginning of the eighteenth century, says, that the richest statues were those of cast brass, lead gilt, and marble: the ordinary sort are of iron, stone, or stucco.

"The Chinese," says Sir William Chambers, in *Dissertations on Oriental Gardening*, "are fond of introducing statues, busts, bas-reliefs, and every production of the chisel, as well in other parts of their gardens as around their dwellings, observing that they are not only ornamental, but that, by commemorating past events and celebrated personages, they awaken the mind to pleasing contemplation, hurrying our reflections up into the remotest ages of antiquity; and they never fail to scatter inscriptions, verses, and moral sentences about their grounds, which are placed on large ruined stones, and



columns of marble, or engraved on trees, or rocks; such sentences being always chosen for them as correspond with the scene of the inscriptions, which thereby acquire additional force in themselves, and likewise give a stronger expression to the scene."

*Busts and Pedestals.* — Busts, when placed on appropriate pedestals, become, as it were, connected with statues, and their disposal will be governed by the same rules. They are, perhaps, more appropriate appendages to the walls of a house, or for niches in the walls. They are sometimes, however, placed on pedestals along the sides of walks, as at the grounds at Stoke Park, long the residence of the descendants of the celebrated William Penn; and on some places on the Continent, such as that of the Baron Joseph D'Hoogvorst, at Limmel, near Brussels, and elsewhere, where taste for this kind of decoration seems greater than with us.

The grounds at Stoke were originally laid out in the geometric style, and in accordance with the original mansion, which was considered as one of the best

Elizabethan houses in England. The present house is in the Grecian style, and the grounds are completely changed, and laid out in what may be called the classical style of the poet Mason; the forms of the masses of shrubs and flower-beds being chiefly circular or elliptical, and each seems distinguished by appropriate statues or busts placed on pedestals or therns. They are, no doubt, good likenesses of the great men they represent; but for the edification of those who had not a personal acquaintance with them, in general (or at least they did some years ago) they carry their names attached to them.

### § 5.—SEATS.

These, if of architectural forms, are admissible in gardens of the geometrical style, both as being ornamental and useful.

The chairs, of which figs. 881, 882, 883 are examples, are from designs furnished by the celebrated Professor Heideloff to the "Art Union of London," and form part of a stupendous work preparing by

Fig. 881.

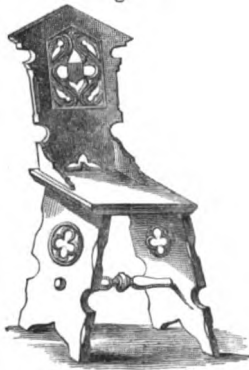


Fig. 882.



Fig. 883.



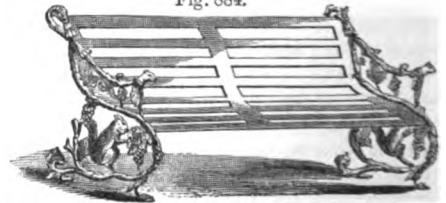
him, illustrative of the ancient designs in Germany.

We have selected these subjects from the rich collection of Professor Heideloff, not that they are by any means the finest specimens of his research, as they are, for the most part, intended for mansion decoration. Those we have chosen are, however, adapted to garden purposes, and being of simple Gothic forms, are of easy execution, and could be made at little expense, now that the process of wood-carving is so easily applicable to curved

lines. Nor would it be difficult, if desirable, to cut them in stone.

Cast-iron chairs, both architectural and artistical, as figs. 884, 885, 886, are also

Fig. 884.



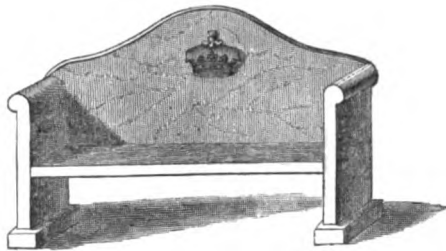
admissible in the highest order of gardens. The two first are specimens of the supe-

this endeavour to imitate stone must not, although often done, be tried on those

Fig. 885.



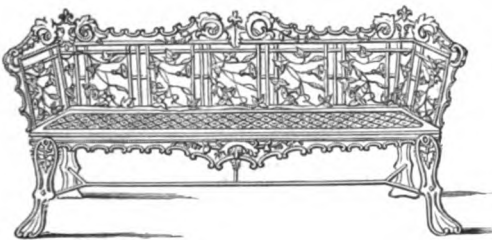
Fig. 888.



rior castings of the Coalbrooke Dale founderies; and the last may, as well as vari-

whose form and style indicate the material of which they are formed. Their durability is not proportionable to their cost; for, as garden ornaments, their presence is as much required during winter as in summer, and therefore they cannot be placed under shelter during that period.

Fig. 886.

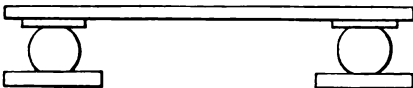


Seats are essential objects in all gardens, in those of the most extensive as well as in those of smaller size and of less pretensions.

ous other forms, be had of any respectable foundery or ironmonger.

Fig. 887, and forms nearly allied to it, by changing the form of the supports,

Fig. 887.



are made of Aberdeen or Peterhead granite, sandstone, or, indeed, any other pavement, and even of coal, as exemplified by a specimen made of Fifeshire coal in the late Exhibition. Polished Aberdeen granite seats of this kind are exceedingly beautiful, but they become expensive from the amount of labour bestowed upon them. Some good specimens exist in the Duke of Buccleuch's gardens at Drumlanrig, the royal grounds at Windsor, and elsewhere.

Fig. 888 is another form of the same material. Richly-carved and highly-architectural chairs are occasionally met with in our gardens; and these, when newly painted, if sanded over in imitation of stone, have a pretty good effect. But

#### § 6.—TEMPLES AND ARBOURS.

In architectural gardens and grounds these are also very appropriate, both for the shelter they afford and the opportunity they give the owner of displaying both his wealth and taste. These, however, should be strictly architectural, and of the same order with the mansion and principal parts of the grounds. They are, perhaps, too large for the flower-garden, strictly so called, but, for the pleasure-grounds, they are essentially necessary. They should, in general, be placed on elevated ground, if the object mainly is to make them objects seen from a distance. At other times they may be placed at the termination of a long vista, or in a situation from whence may be viewed some interesting object or beautiful landscape.

Such structures become necessary adjuncts to all large places, as the eye, long wandering over vegetable landscape, is relieved and attracted, and rests with pleasure on a new object. The same

refreshing sensation is felt when, wandering long amongst trees and verdure, the eye catches the first glimpse of a fine sheet of water. Temples and resting-places may be denominated eye-traps of utility.

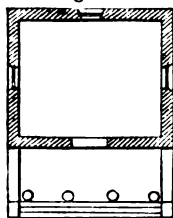
Porches and porticos are often admitted in garden scenery as decorative objects or eye-traps only. These deceptions are, however, not in the most correct taste; for nothing having the appearance of a temple, or house, or place of shelter, *that can be approached*, should be other

Fig. 889.



than what it really professes to be. The falsity of this taste is as great as the disappointment would be to those seeking shelter from a storm and finding none.

Fig. 890.



That the effect of such objects is good when seen from a distance is undeniable; but they should combine the useful at the same time, by having a room behind, as shown in elevation and plan, figs. 889, 890.

The erections which come under this head should be regarded as permanent and substantial, therefore stone or brick covered with cement should be the material employed—the former always where the necessary expense can be afforded. Both the design and disposal of them require due consideration, so that every structure of the kind should be in harmony with the site in which it is placed, else, if executed without taste, or in an inappropriate style, they will appear ridiculous, and greatly diminish the pleasure with which we view the works of nature, aided, as they may be made to be, by the introduction of the works of art.

Figs. 891 to 896 are suitable buildings of this kind for grounds laid out in the

geometric or architectural style.

They are taken from a very useful work on "Designs for Cottage and Villa Architecture," by S. H. Brookes, Esq.

Figs. 891 and 892 are a redesign of an octagonal pavilion in the plain Grecian style.

That represented by figs. 893 and 894 is in the same style, only more simple in its character and outline than the last; while

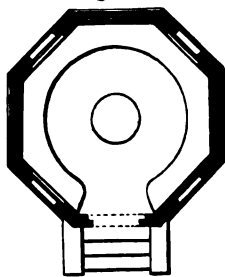
that shown in figs. 895 and 896 is a design in the Ionic style, and well adapted for an eminence commanding an extensive view of the surrounding grounds or distant landscape.

They are in a style we would wish to see more generally introduced into pleasure-grounds of the present day, instead

Fig. 891.



Fig. 892.



see more generally introduced into pleasure-grounds of the present day, instead

Fig. 893.



of the incongruous and fugacious buildings we occasionally meet with, erected at great

expense, and associating with nothing around them. If the scale of these examples be enlarged—and they should be so if placed in grounds of large extent—a spiral stair may be placed within them leading to the balconies or lantern tops above, so that they may become useful as prospect towers, or even be converted into select museums for specimens of natural history.

Fig. 897 represents an open temple on three sides, with a niche opposite the entrance in which a statue, urn, or other sculptural subject, should be placed. It is a fitting object to be placed at the termination of a long walk or vista. The back part, if not backed up with buildings of some sort, should be densely screened by shrubbery or plantations; the open part only of the structure should be seen. A retiring-room, if completely hidden from without, may be placed behind, the entrance to which would occupy the place of the niche, and of course the sculptural subject would be dispensed with.

Fig. 898 exhibits a specimen of an Italian arbour, which, although now little used, were at one time much es-

teemed in this country; their disuse probably arising from the expense of formation

Fig. 894.

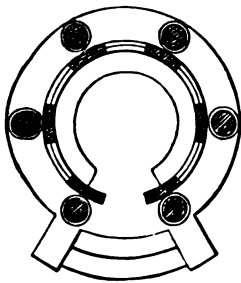


Fig. 895.

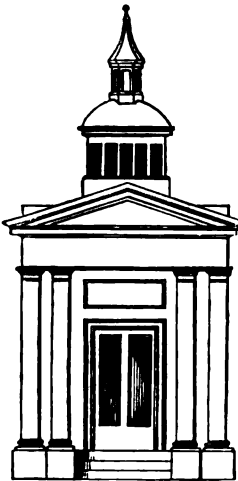


Fig. 896.

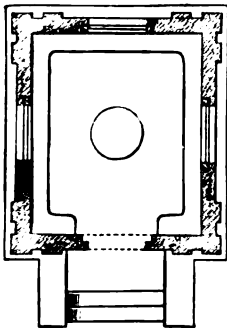


Fig. 897.

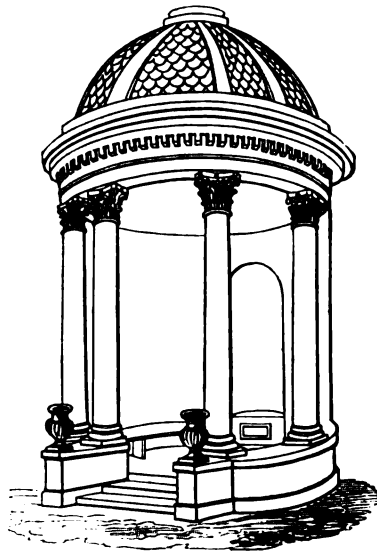


Fig. 898.



and their liability to decay, as they were usually made of wood, more than from

any objection to them as architectural subjects. The present increasing taste for geometrical flower-gardens, and the facility by which all such structures can now be formed of iron, will, no doubt, reintroduce them once more into garden scenery. On the Continent they have continued to occupy a place in most of the best gardens, particularly in those of France and Germany. We regret, however, to see that in the latter country they are destroying many of the noble gardens of antiquity, and laying them out in what they are pleased to call the English or natural style; and, whether from not fully understanding the principles abundantly laid down for their composition in works on landscape

gardening, or from a desire to improve upon those principles, we know not ; but certainly in many cases they have sadly erred, and, by carrying the natural part of the subject too far, have destroyed the features of a garden, when on a large scale, and converted it into a park in miniature : upon smaller scales, it is difficult to say whether a garden or park is intended. The specimen we offer is that of an arbour that existed in the famous garden of the Duke of Baden at Schweitzingen, which, when we saw it, was going into decay, and is since converted into an occasional hunting-lodge, although once one of the richest in the Rhenish provinces as regards sculpture and garden ornament.

Arbours of this description can be readily constructed of iron. We would, however, in all cases, have the roofs made watertight, by covering them with thin plates of corrugated galvanised iron. They would then enter into the catalogue of useful decorations, and, in such a climate as that of Britain, would be almost useless unless so constructed, as they would fail to afford shelter in the event of a storm. A very scanty covering of climbing plants may be indulged in, but by no means to the extent of destroying the character of the structure.

#### § 7.—MAUSOLEUMS, CENOTAPHS, OR SEPULCHRAL STRUCTURES.

These are adapted to every style of grounds, whether natural or artificial. The situation chosen should be that of quiet and repose.

The mausoleum erected in memory of the Princess Charlotte of Wales, in the grounds at Claremont, is in as bad taste, from its diminutive size and perishable material, as the marble cenotaph in the Chapel Royal at Windsor, erected for the same purpose, is chaste, imperishable, and beautiful. The mausoleums at Brockelsby, Trentham, Belvoir, Hamilton Palace, and Castle Howard, are worthy of their tenants and the commanding situation they occupy. Those of Brockelsby and Trentham are in open and exposed situations, without any indication around them as to what they really are. That at Belvoir is approached through a magnificent, although sombre and sepulchral, avenue of aged yews, and is well hidden until nearly approached. That at Castle Howard is placed in a retired spot upon the banks of the lake.

As architectural objects, they have their effect in landscape, and the order should accord with the style of the mansion and the other decorative buildings that may exist in the grounds.

## CHAPTER XIII.

### GARDENESQUE STYLE OF FLOWER-GARDENS.

#### § 1.—THEIR GENERAL ARRANGEMENT.

THE gardenesque style may be considered as partly picturesque and partly geometrical, inasmuch as the surface may be diversified—either level or slightly hilly—the trees and shrubs partly exotic and partly indigenous, but planted and grown as distinct subjects, neither crowded into dense masses nor placed in direct lines. The forms of clumps and parterres may be both regular and irregular, and the more permanent decorations may be composed of architectural and sculptural objects.

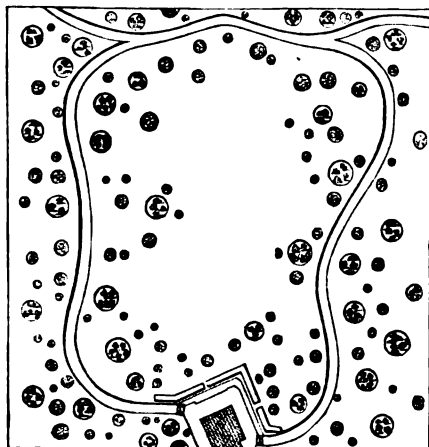
The gardenesque style is represented by fig. 899, which is on a lawn laid out with trees and shrubs in vertical profile. The

of garden, and, by graduating their sizes according to the magnitude of the sphere, producing that pictorial beauty aimed at in it. Much as we admire circular figures, judiciously arranged, in the composition of a subject, still we do not hold that no other figures should be indulged in. Circular figures of themselves, by reason of their entering well into composition either with themselves or with scattered trees and shrubs, will produce a very perfect garden, as in the figure now referred to. Other figures will produce an equally perfect whole, if judiciously arranged with trees and shrubs in another garden, or in another sphere.

In the present subject a terrace is introduced, separating the lawn immediately in front of the house from the rest of the grounds, and thus far blending the architectural style with the gardenesque, this terrace having its accompanying ornaments of vases, &c., placed on the top of the parapet-wall, which, if the grounds slope much from the house, need show little more than a plinth 12 inches in height on the side next the mansion. Its height on the other side must of course be regulated by the extent of declivity. If the house be on a level with the rest of the grounds, then the terrace must be separated from it, not by a dead wall, which would shut the garden out from being seen from the windows, but by a parapet of open work from the plinth to the coping.

This terrace must be in breadth in proportion to its length, the size of the house, &c., and be occupied with a broad and spacious gravel walk, with a parterre border between it and the terrace wall, but of a breadth not to exceed half of that of

Fig. 899.



walks are serpentine, or gracefully curved. The beds in this instance are circular, a form which has been considered by some artists as all that is necessary in this style

the walk. This border, if exceeding 6 feet, may be laid out in form of any of the four figures, 900 to 903, but with gravel

Fig. 900.

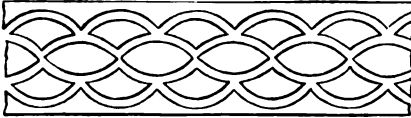


Fig. 901.



Fig. 902.



Fig. 903.



walks, and stone, slate, tile, or composition edgings, as should also be those of the broad walk. There is no impropriety, in such cases, in having a border of 18 inches or 2 feet close to the walls of the house, for creepers to be trained on the walls, and also for small, and, as much as can be, odoriferous flowering plants to cover the soil—which is desirable on account of appearance, as well as for preventing the splashing of the walls during heavy rains.

There can only be one objection to such a border, and that is, the fear of damp penetrating the walls. This, however, can readily be provided against, by draining well under it, and cutting off the connection between the border and wall, by introducing slate or pavement set on edge, and placed parallel to the walls, and from 2 to 4 inches distant from them. The opening above may be left open, but it were much better that it should be covered with a neat cast-iron grating, to prevent leaves or other litter falling in. These, however, should not be fastened down, as it may become necessary at

times to remove them for the purpose of clearing out any matter that may fall into the space.

We may here remark that, if circumstances are otherwise favourable, the garden should be placed on the north side of the house—that is to say, if immediately connected with it—because all flowers naturally turn to the sun, and would in that case present their faces, as it were, to the windows from whence the garden is viewed. In no instance have we seen this better exemplified than at Belton House, the seat of Earl Brownlow, where the magnificent flower-garden is thus placed.

This is a very important point to be kept in view in fixing on the proper situation for a flower-garden—namely, the form and arrangement of the mansion. If the principal sitting-rooms be on the north side, the garden may be so placed; but, on the other hand, if these are on either of the opposite sides, so also should be the flower-garden; and hence the necessity of co-operation between the architect who builds the house, and the landscape-gardener who arranges the grounds. In this style the surfaces, whether level or undulated, are to be rendered smooth and regular—not so truly mathematically level as in the geometric, nor so rugged or uneven as in the picturesque style. The grass here requires to be kept in trim order, the walks graceful in their curves, or straight, as the case may be—their risings and fallings made so gradual that their ascent or descent may be easy and agreeable.

From the house there must always be a main walk, from appropriate points of which others should branch to the several parts of the garden, park, &c., and should be so disposed as not to command a view into any of the rooms. Gravel walks should be rarely seen from the windows. Where the extent of the grounds will admit, they should be dispersed amongst the plantations, with occasional openings upon different views. The great art in this depends upon judiciously directing the windings of the walks, and varying the views of natural and artificial objects, so that the spectator may not be aware that he is at times nearly retracing the ground he has previously passed. Thus a greater extent will be made to appear

than really exists. Wherever the paths are turned, they should lead to the beauties of the scenery; "and where such do not naturally exist, they should lead to artificial objects, such as resting-places, statues, &c.; for nothing can be more ridiculous than to be made to traverse a walk that leads to nothing. In short, such walks should be judiciously directed, and lead wherever any object may be seen to excite admiration, or tranquillise the mind to calm reflection."—BROWN.

The gardenesque style possesses certain properties which the geometrical wants. The latter claims our admiration for its grandeur and richness of decoration, both in works of art and symmetry in design, and its gorgeous display of harmoniously arranged parterres; the former, for the privacy it affords, the economy by which it can be produced, and the variety it is capable of being made to possess;

In this style also, the shrubbery, which forms one of its most prominent features, becomes the natural substitute for the terraced wall in the former. "Shrubberies," says Brown, "are the most prominent features in rendering a country seat an object of ornament and delight; and it is in this department of laying-out and planting, combined with taste, and a skilful appropriation of the ground, that an extensive practical knowledge is required to produce all the desired effect, not only for the judicious arrangement of the plantations, but of the various trees of which they are composed, and demands the exercise of true taste, that the component parts may be suitably disposed, as well in contrasts of form as of colour, so that they may appear to advantage when viewed individually or collectively. Vases and statues, tastefully disposed about the pleasure-grounds belonging to classic architecture, have a pleasing effect; and in extensive shrubberies the arrangement of statues and busts, if numerous, should be directed by classic taste, that they may be disposed with propriety and truth. No greater absurdity can appear than where such decorations are indiscriminately mixed, without literary order or classic associations." Stewart, however, observes of them, that they have added immensely to our natural resources; but, at the same time, they have warped our taste in various instances.

In the gardenesque style, when the garden is to embrace within it the whole lawn, abundance of evergreens should be interspersed amongst the deciduous trees and flowering shrubs, to preserve a lively and interesting appearance, as well in winter as in summer. "Although green turf is very pleasing and ornamental upon a lawn, still a large surface requires trees, decorative flowering shrubs, and plants, to relieve the monotony of its appearance, and render the scene more pleasing and interesting. Care must be taken to leave uncovered a sufficient portion of lawn for turf, as shall admit a free circulation of air, and breadth of light, to display the form and effect of the surrounding plantations. Alleys leading to shady walks should be formed between the trees and shrubs. Vistas which guide the eye to artificial objects, or to distant beauties, should be particularly attended to. The characteristics of a pleasure-ground—that is, a gardenesque garden—should be elegance, variety, and harmony, by the judicious contrasts in the distribution of partial flower-beds, shrubs, and plantations, with other tasteful and appropriate decorations."—BROWN.

The majority of trees and shrubs employed ought to be of exotic species, to render, in this part, the distinction more obvious between it and the picturesque style. Nor should they be too closely planted, as, in that case, they would be apt to run into the picturesque, and become masses of natural confusion: whereas, they ought to be so planted, and afterwards managed, that each may arrive at perfection, and develop its natural beauties, as if it were cultivated for that purpose alone. Each tree and shrub must stand perfectly clear and distinct; for on this, in a great measure, depends one of the leading principles of this style.

Regularity in planting, to a certain extent, is not excluded from this style, nor are the various attractions of sculpture and architecture to be entirely neglected. On the contrary, they are to be indulged in. Statues of a certain class, fountains, vases, architectural or rustic, may be introduced with becoming effect.

Although it is recommended here that the trees and shrubs are to stand free and distinct from each other, it does not follow but that groups of three, five, or



seven should here and there be planted together. If of one species, they form ultimately one object; and, in large places, such a proceeding becomes necessary, for the purpose of proportionate effect. A group, for example, of Rhododendrons, Azaleas, &c., if confined to one variety, appears, when fully established, as one large and imposing subject. Fastigate or spire-like growing trees should not, however, be thus grouped, as their many points shooting through the general outline of the group would betray and expose the deception. Pruning well in this style becomes necessary, but this should only extend so far as the removal of any overgrown or misplaced branches. Fore-shortening, in many cases, should be attended to, that the outline of the shrubs may appear close and compact; but all clipping, and the use of the shears, should be avoided. The trees and shrubs should

Fig. 904.



baskets, (figs. 904, 905,) may be freely indulged in, notwithstanding the denunciations of Seekyl, and other modern landscape-gardeners, against these, as having an appearance of want of durability.

Fig. 905.

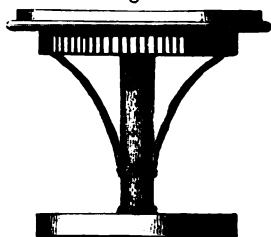


nosegays, rising out of the ground, in

their most happy form. This mode also gives the semblance of order and symmetry, and prevents the appearance of those irregular lines, and the destruction of the turf, which always ensues where plants are allowed to ramble beyond their proper limits. It is well also to stick in neat branches, of a foot or so in height, where the plants are a few inches high, to act as conductors or supports to them, and to prevent their lower parts rotting from want of air. According to the form desired for the bed, so should the arrangement of these supports be. If conical, they should, as well as the kind of plant, be highest in the centre. If flat-headed, they may be all of the same height. The plants will soon cover these supports, and their duration in beauty will amply repay the trouble.

Elevated stands for rock-plants of the rarest kinds, and most minute species,

Fig. 906.



(fig. 906,) although recommended now, for the first time, may be added with utility and effect. The use of such a stand is twofold —

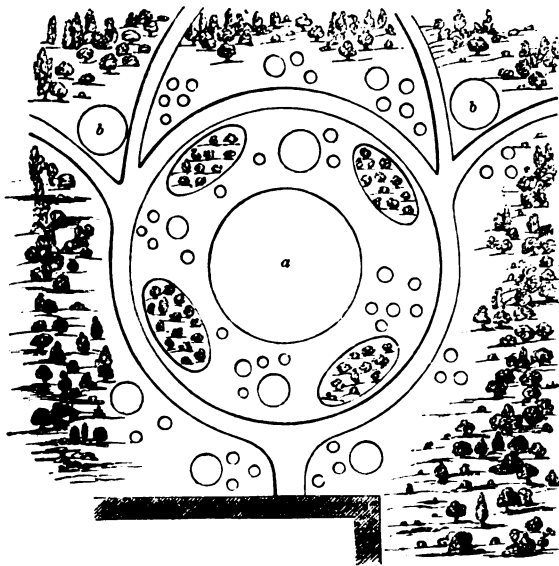
namely, preserving them from being run over by stronger young kinds, and placing them in a more convenient position to be seen. Such a stand, however, should contain only such as *Houstonia cærulea*, *Anagallis tenella*, *Bellium minutum*, and the like.

Fig. 907 exhibits another specimen in this style, but without terraces in front of the house, and having elliptical clumps of shrubs, with a bowling-green in the centre of the lawn, sunk eighteen inches below the general level of the ground. The shrubs in the elliptical clumps are to be planted and kept, so that each may appear perfect in itself, and not crowded in dense masses, as is too frequently done.

A garden, of which this is a pretty correct representation, existed in Perthshire, until swept away, in consequence of the erection of a new mansion upon another site, about thirty years ago. Of the artist who designed it we know nothing, as it

must have been laid out about the beginning of the last century. We avail ourselves of it to show that considerable progress had been made in the gardenesque style even at that period. We may here remark, because it should be considered a general rule in this style, that the ground between the shrubs in the oval borders, in fig. 907, should be kept clear of weeds,

Fig. 907.



by fork-digging or hoeing; and that the outline or boundary of them should be definite, having the edges of the turf regularly cut, but not so deep as to show a harsh line: and this rule should be followed in all cases wherever shrubberies or plantations exist in such gardens, that the forms of the beds, borders, and shrubberies may indicate, by the regularity of their forms, as much as in the disposal and management of the shrubs and plants, that art and keeping are here to be recognised; while in the picturesque style, that recognition is to be scarcely appreciable.

In this figure we have introduced a bowling-green, *a*, a very old component part of the gardenesque style. It enters not into the Italian, or other strictly geometrical garden, and appears, so far as history informs us, to be only of modern use in Britain—somewhat, however, older than the date of the origin of the gardenesque style. To landscape-gardening it

adds nothing, only a circular, square, or oblong piece of lawn, rendered as level as possible, and sunk somewhat under the general level of the surrounding grounds, so as to present a small bank of turf, to stop the progress of a strong bowl; otherwise, as dryness and nicety of level are two essentials, we would have thought an elevated position would have answered as

well. With bowling-greens we quarrel not—they do not interfere with the beauty of a landscape; with their use we quarrel not, more than with that of curling, quoiting, or cricket. They afford exercise to those who may require it, and of a much more humanising and less demoralising character than those which are considered the more refined amusements—viz., steeple-chases, fox-hunting, and *battue* shooting. We have also, while keeping to a certain extent to circular clumps, introduced elliptical ones, and, as affording variety, have added at *b b* two small gardens of circular outline, but which are to be subdivided into smaller compartments, according to the taste of the owner.

In regard to the planting, and arranging the clumps, groups, and trees, as well as indicating the lines of walks in such a garden, the following hints may be studied with practical advantage. It may be laid down as a pretty general rule, that all walks should be straight when there is no obvious reason to the contrary. No person would take a circuitous route to reach an object, if that object could be approached by following a direct line. Hence, therefore, in the case of all winding walks, if there is not a natural, and apparently unavoidable obstacle, as a reason (such as a tree, a rock, a building, &c.) for thus deviating from the straight line, an artificial one ought to be created. To twist a walk into a tortuous direction, where no reason can be assigned for so doing, is one of the many fallacies so often displayed by the layers-out of many of our modern gardens, and is nothing short of an outrage against the principles of correct taste. This is a subject deserv-

ing reflection and consideration, as it is an error of judgment to be met with in most gardens. Reasons may easily be created for a winding path, even on flat surfaces, as by taking advantage of the position of existing trees or shrubs, by planting others, or by placing some artistic object at the point where the change of direction is required. On unequal surfaces, inequalities may be heightened or deepened, by digging a pit or throwing up a fosse. When a winding walk is to be bent to the right, the obstacle, be it trees or shrubs, ought to be chiefly conspicuous on the left hand, and *vice versâ*; and the same rule applies to inequalities of surface. These latter, however, should not be of so formidable a character as in the case of the picturesque arrangement. In the case of walks proceeding in a straight line, however short that line may be, the surface of the ground on both sides, and for some feet in breadth, should be rendered perfectly level and smooth, excepting in the case of terrace walks, where the verge on one side should be level, the slope on the other side rising gradually, in a regular and uniform manner. The verge in such cases should be broad, and the ground declining from it in a uniform fall. Every straight walk should have a terminating object—either a temple, a seat, an alcove, an arbour, a resting-place, or a cross parapet, over which some distant view, or object of interest, is to be seen. Be the terminating object what it may, it is essential that it be seen the instant the walk is entered upon, and be, as it were, an object to reach, to satisfy the mind that the labour of walking is not in vain.

In the case of winding walks, no such objects are required, because every turning presents some fresh object to arrest the eye and satisfy the mind, and lead it on, as it were, to see what is beyond. The same rule that has been given for changing the directions of a walk by deviating from the straight line, applies also to that where one walk joins or branches off from another at a nearly right angle. To show a cause for this deviation, advantage should be taken of some obstruction, such as a tree, shrubs, &c.; or an artificial reason must be created by placing some specimen of art, a seat, a mound, &c., to show that the walk could proceed

no farther in its original direction; but, to avoid the obstacle, has to be turned aside. Another walk may branch off in a different direction at such points rather than elsewhere—the same apparent cause opening a reason for both. The advocates for the natural style of laying out grounds say, that in tracing the direction of walks, nature should be imitated, and they adduce the track of sheep in pastures, or wild animals on commons, as examples. "But to imitate such walks," Mrs Loudon very properly observes, "would be to copy vulgar nature; and therefore art refines on those lines, by rendering them more definite and elegant—in short, by exhibiting in them a choice of form or line for its own sake; because, of the various lines, or parts of lines, found in accidental footpaths, some must be more agreeable to the eye than others, and it is only these agreeable parts which are to be imitated and combined in garden scenery. All this is founded on the recognition of a principle which is, or ought to be, the foundation of all the fine arts—viz., that nature is to be imitated, not to be copied. To copy nature exactly as she appears before us, is the province of common art, and may be pleasing to many minds; but to minds of culture and refinement, nature requires to be copied in such a manner, or in such a medium, as to show art. If this were not the case, and if we were to copy footpaths exactly, then we should, of course, not gravel them, or define them by regular edges."

For remarks on planting in the gardenesque style, *vide* article PLANTING WITH A VIEW TO PRODUCE EFFECT, in Chap. PRELIMINARY REMARKS ON THE CLASSIFICATION OF STYLES.

Plate XXXII. exhibits a garden in the gardenesque style. The beds, it will be observed, are all circles of greater or lesser size: the former of these should be planted with flowering and evergreen shrubs only; and if each bed be limited to either different varieties of the same species, or to different species of the same genus, the effect will be enhanced. The smaller beds should be in like manner planted chiefly with flowering plants, either of one species or variety, or with the different species and varieties of the same genus. In certain of the flower-

beds, however, we would have changes made, as bulbs to flower during winter and spring, and to be succeeded by annuals, or planting out things to flower during summer and autumn. No herbaceous, annual, or other flowering plants, should be set in the margins of the beds of shrubs; they have no connection here whatever, and have, at best, but a meagre appearance, and in no wise harmonise with the shrubs, either in a botanical or gardenesque point of view. Circular beds are here adopted irrespective of their size; yet they are so grouped and mingled together as to produce an agreeable effect when looked upon as a whole. Their distance from the walks, and from each other, in no case exceeds 12 feet. The simplicity of this form is a great recommendation in this style of arrangement, in point of beauty, the symmetry of disposal, as well as in regard to setting off the flowers to advantage—each bed being, as it were, a huge nosegay. It is, besides, the best of all forms for, and most adapted to, culture, as well as for viewing the plants to advantage. The difference in the sizes of the beds, and the disposal of them on the turf, will produce a pleasing variety of outline that cannot be attained by any other means whatever. To produce the greatest amount of variety and beauty from objects of the greatest simplicity is a most agreeable and satisfactory sort of task; whereas to attempt the production of beauty and variety by an endless number of anomalous forms is never by any means satisfactory. For it may be asked, why is one modification of irregularity adopted rather than another? In answer to this, it may be said, that irregular forms are never satisfactory when planted entirely with flowering plants. When planted with flowering plants and shrubs, or with the latter only, the entire form of the bed is then never seen at the same time: the intricacy and variety of the outline occupying the mind as far, at least, as form is concerned, the result produced rarely fails to be a pleasing one.

Presuming that the foregoing observations are founded in truth, those engaged in planting irregular beds, particularly if large ones in flower-gardens, should always place both shrubs and flowering plants in them, and in such proportion

that the shrubs may prevent the entire outline of the figure from being seen at once. When the beds are either of regular forms, or when they combine with other figures, forming either irregular or symmetrical wholes, (the two being quite different,) flowering plants only should be employed, unless the beds be very large; and, in that case, shrubs only should be planted. When beds of different sizes, but of one form, only are employed, they must be connected by a common principle. Circular figures of different sizes disposed and connected together, as shown in our Plate, will form a much more satisfactory garden than can be done by the use of irregular forms only, or by irregular and regular forms blended together. The effect of the latter mode of arrangement is, in general, unsatisfactory. A very prevalent error, often fallen into, is that of mixing herbaceous flowering plants with shrubs and trees: such a mixture cannot be tolerated in a well laid out garden in the gardenesque style, if regular forms be adhered to. It is, however, upon a small scale, as that of the specimens we have given, figs. 907, 908, 909, and Plate XXXII., that a repetition of circles can be employed, so as to produce all that we have said of them; but to continue them over 10 or 20 acres, would be monotonous in the extreme. In medium cases, as respects extent, we would propose the partial introduction of circular figures subdivided, at least where flowering plants are to be employed: where shrubs are planted, subdivisions are unnecessary. Our reason for this is, that to sow or plant a circular bed of 15 or 20 feet in diameter—which would be the case, upon a large scale, with one species, and, of course, of one colour—would produce a far less satisfactory appearance than if that circle were divided into equal parts; and in these parts the habits of the plants and the colours were so disposed as to produce a harmonious arrangement, producing in themselves perfection individually, and collectively a perfect whole. The very circumstance of these subdivisions would give variety, and still the principle would not be departed from. The divisions of circles may be into six portions, or into three or six zones, or concentric circles, admitting the three primary colours in

succession.—*Vide* section HARMONY OF COLOURS.

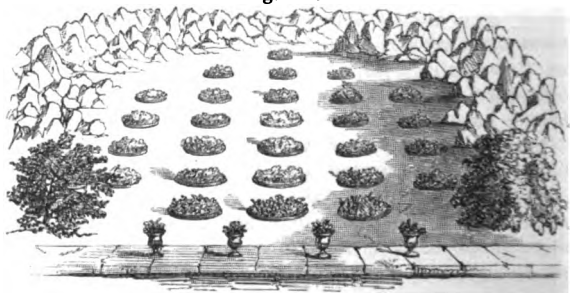
From all this, it will be seen that in the gardenesque style, where circular figures are only to be employed, the field of operation must not be upon a large scale. When such, however, is the case, recourse must be had not only to a greater variety of figures, but also to a partial introduction of the geometric style, as exhibited in Plate XXXII.

In Plate XXXII. we have shown the arrangement of a garden in this style: the groundwork, it will be seen, is a grassy lawn, reduced to uniformity of surface. The shrubs which occupy the margin are planted singly, and, although irregularly dispersed, are nevertheless individually distinct, and allowed to develop their natural characters. The grass is mown around them, nor is the surface anywhere broken. The larger circles are planted with shrubs, both deciduous and evergreen, and one genus of plants only is admitted into each. The outlines of the figures are kept scrupulously perfect, while the ground between the shrubs is kept under the hoe and rake. The smaller circles are each planted also with one genus of plants, and those of the same colour, and as far as possible with the same variety. Thus, for example, the scarlet beds may be planted with scarlet geraniums, scarlet verbenas, &c.; the blue beds with *Salvia patens*, *Nemophilla insignis*, &c.; the yellow beds with yellow calceolarias, *Lasthenia californica*, &c.;—and so of the rest. These beds should all be enclosed within wire basketwork, to prevent the branches from encroaching upon the grass, as well as more perfectly to retain the regularity of outline. The larger beds do not require this precaution, as judicious pruning will keep the shrubs within their proper bounds. Besides, they being grown as distinct subjects, which of itself constitutes a principle in this style, their encroachment on the grass will not readily take place; and should they do so, it is easy to increase the size of the beds. The walks are of gravel, and should not be less than 6 feet in breadth. Their direction is serpentine, to

prevent their being seen from the windows of the house, as well as to admit of their greater extension. Where they break off into different directions, apparent obstructions are thrown in, to give, as it were, a reason for the deviation: hence, to avoid cutting through the two largest circular clumps of shrubs, *a a*, they make a detour round them; while the two vases, set on proportioned square pedestals, *b b*, afford a reason for their branching off at these points. The covered resting-places *c c* offer an excuse for the walks taking these directions; while those terminating at *d d* either lead to distant prospects, or, in the case for which this design was composed, the one leads towards the kitchen-garden and the other to the home-farm. The ground beyond the lawn, as shown dotted with single trees and shrubs, is planted with a thick screen plantation, which separates it completely from the surrounding grounds, which are used for agricultural purposes, and possess no features which it would be desirable should be seen from the principal windows on this side of the house.

The house is a Grecian villa, before which we have laid out, on the terrace in front, a small geometrical garden, surrounded by a parapet wall and a 2-feet open balustrading, with vases of artificial stone set at regular distances along its top. The flight of steps leading from this geometrical garden to the lawn garden below is furnished with an open stone hand-rail, of the same pattern as the balustrading above, with two terra-cotta vases on the top and bottom ends of the hand-rail. This upper garden is laid out with gravel walks and box edgings. The lawn has a gentle declivity from the terrace wall to its farthest extremity, but

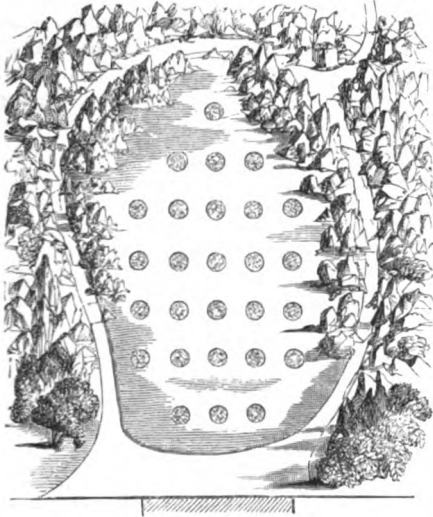
Fig. 908.



is nearly level in the opposite direction.

We have no doubt that many will be surprised at our recommendation of circular figures only. Those who have seen the unique garden of Lady Broughton at Hoole House, near Chester, figs. 908 and 909, will not, we are certain, be amongst

Fig. 909.



that number. The area of that flower-garden is 60 yards long by 34 in breadth, and its whole arrangement consists of five straight rows of circles, each 9 feet 5 inches in diameter, and each surrounded with wire basketwork, painted a yellow stone colour, to harmonise with the very tasteful rockwork (*vide art. Rockwork*) which surrounds the garden. The distance between each of these circular beds is 4 feet across the lawn, and 8 feet 10 inches in the longitudinal direction. Of this garden, as it existed in 1847, when we saw it, we give the plan as seen from the house; and as we could not procure drawings of the splendid rockwork which surrounds it, we can only observe that it environs three sides of the ground, interspersed with the trees and shrubs, as shown in the margin of our plan, and completely shutting out all other objects.

We have given the ground-plan as well as a perspective view of this garden, to show the difference in the effect in looking at a plan on paper, and one on the ground, when finally planted, as

well as to show the difference of shapes on paper and shapes on ground. Many, we know, would object to the plan of a flower-garden composed entirely of circles, as wanting in variety; but it will be found in reality that a proper combination of circles, if not too large and of too uniform a size, is productive of greater variety than any irregular figures could produce. Next to circles, ovals may be adopted; but squares and polygons should be avoided. In size, circles should vary from 18 inches to 10 feet in diameter, and be at least 3 feet apart, and thrown together in groups or constellations, as the stars are in the firmament. To be satisfied that the circle, when in combination as above, is capable of producing greater variety than any other figure, the oval not excepted, let us consider that this form is always seen, from whatever point it may be viewed, from the side of the combination, and that, when planted with shrubs, or filled with flowers, its shape can never be detected from a side view. Size and connection form the art, therefore, of disposing of a modern garden by the use of circles alone.

Nor is the use of circular figures by any means a modern invention, in laying out flower-gardens. Although of late years strongly advocated by the late Mr Loudon, he himself reminds us that this figure was chiefly used by Mason the poet, in laying out the flower-garden at Nuneham Courtenay, and by Major Price, in laying out the flower-garden, at Monewell House; and we may add to these examples the original grounds at Frogmore. In more recent times, circles and ovals have been employed by Mr Wells in his English flower-garden at Redleaf, and also at Norbiton House, Teddington Grove, Trent Park, and Bayfordbury, near Hertford. "This last place," says Mr Loudon, "being the largest in extent, and containing the greatest variety in the diameter of the circles, we consider as a singularly felicitous example."

We have already stated that a garden, to be laid out in the true gardenesque style, should not be upon a large scale, if the rules we have just laid down are to be closely adhered to. There are, however, other modifications of this style, by which many acres may be covered; and one of these is the combination of various

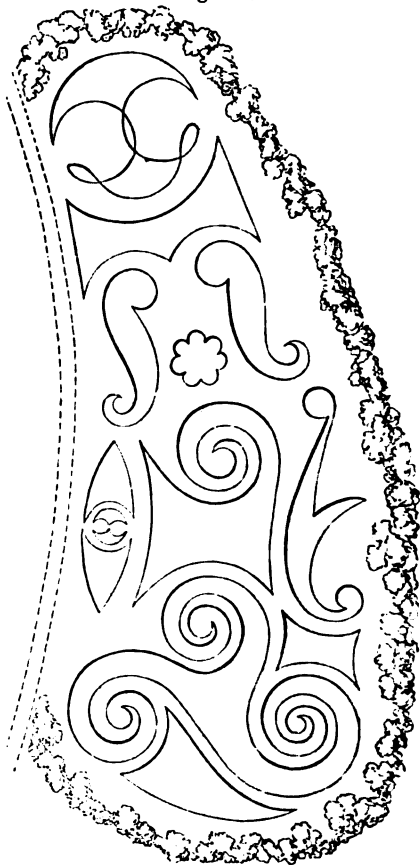
gardens—each sufficiently distinct in itself, yet, taken together, producing a very happy effect; and this effect will be both heightened, and the arrangement simplified, if the grounds present a diversified surface. Such arrangements are also, no doubt, the best of any, when the expense of a geometrical garden is an object, and where, from local circumstances, its formation would be interrupted, or where other causes (chiefly the want of architectural associations) would render it misplaced. A judicious combination of the following will be effective: namely, a terrace, around one or more fronts of the mansion, laid out symmetrically, or in the gardenesque manner, according to the style of the house; beyond this a lawn, and trees and shrubs so arranged, by judicious grouping, &c., that one or all of the following may be laid out—but only one of them should be seen at the same time; the American garden, in rather a low, flat, and sheltered situation, where water can be laid on during the growing season of the plants; a rosary, in a sheltered place, yet fully exposed to the sun; a herbaceous garden, an annual garden, a bulb-garden, an aquarium, a heath-garden, and, if the proprietor has a taste for cryptogamic botany, a garden for ferns and mosses. Besides these, a spring garden and a winter garden will have their attractions.

Each of these would be complete in itself, and in high perfection at various seasons of the year. They may be separated, and completely insulated from each other, by a judicious disposal of shrubby lawn and walks, which in itself would constitute the arboretum. Mixed gardens seldom please, as they at no time present a perfect whole. Such subdivisions, however, can only be carried out in extensive domains, particularly where the surface is undulated or much broken. Such may be called the systematic arrangement, and will afford additional gratification to those partial to plants, and the study of them botanically.

*American Garden.*—A garden, to deserve this denomination, should consist of trees, shrubs, and herbaceous plants, natives of North America. As they are both numerous and interesting, a large space will be required; and also, as so many of them are strong-growing herba-

ceous plants and low shrubs, the borders should be decidedly cut out on turf. Medium-sized shrubs should occupy groups by themselves, thinly mixed with the lower class of trees, while the more curious or rare of the latter should stand singly on the grassy lawns. The smaller beds should be entirely dedicated to herbaceous and annual flowering plants. The side screen, or surrounding shrubbery, should be entirely planted with American trees and shrubs; while one of the principal walks should pass on one side, as shown in fig. 910, by which a proper

Fig. 910.

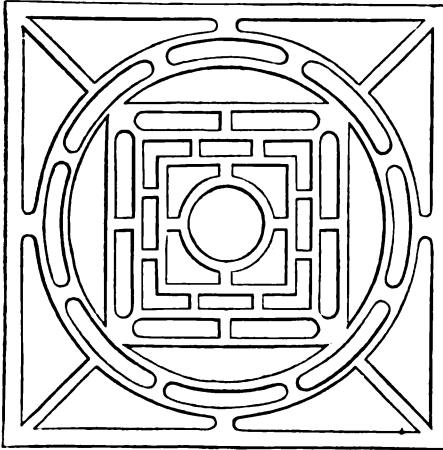


connection would be formed between this garden and the rest of the grounds, as well as inspection allowed, when the grass might be too damp to walk upon.

*The rosarium, or rose-garden.*—In the gardenesque style geometric figures are not excluded. We offer, therefore, fig.

911 as a rosarium, on account of its being sufficiently divided to bring the visitor

Fig. 911.



close to the object to be viewed, and to enable him to reach the flowers without going off the walks. In this design we have not attempted to show anything productive of gardenesque effect, as the situation of the rosarium should be apart from the general garden in connection with the house. Our reason for this is, that roses produce no striking effect in themselves, unless when they are in flower, and also that, to grow them in perfection, they require cultural attention not always in keeping with the trimness of the flower-garden. The multiplicity of walks, and narrowness of the borders, in our figure, are not only intended to place the flowers within the easy reach of the admirer, but also, where the utmost neatness is attended to, and the plants wrought on single stems of various heights, that the beds may be covered during summer with dwarf-growing annuals, and during winter covered with green moss. The stems of the trees, when tall, should be enveloped in moss, both for appearance, and also to prevent too much evaporation taking place in the stems during the droughts of spring and summer. Those who are, as it is called, high in the fancy, will disclaim covering the ground with annuals, and maintain that it should be covered with rich manure, to feed the roots and keep them moist. The utility of surface mulching we do not deny, but

VOL. I.

object to it on account of appearance. The annuals shade the roots during summer, and an abundant supply of food may be given in a liquid form. The borders in such a garden should be made both deep and rich, and the walks should be of gravel, edged with box. Poll roses may be planted along both sides of the surrounding walk, or may be placed in the large angular borders and circular centre. Shelter and seclusion might be advantageously obtained by covering the exterior walk all round with iron trellis-work, and training climbing roses over it.

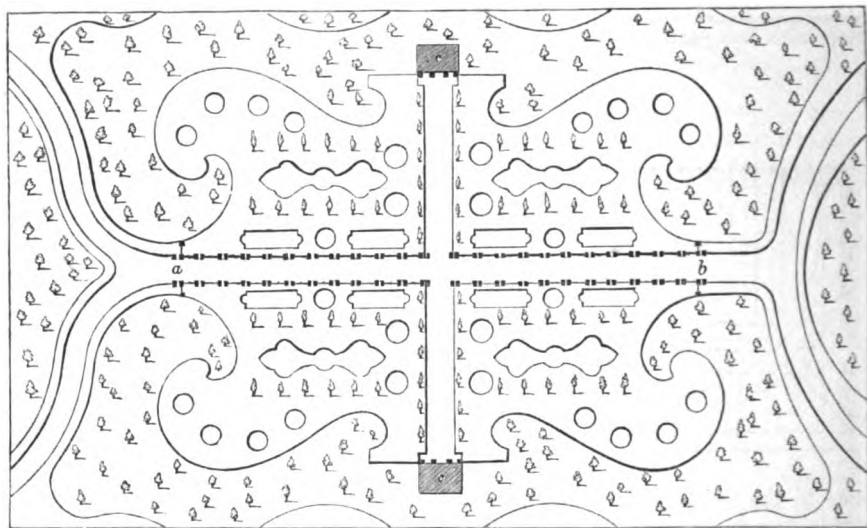
As a rosarium in the strict gardenesque style, the annexed example, fig. 912, may be given. It is one of two original designs prepared by Messrs Major and Low, landscape-gardeners, of Knosthorp, near Leeds, for Messrs Paul's excellent work on roses, "The Rose Garden," a work which every rose cultivator would do well to possess. The designers remark: "We have arranged them in the formal style, which we decidedly prefer to any other. In grounds sufficiently extensive for the introduction of various scenes, the rosarium is one calculated to produce considerable interest; and, being formal and a separate scene, it is necessary that it should be masked out from the general pleasure-ground by shrubs and low ornamental trees, blending with the adjoining ground in the natural or English style." It will be observed, by a glance at our figure, that the longest central walk, from *a* to *b*, is furnished with an arcade of trellis-work, and this arcade is for "exhibiting climbing roses, which, we need not say, will produce a very imposing effect. It should be formed of latticed pilasters 12 inches wide, and about 6 feet high to the spring of the arches, each pilaster having four uprights  $1\frac{1}{4}$ -inch square, placed two and two, an inch apart, with balls between them at proper distances, and fitted up in the middle with lattice-work, showing five-eighths of an inch in front. The openings between the pilasters may be from 4 to 5 feet, according to the height. The arch over the walk must be of lattice-work. Some of the round beds may be of basket-work 12 or 15 inches deep, especially those shown with a varied outline. In order to make the rosarium as interesting as possible, the beds might be planted with

4 P



patches of early flowering bulbs to precede the general bloom of roses, which bulbs, after flowering, might be lifted, and their places supplied with different kinds

Fig. 912.



of annuals, to succeed the general bloom of roses, so that there would be, first a show of early bulbous flowers, then the grand display of roses, and lastly, the show of annuals." This arrangement is very much to our mind. The walks, in this design, are of gravel, the body of the garden of grass, with standard roses planted in lines, and various beds cut out on the turf, in which the dwarf varieties are placed; beyond this turf, indicated by the curved lines, the ground is dug, and the roses planted in the dotting manner. At each end of the cross walk, at *c c*, are covered seats. Rosariums, when made to form a part of an extensive garden, should be shut out from the other parts of the grounds, and this can seldom be effectually done without employing evergreens; but these should be made so as to form the back-ground, while that much neglected section, Scotch roses, should form the front.

On the formation of the rosarium, Mr W. Paul, in his interesting work on this charming tribe of plants, "The Rose Garden," observes: "In the formation of the rosarium, it appears to us that the simpler the forms of the beds the better. The plants of which it is composed are, for the most part, budded on stems and

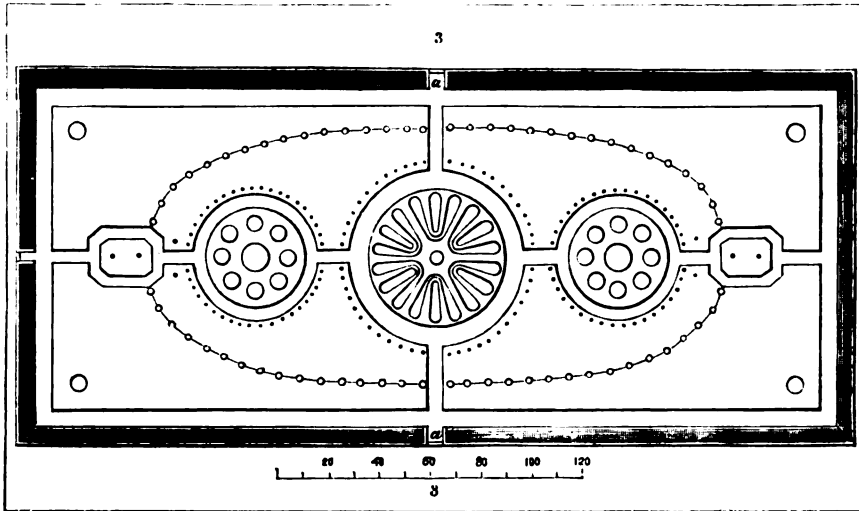
decidedly artificial objects; and parallelograms, squares, ovals, circles, and other regular figures, are in perfect harmony with the character of the plants, admit of the most perfect arrangement, and display the roses to greatest perfection." The rosarium is not planted for effect, like most other flower-gardens; it may be said to be more for culture than for effective display. No doubt, during the season of bloom, the general effect is pleasing when viewed as a whole, but, like other departments in floriculture, the true beauties are sought in individual flowers, therefore the nearer these can be brought to the eye the better. The far-famed rose-garden of the Luxembourg at Paris, under the direction of Monsieur Hardy, is laid out in parallel longitudinal beds, each 7 feet wide, and the roses are planted in rows, two to each bed—a standard and a dwarf of the same variety—3 feet apart from each other, so that each standard has a dwarf behind it. There are several rosariums in that establishment; the one in which the above order of planting is followed, appears to have no regard paid to keeping the various groups or sections of sorts distinct. Another garden, however, is planted wholly with autumnals, and a third with

the various groups of summer roses. Where large collections are cultivated, no doubt the grouping system should be followed; and some prefer the walks between to be of grass, as harmonising better with the plants than gravel walks

with natural or artificial edgings. This is, however, a matter of taste, excepting in so far as walks of gravel are more comfortable to walk upon in damp weather.

In fig. 913 another rosarium or rose-garden is exhibited, sunk 5 feet under the

Fig. 913.



level of the surrounding lawns. *aa* are the entrances, the descent being by stone steps from the lawn above to the gravel walk below, which surrounds the whole. The beds, in which dwarf roses only are planted, are cut out on turf, surrounded and connected by a gravel walk, along one side of which standard roses are arranged at equal distances, while, along the elliptical line, climbing roses are trained to cast-iron pillars connected together by a light chain, to which the branches of roses are trained, forming a continuous line of festoons all round. Two standard roses occupy the grass figures at each end, while two others connect these figures with the circles next to them. In the four corners of this rosarium are placed vases upon corresponding pedestals; but these might be substituted by strong-growing roses trained in the pyramidal form.

*The fernery and muscarium.*—A garden for the cultivation of ferns and mosses is not often met with; examples, however, do exist. Many ladies now bestow great attention on their cultivation, more especially the former; and so great has a taste for them now become, that one

commercial cultivator, Mr Stark, of the Edge Hill nurseries, Edinburgh, cultivates them for sale. Several gardeners around Edinburgh have also for years cultivated collections of mosses with great success, Mr Veitch of Arniston having several hundred species cultivated in pots after the manner of Alpine plants. The situation for such a garden, it is perhaps needless to state, should be warm, moist, and shaded. The style of garden should be long and narrow, and if on the side or the bottom of a moist dingle or deep ravine, so much the better. To give it the appearance of culture, and so place it within the bounds of the gardenesque, the ground should be levelled and turfed, the figures cut out on it, and elevated or depressed according to the nature of the plants to be set in or on them—some ferns, for example, preferring a rather dry situation, whilst others require one that is much more moist. The beds should be covered with stones in as irregular a manner as possible, and between and on those masses the plants should be set. The mosses, many of them by no means of difficult culture, should be

planted between them, and so, in fact, cover the ground. We would, however, prefer to have each species in a flower-pot, plunged to the rim; for without this separation the stronger kinds would overrun the weaker, and often the more rare species. If the situation be shaded, and yet not moist, the latter effect can be readily remedied by bringing water in pipes, and so disposing of them that they may form little fountains, or be perforated along their sides, and so give out a sufficient supply to the masses on which the plants grow, and from them to the ground and lower parts, which require the most; but that saturation or overflow may not take place, provision can readily be made to allow the superfluous water to pass off in a drain.

This garden would be, perhaps, more appropriately placed in one in the strict picturesque style; but if the owner of a garden in the gardenesque desire such, there is no reason why he should not have it.

Many of the more rare and most minute of both sections can scarcely be cultivated in the open air. This, we believe, does not arise so much from climate as from their inability to stand the effects of the same amount of air that other plants so much require. These, therefore, should be cultivated in pots, and placed under a glass frame set in a shady quiet spot; nor will such a frame, partially hid by rockwork, be at all out of place in such a garden.

In the picturesque style many eligible situations will present themselves naturally, where such plants may be cultivated with much less attention and greater success.

*The winter garden.*—The principal advantages to be aimed at from a winter garden in the open air of our climate are the maximum of shelter, with great extent of walks, these being so disposed that a return to the point of starting from may occur at short distances apart; that every shrub and plant that flowers from October till the end of March may be congregated; that, as there is a great want of flowering plants during that period, evergreens be abundantly planted; and those having curious or variegated leaves be added, with a view to render the garden as attractive, and at the same time as comfortable, as possible. Still farther to carry out these views, as the means used for

producing shelter would have some tendency to keep the walks rather damp, from want of a full circulation of air, we would propose to render them thoroughly dry by under-drainage, and a sufficiency of broken stones, or rough-sifted gravel, and over that a thin coat of small sea or river gravel. These, although they do not bind into a hard surface, admit of the rain passing through, and leaving the surface at all times dry to walk upon.

Were it not for the colour, coal-ashes, finely sifted, make the driest and best of all walks for such situations. The ashes from some steam-engines are excellent for this purpose, as they are often to be had of a reddish as well as of a cream-colour, depending on the nature of the coal used. In default of either of these, pitching the walks with small pebbles, not more than 2 inches in diameter, set in prepared clay, will make a dry and comfortable winter walk.

In such a garden the walks should not be too narrow, nor should the trees and shrubs be planted too close. If they are so, the person who goes into them to be free from the sun is choked for want of air; and the same closeness occasions a perpetual dampness, and an atmosphere highly charged with malaria. Everything in them is gloomy and disagreeable, more the abode of melancholy than of cheerfulness. Instead of this, we ought to have a kind of retired pleasure in such a garden; for solitude, shade, shelter, or retirement need have no connection with savage darkness, or a dreary walled-above or hedged-in passage. If the walks be serpentine, let them not be too much curved, twisted, and narrow;—on the contrary, let them be of a respectable breadth, so that we shall be able to walk in them with pleasure. The trees will not then close so completely at top as to shut out air, while they will still give a sufficient shade from the sun, and shelter from the piercing blast: we shall also have at the same time freedom, ease, and elegance.

Alcoves, temples, or places of shelter and rest, should be placed at convenient distances, but always fully exposed to the sun on one side, for winter enjoyment, and to the opposite aspect also, for the heat of summer. The borders should be planted with evergreens, introducing *laurustinus* abundantly on account of its

flowers. Form all the borders curvilinear, and make them narrow, so that both surfaces may be equally seen. It will be bad management if they assume the appearance of hedges. Hollies, pines, cypresses, red cedars, arborvitæ, &c., should occupy the centre, filling in with Portugal and common laurel, junipers, aucubias, rhododendrons, &c. Along the margins of the walks, but not as edgings, which latter should be of larger pebbles than those used for the walk—say 6 inches in diameter—should be planted snow-drops, crocuses, winter aconite, Christmas rose, primroses, and all such plants as flower at this particular season. The general shelter of the whole garden, and, in addition, that of the branches of the trees and shrubs above them, will greatly protect them from the frost.

In planting such a garden, although shelter is a leading object, still the trees and shrubs should not be placed too close together, but each be allowed to develop its own true character. The pines and hollies will elevate their heads above their more humble neighbours, and, with the cypress, Irish yew, and red cedar, break up the uniformity of outline the laurel is apt to assume. The box, juniper, and laurustinus may be planted in groups of from six to twenty plants in each. The common whin, *Rhododendron dauricum*, *atro-virens*, *Rhododendron hirsutum* and *ferrugineum*, should also be grouped in the same manner; whilst *Juniperus prostrata*, *Arbutus uva-ursa*, *Gaultheria Shallon*, &c., may cover the ground, in irregular groups, at a still lower height; while the remaining surface should be covered with *Erica carnea*, herbacea, and the varieties of *Vinca minor*.

In such a garden as we have described, it will sufficiently appear that effect is sacrificed to comfort, the latter being the object sought for.

*The bulb garden.*—The majority of bulbous hardy plants being spring-flowering, it is necessary that a dry, warm, sheltered spot be chosen for them. In regard to arrangement, nothing is better than narrow longitudinal beds, to facilitate the operation of covering, by means of glass or canvass awnings, during the frosty nights of spring. In the beds dedicated to hyacinths, tulips, &c., neat and sufficiently substantial iron framework should

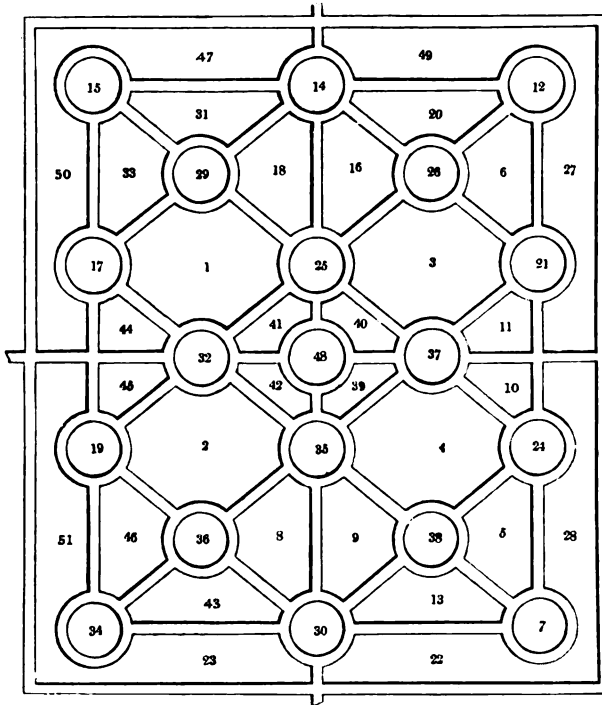
be erected, for supplying whatever covering of a flexible nature may be applied.

*The annual flower-garden*, like the herbaceous flower-garden, should occupy a situation moderately sheltered, but fully exposed to the sun. The approach to it, for reasons already given, should be from the south side, so that the flowers may be seen to the greatest advantage. Annuals of themselves will produce, during their season of flowering, a most brilliant effect; but after autumn, the whole becomes an uninteresting spot. Here is one reason why gardens for different descriptions of plants should be kept apart; for in no case are they interesting throughout the year; and at the seasons of interest only should they be visited, with the expectation of deriving satisfaction from them.

*The herbaceous plant garden.*—A general collection of herbaceous plants, unless for botanical study, seldom produces a very pleasing aspect. It is better, therefore, to limit the number of species to such as flower freely, and produce effect by their colours or habits; nor should botanical arrangement be attempted, unless the collection is formed for that especial purpose. Single specimens should be avoided, and all deemed worthy of culture grown in masses, according to the space and description of plant. The figure given, (fig. 914,) although of symmetrical form, is as admissible into grounds in the gardenesque style, as it is convenient for the purposes of culture. Our figure is divided into 52 parts of unequal-sized circles, thus giving accommodation to 51 genera of plants, which will comprise about as many as are truly valuable for such a purpose; and as each compartment is capable of holding from 10 to 50 plants, the whole will contain about 1500 species, which will embrace the majority of herbaceous hardy plants really worth cultivating for their flowers. The following list of genera will better explain our views, and may be added to, or altered, to suit the taste of the planter:—1. *Campanula*; 2. *Phlox*; 3. *Aster*; 4. *Delphinium*; 5. *Aconitum*; 6. *Penstemon*; 7. *Helleborus*; 8. *Alstræmeria*; 9. *Anemone*; 10. *Aquilegia*; 11. *Cheiranthus*; 12. *Dodecatheon*; 13. *Dracocephalum*; 14. *Erigeron*; 15. *Gentiana*; 16. *Hemerocalus* and *Funkia*; 17. *Iberis*; 18. *Lathyrus*; 19. *Liatris*; 20. *Lupinus*; 21. *Monarda*; 22. *Pæonia*;

23. *Potentilla*; 24. *Primula*; 25. *Ranunculus*; 26. *Salvia*; 27. *Saxifraga*; 28. *Se-* to cut off the flower-stalk, to prevent intermixture by that means.

Fig. 914.



dum; 29. *Silene*; 30. *Spiræa*; 31. *Statice*; 32. *Uvularia*; 33. *Iris*; 34. *Chelone*; 35. *Armeria*; 36. *Lythrum*; 37. *Astragalus*; 38. *Euphorbia*; 39. *Helonias*; 40. *Alysum*; 41. *Lychnis*; 42. *Asclepias*; 43. *Coronella*; 44. *Acanthus*; 45. *Fraxinella*; 46. *Achillea*; 47. *Orobus*; 48. *Yucca*; 49. *Scabiosa*; 50. *Dianthus*; 51. *Æno-*  
*thera*.

*The grass garden.*—the natural order Gramineæ form a very interesting garden, but must, at the same time, be considered as pertaining more to botanical science than to garden display. They, however, claim our attention as being so intimately connected with the useful arts and the food of man. Each species should be grown in a flower-pot in proportion to its size, or planted in patches divided from each other by brickwork 9 or more inches square, or by enclosing them with slate or stone pavement, to prevent intermixture by their roots. As most grasses seed abundantly, it will be necessary, at the season the seeds are beginning to ripen,

*The hardy heath garden.*—A collection of hardy Ericæ forms of itself a very interesting detached garden at all seasons of the year. The same necessity does not occur here of enclosing within a proper boundary of trees or shrubs as in the case of the rosarium, for the heaths are at all times sufficiently ornamental in themselves to claim a place, and that a prominent one too, on the lawn, in the gardenesque style of grounds. The most perfect specimen of such a garden we have seen, and it is perhaps the best example in Europe, is that at Woburn Abbey. It occupies an irregular triangular lawn in front of the exotic heathery, and in this lawn the beds are laid out somewhat in the

geometric style. "Each species or variety is confined to separate beds, which are all edged with *Calluna vulgaris* and *Erica tetralix*, and so disposed that the tallest-growing kinds are arranged towards the centre of the parterre, while the whole are so intermixed, in point of colour, as to produce the most lively contrast possible. It hence becomes an interesting spot at all seasons of the year, as there are always some of the sorts expanding their beautiful blossoms. During the summer months, many of the duplicates from the heath-house are turned out of their pots and planted in this compartment, where they generally flower, grow vigorously, and form themselves into handsome bushy plants."—FORBES in *Hortus Woburnensis*.

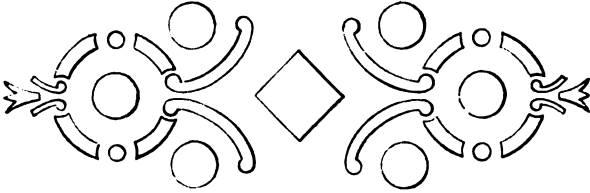
Such figures as the following are appropriate either for small flower-gardens of themselves, or for detached ones in grounds of great extent.

Fig. 915 is exemplified in the flower-garden of Lady Grenville at Dropmore,

and is cut out on grass, and admirably adapted for planting out in the massing

This figure is best cut out on grass, and, if surrounded with a mass of shrubs, the outline of which runs nearly parallel with the outer edge of the figure, and at a proper distance from it, the effect will be good. The figures here terminate too abruptly, for which reason we have copied it from "The Gardeners' Magazine," in order to point out a very

Fig. 915.

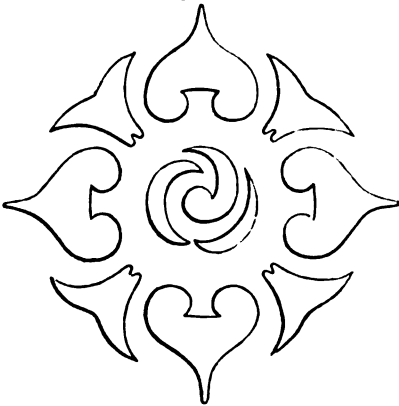


style. The beds are not too large to be each occupied with a distinct colour; and when planted in this way the effect has been satisfactory.

Irregular parterres are chiefly adapted to the gardenesque style, and, when laid out on grass, are calculated for level or undulating surfaces. When large, and the ground very much distorted, the beds may be elevated several feet at their centres above the grass-level, and so form, as it were, natural labyrinths, without the formality of geometrical ones. They may also be planted with shrubs in the centres, the masses graduating downwards with very dwarf shrubs, and terminating at the edges of the borders with dwarf annuals or verbenas, and similar procumbent plants. Again, upon a small scale, and on a level surface, they may be planted in the grouping manner with plants similar to those recommended for geometrical parterres.

In fig. 916, as the beds towards the centre are small, so should also the plants

Fig. 916.

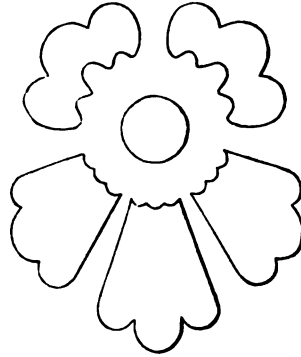


be; and hence this figure is calculated for a piece of ground hollow in the middle.

prevailing error.

Fig. 917 is exemplified in the beautiful and well-managed flower-garden of Earl Brownlow, at Belton House, Lin-

Fig. 917.

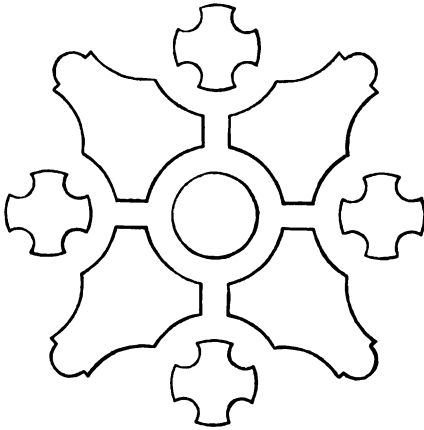


colnshire. It is there, upon a large scale, cut out on the lawn, and richly planted with the usual flower-garden plants, amongst which the dahlia and holyhock predominate, the latter in the centre of the beds, and the former nearer to the front, forming, as it were, the reserve oaks in the forest; while the underwood is admirably imitated by immense masses of petunias, salvias, larkspurs, and similar plants, the whole feathering down to the well-kept lawn with verbenas, and similar procumbent plants. This figure, as well as a great portion of the garden to which we have alluded, is planted in the mixed style; but, on account of the exceedingly high keeping of the lawns and borders, and the judicious arrangement as to heights and colour in the masses, the whole produced on our mind more pleasing emotions than we ever recollect to have experienced in any other garden of the same kind.

Figs. 918 and 919 are figures properly

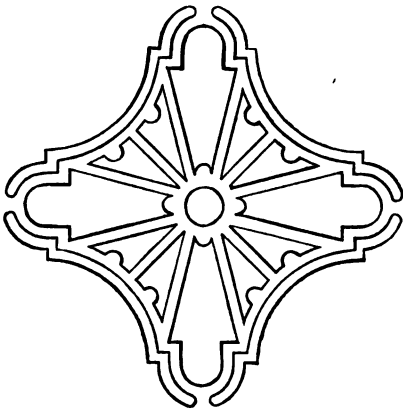
geometrical, but quite admissible into the gardenesque style, more especially near the house, and upon the grass lawn.

Fig. 918.



Their size may be regulated by circumstances; but, if upon a large scale, shrubs should be partly introduced, and on a

Fig. 919.



small scale, the bedding-out principle of planting followed.

Figs. 126, 127, 128, 129 are all adapted to this style, and may be used as wholes in small gardens, or as centre-pieces for larger compositions in gardens of the largest size. In fig. 920, the beds might be planted as indicated by the figures *a b* and *c*, which represent the three primary colours, yellow, scarlet, and blue. The scarlet is placed in the centre, being the most intense, while the blue is placed next the edge, which is supposed to be

Fig. 920.

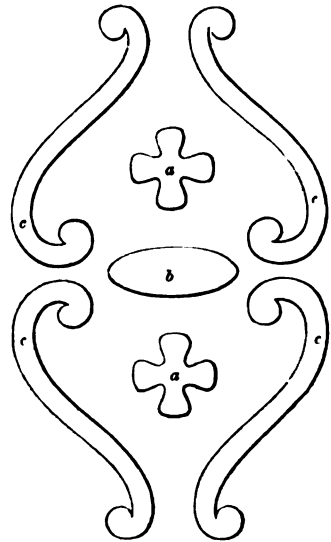


Fig. 921.

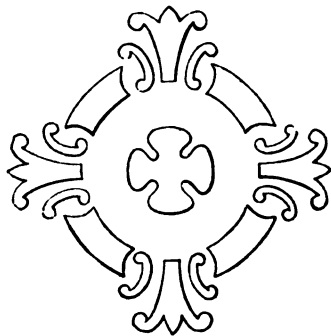
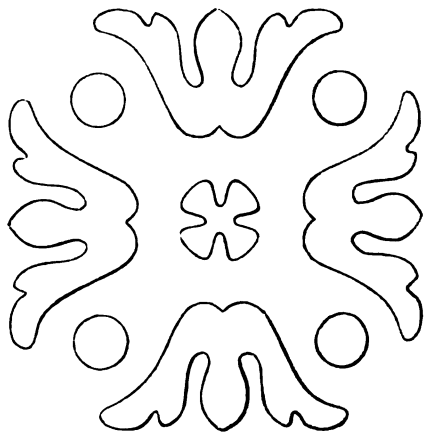


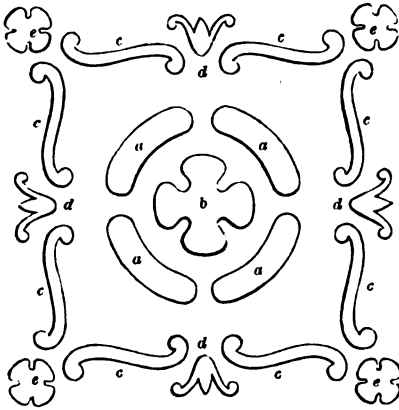
Fig. 922.



surrounded with grass. And, for the same reasons, fig. 923 is similarly ar-

lasts from the end of June till the beginning of November. Fig. 925 is a modi-

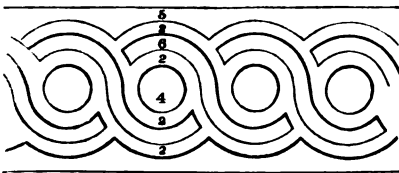
Fig. 923.



ranged, with the addition of *d* and *e*, the representations of rose colour and white, which, being light colours, shade off better towards the extremity of the piece.

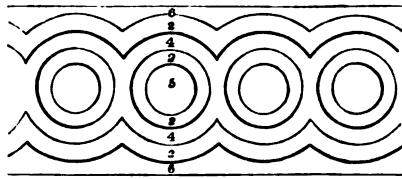
We have remarked in the geometrical style, that long narrow borders are the most difficult to find appropriate figures for; such also frequently occur in the gardenesque; and when used as marginal borders, either on grass or gravel, they have a very good effect. Fig. 924 is

Fig. 924.



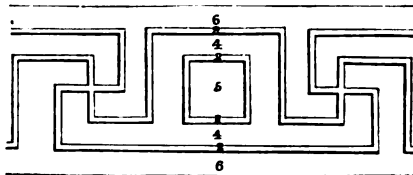
exemplified in the gardens at Dalkeith, separating a grass lawn from the gravel walk, and extending about 300 feet in length. The centre circular bed is planted with *Calceolaria amplexicaule*—colour yellow; it is pegged down so as to be about a foot in height. The scroll figure between the gravel walks is sown with *Nemophila insignis*—colour light blue, height 4 inches. The Vandyke figures on each side are planted with *Verbena melindres*, *Tweedia grandiflora*—colour bright scarlet, height 3 inches. The whole is in bloom at the same time, and

Fig. 925.



fication of the last, and should be planted in the same way. Fig. 926 is adapted for

Fig. 926.



either the geometrical or gardenesque styles, and, if planted with the same things as the last are, has also a good effect. The figures indicate the colours: viz., 4 5 6—yellow, scarlet, blue; and 2 the gravel walks.

Two long borders, each 624 feet in length, with a broad gravel walk between them, exist in front of the kitchen-garden at Trentham, and form one of the entrances to the beautifully laid out flower-garden extending onwards towards the house. These are admirably managed by Mr Fleming, and are each planted with three continuous lines of colour, extending from end to end. The line next the walk on both sides is sown with *Nemophila insignis*, blue. The second is planted with *Calceolaria rugosa*, yellow; and the third with scarlet geranium. The whole flowering at the same time has a very imposing effect, planted thus with the three primary colours, which harmonise agreeably together. By this arrangement, the whole remains long perfect and unbroken; whereas, if planted in beds, as is usually done, and with a great variety of colours and forms, blanks would occur, as some of the species go out of flower sooner than others; and no care on the part of the cultivator could bring about so complete a unison of plants, if discordant colours and forms were employed.



## § 2.—FOUNTAINS AND VASES.

These are to be considered as part of the decorations in this style; and although not so abundantly used, nor upon a scale of such magnitude as in the geometric, still their admission adds greatly to the interest of the scene. In style they may be less architectural; but, on the other hand, they should not be puerile or childish. The ball balanced on a jet of water—the metallic tree, from the leaves of which drops of water are perpetually oozing—the hidden springs and wires placed under walks, which, when trodden upon, deluge the unconscious passer-by with a shower of water, are all equally contemptible, and unfitting for the present age. The musical fountains described by a romantic traveller, as said to have existed in the gardens of the ancient Moors, if the art of constructing them were known, might be admissible in this style, and so please the senses both of hearing and seeing at the same time.

“Nothing, in my opinion,” says the late Sir Thomas Dick Lauder, “can be more beautiful than a well-arranged fountain—nothing can produce a happier effect, in what I would call the home garden, than an architectural *jet d'eau*, the symmetry of which, and the sparkling effects of its ascending column, are calculated to harmonise so well with the various features of the house and its accompaniments. Then what can be more soothing than the gentle murmur of its falling waters, heard only when everything else in nature is silent, as if it were the voice of the genii of the fairy ground in which it is placed.”

The specimens of art exhibited in the Industrial Palace presented many new forms, suggesting to us new ideas. In few departments in the Exhibition has a greater number of subjects, which come within the limits of garden decoration, been presented to us than in that of castings in iron and other metals, and mouldings in clay of various descriptions. Amongst the former of these, we may rank fountains, one of which we have chosen, as we believe it associates better with natural landscape than many strictly artistic subjects hitherto employed. We think so, because in the composition the objects represented belong to nature, and

not to art; and also because they are associated with water, amphibious animals, and aquatic plants. The celebrated iron-works of Mons. Andre, of Paris, furnished the example; and although its novelty and want of precedent as a garden ornament in this country may raise grave objections to it in the minds of some, still we are of those who think that there is room for vast improvement in such decorations, and on such grounds introduce the annexed fig. 927, to the notice of garden artists, and to our readers in general.

Fig. 927.



The chief subject in the composition is a crocodile holding a fish in his mouth; the mouth of which latter serves for the top jet of the fountain. Beneath this is an otter to the right, a tortoise to the left, and a large frog at the third angle. From the mouths of these animals the jets of water are intended to rise, and they are surrounded by the water lily, floating reeds, and bending rushes. The whole group should be placed on a rock occupying the centre of a spacious metallic basin. Such fountains are far more in keeping with picturesque scenery than the convolvulus, the jet balancing a ball, and a variety of others, which are outrages upon both nature and art.

Vases and all sculptural ornaments

ought to be used sparingly in those parts of the grounds that are distant from the mansion; this applies to gardens, in all styles, but more especially to those in the gardenesque. In the picturesque they are next to inadmissible. But in this style, when mixed up with groups of flowers and shrubs, they have the effect of partially dividing the attention of the observer, and directing it, as it were, at the same time to the works of nature and of art. As the mind, however, becomes distracted when objects of so dissimilar a description are brought to bear upon it, and as the former should predominate over the latter in such situations, the latter should always be subordinate to the former, and be kept nearer to the house, buildings, or other artistic objects, with which only they can be said to be in association or connection.

The vase or flower-basket, represented by the annexed sketch, is one of several

Fig. 928.



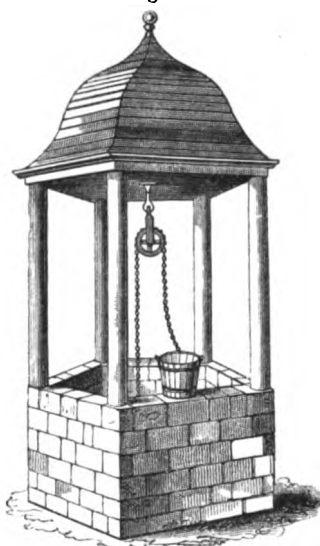
we observed some years ago in the gardens at Stoke Place, near Windsor. They were constructed by Mr Patrick, the very intelligent gardener there. They are formed of wood, and covered afterwards with larch or oak bark. The pedestals are in

one piece, and the top or basket is in another, and is screwed off or on, so that they may be put under cover during winter, or the plants in them forwarded in spring in frames or pits, so as to be ready to put upon the pedestals as soon as the weather will permit, thereby enabling the owner to decorate his garden at once. From the specimen given it will readily be seen that any plain architectural form may be given them, so that they may form harmonious combinations even in highly artificial scenery.

In the gardenesque style, as well as in the picturesque, wells are admissible, for the purpose both of ornament and utility. The annexed cuts, 929, 930,

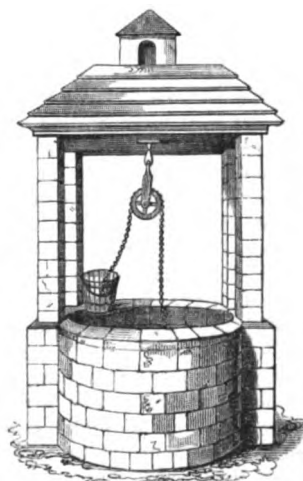
exhibit specimens, in both of which the bucket is suspended from above by a

Fig. 929.



chain, which is made to pass over a pulley, which renders the operation of raising the

Fig. 930.



water easy. The opening of the well in each case is safely guarded by a parapet of brickwork or ashlar, giving character to the structure, while at the same time the purity of the water is preserved. In Scotland, draw-wells are seldom met with, while in England they are of very frequent occurrence—indeed, so much so that most

cottages have such an appendage; and beautiful and artistic specimens, some of which are of great antiquity, occasionally occur. Whether regarded as garden ornaments or as cottage appendages, we think them deserving of greater notice than has hitherto been bestowed upon them. The specimens we offer in our cuts are without architectural pretensions, although in each case adapted to the style of an ordinary English cottage or farmhouse. As the habitation of the owner rises in architectural importance, so should also the style of the draw-well; so that, in whatever style the house may be, the well should be in the same.

### § 3.—BASKETWORK.

Basket-work, both rustic and artistical, enters into the list of gardenesque decorations, and, when filled with plants, either in pots to be removed when they get out of flower, or having them planted in them, has a good effect.

They are valuable in another point of view—namely, to be set on lawns or in flower-gardens to which rabbits and hares have access. The flowers, being placed beyond their reach, may be cultivated, where otherwise they could not.

Another class of decorations for this style is rustic baskets. Their forms and characters are endless, depending entirely on the ingenuity of the maker. They are usually formed of young larch trees, having the bark left on, the form and substance of the work being first given by a strong box or other frame of the required shape, or a barrel cut transversely through the middle. The outer surfaces of these are covered, and formed into various designs, by splitting pieces of timber of uniform size and in the requisite lengths, and, after arranging them, which is most correctly done by drawing the pattern on the surface to be covered, nailing them firmly on with small-headed nails. Fig. 931 supplies an example, where the top, being supported upon a rustic leg supported by four equally rustic brackets, is formed of  $1\frac{1}{2}$ -inch plank. Larch, hazel, or other uniform-growing rods are nailed on the surface, the smaller ends of the rods being always kept towards the centre; and

these may even be considerably reduced in breadth, and, in some cases, reach only

half or third way towards the point of termination. This reduction must, however, be carefully made so that the bark may not be disturbed, if the object be to have the bark left on. In cases where the rods are peeled, this is a matter of no consequence. The top surface being finished, the side all round is to be covered in like manner; and, where the top does not

exceed  $1\frac{1}{4}$  inches in thickness, the rods had better be placed side by side vertically. To cover the ends of these vertical rods, or if those of the top surface project over them, which is usually done, a bead should be placed over these ends by bending rods of the same material to cover the joining or sections of the horizontal rods. A vase or flower-pot is placed on the top. In some cases three-fourths of an old cask are used, supported upon four larch or other rustic legs with the bark on, and as nearly of a size as possible; the sides of the cask being covered with rods as above, placed vertically; and, for greater variety, three shields may be formed at equal distances apart—or, indeed, any other device; or the sides may be covered with large pieces of rugged bark of oak, elm, &c., nailed on; and over it shields may be nailed, which are easily cut out. This mode of covering rustic vases is the most expeditious. In some cases a thick rope, say an inch in diameter—but this entirely depends on the size of the vase—is wound round the legs, forming a beaded moulding round the top and bottom so as to hide the ends of the cut bark. One or more tiers of rope may encircle the vase, in imitation of hoops; and the same material may be used to form festoons or other ornaments round the surface. Such a

Fig. 931.

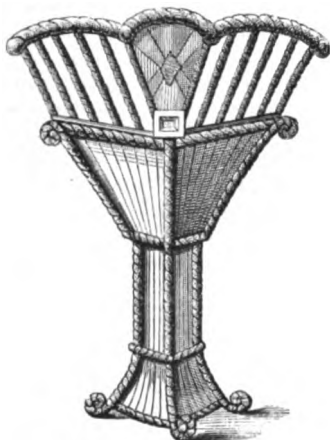


vase is intended to be filled with mould, and plants set in it.

We object very much, however, to the use of hempen rope for this purpose, or, indeed, for any other kind of ornament in connection with wood or more durable material. A better substitute could be found by using the auburn-coloured *Polytrichum commune*, a moss of great length and durability, and to be found in abundance in bogs and mountain woods.

Fig. 932 is a very excellent rustic vase or basket. The form is given by con-

Fig. 932.

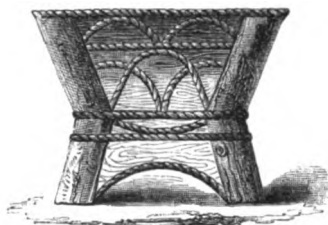


structing a box of durable timber, and elevating it on a pedestal formed also of plank. The pedestal and lower part of the basket are covered with thick rugged bark of oak or elm, or with thin slabs cut off trees of that description. The angles are covered with a beading of moss rope, as are also the bands round both pedestal and basket. The upper part is also covered with bark; and on it are nailed, at equal distances, rustic rods placed in a slightly diagonal direction. The top is cut in an undulated manner, of unequal lengths, and finished in the same manner, only of a larger size, as the angles and bands are.

Fig. 933 is formed of four kneed rustic pieces of wood as near in size and form as can be procured. The panels between them are filled up with planking, the surface of which is covered with rods or with rustic bark; and over that, with moss rope or rustic rods, are given any curious appearances the ingenuity of the maker can suggest. Sometimes the

cones of any of the species of pine are chosen; and with them lines, either

Fig. 933.



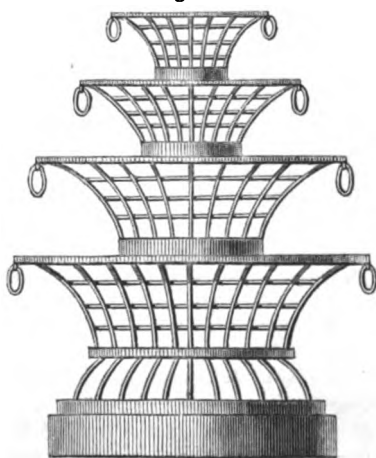
straight or curvilinear, may readily be formed. The top, for greater strength, may be caped with a piece of rustic timber of the same diameter as the main supports, sawn through the middle, and neatly mitred at the corners.

Figs. 934 to 937 exhibit a style of flower-baskets not hitherto published.

Fig. 934.

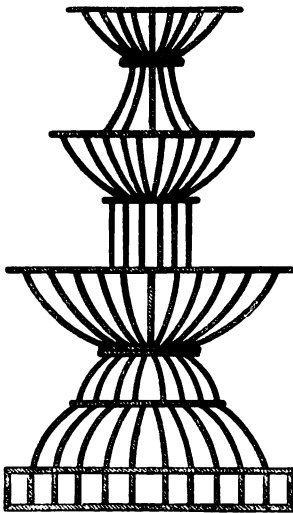


Fig. 935.



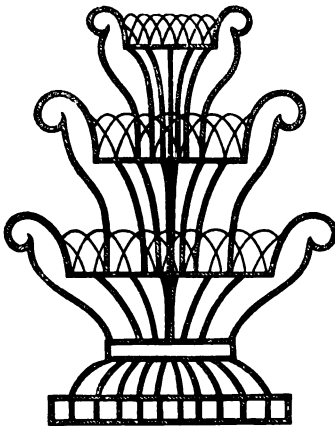
Permission was kindly given us by the Duchess of Buccleuch to copy them from

Fig. 936.



her grace's private portfolio of drawings. They are formed of strong narrow hoop-

Fig. 937.



iron, which gives them a more substantial appearance, as well as, in reality, a degree

of firmness and durability which the wire baskets in common use do not possess. They all stand, as it were, on plinths, either formed of open work or solid plates of iron—thus giving them the true appearance all subjects of this kind should show.

In the manufacturing of rustic baskets it is next to useless to employ a carpenter. They work too much by square and rule, and, from habit, give their work too much the appearance of art. An intelligent labourer, who has a natural taste for these things, makes the best flower-baskets, and indeed all other rustic work whatever. It is also fitting employment for them during winter, when they can put together the material picked up from time to time during their usual occupations in the woods and forests. Men having this object in view, will select the curious excrescences found on old trees, and the natural-bent branches, to form the different parts with as few joinings as possible—for on this much of the art depends.

It is hardly necessary to give specimens of the wire flower-basket in ordinary use. The great majority of those made by wire-workers have not sufficient strength at their bases, which unfits them for garden purposes, where they have not only the weight of the pots and plants to support, but also the resistance of the wind, which, in open-air gardens, has a considerable effect upon them.

Edgings for borders are very necessary appendages in this style of garden. They are formed of various materials, such as wire, cast-iron, earthenware tiles, rustic pieces of wood, slates, pavement, and various cements. The annexed forms may serve as examples of portable wire-work, (figs. 938 to 946.) They should be made in convenient lengths, so that they may be removed and stored by when not in use.

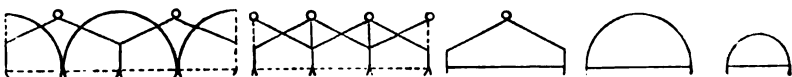
Figs. 938.

939.

940.

941.

942.

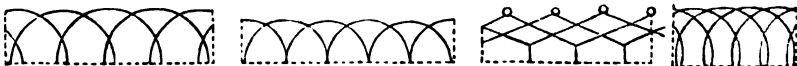


Figs. 943.

944.

945.

946.



Opinion seems to be at variance in regard to the propriety of introducing basketwork edgings in flower-garden scenery. For ourselves, we think them not only ornamental, but highly useful; and if judiciously managed, they not only harmonise with our notions of propriety, but give a seeming protection to objects utterly helpless. To produce a good effect, however, much taste and judgment are necessary in their arrangement, so as to suit the place and circumstances, as well as to suit the "basket to the flowers, and the flowers to the basket."

Fixed edgings, or baskets (if large) in one piece, are objectionable, because at one time they are too large, and at another time as much too small, for the plants growing within them. Unattached materials, therefore, like the specimens given, are best for most purposes, as they can be readily extended or contracted to suit existing circumstances.

Cast-iron and earthenware edgings are of necessity in pieces. They can, therefore, be removed or altered in position as required. Slate and pavement edgings being, from the nature of the material, also in pieces, can be easily removed, and may be adapted to curvilinear lines as well as to straight ones, as described p. 590, as practised by Mr Beck of Isleworth. In the multitude of wire, wicker, and cast-iron patterns, no difficulty can exist as to finding sufficient for any probable demand.

#### § 4.—BRIDGES.

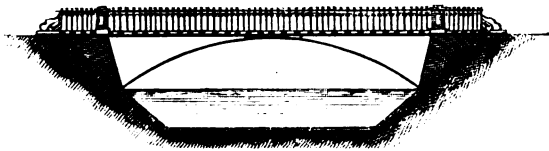
Few objects form a more interesting feature in landscape than a bridge; and the more suitable the design to the situation, and the plan to the purpose, the more striking and pleasing is the effect produced. Bridges are not only valuable as beautiful objects, but they are also useful—nay, often indispensable—for connecting parts of the grounds separated from other parts by brooks and rivers—as is the case at Dalkeith Park, for example, through which the two rivers, the North and the South Esk, flow. There are also other cases where grounds are separated

by the intervention of roads, over which it is desirable to pass, as is the case at Pains Hill, in Surrey, and in the palace grounds at Laeken, near Brussels, where, on account of a public road separating the old garden grounds from the new kitchen garden, a bridge was found to be the only eligible means of access. And in the former case, a bridge spans the Portsmouth road at a considerable height.

In such cases as the above, architectural bridges should be employed; at least they should be so much so as to remove them from the class usually employed in grounds when the space to be spanned is little more than that of a brook.

Fig. 947 is intended for a foot-bridge, of iron, to connect the lawn near Dalkeith Palace with some grounds on the opposite side of the North Esk.

Fig. 947.



Suspension bridges are well adapted, not only for crossing rivers, but also for connecting those parts of pleasure-grounds that may be separated by deep gullies or ravines. They are of two kinds—suspension wire bridges, and suspension chain bridges. The former of these are the simplest, and consequently the least expensive. As an instance of the economy of wire bridges, we may state that there was one of them thrown across the Gala Water in Scotland, with a span of one hundred and eleven feet, at a cost, it is asserted, of only forty pounds. And another was soon after constructed over the Tweed—a much larger river—the footway of which was four feet wide, at a cost of one hundred pounds. The annexed sketch, fig. 948, will show its principle. It is sustained by wires radiat-

Fig. 948.



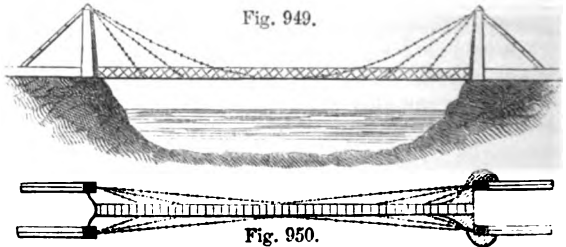
ing from the top of two cast-iron columns at the ends of the bridge. These columns were cast hollow, and within each of them was placed a vertical bar of wrought iron, two inches and a half square, to which the wires were attached. Those who agree with F. L. Von Sckell, of Munich, that rustic bridges are inadmissible in garden scenery, on account of their temporary and insecure appearance, may safely adopt the wire or chain suspension bridges, as being of a more permanent character, and as being less expensive than stone ones.

Both the iron arched bridge, and also the suspension bridge of the same material, according to Sir Thomas Dick Lauder's views, are deficient in picturesque effect—the former wanting the massiveness of stone, and the latter that pictorial effect which he believes is produced by wooden ones. He remarks "that several ages must elapse before the eye becomes so much accustomed to their flimsy appearance, as to be able fully to tolerate them. The wire bridge, indeed, may furnish a cheap and commodious means of passing a river, but it is so devoid of substance that it never can become an object that may be admired as a feature in landscape." It appears to him that, of iron bridges, those are of best appearance which consist of the fewest parts, and those parts of the most massive description; while those are least so which have the greater number of parts, and those parts thin and fragile-looking. If intricacy of construction be considered by some as an ingredient that constitutes beauty, "I certainly think," he says, "that it does not do so in the article of iron bridges; indeed, it has often occurred to me that the way to make an iron bridge look well would be to board up its sides and the interior of the circle of the arch underneath, so as to give it the appearance of solidity, and to paint it in such a manner as to give it the semblance of stone."

On the character and effect of wooden bridges, Price observes—"Many of the wooden bridges in Alpine scenes, with the supports irregularly crossing each other, are universally admired for their

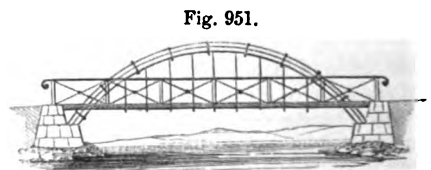
wild picturesque character, so well suited to that of the scenery; and even where wooden bridges are executed with great mechanical skill, on a regular plan, still a great degree of intricacy, though of a less picturesque kind, must arise from the necessary crossings of the timbers. Intricacy is, therefore, a principal characteristic of wooden bridges, as solidity, and consequently a certain degree of massiveness, is of stone bridges; for whatever is solidly built of any hard material, however light the general appearance, must be massy in parts, when compared with that which is of wood only, and where the different supports, (whether upright or slanting,) together with the pieces which, by intersecting, tie them together, are all visible."

Figs. 949, 950 show elevation and plan of a very simple suspension bridge, made



of light iron rods, and erected over the Tweed at Dryburgh.

Several specimens, of which fig. 951 is an example, have been built of late years



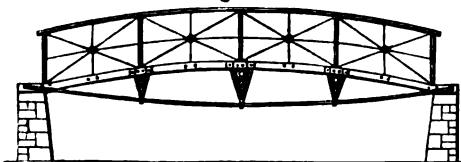
in the Regent's Park and elsewhere, upon a principle in which a singularly small consumption of iron is required, a great portion of the heavy weight of the chain being dispensed with.

The late Mr Loudon remarks, in "Villa Architecture," "that bridges are amongst the noblest structures which can be erected in pleasure-grounds; and, unlike rustic seats and root-houses, they maintain this character even when constructed of materials of temporary duration, from their obvious and unquestionable utility."

A mere plank or tree, when thrown across a stream, assumes a character of grandeur. It commands respect, from its powers of effecting for man what he could not by any possibility effect for himself. On the other hand, when a trifling stream, or an artificial river, displays a highly architectural bridge of masonry or cast-iron, the effect is offensive, because the means seem out of all proportion to the end. In short, a massive architectural stone bridge, built across a tame piece of water, not, perhaps, more than knee-deep, and an elaborate covered seat of rustic cabinet-work, which cannot endure many seasons, offend precisely for the same reason—viz., the unsuitableness of means to ends."

Fig. 952 is an iron tension and suspension bridge, also intended for foot-passen-

Fig. 952.



gers, but which by an extension in width and strength of material may be adapted for carriages also. For short spaces, the tension bridge, as represented in our woodcut, has all the advantages of the suspension, and is in some situations more suitable. It can be erected at a trifling cost; that for a bridge for foot-passengers not exceeding 25s. per foot in span—a cost probably below that of any other bridge of equal strength, durability, and elegance of form.

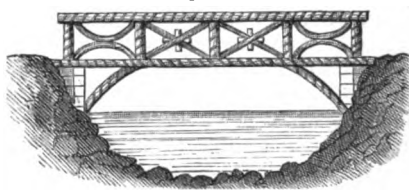
Rustic bridges are of more humble pretensions than those already noticed. They, however, have the merit of being cheap, the material in general being on the proprietor's own property. They also associate well with garden scenery, and admit of great variety of form. We believe that, with one or two exceptions, the designs of the following bridges have not been published.

Figs. 953, 954, have stone abutments, upon which the principal timbers rest. They are adapted to cross rivulets, or spaces from ten to twenty feet in width. They are best constructed if from three to five feet in width—a breadth quite

VOL. I.

sufficient for foot-passengers, for which purpose they are chiefly intended; but

Fig. 953.

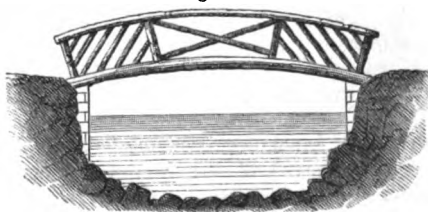


they can be so built as to carry carts or carriages, by laying from each abutment three 6-inch Baltic battens, set on edge across, and tied together at the ends and middle with an iron bar, to keep them in their places. Over this a flooring of deal or oak is laid, rough from the saw, the upper surface of which is to be covered with a coat of asphalt, to form the footway, and to keep the flooring dry. The outer sides of the two outer battens are covered with larch bark, and the parapets or hand-rails are constructed of pieces of the same kind of tree, cut into the necessary lengths, and selected so as to be of as near the same thickness as possible. The middle of the footway should be rather higher than the sides, to allow of the escape of rain water, which can easily be done, by laying on the asphalt rather thicker in the middle than at the sides.

If the span be great, or the contemplated weights to which it may be subjected considerable, struts may be placed in the abutments; and if partially curved, as shown in the figure, the effect will be improved, and considerable strength added to the bridge, by shortening the length, as it were, of the principal beams.

Fig. 954 is somewhat differently constructed. A slight curvature is given to

Fig. 954.



the principal bearers; and instead of their being covered with boarding, they are

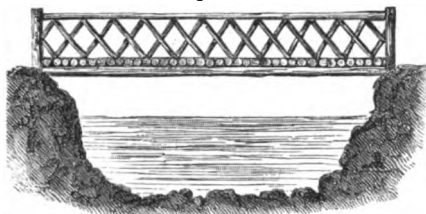
4 R



to be covered with larch, or any other straight-growing trees, of 4 or 5 inches in diameter, and laid close together, reversing them alternately, so that the thick end of the one shall come next the smaller end of the next—thus keeping them always square across the footway. The ends of these should be all cut square, to be of equal lengths, and each covered with a piece of bark, so as to hide the transverse section. The hand-rail is to be divided into panels—the principal upright pieces being double the size of the subordinate or diagonal ones. These should all, however, be of as near the same diameter as possible.

Fig. 955.—In this example the footway is shown level; and the abutments

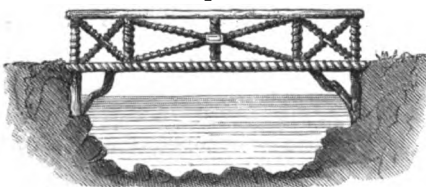
Fig. 955.



may be covered with rough stones, ivy, and trailing plants. The floor of the footway is covered with larch, or other straight poles, and laid as directed for fig. 954. The hand-rail is a simple trellis-pattern, one series of the bars being entire, while the others are cut into pieces of the required lengths, and neatly hollowed out at the ends, so as to form a mitre joint, with the bark entire.

Fig. 956.—Here the abutments are also of timber, but so selected as to have

Fig. 956.

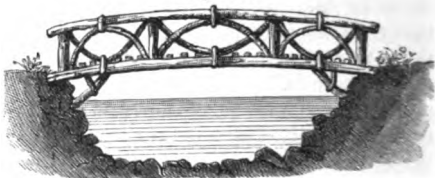


an arm or bracket proceeding from them for the support of the footway. These arms will look best if of the natural growth of the tree; otherwise they must be attached in the most natural manner possible. The outer sides of the outside

battens in this bridge, as well as the whole of the hand-rail, should be covered with *Polytrichium commune*, twisted in form of ropes, and neatly wound round the respective parts, and nailed on to the face of the battens. The top and principal rails of the hand-rail should have ropes of greater thickness than the diagonal or smaller parts. The supports underneath may be left with their natural bark attached to them.

Fig. 957 is a very pretty bridge when neatly executed. The bearers show a

Fig. 957.

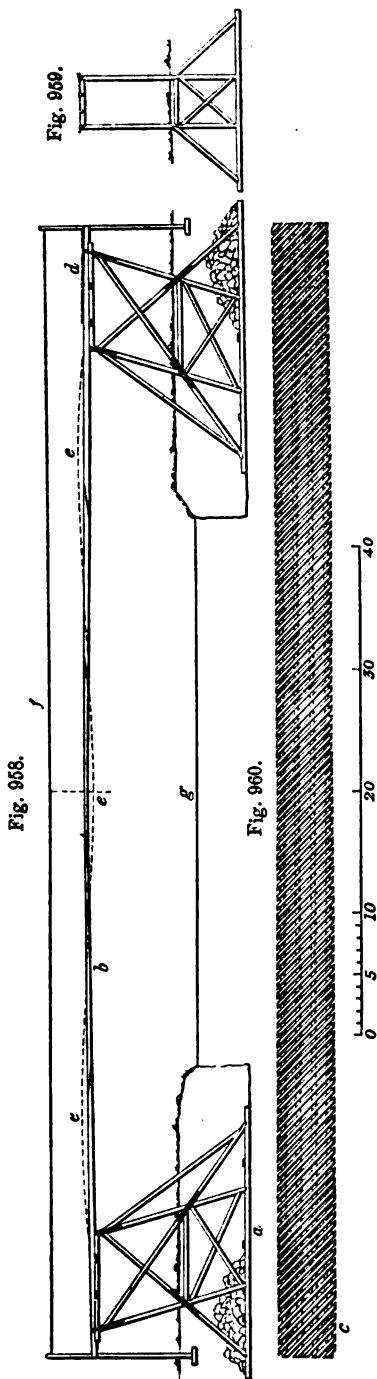


slight curvature. The footway is covered with larch poles, laid across. The supports beneath are let into the abutments, which are covered with rough stones and wild plants; and although they are securely enough fastened to the bearers above, still they have the appearance of only being tied to them by a rope of *Polytrichium*. The same occurs in the hand-rail. The bent pieces which fill the panels should each be in one piece if possible.

Abutments to bridges, as shown in our figure, are not only of great importance to the structure itself—they show stability and an appearance of safety. When exposed to view, they are also quite in keeping in this style; because it forms, as it were, the connecting link between the architectural and picturesque.

One of the most economical and elegant of all wooden bridges for such purposes is that of Remington, an American of great ingenuity, who, under the greatest privations and disadvantages, erected the first bridge of this kind seen in Britain a few years ago in the gardens of the Surrey Zoological Society. One of great strength and size was erected by him at Ingestre Hall, Staffordshire, over which carriages and waggons pass daily. The only example of such a design in Scotland, that we are aware of, is that in Dalkeith Park, of which figs. 958, 959, 960, are a representation. It connects

two sides of a deep and retired dingle of considerable width, and was erected at the



cost of a few pounds only. The following references will explain its principle:—  
*a*, strong-framed tressel to form abutments, made of 5-inch square timber, 4 feet wide from out to out, weighted at bottom with stones, &c. &c. *b*, four stringers, spliced in four places, the joints broken alternately: let the grain be straight and clean, the top and one side cut straight: plane the bevelled part from the under side, and the remaining side to the centre: these stringers to be at the end 3 inches by 3, increasing to 4 inches by 3 where they leave the tressel, and from thence tapering to 1 inch at the centre: let the splices be good, and put together with marine glue and screws: let it dry two or three days, and give two coats of paint before putting them on the abutments: the best sort of timber for the stringers is Memel. *c*, a 2½-inch strap of iron by ½ inch, that crosses over the end of the stringers and down each side of the tressel; with one bolt in each stringer, and one where marked farther on. Fig. 959, Section of tressel. *d*, showing the ends of lath keeping clear of the remainder, to show the splices on stringers. Fig. 960, The lath that goes across the bridge, 4 feet 4 inches long, 2½ inches broad, leaving 2½ inches apart: common white deal, 1½ inch thick, half checked, to lie on top of stringers, glued down, and nailed with 4-lb. clasps—(N.B. Do not cut anything out of the stringers.) *e*, a dotted line, showing the run the bridge will have when finished. *f*, the rope for hand-rail.

§ 5.—TRELLIS-WORK, GATES, FENCES, AND TREE-GUARDS.

Trellis-work for training plants and shrubs of scandent habits—for forming arbours—for covering walks often of great length—for entrances to flower-gardens, or to detached portions of the same—is both useful and highly appropriate in this style of garden.

For covering walks of great length, cast-iron columns are set in stone blocks at distances of six, eight, or ten feet apart. From the top of these, wrought-iron rods proceed, and form the arch, of whatever breadth; but this seldom exceeds 6 feet, nor should it be much narrower: the

height ought to be from 8 to 9 feet. These columns are cast hollow, so as to give increased diameter with the least expenditure of metal, unless they are under 2 inches in thickness, in which case they are cast solid. The others should be from  $3\frac{1}{2}$  to 5 inches in diameter; but this, as well as the height and width of the walk, must be regulated by its intended length. Sometimes these columns are cast with perforations through them, and at other times they have eyed studs screwed into them for receiving the wires, which should run lengthwise of the walk, and be 14 inches asunder. These longitudinal wires are placed along the sides and roof also, and to them the plants are fastened. In giving these dimensions, we allude to walks of great length, and intended to be covered with climbing roses, clematis, and similar rapid-growing plants.

For covered walks upon a smaller scale, and to be covered with plants of less rapid and strong growth, the trellis must be closer—say from 9 to 12 inches apart in the wires; and for still smaller plants and situations, from 4 to 8 inches. Covered walks in this country are, no doubt, a remnant of the old French style, and a kind of substitute for the ancient *berceaux* walks, so much prized in former times on the Continent. In those countries they are of much more use than with us, as affording shade during summer, and shelter in winter. They, to a certain extent, are prized for the same reason here, but more so for the facility they afford for training climbing plants. Covered walks are also valuable, as hiding out disagreeable objects, and forming a connection between one garden and another.

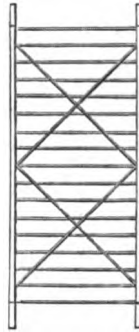
The arcade, when well covered, affords a pleasant shady walk; but the beauties of the flowers can only be seen by viewing it externally. To enjoy both shade and the beauty of the flowers, the arcade ought to be formed of arches placed at regular distances, so as to admit the air and light between, by which means the plants will be covered with flowers from the ground upwards. The arches may either cross the walk at right angles, or they may cross each other, so that the vertical profile of every two arches would form a cross.

*Hidden or private walks.*—It frequently

occurs that a communication is necessary between two parts of a domain, and that it is desirable this communication should be as little seen as possible. Various plans have been purposed to effect this—we mean in situations where the walk cannot

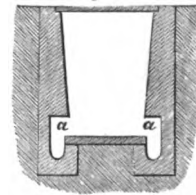
be planted out by shrubs. A ha-ha or sunk fence, in some situations, may be adopted, having a walk along the bottom of the excavation. This, however, although a good blind on one side, may be objectionable on the other, as the wall will be seen. Sunk walks may be substituted, 8 feet in depth, with the sides walled, the bottom paved, with drains on each side, and the top covered with a horizontal iron grating, fig. 961. Fig. 962

Fig. 961.



will show the principle, being a vertical profile of the path, covered with the horizontal grating.

Fig. 962.



Where this path is crossed by gravel walks on the surface, the gravel, and a margin of turf on each side of it, can easily be supported by a flat brick arch, or a trough of cast-iron.

Side drains are also shown in the sketch, *a a*, which, connected with main drains, would render the walk perfectly dry. Such a plan would have been certainly preferable to the open ditch in which the public footpath is placed that crosses the Home Park at Windsor.

The greatest objection to sunken walks is the difficulty of rendering them dry; and this difficulty increases as the grounds through which they pass approach to a level, and where the soil is clayey or retentive of water. The most efficient mode of draining such walks must be carrying a sufficiently capacious drain under them, extending to one or both extremities, and means being there taken of letting off the water. In the case of a sunken walk passing through private property where the public has a right of way, then the horizontal grating over it is indispensable, as completely preventing intrusion on the part of the public; but

when intended only for the use of the proprietor's establishment, such precaution need not be taken unless to prevent accidents from men or beasts falling in. Drifted snow is apt for a time to render them impassable; but this does not often occur, and, if it does, is only of short duration.

In carrying private walks past objects, or parts of a domain that may, from various causes, be wished to be excluded from sight, various means may be adopted, such as tunnelling where the ground will admit, carrying the walk over by bridges with high parapets, or trellised coverings interwoven with ivy and other creeping plants, of which fig. 963 may

Fig. 963.



serve as an example, or as already alluded to in speaking of covered walks.

Tunnelling, where the nature of the ground admits of it, is one of the best modes of forming a communication between different parts of the grounds, and may be effected by cutting through rock, which, of itself, will be self-supporting, while, at other times, the ground has to be opened and walled up at the sides, as well as arched over and then covered with the natural soil. The building, in such cases, should be in the rustic style. In forming tunnels, they should, where possible, be carried through in a straight line, so that the light may be seen at the opposite end. To render them tortuous in direction is to render them dark, and to raise in the minds of some an idea of the tricks of the grotto-work so much practised during the seventeenth century. Another way of effecting communication between distant parts of the grounds, or of passing a walk which is wished to be unseen, is by carrying a half rustic bridge

of stone or wood over it, but so disguised by vegetation as to hide the intention, and not to interrupt the idea of the continuance of the walk.

Few things contribute more to the embellishment of gardens and grounds than properly designed and correctly proportioned gates. Hence the necessity of as much care being taken in the selection of the designs as in the execution of the work.

Gates for walks and footpaths are denominated wicket-gates, and are, in general, even in places of great extent, seldom to be met with in good taste, their construction being, in general, left to the village carpenter or blacksmith.

There can be no economy in using wooden gates for any purpose, as their first cost is nearly as much as that of iron ones, while the durability of the one can bear no comparison with that of the other; and after fifty years' use, the material of the one is not much lessened in value, while, long before that, the other is either rotten or broken to pieces.

The previous remarks on wicket-gates apply to those on carriage approaches, drives, and the broader description of walks. With the decay of architectural and geometrical gardens, gates have also shared in the downfall. The beautiful wrought-iron gates at Hampton Court are one example out of many that could be given of the style of gates thought to be worthy concomitants to the geometrical gardens to which they lead.

As house architecture is rapidly rising into repute amongst us, so will garden architecture also be cultivated. As an instance of this, we need only point to the elaborate and elegant entrance-gates to the grounds at Kew, which, had they existed in the days of Pope, Bridgman, and Co., would have been consigned to the foundry as old iron, and wooden hurdles erected in their stead; and to the beautiful specimens furnished by the Colebrooke Dale Company, exhibited in the Crystal Palace last year.

All fences for this style of garden should either be of wire or be ha-ha's—both, we believe, the invention of the Chinese. The ha-ha forms a fence on one side only, unless surmounted by a hedge, or *chevaux-de-frise*. The wire fence protects on both sides equally, and, in addition, is scarcely seen at a distance; hence the term "in-

visible fence." They are also strong, and although they may be bent by violent concussions, they are scarcely capable of being broken; to which advantages may be added their durability and elegant appearance, and the fact that they can be erected at less cost than any other equally efficient fence whatever. They are of a great variety of patterns, strength, and sizes.

Tree-protectors are used where rabbits or hares abound, and also for protecting

Fig. 964.

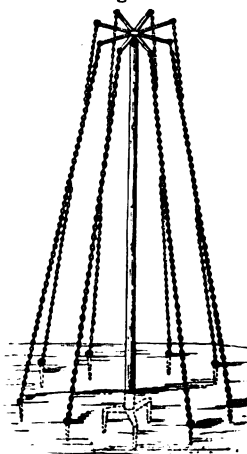


single trees from injury by cattle, and are of various forms, and of different material. Those made of small iron rods, or strong wire, are not only the neatest, but the most durable, and by a simple contrivance may be joined by hooks and eyes; so that they may be removed from one tree to another without being taken to pieces. Fig. 964 represents one form of these.

Trainers for climbing plants, when of elegant forms, and judiciously disposed, add greatly to the beauty of a well-kept flower-garden. They are also employed for climbing-plants in pots. The form and size of trainers should be consistent with and proportioned to the character of the plant to be supported. Single polls without branches may appropriately enough be used for hollyhocks and similar growing plants, although we think a far more elegant form would be to train them to a series of arches. Roses are trained in a variety of forms, according to the effect wished to be produced. Pyramidal training is well adapted to some of the strong-growing sorts, and is in general formed by setting three larch poles in the ground in a triangular form, having their but-ends charred to secure durability, and their tops brought together to a point, and fastened by an iron hook. The plants may be trained up the single polls—and

this we think the best way; or they may be connected together by laths or wires, and the whole surface densely covered. Standard roses should always be supported so that the support may not be seen; and for this nothing is better than iron stakes, with three prongs to set in the ground to keep them steady, and then to envelop both stem and support in clean green moss. This obviates the effects of frost during winter, and keeps the stem moist during the heats of summer; besides, it gives the tree really the appearance of a trunk, bearing a much better proportion to the head than the stem, without such coverings, would have; for, as standard roses are at present grown, they have much more the appearance of mops stuck upon a pole than natural-grown trees. We have stated in the article *ESPALIERS* the effects of frost on the stems and branches of plants when brought into close contact with iron. To avoid that, and give durability at the same time, we use wrought-iron sockets as in the following cut. These are set in the ground, till the cross-bars at top of the prongs (all of which should be flat) firmly rest on the surface of the ground. In these sockets, when placed in the ground at the root of the tree, are inserted larch-poles that have been a year cut, dressed and perfectly seasoned, of a diameter at least half an inch greater than that of the hole in the socket; so that, when inserted, they may form a shoulder or projection of not less than a quarter of an inch over the opening in the socket, that the wet, which

Fig. 965.



may run down the poles, may fall over the iron, and not into it. Such supports will last for years; and from the way they are set in the ground, they cannot be blown over by the wind. Any neat and efficient trainer for roses and strong climbing plants may be formed, as

in the annexed sketch, fig. 965, which consists of a strong post set in the ground, to the top of which an iron cap is fixed, and from which six or eight iron arms project, from 9 to 18 inches in length, each of which is furnished with an eye, to which a chain is fixed and brought down, and secured near the ground to an iron bolt driven firmly and slantingly into the soil.

The annexed sketch, fig. 966, shows a natural and efficient trainer, well adapted for single clumps of sweet-peas, *Tropæolums*, *Eccremocarpus*, or other fast-growing plants of one year's duration. It consists of a young larch tree selected in thinning the plantations, the bottom of which is bared of its branches to the height of 18 inches: the remainder of the branches are shortened in a tapering manner towards the top. They are planted in the ground to the depth of 18 inches, and the soil made firm about them; or, for greater security and durability, set in

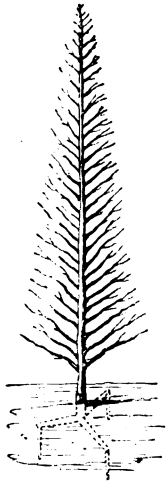


Fig. 966.

iron-pronged sockets, as shown in the cut. When so placed, the seeds may be sown, or the plants set at their base, and allowed to climb up amongst the branches. Very little attention is required afterwards, as the branches attach themselves to the support, and assume quite a natural character—that of all others the best for showing climbing plants to the greatest advantage. There is one universal principle in the employment of supports, which should never, if possible, be departed from—namely, to make them subordinate to the plant to be trained on them. If this principle were kept in view, we would see fewer of those glaring errors which occur in regard to climbers in most gardens.

Another glaring error, and one of almost universal occurrence, is painting supports a green colour—no doubt with a view to imitate nature; but in imitation of this kind, care should ever be taken to avoid an imitation that might be taken

for a reality. Stone, or brown colour, resembling that of the bark of trees, would be a much more artistic colour.

### § 6.—MOSS-HOUSES, SEATS, AND RESTING-PLACES.

Rustic seats, arbours, and resting-places, are as admissible in gardenesque scenery, as the most classic temple, vase, or piece of sculpture in the geometrical style. Great ingenuity has been displayed in the formation of such structures, which may be considered as being of two different orders—viz., the artificial rustic and the natural rustic. A taste for these appears to have risen in this country cotemporary with the introduction of the modern style of landscape gardening. They are usually constructed of the trunks of trees, having the bark on, planted in the ground, to give stability to the structure. The panels, or spaces between, unless where left open for entrances, are filled with boards or clay noggin; the inside being covered with moss, hazel rods, or similar material, also with the bark on; the outside with the rough bark of trees, moss, heath, and often with split rods of young trees, paneled into various forms. The roof is almost invariably thatched with heath, or with reeds where the former does not abound. The interior is, however, always cleaner and drier when covered with rods of wood, and there is also much less harbour for insects. The ceilings are usually of moss, sometimes paneled in rude architectural forms with various coloured mosses, and cornices are introduced, made of the cones of different species of the pine tribe.

The specimens we offer in the present section may be considered as the artificial rustic, of which the following figures are examples.

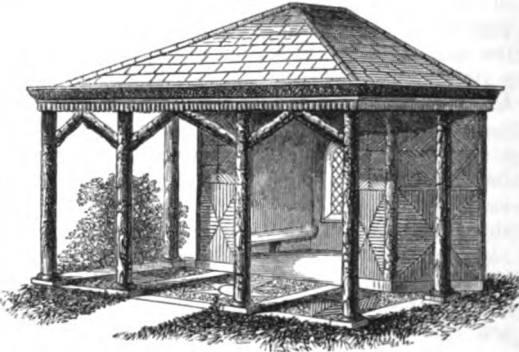
The tasteful construction of moss-houses, rustic seats, vases, &c., is an art, if we may so call it, not easily taught; nor is it at all an easy matter to convey anything like written instructions, at least such as can be useful, to others, even by those who are themselves proficient in the matter. It is a sort of natural taste that one man possesses, which a thousand around him have not the slightest idea of.

Hence it is that we have so few written instructions how these things are to be managed; and also because those who, for the most part, have excelled in this kind of work, have been unable to communicate even their ideas of it to paper, because they are in general men in the humblest walks of life, and without the advantage of education. Still we see nature has endowed even them with a peculiargift that few educated men possess.

The best article we have met with upon rustic architecture is a paper communicated to "The Gardeners' Magazine," vol. x. p. 532, by our esteemed friend, Mr Toward, who fortunately possesses both the natural gift, and also the ability of conveying his ideas of construction to us in a very clear and perspicuous manner. The subject of elucidation is a very complete and tasteful rustic-house, erected in the

grounds at Bagshot Park by himself, of which a view and ground-plan are given in figs. 967 and 968, and is to the following effect: "The form is an irregular heptagon, with a Gothic portico in front, supported on rustic pillars. The ceiling of the portico is inlaid with moss of various colours, representing a star and diamonds, as shown in fig. 969, with a cornice of pinaster cones. The floor under the portico is a copy of the ceiling, in different coloured elliptical-shaped stones of a small size. On each side of the doorway are panels formed in the rustic style, with different coloured woods. The entrance into the house is Gothic, opposite to which are two Gothic windows, with stained glass of various colours. Under these are four square panels, with a large

Fig. 967.



diamond in the centre of each, all formed with moss. Along the sides, between the

Fig. 968.

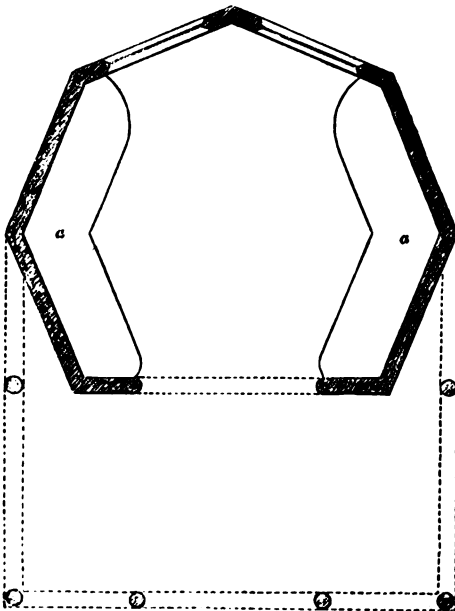
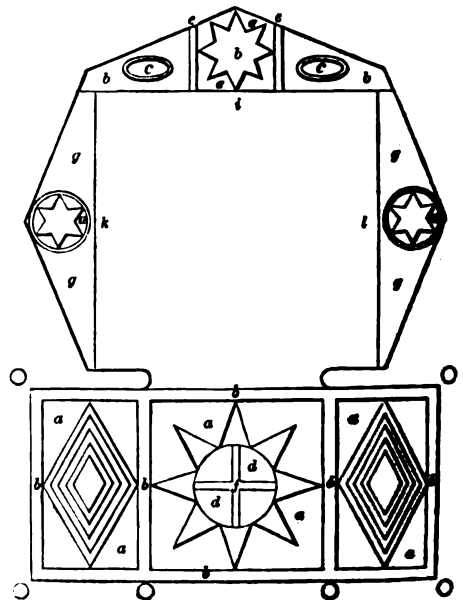


Fig. 969.

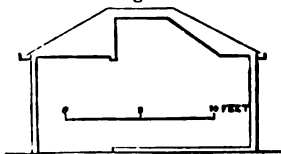


doorway and the windows, are seats, *a a*, fig. 968, made of stained cherry-tree. Above these is a skirting of rustic wood, eighteen inches deep, the surbase of which projects about three-eighths of an inch beyond the moss, to prevent the back from brushing against it. Each side above the skirting is divided into four panels, and these into a succession of squares. On the right and left of the Gothic entrance is an oblong panel, with between twenty and thirty of the most common species of moss arranged in horizontal stripes. In the spangles over the doorway are upwards of sixty species of moss and lichens, such as are too diminutive in growth to be incorporated in the body of the work. Over the seats and windows are three horizontal pieces, on a level with the ceiling of the portico, with various devices, (fig. 969, *h i k l*.) These pieces serve as a kind of plançier to the inner roof, which is a common span, with a gable end over the entrance, on which is represented the elevation of the building. The opposite end is hipped in, and has the figure of the English crown. The whole of the design is executed in particoloured moss. The ceiling of the span part of the roof is inlaid with light-coloured mosses in the form of diamonds. All the styles, rails, and mullions of the panels are formed with *Cenomyce rangiferina*, a white lichen. The ridge of the outer roof is about four feet in length, with six hips, and projecting eaves. The plançier is of rough bark, and the fascia of pinaster cones, within which is a gutter to carry the water to the back part of the building."

Mr Toward remarks, "that, had the whole structure been 1 foot higher, it would have appeared to much greater advantage. The walls are barely 7 feet, and they ought to have been nearly 8 in height.

"Fig. 967 is the elevation, showing the situation of the window, the seats, the outer cornice of pine cones, floor of the portico, &c. Fig. 968 shows the ground-

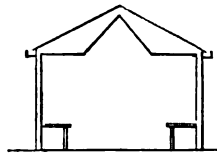
Fig. 970.



VOL. I.

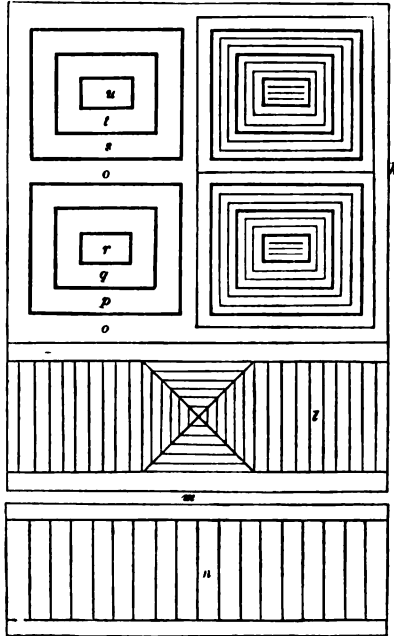
showing the interior and exterior roofs. Fig. 971, section from right to left,

Fig. 971.



shows the seats, and the inner and outer roofs, with gutters. Fig. 972 is a sketch of one of the sides. In this figure, *k* shows the disposition of the rods before the moss is introduced between them; *o* is *Cenomyce ran-*

Fig. 972.



*giferina*, (a white lichen;) *p* *Hypnum Schreberi*, (a green moss;) *q* *Dicranum glaucum*, (light-grey moss;) *r* *Bryum hornum* (green moss;) *s* *Sphagnum acutifolium*, pink var.; *t* *Sphagnum obtusifolium*, (white moss;) *u* *Bryum cuspidatum*, (green moss;) *l* is the rustic skirting above the seat; *m* the seat; and *n* the rustic-work under the seat.

"Fig. 969 is a plan of the ceiling of the portico, and of the horizontal part of the ceiling of the interior. In this figure *h i k* and *l* are the horizontal panels of the ceiling of the interior over the seats. The patterns of these panels are formed by round rods, as above described, between which are introduced the follow-



ing kinds of moss :—*a* Bryum hornum ; *b* Cenomyce rangiferina ; *c* Sphagnum acutifolium, pink var. ; *d* Sphagnum obtusifolium ; *e* Dicranum glaucum ; *f* Bryum cuspidatum ; *g* Hypnum squarrosum ; *h* Dicranum scoparium. The same letters refer to the ceiling of the portico.

“The following is the method in which the work is performed. The first thing necessary, before commencing operations, is to have an even close-boarded surface to work upon, and upon this ground draw whatever figures, forms, or devices, you intend to represent.” From this it will be understood that the walls, if we may so call them, are formed by placing uprights of sawn timber to form the shape of the house, and to cover these with boarding on all sides where rods are to be used for throwing up the figures ; but where moss or heath is to be employed for the whole surface, no boarding is required, as rods will be nailed to the uprights in the manner of laths for plaster, and the moss forced in the spaces between with a blunt chisel or piece of wood. Where heath is to be used, the rods need not be so close, as the heath will be secured to them by sewing it on with a long packing needle and tarred cord. But on boarded surfaces to be covered with rods, and where devices and figures are to be made with different coloured mosses, the first thing is “to get round rods, about half an inch or five-eighths of an inch in diameter, nearly of equal size, and well seasoned. These rods are to be nailed on agreeably to the drawing, about an inch from centre to centre, this being the average space, though it is necessary to regulate the distance, in some measure, according to the space allotted for each sort of moss. Each species should be collected separately, when perfectly dry. It must be adjusted by placing the top of each piece as evenly as possible, and cutting off a part of the root end if it should be found too long. Take a small quantity at a time, and ram it between the rods with a blunt wedge-shaped piece of wood. The round rods act as a dove-tail ; and, if the moss be properly rammed in, it cannot be pulled out again without tearing it to pieces. The bottom part being compressed between the rods, the top expands,

and so completely covers the rods that not a vestige of them is to be seen in the whole building.”

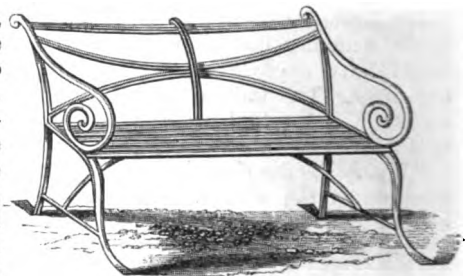
Seats and resting-places are very necessary appendages to all gardens, more especially those of great extent. There are few places where a tithe of the necessary number is to be met with. They are not only to be considered in the light of ornamental furniture to a garden, but as articles of indispensable utility.

Seats, whether open or covered, are objects of considerable interest in grounds ; for, besides being useful, they produce of themselves variety both as foregrounds to look from and as objects to look at. Like statuary in the geometric gardens, their number and disposal require tasteful consideration. In small gardens they should not be too numerous, nor should they be of a cast to produce too striking an effect. Where the grounds are extensive, their utility becomes much more apparent, therefore they may be more abundantly scattered about, as well as made to form important objects when seen from a distance.

Metallic chairs are certainly, if we except marble or granite, the most durable ; and the only objection urged against them is oxidation, which is apt to spoil ladies' dresses. This, however, can easily be got rid of, by painting them annually with anti-corrosion paint, of which there are several sorts noticed in this work.—*Vide* p. 562.

Fig. 973 is a wrought-iron chair, greatly admired for its elegant appearance and

Fig. 973.



the comfort and ease of its seat. It is less liable to be broken ; and being lighter than cast-iron chairs of the same size, it is much more easily moved from place to place.

Fig. 974 is also of wrought-iron, and adapted to be fixed under the shade of a

Fig. 974.



tree, as shown in our cut. It may be divided into four compartments or not, according to fancy.

Although the material of the chair shown in fig. 975 is sufficiently rustic,

Fig. 975.

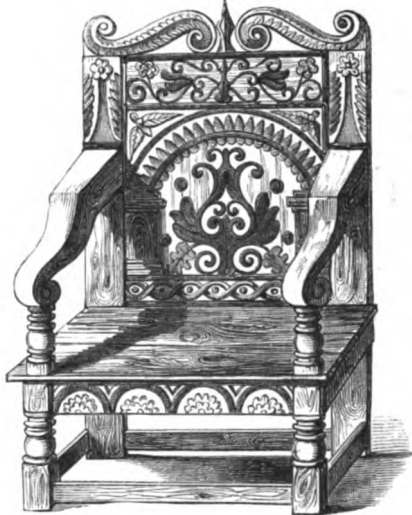


still there is something so truly artistic about the design that we think it might be admitted with all propriety of taste

into a garden of the highest pretensions to art. This elaborate chair was made by Mr G. Collinson of Doncaster, and, independent of its merits otherwise, has a little history connected with it. Two oak trees of very large dimensions were lately found under the bed of Dun river, and are believed to have been thus buried for upwards of 2000 years. From the fragments, after about 200 cubic feet of timber had been secured, Mr Collinson fabricated this chair, the original of which is now in possession of W. Chadwick, Esq. of Arksey, near Doncaster.

Fig. 976 represents another exceed-

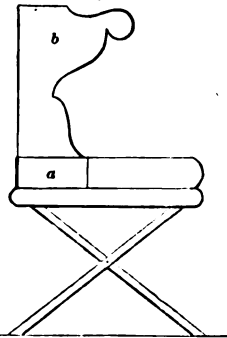
Fig. 976.



ingly rich chair, of somewhat similar design.

The annexed figs. 977, 978, represent a garden seat, described some time ago in "The Gardeners' Journal." It is both convenient and portable—a very desirable property, as it can be moved into the shade in hot weather, and into the warmer situa-

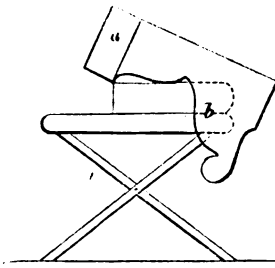
Fig. 977.



tions in cold weather. They are of vari-

ous lengths, of from 3 to 9 feet, and "so light as to be removed with the greatest

Fig. 978.



ease from one part of the garden to another; and, when not in use, the back folds over the seat, keeping it dry and clean. On each side is a rest for the arm, *b*, which, when the back is shut down, passes the end of the seat, as shown in the sketch. At *a* is a small box, 6 inches wide, running the length of the seat, and may be about 2 or 3 inches deep. It is covered by the last rail forming the back part of the seat. It is loose, but kept in its place by a button, and is readily lifted up or down. In this box a cloth may be kept, by which the seat may at any time be wiped down."

The Norwegian portable seat, figs. 979, 980, is extremely useful. They are imported annually in considerable numbers by the Baltic ships to the port of Leith.

Being portable and light, they are capable of being carried from place to place,

Fig 979.

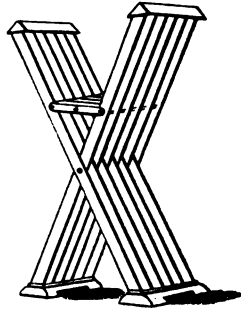
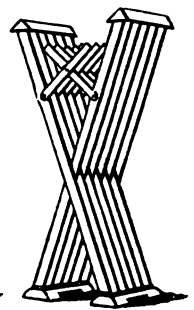


Fig. 980.



even by ladies, who may wish to avoid the sun or enjoy a fresh object or view; and can also, for the same reason, be packed by in winter when not required. Fig. 979 shows the chair as it is used; fig. 980 in its compressed form.

Chairs in the rustic style, but of cast-iron, appear to be becoming very prevalent. They are painted so as to resemble the unbarked branches of trees. Whatever may be said of the correctness of this taste, such chairs have durability in their favour, which those made of the branches of trees have not.

## CHAPTER XIV.

### PICTURESQUE STYLE OF FLOWER-GARDENS.

#### § 1.—THEIR GENERAL ARRANGEMENT.

The picturesque style, as has already been observed, is divided into three pretty distinct kinds, viz.—the rough, the trivial, and the polished or refined. In the latter, which is also called the modern or English style, slight indications of the gardenesque, and still slighter of the architectural and geometrical, may with propriety be blended.

There are few words whose meaning has been less accurately determined than picturesque. If we consult a dictionary, we find it is said to mean a thing "expressed happily as in a picture." In connection with such natural objects as surfaces covered with vegetation, in its general acceptance, it means the same thing. Sir Uvedale Price, in his "Essays on the Picturesque," defines it to apply "to every object and every kind of scenery which has been, or might be, represented with good effect in painting, just as the word beautiful, when we speak of visible nature, is applied to every object, and every kind of scenery, that in any way gives pleasure to the eye." Mr Gilpin defines picturesque objects to be those "which please from some quality capable of being illustrated in painting;" and again, in his letter to Sir Joshua Reynolds, "such objects as are proper subjects for painting." The late Sir Thomas Dick Lauder says, "A picturesque object may, in fact, be defined as that which, from the greater facilities which it possesses for readily and more effectually enabling an artist to display his art, is, as it were, a provocative to painting."

Applied to gardening, we think, like the equally modern terms gardenesque,

sculpturesque, &c., the term means such objects as are best fitted for displaying the powers of the artist, or which would most readily provoke him to the exercise of his art.

The picturesque style in gardening has too often been misunderstood even in another sense, and hence too many have carried the wildness of what is properly the trivial picturesque up to the very walls of their houses—just reversing its position, as it should always form the connecting link between the polished or refined picturesque style and the park, grove, or forest. Another misunderstanding of the term has been an over affectation of simplicity, and an attempt merely to imitate nature in its most unpolished form. To this we may add a desire to banish all embellishments of art from near and around the house, where they ought to be not only employed, but displayed. "Wherever architecture," says Price, "even of the simplest kind, is employed in the dwellings of man, art must be manifest, and all artificial objects may certainly admit, and in many instances require, the accompaniments of art; for, to go at once from art to simple unadorned nature, is too sudden a transition, and wants that sort of gradation and congruity which, except in particular cases, is so necessary in all that is to please the eye and the mind."

The gradations of the grounds from the front of a mansion or house, however devoid of architectural pretensions they may be, should always begin with an appearance of art; and if ever the picturesque style is to be indulged in to its fullest extent, the transition must not be abrupt, but gradual. In considering the pleasure-

grounds of a place, Sir Thomas Dick Lauder observes, "No one can be more desirous than I am to see nature everywhere triumphant, and that, even when educated by art, she shall still be nature. But much as my feelings coincide with this view, as regards the garden or grounds that recede from the mansion, there is nothing of which I am more convinced than of the propriety and necessity of allowing the art to become more apparent in the gardening which comes into more immediate contiguity with the mansion. My rule would be, that the house and its subsidiary buildings should be directly associated with designs of a character which may have much of architectural regularity, as well as actual architectural feature about them. By this means the house itself not only becomes a more pleasing object to look at from all points, but the different views enjoyed from it become much more interesting from the enrichment of the foreground by minor architectural objects. Straight-lined terraces, bowling-greens, balustrades, vases, sun-dials, architectural seats, fountains, and statues, mingled with a profusion of shrubs, plants, and creepers, are all appropriate and useful decorations for such a place. The more formal trees, such as cypresses, Lombardy poplars, Irish yews, &c., come well into harmony with the architectural design; and in some instances box-hedges may be desirable, especially where they are contrasted with shrubs of a freer growth, the general design being to produce that intricacy and richness which begets interest, and to furnish an assemblage of objects to throw back the distances."

These few years past have shown a great advance in this species of taste, as few modern houses are built without the minor architectural details of terraces, vases, balustrades, &c., being introduced as immediate accompaniments. The dressed parterre connects them with the polished or refined picturesque, and that carries the eye to the trivial, beyond

which is seen the rough picturesque uniting with the natural scenery in the distance.

The general rules for laying out gardens in this style are thus laid down by Monsieur de Girardin, and truly merit the attention of the garden architect:—

"1. To form the perspective or side scenes of the foreground that may best connect the distance with the principal points of view.

"2. To raise such elevations or scenes as may give relief even to a flat.

"3. To hide all disagreeable objects.

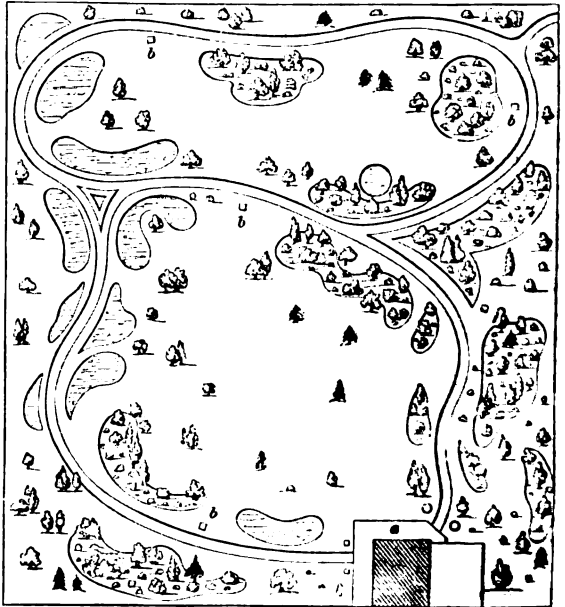
"4. To give more extent to those that are pleasing, by concealing their termination behind a mass of wood, by which means the imagination continues them beyond the point where they are seen.

"5. To give an agreeable outline to all surfaces, whether of land or water."

These are the ideas of one who thoroughly understood the subject; and if we would reduce these rules to practice, we must perfectly understand the subject also; and before we commence the improvement of nature, we should understand what her peculiarities and beauties are.

Fig. 981 exemplifies this style; but, at the same time, there is a combination of

Fig. 981.



the gardenesque and architectural, and, in a slight degree, of the geometrical also.

In the terrace-garden next the house, the geometric style is slightly shown at *a*, which may be laid out as a simple parterre. The rest, composed of trees, shrubs, and flowers, grouped together in tolerable masses, shows the picturesque style; statues and vases (*b b b*) on pedestals, thinly scattered about, the architectural or sculptural style—showing, in fact, a harmonious combination of the three leading styles. Without some of these innovations the picturesque style would be little better than a well-thinned and moderately well-kept sylvan scene.

The admission of the architectural style in association with the refined picturesque, especially near the house, is thus excused by the high authority of Price, in "Essays on the Picturesque:"—"A broad dry walk near the house is indispensable to the comfort of every gentleman's habitation. In the old style, such walks were very commonly paved; in the modern, they are very generally gravelled. But the great difference in their character arises from their immediate boundaries. That of the gravel walk is of paved ground, than which nothing can be more meagre or formal, or have a poorer effect in a foreground." And this meagreness increases in proportion to the importance of the mansion. "But the paved terrace, in its least ornamental state, is bounded by a parapet; and the simple circumstance of hewn stone and a coping, without any further addition, has a finished and determined form, together with a certain massiveness which is wanting to the other, on which account, and from the opposition of its colour to the hue of vegetation, such mere walls are sometimes introduced as parts of the foreground by the greatest painters." A sloping terrace of turf in such a situation never can produce the same effect or association with the surrounding objects: it wants the parapet which, either plain or ornamental, is its chief feature. "When the walk before the door is gravel, and that gravel is succeeded by the mowed grass of the pleasure-ground, and that again by the grass of the lawn, nothing can be more insipid. If broken by trees and shrubs only, however judiciously they may be disposed, still the whole makes a

comparatively flat and unvaried foreground, whether it be viewed in looking at, from, or towards the house. But where architectural ornaments are introduced in the garden immediately about the house—however unnatural raised terraces, fountains, flights of steps, parapets, with statues, vases, balustrades, &c., may be called—however our ancestors may have been laughed at"—for, as Walpole, in "Modern Gardening," has it, "walking up and down stairs in the open air"—the effect of all these "objects is very striking; and they are not more unnatural—that is, not more artificial than the house which they are intended to accompany.

"Nor is their own form and appearance singly to be considered; for their influence extends to other objects. Wherever trees are mixed with them, whether pines and cypresses, or the many beautiful varieties with which our gardens abound, they give a value to the tints of vegetation which no opposition between trees of different sorts can give to each other; and this is a consideration of no small amount. The contrast which arises from the tint of stone, either worked or in its natural state, has the great advantage of detaching objects from each other by a marked difference of form and tint and character, but without the smallest injury to general harmony."

The superiority of the terrace walk, in its simplest state—that is, with a mere parapet—"over the gravel walk, with its pared edges of grass as an immediate foreground," has been already noticed; "and it is clear that one cause of that superiority is the contrast between the colour of stone and the tints of vegetation. The inferiority of the gravel walk, in such a situation, proceeds likewise from another circumstance; its boundary is not only meagre as well as formal, but it is incapable of receiving any ornament, or being varied with any effect. The parapet, on the contrary, admits of a great degree of ornament, and also, what is very material, of a mixture of the light and pliant forms of vegetation with the uniform unbending substance of stone, and the enrichment of sculpture. Should the solid wall be thought too heavy, a balustrade, without destroying the breadth, gives a play of light and shadow of the most striking kind, which occurs

in the works of all the painters. On the top of the coping, urns, vases, &c., of every shape and size, find their place. Vines, jessamines, and other beautiful and fragrant climbing plants, might add their loose festoons to those imitated in sculpture, turning round and between the balustrades, clustering on the top, and varying the height of the wall in every style and degree that the painter might direct; and vases of elegant forms, as well as the plants contained in them, would add to the general richness and variety."

Upon the introduction of the natural, English, or picturesque style into our gardens, a complete crusade was begun against every object or work of art met with in grounds. This was going too far; but happily a better taste has sprung up, and we find the intermediate space surrounding the house now laid down in a style corresponding with the architecture of the building and with its usual accompaniments of artificial decoration.

The rough and trivial forms in this style admit of decorations peculiar to themselves, except in so far as they are at times admitted into the gardenesque style; and these decorations are, for the most part, of a rustic character. The highly-enriched classic vase, fountain, and temple, give place here to the rustic vase, cascade, and moss-house; and the architectural bridge and highly-carved garden seat to the rustic bridge and moss-covered resting-place, often formed from the stump of a tree, or of a combination of the most crooked and misshapen of its branches. Instead of the architectural walls surrounding the geometrical flower-garden, wire fences are here required, and the fewer of them there are the better will the garden represent the freedom of nature. Trellised fences of unbarked trees should be used, although wire fences of the plainest forms may not be excluded; but both should be carried in natural windings through the outskirts, so as to be as little seen as possible.

The wire fence is by no means an invention of our own. The Chinese have employed it as an invisible or hidden fence for ages; and, instead of using posts of wood or iron uprights wherewith to fasten the wires to, they secure theirs

to trees, shrubs, &c., and carry them in the most irregular lines possible, so as completely to hide them from view.

As the expense of forming and afterwards keeping up a garden in the rough and trivial picturesque styles is, for its extent, much less than that for a geometrical one, it may be, and ought to be, upon a much larger scale. The picturesque garden, therefore, may be extended through a great part of a park, if that park possess sufficient natural beauties.

Walks may be extended in all directions, but leading to the most interesting points. Near to the principal walks, after quitting the lawn immediately surrounding the house, may be introduced a roseroy, a heathery, a rockery; and, as we recede farther from the house, collections of ferns in groups, of grasses, and of interesting genera of shrubs, both evergreen and flowering, of native species, which, although few in number, are pretty extensive in varieties, as the yew and holly exemplify.

The Chinese, who appear to have had for ages a right conception of winding walks, thus reason: "There are few things more variously entertaining than a winding 'road,' which, opening gradually to the sight, discovers at every step a new arrangement; and although, in itself, it has not the power of raising powerful emotions, yet, by bringing the passenger suddenly and unexpectedly to great or uncommon things, it occasions strong impressions of surprise and astonishment, which are more forcibly felt as being more opposite to the tranquil pleasure enjoyed in the confined parts of the road; and, in small compositions, they find crooked directions exceedingly useful to the planter, who, by winding his walks, may give an idea of great extent, notwithstanding the narrowness of his limits.

"In disposing the walks of their gardens, the Chinese artists are very attentive to lead them successively to all the principal buildings, fine prospects, and other interesting parts of the composition—that the passenger may be conducted insensibly, as it were by accident, and without turning back, or seeming to go out of the way, to every object deserving notice.

"The Chinese gardeners very seldom

finish any of their walks *en cul de sac*, carefully avoiding all unpleasant disappointment; but if, at any time, the nature of the situation obliges them to it, they always terminate at some interesting object, which lessens the disappointment, and takes off the idea of a childish conceit.

“In their crooked walks, they carefully avoid all sudden or unnatural windings, particularly the regular serpentine curves, of which our English gardeners are so fond; observing that these eternal, uniform, undulating lines are of all things the most unnatural, the most affected, and the most tiresome to pursue. Having nature in view, they seldom turn their walks, without some apparent excuse—to avoid impediments either naturally existing, or raised by art to improve the scenery. A mountain, a precipice, a deep valley, a marsh, a piece of rugged ground, a building, or some old venerable plant, afford a striking reason for turning aside; and if a river, the sea, a wide-extended lake, or a terrace commanding rich prospects, present themselves, they hold it judicious to follow them in all their windings, so as to protract all the enjoyments which those noble objects procure. But on a plain, either open or formed of groves and thickets, where no impediments oblige, and no curiosity invites, to follow a winding path they think it absurd, saying that the road must either have been made by art, or been worn by the constant passage of travellers; in either of which cases, it cannot be supposed that men would go by a crooked line, when they could arrive by a straight one. In general they are very sparing of their twists, which are always easy, and so managed that not more than one curve is observable at the same time.

“They likewise take care to avoid an exact parallelism in these walks, both with regard to the trees which border them and the ground of which they are composed. The usual width given to the walk is from 8 to 20, or even 30 feet, according to the extent of the plantation; but the trees on each side are, in many places, more distant, large spaces being left open, and covered with grass and wild-flowers, or with fern, broom, briars, and underwood.”

Such are some of the data upon which

VOL. I.

the Chinese act in the disposal of their grounds, when an imitation of natural scenery is intended. An English author on landscape-gardening, on the subject of walks, observes: “Wherever paths are turned, they should lead to the beauties of the scenery. Hilly or mountainous walks should have gradual and regular ascents,—at times amidst broken rocks, interspersed with alpine shrubs; then winding through the umbrageous plantations to the sequestered vale, treading the banks of a gentle stream, embellished with appropriate plants; then toward a piece of statuary, on the border of a shady grove; or to the Temple of Peace, to a cascade, or where a river falls and foams along its rocky bed. In short, such walks, if judiciously directed, lead wherever any object may be seen to excite admiration, or tranquillise the mind to calm reflection. The edge of a precipice or of a torrent is to be avoided, unless they be well guarded; and seldom should those views be seen which are calculated to disturb that tranquillity of mind which is best disposed to receive impressions pleasing and satisfactory.”

If the grounds are broken into deep glens, or even simple dingles of a few yards in breadth, with water permanently or occasionally in them, it will afford an opportunity for displaying artificial rock-work and cascades, which latter, in many cases, may easily be made to perform their part, by having reservoirs in the higher parts of the grounds, which, if sufficiently capacious, will afford a supply of water to operate on the cascades when required.

Embankments should be avoided in forming the walks, and the communication kept up by the introduction of rustic bridges.

To lay out a garden in either of the picturesque styles, in a tame alluvial meadow, or on ground having no natural features in association with this style, is a most difficult task. Under such circumstances, it would be better to adopt either the gardenesque style or the geometrical, the latter depending entirely on the character of the mansion.

Mounds may be thrown up, ravines dug, and abrupt undulations may be formed by man; but all his art can never give, upon an extended scale, such a character to such a field as nature has

4 T



done in situations of a different cast. It is in endeavouring to imitate nature that man's littleness appears most conspicuous. A painter can give a pretty good imitation of natural subjects on canvass, but it is a different thing for the landscape gardener to mould the appearance in reality; and it is here that we are all at fault, and here some of the most eminent garden artists have fallen into the uttermost absurdities.

The wildness of nature may be partly softened down, and rendered more convenient to man's use and enjoyment, by forming walks, foot-paths, building bridges, tunnelling through obstacles, making easy ascents and descents; enriching the landscape by the introduction of colour, by planting flowering trees and shrubs, providing shade and shelter for himself, by the erection of arbours or covered seats; increasing the magnitude of, or rendering more constant, the rippling stream or gurgling cascade; and giving a greater degree of boldness to the projecting rock, by laying bare more of its surface, or removing from its bottom the fragments which the hand of time has fretted away. Characteristic decorations may be introduced, but they should ever be sparingly employed.

The arrangement of the natural covering of trees and shrubs, as well as those additions deemed necessary to thicken up where they may be required, deserves particular attention.

In the gardenesque style, we have shown how each tree and shrub should stand distinct and apart. Here the case is different, and we think that in this particular chiefly lies the distinction between that and the picturesque style. In this, the trees, and shrubs, and under-growth should freely mingle with each other, and still produce a broken, irregular, yet perfect undulating surface, feathering down to the lawn, so that no part of the surface under plantation shall be seen.

Here, also, less of exotic character should be displayed, excepting in the foreground, where laurels, rhododendrons, &c., may find a place in groups between those of common whin, broom, roses, and similar indigenous plants. The elements to work with in producing a picturesque garden are few; for, as the Chinese artist says, "Nature affords us but few mate-

rials to work with. Plants, ground, and water, are her only productions; and though both the forms and arrangements of these may be varied to an incredible degree, yet they have but few striking varieties, the rest being of the nature of changes rung upon bells, which, though in reality different, still perform the same uniform kind of jingling, the variation being too minute to be easily perceived."

The elements found on the ground, if judiciously managed, may be considered the amount of man's material in interference with natural objects within the limits of the rough picturesque style.

In the trivial picturesque, he may soften the natural roughness of the surface, make walks of greater breadth, and ease their curves and gradations, introduce slight symptoms of keeping in the grass lawns, and indulge in a higher grade of characteristic decorations.

In the polished or refined picturesque, Plate XXXIII., the surface may be reduced to smooth and graceful undulations, the trees and shrubs be more of exotic kinds, particularly in the foregrounds, and some order be displayed in their arrangement, such as grouping various species in considerable numbers together, as was so well exemplified by Brown in laying out the grounds at Claremont. The walks should be carried in graceful curves—their sides, when of gravel, parallel; the grass ones running into slight sinuosities along their margins, and their surface smooth.

Parterres may be introduced, avoiding, however, all stiff, formal, or geometric figures. Higher keeping should be manifested, both in the borders and lawns. Characteristic decorations may be indulged in; and they should be of a more refined and studied character than those admitted into the rough or trivial styles. In fact, in this style the highest grade of keeping is required.

With regard to the introduction of ornaments into the polished picturesque style, or objects to be seen at a distance, the former ought to be of the useful, and the latter, upon close inspection, should not turn out to be mere impositions, or "eye-traps," as such deceptions have been termed. "A temple," says F. L. Von Sckell, "consisting only of a façade, a representation of a bridge over which you

cannot pass, are imperfections and fallacies, the employment of which cannot be recommended; for, in forming a garden, the lovely virtue truth should always be your guide."

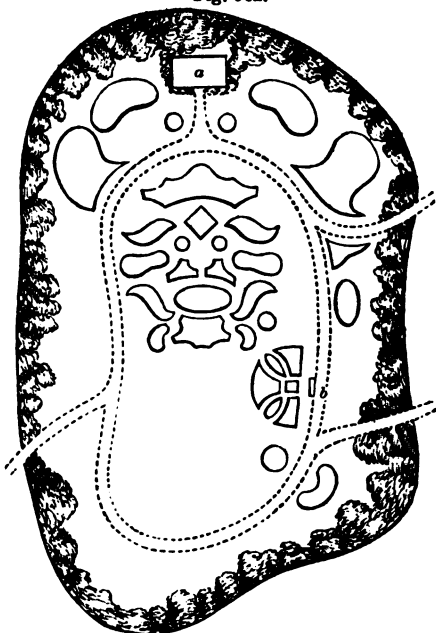
In regard to the employment of artificial decorations, we find the author of "Essays on Landscape Gardening" admitting them fully. "Vases and statues, tastefully disposed about the pleasure-grounds, have a pleasing effect; and, in extensive shrubberies, the arrangement of statues and busts, if numerous, should be directed by classical taste, that they may be disposed with propriety and truth: no greater absurdity can appear than such decorations indiscriminately mixed, or without literary order." "Classical associations," Stewart observes, "have added immensely to our national resources, but, at the same time, have warped our taste in various instances," acquiring, as Alison adds, "a superiority over the more permanent principles of beauty, and determining for a time the taste of nations."

The style of house with which the picturesque in any of its modifications accords best, is that of the cottage ornée. On this subject Brown judiciously remarks: "Some persons are satisfied if their house and the scenery around it meets with separate approbation; but such are totally deficient in architectural taste—or rather uninformed as to the general principles which govern domestic architecture in reference to its natural accessories, both immediate and remote. Now, the connection between a house and the adjacent grounds, though not intimate, requires congruity: the character of the home-landscape with that of the house should therefore accord, and appear as if they were both designed, planned, and planted by one great master, and severally embellishing and enhancing each other."

Fig. 982 is an example of a flower-garden adapted to the refined picturesque. The figures are to be cut out of the grass, and the walks to be of gravel. *a* is a moss-house, having little more than the front seen, the rest being hid amongst the shrubbery; *b* is a seat. The whole is surrounded by a wire fence, as indicated

by the outer line. The shrubbery within the fence is planted both for shelter and

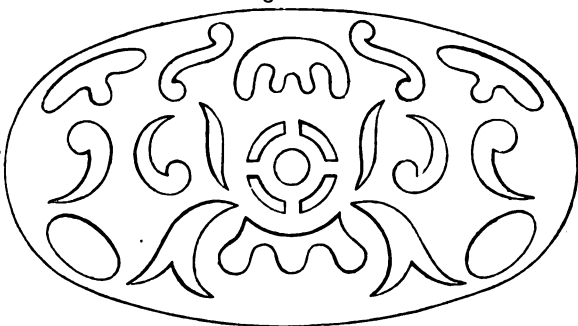
Fig. 982.



privacy, and need not be constituted of tall trees, but only of laurels, rhododendrons, &c. The outer surface of this shrubbery should be undulated, and gracefully feathering down to the grass, so that no dug border or stems of the shrubs can be seen. In planting the borders, the larger ones may be filled with dwarf shrubs, the others with low-growing flowering plants; the smaller clumps to be confined to one species and colour only. The situation is supposed to be at some distance from the mansion.

Fig. 983 is adapted to a similar situa-

Fig. 983.



tion, also cut on grass, and surrounded with a shrubbery and wire fence.

In regard to the form of beds in the picturesque style, if we except the circle and oval, all other geometrical figures should be excluded, as being less adapted to this style than figures of an irregular shape; and those terminating in obtuse ends are to be preferred to such as terminate acutely, as seen in some of those in fig. 983.

We need hardly remark that all figures of an unnatural character should be excluded, such as the figures of fish, birds, coats of arms, initials of names, &c. The picturesque style is considered to be a representation of nature, and therefore all forms which do not partake of the original are to be rejected, as unworthy to be introduced.

A clever writer in the "Quarterly Review," in drawing a distinction between the ancient and modern styles of laying out gardens, observes: "If we have made more of this matter than it deserves, we care not, for our great object is to impress upon our readers that this word 'picturesque' has been the ruin of our gardens. Price himself never dreamed of applying it, in its present usage, to the plot of ground immediately surrounding the house. His own words are all along in favour of a formal and artificial character *there*, in keeping with the mansion itself. He might, indeed, have used the term *picturesque* with reference to those splendid terraces, arcades, and balconies of Italy, with which we are familiar in the architectural pictures of Panini; but he would have shrunk with horror to have his theory applied to justify the substitution of tadpole, and leech, and comma, and sausage designs, for the trim gardens of symmetrical forms."

Sir Walter Scott had no great affection for what has been called the natural, picturesque, or modern style, and would even banish the term landscape gardening from our vocabulary altogether, and admit of some other term, which would represent the laying out of park scenery, which he considers as distinct from laying out gardens as the things themselves are. Sir Uvedale Price clearly recognises a threefold division of the domain, which we have already referred to—namely, the architectural terrace and flower-garden,

in direct connection with the house, where he admits the formal style; the shrubbery or pleasure-ground, a transition between the flowers and the trees, "which he would hand over," says the writer in the "Quarterly Review" already quoted, "to the natural style of Brown and his school; and, thirdly, the park, which he considers the proper domain of his own system. This is a distinction which it would be well for every proprietor to keep in view, not for the sake of a monotonous adherence to its divisions in every case, but in order to remember that the tree, the shrub, and the flower, though they be occasionally mingled with effect, yet require a separate treatment, and the application of distinct principles where they are to be exhibited each in its full perfection. Our present subject of complaint is the encroachments which the natural and picturesque styles have made upon the regular flower-garden. Manufactures of by-lanes and lightning-struck cottages are all very well in their own department, but they must not be in the vicinity of the house. We suppose that even Whately himself would admit that the steps and threshold of the door must be symmetrical, and would probably allow a straight pathway to be more appropriate, and even more *natural*, than a winding one, leading directly to the door of the house. Once get a straight line, even the outline of the building itself, and it then becomes merely a matter of situation, or convenience, or taste, how far the straight lines and right angles shall be extended; and, though nature must needs be removed a few paces further into her proper retreat, yet simplicity may still remain in regular and systematical forms, as much as in undulations and irregularities and mole-hills under the very windows of the drawing-room. Nothing, as Scott has remarked, is so completely the child of art as a garden. It is, indeed, in our modern sense of the term, one of the last refinements of civilised life. To attempt, therefore, to disguise wholly its artificial character, is as great folly as if men were to make their houses resemble as much as possible the rudeness of a natural cavern. So much maukish sentimentality had been talked about the natural style, that even Price himself dared not assert that a garden must be avowedly

artificial ; and, though now it seems nothing strange to hazard such a remark, yet its truth still requires to be brought more boldly and closely home to us before we can expect to see our gardens what they ought to be."

## § 2.—ROCKWORK.

Rockwork is a department in ornamental gardening too much neglected. The great difficulty in many situations of procuring proper materials, and still more so of finding men of natural taste and judgment to construct it properly, may account for the few instances we meet with of anything like natural imitations, and the many absurd and incongruous masses of stones, shells, petrifications, vitrified bricks, &c., huddled together in ample confusion.

An excellent specimen of rockwork was erected some years ago in the grounds at the Colosseum in the Regent's Park, composed entirely of stone, and upon a very large scale, many of the blocks being nearly two tons in weight.

The rock garden at Blenheim extends over an acre of surface, and is intended to imitate rocky scars on the face of a steep bank. It is composed of limestone, full of organic remains ; that kind of material abounding in, and being natural to the locality. Access is got from one part of the rock to another by means of well-contrived stairs, which run in oblique lines from one part to another.

The rockwork at Sion is intended to display a ridge of massive rock, intermingled with Alpine vegetation, but is exceedingly poor and trifling, and, at the same time, misplaced. A rich architectural wall, with all its accompaniments of balustrading, vases, &c., would have been more in character with the place and circumstances. It is intended to form the boundary of a geometrical flower-garden, in front of a highly architectural range of conservatories, (*vide* Plate XVI.) We have noticed in the very extensive nursery-grounds of Mr Skirving, at Liverpool, an imitation of natural rock, formed of heterogeneous materials, and surfaced over with cement, where a screen is thrown across a part of the grounds in very excellent taste, and exemplifying a principle

that might frequently be used for shutting out disagreeable objects, or dividing one part of a flower-garden from another, as in the case alluded to, which is placed so as to enclose the pleasure-grounds round Mr Skirving's house from the public nursery-grounds, and may be described as an arch thrown across the main walk, having wings, or rugged masses extending into, and losing themselves amongst, evergreen shrubbery.

The skeleton is formed of common quarry stones, the fused masses of brick procured from the brick kilns, or, indeed, any coarse material most convenient to be got. These are built up in the most rugged and misshapen forms imaginable, and afterwards covered over with Roman cement, and formed into recesses, projections, and overhanging crags, according to the taste of the artist. Sufficient apertures are left for receiving soil, in which rock-plants are planted. When the whole is perfectly set and dry, it is painted with oil-paint to represent veined or stratified granite, or any other kind of natural rock that may be desired. Here is no unnatural mixture of shells, fossils, petrifications, architectural remains, and natural masses of stone huddled together, as if it were the *omnium-gatherum* of the *vestiges of creation*.

The rockwork lately erected at Chatsworth is certainly upon the most stupendous scale of anything of the kind in the world, and forms a screen, or rather a piece of alpine scenery, dividing the grounds around that princely mansion, with its enriched parterres, from the Mammoth Conservatory.

Here there is no dwindling away into mere imitations. The thing is really and substantially as natural as if Sir Joseph Paxton had, by some supernatural means, removed a slice of one of the Derbyshire hills, and set it down where it is. Many of the stones are several tons in weight.

There appear to be two leading objects to be kept in view in the construction of artificial rockeries—namely, an imitation of the surface, broken and disturbed, and intermingled with alpine vegetation. In this point Sir Joseph has eminently succeeded. The other is an imitation of the natural stratification of some particular section of rock, geologically arranged. This we have never seen more than faintly

attempted. The panoramic rockwork at Hoole House, near Chester, the residence of Lady Broughton, is of a description different from either, the object being to show alpine scenery of great magnificence, as it were by model. The design was taken from a model of the mountains of Savoy, with the valley of Chamouni and the "Mer de Glace," forming the highest pinnacles of it. The latter is constructed of grey limestone, quartz, and spar; and the spaces, which in ordinary rockwork are filled with plants, are in this case filled with broken fragments of white marble, to look like snow, and the spar is intended to represent the glacier. It would be impossible for us to give anything like a correct delineation of this superb rockwork, even had we had it in our power to take drawings of it. At the time we saw it, (now seven years ago,) Lady Broughton was averse to have drawings made of it; and being quite unprepared to see such a complete rockery and garden, had time permitted and leave been given, it would have been a task beyond our powers to have done anything like justice to it.

The late Mr Loudon was, however, more fortunate; for, having obtained a *reluctant* permission, he, with the aid of a land-surveyor and "the water-colour drawings by Mr Pickering of Chester," has contrived to give, as far as the original is capable of being given without the aid of colours, a faithful representation of this rockery in the fourteenth volume of the "Gardeners' Magazine," pp. 360, 361. To give some idea of the magnitude of this model of alpine scenery—for we can call it by no other name—we may state that the highest part is thirty-four feet above the level of the lawn. The lower parts are planted with a very good selection of alpine plants. Lady Broughton's is a villa garden, and the rockery forms not only shelter, but seclusion also—a matter of no small importance where the grounds are so situated as to be overlooked by one's neighbours, because it forms a permanent screen, alike effective in winter as in summer, which plantations, unless of considerable breadth, do not.

A rockery, if judiciously disposed, is a very fitting arrangement for a town garden, as it presents a greater *apparent* extent of space, in consequence of its abruptly

undulated surface admitting of the walks being carried along within a few feet or yards of each other, and yet being completely hid. We once saw a garden of this description, formed by the owner, who, being a man of taste, laid out a small piece of ground so as to produce, perhaps, the fullest amount of enjoyment both in water, rocks, and plants, that could be done on the same extent of surface. He also produced a highly creditable landscape, gave himself extent of walks, chiefly open to the day, but partly subterraneous, to admit of the walks crossing each other without a stranger being at all aware of the fact, and hence increasing the illusion that the place was of far greater extent than it really was, as you proceed on from one object to another, without being aware that you have gone over part of the same line before, only a few feet above or below where you stood.

The piece of the ground overspread with this rockwork only occupied ninety feet in length, by seventy-five in breadth, and in the centre of this space was a lake in miniature, one hundred and twenty feet in circumference, and two to three feet in depth, of a very irregular and natural form. Even in this small space, when the bridge is introduced to connect the walks which pass over a part of it, and that no material part of the landscape may be omitted, a rocky island rose considerably above the water, in peaks, clefts, and projecting points, to throw their shadows in the water. The margins were, as we have stated, very irregular—in some parts rising abruptly, at others receding and rising gradually, while at others sloping pebbly banks, or gravelly shores, united these with the surface of the water. There was even the dark cave, rocky ravine, and what appeared to have been, at some period long ago, the track of a mountain cataract, indicated by the bare shelving rocks and confused masses of smaller stones, left by the imaginary dashing of the water.

The winding walks were amazingly well contrived, some being merely footpaths leading to heights, from whence the whole was seen in one view, but the principal ones avoiding these points.

To effect this rockery, about one hundred and thirty tons of stones, presenting the most fantastic forms, as they had

been moulded out by the action of the weather as they lay scattered along the sea beach, were transported about three miles. These stones had all the appearance of age—a point of much consequence in collecting materials for rockwork—and were profusely covered with moss and lichens. The spaces between were well covered with creeping plants, bushes, and trees; and the lake was stored, not only with gold and silver fish, but with aquatic plants also. Indeed, if the proprietor were fond of Alpine plants, we believe that the majority of the flora of Switzerland might be cultivated in this spot, and make it, in a botanical point of view, still more interesting and unique. The lake is, of course, supplied by artificial means; but upon a more extended scale, and in localities where water can be had, it might be laid on; and in that case, the apparently long empty cataract might be restored to its pristine use.

Rockwork should always be kept in the back ground, if artificial; and in a garden, placed on a level surface, because it is an attempt to imitate nature, where all around it is art. The case is different where the situation is naturally rocky, and where projecting portions of rock can be laid bare to form the ground-work. Art may here step in, and dispose of additional pieces of rocky substances, avoiding the employment of such as are foreign to the locality, to give greater height, ruggedness, or character to the other. It may be advantageously employed in the formation of screens for shutting out objects which are not wished to be seen; to render more secluded and sheltered small places, such as villa-gardens, as has been already shown; it may form the termination of a long, or even principal walk, provided nothing better can be substituted. It should never rise out of the smooth-dressed lawn, nor be placed too near the house, shrubbery and terraced banks being better for shutting out objects in the foreground. When the culture of rock-plants is an object, the rockery should present two or more aspects, one damp and shaded, the other fully exposed to the sun. Ferns and plants of shade should occupy the former, while sun-loving plants should inhabit the latter. Rocks associate naturally with water; and where a pool can be placed at its

base, with its margin sufficiently broken and rugged, the effect will be heightened, and the plants derive advantage from the aqueous exhalations rising during the heat of summer. The pool also becomes an aquarium, and in it many interesting plants can be grown. The rock-garden may, with great propriety, be surrounded by shrubbery, shutting it out, as it were, from the general plan of the flower-garden; and, if approached through a rustic arch, or even, if upon a large scale, through a partially darkened tunnel, the surprise will be greater, and the mind will, in general, be pleased. "No appearance of art, and no approach to the regularity or smoothness proper to works of art, will be at all in place here. On the contrary, the surface of the whole cannot be too irregular, or too varied, indented, or prominent. An additional projection must be given to some of the parts, by moderate-sized bushes, or short-stemmed weeping-trees. Evergreen shrubs or low trees will be particularly useful. For ordinary practice, the materials of which a rockery, however small, is formed, should lie on their broadest or flat sides, and not be set on edge, much less be placed with their points upwards. A little deviation may occasionally be allowed, for variety; but the mass will have more the appearance of solidity and strength, and be more according to nature's teaching, if each piece be laid flat, with the outer edge shading a little downwards rather than upwards. A rock-garden, if its size demands it, may be traversed, or made more accessible, by very narrow walks just capable of admitting one person. These need not be of any uniform width, and should have no regular margin. They may be made of some quiet coloured material, and not covered with dressed gravel. Any great elevation should never be sought in small rockeries. This would be inconsistent with their breadth, and would render them too prominent and artificial. They should not be carried higher than the point at which they can be well supported and backed with a broad mass of earth and vegetation. Additional height may sometimes be given, if desired, by excavating into a hollow the base from which they spring." —KEMP on *Small Gardens*.

We have already remarked that rocks should not appear to rise out of the

polished grassy lawn : grass and rocks do not harmonise ; it is rare to find them so in nature. The vegetation around the base of rockeries should be of rustic plants, such as the varieties of our hardy native heaths, and similar plants. These should, however, bear no resemblance to having been planted, but as if they had been brought in large masses, and scattered irregularly around the margin, with here and there a moss-clad boulder-stone, partly or in whole above the surface. The proper arranging of the base-line is not the most easily executed part of the rockery.

Rockwork may be introduced both in the gardenesque and picturesque styles of flower-gardens, but never into the geometric. The intention of rockwork is to shut out objects not wished to be seen ; to divide the garden into different compartments ; to cover sterile banks, in the gardenesque style ; and to imitate natural rocks, cascades, alpine rivulets, and to divide into different compartments, or to exemplify the natural stratification of some particular locality, in the picturesque style. To accomplish these with judgment and taste is an art that cannot be taught by books ; the lessons must be taken from the great book of nature. The rockwork, being formed, should be sufficiently clothed with plants indigenous to similar situations naturally.

There is one, and singularly enough the most common of all kinds of rockwork, but certainly not deserving the name, to be met with in most gardens ; that is, mounds or banks thrown up and covered with pieces of curious stones, clinkers, vitrified bricks, &c., and not unfrequently roots of trees, and fragments of sculptured stones. Such materials as these, having no relation whatever to one another, or to any rock in nature, can only be admitted into gardens as affording shade and shelter to the plants set amongst them, for which they are admirably suited. But to introduce such incongruous materials into landscape is equally ridiculous and absurd.

The Chinese, who are partial to imitations of the grander features of nature in miniature, frequently construct rockworks in their smallest gardens ; and we have no doubt but with these, and the stunted forms of trees which they have the art of producing, they can compose pretty good models of natural or alpine

scenery, and all within a very limited space.

The subject of rockwork appears to have been hitherto, as it were, carefully avoided by writers on landscape, as well as on flower gardening.

The following sensible remarks, which appeared in "Chambers's Edinburgh Journal," are so replete with good advice on the subject, that we are induced to give them nearly at length :—

"The rocky ravine, the mountain brow, and the sea beach, are the most fertile sources of materials for a rockery ; and it is necessary, in selecting them, to pay minute attention to the manner in which the various rocks are deposited in their several beds, and also to the mosses, heaths, and ferns, which are congenial to them ; for in proportion as the selector shall succeed in imitating nature will he please his own eye and gratify his friends. Having fixed on the quarter whence materials are to be procured, the next step is to find out an intelligent workman, who may execute the charge intrusted to him with care. On this a good deal depends, and some pains should be taken to make him understand thoroughly what is wanted. The size of the stones should always be varied, but proportioned upon the whole to the intended size of the rockwork. A number of detached erections never look well ; they are stiff and artificial. The whole should show an evident and well-defined connection ; and with regard to the stones, the greatest possible variety in form and size should be studied. The foundations should consist of mounds of earth, which answer the purpose as well as any more solid erection, and will make the stones go farther. Rocks of the same kind and colour should be placed together ; if intermixed, they seldom wear a natural appearance. A dark cave, penetrating into the thickest part of the erection, is not very difficult to construct ; and when encircled with ivy, and inhabited by a pair of horned owls," alive of course, "which may be easily procured, it will form a most interesting object. Rock plants of every description should be profusely stuck around, and in one short twelvemonth the whole scene will exhibit an impress of antiquity far beyond anticipation. The whole should be enclosed with forest trees

of large foliage, that the visitor to the scene may step upon it unexpectedly. Water in all cases adds greatly to the general effect, and a small pond permits the construction of a rocky island, which should be formed with jutting points, for the sake of the reflection in the water. By a simple expedient, streams of water may be made to issue from the rocks, or to spout into the air, and fall into beautiful cascades."

"Rockwork," says the authoress of the *Ladies' Companion to the Flower Garden*, "should always be an independent feature. It rarely looks well when piled up against a wall, or around the roots of a tree, or in any situation where it is overshadowed by trees; in short, where it does not form the prominent feature in the scene. It looks well near water, and merging into it; or in an open airy garden, where it is surrounded by a gravel walk; but it does not look so well when rising from turf, without an adjoining walk, or where large shrubs grow up amongst the stones. In short, it may be laid down as a general principle, that rockwork should either adjoin gravel or a piece of water, and that it should seldom or never adjoin trees, or grass, or walls in buildings." Round the margins of ponds—forming the base of fountains, if not of a highly architectural character—or on the sides and tops of steep banks, rockwork may be placed with becoming propriety. In regard to construction, it should be made as closely as possible to imitate some natural piece of rock, possessing some peculiarity either of outline or stratification. The material should be all of the same nature and character, and in as large pieces as possible. If otherwise, it can have no claim to a natural imitation, and can only be regarded as a stonery—a nidus for the growth of alpine plants, or a heap of rubbish, and a blotch in the garden scene.

*Rootwork* has a somewhat near connection with rockwork, but sufficiently distinct to admit of not mixing them together. The best specimens we have seen of rootwork were that many years ago formed by Lady Grenville, at Dropmore, and that of more recent erection at Drumlanrig Castle. At the latter place, in a low and somewhat obscure ravine, nearly attached to the splendid flower-garden, and con-

nected with it by a private walk, very well designed, is placed the rootwork garden, which, like everything about that ducal residence, is upon a large scale. Here conglomerations of the roots of trees, dug from some neighbouring peat-bogs, and of huge dimensions, are scattered about in tasteful confusion, or piled up into most grotesque forms; the whole being placed on a grassy base, intersected by tortuous gravel-walks, connecting the various parts together. In the hollows formed by decay, and in the angles formed by the original position of the larger roots, are planted rock plants in great variety, and harmonising well with the blackened appearance of the roots which supported the monarch oaks of some former century. In constructing this description of garden ornament, one object must ever be steadily kept in view, namely, that of creating artificial ornaments without much expense, and arranging the roots so that they may not appear to have been thrown down carelessly, but placed there by design. Such conglomerations, even considered merely as receptacles for dwarf and trailing plants, are perhaps more pleasing than conglomerations of stones, because less effort is displayed to attain the object desired.

Roots are often employed in the construction of rustic seats, alcoves, and places of shelter, as imaginary fences, and, as in the case of the root-garden at Drumlanrig, for hand-railings or balustrading to the rustic stairs leading from one part of the garden to another.

### § 3.—HERMITAGES, ARBOURS, MOSS-HOUSES, AND SEATS.

These are all very pleasing and useful objects, particularly in extensive grounds. They not only serve as places of rest and shelter, but also as guides to the points from which the beauties of the surrounding scenes are to be seen to most advantage. The style of these erections must depend on the situation in which they are placed, or the situation must be selected for the intended erection.

In romantic and wild scenery, rustic seats or houses should be placed; but where the hand of art has been more



scientifically employed, a higher grade of accompaniments must be introduced.

“While the spectator rests,” says Morris in ‘*Essays on Landscape Gardening*,’ “the rustic or the decorated seat gives opportunities for examining some natural or artificial beauty which might not otherwise have received any particular attention. These resting-places afford to kindred tastes an opportunity of pointing out to each other innumerable effects and combinations that else might have been unnoticed. They are the points whence the highest gratification of the spectator is derived, and they contribute the most satisfactory reward to the landscape gardener.”

The choice of garden-seats, as well as of the spots on which to place them, requires a degree of taste and judgment apparently seldom bestowed on the subject. There should always be some kind of analogy between the seat and the scene of which it forms a part; and, for this reason, rustic seats should be confined to rustic scenery; and the seats for a lawn, or highly-kept pleasure-ground, ought to be of comparatively simple and of architectural forms.

In the disposal of seats, some should be placed in the sun, and some in the shade; and, when placed by the sides of walks, gravelled recesses ought to be formed to receive them. All garden seats, except the rustic, should be painted stone-colour, as harmonising better with vegetation than any other colour; and, of all colours, the most unfitted for the purpose is green.

The hermitage is a species of resting-place, and was much more in vogue in former times than now. They associate better with grounds of the picturesque style than with any other. It may be said of them, as of all similar garden devices, that they have lost caste since the introduction of so many new plants. Formerly, when our gardens possessed few plants, art was called in to make up the deficiency in variety. Now plants have multiplied, and a different style of arranging them has taken place. The attention of the owner is pretty well occupied, during the gardening season, in making additions to his collection, and in arranging and re-arranging these, so as to produce a harmony of colouring, and

to keep up that effect for as long a period as our short seasons will admit of.

All these kinds of structures have been condemned by most of our modern writers on garden arrangement and landscape; but, in peculiar situations, and under certain circumstances, they have their interest notwithstanding. However, like choosing the situation for a mansion, a temple, or a seat, or even viewing a painting hung against the wall, all depends on the position the object is placed in, and the point from which it is to be viewed.

Retired and sequestered situations are the proper place for a hermitage, and, at the same time, a position that could be easily defended in the event of intrusion, and from which some natural beauties can be seen. In this respect, the hermitage at the Falls of the Bran, near Dunkeld, as well as the one at the Falls of Acharn, near Taymouth, are excellent examples; while that which existed some years ago in the royal grounds at Frogmore was in as bad taste.

The furniture should be of the most simple description possible, and nothing artistical admitted excepting books; and these should be of the philosophic caste. The deception of placing imitation books, however splendidly they may be gilt and lettered on the back, may lead to deserved exposure.

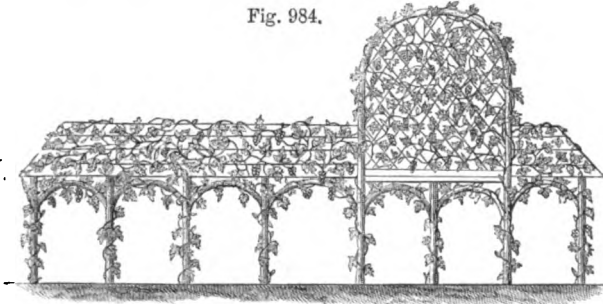
Grottos, like hermitages, are admitted as adjuncts into picturesque grounds. Those at Painshill and Oatlands were superb of their kind. The former was placed so that it could be approached by a boat from the river Mole, a portion of which flowed through it. It has long been suffered to go to decay; and the latter, once extremely rich in specimens of conchology, is now to be spoken of as a thing that was. It was entirely broken up, and the fragments sold a few years ago. It was buried in the side of a bank, and admittance gained to it through a labyrinth passage; and immediately in front of it was situated the grand royal cemetery of dogs, in which reposed the ashes of all the favourite animals of that family, who had the good fortune to gain the love, affection, and esteem of their royal mistress, the late Duchess of York.

Caves, caverns, and subterraneous passages, in rocky localities, may be indulged in. The two former are to be regarded,

in this country, more as singularities than places of enjoyment; but, in warm countries, they are amongst the first of garden luxuries.

Arbours, covered walks, and shaded resting-places, come within the limits of picturesque grounds, if they are formed of living trees or shrubs. On the Continent, the vine is much used for this purpose; and so it may, to a certain extent, in the south of England; but beyond the midland counties, and in Scotland, the hop, clematis, ivy, honeysuckle, and climbing-roses, must be used as substi-

Fig. 984.



tutes. The above figure, 984, displays the taste of the French and Germans in this matter, who in general place them against walls, and often carry them by a flight of steps to a considerable height, as in our figure.

In Germany, arbours are often fitted up amongst the branches of very large and old trees, and access got to them by means of a ladder. If study or privacy induce the visitor to ascend, the ladder can be drawn up, and so intrusion be prevented. We may here remark, that in general the terms arbour and bower have been considered synonymous: it appears that properly they are not. Mr Mallet of Dublin, frequently quoted in this work, says: "An arbour is a space covered and enclosed by the interweaving branches of trees, and reticulated stems of living plants, intended to afford shade and retirement. The words arbour and bower are properly very distinct; the former alone being formed of the living branches and stems of trees, whereas the bower, which is not derived from *bough*, or any analogous word, means simply any small chamber; yet they are used indiscriminately by the best writers."

The term bower seems, as it were, the

word of poetry, in which it is frequently made use of; whereas arbour seldom is, if ever.

With us few natural arbours are to be met with. The least artistical are those formed by slightly arranging the pendant branches of the weeping ash, or similar-growing trees. A few props within, to support a rod or hoop, to carry up the pendant branches, is all that is required; and if these have too much the appearance of art, the smaller branches of the tree may be trained down upon them, or ivy may be planted and trained over them, and allowed to intermingle with the branches forming the roof.

The next kind of arbour for simplicity of form is that formed of tall, straight, young trees, of beech, hornbeam, mountain ash, willow, &c. These planted close together in a line, forming the back and sides of the purposed arbour, the front being in general left open, are bent over at the tops to form the roof, and tied together to keep them in their proper places. Sometimes the stems are crossed in trellis fashion, and after a time they unite by a species of natural engrafting, and become exceedingly strong, and will last for years.

Fig. 985 represents a Gothic rustic

Fig. 985.



arbour, or resting-place ; the basement to be of stone, the superstructure of unbarked timber, and the roof thatched with heath. The floor should be pitched with pebbles in Gothic pattern, and the seats be made of oak plank.

The authority last quoted says, in "Encyclopædia of Architecture," p. 986: "In the grounds of less ambitious villas, plain unarchitectural buildings may be employed ; or wooden structures, simply protecting the seat from the weather, may be resorted to. In England, it has always been customary, since the introduction of the modern style of gardening, to form what are called rustic covered seats." And we may add, since flower-gardens have been conducted upon anything like correct principles, other rustic ornaments have been freely introduced, and, when properly placed and adapted to the situation, have given great interest to the scene. Out of the English or natural garden, we, of course, would not any more tolerate them than we would a temple of Grecian or Gothic architecture, or a Chinese Pagoda, in them. Rustic work, however well designed and elaborately executed, would be preposterous in the grounds immediately surrounding Blenheim, Chatsworth, or Eaton Hall. Architectural mansions should have their architectural gardens ; and architecture, of whatever order, has abundant stores of garden decoration without interfering with the rustic. These principles are, however, not strictly attended to ; and hence we some years ago saw a rustic thatched summer-house placed in a flower-garden closely attached to the princely palace of Blenheim, and could adduce numerous other instances of the same bad taste. At the same time, there is nothing incongruous in rustic-work existing at Blenheim, if sufficiently removed from the house and all other architectural objects. There may be a natural garden at Blenheim as well as at any other place, but it ought to be as far removed from the mansion as possible. Indeed, in such large places, it is perhaps proper that such should exist, as it relieves the mind, and remedies the monotony of wandering through architectural alleys, vases, statues, fountains, and mural decorations.

Around cottage and villa residences,

nothing is so appropriate as the natural style of gardening, and no ornament so proper as rustic work ; but that should always be of a substantial and tasteful description. An ingenious correspondent in "The Gardeners' Magazine," vol. x. p. 485, on this subject remarks : "One advantage of wooden rustic work is, that it can be adapted to a great variety of purposes. Thus very beautiful, and even very architectural temples may be formed of unbarked wood. Ornamental doors, every description of garden seats, and flower-baskets, and vases of very elegant forms, may be composed of the same material. Shady walks also, having the shady gloom and enriched effect of a Gothic cloister, may be made of wooden rustic work : indeed, there is scarcely any kind of garden ornament to which it may not be applied. I allude," continues this correspondent, "more particularly to what I call wood mosaic, which is, I believe, rather a modern invention. It is formed of split sticks, of various lengths and sizes, and having bark of different colours. The pieces are nailed to any flat surface of wood, and very beautiful and elaborate patterns may be produced by arranging the pieces according to their sizes and the various colours of their barks. Elegant garden seats, and vases of almost any shape, may be covered with this kind of mosaic work ; but as it is not durable when constantly exposed to the weather, it is the most suitable for the inside of summer-houses and garden temples. In such situations, the richest specimens may be introduced, and, if varnished over, they would last for a number of years."

In corroboration of this, we may state that there are summer-houses in Dalkeith Park of this description that have stood uninjured for nearly forty years.

The garden seat represented in fig. 986, is the invention of the correspondent above alluded to, and, as he informs us in "Gardeners' Magazine," vol. x. p. 487, is placed against the stump of an old walnut tree in his own garden.

Figs. 987, 988, and 989 represent other forms of rustic seats, which need no description.

Structures, such as arbours, moss-houses, &c., should be always placed in positions to command a perfect view of

some object of interest; indeed, this should not be lost sight of in placing

Fig. 986.



seats and all other appendages, whether for shelter or repose. Some excellent

Fig. 987.

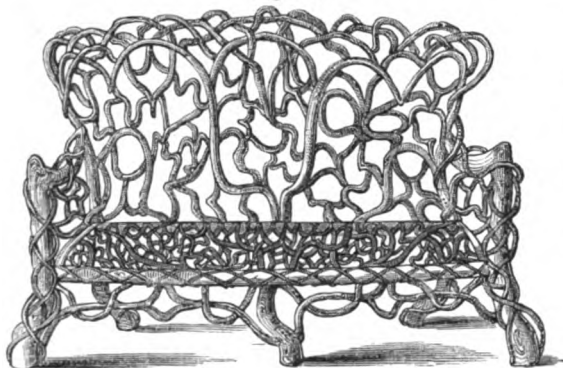
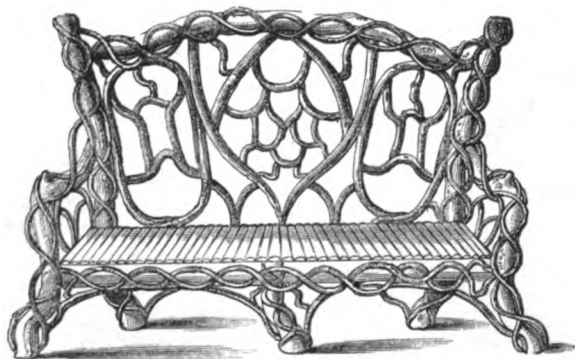


Fig. 988.



structures of this kind have lately been erected through the very extensive and

highly varied grounds at Drumlanrig Castle; and so capacious are some of

them, that not only the family and their visitors, but their attendants also, can find shelter in them. There is a degree of humanity in having such shelters distributed through an extensive domain, as they afford shelter to the workmen in bad weather. Highly useful and ornamental, however, though they be, care must be taken, particularly

in small places, that they do not appear too close together, as structures in any way relating to buildings are far more conspicuous than sculptural subjects. They require to be introduced more sparingly, and never without the appearance of obvious purpose or utility.

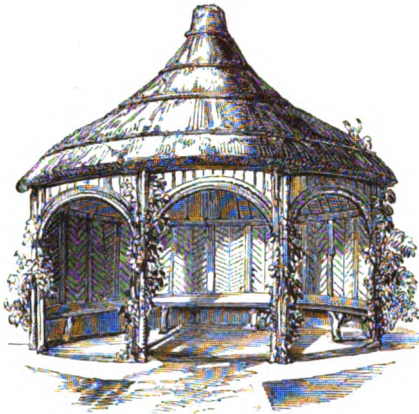
Fig. 990 is thatched with heath, attached to the timbers of the roof with tarred cord, but, for appearance sake, secured with four bands of rope made of *Polytrichum commune*, or any other similar strong-growing moss. The interior of the roof is first lathed, as it were, with hazel rods about one inch apart, into the spaces between which mosses of various colours are thrust firmly in; and by so doing, the whole of the roof is completely covered. The different colours may be placed in concentric circles or zones, or in any other pattern the artist chooses. The back and sides, as high as 3 feet above the seat, are covered with larch, hazel, or other straight-growing rods; and, if divided into panels, the rods may be so arranged as to produce any device desired; and, for the purpose of effecting this in a proper manner, that part to be

Fig. 989.



so covered should be lined with boarding, and the device drawn upon it with chalk

Fig. 990.



or black coal. The seat is supported upon rustic legs in front, and to the timbers of the structure behind; it is then covered with planking, and that with small rods similar to the back and sides. The front of the roof is supported upon columns of larch, oak, or any other kind of wood, having the bark on; the arches at top are easily constructed by using two pieces of curved wood; creeping plants are planted at their base, and trained over them and round the circular heads of the doorways. The spaces over the doorways may be either filled in with rods placed closely together, or in open lattice-work, according to taste.

Fig. 991 is constructed much in the same manner, only the supports in front

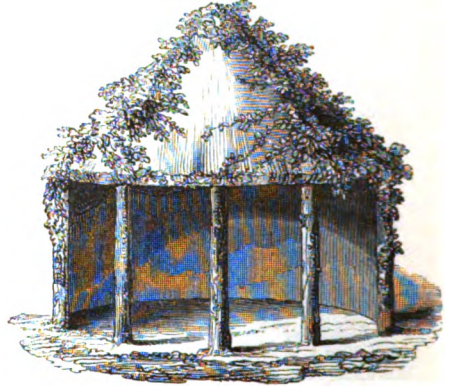
Fig. 991.



are set upon a stone plinth to insure their durability. The seat and covering of the back and sides are covered with rods, laid in what is called the herring-bone fashion, as seen in the sketch. The roof is in two parts, the top part being thatched with reeds, and the lower part, after being boarded over, is covered with rods, so as to give that portion the appearance of a corrugated roof. The floors of both should be pitched with different coloured pebbles set in concrete or cement, and disposed in a tessellated manner.

Fig. 992 is still more in the rustic style. One-half, which forms the front,

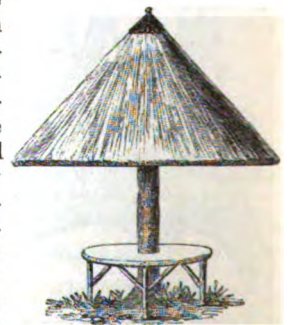
Fig. 992.



is supported upon larch or oak posts, without plinth or pediment. The roof is simply thatched with heath or reeds, and the whole exterior nearly covered with creeping roses, clematis, &c. The whole of the inside is covered with moss of the commoner kinds. The floor may be clay or dark-coloured concrete.

Fig. 993 is supposed to be built round

Fig. 993.



a living tree, or one whose top has been cut off on purpose. The interior structure of the roof is secured to the stem by having curvilinear ribs radiating from it, and propping up the rafters near their middle, much in the way of an um-

brella when opened. The roof, for this reason, is light, and covered externally with heath, and internally with moss, taking care that the ribs are fully shown, and they themselves also covered with moss, or with the bark of some smooth-barked tree. The seat is in the usual rustic style.

Such resting-places may also be built in the longitudinal form, with a pavilion or hipped roof thatched with heath, which is by far the best, as it is also the most durable, of all coverings. The sides all

round are divided into panels, the uprights or supports forming the principals, and the diagonal pieces the subordinate ones. The spaces between, being filled up with larch or oak pieces of half the diameter of the uprights and diagonals, will show the same pattern on both sides. Resting-places of this description are very easy of construction.

Fig. 994 shows the elevation of a very elaborate moss-house in the grounds at Dalkeith Palace. It is now thatched

Fig. 994.



with straw, but was formerly with heath. The roof projects 4 feet over the walls, forming a piazza or colonnade round the four sides, and is supported in front

with oak rustic columns, and curvilinear brackets between. The floor is laid in manner of a brick floor along the front and ends.

Fig. 995 is an elevation of the front wall under the colonnade, showing the

Fig. 995.

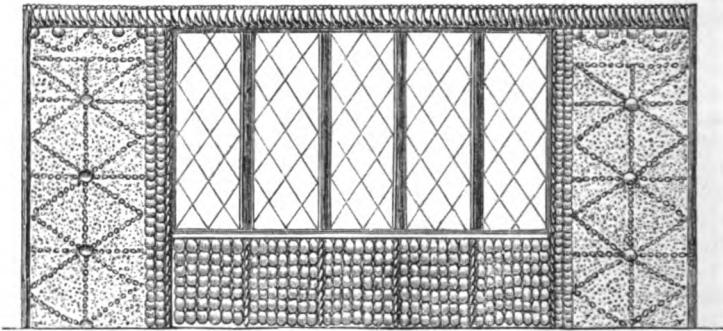


casement windows, of which there are four in the building, the other two being placed one in each end. In front of these two windows are placed two rustic seats with open backs, which protect the glass, and, at the same time, do not much exclude the light. The mullions and frames of these windows are of oak, with the bark carefully preserved. The other parts are, as usual, of lead and iron, the centre part of each opening for ventilation. The door is in two parts, and

simply covered with thick pieces of oak bark on both sides. The door frame is the same as that of the windows. The three panels over the door and windows are inlaid with pieces of oak, each cut into four sections, as are also the margins at the two ends. The roof of the colonnade all round is covered with different coloured mosses within.

Fig. 996 is the elevation of the two ends, showing the position of the windows. The surface is covered with shells, set in

Fig. 996.



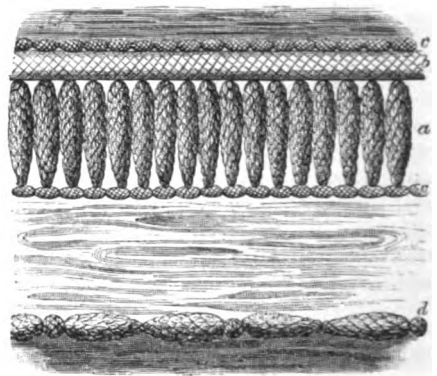
plaster of Paris, those under the windows being oyster shells, the other parts being done with smaller ones, found abundantly by the sea-side.

The floor of the interior is of brick, not by any means in accordance with the other parts of the building. The seats are all portable, and consist of a sofa and six chairs, two of which are representations of arm-chairs, hollowed out of the trunks of two old oak trees, very much covered with excrescences; the others are light chairs, formed of hazel, and the seats cushioned with *Polytrichum commune*. The sofa is also cushioned with the same, the back being open wickerwork. The table is circular, set on a clawed stand, and covered with a matting of *polytrichum*.

The side walls are all covered with moss. In the centre of the back wall is a representation of a ducal coronet, done in fir cones. The roof is of *Sphagnum palustre*, a white moss; and in the centre is a stag, three-fourths of the natural size, (the crest of the Scotts of Buccleuch,) done in a very ingenious manner with small rods of young larch. A cornice runs round the interior, formed of spruce

cones, (fig. 997, *a*.) with those of *Pinus sylvestris*, or Scottish fir, (*c c*.) and of

Fig. 997.



both alternately, as at *d*, and square knobs of oak, divided into four sections, as at *b*.

Summer-houses are and may be constructed in a great variety of forms, and of different materials. Very neat resting-houses may be formed of 4-inch quartering, set upon a base of brick or stone, so as to raise the timbers one foot from the ground. These may be lined on one or

both sides with boarding, and that covered with imitation basketwork, or designs formed of larch, oak, hazel, or any other wood, selecting the smooth branches; or, if desired, it may be covered with cones of various species of pines, so arranged as to produce a very pleasing effect. The rough bark of trees—oak, for example—may be used to cover the whole, or the sides may be divided into panels, with pieces of branches or cones, and the panels filled in with smooth or rough bark, according to fancy.

Similar houses may also be constructed, by covering the quartering with lath, and plastering with good sound hair plaster, the surface of which, while wet, may be dashed with clean gravel, pebbles, small shells, scorixæ, spars, &c., sifted so as to be of a uniform size. Shells of various kinds are often used for such purposes, and are stuck in while the plaster is soft, and very pretty devices are often formed by them. As this work requires to be done expeditiously, it is necessary to have the shells sorted and close at hand; and to render the pattern or design as perfect as possible, it should be traced on the plaster first; and this process will be much facilitated, if the pattern is cut out in sheet-iron, thin boarding, &c., which being laid on the plaster, the lines can be traced with great accuracy and despatch.

Again, great variety of design may be given to the plastered walls. "Lines may be drawn by the trowel, straight, wavy, angular, intersecting, or irregular. Stripes, checks, squares, circles, or trellis-work, may be also imitated. Wickerwork is a very general subject of imitation, and this is produced by pressing a panel, generally a foot square, of neatly wrought wickerwork against the plaster when moist. It is evident that this description of ornament might be greatly varied and extended, and that, instead of the panel of wickerwork, wooden plates, of patterns such as those used by room-paper printers, might cover the walls with hieroglyphics, with sculptures of various kinds, with imitation of natural objects, or with memorable or instructive sayings, or chronological facts."—*Encyclopedia of Villa Architecture.*

Such walls may have the appearance of age given them by the process called splashing; but in this case they require

to be thoroughly dried, if the splashing is to be composed of glutinous material, or in oil colours, which are by far the most durable. If splashing is to be done in water colours, it matters not whether the walls be dry or not. As a general rule in splashing or even plain-colouring walls with oil colours or with glutinous material, the walls should be thoroughly dry, and it should be done at a season when they are not saturated with moisture. "The reason for these rules is, that water colours do not impede the evaporation of moisture from the wall, and the absorption by the mortar of carbonic acid gas, by which it is hardened and rendered durable; while glutinous colours, by closing up the pores of the surface, do both."

#### § 4.—BRIDGES.

Rustic architecture—that is, the building of bridges, covered seats, moss-houses, &c., and the use of vases, baskets, and arbours, made of timber in its natural state, without or with the bark on—has been deemed by some of our own country a species of child's play, which may freely be left to the fancy of those who indulge in it; and F. L. Von Seckyl, a German author, is of the same opinion. We think very differently, and consider that there has been, in many instances, as much taste and talent shown in designing and erection of some of these, as in the erection of many architectural buildings for the same purpose. To those who think the English or natural style of laying out grounds the perfection of principle, and to such as cannot afford more expensive erections, we would recommend the introduction of rustic work in preference to the more elaborate and classic, because it harmonises with that style, and is compatible with the means of the less affluent.

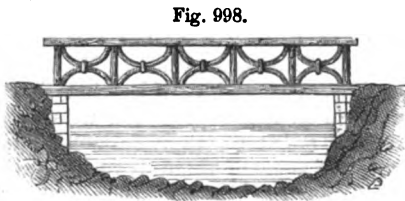
Again, exotic trees, shrubs, and flowering plants, are made use of in the composition of even what is called a natural garden. They are introduced for variety and effect, when those materials indigenous to our country are found inadequate to the artist's purpose. The ground is partially smoothed, the route defined by gravelled walks, form and shape given to the borders, till at last nature is almost obliterated by art. Why then not introduce



rustic bridges, vases, baskets, fences, &c. ? They are only art in its first remove from nature, and only proclaim more boldly that the hand of man has been here.

Such bridges are constructed by merely laying two trees, with their bark on—a feature which, we need hardly observe, should be attended to in all such structures—from side to side of the space to be spanned. No abutments need be used if the banks are firm. Both for strength, especially if the space be broad, and also for effect, struts may be fixed in the banks, and bolted with oaken dowels to the under side of the bridge. The covering for the footway should be of young larch trees laid across, placing the but-end and top-end alternately, so that all may be straight across the bridge. These may be spiked down with large nails, or with oaken pins, in which latter case no iron will be required for the structure. If the larch poles exceed 4 inches in diameter, they should be ripped up, the sawn side being laid, of course, undermost.

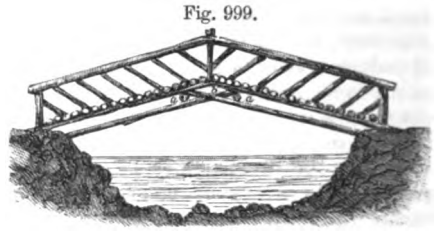
Fig. 998 is a specimen where, supposing the banks to be insecure, rough rubble



abutments are introduced. The nearer they resemble a piece of rock of the same character as that existing naturally in the vicinity, the better. A parapet, or hand-rail, is also introduced, both for safety and effect. The footway is covered as just described, and as in all the other examples. The uprights in the parapet are mortised into the floor of the bridge, and also into the top of the hand-rail, as are also the slightly-curved pieces between them; and, although bolted together at their middles, a strong withing is wound round them, as if they were tied by that means alone.

Fig. 999 is a bridge of great strength and simple construction. It will be seen that it is upon the principle of the arch: the greater the weight on the centre, the

greater the pressure on the abutments; and while these remain sound, no weight



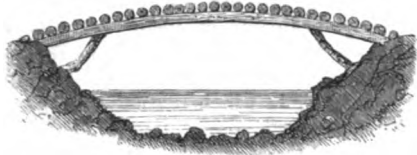
can break it down. We believe that this bridge was the invention of Napoleon, and first used during his inroads into Germany in the early part of his eventful career. We have often used this sort of bridge for temporary purposes, as it can be put up and taken down in a very short time. The principal part of the construction is to make the abutments sound with coarse stone-work. Four larch trees (or any other that are straight) are cut into lengths, a little more than half the width to be spanned. Their but-ends are set in holes left in the abutments for their reception; the other ends are elevated upon tressels, or held up by men, until the two cross bearers, the sections of which are shown at *a a*, are placed; the one resting on the top of the longitudinal bearer, or tree, on the right-hand side, and the other on that on the left-hand side. The top ends of the longitudinal bearers on each side then fall down, and rest on the top of the cross bearers, thus forming a rude arch of great strength. The cross bearers are kept in their places by having an iron or timber bolt driven through them and into the longitudinal beams; and this, for mere foot-bridges, is sufficient. But when greater strength is required, four pieces of timber are bevelled off at top, and laid on the longitudinal beams, having their square or section end brought close up to the back of the cross bearers, and nailed down fast to the long beams. A piece of wood is fitted into the angle (*b*), when the whole is ready to be covered with cross-pieces, to form the footway. The parapet, or hand-rail, may be fitted up according to fancy, and for temporary purposes may be dispensed with.

A modification of the same kind of bridge may be constructed, having a

double set of cross bearers, by means of which an additional set of principal beams is introduced, adding considerably to the length of the bridge. A space of 40 feet may readily be spanned by this means, by making the beams resting in the abutments cover a space each of 15 feet, and the level pieces in the centre 10 feet. A very simple hand-rail may be constructed, consisting of forked uprights, having a strong rope, or withy plaited of flexible heath, running through the forks.

Fig. 1000 is a bridge of simple contrivance, and suited for spaces not exceed-

Fig. 1000.



ing 15 or 18 feet. It is slightly curved, and, after previous remarks, requires no explanation. Such bridges are not only useful, in so far as they serve for the purpose of communication, but they have value as objects enriching the landscape, more especially when seen from the walks which may be at a lower level. It is improper to cover the roof of such bridges with gravel, as it is both out of character, and it lays an unnecessary load upon them, which their construction is not suited to carry.

### § 5.—RILLS, RIVULETS, AND CASCADES.

In this style, artificial rills, rivulets, and cascades, may be introduced: if they exist naturally, even to a limited extent, they may be extended; or if the situation is naturally favourable to their introduction artificially, happy effects may be produced; but they must be natural to the scene—and such scenes, says the author of "Observations on Modern Gardening," "commonly require every accompaniment which can be procured for them. Mere rocks, unless they are peculiarly adapted to certain impressions, may surprise, but can hardly please. They are too far removed from common life—too barren and inhospitable—rather desolate than solitary, and more horrid than terrible; so austere a character

cannot be long engaging, if its rigour be not softened by circumstances, which may belong either to those or more cultivated spots; and when the dreariness is extreme, little streams and waterfalls are of themselves insufficient for the purpose—an intermixture of vegetation is also necessary;" and, we may add, the softening hand of art to a limited extent. "If such a scene," says the same authority, "occurs within the precincts of a park or garden, no expense should be spared to meliorate the soil. Without some vegetation amongst the rocks, they are only an object of curiosity, or a subject of wonder; but verdure alone will give some relief to the scene; and shrubs and bushes, without trees, are a sufficiency of wood. The thickets may also be extended by creeping plants, such as pyracantha, cotoneasters, and ivy, to wind up the sides, or cluster on the top of the rocks." In such situations artificial rills, rivulets, and cascades, may be appropriately imitated; and their construction requires much taste, as well as a knowledge of the resisting power of fluids, in forming the dam or bank at the end of the reservoir. "With respect to strength," is as Mr Loudon, "the pressure of water says its depth; and consequently a dam, whose section is a right-angled triangle, and whose hypothenuse forms an angle of 45° with the base formed of any material of greater specific gravity than water, would, so far as strength is concerned, hold in equilibrium a body of still water of a depth equal to its perpendicular. If the hypothenuse, or sloping side, be placed next the water, it will more than hold the water in equilibrium, by the weight of the triangle of the water superincumbent on the dam or bank.

"That the materials of the bank must be of a nature impervious to the water, and also must adhere to the base or bottom, so as not to admit water to escape beneath it, are obvious conditions of the foregoing proposition. The practice of forming dams or heads is derived from this theory; but to guard against accident, the base of the triangle is always more than three or more times greater than its height. The slope next the stream may form an angle with the horizon of from 40° to 20°, and that on the lower side is regulated by the uses of the

dam. If for raising water, so as to cover a hollow, where there is little or no overflow expected, then the slope on the under side is generally of earth, 40° or 35°, turfed or planted; if for a cascade, the slope is regulated by the form or undulations, on which the rocks to produce the breaking of the water are to be placed; and if for a waterfall, a perpendicular wall is substituted, over which the water projects itself in a sheet or lamina, in breadth proportioned to the current. In all these cases, instead of forming the dam entirely of materials impervious to water, it is sufficient if a vertical stratum of wrought clay be brought up its centre, and the surface of the bank rendered firm, by a coating of gravel on the slope next the water.

“The construction of the waterfall, where avowedly artificial, is nothing more than a strong-built wall across the stream, perfectly level at top, and with a strong, smooth, accurately-fitted, and well-jointed coping. On the perfection of the coping, both as to level and jointing, depends the regular distribution of the thin sheet of water to be projected. Formerly, artificial cascades of this sort were curved in the grooved plan, the concavity pointing down the stream, by which some strength and a better view of the water were supposed to be obtained. With respect to strength, this can only hold true, or at least be of consequence, in cases where the upper slope of the dam is very steep, and the force of the current great; and as to a fuller view, this can only take place when the eye of the spectator is in the focus of the segment. Where a natural waterfall is to be imitated, the upright wall must be built of huge irregular blocks; the horizontal lamina of water broken in the same way, by placing fragments of rocks, grouped here and there, so as to throw the whole into parts; and, as nature is never methodical, to form it as if in part a cascade.

“In imitating a natural cascade in garden scenery, the horizontal line must be perfect, to prevent waste of water in dry seasons; and from this to the base of the lower slope the surface must be paved by irregular blocks, observing to group the prominent fragments, and not distribute them irregularly over the surface.

“The greatest danger in imitating cascades and waterfalls consisting in attempting too much, a very few blocks, disposed with a painter’s eye, will effect all that can be in good taste in most garden scenes; and in forming or improving them in natural rivers, there will generally be found indications both as to situation and style, especially if the country be uneven, or stony, or rocky. Nothing can be in worse taste than piles of stones and rocks across a river, either natural or artificial, in a tame alluvial meadow. They may be well-chosen fragments from suitable materials, and arranged so as to form a cascade or waterfall very beautiful of itself, but whose beauty is really deformity or monstrosity, relatively to the surrounding scenery, or to that whole of which it should form an accordant part.”

We have given this long extract, because it contains in few words almost all that immediately relates to the subject. We may, however, add, that in choosing materials for this purpose, such only ought to be selected as are found in natural cascades, and that all artificial material—such as clinkers, vitrified masses of brick, &c.—should be discarded, as being perfectly unnatural. Several species of mosses will bear being transplanted, and such should be introduced to give the appearance both of age and nature to the work.

Although a rivulet in itself is not of sufficient importance to become an object very conspicuous, still in sequestered situations it affords such a degree of pleasure, variety, and refreshing coolness, as to render it a desirable adjunct in picturesque scenery.

“Perhaps,” says Morris, “the most striking effect water is capable of producing is in a cascade or natural waterfall. The mind receives pleasing impressions of wonder and delight, when witnessing the liquid element descending from on high in various sheets, which sparkle with a diamond lustre as they fall, the cloudy spray reflecting the soft and blended colours of the rainbow; then dashing, with furious irregularity, over bold projections and stupendous rocks. Such a scene as this must be presented principally by nature, but much may be done artificially to add to its grandeur.

Where such an object exists, the character of the sublime and picturesque in the surrounding scene must be maintained."

Cascades of a tamer description are found useful in another respect—they make, of all other fences, the best for excluding trespassers, and preventing cattle from following the course of a stream or river. We have one of this kind in Dalkeith Park, which is built across the North Esk, and is six feet in height, built in a very substantial manner. The bed of the river is filled up behind it, so as to keep the water of a uniform depth, as well as to lessen the pressure on it. The water falls regularly over it in one sheet, and prevents any passage upward. There might be objections raised against the water wall, as some may think that it prevents fish from ascending. With us, however, there are no fish, the refuse of so many manufactories farther up having driven them to seek shelter in other streams. Even were it otherwise, it is a well-known fact that such an impediment would be no real barrier, as salmon, at least, are known to leap over much greater heights.

### § 6.—RUSTIC FENCES.

The fewer fences admitted into picturesque scenery, the better. Everything having the appearance of confinement, or defined limits, takes off from that freedom and expanse which form a leading feature in this style of gardening.

It becomes necessary, however, under certain circumstances, to introduce them as means of protection; and when such is the case they may be used with propriety, for what is useful cannot be in bad taste.

The varieties of fences are numerous, and range from the rudest barriers, without nails or ironwork, to the highest grade of architectural pallisading.

The fences admissible into the picturesque style should be of the simplest construction, and, excepting the *ha-ha* and *chevaux-de-frise*, chiefly of a rustic character. They are formed of young larch trees, generally on account of their being straight, and, being the thinnings of plantations, they are unfit for purposes requiring more strength.

Figs. 1001 to 1008 are of this description. They are in general fixed structures, although they may be easily constructed in separate pieces, and fitted up

Fig. 1001.

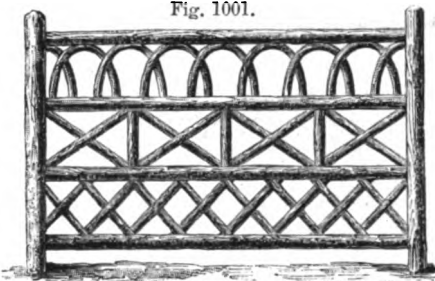


Fig. 1002.

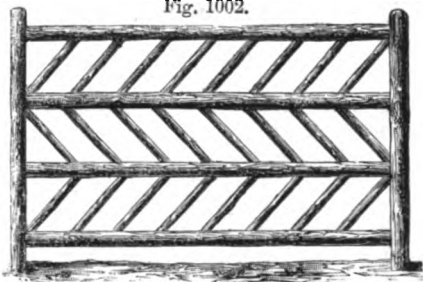


Fig. 1003.

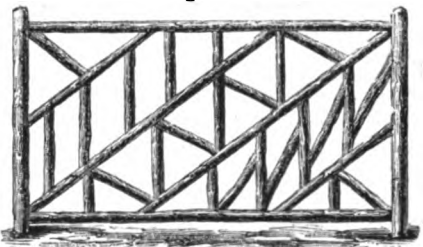
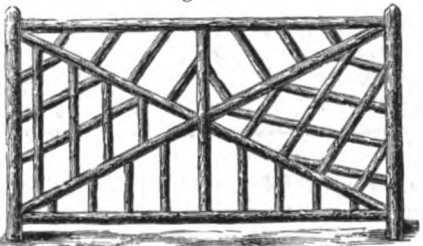


Fig. 1004.



after the manner of portable hurdles. The side-posts or uprights should be of sufficient size, to give, not only in appearance, but in reality, the necessary strength.

The longitudinal rails, or principal members, may be of less size; while the pieces used for the minor details should be proportionably more slender, as less strength is required of them. The chief difficulty in the construction of rustic fences is pro-

curing proper material; and this difficulty is increased as we depart from straight lines. When curved lines are used, then dependence must be placed on wood of a flexible nature, such as the willow, hazel, mountain or common ash, &c. Much of

Fig. 1005.

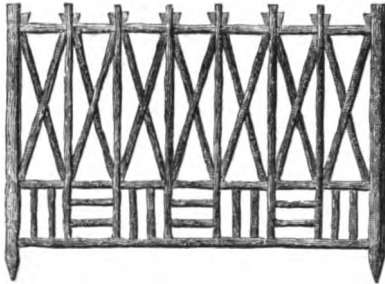


Fig. 1006.

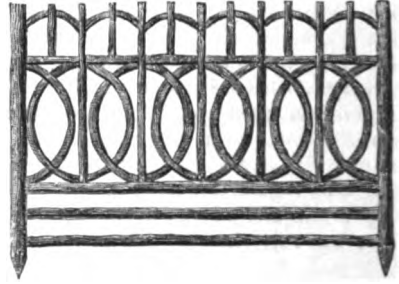


Fig. 1007.

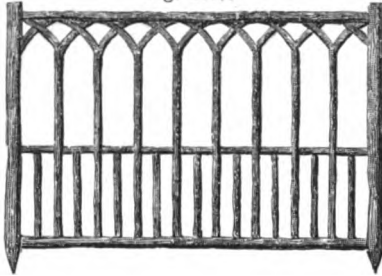
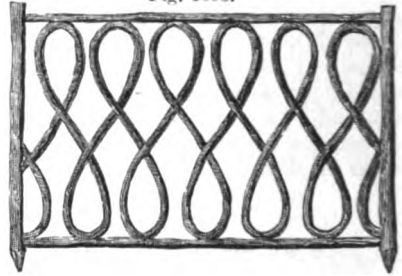


Fig. 1008.



the elegance of such fences depends on the correctness with which the joints are fitted together; and to do this in the best manner, mitred joints only should be employed. It is also of much importance, so far as appearance goes, that the bark of the wood be carefully preserved. No doubt rustic fences of peeled wood are

often very prettily constructed; but these, till softened down by age, have a very harsh appearance, and few attempts at painting them have been very successful. Those colours which most nearly resemble the natural bark are the best; and greens and reds are the worst of all.

The highest grade of rustic fences is

Fig. 1009.

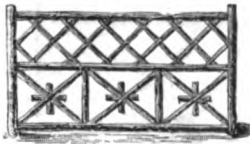


Fig. 1010.

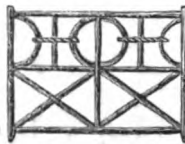
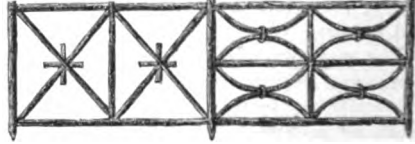


Fig. 1011.



represented by figs. 1009, 1010, 1011. They may be made portable, and moved about like hurdles, or be stationary and in conti-

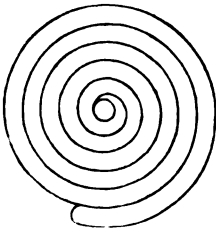
nuous pieces as far as the fence extends. They may be barked or unbarked, according to taste, but should never be painted.

## CHAPTER XV.

### PRACTICAL DIAGRAMS EXPLANATORY OF THE RULES FOR LAYING OUT GARDENS, MORE PARTICULARLY FOR FORMING CURVED LINES.

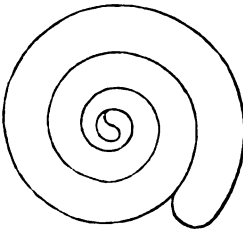
To form a Volute where the border is of equal breadth.—The usual mode of forming a volute or spiral line is one of the simplest problems in geometry, and therefore requires no explanation here. The following method is, however, both original and better adapted for throwing up such a figure in groundwork. It is the invention of Mr Alexander Forsyth, and was by him first described in "The Gardeners Magazine," from which source our four following figures and descriptions are taken. "Make a circle around

Fig. 1012.



the centre of your intended volute, as much in circumference as you intend the breadth of your circuitous border to be; stick this circumferential line full of pegs, and tie one end of a garden line to one of them. Taking the other in your hand, go out to the point where you intend the volute to begin; and as you circumambulate, holding the line strained tight, you will delineate on the ground the annexed fig. 1012.

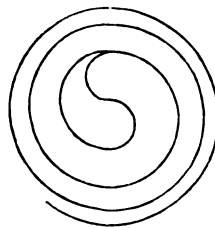
Fig. 1013.



A volute where the border is intended to be gradually narrowed towards the centre, as in fig. 1013, may be thus formed:—"Make a circle as before, and instead of driving the pegs

upright, let them form a cone; or, instead of pegs, use a large flowerpot whelmed, and, if necessary, a smaller one whelmed over it. Measure the radius of your volute, and wind that complement of line round the cone in such a manner as to correspond with the varying breadth of your intended border, and commence making the figure at the interior by unwinding the line."

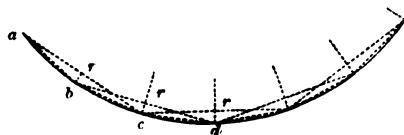
Fig. 1014.



A volute, the border of which widens as it approaches the centre, is produced upon the same principle as the last; only, as the figure is as it were reversed, unwind the line from the other end, and fig. 1014 will be produced.

The following ingenious method of forming circles or other curvilinear lines, is the invention of Mr Forsyth, and must be of great practical use to those who have the laying-out of grounds, particularly intricate figures in geome-

Fig. 1015.



trical gardens. Suppose  $a b c$ , fig. 1015, to be three points in the curve, taken at equal distances (say fifty links): placing

the cross-staff at  $b$ , with one of the sights pointing to  $a$ , make  $br$  perpendicular to  $ab$ , and measure its length. Then, removing the cross-staff to  $c$ , make  $cr$  perpendicular to  $bc$ , and equal to  $br$ ; and make the line  $brd$  equal to  $arc$ . Then  $d$  is a point in the curve; and in the same manner other points may be found successively.

Fig. 1016 differs from the above only in this, that the angles are taken outside.

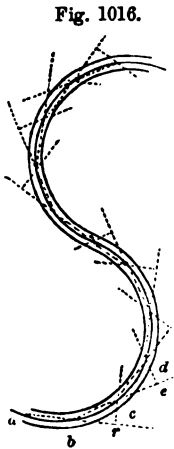


Fig. 1016.

Set up three pegs, say fifty links apart, as before, and fix the cross-staff in  $r$ , with one sight on the line  $rb$ , and the other pointing to  $c$ . Then measure  $rb$  and  $rc$ , and remove to the line  $ecb$ ; draw  $ec$  equal to  $rb$ , and  $ed$  equal to  $rc$ , and so on. The same end may be obtained by a theodolite, or by any other instrument for taking angles; or even with three needles stuck in a board, forming the requisite oblique angle.

Setting the instrument in  $b$ , fifty links from  $a$ , with one leg of the angle on the line  $ba$ , and by the other peg directing an assistant to place the peg  $c$  at the distance of fifty links; then remove to  $c$ , and so on.

To find the centre of a circle, whose circumference will pass through three

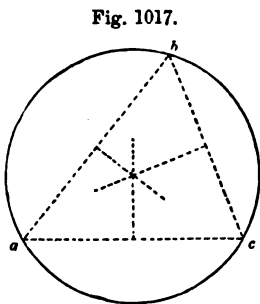


Fig. 1017.

given points (not in a straight line,) connect the three points  $a$ ,  $b$ ,  $c$  together; from the middle of each, erect lines perpendicular to them, and where these perpendiculars cut each other is the centre required.

To find the centre of a circle.—Connect three points in the circumference, and from the middle of the two lines erect perpendiculars; where these

intersect each other is the centre required.

To construct a hexagon.—Divide the circle into three equal parts; from the middle of each line erect a perpendicular; and where these cut the circumference of the circle are the points where the sides of the hexagon meet.

To construct an octagon.—Divide the circle into four equal parts, by describing a square within it; erect perpendiculars from the middle of each side of the square; and where they intersect the circle are the points where the sides of the octagon meet.

To construct a pentagon.—Draw a line through the centre of the circle, from the centre of which erect a perpendicular,  $cd$ ; divide the

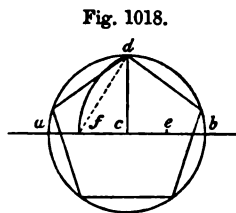


Fig. 1018.

straight line from  $c$  to  $b$  into two equal parts; take  $ed$  as a radius, and describe a circle, making  $e$  the centre, and when that circle cuts the

straight line at  $f$  the distance from  $f$  to  $d$  is the length of the side of the pentagon.

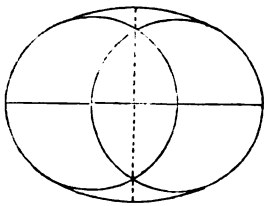
To describe a circle the centre of which is occupied with a square, say the base of the pedestal of a statue, fountain, &c.—Tie a cord round the square, not over tight; to that attach a line, in length equal to the radius, minus half the size of the square base; with that line describe the circle.—This is a plain working plan, and near enough for all practical purposes in laying out grounds. The same rule may be applied when the base is circular, or of any equal-sided figure, a pentagon, hexagon, &c.

To describe a circle when the base of the fountain, statue, &c. is oblong.—Lay the oblong correctly down on paper; find its centre, by drawing two lines diagonally through it; from that describe a circle of any size; draw two lines across the circle parallel to the longest sides of the oblong figure; from these erect perpendiculars, at equal distances, and note their respective lengths; on the ground draw two lines parallel to the longest sides of

the oblong; erect perpendiculars as before, and measure their lengths from the drawing, putting in a peg at the end of each, which will describe the circle required. A line applied as in the last example, will describe an elliptical figure.

To describe an Oval whose length is given.—Divide the length into three equal parts; let

Fig. 1019.

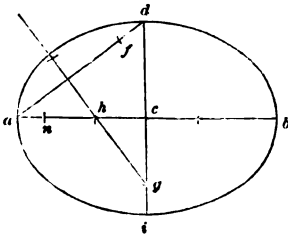


the two inner points so found be the centres of two circles, which shall form the ends of the oval: the intersecting points of these circles will be

centres to the two segments required to complete the figure 1019.

To describe an Oval, when the length and breadth are both given.—Lay down the length and breadth perpendicular to each other; combine  $a$  and  $d$ ; measure the distance from  $c d$ , on the line  $a c$  from  $c$ , which will give  $c n$ ; measure the distance from  $n a$ , on the line  $d a$ , which will give  $f$ ; divide  $f a$  into two equal parts, at the middle of which erect a perpendicular, and where that perpendicular cuts the line  $a b$  will be the centre  $h$ , for the end

Fig. 1020.



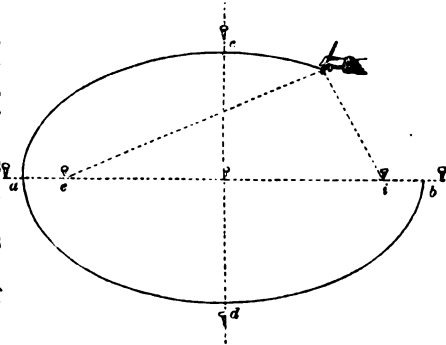
of the oval; and where it cuts the line  $d i$  at  $g$ , is the centre for the side, (fig. 1020.)

The Gardener's Oval, when both the length and breadth are given, is thus formed: Set off the length  $a b$ , and breadth  $c d$ , perpendicular to each other; take half the long diameter, and measure from  $c$ , to the line  $a b$ , with that length; when that line cuts the line  $a b$ , put in a peg; do the same on the other side, and the point  $e$  will be found; stick in there also a peg; then, with a cord passing round

VOL. I.

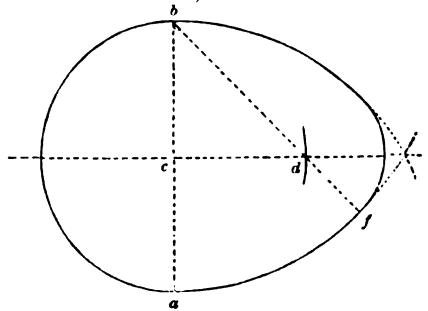
the pegs  $i e$  and  $e$ , with the addition of the space from  $a$  to  $e$ , describe the figure with the peg  $c$ . (Fig. 1021.)

Fig. 1021.



To form an egg-shaped figure (fig. 1022.)—The line  $a b$  being given, divide

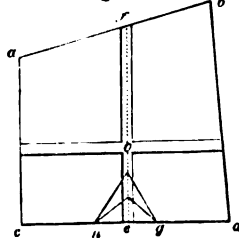
Fig. 1022.



it into two equal parts; from the point  $c$ , where these lines intersect each other, construct a circle with the radius  $c a$  or  $c b$ ; draw the line  $c d$  perpendicular to  $a b$ ; taking  $a$  and  $b$  as centres, describe two arcs; draw a line from  $b$  through  $d$ , till it cuts the arc at  $f$ ; then, with  $d f$  as a radius, complete the figure.

To set off a walk perpendicular to the

Fig. 1023.



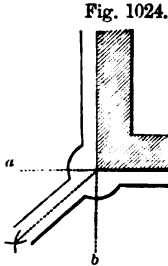
line  $c d$ .—From the centre  $e$ , on the line  $c d$ , set off  $e g$  and  $e h$ , at equal distances. From the points  $h g$  draw two arcs of different radii; if, where these arcs bisect each other, a line

4 Y



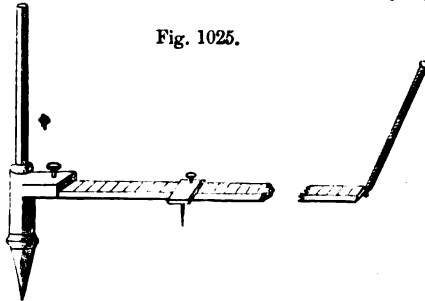
be drawn, it will be perpendicular to  $c d$ . By the same rule the centre of a walk will be found perpendicular to the line  $e f$ , taking  $o$  as the centre, fig. 1023.

To set off a walk perpendicular to the corner of a wall: Carry out the lines  $a$  and  $b$  straight with the face of the wall, and of equal lengths; from the two ends of these lines, with equal radii, describe two arcs; from where they bisect each other, draw a line to



the corner of the wall, which line will be the centre of the walk, fig. 1024.

The annexed diagram, fig. 1025, illustrates an instrument very useful in laying



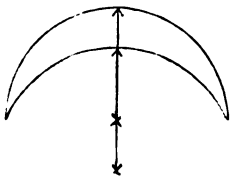
out mathematical figures. It consists of an upright pole 2 feet in length, shod

with iron, upon which revolves a metallic tube with a projecting shoulder, to which is attached, by a screw, a wooden rod 8, 10, or more feet in length, marked in feet and inches. Upon this rod there is a movable iron slide with an iron sharp-pointed stud. The 2-foot pole being placed in the centre, or point from which the figure is to be described, the slide is moved along the rod to the proper distance, and fixed there by means of a screw. An iron handle, turned up at the end of the rod, about 18 inches in length, is taken hold of, and, as it is moved round, the iron stud in the horizontal rod describes the figure intended.

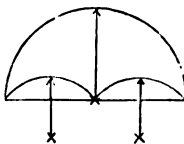
Another useful instrument is a pair of wooden compasses shod with iron, the legs of which are 5 feet in length. To one leg a quadrant bar of iron is attached, and made to pass through the other leg. This quadrant-shaped iron rod is perforated at every 3 inches, and furnished with a screw-pin to keep the legs of the instrument distended to the extent required. The quadrant rod is placed exactly in the middle of the leg of the instrument, so that when the leg is moved, for example, 3 inches on the quadrant, it gives 6 inches at the points of the compasses; if moved 1 foot on the quadrant, it gives 2 feet, and so on, being always double the former extent.

The following figs. 1026 to 1040, which sometimes occur in flower-gardens, are given, with their centres marked to facilitate their being laid down on the

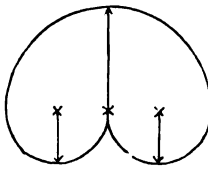
Figs. 1026.



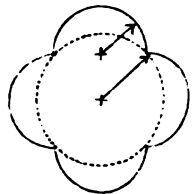
1027.



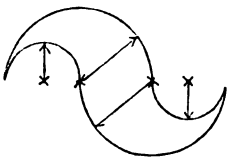
1028.



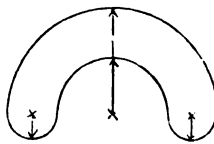
1029.



Figs. 1030.



1031.



1032.

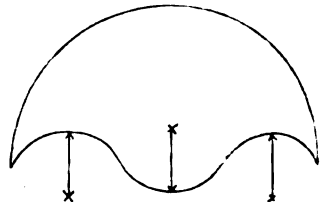


Fig. 1033.

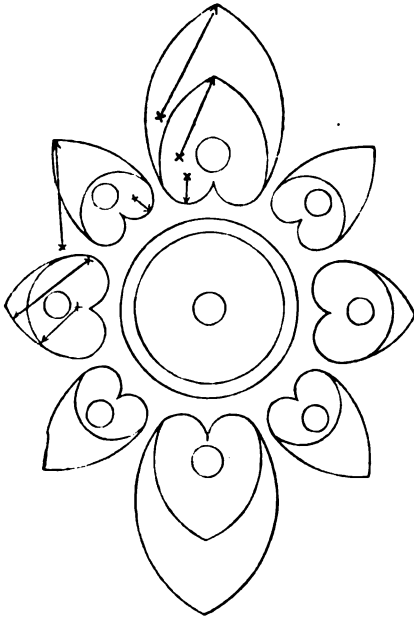


Fig. 1036.

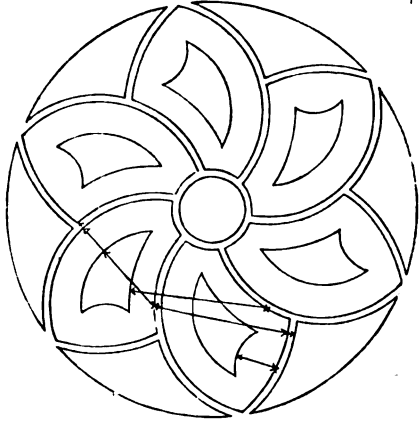


Fig. 1037.

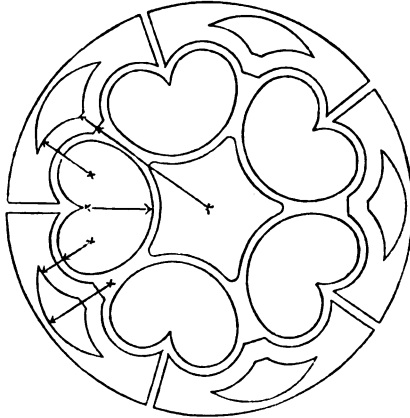


Fig. 1034.

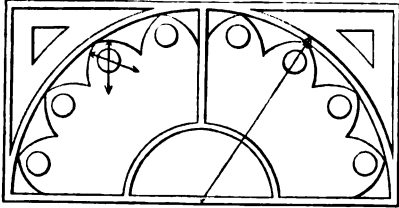


Fig. 1035.

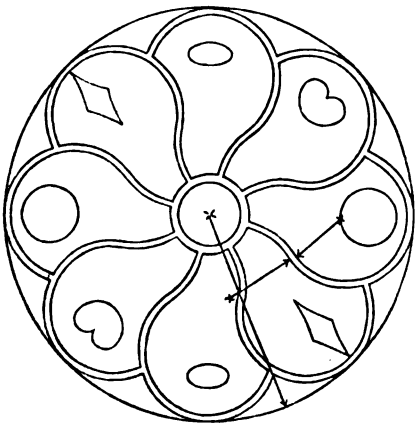


Fig. 1038.

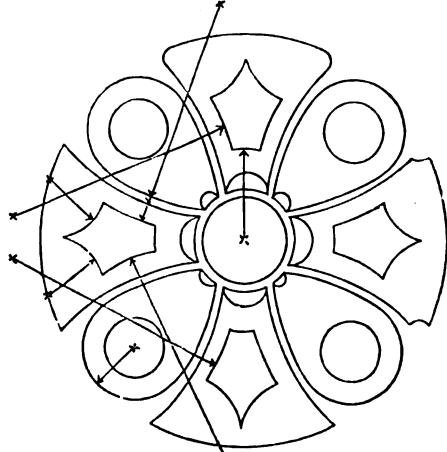


Fig. 1039.

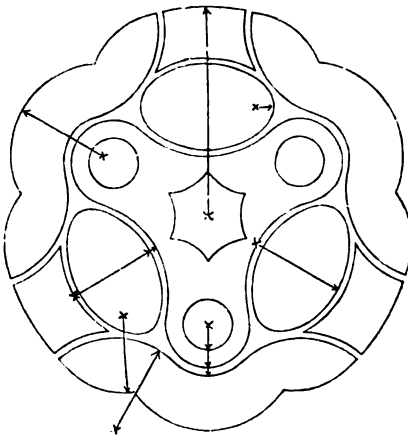
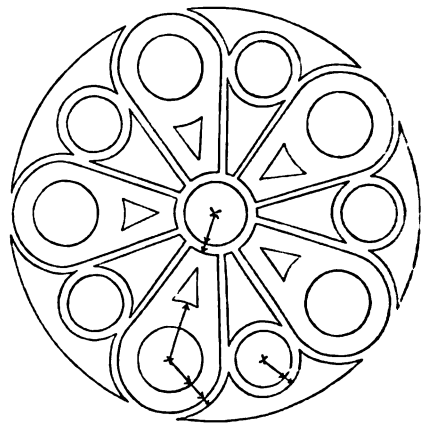


Fig. 1040.



ground. They are from a German work entitled "Handbibliothek für Gärtner," by Ligilir of Berlin.

*Rules for calculating the length of shadows.*—In selecting situations for gardens, and also for planting trees for shelter, the length to which their shadows will reach during winter deserves consideration, as also does that of the shade caused by walls and other buildings; for no screen should be planted so close as to shade any part of the ground, nor any glass roof be erected on which the sun may not shine every day in the year.

Several rules are given for determining this. The relation between the height of a tree and the length of its shadow depends on the latitude of the place and the sun's declination, which latter will be found by consulting an almanack, and the former by the sun-dial—at least, most sun-dials have the latitude engraved on them; if not, the map of the county will give it. The height of the tree, wall, or building, and the length of its shadow on the ground, form the perpendicular and base of a right-angled triangle, the hypotenuse of which angle is represented by that of the sun's rays from the top of the tree to the ground. This hypotenuse, or direction of the sun's rays at noon, always forms, with the ground line, an angle equal to the amount of the latitude and the sun's declination added together,

from the 20th of March till the 22d of September; but, from the 22d of September till the 20th of March, the sun's declination is to be subtracted from the amount of the latitude. This angle being found, and the height of the wall, house, or tree taken, all the rest will be found by the rules of trigonometry.

The following simple rule may be of use to such as do not understand geometry or trigonometry, and will give the shadow near enough for practical purposes:—

Multiply the height of the wall, tree, or building—

In latitude	51½°	by 3.719.
---	52°	- 3.852.
---	53°	- 4.149.
---	54°	- 4.402.
---	55°	- 4.895.
---	56°	- 5.369.
---	57°	- 5.944.
---	58°	- 6.651.

The product will give the length of the shadow at noon on the shortest day.

*Example.*—What will be the length of the shadow of a tree 10 feet high, in latitude 52° on the shortest day?

3.852 the multiplier for latitude 52°.  
10 the height of the tree.

38.520  
12  
-----  
6.240  
12  
-----

2.880 *Ans.* 38 feet, 6 inches, 2 parts.

## CHAPTER XVI.

### TOWN AND SMALL SUBURBAN GARDENS.

VILLA gardens, as connected with plants and flowers, must ever be considered as possessing extremely varied characters, on account of the different tastes, requirements, and accommodation possessed by their owners. One, for example, has his garden a complete compound of zoology and botany; another has his filled with the latest introductions from all parts of the world, and prizes as much a new species of nettle from the back of the Andes as a neighbouring lady does her collection of roses, tulips, and ranunculuses; while a fourth concentrates his whole floral hope on watching with intense anxiety the opening bud of a seedling camellia, and would not be prevailed upon to look over his garden wall to see the untiring energy of one who grows leeks and rhubarb, the stems of which are nearly as large as his own body. So varied are the tastes of humanity, that it is a most difficult task to handle the subject of villa gardens in such a way as to afford the hope of being of much advantage to all.

We have, at page 22 of this work, given some general hints on the formation and disposal of villa gardens of the higher class—that is to say, if size is the scale by which we are to estimate their merits. This, however, is, we believe, not the true standard by which they should be measured; for we know of some of very limited extent, which to us appear the very *beau-ideal* of perfection both in arrangement and management. In one we visited lately, artistic taste has been made to bear on even the most minute details. Statuary of the highest cast is therein exhibited, the parterres are arranged with scrupulous attention

to the harmony both of form and colour, and the very wire-trellising which covers the windows of the drawing-room, which look out into the conservatory, is so exquisitely coloured and designed, that at first sight, from within, we thought we had before us a style of painted windows we had never before seen. This, however, is the work of one who has distinguished himself more than any other in Scotland in the decorative art, and who is the author of some interesting works on the laws of harmonious colouring.

Another, under the management of a most amiable lady, contains a rich selection of very choice plants, both hardy and tender. From a very splendid drawing-room a door enters on an *up-stairs* conservatory with a span-roof and pavilion end, from which access is gained to it for the gardener, and for the moving out or in of the plants. Here the plants brought from the other houses are introduced just as they are coming into flower, which, together with the situation of the conservatory, is in exact accordance both with utility and good taste. From an ante-room on the ground floor a French window opens into a greenhouse, and at a short distance from it, in a sheltered corner, stands a small hothouse containing orchids, tropical ferns, and various fine-flowering stove plants. Making a short detour through the garden, which is chiefly laid down on gravel with geometrical figures, planted some with mixtures of the most choice herbaceous plants and bulbs, while others are filled in the grouping manner, we come to a large house filled with camellias and other flowering plants, while vines are trained up the

rafters, the front table being occupied with heaths and smaller plants. The potting-sheds, stoke-holes, &c., are very properly placed in the courtyard behind. Trainers for climbing plants, roses, vases, flowering shrubs, rockwork, an arbour, &c., complete the whole.

We shall now confine ourselves to villa gardens of smaller dimensions than those noticed at pp. 22, 23, and presume that they are dedicated to flowers and plants only.

In villa gardens of the size and importance of those we have already noticed, the amateur may indulge in the cultivation of a considerable variety of plants, shrubs, and trees; but, as we descend in the scale of size, so should we also limit ourselves to fewer species, and those of more humble growth.

A villa garden under 3000 square feet in area, or one that is 60 feet long and 50 in breadth, should never attempt grass as a ground-work, unless the garden be fully exposed to the sun, and unsurrounded by buildings, nor the introduction of fruit trees or others exceeding 12 feet in height. The former will not repay the ground it covers, while the latter bear no proportion to the space. If shutting out a neighbour, or obtaining privacy and seclusion be an object, it were better to do so by wire fences of sufficient height, and to make them the conductors of rapid-growing evergreens or other climbers. The taste for privacy and seclusion in a garden appears to be almost confined to our own country, the true origin of which it is difficult to trace. It may, however, to some extent be owing to a sort of aristocratic pride which the constitution of our country and our increasing wealth has forced upon us, but with which true taste and good sense have little to do. If we enclose our small villa gardens with high walls, or encompass ourselves around with high-growing trees or hedges, we destroy greatly their healthy condition, by preventing a free circulation of air around our dwellings, as well as rendering the garden damp and unwholesome even for the growth of plants. Much, however, in this respect, depends on situation.

No villa garden under the size we have stated above, should contain trees or shrubs much higher than a full standard

rose. Pole or pillar roses, however, when the atmosphere is suitable, are, to a limited extent, quite admissible. The ground surface should be gravel or pavement, as affording a dry walk at most seasons, taking up less room than paths or patches of grass, being less expensive to keep, and far more likely to be kept in good order. In confined situations the plants may be, for the most part, grown in large vases or tazzas, as elsewhere noticed; or on elevated borders, supported by sides of masonry or rockwork. In such positions the plants will be better exposed to the sun and air, two elements often greatly wanting in closely pent-up villa gardens.

If in connection with an architectural house, the parterres should be laid out in the geometrical style; the walks laid with pavement or ornamental tiles, and well drained below; the edgings should be of stone or slate, the beds of soil small, and planted with small plants. The more simple forms may have box edgings and gravel walks, while the more artistic should have the decorations of vases, tazzas, and probably a fountain as near the centre as possible. There are hundreds of beautiful flowering plants which do not exceed 2 feet in height, and those, with the exception of a few of peculiarly graceful forms, should constitute the collection. In such gardens all coarse plants requiring the support of tall stakes, such as dahlias, hollyhocks, &c., should be discarded.

The objection to grass in villa gardens, and more especially in town ones, is, that it is seldom found in good condition in such places, and all the art of man cannot render it so; and unless grass be kept nearly as smooth as a carpet, it gives the garden the appearance of want of keeping, although everything else should be in the highest state possible. In a damp climate like ours it is seldom that grass is fit to walk upon, in confined and perhaps shaded places, till towards the after part of the day—and to invalids, probably not then; and, in addition to all, it is expensive to keep.

There are two styles of villa gardens we have long wished to see carried into effect, and if not exceeding the size we have stated above, they would be neither expensive nor difficult to construct. The one would be after the manner of the

Chinese, in which every plant is portable, and capable of being removed so soon as its flowering is over, to be replaced by others to flower in succession. With the aid of a small reserve-garden this could be easily effected; and in the absence of this, if the taste become general, there would be no difficulty in procuring a supply from commercial growers. The plants could be arranged either by being plunged in the parterres or being set in groups on the surface, as done in some conservatories. The other would be of a much higher cost—namely, covering the whole with glass. In such a garden the valetudinarian could enjoy a dry and pleasant promenade, while the erratic man might wander through it until he becomes himself again, and the admirer of flora enjoy a never-failing supply of flowers *throughout the whole year*.

The following estimate will give some idea of the cost of roofing over such a garden, presuming it to be, as is very generally the case, walled in on all sides, and taking one of these at 40 feet by 60 feet—that is, 2400 square feet in area. The roofing of such a space—with cast-iron valleys, ornamental tubular columns for support, wooden astragals and ridges glazed with Hartley's patent glass, including a tank under ground for the reception of the whole of the rain-water that falls on the roof—that is, 3600 cubical feet, taking the depth of rain at 18 inches per annum, with the necessary ventilation—would cost about £160; and if heated with hot water to the extent of repelling frost, which is all that is required, an additional cost of £25, the stoke-hole and furnace being placed in a covered vault under ground, or otherwise placed in some convenient part of the offices.

In such a covered garden the most fastidious might ramble about without being seen by the prying eye of an over-inquisitive neighbour, as Hartley's glass has the property of being translucent without being transparent—that is, it admits the rays of light to pass through it in sufficient amount for the growth of plants, but prevents any object within from being seen from without. Here, also, the weather would be set at defiance, and as much comfort and privacy enjoyed as in the drawing-room. In this respect, we think that, particu-

larly for ladies, such covered gardens would be an invaluable addition to the luxury, or even comfort, of a town residence. Many may be startled at such a proposition, because, perhaps, their house does not front the meridian sun. This is a matter of far less importance, in many cases, than is generally believed. No doubt the sun is the all-invigorating element of vegetable life, but many plants of very great interest adapt themselves to a very small share of its influence so long as abundance of light is admitted to them; and there are few houses of that description, where such a structure is likely to be erected, so situated that such a covered garden might not be with all propriety constructed. One reason why plants do not thrive in close pent-up town gardens, is the want of a circulation of air, more especially close to the ground, the air there becoming stagnant and replete with deleterious gases, in consequence of its remaining stationary and unchanged. This would not be the case were the whole covered with glass, as the increased temperature immediately under the roof would, in consequence of its buoyancy, draw up the colder and impure air from the surface. This circulation would be promoted if a supply of cold air were admitted close to the surface of the floor by apertures cut in the wall next to the street, or otherwise; and it might be increased to any useful extent by throwing in warm air by means of hot-water pipes, or otherwise, placed near to the ground. Indeed, we have no hesitation in stating, that by means of the difference in gravity between warm and cold air, if properly balanced, a far more healthy and purer atmosphere may be created within such a covered garden than that of the natural atmosphere in town gardens in general. In a sanitary point of view, such a garden would be invaluable to invalids, for in it the temperature could be assimilated to that of Madeira or any other climate suited to the case of the patient, and the hygrometric conditions regulated to any degree of humidity or elasticity, and to an extent that even our most perfectly fitted up drawing-rooms, saloons, &c., do not and cannot equal.

The day is, we apprehend, not far dis-

tant when immense spaces will be covered in for the purpose of securing sanitary promenades. Indeed, something of the kind has already been projected in connection with an establishment for consumptive patients.

Gardens of this size, and surrounded on three sides by walls, may be made exceedingly interesting by covering the walls with a glass veranda 6 feet or more in width and 8 feet high, and paved with Caithness pavement or encaustic tiles; the walls all round to be covered with flowering plants trained against them, and growing in a prepared border under the pavement, as well as on the inside of the metallic columns that support the roof in front. Such a veranda as this would not only afford a supply of flowers during the most of the year, but would form a dry and comfortable communication between the front door of the house and the street. The area unenclosed with glass should be gravelled or paved over, and furnished with vases, tazzas, and ornamental cases more or less elevated according to their sizes and forms, to be filled with plants during the summer. When the front lights are removed, which they might be during several months in the year, the whole would form one very perfect whole; and if a fountain be placed in the centre, the interest of such a garden will be greatly enhanced.

Villa or town gardens, surrounded on all or most sides by walls or buildings, might be rendered much more enjoyable than they at present are, if such a veranda or covered walk were made to pass all round them, excepting perhaps that side adjoining the house, which it might be found expedient to leave open, to prevent the light to the ground floor being intercepted. This veranda might be covered at top with galvanised plates of corrugated iron, or with Hartley's patent rough glass, supported at front on cast-iron hollow columns, through which the rain-water could be carried down into a drain or tank, to prevent the ground being saturated with wet. Such a covered walk would afford at all times a dry and comfortable means of enjoying the garden, and at the same time take off the apparent confinement of the place by hiding the boundary wall. It would also, in either case—a few wires being run

over it—afford a ready means for being covered with climbing roses or other similar plants; creepers to be planted at the foot of the supporting columns, and conducted up them to the roof. To render such a promenade still more valuable, particularly during winter, the floor should be elevated at least 6 or 8 inches above the level of the ground, and the front sashes made to fit the spaces between the supporting columns, and arranged so as to run past each other on rails placed below them, or by being hung on the suspension principle from above. The breadth of such passages should not be less than 6 feet, but a foot or two would make very little difference in the expense of erection; while, with the above width, the walls might be covered with many of the hardier species of greenhouse plants, which, the roots being placed beyond the reach of frost, would be found to stand fully better than in most greenhouses.

It has often struck us that, while there is such a professed love of flowers and plants existing amongst the occupiers of town houses, more has not been done to gratify this taste. We know of no plan that would accomplish this at less expense, and with greater certainty, than covering the whole garden as noticed above, or by such a veranda as we have now described.

In covering a villa or town garden entirely with glass, the height should not exceed 8 or 9 feet, which would in no way interfere with the windows on the second floor; nor would it in any way destroy the effect of the elevation of the house more than that of the wall that may separate it from the street or public road, as the ridge-and-furrow roof can be made, *and it should be made*, quite level from side to side. And where the space to be covered exceeds 15 or 18 feet, tubular metallic columns could be introduced for its support, which would, at the same time, serve the purpose of supports to climbing roses, or the like. And if such internal supports be objected to, the roof can be supported upon the suspension principle from without, as shown fig. 516.

Another advantage that would arise from roofing over or covering town gardens in particular, in this way, would be

the securing of a healthy atmosphere for the growth of plants, an atmosphere very differently constituted from that of the open air. In fact, such gardens would become huge Wardian cases, the air admitted into which would be so sifted, so to speak, that little of the deleterious gases, and still less of that great enemy to town vegetation, smoke and soot, would find their way in. Indeed, an artificial atmosphere would be created upon the principle for which the cases which bear Mr Ward's name have been so long and so justly eulogised. Detached villa gardens, and such as are situated on the outskirts of towns, much less require this protection from intrusion by the curious eye of neighbours, by *their cats*, which are often intolerable nuisances, and from the effects of a polluted atmosphere, and therefore may be managed more in the usual manner.

In regard to expense, we are quite certain that many have thrown away double the amount of money in building up and pulling down badly constructed greenhouses and pits, than would have covered in their whole garden, and heated it into the bargain.

There are, in connection with villa gardens, certain appliances which merit a share of our attention. One of these is, the generation of extra heat upon a small scale for certain purposes, as the rearing of tropical seeds, propagation by cuttings, &c. The means employed by Isaac Anderson, Esq., whose name is now well known to most cultivators as the originator of many very curious and really unexpected hybrids, as well as for raising from seeds many new and hitherto unknown plants, are simple in the extreme. At the end of his range of glass-houses nearest to his offices, he has a small internal hothouse or large Wardian case, which is used chiefly for these purposes. This internal hothouse, if we may call it so, is heated in a very complete manner by a flow-and-return hot-water pipe laid under the sand in which the pots are plunged: these pipes are supplied with heated water from a copper boiler of the capacity of about half a gallon or so, under which is placed a gas jet taken from the supply of his house, and which can be turned on or shut off at pleasure. To prevent the injurious effects of the ex-

halations from the gas, which are so well known to be extremely hurtful to vegetation, this enthusiastic amateur has it so arranged that the gas which escapes combustion, as well as the products of it, is carried away in a pipe which conveys the deleterious effluvia to the exterior of the building. Such means of heating as this, and that noticed in various parts of this work, will be quite sufficient for the amateur's purpose, and exempt him from the expensive, laborious, and uncertain mode of heating by fermentation—a mode which should never be risked. We have also elsewhere noticed, that where a hot-water pipe can be taken from the back of a kitchen range, or wherever else a constant fire is maintained, and carried through some conducting medium, a sufficient supply of heat may be obtained without the expense attending a furnace, boiler, &c.; and also that leaden pipes may be employed from half an inch in diameter to 3 inches, according to the temperature required. Leaden pipes are convenient, because they can be put together with union screws, bent to suit the angles they come in contact with, and be fitted up, altered, or removed by a handy labourer. Gas-burning in plant-houses should not be thought of; but, if applied externally, as described above, to heat water, it may be used with safety and economy.

No doubt, hot-air stoves, and stoves with or without flues, whether heated by prepared or unprepared fuel, are all very specious suggestions; but those requiring a healthy atmosphere—and who does not?—will do well to avoid them, if they are constructed of metallic material. Reasons for this will be found in the section HEATING BY HOT-AIR STOVES, &c.

Mr Rivers' modification of Dr Arnott's stove will be found admirably adapted for slight forcing, and for excluding frost from greenhouses during winter. For description and fig., *vide* page 215.

As an important improvement on Mr Rivers' original stove, he afterwards added a hot-water boiler and pipes; and this, he says, "is perhaps the most economical and efficient hot-water apparatus ever introduced. It is merely a boiler placed over the fire-box of an Arnott stove, which does its duty most admirably,



at a less cost for fitting up and fuel than any boiler Mr Rivers has yet seen in operation."

"I have now four in full work," Mr Rivers informs us; "they have been hitherto cast of three sizes—14-inch, 16-inch, and 18-inch. One of 14 inches, (14 inches square,) which holds just eight quarts of water, is now heating an orchard-house 40 feet by 12: it does this well, at a very small cost for fuel, coke, &c. Another 16-inch boiler heats two propagating pits with gutters, each 60 feet long by 6 feet, also most efficiently: another also heats a propagating pit 60 feet long by 6 broad. These two last-mentioned boilers have superseded two of those ribbed monstrosities which cost four times the amount to 'set,' and devoured four times the quantity of fuel required by the above very simple form of boiler. When used for heating houses, the feeding and draught doors may be outside, although I do not adopt this plan; but the stove should be, if possible, inside, as the dry gentle heat of the stove, with the moist heat from tanks or gutters, forms a perfect combination." The cost of these boilers is from £1, 10s. to £1, 15s. each.

In regard to structures suited to amateurs of moderate pretensions, perhaps there has been none so combining economy of erection with fitness of purpose, at the same time being portable if wished, (in itself important to rent-paying owners,) as those structures erected by Mr Rivers, and known as orchard-houses, described by him in his interesting little work entitled "The Orchard-house; or, the Cultivation of Fruit Trees in Pots under Glass." To this work we would refer amateurs, whether their intention be to grow fruit-trees in pots set on the floor, or flowering plants set, as usual, on benches or stages. As the profits of the work are to be applied to a very laudable purpose, it will be supplied by the churchwardens, Sawbridgeworth, Herts, on application to them, enclosing thirty postage stamps. Briefly, the whole may be described as a huge garden-frame, constructed of timber, covered with glass, and heated as above described. It may be of any required dimensions; and, to prevent its being claimed as a fixture, we see no reason why it should not stand on a course of

bricks laid dry, to prevent the timbers from rotting where they touch the ground. In the present state of hothouse-building, amateurs put themselves to a very unnecessary expense, and secure little advantage, by building massive parapet walls, and setting thereon a structure composed of wall-plates, framed sashes, and rafters, upon which there is about the same amount of labour as the whole cost of the materials. To give some idea of the cost of such a structure, Mr Rivers has given in his book a detailed estimate for a "forcing-house 21 feet long, 12 feet 6 inches wide, 2 feet 9 inches high in front, and 7 feet 6 inches at back." Total cost, £17, 8s. 9d.

Artificial heat is a rather dangerous element in the hands of inexperienced amateurs, as it is even with gardeners of a certain class, more harm arising from an injudicious use of it than the reverse. We have given so many examples of heating, even to the smallest (to be useful) structures, that we can only recommend a modification of some of those, which, if properly applied, will answer all useful purposes, and may be applied in all reasonable circumstances. Excluding cold by covering, and counteracting damp by ventilation, a dry bottom, and preventing the unnecessary application of water during the dark and dead season, will do more for securing health and vigour at the proper time to greenhouse plants, than all the heat that could be applied during winter, if these conditions are not complied with.

Villa gardens of the smallest size are usually of the breadth of the front of the house, their length corresponding with its distance from the street, and consequently are in form either squares or parallelograms—forms, combined with their size, affording the very minimum opportunity of displaying taste in their arrangement. All, therefore, must depend on the introduction of such shrubs and flowers as will adapt themselves to the situation, and have some association with the surrounding objects, which may be placed in vases, or on raised platforms, which of themselves would give a becoming character, and elevate into greater importance the plants growing in them than if they were merely rising out of the ground. If the garden be well exposed

to the sun, then showy flowering plants should be employed. If much shaded, then the whole dependence must be placed on evergreens and plants of shade, but these should neither be of tall growth nor much crowded. Indeed, every plant should not only stand perfectly clear of the others, but be kept at a considerable distance from them, and be itself of symmetrical form. The *Laurustinus*, *Aucuba*, *Arbutus*, and double-blossomed *whin*, are amongst those best adapted for such places. The less attempt made at intricacy, either in the forms of the beds, where the taste of the owner leads to their admission, or the direction of the walks, the better; and neither flower-beds nor shrubs should be allowed to come in contact with the walls of the house. Damp, from want of a free circulation of air, and probably imperfect drainage, is a great drawback to the villa gardener; therefore, crowding such places with trees and shrubs should be avoided, as increasing the evil. Even surrounding the garden, for greater privacy, with a hedge, has its objection in this respect; yet, in many cases, this must be submitted to; and, when such is the case, a hedge of variegated hollies will have a much less sombre appearance than one of yew, or of the common dark-green variety of holly. The most convenient mode of reaching the front door from the street is certainly by having a straight walk leading direct from the one to the other; and the only objection of consequence to this is, that those who may be passing see directly into the lobby, or entrance-hall, as soon as the door is opened for the admission of the visitor. To obviate this, which is an objection, a circular clump of evergreens should be placed in the centre of the plot, and the walk made to pass round it, on both sides, or be carried parallel with the boundary of the garden; and if such a walk, which should not be less than 4 feet in breadth, were laid with pavement supported on piers below, a border of 18 inches would be all that would be required between it and the wall, as the plants trained upon it would find sufficient scope for their roots under the pavement, the soil under it being prepared on purpose. The space unoccupied with the walk and circular clump, as we have already suggested, should be gra-

velled all over, and rendered perfectly dry; and on it plants in vases or baskets should be set, no appearance whatever of dug border being seen, except the narrow one by the side of the walk; and even that, if densely planted with procumbent-growing flowering plants, would give a considerable amount of colour, and render the whole less troublesome to keep in trim order; for unless such gardens are exceedingly neatly kept, they will never give that satisfaction to their owner which they would, if kept in the highest order possible. We have stated our objection to grass in such places, and we have even a still greater objection to uncovered borders, which always have a harsh, cold, and untidy appearance. Indeed, so far would we carry this point, that when, from circumstances, a border becomes uncovered with living plants, we would, for the time, cover it with green moss, as associating better with the surrounding parts than if it were left empty and uncovered. A small garden can never be too perfect in itself; it should never show a blank, or appear, when seen, at any time otherwise than as a very perfect whole. Those having a reserve or back-garden may, with little trouble, cover their front border, during winter, with *Erica herbacea*, *carnea*, *Vinca major* and *minor*, *Gaultheria procumbens*, *Shallon*, *Ulex europea* and *Nana*, *Arbutus*, *Uva-ursi*, dwarf rhododendrons set with flower-buds before planting, &c., all of which may be readily removed, and with perfect safety, and returned again when their season of flowering is past, or when it is desirable to replant the front garden with such plants as are to remain during the summer. Indeed, such a garden should have, as it were, its winter and summer dresses, without which it can never be considered perfect.

In planting the boundary wall, the most ornamental and showy climbing-plants should be chosen, preferring such as are profuse flowerers, or such as the red fruit in cotoneasters, *pyracanthas*, &c. The following will be found to stand the atmosphere of town or suburban villa gardens, and are at the same time free and abundant bloomers:—*Clematis azurea*, *florida*, *Viorna*, *montana*, *Wistaria sinensis*, *Jasminum nudiflora*, (flowering all the winter,) *officinale*, *Lonicera flexuosa*. And of those

which are not decided climbers, *Cydonia japonica*, *Cineraria maritima*, with its pure white leaves; *Ribes sanguineum*, *Ceanothus dentatus*, *rigidus*, *papillosus*, *azureus*, *divaricatus*, *Escallonia*, various species; the common *Laburnum*, which luxuriates as much in the city of London as it does in its native habitat; *Fuchsia discolor*, *Kerria japonica*, *Deutzia scabra*, *corymbosa*, *Fabiana imbricata*, *Forsythia viridissima*; *Mahonia*, several species; *Rhododendron*, various species and varieties; *Weigela rosea*, *Laurus nobilis*, *Magnolia grandiflora conspicua*; *Spiræa bella*, *Chimonanthus fragrans*, &c. Roses, excepting the more hardy sorts, such as *ruga*, seldom flower in confined places. However, where the situation is open, many varieties of them may be intermixed with plants which retain their leaves all the winter.

If anything more than another renders street-gardens unsightly, it is the want of a judicious selection of the plants employed. All weedy-looking sorts should be rejected, and all which are of weakly growth will, under such circumstances, assume that character. The prevailing desire to grow a little of everything, and of this thing, and of the other, without considering their adaptation to the situation, should be curbed, and those encouraged only which are known to prosper best. *Mignonette*, the favourite of all border-plants, thrives ill in such places, and more especially if somewhat shaded and damp. It will, however, with many annuals of similar habit, continue a tolerable existence, if sown in *gravel* instead of rich mould; and although assuming a more stunted appearance, will nevertheless continue to flower throughout the season, in tolerable perfection, requiring only, in very dry weather, a slight watering overhead to clear the foliage of dust, and partially to refresh the roots. *Nemophila insignis*, *Clarkia pulchella*, *Collinsia bicolor*, *Leptosiphon densiflorus*, *androsaceus*; *Brachycome iberidifolia*; *Calandrinia*, most of the genus; *Campanula Lorei*, *pentagona*; *Chænostoma polyantha*; *Helianthemum guttatum*, and all the annual species; *Kaulfussia amelloides*; *Lobelia erinoides*, *erinus*; *Lupinus nanus*, *bicolor*; *Malcomia maritima*; *Mesembryanthemum tricolor*; *Oxyura chrysanthemoides*; *Portulaca*, most of the genus, are annuals

well suited for such situations; and, if sown in autumn, will flower early in spring, and continue till the beginning of summer, when their places should be taken up with scarlet geraniums, *heliotropes*, *verbenas*, &c., grown in pots, and set on or plunged in the gravel.

*Nemophila insignis*, *Cochlearia acaulis*, *Calandrinia speciosa*, *Lasthenia californica*, *Saponaria calabrica*, will prosper better than most other good annuals in a rather damp and partially shaded situation. While, amongst low-growing abundant-flowering herbaceous plants, the following may be named as suitable for a similar situation:—*Caltha palustris flore-pleno*, *Anemone japonica*, *pulsatilla*, *nemorosa flore-pleno*; *Bellis perennis*, (the double daisy, in great variety); *Campanula carpatica*, *pumila*; *Convallaria Majales*, *Cardamine pratensis*; *Dracocephalum grandiflorum*; *Trollius*, all the genus; *Eranthis hyemalis*; *Helleborus niger*, *viridis*; *Ficaria ranunculoides plena*, *Ranunculus gramineus*, *aconitifolius*, *amplicaulis*, *repens*, *flore-pleno*; *Hepaticas*, several varieties; the fine and too little cultivated genera *Trillium*, *Helonias*, *Uvularia*, and *Smilacina*, and the autumnal flowering *Colchicums*; and, where there is sufficient space, the noble *Yuccas* of North America, and the beautiful family of *Monarda*, in general lost in gardens, from being planted in too dry soils, and in too hot situations; *Gentiana acaulis*, *verna*; *Lobelia cardinalis*; *Mimulus cardinalis*, *moschatus*, and most of the hybrid varieties; *Myosotis palustris*, *Saxifraga*, most of the genus; *Sedum*, many of the genus; *Soldanella*, most of the genus; and, where the soil is of a loamy character, many of the primroses.

The following plants adapt themselves to the driest and most exposed situations, many of them delighting to grow on the tops of walls, and in the joints of the mortar:—*Helianthemum*, most of the species of procumbent habits; *Fumaria lutea*, *Erinus alpinus*, *hispanicus*; *Grammanthes gentianoides*, *Linaria tristis*, *Cymbalaria vulgaris*; *Antirrhinum majus*, *Cheiranthus cheiri*, in all its varieties, *fruticosus*; *Arabis*, many of the genera; *Lunaria rediviva*, *Aubrietia deltoides*, *Alyssum saxatile*, *murale*, *olympicum*; *Draba aizoides*, *ciliaris*, *Aizoon*, *Iberis saxatilis*, *sempervirens*, and *gibraltarica*, in warm

places ; *Thymus*, all the genus ; *Dryas octopetala* ; *Sempervivum*, all the hardy species ; *Sedum*, most of the genus ; *Cotyledon umbilicus*, *lutea* ; *Arenaria rubra* ; *Silene acaulis excapa*, *Saponaria ocymoides* ; *Dianthus rupicola*, *Caryophyllus*, *deltoides*, *glaucus*, *cæsius*, *petræus*, and various others ; *Campanula rotundifolia*, *Phyteuma orbiculare*, &c.

Suburban villa-gardens are usually of much greater extent than those we have above alluded to ; besides, they are better situated as regards atmosphere and exposure. They, nevertheless, in common with town gardens, suffer, to a certain extent, from want of light and air, and very often from the soil becoming sodden, cold, and wet, especially where provision is not made for carrying off the rain which falls on adjoining buildings, aggravated by an unnecessary quantity of manure being buried in it. Amateurs often err in the over-application of rich manures, without taking into consideration the state of the plants, and whether they are in a fit condition to digest those that are of a very rich description. Plants can only assimilate the rich food that may thus be presented to their roots, in proportion to their state of health, which, in such situations, is seldom so vigorous and robust as in those growing under different circumstances. As a primary operation in the formation of such gardens as those we have alluded to above, we may remark, that they can scarcely be rendered too dry below ; and we believe that, were they even vaulted underneath, leaving only a foot or 18 inches of soil for the plants to grow in, greater success would attend this department of gardening. Where the expense of vaulting cannot be borne, then the next best substitute would be, to lay in 18 inches of broken stones, coarse gravel, or other equally porous material, and on that to lay the soil for the plants. The soil of all town-gardens, and many suburban ones too, from a combination of circumstances, becomes completely exhausted of those ingredients necessary for the growth of most plants. This, probably, more than has been in general supposed, may be the cause why few plants thrive in such places. There is little or no rotation of crop in them ; the same plants—or at least the same species of plants, which is the same thing—continue

to feed on the same soil for years. There is no change of food, further than copious doses of manure, little of which the plants are able to assimilate or make use of ; they become satiated by repletion, and cease to feed at all.

Were manures dispensed with entirely, or those only used which would act as slight stimulants, say lime, guano, salt, carbonate of ammonia, &c., with a little leaf-mould, mixed with sharp sand—all of which could be applied with little trouble or expense, and without causing any disagreeable or unhealthy effluvia—they would answer the purpose much better, and would maintain the soil for several years in a very good condition, provided it was good at first. All small gardens may be considered very much in the light of a large flower-pot or flower-box, in which the same kinds of plants have been grown for several years ; and, although duly watered, and perhaps the surface profusely mulched with rich manure, or copious draughts of liquid manure applied, still the plants in a year or two show evident symptoms of disease and debility, and if not taken out of the pot or box, the exhausted soil removed from their roots and replanted in fresh compost, death is the inevitable consequence. So it is exactly with small gardens cropped with the same plants for several years ; their soil ceases to afford the sustenance the plants require, and hence they dwindle and ultimately die. But if a great portion of the soil be removed entirely—and the more the better—and replaced with fresh good soil, in which similar plants have never grown, then a restoration to health would assuredly be the consequence, although the labour and expense would be considerable. If, however, instead of laying out several pounds per annum on the purchase of rich manure, the same amount was expended in purchasing and laying in fresh soil, a far more healthy state would be maintained, and that for a considerable number of years. The flower borders may have sunk considerably in consequence of the decomposition of organic matter originally contained in them ; the addition of several inches of fresh turfy soil mixed with sharp river-sand, would bring them up to their proper level, and, where well incorporated with the old soil, would

place them in a good condition to support the plants to be set in them. Shrubs and trees are much benefited by the operation of what is called root-pruning, particularly those that are over-growing their allotted spaces. This checks the disposition to over-luxuriance, which all the pruning and reduction of the branches would only greatly encourage. A trench is cut round the outer circumference of the roots to admit of the root-pruning taking place, which need not be above a foot or 15 inches in breadth; but this depends on the size of the tree or bush, and the depth of its roots, for it is essential to cut off all that descend in a downward direction, as well as all those extending horizontally beyond the inner edge of the trench. As much of the soil should be removed as can be done without materially injuring the roots, and fresh soil laid in its place. The trench should then be filled in with fresh soil, or at least three parts of it to one of the former, which finishes the operations both of root-pruning and renewing the soil about the roots of the plant. We need hardly remark, that no manure should be applied, unless it be with a view to greatly encourage the magnitude of the plant; and in some cases this is necessary, as in the case of getting up rapidly screen fences, climbing plants to hide disagreeable objects, and the like. But even in this case, ground bones or other slow-decomposing matter should have the preference to stable-yard or other very rich manure. Every tree in a villa garden need not be done at the same time; a few may be operated on yearly, taking those first which seem most in need of such a renewal. By following these suggestions, such gardens would assume a very different appearance from what they do at present.

Plants take up much of their food from the soil; and to enable them to do so the more completely, a beautiful provision is made, each rootlet being furnished with an appendage called a spongiol, from its resemblance to a small sponge: these collect the food in a state of solution from the soil, and deliver it to the roots, which convey it to the other parts of the plant. But plants derive food also in a gaseous form through the pores of their leaves, which pores are

much smaller in some plants than in others; and on this also depends, to a great extent, their fitness or unfitness for the impure air of towns. Plants with very small pores, such as heaths, roses, &c., are, in consequence, amongst the least proper for town gardens. The *Aucuba japonica*, Virginian creeper, and even the vine, having large pores, are found to thrive in situations where many others could not exist. The dust, soot, &c., which fall on the leaves close up these pores, and respiration is suspended; and the consequence, if this is not removed, is death. The best means of remedying this evil is powerful syringing; and those amateurs do well who attach a flexible hose to the water-supply pipe, and apply it with all the force of the pressure to their trees and shrubs in the evenings, making it play over, around, and up through the branches, that every leaf, and the whole surface of the bark, may be washed clean. This necessary operation will account, to a certain extent, for our recommending well-drained and shallow soils for such gardens, that this extra supply of water may find a ready escape, and so preserve the soil from saturation.

*Fruit trees.*—It may be expected we should give a list of such fruit trees and culinary vegetable seeds as are adapted to villa gardens. Under the conditions stated above, all fruit trees and bushes sufficiently hardy to stand the climate of the locality are equally suitable; and, as we have given such copious descriptive lists elsewhere, (*vide* Vol. II.,) we think the reader will find sufficient data to form his collection from them; and in the select lists of culinary seeds the villa garden will not be overlooked. We may, however, observe, that apples wrought on Paradise stocks, pears on the Quince, &c., will be found the most valuable, as requiring little space, and creating scarcely any shade. The upright espalier mode of training will afford the greatest surface for fruit on the least extent of ground; and, indeed, in such gardens, the gooseberry, currant, &c., should be subjected to the same mode of treatment; and where a covered espalier (*vide* fig. 797) is admissible—as, for example, separating the flower part of the garden from that occupied with fruits or vegetables—it

will be found of advantage. Vertical espaliers, fig. 791 to 795, may be used with equal effect.

*Herbs.*—Every garden, however small, should have a small space dedicated to the growth of herbs for seasoning and domestic purposes, and these should be always grown by themselves, as being more conveniently got when wanted. For list of herbs, &c., *vide* Olitory, vol. II.

*Trees.*—Few trees can be admitted, with propriety, into any garden of the kind we are alluding to at present. The lime has been a popular city tree for ages; it bears cutting and training, so as to form a sort of verdant wall, and for this purpose is much used on the Continent. The laburnum, although seldom employed, is preferable, more suited to the atmosphere, and very beautiful while in flower. The almond, where the climate is mild enough, cheers us in early spring with its magnificent peach-coloured blossom; the acacia, with the gracefulness of its foliage, and, when of sufficient age, with its beautiful racemes of flowers. Its only defect is the brittleness of its branches, and their liability to be broken with the wind. Whoever has a stream passing through his garden, or a pond of water, cannot choose a more appropriate tree than the weeping willow, immortalised since the Babylonian captivity, and in modern times by Pope the poet, and the memory of Napoleon I. It is the most graceful of all weeping trees, and associates both in landscape and in connection with buildings, where its kinsman the weeping ash would only be regarded as a monstrosity, the fit inhabitant of a London tea-garden. Few of the Coniferæ, with the exception of the cedar of Lebanon and Deodar, will live in confined places, or even in villa gardens of considerable extent: their effect is scarcely worth the room they occupy. *Salix annularis* and *Napoleona* are graceful smallish trees; and *Ailanthus glandulosa*, *Aralia japonica*, *Araucaria imbricata*, *Catalpa syringæfolia*, *Broussonetia papyrifera*, *Cercis siliquastrum*, *Gleditschia triacanthos*, *horrida*; *Kolreuteria paniculata*, *Liriodendron tulipifera*, *Paulownia imperialis*, *Magnolia grandiflora*, *acuminata*, *Salisburia adiantifolia*, &c., are all to be preferred to our elms, poplars, &c.,

with which most small gardens are impoverished under ground, and shaded above. These, we should observe, for the gardens of northern amateurs, stand the climate at Dalkeith: some trees of them there are of considerable size and age.

*Deciduous shrubs.*—Most of the following are too seldom met with in villa gardens:—*Amygdalus nana*, *nana florepleno*, *Aralia spinosa*, *Caragana Chamagalu*, *spinosa*; *Cercis canadensis*; *Cratægus*, most of the genera; *Cytisus*, most of the genera—if wrought as standards, they make fine lawn-plants. *Cydonia japonica* makes beautiful scarlet-flowering hedges. *Halesia diptera*, *tetraptera*; *Liquidambar styraciflua*, *imberbe*; *Robinia hispida*, *pseudo-acacia*, *var. macrophylla*, *var. grandiflora*, *var. pendula*, *var. crispa*; *Berberis vulgaris fol. violacea*; *Colutea cruenta*, *frutuosa*; *Dirca palustris*; *Genista*—most of the genus, when wrought as standards, make fine lawn-plants; *Hibiscus*, all the varieties of *H. syriacus*; *Hypericum chinense*, *nepaulense*; *Maclura aurantiaca*; *Magnolia conspicua*, *obovata*; *Pæonia Moutan*; *Purshia tridentata*; *Rhus*, most of the genus; *Ribes*, most of the genera; *Spiræa ariæfolia*, *bella*, *Douglassi*, *Lindleyana*, *prunifolia florepleno*; *Syringa Emodi*; *Notyche*, *Saugeana*, *Josikæa*; *Weigela rosea*; *Andromeda*, many of the species; *Azalea*, most of the recently originated hybrid varieties; *Rhodora canadensis*.

*Evergreen shrubs.*—*Acacia Julibrissin*; *Cerasus ilicifolia*; *Euonymus japonicus*, *var. argenteus*, *var. aureus*, *latifolia*; *Ilex æstivalis*, *angustifolia*, *atro-virens*, *crassifolia*, *latifolia*, *excelsa*, with a host of curious varieties of *I. Aquifolium*; *Photinia glabra*, *dubia*, *serrulata*, *arbutifolia*; *Quercus coccifera*, *suber*; of *Q. Ilex*, the *vars. ilicifolia*, *Fordi*, *rotundifolia*, *Ballota*, *latifolia*, *Shepherdii*; *Benthamia fragifera*; *Berberis*, most of the evergreen species; *Buxus balearica*; *Cistus*, most of the genus; *Colletia ferox*, *spinosa*; *Cotoneaster*, most of the genus. Many of these, when trained as standards, make fine lawn-plants, and all of them excellent covering for rocks, old walls, or other objects which it may be desirable to hide. *Daphne*, all the hardy species; *Escallonia*, all the genera; *Fabiana imbricata*; *Fontanesia phillyræoides*; *Garrya elliptica*; *Laurus sassafras colchicus*, *Benzoin*; *Mahonia*,

all the genera; *Olea europæa*; *Phillyrea*, all the species; *Prinos*, all the genera; *Rhamnus alaternus*, *laurifolius*; *Yucca*, all the hardy species; *Arbutus*, all the hardy species; *Kalmia*, all the genera; *Ledum*, all the genera; *Pernettya*, all the genera; *Rhododendron*, *alta-clerense*, *Jacksoni*, *sanguineum*, *Cunninghami*, *dauricum*, *var. atrovirens*, *Nobleanum*, *Purshii*, *Russellianum*, *tigrinum*, *vesticum*, *barbatum*, *campanulatum*, *catawbiense* (true.) The important additions made to this family by Dr Joseph Hooker, from the Sikhim range of the Himalayas, have not as yet been proved to be sufficiently hardy (although there is little doubt that they are so) to warrant our recommending them to the proprietors of villa gardens in general, although we are quite aware that many amateurs are already possessed of them. The following are a few of the newer varieties which have been proved hardy: *Towardii*, *sabrina*, *cerito*, *Queen Victoria*, *Albion*, *Paxtonii*, *bouquet de Flora*, *Raeanum*, *vivid*, *Blandyanum*, *Standishii*, *erectum*, *regina*, *gem*, *ignescens*, *compactum*, *Lindseyii*, *coccineum*, *Ianthe*, *Reedianum*. The number of hybrids is so great that it is difficult to make a selection. We admire the scarlet and bright-coloured varieties most, and therefore think many will do so too. The above small selection embraces many of them.

*Coniferae*.—In the best exposed villa gardens the following rather rare interesting plants deserve a place: *Thuja cuneata*, *gigantea*, *plicata*, *flagelliformis*; *Cupressus benthami*, *funbris*, *Goveniana*, *Lindleyi*, *macrocarpa*, *torulosa*, *cricoides*; *Taxodium hetrophyllum*, *sempervirens*, *adscendens*, *Hugeli*; *Cryptomeria japonica*; *Juniperus drupacea*, *hemispherica*, *chinensis*, *mexicana*, *recurva*, *gossainthanea*; *Taxus drupacea*, *pedunculata*, *Fortunii*, *tardiva*, *umbraculefera*, *montana*, *baccata*, *var. Dovastoni*, (or weeping yew, a very handsome lawn-plant,) *recurvata*; *Saxegotha conspicua*, (a very interesting evergreen tree, named in compliment to His Royal Highness Prince Albert, inhabiting the frigid regions of the mountains of Patagonia;) *Fitz-Roya patagonica*, from the same regions, equally hardy, and both recently introduced. This section of *Coniferae* appears to stand the atmosphere of confined gardens much better than those of

*Pinus*, *Abies*, &c., and are more in unison with dressed grounds and buildings.

*Select list of hardy herbaceous plants suitable for a villa garden*.—Our object in presenting this list is, that we have so often seen in such gardens very good selections of other plants, while a worse choice could scarcely be made of the plants in the open borders. *Adonis vernalis*; *Alyssum saxatile*; *Corydalis nobilis*; *Dielytra formosa*, *eximia*, *spectabilis*; *Coronilla iberica*; *Lathyrus grandiflorus*; *Orobus vernus*, *formosus*; *Ammobium alatum*; *Liatris*, all the species; *Antennaria triplinervis*; *Erigeron grandiflorus*, *Villarsii*; *Aster alpinus*, *pulchellus*, *Novæ angliæ*, *cyaneus*, *grandiflorus*, *pulcherrimus*, *Amellus*, *Novi belgii*, *spectabilis*, *amelloides*, *blandus*; *Tagetes lucida*; *Pyrethrum uliginosum*, *roseum*; *Achillea grandiflora*, *speciosa*, *nobilis*; *Lupinus polyphyllus*, and *var. albiflorus*, *sericeus*, *argenteus*, *macrophyllus*; *Lobelia fulgens*, and varieties from it; *Tigridia pavonia*, *conchiflora*; *Hesperis matronalis*, with its double varieties; *Iberis semperforens*, *gibraltarica*, *saxatilis*, *corifolia*, *Tenoreana*; *Vesicaria utriculata*; *Cheiranthus mutabilis*, *Marshallianus*; *Mimulus variegatus*, *cardinalis*, *propinquus*, *roseus*; *Linaria triornithophora*, *genistæfolia*; *Verbena venosa*; *Chelone obliqua*, *Lyoni*, *barbata*; *Penstemon campanulatum*, *digitale*, *atropurpureum*, *gentinoides* *et var. alba*, *coccineum*, *splendens*, *Scouleri*, *speciosum*, *venustum*, *crassifolium*; *Dracocephalum speciosum*, *botryooides*, *denticulatum argunense*; *Trollius asiaticus*; *Anemone Halleri*, *japonica*, *palmata*, *apennina*; *Hepatica triloba*, with its varieties; *Aquilegia glandulosa*, *canadensis*, *fragrans*, *alpina*, *grandis*, *speciosa*, *Whitmanni*, *Skinneri*, *glauca*; *Delphinium grandiflorum*, and its varieties, *chinense*, *cheilanthum*, *elegans*, *azureum*; *Lychnis chalconica* *alba-plena*, *coronaria*; *Saponaria officinalis plena*; *Dianthus latifolius*, *japonicus*, *suaveolens*, *superbus*, *pulchellus*; *Epilobium latifolium*; *Cenothera speciosa*, *glauca*, *missouriensis*, *taraxifolia*, *macrocarpa*; *Muscari comosum*, *botryooides*; *Phalangium Liliago*, *ramosum*; *Scilla peruviana*, *sibirica*, *campanulata*, *verna*, *præcox*, *autumnalis*; *Uvularia*, all the genus; *Bulbocodium vernum*; *Erythronium*, all the genus; *Tritonia*, all the genus; *Lilium lanci-*

folium and its varieties, longiflorum, penduliflorum, tigrinum; *Fritillaria*, all the genus; *Funkia Sieboldiana*, undulata; *Alstroemeria pulchella*, psittacina; *Narcissus*, most of the genus; *Gentiana*, all the genera; *Asclepias amœna*, incarnata, tuberosa; *Phyteuma*, most of the genus; *Campanula pulla*, carpatica, cœspitosa, pumila, elegans, persicifolia with its varieties, pyramidalis, versicolor, lac-tiflora, grandis, nobilis; *Phlox*, most of the genus; *Pulmonaria virginica*, *Sisyrinchium grandiflorum*; *Iris susiana*, verna; *Gladiolus*, many of the species; *Morina longifolia*; *Potentilla M'Nabiana*, *Menziesia*, *Mackayana*, *hæmatochrus*; *Veronica corymbosa*; *Viola palmensis*; *Baptisia australis*, *exaltata*; *Dictamnus Fraxinella*, *vars. rubra et alba*; *Lythrum roseum grandiflorum*; *Meconopsis cambrica*, &c.

## APPENDIX.



## APPENDIX.

### DETAILS OF THE COST OF CONSTRUCTION IN DIFFERENT LOCALITIES, TABLES, &c.

#### BRICKLAYERS' WORK.

IN England, brickwork is calculated by the *rod* of 30 square yards and 2 feet, or 272 superficial feet; in Scotland, by the *rood* of 36 square yards, or 324 superficial feet, the standard thickness of all brick-walls being a brick and a half—that is, the length of one brick and breadth of another. Supposing, therefore, bricks to be 10 inches long, and 4½ inches broad, such walls are called 14-inch walls; and, in measuring brick-work, all walls must be reduced to that standard. *N.B.*—It is necessary, in making calculations, and in taking dimensions, to observe the difference between the *rod* and *rood*; and it would be well, instead of expressing the thickness in inches, to do so in bricks or half-bricks, &c. 306 feet cube, or 11 yards 9 feet, or 408 feet superficial, of one brick in thickness, is equal to 272 feet superficial of brick-and-half work, or one rod standard thickness, or 317½ feet, calculating the thickness at 13½ inches, or 14 inches, as usually expressed: 14⅙ bricks to the foot superficial are required, of Scotch bricks. When English bricks are used, 1 foot superficial, of reduced work, will take 16 bricks; 1 foot ditto, gauged arches, 10 bricks; 1 foot ditto, facings, 7 bricks, &c.

On account of the difference in size between the English and Scotch bricks, the former being usually 8¾ × 2½ × 4½, although in general called 9 inches, and the latter 9¾ × 4½ × 3½, it is necessary to add to each yard English, when Scotch bricks are used for walls of 4½ inch, or half-brick work, 5 bricks; for 9-inch work, or one brick, 10 bricks; for 13½-inch, or brick-and-half work, 15 bricks; and for 18-inch, or two-brick work, 20 bricks. Since the repeal of the excise duty, bricks may be made of any size: the above, however, approximate the usual sizes.

Previous to the repeal of the duty on bricks, they were not allowed to be made in moulds containing more than 150 cubic inches. If larger than that, they were liable to double duty. The Scotch makers, aware of this, made their bricks as near to the above size as possible, they in general running from 147¾ to 148 cubic inches. Why the English makers did not do so, we know not. The loss did not, however, fall on the maker, but on the purchaser; because

1000 Scotch bricks would do more work than the same number of English made ones. Hence in purchasing bricks, the larger size, if well burnt, should be chosen. In Scotland, bricks for general purposes are divided into common red bricks, composition bricks, and fire-bricks. The size of the first has been given above. They weigh per 1000, on an average, 3 tons. The second, 3 tons 7 cwt.; and the third, 3 tons 15 cwt. They are all of the same size, the nature of the material making the difference in weight. English place and stock bricks weigh 2 tons 5 cwt., or 5 lb. each, as an average weight, according to Skirving's calculations, but more correctly, 2 tons 4 cwt. 2 qrs. 16 lb.

For the following calculations relative to Scotch made bricks, we are indebted to Mr Dean, a respectable manufacturer at Wishaw, Lanarkshire:—

3620 bricks will build a *rod* of 1½ brick work of 272 feet superficial, allowing 20 for breakage, if composition, and 40 for common brick.  
4320 ditto, a *rood* of 1½ brick work, of 324 feet superficial.  
2414 ditto, a *rod* of 10-inch work, of 272 feet do.  
2880 a *rood* of ditto, of 324 feet ditto.  
1207 ditto, a *rod* of 5-inch work, of 272 feet do.  
1440 ditto, a *rood* of ditto, of 324 feet do.

The above calculations are made for Scotch made bricks only, and include breakage in the proportion stated in the first item.

4500 place bricks, or 4300 stock bricks, laid in mortar, is the London allowance for doing a *rod* of work. This, however, includes breakage and waste. For other calculations of the number of bricks required for garden-walls, *vide art. Construction of Brick Walls*, p. 79.

A rod of solid 1-brick work requires 3000 bricks; and a rod of hollow brick-and-half work requires 3600; and a rod with only half the number of cross-bonds requires 3200 bricks: 3000 is sufficient for a rod, if built on Dearn's principle, *vide* p. 81. If the whole of the brick-work were set on edge, then, for common 9-inch wall, hollow, the number of bricks required per rod will be 2000; for a brick-and-half hollow wall, with the bricks set on edge, the number per rod will be about 3000; and for a wall, brick-on-edge, with only half the number of cross-bonds, the number will be 2500.—*N.B.* These calculations are for English made bricks.

## SCOTCH PRICES.

Cost of brickwork in Scotland, top price, and considering the workmanship and all material to be of the best description and quality.

*Solid walls.*—2-brick, or 20-inch walls solid, builder finding all material and scaffolding, (but exclusive of digging foundations,) within three miles of a brick field, or brick depot, and six miles from lime, £14 per rood of 36 yards. For 1½-brick, or 15-inch work, £10, 10s.; for 10-inch, or 1-brick work, £6, 18s.; and for 5-inch walls, £3, 10s.

*Hollow walls.*—2-brick, or 20-inch work, ties every 2 feet, £10, 7s.; 15 inches, £8, 10s. Flemish bond, to be wrought fair on both sides, and joints to be kept perpendicular, no four courses to exceed 14 inches in height.

*For labour only,* proprietor finding all material and scaffolding. For 20-inch walls, whether solid or hollow, £2, 8s.; 15-inch walls, 4s.; 10-inch walls, 3s.; 5-inch walls, 18s.—the latter pointed on one side only, the others pointed on both sides.

If the distance exceeds three miles from a brick-field, the extra expense can be easily calculated by adding the carriage of bricks from a greater distance, taking 1000 bricks at 3 tons.

1 ton of lime is allowed for hollow walls per rood of 36 yards, and 1½ tons for a solid wall is an ample allowance.

*Average price at present (1852)* of common bricks of the very best quality for garden walls, at Wishaw Works, near Hamilton, 21s. 6d. per 1000; at Edinburgh, 25s.; at Glasgow, 23s.; at Perth, 25s.; at Aberdeen, 25s.

Composition bricks, manufactured by Mr Dean, of the Wishaw Works, of a larger size than ordinary bricks, of a soft stone-colour, and warranted to stand all weathers, being made chiefly for horticultural purposes, 27s. 6d. to 30s. per 1000. These bricks have been pronounced by a celebrated London architect as very superior in quality, and absorbing less water than any before submitted to his inspection.

Fire-bricks, at the same works, 35s. per 1000; at Edinburgh, 45s.; at Glasgow, 40s.; at Perth, 45s.; at Aberdeen, 45s.

The above prices are the field prices.

Fire-clay per ton, from 7s. to 8s. at the works.

Concrete for foundations, £4 to £4, 10s. per rood, calculating that coarse gravel or stone-chips have not to be carted above one mile.

9-inch paving-tiles, 2 inches thick, £6 per 1000, weigh 4 tons, being thicker than the London ones; 12-inch ditto, £8, weigh about 6 tons. 1 load of bricks, 350 in number.

1 ditto of tiles for roofing, 500 in number, weigh nearly 1 ton 7 cwt.

The following are Mr Dean's calculations for brickwork in cement in Scotland:—1 rood of 272 feet superficial, of a 15-inch or brick-and-half wall, distance from brick-field, say three miles, £12, contractor finding all material, labour, &c.; the same for cement and labour only, £5; and 5-inch walls in proportion to the above price, taking the cement at 8s. per barrel, and to be mixed with one-half of sharp sand to one of

cement; and for labour only £3, 2s. and 20s. respectively, according to thickness.

36 bushels of cement, with the same quantity of sharp sand, will do a rood of brickwork.

*Tuck-pointing* new walls, 12s. per 100 feet superficial. If the wall is old, and requires washing down and colouring, and the joints raked, add 4s. per 100 feet superficial.

*Flat-joint pointing.*—With blue mortar, an excellent method, 8s. per 100 feet superficial. If old walls, requiring cleaning and colouring, and the joints raked out, 10s. per 100 feet superficial. In both cases, if there are many decayed bricks to be taken out and renewed, this latter is not included in the above charges. These are Scotch prices.

The prices of labour should always depend on the abilities of the workman. One bricklayer will lay 1000 bricks in one day, in 14-inch work, and 1250 in walls of greater thickness, while others cannot lay 700. Wages for first-rate English bricklayers, employed in Scotland, at the rate of ten hours per day, are from 5s. to 4s. 6d.; for ordinary men, 4s.; and bricklayers' labourers receive 2s. 4d. to 2s. 6d. per day. These are masters' prices, and taken as an average for Scotland. There is no economy in employing common labourers in such work, as the preparation of the material and service depends upon them.

## ENGLISH PRICES.

From Skirving's very useful "Builders' Price-Book," published annually, we extract the following data as to quantity and cost in the neighbourhood of London. There are two sorts of bricks in ordinary use about London used for horticultural purposes—namely, stock and place bricks: the former are the best.

"5000 place, or 4750 stock bricks, laid dry in wells and cesspools, 4500 place, or 4300 stock bricks, laid in mortar in external and party walls, will build 1 rood; 27 bushels of chalk-lime, and 3 loads of road-drift, (a substitute for sand,) 18 bushels of stone-lime, 3¼ loads of sand, will do 1 rood of reduced brickwork." This difference in number does not arise from a difference in size, but from greater breakage in the one case than in the other.

The following is given by the same authority as the masters' prices per rood, in party and external walls. Stock bricks are considered superior to place bricks in the proportion of 30 to 22—that is to say, when the former are worth £1, 10s. per 1000, the latter are only worth £1, 2s., which, at this time, (1852,) is the average price of both near London, delivered at the work; and £1 and 18s. respectively, in the field. Bricks, like most other materials, are subject to sudden rises and depressions in price: for example, in our return of present prices, Dec. 20th, we find them quoted at 28s. and 35s. respectively at Kingston-on-Thames. In making calculations, the field price should be ascertained first, and the rise or fall added to, or deducted from, which will leave our calculations in other respects correct.

If all place bricks, contractor finding all mate-

rial, labour, &c., £9, 15s. per rod; if lime and labour only, £4; if labour only, £2. Three quarter place bricks, and one quarter stocks, contractor finding all material and labour, £10, 5s.; lime and labour only, £4; and if labour only, £2. If half place and half stock, contractor finding all material, &c., £10, 10s.; if lime and labour only, £4; and if labour only, £2. If three quarter stocks and one quarter place bricks, £11; lime and labour, or labour only, same as above. If all stocks, £11, 10s.; lime and labour, or labour only, same as above.

Brick walls done in the best manner, the bricks picked for the outside, and jointed, four courses not to exceed 11½ inches, £12, contractor finding all material, labour, &c.; for lime and labour, £4, 4s.; and for labour only, £2, 2s. per rod. If the work is done with stone-lime, add 5s. per rod for material and labour; 5s. per rod for lime and labour. If done with river sand, add the same as above.

As regards garden walls, the London practice is, where both sides are wrought fair and jointed, to add 10s. per rod, or 1d. per foot superficial, on one side, when all material and labour is furnished by the contractor; or 1s. 2d. per foot when lime and labour only is supplied; and the same when labour only is found.

The usual mode of building garden walls round London is four stretchers and a header, and is called garden-wall bond.

*Concrete for foundations of walls.*—In the proportion of 1 of lime to 6 of gravel, exclusive of digging, 7s. per cubic yard, or £3, 19s. 4d. per rod. In regard to the variation in the price of bricks, the London practice is to allow 5s. per rod, either of addition or reduction, for every shilling the bricks rise or fall per 1000.

London made bricks weigh 2 tons 5 cwt. per 1000, or 5 lb. each brick. 9-inch paving-tiles, £8 per 1000—weight, 2 tons 18 cwt., or 6½ lb. each; 10-inch do., £9, 10s. per 1000—weight, 3 tons 11 cwt. 1 lb., or 8 lb. each; 12-inch do., £9, 15s. per 1000—weight, 5 tons 7 cwt. 16 lb., or 12 lb. each.

1 load of bricks, 500 in number, weighs 1 ton 2¼ cwt.; 1 load of tiles for roofing, 1000, weighs 1 ton 11 cwt.: they are smaller and lighter than Scotch made ones.

*Brickwork in Roman cement.*—If all stock bricks are used, £14 per rod, contractor finding all material and labour; £6, 10s. for cement and labour only; and £2, 10s. for labour only. Half-brick work laid in cement, with cross-joints bedded, 5d. for material and labour; 2¼d. for cement and labour; 1d. for labour only, per foot superficial. One brick thick, 9¼d. for material and labour; 4¼d. for cement and labour; and 2d. for labour only, per foot superficial. 12-inch tiles bedded and edge-set in cement, 6d. for material and labour; 2¼d. for cement and labour; and 1¼d. for labour only, per foot superficial.

*Pointing brick walls.*—Garden walls, if well built, care being taken to keep the joints at the headers perpendicular, and confining the builder in specification not to exceed 11½ inches to every four courses in height in England, and 12½ in Scotland, require no pointing when first

built. But old walls, and such as have been defaced by the old and barbarous practice of driving nails into the joints, will be much improved by pointing, and, indeed, made to look almost as well as when new. Old walls, to be common pointed, should have all the joints carefully raked out, and made good with best mortar, the whole surface of the face washed over with hot-lime white-wash of sufficient consistency to fill up all the nail holes, taking care that holes of larger size and fractured corners be made good with Roman cement. Lay on afterwards two coats of brick-coloured paint, formed of Mulgrave cement and red lead mixed in oil; the joints may afterwards be drawn in with black wax, for the sake of appearance. Where walls are coped with brick or tile, the joints should be examined and repaired at least every second year; and, for the repair of such joints, cement of the best quality only should be used.

*Flat-joint pointing* with smithy-ash mortar for new walls, 2¼d. for material and labour; 1¼d. for labour only. If done in cement, add 1d. per foot for material and labour; and ¼d. per foot for labour only.

*Tuck-pointing* on new work, 3¼d. for material and labour; and 2d. per foot superficial for labour only. If the scaffolding has not been removed, deduct ¼d. per foot for the charge for material and labour; and ¼d. per foot for labour only. Old walls requiring tuck-pointing, scrubbing down the face with water, staining the same a fresh brick colour, and raking out the old joints, drawing in the fresh joints, with the perpendiculars regarded, 5d. per foot superficial for material and labour; 2¼d. per foot for labour only.—The above are English prices.

Bricklayers' wages per day in London, 5s. 3d. from Lord Mayor's Day to Lady-day, and 5s. 9d. the rest of the year. Labourers' wages, 3s. 6d. for the same period, and 3s. 9d. the rest of the year. Bricklayers employed in fire work, cleaning flues, and in fine work, such as tuck-pointing, cutting arches, &c., 7s. per day. Labourer at do., 4s. Bricklayer jobbing by the single hour, 7d.; labourer, 5d.—These are masters' prices.

Bricks vary in price in various parts of England. From lists of prices before us, we find common bricks charged at Lichfield, £1, 4s., while the best are £2, 10s. per 1000. At Burton-on-Trent they vary from £1, 2s. to £3. At Newport, Monmouthshire, transported from Bridgewater, Somersetshire, by water, best red bricks, £1, 7s.; common red do., £1 per 1000. And near Oxford, the field price is from £1, 8s. to £1, 9s. per 1000. At Carlisle, 18s.—very small, and not good in quality. Newcastle, £1, 1s.; fire-bricks, £2, 10s. per 1000. In extremity, however, the field price being given, whatever it may be, the gardener will have no difficulty in counting the cost from the data furnished above; or by allowing 5s. per rod for each shilling per 1000, either in addition or reduction on the field prices.

#### BRICK DRAINS.

The use of drain-tiles and pipes has very properly superseded the building of drains

under 12 inches in diameter. The following are the London prices. (Brick barrel-drains are rarely built in Scotland, stone being a cheaper material.)

15-inch barrel-drain, 1 brick all round, 3s. 6d. per lineal foot, finding all material and labour, but exclusive of digging the drains; 1s. 3d. per foot finding lime and labour only; 9d. per foot finding labour only.

18-inch barrel-drain, 1 brick all round, 4s. per lineal foot, finding material and labour; 1s. 5d. per foot finding lime and labour; 10d. per foot for labour only.

2-foot barrel-drain, 1 brick all round, 5s. per lineal foot, finding material and labour; 1s. 9d. per foot for lime and labour; 1s. per foot finding labour only.

2½-foot barrel-drain, 1 brick all round, 6s. per lineal foot finding material and labour; 2s. finding lime and labour; 1s. 2d. finding labour only.

3-foot barrel-drain, 1 brick all round, 6s. 9d. per lineal foot finding material and labour; 2s. 6d. per foot finding lime and labour; 1s. 4d. per foot finding labour only.

If any of the above is done in cement, add one-fourth.

An 18-inch drain, 1 brick all round, contains 14 feet 2 inches of reduced brickwork per lineal yard, and requires 226 bricks of the London size to do the same.

A 2-foot drain, 1 brick all round, contains 17 feet 3 inches reduced brickwork per lineal yard, and requires 277 bricks.

A 2½-foot barrel-drain contains 20 feet 5 inches reduced brickwork per lineal yard, and requires 327 bricks.

A 3-foot barrel-drain contains 23 feet 7 inches reduced brickwork per lineal yard, and requires 377 bricks.

N.B.—If the bricks are laid dry, (which, however, should seldom be done, unless where a difficulty occurs to get rid of the contents, and where dependence is to be placed on the strata through which the drain passes to absorb it,) then about one-tenth more bricks will be required than in the above calculations. According to Skirving's calculations, it takes upon an average 16 bricks, of the London size, to complete 1 foot of reduced brickwork, which at 10½d. per foot is £11, 12s. 4d. per rod. Upon these data we may easily calculate the value of every description of brick drain, by counting the number of bricks in every foot lineal. And again, upon a more simple principle, charge 2½d. for every three bricks used. Both plans will amount to nearly the same, including labour, mortar, and tradesman's profit.

#### SLATES AND SLATING.

Slate is now very generally employed as a substitute for wood, and for the following horticultural purposes it is admirably adapted, viz., for copings of walls, pits, &c., pavement and shelving for greenhouses, fruit-rooms, mushroom-houses, tubs for large plants, flower-boxes for balconies and window sills, edgings for walks, &c.

The slates of Wales and of Ireland are the

best, and can be procured of almost any size and thickness; and for the above purposes can be purchased, cut to order, at London, Liverpool, Glasgow, and Leith, at ¼-inch thick, 6d. per superficial foot, ¾-inch, 9d., 1-inch, 1s. If rubbed on each side, add 2d. per foot superficial.

The English nomenclature of slates is as follows:—

*Ladies*, per 1000, (long tale, that is, 1200,) weigh 1 ton 5 cwt., or 2 lb. 6 oz. each; are 16 inches by 8 inches each, and will cover 4½ squares of roofing.—£3, 15s. per 1000 of 1200.

*Countesses*, per 1000, do., weigh 2 tons, or 3 lb. 12 oz. each; are 20 inches by 10 inches, and will cover 7½ squares of roofing.—£6, 10s. per 1000.

*Duchesses*, per 1000, do., weigh 3 tons, or 5 lb. 10 oz. each; are 24 inches by 12 inches, and will cover 10 squares of roofing.—£10 per 1000 of 1200.

*Doubles*, 1000 will cover 2½ squares of roofing; 1 ton of Rags from 1½ to 2 squares, (£3 per ton); 1 ton of Queens, 2½ to 2½ squares; 1 ton of Imperials, 2½ to 2½ squares; 1 ton Westmoreland, 2 squares.

1000 Scotch slates, say Easdale or Ballahulish, are required to cover a rood, or 36 superficial yards.

N.B.—In England, slating is calculated by the square of 100 superficial feet each; in Scotland, generally by the rood of 36 square yards.

The cost per square, the slater finding all material, taken at the London masters' prices, are, *Doubles*, 21s.; *Ladies*, 22s.; *Countesses*, 25s.; *Duchesses*, 27s.; *Queens*, 36s.; *Rag*, 36s.; *Imperial*, 42s.; and *Westmoreland*, 52s. Metallic nails, boiled in oil, to be used. Where copper nails are used, add 2s. per square to the above.

When roofs are stripped and relaid.—For *Doubles*, per square, 9s. 6d.; *Ladies*, 9s.; *Countesses*, 7s. 6d.; *Duchesses*, 7s.; *Queens*, 10s. 6d.; *Rag*, 11s. 6d.; *Imperial*, 11s. 6d.; *Westmoreland*, 13s. 6d. If copper nails are used, add as above. The cost of labour only, from 5s. to 7s. 6d. per square.

Slaters' wages per day in London, 5s. 9d.; do. labourers, 3s. 6d.; do. boy, 2s.

Slate cisterns, London prices.—7d. per gallon, 1 inch thick; including bolts, 1s. 9d. per superficial foot; and for every half-inch extra in thickness add 6d.

*Scotch prices*.—Slater per day, 3s. 6d. to 4s.

Easdale or Ballahulish slates, slater finding all material and scaffolding, 2s. per square, or £3, 18s. to £3, 15s. per rood of 36 yards.

Welsh slates nailed on battens.—*Duchesses*, 2 feet by 1 foot, with 2-inch overlap, slater finding all materials, £3, 12s. 6d. per rood of 36 square yards. With *Countesses* £3, 10s. per rood, finding all materials. 20s. per rood for laying on, as that is labour only for Scotch slates.—Glasgow price, 17s. 6d.

Slates are fastened to the sarking with malleable-iron nails, weighing 12 lb. per 1000, after being steeped, when heated, in linseed oil. These nails cost 3s. 4d. per 1000, 1300 being required for a rood. Cast-iron nails were formerly used, but are seldom used now. Cop-

per nails, although expensive, are the best. Grey slates are derived from the inferior grey sandstone of the old red sandstone formation, and are used in many parts of Scotland where such material exists. They make a very heavy roof. They are laid on roofs, furnished with laths, much in the same way as pan-tiles, the largest being placed at the lower part, diminishing in size towards the ridge. 360 of ordinary sizes are sufficient for a roof. They cost in Forfarshire, and where they are quarried, £4 per 1000. Expense to slater for dressing, finding nails, mortar, and putting on, 19s. per roof. Slater's allowance for measured work is 9 inches at the eaves, 18 inches on flanks and ridges, and 3 inches at the skewers.

Slate plant-boxes, camellia tubs, &c.,

12 inches square,	.	6s.	0d.	each.
14 "	"	11s.	0d.	"
15 "	"	12s.	6d.	"
16 "	"	16s.	0d.	"
18 "	"	19s.	0d.	"
20 "	"	22s.	6d.	"
22 "	"	25s.	0d.	"
24 "	"	32s.	0d.	"

#### PLASTERING.

Rendering one coat on brick or stone walls, 5d. per yard—masters' price for all material and labour. For labour only, 2d. per yard. Two coats, with angles floated, 9½d. for all materials; 4d. for labour only. Lath and plastering.—Lath only 7½d. for all materials; 1½d. for labour only per yard. Lath and plaster, one coat, 1s. 2d., all material; 3d. for labour only. Lath and plaster, two coats, 1s. 6d. for all materials; 5½d. for labour only. Lath and plaster, three coats, 1s. 8d. for all materials; 6½d. for labour only.

Rough-casting (*harling*) one coat on brick or stone external walls, 9d. for all material; 4d. for labour only per yard. Rendering on brick or stone walls, with Roman cement, 1s. 6d. for all materials; 6d. for labour only. Ditto, with Portland, or Johns & Co.'s patent paint cement, 1s. 9d., one coat, for all material; 9d. for labour only, per yard.

Plasterers' wages per day, from November till March, 5s. 6d.; the remainder of the year, 5s. 9d. Common laths per bundle, 2s.; lath and half, per do., 3s.; double lath, per do., 4s. Add 4d. to each bundle, if nails be included. Hair per bushel, 1s. 2d.—The above are English masters' prices. Clean river or pit sand only should be used.

*Scotch prices.*—Plastering in one coat, 3d.; in two coats, 4d. to 4½d.; in three coats, 5d. to 6d. per superficial yard. Lathing, 5d. per yard; dooking and strapping the walls, 8d. per yard, or 1s. 6d. per yard, including the three operations, and finding all material. Lathing and plastering per square yard, if for labour only, 6½d. Plasterers' wages per day, 3s. 6d. to 4s., masters' prices.

#### CARPENTER OR JOINER WORK.

The various kinds of timber fit for hothouse building and garden purposes, where durability

is a primary object, stand in value as follows:—Memel, Quebec red pine, and Dram or yellow pine. Dantzic, Riga, and Swedes, are almost similar in quality to Memel. Timber is sold in London, and most parts of England, by the load of 50 cubic feet; and all the above, excepting yellow pine, are calculated to weigh 18 cwt. 3 qrs. per load, or 42 lb. per cubic foot, and yellow pine 17 cwt., or 38 lb. per foot cubic. In regard to the relative value of these, they stand as follows in the London market: Dantzic, Riga, Memel, or Swedes, 2s. 4d.; Quebec red pine, 2s. 2d.; Dram or yellow pine, 2s. per cubic foot, in the timber yard, including cartage, sawing, waste, and profit. That is, taking the load of 50 cubic feet at 70s. at first cost at the wharf. For cartage add 5s.; sawing, 15s.; waste, 8s. 8d.; and 20 per cent profit, or 18s., gives the value of the load, to be charged in day work, taken as an average, £5, 16s. 8d. This may be taken as the value of all fir timber, without labour, in all kinds of work. Wall-plates, lintels, rafters, &c., 2s. 10d., for all material and workmanship, per foot cubic. Planing per foot superficial, from the saw, 1d. for labour only; chamfered edges per lineal foot, ½d.; sunk rebate, up to 2 inches by ½ of an inch, in astragals, &c., ½d. per lineal foot; common shed or lean-to roofing on ground story, 3s. 6d. per 100 square feet, for labour and nails; 2s. 6d. for labour only; 1-inch yellow deal, clear of sapwood, tongued headings, flooring, 45s. per 100 superficial feet, all materials and workmanship; ¾-inch white deal rough, edges shot, 26s., do. do. Astragals, 1½d. per lineal foot; 6-panel 2¼-inch square framed doors, 1s. 5d. per foot superficial, all material and workmanship; 2-inch ovolo, 2-panel square-framed sash door, 1s. 2d. per superficial foot, all materials and workmanship; 2-inch deal, framed and braced garden doors, fitted in with inch deal, ploughed, tongued, and beaded, 1s. 6d. per foot superficial, all material and workmanship. If hung with town-made hinges and screw-bolts, add 2d. per foot superficial.

*Leith Prices.*—St Petersburg red battens, 3d. to 3½d. per lineal foot. White do., 2½d. to 3d. Memel logs sell from 1s. 9d. to 2s. 3d. per cubic foot. The principal objection to Memel timber for hot-house roofs is its nottiness, on which account Norway battens are preferred. American red pine is clean and resinous, and fetches from 1s. 8d. to 2s. per cubic foot. American yellow pine is well fitted for interior work, such as fitting up seed, fruit, or store rooms. The logs are of large size, and afford great economy in cutting up. Its price is from 1s. 6d. to 1s. 10d. per cubic foot. Swedish 11-inch red wood plank sells at 6d. to 7d. the lineal foot; the white wood, at 5d. to 6d.

Memel timber is the produce of the Scots pine, *Pinus sylvestris*; the Swedish, of *Abies excelsa* or *communis*, our spruce-fir; the Canadian red pine is the *Pinus resinosa*; the yellow pine the *Pinus variabilis*, &c.

Greenhouse and hothouse lights manufactured in London, 1½-inch yellow deal, from 9d. to 10d. per foot superficial. 2-inch ditto, from 10d. to 11d. per foot superficial, priming and glazing included. Hothouses of the usual forms, best

Memel timber, erected at 2½d. per superficial foot, measuring over the whole surface for timber, and 2¼d. per foot for workmanship on the same. Hothouse roofs finished, the glass being 16 and 21 ounce to the foot, and in sizes, 3 feet long by 1 foot in breadth, at the rate of 1s. 3d. to 1s. 6d. per superficial foot. Dench's patent hothouses are, for economy in the first instance, the most economical we have seen; we only regret that any timber should be employed in them, as all combinations of timber and metallic substances are, we think, objectionable. His principle of glazing without putty is good, and his rate of charges exceedingly moderate, as will be seen by his prospectus, wherein he offers to deliver at any railway station or wharf round London, the whole material of a hothouse, exclusive of the brick wall it stands on, at the rate of 1s. 2d. per foot superficial. The glass used being from 1 to 2 feet wide, and 3 feet long, fitted with brass locks, lines, pulleys, quadrants, &c.; the little woodwork used being primed, and the whole marked so as to be readily fitted up. As examples, we may state that the cost of one of his patent houses, 12½ feet long, 9 feet wide, amounts only to £16, 12s. 6d., and of another, 40½ feet long, and 16 feet wide, containing 1,123 feet superficial, is £65, 10s. 2d. 2-inch Baltic timber of the best quality, primed, and glazed with crown glass, 6 inches by 4 inches, and painted two coats stone colour, we have had erected near Edinburgh at from 11d. to 1s. 1d. per foot superficial. Sashes of the best Memel timber, 6 feet 6 inches long by 3 feet 7 inches wide, with checked astragals, and iron straining-bar, the side-rails 2½ inches square; the top-rail the same size; bottom ditto 3 inches broad by 2½ inches thick; and astragals 1½ inches deep, and 1 inch thick at the shoulder, are made for us at Dalkeith, to order, at 8s. 6d. each. The same size of sashes, with the astragals grooved to receive the glass, at 7s. 3d. each, not glazed or painted.

Carpenters' or joiners' wages per day 5s. 6d., London masters' prices. Ditto Scotch prices, 3s. 6d. to 4s.

#### IRONWORK AS USED IN HOTHOUSE-BUILDING.

The great variations in the price of iron, arising from extraordinary demands, and other causes, render it impossible to give a list of prices that shall remain long exactly the same. The following will, however, be found sufficiently correct to enable gardeners and their employers to calculate the cost of a hothouse to within a pound or two of its actual expense.

We may here also remark, that it is better to contract for hot-water pipes by measure than by weight, as by so doing it holds out an inducement to the manufacturer to cast them thin to save his metal; whereas, if contracted for by weight, the case, in the hands of some people, would be different. All hot-water pipes should be cast vertically, and not horizontally.

*Scotch prices.*—4-inch spigot-and-faucet pipes, proved at 200 feet pressure, 2s. 6d., 2s. 10d. to

3s. per lineal yard. 3-inch ditto, 2s. 8d. to 2s. 6d. per yard. 2-inch ditto, 1s. 8d. to 1s. 9d. per yard. 5-inch ditto, 3s. 5d. per yard. 6-inch ditto, 3s. 7d. per yard. 50 feet in length of a 4-inch pipe contain 272 lb. of water, and every square foot of cast-iron plate or pipe 1 inch thick will, upon an average, weigh 40 lb. The above prices are taken from a variety of estimates before us, furnished within the last two years, and may be considered a fair average of Scotch prices at the foundry. 4-inch pipes are the most generally used, although 3-inch ones may be advantageously employed for heating pits, greenhouses, &c. The usual length of hot-water pipes is 9 feet, and the maximum thickness should not exceed ¼ of an inch, and such a pipe should weigh 1 cwt. 1 quarter 10 lb., and should cost, upon an average, 8s. 6d. Elbows, bends, &c., are charged by weight or by double measure; and, unless of extraordinary forms, requiring new moulds to be made expressly for them, are charged at from 9s. 4d. to 10s. per cwt. Gutters for ridge-and-furrow roofs, and ornamental tubular columns, are charged the same as above. Flange joints will cost for white lead, millboard, canvass, india-rubber collars, or hempen cord, including labour, 1s. 6d. each, inclusive of workmanship. Nuts and bolts for ditto, as well as for putting together wrought-iron boilers, will cost 4d. per lb.

*London price* of hot-water pipes, 7s. 6d. to 8s. 6d. per cwt. Ditto cast-iron rain-water pipes, 2 inches in diameter, 1s.; 2½-inch, 1s. 3d.; 3-inch, 1s. 6d. per lineal yard. Cast-iron gutters, 4 inches in diameter, 1s. 2d. O. G. gutters, 4 inches, 1s. 2d.; 4½ inches, 1s. 6d. per lineal yard.

*Scotch prices.*—Cast-iron gutters, or roans, half-checked into each other, with screws and nuts complete, 3 inches wide, 4d. per lineal foot; 4 inches wide, which is safest for the front of ordinary hothouses, 5d. per lineal foot. Angle bends, 6d. extra each size. Rust, for joining hot-water pipes, 1½d. per lb. Furnace fronts and doors, full mounted, 12s. to 14s. per cwt. Furnace bars, 7s. to 8s. per cwt. Dampers and soot-traps, mounted complete, 12s. to 14s. per cwt.

Wrought-iron small screw bolts and nuts, 4d. per lb. Ditto large, 3½d. Cramps, 3d. Strong brackets for shelves, 5d. Wrought-iron columns, with caps and bases, 2d. per lb. We pay in the neighbourhood of Edinburgh 5s. per day, exclusive of travelling expenses, and can send excellent workmen to fit up boilers and pipes in the best manner to any part of the country, at that rate. In England the charges are somewhat higher, but we have never paid more than 6s. 6d. or 7s. per day. These prices are taken when pig-iron is at 38s. per ton, and malleable iron at 120s. per ton.

#### BOILERS.

Boilers, for general purposes, are either of cast-iron, or of plates of malleable iron, put together by overlapping the joints, and securing them with wrought-iron bolts and nuts. They

are both charged by weight, or by the number of gallons of water they contain; but in general by weight. Close boilers of malleable-iron plates cost about 20s. per cwt. Cast-iron boilers, cast in loam, will cost about half that sum, say 14s. per cwt., although in some cases charged 10s. Best malleable-iron boilers,  $\frac{3}{4}$  of an inch in thickness, in plates, securely bolted and riveted, 30s. per cwt., Scotch prices. We in general use wrought-iron boilers of the above thickness all round, but some prefer to use them  $\frac{3}{4}$  of an inch in the bottom, and  $\frac{1}{2}$  on the sides and top.—Of the latter thicknesses are the boilers used in the New Reform Club House, Pall Mall, London. Bolts and nuts,  $\frac{1}{2}$ d. per lb.

*Estimate of Prices.*

The cost of furnishing a brick wall with eyed studs, at the rate of 5000 to 100 square yards, the studs weighing 40 lb., at 2d. per lb.,	£0 6 8
With common cast-iron square-headed nails, 5000 to the 100 square yards, at $\frac{1}{2}$ d. per lb., weight 50 lb.	0 6 3
Cost of wiring 100 square yards with iron wire, requiring 600 drilled studs, 30s. 1200 yards iron wire, (No. 12,) 112 lb., at $\frac{3}{4}$ d. per lb., £1, 12s. 8d.,	3 2 8
Ditto, with copper wire, (No. 15,) will cost, for 100 square yards,	5 17 6

CAST AND WROUGHT IRON FOR VARIOUS PURPOSES USED IN HOTHOUSES.

Cast-iron rafters are usually 4 inches deep, and  $\frac{1}{2}$  an inch thick, cost from 8s. to 10s. per cwt.; and for the same may be purchased spouting, pillars, wall-plates, &c. Sashes cast in a piece, if not large, 10s. to 12s. per cwt. Cast-iron astragals, or sash-bars, of the size and weight of 1 lb. to the lineal foot, 10s. to 12s. per cwt., cast vertically. Cast-iron footpaths of elegant patterns, from 11s. to 12s. per cwt. If laid on rails, and 18 inches wide, at 1s. 6d. per square foot; without rails, at 1s. per square foot. Cast-iron espalier railing, of good form and sufficient strength, weighs about 1 ton per 100 running feet, and may be purchased at from £10 to £12 per ton.

As there is little difference between the weight of cast and wrought iron, the following table may be useful, and is taken from Skirving's calculations:—

	lb.	oz.
Half-inch square bar, per lineal foot, weighs	0	13 $\frac{1}{2}$
Five-eighth ditto,	1	5
Three-quarter ditto,	1	14
Seven-eighth ditto,	2	9
Inch ditto,	3	6
Inch and one-eighth ditto,	4	4
One and a quarter, ditto,	5	4
One and a half ditto,	7	8
Half-inch round bar, per lineal foot,	0	10 $\frac{1}{2}$
Five-eighth ditto,	1	0
Three-quarter ditto,	1	8
Seven-eighth ditto,	2	0
Inch ditto,	2	10
Inch and one-eighth ditto,	3	5
One and a quarter ditto,	4	1
One and a half ditto,	5	14

The following are Scotch prices:—

Half-inch square bar costs	4d.	per lin. yd.
Five-eighth ditto,	6d.	"
Three-quarter ditto,	9d.	"
Seven-eighth ditto,	1s. 0d.	"
Inch ditto,	1s. 3d.	"
Inch and one-eighth ditto,	1s. 7d.	"
One and a quarter ditto,	2s. 0d.	"
One and a half ditto,	2s. 11d.	"
Half-inch round bar costs	3d.	per lin. yd.
Five-eighth ditto,	5d.	"
Three-quarter ditto,	7d.	"
Seven-eighth ditto,	9d.	"
Inch ditto,	1s. 0d.	"
Inch and one-eighth ditto,	1s. 3d.	"
One and a quarter ditto,	1s. 7d.	"
One and a half ditto,	2s. 3d.	"

—exclusive of workmanship.

CEMENTS.

The cements in general use in Scotland are—Calderwood cement, 6s. 6d. per barrel of 3 cwt. in Edinburgh; in Glasgow the same.

Borrowstownness cement, manufactured in Edinburgh, 10s. per barrel of 3 cwt.

Broxburn cement, from 8s. to 10s. per barrel of 3 cwt.—inferior in quality.

Mulgrave or Atkinson's cement—excellent—14s., in Edinburgh, Leith, or Glasgow, per barrel of 2 $\frac{1}{2}$  cwt.

Dark Roman cement, 14s. per barrel of 2 $\frac{1}{2}$  cwt., in Edinburgh, Leith, or Glasgow—good quality.

Roman cement is sold in London at 2s. per bushel, 6s. 3d. per barrel, and weighs 80 lb. per bushel. Laid on brick at 2s. 2d. per square yard.

Metallic cement is sold in London at about 1s. 3d. per bushel, and weighs 100 lb. per bushel.

Mastic is sold in London at about 4s. per cwt. This cement is the same as trowelled stucco.

10 barrels of good cement, with the proper proportion of sharp sand, will plaster a rood of 36 superficial yards on the face of the wall brickwork for tanks or reservoirs to contain water.

36 bushels of cement, and an equal quantity of sharp sand, will do one rood of brickwork.

Portland cement, 2s. 3d. per bushel, London price, weighs 3 cwt. 16 lb. per barrel. This is considered the strongest cement in use, and therefore takes more sand.

STONE-MASONS' WORK.

On account of the weight of this material, the difficulty with which some quarries are worked compared with others, and the distance it has often to be transported, the price of stone varies considerably.

The principal pavement stone in Scotland is that of Arbroath and Caithness; the former costing from 2d. to 4d. per square foot, according to thickness, at the quarry. Other districts produce pavement of varied quality, as may be

well supposed in a country abounding in rocks and quarries. The common stone pavement used in Edinburgh costs 8d. per square foot, delivered.

*Arbroath pavement* costs in Edinburgh, when cut to required sizes, and 3 inches in thickness, 1s. per superficial foot, laid on sand or engine ashes. Second price and quality, as regards size, 10d. per foot.

Ditto, at Leith and Glasgow, for material only, 4½d. to 5½d. per foot, straightened at the edges and squared at the ends.

Ditto, half-polished, or rubbed on one side, 6½d. per superficial foot.

Ditto, full-polished on one side, 7½d. per superficial foot.

N.B.—Price depending on thickness.

*Caitness pavement*, cut to any dimension given, 4½d. to 5d. per superficial foot, the sides and ends cut straight, delivered at Leith and Glasgow.

Ditto, half-polished, or rubbed, 6½d. per superficial foot, at ditto.

Ditto, polished above, sides and ends squared to joint, 7½d. per foot at ditto. The above 1½-inch thick.

N.B.—Price depending on thickness.

The principal pavement stones in England are Yorkshire and Portland.

*Yorkshire pavement*, about 2 inches in thickness, costs, in London, from £2, 5s. to £2, 10s. per 100 superficial feet, and weighs 1 ton 5 cwt. The same, 2½ inches thick, weighs 1 ton 15 cwt., or 39 lb. per superficial foot, and costs, in London from £2, 10s. to £2, 15s. per 100 superficial feet. Ditto, 3 inches thick, weighs 2 tons 5 cwt., or 50½ lb. per foot, and costs in London from £2, 16s. to £3 per 100 superficial feet.

3-inch Yorkshire tooled or wrought pavement, for shelves, &c., costs, at Bedworth, Warwickshire, 1s. 2d. per superficial foot. Ditto, rubbed for floors, 1s. 4d. Ditto, for steps, 2s. 6d. per foot. 2½-inch ditto, laid in London, 7d. per superficial foot.

*Marston pavement*, for floors, 1s. per foot; wrought steps, 1s. 6d. per superficial foot.

*Portland pavement*.—This pavement, 1 inch thick, weighs 11½ lb. per superficial foot, and costs in London 1s. per superficial foot.

The best stones in the neighbourhood of Edinburgh are Craigleith, Hailes, Redhall, Humberie, Binnie, and Granton. By experiments made by the Royal Scottish Society of Arts, the *tensile* strength of these was found to be as follows:—

	Breaking weight
Craigleith stone, . . . . .	453 lb.
Hailes, . . . . .	336 "
Redhall, . . . . .	326 "
Humberie, . . . . .	283 "
Binnie, . . . . .	279 "
Granton, not tested.	

The *compressive* strength was as under:—

	lb.
Craigleith gave way to a pressure of 4900	
Humberie " " "	3740
Hailes " " "	3530
Redhall " " "	3220
Binnie " " "	2820

*Hailes quarry pavement*, a celebrated quarry near Edinburgh.—Pavement or coping for garden walls, 3 inches thick, wrought flat on the bed, both edges droved, and the top and bottom edges 3 inches deep, droved and joints made fair. Delivered in Edinburgh, 18 inches broad, 10d. per lineal foot. Do. coping, 3 inches thick, and 16 inches broad, wrought all round, 1s. per foot lineal.

*Portland stone*.—This celebrated stone weighs 1 cwt. 1 qr. per cubic foot, and costs in London from 2s. to 2s. 6d. per foot.

The midland counties of England are chiefly supplied with stone from Kettelbrook, Tikesall, Derby, Stoke, and Wheatly; the east from Whitby; the west from Bath and Monmouthshire; and the south from the isles of Portland and Purbeck.

At Elford, in Staffordshire, stone for ashlar, dressed and built, 2s. 6d. per cubic foot; rubble at 1s. 10½d. per cubic foot.

The red sandstone of Newport, Monmouthshire, in large blocks, of half a ton each, costs 6s. per ton at the quarries; smaller sizes, 3s. to 4s. per ton, and for rubble, 2s. per ton.

*Pennant stone*—a superior kind of hard grey sandstone, found within the limits of the Bristol coal formation—rises in large blocks, and costs at quarry 6s. per ton.

*Isle of Purbeck stone*, in blocks fit for ashlar, 9 to 14 inches thick on the face, and from 6 to 15 inches deep on the bed, tooled or dressed, costs 1s. 3d. per superficial foot.

Ditto, 9 inches to 14 thick in the face, and from 6 to 9 inches deep on the bed, tooled and dressed, 1s. 1d. per superficial foot.

Ditto, steps, 4 feet 6 inches to 5 feet 6 inches in length, and 6 inches thick, costs 10d. per lineal foot.

Ditto, for window sills, from 3 to 4 feet 6 inches in length, 1s. 2d. per lineal foot. Ditto, 4 feet 6 inches to 5 feet in length, 1s. 5d. per lineal foot. Ditto, curb, 6 inches thick, and from 10 to 12 inches deep, costs 4½d. per lineal foot.

*Headington freestone*, near Oxford, (inferior in quality,) 10d. per cubic foot in quarry. Harder and better quality from same place, 1s. 2d. per foot. Ashlar from same varies according to thickness; in blocks at quarry, from 5½d. upwards.

*Combe Down bath stone* costs in London 2s. to 2s. 6d. per cubic foot.

EDINBURGH PRICES.

*Hailes Quarry stone*, 4 inches thick, 1 foot 6 inches broad, wrought all round, and delivered in Edinburgh, 1s. 6d. per lineal foot for material and workmanship.

*Binnie Quarry stone*.—Hewing and polishing, 7d. per superficial foot, for labour only. Ditto, per foot cubic, at quarry, 1s. 4d.

*Granton and Craigleith quarries*.—Soles and lintels, neatly droved, 1s. 6d. per lineal foot.

*Killalio Quarry, Fifeshire*.—A fine soft sandstone. Soles, lintels, &c., 1s. 2d. per lineal foot, droved, labour and material; and 1s. 4d. per foot polished. Droved hewing, do., 4d. per foot superficial, for labour only.



*Rubble-work* for foundations and ordinary purposes.—30 ordinary carts, or nearly 30 tons of stones to a rood of 36 square yards, of a 2-foot wall, £10 per rood, the builder finding all materials. This is the top price, but, of course, varying according to the distance from the quarry, state of roads, turnpikes, &c. In some parts of the country, where the stone is soft, and the quarry near, the same can be done for from £5 to £7 per rood. For 18-inch rubble walls, as above, £7, 10s. to £8, properly bonded with headers going through the wall in alternate courses, and at distances say from 5 to 8 feet; Wishaw, Lanarkshire, £6, 15s.

Rubble-work in foundations, proprietor finding all material, and digging out foundations, 55s. per rood for 2-foot walls, for labour only.

Laying coping, 2d. per lineal foot.

AVERAGE PRICES OF MASON-WORK IN THE NEIGHBOURHOOD OF DALKEITH, 1852—BUILDER FINDING ALL MATERIAL AND SCAFFOLDING.

Common rubble building, walls 2 feet thick, . . . . .	per sup. yd.	4s.	2d.
Additional, if faced with pick-dressed coursers, . . . . .	3s.	6d. to 4s.	0d.
Square-built rubble-work, . . . . .	6s.		2d.
Droved ashlar, . . . . .	per foot	1s.	0d.
Broached do., (chimney-tops,) . . . . .	0s.		10d.
Corners, . . . . .	per lineal foot	1s.	6d.
Ryats, . . . . .	1s.		8d.
Sills and lintels, . . . . .	1s.		4d.

Mason per day, London, 6s. Scotch wage, 3s. 6d. fair average.

LIME AND SAND.

One ton of stone lime, such as is in use in the neighbourhood of Edinburgh or Glasgow, will build a rood of hollow brick wall; and 1½ tons of the same will build a rood of a solid brick wall, if the material is not wasted. Each ton of lime will take 2¼ tons of sharp river sand.

The price of such lime is pretty generally, throughout Scotland, 9s. per ton, delivered within six miles of the kiln. In districts where fuel is expensive, it is rather higher. Sand varies in price, according to local circumstances, even from 6d. to 6s. per load, much depending on the distance it has to be carried. Sea sand should never be used for building purposes upon any account whatever, on account of the quantity of salt contained in it. In the neighbourhood of London, and throughout the whole range of the chalk formation, chalk-lime is in general use; whereas, throughout the range of the limestone formation, stone lime is used.

The greystone lime, and the blue lias lime, are undoubtedly the best for building purposes, and hence they are recommended for the best kind of work. Chalk lime is recommended for plastering, for which purpose it is said by some architects to be better adapted than any other. Mr Skirving, a London surveyor of respectability, says—

\* The London chalk lime, when well mixed with a double proportion of sharp sand, is quite sufficient for the general purposes in which it is used.

"One hundred of chalk lime contains 18 bushels, and weighs 9 cwt. 3 qr., and is sold at the London wharfs at 9s. per hundred. Stone lime per hundred, of the same quality, and of the same weight, sells at 12s.

"Sand per yard of 18 bushels weighs 1 ton, and costs in London 4s."—*Skirving's List of Prices.*

*Chalk lime*, 7d. per bushel at the wharf. It is generally sold by the chaldron, and 10s. is an average price. Two loads of lime allowed to the rood of 272 feet, and 4 loads of sand, at 2s. 6d. per load or ton.

*Stone lime or Dorking lime*, 16s. per chaldron.

*Greystone lime*, from Merstham, near Reigate, Surrey, 14s. per chaldron, but varying in price according to the credit given. Present price, 6s. per yard of 22 bushels. One chaldron of Dorking lime will take 4 carts of Thames sand, and build 1 rood of brickwork, if properly made up. Thames sand, 2s. 6d. per ton in London.

*Scotch lime*, 9s. per ton, including cartage, say to the distance of 6 or 7 miles from the kiln. Price at the kiln, from 6s. 6d. to 7s. per ton, according to quality. One ton of lime and 2½ of sand are allowed to do a rood of 36 yards superficial, 15 inches thick. Price of sand 2s. per load, unless carted a great distance. It will take one-third more lime for stone building than for brick, at any thickness—say rubble stone wall 15 inches in thickness, and brick the same.

One bushel of unslaked lime absorbs five gallons of water.

*Lime* in the neighbourhood of Oxford, 6s. per quarter of 8 bushels.

*Lias lime*, at Newport, Monmouthshire, 9s. per dozen bushels of 8 gallons each. This is excellent lime, equal to most cements.

GLASS AND GLAZING.

British sheet glass can be purchased for cash in crates, 16 oz. to the square foot, in sizes up to 40 inches in length, at from 3¼d. to 1s. per foot: 21 oz. from 5d. to 1s. 3d.; 26 oz. from 6¼d. to 1s. 6d.; 32 oz. from 9d. to 1s. 9d., according to first, second, third, or fourth quality. These average in thickness respectively, ⅞, ⅝, ½, and ⅜ of an inch each. If taken in boxes containing 200 each, 16 oz., from 2¼d. to 6d. per foot.

ROUGH PLATE-GLASS.

	¾-inch thick	⅝-inch thick
	per foot.	per foot.
Plates under 35 inches long,	1s. 1d.	1s. 3d.
" " 75 " "	1s. 3d.	1s. 4d.
" " 100 " "	1s. 4d.	1s. 6d.
" above 100 " "	1s. 6d.	1s. 9d.

Crown glass for ordinary purposes, in squares 8 inches by 6 inches, to 10 inches by 8 inches, if taken in boxes containing 100 superficial feet, 2d. per foot; above this size, if taken in the above quantities, 2¼d. to 3d. per foot. Green-tinted crown glass, 3¼d. per foot. As regards quality, 2d crown, not exceeding 14 inches by 10, 7d.; 3d crown, 6d.; 4th crown, 4¼d.; common crown, 3¼d.; and coarse crown, 3d. per foot, when taken in small lots. Extra thick crown of same dimensions, 10d., 9d., 6¼d., 5d.,

and 4d., respectively. Bending, 6d.; obscuring, 4d.; and flattening, 3d. per foot.  
Sheet-glass tiles, No. 16, 6d.; No. 21, 8d.; No. 26, 10d.; No. 32, 1s. each.

*Russell's patent sheet-glass tiles for roofs of conservatories, vineries, greenhouses, and for skylights of warehouses, markets, &c.*—This tile requires no sash, and it leaves neither wood nor putty exposed. The flange joint of the tile is covered with a metal bead. It is made 34 to 40 inches long, and about 11 inches broad, generally

of 21-oz. sheet glass; and, including fixing in any ordinary situation, costs 11d. to 1s. per foot, and, with the bearings, is fully cheaper than ordinary rafter and glazed sash roof, while subsequent repairs of putty and paint are altogether avoided.

Glass slates, 20 inches by 10 inches, No. 16, 7d.; No. 21, 10d.; No. 26, 1s.; No. 32, 1s. 3d. each. These numbers have reference to the weight in ounces per foot, and average in thickness  $\frac{1}{3}$ ,  $\frac{1}{6}$ ,  $\frac{1}{2}$ , and  $\frac{2}{3}$  inches in thickness.

GLASS SLATES, (drilled with holes for the reception of the nails by which to fasten them,) cost each:—

		1-13th	1-10th	1-8th	1-6th	1-4th	3-8ths	$\frac{1}{2}$ -inch
		inch thick.	inch thick.	inch thick.	inch thick.	inch thick.	inch thick.	inch thick.
		s. d.	s. d.	s. d.	s. d.	s. d.	s. d.	s. d.
Duchess,	24 by 12	1 6	1 10	2 3	2 6	2 9	3 6	6 0
Small imperial,	20 " 14	1 5	1 9	2 2	2 5	2 7	3 4	5 9
Small duchess,	22 " 12	1 4	1 8	2 1	2 4	2 6	3 2	5 6
Countess,	20 " 10	1 2	1 6	1 10	2 0	2 2	2 9	4 6
Viscountess,	18 " 10	1 1	1 4	1 8	1 10	2 0	2 6	4 0
Large ladies,	16 " 10	1 0	1 3	1 6	1 8	1 10	2 3	3 8
Ladies,	16 " 8	0 11	1 2	1 5	1 6	1 8	2 0	3 3
Doubles,	13 " 7	0 10	1 0	1 2	1 4	1 6	1 8	3 0

LOGHEAD'S PATENT PERFORATED GLASS FOR VENTILATION.

per foot.  
Best quality, 6s. 3d. to 9s. according to size.  
Second do., 4s. 3d. to 6s. 9d.  
Third do., 3s. to 5s. 6d.

All fractional parts of inches will be charged full inches.

BAILLIE'S PATENT TRANSPARENT SLIDE VALVE VENTILATORS, OF WHICH JOHN RUSSELL IS SOLE LICENSED MAKER IN EDINBURGH.

Plain edge, . . . from 6s. 0d. }  
Smooth edge, . . . " 7s. 6d. } Upwards  
Polished edge, . . . " 10s. 6d. } according  
Plain edge without valve, " 4s. 0d. } to size.

Made to any size on the daylight dimension of the opening into which the ventilator is to be placed being supplied—the height being distinguished from the breadth.

The slide valve can be made to move upwards, downwards, or sideways.

Crown glass of best quality, 9 inches x 22 inches, and 12 oz. per foot, 3 $\frac{1}{4}$ d. to 4d. Superior crown, manufactured by Hartley, stronger than 16-oz. sheet, and of a uniform thickness and great transparency, 4 $\frac{1}{2}$ d. to 5 $\frac{1}{2}$ d. per foot. Patent rough plate, now much used for hot-house roofs,  $\frac{1}{2}$  of an inch thick, weighing 2 lb. to the square foot,  $\frac{1}{3}$  of an inch in thickness, weighs 3 lb.;  $\frac{1}{4}$  of an inch, 4 lb. per foot.

PATENT ROUGH PLATE-GLASS.		$\frac{1}{2}$ -inch thick.	3-16ths inch thick.	$\frac{1}{4}$ -inch thick.
Packed in Crates, for cutting up of the sizes as manufactured.				
30 inches wide, and from 40 to 50 long,		s. d.	s. d.	s. d.
Or 20 " ; " 50 to 70 " . . . . }		0 6	0 8	0 10
IN SQUARES, cut to the sizes ordered.				
Under 8 by 6, . . . . .				
8 by 6, and under 10 by 8, . . . . .				
10 by 8, " 14 by 10, . . . . .				
14 by 10, " 1 $\frac{1}{2}$ feet sup., if not over 20 inches long,				
1 $\frac{1}{2}$ feet sup. " 3 " if not above 30 inches long,				
3 " " 4 " " " " "				
4 " " 5 " " 35 " "				
5 " " 6 " " 40 " "				
6 " " 8 " " 45 " "				
8 " " 10 " " 55 " "				
10 " " 12 " " 70 " "				
12 " " 15 " " 85 " "				
Quarries, . . . . .				
		0 6	...	...

NOTE.—Squares are charged according to the superficial contents, except where the length exceeds the restriction above, in which case the higher price is charged, irrespective of the contents. Irregular shapes are charged as squares.

The kinds of glass used in hothouse erection are British plate, patent plate, rough plate, patent rough plate, crown of various qualities, British sheet, and Belgian sheet.

London charges for glaziers per day, 5s. Edinburgh town charges for do., 4s. to 4s. 6d.; country, 5s. per day. London price of best old putty, 5d. per lb. Edinburgh price, 3d. per pound. Black putty, 4d.

## PROPAGATING GLASSES.

2 inches diameter,	Os.	2d.	each.
3 " " "	Os.	3d.	"
4 " " "	Os.	4d.	"
5 " " "	Os.	6d.	"
6 " " "	Os.	8d.	"
7 " " "	Os.	10d.	"
8 " " "	1s.	0d.	"
9 " " "	1s.	2d.	"
10 " " "	1s.	4d.	"
11 " " "	1s.	6d.	"
12 " " "	2s.	0d.	"
13 " " "	2s.	6d.	"
14 " " "	3s.	6d.	"
15 " " "	4s.	0d.	"

## GLASS FLOWER-POTS.

Inches diameter.		With saucers.
3	Os. 3d.	Os. 4½d. each.
4	Os. 5d.	Os. 7½d. "
5	Os. 7d.	Os. 10½d. "
6	Os. 9d.	1s. 1½d. "
7	1s. 0d.	1s. 6d. "
8	1s. 3d.	1s. 10½d. "
9	1s. 6d.	2s. 3d. "
10	2s. 0d.	3s. 0d. "

## PAINTING.

Stone-colour, *thick*, for hothouse work, 5d. per lb. Lead-colour, *thick*, 5d. per lb. Prepared oil, 1s. per quart in Edinburgh; 5s. 6d. per gallon in London. Boiled linseed oil, same price—a gallon of either weighs 9 lb. 6 oz. Cold-drawn linseed oil, 11d. per quart in Edinburgh; in London, 4s. per gallon. Painters' wages in Edinburgh and Glasgow, 4s. to 4s. 6d., Perth and Aberdeen, 3s. 9d. to 4s. per day; in London, 6s. per day—both masters' prices. Painting in imitation of oak, outside-work for garden doors, &c., 1s. 8d. per superficial yard, including varnishing, in Edinburgh, Glasgow, &c.; 1s. 6d. in London. White-lead, *thick*, 4d. per lb., or £1, 14s. per cwt. in Edinburgh and Glasgow; £2 in London. Turpentine, 8d. per quart in Edinburgh, Glasgow, &c.; in London, 4s. to 4s. 6d. per gallon, and weighs 8 lb. 6 oz. White-lead, *dry*, £1, 6s. per cwt.; do., in best paint, £1, 7s.; 2d quality, £1, 5s.; 3d, £1, 3s. per cwt. Newcastle prices, when taken in quantity, say of 3 or 4 cwt.: Green paint, 1s. to 1s. 2d. per lb. generally; Bronze-colour, in two coats on iron railing, 7d. per yard; do. on wooden doors, 9d. Stone-colour, and varnished in four coats on walls or plaster, 11d. per superficial yard; do., two coats on wood, 6d. per yard; do., three coats on do., 8d. per yard. Stone-colour, in two coats on roofs of hothouses, 5d. per yard; do., in three coats, 7d. to 8d. The above prices of painting are

the Edinburgh charges, and are pretty general throughout Scotland. If the men have to go to the country, the carriage of the materials, their travelling expenses, and an allowance of 1s. to 1s. 3d. per day, to be added to their usual wages, if the work is to be done by the day.

Painting in all common colours, once in oil, including knotting, is charged in London 3d. per superficial yard; twice in do., including stopping, 5d.; and three times, 7d. per yard superficial; and for every additional coat add 2d. It is seldom that more than three coats are given to hothouse work at one time. We think it better to give only two coats, and to repeat the operation every second year at the least. The following are provincial prices for work done in three coats in best manner and with best material:—At Broomsgrove, 8d.; Cheltenham, 9d.; Gloucester, 9d.; Bedworth, Warwickshire, 8d.; Tewkesbury, 9d.—about the averages for England. Cleaning old work, rubbing down with pumice-stone, or bringing to be fit for laying on the colour, is to be charged by the day. This is a very necessary operation, and requires to be carefully done, particularly in the case of hothouse roofs, and to have the putty properly repaired. Bird and Miller's antiseptic mineral black paint, £1, 3s. per cwt.; do., superior in quality, for cordage and canvass, £1, 8s. An economical paint for ironwork, hurdles, and iron fences, is composed of ¼ Stockholm tar, ¼ gas tar, laid on quite hot, in three coats—cost, ¼ of a penny per yard superficial. Painting the same in oil would be nearly 6d.: the latter will last only three years, while the former will last nine.

White-lead, £24 to £24, 10s. per ton. White oxide of antimony, a new substitute for the above, £12 per ton.—Liverpool wholesale prices.

## PLUMBER-WORK.

The price of lead, like that of iron, is subject to considerable variation, according to the state of the market. Cast lead in London may be taken at £1 per cwt., and in Edinburgh and Glasgow at £1, 2s. as present price, February 1852. Recently a rise of nearly 25 per cent has taken place. Milled lead in London, £1, 2s., and in Edinburgh and Glasgow, £1, 4s. Ditto for gutters, £1, 6s. in London, and £1, 5s. in Edinburgh and Glasgow. Solder in London, 8d. per lb., and in Edinburgh and Glasgow, 10d.

## London Prices for Lead Pipe.

	per lin. foot.	per lin. foot.
Half-inch bore, strong,	Os. 5d.	ordinary, Os. 4d.
Three-quarter ditto,	Os. 7d.	" Os. 6d.
Extra strong ditto,	1s. 0d.	" "
One-inch ditto,	Os. 9d.	" Os. 8d.
One and a quarter ditto,	1s. 0d.	" Os. 10d.
One and a half ditto,	1s. 6d.	" 1s. 3d.
Two-inch ditto,	2s. 2d.	" 1s. 9d.
Two and a half ditto,	2s. 6d.	" 2s. 0d.

In England, plumbers usually charge so much per joint, according to the size of the pipe. In Scotland, the usual practice is to charge accord-

ing to the quantity of solder used, including labour. This latter is by no means a satisfactory plan, as will appear by simply considering that, in English practice, the charge is in proportion to the size of the pipe, and the price is fixed, as will be seen below, so that the less solder used the better for the master; while in Scotland, as the charge is chiefly on the solder, the plumber takes care to use a large, often an unnecessary quantity, and the cost of the joint is in proportion. The English practice is to charge for (including 1 foot of pipe)  $\frac{1}{2}$ -inch joint, 2s. 2d.;  $\frac{3}{4}$ -inch joint, 2s. 4d.; 1-inch joint, 2s. 8d.;  $1\frac{1}{4}$ -inch joint, 3s.;  $1\frac{1}{2}$ -inch joint, 3s. 6d.; 2-inch joint 4s. 6d., &c. All joints exceeding the above diameters vary according to the size of the pipe.

The following list of prices we are favoured with from a highly respectable firm; and, as the weight per yard is given, they cannot fail to be useful. They may be regarded also as the average price for Scotland.

Half-inch pipe, 3 lb. to the yard, 5 $\frac{1}{2}$ d.; 4 lb., 9d.; 5 lb., 11 $\frac{1}{2}$ d. per lineal yard.  
 Three-quarter-inch pipe, 6 lb. to the yard, 11 $\frac{1}{2}$ d.; 7 lb., 1s. 3d.; 8 lb., 1s. 6d.  
 One-inch pipe, 8 lb. to the yard, 1s. 5d.; 9 lb., 1s. 8 $\frac{1}{2}$ d.; 11 lb., 1s. 10 $\frac{1}{2}$ d.  
 One-and-a-quarter-inch pipe, 12 lb. to the yard, 2s. 3d.; 14 lb., 2s. 7 $\frac{1}{2}$ d.; 16 lb., 3s.  
 One-and-a-half-inch pipe, 14 lb. to the yard, 2s. 7 $\frac{1}{2}$ d.; 16 lb., 3s.; 18 lb., 3s. 4 $\frac{1}{2}$ d.  
 Two-inch pipe, 20 lb. to the yard, 3s. 9d.; 22 lb., 4s. 1 $\frac{1}{2}$ d.; 26 lb., 4s. 10 $\frac{1}{2}$ d.

#### *Extra Strong.*

Three-quarter-inch, 9 lb. to the yard, 1s. 8 $\frac{1}{2}$ d.  
 One-inch, 12 lb. to the yard, 2s. 3d.  
 One-and-a-quarter-inch, 18 lb. to the yard, 3s. 4 $\frac{1}{2}$ d.; 22 lb., 4s. 1 $\frac{1}{2}$ d.  
 One-and-a-half-inch, 22 lb. to the yard, 4s. 1 $\frac{1}{2}$ d.; 26 lb., 4s. 10 $\frac{1}{2}$ d.  
 Two-inch, 31 lb. to the yard, 5s. 7d.; 35 lb., 5s. 9d.

*Average price of stopcocks in London.*— $\frac{1}{2}$ -inch, 3s.;  $\frac{3}{4}$ -inch, 3s. 9d.; 1-inch, 7s.;  $1\frac{1}{4}$ -inch, 10s. 6d.;  $1\frac{1}{2}$ -inch, 15s.

*London prices for brass washers, washers, and plugs.*— $\frac{3}{4}$ -inch, 1s. 6d. each; 1-inch, 2s. 6d.;  $1\frac{1}{4}$ -inch, 3s. 6d.;  $1\frac{1}{2}$ -inch, 4s.; 2-inch, 6s. 6d.; 3-inch, 16s.

Formerly, lead was much used for roans, or water-gutters; these have very properly given way to light cast-iron ones, which are not only much cheaper, but also last much longer.

Plumbers' wages in London, 6s. per day; in Edinburgh, Glasgow, Perth, Aberdeen, 4s. Lead-headed nails, both in Edinburgh and London, 6d. per dozen; zinc tacks, 1s. per lb., &c. &c.

Milled lead, 6 lb. per superficial foot, sufficient for lining cisterns and covering ridges.

7 lb. for gutters, and these should have a fall of 1 inch in 10 feet.

5 lb. for aprons and flashings. 25 to 30 lb. to the superficial foot for leaden boilers, and these should be always of a cylindrical form.—*Vide* Boilers, fig. 219.

8 lb. for water-runs, roans, or eaves-gutters.

Cast-iron is, however, preferable. Where leaden ones are used, it is advisable to introduce a  $\frac{3}{8}$ -inch malleable-iron rod in outer edge of 4 and 5-inch roans, and also smaller ones, in proportion to the size of the roans—such as, 3-inch would require  $\frac{1}{2}$ -inch rods to give strength and assist expansion.

In measuring plumber-work, the lead on roofs is by the superficial foot, and is charged according to the weight per foot.

#### WIRE-WORK.

Wrought-iron hurdles, for the permanent or temporary division of grounds, having double knees and prongs to fix them in the ground, requiring neither stones nor blocks, and which can be put up and taken down with facility:—

For horses, cattle, and sheep, 2s. 6d. to 2s. 9d. per lineal yard.

Such hurdles should be of the following dimensions:—Length, 6 feet 6 inches each; 3 feet 6 inches high above ground, exclusive of the knees and prongs; top bar,  $\frac{1}{2}$  diameter; five under bars, each  $\frac{1}{4}$  inch in diameter; side uprights,  $1\frac{1}{4}$  inch by  $\frac{1}{4}$  inch; and the middle upright,  $1\frac{1}{4}$  inch by  $\frac{1}{4}$  inch; and the average cost of which is 3s. per lineal yard. But the proprietors of the St Leonard's Works, Edinburgh, are now (1852) making hurdles of the above size at 1s. 7 $\frac{1}{2}$ d. per lineal yard, taking advantage of mechanical power, and an organised system of operating.

For cattle and sheep, 2s. 3d. to 2s. 6d. per lineal yard.

For sheep and lambs, 2s. to 2s. 3d. per lineal yard.  
 For deer and lambs, 4s. to 5s. 6d. per lineal yard.

*Portable hare and rabbit hurdles.*—When put up they resemble strained wire-fences of good pattern. These have long-kneed prongs to fix them in the ground, and are fastened together at the ends with wire:—

Price per lineal yard, 24 inches high, 2s. 6d., painted green.

Price per lineal yard, 27 inches high, 2s. 9d., painted green.

Price per lineal yard, 30 inches high, 3s., painted green.

Rabbit-proof wire-flake, or hurdle, diamond pattern, 3s. per yard.

Ditto, with vertical wires, 2s. 6d. per yard.

Wire continuous fences, with iron pillars and standards:—

For horses, cattle, and sheep, 1s. 6d. to 1s. 9d. per lineal yard.

For cattle and sheep, 1s. 3d. to 1s. 6d. per lineal yard.

For sheep and lambs, 1s. to 1s. 3d. per lineal yard.

according to height, strength, and number of wires. In curved lines, iron stays are required to give the necessary sweeps: these are charged 1s. 6d. each extra.—These are Edinburgh prices, and include the erection of the fences and the travelling expenses of the men, in all cases where the order exceeds £25.

Those wishing for material only, will be supplied with the same, completely fitted and ready to put up; and printed instructions will be sent for the efficient erection of it, at the following prices:—

Prices, for fence 3 feet 6 inches high, having 6 horizontal wires, with wrought-iron straining-posts 1½-inch square for every 75 yards, complete with screwed eye-bolts for straining the wires, and wrought-iron intermediate standards 1½ × ¾ inch for every 8 feet distance:—

For horses, cattle, and sheep, No. 4 wire, 1s. per lineal yard.  
 For cattle and sheep, No. 6 wire, 10d. per lineal yard.  
 For sheep and lambs, No. 8 wire, 9d. per lineal yard.  
 Iron stays for curves, 1s. each extra.  
 Strong stays for angles and extremes, 4s. 6d. and 5s. 6d. each.

*Wire-fences stapled to wood sufficient to resist horses, cattle, sheep, and lambs.*—A strong and efficient fence is formed by using wooden posts and uprights, instead of iron, at about the same expense as common paling. The wires are strained and kept tight by strong wooden posts let down 2 or 3 feet into the ground, which are spurred with wooden stays, either below or above the surface. Also the wires are stapled to the sides of the intermediate uprights, which are driven a little way into the ground, and placed 6 feet apart. One important advantage obtained by stapling the wires to the sides of the uprights is, that, when any of them decay, the staples are simply pulled out: the wires are thus freed, and a new post can be put in the place of the old ones and the wires again stapled without the fence being taken down, or the least injured.

Prices, including cost of erection, and travelling expenses of workmen, when the order exceeds £25:—

For horses, cattle, and sheep, 9d. to 10d. per lineal yard, with six wires;  
 For cattle and sheep, 7d. to 9d. per lineal yard, with six wires;  
 For sheep and lambs, 6d. to 7d. per lineal yard, with six wires,—

according to their strength. The proprietor furnishes the wooden posts and uprights, and puts them into the ground.

These fences may also be put up with iron straining-posts, placed at distances of about 70 or 80 yards, the intermediate posts being of wood, at 1d. or 2d. per yard additional.

Prices, for the materials of the above fences for wooden posts and uprights, having six horizontal wires, complete with staples and screwed eye-bolts for straining the wires:—

For horses and cattle, No. 4 wire, 7½d. per lineal yard, with six wires.  
 For cattle and sheep, No. 6 wire, 5½d. per lineal yard, with six wires.  
 For sheep and lambs, No. 8 wire, 4d. per lineal yard, with six wires.

If with wrought-iron straining-pillars, for every 75 yards, 1d. to 1½d. per yard extra; or 6s. 6d. and 7s. 6d. each.

Printed instructions are given, with orders for erecting them.

Delivered at Aberdeen, Inverness, Berwick, Newcastle, London, and Hull, at ¼d. per yard extra, and delivered free at Liverpool and Glasgow.

Plain hare-and-rabbit-proof strained wire-fences, with vertical straight wires, with wrought-iron uprights, and four horizontal wires, adapted for shrubberies and flower-gardens, from 2s. 6d., 3s., to 3s. 6d. per lineal yard.  
 Ornamental ditto, 3s., 3s. 6d., to 3s. 9d. per lineal yard, according to the height and strength of the fence.

Wire-netting of best quality, with twisted selvages, for the exclusion of hares and rabbits:—

18 inches high,	0s. 9d. per lineal yard, painted.
24 " "	1s. 0d. " "
30 " "	1s. 3d. " "
39 " "	1s. 6d. " "

Wire-netting, second quality, adapted to the same purposes as the above:—

18 inches high,	4½d. per lineal yard, painted.
24 " "	6d. " "
30 " "	7½d. " "
36 " "	9d. " "

Wire-netting fence for the exclusion of sheep and lambs, made wider in the mesh than the above:—

3 feet high,	1s. 0d. to 1s. 3d. per yard.
3 feet 6 inches high,	1s. 3d. to 1s. 6d. " "

All the above are Edinburgh prices, from "Treatise on Wire-Fencing, &c." by C. D. Young.

*Galvanised wire-netting.*—This netting is said to require no painting, as the atmosphere has no effect upon it. The London prices are—

12 inches wide, 4d. per yard; 30 inches wide, 8½d. per yard.  
 18 inches wide, 5½d. per yard; 36 inches wide, 10d. per yard.  
 24 inches wide, 7d. per yard; 48 inches wide, 1s. 1d. per yard.  
 The same, not galvanised, 1d. per yard cheaper.

Wire-netting of the kind called "Improved double mesh" is in meshes 1½ inches to half the height, and 3½ inches above—a very good means for excluding rabbits and hares.

Double mesh net, 24 inches wide, and of the above size in the openings, 6½d. per yard, extra strong, 9d. per yard.

Ditto, 2 and 4 inches strong, 5½d.; extra strong, 7½d. per yard.

Single mesh—that is, of the same mesh throughout the whole breadth—1½-inch, light, 7d.; ditto, strong, 9d.; ditto, extra, 1s. per yard.

Ditto, 2-inch mesh, light, 6d.; strong, 7½d.; extra, 10d. per yard.

This netting is twice dipped in an anti-corrosive composition, and sent free to London or Hull.

## FIRECLAY WATER-PIPES,

(Of a superior Quality, both as to Material and Manufacture, and in 3-feet lengths.)

2-inch bore, 6d. per lin. yard; 6-inch bore 1s. 6d. do.  
 3-inch do., 8d. do. 7-inch do., 2s. do.  
 4-inch do., 1s. 3d. do. 9-inch do., 2s. 9d. do.  
 5-inch do., 1s. 3d. do. 10-inch do., 3s. 3d. do.  
 12-inch bore, 4s. per lineal yard.

16 inches by 9 inches, and 2 inches thick, 2s. per foot; 24 inches by 18 inches, and 2 inches thick, 2s. 6d. per lineal foot. These are elliptical, or egg-shaped pipes.

As has been already noticed, the use of drain-tiles and earthenware tubes has completely superseded the brick drains formerly used for all sizes under twelve inches in diameter.

Drain-tiles are used either laid upon a sole or floor of the same material; or 2 tiles are laid one on top of the other, so as to form between them an elliptical opening for the water to pass through.

*Fire-tiles of the same Material.*

2-inch drain-tile, 15s. per 1000, weighs 1 ton 2 cwt.  
 3-inch do., 22s. 6d. do. 1 ton 10 cwt.  
 4-inch do., 30s. do. 2 tons 5 cwt.  
 6-inch do., 50s. do. 4 tons 10 cwt.  
 These tiles are from 13 to 14 inches long.

Water-pipe earthenware tubes are a great improvement in conveying water without the loss of its bulk, and also because it can be conveyed any distance in a more perfect and purer state than if conveyed in iron or leaden pipes, and more so when coated with glass within. Indeed, when these pipes are glazed the water is less deteriorated by passing through them than through any metallic pipes whatever. Nor is this the only advantage of earthenware pipes, as a glance at the prices of iron or leaden pipes will abundantly prove:—

	Per Yard.
4-inch spigot-and-faucet, 7d. in 3 feet lengths.	
5-inch	9d.
6-inch	1s. 0d.
7-inch	1s. 3d.
8-inch	1s. 4½d.
9-inch	1s. 6d.
10-inch	1s. 9d.
11-inch	2s. 1½d.
12-inch	2s. 6d.

If cash, deduct 1d. per yard up to 6 inches; 2d. upwards, to 12 inches. If glazed, double the above prices. These are the prices in the brick-field at Wishaw, near Hamilton, or delivered at the railway one mile distant.

## BRICK PAVING.

Paving floors with bricks is found expedient where stone pavement is difficult to procure. They are also sometimes employed for paving the spaces between pits, and for similar purposes. Dutch clinkers are, although more expensive, much the best material for the latter purposes.

Common hard stock bricks, laid flat on sand, will cost 2s. 6d. per square yard, bricklayer find-

ing material and labour; 8d. per yard, finding sand and labour; 4d. per yard, finding labour only, 36 bricks being required for the purpose. If laid on edge, 3s. 9d., 10d., and 5d. per square yard: 56 bricks will be required per yard. If laid flat, and set in mortar, 3s. per square yard for material and labour; 1s. for mortar and labour; 6d. for labour only. If laid on edge, set in mortar, 4s. 3d., 1s. 4d., 8d.

Paving bricks laid flat in sand, 3s. 9d. per square yard, for material and labour; 8d. for sand and labour only; and 4d. for labour alone: 32 bricks will be required.

Paving bricks on edge, in sand, 7s. 6d. per square yard, for material and labour; 1s. for sand and labour; 6d. for labour only: 84 bricks will be required.

Paving bricks laid flat in mortar, 4s. 3d. per square yard, for material and labour; 1s. for labour and mortar; 6d. per yard for labour only.

Paving bricks laid on edge, in mortar, 8s. 6d. per square yard, for material and labour; 1s. 6d. for mortar and labour; 10d. for labour only.

Paving bricks laid flat in cement, 5s. per square yard, 1s. 8d.; and 9d. for labour only.

Paving bricks laid on edge, in cement, 10s.; per square yard, 2s. 4d.; 1s. if for labour only.

If any of these be laid herring-bone fashion, add 2d. per yard to the items material and all labour, and labour with sand, mortar, &c.; and 1d. per yard for labour only.

If grouted with stone, lime, and sand, a very common practice, add 3d. to the first two items, and 1d. to the last.

10-inch tiles laid in mortar, 7d. per foot superficial, for material and labour: 12 tiles will be required to the square yard.

12-inch tiles laid in mortar, 8d. per superficial foot, for material and labour; 2½d. per foot for mortar and labour; 1d. per foot for labour only; 9 tiles will be required per yard. If set in cement, add 2d., 2d., and 1d. If rubbed and faced to close-joint for greenhouse-flowers, &c., add 4d., 3d., 2d. per foot superficial. The natural face or surface of neither bricks nor tiles should be broken, as their durability is thereby greatly lessened. This is, however, sometimes necessary when very neat and even floors are desired.

Dutch clinkers, set on edge, per square yard, 14s. for material and labour; 2s. 3d. for mortar and labour; 1s. 6d. for labour only; 144 clinkers are required per yard superficial.

Dutch clinkers laid herring-bone fashion, 15s. per square yard, for material and labour; 2s. 9d. for mortar and labour; 2s. for labour only. About the same number will do a yard in this fashion also.

Levelling the floor preparatory to laying down the bricks, not included in the above; the prices are those in the neighbourhood of London.

At Spilsby, Lincolnshire, brick-on-edge paving, 6s. 6d. per square yard, builder finding material.

Paving tiles, 10-inch by 10-inch, 2d. each—Granton price. 12-inch by 12-inch, and 2 inches thick, 2½d. each—average price for Scotland.

Scotch-made foot or 12-inch tiles weigh 12 cwt. per 100. English-made ones considerably less, quoted by Skirving at 8 cwt., because they are much thinner.

Ornamental tiles or quarries, 6 inches on the side, coloured blue, red, drab, and black, 2s. 2d. to 2s. 6d. per square yard.

Newcastle-under-Line prices, also a very superior description, 10s. a yard.

Wrights' quarries, which are on a pale yellow ground, have dark-brown figures in pigment lot in, and are very hard and beautiful; sold in Staffordshire, at 25s. per yard superficial.

Those made by Minton & Co., Copeland & Co., are still more beautiful, and, although expensive, make the most elegant of all conservatory floors.

Common fire-tile, 12 inches by 12 inches, 5d. each; 12 inches by 15 inches, 7d. each; 12 inches by 18 inches, 1s. 2d. each; 18 inches by 10 inches, 1s., &c., cash prices; if on credit, add 1d. each 12 by 12; 1½d. to 12 by 15; 2d. to 18 by 12—Wishaw Tileworks' prices.

Of common red pan-tiles for roofing, laid on laths 1½ inches square, and at 10 or 11 inches apart, 576 are required to cover a rood of roofing. The overlaps should not be less than 3 inches, and bedded and pointed with best plaster-mortar. Scotch price for putting on, finding pegs and mortar, 50s. per rood.

**COST OF TANKS FOR HEATING,**  
*(Made of various materials, as Wood, Iron, Slate, Lead, Brick, &c.)*

Mr Rendle's estimate of the cost of a wooden tank, of the best Memel pine, 2 inches in thickness, the whole to be ploughed and tongued, and jointed with best white-lead, with a division-board in the centre, and strengthened at the corners with fillets: cost per foot superficial, 7d.

Cast-iron tanks, cast in pieces, and bolted together, 2s. 4d. per superficial foot.

Wooden tank, covered with lead; the timber to be rough off the saw, and firmly put together; the inside covering of lead, 5 lb. to the foot, including solder and workmanship: cost 1s. 3d. per superficial foot;—that is, for timber-work 3d., and for lead 1s. per foot.

Brick and cement tanks, taking bricks at 5s. 6d. per 100, and cement at 14s. per barrel, of 36 gallons: cost of tank about 1s. per superficial foot. It will be understood that this calculation was made before the duty was taken off bricks, but including cartage, &c. There are many places where bricks will cost little less at present.

Slate tanks.—The slates can be furnished, fitted, and ready to be fitted up, (at Plymouth,) at about 10d. per superficial foot.

Very great confusion exists in regard to measures of length, surface, and solidity, and no Act of Parliament appears to be sufficiently stringent to cause an equalisation of these; and hence great confusion occurs in buying, selling, and measuring, all sorts of productions and works. The scale of allowances is equally variable, and requires a clear understanding between contracting parties, in drawing up specifications,

as to how the work is to be measured, &c. It would be desirable if all allowances were done away with, and the superficial or cubic contents, as the case may be, only regarded.

In regard to fruit, lime, grain, &c., we find the following differences in measures of solidity, viz., the imperial bushel is an arbitrary measure of 8 gallons, each containing 277.274 cubic inches; while in Monmouthshire, and some parts of South Wales, the bushel contains 10 gallons; at Abingdon and Andover, 9 gallons; at Stamford, 16 gallons; at Dorchester, 10 gallons; at Falmouth 20, and usually 21 gallons; at Chepstow, 10½ gallons; at Appleby and Penrith, 16 gallons for pease, rye, and wheat, and for barley, malt, and oats, 20 gallons; at Kingston-on-Thames, 8½ gallons; at Wycomb and Reading, 8¾ gallons; at Carlisle, 24 gallons. At Chester, a bushel of wheat contains 32 gallons, and of oats 40 gallons.

In Scotland, where such articles are often computed by the boll, a like discrepancy occurs. At Stranraer, a boll of oats or of lime contains 12 bushels; in Berwickshire and East Lothian it contains 6 bushels; in Wigtownshire, the boll of oats contains 12 bushels, and that of potatoes 16 bushels, of half a cwt. each. Potatoes are bought and sold in the Isle of Thanet by the sack of 200 lb. each; in Suffolk, by 3 heaped bushels per sack, and in some parts of the same county the bushel contains 5 heaped bushels, and weighs 2½ cwt. At Rayleigh it weighs 252 lb.; and at Collumpton, 160 lb.

In regard to measures of length, an equal confusion exists, viz.—the pole, perch, or, as it is in some places called, the rope or lug, which is properly 5½ yards, or one-fourth of a chain. In Fifeshire and Berwickshire it is 18 feet; in Wigtownshire, it is 20 feet; and for certain kinds of work, in East Lothian, it is 18½ feet. Over most of Ireland it is 21 feet. In many parts of Yorkshire, and in parts of Sussex, it is 21 feet; and for some kinds of work at Chepstow it is the same, while for other work it is 18 or 20 feet. In some parts of Devonshire it is 20 feet; and at Swansea, in South Wales, and in south Lancashire, it is 24 feet. At Witney and Cardiff it is 18 feet. The imperial acre contains 4840 square yards; the acre of South Wales, 5120 square yards. In Ireland and Lancashire it is 4840; and in Cornwall the same as the Scotch, 1½ imperial acres. The Cheshire acre contains 10,240 square yards.

**DIGGING FOUNDATIONS,**  
*(Or other work of a similar nature.)*

The London prices are, for common foundations in ordinary soil, and where they do not exceed six feet in depth, for digging and throwing out, 5d. per cubic yard, when all materials are found by the excavator; 4d. for labour only. In gravelly or clay soils, add 1d. per cubic yard. If wheeled, not exceeding twenty yards distant, add 2d., when barrows, planks, &c., are found, and 1d. for labour only. From twenty to forty yards, add 4d. and 2d. respectively, and for every twenty yards add 2d. and 1d. Carting, per cubic yard, to any distance within half a mile, 2s. 3d.; and to any greater

distance, not exceeding one mile, 3s. per cubic yard.—Scotch prices from 1d. to 1½d. less.

*Plain-tiling.*—760 tiles to 3½ gauge, 5 hods of mortar, 500 of 4 lb. nails, 1 bundle of fir laths, 1½ inch by ½ inch, (500 feet in length,) and 1 peck of tile-pins, are sufficient for one square (100 superficial feet) of roofing; and the cost 42s. for all materials, 15s. 6d. for all but tiles, 10s. 6d. for lime and labour only, and 6s. for labour only. If oak laths are used, add for the two first 2s., and the two last 6d. per square.

*Pan-tiling.*—165 pan tiles, 120 of 6d. nails, 1 bundle (or 500 feet in length) of laths 1½

inch by 1 inch, are sufficient for a square of 100 superficial feet; and the expense, if laid dry to a 10-inch gauge, 23s. for all materials, &c., 9s. 6d. for all but tiles, 3s. 6d. for lime and labour only, and 3s. for labour only.—The above are London prices. Scotch prices nearly 25 per cent less.

*In measuring brick-work,* multiply the superficial face of the wall by the number of half bricks it is thick, which will reduce it to half-brick work, and divide that sum by three, which will reduce it to brick-and-half work, or standard thickness; dividing this by 272, the exact quantity in rods will be given.

TABLES AND RULES USEFUL FOR ARITHMETICAL CALCULATIONS  
IN MATTERS RELATING TO GARDENING.

MEASURES OF LENGTH.

Inches.	Links.	Feet.	Yards.	Pole or Perch.	Chains.	Furlong.	Mile.
7.92	1						
12	1.515	1					
36	4.545	3	1				
198	25	16.5	5.5	1			
792	100	66	22	4	1		
7,920	1,000	660	220	40	10	1	
63,360	8,000	5,280	1,760	320	80	8	1

3 inches make 1 palm; 4 inches a hand; 5 feet a pace; 6 feet a fathom.

SQUARE MEASURE.

Inches.	Links.	Feet.	Yards.	Pole or Perch.	Chain.	Rood.	Acre.
62.726	1						
144	2.295	1					
1,296	20.661	9	1				
39,204	625	272.25	30.25	1			
627,264	10,000	4,356	484	16	1		
1,568,160	25,000	10,890	1,210	40	2.5	1	
6,272,640	100,000	43,560	4,840	160	10	4	1

By this measure all things having length and breadth are measured and calculated.

In England, carpenters measure their flooring, sarking of roofing, &c., by the square containing 100 square feet. Slaters, particularly in England, adopt the same rule; while in Scotland both slaters and carpenters in general measure by the rood of 36 superficial yards.

Masons, bricklayers, painters, glaziers, and often slaters, calculate by the rood of 36 square yards; the two latter also by the square foot or square yard.

The Scotch chain, like the imperial one, consists of 100 links, and is generally reckoned to have been 74 imperial feet in length, but was in reality 74.1196 feet. 5760 square ells—160

falls—10 square chains—4 roods—1 acre; equal to 1.261183 imperial acre. 23 Scotch acres make about 29 imperial; or, more nearly, 134 Scotch are equal to 169 imperial acres.

To reduce Scotch acres, therefore, to imperial ones, multiply by 1.261183. 66 feet make 1 imperial chain.

SOLID MEASURE.

1728 cubic inches make 1 cubic foot; and 27 cubic feet one cubic yard.

By this measure all excavations of earth, stones, gravel, &c., are calculated; as well as timber in logs, &c.; stone, marble, &c., in blocks.



## LIQUID AND DRY MEASURE

Pounds of Water.	Cubic Inches.	Gills.	Pints.	Quarts.	Pottles.	Gallons.	Pecks.	Bushels.	Coombes.	Quarterns.
1.25	34.659	4	1							
2.5	69.318	8	2	1						
5	138.637	16	4	2	1					
10	277.274	32	8	4	2	1				
20	554.548	64	16	8	4	2	1			
80	2,218.191	256	64	32	16	8	4	1		
320	8,872.763	1,024	256	128	64	32	16	4	1	
640	17,745.526	2,048	512	256	128	64	32	8	2	1

The six latter of these are dry measures only, and by them grain, fruit, &c., are bought and sold. The others are for liquids, &c.

## HEAPED MEASURE.

2 gallons make 1 peck, or 704 cubic inches, nearly.  
 8 gallons „ 1 bushel, or 2815½ „ „  
 3 bushels „ 1 sack, or 4½ cubic feet, nearly.  
 12 sacks „ 1 chaldron, or 58½ „ „

By this measure lime, fruit, potatoes, coals, culm, &c., are calculated. The outside diameters of these measures are to be at least double the depth. The goods to be heaped up above the rim to a height at least double the depth of the measure, their diameter being not less than—bushel, 19¼ inches; half bushel, 15¼; peck, 12¼; gallon, 9¾; half gallon, 7¾.

36 bushels 1 chaldron of coals in London, but sold by weight. 1 chaldron of coals at Newcastle is 53 cwt. A cart of coals in Scotland is 12 cwt.; and a deal of coals is 23 cwt.

1 imperial gallon contains 10 lb. avoirdupois of pure or distilled water; 1 pint, 1½ lb.; 1 bushel, 80 lb.—*Vide* above table.

40 cubic feet of rough, or 50 of hewn timber, make a load or ton; and 42 cubic feet a ton of shipping.

1 square yard of 9-inch brickwork contains 100 bricks—at least that number is taken for general purposes; 16¼ square feet of 14-inch brickwork is a rod. In measuring brickwork, walls of greater thickness than 14 inches, which is the length of one brick and breadth of another, must be reduced to that standard, and those of less thickness made up to it.

## EXPANSION OF METALS.

The expansion of copper is greater than that of brass, and that of brass greater than that of iron, in the proportions of 95, 89, 60.

A rod of copper expands 100,000th part of its length with every degree of heat; and iron expands 165,666th part of its length.

## TABLES USEFUL IN MAKING OUT ESTIMATES.

1 cubic foot of rain water weighs 62½ lb., or 6 gallons and 1 pint, and an English pint about 1 lb.

1 ditto of salt water weighs 64½ lb.

Every 20 gallons of water, when heated, become 21 gallons by expansion.

1 cubic inch of Zinc weighs	Ounces.
„ Cast-iron, . . . . .	4.16
„ Steel and bar-iron, . . . . .	4½
„ Brass, . . . . .	4.858
„ Copper, . . . . .	5
„ Silver, . . . . .	6
„ Lead, . . . . .	6½

1 cubic yard of earth, before being dug, will occupy 1¼ cubic yards when dug, and contains 21 striked bushels, and is considered a load; double these quantities, a double load.

27 cubic feet is considered a load of mortar, requiring in its preparation 9 bushels of lime and 1 cubic yard of sand. The mass will lessen one-third in bulk when made into mortar.

1 cubic foot of Paving-stone weighs	lb.
„ Mill-stone, . . . . .	151
„ Granite, . . . . .	165.87
„ Slate, . . . . .	167

	lb.
1 cubic foot of Marble weighs . . .	171½
"    Chalk, . . .	174
"    Basalt, . . .	179
"    Limestone, . . .	198½
"    Oak, from 54 to 73 . . .	
"    Box, . . .	57
"    Yew, . . .	50½
"    Ash, . . .	47½
"    Beech, . . .	43½
"    Walnut, . . .	43
"    Elm, . . .	34½
"    Larch, . . .	34
"    Poplar, . . .	24
"    Cork, . . .	15

	Cubic Inches.
1 cwt. of Cast-iron contains, . . .	430.25
"    Bar-iron, . . .	397.60
"    Cast-brass, . . .	368.88
"    Cast-copper, . . .	352.41
"    Cast-lead, . . .	272.8

126 gallons of rain are calculated by Waistell to fall on every square yard annually in Britain, or 272¼ tons per imperial acre. Other authorities say, taking the annual fall of rain at 31 inches, it would give 3100 tons per acre.

The constituents of our natural atmosphere are nitrogen, oxygen, aqueous matter, and carbonic acid, in the following proportions:—In 100 parts of

Nitrogen, by weight, 77.50, or by measure, 77.55	
Oxygen, " " 21.0 " " 23.32	
Aqueous matter, " 1.42 " " 1.03	
Carbonic acid, " 0.8 " " 0.10	

The mean force of the wind during the year has been computed to be at 9 A.M. 0.855, at 3 P.M. 1.107, and at 9 P.M. 0.605, showing a greater force during the day—no doubt to be accounted for from the difference of temperature between day and night.

Temperature sinks about 1° Fahr. for every 352 feet of elevation; but this varies a little with the season, and very considerably with the latitude. The above is near the proportion in the temperate zones.

TABLE OF THE SPECIFIC GRAVITY OF A FEW MATERIALS USED IN HORTICULTURE.

Of Rain-water, (distilled water being taken as 1.000,) . . .	1.0013
Sea water, . . .	1.027
Common earth, . . .	1.48
Rough sand, . . .	1.92
Earth and gravel, . . .	2.02
Moist sand, . . .	2.05
Clay, . . .	2.15
Clay and gravel, . . .	2.48
Lime unslaked, . . .	1.842
Basalt whinstone, . . .	2.8 to 3.1
Granite, . . .	2.5 to 2.66
Limestone, . . .	2.64 to 2.72
Stones for building, . . .	1.66 to 2.62
Brick, . . .	1.41 to 1.86
Iron-wrought, . . .	7.207 to 7.788
Lead flattened, . . .	11.388
Rock salt, . . .	2.257
Woods—Alder, fresh felled, 0.8791 Dry, 0.5001	
Ash, . . .	0.9036 " 0.6440
Aspen, . . .	0.7654 " 0.4302
Birch, . . .	0.9012 " 0.6274
Elm, . . .	0.9476 " 0.5474
Horse chestnut, . . .	0.8614 " 0.5749
Larch, . . .	0.9206 " 0.4735
Lime, . . .	0.8170 " 0.4390
Oak, . . .	1.0754 " 0.7075
Spruce, . . .	0.8699 " 0.4716
Scots fir, . . .	0.9121 " 0.5502
Poplar, Italian, . . .	0.7634 " 0.3931
Willow, . . .	0.7155 " 0.5289

—PFSCHEL'S *Elements of Physics*, vol. i. p. 151, 187.

TABLE showing the Number of Plants required to Plant an Acre, Scotch or Imperial Statute Measure, from One Foot to Thirty Feet distance, plant from plant.

Distance.	Scotch acre.	Imperial acre.	Distance.	Scotch acre.	Imperial acre.
Feet.			Feet.		
1	54,760	43,560	8	855	680
1½	24,387	19,360	8½	758	602
2	13,690	10,890	9	676	537
2½	8,761	6,969	10	547	435
3	6,084	4,840	12	380	302
3½	4,470	3,556	14	279	222
4	3,422	2,722	16	213	169
4½	2,704	2,151	18	169	134
5	2,190	1,742	20	136	110
5½	1,810	1,440	22	113	90
6	1,521	1,210	24	95	75
6½	1,296	1,031	26	80	64
7	1,117	884	28	69	55
7½	973	774	30	60	48

## INDEX.

- ABERCROMBIE, Mr.**, form of garden recommended by, 13—on the angle of elevation to be given to hothouses, 135—his opinion of espaliers, 556.
- Abraham, Mr.**, conservatory at Alton Towers designed by, 367.
- Academus**, the gardens of the, 2.
- Acharn**, the falls of the, hermitage at, 706.
- Acis and Galatea fountain**, the, 634.
- Acon, Mr.**, the early and late vineries of, 301.
- Acre**, number of plants at different distances required to plant the, 755.
- Addison**, the garden of, 8.
- Adonis**, the gardens of, 2.
- Aération of hothouses**, what, 272.
- Aération**, subterranean, for fruit-tree borders, 27.
- Agri-Horticultural Society of India**, report on kyanising wood by the, 568.
- Ainger, Mr.**, on the proper size of boilers, 232—on the setting of them, 235—on correcting the dryness of the heat from hot-water pipes, 248—on the circulation of hot water, 266, 268—his plan for heating vine borders, 328.
- Air**, on the admission of, into furnaces, 254—quantity requisite, mode of its admission, &c., 257—its admission to glass houses, *see* Ventilation.
- Air-traps for cisterns**, construction of, 522.
- Alderstone pit**, construction, &c. of the, 431.
- Alhambra**, ventilation of the, 271.
- Alison, Mr.**, on the different styles of gardening, 606.
- Allcard, John, Esq.**, ridge-and-furrow roofed pits constructed by, 457.
- Allen's Archimedean stove**, description of, 216.
- Alton Towers**, the conservatory at, 366.
- Amateur propagating box**, description of the, 428.
- American hive**, the, 525.
- American garden**, laying out, &c. of the, 664.
- Ancients**, gardening and gardens among the, 1.
- Anderson, Isaac, Esq.**, mode of heating employed by, 729.
- Anderson, Dr.**, mode of heating proposed by, 215.
- Anderson's self-acting ventilator**, description of, 279.
- André, M.**, fountain executed by, 674.
- Angle of elevation for hothouses**, on the, 134.
- Angular walls**, construction of, 100.
- Annual flower garden**, laying out, &c. of the, 669.
- Anson's Parian cement**, 566.
- Anthæum**, conservatory called the, 131.
- Anti-corrosion paints**, Carson's, 562—common, *ib.*—Zeno's, 563.
- Antonica**, use of, as a cement, 567.
- Apiaries**, the construction of, 522—the common straw hive, *ib.*—Munn's patent bar and frame hive, *ib.*—Nutt's, 523—Taylor's improved collateral ventilating, *ib.*—Huish's, 524—the Grecian, *ib.*—the Polish, *ib.*—the American, *ib.*—Pulteau's, *ib.*—two from the Gardeners' Chronicle, *ib.*—Bagster's, improved by J. D., 526—Dr Howison's, *ib.*—the Kashmir, *ib.*—Wighton's improved Polish, *ib.*—sheds or houses for them, *ib.*—revolving hives, 528—improved Polish, *ib.*—Young's, *ib.*—Pillans', 529—the Hexagon, 530—the Unicombe Observatory, *ib.*—stand with three tops, *ib.*—Dr Bevan's storified, *ib.*—that at Pishobury, *ib.*—objects to be aimed at in their construction, *ib.*
- Apricots**, forcing of, and houses for it, 355.
- Aquarium**, the construction of the, 412—example of a span-roofed one, 413—a lean-to one, 414—a circular one, *ib.*—that formerly existing at White Knights, 417—that of Mrs Lawrence, *ib.*—construction of them for hardy plants, *ib.*—that designed by Sckell at Munich, *ib.*—an octagon one, 418—the tropical one at Chatsworth, 419.
- Aquatic plants**, beauty of, 410.
- Arboretum**, formation and arrangement of the, 584—that of Messrs Loddige, 585—that at Kensington gardens and others, *ib.*—various modes of arranging the trees in it, with examples, 586.
- Arbours**, on the introduction of, into the geometrical flower-garden, 651—various modes of constructing them, 707.
- Arcades**, the formation of, 684.
- Arched pit**, the, 432.
- Arched walls**, construction of, 93.
- Architectural style in flower-gardening**, the, 573—situation adapted to garden in it, its peculiarities, &c., 611. *See also* Geometrical Flower-garden.
- Architectural walls**, construction of, 92.
- Argand furnace**, the, 254.
- Arnott's hot-air stove**, remarks on, 214, 215.
- Arnott's ventilating valve**, 295.
- Artesian wells**, the boring of, 17—the theory of them, *ib.*

- Artificial stone, employment of, for the construction of fountains, 632.
- Arundel castle, Porte-fleurs at, 631.
- Ashburton, Lady, the Conservatory of, 361.
- Asparagus, pit for the forcing of, 454—improved one, *ib.*
- Aspect of garden walls, different views with regard to, 65.
- Asphalt, employment of, as a coping for garden walls, 71—employment of it as a covering for glass houses to economise heat, 554—as a cement, 566—construction of garden edgings of it, 591.
- Assistant gardeners, accommodation for, 485—their duties, &c., 486.
- Astragals, the construction of, 545—cast-iron ones, 547—Waldron's, *ib.*—Sir Joseph Paxton's, 548—machine for cutting them, *ib.*—as made by the machine, 549.
- Atkinson, Mr, his system of heating by hot-water pipes, 154—the boiler originally used by him, 178—improvements introduced into hothouse furnaces by him, 251—on the management of furnaces, 261—improvements in ventilation introduced by him, 276—the construction and arrangement of his vineries, 303—his vineries heated by hot water, 304—pinery designed by him, 331—his peach-houses, 348—early forcing pit by him, 434—late forcing pit by him, *ib.*—his melon pit, *ib.*—his succession pine pit, 437—succession pine pit by him, with hot water and dung linings combined, 449.
- Atkinson's or Mulgrave cement, 565.
- Atmosphere, constitution of the, 755.
- Austin's stone-coloured cement, 566.
- Austin and Seeley, examples of balustrading manufactured by, 646.
- Ayres, Mr W. P., on the angle of elevation for hothouses, 135—on hot-air stoves, 227—his cucumber-house, 464.
- Babington, Dr, his process for preventing incrustation in boilers, 237.
- Babylon, the hanging gardens of, 1.
- Bacon, Mr, his system of hot-water heating, 154.
- Bagshot park, the garden at, 627—parterres from it, 629.
- Bagster's beehive improved by J. D., description of, 526.
- Bailey, Messrs, their method of tank-heating described, 194—conservatory at Bretton hall erected by them, 364—boilers invented by them, 177, 179.
- Bailey's cement, 565.
- Baker, colonel, system of tank-heating in the garden of, 209.
- Baldwin's pine-pit, description of, 432.
- Ballahulish slate, qualities of, 572.
- Balustrade, stone, at Dalkeith conservatory, 366.
- Balustrading, examples of, suitable for the geometrical style of gardening, 616, 646.
- Bamford Hall pine-stove, the, 340.
- Barberini palace, fountain from the, 627.
- Barchard's system of hot-water heating, description of, 171.
- Barratt's method of glazing, 540.
- Barron, Mr, covered peach borders used by, 323.
- Barry, C., Esq., the flower-garden at Trentham designed by, 613.
- Basins of water, objections to, in gardens, 15.
- Basket-work, examples of, suited to the gardenesque style, 676 *et seq.*
- Baths and bath-rooms, arrangements of, for gardeners' houses, 477.
- Bayfordbury, the garden at, 663.
- Beaumanor park, mode of ventilation employed at, 290.
- Beaumont, Mrs Colonel, the conservatory of, 363.
- Beck, Mr, mode of preparing slate edging by, 621.
- Beddington, the orange trees at, 402.
- Bees, antiquity of the keeping of, 522. *See* Apiaries.
- Belfast botanic garden, the, 10—the orchid-house in it, 410.
- Belgium, system of window-culture of flowers in, 421—treatment of liquid manure in, 519.
- Belstane, pinetum at, 587.
- Belton house, the flower-garden at, 656—flower-beds taken from it, 671.
- Belvoir Castle gardens, size of, 12—the mausoleum at, 654.
- Bernan, Mr, description of Perkins' system of heating by hot water by, 158—on heating by steam, 229—on the circulation of hot water in pipes, 250, 269.
- Bethell's preparation for the preservation of timber, 570.
- Betts, E. L., Esq., fountain in the garden of, 634.
- Bevan, Dr, his storified hive, 530.
- Bicton, arboretum at, 586.
- Bicton pine stove, the, 335.
- Biel house, the conservatory at, 373.
- Birch, Mr, improvements on the sash-bar cutting-machine by, 548.
- Black paint, disadvantages of, 563.
- Blenheim, the rock garden at, 701.
- Blinds for glass-houses, the preparation of, 555.
- Boerhaave on the angle of elevation for hothouses, 135.
- Boilers for hot-water heating, description of various—Garton and Jarvis' cylindrical and double drum, 169—Stephenson's double cylindrical, *ib.*—Stephenson's conical, *ib.*—Wood's conical, *ib.*—Neeves', 176—Waldron's, 177—the Scotch distillers', *ib.*—Bailey's, *ib.*—Cottam and Hallen's, *ib.*—various shapes employed for them, 178—Atkinson's, *ib.*—Thomson's, *ib.*—Burbidge and Healy's new, *ib.*—Dalkeith wrought-iron, *ib.*—Fowler's, 179—Bailey's new, *ib.*—Williams', 180—Weeks', *ib.*—Kerslake's universal flue, 181—the Captain, *ib.*—one for ordinary kitchen, 183—general remarks on them, 231—materials for them, *ib.*—those constructed of iron, 232—earthenware ones, *ib.*—their size, *ib.*—the proper setting of them, 234—best kind of water for them, 237—modes of preventing incrustation in them, *ib.*—prices, &c., of them in different localities, 743.
- Bond, what, in bricklaying, 107.
- Bonnemain, M., hatching of chickens by hot water by, 153—his system of heating by hot-water pipes, 161.

- Booth, Messrs, mode of ventilation used by, 279  
—the orchid-house of, 409—mode of covering their glass-houses used by, 552.
- Borders, disposal and laying out of, in the gardenesque style of flower-garden, 656, 673—edgings for them, 678.
- Borders for vines, formation of, 320—system of ventilating them, *ib.*—chambering them, 321—concreting them, 322—the subterranean chambering of them, 325—heating them, 326.
- Borghese family, advancement of Italian gardening by the, 574.
- Borghese vase, the, 637.
- Borrowstownness cement, the, 567.
- Boucherie, Dr, his method of preserving timber, 570.
- Bowers, construction of, 707.
- Bowling-green, introduction of the, in the gardenesque style, 658, 659.
- Bowood, system of aerating vineries followed at, 323—the pinetum at, 588.
- Box edgings, management of, in flower-gardens, 590.
- Boyd and Miller's antiseptic paint, 570.
- Braithwaite, Mr, his mode of heating by hot water, 153.
- Bran, the falls of the, hermitage at, 706.
- Bretton hall, the large conservatory at, 129, 363.
- Brewster, Sir David, on colours, 595.
- Brick, remarks on, as a material for garden walls, 68—as a material for hot-water tanks, 197.
- Brick drains, specifications as to expense of, 740.
- Brick flues, introduction of, for heating, 141—various modes of constructing them, 146.
- Brick paving, prices of, 751.
- Brick walls, the durability of, 572—construction of them solid, 78—hollow, 79—heated, 80.
- Brick and concrete walls, construction of, 79.
- Brick and stone walls, construction of, 79.
- Bricks, employment of, for coping garden walls, 71—inferiority of those made in Scotland, 571—employment of them for constructing edgings in gardens, 590—their sizes, prices, &c., in various places, 739.
- Brickwork, explanation of terms used in, 106—specifications regarding it, modes of measuring, estimates, &c., in different localities, 738 *et seq.*
- Bridgeman, changes introduced into gardening by, 8.
- Bridges, kinds of, suited to the gardenesque style of flower-gardening, 679—various kinds of wire and suspension, *ib.*—tension and suspension, 681—rustic, *ib. et seq.*—Remington's, 682—construction of those suited to the picturesque style, 713.
- British sheet-glass, prices, &c. of, 532—its alleged defects, &c., 536.
- Brockelsby, the mausoleum at, 654.
- Brookes, S. H., designs for garden temples by, 652.
- Broughton, Lady, the flower-garden of, at Hoole house, 662, 663—description of the rockery in it, 702.
- Brown, Mr, remodelling of the grounds at Claremont by, 92—on the arrangement, &c. of the gardenesque garden, 657—on the picturesque style of gardening, 699.
- Brown, Mr, design for a geometrical flower-garden by, 611.
- Brownlow, Earl, the flower-garden at the seat of, 656, 671.
- Broxburn cement, quality of, 567.
- Bruce, Lord E., parapet constructed by, 646.
- Bruce, O. Tyndal, Esq., of Falkland, the house and flower-garden of, at Nuthill, 10, 618, and Plate xxix.—fountains at it, 635.
- Buchanan, Mr, his work on heating by steam, 229.
- Buffon, experiments on colours by, 595.
- Bulb-garden, laying out of the, 669.
- Burbidge and Healy, Messrs, their boiler and furnace for hot-water heating, 168—their new boiler, 178—their method of tank-heating, 211—their hot-air stove, 223.
- Burn, Mr, Tottenham Park, his vinery for pot-culture, 312—his pinery, 333.
- Burn, W., Esq., the circular conservatory at Dalkeith designed by, 364.
- Burnettised canvass, employment of, for covering hothouses, 555.
- Burnettising timber, on, as a preventive of dry rot, 569.
- Burnhead, range of hothouses at, 118.
- Burton, Mr, the Kew palm-stove designed by, 119.
- Busta, introduction of, into the flower-garden, 650.
- Butler, Mr, his mode of heating by steam, 229.
- Butt, J. P. W., Esq., conservatory designed for, 378—and flower-garden, 621, and Plate xxiii.
- Cairnies, pinetum at the, 587.
- Caithness pavement, the merits of, 70—construction of walls of it, 96—construction of hot-air flues of it, 147.
- Calderwood cement, 567.
- Callander, W. B., Esq., arboretum formed by, 586.
- Cambridgeshire, mode of constructing clay walls in, 98.
- Camden hill, flower-garden at, 615.
- Cameron, Mr, his mode of tank-heating, 194.
- Can flues, various forms of, 145.
- Canvass, employment of, as a covering for glass-houses, 554—various forms of rendering it waterproof, *ib.*
- Cape of Good Hope, the heaths at the, 403.
- Captain boiler, the, 181.
- Carlisle, Rev. Mr, a claimant of the invention of ridge-and-furrow roofs, 109.
- Carpenter-work, specifications as to expense of, in different localities, 742.
- Carson's original anti-corrosion paint, 562.
- Cascades, construction, &c., of artificial, 715.
- Cast-iron, construction of vases in, 642. *See also Iron.*
- Castle Howard, the mausoleum at, 654.
- Caus, Solomon, Gothic flower-garden designed by, 615—design for a fountain by, 632.
- Caves, artificial, construction of, 706.
- Cellars, employment of, for the preservation of fruit, 495.
- Cements, various kinds of—Parker's, 565—Atkinson's or Mulgrave, *ib.*—Bailey's, *ib.*—Frost's, *ib.*—Puzzolano earth, *ib.*—Tarras, *ib.*—gypsum, *ib.*—mastic, *ib.*—metallic, *ib.*—Dr Ure's asphalt, 566—*ib.*—the Portland, *ib.*—

- Lusor's, *ib.*—Austin's stone-coloured, *ib.*—Anson's, *ib.*—Water, *ib.*—Dihl's water, *ib.*—Mrs Marshall's antonica, *ib.*—oropholite, *ib.*—Calderwood, Broxburn, and Borrowstownness, *ib.*—employment of it for the construction of edgings in gardens, 591—qualities and prices of the different kinds of, 744.
- Cenotaphs, introduction of, into the flower-garden, 654.
- Chairs, kinds of, suited to the gardenesque garden, 691.
- Chamber flues, Loudon's, 148—the Dalkeith, *ib.*
- Chambers, Sir William, the gardens at Kew originally laid out by, 621—on Chinese gardening and gardens, 649.
- Chambers's Journal, extract from, on rockwork, 704.
- Chanter's smoke-consuming furnace, 255.
- Charlotte, the princess, the mausoleum to, at Clarendon, 654.
- Chatsworth, size of the gardens at, 12—their situation, 20—conservative walls at, 101—in-sufficient ventilation of the large conservatory at, 180—description of the large conservatory, 374—ridge-and-furrow greenhouse at, 395—the tropical aquarium at, 419—melon-house at, 462—appropriateness of the Italian garden at, 605—the Emperor fountain at, 632, 636—history of the waterworks at, 636—vases in the gardens of, 637—the rockwork at, 701.
- Cherry, Mr, pinery designed by, 340.
- Cherry-houses, construction of, 355—span-roofed one, 356—those at Frogmore, *ib.*—forcing by temporary coverings, 357.
- Chevreul, M., views of, regarding the harmony of colours, 596.
- Chimney-tops, kinds, &c. of, 561.
- Chinese, the, invention of heating by hot-air flues by, 145—their mode of preparing ice and constructing ice-houses, 504—their introduction of statues, busts, &c., into gardens, 649—invention and employment of the wire fence by them, 696—their system of constructing garden walks, *ib.*
- Chiswick, the Italian flower-garden at, 619, and Plate xxvi.
- Chiswick Horticultural Society, fruit-room of the, 493.
- Circles, various modes of drawing, on the ground, 719, 720—modes of determining their centres, 720.
- Circular flower-beds, employment of, in the gardenesque style, 661.
- Circular flower-garden, design for a, 629.
- Circular flues, construction of, 149.
- Circulation of hot water, *see* Hot water.
- Cisterns, mode of connecting, with boilers, 267—mode of constructing them in gardens, 520. *See also* Tanks.
- Clarendon, situation of the garden at, 19—the architectural walls at, 92—the mausoleum to the Princess Charlotte at, 654.
- Clarence Lodge, conservatory at, 371.
- Clay walls, construction of, 98.
- Climbing plants, trainers for, 686.
- Clinker walls, construction of, 99.
- Clive, the Hon. Robert, his method of tank-heating, 194—his improved mode, 201.
- Close-topped boilers, pressure, &c. on, 265.
- Closers, what, in bricklaying, 106.
- Coal tar, employment of, as a paint, 562.
- Coalbrookdale Company, vase executed by the, 643—and iron garden seats, 650.
- Cob walls, on the construction of, 98.
- Cobbett, William, on the construction of ice-houses, 505—his plan of one, 506.
- Cockerell, C. R., Esq., conservatory at the Grange designed by, 361.
- Cockling, what, in glass, 533.
- Cold Pits, *see* Conservative Pits.
- Coldridge's system of heating by hot water, 175.
- Collinson, Mr G., chair designed, &c. by, 691.
- Colosseum, rockwork at the, 701.
- Colour, suitable, for garden walls, 77.
- Colours, harmony of, in relation to the laying out of flower-gardens, 593—designs illustrating it, 603, Plates xxvii., xxviii.
- Columella, description of Roman gardening by, 2—mode of preserving grapes after gathering employed by, 491.
- Combustion, imperfect, on, 258—insensible, 259.
- Complementary colours, what, 596.
- Concrete, employment of, for the foundations of walls, 67.
- Concrete walls, construction of, 98.
- Concreting, application of, to fruit-tree borders, 30.
- Conduction, diffusion of heat by, 191, 212.
- Cone joint, the, 247.
- Conifers, kinds of, suited to the suburban garden, 736.
- Connecting-joints, forms of, for hot-water pipes, 246.
- Conservative pits, different kinds of, 471—with solid walls, *ib.*—with hollow walls, *ib.*—with bottom ventilation, 472—span-roofed cold one, *ib.*—cold one for preserving vegetables, 473—span-roofed vegetable one, *ib.*
- Conservative walls, construction of, 101.
- Conservatories, evils of too lofty ones, 129—the erection and arrangement of them, 360—importance of the subject, *ib.*—style in which they should be erected, *ib.*—corridors to them, *ib.*—that of Lady Ashburton at the Grange, 361—distinction between them and green-houses, 362—different modes in which the plants may be grown in them, *ib.*—remarks on their size, 363—that formerly existing at Bretton Hall, *ib.*—the circular one at Dalkeith Palace, 364, and Plate xv.—that at Alton Towers, 366—the detached one at Kew, 367— that at Sion House, 368, and Plate xvi.—the Botanical Society's in the Regent's Park, *ib.*—Mr Marnock on their construction, 369—that at the Deepdene, 371—that at Dunneymarle, *ib.* 373—one in connection with town mansion, 372, and Plate xvii.—that at Biel, 373—the large one at Chatsworth, 374—one for first-class residence, by R. Turner, Esq., 375 and Plate xix.—one, with fruit-houses attached at Killikee, 376, and Plate xx.—domical one designed by R. Turner, Esq., 377, and Plate xxi.—that of Mr Butts at Grovesfield, 378—the arrangement of the plants in them, 380—their floors, 381—Mr Llewellyn's, *ib.*—proposed suspension ridge-and-furrow roofs for them, 382.

- Continent, modes of heating on the, 141—and of ventilation, 272—form of vinery common on the, 299, 302—construction of orangeries on the, 400—treatment of the orange on the, 401—means employed on the, for the preservation of fruit after gathering, 495.
- Contrasting colours, what, 596.
- Cooper's pit for forcing grapes, 437.
- Copeland, Mr, the Dove Tazza executed by, 642.
- Copeland's tiles, employment of, for footpaths, 560.
- Copings, various kinds of, for garden walls, 69—forms of them, 72.
- Copper, employment of, for sashes, 545—for astragals, *ib.* 547.
- Corbett, Mr, on ice-houses, 503, 512.
- Corbett's system, pit on, 444.
- Corbett's system of tank-heating, 199.
- Cornwall slates, the qualities of, 572.
- Corridors, formation of, to conservatories, 360.
- Corroborated glass, 537.
- Cottam and Hallen, Messrs, their system of hot-water pipes, 167—their boiler, 177—their stink-traps, 618.
- Courses, what, in bricklaying, 107.
- Covered garden, proposed, at Dalkeith palace, 110, and Plate xii.—uses to which such a structure might be turned, 113.
- Covered walks, various modes of forming, 684.
- Cramps, employment of, 572.
- Creelman, Mr, inclined walls constructed by, 95.
- Crosskill, Mr, vineries constructed by, 305—peach-houses, 352—conservatory at Everingham, 391—his mode of constructing sashes, 545.
- Crown glass, remarks on, 532—prices of, *ib.*
- Cruikshanks, Mr, his system of heating by hot water, 162.
- Cucumber and melon houses, general remarks on, 458—example of one, 459—those at Poltalloch, 461—those at Chatsworth, 462—Davidson's, 463—Ayre's, 464—those at Frogmore, *ib.*—plan for ventilating them, 465.
- Cucumber pit, a span-roofed, 449—Dawson's, 458.
- Culinary gardens, *see* Gardens.
- Curtis and Harrison's mode of glazing, 540.
- Curvilinear espaliers, various forms of, 559.
- Curvilinear form, advantages of, for the greenhouse, 385.
- Curvilinear hothouses, origin of, 108—advantages and disadvantages of them, 123—their construction, *ib. et seq.*—mode of ventilating them, 281, 288.
- Curvilinear lines, mode of drawing, on the ground, 719.
- Curvilinear mode of glazing, the, 540.
- Curvilinear vinery, a, 318.
- Cyrus, the gardens of, 1.
- D. T. F., mode of tank-heating by, 204.
- Dalhousie castle, the garden at, described, 47.
- Dalkeith palace, size of the gardens at, 11—provisions for collecting rain-water in them, 14—their situation, 20—direction, &c. of their slope, 21—formation of artificial soil in them, 26—the various entrances of them, 32—style in which they are laid out, 37—description of them, and of the various plant and fruit houses, 38, and Plates iv. and v.—mode of coping the walls in them, 70—construction of hollow brick walls in them, 79—description of proposed covered garden in them, 110, and Plate xii.—furnace constructed entirely of fire-clay at, 253—description, &c. of the vineries in, 307—the pineries, 337—mode of wintering the vines in them, 339—the peach-houses, 349—the circular conservatory, 364, and Plate xv.—the orchid-houses, 406—propagating pit, 446—bulb pit, 447—cucumber pit, *ib.*—nursing pine pit, *ib.*—succession pine pit, 448—tanks at, 519—various forms of rafters used in the glass houses, 546, 547—experiences with regard to kyanised timber in, 568—chain-pattern flower-border at, 673—wire bridge at, 679—Remington's American bridge at, 682—moss-house at, 711.
- Dalkeith chamber flue, 148.
- Dalkeith wrought-iron boiler, the, 178.
- Dalmeny garden, arrangements for the supply of water in, 15.
- Daniell, professor, on the temperature, &c. of hothouses, 126.
- Danish vinery, the, 302.
- Darwin on low-lying gardens, 20.
- Davidson, Mr, his mode of tank-heating, 194.
- Davidson's cucumber-house, 463.
- Davy, Sir H., on insensible combustion, 259.
- Dawson's cucumber-pit, 453.
- Deacon's Eolian machine for ventilation, 279.
- Dead plate, the, in the hothouse furnace, 251, 252.
- Dearn's hollow brick wall, 81.
- Deepdene, the, the conservatory at, 371, 373.
- Dench, Mr, improvements in hothouse building by, 108.
- Denmark, form of forcing-house for peaches used in, 347—amateur's propagating-box used in, 428.
- Dennybole slates, qualities of, 572.
- Desaguliers, Dr, mode of heating invented by, 219.
- Desalongchamps, M., on the preservation of fruit, 491.
- Detached flue, construction of the, 147.
- Devonshire, the duke of, the large conservatory built by, 374—his Italian flower-garden at Chiswick, 619, and Plate xxvi.
- Devonshire, the cob walls of, 98.
- Devonshire slates, qualities of, 572.
- D'Hoogvorst, the baron von, the mushroom-house of, 470—statuary, &c. in the gardens of, 650.
- Dick's protecting frame, 104.
- Dihl's water-cement, 566.
- Dome-shaped espalier, a, 560.
- Domical conservatory, a, 377, and Plate xxi.
- Domical conservatories, disadvantages of, 129, 130.
- Doors, peculiar, for hothouses, 54.
- Doullier, inclined walls introduced by, 94.
- Doulton & Watt, Messrs, vases executed by, 643.
- Dove Tazza, the, 642.
- Downing, Mr, remarks on his work on landscape gardening, 6—on planting in relation to the different styles, and the distinction between grouping and clumping, 581—on the disposal of garden ground, 592.

- Draw-wells, examples of, 675.
- Dropmore, examples of flower-beds from the garden at, 670—the root-garden at, 705.
- Drumlanrig castle, the entrance to the flower-gardens at, 32—style in which they are laid out, 37—specimens of the French parterre from, 609—the flower-garden at, 619—the root-garden, 705.
- Drummond castle, sun-dials at, 645.
- Dryburgh, suspension bridge at, 680.
- Dry rot, causes of, and means for its prevention, 567 *et seq.*
- Ducel, M., fountain designed by, 633, 634—vase in cast-iron by, 644.
- Duncan, J., Esq., hothouses constructed for, 118.
- Dung, pits heated by, *see* Pits.
- Dunneymarle, architectural walls at, 93—Gothic conservatory at, 371, 372, 373.
- Duro, Mr., on the fruit-room and the preservation of fruit, 489.
- Dutch, mode of heating first employed by the, 140—their peach-houses, 347.
- Dutch style of gardening, derivation of the, from the Romans, 2—its characteristics, 3—the introduction of it into England, 8.
- Dutch style of flower-garden, the, 573, 574, 611.
- Ealing park, combined orchid-house and aquarium at, 405, 417.
- Earthenware boilers, 243.
- Earthenware copings for walls, 71.
- Earthenware flues, employment of, for heating, 141—various forms of them, 145.
- Earthenware pipes and evaporating pans, 242.
- Eckstein and Bushby's system of heating by hot-water pipes, 160.
- Edgings for flower-garden borders, various kinds of, 590—kinds of, suited to the gardenesque style, 678.
- Edmonstone pit, the, 433.
- Egg-shaped figure, to describe a, 721.
- Eisdale slates, qualities of, 572.
- Elevation, the angle of, for hothouses, 134.
- Elizabethan style of flower-garden, the, 576.
- Elvaston castle, covered peach-borders at, 323.
- Embrasure flue, the, 146.
- Emperor fountain, the, at Chatsworth, 632, 636.
- Enamelled pipes, on, 249.
- England, treatment of the orange tree in, 401—specifications regarding the prices, &c. of brickwork in, 738 *et seq.*—of slates and slating, 741—of plastering, 742—of carpenter-work, *ib.*—of iron-work, 743—of cements, 744—of mason-work, 745, 746—of lime and sand, 746—of glass and glazing, 747—of painting, 748—of plumber-work, *ib.*—of wirework, 749.
- English bond, what, in bricklaying, 107.
- English style of gardening, origin of the, 607.
- Entrances to the kitchen-garden, forms, &c. of, 32.
- Errington, Mr., on coping for walls, 69—on ventilation, 297.
- Erskine house, flued walls at, 87—ice-house at, 510.
- Espalier railings, various opinions entertained regarding, 556—their construction, *ib.*—various forms of iron ones, *ib.*—wooden ones, 557 wire one, 558—span-roofed timber ones, *ib.*—
- inclined and curvilinear ones, 559—dome-shaped one, 560.
- Evaporating pans, construction, &c. of, 242, 249.
- Evergreen hedges in flower-gardens, 579.
- Everingham hall, greenhouse at, 391.
- Everingham park, vinery at, 305.
- Ewing's glass walls, construction of, 88, and Plate xi.
- Excavating, the prices, &c. for, 752.
- Expansion joints for hot-water pipes, 247.
- Felt shutters, employment of, for covering glass-houses, 552.
- Fences, varieties of, for flower-gardens, 579—kinds of them suited to the gardenesque style, 685—and to the picturesque, 717.
- Fenn's system of tank-heating, 211.
- Fermentation, pits heated by, *see* Pits.
- Fermenting materials, superiority of the heat derived from, 184.
- Fernery, formation, &c. of the, 667.
- Ferns, the cultivation of, 667.
- Field, Mr., views of, on colours, 595.
- Figs, forcing of, and houses for it, 355.
- Filtering tank, a, 513—another, 515.
- Fireclay, construction of a furnace of, 253.
- Fireclay flues, various forms of, 145.
- Fireclay tiles, prices of, 751.
- Fireclay water-pipes, prices of, 751.
- Flagstone flues, construction of, 147.
- Flange joint, the, 246.
- Fleming, Mr., his system of tank-heating, 202—mode of ventilation employed by him, 286—heating vine-borders by, 326—pinery constructed by him, 344—and peach-houses, 353—his melon and pine pits, 455—his economical paint, 564.
- Flemish bond, what, in bricklaying, 107.
- Flint walls, construction of, 98.
- Floors, conservatory and greenhouse, materials for, 381.
- Florence vase, the, 637.
- Florentine style, flower-garden in the, 575.
- Flower-baskets, examples of, 426, 428.
- Flower-baskets, styles of, for the gardenesque garden, 658.
- Flower-beds, form, &c. of, in the gardenesque style, 661.
- Flower-gardens, the laying out of, preliminary remarks on the classification of styles, 573—definitions of the different styles, *ib. et seq.*—examples of the Panopticon, Florentine, and Tudor, 575—the Stuart style, 576—that of Holland house, *ib.*—the irregular, 578—the mingled, *ib.*—situation of them, *ib.*—fences for them, 579—planting in relation to the different styles, 580—the arboretum, 584—the pinetum, 587—edgings for borders, 590—the reserve one, 591—general disposal of the ground, 592—on terracing the ground, 593—the harmony of colours in relation to them, *ib.*—the geometrical style, 604—the gardenesque style, 655—the picturesque style, 693.
- Flower-stands, style of, for the gardenesque garden, 653.
- Flower-tables, examples of, 427.
- Flowers, kinds of, suited for cultivation in the town garden, 730, 731, 732—to the small suburban one, 734 *et seq.*



- Flowers, cut, means for the preservation of, 425.
- Flues, heating by, 145—earthenware or can ones, 141, 145—brick ones, 141, 146—those of iron, flagstone, &c., 147—the detached, *ib.*—chamber ones, 148—circular ones, 149—the cleaning of them, 150, 151—precaution against their bursting, 151—modes for securing all their heat, 152—their heating capabilities, *ib.*
- Flued walls, construction of, 86.
- Folkstone, inclined walls at, 95.
- Footpaths, construction of, for Conservatories, &c., 560.
- Forcing garden, plan and description of a, 49.
- Forrest, Mr, mode of covering glass-houses invented by, 555.
- Forrest's new white paint, 564.
- Forsyth, Mr, on the disadvantages, &c. of low-lying gardens, 20—on soil, 26—on fruit-tree borders, 29—on shelter, 35—on the proportion of pipe requisite for heating, 241—early forcing pit designed by him, 486—his mushroom-house, 470—method employed by him for the preservation of fruit after gathering, 493—plans for drawing volutes, &c. on the ground designed by him, 719.
- Fortune, Mr, his mode of ventilation, 281—his plant pit, 452.
- Fortune, Mr, account of a Chinese ice-house by, 504.
- Foundations, kinds of, for garden-walls, 66.
- Fountains, examples of, suited to geometrical gardens, 627—Triton from the Barberini palace, *ib.*—defence of their introduction into the flower-garden, 631—their suitability to the geometrical style, *ib.*—materials now employed for their construction, 632—the supply of water to them, *ib.*—the size and arrangement of the pipes for them, 633—one by Ducl in iron, *ib.*—the Acis and Galatea, 634—those in Nuthill garden, 635, 636—heights to which the water is thrown by various ones, 636—kinds of them adapted to the gardenesque style, 674—one by M. André in iron, *ib.*
- Fowler, C., Esq., conservatory at Sion house designed by, 368, and Plate xvi.
- Fowler, Mr, his system of heating by hot water, 156—his boiler, 179.
- Fragment mode of glazing, the, 540.
- Frames, *see* Pits.
- France, construction of the first hothouses, &c. in, 4—modes of heating employed in, 141—mode of preserving fruit after gathering in, 486.
- Freezing mixtures, list of, 513.
- French, Mr, the vinery of, 303.
- French beans, pit for forcing, 403.
- French style in flower-gardening, origin and characteristics of the, 4, 573, 574—its peculiarities, 608—example of one, 610—one in the modern style, 611.
- Frogmore gardens, size of, 11—style in which arranged, 36—description of them and of the forcing-houses, &c., 60, and Plates ix. and x.—mode of ventilation employed at, 288—vineries, 314—cherry-house, 356—asparagus pits, 454—plant pits, 456—cucumber-houses, 464—mode of constructing the sashes at, 545—curvilinear espaliers used at, 560—the hermitage at, 706.
- Frost's cement, 565.
- Fruit, on the preservation of, after gathering, 486—causes of its decay, 491.
- Fruit-gardens, *see* Gardens.
- Fruit-houses, comparative advantages, &c. of narrow and broad, 132—the construction of them—vineries, 299—pineries, 330—peach-houses, 346—cherry, fig, plum, and apricot houses, 355—tropical-fruit house, 358.
- Fruit-room, construction of the, 486—Mr Thompson on them, 487—Duro on them, 489—the Gardeners' Chronicle on them, 490—Deslongchamps on them, 491—Mr Knight on them, 492—Maher on them, *ib.*—that of the Chiswick Horticultural Society, 493—Justice, Hitt, and others on them, *ib.*—proper situation for them, 495—Mr Moorman's, 496.
- Fruit-trees, kinds of, suited to the suburban garden, 734.
- Fruit-tree borders, formation of, 27—aeration of them, *ib.*—paving of them, 29—depth they should be for different fruits, *ib.*
- Fuel, on regularity of supply of, to furnaces, 258—waste of it caused by opaque smoke, 259.
- Furnaces, hothouse, on the construction of, 251—the first improvers of them, *ib.*—their general defects, *ib.*—one constructed entirely of fireclay, 253—Williams' improved or argand, 254—the admission of air into them, *ib.*—another by Williams, 255—Witty's or Chanter's smoke-consuming, *ib.*—various forms of smoke-consuming ones, 256—Joseph Williams', 257—Jucke's, *ib.*—Galloway's, *ib.*—causes of the production of smoke from them, 258—the effects of it, 259—loss of heat caused by it, *ib.*—the proper management of them, 261—stoke-holes, doors, &c. for them, 262.
- Gala water, wire bridge over the, 679.
- Galloway's patent boilers, furnace, &c. 257.
- Garden, the culinary or kitchen and fruit, general plan of, 11—proper extent for it, *ib.*—sizes of various ones, 12—different forms given to it, and respective advantages of these, *ib.*—advantages of its being of regular form, 13—the supply of water to it, 14—importance of irrigation to it, 15—various modes of procuring water to it, 16 *et seq.*—the proper situation for it, 19—best slope for it, and direction of this, 21—example of a suburban one, 22, and Plate i.—the same with certain improvements, 23, and Plate ii.—example showing the connection between it and the house, 23, and Plate iii.—another villa or suburban one, 24—soil suitable to it, 25—formation of fruit-tree borders in it, 27—the principal entrance to it, 32—production, &c. of shelter to it, 34—style in which to be laid out, 36—that at Dalkeith palace, 38, and Plates iv. v.—example of one on the largest scale, 40—plan, &c. of one in Ireland, 45—one in the mixed style, *ib.*—that at Dalhousie castle, 47—that at Woburn abbey, 48—forcing one on a limited scale, 49—one by Hay, 50—that at Pottaloch, 51, and Plates vi.

- vii. viii.—that at Frogmore, 60, and Plates ix. x.
- Garden, the flower, *see* Flower-garden.
- Gardens, town and small suburban, laying out of, 725—difficulties of the subject, *ib.*—illustrations of good ones, *ib.*—objections to laying them down in grass, 726—forms of parterres, &c., for them, *ib.*—proposed filling of them with plants in a portable state, 727—covering them in with glass, cost, advantages, &c. of it, *ib.*—formation of covered verandahs in them, 728—means of providing extra heat in them, 729—Rivers' orchard-house, 730—plants, flowers, &c. for them, and disposal of these, 731—laying out, &c. of suburban villa ones, 733—fruit-trees for them, 734—herbs, 735—trees, *ib.*—deciduous shrubs, *ib.*—evergreen shrubs, *ib.*—coniferæ, 736—hardy herbaceous plants, *ib.*
- Garden gates, designs for, 33—style of, in the gardenesque garden, 685.
- Garden seats, kinds of, suited to the geometrical style, 650—to the gardenesque, 687—and to the picturesque, 706, 708.
- Garden structures, miscellaneous, erection, &c. of—gardeners' houses, 475—fruit-rooms, 486—ice-houses, 497—tanks and cisterns, 513—apiaries, 522.
- Garden walls, *see* Walls.
- Gardeners' Chronicle, extracts from the, on copings for garden walls, 72—on the best colour for garden walls, 77—on the advantages and disadvantages of metallic hothouses, 128—on the proper angle of elevation for hothouses, 137—on tank-heating, 210—on vine borders, 327—description of plant stages for greenhouses from the, 393—description of an orchid-house from the, 405—account of ridge-and-furrow roofed pits from the, 457—description of a mushroom-house from it, 467—another, 469—extract from it on the preservation of fruit, and the construction of the fruit-room, 487, 490—description of a Chinese ice-house from it, 504—various forms of ice-houses taken from it, 506, 507—on the preservation of ice, &c., 511—descriptions of various apiaries from it, 525—method of glazing described in it, 539—description of Kent's mode of glazing from it, 543—extracts from it on the contrast and harmony of colours, and on M. Chevreul's views regarding them, 596, 599—on the flower-garden at Trentham, 613.
- Gardeners' houses, general remarks on the style, &c., in which they should be built, 475—one for a first-class residence, 476—a two-storied one, 479—paving for them, 480—parapets for them, 481—a cottage one, 480—another, 481—another cottage one, 481, 482—another, 483—a two-storied cottage one, 483, 484—one in the old English style, 484, 485—the accommodation which should be provided for the assistant gardeners, 486.
- Gardeners' Journal, mode of tank-heating described in the, 204—and mode of ventilation, 290—extract from it on the contrast and harmony of colours, 598—garden seat from the, 691.
- Gardeners' Magazine, mode of ventilation from the, 290—mushroom-house described in it, 470—and moss-house, 688.
- Gardenesque flower-garden, general arrangement of the, 655—introduction of the terrace into it, *ib.*—laying out of the borders in it, 656—proper situation for it as regards the house, *ib.*—trees and shrubs suited to it, 657—style of planting adapted to it, *ib.*—basket-work and flower-stands for it, 658—one with oval parterres, 659—direction, formation, &c., of the walks, *ib.*—one with circular flower-beds, 660, and plate xxxii.—the planting and dividing of the flower-beds, 661—that of Lady Broughton at Hoole house, 662, 663—various examples with circular beds, 663—subdivision of it into various departments, and the laying out of these—the American garden, 664—the rosarium, *ib.*—other examples of the rosarium, 665, 667—the fernery and muscarium, 667—the winter garden, 668—the bulb garden, 669—the annual flower-garden, *ib.*—the herbaceous plant-garden, *ib.*—the grass-garden, 670—the hardy heath-garden, *ib.*—various figures for flower-beds appropriate to it, 671 *et seq.*—laying out of long flower-borders in it, 673—fountains and vases suited to it, 674—introduction of draw-wells into it, and examples of these, 675—basket-work for it, 676—odgings for flower-borders for it, 678—style of bridges suited to it, 679—trellis-work, gates, fences, and tree guards, 683—moss-houses, seats, and resting-places, 687.
- Gardenesque style in flower-gardening, definition of the, 573—kinds of trees and shrubs, and general style of planting adapted to it, 581—levelling, &c., of the ground in it, 593.
- Gardening, general sketch of the history of, and its different styles, 1—the Dutch style, 3—the French style, 4—the mixed style, 36.
- Garnaud, M., vase in terra-cotta by, 643, 644.
- Garnkirk Company, construction of a furnace entirely in fireclay by the, 253—examples of balustrading manufactured by the, 646.
- Garton and Jarvis, Messrs, the cylindrical horizontal boiler of, 169—their double drum boiler, *ib.*
- Gas liquor, employment of, as a paint, 562.
- Gates, garden, designs for, 33—style of, suited to the gardenesque style, 685.
- Gemini's process for the preservation of timber, 571.
- Geometric-gardenesque style in flower-gardening, the, 573, 574.
- Geometrical diagrams, practical, for laying down figures of various kinds on the ground—for volutes of various kinds, 719—for circles and curvilinear lines, *ib.*—for determining the centres of circles, 720—for a hexagon, *ib.*—for an octagon, *ib.*—for a pentagon, *ib.*—for describing circles round various objects, *ib.*—for ovals and egg-shaped figures, 721—for setting off walks in various directions, *ib.* 722—various instruments useful in them, 722—various figures with their centres shown, *ib.*—rules for determining the length of shadows, 724.
- Geometrical flower-garden, general arrangement of the, 604—its superiority to the modern or

- English, 605 *et seq.*—the French modification of it, 608—example of a French one, 610—one in the modern French style, 611—proper position of the architectural one, *ib.*—the terraced one, *ib.*—a design for one by Mr Brown, *ib.*—one by Mr Smith, 612—that at Trent-ham, 613—examples of parterres suited to it, 614—a triangular one, *ib.*—a Gothic one by Solomon Caus, 615—a geometrical one, *ib.*—an architectural one with terraces designed for the west of Scotland, *ib.*, and Plate xxxiv.—examples of balustrading for it, 616—that at Nuthill house, 618, and Plate xxix.—that at Drumlanrig castle, 619—the Duke of Devonshire's Italian one at Chiswick, *ib.*, and Plate xxvi.—that around the palm-stove at Kew, 620, and Plate xxx.—that at Grovefield, with conservatory, 621, and Plate xxiii.—a plain one without sculptural ornaments, 622—one in Oxfordshire, *ib.*, and Plate xxxi.—another, 623, and Plate xxv.—two illustrating the harmony and contrast of colour, 601, 603, and Plates xxvii. xxviii.—various figures for flower-beds suited to it, 623—designs with raised flower-beds, 624—various designs for parterres, &c., 625—a fountain suitable to it, 627—various geometrical parterres, *ib. et seq.*—one at Bagshot, 629—porte-fleurs suitable to it, 630—marginal flower-borders, 631—various designs for fountains, *ib.*—vases, urns, sun-dials, and mural decorations, 637—statues, 648—seats, 650—temples and arbours, 651—mausoleums, cenotaphs, &c., 654.
- Geometrical style in flower-gardening, definition of the, and its subdivisions, 573—trees, shrubs, and style of planting suitable to it, 581.
- German hotbed, the, 430.
- German mushroom-house, the, 466.
- German pit for forcing French beans, strawberries, &c., 453.
- Germany, sketch of the history of gardening in, 45—method of heating employed in, 141—mode employed in, for the preservation of fruit after gathering, 486—mode of constructing arbours in, 707.
- Gilpin, Mr, on the geometrical flower-garden, 605, 607—definition of the term picturesque by him, 693.
- Girardin, M. de, on the picturesque style of flower-gardening, 694.
- Glasgow, the prevalent winds at, 35.
- Glass, different varieties of, 532—that of large size, and the alleged dangers attending its use, *ib.*—mode of testing its quality, 533—the cockling of it, and how to prevent it, *ib.*—Hartley's patent rough plate, 634—on the colour of it most suitable for hothouses, 535—British sheet, and its imperfections, 536—corroborated, 537—polished thick plate, and its inapplicability to hothouses, *ib.*—Russell's patent tile, *ib.*—employment of it for the construction of fountains, 632—proposed covering over of town gardens with, 727.
- Glass and glazing, specifications as to expense of, in different localities, 746.
- Glass copings for walls, on, 71.
- Glass houses known to the Greeks and Romans, 2—first employment of them in modern Europe, 5—origin of them in Scotland, 9—covering their roofs for the economising of heat, 551.
- Glass louvre ventilators, 293.
- Glass pipes, on, 249.
- Glass tile, Russell's, 537.
- Glass walls, Ewing's, 88, and Plate xi.—Spencer's, 91.
- Glauber, R., suggestion for hot-water heating by, 153.
- Glazing, various modes of, 538—without overlaps, *ib.*—without fore putty, *ib.*—Read's mode, 539—Stevenson's, *ib.*—Curtis and Harrison's, 540—Saul's, *ib.*—Barratt's, *ib.*—in various ways with leaden lapa, *ib.*—the rectangular, fragment, shield, curvilinear, &c. *ib.*—with vulcanised India-rubber, 541—Spencer's mode, *ib.*—with Jeffrey's marine glue, 542—the putty for it, and importance of its being of good quality, *ib.*—reversing the position of the sash-bar, 542—Rishton's registered sash, 543—Kent's mode, *ib.*—removing old glass, 544—different varieties of putty, *ib.*—various devices for collecting condensed steam, *ib.*—Neeve's sash-bar, *ib.*—Paxton's sash-bar, *ib.*—Saul's gutter, *ib.*—specifications as to expense of, in different localities, 746.
- Glendinning, Mr, his system of tank-heating, 202—on the setting of boilers, 234—on ventilation, 295—pine-stove by him, 335—pine-pit by him, 436—his melon-pit, 439—his fruiting pine-pit, 440—pit on Corbett's system by him, 444—melon-pit by him, 455.
- Gorinki, conservatories at, 6.
- Gorrie, Mr, on garden walls, 65—on copings for them, 73—arboretum at Preston hall constructed by, 586.
- Gothic arbour, design for a, 707.
- Gothic flower-garden, a, 615.
- Gowen's flue, 146.
- Grahame, H., Esq., his pinetum, 587.
- Graining in painting, what, 564.
- Grange, the Conservatory at, 361.
- Grangemouth Coal Company, ornamental flue by the, 153—urn in fireclay executed by them, 645.
- Grapes, preservation of, after gathering, 494.
- Grass, objections to, in small town-gardens, 726.
- Grass garden, laying out, &c. of the, 670.
- Great Britain, general sketch of the history of gardening in, 6—defective mode of preparing ice in, 499.
- Grecian hive, the, 525.
- Grecian vases, examples of, suitable to geometrical gardens, 638.
- Greece, ancient, state of gardening in, 2—glass houses known in, *ib.*
- Green, Messrs, their mode of tank-heating, 194.
- Green paint, disadvantages of, 563.
- Greenhouses, on the construction of, 385—example of a span-roofed one, *ib.*—one with hexagonal end, 386—arrangement of the plant stages in them, *ib.*—a curvilinear lean-to one, 387—a detached one for the lawn, 388—another curvilinear lean-to one, and its internal arrangements, 389—the one in the botanic garden at Kew, *ib.*—one built by the Messrs Crosskill, 391—a span-roofed one for winter-

- ing plants in, 392—various kinds of stages for them, 393—different forms of plant tables and shelves for them, 394—a ridge-and-furrow roofed one, 395—that at Poltalloch, 397—the superiority of span-roofed over lean-to ones, 398.
- Grenville, lady, the garden at the seat of, 670—the root-garden, 705.
- Grillet, M., the first fountain at Chatsworth erected by, 636.
- Grissell and Redwood, Messrs, the process of, for coating metals, 128.
- Grottoes, the construction of, 706.
- Grout, what, in bricklaying, 107.
- Grovesfield, the Conservatory and projected flower-garden at, 378, 621, and Plate xxiii.
- Gunnelsbury house, span-roofed vinery at, 317.
- Gutters, the construction of, 548—peculiar, used at Poltalloch, 58, 116, and Plate viii.
- Gutter-heating, *see* Tank-heating.
- Gypsum as a cement, 565.
- Ha-ha, employment of, in the picturesque garden, 685.
- Hamilton, Mr, pine-stove by, 336.
- Hamilton palace, the mausoleum at, 654.
- Hampton Court garden, the origin of, 7—the vine at, 323—the orangeries at, 400.
- Hankin's mushroom-house, 469.
- Hardy, M., the rose-garden at the Luxembourg designed by, 666.
- Harmony of colours, on the, in relation to flower-gardening, 593—designs illustrating it, 601, 603, Plates xxvii. xxviii.
- Harrison, Mr, on fruit-tree borders, 30.
- Hartley's patent rough plate-glass, 534.
- Hay, D. R., on taste in colours, 594—on the combinations of them, 595.
- Hay, J., his arrangements regarding water in Dalmeny garden, 15—example of kitchen garden designed by him, 50—employment of heating by steam by him, 229—the peach-houses of, 348.
- Haycroft's mode of tank-heating, 203.
- Hazard's hot-air stove, description of, 224.
- Headers, what, in bricklaying, 106.
- Heat, means of securing in a moist state, 185—various modes of economising it in hothouses by external coverings, 551.
- Heath garden, laying out, &c. of the, 670.
- Heath-houses, advantages of the span-roof for, 402—conditions requisite for them, 403—examples of them, *ib.* 404—that at Woburn abbey, 405.
- Heaths, the proper culture of the, 403.
- Heating of glass-houses, preliminary remarks on, 140—by flues, 145—by hot-water pipes, 153—by tanks or gutters, 192—by hot-air stoves, 213—by steam, 228—boilers and pipes for it, 231—furnaces for it, 251—means of it in small town-gardens, 729.
- Heckfield melon pit, the, 433.
- Hedges, styles of flower-garden into which admissible, 579.
- Heidelberg, the gardens at, 615.
- Heideloff, professor, garden seats from work by, 650.
- Henderson, Mr, his system of heating, 192—mode of ventilation employed by him, 293—the vineries of, 309, 312—pinery by, 334.
- Herbs, kinds of, for the suburban garden, 735.
- Herbaceous plants, garden for the cultivation of, 669.
- Hermitages, construction of, in the picturesque style, 705, 706.
- Hexagon, laying down on the ground of a, 720.
- Hexagon box-hive, the, 530.
- Hirscl, the ice-house at the, 509.
- Hitcher's rebated brick wall, 84.
- Hitt, Mr, form of garden recommended by, 13—on garden walls, 65—mode employed by him for the preservation of fruit after gathering, 493.
- Hives, *see* Apiaries.
- Holland, modes of heating employed in, 140, 141.
- Holland house, the garden at, 576, and Plate xxiv.
- Hollow brick walls, on the construction of, 79—heated ones, 80—Dearn's, 81—Silverlock's, 83—others, *ib.*—those at Woburn abbey, 84—Hitcher's patent rebated, *ib.*—another, 85.
- Hood, Mr, remarks on heating by, 144—experiments, &c. by him on heating, 191—on the conduction, &c. of heat, 213—method of setting boilers employed by him, 234—on removing incrustations from boilers, 237—on the quantity of hot-water pipe needed to heat a given surface, 239—on the construction of furnaces, 252—remarks on ventilation by him, 273—on the circulation of hot water, 264 *et seq. passim.*
- Hoogvorst, the baron Joseph von, the mushroom-houses of, 470—the gardens of, 650.
- Hoole house, the flower-garden at, 662, 663—the rockwork at, 702.
- Hopean apparatus for cut-flowers, the, 425.
- Hopeton house, the garden at, 47—its slope, 21.
- Horizontal hot-water system, the, 154.
- Horticultural society of Chiswick, fruit-room of the, 493.
- Hot-air stoves, *see* Stoves.
- Hotbeds, *see* Pits.
- Hothouses, comparative absence of, in southern Europe, 3—the first introduction of them, 4—general principles of the building of them, 108—want of improvements in it, *ib.*—the ridge-and-furrow roof, and the different claimants to its invention, 109—one showing the covering in a whole garden, 110, and Plate xii.—the advantages of ridge-and-furrow roofs, 114—Sir Joseph Paxton on these, *ib.*—mode of constructing these, 115—description of a range with these, 41—suspension roofs, 114—Loudon on ridge-and-furrow roofs, 116—a series of them, 117, and Plate xiii.—those at Burnhead, 118—the palm-stove at Kew, 119, and Plate xiv.—curvilinear ones, and their construction, 123—examples of these, 124—metallic ones, their advantages and disadvantages, 125—Loudon on these, 126—the Gardeners' Chronicle on these, 128—disadvantages of too lofty ones, 129—the domical one at Bretton hall, *ib.*—the new one at Trentham, 131—the domical form, and its disadvantages, *ib.*—the Anthæum, *ib.*—importance of height of base

- to them, 131—proper proportions of them, &c., 132—trellises for them, 134—the proper angle of elevation for them, *ib.*—on covering their roofs with a view to economise heat, 551. *See* also Vineries, Pineries, Peach-houses, Conservatories, Greenhouses, &c.
- Hothouses, furnaces for, *see* Furnaces.
- Hothouses, heating of, preliminary remarks on it, 140—by flues, 145—by hot-water pipes, 153—by hot-water tanks or gutters, 192—by hot-air stoves, 213—by steam, 228—boilers and pipes for it, 231—furnaces for it, 251.
- Hothouses, ventilation of, *see* Ventilation.
- Hot water, general remarks on heating by, 185 *et seq.*—comparison between it and steam, 191—cause of the circulation of it, 263—Tredgold's theory of its circulation, *ib.*—Hood on it, 264—effects of friction on it, *ib.*—on circulation above the level of the boiler, 266—and below it, 267—Ainger on it, 268—Bernan on it, 269—Tomlinson on it, 270.
- Hot-water pipes, heating by, 153—claims to the invention, &c. of it, *ib.*—Atkinson's system, 154—Bacon's system, 155—Kewley's, *ib.*—construction, &c. of joints, 156—Fowler's system, *ib.*—Weeks', *ib.*—Perkins', 157—Eckstein and Bushby's, 160—Bonnemain's, 161—Watson's, *ib.*—Cruickshanks', 162—Rogers', 165—Rettie's, 166—Sampson's, 167—Cottam and Hallen's, *ib.*—Burbidge and Healey's, 168—Garton and Jarvis', 169—Stephenson's double cylindrical, *ib.*—Stephenson's conical, *ib.*—Wood's, *ib.*—Barchard's, 171—Walker's, *ib.*—Penn's, 173—Coldridge's, 175—Smith's, *ib.*—Neeve's, 176—Waldron's, 177—Scotch distillers' boiler, *ib.*—Bailey's boiler, *ib.*—Cottam and Hallen's boiler, *ib.*—Atkinson's boiler, 178—Thomson's boiler, *ib.*—Burbidge and Healey's new boiler, *ib.*—Dalkeith wrought-iron boiler, *ib.*—Fowler's boiler, 179—Bailey's new boiler, *ib.*—Williams' boiler, 180—Weeks' improved boiler, *ib.*—Kerslake's boiler, 181—the Captain boiler, *ib.*—general remarks on the subject, 184—radiators for, 189—comparison between this method and steam, 191—Henderson's method, 192—effects of various sizes of pipes on the circulation, 264—prices, &c. of, in different localities, 744.
- Howie, Mr, fountains at Nuthill executed by, 619, 635.
- Howison, Dr, the hive of, 526.
- Huish's hives, 524.
- Humidity, means of increasing, in hothouses, 243, 248.
- Hunt, R., on the colour of glass best suited to hothouses, 535.
- Hurwood's mode of ventilation, 280.
- Huyshe's system of tank-heating, 200.
- Hydraulic ram, description of the, 18.
- Ice, history of the economic employment of, 497—the best kinds of it, 498—the preparation of it in the United States, *ib.*—the defective mode of preparing it in Great Britain, 499—the production of it by artificial means, 512—list of various mixtures for this, 513.
- Ice-houses, on the construction of, 497—example of one, 500—another, 501—an ornamental one, 502—the stack system, *ib.*—the proper situations for them, 503—Mr Corbett on them, *ib.*—mode of constructing them in China, 504—probable changes which will ensue in the mode of constructing them here, 505—Cobbett on them, and his plan of constructing them, *ib.*—one from the Gardeners' Chronicle, 506—another, 507—that at the Hirsal, 509—that at Erakine house, 510.
- Icolmkill, supposed traces of garden at, 7.
- Inclined walls, on, with examples of them, 94.
- Incrustation in boilers, prevention of, 237.
- India-rubber, glazing with, 541.
- Ingestrie hall, Remington's bridge at, 682.
- Inverack, prevalent winds at, 36.
- Ireland, origin, &c. of gardening in, 8—a kitchen garden in, 45.
- Iron, employment of, for coping walls, 72—processes for preventing the corrosion of, 128—experiments on the strength of it, *ib. et seq.*—employment of it in the construction of tanks and cisterns, 521—for sashes, 545—for rafters and astragals, *ib.*—for edgings in gardens, 590—in the construction of fountains, 632—casting of vases in it, 642—employment of it for statues in the flower-garden, 648—prices, &c. of it in different localities, 744.
- Iron bridges, various kinds of, 679 *et seq.*
- Iron espaliers, construction of, 556, 557.
- Iron flues, construction of, 147.
- Iron garden seats, specimens of, 650, 651, 690.
- Iron grating, employment of, for footpaths, 561.
- Ironwork, specifications as to expense of, in different localities, 743.
- Irregular flower-garden, the, 578.
- Irrigation, importance of, in gardens, 15.
- Italian labour, example of a, 653.
- Italian style in flower-gardening, the, 573.
- Italy, revival of gardening in, 3.
- James' translation of Le Blond's work on gardening, 609.
- Jeffrey's marine glue, use of, in glazing, 541, 542.
- Johns & Co., their process for coating iron, 128.
- Joiner-work, specifications as to expense of, in different localities, 742.
- Joints, the construction of, for hot-water pipes, the composition for closing them, &c., 156—various kinds of them, 246.
- Jucke's smoke-consuming furnace, 257.
- Justice, Mr, method for the preservation of fruit after gathing employed by, 493.
- Kames, lord, improvements in gardening introduced by, 8.
- Kashmir hive, the, 526.
- Kemp, Mr, on rockwork, 703.
- Kendall's hot-air stove, description of, 225—double pit, 435.
- Kensington gardens, the arboretum in, 585.
- Kent, Mr, cultivation of aquatics by, 414.
- Kent's mode of glazing, 543.
- Ker, B., Esq., form of espalier used by, 558.
- Kerslake's universal flue-boiler, 181.
- Kew, the palm-stove at, 119, and Plate xiv.—the architectural conservatory at, 367—greenhouse at, 389—the orangery at, 400—the orchid-house at, 408—form of rafter used at,

- 545—the palm-stove and flower-garden at, 620, and Plate xxx.
- Kewley, Mr, his system of heating by hot-water pipes, 154.
- Kilikee, conservatory with fruit-houses at, 376, and Plate xx.
- Kitchen boiler, a, for hot-water heating, 183.
- Kitchen gardens, *see* Garden.
- Knight, R. P., on harmony of colours, 599.
- Knight, T. A., improvements in hothouse-building introduced by, 108—on the proper angle of elevation for hothouses, 135—improvements in ventilation introduced by, 276—the peach-houses of, 346—improvement of hotbeds by, 429—his system of ventilating them, 430—his melon pit, 433—on the preservation of fruit after gathering, 487, 488.
- Kyanising wood, effects, &c. of, 568.
- Kyle, the peach-houses of, 346.
- Ladiston, the orchid-house at, 410.
- Lambton castle garden, size of, 12.
- Lansdowne, the marquis of, pinetum formed by, 588.
- Latour, Mr, mode of ventilation used by, 279.
- Lauder, Sir Thomas Dick, on geometrical flower-gardens, 606—on the introduction of fountains into the flower-garden, 674—on wire and suspension bridges, 680—definition of the term picturesque by, 693.
- Lawe's hot-air stove, 217.
- Lawrence's system of tank-heating, 206.
- Lawrence, Mrs, the orchid-house of, 405—her aquarium and orchid-house combined, 417.
- Le Blond on terraces, 593.
- Le Notre, the style of gardening of, 4.
- Lead, employment of, for coping walls, 71—pipes made of, 242—employment of, for the construction of cisterns, 520.
- Leaden laps, various modes of glazing with, 540.
- Leaden pipes, prices of, in different localities, 748.
- Leaf, Mr, his mode of ventilation, 276.
- Lean-to hothouses, on, 108.
- Lean-to roofs, disadvantages of, for greenhouses, 385, 398.
- Legg's hydraulic engine, description of, 19.
- Light, influence of, on the preservation of fruit, 487.
- Lights or sashes, construction of, 545.
- Lime, prices of, in different localities, 746.
- Limekilns, on the attaching of, to hothouse furnaces, 259.
- Lindley, professor, on the circulation of air, &c., 212—on the general principles of ventilation, 271—on the way in which it is generally practised in relation to glass houses, 272—on the indoor culture of plants, 424—on the preservation of fruit after gathering, 491—on the causes of scorching of leaves, &c., in green-houses, 538.
- Lindley, J., his self-acting regulator, 278.
- Liquid manure, value of, to the kitchen-garden, 15.
- Liquid-manure tanks, construction, &c. of, 518—stink-traps for them, *ib.*—those at Dalkeith palace, 519.
- Liverpool Chronicle, the, on aquatic plants and their culture, 412.
- Llewellyn, Mr, the stove conservatory of, 381.
- Loddige, Messrs, effects upon plants experienced from the kyanising of timber by, 568—their arboretum, 585.
- London and Wise, Messrs, architectural walls constructed by, 93.
- London Horticultural Society, experiments with kyanised wood by the, 568.
- Loudon, Mr, on the situation of gardens, 19, 20—example of a suburban villa garden from, 22—on soil, 26—on conservative walls, 105—the ridge-and-furrow roof first proposed by, 109—on the advantages, &c. of ridge-and-furrow roofs, 116—on the advantages, &c., of metallic hothouses, 126, 127—on large conservatories, 131—on narrow ones, 132—on the most suitable angle of elevation for hothouses, 135, 136, 138, 139—improvements in heating introduced by him, 143—his chamber flue, 148—on heating by steam, 229—improvement of hothouse furnaces by him, 251—forms of peach-houses employed by him, 349—span-roofed one by him, 351—on the size of conservatories, 363—on the construction of ice-houses, 501—on the pressure, &c., on tanks and reservoirs, 516—his opinion regarding espaliers, 556—views of, on the harmony of colours, 598—on geometrical flower-gardens, 604, 608—on the pipes, &c., for fountains, 633—on the introduction of vases into gardens, 637, 639—on the disposal of statues in the flower-garden, 649—on the use of circular beds in the gardenesque style, 663—on bridges, 680—on the construction of artificial cascades, 715.
- Loudon, Mrs, definition of the pleasure-ground by, 879—on the French flower-garden, 609—on the formation of walks in the gardenesque style, 660—on rockwork, 705.
- Louvre ventilators, glass, 293.
- Lucas's self-acting pump, description of, 19.
- Lucombe and Pince, Messrs, the camellia-house of, 128.
- Lucullus, the gardens of, 2.
- Lusor's cement, 566.
- Luxembourg, the rose-garden of the, 666.
- Lyle, Mr, peculiar flue constructed by, 149.
- Lyon's system of tank-heating, 208.
- Lyon, Mr, the orchid-house of, 410.
- Mackenzie, Sir George, on the best form, &c., for hothouses, 108—embrasure-flue proposed by him, 146.
- Mackenzie & Mathews, Messrs, conservatory in connection with town mansion-house designed by, 372, and Plate xvii.
- M'Nab, Mr, experiments by, on the comparative advantages of span-roofed and lean-to greenhouses in winter, 398.
- M'Phail, Mr, form of garden recommended by, 13—on soil, 26—pit designed by him, 431—his opinion on espaliers, 556.
- Magazine of Botany, geometrical garden from the, 612.
- Maher, Mr, on the construction of the fruit-room, 493.
- Main, Mr, example of villa garden from, 23.
- Major and Low, Messrs, rosarium designed by, 665.

- Malgwyn castle vinery, the, 308.
- Mallet, Mr, on the construction of slate walls, 97—water-tank designed by him, mode of constructing it, 515.
- Marginal flower-borders, designs for, 631.
- Marnock, Mr, on the advantages, &c., of metallic hothouses, 125—account of the large conservatory at Bretton hall by him, 129—on concreting the surfaces of vine-borders, 322—on the construction of conservatories, 369.
- Marshall, Mr, on the proper extent of the kitchen-garden, 12—his opinion with regard to espaliers, 556.
- Marshall's antonica as a cement, 567.
- Mason the poet, employment of circular flower-beds by, 663.
- Mason-work, specifications as to the expense of, in different localities, 744.
- Masters, Mr, on the artificial production of ice, 512.
- Mastic cement, 565.
- Materials, on the durability of, 571.
- Mausoleums, introduction of, into the flower-garden, 654.
- Mawer, Mr, system of heating by steam by, 229.
- Mearns, Mr, introduction of chambered vine-borders by, 321—pit designed by him, 431.
- Measures of length, &c., tables of, 753.
- Medici, family of the, revival of gardening in Italy by the, 3, 573.
- Meek, Mr, account of the Polmaise mode of heating by, 219.
- Melon-houses, *see* Cucumber and Melon houses.
- Melon pit, description of a span-roofed, 449—that at Trentham, 455—Glendinning's, *ib.*—another, 458.
- Merrifield, Mrs, on the harmony of colours, 600.
- Metals, the expansion of different, 754.
- Metallic cement, 565.
- Metallic hothouses, advantages and disadvantages of, 125.
- Metallic paint, 564.
- Mill's cucumber pit, 441.
- Miller on the angle of elevation for hothouses, 135.
- Mingled flower-garden, the, 578.
- Minton, Messrs, orange-boxes executed by, 399—employment of their tiles for footpaths in conservatories, 560.
- Mitchell's system of tank-heating, 201—forcing pit, 444.
- Mixed garden, example of a, 45.
- Moist heat, advantages of, in hothouses, and means of securing it, 185.
- Monewell house, the grounds at, 663.
- Montgomery, Messrs, the sash-bar manufactory of, 548.
- Moor's lever ventilator, 295.
- Moorman, Mr, his mode of preserving fruit after gathering, 496.
- Moore, Mr, mode of ventilation employed by, 276—mode of covering glass-houses for the economising of heat proposed by, 553—on the harmony of colours in relation to the flower-garden, 598.
- Morris, Mr, on rustic seats, 706—on the introduction of artificial cascades into the picturesque style, 716.
- Moss-houses, on the construction of, 687—one by Mr Toward described, 688—that at Dalkeith palace, 711.
- Mosses, garden for the cultivation of, 667.
- Mouldings, objections to, in rafters, 545.
- Mud walls, construction of, 98.
- Mugliston's self-acting ventilator, 278.
- Mulgrave's cement, properties, &c. of, 565—employment of it as a paint, 562.
- Muller, Dr, on insensible combustion, 259.
- Munich botanic garden, aquarium at, 417.
- Munn's patent frame and bar hive, 522.
- Mural decorations, varieties, &c. of, 646.
- Murray, Mr, invention of the Polmaise mode of heating by, 219.
- Muscarium, the, 667.
- Musket, Mr, vinery constructed by, 306, and Plate xviii.
- Mushroom-houses, various kinds of, 466—the German, *ib.*—Seller's, 467—Hankin's, 469—one from the Gardeners' Chronicle, *ib.*—Patrick's, *ib.*—Baron d'Hoogvorst's, 470—Forsyth's, *ib.*
- Neeves, Mr, his boiler for hot-water heating, 176—his meridian pit, 430—his sash-bar, &c. 544.
- Neill, Dr, on garden soils, 27—on shelter to the garden, 35—opinion regarding espaliers held by him, 556.
- Nesfield, Mr, the garden at Kew laid out by, 620.
- Netherlands, mode of heating employed in the, 141.
- Newbattle abbey, the flower-garden at, 609—sun-dials in it, 645.
- Newton, Sir Isaac, views of, regarding colour, 595.
- Nicoll, Mr, form of garden recommended by, 13—on situation, 19—on soil, 26—on the formation of fruit-tree borders, 29—on garden walls, 66—on copings for them, 71—on the height proper for garden walls, 75—on the arrangement, &c. of them, 76—on wooden walls, 91—description of a hothouse furnace by him, 251—on ventilation, 291—his early vinery, 300—his late vinery, 301—his pineries, 331—his peach-houses, 348, 349—his opinion with regard to espaliers, 656.
- Niven, Mr, on insufficient ventilation, 130—vinery and pinery combined by him, 340—pine pit by him, 439.
- Noisette, M., account of a mode of ventilation by, 283.
- Nonesuch, gardens, &c. of, 6.
- Norbiton house, the garden at, 663.
- Norwegian portable seat, the, 692.
- Nuneham Courtenay, the orangery at, 402—the grounds at, 663.
- Nuthill, peach-houses at, 351—the flower-garden at, 618, and Plate xxix.—the fountains at, 635.
- Nutt's hives, 522.
- Nymphenberg, the fountain at, 632, 636.
- Oak, employment of, for edgings in gardens, 591.

- Otlands, the grotto at, 706.  
 Octagon, to construct a, on the ground, 720.  
 Oldacre, Mr, form of hot-air flue proposed by, 146—introduction and description of the German mushroom-house by, 466.  
 Orange boxes, examples of, 399.  
 Orange tree, mode of treatment of the, in England and on the Continent, 401.  
 Orangeries, construction of, 399—boxes for the trees, &c., *ib.* 400—those on the Continent and in England, 400—and treatment of the trees in the two, 401—example of one, *ib.*—various old ones, 402—proper form, &c. for them, *ib.*  
 Orchid-houses, construction of, 405—that of Mrs Lawrence, *ib.*—that of Mr Rucker, *ib.*—those at Dalkeith palace, *ib.*—that at Kew garden, 408—that of Messrs Booth at Hamburg, 409—that of Mr Lyons, 410—those of the Belfast botanic garden, 411.  
 Orchids, increasing taste for, 405.  
 Orontes, the grove of, 1.  
 Oropholite cement, 567.  
 Oval, to describe an, 721.  
 Oxford, walls at the botanic garden of, 93.  
 Oxfordshire, geometrical flower-garden in, 622, and Plate xxxi.  
 Oxidation, prevention of, in hot-water pipes, 241.  
 Painshill, conservatory at, 371—grotto at, 706.  
 Painting, specifications as to the expense of, in different localities, 748.  
 Painting and paints, various kinds of, &c., 562—Carson's anti-corrosion, *ib.*—Todd's patent protoxide, *ib.*—gas liquor, coal tar, &c., *ib.*—spirit of tar, *ib.*—Mulgrave's cement, *ib.*—Smith's economical paint, *ib.*—common anti-corrosion, *ib.*—Zeno's anti-corrosion, 563—black, *ib.*—green, *ib.*—white-lead, *ib.*—new white, 464—graining, *ib.*—spelter or white zinc, *ib.*—Fleming's, *ib.*—metallic, *ib.*  
 Palm-stove, the Kew, construction of, 119, and Plate xiv.  
 Panopticon flower-garden, a, 575.  
 Pantheon porte-fleur, the, 630.  
 Paquet, M., on window gardening, with examples, 421.  
 Parapets, construction of, with tiles, for gardeners' houses, 480, 481—various designs for them in gardens, 646.  
 Parker's cement, 565.  
 Parterre, origin of the term, 609.  
 Parterres, designs for, suited to the geometrical style, 623 *et seq.*—forms of, adapted to the picturesque, 698—examples of them, 699.  
 Pasley, T. S., on hot-air stoves, 227.  
 Patrick's mushroom-house, 469.  
 Patton, G., Esq., his pinetum, 587.  
 Paul, Messrs, work on the rose-garden by, 665, 666.  
 Pavement, employment of, for the copings of walls, 70—mode of constructing walls of it, 96—imitation of tessellated, 480—employment of it for the construction of water-tanks, 519, 521—best kinds, &c. of it for footpaths, 560—employment of it for constructing edgings in flower-gardens, 590—prices of different kinds of, 744.  
 Paxton, Sir Joseph, on conservative walls, 101—ridge-and-furrow roofed greenhouses first erected by, 109—on the ridge-and-furrow roof, 115, 116—on the proper angle of elevation for hothouses, 135—on Cruickshanks' mode of heating, 164—the large conservatory at Chatsworth built by him, 374—ridge-and-furrow greenhouse at Chatsworth erected by him, 395—on ridge-and-furrow roofed pits and their construction, 457—melon-house designed by him, 462—the form of sash-bar used by him, 544, 547—and of gutter, 549—on the geometrical flower-garden, with examples, 611—rockwork at Chatsworth constructed by him, 701.  
 Peach-houses, the construction of, 346—the ordinary form, *ib.*—the Dutch, 347—the Danish, *ib.*—the Scotch, 348—Atkinson's, *ib.* Nicol's, 349—Loudon's, *ib.*—the Dalkeith, *ib.*—the Nuthill, 351—a span-roofed one, *ib.*—Crosskill's, 352—Fleming's at Trentham, 353.  
 Pearson, Mr, on the preservation of ice in stacks, 502.  
 Pedestals for the flower-garden, on, 650.  
 Pellatt, Mr, introduction of corroborated glass by, 537.  
 Pelvilain's pine pits, description of, 448.  
 Penn's system of hot-water heating, 173.  
 Pentagon, to construct a, 720.  
 Perceval, Mr, on the angle of elevation for hot-houses, 138.  
 Perkins' coil system of hot-water heating, identity of the Roman *dracones* with, 153—description of it, 157 *et seq.*  
 Perspiration of plants, the, 273.  
 Peterhoff fountain, height of the, 636.  
 Petworth gardens, size of, 12.  
 Pictorial-gardenesque style in flower-gardening, the, 573, 577.  
 Picturesque, definition of the term, 693.  
 Picturesque flower-garden, general arrangement of the, 693—divisions of it, *ib.*—definition of its name, *ib.*—example of it, 694—partial admission of the architectural style along with it, 695—the rough and trivial varieties of it, 696—the arrangement, direction, &c. of the walks in it, *ib.*—general character of the ground required in it, 697—character of the trees, shrubs, &c., and style of planting suited to it, 698—example of the refined style of it, *ib.*, and Plate xxxiii—on the introduction of artificial decorations into it, 698—style of house which it suits, 699—various examples of it, *ib.*—the construction, &c. of rockwork in it, 701—hermitages, arbours, moss-houses and seats, 705—bridges adapted to it, 713—the employment, &c. of rills, rivulets, and cascades in connection with it, 715—rustic fences suited to it, 717.  
 Picturesque style of flower-gardening, definition of the, and subdivisions of it, 573—style of planting suited to it, 581.  
 Piered walls, construction of, 93.  
 Pillars' hive, 529.  
 Pine apple, first fruiting of the, in Great Britain, 7.  
 Pine or melon pit, a, 458.  
 Pine pits, *see* Pits.



- Pineries, construction of, 330—Speechly's form, 331—Nicol's, *ib.*—Atkinson's, *ib.*—Burns', 333—Henderson's, 334—the Bicton, 335—Hamilton's, 336—the Dalkeith, 337—the Bamford hall, 340—Nivens' combined with a vinery, *ib.*—a span-roofed one, 343—Fleming's, at Trentham, 344—the Pottaloch, 345.
- Pinetum, formation and general arrangement of the, 587—that at Bowood, 588.
- Pipes, size, arrangement, &c. of, for fountains, 633.
- Pipes, hot-water, proportion between them and the boiler, 232—their proper arrangement, size, &c., 233—modes of protecting them when carried to great distances, *ib.*—form best suited to them, 234—quantity required to heat certain surfaces, 238—tables of this, 240—best material for them, 241—means of preventing oxidation in them when of iron, *ib.*—earthenware ones, 242—various forms of stopcocks for them, 244—different kinds of connecting joints for them, 246—composition for joining them, *ib.*—with troughs attached to them, 249—glass and enamelled ones, *ib.*—prices of iron ones, in different localities, 743—of leaden ones, 748—of fireclay ones, 751.
- Pishobury, apiary at, 530.
- Pits, on covering the roofs of, to economise heat, 465—plan for ventilating them, 551.
- Pits and frames, various kinds of—those heated by fermentation, 429—by hot-water pipes, flues, &c., 438—cucumber and melon houses, 459—mushroom-houses, 466—conservative pits, 471.
- Pits heated by fermentation, general remarks on, 429—Knight's, 430—Neeves', *ib.*—the revolving, *ib.*—the German hotbed, *ib.*—the Alderstone, 431—M'Phail's, *ib.*—Mearns', *ib.*—the arched, 432—Baldwin's pine, *ib.*—the Edmonstone, 433—Knight's melon, *ib.*—the Heckfield melon, *ib.*—Atkinson's early forcing, 434—Atkinson's late forcing, *ib.*—Atkinson's melon, *ib.*—Thompson's, 435—Kendall's, *ib.*—Watson's cucumber, *ib.*—Glendinning's pine, 436—Forsyth's early forcing, *ib.*—Atkinson's succession pine, 437—Cooper's, for grapes, *ib.*
- Pits heated by smoke flues, hot water, &c., remarks on, 438—the Valleyfield, *ib.*—one for plants, 439—Niven's pine one, *ib.*—Glendinning's melon, *ib.*—Glendinning's fruiting pine, 440—the Worsley, *ib.*—Weeks and Day's, for hot-water bottom heat, 441—Mill's cucumber, *ib.*—Reid's propagating, *ib.*—Rogers', 442—Glendinning's, heated on Corbett's system, 444—Mitchell's forcing, *ib.*—the Dalkeith propagating, *ib.*—the Dalkeith bulb, 447—the Dalkeith cucumber, *ib.*—the Dalkeith nursing pine, *ib.*—the Dalkeith succession pine, 448—Pelvilain's pine, *ib.*—Atkinson's succession pine, with hot water and dung linings combined, 449—a melon or cucumber one, *ib.*—a tank-heated one, 450—a span-roofed one, 451—Fortune's plant one, 452—Dawson's cucumber, 453—German, for forcing French beans, &c., *ib.*—another for the same purpose, 454—one for forcing strawberries, *ib.*—one for forcing asparagus, *ib.*—improved asparagus one, *ib.*—Trentham melon and pine one, 455—Glendinning's melon one, *ib.*—plant ones at Frogmore, 456—ridge-and-furrow roofed ones, 457—pine or melon one, 458.
- Pits, conservative, different kinds of, 471—with solid walls, *ib.*—with hollow walls, *ib.*—with bottom ventilation, 472—a span-roofed cold one, *ib.*—a cold one for preserving vegetables during winter, 473—a span-roofed vegetable one, *ib.*
- Pitmaston, mode of ventilation employed at, 293.
- Plan, importance of, in forming a garden, 11.
- Plants, importance of aëration to, 272—method, &c., of their perspiration, 273—the growing and arrangement of them in conservatories, 362, 380—kinds of, suitable for growing in vases, 640.
- Plant cases, house, examples of, 423.
- Plant-houses, erection, &c. of—conservatories, 360—greenhouses, 385—orangeries, 399—heath-houses, 402—orchid-houses, 405—aquariums, 412—window gardening, 420.
- Plant pit, Fortune's, 452—the Frogmore one, 456.
- Plant stage, peculiar, for greenhouses, 393.
- Plant tables for greenhouses, forms for, 394.
- Planting to produce effect, remarks on, and the styles suited to each style of flower garden, 580—style of it suited to the gardenesque garden, 657—and to the picturesque, 698.
- Plastering, specifications of expense of, in different localities, 743.
- Plate glass, employment of, for hothouses, 537.
- Platt, Sir H., suggestion by, regarding heating, 153, 228.
- Pleasure-ground, the, as distinguished from the flower-garden, 579.
- Pliny, the garden of, 2.
- Plumberwork, specifications of expense of, in different localities, 748.
- Plums, forcing of, and houses for it, 355.
- Polish bee-hive, the, 525—improved one, 527—variety of it, 528.
- Polmaise hot-air stove, the, 219 *et seq.*
- Pottaloch, average fall of rain at, and quality of the soil, 27—entrance to the garden at, 34—description of the garden, 51, and Plate vi.—peculiar gutter used in the hothouses, 116, and Plate viii.—stopcocks for hot-water pipes used at, 244—pineries at, 345—the greenhouse at, 397—cucumber and melon-houses at, 461.
- Polyproseopic houses, ventilation of, 288.
- Ponds, objections to, in gardens, 15.
- Pope, the garden of, at Twickenham, 8.
- Porte-fleurs, designs for, 630.
- Portland cement, 566.
- Pressure, amount of, on boilers, 265.
- Preston hall, the arboretum at, 586.
- Price, Sir Uvedale, on geometrical flower-gardens, &c., 605, 607—on fountains, 631, 637—on the introduction of vases into gardens, 641—on the introduction of artificial decoration into the flower-garden, 647—on wooden bridges, 680—on the meaning of the term picturesque, 693—on the picturesque style of gardening, *ib.* 695.

- Primary colours, what, 595.  
 Pugin, Mr, orange box designed by, 399.  
 Fulham, Mr J., vase in terra-cotta by, 644.  
 Pulteau's hive, 525.  
 Putty, different kinds of, used in glazing, 544.  
 Puzzolano earth cement, 565.
- Quarries, a kind of paving tiles, 561.  
 Quarterly Review, the, on the different styles of flower-gardening, 700.
- Radiation, diffusion of heat by, 191, 212.  
 Rafters, the construction of, 545—form of them used at Kew, *ib.*—objections to mouldings in them, *ib.*—one without these, 546—the cast-iron ones used at Woburn abbey, *ib.*—one without projecting styles, *ib.*—those used in Dalkeith gardens for pits, *ib.* 547—a wooden one with double groove, 547—wooden ones, *ib.*—copper ones, *ib.*
- Rain, average fall of, and its values, 514, 755.  
 Rain water, advantages to the garden of the collection of, and provision for collecting it at Dalkeith gardens, 14.  
 Ransome and Parsons, the patent stone of, 647.  
 Read, Mr, his mode of glazing, 539.  
 Rectangular mode of glazing, the, 540.  
 Redleaf, the garden at, 663.  
 Reed walls, construction of, 100.  
 Refined picturesque style in flower-gardening, definition, &c. of the, 573, 577—example of it, 698, and Plate xxxiii.
- Regency cottage, conservatory at the, 371.  
 Regent's Park, ventilation of the Botanical Society's conservatory in the, 292—construction, &c. of the conservatory, 368—suspension bridges in the, 680.
- Registers, introduction of, into furnaces, 251.  
 Reid's propagating pit, 441.  
 Reid's ventilating chimney, 279.  
 Remington's bridge, description, &c. of, 682.  
 Rendle, Mr, introduction of tank-heating by, 192—his system of it, 198, 196, 198.  
 Repton, Mr, on harmony of colours, 595.  
 Reserve flower-garden, the, 595.  
 Respiration of plants, the, 272.  
 Rettie, Mr, his system of heating, 166.  
 Revolving frame, the, 430.  
 Revolving hives, 528.  
 Rhomboidal mode of glazing, the, 540.  
 Ridge-and-furrow roof, introduction of the, and the different claimants to the invention of it, 109—example of a greenhouse with it, 395—application of it to pits, with examples, 457.  
 Ridge-and-furrow roofs, the construction of, 115—the ventilation of houses with them, 288—application of the suspension principle to them, 382.
- Rills, treatment of, in the picturesque style, 715.  
 Rishton's registered sash, 543.  
 Ritterbandt, Dr, his process for preventing incrustation in boilers, 237.  
 Rivers' improved Arnott's stove, 215—and its application to small town-gardens, 729—his orchard-houses, 730.  
 Roberts' hollow-brick walls, 86.  
 Rock plants, stands for, 658.  
 Rockwork, construction of, 701—that at the Colosseum, Regent's Park, *ib.*—that at Blenheim, *ib.*—that at Sion house, *ib.*—Mr Skirving's, *ib.*—that at Chatsworth, *ib.*—that of Lady Broughton at Hoole house, 702—another example of it, *ib.*—general remarks on it, 703 *et seq.*
- Rogers, Mr, on fruit-tree borders, 29, 30—on the height of garden walls, 76—his system of heating by hot-water pipes, 165—on the securing of moist heat, 185—general remarks by him on heating by hot water, 186—on combustion and management of fuel, 260—pit designed by him, 442—his opinion with regard to espaliers, 556.
- Rollo, lady, the arboretum of, 586.  
 Romans, state of gardening and gardens among the, 2—glass houses known among them, 153—mode of heating by hot water practised among them, *ib.*—use of ice among them, 497.  
 Roman cement, employment of, for constructing the copings of garden walls, 71—varieties, &c. of it, 565, 566.
- Roofs, curvilinear, construction of, 123.  
 Roofs, suspension, proposed, 114.  
 Rootwork, construction of, 705.  
 Rosarium, formation of the, 664—examples of it, 622, 665 *et seq.*
- Rose garden, the, *see* Rosarium.  
 Rough picturesque style in flower-gardening, the, 573, 577.
- Rous, M. de, fountains at Nuthill garden designed by, 619, 635.  
 Royal Botanical Society, conservatory of the, at the Regent's Park, 368.  
 Rucker, Mr, the orchid-house of, 406.  
 Runford, count, improvements in the mode of heating introduced by, 143—on hot-air stoves, 226—improvements in furnaces by, 251.  
 Running bond, what, in bricklaying, 107.  
 Russell's patent glass tile, 537.  
 Russia, history of gardening in, 5—mode of heating in, 141.
- Rustic architecture, designs for, 713.  
 Rustic basketwork, employment of, in the gardenesque style, 676 *et seq.*
- Rustic bridges, examples of, for the gardenesque style, 681 *et seq.*—examples suited to the picturesque style, 713.  
 Rustic fences, styles of garden into which admissible, 579—kinds of, suited to the picturesque style, 717.  
 Rustic vase, example of a, 675.  
 Rustic work, general remarks on, 708, 713.
- Saddle joint, the, for hot-water pipes, 246, 247.  
 St Cloud, height of fountain at, 636.  
 St Mary's chapel, mode of heating, 144.  
 Salt, the mixing of, with ice, 497.  
 Sampson's system of heating by hot water, 167.  
 Sand, prices of, in different localities, 746.  
 Sanders, Mr, vinery by, 313.  
 Sashes, the construction of, 545.  
 Sash-bar, reversing the position of, in glazing, 543.  
 Sash-bar cutting machine, the, 548, 549.  
 Saul, Mr, mode of cleaning flues employed by, 150—vinery by him, 311—his mode of glazing, 540—his sash-bar, 545.  
 Schoenbrunn, the hothouses of, 5.  
 Sckell, aquarium designed by, 417.  
 Scorching, causes of, in hothouses, 533.

- Scoria walls, construction of, 99.  
 Scotch distillers' boiler, the, 177.  
 Scotland, history of gardening in, 7—origin of glass houses in, 9—form of peach-house used in, 348—inferiority of the bricks made in, 571—specifications regarding the prices, &c. of brickwork in, 738 *et seq.*—of slates and slating, 741—of plastering, 742—of carpenter-work, *ib.*—of ironwork, 743—of cements, 744—of mason-work, *ib.* 745—of lime and sand, 746—of glass and glazing, 747—of painting, 748—of plumber-work, *ib.*—of wire-work, 749.  
 Scott, Mr, on the proportion of pipe requisite for heating, 241.  
 Screen walls, construction of, 101.  
 Sculpturesque style in flower-gardening, the, 573.  
 Seats, kinds of, adapted to the geometrical flower-garden, 650—kinds of, for the gardenesque garden, 690 *et seq.*—and for the picturesque, 706, 708.  
 Secondary colours, what, 595.  
 Self-acting ventilators, various kinds of, 277.  
 Sellers' mushroom-house, 467.  
 Sepulchral structures, introduction of, into the flower-garden, 654.  
 Serpentine walls, construction of, 100.  
 Seysse's asphalt, 566.  
 Shadows, rules for calculating the length of, 724.  
 Shearer, Mr, gardener at Yester house, 19—chambered fruit-tree borders constructed by, there, 31—vinery by, 328.  
 Sheet glass, various qualities and prices of, 532—mode in which manufactured, and imperfections to which liable, 538.  
 Shelter, importance of, and how to provide it, 34.  
 Shelves, greenhouse, construction of, 394.  
 Sheringham's ventilator, 295.  
 Sherwood, Mr, on tank-heating, 196.  
 Shield mode of glazing, the, 540.  
 Shiells, Mr, account of flued walls by, 87.  
 Shrewsbury, the earl of, conservatory at the residence of, 366.  
 Shrubs, kinds, &c. of, suited to the gardenesque garden, and mode of disposing them in it, 657—kinds suited to the picturesque garden, &c., 698—to the town garden, 731—to the small suburban garden, 735 *et seq.*  
 Silverlock's hollow-brick wall, 83.  
 Sion house, insufficient ventilation of the large conservatory at, 130—description of the conservatory, 368, and Plate xvi.—results experienced with kyanised timber at, 568—strictures on the rockwork at, 701.  
 Situation, importance of, as regards the kitchen garden, 19—evils of a low one, 20—to be preferred to soil, *ib.*—direction and slope of it, 21.  
 Skirving, Mr, rockwork formed by, 701.  
 Slate, employment of, for constructing the copings of garden walls, 71—construction of walls of it, 96, 97—employment of it for the construction of water cisterns, 521—durability, &c. of the different kinds of, 572—employment of it for border edgings in gardens, 590, 621—and for coping, terraces, &c., 647.  
 Slates and slating, considerations as to the expense of, in different localities, 741.  
 Slate plant-boxes, prices of, 742.  
 Sluices for tank heating, construction of, 195.  
 Smith, A., Esq., hothouse built by, 128.  
 Smith, C. H., hot-water apparatus invented by, 175.  
 Smith, Mr, tank heating first used by, 192.  
 Smith, Mr, mode employed by, for the preservation of fruit after gathering, 493.  
 Smith, Mr, ice-house at the Hirsal constructed by, 509.  
 Smith, Mr, of Snelston hall, geometrical flower-garden designed by, 612.  
 Smith's economical paint, 562.  
 Smoke, importance of the consumption of, 143—causes of the production of it in furnaces, 258—its effects on vegetation, 259—loss of fuel by it, *ib.*  
 Smoke-consuming furnaces, on, 254.  
 Smoke flues, *see* Flues.  
 Snow, Mr, his mode of glazing without overlaps, 538.  
 Soil, importance of, to the garden, 25—nomenclatures of the different kinds of it, 26—the formation of artificial, *ib.*—the amelioration of bad, 27—proper depth, &c. of it, *ib.*  
 Solomon, the gardens of, 1.  
 Spain, plant-houses, &c. in, 3.  
 Span roof, advantages of the, for the health-house, 402—comparison between it and the lean-to for the greenhouse, 385, 398.  
 Span-roofed cold pit, a, 472.  
 Span-roofed conservative pit, a, 473.  
 Span-roofed espalier, a, 558.  
 Span-roofed hothouses, remarks on, 108—ventilation of them, 289, 291.  
 Span-roofed peach-houses, construction of, 351.  
 Span-roofed pineries, construction of, 343.  
 Span-roofed pit, a, heated by hot water, 451.  
 Span-roofed vegetable pit, a, 473.  
 Span-roofed vineries, construction of, 317.  
 Specific gravities, tables of, 755.  
 Speechly, Mr, the early vinery of, 300—his pineries, 331—his peach-houses, 346.  
 Speltre paint, 564.  
 Spencer, Mr, the glass walls of, 90—account of the mode of aerating a vinery by, 323—his mode of glazing, 541—account of the pinetum at Bowdoy by, 588.  
 Spigot-and-faucet joint for hot-water pipes, the, 246, 247.  
 Spirit of tar, employment of, for painting, 562.  
 Square fret-wall, the, 99.  
 Stafford's vinery for pot culture, 312.  
 Stages, arrangement of, in the greenhouse, 386, 389, 393.  
 Stark, Mr, cultivation of ferns by, 667.  
 Statues, on the introduction of, into the flower-garden, 648—their formation of iron, *ib.*—various materials in which made, 649.  
 Steam, comparison between heating by, and hot water, 191—on heating by, 228—the history of it, *ib.*—Loudon on it, 229—its disadvantages, *ib.*—method of it, 230—employment of it for increasing humidity in hothouses, 243.  
 Stephenson's double cylindrical boiler, 169—his conical boiler, 170.  
 Stevenson, Mr, form of flue proposed by, 146—his method of glazing, 539.

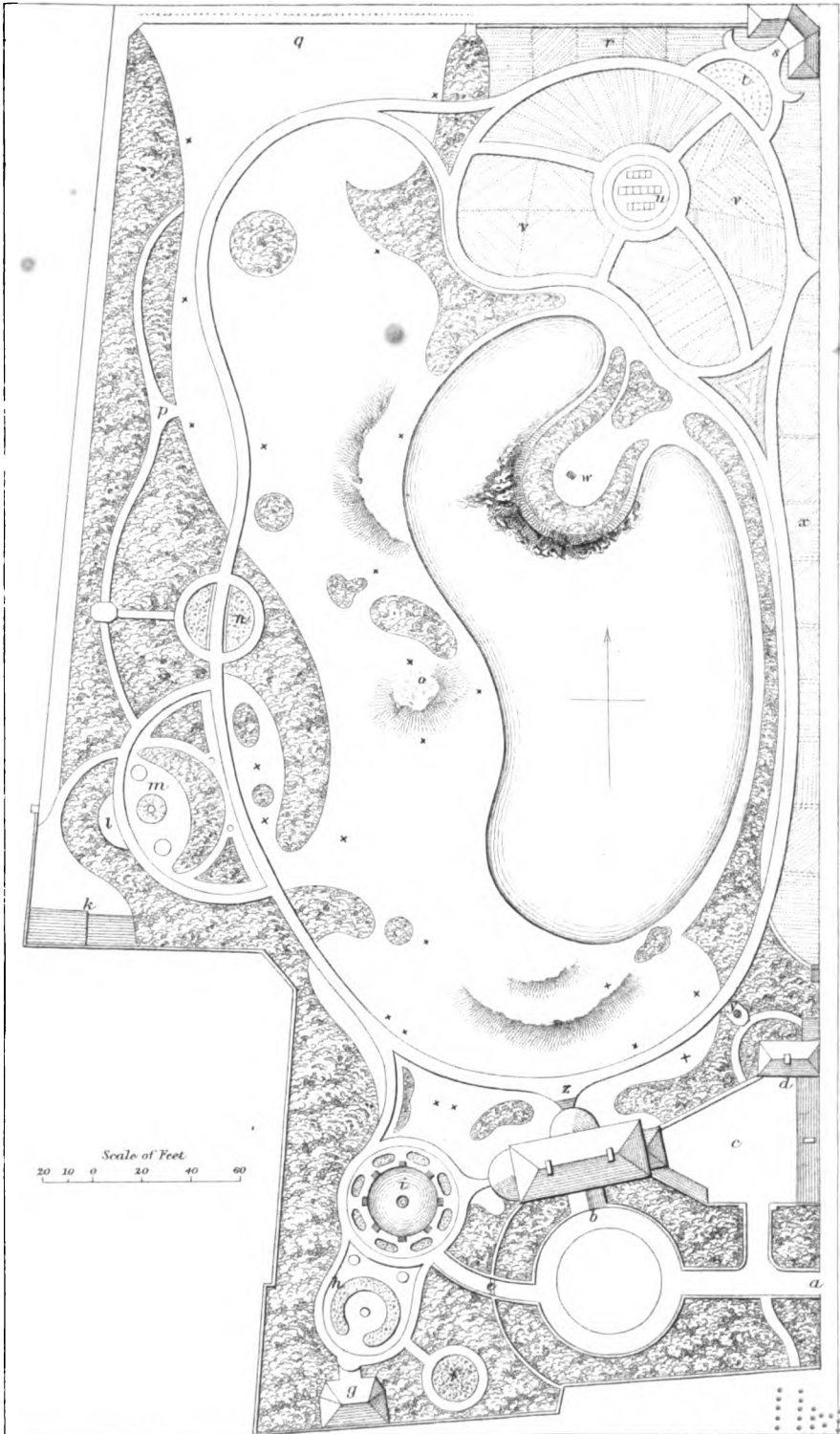
- Stewart's pit, construction of, 438.
- Stewart, Mr, of Valleyfield, his pits for preserving vegetables, 473.
- Stewart, Mr, mode employed by, for the preservation of fruit after gathering, 493.
- Stink traps, construction of, for liquid-manure tanks, 518.
- Stoke park, the gardens at, 650.
- Stoke place, mushroom-houses at, 469—rustic vase from, 675.
- Stoke-holes, importance of the drainage of, 262.
- Stone, on, as a material for walls, 68—durability of different kinds of it, 572—employment of it for garden seats, 651—prices, &c. of different kinds of, 744 *et seq.*
- Stone walls, comparative durability of, 572—hollow, 82.
- Stopcocks, kinds of, for tank-heating, 195—construction of, for hot-water pipes, 244.
- Storch, description of the Taurida winter garden by, 5.
- Stoves, hot-air, heating by, 213—objections to it, *ib.*—Rivers' improved Arnott's, 215—Allen's Archimedean, 216—White's, *ib.*—Lawe's, 217—one from Dr Ure's Dictionary, 218, 219—the Polmaise system, 219—Burbidge and Healy's, 223—Hazard's, 224—Kendall's, 225—general remarks on them, 226 *et seq.*
- Stratton park, the orangery at, 400.
- Strawberries, pit for forcing, 453—another, 454.
- Stretchers, what, in bricklaying, 106.
- Strutt, Mr, his mode of heating, 215.
- Stuart style of flower-gardening, the, 576.
- Studs, kinds of, for wall trellises, 74—permanent, for garden walls, 106.
- Styles, classification of, in laying out the flower-garden, 573.
- Suburban villa garden, example of a, 22, and Plates i. ii.—another, 23, and Plate iii.—another, 24.
- Suburban villa gardens, small, laying out, &c. of, 733—fruit trees for them, 734—herbs, 735—trees, *ib.*—deciduous shrubs, *ib.*—evergreen shrubs, *ib.*—coniferæ, 736—hardy herbaceous plants, *ib.*
- Sulphate of copper, employment of, for preserving timber, 569.
- Summer-houses, designs for, 710—remarks on, 712.
- Sunderland-Wick, vinery at, 305—greenhouse at, 391.
- Sun-dials, introduction of, into the geometrical flower-garden, 645—those at Newbattle abbey, &c., *ib.*—another, *ib.*
- Sunk walks, formation of, 684.
- Sunk walls, construction of, 94.
- Suspension bridges, various kinds of, 679 *et seq.*
- Suspension principle, proposed application of the, to the roofs of conservatories, 114, 382.
- Swinton park, the conservatory at, 371.
- Switzer, Mr, on garden walls, 65—on the proportions, &c. of the parterre, 609.
- Sylvester's furnace-doors, 262.
- Syphon system of hot-water pipes, the, 155.
- Tan, pipes heated by, *see* Pits heated by fermentation.
- Tank, melon pit heated by, 450.
- Tank-heating, origin, &c. of, 192—Rendle's system of it, 193—Cameron's system, 194—Weeks', *ib.*—the Hon. Robert Clive's, *ib.*—Bailey's, *ib.*—Green's, *ib.*—that used at Dalkeith palace, 195—stopcocks and sluices for it, *ib.*—Rendle's improved system of it, 196, 198—on the use of a large or a small body of water in it, 196—materials for the tanks, 197—Corbett's system, 199—Huysh's system, 200—Clive's improved, 201—Mitchell's, *ib.*—Glendinning's, 202—Fleming's, *ib.*—Haycraft's, 203—one from the Gardeners' Journal, 204—Toy's, 205—Lawrence's, 206—Tinker's, 207—Lyon's, 208—Baker's, 209—general remarks on it, 210—Burbidge and Healy's system, 211—Fenn's, *ib.*—Dr Lindley on it, 212.
- Tanks, specifications as to prices of, 752.
- Tanks, cast-iron, for heating, 211.
- Tanks and cisterns for water, construction of, 513—filtering tanks, with examples, *ib.*—another, 515—Mallet's, *ib.*—calculation of the pressure, &c. on them, 516—amount of friction, &c. in the conducting pipes, 517—construction of liquid-manure ones and traps for them, 518 *et seq.*—common rain-water ones, 520—cast and wrought iron ones, 521—brick ones, *ib.*—air and vermin traps for them, 522.
- Tarras cement, 565.
- Taurida palace, the winter garden of the, 5.
- Taylor's improved collateral ventilating hive, 623.
- Taymouth, entrance to gardens at, 32.
- Teddington grove, the garden at, 663.
- Tedworth park, hothouse at, 128—vinery at, 313.
- Temperature, the proper, for the preservation of fruit, 487.
- Temple, Sir William, on the proportions of the parterre, 609.
- Temples, introduction of, into the geometrical flower-garden, 651.
- Tension and suspension bridge, a, 681.
- Terra-cotta, vases in, 643.
- Terrace gardens, what, 611.
- Terrace walk, the, 695.
- Terraces, laying out of gardens in, 21—construction of them in flower-gardens, 593—various kinds of them, *ib.*—construction of them in the gardenesque style of flower-garden, 655.
- Terracing walls, on, 95.
- Terracing the ground in flower-gardening, on, 593.
- Tertiary colours, what, 596.
- Tesselated pavement, imitation of, with common bricks, 480.
- Thatch, employment of, for coping walls, 71.
- Thimble joint for hot-water pipes, the, 246, 247.
- Thomas, Mr, the Acis and Galatea fountain by, 634.
- Thompson, Mr, mode of ventilation employed by, 293—on the preservation of fruit and the construction of fruit-rooms, 487.
- Thompson's pit, 435.
- Thomson's boiler, 178.
- Thorsby hall, experiments at, on kyanising timber, 568.

- Tiles, various kinds of, 572—employment of, for edgings in gardens, 590.
- Timber, on the preservation of, as used in hot-house-building, 567—the causes of its decay, *ib.*—means for the prevention of decay in it, kyanising and its defects, 568—Burnettising, 569—preparing it with sulphate of copper, *ib.*—Bethell's preparation, 570—Boucherie's method, *ib.*—Boyd and Miller's antiseptic paint, *ib.*—Gemini's method, 571—various qualities of it, and their comparative values, *ib.*—prices and qualities of it in different localities, 742.
- Tinker's system of tank-heating, 207.
- Todd, Mr, aquarium constructed at White Knights by, 417.
- Todd's patent protoxide paint, 562.
- Tomlinson, Mr, on tank-heating, 212—on the conduction and radiation of heat, 213—on the joints of hot-water pipes, 248—on the causes, &c. of the circulation of hot water, 270.
- Tonsile style in flower-gardening, the, 573, 574, 611.
- Tottenham park gardens, size of, 12—pinery at, 333—the orangery at, 400.
- Toward, Mr, designs laid out at Bagshot park by, 629—account of moss-house constructed by, 688.
- Towers, Mr, on shelter, 35.
- Town gardens, employment of vases for culture in, 639—laying out of them, 725—disadvantages of laying them down on grass, 726—forms of parterres, &c. for them, *ib.*—filling them with plants in a portable state, 727—proposed covering them over with glass, *ib.*—covered verandahs for them, 728—means of providing artificial heat in them, 729—plants and flowers suitable for them, 731.
- Toy's system of tank-heating, 205.
- Trainers for climbing plants, 686.
- Tredgold, Mr, on the quantity of pipe required to heat a given surface, 238—on the construction of furnaces, 252—on the causes of the circulation of hot water, 263.
- Tree-guards, kinds of, for the gardenesque garden, 686.
- Trees and shrubs, kinds of, suited to the different styles of flower-garden, 581—the planting and grouping of them, *ib. et seq.*—kinds of them suited to the gardenesque style, 657—and to the picturesque, 698—for the suburban garden, 735.
- Trellis-work, formation of, in the gardenesque style, 683.
- Trellises, hothouse, construction of, 134—for vineries, 330.
- Trellising, application of, to garden walls, 74.
- Trent park, the garden at, 663.
- Trentham hall, situation of the garden at, 19—new conservatory at, 181—mode of ventilation employed at, 286—heating vine borders at, 326—pineries at, 344—peach-houses at, 353—melon and pine pits at, 455—curvilinear espaliers used at, 559—the flower-garden at, 613—the mausoleum at, 654—flower-borders at, 673.
- Triangular garden, plan of a, 614.
- Triewald, Sir M., mode of heating proposed by, 153.
- Triton fountain, the, from the Barberini palace, 627.
- Trivial picturesque style in flower-gardening, the, 573, 577.
- Tropical fruit house, construction of the, 358.
- Tudor style, flower-garden in the, 575.
- Turner, Mr, the Kew palm-stove erected by, 119—mode of ventilation employed by, 292—conservatory for first-class residence designed by, 375, and Plate xix.—conservatory with fruit-houses at Killikee by, 376, and Plate xx.—domical conservatory by, 377, and Plate xxi.
- Tweed, wire bridge over the, 679.
- Tweedie, Mr, mode of ventilation employed by, 280.
- Twickenham, Pope's garden at, 8.
- Tyson, Mrs, description of Lawe's hot-air stove by, 217.
- Unicombe observatory hive, the, 530.
- United States, present state of gardening, &c. in the, 6—the ice trade of the, mode of preparing the ice, &c., 497.
- Ure, Dr, on the theory of artesian wells, 17—hot-air stoves described from his dictionary, 218, 219—on hot-air stoves, 228—on insensible combustion, 259.
- Ure's asphalt, 566.
- Ure's ventilating fan, 279.
- Urns, distinction between, and vases, 642. *See* Vases.
- Valentia slates, qualities of, 572.
- Valleyfield pit, the, 438.
- Vanbrugh, Sir John, the gardens at Claremont laid out by, 92.
- Vanhuysen, the flower-pieces of, 599.
- Varden, Mr, designs of parapets by, 647.
- Vases, heating by radiation from, 112.
- Vases and urns, introduction of, into the geometrical style of flower-garden, 637—examples of different styles of them, 638—their employment in town gardens, 639—plants suitable for growing in them, 640—Sir Uvedale Price on their introduction into the garden, 641—the Dove Tazza, 642—cast-iron one from the Coalbrooke-dale Company's works, 643—two in terra-cotta, *ib.*—one by M. Garnaud, 644—one by M. Ducler, *ib.*—one by J. Fulham, *ib.*—urn from the Grangemouth Company's works, 645—employment of them in the gardenesque style, 674—specimen of the kinds suited to it, 675.
- Vegetables, pits for the preservation of, during winter, 473.
- Vegetation, effects of smoke on, 259.
- Veitch, Messrs, mode of tank-heating employed by, 198.
- Veitch, Mr, cultivation of mosses at Arniston by, 667.
- Ventilation, provisions for securing, in the Poltalloch hothouses, 55—difficulty of providing it in curvilinear houses, and means of doing so, 124—difficulty of effecting, in large conservatories, 130—neglect of it generally prevalent, 271—general theory and principles of it, *ib.*—modes of it first adopted, *ib.*—Professor Lindley on it as generally practised,

- 272—mechanical inventions for it, 273—amount of it required, *ib.*—Hood on it, *ib.*—Mr Williams' mode, 275—importance of the air being warmed, *ib.*—purposes for which it is required, *ib.*—Moore's method, 276—Leaf's, *ib.*—Atkinson's, *ib.*—Williams' self-acting method, 277—Mugliston's self-acting, 278—Dr Anderson's, &c., 279—Latour's and Booth's methods, *ib.*—Tweedie's, 280—Hurdwood's, *ib.*—Fortune's, 281—that of curvilinear houses, 282—modes employed on the Continent, 283—Clive's method, *ib.*—various modes, *ib. et seq.*—Fleming's at Trentham, 286—that at Frogmore, 288—that of houses with curvilinear and ridge-and-furrow roofs, *ib.*—that of span-roofed houses, 289, 291—methods selected from the Gardeners' Journal and Magazine, 290—Nicol's method, 291—Turner's, 292—Weeks', *ib.*—Sheringham's ventilator, 295—Arnott's ventilating valve, *ib.*—Moor's lever ventilator, *ib.*—Glendinning on it, *ib.*—example of insufficient, in a large house, 296—Errington on it, 297—peculiar, for circular aquariums, 416—plan of it for pits, 465.
- Verandahs, construction of, in town gardens, 728.
- Vermin-traps for cisterns, 522.
- Versailles, the gardens of, 4—height of the waterworks at, 636.
- Vesta stove, the, 226.
- Victoria regia, house for the, at Dalkeith palace, 408.
- Villa garden, example of a, 22, and Plates i. ii.—another, 23, and Plate iii.—another, 24.
- Villa gardens, small, laying out of, &c. 733 *et seq.*
- Vineries, the construction of, 299—those common on the Continent, *ib.*—curvilinear ones for early forcing, *ib.*—Speechly's early, 300—Nicol's early, *ib.*—Acon's early, 301—Acon's late, *ib.*—Nicol's late, *ib.*—various forms used on the Continent, 302—the Danish, *ib.*—French's, 303—Atkinson's, *ib.*—Atkinson's, with hot water, 304—Crosskill's, 305—Musset's, 306, and Plate xviii.—those used in Dalkeith gardens, 307—that at Malgwyn castle, 308—Henderson's, 309—for vines in pots, 310—Saul's, 311—Stafford's, for pot culture, 312—Burn's, for pot culture, *ib.*—for two crops annually, 313—Sanders', *ib.*—those at Frogmore, 314—White's, 315—Span-roofed ones, 317—curvilinear span-roofed ones, 318—formation of the borders, 320—chambered borders, 321—concreted borders, 322—aération of them, 323—subterranean chambering the borders, 325—heating the borders, 326—those at Yester, 328—trellises for them, 330—Niven's, combined with pinery, 340.
- Volutes, plans for drawing, on the ground, 719.
- Waistell, Mr, estimate of the annual fall of rain by, 14—filtering tank invented by, 513.
- Wakefield, heating by steam first employed by, 228.
- Waldron's boiler, 177—sash-bar, 547.
- Walks, formation of, in the gardenesque garden, 659—and in the picturesque, 696—geometrical diagrams for setting them off, 721, 722.
- Walker, Dr, on garden walls, 66.
- Walker, Mr, his system of hot-water heating, 171—his method of forming radiators for hot-water heating, 188 *et seq.*—on hot-air stoves, 214—on the general principles of ventilation, 271.
- Wall-plates, construction of, 549.
- Wall trees, arrangements for watering, 16.
- Walls, first introduction of heated, into England, 5.
- Walls, garden, construction of—proper aspect for them, 65—their foundations, 66—different materials for them, 68—copings for them, 69—trellised ones, 74—proper height for them, 75—the arrangement of them to suit different situations, 76—most suitable colour for them, 77—various ways of constructing them, 78—the solid, *ib.*—the solid brick and concrete, 79—the hollow brick, *ib.*—hollow stone, 82—Hitcher's, of rebated bricks, 84—various others, 85—Roberts', 86—flued, *ib.*—Ewing's patent glass, 88, and Plate xi.—Spencer's glass, 90—wooden ones, *ib.*—architectural ones, 92—piered ones, 93—arched ones, *ib.*—sunk ones, 94—inclined ones, *ib.*—terraced ones, 95—those of slate, glass, &c., 96—brick, with iron uprights, 97—concrete ones, 98—clay ones, *ib.*—cob ones, *ib.*—flint ones, 99—various economical ones, *ib.*—on an inclined surface, 100—conservative ones, 101—studs for them, 106—explanation of terms used in relation to the building of them, 106.
- Wallace, Mr, the mortice-cutting machine of, 549.
- Walpole, Horace, on fountains in gardens, 637.
- Walsh, Mr, circular flue invented by, 149.
- Walton, Mr, mode of ventilation employed by, 294.
- Ward, Mr, his method of growing plants in the house, 420—examples of his cases for the purpose, 423, 424, 425.
- Warwick vase, the, 637.
- Water, the supply of, to the garden, and means for providing it, 14—kind best adapted for boilers, 237—importance of it in the garden, 513—tanks and cisterns for filtering and collecting it, *ib. et seq.*—annual fall of rain, 514—the supply of it to fountains, 632.
- Water cement, 566—Dihl's, 567.
- Waterfalls, artificial, construction of, 716.
- Water plants, beauty of, 410—their culture, *see* Aquariums.
- Water tanks, construction of, 520. *See also* Tanks and Cisterns.
- Waterproof canvass, preparation of, 554.
- Watson, Mr, his system of hot-water heating, 161.
- Watson's cucumber pit, 435.
- Weeks, Mr, his system of heating by hot water, 156—his improved boiler, 180—his saddle-shaped pipe-boiler, 181—his mode of tank-heating, 194—his mode of ventilation, 292—his forcing frame, 429.
- Weeks and Day's pit, 441.
- Welbeck, subterranean chambered vine-borders at, 325—the orangery at, 400—experiments on kyanising timber at, 568.
- Wells, Mr, employment of circular flower-beds by, 663.
- Welsh slates, qualities of, 572.

- Wenham Lake ice company, the, 497.  
 Westmoreland slates, qualities of, 572.  
 White's patent hot-air stove, 216.  
 White's vinery, 315.  
 White, Mr, sash-bar used by, 544.  
 White Knights, the aquarium at, 417.  
 White lead paint, 563.  
 White zinc paint, 564.  
 Whytehead, W. K., on the production of opaque smoke, 258.  
 Wicket gates, style of, in the gardenesque garden, 685.  
 Wighton's improved Polish hive, 527.  
 Wilhelm fountain, the, 636.  
 Wilkinson, Mr, on the angle of elevation for hothouses, 137.  
 William III., introduction of the Dutch style of gardening by, 611.  
 Williams, Mr, mode of ventilation employed by, 275.  
 Williams, Joseph, smoke-consuming furnace by, 257.  
 Williams, Mr Wye, smoke-consuming furnace by, 255.  
 Williams' argand furnace, 254.  
 Williams' boiler, 180.  
 Williams' self-acting ventilator, 277.  
 Williamson, Mr, on the angle of elevation for hothouses, 135.  
 Wind, force of the, 755.  
 Winds, the prevalent, 35.  
 Window gardening, general remarks on, 420—Mr Ward's plan, *ib. et seq.*—the kind of it prevalent on the Continent, with examples, 420—examples of Wardian cases, 423 *et seq.*—the Hopean apparatus for the preservation of cut flowers, 425—specimens of flower-baskets, flower-tables, &c. 426—the amateur's propagating-box, 428.  
 Windsor, the orangery at, 400—vases in the gardens of, 637.  
 Winter, pits for preserving vegetables during, 473.  
 Winter garden, laying out, &c. of the, 668.  
 Winter garden, the Taurida, 5.  
 Wintering vines, Mr Sanders' method of, 313—the method employed at Frogmore, 315—that practised at Dalkeith, 339.  
 Wire bridges, examples of, 679 *et seq.*  
 Wire espalier, a, 558.  
 Wire fences, remarks on, for flower-gardens, 579—introduction of it into the gardenesque garden, 685—the invention of it by the Chinese, and mode of its employment by them, 696—its suitability to the picturesque style of flower-garden, *ib.*  
 Wire-work, formation of live fences with the aid of, 580—employment of it for border edgings in flower-gardens, 591—specimens of these, 678—prices of it, 749.  
 Wise, changes introduced into gardening by, 8.  
 Witty's smoke-consuming furnace, 255.  
 Woburn abbey gardens, entrance to, 32—description of them, 48—walls heated by hot water at, 84—pinery at, 331—the peach-houses at, 348—the heath-house at, 405—cast-iron rafters used at, 546—the heath-garden at, 670.  
 Wolsey, cardinal, Hampton Court garden laid out by, 7.  
 Wood's copper conical boiler, 170.  
 Wood, on, as a material for constructing hot-water tanks, 197—construction of cisterns of, 521—employment of, for the construction of sashes, 545—and for that of rafters and astragals, *ib.*  
 Wooden bridges, Sir Uvedale Price on, 680—examples of them suited to the gardenesque style, 681—and to the picturesque, 713.  
 Wooden espaliers, construction of, 556, 557.  
 Wooden hothouses, comparison between, and metallic ones, 127.  
 Wooden walls, construction of, 91.  
 Worsley pit, the, 440.  
 Wright's quarries, employment of, for footpaths, 561.  
 Yester house gardens, proposed application of water in, 19—chambered fruit-tree border at, 31—vinery at, 315—heated vine-borders, &c., at, 328.  
 Young's beehive, 528.  
 Zeno's anti-corrosion paint, 563.  
 Zigzag wall, the, 100.  
 Zinc, pipes made of, 242—employment of, for the construction of sashes, 545—and of astragals, *ib.*  
 Zinc paint, 564.  
 Zubow, count, his mode of tank-heating, 194.

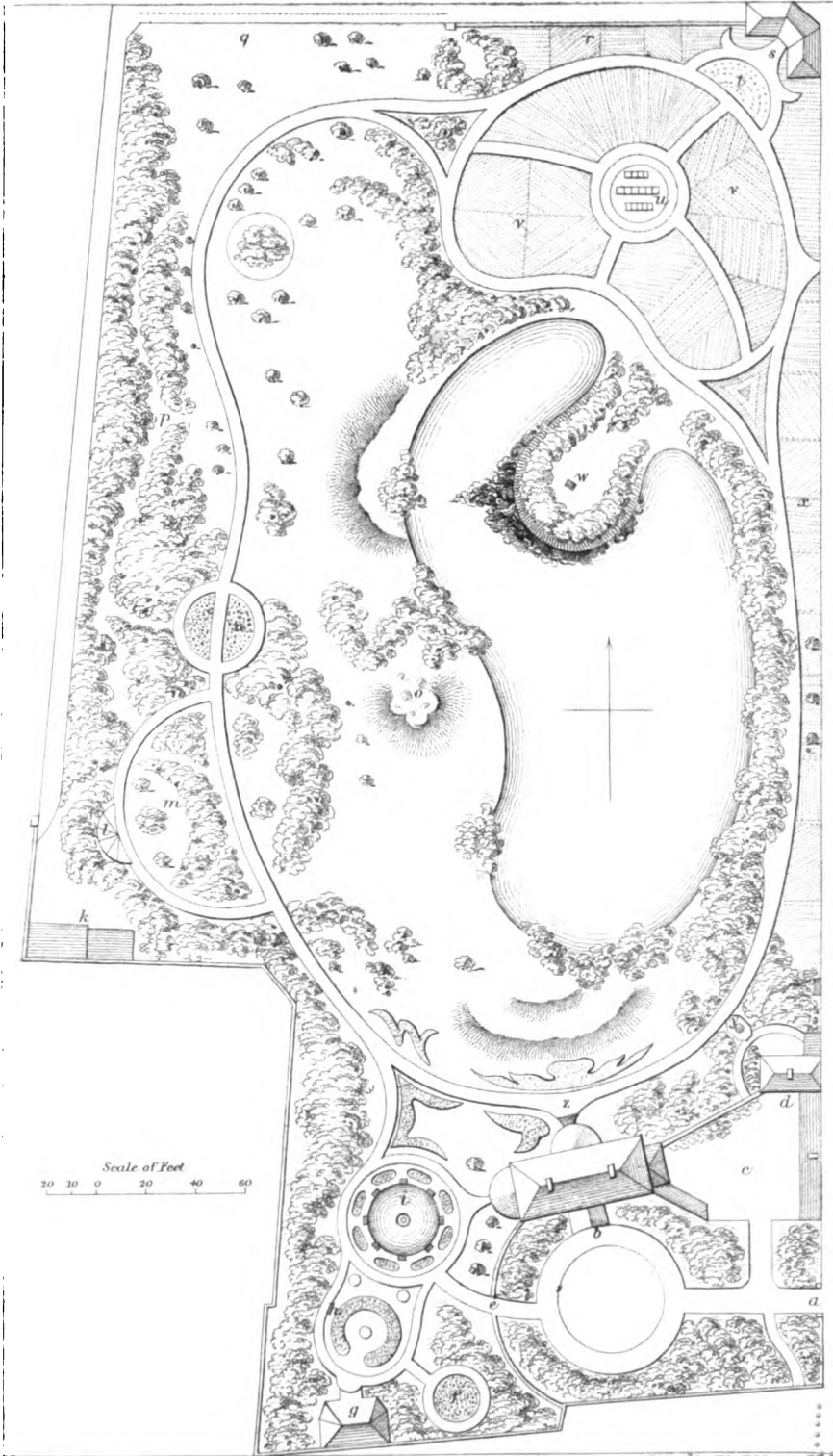
END OF VOL. I.



SUBURBAN GARDEN.



4



SUBURBAN GARDEN IMPROVED.

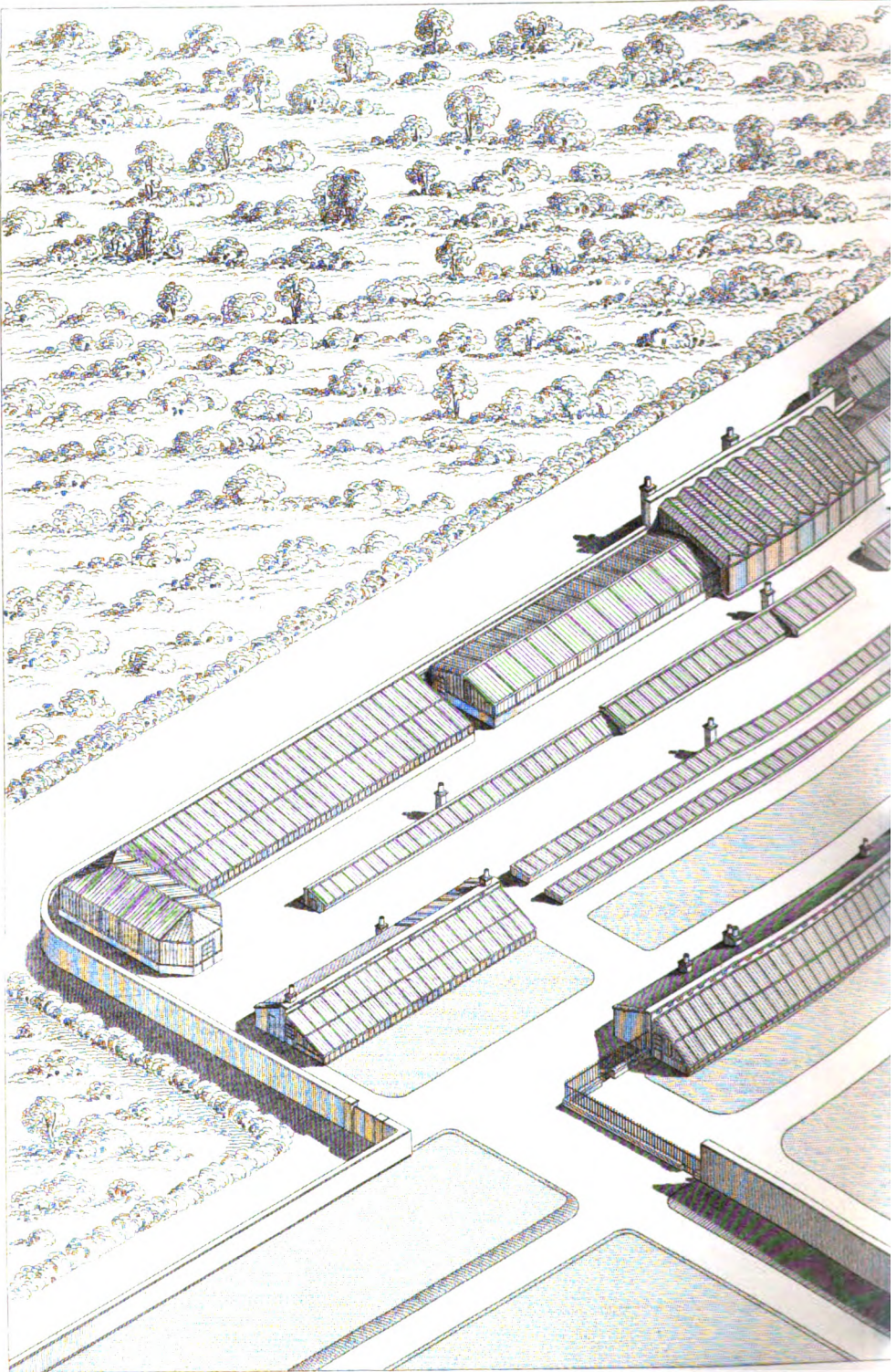
William Blackwood & Sons Edinburgh & London.

4

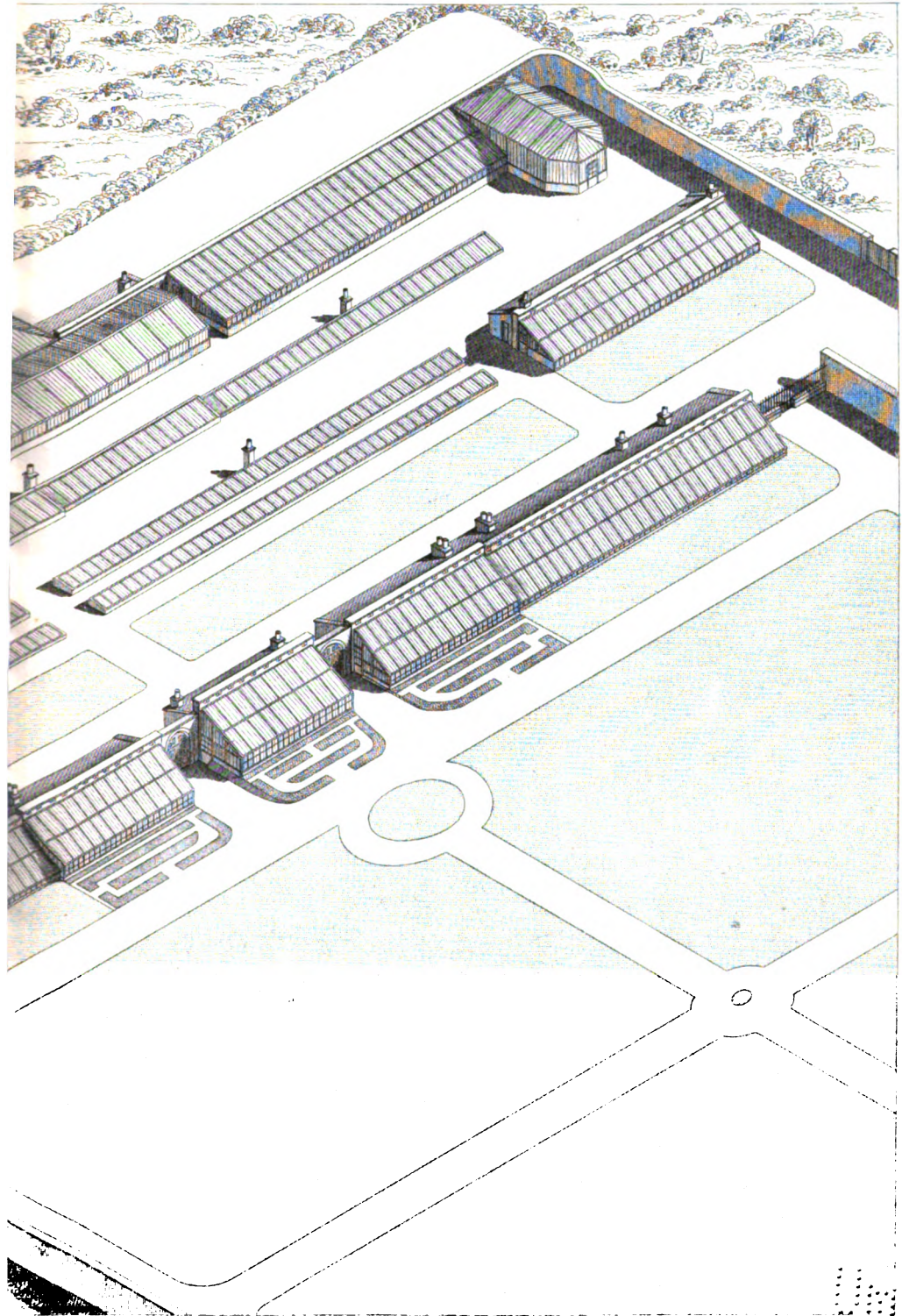


11





ISOMETRICAL VIEW OF HOT-HOUSES

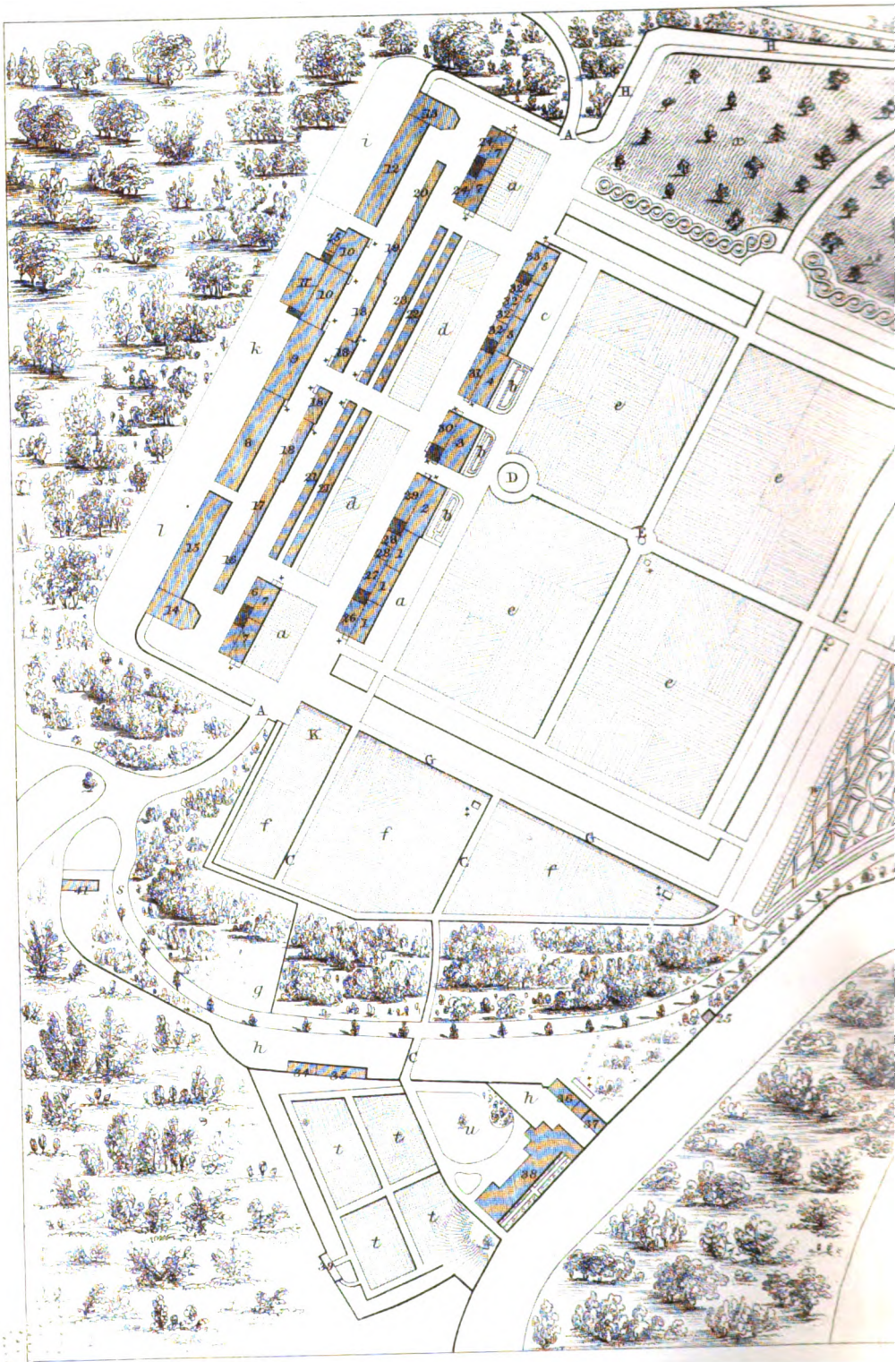


THE INTERIORS OF THE NEW LATERAL RAILROAD



44





PLANNING OF THE CITY OF ...

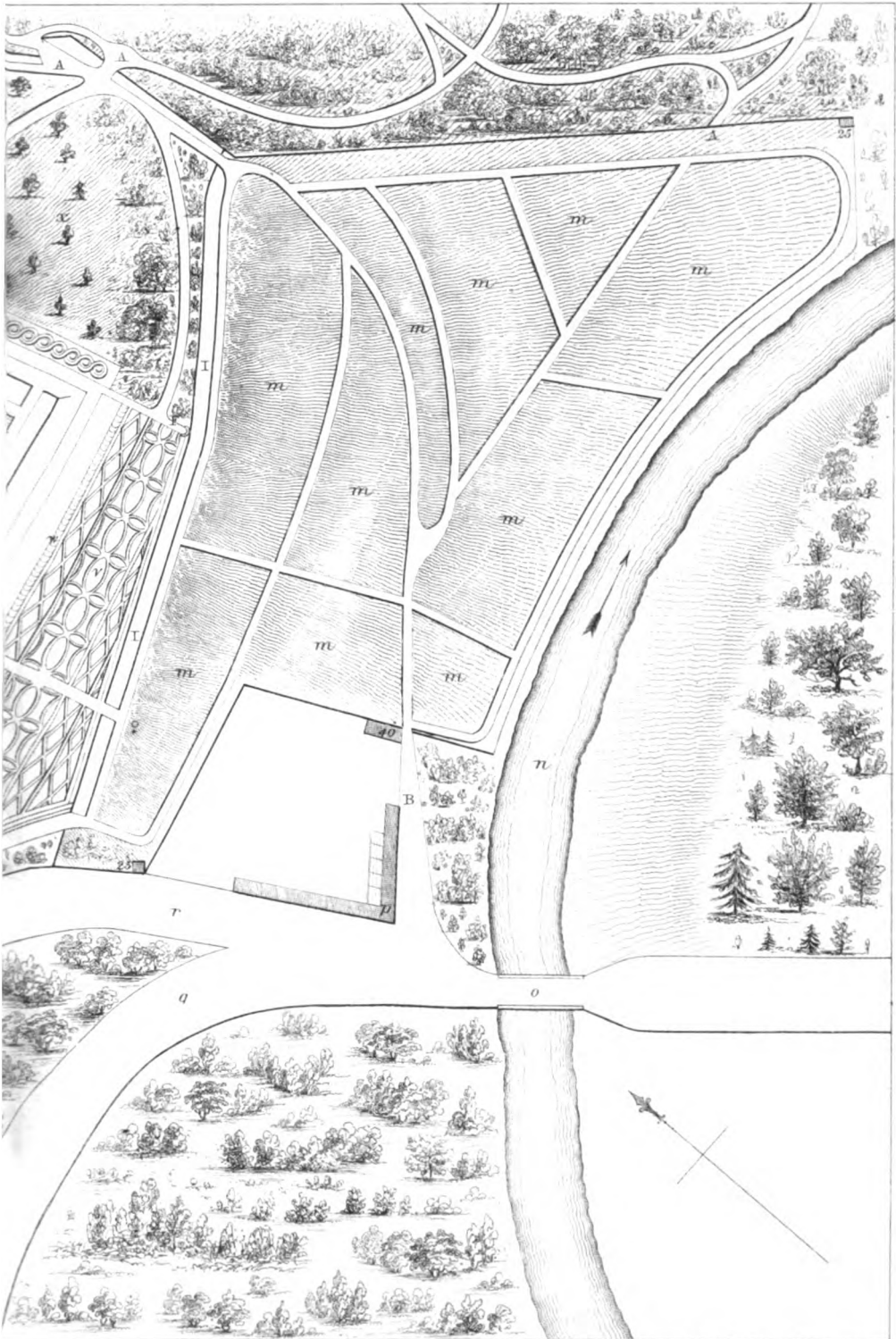






FIG. 6

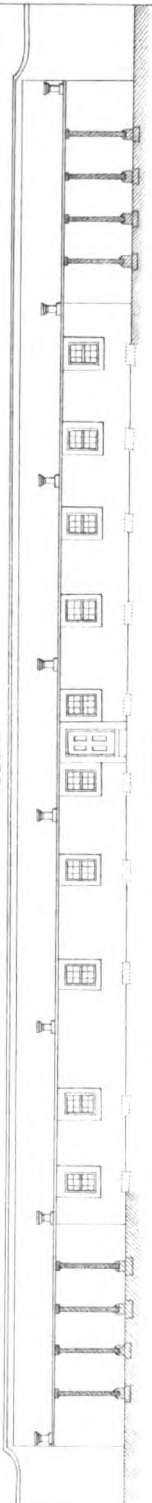


FIG. 1

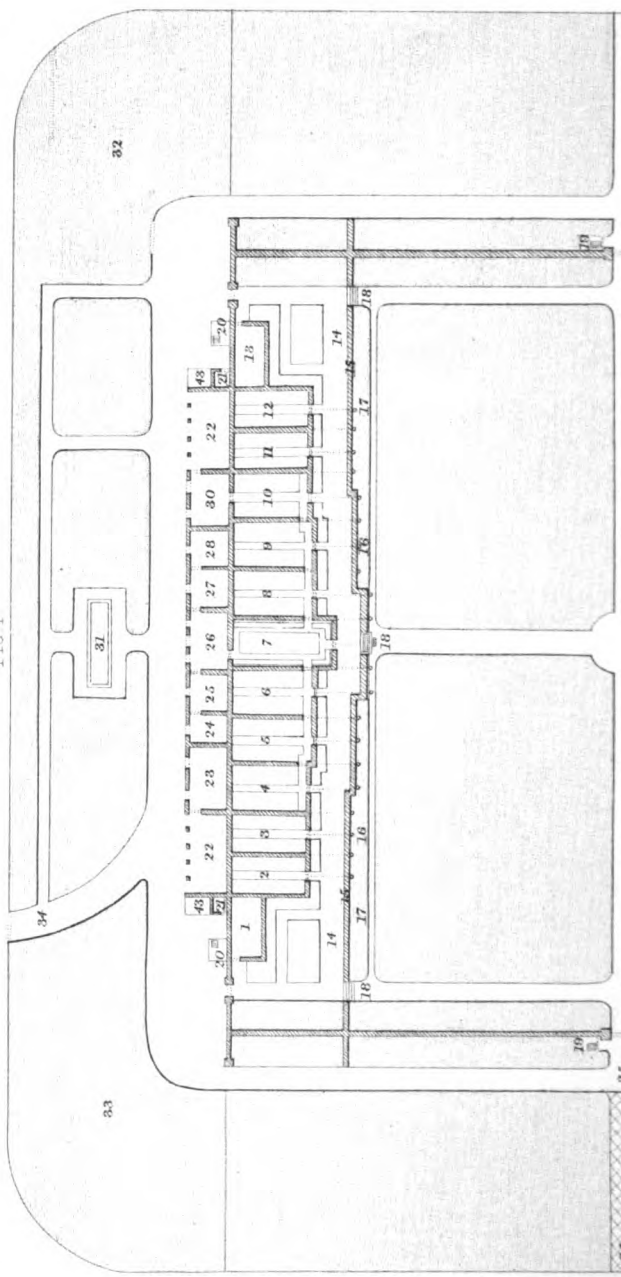
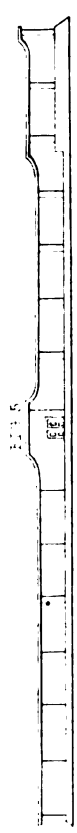
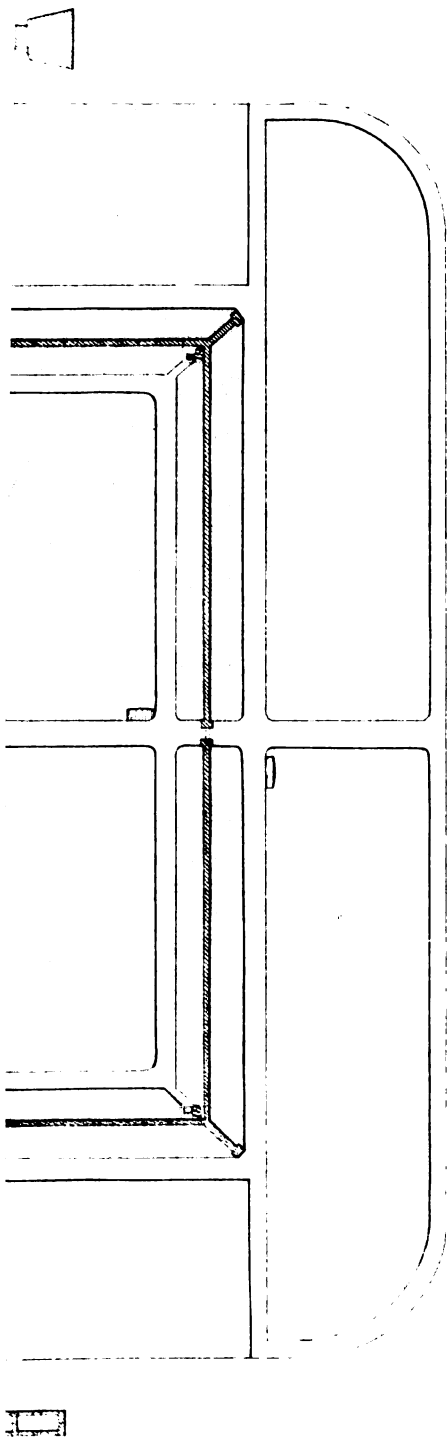


FIG. 4



FIG. 3

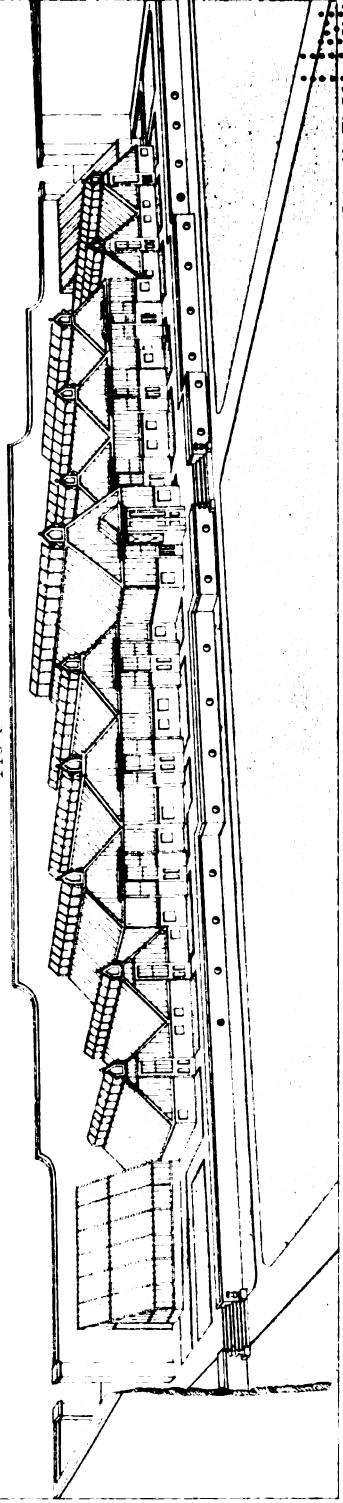




Scale to Elevations

Scale to Plan

FIG. 2



Designed by WILLIAM BROWN

GROUND PLAN OF POTTALOUCHE GARDEN, WITH ELEVATIONS.

William Brown and John Skidmore & Partners





FIG. 1

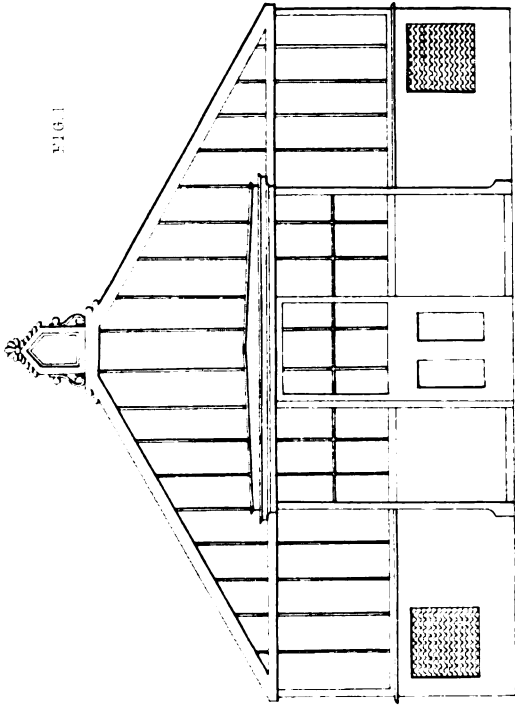
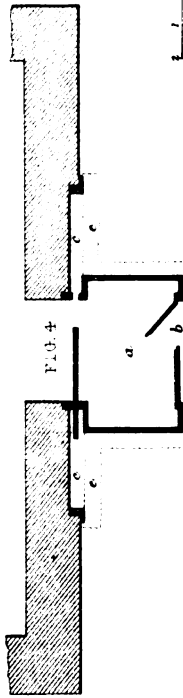
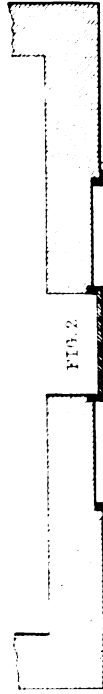
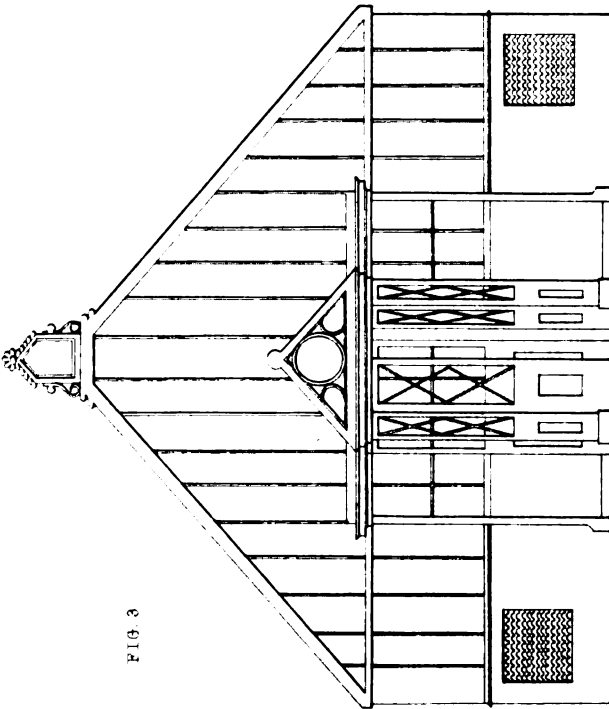


FIG. 3

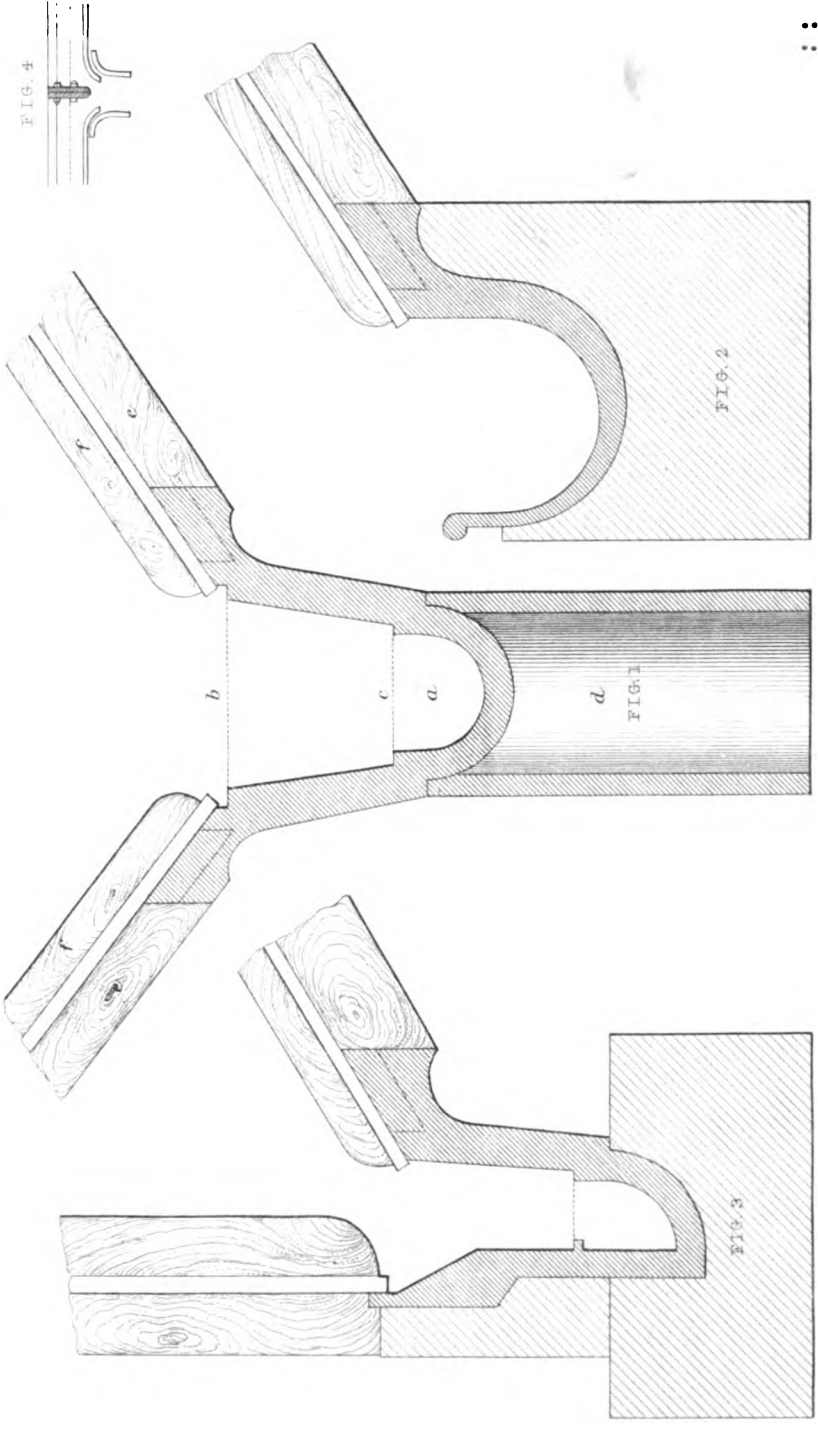
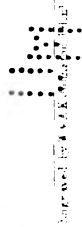


Engraved by W. & A. Johnston, Edin.

END ELEVATIONS OF VINEYES & POLLALLOCH GARDEN.

William Blackwell & Sons, Edinburgh & London.

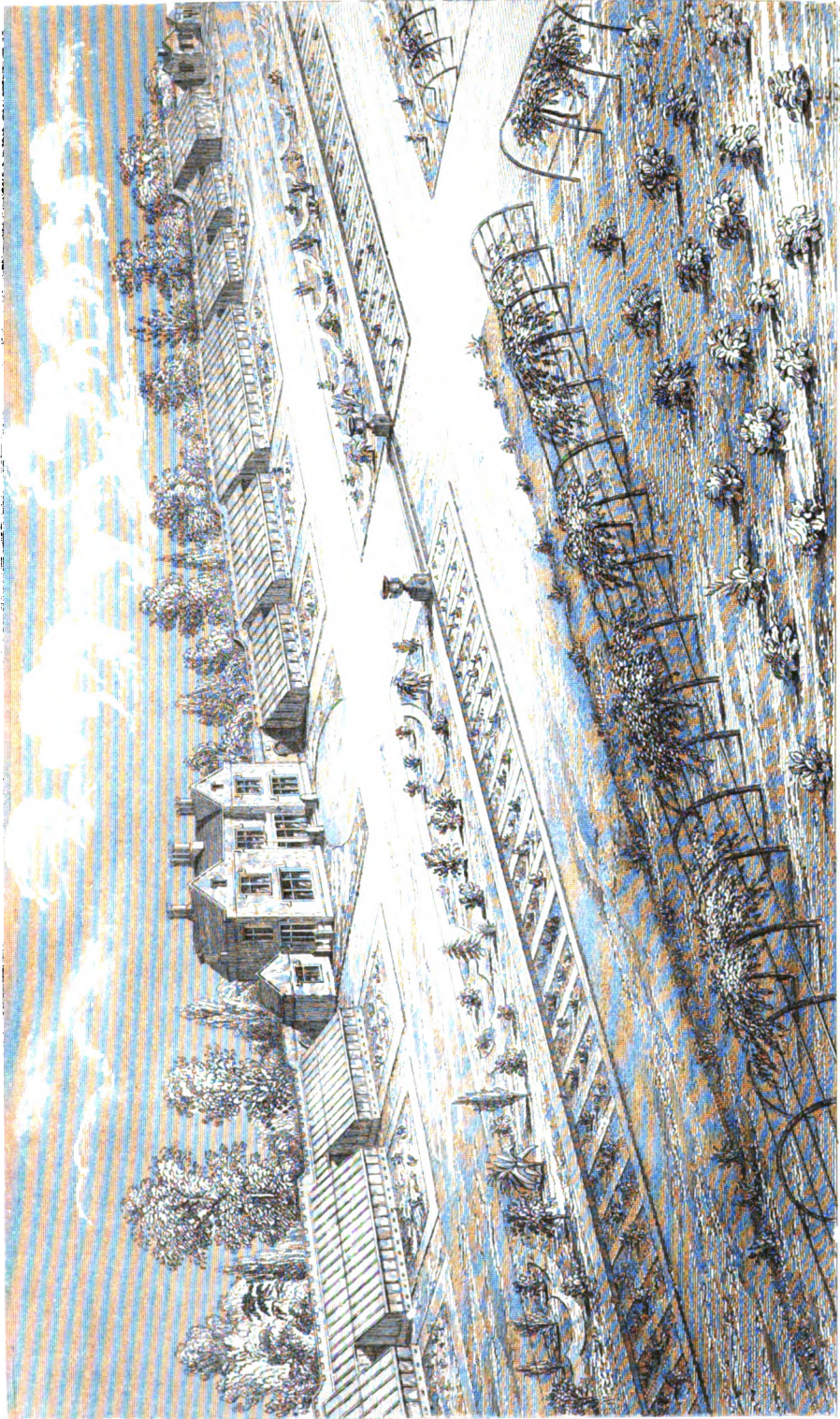
100  
100  
100



C A B I N E T

William F. Schickel & Son, East Longmeadow, Mass.





Engraved by W. & A. G. Smith.

VIEW OF HOT-HOUSES, FROGMORE.

William Blackwood & Sons, Edinburgh & London.

11111  
11111  
11111  
11111  
11111

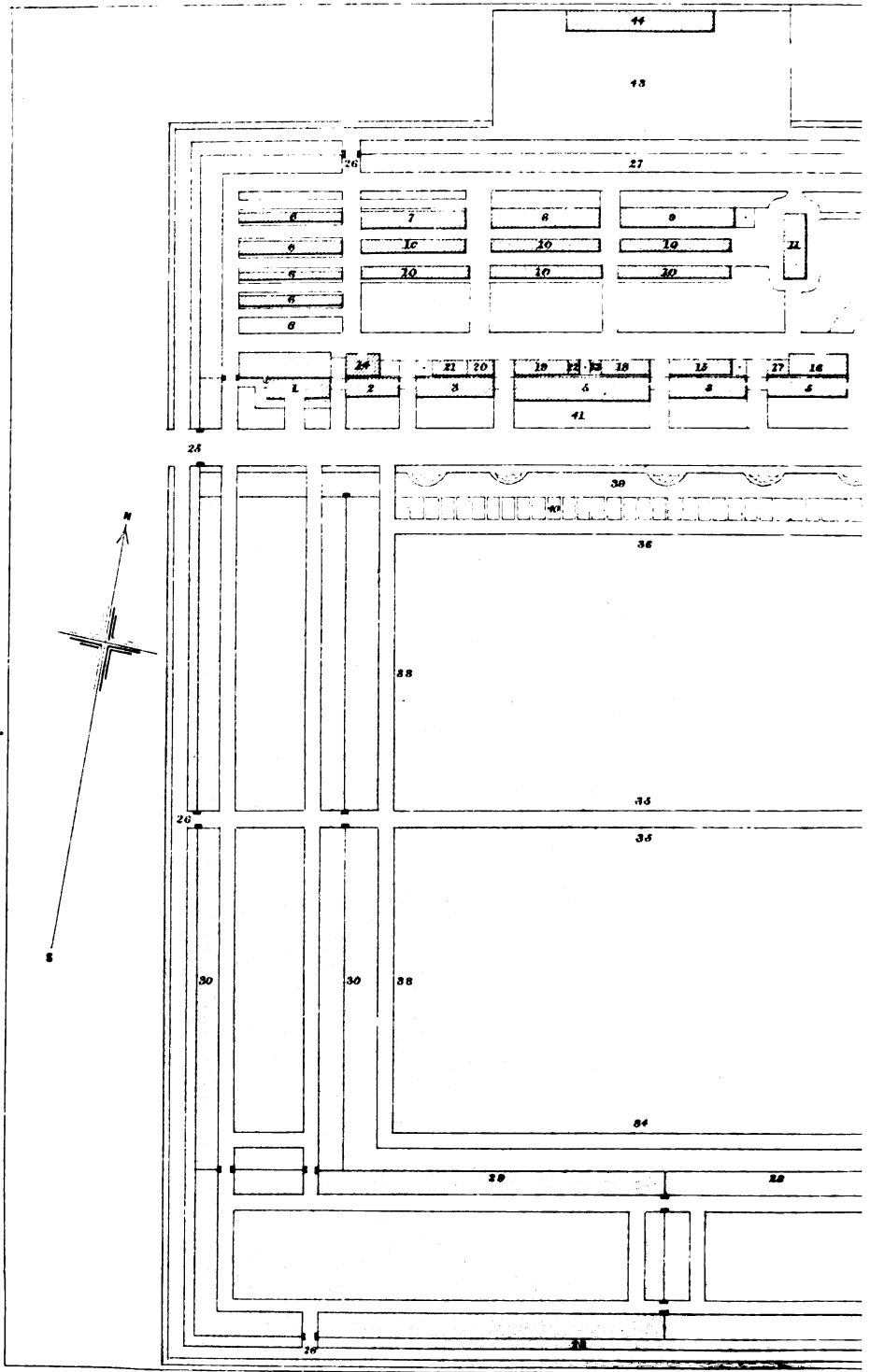
•

•

—



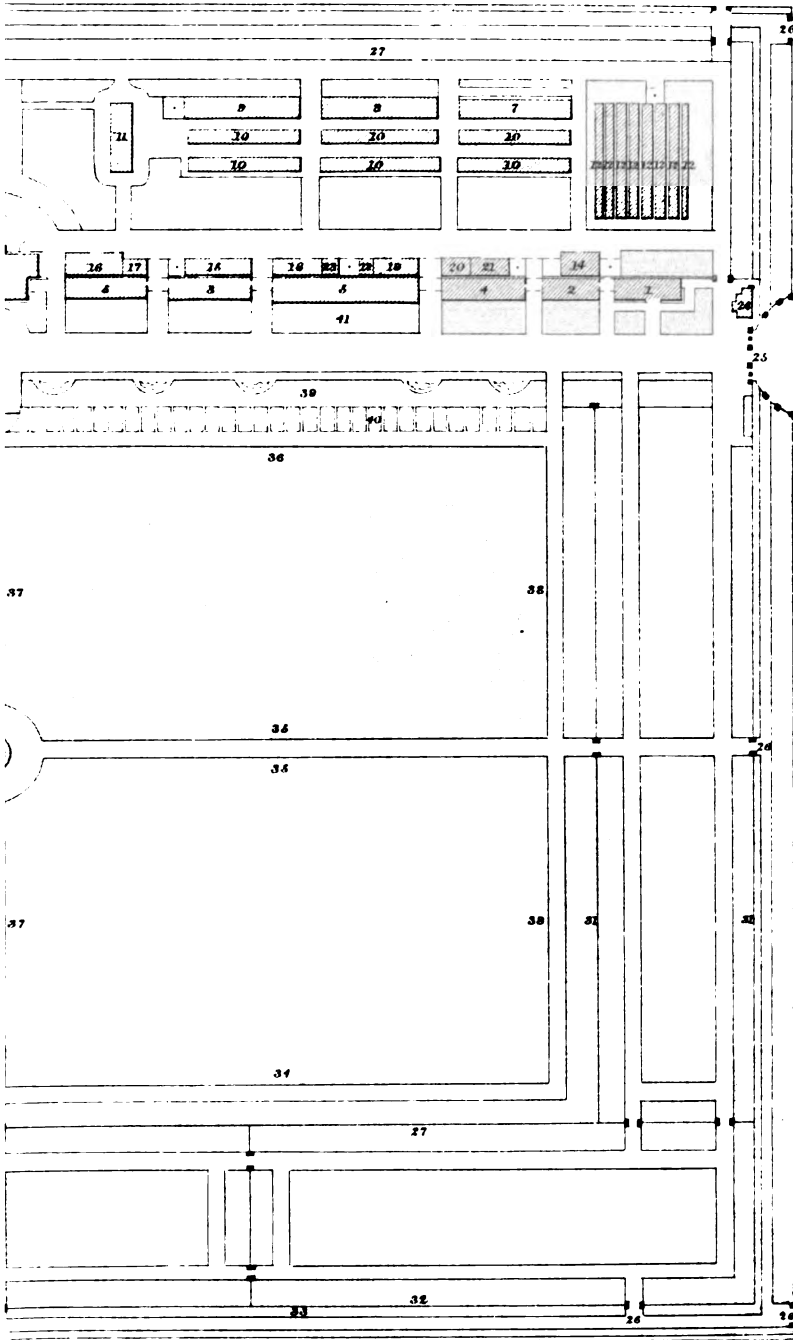




PLAN OF THE HCL

William Blackwell

Scale of Feet

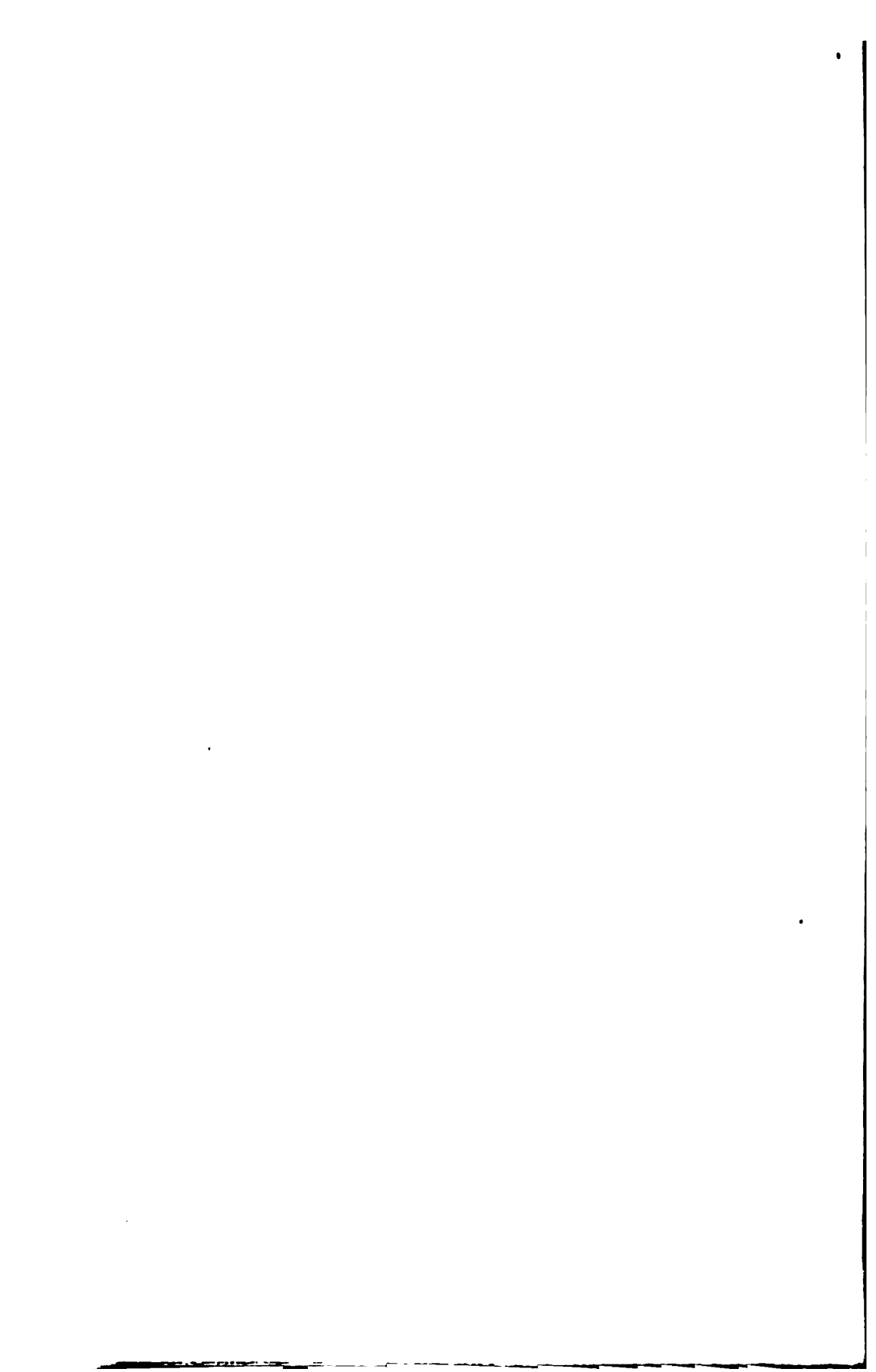


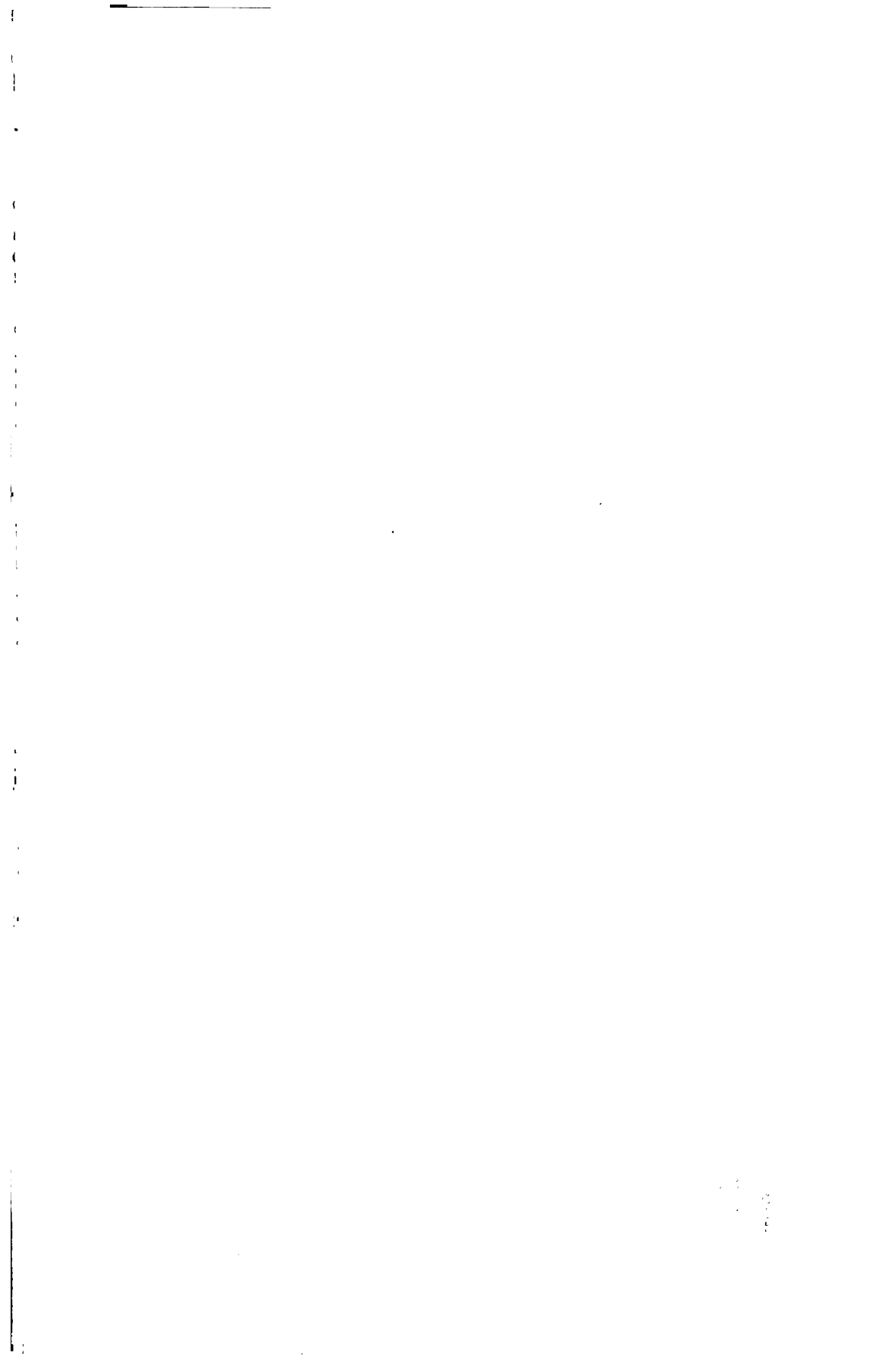
Engr. by W & A K Johnston, Edin.

GARDENS, FROGMORE.

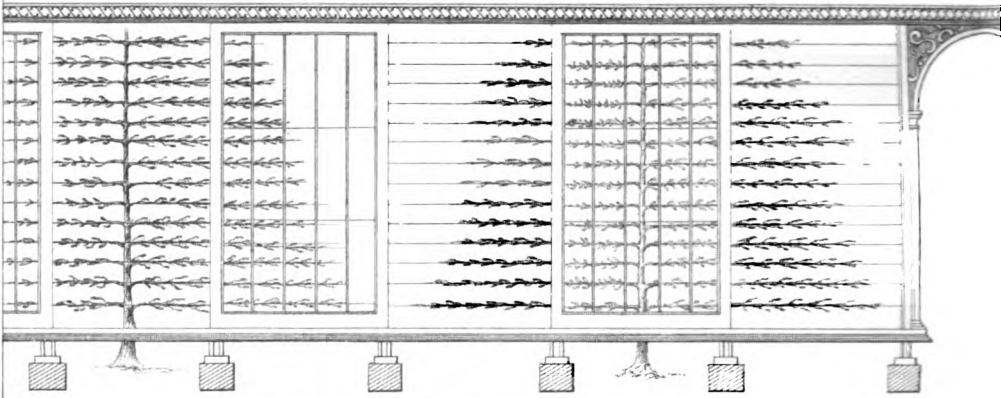
11  
12  
13  
14  
15  
16  
17  
18  
19  
20  
21  
22  
23  
24  
25  
26  
27  
28  
29  
30  
31  
32  
33  
34  
35  
36  
37  
38  
39  
40  
41  
42  
43  
44  
45  
46  
47  
48  
49  
50  
51  
52  
53  
54  
55  
56  
57  
58  
59  
60  
61  
62  
63  
64  
65  
66  
67  
68  
69  
70  
71  
72  
73  
74  
75  
76  
77  
78  
79  
80  
81  
82  
83  
84  
85  
86  
87  
88  
89  
90  
91  
92  
93  
94  
95  
96  
97  
98  
99  
100

11  
12  
13  
14

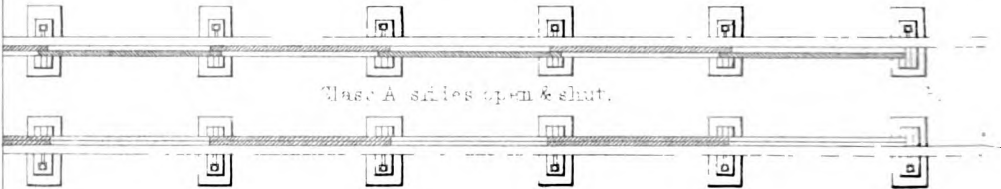




A



Elevation class A showing alternate sashes open.



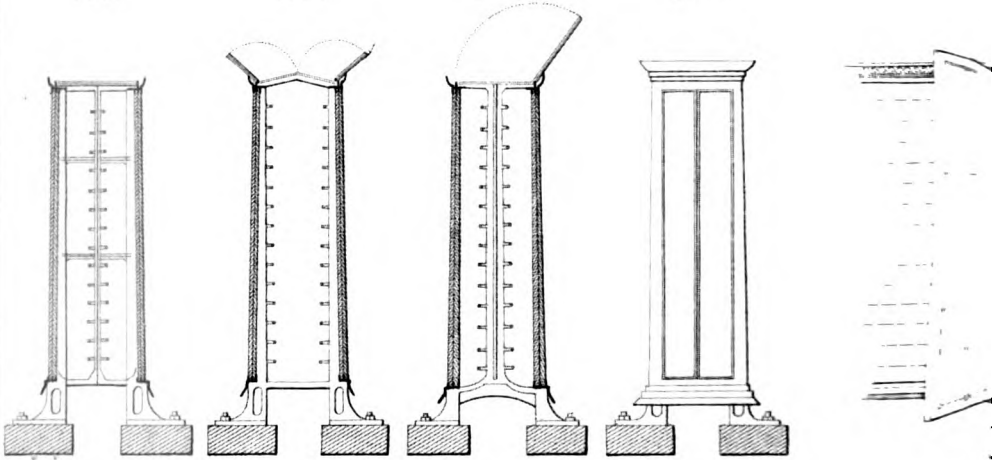
Class A sashes open & shut.

FIG. 1

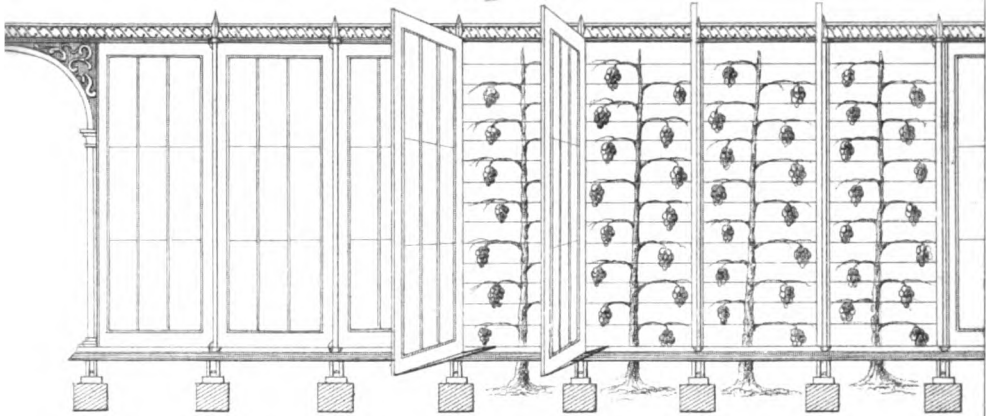
FIG. 2

FIG. 3

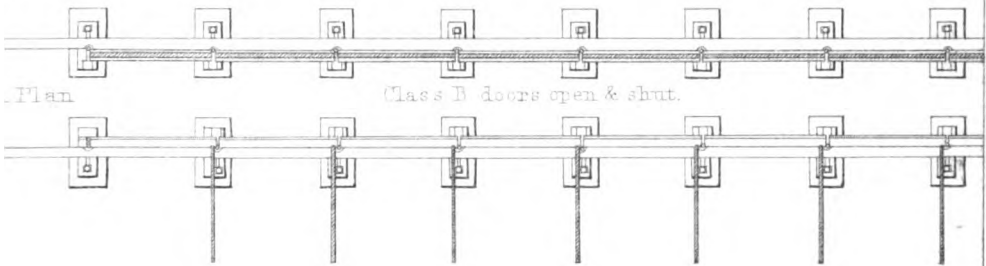
FIG. 4



Sections Class A.



Elevation class B with glass doors open & shut.



Plan Class B doors open & shut.

FIG 7

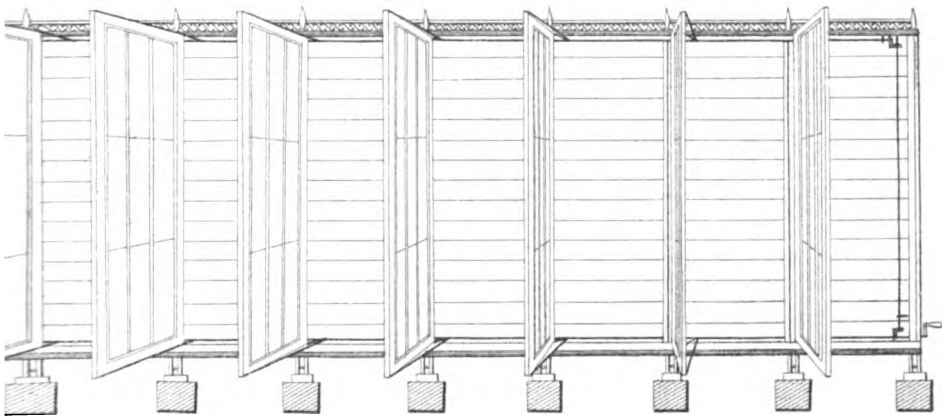


Diagram illustrating the operation of the opening & closing of doors



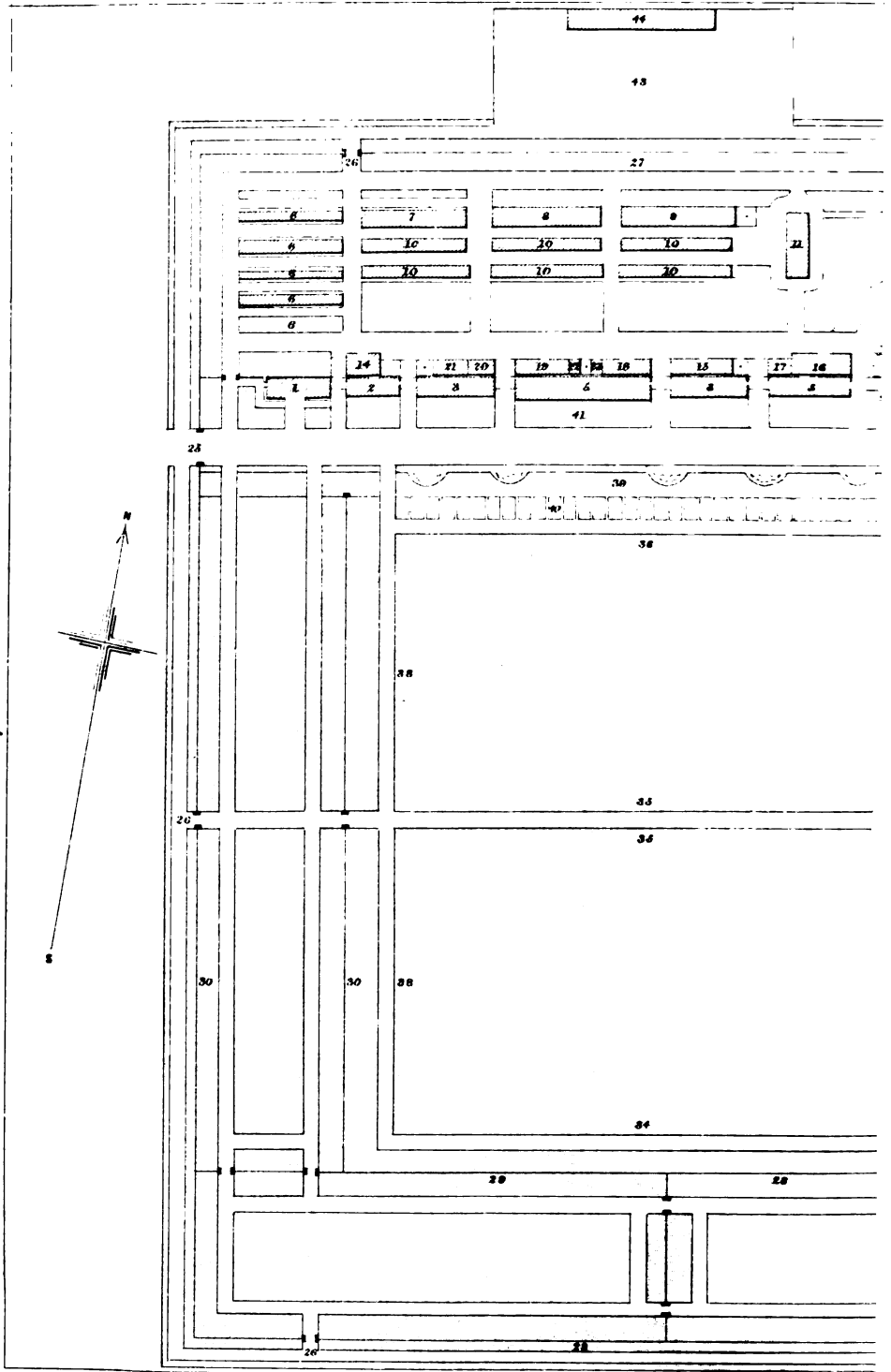
1000  
1000  
1000  
1000

•

✓

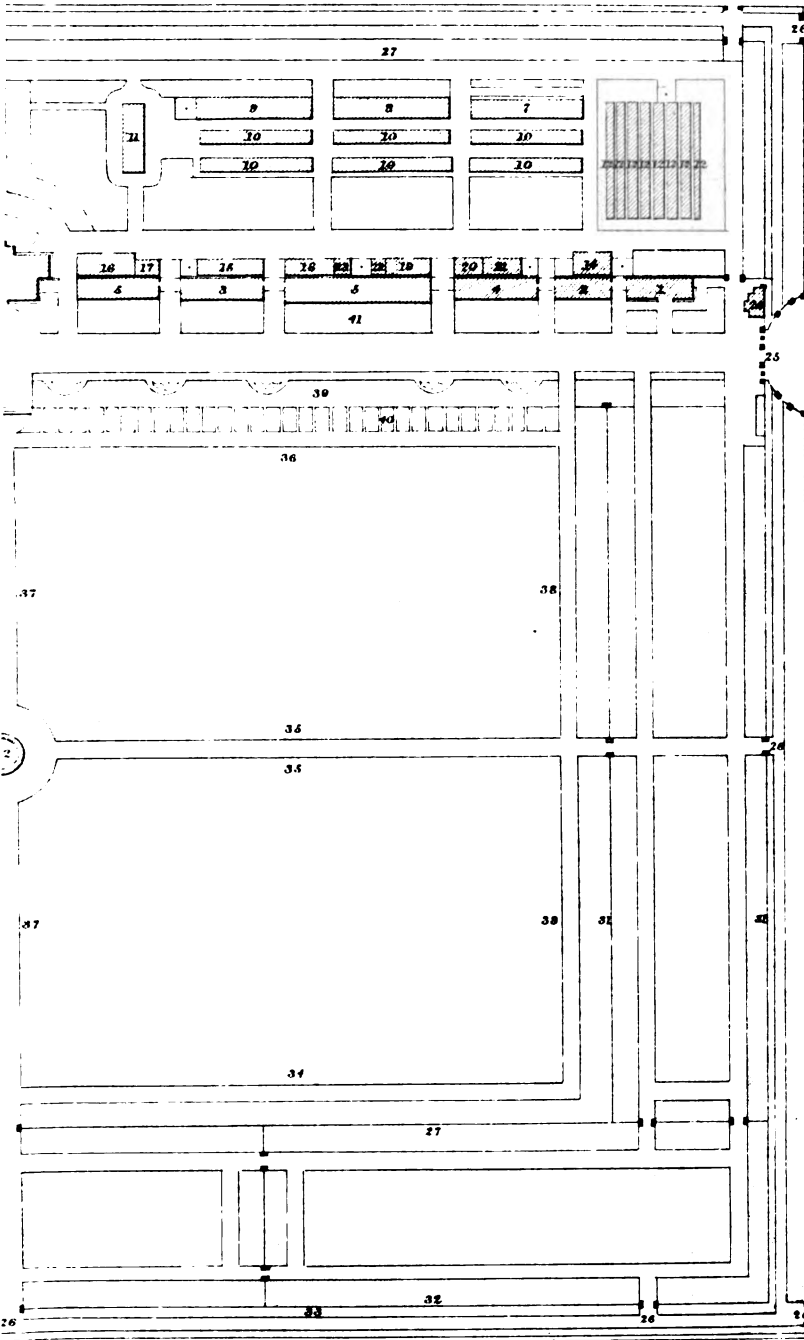
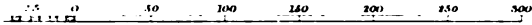
1000





PLAN OF THE ACY

Scale of Feet



Engd. by W.A.A.K. Johnston, Esq.

W. GARDNER, FROGMORE.

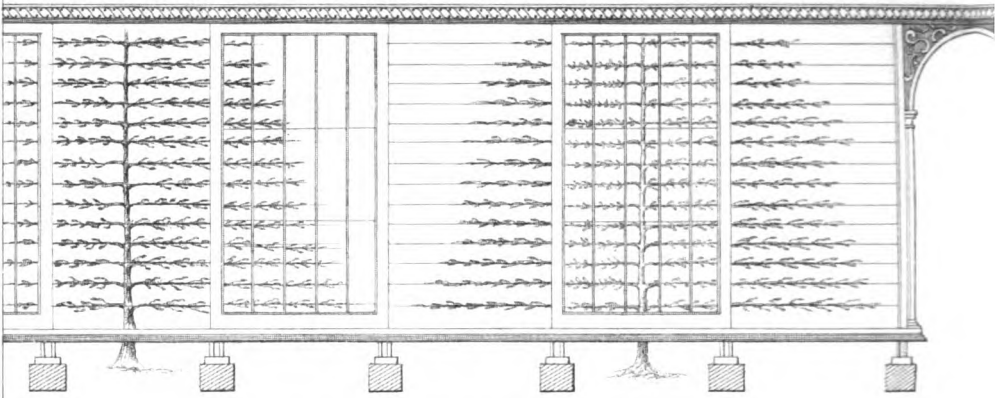
Edinburgh & London.

100  
100  
100  
100  
100



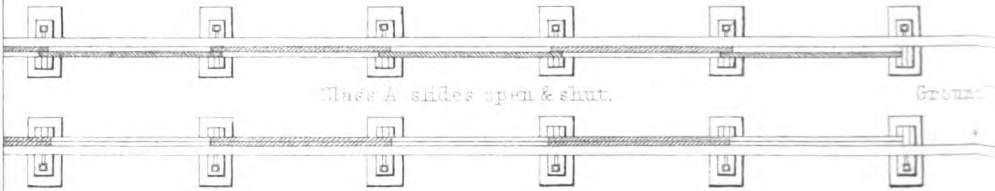
A

FIG. 1



Elevation class A showing alternate sashes open.

FIG. 2



Class A slides open & shut.

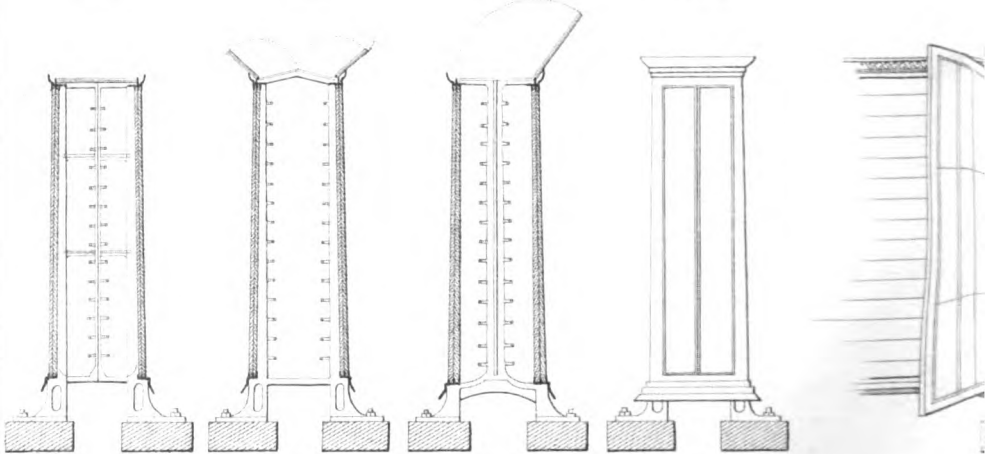
Ground

FIG. 3

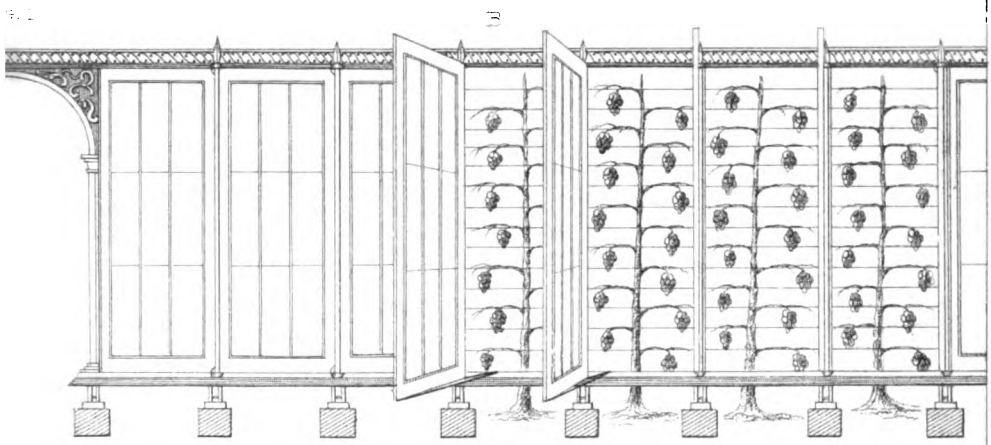
FIG. 4

FIG. 5

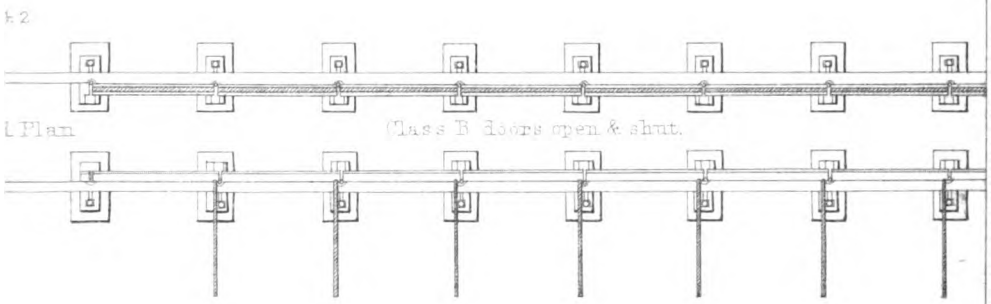
FIG. 6



Sections class A.



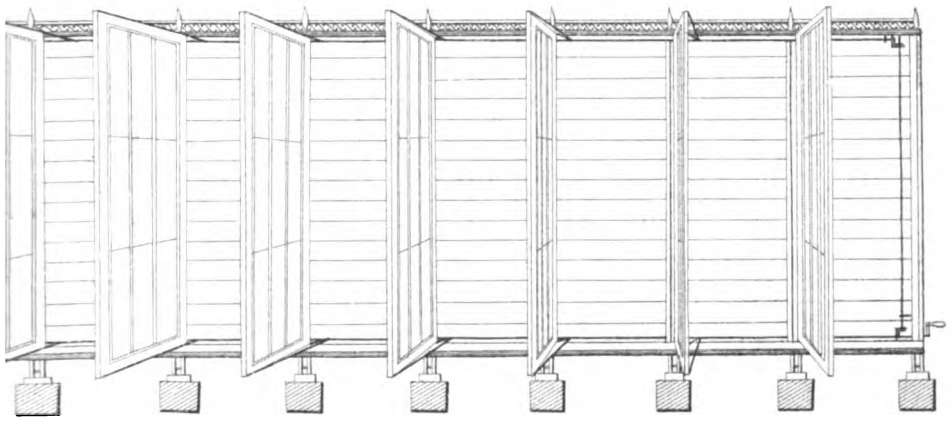
Elevation class B with glass doors open & shut.



Plan

(Class B doors open & shut.)

FIG 7



Side view showing arrangement of glass doors & supporting frame.





1 -

1

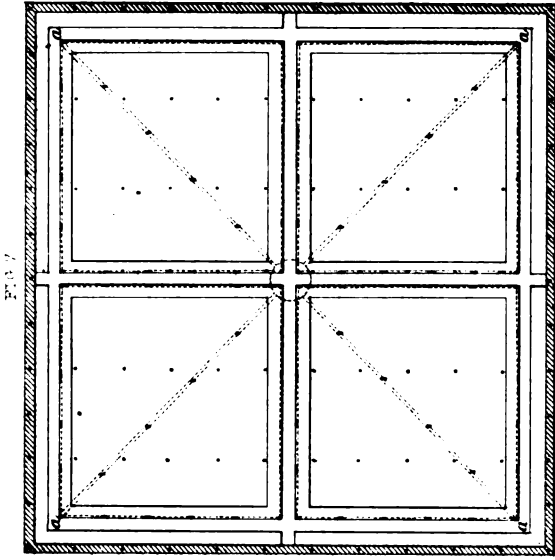


FIG. 7

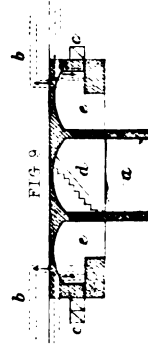


FIG. 9

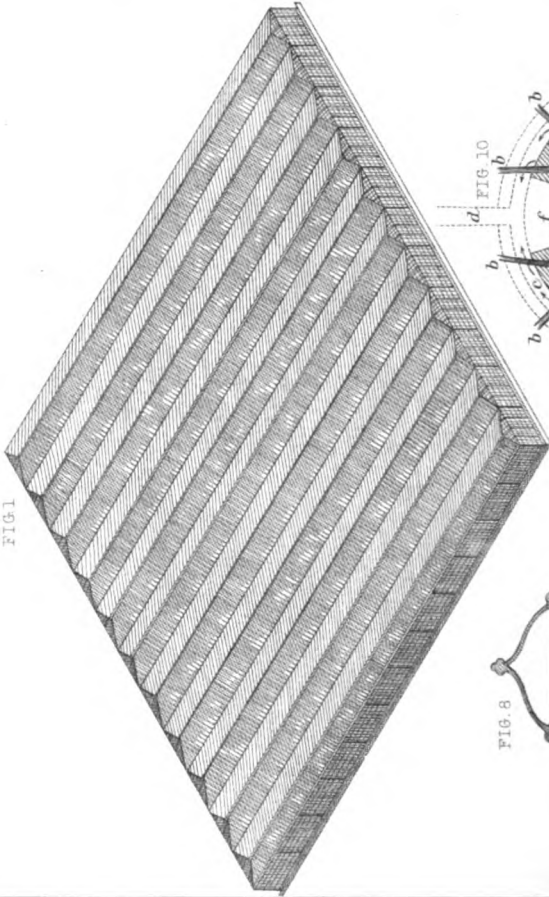


FIG. 1

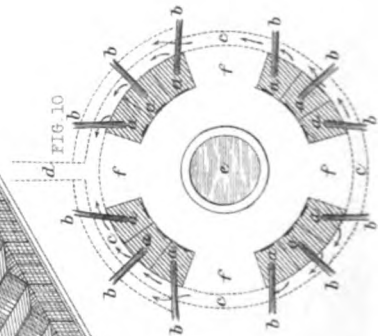


FIG. 10

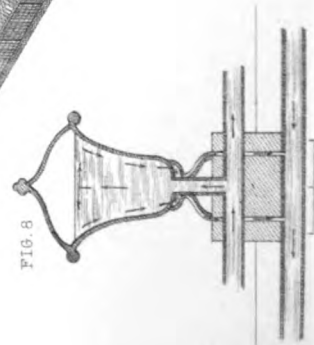
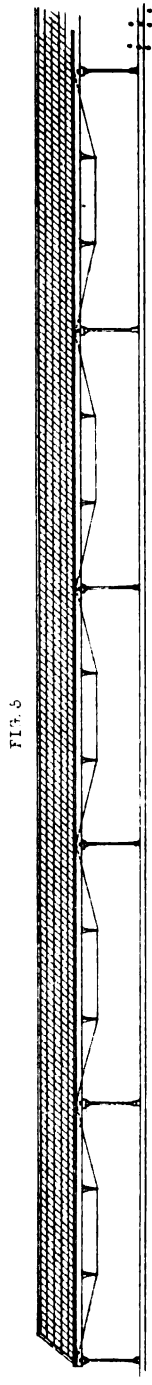
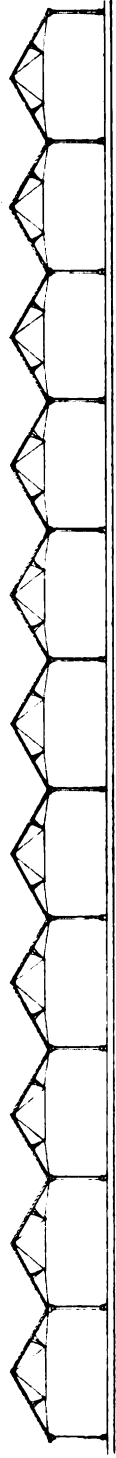
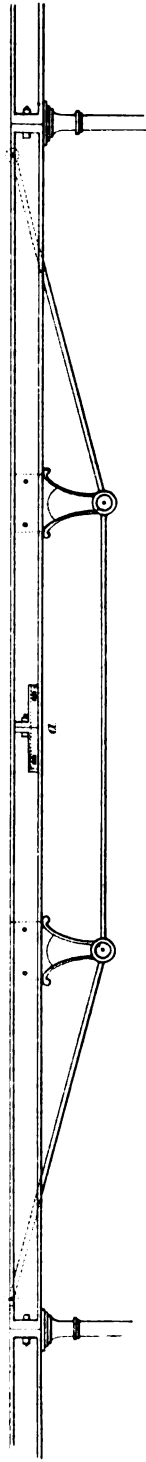
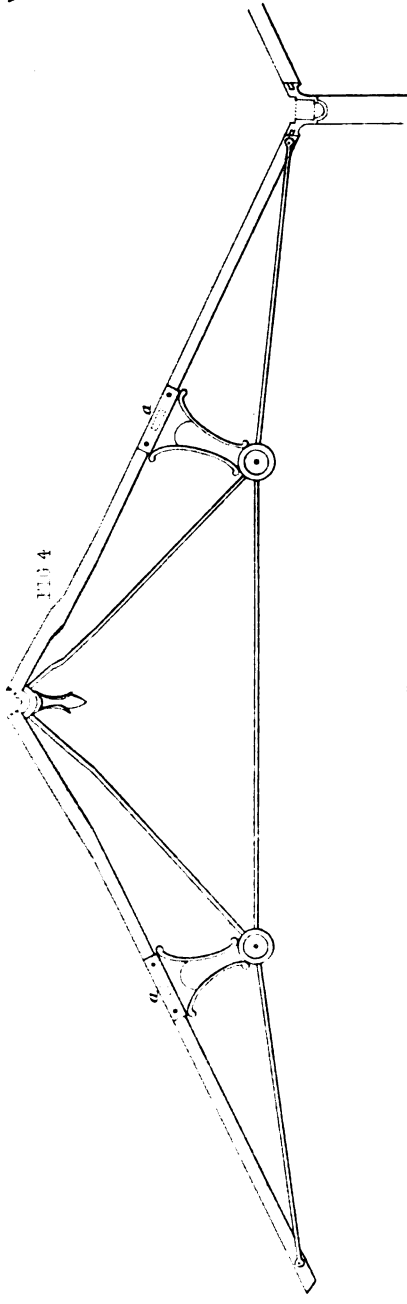


FIG. 8



FIG. 2

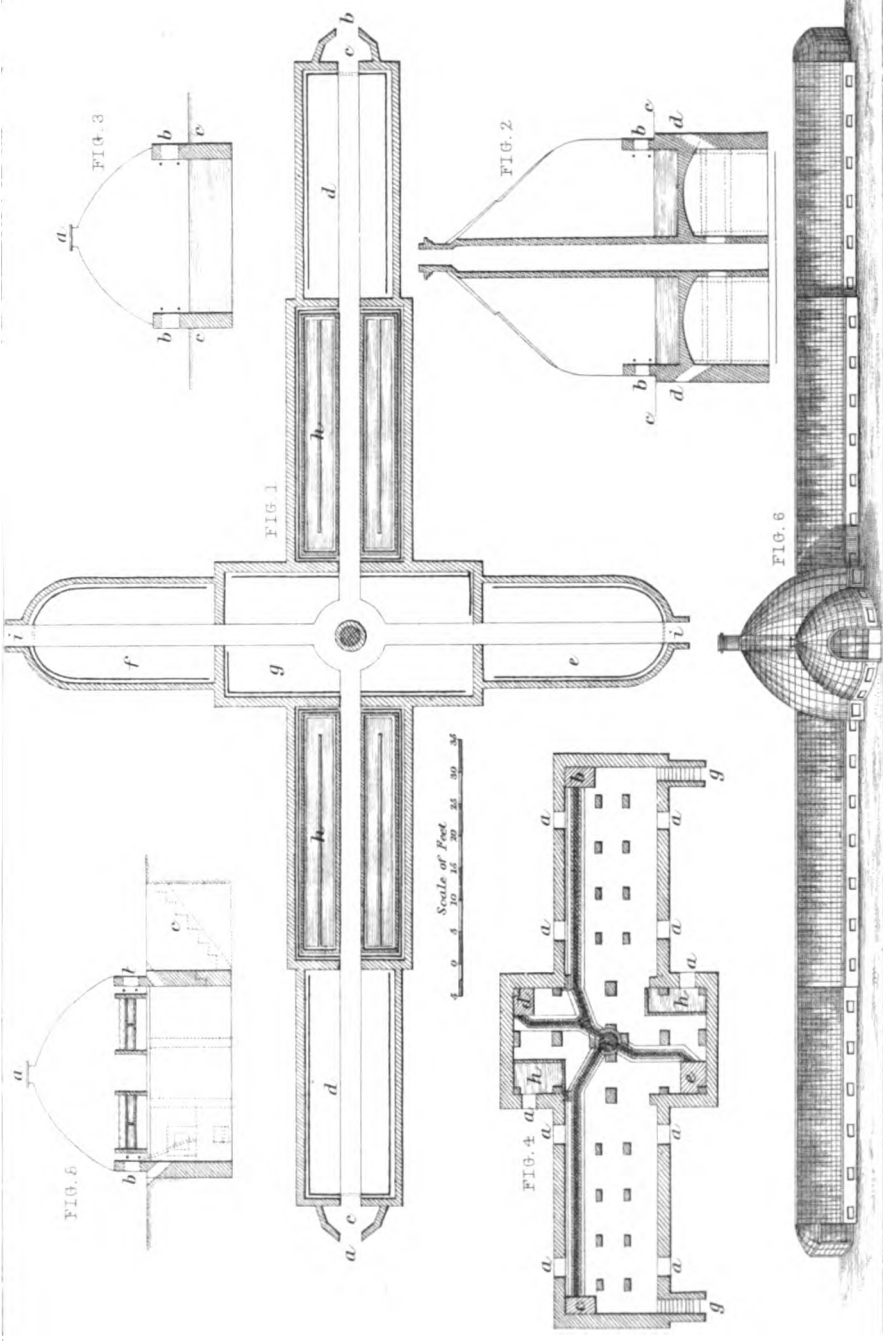


Engraved by W. H. Sturges

PROPOSED COVERED GARDEN, DALKEITH PALACE.

W. H. Sturges & Co. S. E. London.



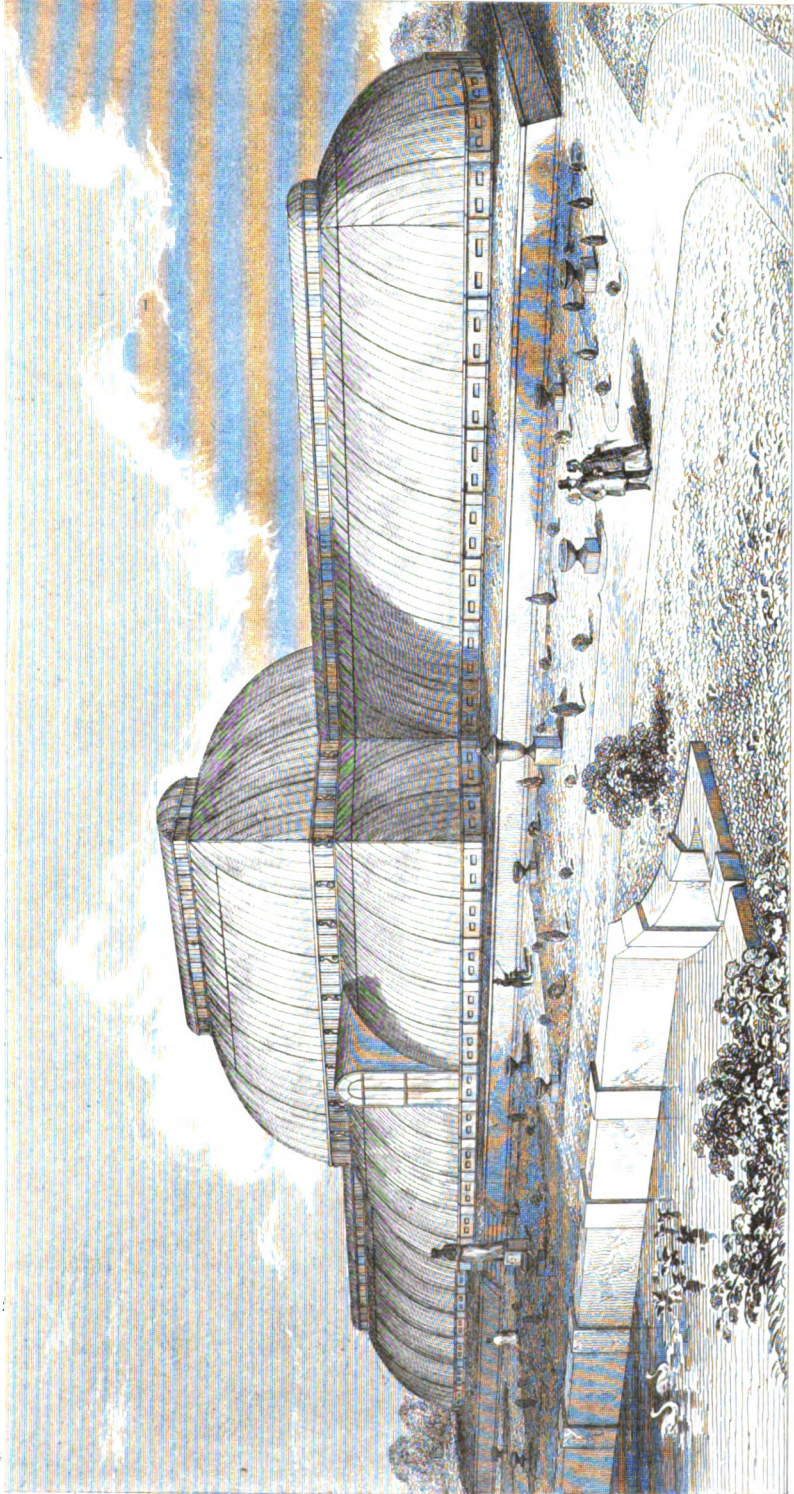


Engineered by W & A E Johnstone & Partners

RANGE OF HOT-HOUSES ON CURVILINEAR PRINCIPLE.

William Blackwood & Sons, Edinburgh & London.





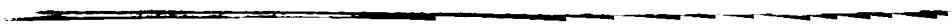
Engraved by W. A. Johnston, 41, Pall Mall

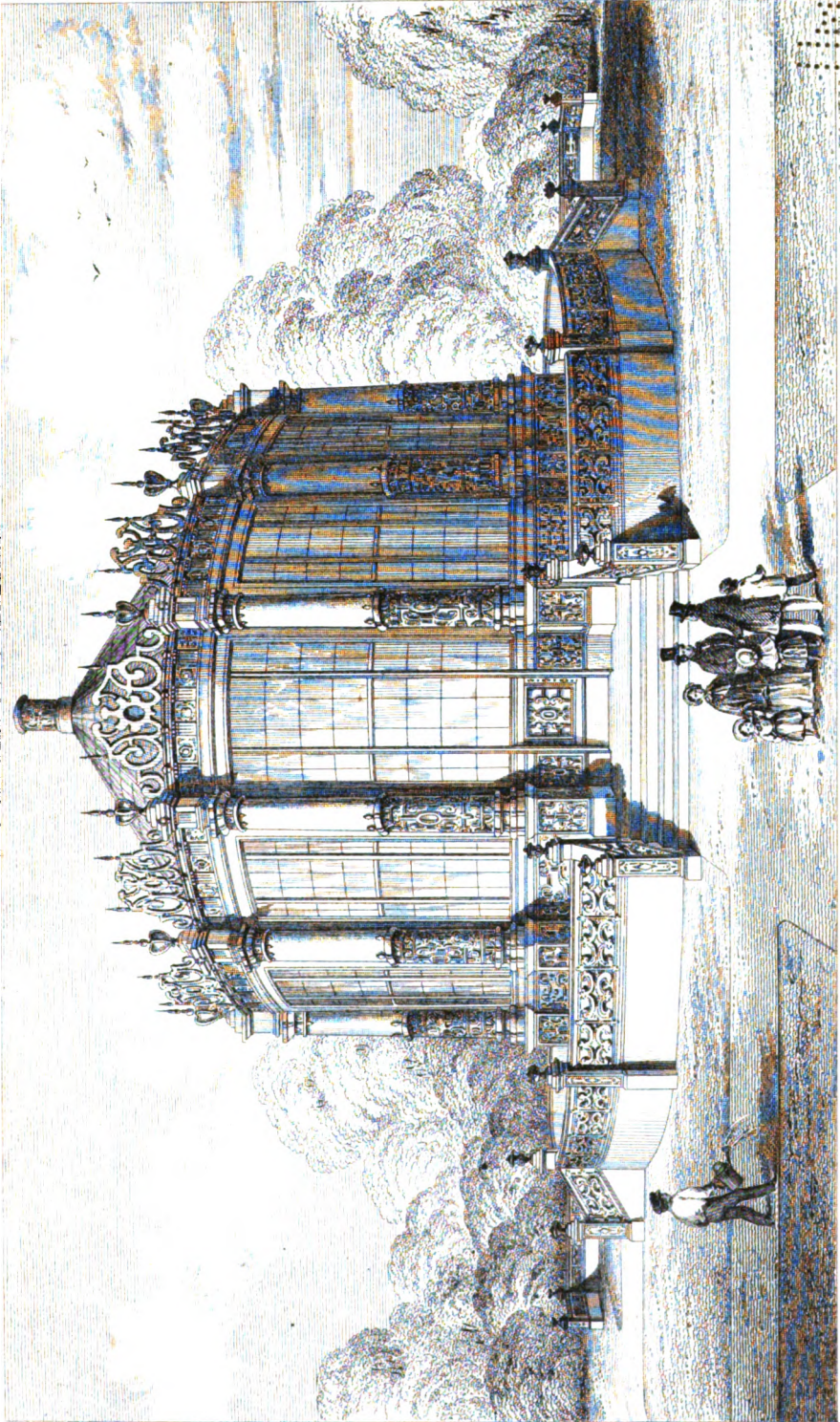
VIEW OF PALM GROVE AT EL W.

W. H. Sturges, Architect, 41, Pall Mall, London.



100  
100  
100  
100  
100  
100  
100  
100  
100  
100

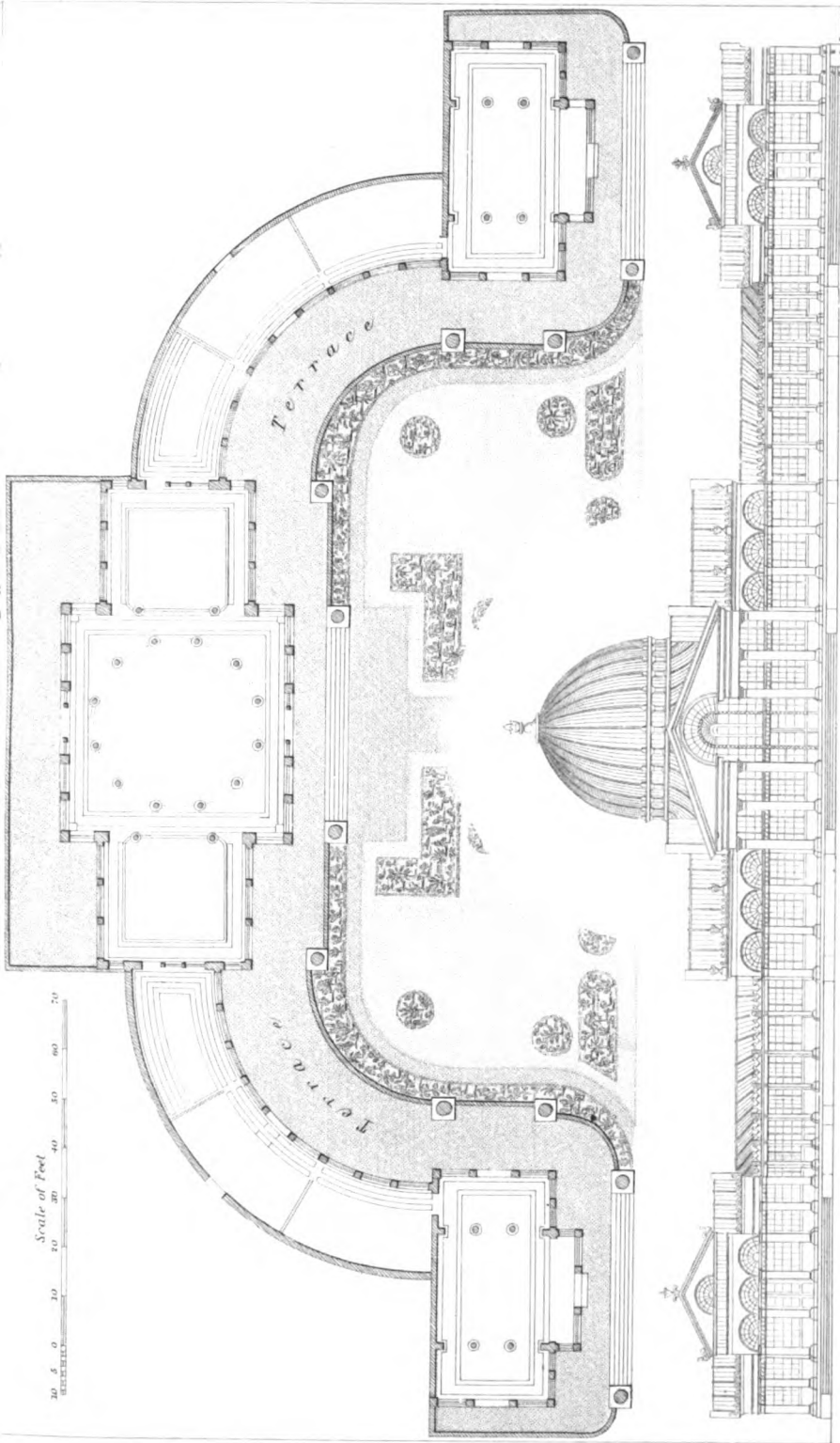




CIRCULAR CONSERVATORY, DALKEITH PALACE.

*William Blackwood & Sons, Edinburgh & London.*



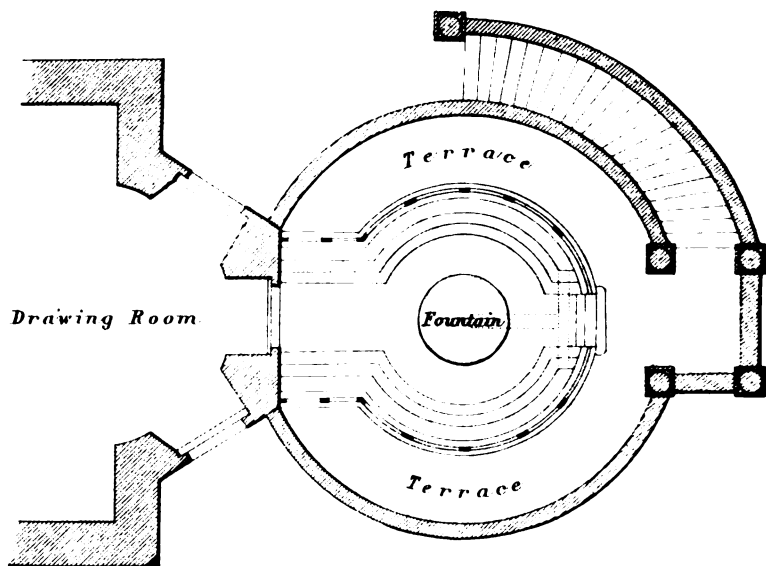


PLAN AND ELEVATION OF CONSERVATORY, SION HOUSE.

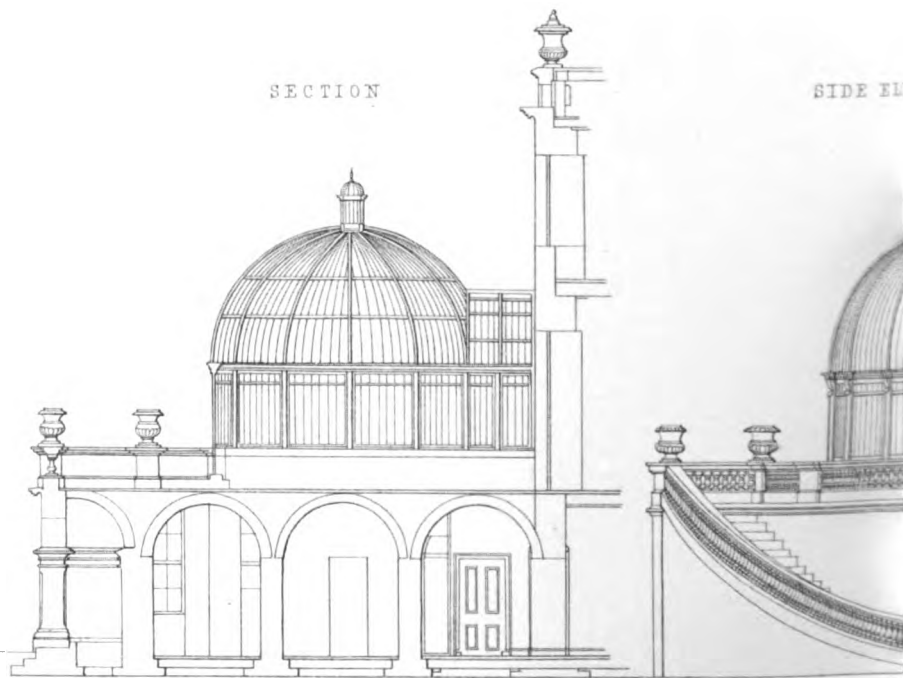
DESIGNED BY W. & A. G. SMITH

11  
12  
13  
14  
15





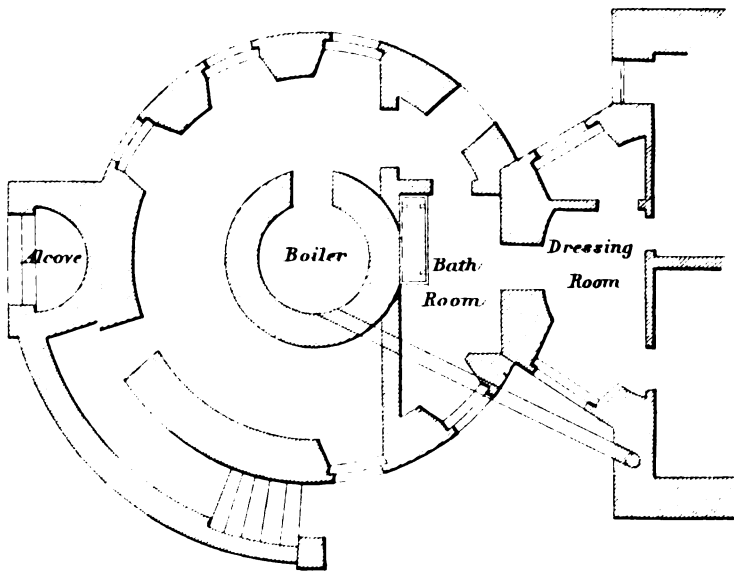
UPPER FLOOR



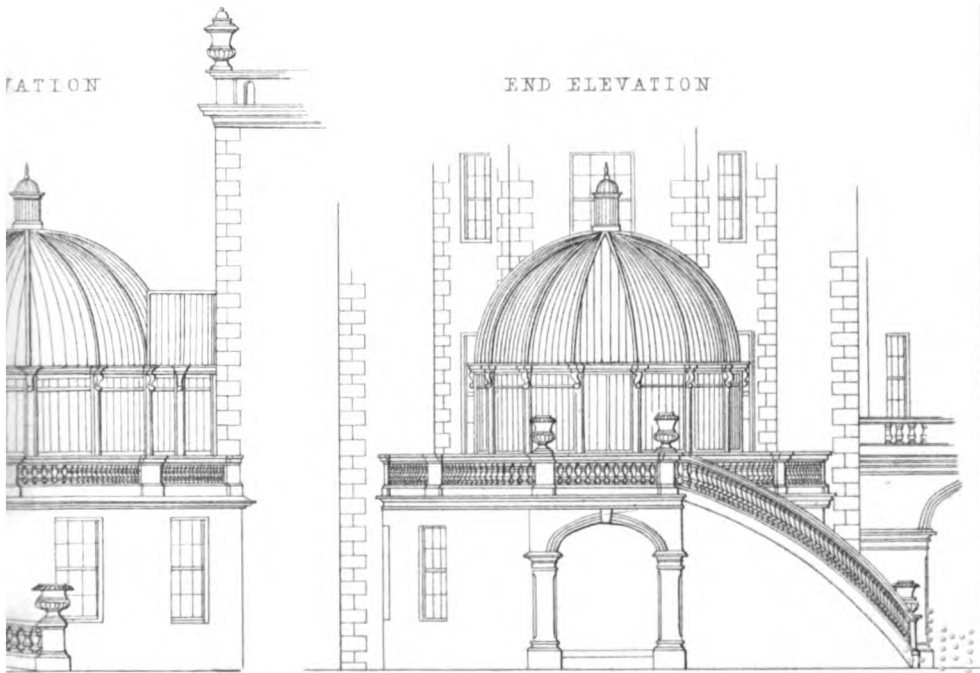
Messrs Mackenzie & Mathews, Des<sup>rs</sup>

CONSERVATORY IN CONNECTION

William Blackwood & Co



GROUND FLOOR

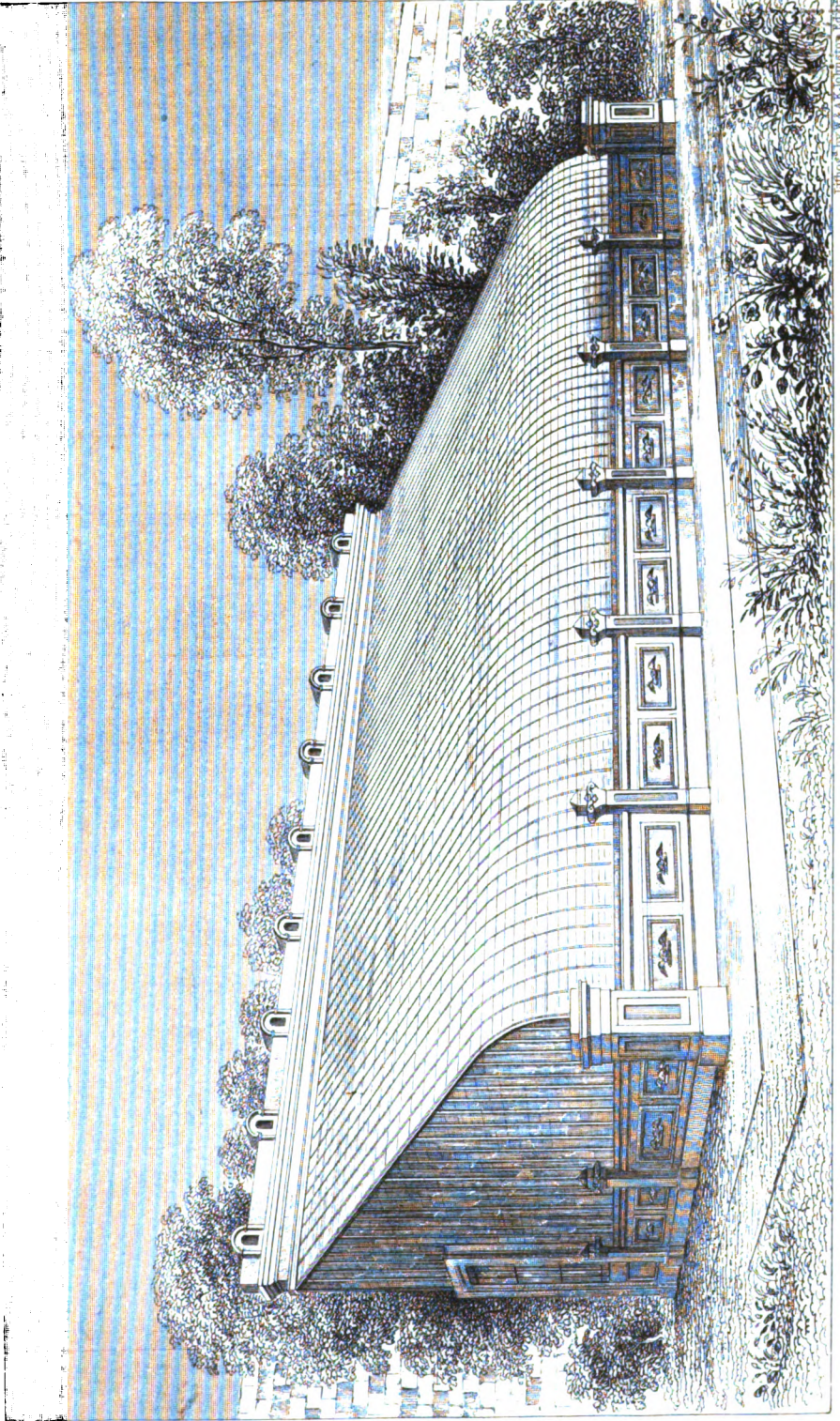


Engraved by W & A K Johnston, Edin'

WITH TOWN DWELLING HOUSE.



11  
12  
13  
14  
15  
16  
17  
18  
19  
20  
21  
22  
23  
24  
25  
26  
27  
28  
29  
30  
31  
32  
33  
34  
35  
36  
37  
38  
39  
40  
41  
42  
43  
44  
45  
46  
47  
48  
49  
50  
51  
52  
53  
54  
55  
56  
57  
58  
59  
60  
61  
62  
63  
64  
65  
66  
67  
68  
69  
70  
71  
72  
73  
74  
75  
76  
77  
78  
79  
80  
81  
82  
83  
84  
85  
86  
87  
88  
89  
90  
91  
92  
93  
94  
95  
96  
97  
98  
99  
100



METALLIC CORRUGATED ROOFED VIGNETTE

William Fairbank and Sons, Edinburgh & London.

Printed by W. & A. G. 1871

1111  
1111  
1111  
1111  
1111

1

1



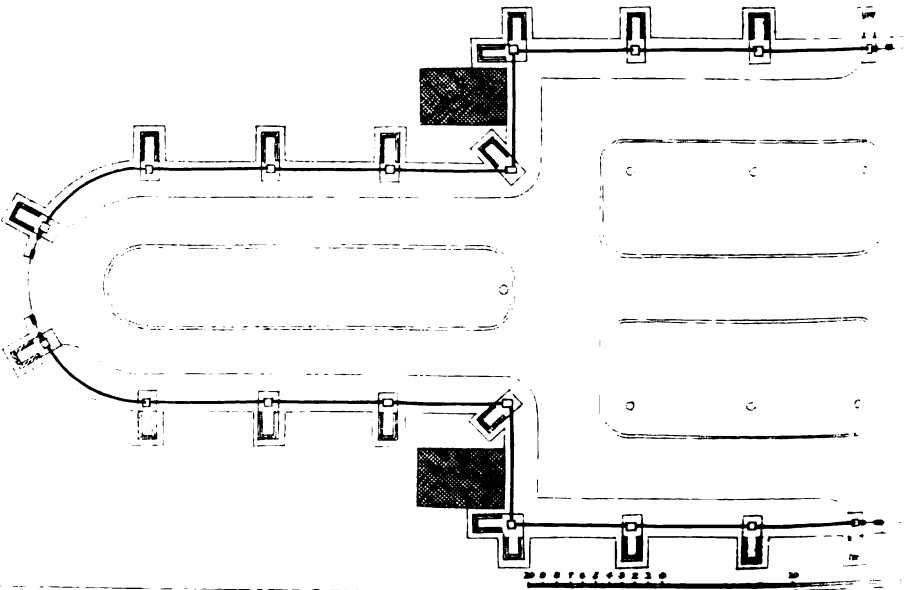
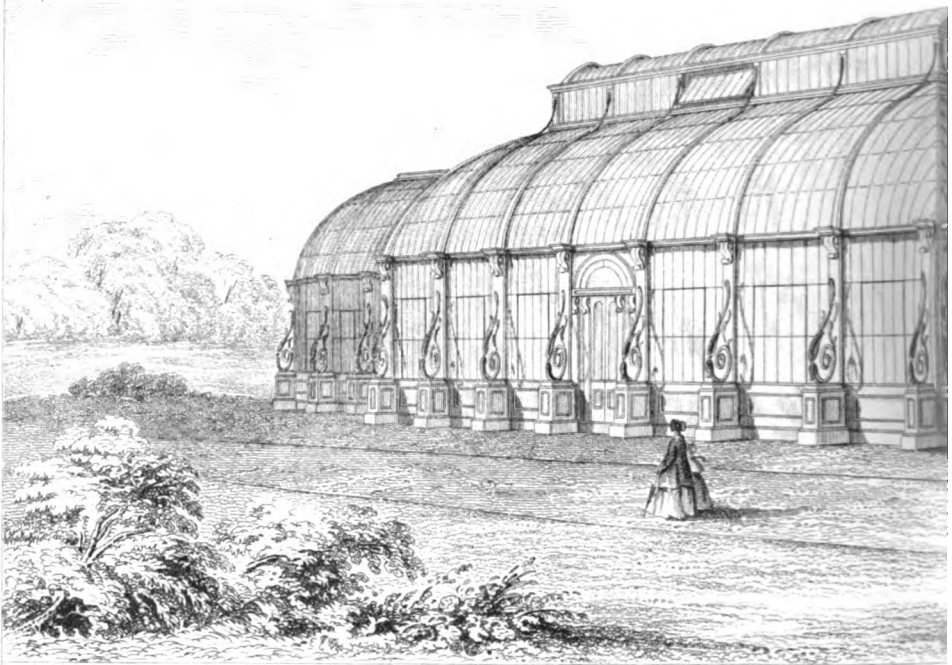
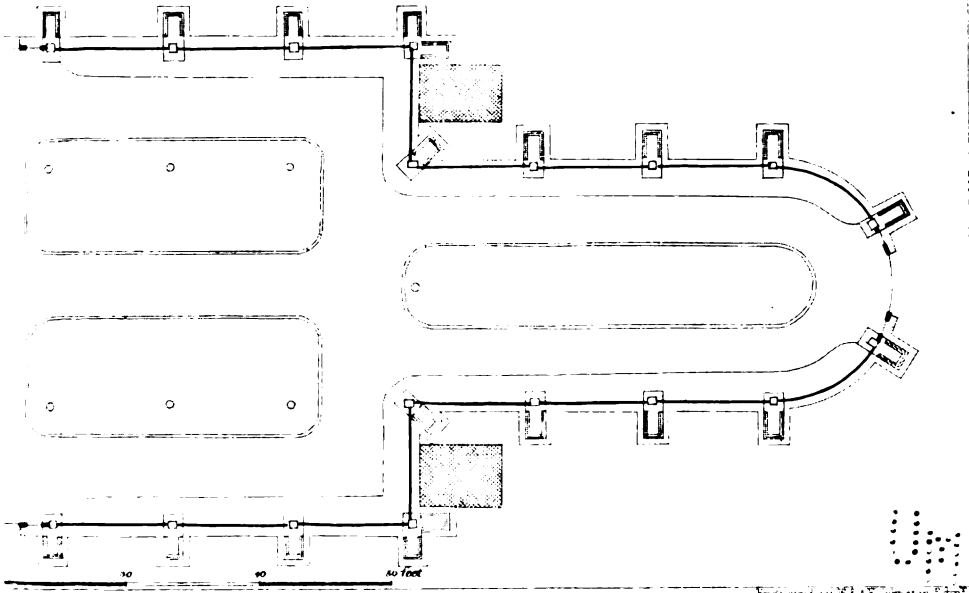
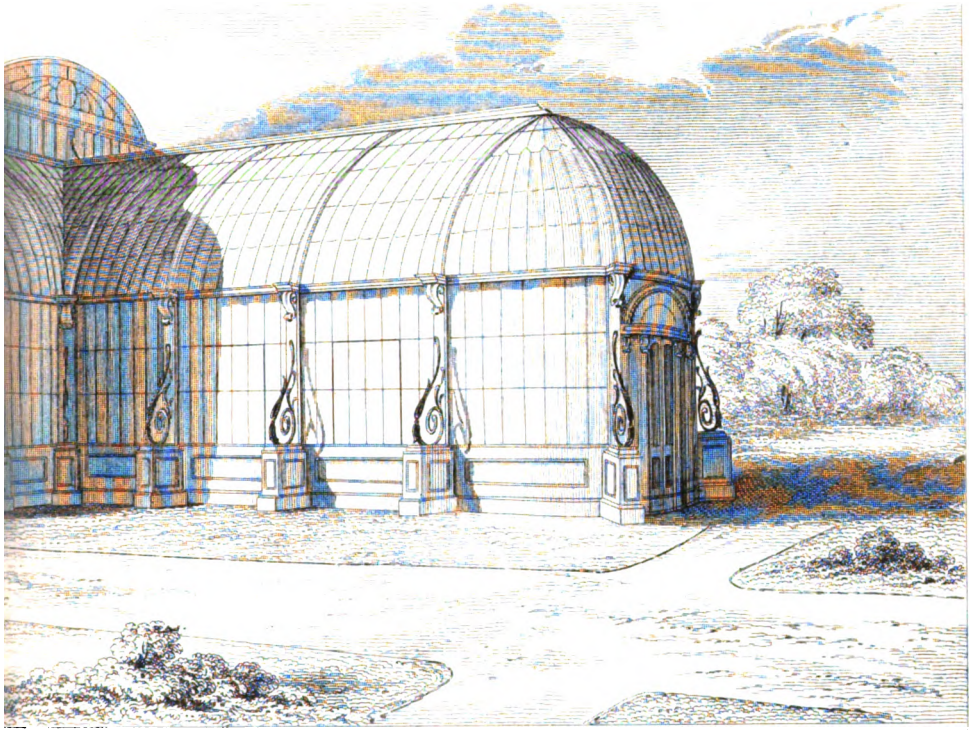


FIG. 10.

CONSERVATORY FOR THE

1851

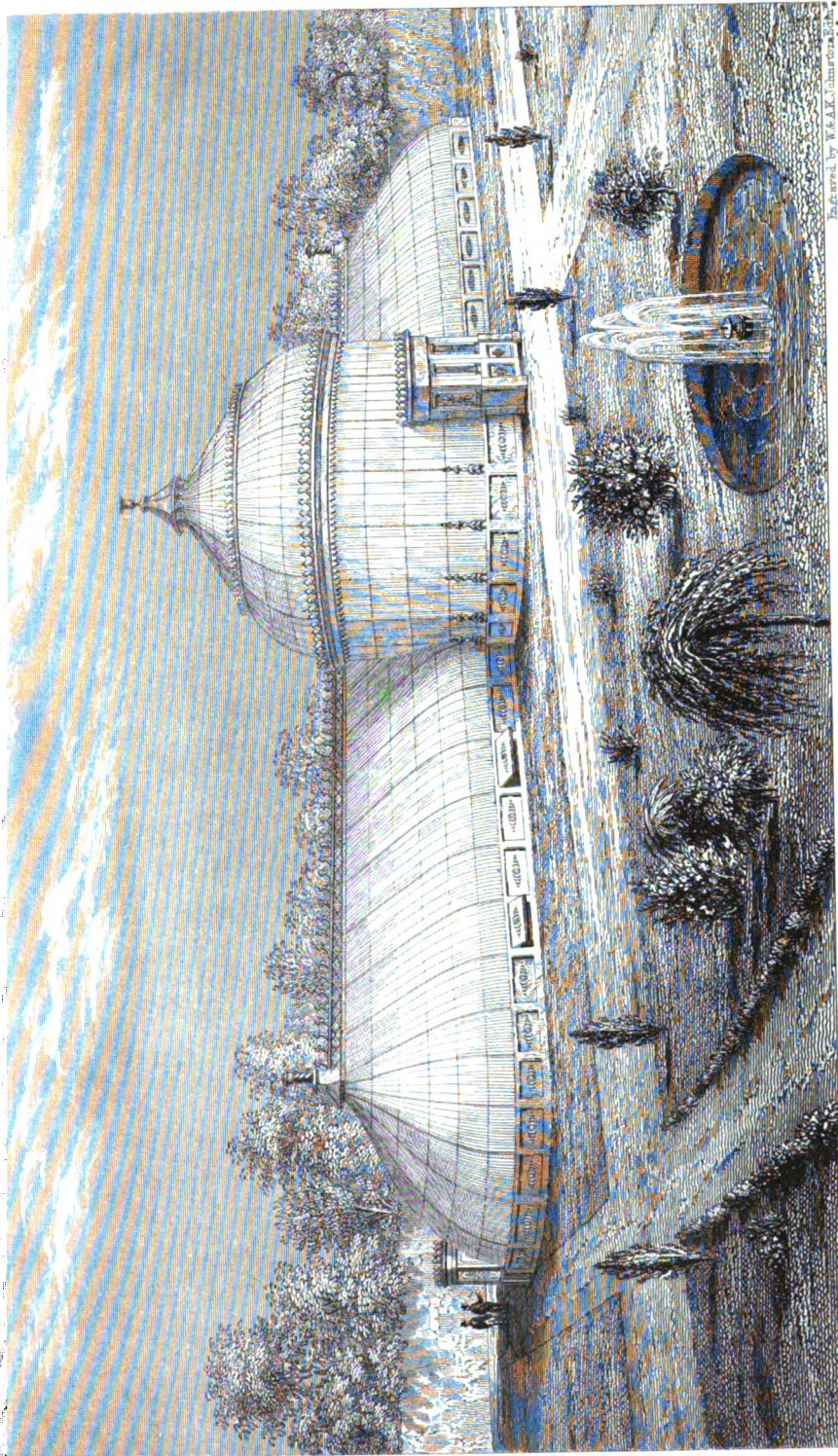


Designed by W. & A. Robertson, Edin.

1857 CLASS RESIDENCE.

J. & J. Smith, London.





Designed by W. A. C. Johnston & Co.

CONSERVATORY AND REPTILE HOUSE, AT MILLER'S.

W. A. C. Johnston & Co., Architects, London.

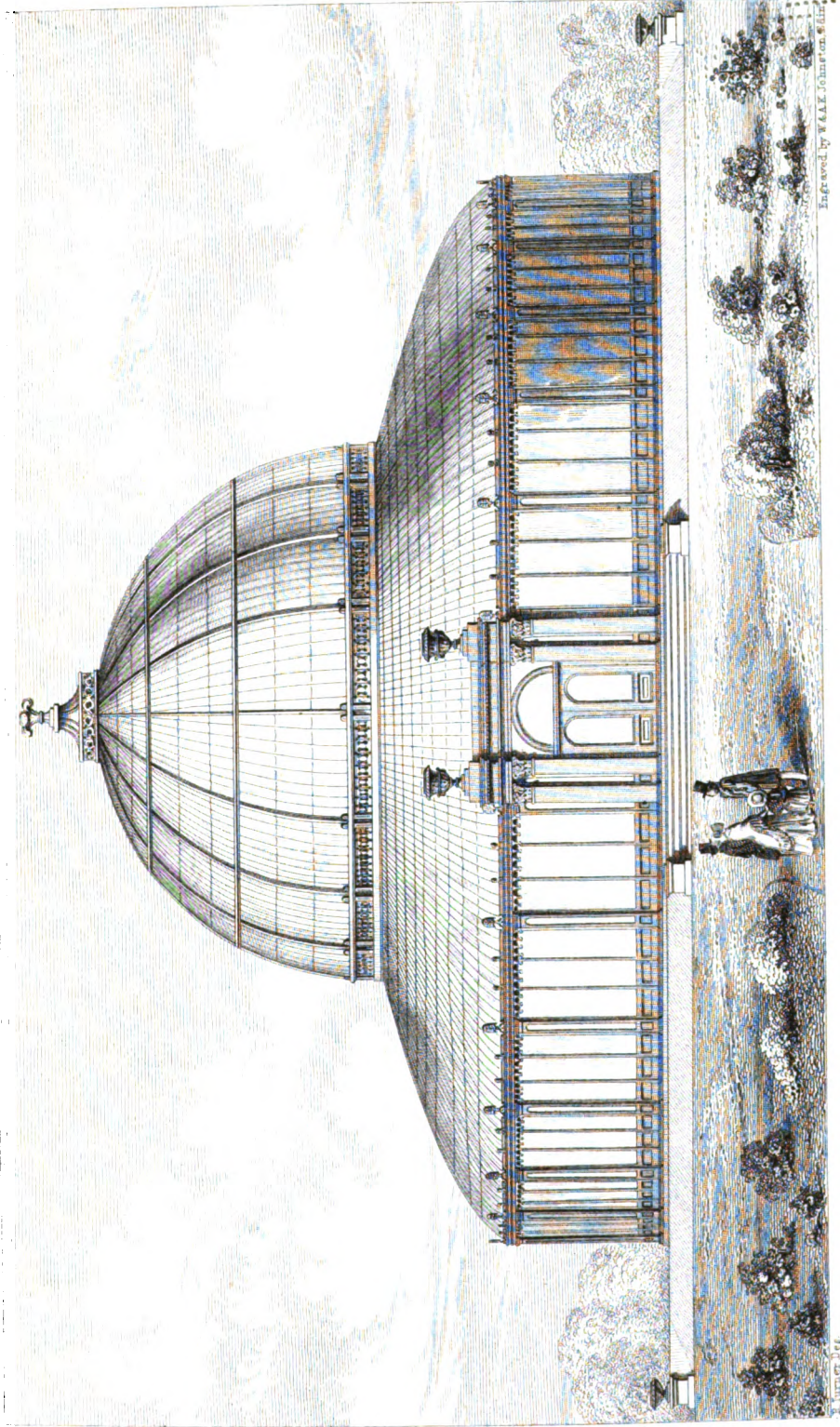
E. Thomas, Del.





.





BOTANICAL CONSERVATORY

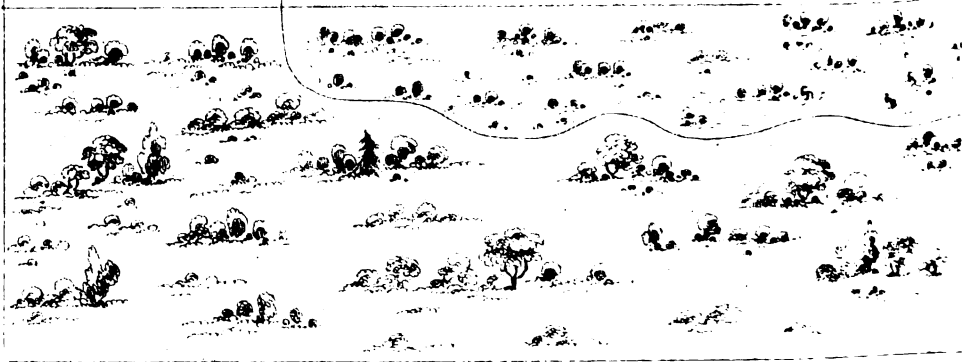
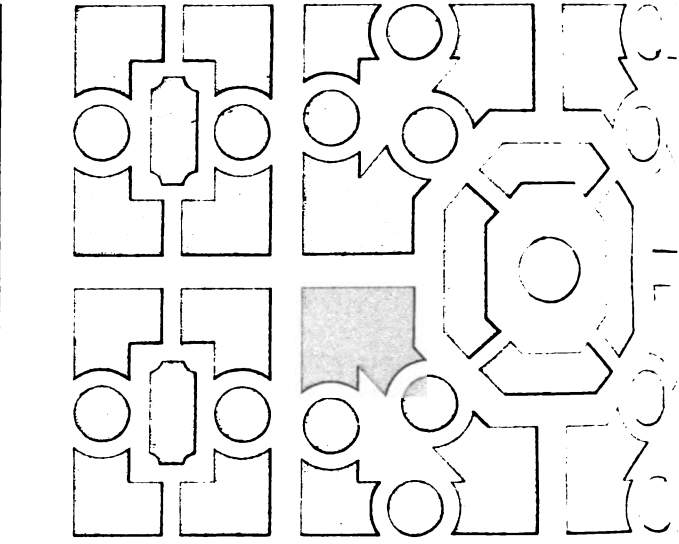
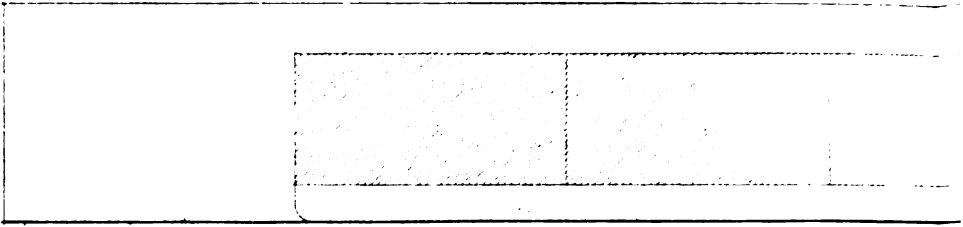
William Blackwood & Sons, Edinburgh & London.

111111  
111111  
111111  
111111  
111111

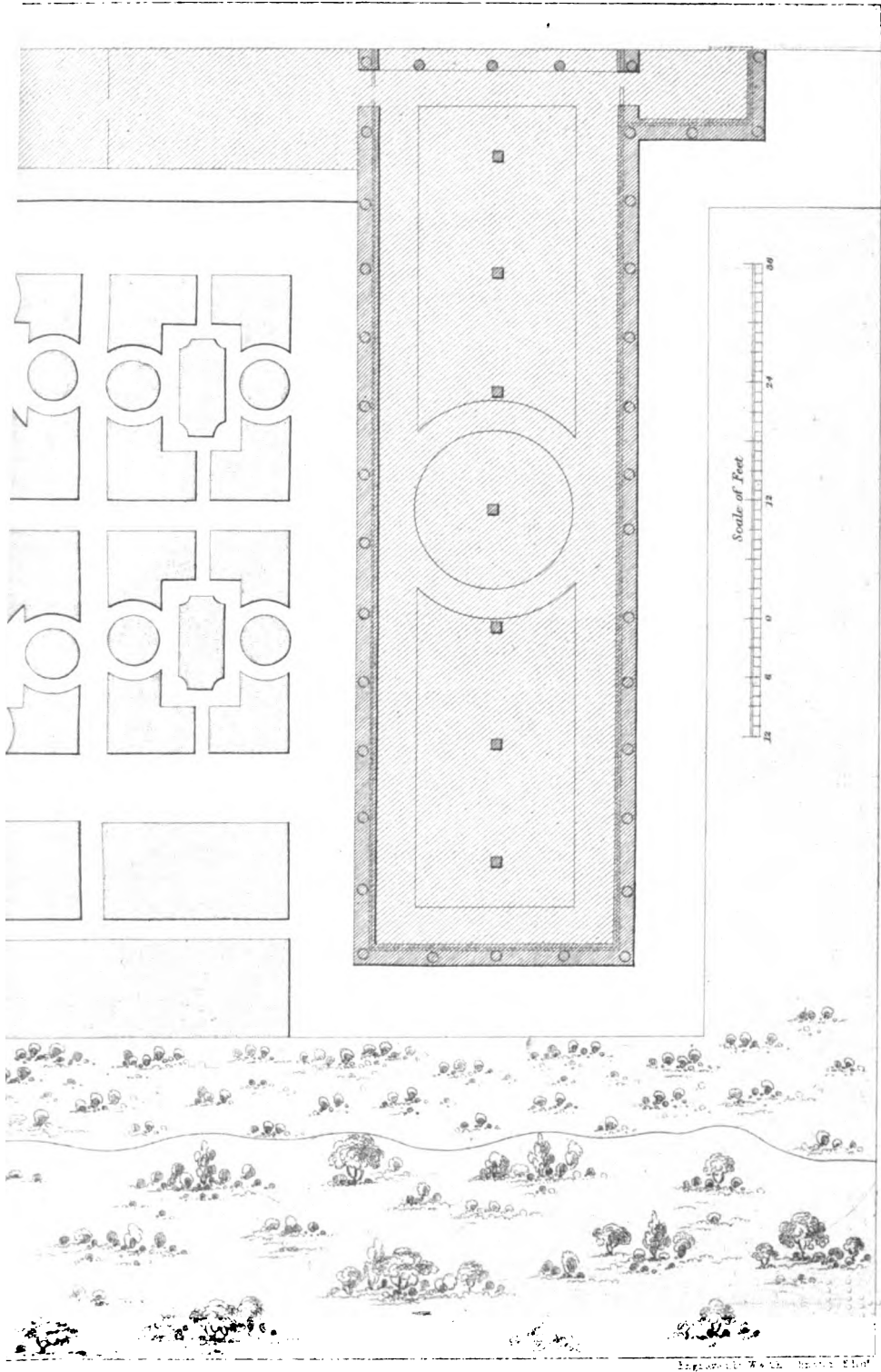


1111  
1111  
1111  
1111  
1111





PLAN OF CONSERVATORY AND GARDEN

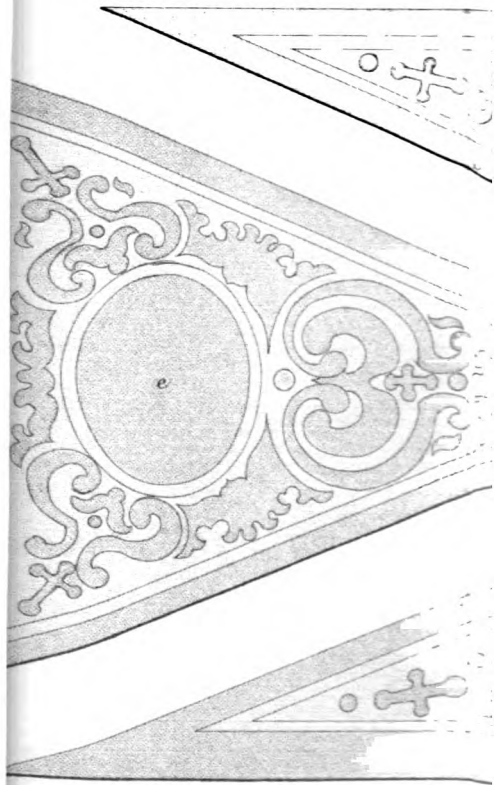
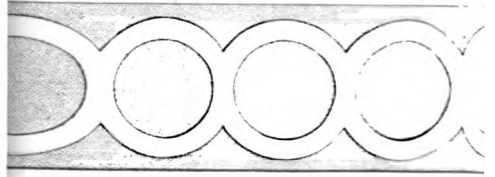
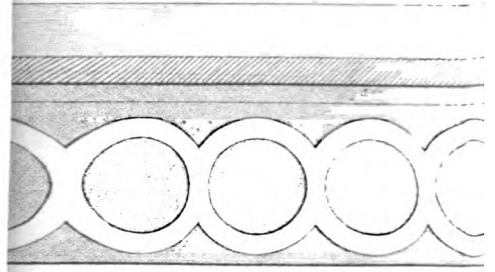


THE LOWER GARDEN, ORVISFIELD.





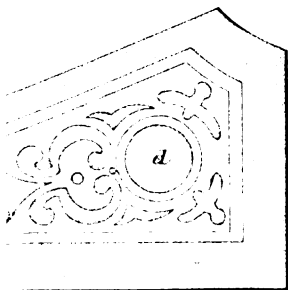
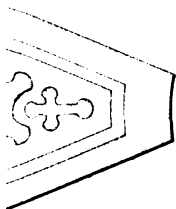
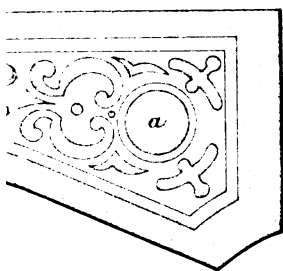
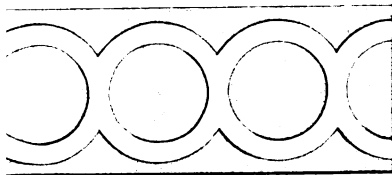
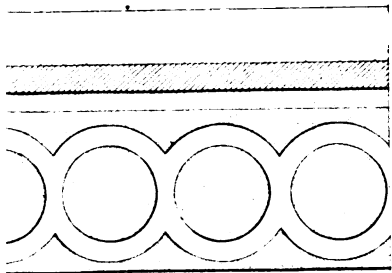




FLOWER GARDEN AT THE

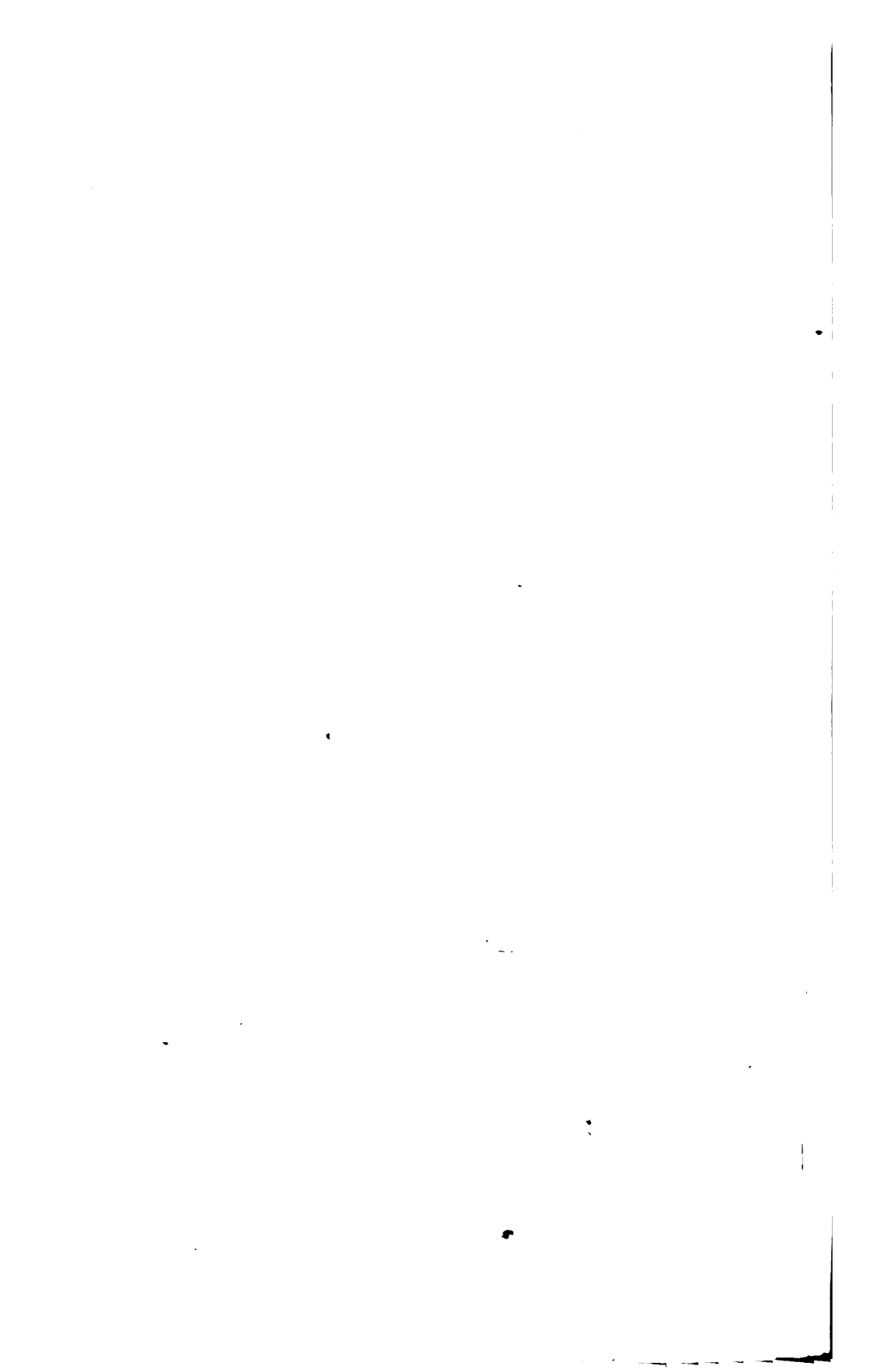
Wilton

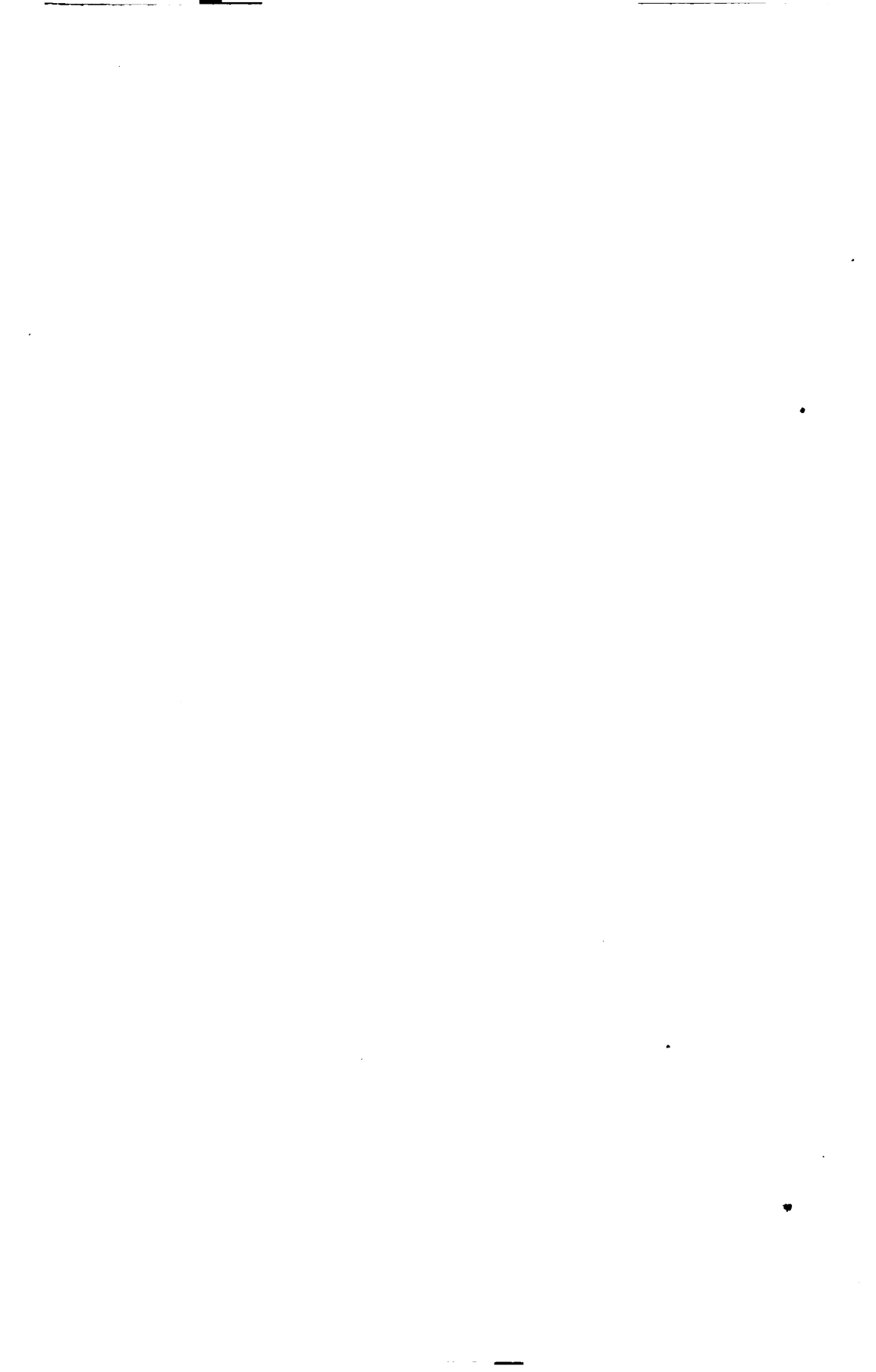


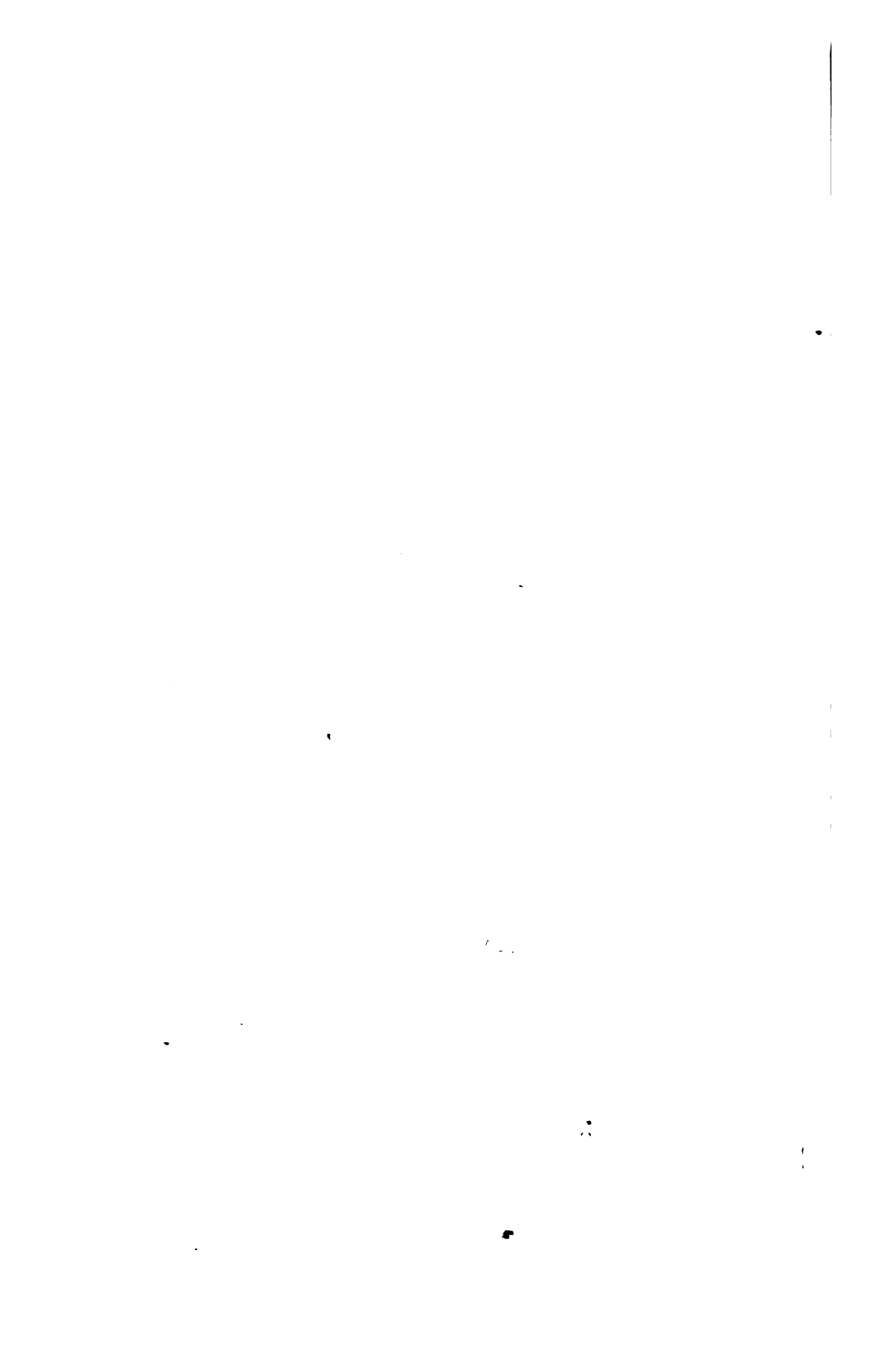


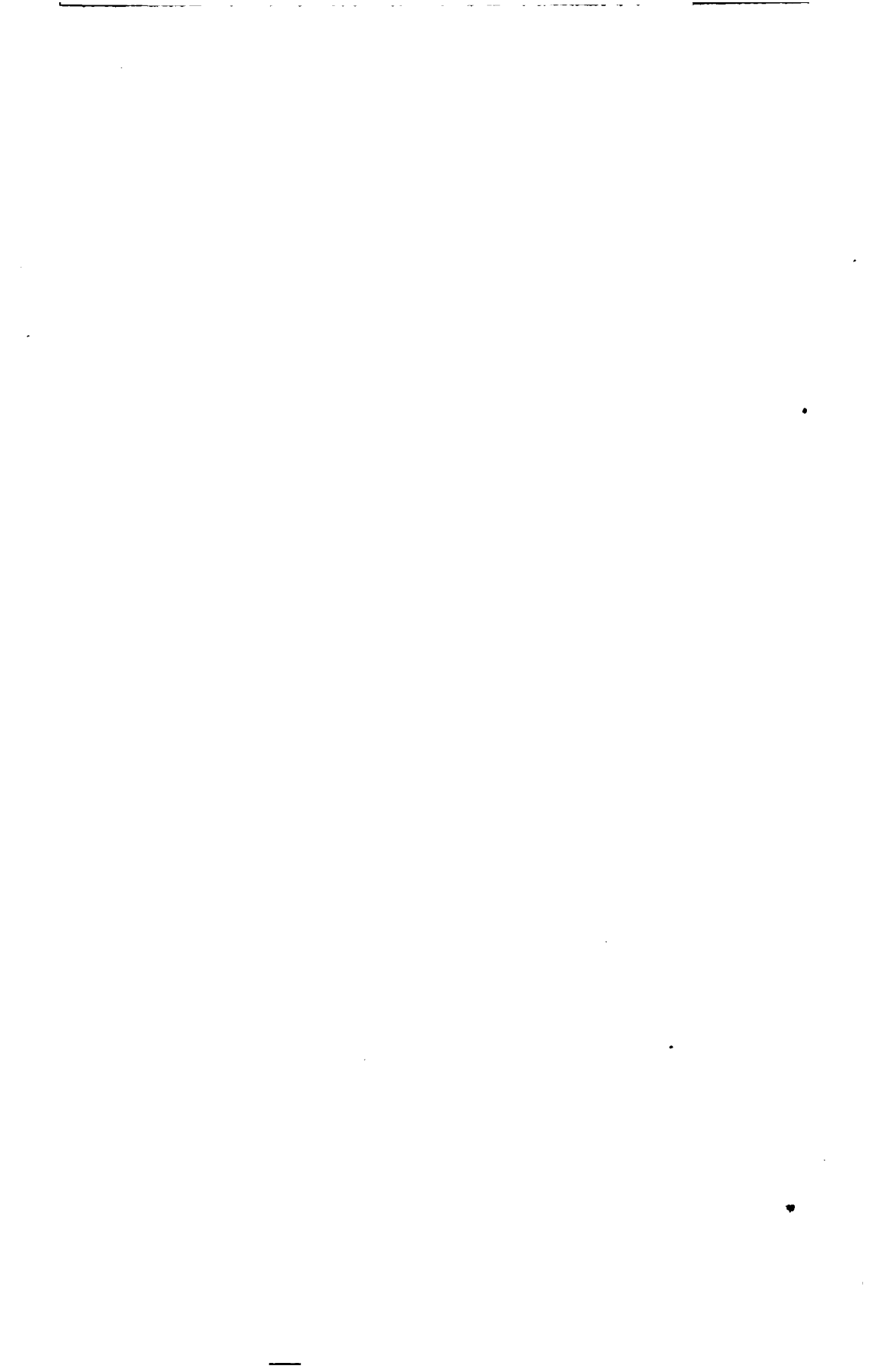
ART. 1076 CALLED

Design of London

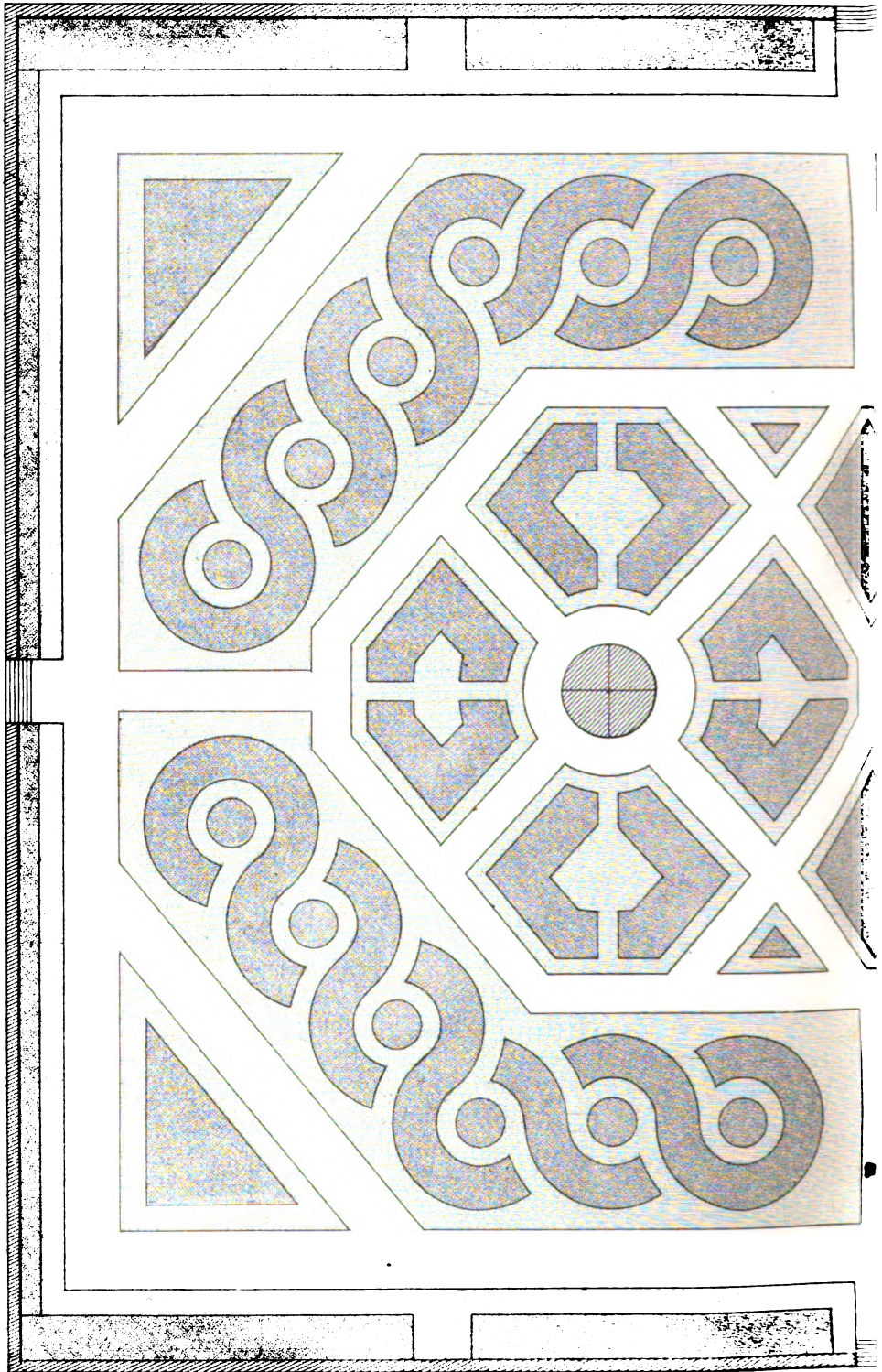






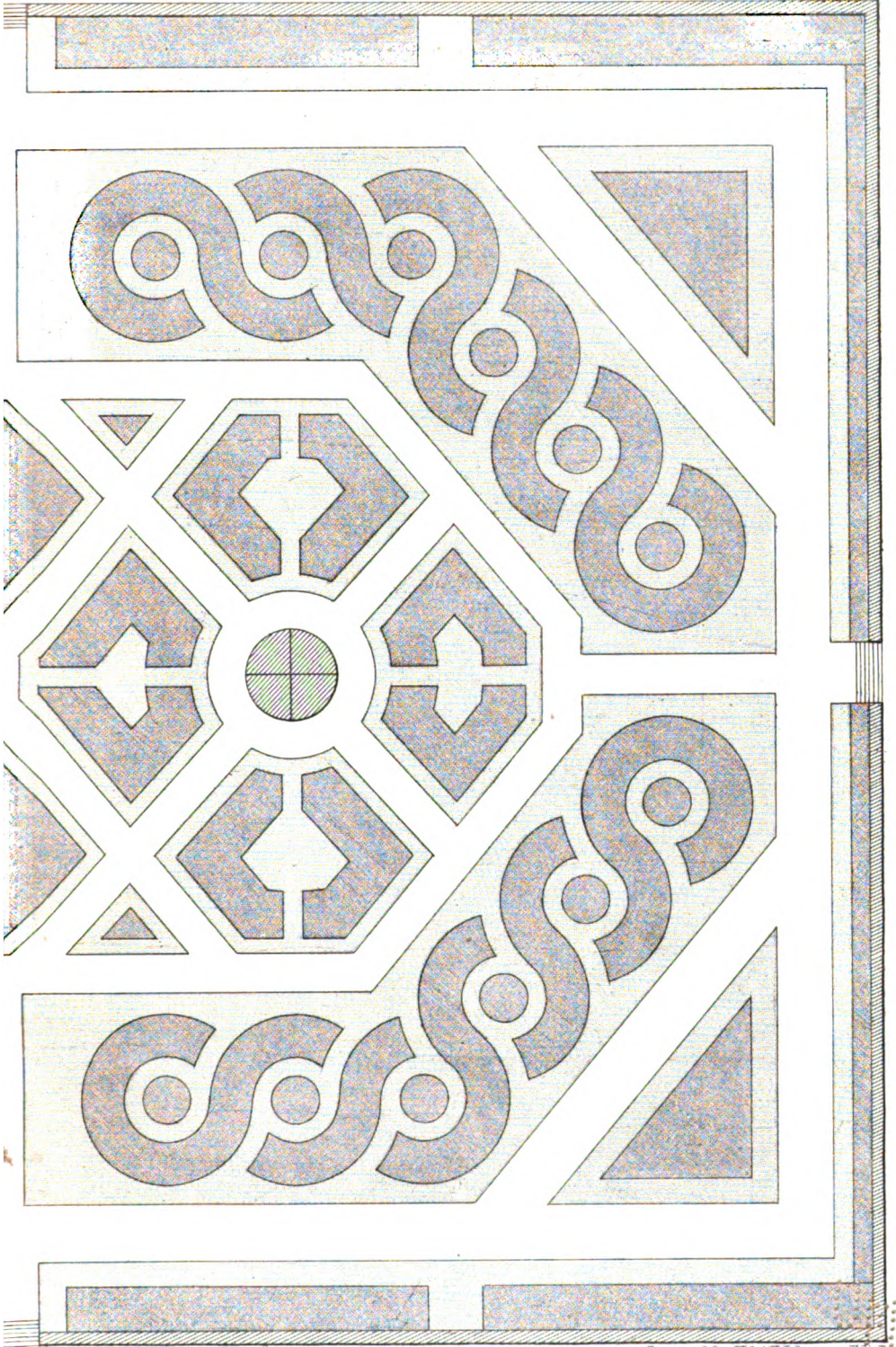






G E O M E T R I C A L

*William Blackwell*



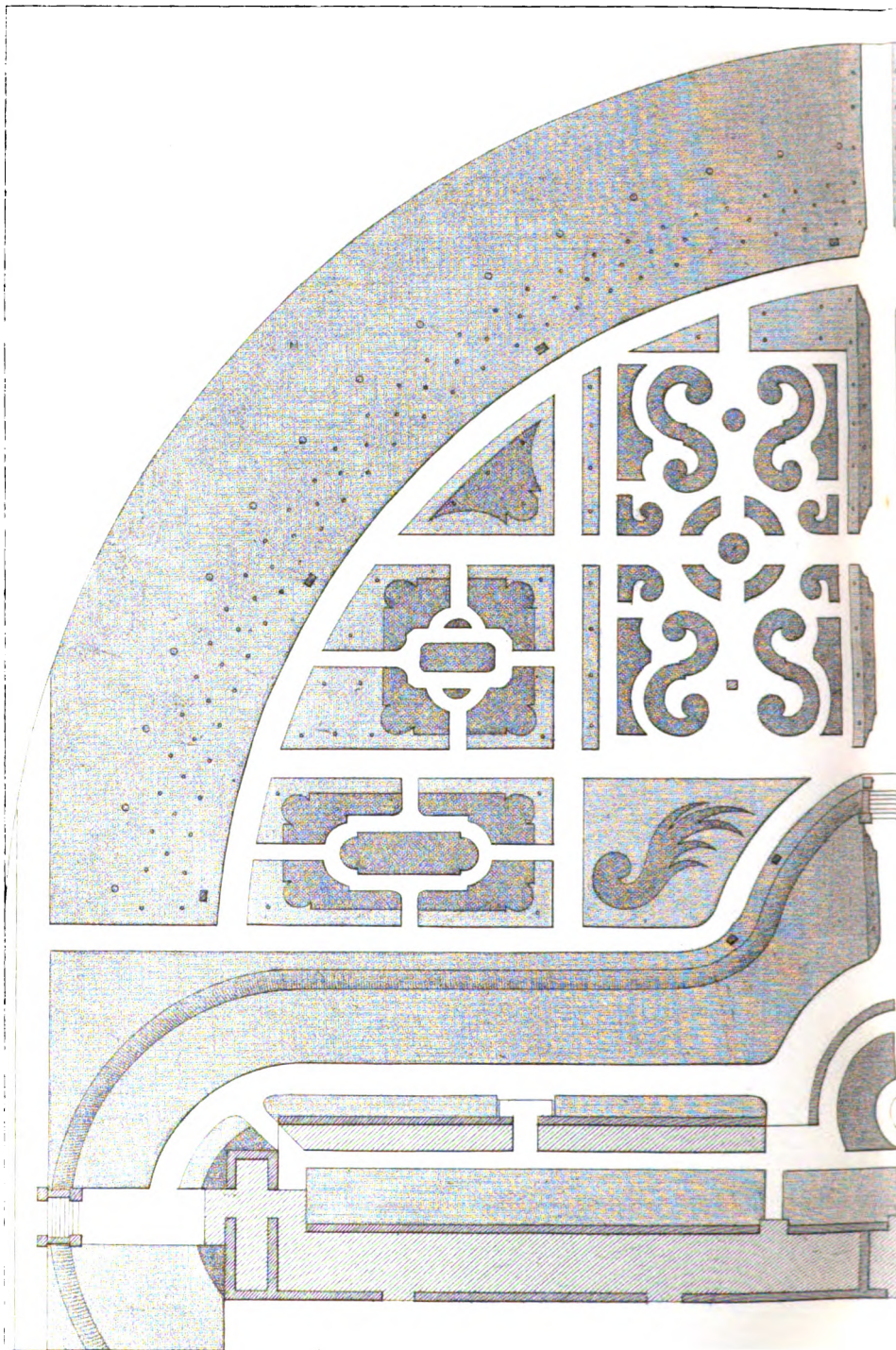
Engraved by W & A.K. Johnston, Edin.

FLOWER GARDEN.

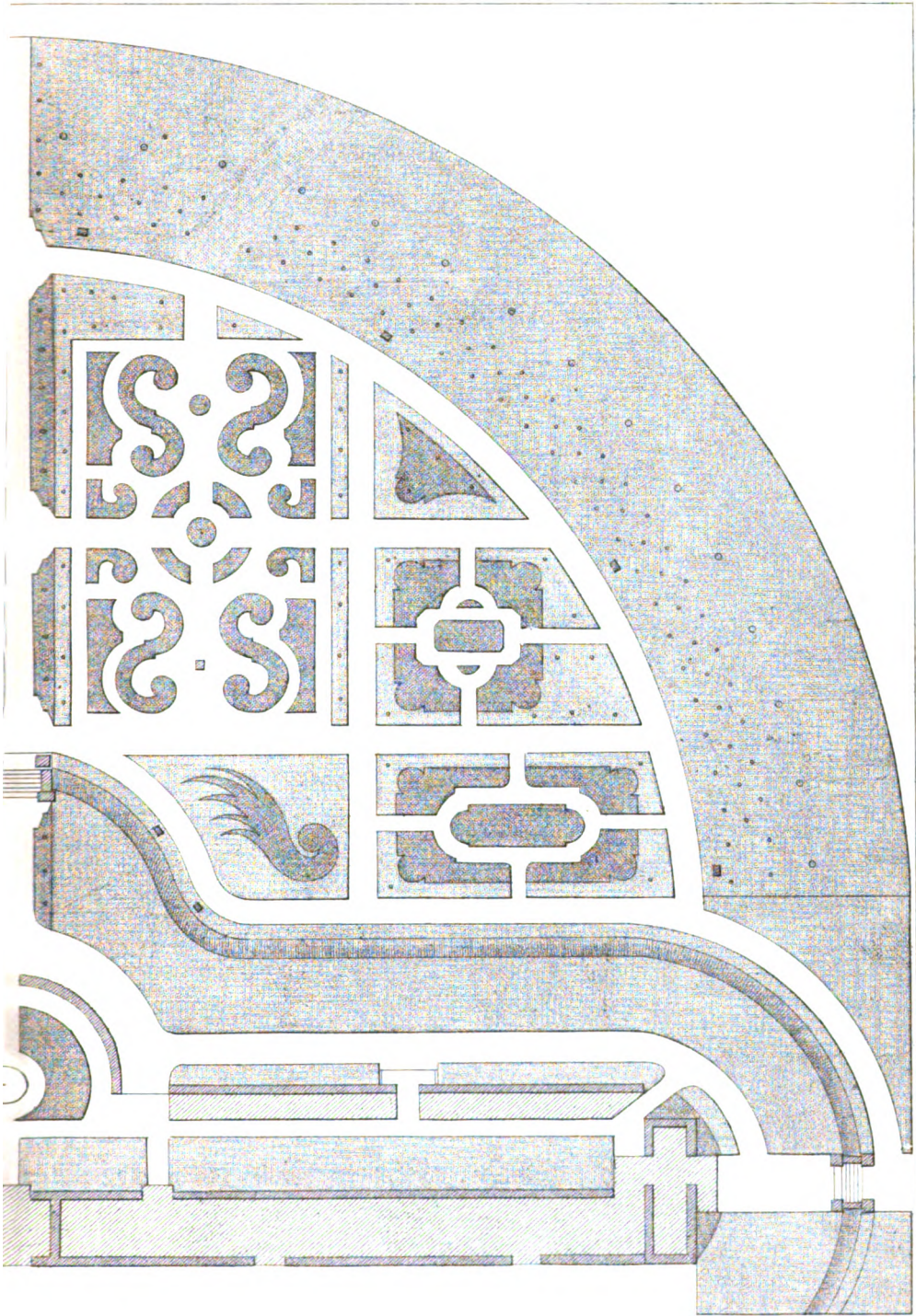
Edinburgh & London.

Digitized by Google





ITALIAN FLOWER 3A



Engraved by K. S. & C. from a drawing by the architect

EDWIN, CHICAGO, ILLINOIS.

The Eastlight & L. Co.





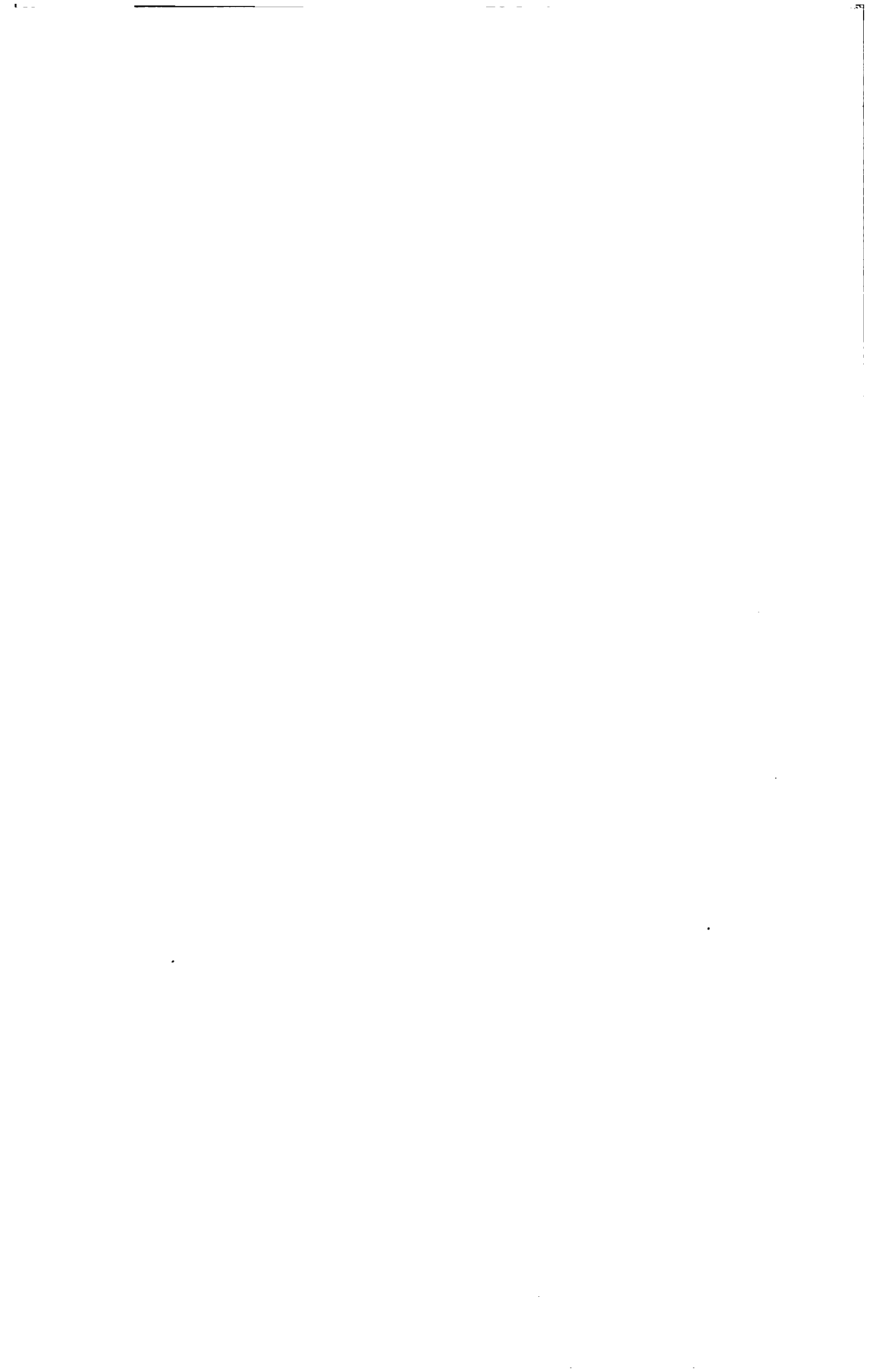
Chromo-lithogr. by W.A.K. John van Ydral.

PORTION OF GARDEN IN GEOMETRIC STYLE.

*William Blackie & Sons, Edinburgh & London.*



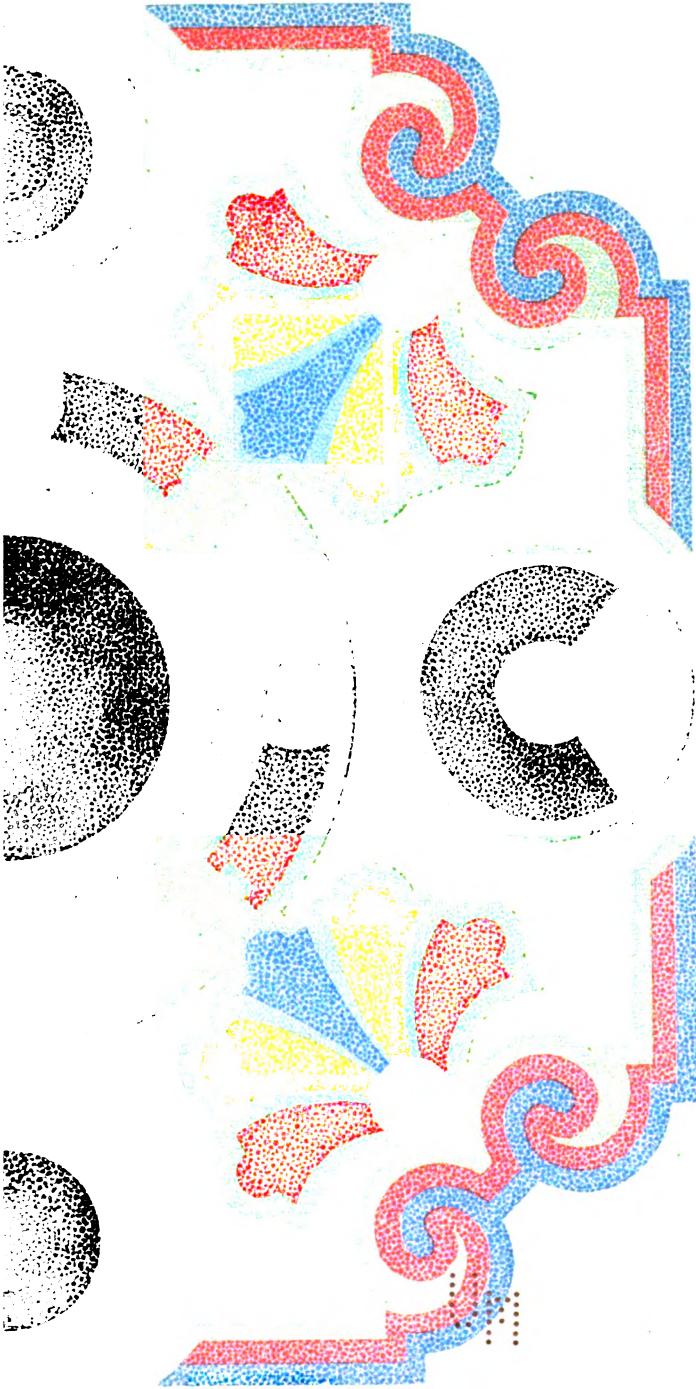
• 1911  
• 1912  
• 1913  
• 1914  
• 1915  
• 1916  
• 1917  
• 1918  
• 1919  
• 1920  
• 1921  
• 1922  
• 1923  
• 1924  
• 1925  
• 1926  
• 1927  
• 1928  
• 1929  
• 1930  
• 1931  
• 1932  
• 1933  
• 1934  
• 1935  
• 1936  
• 1937  
• 1938  
• 1939  
• 1940  
• 1941  
• 1942  
• 1943  
• 1944  
• 1945  
• 1946  
• 1947  
• 1948  
• 1949  
• 1950  
• 1951  
• 1952  
• 1953  
• 1954  
• 1955  
• 1956  
• 1957  
• 1958  
• 1959  
• 1960  
• 1961  
• 1962  
• 1963  
• 1964  
• 1965  
• 1966  
• 1967  
• 1968  
• 1969  
• 1970  
• 1971  
• 1972  
• 1973  
• 1974  
• 1975  
• 1976  
• 1977  
• 1978  
• 1979  
• 1980  
• 1981  
• 1982  
• 1983  
• 1984  
• 1985  
• 1986  
• 1987  
• 1988  
• 1989  
• 1990  
• 1991  
• 1992  
• 1993  
• 1994  
• 1995  
• 1996  
• 1997  
• 1998  
• 1999  
• 2000  
• 2001  
• 2002  
• 2003  
• 2004  
• 2005  
• 2006  
• 2007  
• 2008  
• 2009  
• 2010  
• 2011  
• 2012  
• 2013  
• 2014  
• 2015  
• 2016  
• 2017  
• 2018  
• 2019  
• 2020  
• 2021  
• 2022  
• 2023  
• 2024  
• 2025





GARDEN IN GEM

Richard M. Black: 1914



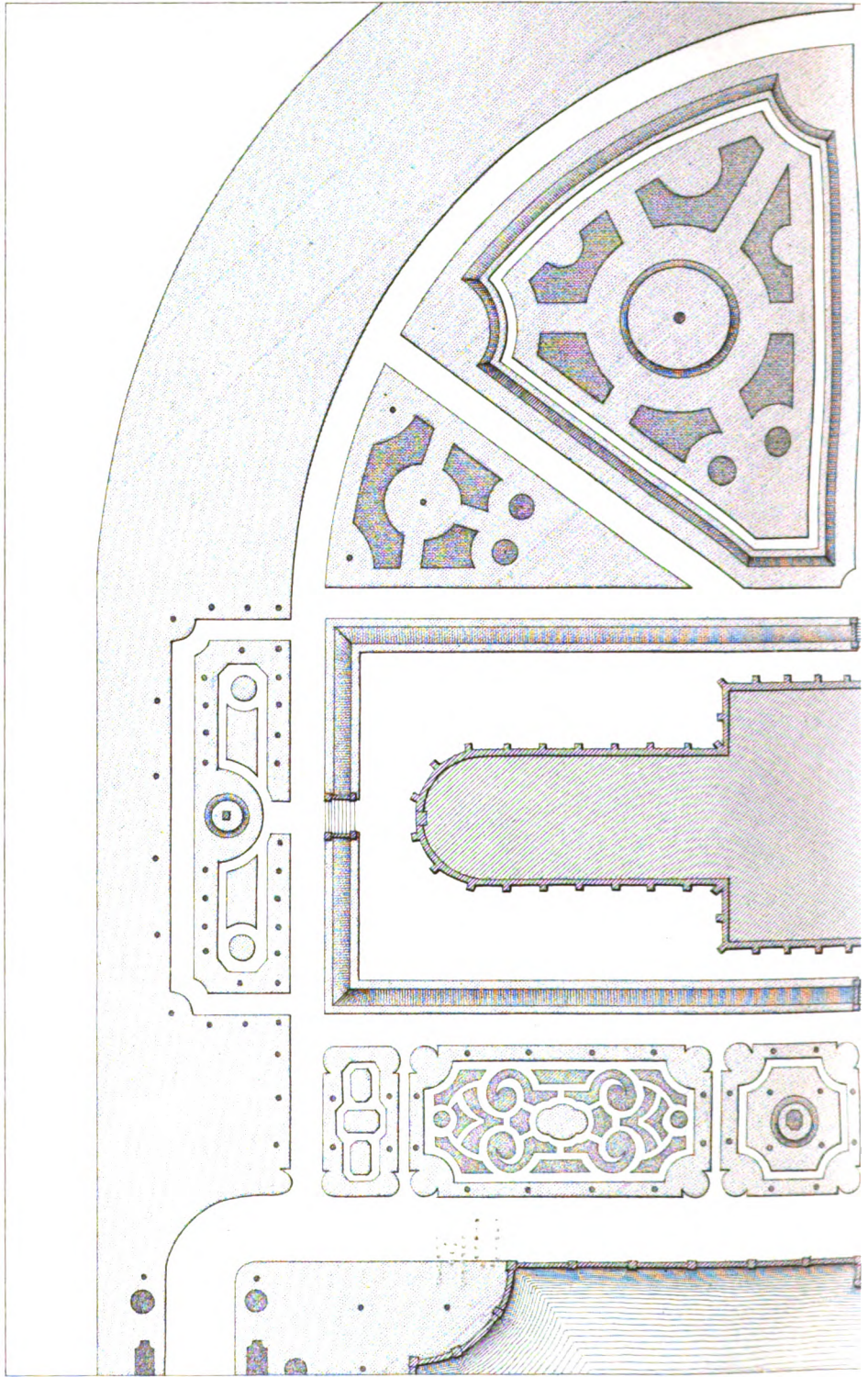
Chromo Lithog<sup>d</sup> by W & A R. Johnston, Edin<sup>g</sup>

SYMMETRIC STYLE.

Edinburgh & London.

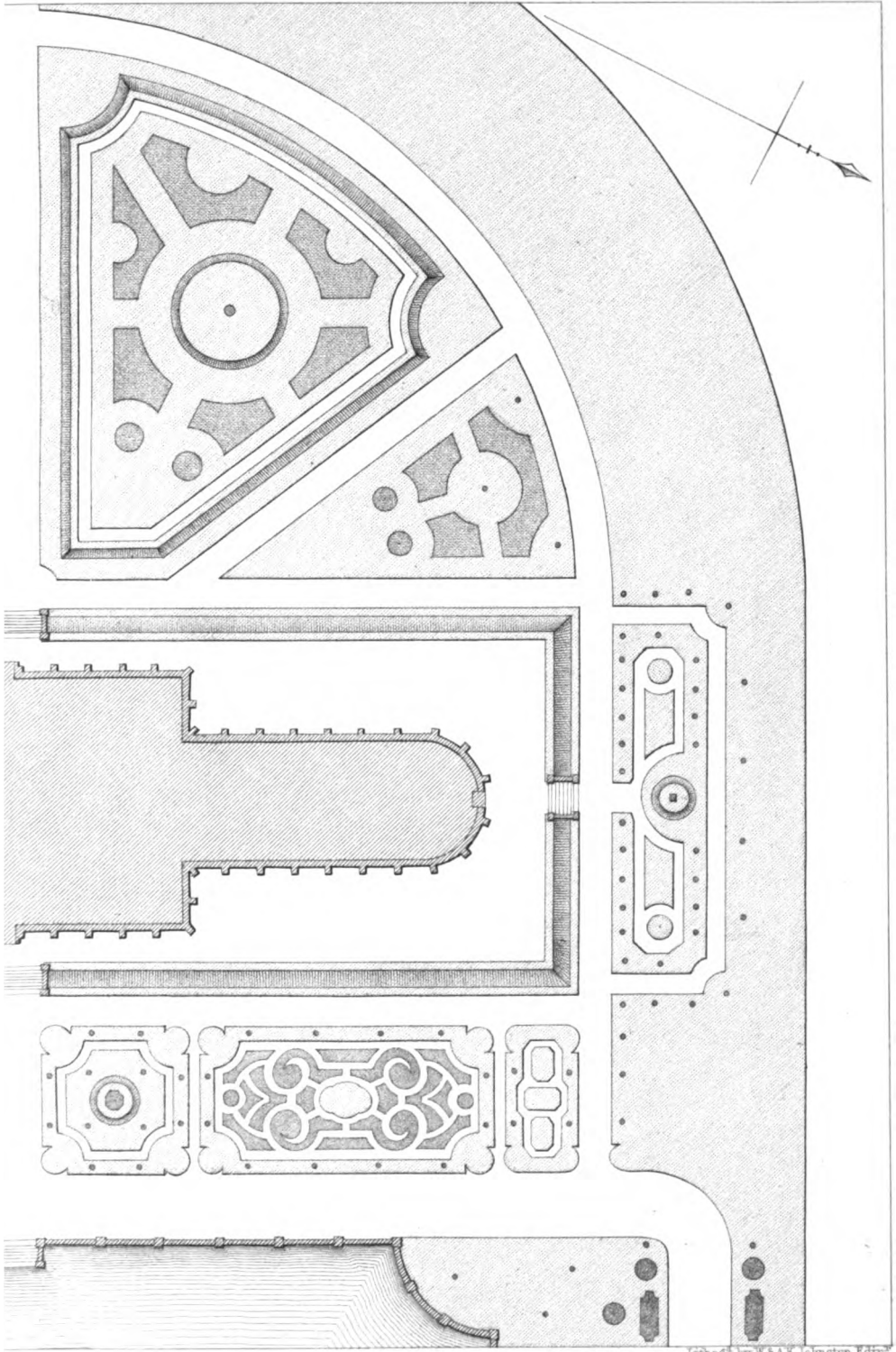


100



GROUND PLAN OF  
AUSTRIAN PALACE

*Walter Pichler*



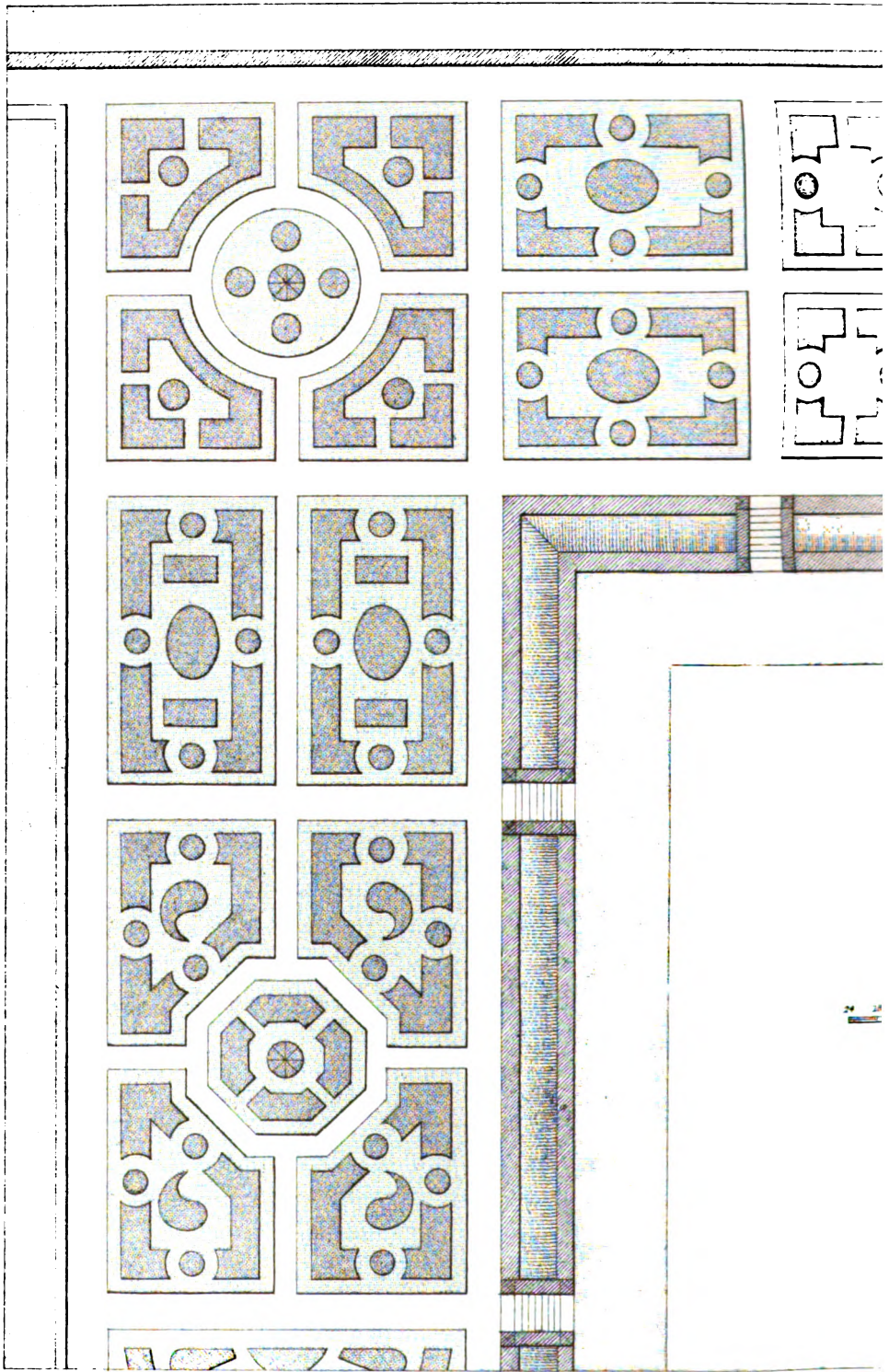
Lithog<sup>d</sup> by W & A. C. Colman, Edin<sup>g</sup>.

PLAN OF THE GREAT CHURCH  
OF ST. MARTIN'S, LONDON.  
See *Engraving*, London.

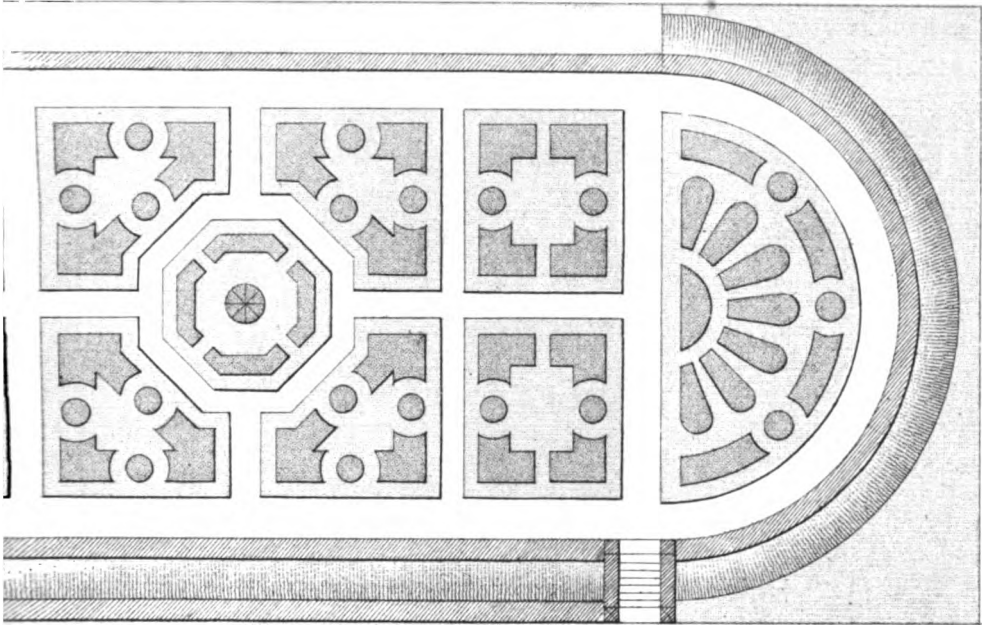








ARCHITECTURAL FLOOR



Scale of Feet



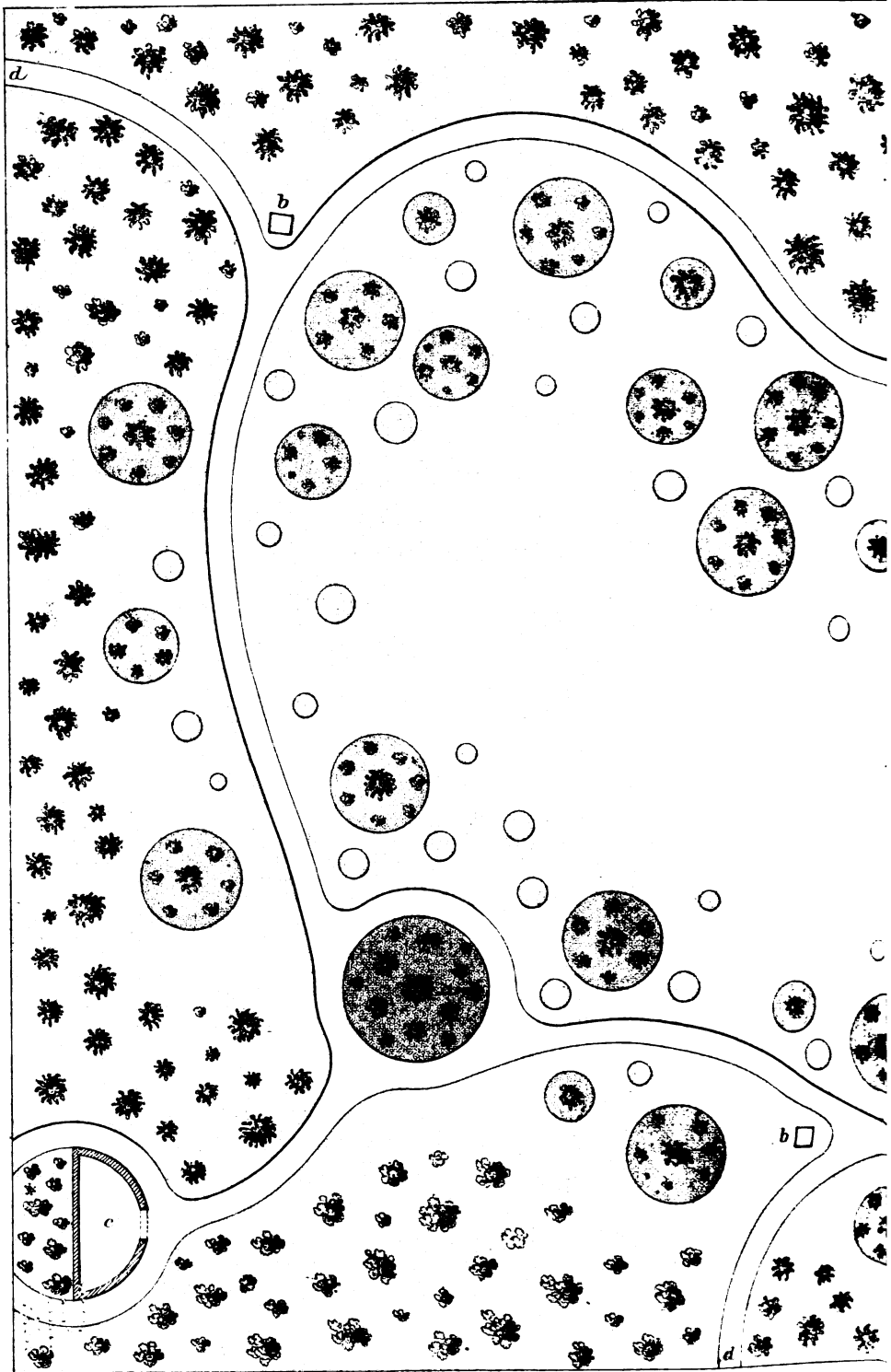
Engraved by W. & A. G. Johnston

GARDEN, CHYKOR SITES.

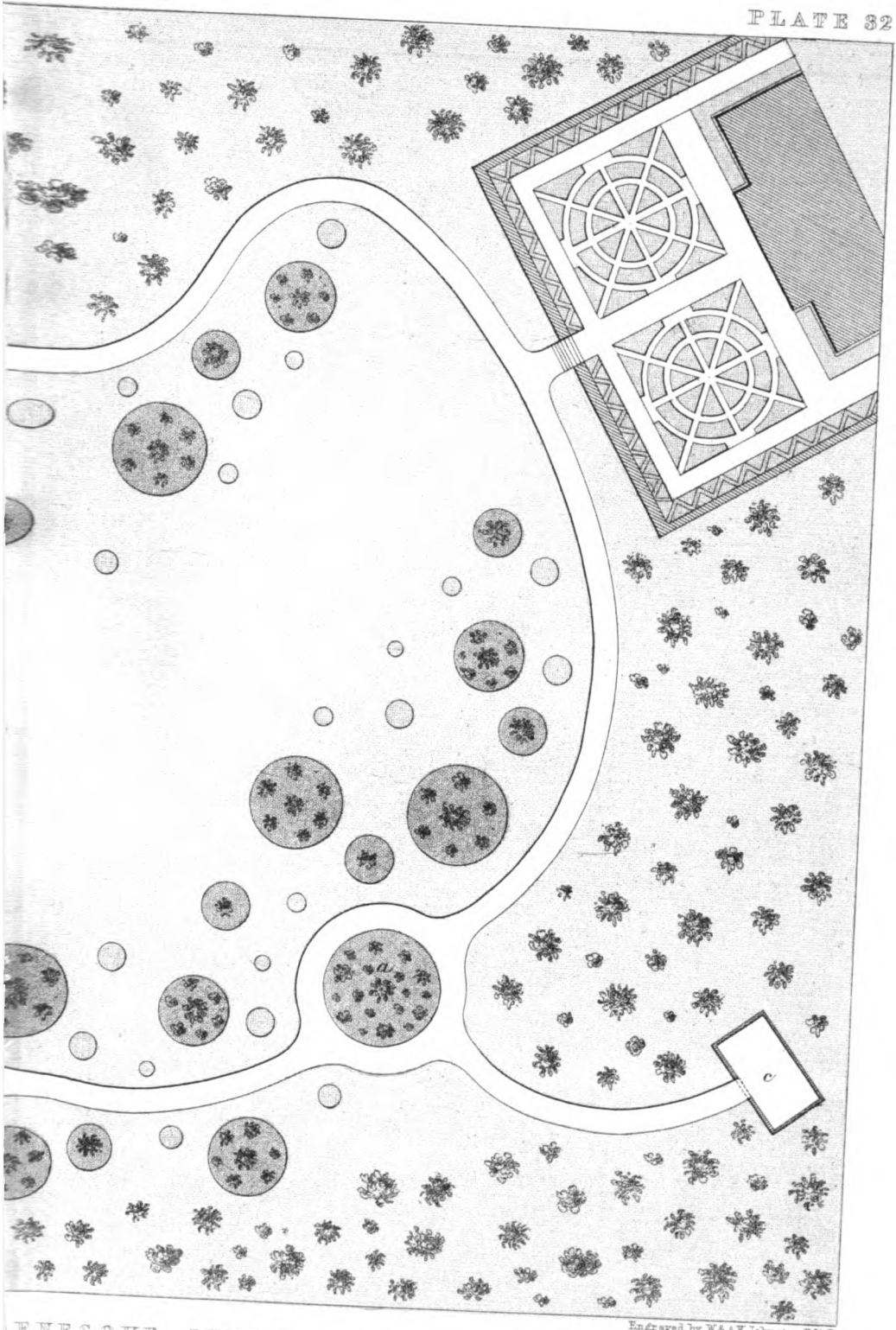
PLATE 81

4





GARDEN IN GARDEN



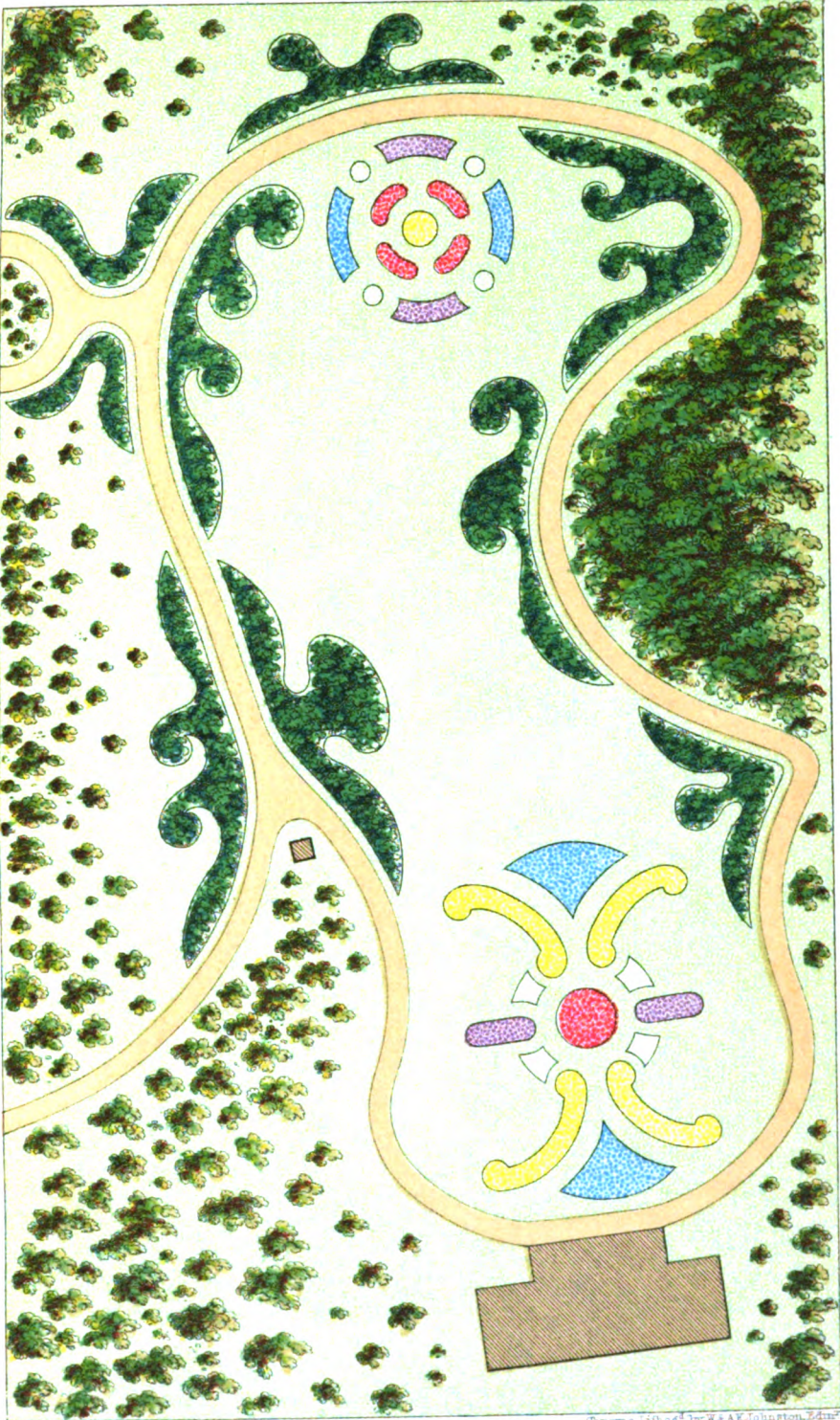
ENESQUE STYLE.

Engraved by W & A E Johnston, Edin<sup>g</sup>

*Forbush & Landon*





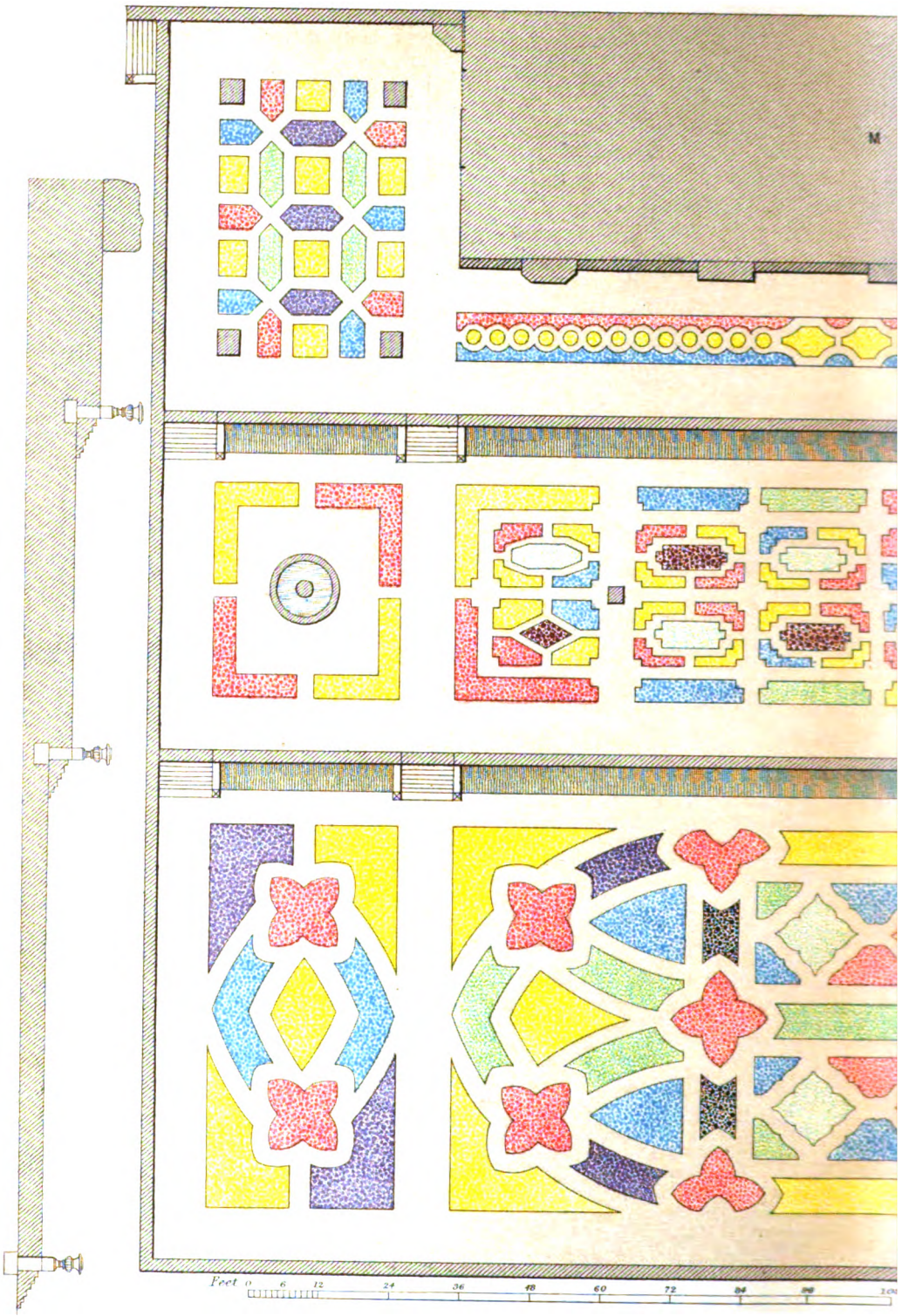


Chrome lithog<sup>d</sup> by W. A. K. Johnston, Edin<sup>g</sup>

GARDEN IN THE PICTURESQUE STYLE.

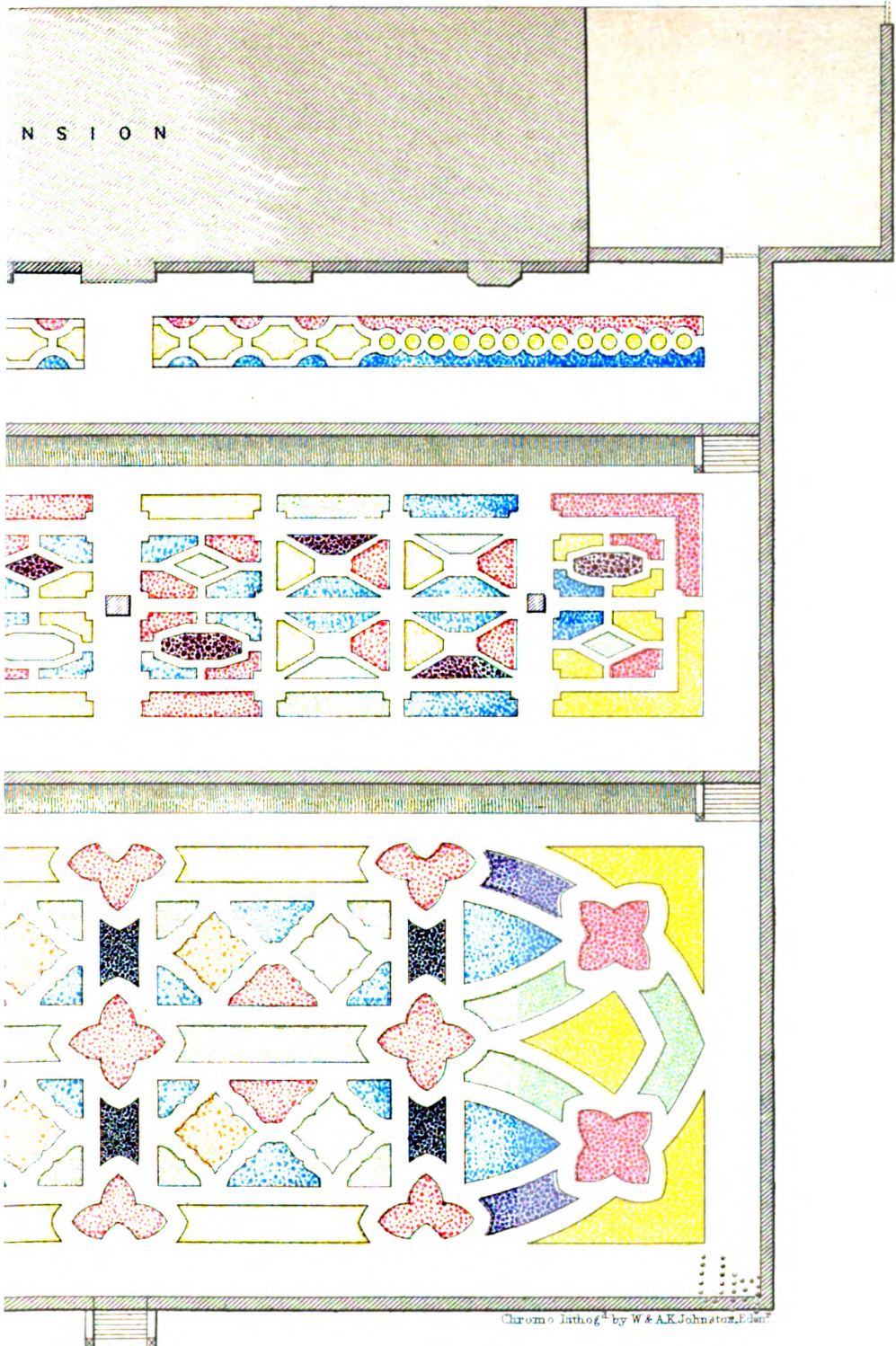






ARCHITECTURAL DRAWING

Scale: Feet



THE GREAT HALL IN OXFORD

W & A.K. Johnston



