

THE
BOOK OF FARM-BUILDINGS

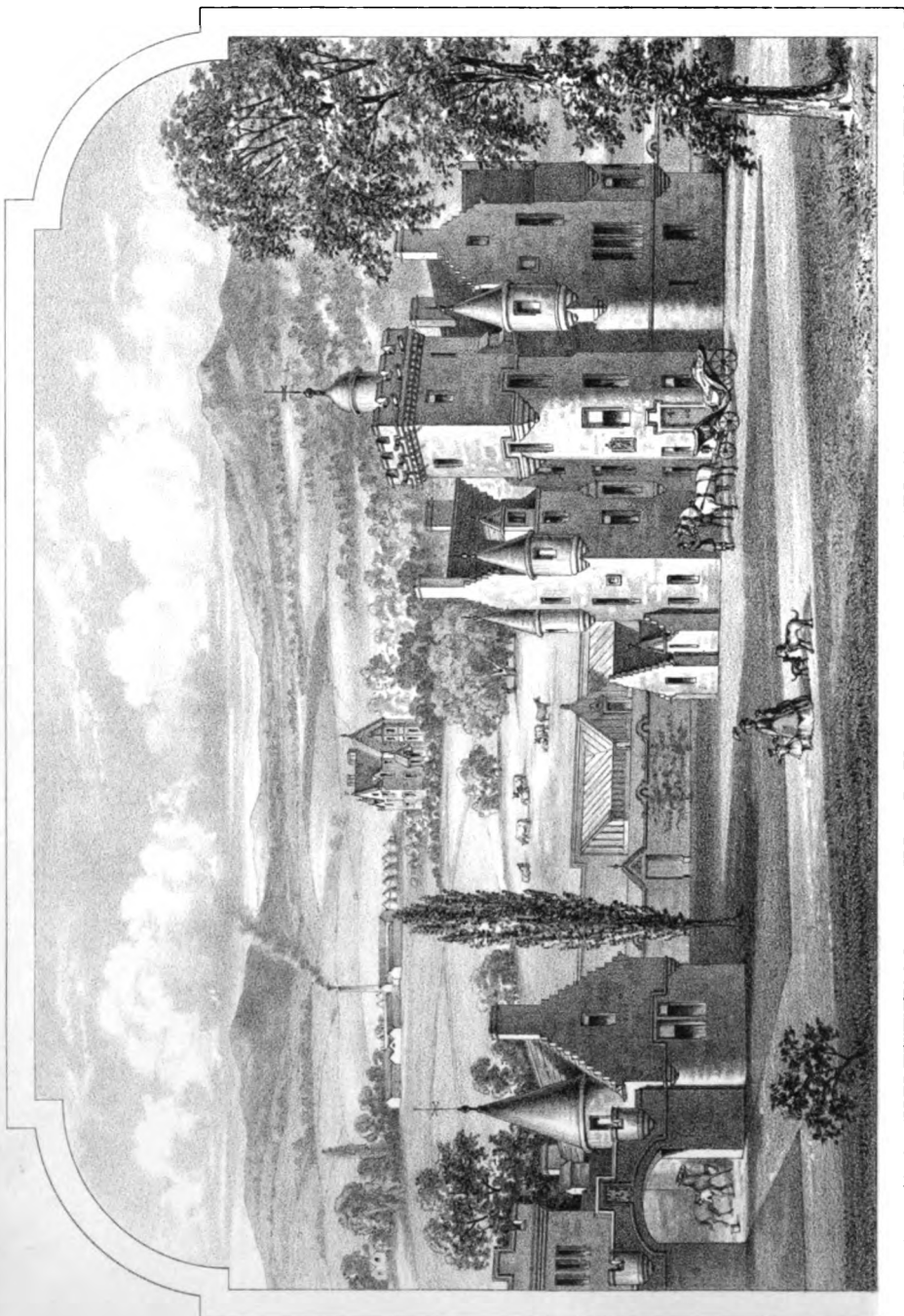



W. R. M. Furness Lith. Phila.

FRONTISPIECE

THE
BOOK OF FARM-BUILDINGS

THEIR ARRANGEMENT AND CONSTRUCTION

BY

HENRY STEPHENS, F. R. S. E.

AUTHOR OF THE "BOOK OF THE FARM," ETC.

AND

ROBERT SCOTT BURN

ENGINEER

"He's got no notion about buildings: you can so seldom get hold of a man as can turn his brains to more nor one thing; it's just as if they wore blinkers like th' horses, and could see nothing o' one side of 'em. Now, there's Mr Irwine has got notions o' building more nor most architects; for as for th' architects . . . most of 'em don't know where to set a chimney so as it shan't be quarrelling with a door. My notion is, a practical builder, that's got a bit o' taste, makes the best architect for common things; and I've ten times the pleasure i' seeing after the work when I've made the plan myself."—*Adam Bede*, vol. iii. p. 221.

WILLIAM BLACKWOOD AND SONS
EDINBURGH AND LONDON
MDCCCLXI

~~170 a b~~

173 . e . 82 .

P R E F A C E .

THE object of this work is twofold—one, to establish principles upon which the planning of farm-buildings should be based—the other, to concentrate correct and valuable information on the nature and use of the materials employed in constructing farm-buildings.

It may astonish those of our readers who are agriculturists, to learn for the first time that principles should still be sought for in the planning of farm-steadings, after so long an experience of their use. The surprise would be greatly modified were they to take into consideration the care that should be bestowed in placing the numerous apartments of steadings relatively where they should be ; and they would then discover that these are generally by no means so conveniently arranged as they might be. At any rate, it is clear that the same arrangement of apartments in a steading for a pastoral farm, where live-stock alone are reared, would not be suitable for a strong clay land farm, where no stock are reared at all. We contrast these two extreme cases to make our meaning the clearer. But, however great a difference of arrangement is required in such extreme cases, a material difference also exists in cases even more alike. It will at once be admitted that a different arrangement should be made where stock are reared from where they are not ; but even where stock are reared, it must also be conceded that considerable difference in the arrangement is required where the sorts of farming differ. For example, stock are reared on both pastoral and dairy farms, but the

arrangement of apartments should be as different in these as between a pastoral and a carse farm, although the apartments themselves may be formed alike. Again, stock are reared in both dairy and mixed husbandry farms, yet the arrangement of the apartments should be quite different in such different modes of farming. Moreover, stock are fattened in both common and mixed husbandry farms, but the apartments in breeding should be quite differently placed from those in feeding farms. We may therefore safely conclude that each mode of farming requires its own arrangement of apartments in the stead- ing, so that each class of stead- ing should have its distinguishing features. Having arrived at this conclusion, the question naturally arises, Do existing steadings really possess such distinctive character- istics? We believe they do not. We suspect very many do not indicate at a glance the purpose for which they were constructed. And why should this be so? In other mechanical arts we find no difficulty in distinguishing one building from another. No one would mistake a flour-mill for a spinning-mill, or a factory for a warehouse. So ought we to be able to distinguish the system of farming by the structure of the steadings, and we could do so easily were steadings really constructed in conformity with the system of farming they are intended to accommodate.

It is our ambition to plan steadings that will at once tell the system of farming they are intended for. If we can do this, we conceive we would do a good thing for the agricultural community, and we believe we have done it. But we are sure we could not have done it without following principles, and those we have followed have only been apprehended after much practical thought and observation. On fol- lowing them out, convenience and economy in construction gradually developed themselves: and the entire results we here endeavour to place before our readers, accompanied with copious illustrations. The principles referred to are fully explained at p. 6, and their particular application to each sort of farming is illustrated in the Description of Plates I. to VIII.

Besides steadings, the construction of farmhouses should be based upon the requirements incidental to the occupation of such a dwelling. These requirements are enumerated in pp. 54-57. The leading prin-

ciples are, that the working and dwelling parts of a farmhouse should be kept separate; that the working part should be, in all cases, nearly of the same dimensions, because the utensils employed and the room required for work are nearly the same in all cases; and that the dwelling part should be enlarged and embellished in conformity with the importance of the farm.

Farm-cottages require careful consideration in their construction. We have endeavoured to evince that care in the observations we have made on that interesting class of dwellings in pp. 93, 94. The guiding principle is that farm-cottages should be made to suit the number of the family to occupy them, and not to make them all of one size. A married couple only require one room; while the same, with a family, require at least three, and even more rooms, according to the number of the family. Wherever a hind is bound to provide a field-worker, his cottage requires one apartment more than where no such obligation exists.

In drawing out the plans of farm-cottages, the principle in all cases has been rigidly adhered to, of first deciding what was required in the way of apartments, sculleries, &c., to make the cottages, when constructed, absolutely convenient, so as to secure in the best possible manner, not the comfort merely of their inhabitants, but also to aid in the exercise of economical and orderly housewifery; for it appeared to us axiomatic that, in order to secure household order and economy, it is essential that those constructive conveniences be supplied to all cottages by which these alone are attainable; for it is an easy thing to demand of the labouring man's household that everything shall be in its proper place, but not so easy—nay, impossible—to do this if the place is not provided. The primary aim, then, of a planner of a house being to arrange it so that it shall in the fullest and widest sense of the term be fit to live in, we so endeavoured to plan the structures, without reference to what their external form would be. The plan in all cases defined the *design*, not the design the *plan*. There is an essential distinction between these two terms here *italicised*, which we endeavoured to keep in view. For the system, not seldom followed, of predetermining what the external form of a house shall be—that is to say, how it shall *look* when finished—and thereafter crushing into the

outline thus obtained, not what should be, but what can be got into the outline in the way of apartments and conveniences, is obviously subversive of all sound attempts to obtain a thoroughly convenient house. This principle, if principle it can be called, we endeavoured to avoid. Hence, however, we do not conceal from ourselves the objections which will be made to the *designs* of their structure, architecturally speaking. These, as indicated above, having been defined by the plan, which was carefully elaborated beforehand, do not perhaps admit of the architectural *pose*, so to speak, which another system of planning would perhaps have admitted of. Our aim, however, we do not hesitate to say, has been to plan houses fit to live in, rather than to design structures pretty or pleasing to look at. And yet, we believe, few will be disposed to deny that the perspective designs of farmhouses and cottages to be seen on some of the plates, founded upon the ground-plans we have given, are both pretty and ornamental. Nor, on the other hand, are we ignorant of this, that adverse criticism will be freely given as to the mere planning or arrangement of the apartments. But for this we are prepared. Some experience in the matter leads us to know that, however well arranged a house may seem, it is an easy matter to pick out faults in it, and to suggest improvements. But as the opinions of many men are various—"Many men, many minds," says the truthful proverb—and as the mere changes of which a given number of apartments are susceptible, so far as regards change of position, are exceedingly numerous, it would be strange indeed if one plan pleased all. It is sufficient for us to know that we have in all cases attempted, to the best of our ability, to plan structures which will enable all the operations for which they are designed to be carried on with comfort and economy.

So much for the first object of the work—namely, the establishing of principles upon which the *planning* of farm-buildings should be based. With reference to the second object—the concentration of information on the nature and use of the materials employed in their *construction*—we may be permitted to say that we have endeavoured to secure this concentration, and that we believe we have in some degree practically attained it, by the adoption of a style of description which, while conveying sound information, is yet so free from all un-

necessary technicalities, as to be within the easy comprehension of all not practically conversant with the various branches of construction. To aid in this, illustrations have been given, to a degree of profusion not often attempted in similar works ; and these have been specially, in the great majority of instances, designed for the purposes of this work, and drawn to scale, so as to be practically available in the workshop of the mechanic, as well as useful in elucidating the study of the amateur in construction. We do not lay claim to having illustrated and described *all* the constructive appliances which inventive genius is daily elaborating and multiplying : to do this would have been impossible in any work within the limits of a Cyclopædia ; and if it had been possible, it would have been unnecessary. Enough that we have embraced within the pages of our work, leading and practically useful examples of the various constructive and economical appliances of farm-buildings. Modifications of these are obviously endless ; and to have given these—as it would have been easy enough to have done—while they might have added to the bulk, could not have added much to the practical value of the work. At the same time, we may be allowed to say that, so far as the different branches of farm-building construction and appliances are concerned, we have concentrated within this work a vast amount of information, which, lying scattered through the pages of numerous works, many of which are, from their high price, rarity, or being clothed in foreign languages, practically inaccessible to the great majority of readers. Further, a large amount of the information and illustration in the work being specially prepared for its pages, cannot, we have reason to believe, be elsewhere met with.

On the whole, viewing the copiousness of its descriptions, and the profusion of drawings and figures by which these are illustrated, we venture to hope that the work will take its place as a trustworthy guide to the mechanic who may be constructing, or the agriculturist who may be planning, highly interesting varieties of farm-buildings, required in the various forms of agriculture practised in the United Kingdom.

The description of the individual Plates affords full information of the subjects they contain. To produce a pictorial effect, the isometrical perspectives of the steadings for Carse, Dairy, and Common farming,

have been executed with the view of comparing them with the simpler, but perhaps more useful, isometrical plans. For the same reason, perspective ornamental designs of the different classes of Farm-houses and Cottages have been sketched upon the same ground-plan as the simpler designs, that a contrast might be exhibited between the simplest and the most ornamental—the least costly and the most costly structure.

HENRY STEPHENS.

ROBERT SCOTT BURN.

EDINBURGH, *June* 1861.

CONTENTS.

I. PRINCIPLES OF ARRANGEMENT.

	PAGE		PAGE
1. PLANS OF STEADINGS BASED UPON FIXED PRINCIPLES,	1	PLANS OF FARMHOUSES—Continued.	
Cattle Pastoral Farming,	7	Third-class Farmhouse,	76
Sheep Pastoral Farming,	9	Third-class Farmhouse,	77
Cattle Pastoral Farming, with Arable Culture,	11	Third-class Farmhouse,	79
Sheep Pastoral Farming, with Arable Culture,	13	Third-class Farmhouse,	80
Carse or Clay-land Farming,	14	4. PLANS OF FARM COTTAGES,	83
Dairy Farming (large),	16	Single-roomed Single-storeyed Cottages,	94
Dairy Farming (small),	19	Single-storeyed Cottage,	96
Suburbial Farming, with Arable Cul- ture,	21	Single-storeyed Cottage,	98
Suburbial Dairy Farming,	22	Single-storeyed Cottage,	98
Common Farming,	24	Two-storeyed Cottage,	101
Mixed Husbandry,	28	Double-detached Cottages,	102
Plans of Roofs of Steadings,	32	Single-storeyed Double-detached Cot- tages,	102
2. PLANS OF EXISTING STEADINGS,	38	Two-storeyed Double-detached Cot- tages,	105
Southhill Park, Surrey,	39	Single-storeyed Double-detached Cot- tages, with Houses of different sizes,	110
Drumkilbo, Forfarshire,	40	Two-storeyed Double-detached Cot- tages, with Houses of different sizes,	111
Morphie, Kincardineshire,	42	Improving defectively arranged Cot- tages,	113
Coleshill, Berkshire,	44	Composite Cottages,	114
Wark, Northumberland,	47	Bothies,	118
Inverquharity, Forfarshire,	48	Outhouses for Single Cottages,	122
3. PLANS OF FARMHOUSES,	52	Outhouses for Double-detached Cot- tages,	122
First-class Farmhouse,	58	Outhouses for Two Double-detached Composite Cottages,	123
First-class Farmhouse,	62		
First-class Farmhouse,	67		
Second-class Farmhouse,	72		

II. PRACTICE IN CONSTRUCTION.

	PAGE		PAGE
1. MATERIALS EMPLOYED IN CONSTRUCTION :—		PRACTICAL CONSTRUCTION—Continued.	
		<i>Timber Construction.</i>	
Stones,	131	Joinings of Timber,	281
Brick,	138	Floors,	292
Slates, Tiles,	140	Partitions,	294
Mortar, Concrete, Beton, Hydraulic Cements, and Cements,	141	Roofs,	297
Exterior Finishings, Rough-casting, Stuccoing,	147	Gutters,	321
Finishings of Interior Walls, Plaster- ing,	148	Stairs,	314
Painting,	149	Fittings of the Farmhouse in Wood,	317
Timber,	152	Doors,	317
Metals,	159	Windows,	321
		Fittings of the Steading in Wood,	333
2. SPECIFICATIONS OF BUILDINGS :—		Stables,	333
General Specifications,	165	Ventilators in Wood,	339
Specification adapted to a Steading of Stone,	169	Byres,	343
Specifications adapted to a Farmhouse of Brick,	181	Cattle-boxes,	346
Measurements in Specifications,	187	Calves' Houses,	348
Specifications adapted to a Farmhouse of Stone,	191	Courts,	349
Specifications adapted to Cottages of Brick,	194	Straw-barn,	351
Specifications adapted to Cottages of Stone,	200	Corn-barn,	352
Contracts,	204	Granary Windows,	354
		Stackyard,	355
3. PRACTICAL CONSTRUCTION :—		Centres for Arches,	356
Foundations,	205	Bridges of Wood,	357
<i>Stone Construction.</i>		Sluices,	360
Stone Masonry,	209	Gates of Wood,	363
Brick Construction,	214	Timber Houses and Sheds,	368
Embankments,	224		
Dams, Weirs,	233	<i>Iron Construction.</i>	
Conduits,	237	Iron Beams,	375
Drains,	239	Iron Columnna,	381
Dry-stone Dykes,	242	Iron Roofs,	384
Farm Roads,	247	Fittings of the Farmhouse in Iron,	402
Well-Sinking,	250	Locks,	402
Liquid-manure Tanks,	253	Hinges,	405
Horse-pond,	259	Fastenings of Window-blinds,	406
Fittings of the Farmhouse in Stone and Brick,	259	Fastenings for Stair-rods,	407
Fittings of the Steading in Stone,	273	Iron Ventilators,	408, 417
Pisé Walls,	276	Iron Chimney-guards,	408
		Gas Regulators,	410
		Bells,	411
		Taps and Cocks,	411
		Traps,	413, 416
		Grates,	414
		Cooking-apparatus,	414
		Gas Stove,	415
		Fittings of the Steading in Iron,	415
		Gutters for Stables,	415
		Gratings,	416
		Stalls,	419
		Feeding-troughs,	422
		Bridges of Iron,	424

PRACTICAL CONSTRUCTION—*Continued.*

	PAGE
Sluice-valves,	427
Gates of Iron,	429
Wire Fences,	434
Iron Sheds,	442

Combined Construction.

Wood combined with Iron,	446
Wood combined with Stone and Brick,	454
Iron combined with Concrete,	456
Iron combined with Wood,	461
Iron combined with Slate,	462
Iron combined with Zinc,	462

4. MISCELLANEOUS APPLIANCES :—

Tools of the Joiner,	466
Tools of the Mason,	468
Tools of the Smith,	469

Machines for the Workshop.

Vertical Saw Frame for cutting Trees,	473
Endless Band Saw,	474
Mortising, Boring, Tenoning Machine,	475
Sheep-fence-making Machine,	476
Lathe,	477
Drilling and Boring Machines,	477

Useful Apparatus for the Farm.

Caldrons and Furnace,	478
Fire-engine,	479
Pumps,	479
Hydraulic Ram,	480
Steam-pump,	481
Cranes,	482
Gas Apparatus,	485

5. DETACHED ERECTIONS :—

Isolated Byre,	487
Isolated Dairy,	488
Sheep-feeding Sheds,	489
Poultry-houses,	490

DETACHED ERECTIONS—*Continued.*

	PAGE
Pigeon-houses,	491
Rabbitry,	492
Piggeries,	492
Slaughter-house,	493
Grain-drying Kilns, Sheds, and Ma- chines,	494
Tank Granaries,	507
Brick-kilns and Drying-sheds,	509
Drain-tile Work,	510
Plans of Farm Carpenter's Shop and Smithy,	510

6. FOREIGN FARM-BUILDINGS :—

Belgian and Dutch Steadings,	513
American Barns,	517
French Steading at Vincennes,	525

7. ESTIMATES AND CALCULATIONS OF
ARTIFICERS' WORK OF VARIOUS
KINDS :—

Diggers' and Excavators' Work,	526
Brickwork,	526
Stone-paving,	527
Carpentry and Joinery Work,	528
Tables for Calculating the Quantity of Timber in Joists, Roofs, Parti- tions, Roof-trusses, &c., in a given Scantling and Space Apart,	529
Calculations of the Cubical Contents of Timber in 1 Square of 100 feet of Roofing,	530
Calculations of the Cubical Contents of Timber in 1 Square of 100 feet of Partition,	533
Wrought-iron Girders and Beams,	533
Weight of Round Iron Bars as Ten- sion-rods for Roof-trusses,	534
Weight of Lead and surface covered by it of a given weight to the foot,	534
Glossary of Technical Terms,	535
Index,	547

DESCRIPTION OF THE PLATES.

ON inspecting the Plates in this volume, the reader is requested to keep in mind the following explanations regarding them.

The Plans of the Steadings, from Plate I. to X., are not plans of any existing steadings; they are only illustrations of the principles upon which the Authors consider that the apartments of all steadings ought to be arranged. The principles are simple, as expressed in general terms at p. 6, and, in particular, they are these: That straw, being the most bulky and most useful ingredient in a steading in winter, should be placed at its centre, as the point most accessible to every apartment; that the apartments required for each sort of work in the steading should be placed next each other, as it were in groups, to avoid crossings when different sorts of work are simultaneously carried on, as are inconveniently experienced in too many existing steadings; that ample accommodation should be afforded to each sort of work to be done; and that the groups of apartments should bear such a relation to each other as to be in strict conformity with the system of agriculture adopted on the farm. The plans, in illustration of the principles just enunciated, are the results of much thought and practical experience in the endeavour to apply them to actual use. In this endeavour, it will be observed that the apartments appropriated to arable culture—such as the work-house stable, cart-shed—are placed on the one side of the straw-barn, while those devoted to live stock, whether in a dairy, breeding, or feeding farm, are placed on the other side. The plans might be adopted just as they stand, or modified according to circumstances—the arrangements being rather suggestive than imperative. For example, the apartments consigned to the use of the arable part of the farm may be placed on the right or the left of the straw-barn, according to convenience in relation to the fields; and the same transposition may be made as regards the apartments occupied by breeding, feeding, or dairy stock; or any apartment may be larger or smaller, according to the work expected to be done in it.

The attention of the reader is particularly directed to the construction of the plans, they being neither the common ground-plan, nor the isometric perspective. The obvious objection to the ordinary ground-plan is, that it exhibits no more than a horizontal section of the walls at the level of the ground, which affords nothing more than a mere outline of the building. The elevated, horizontally-sectional, perspective plans here adopted, convey to the mind a clear idea of the form and capacity of each apartment, with its doors and windows, as if finished for use; while the isometric mode of perspective, as far as it is given, affords equal facility for the measurement of the walls with the compasses as the common ground-plan, and at the same time preserves the value of a full isometrical perspective. A ground-plan, moreover, im-

parts no idea of the external form of a building, which a perfected isometric perspective certainly does; but this, on the other hand, gives no insight into the interior arrangement of the apartments, whilst the sectional isometric here submitted, it is believed for the first time to the public, not only manifests the interior arrangement, but the dotted lines above the sectional walls in conjunction with them, give as complete an idea of the exterior form of the building with its roof as may be desired. On account of these advantages, we think that this particular plan should be adopted for all buildings, by builders and their employers; and both the mason and the carpenter might make it their working plan.

These plans of steadings are intended to suit the different kinds of farming practised in this kingdom. For Pastoral Farming there are four plans; Carse Farming, one plan; Dairy Farming, two plans; Suburbial Farming, two plans; Common Farming, one plan; and for Mixed Husbandry, one plan: in all, eleven plans. At all the plans the Arrow points to the North.

We shall now describe each Plan separately, as exhibited upon its Plates.

PLATE

I.—PLAN OF A DETACHED PASTORAL FARM-STEADING FOR REARING CATTLE.

Fig. 1 illustrates courts and sheds for sheltering cattle during a storm in winter on the hills. These may be constructed to any extent in one place, or at different places, where it may be most convenient to make hay. The farm may be of any extent.

Fig. 2 represents the steading suitable for such a farm, and its simplest form is the single row. The farmhouse should be near the steading.

I.—PLAN OF A COMPACT PASTORAL FARM-STEADING FOR REARING CATTLE.

Fig. 3 combines the courts and sheds with the apartments of the steading, which form wings to the courts and afford them shelter, one wing being devoted to the working animals, and the other to the animals useful to the house. A steading of this form necessarily limits the extent and number of the cattle-courts, and is therefore adapted to a smaller farm than Fig. 1.

II.—PLAN OF A FARM-STEADING FOR REARING CATTLE, WITH ARABLE CULTURE.

Fig. 1 represents the first attempt to illustrate the principles enunciated in the preliminary remarks, by placing the straw in the centre, supported on each side by cattle-courts, and flanked on one side with a wing containing the apartments used in arable husbandry, and on the other with a wing containing those for domestic use. The cart-horse stable contains two pairs of horses, which indicates a size of arable hill-farm of from 120 to 140 acres.

II.—PLAN OF A FARM-STEADING FOR REARING SHEEP, WITH ARABLE CULTURE.

Fig. 2 contains the straw in the centre, flanked on either side with a wing, such as has been described above for cattle, no courts for sheltering sheep on a pastoral farm being required at the steading, stells being used for that purpose, and which are represented in the body of the work by woodcuts. The cart-horse stable accommodates two pairs of horses, which will cultivate a hill-farm of from 120 to 140 acres.

III.—PLAN OF A CARSE FARM-STEADING.

This is a steading for farming strong clay-land, which species of soil was almost solely devoted to the cultivation of the cereal crops, cattle being used chiefly for trampling down the straw, until thorough-draining came into vogue and guano was employed in raising green crops: since then cattle are fattened on turnips and mangold-wurzel, and must therefore be accommodated, which they are, in this plan, on both sides of the straw. The cart-horse stable accommodates six pairs of horses, which will cultivate a clay farm of 240 acres.

IV.—PLAN OF A LARGE DAIRY FARM-STEADING.

A large dairy farm-steading should afford ample accommodation for a considerable number of milking cows, and for the products derived from milk, as well as for the young stock which are to replace the cows when they become aged, and for the pigs which consume

PLATE

the refuse of the dairy. No dairy farm can be conducted without some arable culture to raise roots, hay, and straw, for the stock. In this plan it will be seen that the wing appropriated to the use of the arable culture is separated from the buildings connected with the dairy by the straw-barn, which takes up its proper position between the two. The byre contains stalls for fifty-six aged cows, and others for heifers in calf. The cart-horse stable contains three pairs of horses, which will cultivate an arable farm of from 180 to 210 acres.

V.—PLAN OF A SMALL DAIRY FARM-STEADING.

Fig. 1 is a steading for a small dairy farm, which may be somewhat differently arranged from that of a large one, inasmuch as the space is necessarily much contracted for the fewer number of apartments required, but which circumstance, on the other hand, enables them to be compactly arranged. While the separation of the arable from the dairy apartments is preserved, it will be seen from the plan that the straw still maintains its central position, between the two separate departments of farm labour. The byre contains stalls for thirteen cows. The cart-horse stable contains three horses, which will cultivate an arable farm of 70 to 100 acres.

V.—PLAN OF A SUBURBIAL FARM-STEADING FOR ARABLE CULTURE.

Fig. 2 shows how the arrangement of the apartments of a steading for a farm in the neighbourhood of a town may be adapted alone for arable culture, while keeping the farming and domestic apartments separate by the central position of the straw. The cart-horse stable accommodates four pairs of horses, which will cultivate an arable farm, in easy land near a town, of from 240 to 280 acres.

VI.—PLAN OF A SUBURBIAL FARM-STEADING FOR DAIRY.

Besides arable culture, the suburbial farm—the farm in the neighbourhood of a town—may have a dairy, and this plan is suited for that purpose. The two great divisions of arable and dairy culture are separated by the central supply of straw and other conveniences. The byre contains stalls for fifty cows. The cart-horse stable accommodates five horses, which will cultivate an arable farm of easy land, near a town, of from 160 to 180 acres.

VII.—PLAN OF A COMMON FARM-STEADING.

Fig. 1 is a steading adapted for the ordinary farming of the country, at a distance from towns, consisting of arable culture, in conjunction with the fattening of oxen purchased for the purpose. The fattening cattle may be accommodated in three different ways,—in hammels, in boxes, and in byres. The plan shows the space on each side of the straw-barn to be occupied by hammels.

Fig. 2 shows the boxes which might in lieu occupy the same space; and

Fig. 3 shows the byres which may be substituted in the same place for either.

The cart-horse stable contains stalls for six pairs of horses, and, according to the rotation of husbandry pursued, four to six shift, this steading will answer for 360 to 480 acres.

VIII.—PLAN OF A FARM-STEADING FOR MIXED HUSBANDRY.

Fig. 1 is also a steading adapted for a farm at a distance from a town, like that for common farming, but the stock on a farm of mixed husbandry are bred and fattened upon it. These may be accommodated here, as there, in hammels, boxes, or byres. The plan shows the adoption of the hammels, and their position is on one side of the straw-barn, while the breeding stock are accommodated on the other side.

Fig. 2 contains the plan of the boxes; and

Fig. 3 that of the byre; with

Fig. 4, the plan of dung-stance and food-stores in connection with the byre.

The cart-horse stable contains only six pairs of horses, in consequence of a longer stable not finding room in the Plate, but the stable may be extended to any desired length. The part of the steading appropriated to the breeding and fattening stock is intended for a farm of 500 acres, which would require seven pairs of horses, in a five-course shift. The byre contains stalls for twenty breeding cows.

IX.—ISOMETRICAL ELEVATION OF A FARM-STEADING FOR MIXED HUSBANDRY.

This isometric perspective of the steading in Plate VIII. is introduced merely to show the extent of accommodation, and the form in the simplest style of building and roofing. These may be ornamented to any degree to please the taste of the owner; but our opinion is, that the more simple the style of a farm-steading is, the more durable it will prove, if constructed in the most substantial manner.

PLATE

X.—PLANS OF THE ROOFS OF THE FARM-STEADINGS IN PLATES I. TO VIII.

The roofs are all in straight lines, and terminate in gables, in raglins against a wall, or at right angles in gutters against another roof. With one exception, in fig. 7, pavilion roofs are avoided, on account of primary expense, and after-liability to be affected by the weather.

The plans of the steadings, in Plates XI. to XVI., have recently been constructed in different parts of the country, and are here introduced by way of contrast to or comparison with the principles which we here endeavour to establish.

XI.—PLAN OF FARM-BUILDINGS on the property of Sir W. G. Hayter, Bart., M.P., at Southhill Park, Bracknell, Surrey.

It will be observed that there are two apartments for straw in this steading besides the straw-barn, which at once indicates the inconvenient position of that primary and indispensable apartment. The work-horse stable contains ten stalls for horses, which number will cultivate a farm of ordinary soil of 300 to 350 acres.

XII.—PLAN OF THE FARM-STEADING AT DRUMKILBO, FORFARSHIRE, belonging to Lord Wharncliffe.

This plan nearly illustrates the principles we have enunciated; the straw-barn, however, being a little too far removed from some of the cattle-courts and stables. The work-horse stable contains ten stalls for horses, which should cultivate a farm of ordinary soil of 300 to 350 acres.

XIII.—PLAN OF A FARM-STEADING AT MORPHIE, KINCARDINESHIRE, belonging to Barron Graham, Esq.

This is an example of an entirely covered steading, a plan of but recent commendation, suggested, without doubt, by the covered stations at railways. The straw-barn here is conveniently situated for the principal feeding-byre and work-stable, but is too far removed from the other cattle-courts, and the straw has to be objectionably carried from it through one apartment into another. The cart-horse stable contains accommodation for six pairs of horses, which should cultivate from 360 to 420 acres of ordinary soil.

XIV.—PLAN OF FARM-BUILDINGS, belonging to E. W. Moore, Esq., at Coleshill, Highworth, Berkshire.

This is another illustration of a covered steading. The straw-barn is too far from the principal feeding-boxes for cattle. The pigsties, too, are nearer the straw-barn than the cattle-boxes, which should not be. The straw is, moreover, obliged to be put in one instance into another apartment. The cart-horse stable contains twelve stalls, which number of horses should cultivate from 360 to 420 acres.

XV.—PERSPECTIVE VIEW OF COLESHILL FARM-BUILDINGS.

It will be observed that the architecture of this steading is somewhat of an ornamental description, and looks very well.

XVI.—PLAN OF FARM-BUILDINGS AT WARK, COUNTY OF NORTHUMBERLAND, belonging to the Earl of Tankerville.

It will at once be observed that the straw-barn of this steading is placed at one side of the building, and far away from most of the feeding-boxes and courts; the consequence of which inconvenience is, that a straw stack has to be built near these apartments. The cart-horse stable contains twenty-four stalls, which number of horses will cultivate from 840 to 1200 acres. The greater number of horses on a farm will cultivate, in proportion to the number, a larger extent of land.

XVII.—PLAN OF A FARM-STEADING AT INVERQUHARITY, FORFARSHIRE, belonging to the Trustees of the late Charles Lyell, Esq. of Kinnordy.

This is an example of converting an old into a new steading, and a good example it is. It is a partially covered-in steading, but the objectionable pavilion form of roof prevails.

PLATE

XVIII.—FRONT ELEVATIONS OF FARMHOUSES.

Fig. 1 is the front elevation of a first-class farmhouse in the Tudor-Gothic style.

Fig. 2 is a second alternative front elevation of a first-class farmhouse in the Tudor-Gothic style, adapted for three storeys.

Fig. 3 is an alternative front elevation of a first-class farmhouse in the Italian style, to the front elevation of the same style in fig. 36, p. 64. Fig. 26 is a side elevation; fig. 27 a back elevation, p. 60; fig. 28 a side elevation, finished to show stone rubble walling; and fig. 29 a longitudinal section, p. 61.

A back elevation of an alternative Italian style is shown at fig. 30, p. 62.

XIX.—VERTICAL SAW FRAME FOR CUTTING UP TREES.

Fig. 1. End elevation of the saw-frame, with the tree in cross section.

Fig. 2. Side elevation of the saw-frame, with the trunk of the tree in length.

XX.—CIRCULAR SAW FRAME.

Fig. 1. Side elevation of the circular saw and frame.

Fig. 2. Plan of the circular saw and frame.

Fig. 3. End elevation of the circular saw and frame.

XXI.—ENDLESS-BAND SAW.

Fig. 1. Side elevation of the endless-band saw.

Fig. 2. End elevation of the endless-band saw.

The plans of the steadings in Plates I. to VIII. may be regarded as working plans, without any attempt at embellishment, and even the isometrical elevation of the stading for mixed husbandry on Plate IX. exhibits but the simplest form of a perspective view that is possible to delineate; yet it is quite sufficient to convey to the mind the external aspect of the building, and may therefore be regarded as a representation well suited to an architect for an accompaniment to a plan. But in order to show how easily the bare outline of the isometric elevation may be converted into a picturesque form, we give in shaded isometrical perspective three of the steadings which have been described.

XXII.—ISOMETRICAL ELEVATION OF A CARSE FARM-STEADING.

The position of the stackyard, which is always a prominent figure in a carse farm, is here given, and the road leading to it, as well as the relation of the adjoining fields, with the direction of the ridges.

XXIII.—ISOMETRICAL ELEVATION OF A LARGE DAIRY FARM-STEADING.

Here the stackyard is of less importance and bulk than on a carse farm. The cow-byre on the other hand, and accommodation for young stock, along with pigs, demand paramount consideration.

XXIV.—ISOMETRICAL ELEVATION OF A COMMON FARM-STEADING.

The stackyard here is of considerable extent, and the accommodation for fattening cattle bears a prominent part in the arrangement of the apartments. A watering-pond for the horses is here introduced in front of the stading, as well as one for the aquatic poultry.

The elevations given in the text from page 60 to 116, and in Plate XVIII. of the farmhouses and cottages, in illustration of the ground-plans, are of the simplest description, and are presented more with the view of exhibiting the different styles of architecture recommended, than as specimens of ornamentation. As they are, however, they will bear a favourable comparison with the very plain and very tasteless examples of farmhouses and cottages constructed in the country up to only a dozen of years ago. But the plans are capable of being illustrated with really beautiful elevations, as may be seen in Plates XXV. to XXX., more beautiful than any that have yet been erected. We give one specimen of each class of farmhouse and of each class of labourers' cottages and of a mansion-house.

PLATE

XXV.—ALTERNATIVE DESIGN IN PERSPECTIVE FOR A FIRST-CLASS FARMHOUSE.

This design is reared upon the ground-plan of a first-class farmhouse in fig. 23, on page 58. A front elevation, adapted to this plan, will be found in No. 3, Plate XVIII.; a side elevation in fig. 26, and a back elevation in fig. 27, both on p. 60. A side elevation, somewhat ornamented in the face of the stone, is given in fig. 29, p. 61, and a back elevation of an alternative design is given in fig. 30, p. 62. These are all in the Italian style. The perspective view in this Plate is in the Elizabethan style, which has now become fashionable, and is well adapted in picturesque effect for farmhouses.

XXVI.—ALTERNATIVE DESIGN IN PERSPECTIVE FOR A SECOND-CLASS FARMHOUSE.

This design is reared upon the ground-plan in fig. 53, p. 73. A front elevation of it will be found in fig. 56, p. 74, and two side elevations in figs. 57 and 58, on p. 75. All the designs are in the Elizabethan style, massive and effective. Were it desired to simplify the front, the V and oriel windows might be taken away, and the balusters removed from above the front door. The beauty of this elevation consists of the V window in conjunction with the scrolled architrave around the upper window.

XXVII.—ALTERNATIVE DESIGN IN PERSPECTIVE FOR A THIRD-CLASS FARMHOUSE.

This design is reared upon the ground-plan of fig. 68, p. 81. Its front elevation is in fig. 71, p. 82. The style in the Plate is Elizabethan, that in fig. 71 Italian. The front might be simplified by removing the oriel windows.

XXVIII.—DESIGN IN PERSPECTIVE OF TWO-STOREYED DOUBLE-DETACHED COTTAGES, WITH HOUSES OF DIFFERENT SIZES.

This Plate presents two such cottages. We consider that all hinds' houses on farms ought to be constructed on this principle. Such an arrangement of houses would not only look more picturesque, but they would be much more convenient for the inmates than the long rows of houses so often to be met with in the country, inasmuch as the garden behind would not only be more accessible, but the ground in front would afford an open playground for children; or, should the entire piece of ground in front be laid out as a flower-plot, it would the more enhance the beauty of the place. We have advocated more than once the houses of farm-servants being made of different capacities, to suit the number of the family who are to occupy them; and, with this principle in view, we would place a large and small house together, in order to separate the larger families from one another. These houses could be made one-storeyed as well as two-storeyed, as seen in the Plate, and they may be ornamental or plain, as the taste and ability of the proprietor may desire. The elevations of these houses are raised upon the ground-plans of figs. 111 and 113.

XXIX.—DESIGN IN PERSPECTIVE OF TWO-STOREYED SINGLE-DETACHED COTTAGES.

These cottages would suit a farm steward or bailiff, gamekeeper, or forester of an estate. Being two-storeyed, they would afford ample accommodation for a family; and if one storey, they would equally suit an ordinary day-labourer, such as a hedger or roadmaker. The upper cottage is in the Elizabethan, and the lower in the Rustic Gothic-style.

XXX.—DESIGN IN PERSPECTIVE OF A MANSION-HOUSE, OFFICES, STEADING, FARMHOUSE, AND HINDS' HOUSES.

This is the Frontispiece, intended to show the relation which the proprietor's mansion should hold with the houses of his tenantry and labourers. The mansion-house is seen in the centre, flanked on the one hand by its offices, and on the other, at a greater distance, a farm-steading, farmhouse, and cottages of the farm-servants.

LIST OF WOOD ENGRAVINGS.

Fig.	Page	Fig.	Page
1. Simple Forms of Outside Stells,	10	25. Alternative Arrangement of Part of the Chamber-Floor Plan,	59
2. Outside Stell, affording shelter in all directions,	10	26. Side Elevation of a First-Class Farmhouse,	60
3. Inside Circular Stell, with Plantation,		27. Back Elevation of a First-Class Farmhouse,	60
4. Inside Circular Stell, with Hay-Stack and Racks,	11	28. Side Elevation of a First-Class Farmhouse, finished to show Stone-rubble Walling,	61
5. Outside Stell, sheltered by Plantation on every side,	11	29. Longitudinal Section of a First-Class Farmhouse,	61
6. Upper Floor of a Steading for Cattle Pastoral Farming with Arable Culture,	12	30. Back Elevation of Alternative Design of a First-Class Farmhouse,	62
7. Upper Floor of a Steading for Sheep Pastoral Farming with Arable Culture,	14	31. Vertical Section of Milk-House and Cheese-Room of a Farmhouse,	62
8. Upper Floor of a Steading for Carse Farming,	16	32. Ground-Plan of a First-Class Farmhouse,	63
9. Upper Floor of a Steading for a Large Dairy Farm,	18	33. Cellar Plan,	63
10. Upper Floor of a Steading for Small Dairy Farming,	20	34. Alternative Cellar Plan,	63
11. Upper Floor of a Steading for Suburbial Farming with Arable Culture,	22	35. Chamber-Floor Plan of a First-Class Farmhouse,	64
12. Upper Floor of a Steading for Suburbial Dairy Farming,	24	36. Front Elevation of a First-Class Farmhouse in Italian Style,	64
13. Upper Floor of a Steading for Common Farming,	27	37. Back Elevation of a First-Class Farmhouse in Italian Style,	65
14. Upper Floor of a Steading for Mixed Husbandry,	30	38, 39. Side Elevations of a First-Class Farmhouse in Italian Style,	65, 66
15. Isometrical Perspective of a Covered Stackyard,	36	40. Longitudinal Section of a First-Class Farmhouse,	66
16. Ground-Plan of a Covered Stackyard,	37	41. Ground-Plan of a First-Class Farmhouse,	67
17. Plan of Second Floor, and Roof-Plan of Ground Floor of the Steading at Coleshill, Berkshire,	45	42. Chamber-Floor Plan of a First-Class Farmhouse,	67
18. Elevation of a Gable in a simple Elizabethan Style,	50	43. Attic and Part Roof Plan,	68
19. Elevation of a Gable in an Ornamental Elizabethan Style,	51	44. Cellar Plan,	69
20. Elevation of a Gable in the Gothic Style,	51	45. Front Elevation of a First-Class Farmhouse in Tudor-Gothic Style,	70
21. Ground-Plan of a Kitchen, &c., of Farmhouse,	54	46. Back Elevation of a First-Class Farmhouse in Tudor-Gothic Style,	70
22. Cheese-Room, &c., of a First-Class Farmhouse,	57	47, 48. End Elevations of a First-Class Farmhouse in Tudor-Gothic Style,	70
23. Ground-Plan of a First-Class Farmhouse,	58	49. Transverse Section,	71
24. Chamber-Floor Plan of a First-Class Farmhouse,	59	50. Enlarged View of Part of Front Elevation,	71
		51. Enlarged View of Part of Back Elevation,	72

LIST OF WOOD ENGRAVINGS.

xxi

Fig.		Page	Fig.		Page
52.	Enlarged View of Part of End Elevation,	72	88.	Ground - Plan of Single-Storeyed Double-Detached Cottages,	103
53.	Ground - Plan of a Second-Class Farmhouse,	73	89.	Alternative Ground-Plan of Single-Storeyed Double-Detached Cottages,	103
54.	Cellar Plan,	73	90.	Front Elevation of Single-Storeyed Double-Detached Cottages,	103
55.	Chamber-Floor Plan of a Second-Class Farmhouse,	74	91.	Alternative Front Elevation of Single-Storeyed Double-Detached Cottages,	104
56.	Front Elevation of a Second-Class Farmhouse,	74	92, 93, 94.	Alternative Ground-Plans of a Single-Storeyed Double-Detached Cottage,	104, 105
57, 58.	Side Elevations of a Second-Class Farmhouse,	75	95.	Ground-Plan of Single-Storeyed Double-Detached Cottages,	105
59.	Ground-Plan of a Third-Class Farmhouse,	76	96.	Front Elevation of Single-Storeyed Double-Detached Cottages,	106
60.	Chamber-Floor Plan of a Third-Class Farmhouse,	76	97.	End Elevation,	106
61.	Front Elevation of a Third-Class Farmhouse,	77	98.	Vertical Section,	106
62.	Ground - Plan of a Third-Class Farmhouse,	77	99.	Ground - Plan of Two-Storeyed Double-Detached Cottages,	106
63.	Chamber-Floor Plan of a Third-Class Farmhouse,	78	100.	Chamber - Floor Plan of Two-Storeyed Double-Detached Cottages,	107
64.	Front Elevation of a Third-Class Farmhouse,	78	101.	Front Elevation of Two-Storeyed Double-Detached Cottages,	107
65.	Ground - Plan of a Third-Class Farmhouse,	79	102.	End Elevation,	107
66.	Chamber-Floor Plan of a Third-Class Farmhouse,	79	103.	Ground - Plan of Two-Storeyed Double-Detached Cottages,	108
67.	Front Elevation of a Third-Class Farmhouse,	80	104.	Chamber-Floor Plan of Two-Storeyed Double-Detached Cottages,	108
68.	Ground - Plan of a Third-Class Farmhouse,	81	105.	Front Elevation of Two-Storeyed Double-Detached Cottages,	108
69.	Chamber-Floor Plan of a Third-Class Farmhouse,	81	106.	Ground - Plan of Two-Storeyed Double-Detached Cottages,	109
70.	Cellar Plan,	82	107.	Chamber-Floor Plan of Two-Storeyed Double-Detached Cottages,	109
71.	Front Elevation of a Third-Class Farmhouse,	82	108.	Cellar Plan,	110
72.	Ground - Plan of a Hind's Small House of One Room,	94	109.	Front Elevation of Two-Storeyed Double-Detached Cottages,	110
73.	Ground-Plan of a Hind's Large House of One Room,	95	110.	Ground - Plan of Single-Storeyed Double Cottages, consisting of Larger and Smaller Houses,	111
74.	Ground - Plan of a Hind's Small House of Two Rooms,	95	111.	Small Two-Storeyed Double Cottages,	111
75.	Ground-Plan of a Single-Storeyed Detached Cottage,	96	112.	Elevation of Small Two-Storeyed Double Cottages,	112
76.	Front Elevation of a Single-Storeyed Detached Cottage,	96	113.	Ground-Plans of Double Cottages of Different Sizes,	112
77.	Ground-Plan of a Single-Storeyed Detached Cottage,	97	114.	Chamber-Floor Plan of Double Cottages of Different Sizes,	113
78.	Front Elevation of a Single-Storeyed Detached Cottage,	97	115.	Unimproved Single-Roomed Cottage,	113
79.	Ground-Plan of a Single-Storeyed Detached Cottage,	98	116.	First Improved Arrangement of Cottage,	113
80.	Front Elevation of a Single-Storeyed Detached Cottage,	98	117.	Second,	114
81.	Ground-Plan of a Single-Storeyed Detached Cottage,	99	118.	Third,	114
82.	Front Elevation of a Single-Storeyed Detached Cottage,	99	119.	Fourth,	114
83.	Back Elevation of a Single-Storeyed Detached Cottage,	100	120.	Fifth,	115
84.	Vertical Section of a Single-Storeyed Detached Cottage,	100	121.	Composite Cottage,	115
85.	Ground - Plan of a Two-Storeyed Detached Cottage,	101	122.	End Elevation of Composite Cottage,	116
86.	Chamber-Floor Plan of a Two-Storeyed Detached Cottage,	102	123.	Upper Storey of Composite Cottage,	116
87.	Front Elevation of a Two-Storeyed Cottage,	102	124.	Upper Storey of Composite Cottage,	117

Fig.		Page	Fig.		Page
125.	Upper Storey of Composite Cottage,	117	164.	Summer-Stone,	212
126.	Upper Storey of Composite Cottage,	117	165.	Mouldings of Jamb and Mullion of Doorway,	212
127.	Upper Storey of Composite Cottage,	118	166.	Stone Finial,	212
128.	Upper Storey of Composite Cottage,	118	167.	Mouldings of Capping,	213
129.	Ground-Plan of a Two-Storeyed Bothy,	119	168.	Mouldings of Window Cornice,	213
130.	Chamber Floor of a Two-Storeyed Bothy,	119	169, 170.	Stone Balcony Fronts,	213
131.	Ground-Plan of a Single-Storeyed Bothy,	120	171.	Stone Finial,	213
132.	Plan of Outhouse for a Single Cottage,	122	172.	Drip-Stone,	213
133.	First Alternative Plan of Outhouses for Single Cottages,	122	173.	String-Course,	213
134.	Second Alternative Plan of Outhouses for Single Cottages,	122	174.	Stone Window Cornice,	214
135.	Plan of Outhouses for Double-Detached Cottages,	123	175.	Moulding to Chimney Cap,	214
136.	First Alternative Plan of Outhouse for Double Cottages,	123	176.	Header and Stretcher (Bricks),	214
137.	Second Alternative Plan of Outhouses for Double Cottages,	123	177.	Footings for a 14-inch Brick Wall,	215
138.	Third Alternative Plan of Outhouses for Double Cottages,	124	178.	Plan of Lower Course of Footings,	215
139.	Plan of Outhouses for Four Cottages of Two Double Composite Cottages,	124	179.	Plan of Second Course of Footings,	215
140.	Alternative Plan of Outhouses for Four Double Composite Cottages,	124	180.	Plan of Third Course of Footings,	215
141.	Elevation of Front Door for Cottage,	125	181.	Plan of First Course of 14-inch Wall,	215
142.	Three-Light Window for the Living-room of a Cottage,	125	182.	Old English Brick Bond,	215
143.	Two-Light Window for the Bedroom of a Cottage,	125	183.	Flemish Bond,	215
144.	Small Two-Light Window for the Staircase of a Cottage,	125	184.	Tyermann's Hoop-Iron Bond,	216
145.	Preparation of the Timber for Boucherie's Method of preserving it,	158	185.	Plan of First Course of 9-inch Wall in Old English Bond,	217
146.	Timber prepared for Boucherie's Method of preserving it,	158	186.	Plan of Second Course of 9-inch Wall in Old English Bond,	217
147.	Pier and Protecting Apron for Foundations,	207	187.	Plan of First Course of 9-inch Wall in Flemish Bond,	217
148.	Section of Cofferdam,	207	188.	Plan of Second Course of 9-inch Wall in Flemish Bond,	217
149.	Section of the Foundation of a Hind's House,	208	189.	Mode of carrying up Brick Courses,	217
150.	Stone Footings,	208	190.	Good and Bad Methods of Setting Flooring-Joists,	218
151.	Plan of Stone Footings,	209	191.	Mode of Fixing Beams of Upper Floors,	218
152.	Breaking Joint with Stones,	209	192.	Bearing Walls,	218
153.	Inverted Arches for Foundations,	209	193.	Curved Arch and Lintel,	218
154.	Defective Ashlar-work,	210	194.	Flat Arch and Lintel,	218
155.	Mode of Building Ashlar Walls with Rubble Filling-in,	210	195.	Disposition of the Parts of an Arch,	219
156.	Lewis for raising Blocks of Stone,	210	196.	Segmental and Semicircular Arches,	219
157.	Lewis fixed in a Stone Block,	211	197.	Dearn's Hollow 9-inch Walls,	220
158.	Dowels, Joggles, and Cramps for joining Blocks of Stone,	211	198.	11-inch Walls,	220
159.	Joggled Joint of Stones,	211	199.	14-inch Walls,	220
160.	Elevation of Stone Finial,	212	200.	Elevation of Dwarf Wall in Roberts' Hollow Brick,	221
161.	Moulding of Corbel to Chimney,	212	201.	Sections of 12-inch Hollow Wall,	221
162.	Moulding of Chimney Cap,	212	202.	Section of 14-inch Hollow Wall,	221
163.	String-Course,	212	203.	Views of "External Jamb" and "Centre" Hollow Bricks,	221
			204.	Views of Jamb and Chimney Hollow Bricks,	221
			205.	Views of Partition Hollow Bricks,	222
			206.	Section of Partition Hollow Bricks,	222
			207, 208.	Hollow Brick for Door Jamb in Alternate Courses,	222
			209, 210.	Plan of Angles for Door Jamb in Alternate Courses,	222
			211.	Fireproof Floors and Ceilings in Roberts' Hollow Bricks,	223
			212.	Grooved Bricks,	223
			213.	Norton and Borrie's Hollow Bricks,	223
			214.	Dean's Hollow Bricks,	223
			215.	Stewart's Partition Tile,	223
			216.	Embankment and Face-Dyke against a Rivulet,	224
			217.	Section of River Embankment,	226

Fig.		Page	Fig.		Page
218.	The most effectual Embankment on a Gravelly Bottom, . . .	228	265.	Peake's Oblong Roof-Tiles, . . .	261
219.	Cutting of River-Banks to Prevent Washing Away, . . .	228	266.	Peake's Roof-Tiles with Rounded Ends, . . .	261
220.	Protection of River-Banks by means of Breakwaters, . . .	229	267.	Peake's Ridge-Tiles, . . .	261
221.	Plan of River-Banks requiring Protection, . . .	229	268.	Quoined Valley-Tiles, . . .	261
222.	Weirs for Protecting River-Banks, . . .	229	269.	Hip-Tiles, . . .	261
223.	Misuse of a Tree in the Protection of River-Banks, . . .	230	270.	Ridge-Tiles, . . .	261
224.	Common Piling for River-Banks, . . .	230	271.	Grooved Ridge-Tiles, . . .	261
225.	Improved Piling for River-Banks, . . .	230	272.	Various Ornamental Tiles to fit in Grooves of Ridge-Tiles, . . .	261
226.	Protection of Sea-Banks, . . .	231	273.	Corrugated Tile, . . .	262
227.	Protection by Sea Embankment, . . .	231	274.	Hollow Roof-Tile, . . .	262
228.	Plan of Proper Inclination of the Embankment of a Dam, . . .	234	275.	Beadon's Gutter-Tiles, . . .	262
229.	Embankment for a Water Reservoir, . . .	234	276.	Section of Earthenware Blocks for Staircases, . . .	264
230.	Section of Dam or Weir, . . .	235	277.	Section showing mode of Heating Upper Rooms from a Kitchen Fire, . . .	265
231.	Plan of Dam or Weir, . . .	235	278.	Section of Smoke and Ventilating Flue, . . .	265
232.	Section of Groin and Dam for Protecting a River-Side, . . .	236	279.	Plan showing mode of Heating Upper Rooms from a Kitchen Fire, . . .	265
233.	Conduit or Drain with Flat Sides and Bottom, . . .	237	280.	Plan, Elevation, and Section of Pierce's Fire-Lump Stove-Grate, . . .	266
234.	Drain with Angular Bottom, . . .	237	281.	Perspective View of Pierce's Cottage Fire-Lump Grate, . . .	266
235.	Conduit with Segmental Bottom, . . .	237	282.	Plan of Fireclay Hearth, . . .	266
236.	Elliptical or Egg-shaped Drain, . . .	237	283.	Section of Fireclay Hearth, . . .	266
237.	Segmental Bricks for Drains, . . .	238	284.	Section and Plan of Chimney and Ventilating Tube, . . .	267
238.	Doulton's Patent Junction Block for Drains, . . .	239	285.	Front Elevation of Chimney-Breast, showing Opening to Ventilating Tube, . . .	267
239.	Doulton's Invert Block, . . .	239	286.	Ornamental Grating to Ventilator, . . .	267
240.	Liquid-Manure Conduit, . . .	239	287.	Ventilating Chimney-Tube, . . .	267
241.	Spigot and Faucet Drain-Tube, . . .	239	288, 289.	Sectional Plan of Chimney and Ventilating Tube, . . .	267, 268
242.	Half Socket Drain-Tubes, . . .	240	290.	Perspective View of Doulton's Ventilating Chimney-Tube, . . .	268
243.	Rabbit-jointed Drain-Tubes, . . .	240	291.	Sections of Ventilating Chimney-Tube, . . .	268
244.	Clayton's Cored-Joint for Drain-tubes, . . .	240	292.	Looker's Tubular Ventilator, . . .	268
245.	Section of Doulton's Lidded Drain-Tubes, . . .	241	293.	Glazed Clay Scullery-Sink, . . .	269
246.	Perspective View of Doulton's Lidded Drain-Tubes, . . .	241	294.	Glazed Clay Trap, . . .	269
247.	Perspective View of Cooper's Lidded Drain-Tubes and Saddles, . . .	241	295.	Syphon-Trap, . . .	269
248.	Perspective View of Saddles for Cooper's Lidded Drain-Tubes, . . .	242	296.	Court Cesspool-Trap, . . .	269
249.	The building a Dry-Stone Dyke, . . .	244	297.	A Rain-Water Cistern, . . .	270
250.	Expedients for increasing the Height of Dry-Stone Dykes, . . .	246	298.	View of Carbon Filter, . . .	271
251.	Four Watering-Pools formed by Two Dykes crossing, . . .	247	299.	Section of Wash-Hand Pedestal Basin, . . .	271
252.	One Watering-Pool common to Four Fields, . . .	247	300.	Wash-Hand Basins and Pedestals, . . .	271
253.	A Clump of Trees within the meeting of Four Dykes, . . .	247	301.	Jennings' Lavatory, . . .	272
254.	Section of Road on Strong Clay Soils, . . .	249	302.	Closet Soil-Pan and Trap, . . .	272
255.	Section of Cross-Culvert and Under-Drains, . . .	249	303.	Ridgway's Pottery Water-Closet, . . .	272
256.	Flemish Liquid-Manure Tank, . . .	258	304.	Closet-Pan Trap, . . .	272
257.	Plan, . . .	258	305.	Earthenware Closet-Pan with Trap, . . .	273
258.	Section, . . .	258	306.	Section of Jennings' Water-Closet—Tube open, . . .	273
259.	Peake's Oblong Paving-Bricks, . . .	259	307.	Section of Jennings' Water-Closet—Tube closed, . . .	273
260.	Peake's Diamond Paving-Bricks, . . .	259	308.	A Fixed Milk-Cooler of Marble, or of Wood lined with Metal, . . .	273
261.	Peake's Square Paving-Bricks, . . .	259	309.	Perspective View of Forbes's Drainage Pavement-Bricks, . . .	274
262.	Hexagonal Paving-Tiles, . . .	260	310.	Drainage Pavement-Bricks in Perspective, with Gutter partly un-	
263.	Square Paving-Tiles, . . .	260			
264.	Section of Paving-Tiles, . . .	260			

Fig.		Page	Fig.		Page
	covered to show its Connection with Pavement,	274	367.	Joint of Foot of Struts with King-Post,	290
311.	Water-Troughs,	275	368.	Joint of Rafters with King-Post,	290
312.	Section of a Stone Trough for a Byre,	276	369.	Joint of Straining Beam with Queen-Post,	290
313.	Section of Planks for Mould for Pisé Walls,	277	370.	Joint of Purlins to Rafters,	290
314.	Side of Mould for Pisé Walls,	277	371.	Joint of Rafters to Wall-Plate,	290
315.	Section of Mould for Pisé Walls,	277	372.	Bow-and-String Rafter,	291
316.	Plan of Joists of Mould for Pisé Walls,	277	373.	End of Bow-and-String Rafter,	291
317.	Plan and Section of a Joist of Mould for Pisé Walls,	277	374.	Centre of Bow-and-String Rafter,	291
318.	Foot of Posts for Pisé Walls,	278	375.	Bow-and-String Rafter,	291
319.	Top of Posts for Pisé Walls,	278	376, 377.	Method of increasing Depth of Beams,	292
320.	Section showing Arrangement of Parts of Mould of Pisé Walls,	278	378.	Single Flooring,	292
321.	Mode of filling up the Mould in Pisé Walls,	279	379.	Trussing of Flooring Beams,	292
322.	Courses of a Pisé Wall,	279	380.	Trimming or Bridle Joists,	292
323, 324, 325, 326.	Joining Timbers in the Direction of their Length,	281	381.	Double Flooring,	293
327, 328.	The Half-Lap Joint,	282	382.	Double-Framed Flooring,	293
329, 330, 331.	Scarf Joint,	282	383.	Partition for 18-feet Span,	294
332, 333.	Half-Lap Joint,	282	384.	Partition, Span 28 feet,	295
334, 335, 336.	Scarf Joint,	283	385.	Partition, 22-feet Span,	295
337, 338, 339.	Joint to resist Vertical Compression,	283, 284	386.	Partition for 18-feet Span,	295
340.	Mortise-and-Tenon Joint,	284	387.	Partition for 20-feet Span,	296
341.	Joint of Vertical with Horizontal Timber,	285	388.	Trussed Partition,	296
342.	Connection of King-Post with Tie-Beam,	285	389.	Partition for 18-feet Span,	296
343.	Connection of King-Post with Tie-Beam, with Wedge,	285	390.	Double Partition,	296
344.	Connection of King-Post with Tie-Beam, with Bolt,	285	391.	Lean-to and Ridge Roofs,	297
345.	Connection of King-Post with Tie-Beam, with Jibs and Cottars,	285	392.	Hipped Roofs,	297
346, 347.	Dovetail Joint,	286	393.	Pavilion Roof,	297
348.	Tusk Joints,	286	394.	Conical Roof,	298
349.	Joining of Girders and Binding-Joists,	286	395.	Ridged Roofs meeting at Right Angles,	298
350.	Method of "Notching" Wall-Plates together,	286	396.	Ridge-and-Valley Roofs,	298
351, 352.	Joining of Tie-Beam with Wall-Plate,	286, 287	397.	Lean-to Roof, 12-feet Span,	298
353.	Joints of Timber at Right Angles,	287	398.	Lean-to Roof, 20-feet Span,	298
354.	Joining of Beams crossing each other at Right Angles,	287	399.	Truss with Collar, 18-feet Span,	299
355.	Joining of Timbers at Obtuse Angles,	287	400.	Truss with two Collars, 16-feet Span,	299
356.	Joining of Timbers crossing each other at Right Angles,	288	401.	Truss for Collar-Beam Roof,	299
357.	Joining of Timbers at Right Angles,	288	402.	Truss for a Porch,	300
358.	Joint of Foot of Rafter with Tie-Beam,	288	403.	Truss for 20-feet Span,	300
359, 360.	Joining of an Inclined Beam with a Horizontal Beam,	288	404.	Truss with King-Bolt, 20-feet Span,	300
361.	Joint of Rafter with Tie-Beam,	289	405.	Truss for a 30-feet Span,	301
362.	Joint of Collar-Beam with Rafter,	289	406.	King-Post Truss for 25-feet Span,	301
363, 364.	Joint of Collar-Beam with Rafter,	289	407.	Queen-Post Truss, for 30 to 45 feet Span,	301
365.	Joints of Struts and Rafters with Heads and Feet of King-Posts and Queen-Posts,	289	408.	Truss for a 30-feet Span,	302
366.	Joint of Rafter with King-Post,	290	409.	Truss with two Queen-Posts for 47-feet Span,	302
			410.	Roof with Hip-Rafter,	302
			411.	Dragon-Piece and Dragonal Tie to support Hip-Rafter,	302
			412.	Plan of Hipped Roof,	303
			413.	Plan of Timber of a Roof meeting at Right Angles,	304
			414.	Elevation of a Roof,	304
			415.	Side Elevation of a Roof,	304
			416.	Joining of Hip-Rafters with Ridge-Pole,	305
			417.	Hip-Rafters,	305
			418.	Jack-Rafters,	305
			419.	Truss for Flat Roof,	305
			420.	Flat Roof,	305
			421.	Mansard or Curb Roof,	306
			422, 423.	Truss for Gothic or High-Pitched Roof,	306
			424.	Truss for Cambered or High-Pitched Roof,	307

LIST OF WOOD ENGRAVINGS.

xxv

Fig.		Page	Fig.		Page
425.	Curved Rib Truss,	307	481.	Folding Door,	320
426.	Plan and Elevation for Ribs of Truss,	308	482.	Sliding Door,	320
427.	Skeleton of Truss for a Laminated Rib-Roof, 32-feet Span,	308	483.	Plan of Door Stop (door closed),	320
428.	Detail of Part of Roof-Truss,	308	484.	Plan of Door Stop (door partially closed),	320
429.	Detail of Rib of Roof,	308	485.	Door Stop for Bottom Rail of Door,	321
430.	Part Plan of Truss of Roof for Thrashing-Mill Horse-Walk,	309	486.	Plan of Framing for a Fixed Window,	321
431.	Elevation of Truss for Thrashing-Mill Horse-Walk,	309	487.	Plan of Fixed Window,	321
432.	Plan of Walls of Horse-Walk,	309	488.	Elevation and Section of Frame of a Fixed Window,	321
433.	Plan of Hexagonal Truss,	310	489.	Part Section of Sash-Frame,	322
434.	Elevation of Hexagonal Roof,	310	490.	Elevation and Section of Sash-Frame of Window,	322
435.	Section of Hexagonal Roof,	310	491, 492.	Astragals of Sash Window,	322
436.	Elevation and Section of Dormer Window,	310	493.	Section and Elevation of Frame of Sliding Window,	323
437.	Simple Gutter of Metal,	311	494.	Details of Sliding Window,	323
438.	Wooden Gutter,	311	495.	The Inside Elevation of an Improved Window suited for Cottages,	324
439, 440.	Gutters at Ends of Rafters,	311	496.	The Plan of an Improved Window for Cottages,	325
441.	Gutter with Cantaliver,	311	497.	The Vertical Section of an Improved Window for Cottages,	325
442.	Section of Wall showing Gutter with Cantaliver,	312	498.	Elevation of a French or Casement Window,	326
443.	Bridged Gutter,	312	499.	Oak-Hall Window, closed,	326
444.	Valley-Gutter,	312	500.	Oak-Hall Window, open,	326
445.	Section and Elevation of Valley-Gutter,	312	501.	Part Longitudinal and Vertical Section of Oak-Hall Window,	327
446.	Mode of cutting out Roans or Gutters out of Solid Timber,	312	502.	Part Horizontal Plan of Oak-Hall Window,	327
447.	Front Elevation of Belvidere of a Farmhouse,	313	503.	Part Elevation of Shaw's Patent Window,	328
448.	Side Elevation of Wooden Bracket for a Farmhouse,	313	504.	Part Plan of Shaw's Patent Window,	328
449.	Mode of laying out Steps,	314	505.	Longitudinal Section of Shaw's Patent Window,	328
450.	Treads and Risers,	314	506.	Half Plan of Main Window of a Farmhouse	329
451.	Mode of setting out Steps,	314	507.	Enlarged View of Bay Window of a Farmhouse,	329
452.	Plan of Platform Stairs,	314	508.	Part Plan of Bay Window,	329
453.	Section of Platform Staircase,	315	509.	Plan of Shutters,	330
454.	Plan of Staircase with Return,	315	510.	Part Vertical Section of Bay Window,	330
455.	Section of Return Stairs,	315	511.	Part Section of Base of Bay Window,	330
456.	Carriage-Board of a Staircase,	315	512.	Side Elevation of a V Window,	330
457.	Notch-Board of a Staircase,	315	513.	Part Sectional Plan of a V Window,	331
458.	Template for marking out Steps,	316	514.	Plan of V Window Shutters,	331
459.	Mode of using Template in marking out Steps,	316	515.	Plan of Shutters of Window of a Farmhouse,	331
460.	Marking out Steps in String-Board,	316	516.	Part Plan of Bay Window of a Farmhouse,	332
461.	Elevation of Balusters for Farmhouse,	316	517.	Plan of Bay Window Shutters,	332
462.	Section of Baluster,	316	518.	Plan of Bay Window, Chamber Floor,	332
463.	Elevation of Baluster for Farmhouse,	316	519.	Section of Architraves of a Farmhouse,	332
464.	Ledged Door,	317	520.	Skirting and Cornice for Dining-Room of a Farmhouse,	333
465.	Ledged and Braced Door,	317	521.	Skirting for Drawing-Room of a Farmhouse,	333
466.	Framed and Braced Door,	317	522.	Cornice for a Farmhouse,	333
467.	Circular-Headed Door,	317	523.	A Stall for a Work-Horse Stable,	335
468.	Sash Door,	317			
469.	Four-Panel and Six-Panel Doors,	317			
470.	Stiles of a Door,	318			
471.	Rails of Door,	318			
472.	Bottom Rail of a Door,	318			
473.	Middle Rail of a Door,	318			
474.	Muntins of a Door,	318			
475.	Raised Panel. Sunk Panel,	318			
476.	Bead-Butt and Flush Panel,	318			
477.	Panels of Door of Farmhouse,	319			
478.	Panel for Door of Farmhouse,	319			
479.	Gothic Door,	319			
480.	Eight-Panel Raised Door,	319			

Fig.		Page	Fig.		Page
524.	Fittings of Head of Stall with Feeding-Passage,	336	570.	Transverse Section of Self-Acting Sluice,	362
525.	Stall with Cast-Iron Heel-Posts,	336	571.	Sluice-Pipe Valve,	362
526.	Elevation of Ferguson's Ventilator,	339	572.	Rectangular Gate with Diagonal Strut,	363
527.	Section of Ferguson's Ventilator,	339	573.	A Common Field-Gate,	363
528.	Section of Sheringham's Ventilator with Hinged Valve,	340	574.	The Kilmory Wooden Trussed Field-Gate,	364
529.	Section of Sheringham's Ventilator with Suspended Valve,	340	575.	Miles' Wooden Field-Gate with Cast-Iron Heel-Post,	364
530.	A Wooden Ventilator,	340	576.	Wooden Gate suited for the Approach to a Farmhouse,	364
531.	A Stable Window,	341	577.	Secure mode of fastening the Hanging-Post of a Field-Gate,	366
532.	Corn-Chest for Work-Horses,	343	578.	Sliding-Door for Stables,	367
533.	Door through which to supply Mangers with Turnips,	344	579.	Suspended or Hanging Gate for Courtyards,	368
534.	Byre Travis, Manger, Stake, and Turnip-Store,	345	580.	Gate for Centre of Bridge,	368
535.	A Baikie,	345	581.	Swivel-Gate for Centre of Bridge,	368
536.	Cattle Seal or Binder,	346	582.	Frame-House Walls,	368
537.	Byre Window,	346	583.	Foundation Balk for Frame-House,	369
538.	Section of Laycock's Manger for Cattle-Boxes,	348	584.	Plan of Foundation Balks for Timber Shed,	369
539.	Section of Laycock's Rack for Cattle-Boxes,	348	585.	Side Elevation of Timber Shed,	369
540.	A Calf's-Crib Door,	349	586.	Elevation of Timber Shed,	369
541.	Turnip-Trough for Courts,	350	587.	Exterior Finishing of Shed,	369
542.	Wooden Straw-Rack for Courts,	350	588, 589, 590.	Weather-Boarding,	370
543.	Straw-Rack for Sheds,	350	591.	Sections of various forms of Battens,	370
544.	Pigsty Door,	351	592.	Eassie's mode of Joining Boards,	370
545.	Corn-Barn Door,	353	593.	Rebated Battens,	370
546.	Section of Corn-Barn Floor, and Upper Barn,	354	594.	Swedish mode of forming Walls of Frame-Houses,	371
547.	Granary Window and Section of Shutters,	355	595.	Mode of forming Walls of Frame-Houses Fireproof,	371
548.	A Wooden Stathel for Stacks, with Stone Supports,	355	596.	Timber Shelter-Shed at the Corner of Four Fields,	372
549.	Centre for a Door Arch,	356	597.	Plan of Balk Foundations of Shelter-Shed,	372
550.	Centrings for Gothic and Semi-circular Arches,	356	598.	Side Elevation of Timbers of Shelter-Shed,	372
551.	Centres for Stone Circular Arches,	356	599.	End Elevation of Timber Shed,	372
552.	Foot-Bridge for Spanning Ditches,	357	600.	Plan of Belgian Covered Dung-Shed,	373
553.	Beam-Bridge for 15-feet Span,	357	601.	End Elevation and Section of Belgian Covered Dung-Pit,	373
554.	Bridge for 14-feet Span, with Struts,	357	602.	Side Elevation of Belgian Covered Dung-Shed,	373
555.	Trussed-Beam Bridge, Span 8 feet,	358	603.	End Section of American Barn and Byres,	373
556.	Trussed-Girder Bridge for a Span of 32 feet,	358	604.	Isometrical Perspective View of the Balloon Frame,	374
557.	King-Post Truss for Bridge,	358	605.	Elevation Section—Manner of Nailing Balloon Frame,	374
558.	Queen-Post Truss for Bridge,	358	606.	Upper Edge of Joist of Balloon Frame,	374
559.	Trussed Bridge Girder,	359	607.	Section of Strongest Form of Cast-Iron Beam,	375
560.	Elevation of Bridge of 32-feet Span,	359	608.	Plan of Cast-Iron Beam,	375
561.	Elevation of Mid-Pier for Bridge,	359	609.	Elevation of Cast-Iron Beam,	375
562.	Sections of Forms of Piers or Starlings for Bridges,	359	610.	"I"-Shaped Cast-Iron Beam,	375
563.	End and Side Elevation of Central Support for Bridge,	360	611.	Plan and Elevation of Cast-Iron Girder for Span of 18 or 20 feet,	375
564.	Italian Wooden Aqueduct for Conducting Water of Irrigation over Rivers, Ravines, &c.,	360	612.	Section of Girder for Span of 18 or 20 feet,	376
565.	Wooden Sluice-Gate,	361	613.	Connection of Binding-Joists with Cast-Iron Girders,	376
566.	Italian mode of lifting a Sluice.—Italian Sluice-Gate lifted by a Screw,	361			
567.	Wooden Sluice in Stone Grooves,	361			
568.	Longitudinal Section of Self-Acting Sluice,	361			
569.	Plan of Self-Acting Sluice,	362			

Fig.		Page	Fig.		Page
614.	Cast-Iron Girders with "Shoes" for Joists,	376	658.	Joining of Feet of Struts and King-Bolt,	393
615.	Connection of Cross-Beams with Girders,	377	659.	Joining of Upper End of Strut with Rafter,	393
616.	Suspension of Cross-Beams from Girders,	377	660.	Joining of Foot of Queen-Bolt with Strut,	393
617.	Fixing of Truss-Rods of Cast-Iron Beams,	378	661.	Plan of Tie-Bolt,	393
618.	Section of Wrought-Iron Beam,	380	662.	Joint of Queen-Bolt,	394
619.	Section of Rolled Wrought-Iron Beam,	380	663.	Junction of Rafters with King-Bolt-Head,	394
620.	Section of Tie-Rods with Wrought-Iron Beams,	380	664.	Plan of King-Bolt-Head,	394
621.	Fixing of Cast-Iron Pillar,	381	665.	End Elevation of King-Bolt-Head,	394
622, 623.	Base of Cast-Iron Pillar,	382	666.	Side Elevation of Rafter-Shoe,	395
624.	Upper Termination of Cast-Iron Columns to receive Beam,	382	667.	End Elevation of Rafter-Shoe,	395
625.	Upper Termination of Cast-Iron Column to receive Base of Second Column,	383	668.	Plan of Horse-Walk for Thrashing-Mill,	396
626.	Position and Fixing of Tie-Rods,	383	669.	Skeleton Truss for Thrashing-Mill Horse-Walk,	396
627.	Joining of Girders in the Caps of Columns,	383	670.	Shoe for Feet of Rafters, Tie-Beam, and Tie-Rods,	396
628.	Junction of Girders with Circular Neck to Columns,	383	671.	King-Bolt and Rafter-Shoe in Elevation and Plan,	397
629.	Junction of Girders,	384	672.	Shoe for receiving Lower Ends of Struts and Upper Ends of Tie-Rods,	397
630.	Junction of four Girders on Cap of Column,	384	673.	Junction of King-Bolt, Struts, and Tie-Rods,	397
631.	Junction of Wrought-Iron Beams on Cap of Column,	384	674.	Gutter of Iron Roof,	398
632.	Skeleton Truss for an Iron Roof of 18-feet Span,	384	675.	Cast-Iron Gutter,	398
633.	Section of Wrought-Iron Rafters,	384	676.	Cast-Iron Gutter, leading Water to Hollow of Column,	399
634.	Rafter-Shoe for Roof,	385	677.	Gutter for Double-Span Roof,	399
635.	Plan of Rafter-Shoe,	385	678.	Cast-Iron Gutter for Double-Span Roof,	399
636.	Side and End Elevation of Rafter-Shoe,	385	679.	Corrugated Iron Plates,	400
637.	Elevation and Plans of Shoe for Upper End of Rafter,	386	680.	Truss for a Galvanised Iron Roof,	400
638.	Junction of King-Bolt, Struts, Rafters, and Tie-Rods,	386	681.	Section and Side Elevation of Rib,	400
639, 640.	Junction of King-Bolt, Rafters, and Tie-Rods,	387	682.	Cap of Column and Beam,	400
641.	Details of Tie-Rods,	387	683.	Plan of Upper End of Column,	400
642.	Junction of Struts with Rafters,	388	684.	Junction of Struts with Tie-Rod,	401
643.	Skeleton Truss of Double-Span Roof,	388	685.	Connection of Corrugated Iron Plates with Central Shoe of Double-Span Roof,	401
644.	Rafter-Shoes for Roof,	389	686.	Skeleton Truss for Corrugated Iron Roof of 52-feet Span,	401
645.	Skeleton Iron Truss for Span of 25 feet,	389	687.	Elevations and Plan of Shoe for Upper Termination of Rafters,	402
646.	Upper End of Cast-Iron Strut,	389	688.	Junction of Struts with Rafters,	402
647.	Lower Termination of Strut,	389	689.	Junction of Tie-Rods with Rafters,	402
648.	Side Elevation of Strut,	390	690.	Shoes for Tie-Rods,	402
649.	Junction of Rafters, Ridge-Pole, Bracket, and Ties,	390	691.	6-Inch Kitchen Latch,	404
650.	Side Elevation of Rafters, Ridge-Pole, Bracket, and Ties,	390	692.	7-Inch Rim Lock,	404
651.	Shoe for Rafters,	391	693.	5-Inch Press Lock,	404
652.	Shoe in Plan and Elevation for Securing Feet of Rafters,	391	694.	6½-Inch Mortise Lock,	404
653.	End View of Rafter-Shoe and Details of Tie-Rods,	391	695.	Escutcheon for Key-Hole,	404
654.	Upper Termination of Strut,	392	696.	12½-Inch Hinge,	405
655.	Lower Termination of Strut,	392	697.	13½-Inch Hinge,	405
656.	Skeleton of Trussed Roof 30-feet Span,	392	698.	Butt Hinges,	405
657.	Scale for a Number of the Figures,	392	699.	Patent Hinges for Self-Shutting Doors,	405
			700.	Collinge's Patent Spherical Hinge,	405
			701.	Pulley-Stile,	406
			702.	Window-Latch,	406
			703.	Spring Pulley for Window-Blind Cord,	406
			704.	Fastening of French Window—Front View,	406

Fig.		Page	Fig.		Page
705.	Fastening for French or Casement Windows—Side View,	406	755.	Manger and Rack,	422
706.	Lower Bolt of Window-Fastening,	407	756.	Manger and Water-Trough,	422
707.	Upper Bolt and Catch of Window-Fastening,	407	757.	Saddle and Harness Bracket,	422
708.	709. Fastening for Stair-Carpet Rod,	408	758.	Collar Holder,	422
710.	Arnott's Ventilator,	408	759.	Pig-Troughs, with Subdivisions, to stand in an opening of the outer wall of the Sty,	423
711.	Sheringham's Fresh-Air Ventilator,	408	760.	Pig-Trough,	423
712.	Top of a Chimney for Preventing the Down-Draught of Smoke,		761.	Hog-Trough,	423
713.	Chadwick's Archimedean Screw Chimney-Guard with Ventilator,	409	762.	Round Pig-Trough, to stand in a Court,	423
714.	Ball Chimney-Guard,	409	763.	Foot-Bridge of Cast-Iron Beam,	424
715.	Method of Contracting the Top of a Chimney,	409	764.	Plan of Foot-Bridge,	424
716.	Chimney-Valve,	410	765.	Section and Plan of Beam,	425
717.	Elevation of Chimney-Hopper,	410	766.	Shoe for End of Beam,	425
718.	Plan of Chimney Hopper and Bearer,	410	767.	Feet of Uprights for Rails,	425
719.	Cast-Iron Chimney Hopper and Bearer Combined,	410	768.	Uprights for supporting Chains and Rails,	425
720.	Gas Regulator,	411	769.	Studs for Chain and Rails,	426
721.	Hart's Gas Regulator,	411	770.	Cap for receiving Rail,	426
722.	723. Chrimes' Water-Tap,	412	771.	Section of Beams for Bridge,	426
724.	Jenning's India-rubber Tube-Cock,	412	772.	Cast-Iron Beam Bridge,	426
725.	Wheatcroft and Smith's Water-Tap,	412	773.	Section of Roadway with Three Beams,	426
726.	727. Pilbrow's Water Waste Preventer,	413	774.	Corrugated Iron-Plate Bridge,	427
728.	Lowe's Cast-Iron Trap,	413	775.	Section of a Corrugated Plate,	427
729.	Bell Trap,	413	776.	Front Elevation of Sluice-Valve,	427
730.	Cast-Iron Sink,	414	777.	Side Elevation of Sluice-Valve	427
731.	Goddard's Economical Kitchen-Range,	414	778.	Jenning's Sluice-Valve,	428
732.	American Cottage Cooking-Stove,	415	779.	Brown and May's Sluice-Cock,	428
733.	Rickett's Gas-Stove,	415	780.	Wheatcroft and Smith's Hydrant,	429
734.	Cottam's Iron Guttering for closed Surface Stable-Drains,	416	781.	Elevation of Iron Sluice-Valve and Rack,	429
735.	Barton's Stable-Drains,	416	782.	Plan of Iron Sluice,	429
736.	Juncture at Right Angles of Barton's Stable-Drains,	416	783.	Iron Field-Gate with Iron Posts and Stay,	430
737.	Corner Junction of Barton's Stable-Drains,	416	784.	Iron Field-Gate on the Tension Principle,	430
738.	Drain Grating for Courts,	416	785.	Angle-Iron Field-Gate,	431
739.	Bell's Patent Trap for Stables,	417	786.	Elements of the Bracing of a Wire Field-Gate,	432
740.	Cottam's Sanitary Trap for Stables,	417	787.	Wrought-Iron Side-Gate,	433
741.	Cast-Iron Cesspool for Stables and Byres,	417	788.	Foot-Gate for Fence,	433
742.	Section of Valve for admitting Fresh Air to Stables,	417	789.	Top of Sliding-Gate of Corrugated Iron,	433
743.	Front View of Valve,	417	790.	Detail of Sliding-Gate,	434
744.	Ratchet-Valve for admitting Air,	417	791.	Mode of Hanging a Sliding-Gate,	434
745.	Ventilator for Roof,	418	792.	793. Details of Sliding-Gate,	434
746.	Swivel or Cowl Ventilator,	418	794.	Straining-Post of Wire Fence, with Sole and Stay Underground,	434
747.	Muir's Four-Points Ventilator,	418	795.	Straining-Post, with Planks Underground,	435
748.	Cottam's Hind-Posts for Stalls,	418	796.	Straining-Post, with Standard and Stay Aboveground,	435
749.	Cottam's Travises or Stall Divisions,	419	797.	A Wrought-Iron Straining-Post,	435
750.	Patent Manger, Water-Trough, and Wrought-Iron Rack,	419	798.	Block for Straightening Wires,	439
751.	Bruce's Improved Stable Fittings,	420	799.	Joining of Wires,	439
752.	Garood's Adjustable Hay-Rack,	420	800.	Block for Making Eyes in Wires,	439
753.	Cottam's Stable Fittings,	421	801.	Clamps for Twisting the Wire at the Eye,	439
754.	Cottam's Section of Sliding-Manger,	421	802.	Turn-Key for Wires,	440
			803.	Straining-Screw,	440
			804.	Collar-Vice,	440
			805.	Straining-Screw and Collar-Vice Combined,	440
			806.	Wrought-Iron Hurdle,	441
			807.	Wire-Netting and Stake,	441
			808.	Mixed Gauze for Wire-Netting,	442

LIST OF WOOD ENGRAVINGS.

xxix

Fig.		Page	Fig.		Page
809.	Wire-Netting,	442	859.	Cast-Iron Girders, Pillars, and Brick Arches, for Fireproof Flooring,	457
810.	Spiral Wire-Work,	442	860.	Fireproof Flooring,	457
811.	Elevation of Cast-Iron Girder for Sheds,	443	861.	Fireproof Floors with Wrought-Iron Beams,	457
812.	Plan of Shoe for receiving Ends of Girder,	443	862.	Section of Angle Iron, and Junction of Wrought-Iron Plates with Beams,	458
813.	Trussed Beam, or Open Girder,	443	863.	Section of Wrought-Iron Fireproof Flooring,	458
814.	Elevation and Section of Shoe,	443	864.	Plan of Fireproof Flooring,	458
815.	Termination of Central Upright,	444	865.	Plan and Elevation of Fireproof Flooring,	459
816.	Termination of Side Upright,	444	866.	Details of Beam in Système de Mausé,	459
817.	Plan of Octagonal Shed,	444	867.	Loré's System of Fireproof Flooring,	460
818.	Roof-Truss of Octagonal Shed,	444	868.	Cheyne's Corrugated Iron Fireproof Floor,	460
819.	Plan of Central Ring for Shed,	444	869.	Cross Section of Bunnett's Cellular Brick Arch,	461
820.	End of Strut for Shed,	445	870.	Longitudinal Cellular Brick Arch,	461
821.	Widened Part of Tie-Rod for Shed,	445	871.	Part Section of Fireproof Floor, showing Tie-Rods passing through Bunnett's Cellular Bricks,	461
822.	Section and Elevation of Wrought-Iron Columns for Sheds,	446	872.	Section showing Tie-Rod passing under Cellular Bricks,	461
823.	Section of Cast-Iron Pillars for Cattle-Boxes in Sheds,	446	873.	Junction of Wooden Purlins with Iron Rafters,	462
824.	Iron Strap for Foot of King-Post, Struts, and Tie-Beams,	447	874.	Fixing of Slates with Iron Roof,	462
825.	Iron Strap for Foot of Rafter and Tie-Beam,	447	875.	Joining Rafters of Truss for Zinc Covering,	462
826.	Iron Strap for Head of King-Post and Braces,	447	876.	Skeleton Truss for Shed,	463
827.	Iron Strap for Collar and Rafter,	447	877.	Plate connecting the Ends of Tie-Bolts and Struts,	463
828.	Iron Strap for Straining-Beam, Queen-Post, and Strut,	448	878.	Termination of Struts and Tie-Bolts,	463
829.	Iron Saddle for Joining Beams crossing at Right Angles,	448	879.	Riveting Struts to Rafters,	463
830.	Cast-Iron Shoe for receiving End of Girder,	448	880.	Attaching Sheets of Zinc to Wrought-Iron Rafters,	464
831.	Cast-Iron Shoes for "Joists," "Wall-Plates,"	448	881.	Fixing of Sheets of Zinc to Wood Rolls,	464
832.	Cast-Iron Shoe for the reception of Wooden Struts,	449	882, 883.	Joining of Sheets of Zinc from Wall-Plate to Ridge,	464
833.	Shoes for King-Bolt-Heads,	449	884.	Expanded Foot of Rafter,	465
834, 835.	Shoe for Queen-Bolt and Strut,	449	885.	Joining Corrugated Plates of Zinc together,	465
836.	Shoe for Foot of Rafter and Pole-Plate,	449	886.	Elevation and Section of Joiner's Gauge,	467
837.	Shoe for "Purlins,"	450	887.	Elevation of part of Joiner's Bench,	467
838, 839, 840.	Trussed Beam,	450	888.	Plan of Joiner's Bench,	468
841.	Trussed Beam for 12-foot Span,	451	889.	Joiner's Treasels or Horses,	468
842.	Cross Section and Part Elevation of Fitches of Trussed Beam,	451	890.	Claw-Hammer,	468
843, 844.	Details of Truss Rods,	451, 452	891.	Grindstone,	468
845.	Conder's Trussed Beam,	452	892.	Mason's Trowel,	469
846.	Details of Conder's Trussed Beam,	452	893.	Mason's Level,	469
847.	Trussed Beam,	453	894.	Mason's Plumb-Line,	469
848, 849.	Details of Trussed Beam,	453	895.	Fanners for Forge,	470
850.	Details of King-Post Trussed Beam	454	896.	Details of Fanners,	470
851.	Details of Queen-Post Trussed Beam,	454	897.	Eccentric Fanners for Forge,	470
852.	Details of Cornice of a Farmhouse,	454	898.	Forge with Fanners,	470
853.	Front Elevation of Bracket of Cornice,	455	899.	Brace for Drilling Holes in Metal,	471
854.	Section of Base of Principal Window of a Farmhouse,	455	900.	Elevation of Screw-Frame for Boring Brace,	471
855.	Section through Window-Head of a Farmhouse,	455	901.	Ibbotson's Ratchet Brace,	471
856.	Plan of Mullion of Window of a Farmhouse,	456			
857.	Section of Base of Bay Window of a Farmhouse,	456			
858.	Section of Window-Head of Bay Window of a Farmhouse,	456			

Fig.		Page	Fig.		Page
902.	Plan and Section of Fenn's Ratchet Brace,	472	951.	Plan of a Heating Apparatus for a Drying-House,	497
903.	Boring Drills,	472	952.	Roller for a Steam-Pipe,	499
904.	Screw Stocks,	472	953.	Expansion Drum-Joint for Steam-Pipes,	500
905.	Ibbotson's Screw-Stock,	472	954.	Valved Curved Pipe for Steam,	500
906.	Various Views of Spanners or Screw-Keys,	472	955.	Vertical Section of Hands' Drying-Sheds,	501
907.	Riveting Hammer,	472	956.	Another Form or Section of Hands' Drying-Sheds,	501
908.	Portable Vice,	473	957.	Plan of Archimedean Screw Conveyor,	505
909.	Dunn's Lifting Screw-Jack,	473	958.	Vertical Section of Archimedean Screw Conveyor,	505
910.	Halley's Patent Lifting-Jack,	473	959.	Rake between the Threads of Archimedean Screw Conveyor,	506
911.	Perspective View of Turner's Iron Bench for Circular Saw,	474	960.	Section of Hands' Brick-Kiln and Drying-Shed,	509
912.	Endless Band Saw Frame in Perspective,	474	961.	Plan of Drain-Tile Work at Corehouse,	511
913.	Powis's Mortising, Tenoning, and Boring Machine in Perspective,	475	962.	Plan of Drain-Tile Kiln at Corehouse,	511
914.	Perspective View of Macpherson's Sheep-Fence-Making Machine,	476	963.	Transverse Vertical Section of Drain-Tile Kiln at Corehouse,	511
915.	Lathe,	477	964.	Ground-Plan of Farm Carpenter's Shop,	513
916.	Boring Machine,	477	965.	Ground-Plan of Farm Smithy,	513
917.	Breast Boring Machine,	477	966.	Plan of Flemish Barn,	513
918.	Perspective View of Combined Caldron and Furnace,	478	967.	Plan of Dutch Barn,	514
919.	Section of Combined Caldron and Furnace,	478	968, 969.	Sketch - Plan of Flemish Farm-Buildings,	514, 515
920.	Perspective View of Asphalt Caldron and Grate,	478	970.	Plan of Machine-House in Flemish Farm,	515
921.	Perspective View of Fire-Engine or Liquid-Manure Pump,	479	971.	Elevation of Machine-House in Flemish Farm,	515
922.	Perspective View of Holman's Double-Action Pump,	479	972.	Plan of Steading of Britannia Farm, Belgium,	516
923.	Gwynne's Farm Hand-Pump,	480	973.	Dung-Pits and Cinder-Cellars of Britannia Farm, Belgium,	517
924.	Section of Hydraulic Ram,	480	974.	Basement of American "Side-Hill Barn,"	517
925.	Side Elevation of Carrett's Steam-Pump and Portable Steam-Engine,	481	975.	Plan of Second Floor of American "Side-Hill" Barn,	517
926.	Simple Quarry Crane,	483	976.	Perspective View of an American "Side-Hill" Barn,	518
927.	Complex Derrick Crane,	483	977.	Plan of American Barn,	518
928.	Dray's Portable Crane,	484	978.	Plan of Allen's American Barn,	519
929.	Porter's Gas Apparatus for Farm Use,	485	979.	Isometrical Elevation of Allen's American Barn,	519
930.	Perspective View of Messrs Bridges and Aubury's Gas-Making Apparatus,	486	980.	Plan of Basement of American Barn,	520
931.	Plan of Isolated Cow-Byre at Corehouse,	487	981.	Plan of Upper Floor of American Barn,	520
932, 933.	Plan of Isolated Dairy,	488	982.	Plan of American Steading,	521
934.	Plan of Upper Floor in Isolated Dairy,	488	983.	Plan of Western States American Farm-Buildings,	522
935.	Plan of Poultry-House,	490	984.	Plan of American Cheese-Dairy Buildings,	523
936.	Elevation of Poultry-House,	490	985.	Plan of American "Sifting" Piggery,	524
937.	Section of Poultry-House,	490	986.	Ground-Plan of American Poultry-House,	524
938, 939.	Plans of Poultry-House,	491	987.	Section of an American Poultry-House,	524
940.	Plan of Pigeon-House,	491	988.	Section of Nests behind Stairs in American Poultry-House,	524
941.	Part Section of Pigeon-House,	492	989.	Plan of the Imperial Farm-Steading at Vincennes,	525
942.	Elevation of Detached Pigeon-House,	492			
943.	Plan of Rabbitry,	492			
944, 945.	Plans of Detached Piggery,	492, 493			
946.	Ground-Plan of Detached Slaughter-House,	493			
947.	Upper Floor of Detached Slaughter-House,	493			
948.	Vertical Section of Detached Slaughter-House,	493			
949.	Principle of Hot-Water Supply,	496			
950.	Section of a Heating Apparatus for a Drying-House,	497			

LIST OF WOOD ENGRAVINGS.

xxx

Fig.		Page	Fig.		Page
990.	Contents of Timber in Queen- Post Roof,	531	1004.	Roman Ovolo Moulding,	541
991.	Contents of Timber in King- Post Roof,	531	1005.	Grecian Ovolo Moulding,	541
992.	Contents of Timber in Tie-Beam Roof,	532	1006.	Roman Cavetto or Hollow Moulding,	541
993.	Contents of Timber in Collar- Roof,	532	1007.	Grecian Cavetto or Hollow Moulding,	541
994.	Contents of Timber in Partition,	533	1008.	Roman Cyma-Recta Moulding,	542
995.	Back-Flaps,	536	1009.	Grecian Cyma-Recta Moulding,	542
996.	Blockings,	537	1010.	Roman Cyma-Reversa Mould- ing,	542
997.	Clamp,	538	1011.	Grecian Cyma-Reversa Mould- ing,	542
998.	Elevation and Section of Hand- rail,	539	1012.	Ogee Moulding,	542
999.	Mitre-Joint in Wood,	541	1013.	Congee or Apophygee Mould- ing,	542
1000.	Fillet,	541	1014.	Post at Bottom of Stairs,	542
1001.	Bead or Astragal,	541	1015.	Single Quirk in Joinery,	543
1002.	Roman Scotia Moulding,	541	1016.	Double Quirk in Joinery,	543
1003.	Grecian Scotia Moulding,	541	1017.	Sash-Window,	544

ERRATA.

In par. 1721, p. 495, twenty-seventh line from top, *for* "low temperature of hot water system,"
read "low temperature hot-water system."

In par. 1730, p. 501, second line from bottom, *for* "airing" *read* "using."

At p. 285, in fig. 345, in the title, *for* "collars," *read* "cottars."

At p. 289, in fig. 362, in the title, *for* "bottom beam," *read* "collar-beam."

At p. 400, in fig. 682, in the title, *for* "column-beam," *read* "column and beam."

At p. 418, in fig. 746, in the title, *for* "bowl," *read* "cowl."

At p. 458, in fig. 864, in the title, *for* " $\frac{1}{4}$ inch," *read* " $\frac{3}{4}$ inch to the foot."

THE
BOOK OF FARM-BUILDINGS.

BOOK FIRST.—PRINCIPLES OF ARRANGEMENT.

DIVISION FIRST.—PLANS OF STEADINGS BASED UPON FIXED PRINCIPLES.

1. THE farms of this kingdom occupy every available space of ground, from the tops of the highest mountains to the lowest level of the plains. On the variety of ground implied in so wide a range, it is not to be expected that the same kind of husbandry should be followed. On the contrary, as a consequence of the great diversity, a different system is pursued in each variety of soil.

2. It may not therefore excite surprise when it is stated that no fewer than six kinds of farming are practised in the kingdom. The same kind is probably followed in all places of nearly similar soil and locality. Locality apparently determines the kind of farming more than the soil. The comparative influence of soil and locality in determining the kind of farming will best be understood, after considering the particulars incidental to each of the six kinds.

3. The simplest sort of farming is the *pastoral*. It is entirely confined to the mountains. Sheep are reared on the upper, and cattle on the lower, mountain ranges. Cattle and sheep are not always reared on the same farm: they are so only when high and low pasture-grounds unite. When the low-pasture ground lies in a valley, or along the banks of a stream, arable culture is judiciously introduced for the raising of winter food; but arable culture is the exception. A pastoral district is always hilly, the soil thin, poor, various, of light texture, and more suited to the growth of natural pasture grasses and live stock than of grain. The ordinary winter food, in most pastoral farms, is hay. Pastoral farms are always large, containing sometimes many thousands of acres, and even miles in extent; but from 1500 to 3000 acres may perhaps constitute one of common size. The rent is moderate. Locality thus entirely determines this kind of farming.

4. Another kind of farming is practised on *carse* land. In all respects a carse is quite the opposite of a pastoral district. Carse land implies a flat, clay, rich soil, capable of raising all sorts of grain, and is therefore eminently suited to arable culture, and for the same reason unsuited to pasture grasses and live

stock. Soil thus entirely determines carse farming. A carse farm is all arable, requiring much labour, and is never of large extent, seldom exceeding 200 acres; but the rent is always high.

5. A third sort of farming is the *suburbial*, practised in the immediate neighbourhood of large towns. In the vicinity of London, garden vegetables are raised on farms. In the neighbourhood of most other towns, garden vegetables are not so much raised as green crops, such as potatoes, turnips, and grass; as also dry fodder, such as straw and hay. This kind of farming is thus entirely suited to arable culture. The extent of such farms is not large, seldom exceeding 300 acres, and the rent is high. Locality thus entirely determines this kind of farming.

6. A fourth kind of farming is found at a distance from towns, and is called *common* farming. Not being directly dependent upon towns, this kind of farming follows a regular rotation of cropping with green and grain crops, and it fattens purchased cattle and sheep for the market. It is thus also suitable to arable culture. This is the most common kind of farming in the country, and being so extensively practised, necessarily comprehends great variety of soil, the rotations on which are contracted or expanded from the common standard, as the culture of live stock or grain claims the predominance in consonance with the nature of the soil. Locality rather than soil determines this kind of farming. The farms are not of large extent, seldom exceeding 400 acres, but some extend to 1500 acres. The rent is generally moderate.

7. A fifth sort of farming is the *dairy*. It directs its attention to the production of milk, and the making of butter and cheese. For these purposes it requires a considerable proportion of old pasture grass, as well as arable land for raising food for the cows in winter. It is thus suited to both arable and pastoral conditions. Its farms are of small extent, seldom exceeding 150 acres, and the rent moderate. Locality chiefly determines this sort of farming, which has reference to a proximity to good markets.

8. The sixth and last sort of farming is the *mixed husbandry*. It is so named because it embraces the culture of the soil in intimate connection with the rearing of live stock. The system of rotation of crops is therefore solely adapted to promoting the welfare of the live stock reared. Thus pursuing arable culture with the rearing of stock, this mode of farming cannot be practised within narrow bounds. The farms are therefore large, seldom less than 500 acres, and extending to even 1500 acres. Its adoption is determined neither by locality nor soil, its mixed character affording a happy medium for adapting itself to circumstances, whether of the one or the other.

9. The causes which have operated so to diversify the systems of farming in this country, are perhaps the following: Sheep occupy the whole range of pasture from the mountain-tops to the plains. Hence the highest mountain pastures are occupied solely by sheep, and there, in consequence, *pastoral* farms which breed sheep only are to be found. High sheep farms are much subjected to wind and rain; and were it not that the tops of mountains face different directions—one face affording comparative shelter and warmth, whilst the opposite is confronting the fiercest blasts of the elements—such farms would be unfit even for the most hardy breeds of sheep.

10. Since sheep can occupy the whole range of mountain pasture, and cattle only the secondary hills to the plains, it follows that both sheep and cattle may be reared on the same pastoral farm. This constitutes our second description of *pastoral* farms. Few store-masters, however, trouble themselves with breeding both cattle and sheep, where accommodation in steadings for stock of

both kinds is very limited, and where variety of winter provender is not overabundant. But where good haugh or holm land exists, and a thick soil on the adjacent slopes, a commodious steading may be set down with advantage for both cattle and sheep breeding. Cattle and sheep may be reared with advantage on the same pasture, inasmuch as sheep bite the grass closer and distribute their manure better than cattle, and the cropped grass thereby springs up afresh more readily.

11. Upon the slopes and undulations of the ground from the foot of the secondary mountains into the plains, are found the sites of many kinds of farming. The soil generally in these slopes and undulations rests on trap alone, or on sandstone alone, or on mountain limestone containing projecting eminences of trap. Such formations are eminently suited for raising turnips, and, accordingly, we there find prevailing the *mixed*, the *dairy*, and the *common* farming.

12. On the plains, towns and villages are found on the margins of rivers which are making their way to the sea or to an estuary. The soil is either thin clay or gravel, both travelled materials, and resting upon diluvial clay. The farming here is determined by the immediate demands from these towns and villages, and hence arises the *suburbial* farming.

13. Where the plain extends to the banks of a large river or wide estuary, the soil is often a uniform deposit of strong alluvial clay, upon which is practised the *carse* farming.

14. Such are the physical causes which have given rise to the different kinds of farming practised in this country. It is obvious that no change can be introduced into *pastoral* farming, except in the extension of arable culture, for the purpose of raising an increased and sufficient supply of winter food for live stock. *Carse* farming can only be materially altered by raising turnips where none were raised before, by means of thorough drainage. *Suburbial* farms must preserve their peculiar characteristics until the demand ceases from the towns for the peculiar products which they consume. As long as milk, and butter, and cheese, are wanted, *dairy*-farming must be pursued. The only material change that can be effected in the general farming of the country is the transference of the *common* farming at a distance from towns to that of the mixed husbandry. This change would involve the breeding and rearing of live stock upon the farm, instead of their being purchased at markets. What then would become of the live stock reared in the pastoral districts, when there would be no purchasers in the low country? But purchasers would be found by increasing the culture of turnips in the neighbourhood of towns beyond the town demand, and also by increasing them on carse farms by means of thorough drainage, on which classes of farms live stock cannot be reared. Such a change might probably afford accommodation for all the cast stock from the pastoral districts, in every successive year. Any change that could be effected on the *mixed* husbandry, could only be by purchasing live stock instead of breeding them, and such a change would be a retrograde one for the farmer.

15. The general condition of all the sorts of farming referred to above, may be modified materially by the following incidents: The land may be on too steep an inclination. The soil may be too tenacious or too loose; too wet or too dry; naturally poor or naturally rich. The fields may want water in summer. The fences may be injudiciously placed. The position of the farms may be exposed or sheltered; they may be far or near from coal, lime, markets, and railroads. The roads may be difficult or easy to traverse, or be in good or bad repair.

16. Seeing there are so many kinds of farming, it may reasonably be assumed that, for their accommodation, there should be a corresponding diversity in the size and arrangement of the fields and of the buildings on the farm. When the farming is limited in extent, such as in a dairy district, it is not to be supposed that the fields should be as large, in following a regular rotation of crops, as in a farm of mixed husbandry, or that the stable accommodation in the steading should be as extensive as in a carse farm. Although errors in judgment in constructing steadings may not be committed to such extremes as these cases indicate, errors too often prevail in that particular, by neglect of the essential consideration that the steading about to be erected is for the use of a special system of husbandry, and not for every system.

17. But this consideration, essential as it is, does not imply that no general rule or principle can be found which would apply to the construction of all steadings. Such a general rule may and does exist, and it is applicable, and is fit to be a guide, in the construction of steadings for every diversity of husbandry in which *straw* is used. Were the rule kept steadily in view in their construction, steadings would present much uniformity of aspect, whilst, at the same time, the arrangement of their apartments might be so modified as to suit each diversity of farming. It is one of the objects of this work to lay down such a general rule, and to show its applicability to the construction of steadings for every variety of *arable* husbandry in practice.

18. But before explaining this general rule, and applying it to construction, it seems necessary, as a preliminary investigation, to ascertain the particulars which constitute the most proper *site* which the steading of the farm should occupy.

19. Were theory alone to determine the site of the steading, it would be at the centre, as being the point equidistant from the circumference of a circular farm. But, for the sake of practice, farms should not be laid out in the circular form, because their circumference, or lines of boundary with other farms, would not be in straight lines; and not being in straight lines, much space would be lost for culture in the place where every four farms met. Such spaces might indeed afford good shelter, were they planted; but sufficient shelter can be better obtained from judiciously-placed large plantations on inferior soils, though at a greater distance and elevation. Farms are therefore laid out in the quadrangular form, having straight sides, wherever practicable, that is, where no rivulet occurs, the course of which is always obliged to be followed. The centre of such a quadrangle is the proper site for the steading, and from its centre alone, it is obvious that a farm can be most economically conducted.

20. Difficulties, however, of a physical nature often interfere with the choice of the centre as the most proper site. The centre may be very much elevated above the other parts, or it may be a low marsh or a lake. In either case, the steading cannot be placed in the centre of the farm.

21. When the farm contains both permanent pastoral and low arable land, the steading should be placed upon, and at the centre of, the arable portion, whether that be the centre of the farm or not.

22. Convenience often decides the site of a steading. Command of water-power is a strong incentive to place it by the side of a river. But it is worthy of consideration at first, whether the river is capable of affording a constant supply of water throughout all the seasons. If it does, then the steading will be economically placed near the river, though that may not be at the centre of the farm; but if the water be deficient in quantity, if it affords a sufficiency

only in winter, then it is more economical to place the steading near the centre of the farm, and erect a steam-power there.

23. A good road to a market-town or railway-station, is a natural inducement to place the steading beside it. But this advantage, natural as it is, may be purchased by the sacrifice of a greater. Should the steading be placed, in consequence, at the extreme angle of the farm, such a sacrifice would be made. We know a large steading which is thus inconveniently placed, for the sake of a good road and the command of water-power; but these advantages were obtained at the additional expense of maintaining a man and pair of horses with their implements, to work the most distant fields of the farm. Better make a good farm-road to the turnpike from the centre of a farm, and erect steam-power, than place a steading at its utmost corner.

24. Good shelter induces the placing of a steading in it. A warm and comfortable situation in winter conduces much to the well-being of the stock lodged in a steading. But this desideratum alone should not induce the placing of a steading at a point whence the farm would have to be worked at increased cost.

25. A pleasant view from the farmhouse may naturally induce the placing of a steading a short distance away from the centre of a farm.

26. There are particular spots which should be avoided as sites for steadings. A rocky knoll presents difficulties in making a foundation for buildings, and it is unsuited to proper drainage from a steading. Close to a river or lake, on a level with its banks, renders drainage from a steading impracticable, and should be avoided on account of the dampness of such a situation. A bed of dry loose sand is unsuitable for a secure foundation to a steading, though the difficulty might be overcome by artificial means. There is no necessity, however, of incurring an obviously unnecessary expense in forming a foundation for a steading. A clayey substratum in front of a rising ground is not an eligible position for the site of a steading, inasmuch as it will always retain dampness, whatever may be the drainage. A very exposed spot in a gap between two hills, is an uncomfortable position for a steading, both for man and beast.

27. It is a question whether or not it is more economical to place the steading at the higher or lower part of an inclining arable farm. If situate at the higher part, all the produce of grain, turnips, and potatoes, has to be carried up-hill; and if on the lower, the manure is subject to the same inconvenience. Where the surface of a farm forms a round-backed ridge sloping both ways, the apex of the ridge is the most economical site for the steading, and the case is the same when the steading is placed in the centre of a long slope of land. It should not be forgotten that loads have to be carried both to and from a steading, so that the high or low position will answer, provided there be no steep ascent or descent immediately at the steading. When both high and low situations are equally circumstanced, reason and experience would prefer the low.

28. One essential consideration should be given to all sites, which is, whether pump water is obtainable or not. Where it is abundant, some inconvenience may be submitted to; but if scanty, the most eligible site ought to be abandoned at once.

29. It is desirable that the farmhouse should be situated so as to command a view of the fields of the farm, and also be near the steading; and if any sacrifice of position on the part of either is necessary, the house should give way to the steading.

30. Having thus pointed out the best position for the steading to occupy on a farm, our next endeavour shall be to lay down the general principle which should guide the construction of steadings for every variety of arable husbandry.

31. Straw being the most bulky article in the steading, and in great and daily use by all the stock, and having, though heavy and unwieldy, to be distributed in every apartment by manual labour, it should, of necessity, be placed centrally, and at the shortest distance from the stock. Bearing the relations of these particulars in mind, it is obvious that they constitute the principle upon which the construction of steadings should be based; and as the centre is the nearest point to the circumference, it is also obvious that the original receptacle for the straw should occupy the central point of the steading. There can be no exception to this rule for every variety of farming where straw is in use. Every apartment occupied by stock should thus encircle the straw-barn. Different classes and ages of stock require different quantities and kinds of straw, so that those which require the most should be placed nearest the straw-barn; and in all cases straw should be carried short distances, and not at all from any other apartment than direct from the straw-barn.

32. The thrashing-machine supplies the straw at once to the straw-barn: that machine should therefore be erected nearest to it. The stackyard supplies the corn direct to the thrashing-machine, and should thus be contiguous to it; and as the corn and straw are thrashed most easily and quickly in a straight line, it follows that the stackyard, thrashing-machine, and straw-barn, should be in a straight line; and it also follows that as the straw-barn should be in the centre of the steading, and as the thrashing-machine intervenes between it and the stackyard, the stackyard should be placed on the outside of the steading. Another important corollary, as regards the construction of the steading, follows from these premises. The sun is an important source of warmth, and, in consequence, of comfort to the animals in a steading in the winter season. Every facility should therefore be allowed the sun to enter, and the removal of one obstruction to the greatest amount of sunshine is, placing the length of the central straw-barn north and south; and in settling this point, the straw-barn, thrashing-machine, and stackyard, will as a consequence be in a line north and south. This being the case, the building required to accommodate the thrashing-machine, and its accompanying corn-barn, being always two-storeyed, a convenient position for the granaries will be to place them east and west, where they will form a good screen from the north wind. Here, then, we have fixed a principle in the construction of steadings which is indisputable, namely, that the straw-barn should occupy the centre; that the thrashing-machine should be nearest to it and in a line with it; that the stackyard should be near the thrashing-machine; and that all three should be in a line north and south. And as all steadings for arable culture have straw-barn, thrashing-machine, and stackyard, it follows that this principle is applicable to all steadings erected for that purpose.

33. It shall now be our endeavour to illustrate this principle in its application to all classes of steadings. Cattle fattening, whether in hammels, boxes, or byres, requiring most straw, should be placed nearest the straw-barn. Younger cattle, being lighter, require less straw, whether for fodder or litter, and should be placed either at a greater distance from the straw-barn than the fattening cattle, or at the same distance on the other side of it. Horses and cows requiring the least straw, may be placed at the greatest distance from the straw-barn.

34. The leading principle involved in the above arrangement is comprehensive and simple, and is obviously applicable to every size and kind of steading. But indisputably correct as the principle is, it is very seldom adopted in practice; and we may safely assert that, the greater the deviation from it, the less commodious are steadings as habitations for stock in winter.

35. One reason why steadings are not constructed on this principle is, that possibly architects are not conversant with the use of the respective apartments in steadings, and they seem to bestow most attention on outward symmetrical proportions, and on constructing them at the least possible expense, and within the smallest space of ground, as if a few square yards more or less were of great value in the country. No doubt economy is enforced on architects by reluctant proprietors, at whose cost the buildings are to be erected; but economy is a secondary consideration when the proper accommodation of stock comes into competition with it. For, let us suppose that, by inadequate accommodation, cattle thrive by 10s. a-head less than they would have done by the best, the loss on 60 cattle would be £30, which, as an annual loss, is equivalent to a loss of £570 in the course of 19 years, besides interest—a sum much larger than would have been required to make the stabling complete in this respect at the outset. So little is such a loss anticipated, that in too many parts of the country the cattle are placed in courts within a small quadrangle, the southern range of which prevents the sun ever penetrating to them in winter; and on account of that peculiar form the chill air rushes over the corners of the roofs into the courts in whirlwinds, which, if accompanied with rain or sleet, is sure to engender in the cattle the most insidious diseases. Into a large quadrangle, however, the sun does find its way.

36. It is now time to describe the steadings suitable to the different sorts of farming, and to apply the ruling principle propounded above to those in which *straw* is used. We have seen that there are six different modes of farming practised in the country—namely, 1. PASTORAL farming, either simply or in connection with arable culture; 2. CARSE farming; 3. DAIRY farming; 4. SUBURBIAL farming, or that practised in the immediate neighbourhood of towns; 5. COMMON farming, or that practised at a distance from towns; and, 6. MIXED husbandry. We shall take these in the order named.

37. DESCRIPTION OF A STEADING OR ONSTEAD, OR FARMERY, AND STELLS FOR PASTORAL FARMING.—Pastoral farming is that which is simply so, or in connection with arable culture. Simple pastoral farming embraces the breeding and rearing of cattle or of sheep, or of both combined; and that sort of farming, combined with arable culture, devotes itself to the same ends.

38. *Cattle pastoral farming*.—On a pure pastoral farm on which cattle are bred and reared, the stabling required on it is simply a protection in winter for the cows, and this being the case, the rule propounded above does not apply to it particularly. The cows suckle their calves during the summer, and after the calves are weaned, they are put under protection in winter when the weather is severe, or the ground covered with snow, and supplied with hay and water, or let out to the water to drink every day. Such a stabling may be erected in any convenient place detached or near, as desired, to the farmhouse and herd's house. A plan of such a stabling is given at fig. 1, Plate I., where it is named "Detached pastoral farm-stabling for rearing cattle:" *a b, c d*, each 30 feet long, and 18 feet in width, are the sheds for the shelter of the stock, and *e, f, g, h* are their respective courts, each 30 feet square. The entrances to both sheds and courts should be 9 feet in width. The entrance to the sheds *i i i i* may be arched overhead if built of stone and lime, or have a flat wooden lintel. The walls should be 8 feet in height above the ground. The roof may consist of trees placed in the breadth across the walls, and covered with broom, whin, fern, or branches of spruce, all of which materials will last several years. But,

if desired, the roof may be made of ordinary couples of timber and slated. The courts should be provided with water-troughs, one trough to two courts, an arched opening being made in the common wall at *k k*. Gates are placed at the openings *l l l l*. The completed roof and the flat lintels over the doorways may be seen by the dotted lines of the isometrical perspective over the sheds *a b c d*. The walls may be made of dry stone rubble, toothed or pointed with lime on the outside; or they may be made of wood where timber is plentiful on the estate. But the best and most durable materials are stone and lime, where these can be procured.

39. Such a plan may be contracted or enlarged according to the wants and extent of the farm, and several may be erected on the same farm at places convenient for the making of hay, to save the carrying of that fodder to a distance. Cows in calf and calves will be well sheltered in such a steading in wet stormy weather, or when snow covers the ground; and even year-olds may be accommodated on an emergency, or on a much-exposed farm. From the dimensions given, it is easy for farmers to estimate the number of cattle, at their respective ages, which could be accommodated in the sheds.

40. Besides this accommodation for the breeding stock, a pastoral farm requires a steading for various other purposes. The farmer must have a horse and a gig to take him and his family to church and market. One or two work-horses are required to bring corn, provisions, and artificial food to the farm, as well as to carry a carcass to the butcher, and hay to the stacks. The farmer must have a cow or two for his family and those of his herds, and fowls and pigs.

41. Such a steading is represented by fig. 2, Plate I. It is the most easily and economically erected in a long straight building in which the apartments are conveniently arranged. *a* is the killing-house, which is a necessary apartment in a pastoral steading, for when a beast is taken ill, and not likely to recover, it must be killed: it is 18 feet in width, and 20 feet in length, with a window in front and door at the back; *b* is an outhouse in which implements and other articles may be locked up, 18 by 25 feet, with a window and door in front; *c* the gig-house, 18 by 9 feet, with a wide door in front; *d* the riding-horse stable of two stalls, 18 by 12 feet, with a window and door in front; *e* the hay-house, in which the corn-chest may be placed to contain the corn for all the horses, 18 by 15 feet, with a window and door in front; *f* the cart-horse stable, furnished with three stalls, to accommodate a strange horse when it comes, 18 by 18 feet, with a window and door in front; *g* the byre or shippen, 18 feet by 20, with a window and door in front, and four divisions for 8 cows, if as many are wanted,—if not, it can be made proportionally smaller; *h* the hen-house, 18 by 8 feet, with a window in front and a door at the back, and a bole with steps leading up to it by the side of the door; and *i* is the cart-shed, 18 by 12 feet, with a 9-foot opening. The stables and byre, being most in use, are placed at the centre of the building, while the less used apartments are at the outer ends. The hay-house may have internal doors leading into the riding and work stables, but in a small steading such as this it is unnecessary to incur the expense. The walls should be 9 feet above the ground, and the roof made of good couples of wood, and slated. The steading may be placed near the cattle-sheds, fig. 1, or at a distance, as most convenient for both sheds and steading. The dotted lines show the structure of the walls and roof, and the positions and forms of the doors and windows.

42. The farmhouse and cottages for the herds should be near the steading.

43. The scale for figs. 1 and 2, Plate I., is as half an inch to the foot.

44. The extreme length over walls of fig. 1, Plate I., is 125 feet; the extreme

breadth, 51 feet; and the width of the sheds is 18 feet within walls. The length of fig. 2 over walls is 153 feet, and the width of the apartments within walls is 18 feet.

45. The arrow indicates the direction of north.

46. It may be deemed desirable to have the cattle-sheds connected with the steading. Such a plan is represented by fig. 3, Plate I., where it is denominated "Compact pastoral farm-steading for rearing cattle," and where the central part of the building is occupied by the cattle-sheds *a b c d*, each 30 feet by 18, with their respective courtyards *e f g h*, each 30 feet square. With the sheds here, the apartments of the steading are not in a straight line, as in the above case, but are thrown into the form of wings, the lower one in the plate being devoted to the operations of the farm, and the upper one to those of the house. The lower wing is occupied by *i*, the riding-horse stable with three stalls, 18 feet by 18, with a window and door in front; *k* the hay-house, 18 feet by 12, in which a large corn-chest for all the horses may be placed, with a door and window in front; *l* the cart-horse stable, 18 feet by 18, furnished with three stalls, and a door and window in front. The hay-house being placed between the two stables, internal doors of communication may be made if desired. The gig-house *m*, 18 feet by 12, with a wide door in front. The litter-house *n*, 18 by 24 feet, is provided with a window and door in front, as well as a door at the back, to allow the litter to be carried either way, as required.

47. The upper wing contains *o*, the hen-house, 18 feet by 10, with a door in front, and a window and hole with steps at the side. There is another hay-house here at *p*, 18 feet by 10, for the use of the byre *q*, which is 18 feet by 20, furnished with four divisions for two cows in each. Both the hay-house and byre or shippen have a window and door in front. The outhouse *r* is 18 feet by 18, with a window and door in front; *s* the killing-house, 18 feet by 26, with a door and two windows in front, and may be used for other purposes.

48. The walls are 9 feet in height from the floor, and the dotted lines show the structure of the walls, windows, doors, and roof; the roof being made of wooden couples, and slated.

49. The extreme length over walls of fig. 3, Plate I., is 164 feet. The length of the upper wing is 91 feet, and that of the lower 91 feet. The width of the sheds and courts over walls is 52 feet. The width of the apartments and sheds within walls is 18 feet.

50. The scale of fig. 3, Plate I., is in the proportion of three-eighths and a third of an inch to the foot.

51. The farmhouse and cottages for the herds should be placed near the steading, which should be erected in the most accessible part of the farm.

52. The arrow shows the direction of north.

53. *Sheep Pastoral Farming.*—Sheep in pastoral farms are never housed in a steading in winter, although in modern agriculture in the low country they are not unfrequently fed in sheds erected beside the steading. Nevertheless, sheep are at times protected in a certain class of buildings, named *stells*, in the upper pastoral districts. In a pastoral farm where a ewe stock is kept such stells are of much use in stormy weather, and when the ground is covered with snow, to afford both protection and food to the ewes in lamb. Where ewes are kept, a certain proportion of the ewe lambs are retained, to maintain the number of the flock, and these lambs, when weaned and then termed hoggs, require shelter as well as the ewes themselves. Most of the lambs, and all the old cast

ewes, are sold off every year. Where no ewe stock is kept, weaned lambs or hogs are bought from the breeders, and they require shelter at times in winter.

54. Stells are of various forms, and generally constructed of dry stones, though better of stone and lime, and sometimes they are made entirely of grassy turf.

55. The site of a stell should be in a sheltered situation, and, at the same time, not be subject to be overwhelmed with snow.

56. An example of the simplest form of stell is given in fig. 1, where *a*

Fig. 1.

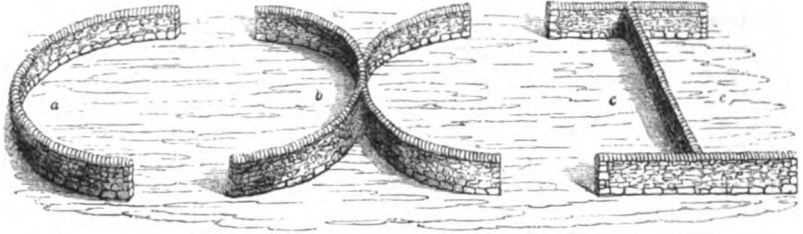

SIMPLE FORMS OF OUTSIDE STELLS.

is the arc of a circle, affording shelter at *a* against the blast on the opposite face of the fence; *b* is of two inverted arcs of circles touching, and they afford shelter on either side, as also in the spaces between the curves; *c* has two parallel walls connected by a wall between them, and these afford equal shelter at *c* and *c*.

57. Another simple form of stell is in the meeting of four arcs of a circle, as in fig. 2, affording shelter in all the curves, according to the direction whence the blast comes.

Fig. 2.

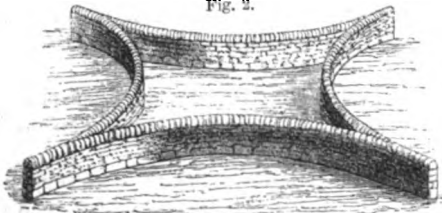

OUTSIDE STELL, AFFORDING SHELTER IN ALL DIRECTIONS.

58. A circular stell, with a simple fence, very common in use, is an objectionable form, inasmuch as its interior is apt to be blown up with snow.

59. A circular stell, however, surrounded by a plantation, affords excellent shelter and protection, as seen in fig. 3, where *a* is the space within for shelter, provided with an entrance *b* through the planting, which should be parallel and winding, and not as shown in the figure, which is the common form of entrance, but which is bad, inasmuch as the sheep, crowding in, are apt to be jammed at the inner narrow point. Such a stell would occupy a considerable space of ground, according to the size of the flock, and it may be reared in the most exposed situation. A number of them might be made on the same farm.

Fig. 3.

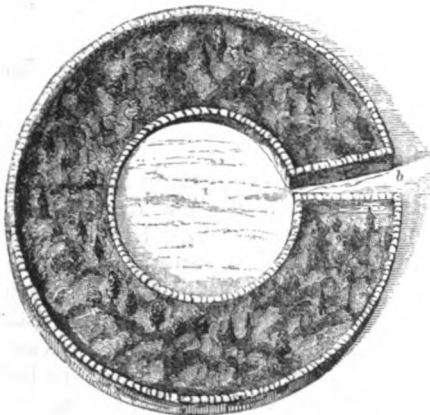

INSIDE CIRCULAR STELL, WITH PLANTATION.

60. Fig. 4 represents an inside stell of 18 yards diameter within, surrounded by a wall 6 feet in height, the lower 3 feet of which may be built of stone, and the upper 3 feet

of turf. It contains a hay-stack, protected by hurdles, and racks for hay against the wall round the inside. Its site should be in a sheltered place,

Fig. 4.

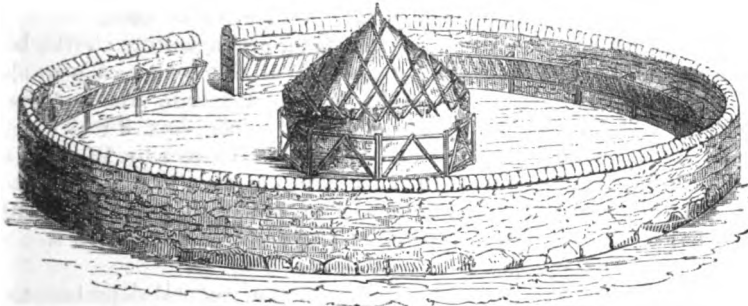

INSIDE CIRCULAR STELL, WITH HAY-STACK AND RACKS.

where deep snow cannot cover it up. The opening into it should be from the side towards the rising ground, or it should be on the sheltered side when the stell stands upon a knoll.

61. An outside stell of large dimensions is represented by fig. 5, where a curved fence of reversed circular form encircles the plantation, and affords shelter from every quarter. It might be erected in the most exposed situations, and multiplied in any number in the same farm or district. Such a form of stell would be an ornament to the country, besides a means of shelter at all times.

Fig. 5.

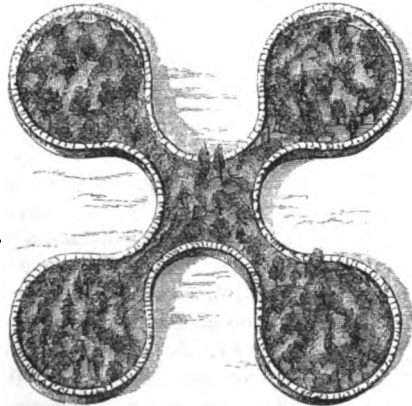

OUTSIDE STELL, SHELTERED BY PLANTATION ON EVERY SIDE

62. *Cattle Pastoral Farming with Arable Culture.*—Every pastoral farm that has much ground in its lower part, in a valley or on the banks of a rivulet, has arable culture connected with it; and every pastoral farmer is desirous of having as much arable land on his farm as will produce corn for the support of his family and servants and horses, and supply straw and turnips for the use of his stock in winter. Such a farm requires an adequate steading, and such a steading is necessarily provided with a thrashing-machine and straw-barn. Wherever these requisites are available, the principle we have advanced above, in par. 32, is applicable in the construction of the steading.

63. Fig. 1, Plate II, presents such a steading, where the central part is occupied with the thrashing-machine and straw-barn in a line north and south of a range of building having apartments in the upper wing connected with the operations of the arable part, and in the lower one, with the pastoral department of the farm: The corn-barn *a* is 18 feet by 26, with a door at the back to the stackyard, and a window looking into the cattle-court *p*; *b* is the site of the thrashing-machine, *c* the chaff-house, 5 feet wide, with an internal door to the straw-barn and a window into the cattle-court *p*; *d* the straw-barn, 18 feet by 21, has four doors, two to cattle-courts, and two outside them, to the stables and byre; *e* the cart-shed, 18 feet by 22, with two

port-holes; *f* the gig-house, 18 feet by 9; and *h* the horse-course, 26 feet in diameter. To the right of the central range of buildings are the cattle-sheds *l* and *m*, 18 feet by 30 each, with their respective courts *p* and *q*, 30 feet by 30 each. To the left of the central range are the cattle-sheds, *i* and *k*, 18 feet by 30 each, with their respective courts *n* and *o*, 30 feet by 30 each.

64. In the right wing are these apartments for arable culture: *r* the boiling-house, 18 feet by 7 feet 6 inches, having a door at the back and a window in front; *s* the implement-house, 18 feet by 8, with a door in front; *t* the cart-horse stable, 18 feet by 32, having four stalls and a loose-box, 8 feet wide, with a door and two windows in front; *u* the hay-house, 18 feet by 12, with a door at the back towards the straw-barn *d* for carrying the straw to the cart-horse stable *t*, and a window in front; *v* riding-horse stable, 18 feet by 12, with two stalls and a door and window at the back; and *w* a turnip-store, 18 feet by 12, for the cattle-courts *p* and *q*.

65. In the left wing are these apartments for the pastoral department of the farm: *b'* the hen-house, 18 feet by 9, with a door in front and a window and bole at the back; *x* an outhouse, 18 feet by 17, with a door and window in front; *y* the killing-house, 18 feet by 18, with a door and window in front; *z*, a turnip-store, 18 feet by 18, for the cattle-courts *n* and *o* and cow-byre *a'*, with a door at the back, and the cow-byre *a'*, 18 feet by 18, with a door and window in front. The killing-house is a convenience in all pastoral farms, and here, as it should be, it is situated between apartments not appropriated to any kind of live stock.

Fig. 6.

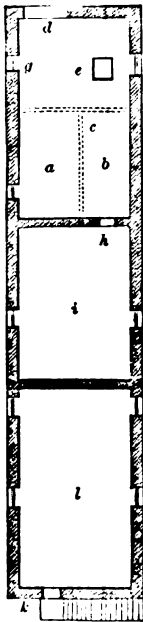

UPPER FLOOR OF A STEADING FOR CATTLE PASTORAL FARMING WITH ARABLE CULTURE.

The cattle-courts and sheds may accommodate either breeding-cows and calves, or young stirks and heifers bought from the breeders. The turnip store *w* may be the gig-house; the gig-house *f* a guano-store, and the turnip-store *z* allotted to any other purpose. Turnip-stores could then be made in front of the walls of the cattle-courts *n o* and *p q* at *b'* and *c'*.

66. The walls are 9 feet high above the ground, and the dotted lines show the structure of the roofs, the two-storeyed portion of the steading, and the position of the doors and windows.

67. The highest part of the building contains two floors or storeys. The upper floor or storey consists of the apartments shown in fig. 6, where *a* is the upper barn immediately above the corn-barn; *b* the site of the thrashing-machine with its gearing, drum, and shakers; *c* the dotted lines showing the position of the beams of wood which support the thrashing-machine; *d* the door, 6 feet wide, which leads into the stackyard, from which the sheaves from the stacks are brought either in wheel-barrows along a gangway, or in carts placed right under the door and forked into the barn; *g* is a window at the right hand of the man who feeds the sheaves into the thrashing-mill; *e* is a hatch, 3 feet by 3, communicating with the corn-barn below, for the purpose of passing the roughs of the grain to be rethreshed, where there are no elevators connected with the mill; *h* is a bole, 4 feet by 3½, communicating with the straw-barn, *i*, through which the straw is forked, to be again passed through the mill when necessary; *l* is the granary over the cart-shed and gig-house, 18 feet by 32, with an entrance by an outside stone stair *k*, with four windows, two on each side. The granary is placed here for simplicity of construction, but it would be better to extend the central range into two storeys over the cattle-sheds *k* and *l*, fig. 1, Plate II., and thus have two

granaries, each 30 feet in length, with an entrance direct from the corn-barn. In that case, the roof of the cart-shed *e* and gig-house *f* should be brought down to one storey, and the end wall of the straw-barn elevated into a gable.

68. The extreme length over walls of fig. 1, Plate II., is 188 feet. The length of the right wing is 96 feet, that of the left wing 95 feet. The length of the middle division over walls is 73 feet. The width of the sheds and courts is 53 feet, and that of all the apartments and of the sheds is 18 feet.

69. The scale of fig. 1, Plate II., is in the proportion of rather more than $\frac{3}{8}$ ths of an inch to the foot. The scale of fig. 6 will be found at fig. 1, Plate II.

70. The farmhouse and the herd's cottage should be placed near the steading, which should be erected in an accessible part of the farm.

71. The arrow points to the north.

72. *Sheep Pastoral Farming with Arable Culture.*—It is as convenient to have some arable husbandry connected with a sheep pastoral farm, as with that for the rearing of cattle, and hence a steading is required for it also. As this sort of farming is furnished with stells for the sheep, and does not require courts, the apartments might be placed in a single row; but as such a form would place the apartments at the extreme ends at a considerable distance from one another, it is more convenient to make it into that of a hollow square or parallelogram. Where arable culture is practised, it is always advisable to have a thrashing-machine. No courts being required, it is not absolutely necessary to place the straw-barn within the hollow square, although it is necessary to have it at hand; and this is the case in the plan of a "Farm-steading, for rearing sheep with arable culture," given in fig. 2, Plate II., showing a slight modification of the principle laid down as an axiom in par. 32, in its application to a case where little straw is required.

73. The corn-barn is *a*, 18 feet by 32, with a door and window in front. Off the corn-barn is the space *b*, 18 feet by 8 feet 6 inches, for the thrashing-machine, as also the space *c*, 5 feet wide, for the chaff-house, with a door to the straw-barn and a window in front. The straw-barn *d* is 18 feet by 40, with a door in front, and another at the back to the stack-yard and horse-course, and also a bole at the back. The horse-course *f* is 26 feet in diameter. The killing-house *g* is 18 feet by 10, with a door and window at the back. This apartment is far removed from any occupied by animals. The cart-shed *h*, 18 feet by 18, has two arched ports. The implement-house *p* is 18 feet by 18, with a door and window at the back. All these apartments are situate in the central range of the building.

74. The two wings are so arranged as the lower one is devoted to the arable work of the farm, and the upper to the pastoral. The lower wing contains the following apartments: The cart-horse stable *i*, 18 feet by 32, having four stalls and a loose-box *k*, 8 feet wide, with a door and window in front. The hay-house *l*, 18 feet by 10, with a door and window in front, as also an internal door leading on the one hand into the cart-horse stable, and, on the other, into the riding-horse stable *m*, 18 feet by 12, with two stalls, and a door and window in front; *n* the gig-house, 18 feet by 10, with a wide door; and *o* the boiling-house, 18 feet by 14, with a door and window in front, and a boiler and furnace at the gable.

75. The upper wing has these apartments in it: the byre or shippen *q*, 18 feet by 25, contains five divisions, for two cows in each, if required, with a door and window in front; *r* the hen-house, 18 feet by 8, with a door at the back, and a bole and a window in front; *s* the outhouse, 18 feet by 17, with a

door and window in front; and the wool-room *t*, 18 feet by 28, with a door and two windows in front, and three windows at the back for air and ventilation, and an internal door to the outhouse for convenience. There is also a fireplace in it at the gable, with a chimney-stalk; *u* is a pump-well shaft, 5 feet in diameter, in the centre of the space common to all the apartments.

76. The dotted lines show the structure of the building, roofs, doors, windows, and chimney-tops.

77. The highest part of this steading is the central range which is divided into two floors or storeys. The upper floor consists of three apartments, as shown in fig. 7, where *a* is the upper barn immediately above the corn-barn, and of the same dimensions; *b*, the site of the thrashing-machine, with its gearing, drum, and shakers; *c*, in dotted lines, are the beams of wood supporting the

Fig. 7.

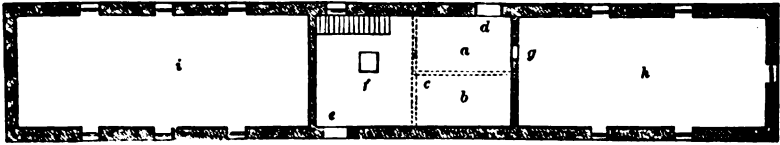

UPPER FLOOR OF A STEADING FOR SHEEP PASTORAL FARMING WITH ARABLE CULTURE.

thrashing-machine; *d*, the door, 6 feet wide, leading to the stackyard, from which the sheaves of the stacks are brought either on wheel-barrows over a gangway, or by carts loaded at the stack, and then placed right under the door, and the sheaves forked from it into the barn; *e*, the window; *f*, a hatch in the floor, $3\frac{1}{2}$ feet by 3, communicating with the corn-barn below, for passing the roughs of grain to be rethashed when no elevators are appended to the thrashing-mill; *g*, a hole, 4 feet by $3\frac{1}{2}$, communicating with the straw-barn, for the purpose of forking up any straw that may require to go again through the thrashing-mill; *h* is the straw-barn, with boles in the wall; and *i*, the granary, 18 feet by 48, extending over the killing-house, cart-shed, and implement-house, with three windows on each side, and entered directly from the corn-barn by a stair.

78. The extreme length of fig. 2, Plate II., over walls is 125 feet. The length of both wings is 113 feet. The width of the apartments within walls is 18 feet.

79. The scale of fig. 2, Plate II., is in the proportion of $\frac{3}{8}$ and $\frac{1}{2}$ of an inch to the foot. The scale of fig. 7 will be found in that of fig. 2, Plate II.

80. The arrow points in the direction of north.

81. The farmhouse and herd's cottage should be near the steading, and in an accessible part of the farm.

82. DESCRIPTION OF A STEADING FOR CARSE FARMING.—Carse farming consisting entirely of arable husbandry, the steading is constructed for that purpose only, accommodation being afforded chiefly for the straw and the animals of labour, cattle being only used to trample the straw down into manure, and a few cows to supply the farmer's family and the work-people with milk.

83. A plan of a steading suited to these requisites is given in Plate III. It will be found that this plan fully illustrates the principle of construction laid down in par. 32, wherein the straw occupies the central position, and all the other apartments cluster around it as a centre.

84. The corn-barn *a* is 31 feet by 28, with a door to the stackyard and a window into a court, containing within it the space for the thrashing-machine *b*, 18 feet by 8 feet 6 inches, and for the chaff-house *c*, 5 feet in width, with a door

leading into the straw-barn *d*, 18 by 46 feet, with four doors, two leading into the cattle-courts, and two into the open space, conducting to the cart-horse stable and cow-byre. The boiling-house *e*, 18 by 24 feet, for the cooking of food for the horses, is a continuation of the straw-barn, and being in a two-storeyed range, is provided with a cock-loft or gangway to contain at hand the ingredients to be cooked, and with a door towards the stable and a window in the gable between the two boilers; *f* is the steam-engine room, 18 by 11 feet, with a door and window, as also a trap door into the boiler-house *g*, 20 by 10 feet, with which is connected by a door the coal-store *h*, 20 feet by 5, having a window at the end. The chimney-stalk, 50 feet in height, is seen at the end of the boiler-house *g*; *i* is a shed for cattle, 18 feet by 30, and *k* a court, 30 feet by 30, connected with it; *l* is a shed for cattle, 18 by 38 feet, and *m* its court, 38 feet by 30; *n* and *o* are the turnip-stores for the respective cattle-courts, *n* being 24 feet 9 inches by 7 feet, and *o*, 26 feet 9 inches by 7 feet. These apartments constitute the central portion of the steading.

85. In the right wing are these apartments: *p*, a loose-box, 18 feet by 18, with a door and window in front; *q*, the gig-house, 18 feet by 12, with a wide door in front; *r*, a hay-house, 18 by 20 feet, with a window and door in front, and an internal door into the cart-horse stable *s s*, 18 by 78 feet; *t* is a central door to bring the straw from the straw-barn into the stalls, and in front are a door and four windows; *u* is another hay-house, 18 by 14 feet, with a window in front and a door at the back; and *v* is the riding-horse stable, 18 feet by 18, with a door and window, and an internal door to the hay-house *u*.

86. In the left wing are the following apartments: *w* is the hen-house, 18 feet by 18, with a door and window in front, and a bole at the back; *x x* the cart-shed, 18 feet by 55, with six arched ports; *y* the cow-byre or shippen, 18 by 40 feet, with 8 double-stalls for 16 cows, should the hinds have a cow's keep as part of their wages, with a door and two windows in front; *z* an implement-house, 18 feet by 18, with a door and window in front; *a'* an outhouse, 18 feet by 15, with a door and window in front; and *b'* another outhouse for any purpose, with a door and window in front.

87. The pigs may share the sheds and courts with the cattle, but a pig-sty for feeding them for domestic use may be erected as a lean-to against the gable of the boiling-house *e*.

88. The dotted lines show the construction of the building and the style of roofing, with the positions of the doors, and windows, and chimneys.

89. They also show the highest part of the building, which consists of two floors or storeys. The upper storey contains the apartments as shown in fig. 8, where *a a* is the upper barn immediately above the corn-barn and steam-engine room, with a bole for air *o*; *b*, the site of the thrashing-machine with its gearing, drum, and shakers; *c*, the dotted lines, the beams of wood which support the thrashing-machine; *d*, the door, 6 feet wide, leading to the stack-yard, from which the sheaves are brought from the stack either on wheel-barrows, or by carts loaded at the stack and placed right under this door, and the sheaves forked into the barn; *e*, the sky-light in the roof for giving light to the barn; *f*, a hatch in the floor, 3 feet by 3, for passing the roughs of grain from the corn-barn, to be again thrashed by the mill when elevators are not appended to the mill; *g* a bole, 4 feet by 3½, communicating with the straw-barn, through which to fork any straw that may require to go again through the mill; *h* the straw-barn; *i* one granary, 18 feet by 45, entered from the corn-barn by a stair through the engine-room, with three windows on one side and two on the other, and one at the gable, and *k* is another granary, 18 feet by 61, entered by a stair direct

from the corn-barn, with three windows on each side and one at the gable; *l* a cock-loft or gangway over the boiling-house, entered by a fixed trap-stair in

Fig 8.

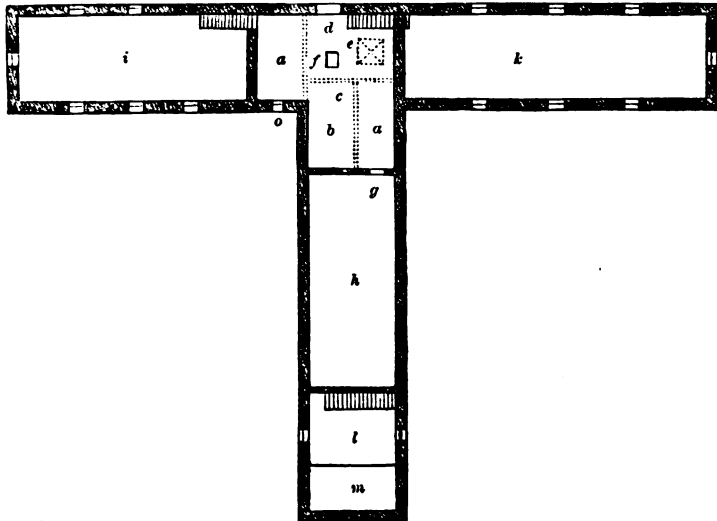

UPPER FLOOR OF A STEADING FOR COARSE FARMING.

that house; and *m* is a good place of warmth from the boiler for a pigeon-house, 18 feet by 6, up to the roof, and the pigeons to enter through the gable.

90. The scale of this plan is in the proportion of $\frac{2}{3}$ and $\frac{2}{3}$ of an inch very nearly to the foot. The scale of fig. 8 will be found in Plate III.

91. The extreme outside length of the principal east and west range of the building is 145 feet; the length of the middle range north and south is 83 feet; the length of the right wing is 169 feet, that of the left 170 feet. The width of all the apartments within walls is 18 feet.

92. The arrow shows the direction of north.

93. The farm and hinds' houses should be placed near the steading.

94. On looking at the plan on Plate III., with the view of amendment, it would make a more compact arrangement to push the hay-houses and cart-horse stable up to the loose-box *p*, and place the gig-house *q* at the end of the building on this side of the riding-stable, with its wide door looking this way.

95. DESCRIPTION OF STEADINGS FOR DAIRY FARMING. — Dairy farming is conducted on two scales, large and small. A large dairy requires ample accommodation for live stock, a considerable extent of arable land, as well as permanent pasture, and can only be prosecuted by large capitalists. A small dairy may be conducted by farmers of small capital. Each of the scales requires a different arrangement.

96. *Large Dairy Farming.*—A large dairy farm comprehends four distinct operations for which accommodation must be provided. The first is, arable culture to produce food for the stock summer and winter; 2. The dairy, comprehending the making of butter and cheese; 3. The breeding of stock in as far as to replenish the stock of cows; and, 4. The rearing and feeding of pigs.

97. The plan of a steading in Plate IV. comprises all these requisites. The

two right wings of the steading are devoted to the use of arable husbandry, the broad division in the centre accommodates the operations of the dairy; while the left wing comprehends the breeding and rearing of heifers and pigs.

98. In the lower one of the two right wings is the corn-barn *a*, 18 feet by 30, with a door and window at the back and a window in front, and in which is the space for the thrashing-machine *b* and chaff-house *c*, with a door leading into the straw-barn *d*, 18 feet by 40, which has two doors, and a straw-cutter placed in it moved by power; *e* is a turnip-store, 18 feet by 24, with a door and window facing the byre. At the outside of the gable, as a to-fall or lean-to, are the hammels for young horses, with their sheds *ff*, 12 feet by 9 each, and courts *gg*, 10 feet by 9 each; *h* is the steam-engine room, 18 feet by 12, with a door and window in front, and a trap-door to the boiler-house *i*, 24 feet by 10, with a door and window. The coal-store is at *k*, 24 feet by 5, with a door from the boiler-house and a window at the farther end. The boiler-house and coal-store are covered by a lean-to roof, and the chimney-stalk, 50 feet in height, is close to the boiler-house; *m* is the cart-shed, 18 feet by 44 feet 6 inches, with five arched port-holes and a door at the back at *l*, to give access to the stackyard; *n* is the implement-house, 18 feet by 18, with a door and window.

99. In the upper right wing is the cart-horse stable *o*, 18 feet by 36, with a door and two windows in front, and provided with a loose box, 18 feet by 8, with an internal door to the stable; *p* is the hay-house, 18 feet by 12, with a door and window in front, and two internal doors, one leading to the cart-horse and the other to the riding-horse stable; *q* is the riding-horse stable, 18 feet by 18, with three stalls, and a door and window in front; *r* is the gig-house, 18 feet by 12, with a wide door; and *s* is the boiling-house for preparing food for the horses and pigs, 18 feet by 20, with a door in front and window at the back, and provided with two boilers. A small pigeon-house could be placed in the couples of this apartment, where the pigeons would derive warmth from the boilers.

100. In the dairy department, *t* is the hay-house, 18 feet by 22, with a door and window in front, and in which the hay-cutter is placed and moved by power; *u* is the turnip-cutting-machine room, 18 feet by 18, with a door and window in front, where the machine is moved by power; *v* is the churn-room, 18 feet by 17 feet 6 inches, with a window at the back, and an internal door leading into the cheese-press room: the churn is moved by power, the entire milk being churned at a time; *w* is the cheese-press room, 18 feet by 17 feet 6 inches, with a window at the back and a door opposite leading into the cow's boiling-house, and an internal door into the milk-house; *x* is the milk-house, 18 feet by 17 feet 6 inches, with two windows at the back and an internal door from the cheese-press room, and provided all round with stone shelving; *y* is the wash-house for cleaning the dairy-utensils in, 18 feet by 17 feet 6 inches, with a window in the side wall and a door opposite leading into the cow boiling-house, and is furnished with a boiler and a separate chimney-stalk; *z* is the cow boiling-house, 18 feet by 17 feet 6 inches, with a door into the wash-house, another into the cheese-press room, and a third, that of entrance, from the passage *e'*; it is provided with two boilers for preparing the food for the cows, from which a double chimney-stalk rises up separately; *a'* is a turnip-store, 18 feet by 17 feet 6 inches, with a door and window in front, and a door to the passage, by which the turnips are carried to the boilers in the boiling-house *z*. The continuation of this range is the cow-byre or shippen, 98 feet by 55, divided into two great heads for the milking-cows, of which

b' b' and *c' c'* are the cleansing passages and grupes; *d d'*, *e e'*, *f f'*, the feeding passages, 4 feet in width; *g' g'* is the part of the byre in which the heifers to be transferred into the cow-stock are lodged. The cleansing passages are furnished with a door at each end for ingress into the byre and egress for the dung, and the feeding passages with a window at each end for light. The roof is provided with ventilators. From *e e'* to *f f'* is a passage, 4 feet wide, down the middle of the byre, to allow the food to be brought in the cooler from the boiling-house to the ends of their respective feeding passages.

101. In the left wing, in the stock department, are the following apartments: *k k* the hammels for bulls, 18 feet by 8 in the sheds, and the same dimensions in the courts *i' i'*, with a port to each shed and a gate to each court; *k' k' k'* are the hammels for heifers, 18 feet by 14 in the sheds, and the courts *i i i* of the same dimensions, with a port to each shed and a gate to each court; *m* is a hammel for yearling heifers, 18 feet by 14 in the shed, and a court of the same dimensions; *o'* is a small turnip-store, 8 feet by 4; and *t'* is a larger turnip-store, 14 feet by 7; *p'* is the hen-house, 18 feet by 18, with a door and window in front, and a bole at the back of the range; *r'* is an outhouse, 18 feet by 16 feet 6 inches, with a door and window in front; *r'* is the calves-house, 18 feet by 32, with a door and two windows, and capable of containing 22 calves; *s' s' s'* are piggeries, each sty 10 feet by 6 in the shed, and 8 feet by 6 in the court, with a door and window in front, and provided with a passage along the back of all the sties, of 4 feet in width; *u'* is a covered dung-stance, 18 feet by 28, with a door in front, and a wide door for a cart at the back.

102. The dotted lines give the form of all the roofs, doors, windows, and chimney-stalks.

103. The highest part of this steading is confined to the extreme right of the principal range, with the spur at right angles containing the straw-barn and turnip-store, the principal range being divided into two floors, the upper one

Fig. 9.

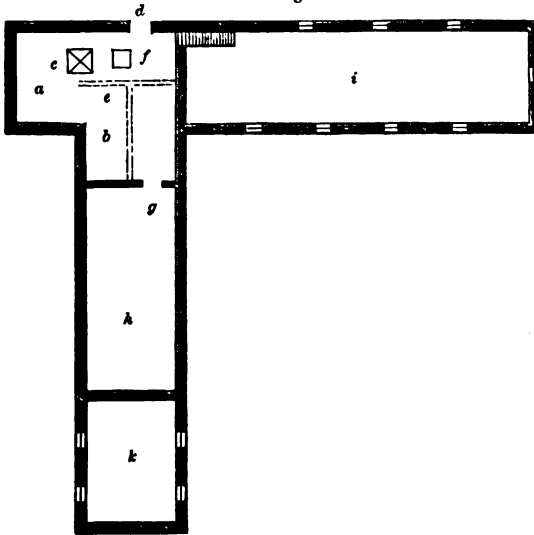

UPPER FLOOR OF A STEADING FOR A LARGE DAIRY.

containing the apartments as shown in fig. 9, where *a* is the upper barn immediately above the corn-barn and the steam-engine room; *b* the site of the thrashing-machine, with its gearing, drum, and shakers; *c* the beams of wood which support the thrashing-machine; *d* the door, 6 feet wide, leading to the stack-yard, from which the sheaves of the stacks are brought into the barn, either on wheelbarrows or on carts loaded at the stack, and then placed right under this door, to be forked into the barn; *e* the sky-light in the roof, to give light to the barn; *f* a hatch in the

floor, 3 feet by 3, to pass the roughs of grain from the corn-barn below, to be rethreshed where no elevators are appended to the mill; *g*, a bole, 4 feet by 3½,

communicating with the straw-barn for the purpose of forking up any straw that may require to be again passed through the mill; *h* is the straw-barn, and *i* the granary, 18 feet by 63, entered by a stair direct from the corn-barn, with four windows on one side and three on the other, and one in the gable; and *k* is the cheese-room, 18 feet by 24, with two windows on each side, and entered by a fixed trap-stair in the turnip-store below.

104. The scale of this plan is in the proportion of $\frac{2}{3}$ and $\frac{1}{3}$ of an inch to the foot. The scale of fig. 9 will be found in Plate IV.

105. The extreme length of this steading over walls is 304 feet, the length of the upper right wing is 138 feet, the length of the lower right wing is 101 feet, the length of the byre division is 121 feet; and the length of the left wing 149 feet. The width of all the apartments within walls is 18 feet.

106. The arrow shows the direction of north.

107. The farm-house and the hinds' and dairymaids' cottages should be near the steading.

108. *Small Dairy Farming.*—Small dairy farming, as well as the large, is practised at a distance from towns, and hence the small system may be regarded as an epitome of the larger one just described. It might therefore be concluded that a reduced scale of the larger steading described above would answer for the smaller system; but such a conclusion is not always a correct one as regards the arrangement of a steading. Many of the apartments of a small steading require to be as commodious as those of a large, while other apartments might be contracted; and hence, that both classes of apartments may bear the same relation to each other, it is necessary to modify somewhat their relative positions in steadings of different sizes.

109. For this reason, the plan of a small dairy steading, given at fig. 1, in Plate V., has a different arrangement from that of the large dairy farm in Plate IV. While the distinctive division of the arable from the dairy portion is preserved, the spare space between the wings is conveniently occupied with the necessary adjuncts of the dairy.

110. The centre is still devoted to the purposes of the straw, where *a* is the corn-barn, 18 feet by 24, with a door and window at the back in the stackyard, including the space appropriated to the thrashing-machine at *b*, and the chaff-house at *c*, 5 feet wide, with a window in front, and an internal door leading into the straw-barn *d*, 18 feet by 24, with a door in front and one at the back into the stackyard; *e* is the horse-course, 27 feet diameter, in which a two-horse power driving-gear is fixed.

111. In the right wing is *f*, the cart-horse stable, 18 feet by 18, for three stalls, and with a door and window in front; *g* cart-shed, 18 feet by 18, with two port-holes; *h* the riding-horse stable, 18 feet by 12, with a door and window in front, and furnished with two stalls; *i* is the gig-house, 18 feet by 9, with a wide door; *k* the implement-house, 18 feet by 10 feet 6 inches, with a door and window in front; *l*, an outhouse, 18 feet by 12, with a door and window in front; and *m*, a bull's hammel, 18 feet by 11, with a door and window in front.

112. In the centre and left wing, connected with the dairy, are the following apartments: *o* is the churning-room, 18 feet by 18, with a door and window in front; *q* is the food-store and cheese-press room, 18 feet by 12, with a window and door in front; *r* the milk-house, 18 feet by 25, with a door in front and two windows at the back, and furnished with stone shelving all round; *s* the byre for heifers, 18 feet by 24, with a door and window in front; *t t* the cow-byre or shippen, 18 feet by 56, having seven double-stalls, each 8 feet wide; and *u* is

the hen-house, 18 feet by 8, with a door at the back, a window in the gable, and a bole in front.

113. In the space between the wings are these apartments: *v* the hay-house for supplying hay to the stables and byres, 18 feet by 24, with a window, and with a door on each side; *w* the wash-house, 18 feet by 12, with a window and door, and boiler for cleansing the dairy utensils; *x* the boiling-house, 18 feet by 18, with a door on one side and a window on the other, and two boilers for preparing food for the cows, horses, and pigs; and *y y* are pigsties, 5 feet 6 inches by 5 feet each, with courts *z z z*, the central one being 5 feet 6 inches by 5 feet, and the two extreme ones each 6 feet by 5. These sties are covered with a lean-to roof against the gable of the adjoining boiling-house.

114. Gearing may be erected for driving a straw-cutter in the straw-barn *d*, and the churn in the churning-room *o*; and the gearing might be extended in front, under-ground, into the hay-house *v*, for driving a hay-cutter there.

115. The dotted lines show the structure of the building, and the position of the windows, doors, and chimneys.

116. The highest part of this steading is confined to the principal range, which is divided into an upper and lower floor. The upper one contains the apartments shown in fig. 10, where *a* is the upper barn immediately above

Fig. 10.

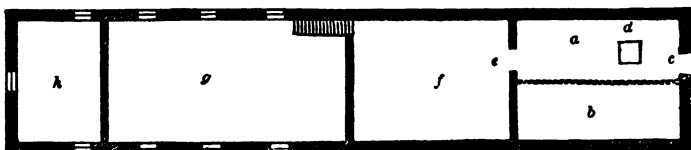

UPPER STOREY OF A STEADING FOR SMALL DAIRY FARMING.

the corn-barn; *b* the site of the thrashing-machine, with its gearing, drum, and shakers. It would be better to have the mill near the power, in which case the positions of the corn-barn *a*, in Plate V., fig. 1, and the mill *b* and chaff-house *c* should be reversed. *c* the door, 6 feet wide, for receiving the sheaves; *d* a hatch in the floor, 3 feet by 3, to pass the roughs of grain from the corn-barn below to be rethashed by the mill; *e* a bole, 4 feet by 3½, communicating with the straw-barn to allow any of the straw to be forked up to be again passed through the mill, if necessary; *f* the straw-barn; *g* the granary, 18 feet by 35, entered by a stair from the straw-barn, to which direct access is given by the back-door of the straw-barn from the corn-barn; and *h* is the cheese-room, 18 feet by 15, with a window on each side, and one in the gable, and entered by a stair from the cheese-press room below.

117. The scale of this plan is in the proportion of $\frac{3}{8}$ and $\frac{1}{8}$ of an inch to the foot. The scale of fig. 10 will be found at fig. 1, Plate V.

118. The extreme length of the central range over walls is 103 feet, that of the right and left wings 119 feet, and that of the intermediate range 71 feet. The width within walls of all the apartments is 18 feet.

119. The houses for the farmer and servants should be near.

120. The arrow points to the north.

121. DESCRIPTION OF A STEADING FOR SUBURBIAL FARMING.—The ground in the immediate vicinity of all towns is devoted to the cultivation of vegetables for the domestic use of their inhabitants. Around large towns this garden culture may extend for a mile or so, and beyond that distance commences what we have

denominated Suburbial Farming, the object of which is to supply those products to the inhabitants which are not afforded by the garden, such as straw, hay, turnips, forage, potatoes, milk, &c. Suburbial farming is therefore either entirely arable or entirely dairy, each of which requires a different arrangement.

122. *Suburbial Farming with Arable Culture.*—The plan of a steading applicable to a farm of this description is given at fig. 2, Plate V. It has its central portion occupied by the straw, and the right wing is devoted to arable culture, while the left is appropriated to domestic purposes. In the central range is the corn-barn *a*, 18 feet by 30, with a window in front, and a door and window at the back, in the stackyard. The barn includes the space for the thrashing-machine *b*, and the chaff-house *c*, 5 feet by 9, with a window in front, and an internal door leading into the straw-barn *d*, 18 feet by 40, with one door in the front, another on the opposite side leading into the cattle-court *u*, and a third into the space in front of the cow-byre *z*; *f* is the boiling-house, 18 feet by 20, with a door and window in front; *g* is the steam-engine room, 18 feet by 12, with a door and window in front, and a trap-door at the back entering at level of the top of the boiler, and leading by steps to the floor of the engine-room; *h* is the boiler-house, 20 feet by 7, with a door in front and a window at the end, and an internal door into the coal-store *i*, 20 feet by 4, having a window at the end. The chimney-stalk is seen rising 50 feet in height from the basement. The cart-shed *l*, 18 feet by 38, has four arched port-holes, with a door at the back at *k*, leading into the stackyard. At the inner end of the cart-shed are three open pig-sties, each 13 feet by 5 feet 3 inches, with a door to each.

123. In the right wing are the following apartments: *n* the cart-horse stable, 18 feet by 50, for eight stalls, with two doors and a window in front and a window at the end; *q* a hay-house, 18 feet by 9, with a door in front, and two internal doors, one leading to the cart-horse, the other to the riding-horse stable; *r* the riding-horse stable, 18 feet by 18, having three stalls and a door and window in front, and an internal door to the hay-house; and *s* the gig-house, 18 feet by 12, with a wide door in front.

124. In the centre and left wing are these apartments: *t* a shed for cattle under the principal range, 18 feet by 32, with an arched port 9 feet wide, and outside a courtyard *u*, 45 feet 9 inches by 26 feet, having a gate to the space outside, and a door to the straw-barn; *v* the hen-house, 18 feet by 13, with a door and window in front; *w* outhouse, 18 feet by 10, with a door and window in front; *x* implement-house, 18 feet by 17, with a door and window in front; *y* turnip-store, 18 feet by 18, with a door and window at the back; and *z* cow-byre, 18 feet by 31, with a door and window at the back.

125. The dotted lines show the structure of the buildings, the position of the doors and windows, and of the chimney-stalks.

126. The highest part of this steading is along the principal range and the south projection as far as the straw-barn, and the range is divided into two floors or storeys, the upper one containing the apartments as shown in fig. 11, where *a* is the upper or feeding-in barn, immediately above the corn-barn; *b* the site of the thrashing-machine, with gearing, drum, and shakers; *c* the beams of wood which support the thrashing-machine; *d* the door, 6 feet wide, leading to the stackyard, from which the sheaves are brought from the stack to the barn, either on wheel-barrows or on carts loaded at the stack, and then placed under this door to be forked into the barn; *f* sky-light in the roof over the head of the man that feeds the sheaves into the mill; *e* a hatch, 3½ feet by 3, in the floor, for passing the roughs of grain to be rethashed by the mill when no elevators are appended

to it; *g* a bole, 4 feet high by $3\frac{1}{2}$ feet wide, communicating with the straw-barn, for allowing any straw to be forked that requires to be again passed through the mill; *h* is the straw-barn; *k* one granary, 18 feet by 64, with four windows on each side, and entered by a stair direct from the corn-barn; *i* another granary,

Fig. 11.

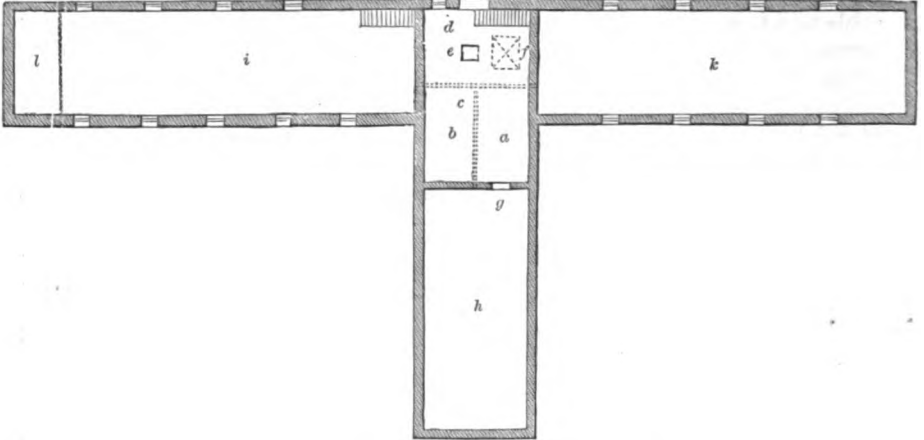

UPPER STORY OF A STEADING FOR SUBURBIAL FARMING WITH ARABLE CULTURE.

18 feet by 62, with five windows on one side and four on the other, and entered from the corn-barn by a stair through the engine-room; and *l* the pigeon-house, 18 feet by 6, entered by a trap-stair from the hen-house below.

127. The scale of this plan is in the proportion of nearly $\frac{3}{8}$ of an inch to the foot. The scale of fig. 11 will be found at fig. 2, Plate V.

128. The extreme length of the principal range over walls is 158 feet, that of the right and left wings 95 feet, that of the middle range 64 feet, and all apartments 18 feet in width within walls.

129. The farmhouse and servants' cottages should be near the steading.

130. The arrow points to the north.

131. *Suburbial Dairy Farming.*—In suburbial dairy farming the chief object is the production of new milk for immediate consumption in towns. For this purpose a large accommodation should be provided for cows, and for the preparation of their food. At the same time, there should be liberty to convert some of the milk into butter, and even into cheese. There must always be arable culture in connection with dairy husbandry, and in case the entire arable products should not be consumed on the farm, the surplus is sent to market. It will thus be easily understood that suburbial dairy farming should be conducted on a somewhat large scale, and that the size of the steading should bear an adequate proportion to the extent of the farming. The cows in a suburbial dairy being purchased, either calved or about to calve, in the weekly markets, no accommodation is required for the rearing of young stock; nor are hammels for bulls needed in such farming, as the cows are allowed to yield milk as long as they can, and are then disposed of to the butcher in fair condition.

132. The plan in Plate VI. affords the accommodation required in a steading for suburbial dairy farming, where the centre is occupied by the straw, and one wing is devoted to arable and the other to dairy operations.

133. In the central range is the corn barn *a*, 18 feet by 31, with a window in

front, and a door and window at the back in the stackyard; *b* is the space occupied by the thrashing-machine, and *c*, that by the chaff-house, 8 feet by 5, with its window in front, and an internal door leading to the straw-barn *d d*, 18 feet by 39, with a door on both sides near the thrashing-machine; *h* is the steam-engine room, 18 feet by 12, with a door and window in front, and a trap-door at the back leading into the boiler-house *i*, 24 feet by 7, having a door in front and a window at the end, and an internal door to the coal-store *k*, 24 feet by 5, with its window at the end. The chimney-stalk, 50 feet high, is seen to rise from its basement; *e* is the boiling-house, 18 feet by 18, with a door in front and window at the back, and two boilers in the corners; *f* is a large turnip-store, 18 feet by 23, with a door and window in front, and an internal door leading into the boiling-house *e*; *g* is the implement-house, 18 feet by 12, with a door in front and window at the back.

134. In the right wing are these apartments: *v v* the cart-shed, 18 feet by 29, with three arched port-holes and a door *v'* at the back leading to the stackyard; *w* the hen-house, 18 feet by 12, with a door and window in front, and a bole at the back; *x* the riding-horse stable, 18 feet by 18, of three stalls, with a door and window in front; *y* the gig-house, 18 feet by 12, with a wide door; *z* hay-house for horses, 18 feet by 9, with a door and window in front, and an internal door leading into the cart-horse stable; *a' a'* is the cart-horse stable, 18 feet by 30, of five stalls, with a door and two windows at the back, and an internal door to the hay-house, and another to the loose-box *b'*, 18 feet by 8; *c'* an out-house, 18 feet by 18, with a door and window at the back; *d'* killing-house, 18 feet by 10, with a door in front and a window at the back; and *e' e' e'* pigsties, 8 feet by 5 feet 6 inches each, with courts 8 feet by 5 feet 6 inches, provided each with a door.

135. In the dairy department of the steading are these apartments: *l* hay-cutting house, 18 feet by 18, with a door and window in front; *m* churn-house, 18 feet by 16, with a door and window in front; *n* wash-house for cleansing the dairy utensils in, 18 feet by 12, with a door and window in front, and a boiler at the back; *o* the cheese-press room and food-store, 18 feet by 18, with two windows at the back and an internal door to the wash-house; *q* milk-house, 18 feet by 18, with two windows in front and a door at the back, and furnished with stone shelves all round; *r* is a passage 6 feet wide; *s s* comprehends the cowbyre or shippen for 45 cows, being 76 feet in length and 54 in width; *u u* is a feeding passage 4 feet wide, and *u u* a feeding passage 6 feet wide; and *t t* a passage and dung-grupe on each side, 6 feet wide, and *t t* a passage and dung-grupe on one side, 4 feet wide. These feeding and dung passages are provided with a door at each end. The byre is lighted and ventilated from the roof.

136. The dotted lines indicate the construction of the different ranges, with their respective gables and chimney-stalks.

137. The highest part of this steading embraces the principal range and part of the central range, the principal being divided into an upper and lower floor or storey, which contain the apartments as shown in fig. 12, where *a* is the upper barn of the same dimensions, and immediately above the corn-barn; *b* the site of the thrashing-machine, with its gearing, drum, and shakers; *c* the beams of wood which support the thrashing-machine; *d* the door, 6 feet wide, into the stackyard, from which the sheaves are brought into the barn; *e e* boles in the outside walls for the admission of air to the sheaves when stored; *f* sky-light in the roof for light to the barn; *g* hatch in the floor, 3½ feet by 3, for passing the roughs of grain from the corn-barn below to be rethashed by the mill; *h* bole

4 feet by $3\frac{1}{2}$, opening into the straw-barn to return any straw that requires re-thrashing; *i* is the straw-barn; *k* one granary, 18 feet by 61, with four windows

Fig. 12.

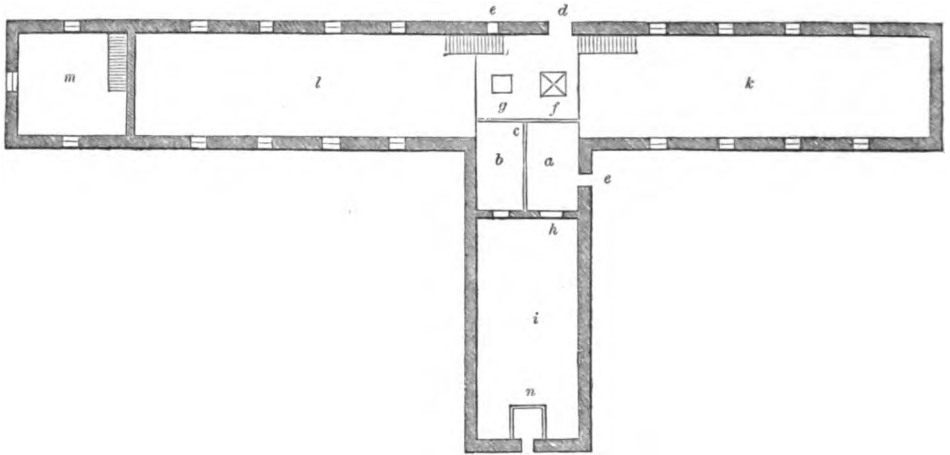

UPPER STOREY OF A STEADING FOR SUBURBIAL DAIRY FARMING.

on each side, and entering by a stair direct from the corn-barn; and *l* another granary, 18 feet by 59, with four windows on each side, and entered by a stair from the corn-barn through the engine-room; and *m* cheese-room, 18 feet by 18, with a window on each side and one in the gable, and entered by a stair from the food-store *o* below; *n* is the pigeon-house, 6 feet cube, in the straw-barn, where the pigeons will receive warmth from the adjoining boiling-house.

138. It is not a desirable arrangement to pass through the engine-room in going from the corn-barn to the granary *l*, and it may be avoided by making the stair to start from the floor of the corn-barn and to pass over the engine-room; but in doing so the communication between the engine-room and the boiler-house will have to be given up, unless a man-hole is left open between them.

139. The gig-house *y* could be removed to between the loose-box *b'* and out-house *c'*, so that the hay-house may be between the two stables, with an internal door to each.

140. If desired, power can be obtained from the steam-engine to drive a hay-cutter in the hay-house *l*, the churn in the churn-house *m*, and a straw-cutter in the straw-barn *d*, and even an oilcake-bruiser in the food-store *o*.

141. The scale of this plan is in the proportion of nearly $\frac{3}{8}$ of an inch to the foot. The scale of fig. 12 will be found in Plate VI.

142. The extreme length of the principal range over walls is 168 feet, that of the right wing 133 feet, that of the middle range 101 feet, and that of the left wing 127 feet. The width of all the ranges, with the exception of the cow-byre *s s*, is 18 feet within walls.

143. The farmhouse, as well as the cottages for the hinds and dairymaids, should be near the steading.

144. The arrow points to the north.

145. DESCRIPTION OF A STEADING FOR COMMON FARMING.—This we have denominated Common Farming because it is the most common system of farming

practised in the kingdom. It is practised on every variety of soil between the two extremes of pastoral and carse farming. Being removed from large towns it is not affected by their immediate and peculiar wants; and as it is not devoted to the breeding of stock, the arrangement of its steading is chiefly designed to preparing them for the butcher. It is essentially an arable system, although it may embrace a large extent of permanent pasture, as well as the raising of forage plants for the fattening of stock in summer.

146. This mode of farming requires a large accommodation for arable purposes and for stock, and the arrangement of the apartments for these two purposes should be kept distinct, to avoid confusion in conducting the business of the steading. This system may be prosecuted either on a large or small scale, but the arrangement of the apartments are similar in both.

147. In fig. 1, Plate VII., we have given a plan of a steading for Common farming on a large scale, in order to show the above requirements of the system in their fulness. In the centre of the principal range, as it should be, is the straw, to the right of which are the apartments for arable purposes, and to the left are those for live stock, and on either side of the straw-barn are the apartments for fattening the cattle in.

148. There are three accommodations for fattening cattle, namely, in hammels, in boxes, and in byres. All these three we have illustrated in the plan. Fig. 1 comprehends the feeding of cattle in hammels, which consist of small sheds with small open courts, in which cattle, few in number—two, three, or four together, according to their size and ages—are accommodated. The hammels are arranged in four divisions, two on one side of the straw-barn and two on the other. Supposing each hammel to contain two large oxen, 120 oxen could thus be fattened at the same time, and of course a proportionate larger number of smaller cattle. Fig. 2 represents the mode of feeding in boxes, which consist of pens large enough to hold one large ox or two small ones, all under a roof. The same number of cattle could be accommodated in a smaller space in boxes than in hammels. Sixty cattle can be contained in boxes in the space represented, as that number are in the two divisions of hammels on either side of the straw-barn. The third mode of feeding is in byres under a roof, as seen in fig. 3, in which the cattle are arranged in double stalls, and tied by the neck to a stake; and in the space represented, the same number, sixty, can be accommodated as in the boxes, fig. 2—so that byres take up the least room of the three modes of feeding.

149. In fig. 1, Plate VII., *a* is the corn-barn, 18 feet by 27 at one part, and 18 feet by 20 at another part, with a door and window in front and one window at the back; *b* is the space occupied by the thrashing-machine; and *c* that by the chaff-house, 9 feet by 5, with a window in front and an internal door leading into the straw-barn *d d*, 18 feet by 85, with two doors opposite at the thrashing-machine, and two opposite at the other end; *f* is the steam-engine room, 18 feet by 12, with a window in front and a door at the back; *g* the boiler-house, 20 feet by 8, with a door in front and window at the end, and an internal door to the coal-store *h*, 20 feet by 5, with a window at the end. The chimney-stalk, 50 feet high, is seen rising from its basement.

150. In the right wing is *i*, a passage, 4 feet wide, leading into the stack-yard; *k k* is a turnip-cutting-machine house, 18 feet by 50, with two doors and two windows in front, and a door at the back leading to the turnip-store *r r*, 58 feet by 4; *l* is a food-store, 18 feet by 24, with a door and window in front; *m m* is the work-horse stable, 18 feet by 72, having twelve stalls and a loose-box *n*, 18 feet by 8, with a door and two windows in front; *o* hay-house, 18 feet

by 23, with a door and window in front, and an internal door to the work-horse stable and to the riding-horse stable *p*, 18 feet by 18, with a door and window in front, and provided with three stalls; *q* is the gig-house, 18 feet by 12, with a wide door; *r* the horse boiler-house, 18 feet by 18, with a door and window at the back towards the work-horse stable; *s* the implement-house, 18 feet by 12, with a door and window in front; and *t t* is the cart-shed, 18 feet by 57, with six port-holes in front.

151. In the left wing are these apartments: *u u* a second turnip-cutting-machine house, 18 feet by 50, with two doors and two windows in front, and a door at the back leading to the turnip-store *h' h'*, 50 feet by 4; *v* another food-store, 18 feet by 24, with a door and window in front; *w w* the cow-byre or shippen, 18 by 40 feet, for eight stalls, with a door and window in front; and *x* the calf-house, 18 feet by 28, with a door in front and two windows at the back. Where only as many cows are kept as serve the farmer's family with milk and butter, and where no calves are brought up, the byres may be of a size to suit the number of cows, and the calf-house dispensed with altogether, and used for some other purpose; *y* the servants' cow-byre, 18 feet by 35, with a door and two windows in front, and furnished with eight stalls. Where the farmer does not breed any cattle, the servants dispose of their calves to other purchasers; *z* the hen-house, 18 feet by 18, with a door and window in front, and a bole at the back; *a'* a hatching-house for poultry, 18 feet by 9; *b'* an outhouse, 18 feet by 18, with a door and window in front; *c' c'* pig-sties, six in number, the sties 8 feet by 4 each, and their courts 10 feet by 4 each. The pig-sties may be extended as desired, or their space occupied for some other purpose, and they erected by themselves elsewhere; *d'* the guano and bone-dust store, 18 feet by 20, with a door and window in front; and *e'* another boiling-house, 18 feet by 18, with a door and window in front.

152. The hammels for containing the fattening cattle are at *f' f'*, *f' f'*, 12 feet by 10 in the sheds, and 14 feet by 10 in the courts *g' g'*, *g' g'*. There are two rows of hammels in each division, on both sides of the straw-barn, each row containing fifteen hammels. We have placed the hammels in the plan in preference to boxes and byres, because we believe they are the best kind of accommodation for cattle to be fattened in the most healthy and sound condition, though the most expensive in construction.

153. A tramway, 3 feet wide, starts from opposite each of the doors *m' m'*, of the food-stores *v* and *l*, and runs parallel to them and the cutting-machine rooms *u u* and *k k*; then turns at right angles and runs parallel to the straw-barn *d d*; turns again at right angles, and runs parallel to the walls of the courts *g' g'*, of the hammels, in the lines *l' l'* and *k' k'*; then passes up the side of the hammels, and along their back, to the door *m'* of the food-stores. The small arrows indicate the routes of the tramways to and from the food-stores. The food prepared in the cutting-rooms *u u* and *k k* is placed in trucks upon the tramway, and delivered to each hammel over the front walls *g' g'* of the courts, into the feeding-troughs inside.

154. Fig. 2, Plate VII., is an illustrative plan of cattle-boxes, which may be adopted where this method of feeding is preferred to hammels: *a a* is the central passage, 10 feet wide, for receiving the cattle and removing the dung from the central boxes; *b b*, *b b* passages, 5 feet wide, along which the food is delivered to each box on each side; *c c* are the boxes, 8 feet square, to hold one ox; *d* are the doors by which the dung is removed when desired. These boxes contain sixty cattle, the same as in a double row of hammels. The bottoms of

the boxes are usually dug 18 inches or 2 feet below the surface of the ground. Cattle-boxes are best lighted from the roof.

155. In fig. 3, Plate VII., is an illustrative plan of cattle-byres, when they are preferred for fattening cattle either to boxes or hammels: *a a* is the middle passage, 5 feet wide, with a dung-grupe on each side; *b b* and *c c* the feeding passages, 5 feet wide, and *d d*, *d d* the stalls affording accommodation to sixty cattle. These byres may be lighted either by windows in the outside walls, or by sky-lights in the roof.

156. Where the arrangement of byre-feeding is adopted, a place for the dung will be required, and this is provided for in the covered dung-stance *e e*, fig. 4, Plate VII., the dimensions of which are 18 feet by 50, and a door, 9 feet wide, at each end, for a cart to be backed through to remove the dung.

157. It may be both curious and interesting to state the space occupied by each ox respectively in hammels, boxes, and byres. The hammels give $191\frac{1}{2}$ square feet to each ox, the boxes $115\frac{1}{2}$ square feet, and the byres $106\frac{1}{2}$ square feet—so that hammels occupy $1\frac{3}{4}$ and boxes 10 per cent more of space than byres.

158. Power can be derived from the engine to drive turnip-cutters in the cutting-machine rooms *u* and *k*, and corn and oilcake bruisers in the food-stores *v* and *l*, as also a straw-cutter in the straw-barn *d*.

159. The dotted lines show the structure of the buildings and their roofs, and the positions of the doors and windows, and of the chimney-stalks, and specially of the engine-stalk rising 50 feet from its basement.

160. The highest part of this steading is a part of the principal range on each side of the thrashing-machine and the centre range, the principal range being divided into upper and lower storeys. In fig. 13 is the plan of the upper storey

Fig. 13.

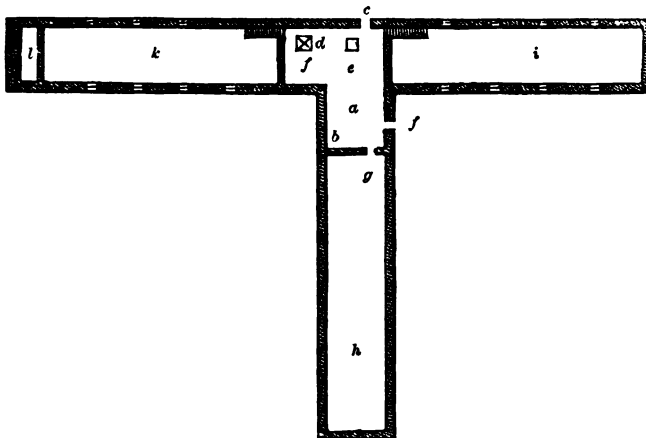

UPPER STOREY OF A STEADING FOR COMMON FARMING.

in both ranges, in which *a* is the upper barn, 18 feet by 30 in the widest part, and 18 feet by 20 in the narrowest, directly over the corn-barn and the engine-room; *b* the site of the thrashing-machine, with its drum, and shakers, and gearing; *c* the door, 6 feet wide, by which the sheaves of corn are brought from the stack-yard; *d* a sky-light in the roof for light to the barn; *e* a hatch in the floor, 3 feet by 3, through which the roughs may be handed up from the corn-barn below to

be again passed through the mill when there are no elevators; *f* bole to admit air to the sheaves when stowed in the barn; *g* an opening, 4 feet wide by $3\frac{1}{2}$ feet high, for permitting straw to be forked up from the straw-barn, when it is desired to be again passed through the mill; *h* the straw-barn; *i* a granary, 18 feet by 76, with four windows on each side, and entered by a stair from the corn-barn; *k* a granary, 18 feet by 72, with three windows to the north and four to the south, and entered by a stair from the corn-barn across the engine-room; and *l* the pigeon-house, partitioned from the granary *k*, 18 feet by 6, with a trap-stair from the food-store *v* below, and entered by the pigeons through the gable.

161. The scale of this plan is in the proportion of rather more than $1\frac{1}{4}$ eighth of an inch to the foot. The scale of fig. 13 will be found in Plate VII.

162. The extreme length of this plan of steading over walls of the principal range is 463 feet, that of the right wing 128 feet, that of the centre range 106 feet, and that of left wing 129 feet. The width of all these ranges is 18 feet within walls. The length of each row of hammels over walls is 174 feet, and width 33 feet. The length of the cattle-boxes, fig. 2, over walls is 125 feet, and width 57 feet. The length of the cattle-byre, fig. 3, over walls is 153 feet, and width 42 feet. The length of the dung-house, fig. 4, is 55 feet, and width 29 feet.

163. The hinds' houses should be near the steading, although the farmhouse may be at a little distance.

164. The arrow points to the north.

165. DESCRIPTION OF A STEADING FOR MIXED HUSBANDRY.—This mode of farming is named *Mixed*, because it establishes an intimate relation between arable culture and the breeding, rearing, and fattening all kinds of live stock. Regarding the treatment of stock as its principal object, it conducts the cultivation of the arable land entirely in subjection to it. It is the most satisfactory system of husbandry practised in the kingdom, inasmuch as the treatment of live stock from their birth to maturity not only insures the whole profit derivable from them, if any, to the breeder himself, who is best entitled to it, but it also insures a regular course of lenient cultivation to the land, because, where much green crop and pasture grass are obliged to be cultivated for the sake of stock, the land can never undergo a deteriorating course of cropping.

166. The *Mixed* husbandry cannot be conducted on a small scale. It is obvious, that where a large amount of food for stock throughout the year has to be raised, and the stock have to be maintained during the whole period of their lives, that both a large extent of ground must be cultivated, and a corresponding extent of accommodation afforded to the stock in the steading.

167. In fig. 1, Plate VIII., we have given such a plan of a steading for *Mixed* husbandry as is suitable to the exigencies of the case. In the centre, as it should be, is placed the straw. The right of the centre of the building is appropriated to arable operations, while the left is devoted to the breeding and rearing of stock. The young stock are placed at the left of the straw-barn, and the fattening at the right. The fattening stock are accommodated in hammels, while these may be substituted, if desired, by cattle-boxes, such as are shown in fig. 2, or by cattle-byres, as seen in fig. 3.

168. Such being the general features of the steading, we shall proceed to describe its constituent parts: *a* is the corn-barn, 18 feet by 15 in its narrowest, and 18 feet by 26 in its widest part, with a window and door in front, and a window at the back; *b* is the space occupied by the thrashing-

machine, and *c* that by the chaff-house, 9 feet by 5, with its window in front, and internal door leading to the straw-barn *d d*, 18 feet by 77, with two doors opposite at the thrashing-machine end, and two at the other end; *g* is the steam-engine room, 18 feet by 12, with a window in front and door at the back; *h* the boiler-house, 25 feet by 9, with a door in front and window at the end, and an internal door to the coal-store *i*, 25 feet by 5, with a window at the end.

169. To the right of the corn-barn is *k*, a passage, 5 feet wide, leading into the stackyard; *l* the gig-house, 18 feet by 12, with a wide door; *m* the riding-horse stable, 18 feet by 18, with a door and window in front, and provided with three stalls; *n* hay-house, 18 feet by 18, with a door and window in front, and an internal door to the riding-horse stable, and another to the work-horse stable *o o*, 18 feet by 72, with a door and two windows in front, and provided with twelve stalls, and a loose box *p*, 8 feet wide; *q* the boiling-house, 18 feet by 18, with a door and window in front, and provided with a boiler and furnace at the gable.

170. To the left of the corn-barn are these apartments: *r r* cattle-sheds, 18 feet by 25 each, with courtyards *s s*, one to the right, 38 feet by 30, having a door to the straw-barn, and the other to the left, 36 feet by 30, both with port-holes to the sheds and gates to the courtyards; *t* a turnip-store, 20 feet by 12; *u*, hen-house, 18 feet by 8, with a door and window in front, and a bole at the back; *v* the calf-house, 18 feet by 40, with a door in front and two windows at the back, and furnished with cribs for 25 calves; *w* calf-shed, 18 feet by 30, with a port-hole leading into the courtyard *x*, 30 feet by 20, with a gate; *y y* the cow-byre or shippen, 18 feet by 80, with a door and four windows in front, and an internal door leading into the calf-house, and another to the boiling-house, and provided with sixteen stalls; *z* boiling-house, 18 feet by 18, with a door and window in front, and an internal door to the foot-passage of the cow-byre, and another to the feeding passage at the head of the cows, and provided with boiler and furnace; and *a'* turnip-store, 18 feet by 18, with a door and window in front.

171. At the end of the straw-barn is the implement-house *e*, 18 feet by 18, with a door and window in front. To the left of the implement-house are 4 hammels *b' b' b' b'*, 12 feet by 10 each, with courts *c' c' c' c'*, 13 feet by 10 each, for bulls and young horses; *d'* a passage, 5 feet wide, for convenience; *e' e'* servants' cow-byre or shippen, 18 feet by 40, with a door and two windows in front; *f'* guano and bone-dust store, 18 feet by 30, with a wide door and window in front; *g'* outhouse, 18 feet by 18, with a door in front and window at the back; *h'* court for small pigs, 18 feet by 5; *i' i'* four sties for breeding sows, two 11 feet by 5, and two 11 feet by 8 each; *k'* three sties for feeding pigs, the sties 6 feet by 5, the courts 13 feet by 10 each: all these sties are under one roof, and have two doors and two windows in front; *l'* the hatching-house for poultry, 15 feet by 13; *m'* geese-house, 12 feet by 5; *n'* chicken-house, 9 feet by 9; *o'* turkey-house, 9 feet by 9; and *p'* a duck-house, 9 feet by 6: these poultry-houses are under one roof.

172. To the right of the straw-barn are the hammels for the fattening cattle, in two rows, and eight hammels in each row. With two oxen in each hammel, 32 can be fattened. The sheds *r' r'* are 12 feet by 10, and the courts *s' s'* 14 feet by 10.

173. To the right of the hammels are the cart-shed *t' t'*, with six port-holes, 16 feet by 48; *u' u'* turnip-stores, 18 feet by 16 each; and *v' v'* food-stores, 18 feet by 16 each, with a window and door to each turnip and food store; *w'* a dung-court, 40 feet by 16, and *x'* a liquid-manure tank, 16 feet by 6, sunk 6

feet. A covered dung-stance *g'*, 18 feet by 23, is placed near the cow-byre *y*, with two doors for putting in and taking out the dung.

174. In fig. 2, Plate VIII., is an illustrative plan, in which box-feeding is substituted for hammel-feeding. If boxes are substituted for hammels, the boxes would occupy the following position: The dotted line *c d* represents the right wall of the straw-barn *d d*. The boxes embraced between *e f h g* would occupy the same relative position to that dotted line *c d* as the hammels *r' s'* do at present to the straw-barn *d d*. Then the cart-shed *l' l'*, &c., would be placed in relation to the boxes as the dotted rectangle *a b* does to fig. 2. The length of space between *c e f a b* would be 16 feet less than that between the hammels and cart-shed *l'*. The boxes *k k, k k*, fig. 2, are 32 in number, each 8 feet by 8, to contain one ox; *i i, i i* are the feeding passages, 5 feet wide each, and *l l, l l* are the doors for the removal of the dung.

175. In fig. 3, Plate VIII., is given an illustrative plan of feeding in byres; and were they substituted for hammels, they would occupy the same position in relation to the cart-shed *l'*, &c., as they do to fig. 4. In the byre, *f g h i*, fig. 3, the feeding passage to the cattle in the stalls *m m* is *k k*, that to the cattle in the stalls *n* is *l l*. The dung passages and grupes, 5 feet wide, are along *p* and *l*. The stalls *m* and *n* will contain 60 oxen. In fig. 4 *a a* are turnip-stores, 18 feet by 18; *b b* food-stores, 18 feet by 18; *c c* cart-shed, 18 feet by 56; *d d* dung-stance, 18 feet by 50; and *e* liquid-manure tank, 18 feet by 6.

176. The dotted lines indicate the form of the roofs and structure of the buildings, with the positions of the windows and doors and chimneys, the stalk of the engine, 50 feet in height, resting upon its basement at the boiler-house *h*.

177. The highest part of this steading extends along the principal range from the thrashing-machine to the hay-house *n* on the right, and to *s*, the cattle-shed,

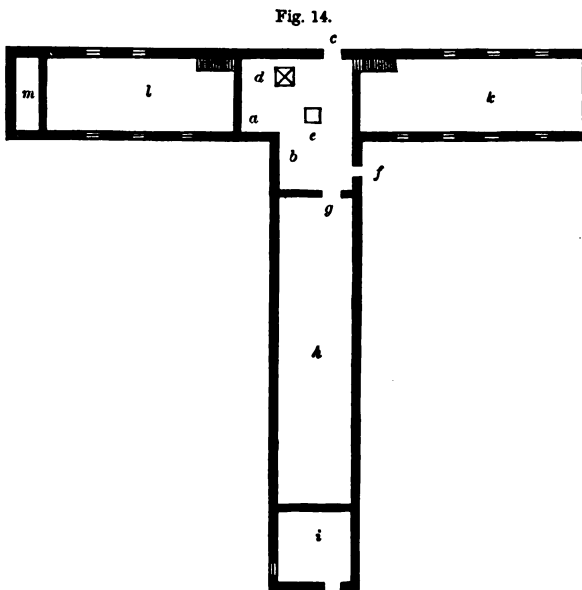

UPPER STOREY OF A STEADING FOR MIXED HUSBANDRY.

on the left, and along the whole of the central range, the principal range being divided into an upper and lower storey, as is also part of the central. Fig. 14 represents a plan of the upper storey in both ranges, where *a* is the upper barn, 18 feet by 38 in the widest, and 18 feet by 14 in the narrowest part, directly over the corn-barn and engine-room; *b* the site of the thrashing-machine; *c* door, 6 feet wide, for the admission of the sheaves of corn from the stackyard; *d* skylight; *e* hatch in the floor, 3 feet by 3, for

receiving roughs from the corn-barn below, where there are no elevators; *f* bole

for the admission of air to the sheaves when stowed up; *g* opening, 4 feet wide by $3\frac{1}{2}$ feet high, for allowing straw to be forked up from the straw-barn, when desired to pass it again through the mill; *h* the straw-barn; *i* wool-room, 18 feet by 18, with a window in each side, and an entrance-door by the gable, reached by an outside stone stair: *k* granary, 18 feet by 55, with three windows to the north and four to the south, and a stair direct from the corn-barn; *l* a granary, 18 feet by 47, with two windows to the north and three to the south, and a stair from the corn-barn across the engine-room; and *m* the pigeon-house, 18 feet by six, partitioned from the granary *l*, with a trap-stair from the cattle-shed *r* below, and an entrance for the pigeons through the gable at *c''*.

178. The scale of this plan is in the proportion of rather more than $\frac{3}{8}$ of an inch to the foot. The scale of fig. 14 will be found in Plate VIII.

179. The extreme length over walls of the principal range of this steading is 431 feet, that of the central range 104 feet, and that of the lower left range 218 feet. The width within walls of the principal range, the middle range, and the lower left range, is 18 feet. The length of the cart-shed *t*, &c., is 91 feet, and width 38 feet, over walls. The length over walls of each row of hammels is 91 feet, and width 32 feet. The length of the cattle-boxes over walls, in fig. 2, is 69 feet, and width 52 feet. The length of the cattle-byre over walls, in fig. 3, is 58 feet, and width 56 feet. The length of fig. 4 over walls is 100 feet, and width 42 feet. The length of the dung-stance *q'* over walls is 25 feet, the width 20 feet.

180. The servants' houses should be near the steading: the farmhouse may be at a little distance.

181. The arrow points to the north.

182. In Plate IX. is given an isometrical elevation of the steading just described, and although only in outline, it is a good representation of what the steading should appear to the eye. A shaded one would have given a more picturesque effect, but not more accurate. It will be observed that all the apartments occupied by the animals have their fronts presented to the sun's light, which is an essentially good feature in winter in any steading. The hammels, in this respect, bear a favourable comparison to either boxes or byres, in as far as the cheerfulness and health, and, in consequence, the well-being, of the animals inhabiting them are concerned. Not only the hammels, but the courts and sheds of the young cattle, the byres, the stables, and the accommodation for the minor animals, are as favourably situated as to sunlight; while those for the straw, the carts, and the manure, are placed in the shade, as they should be.

183. The isometrical elevation is a common and graphic mode of representing steadings; but the combination of the isometrical and the ground-plan, as given in Plate VIII., is a still more satisfactory method of representing such a building in a drawing. The names of the various apartments are marked as distinctly as in the ground-plan, while the horizontal section of the walls at three feet above the ground, gives such a reality to the form of each apartment, with its doors and windows, as at once to indicate its size and use; and the dotted lines above the sectioned walls afford a correct and distinct enough idea of the building as it should appear in a complete isometrical perspective. We would therefore recommend this combined method of representation for all plans of steadings, even for the working places for masons, as the most useful and satisfactory. And farther, this style of perspective affords equal facilities for taking measurements

from the ordinary scale, with ground-plans drawn in the usual way. This is the first instance that we are aware of in which this combined method of perspective and plan has been presented to the notice of the public.*

184. DESCRIPTION OF THE PLANS OF THE ROOFS OF THE STEADINGS DESCRIBED IN PLATES I. TO VIII.—As the roofs of buildings are an expensive item in their construction, it is desirable they should be made in the simplest form. This remark applies forcibly to the roofs of steadings, inasmuch as ornamental work is excusable in many cases in houses and cottages as a matter of taste; whereas in steadings, which are exclusively devoted to rough and common purposes, ornamental roofs seem unsuited to their use. It should therefore be the aim to give the roofs of steadings the simplest form consistent with strength and durability. Now, there cannot be a simpler form of roof than a long stretch, nor a more durable one than when the stretch terminates at both ends at a gable. There should therefore be nothing but stretches, and as few breaks in the roofs of steadings as possible.

185. Another point, as a principle, is, that at the turns of a roof, it is stronger for one stretch to terminate in a gable, and in the other to join the roof, than to make the turn in the form of a pavilion; because a pavilion is always made at a sacrifice of timber, and timber is more expensive than ordinary rubble masonry. A pavilion-roof is only excusable in a steading when the apartment is of extraordinary width; because were gables raised in a proportionate height to inordinate breadth they would seem incongruous and out of proportion to the rest of the building. Some apartments are better for being of great width, as an ox or cow byre in a large establishment, where many animals can be concentrated in a comparatively small space, and viewed and tended with ease and little expense. Now that trussed-roofs of iron are successfully used at railway-stations, pavilion-roofs may be dispensed with altogether, and a series of roofs running parallel with one another, in the form of "ridge and valley," substituted; but it must be remembered that such a form has the disadvantage of having as many rows of iron pillars in the interior of the apartment as there are rows of roofs.

186. An important consideration in the economical construction of the roofs of steadings is the making all the apartments of one width, because the same scantlings or couples will answer for all the apartments, whether in a two or one storeyed building; and when a small steading is pulled down for a larger, the old couples will answer for the new walls, or when an addition is built, the new piece joins in neatly with the old. When animals have to be attended to, ample room in the apartments is a great convenience. Experience has proved that a *less* width than 18 feet is too little for a stable, a cow-byre, a corn-barn, an upper barn, straw-barn, or a granary; and, as a consequence, that width should be adopted in all the working apartments of every steading, and we have adopted that width accordingly in all the steadings described above.

187. Turns in the roofs of steadings are necessary; for were the apartments of the wings placed in a line with the principal range, those in the two extremities of a large steading would be at too great a distance from each other for one cattleman to undertake all his duties. Instead of one very long stretch, which would certainly give the simplest form of roof, a turn at one or both ends

* Those unacquainted with the method of throwing ordinary plans into isometrical perspective, will find the subject fully treated of in a small work, price only two shillings, intitled *Isometrical Drawing*, by Robert Scott Burn, forming a part of "Chambers's Educational Course."

is necessary to concentrate the work within a space consistent with economy of labour. Hence, a principal range with wings is a desirable form of steading; but, as we have said above, the turns of the wings should be at gables, not as pavilions, for the sake of economy in construction. Besides, wings afford shelter, and, along with the principal range and the projection of the central one, screen the courts from the north, east, and west winds.

188. We have endeavoured to follow these principles in the construction of the roofs of the steadings treated of in the foregoing pages, and, in order to show their application, we have given, in Plate X., a plan of the roofs of each of the steadings described in Plates I. to VIII., and we shall now proceed to describe those roofs in detail.

189. Plate X., fig. 1, represents the roof-plan of a *cattle-shed* in a "Detached Pastoral Farm for rearing Cattle." The roof consists of a simple stretch from *a* to *b*, terminating at the gables *a* and *b*. The plan of the shed, of which this is the roof-plan, is given at fig. 1, Plate I.

190. Fig. 2 is the roof-plan of a *steading* for a "Detached Pastoral Farm for rearing Cattle," containing its various apartments. The roof also consists of a single stretch from *a* to *b*, terminating at the gables *a* and *b*. The plan of the steading, of which this is the roof-plan, is shown at fig. 2, Plate I.

191. Fig. 3 represents the roof-plan of a "Compact Pastoral Farm-Steading for rearing Cattle." The roof consists of a principal range *a b*, and two wings *a c* and *b d*, the principal terminating at the gables *a* and *b*, and the wings at the gables *c* and *d*. The wings join in level with the roof of the principal range, gutters being made in the line of junctions at *e* and *e*, to carry off rain-water. The plan of the steading, of which this is the roof-plan, is shown at fig. 3, Plate I.

192. Fig. 4 is a roof-plan for a "Pastoral Farm-Steading for rearing Cattle, with arable culture." Here the principal range *a b* is intercepted by the central one *c d*, which is two-storeyed, and containing the thrashing-machine and straw-barn. The parts of the principal range *a c* and *c b*, and the wings *a e* and *b f*, are on the same level, and are one-storeyed, and their junction is of the same form as at *a* and *b*, fig. 3. The roofs of the principal range *a c* and *c b* terminate in gables at *a* and *b*, but are let in at the other end in the walls of the central range *c d* by means of raglins at *g g*. The wings *a e* and *b f* terminate in gables at *e* and *f*, and the central range *c d* terminates in gables at *c* and *d*; *h* is the circular roof of the horse-course. The plan of the steading, of which this is the roof-plan, is shown at fig. 1, Plate II.

193. Fig. 5 is the roof-plan for a "Pastoral Farm-Steading for Sheep, with arable culture." This plan has the principal range *a b* in two storeys, and which elevates its ridge above the level of the wings *c* and *d*. The principal range terminates in gables at *a* and *b*, and the wings terminate in gables at *c* and *d*, and are at the other end let into the wall of the principal range by means of raglins at *e e*; *f* is the circular roof of the horse-course. The plan of the steading, of which this is the roof-plan, is shown at fig. 2, Plate II.

194. Fig. 6 represents the roof-plan for a "Carse Farm-Steading." The principal range *a b* is two-storeyed, and terminates in gables at *a* and *b*. The central range *c* is also two-storeyed, terminating in the gable at *c*, and on a level with the ridge of the principal range, having the rain-gutters at the corners *f f*. The wings *d* and *e* terminate in gables at *d* and *e*, and are let into the wall of the principal range by means of raglins at *g g*. The roof at *h* is a lean-to covering the boiler-house and coal-store. The plan of the steading, of which this is the roof-plan, is given in Plate III.

195. Fig. 7 is the roof-plan for a "Large Dairy Farm-Steading." The principal range *a b* is interrupted at *c*, from whence to *c b* it is two-storeyed, and the central range *e d* is also two-storeyed and on a level with *c b*. The principal range terminates in gables at *a*, *c*, and *b*, and the central range in a gable at *d*, and in the roof of *c b* at *e e*. The wing *b f* terminates at *f* in a gable, and at *g* is let into the wall of *c b* by means of a raglin. The wing *a h* terminates at *h* in a gable, and at *a* on the roof of *a c*, having the rain-gutters *i i*; *k k* is a wide pavilion-roof covering the cow-byre; *l* is a lean-to roof covering the boiler-house and coal-store; and *m* is also a lean-to roof against the gable *d*. The plan of the steading, of which this is the roof-plan, is given in Plate IV.

196. Fig. 8 is the roof-plan for a "Small Dairy Farm-Steading." The principal range *a b* is two-storeyed, and terminates in gables at *a* and *b*. The wings *a c* and *b d* terminate in gables at *c* and *d*, and are let into the wall of *a b* by means of raglins at *e* and *e*. The central and detached range *f* terminates in gables at *f* and *g*, and *h* is a lean-to roof against the gable *g*. The plan of the steading, of which this is the roof-plan, is given at fig. 1, Plate V.

197. Fig. 9 represents the roof-plan for a "Suburbial Farm-Steading, with arable culture." The principal range *a b* is two-storeyed, and terminates in gables at *a* and *b*. The central range *c* is also two-storeyed, terminating in a gable at *c*, and in the roof of *a b*, with the rain-gutters *d d*. The wings *a e* and *b f* terminate in gables at *e* and *f*, and are let in the wall of *a b* by means of raglins at *g* and *g*; *h* is a lean-to roof covering the boiler-house and coal-store. The plan of the steading, of which this is the roof-plan, is given at fig. 2, Plate V.

198. Fig. 10 represents the roof-plan for a "Suburbial Farm-Steading, with Dairy." The principal range *a b* is two-storeyed, and terminates in gables at *a* and *b*. The central range *e d* is also two-storeyed from *e* to *c*, terminating in a gable at *c*, and joining the roof of *a b* with the rain-gutters *e e*. The remainder of the central range from *c* to *d* is one-storeyed, terminating in the gable at *d*, and against the gable *c*, by means of a raglin. The wing *b g* terminates in the gable at *g*, and in the wall of *a b* by means of a raglin at *f*. The wing *h* terminates in a gable at *h*, and in the wall of *a b* by means of a raglin at *i*; *k* is a detached cow-byre, having ridge-and-valley roofs, terminating at each end in gables; *l* is a lean-to roof, covering the boiler-house and coal-store, and *m* is a lean-to roof against the gable *g*. The plan of the steading, of which this is the roof-plan, is given in Plate VI.

199. Fig. 11 represents the roof-plan for a "Common Farm-Steading." The principal range *a b* is two-storeyed from *c* to *d*, and so is the central range *f e*; *c d* terminates in a gable at *c* and *d*, and *f e* terminates in a gable at *e*, and in the roof of *c d*, with the rain-gutters *f f*. The one-storeyed part of *a b* terminates in a gable at *a* and *b*, and in the gables *c* and *d* by means of raglins. The right wing *h g* terminates in a gable at *g*, and joins the roof of *d b*, with the rain-gutters at *h*. The left wing *k i* terminates in a gable at *i*, and joins the roof of *a c*, with the rain-gutters at *k*; *l m n o* are hammels, having their respective roofs terminating in a gable at each end; *p* is feeding-boxes, having their roof terminating at each end in a gable; *q* is a feeding-byre, having its roof terminating at each end in a gable; and *r* is a dung-stance, having its roof terminating at each end in a gable; *s* is a lean-to roof covering the boiler-house and coal-store. The plan of this steading, of which this is the roof-plan, is given in Plate VII.

200. Fig. 12 represents the roof-plan of a steading for "Mixed husbandry."

The principal range $a b$ is two-storeyed from c to d , and so is the central range $f e$; $c d$ terminates in a gable at c and d , and $f e$ terminates in a gable at e , and in the roof of $c d$, with the rain-gutters at $f f$. The one-storeyed parts of $a b$ terminate in gables at a and b , and at gables c and d , let in by means of raglins. The roof of the hammels $g h$ terminates in a gable at g , and in the wall of the straw-barn by means of a raglin at h . The roof $i k$ terminates at both ends in gables at i and k . The roof $l m$ terminates at both ends in gables at l and m . In like manner, the roof $n o$ terminates in the gables at n and o ; the roof $p q$ in the gables at p and q ; the roof $r s$ in the gables r and s ; the roof $t u$ in the gables at t and u ; the roof of $v w$ in the gables at v and w ; and the roof of x in gables also; y is a lean-to roof covering the boiler-house and coal-store; and z is a lean-to roof as a calf-shed. The plan of this steading, of which this is a roof-plan, is given in Plate VIII., and an isometrical perspective of it in Plate IX.

201. These roof-plans are all drawn to a scale which is given in Plate X.

202. On viewing all the roof-plans in Plate X., it will be seen that the roofs consist of simple stretches of considerable length each, and where they are joined, the joinings are of the simplest form; and there is, besides, not a single break in all the roofs. The natural consequence is, that if made of good materials, put together in a proper manner, such roofs cannot be injured by the weather for a long time.

203. It will also be observed that the stretches of all the roofs terminate, at one end at least, in a gable, and not in a pavilion, nor do they project over the gable. The pavilion, as we have said before, involves a waste of timber; and a projecting roof over the gables, being made of wood, is subject to early decay by the effects of weather. The end of the roof, protected under a stone skew, is safe from the injuries of weather, and it has thus the advantage of being the most durable finishing to a roof. A projecting roof is more picturesque than a skewed one, and is suitable for a dwelling-house or cottage, where ornament is required; but ornament is no commendation in a steading; and that a skewed gable presents no unpleasant aspect, the useful appearance of a steading in the isometrical perspective of the one for Mixed husbandry, given in Plate IX., is a presumptive evidence. Crow steps are sometimes introduced in the gables of steadings as an ornament, but, besides the expense, they afford facilities for burglars to ascend and break into the roofs of buildings.

204. While speaking of roofs, we may express surprise that no proposal has hitherto been made to roof in a stackyard. The light and elegant trussed roofs at railway-stations have suggested the placing of cattle-courts under such a covering, to shelter the cattle from the weather, and thereby promote their warmth and comfort. Chemical physiologists insist on the necessity of having oxen, while feeding, under cover, in order to encourage and preserve in them that animal heat so essential to their growth and condition. Whether oxen moving about under a lofty roof in a courtyard will generate a greater degree of animal heat than under the usual circumstances in which they are placed, may admit of doubt; but, nevertheless, courtyards have been covered with that object, and the effects of such a covering on the animal economy must be left to the test of experience. But there can be no doubt that a stackyard under a roof would be in the best possible state for receiving the corn as it comes from the field. We know that a rick-cloth secures from rain the building of a haystack, however long the process may be prolonged. So a roof over a stackyard should secure the stacks under it from the injurious effects of unfavour-

able weather, and it should confer the additional benefit of entirely saving the thatching of stacks. The thatching of stacks, in first preparing the straw and making the ropes, and then executing the thatching, is attended with considerable labour and expenditure of time, while the thatch-straw, after being so used, bears little value as a constituent of manure. A covered stackyard would admit of the stacks being built in any form or size; and it would afford great facilities and comfort to the work-people in taking in stacks to be thrashed in bad weather in winter. Believing that such a structure would be a great convenience, we have given illustrations of one that might be constructed on any farm; one illustration consisting of an isometrical perspective of ridge-and-valley roofs over a stackyard; and another, a ground-plan of a stackyard, with the stacks in it so arranged as to be in conformity with those roofs over it.

205. Fig. 15 represents an isometrical perspective of a covered stackyard,

Fig. 15.

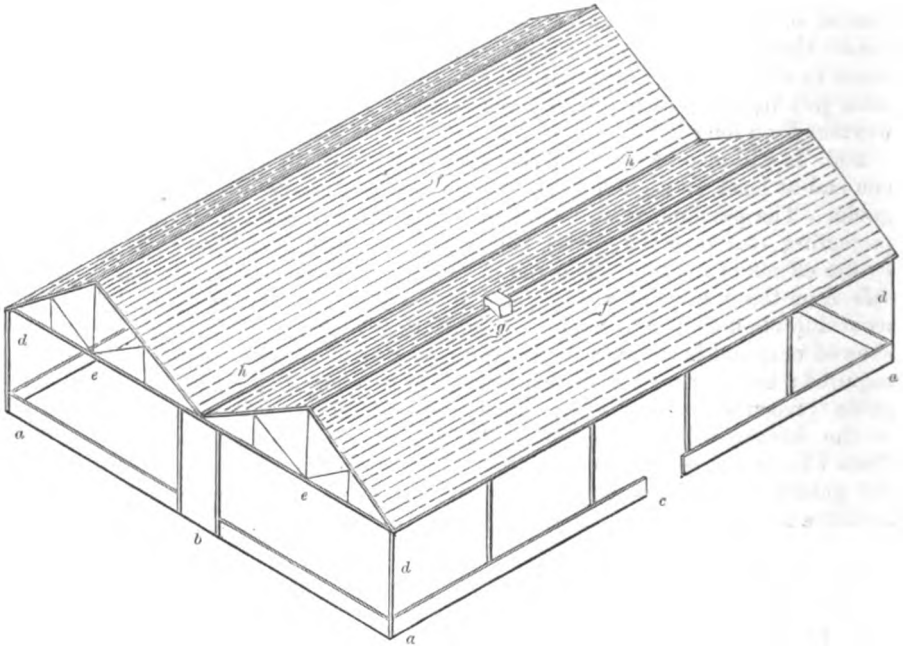

ISOMETRICAL PERSPECTIVE OF A COVERED STACKYARD

where *a a a* is the wall, $3\frac{1}{2}$ feet in height, surrounding the stackyard; *b* a cart entrance into the stackyard, which should admit a loaded cart or waggon of corn, say 32 feet in height and 12 in width; *c* the outlet from the stackyard to the upper barn, whether by means of a cart, or by wheelbarrows along a gangway; *d d d* cast-iron hollow pillars, 32 feet in height; *e e* iron bracings supporting the roof; *f f* the roof of corrugated iron; *g* a vent upon the ridge of the roof, which can be multiplied to any number thought requisite to admit the air through them upwards to prevent the roof being carried up by the wind; but as the supports of the roof are quite open all round the stackyard, and the roofing is well secured to the supports, such a precaution is not deemed necessary; and *h h* is the valley of the roof, along which the rain-water runs and descends through the cast-iron hollow pillars into drains

formed under-ground to carry it off. No stacks are given in perspective under the roof, but their effect in perspective may be seen in Plate I. of Stephens' *Book of the Farm*.

206. The ground-plan of the stackyard, of which fig. 15 is the roof, is given in fig. 16, where *a a a a* is the stackyard wall; *b b* the cart entrances into the stackyard; *c* the gangway from the stackyard to the upper barn, and it may be roofed over; *d d d d* the cast-iron hollow pillars which support the roof along the sides and in the centre of the stackyard at 22 feet apart, and along the ends at 45 feet apart; *e e e e* the hollow cast-iron pillars under each valley, which, while supporting, act as roans for carrying off rain-water from the roof into the underground drains. The space covered by the roof in fig. 15 embraces only half the ground-plan in fig. 16, from *a* to *d*, including two ridges of the ridge-

Fig. 16.

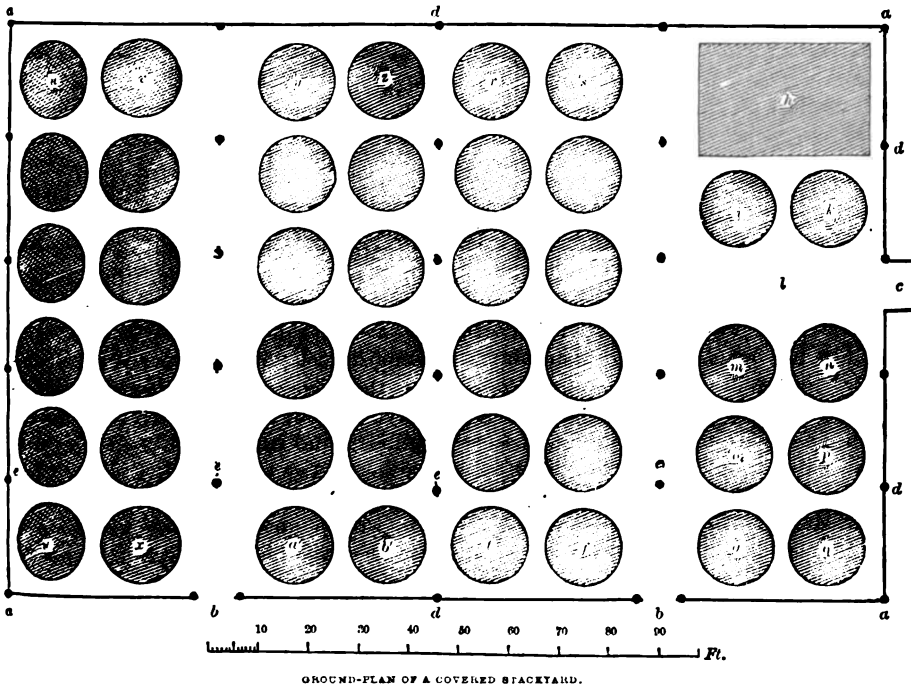

GROUND-PLAN OF A COVERED STACKYARD.

and-valley. The entire space included in the ground-plan, fig. 16, is 178 feet by 142.

207. The stacks *f* or *g* are 15 feet in diameter, and stand 3 feet from the fence-wall, and as much apart from each other, while the distance betwixt the stacks *f* and *g* is 15 feet.

208. The mode of placing the stacks at the time of carrying them is this: The loaded cart enters into the stackyard by the gate *b*, figs. 15 and 16, and in clearing the gate it is taken up the space between *e* and *d*, which is 45 feet in width, until it reaches the farther end of the stackyard, where two stacks may be built of the circular form, or one in the rectangular, as shown at *h*. The two next stacks built, are first *k* and then *i*. A space equal to that occupied by two stacks is left open at *l* for a passage to the gangway *c*. The next two stacks built are *n* and then *m*, and then first *p* and then *o*. When the

work has proceeded thus far, the cart must be differently placed to the building of *g* and *q*. When the cart enters the gate *b*, the cart is backed first as far as *q*, until it is built, and then to *g*. In like manner the stacks from *r* and *s* to *t* and *f* are built, and then that division of the stackyard is finished. The other division of the stackyard is filled with the stacks in the same manner, by entering into the other gate *b*, and first building the stacks from *u* and *v* to *w* and *x*, or from *z y* to *b' a'*, as desired or is convenient.

209. The stacks covered by the two roofs of fig. 15, number twenty-two, of 15 feet diameter; the other half of the stackyard contains twenty-four stacks. The ground-plan of the stackyard in fig. 16 is expansive, for it may be extended to any length beyond *h*, and to any breadth beyond *w x*.

210. Farmers usually adopt a method of arranging the stacks in the stackyard according to the kind of grain. Barley being in demand by the brewers and distillers immediately after harvest, the stacks containing that grain are built nearest the steading at *h* to *g q*. Wheat being generally unfit for the miller until spring, the stacks are built at the farthest side of the stackyard from *u v* to *w x* and *y z*. Oats are built anywhere in the interior, as that grain is used at all times. Beans and pease being the last of being ready, fill up the interior, or are built outside the stackyard.

211. We have thus described every variety of steading applicable to the various kinds of farming practised in this country, on the principles laid down by us at the first; and we feel assured that, where each modification of form is examined and criticised in relation to the kind of farming in which it is intended to be used, it will be allowed, we are confident, that it possesses such a compactness and convenience in the arrangement of its different apartments, as to allow the business to be done in it in the most economical way. Where compactness—not closeness, but at hand, and at the same time with plenty of elbow-room—and convenience of arrangement are combined, one man will perform the duties of cattleman with greater ease to himself and better results in his work, than two where these requisites are wanting. Any one knowing the work to be done in a steading in winter, and looking at the most complicated forms of steadings, given in Plates VII. and VIII., will at once say that compactness and convenience of arrangement for work are combined in these; while the isometrical perspective of the ground-plan in Plate VIII., given in Plate IX., exhibits the elevation of a building which, in its proportions and constituent parts, is at least pleasing to the eye as a picture. It would have been easy to have heightened the effect by shading, but we have preferred showing the effect in the simplest form. We do not think that more ornament should be attempted to give effect to a steading which, be it remembered, is a building intended more for use than ornament—more for economy in use than expense in construction.

DIVISION SECOND—PLANS OF EXISTING STEADINGS.

212. Having thus minutely described a series of farm-steadings, which are based upon the principles we have propounded, and which, in our judgment, are eminently suited to the purposes for which they are respectively intended, we shall now describe, with similar minuteness, plans of a number of existing steadings, both in England and Scotland, which have been recently erected, and which have the character of possessing conveniences suggested by the im-

proved ideas of recent experience. We shall not fail to criticise them on the principles we have laid down, and as little fail to commend them when they can bear that ordeal.

213. DESCRIPTION OF A STEADING AT SOUTHILL PARK, *Bracknell, Surrey*, belonging to Sir W. G. Hayter, Bart., M.P., and planned by Mr John Dougall, farm-bailiff. Plate XI. contains a ground-plan of this steading, wherein *a* is the corn-barn, 30 feet by 19, with a door, and an interior one to the straw-barn; *b* the boiler-house, 22 feet 6 inches by 11 feet, with opposite doors, one to *c*, steam-engine house, 10 feet 6 inches by 7 feet—the other to the sawing-house, *c' c'*, 14 feet by 55; *d d* the straw-barn, 43 feet 9 inches by 17 feet 6 inches, with a door, and internal ones to the corn-barn and piggeries; *e* house for cut litter, 17 feet 6 inches by 8 feet 6 inches, with a door; *f* house for cut chaff, 17 feet 6 inches by 7 feet 6 inches, with a door; *g* wash-house for roots, 17 feet 6 inches by 11 feet, with a door; *h* pigs'-food store, 13 feet by 10, with a door and window; *i* fuel-house, 13 feet by 5, with a door; *k* boiling-house with three boilers, 16 feet by 8; *l l* piggeries, nine in number, in three divisions, each division 11 feet 3 inches by 10 feet 9 inches, entering from two covered yards *m m*, each 34 feet by 26, with wide doors; *n* hay-house, 11 feet by 11; *o* straw-house, 23 feet by 11; *p p* work-horse stable, 73 feet 6 inches by 19 feet, with ten stalls, each 6 feet wide, with three doors and four windows; *q q* cow-byre or shippen, 78 feet 6 inches by 19 feet, with eight stalls, 8 feet wide, for two cows each, with three doors and three windows; *d'* riding-horse stable, 19 feet by 13, of three stalls, with two doors and a window; *r* poultry-house, 18 feet by 19, with two boles and a door; *s* killing-house, 14 feet 9 inches by 9 feet 6 inches, with a door; *t* tool-house, 14 feet 9 inches by 9 feet 6 inches, with a door; *u* mess-room for men, 14 feet 9 inches by 10 feet, with a door, and window, and fireplace; *v v* calf-house, 41 feet 9 inches by 14 feet 9 inches, with seven stalls, with a door and two windows; *w* root-house, 20 feet 6 inches by 14 feet 9 inches, with a door and window; *x x* young cattle shed, 44 feet 6 inches by 32 feet, with a gate, and doors into the root-house and straw-house; *y y* straw-house, 45 feet by 14 feet 9 inches, with doors to the cattle-shed and feeding-boxes; *z z* cattle feeding-boxes, seven in number, 10 feet by 10 each, with doors to the straw-house, root-house, and each box; *a' a'* root-house, 22 feet by 14 feet 9 inches, with a door, and an internal one to the boxes *z*; *b'* is a liquid-manure tank, from which, by means of a portable pump, the dung in the covered yards *m* can be watered; the tank *c'*, away from the steading, is for the surplus liquid-manure. The double-dotted lines indicate the lines of urine-drains. This steading is adapted to Common farming.

214. It will be observed, in the disposition of the various apartments in the above steading, that the straw-barn is not placed in the centre of the premises, so as the principal live stock might encircle themselves around it. On the contrary, it is placed at a corner of the buildings; and instead of the cattle and horses, which require most straw, having their houses situated nearest it, the pigs have that advantage bestowed upon them which require the least straw. That the straw-barn is felt to be inconveniently placed, as regards the stock, is evinced from the fact that additional straw-houses are obliged to be provided at *o* and *y*, in order that the horses and the cattle, both young and fattening, may be supplied with straw near at hand, thus occasioning unnecessary labour in carrying it from the thrashing-machine while in motion, or from the straw-barn afterwards to their several receptacles. The width of the ranges of the buildings also differ, one width being 19 feet and another 14 feet 9 inches.

215. The scale of the plan in Plate XI. is in the proportion of $\frac{2}{3}$ and $\frac{2}{3}$ of an inch to the foot.

216. The extreme length of this steading over walls is 168 feet, and the extreme width 151 feet.

217. DESCRIPTION OF A STEADING AT DRUMKILBO, in *Forfarshire*, belonging to Lord Wharnccliffe.—This is quite a new steading, adapted to Common farming, being removed at a distance from a town. It consists of a principal range and two wings, the space between the wings being also occupied by buildings. Plate XII. presents a ground-plan and sections of certain lines of the steading, where, in the principal range, fig 1, are these apartments: *a a* the corn-barn, 34 feet 6 inches by 11 feet 9 inches, with a door and two windows, and an internal door to the cart-shed leading to the door of the chaff-house *b b*, 34 feet 6 inches by 7 feet 6 inches, with an internal door at the other end in the passage *e*; *c* is a stair from the corn-barn to the upper barn above in the second floor; *d d* the horse-walk for the thrashing-machine, 33 feet diameter, with five port-holes; *e* a passage, 7 feet 6 inches, leading into the stackyard behind; *f f* the straw-barn, 53 feet by 22 feet, having the two doors of the passage *e* for its doors on opposite sides, with six boles in the outside walls; *g* a loose-box, 12 feet by 22, with a wide door, and an internal one to the turnip-store, and a sky-light in the roof; *h* turnip-shed, 15 feet by 22, with a wide door, and an internal door to the loose-box, and another to the feeding-byre; *i i* feeding-byre for cattle, 35 feet by 22, of five double-stalls for ten cattle, with a feeding-passage to the turnip-shed, and a door and one window in front, one at the end, and two at the back. On the other side of the corn-barn is the cart-shed *d' d'*, 60 feet by 22, with four port-holes, and a door at the back leading to the stackyard.

218. In the right wing are these apartments: *k k* feeding-byre for cattle, 43 feet by 17, six double-stalls for twelve cattle, with a feeding-passage at the head from the turnip-shed *l*, and a door and two windows in front, and two windows at the back; *l l* a turnip-shed, 20 feet by 17, with a door, and an internal one to each of two feeding-byres; *m m* feeding-byre for cattle, of five double-stalls for ten cattle, with a feeding-passage along their heads, and a door and two windows in front, and two windows at the back; *n* loose-box, 17 feet by 12, with a wide door in front, and an internal one to the feeding-byre *m*; *o* hen-house, 17 feet by 11 feet 6 inches, with a door in front and a window in the gable.

219. In the left wing are these apartments: *e'* workshop, 17 feet by 11, with a wide door in front; *f'* potato-store, 17 feet by 17 feet 4 inches, with a door in front and a window at the back; *g'* implement-house, 17 feet by 10, with a wide door in front and a window at the back; *h'* boiling-house, 17 feet by 12, with a wide door in front; *i'* giral or meal-house, 17 feet by 10, with a door in front and a window at the back; *k'* gig-house, 17 feet by 10, with a wide door in front; *l'* harness-room, 17 feet by 21, with a door in front and a window at the back; *m'* bothy for the ploughmen, 17 feet by 9 feet 6 inches, with a door in front, and a sleeping apartment off it *n'*, 17 feet by 8 feet 6 inches, with a window in the gable; *o'* coal-house, 6 feet 6 inches by 6 feet 6 inches.

220. In the space on the right between the two wings is accommodation afforded to cattle, where *p p* are two courts for cattle, each 25 feet by 20, with gates in front; *q q* two cattle-sheds, each 25 feet by 18, with a door in front,

connected with the two sheds; *r* liquid-manure tank, 15 feet by 6, and 4 feet 6 inches deep; *s s* two cattle-courts, 45 feet by 25, with two open sheds *t t*, 8 feet wide each, and with gates in front; *u u* feeding-troughs in these sheds, and a passage *v v*, 3 feet 6 inches wide between the troughs; *w w* two cattle-sheds, each 34 feet by 17; *x x* turnip-shed, 23 feet by 17, with a wide door in front, and an opening behind leading into the passage *v*, to the turnip-troughs *u*; *y y* water-troughs under the sheds for the cattle; and *z* a privy, with a door in front.

221. Between these buildings and the left wing is accommodation afforded to horses, where *a' a'* is the riding-horse stable, 22 feet by 18, provided with four stalls, and a door and window in front, and a window in the gable; *q'* guano-shed, 18 feet by 13 feet 6 inches, with a wide door in front; *p' p'* work-horse stable, 18 feet by 64, of ten stalls, with two doors and three windows in front, and a door at the back; *b'* is a water-trough, and *c'* a pump-well.

222. The principal range, including the corn-barn, cart-shed, and straw-barn, is two-storeyed. The granary, 60 feet by 22, extending over the cart-shed, and entered from the upper barn, has five windows on each side. In the upper barn is a 6-feet wide door, for the admission of the sheaves of corn from the stack, when forked from a cart placed under the door. A sky-light is on the roof to give light to the upper barn, immediately above the head of the man who feeds in the sheaves to the thrashing-mill. The site of the thrashing-machine is such as to allow the mill to throw the straw into the straw-barn, over the passage *e*. A sky-light on the roof of the straw-barn gives light at the place where the straw is received from the mill.

223. In Plate XII., besides the ground-plan, fig. 1, are elevations and sections in given lines of the steading just described.

224. Fig. 2 gives the south elevation of the steading, presenting the gables of the bothy, the riding stable, turnip-shed, and hen-house, with the gateways leading into the interior of the steading.

225. Fig. 3 is the north elevation, giving the back of the cart-shed and the granary windows above, the horse-course, and the back of the upper barn and straw-barn, with its boles, in two storeys, and in one storey extending to the right, including the back of the loose-box *g*, turnip-shed *h*, and feeding-byre *i*.

226. Fig. 4 is a section in the horizontal dotted line of *a b* in fig. 1, comprehending the section of the gig-house *k'*, work-horse stable *p'*, with its stall and water-tank *b'*, privy *z*, cattle-shed *t*, with its feeding-troughs *u* and passage *v*, liquid manure-tank *r*, and feeding-byre *m*, with its stall and feeding-passage.

227. Fig. 5 is a section of the perpendicular dotted line *c d* in fig. 1, comprehending the section of the cattle-sheds *q* and *w*, of one storey, and of the straw-barn *f*, of two storeys.

228. Fig. 6 is a section in the perpendicular dotted line of *e f* in fig. 1, embracing the section of the corn and upper barns, in two storeys, and of the horse-walk of the thrashing-machine.

229. The extreme length of this steading over walls is 219 feet, and extreme width 143 feet, of the principal range and wings. The length of the cattle-court buildings over walls is 103 feet, and width 77 feet. The length of the stable division over walls is 104 feet, and width 21 feet.

230. The width of the apartments within walls varies. The width of the principal two-storey range is 23 feet, that of the stables 18 feet, and that of the sheds, byres, and other apartments, 17 feet.

231. The scale of the ground-plan, fig. 1, is nearly $\frac{3}{4}$ of an inch to the foot.

232. The lines of urine-drains are distinctly marked by double lines traversing fig. 1, Plate XII., in different directions.

233. The arrow points to the north.

234. It will be observed that the design of this steading is to have a principal range in the north, with two wings towards the south. The straw-barn is within the line of the principal range, and not placed as a projection into the centre of the premises, in accordance with our principles. Nevertheless, it is conveniently placed in regard to most of the stables, cattle-courts, and feeding-byres, although at a considerable distance from the farthest end of them, for a steading of its limited dimensions. The system of feeding cattle here adopted is partly in byres, and partly in sheds and courts, these last containing each more cattle than in a hammel. The width of the different ranges of the buildings is 23, 18, and 17 feet, thereby discarding the convenience of a similarity of roof, and a unity of timber. Pavilions are also introduced instead of gables, thereby incurring waste of timber in construction. Upon the whole, this is a compact steading, having the straw convenient enough, though not so central as it might have been; the right-hand half of the buildings is devoted to the feeding of cattle—the horses are all together, and away from the cattle; the left wing is appropriated to miscellaneous purposes. The obvious objections to the arrangements are the want of a separate byre for the milk-cows of the farmer's family; two loose-boxes *g* and *n*, one being enough in so small a steading, the carpenter's shop *e'*, and the bothy *m'* of the ploughmen being in the steading, which they should never be, and are more convenient and safe from fire in detached cottages.

235. DESCRIPTION OF A STEADING ON THE ESTATE OF MORPHIE, *Kincardineshire*, belonging to Barron Graham, Esq.—This steading may be seen in ground-plan and front-elevation in Plate XIII., where *a* is the corn-barn, 45 feet by 20, with a door and window in front; *b* the space for the thrashing-machine; *c* chaff-house, 20 feet by 12, with a door in front; *d d* the straw-barn, 76 feet by 18, with a door into the corn-barn, three doors towards the feeding-byres, and one into the hay-house; *e* steam-engine room, 8 feet by 11, with a door in front and another into the corn-barn; *f* the boiler-house, 30 feet by 11, with a wide door in front; *g* granaries, projecting backwards from the corn-barn, in two storeys, each 45 feet by 20, with a door and two windows in front; *h h* feeding-byre for cattle, 92 feet by 37, with twenty-four double-stalls of 7 feet, for two oxen, each standing in two rows, head to head, with a feeding-passage between of 7 feet in width; *i* a cattle-shed, 18 feet by 39 feet 6 inches, which may be fitted up as boxes, with an 8-foot door in front, and two internal ones leading to a passage; *k* another such cattle-shed, 36 feet by 25, with an 8-foot door in front and two internal ones leading into a passage on each side; *l* a third similar cattle-shed, 18 feet by 39 feet 6 inches, with an 8-foot door in front, and two internal ones leading to a passage; *m* a turnip-shed, 18 feet by 25, with a door in front and an internal one to the feeding-byre *h*; *n* cow-byre, 18 feet by 14 feet 6 inches, provided with three double stalls, for two cows each, and a door in front, and an internal one to the feeding-byre *h*; *o* calves' byre, 18 feet by 22 feet six inches, with a door in front, and an internal one to the feeding-byre *h*; *p* infirmary, 18 feet by 14 feet 6 inches, with a door in front; *q q* cart-horse stable, 18 feet by 75, provided with twelve stalls, with two doors, one at each end to the front, and a wide passage into the feeding-byre *h*; *r* two loose-boxes, 10 feet by 10 each; and *s s* two loose-boxes, 10 feet by 15 each;

t riding-horse stable, 18 feet by 18, furnished with three stalls: the riding-horse stable and all the loose-boxes are within the work-horse stable; *u* gig-house, 18 feet by 10, with a 7-foot door; *v* hay-house, 18 feet by 15, with a 9-foot door in front, and an internal one leading into the straw-barn, and another into the feeding-byre *h*; *w w w* cart-sheds, one 18 feet by 27, with three 8-foot port-holes; another, 18 feet by 16, with two 8-foot port-holes; and a third, 18 feet by 9, with one 8-foot port-hole, which last may be a loose-box if desired, having an internal door into the adjoining cart-shed, and another into the tool-house; *x* tool-house, 18 feet by 22 feet 6 inches, with a door in front; *y* cattle-shed, or court, 42 feet by 36 feet 6 inches; *z* a turnip-shed, 11 feet by 14, with an 8-foot door in front, and an internal one to the cattle-court *y*; *a'* pig-sty, 11 feet by 11, with a door in front; *b'* poultry-house, 18 feet by 15, with a door in front; *c'* guano-house, 11 feet by 10, with a door in front; *d'* carpenter's shop, 18 feet by 10, with a door in front; *e'* boiling-house, 11 feet by 11, with a door in front, and boiler and furnace at a back corner; *f'* potato-house, 9 feet by 11, with a door in front; *g'* privy, in the corner of the cattle-court *y*, with a door from a cart-shed; *h'* the water-cistern for the steam-boiler.

236. The extreme length of this steading over walls is 220 feet and width 79 feet. The length of the projection backwards is 93 feet by 23.

237. The steading is entirely under cover, divided into three ranges, the central being 37 feet in width, flanked on each side by a range of 18 feet in width, within walls. The ranges terminate in gables at each end, as seen by the front elevation in Plate XIII. The projection is two storeys, with the upper barn above the corn-barn, and one granary, above the other, is roofed in by itself. The boiler-house, engine-room, and boiling and potato houses are roofed in by themselves, and so is the chaff-house. The front of the calves' byre *o* is elevated into a gable for ornament, and there the pigeon-house may be situated.

238. The scale of this ground-plan is in the proportion of a little more than $\frac{3}{4}$ of an inch to the foot.

239. It will be observed, in the arrangement of the apartments of this steading, that the straw-barn is quite at hand to the feeding-byre *h*, and convenient for the stables, and loose-boxes, and cattle-sheds *i k l*. The cattle-sheds at *y* are a little out of the way of the straw-barn. It is a good idea to place the granaries in two floors, and to project them into the stackyard, but in that case a door will be required on each side of the upper barn to receive the sheaves from either side of the stackyard. The want of a high range east and west along the north side, to screen the buildings from the north wind, is not felt in this case, where all the apartments are under cover.

240. Still there are some inconveniences in the arrangement. The feeding-byre *h* is made a thoroughfare for the straw from the barn *d*. The cattle-sheds *i, k, l*, and *y*, the stables *q* and *t*, the loose-boxes *r* and *s*, the cow and calves' byres *n* and *o*, cannot be reached from the straw-barn but through the feeding-byre *h*; and the cattle-shed *y*, in particular, must have its straw carried through the work-horse stable and boxes besides. The carpenter's shop should, we conceive, never form an integral part of any steading. Upon the whole, this is a compact convenient steading.

241. The arrow points to the north.

242. On the policy of placing all the apartments and courts of a steading under a series of roofs, there may be difference of opinion. The entire covering has a protective, snug, comfortable appearance from the outside, but the comfort

within is more apparent than real. Every animal there is entirely excluded from the sunshine, and this is a positive privation in winter; for the general warmth of sunshine is agreeable to every living creature. There is not a window in all the outside walls of the main part of the building, so that the apartments must necessarily be lighted, if lighted at all, from the roof, and the more numerous such lights the more chances of rain-droppings therefrom. There are, besides, a great many outside doors, and when these must necessarily be placed in opposite walls, on account of the structure of the building, strong and cold draughts of air will be generated. The unpleasant sensation created by such draughts may be sensibly felt by any one who has had to wait for a train on the platform of a large covered railway-station. In such a draught cattle cannot feel comfortable; and where doors are numerous, and the traffic to apartments frequent, the chances are that some of them will be left open in opposite directions at the same time, and a constant draught generated and maintained.

243. DESCRIPTION OF A STEADING AT COLESHILL, *Highworth, Berkshire*, belonging to and arranged by E. W. Moore, Esq.—In Plate XIV. is the ground-plan of this steading, wherein, in the principle range, are: *a* the corn-barn, 24 feet by 44, with a door and two windows in front; *b* root and food store, 24 feet by 44, with a door and two windows in front; *c* loose-box, 15 feet by 11, with a door and window in front; *d* riding-horse stable, 15 feet by 18, of three stalls, and with a door and large window in front; *e* harness-room off the stable, 15 feet by 5, with a fireplace, and a window in front, and an internal door to the stable and another to the gig-house; *f* gig-house, 15 feet by 16, with a large door and window in front; *g* the office, 15 feet by 15, with a fireplace, and door and window in front, and a stair to the floor above; *h* an open shed, 16 feet by 21, with a door at back to a stair down to the waggon-arches; *i* cart-shed, 19 feet by 14, with two port-holes; *k* waggon-arches, five in number, each 20 feet by 10; the steam-engine room, 26 feet by 9, is at the back of the corn-barn.

244. In the central range are: *l* a passage, 14 feet by 45, across the building; *m* the straw-barn, 18 feet by 33, with a door and window in front, a door to the passage *l*, and a door to the steaming and mixing rooms; *n* the steaming-room, 18 feet by 16, having two boilers, with a door to the passage *l*, and two windows in front, and a door to the straw-barn; *o* mixing room, 18 feet by 16, having two vats, with a door to the straw-barn and to the steaming room, and a window in front; *p* cattle-stalls, 18 feet by 62, having stalls for twelve cattle; *q* fattening pig-boxes, 10 feet by 62, in two divisions of two boxes each; *r* breeding-sow sties, 8 feet by 62, in six divisions, with a yard to each, 18 feet long; *s* cattle-sheds, 20 feet by 68, in four divisions, with a yard to each, 16 feet by 23; *t* bulls' stalls, 18 feet by 18; *u* shed, 20 feet by 48, with a cow-yard, 46 feet by 31; *v* cow-yard, 30 feet by 38; *w* cattle-boxes, 26 feet by 182, in thirty-eight boxes, of 10 feet by 10, with two doors and two windows into the yards *o' o'*, and a door at the left gable; and another division, 21 feet by 43, in eight boxes, of 10 feet by 10.

245. In the right wing are: *x* cow-stalls, 11 feet by 100, in eighteen stalls, with an internal door to the calf-house; *y* cow-boxes, 12 feet by 100, in ten boxes, with a door and three windows in front; *z* calf-house, 10 feet by 29, in twelve cribs, with an internal door to the cow-stalls; *a'* hay-house, 18 feet by 29, with an outer door, and an internal one to the cow-boxes, and a window in front.

246. In the left wing are: *b' b'* loose-boxes, 16 feet by 10, with a door and a window to each; *c' c'* cart-horse stable, 16 feet by 88, in twelve stalls, with two doors and four windows in front, and two windows at the back; *d'* hay-

house and corn-room, 16 feet by 15, with a door in front, and a stair to a room above this and the harness-room; *e'* harness-room, 17 feet by 6, with a door and a window at the back; *f'* implement-shed, 16 feet by 17; *g'* shoeing open shed, 16 feet by 17; *h'* smithy, 16 feet by 18, with a door and window in front, and an internal door to the shoeing-shed *g'*; *i'* men's kitchen, 16 feet by 15, with a door in front and window in the gable.

247. In the lowest range are: *k' k'* fattening-sheep house, 14 feet by 108, in two divisions of twenty-two stalls each, with a door and two windows in front, three windows at the back, and a window in each gable. In the centre apartment are four stalls more, and a stair to a room above; *l'* liquid-manure tank, 16 feet by 20; *m'* manure shed and pit, 16 feet by 20; *n' n' n' n'* open sheds, 11 feet in width; *o' o'* yards for sheep or young cattle.

248. In the open space between the central range and the left wing are: *p'* a straw-barn, 20 feet by 37, flanked on three sides with six sheds, 8 feet 6 inches in width, with doors and windows.

249. In Plate XV. is an isometrical perspective of this steading, in which, besides the principal range of the corn-barn and straw-barn, which are central, the cattle-stalls *p*, the cattle-sheds *s*, and cattle-boxes *w*, along with the pig-boxes and sties *q* and *r*, are all included under a continuous roof. The right wing, containing the cow-stalls *x*, cow-boxes *y*, and calf-house *z*, is also under one roof, so that this may be considered an example of a covered steading. The left wing, containing the cart-horse stable *c'*, the lowest range, containing the fattening-sheep house *k'*, and the straw-barn and sheds *p'* in the open space, are detached buildings.

250. A tramway passes from the root-store *b*, by the cattle-stalls and pig-boxes, to the cattle-boxes *w*, where is a turn-table to deliver the food to the left, or to the right, on to the cow stalls and boxes.

251. In fig. 17 is a plan of the second storey of this steading, and the roof-plan

Fig. 17.

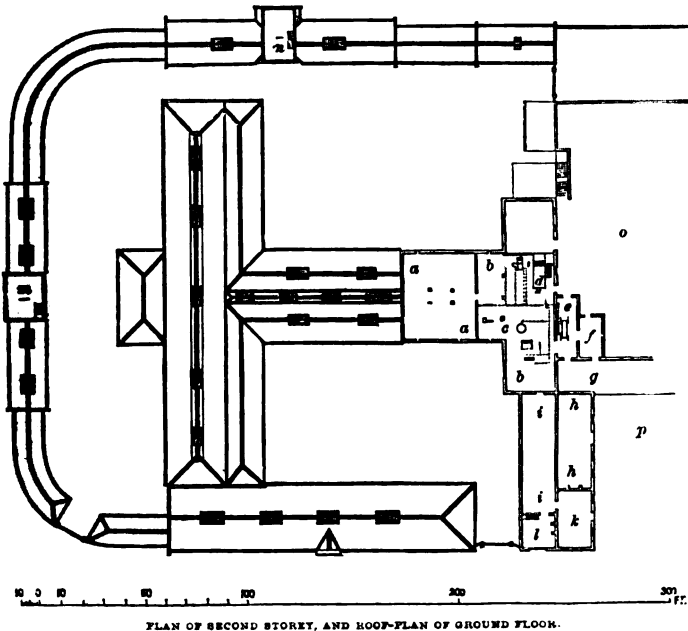

of the ground-floor, in which the principal range is of two storeys, with as much of the central range as includes the straw-barn, steaming and mixing rooms, and the remainder of the building is of one storey; *a a* is the granary, 41 feet 6 inches by 33 feet, over the straw-barn *m*, and steaming and mixing rooms *n* and *o*, Plate XIV.; *b b*, the upper barn, 91 feet 6 inches by 38 feet at the broadest, and 24 feet at the narrowest part, over the corn-barn and root-store below; *c* the corn-mill; *d* the thrashing-machine; *e* the steam-engine room, 26 feet by 9; *f* a coal-store; *g* part of sawing-shed, 16 feet by 56; *h h* carpenter's shed, 16 feet by 46; *i i* loft, 16 feet by 57, over the loose-box, riding stable, and gig-house; *k* nail-house, 16 feet by 27 feet; *l* office, 16 feet 6 inches by 15 feet; *m* a loft at the sheep-house; and *n* another loft at the cart-horse stable. To the right of the nail-house *k* are three apartments, which are not shown in fig. 17, but are seen in perspective in Plate XV., and in plan in Plate XIV.: one, the wheel-wright's shed, 15 feet by 32; another, an open shed, 15 feet by 27 feet 6 inches; and a third, a mason's shed, 15 feet by 28 feet 6 inches; *o*, fig. 17, is the stackyard; *p* the timber-yard.

252. The complete drainage of this steading is shown in Plate XIV., in which the double-dotted lines are the urine-drains, which empty themselves into the liquid-manure tank *l'*. The rain-water from the west side of the roofs is carried into these urine-drains, and is about sufficient to dilute the urine from the animals. The single round dotted lines show how the water for drinking is conveyed from the respective troughs to the several parts of the buildings. The long dotted single lines show the drains from the springs and roofs to the troughs, and also how the surplus water is carried away from the buildings. The chain-like lines in the lower yards *o'o'* show the drains put originally into the land before the levels of the ground were altered, and they are below the foundations of the buildings.

253. The extreme length of this steading over walls within the square of the buildings is 274 feet, and extreme breadth 248 feet. The principal range, with the straw-barn projection, have the termination of their roofs in gables—in the other parts of the buildings the roofs terminate in the pavilion form. The width of the apartments within walls varies, the corn-barn and root-store being 24 feet, the straw-barn, cattle-stalls, and pig-boxes, 18 feet, cattle-boxes 26 feet, cow stalls and boxes 30 feet, cart-horse stable 16 feet, riding stable 15 feet, sheep-house 14 feet. Such a diversity of widths gives an unnecessary diversity of roofing.

254. The scale of this plan in Plate XIV. is in the proportion of $2\frac{1}{2}$ eighths of an inch to the foot.

255. The arrow points to the north.

256. On taking a survey of this steading, the straw-barn *m*, in connection with the corn-barn, is conveniently situated for the stock accommodated in the central range of the buildings, but in its dimensions, 18 feet by 33, it seems too small for the numbers of stock, and it is confined, moreover, in its capacity by having the granary floor over it. It is also at a considerable distance both from the cows and the work-horses. With regard to the horses, the inconvenience seems to be admitted by the erection of another straw-barn nearer them at *p'*; but neither of the straw-barns is convenient for the cows. It seems strange to place the pigs in the central range in preference to the cows, and especially as the odour emanating from them must diffuse itself under the same roof with the cattle. Had all the cattle been placed in the central range, and the pigs sent to the left wing and the horses to the right, the relative positions of the different

kinds of stock would have been improved. As it is, this steading for Common farming shows great adaptation for the purpose it was constructed.

257. DESCRIPTION OF THE STEADING AT WARK, in *Northumberland, near Kelso*, belonging to the Earl of Tankerville.—In Plate XVI. is given the ground-plan of a new and extensive steading, occupying two acres of ground, in the farm of Wark, and adapted to Common farming: *a* corn-barn, 19 feet by 42, with two doors and two windows in front, and a window at the back; *b* corn-room, 19 feet by 19, into which the dressed corn is put in bin, with a window in front and back, and an internal door from the corn-barn; *c* straw-barn, 19 feet by 42, with a door in front and window at the back; *d* corn-mill, 19 feet by 9, with two windows and a door from the corn-barn; *e* steam-engine room; *f* chimney-stalk, 50 feet in height; *g* joiner's shop, 19 feet by 19, with a door in front and two windows at the back; *h* cart-shed, 19 feet by 70, with seven port-holes; *i* guano-store, 19 feet by 12, with a window in front and an internal door from the cart-shed; *k* hen-house, 17 feet by 16, with a door and window in front; *l* loose-boxes, four in number, 17 feet by 18, with a door in front; *m* outhouse, 17 feet by 17, with a door and window in front; *n* cart-horse stable, 17 feet 2 inches by 148, divided into twenty-four stalls, with three doors and six windows in front, and a window in the gable; *o* hay-house, 17 feet 2 inches by 15 feet, with a door and window in front; *p* cattle-feeding boxes, 12 feet by 274, in twenty-nine boxes, each 12 feet by 9 within divisions, with a door, as at *q*, to two boxes, and a feeding-bole, as at *r*, to two mangers; *s* cow-byre, 15 feet by 15, for the farmer's cows, three in number—Common farming requiring no breeding-cows—with a door in front and window at back; *t* servants' cow-byre, 15 feet by 47, with a door and window in front; *u* four cattle-sheds, 15 feet by 38 each, with each a court 24 feet by 48, and an open feeding-shed, 8 feet by 48. A covered turnip-store is placed between every two feeding-sheds, 10 feet by 48 each, provided with six boles in each wall, through which the turnips are served to the turnip-troughs. These apartments are comprehended in the quadrangle of buildings.

258. In the space within the quadrangle are: *v* feeding-pig sties, two in number, each 8 feet by 9, with a common court, 8 feet by 10; pig-court *w*, 10 feet by 19, with a gate in front, and two boles in the back wall for a passage into a cattle-shed *x*; *x x* two cattle-sheds, each 15 feet by 41, with straw-courts, 41 feet by 50 each, with a gate to each; *y* four cattle-sheds, each 15 feet by 38, with a court, 27 feet by 43, an open feeding-shed, 6 feet by 43, and a covered turnip-store, 10 feet by 43, to two feeding-sheds, provided with five boles in each wall to pass the turnips into the feeding-troughs.

259. The extreme length of this steading over walls is 287 feet by 225 in width. The roof turns at the corners in pavilion. The width of the apartments within walls varies from 18 feet in the corn-barn, straw-barn, and cart-shed, 17 feet 2 inches in the cart-horse stable, 15 feet in the cattle-sheds, and 12 feet in the cattle-feeding boxes.

260. The two-storeyed part of this steading comprises the whole of the lower side of the quadrangle, the upper barn being over the corn-barn and corn-room; *z* stair to the granary, 19 feet by 89, from the corn-room *b*, over the cart-shed and guano-house, with windows on each side. There is an outside stone stair to a granary over one of the cattle-sheds *x*, and an interior stair in the outhouse *m*, to a loft over it and the loose-box *l* and hen-house *k*, for containing the horse-corn, which is supplied from thence to the corn-chest below in the cart-horse stable *n*.

261. The scale of this steading, in Plate XVI., is in the proportion of $\frac{3}{8}$ of an inch to the foot.

262. It will at once be observed that the plan of this steading is not in conformity with the principle we have laid down (par. 32). The straw-barn *a*, at one of the corners of the quadrangle, is at a great distance from the cattle-courts *y* and feeding-boxes *p*. To obviate this inconvenience, a straw-stack is built on the space between the cattle-courts *y* and the feeding-boxes *p*. The quadrangular form is objectionable in a small steading; but in a large one such as this, covering an area of two acres, it is not so objectionable, inasmuch as the sun shines freely into its centre into the cattle-courts. Had the thrashing-machine been placed in the centre of the quadrangle, the straw would have been conveniently situated for all the courts, feeding-boxes, and stables. This objection is freely admitted by the tenant, and he would have preferred the stackyard on the rising ground to the west of the steading, instead of the low ground to the east; but a serious obstacle presented itself in a quicksand underground, through which the back lade from the mill-wheel had to be built; and rather than expend a large sum in overcoming such a difficulty, it was deemed expedient to suffer the present inconvenience. Both water and steam power are employed here. The stackyard covers about two acres of ground. Where the sun has free admittance in winter, the quadrangular form has the advantage of having all the premises locked in by one gate at *a'*.

263. We think we have now given abundant examples of steadings both in Scotland and England, as also remarks to illustrate the principles we wish to maintain. It may be advisable, however, before concluding this part of our work, to give an illustration of how an old and inconvenient steading may be altered into a new and convenient one, and this we are enabled to do by the kindness of a friend.

264. DESCRIPTION OF THE STEADING AT INVERQUHARITY, in *Forfarshire*, belonging to the Trustees of the late Charles Lyell, Esq. of Kinnordy, with the *Alterations and Additions*. Plate XVII. contains all the particulars connected with the alterations and additions effected on this steading. Fig. 1 contains the ground-plan of the new and old parts of the steading, the open outlines showing the old, and the shaded lines the new, parts of the steading. Fig. 2 is a roof-plan of the entire steading as amended. Fig. 3 is a south elevation of the steading as amended, the plain part showing the old, and the stippled part the new, portion of the steading. Fig. 4 is a vertical section of the finished buildings, indicated by the horizontal line A B in fig. 1. Fig. 5 is a vertical section at the vertical line C D in fig. 1. And fig. 6 is a vertical section at the vertical line E F in fig. 1.

265. In fig. 1, Plate XVII., in the central range are: *a* the corn-barn, 15 feet by 33, with a door and window in front; *b* chaff-house, 7 feet by 28, with a door into the straw-barn; *c* straw-barn, 22 feet by 51, with two doors opposite near the mill; *d* implement-house and guano-store, 12 feet by 22, with a large gate to the front.

266. In the right wing are these apartments: *e* cart-shed, 19 feet by 58, with five port-holes; *f* hay-house, 18 feet by 19, with a door in front, and an internal one to the cart-horse stable; *g* cart-horse stable, 18 feet by 65, of eleven stalls, with a door and window at the back, a window into the cattle-court *k*, and two sky-lights in the roof; *h* loose-box, 18 feet by 10, with a door in front; *i* cattle-shed, 18 feet by 23, furnished with a feeding-trough and a turnip-shed; *k* cattle-

court, 22 feet by 23, with a gate in front; *l* riding-horse stable, 12 feet by 16, with a door; *m* boiling-house, 12 feet by 11, with a boiler and furnace, and a door in front; and *a'* outhouse, 17 feet by 6, with a door.

267. In the left wing are these apartments: *n* water-wheel ark or steam-engine room, 17 feet by 6, with a window in front, and door into the open passage *v*; *o* cow-byre, 17 feet by 11, with a window in front and door to the passage *v*; *p* cattle-byres, 17 feet by 93, of four compartments, each with a door into the open passage *v* and turnip-shed *q*; *q* turnip-shed, 14 feet by 93, with four doors in front; *r* hen-house, 14 feet by 14, with a door in front; *s s* cow-byre, 16 feet by 60, of nine stalls, with doors into the adjoining cattle-byre *p*, open passage *v*, and cattle-court *w*; *t* loose box, 16 feet by 11, with a door in front.

268. The open space between the left wing and central range is occupied by four covered cattle-courts *w*, one being 31 feet by 41, another 31 feet by 45, a third, 31 feet by 45 at the widest part, and 30 feet at the narrowest, and the fourth, 31 feet by 41 at the broadest part, and 14 feet at the narrowest, with doors into the passages and gates in front; *z* the urine-tank, 15 feet by 5; and *y* turnip-store, 15 feet by 31, with a gate in front. This store supplies turnips from its centre to a double row of feeding-troughs along a 3-foot passage *x*, through the centre of the cattle-courts *w*, as also through three boles in each of its side walls into feeding-troughs in two of the courts at *b' b'*. These covered courts are lighted by eight skylights in the roof, as seen in fig. 2. They are separated from the central range by a covered passage *u*, 5 feet by 72, and from the principal range by an open passage *v*, 6 feet by 97.

269. The two-storeyed portions of this amended steading are the principal range to the right and the central range. The upper storey of the principal range comprehends the upper barn, 33 feet by 22, over the corn-barn and chaff-house, and the granary, 19 feet by 77, over the cart-shed and hay-house, having a stair from the corn-barn, with windows on both sides. The upper storey of the central range consists only of one apartment over the implement-house *d*.

270. The double-dotted lines show the urine drainage from the byres and covered courts to the urine-tank *z*.

271. It will be seen by the plan roof, fig. 2, Plate XVII., that only two stretches terminate in gables, at the loose-boxes *h* and *t*, the most in pavilions, while the outhouse *a'* has a lean-to roof.

272. The extreme length of this steading over walls is 226 feet, and its extreme breadth in the right wing is 98 feet, and that of the left wing 108 feet. The width of the apartments varies from 16, 17, 18, 19, to 21 feet.

273. The scale in Plate XVII. is as $\frac{3}{8}$ of an inch to the foot.

274. The arrow points to the north.

275. What the original form of this steading was, we do not know, but in the amended form, as represented in Plate XVII., it is arranged very much on the principles we have been advocating, having a principal range, a central one, and right and left wings. The straw is conveniently placed in the central range for the stables on the right, and the covered cattle-courts on the left, and not far from the cow-byre *s*. Instead of having the wings extended to afford accommodation to feeding cattle, the space between the central range and left wing is occupied by covered sheds and courts, with access to them by means of passages. This arrangement admits of putting these apartments under one roof. Upon the whole, this is a compact convenient steading, and is a good illustration

of how an old faulty steading may be converted into a good new one. There should be a window in the hay-house to afford light to the men when taking the hay for the horses. The cattle-shed marked *p* should be fitted up as a byre for feeding cattle, in order to allow the turnips to be wheeled into the cow-byre *s* from the store at *q*.

276. The *architecture* of the steadings given in Plates I. to IX. is of the simplest description—plain rubble-work, with broached ashlar corners, rebates, lintels, and skews, and the roofs extending in stretches, and terminating in gables, without points to be affected by the weather. A slight inspection of the isometrical perspective of a steading for Mixed husbandry, in Plate IX., will at once show the simplicity and neatness in which such a structure may be finished. A somewhat more ornamental style is given in Plate XV. of the farm-steading at Coleshill, in Berkshire, the corners and rebates being in raised work, and the skews of the gables ridged and pinnaced. But should an ornamental style be desired in preference to a plain one, we shall give a few examples

of such, two of the Elizabethan, and one of the Gothic. These are not parts of a steading, but are given as examples.

277. Fig. 18 represents a simple form of the Elizabethan, showing the elevation of a gable, with cornices, skews, door, and window.

278. In fig. 19 is represented an ornamental style of Elizabethan architecture of an elevation of a gable, comprehending ornamental cornices, skews, and window. The door is simple enough.

279. In fig. 20 is the elevation of a gable in the Gothic style, in which the ashlar corners, rebates, lintels, and sills are in polished

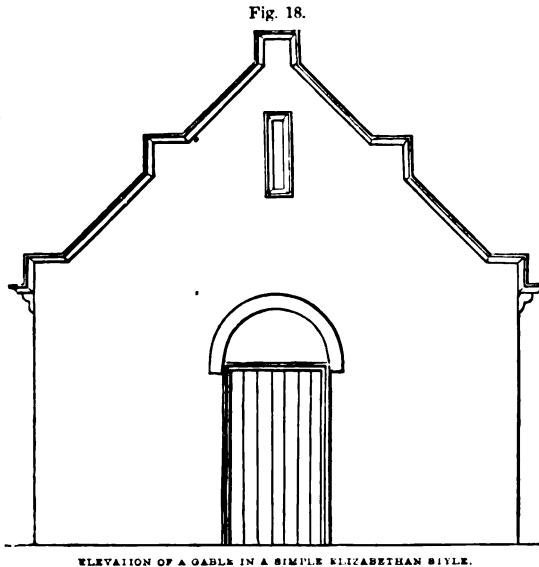

ELEVATION OF A GABLE IN A SIMPLE ELIZABETHAN STYLE.

raised work. There are no skews, the slating projecting over the walls, as much as to allow an ornamental boarding. The pinnacle terminating the gable is an essential feature in Gothic architecture.

280. We would here take the liberty of earnestly directing the attention of landed proprietors to the condition of the steadings on their farms when they are offered to tenants. That a steading is a necessity upon a farm, the wants of the farm obviously demonstrate; and that every steading should be so constructed as to be suitable to the business of the farm upon which it is erected, is a proposition which none acquainted with the culture of land and the rearing of live stock will be disposed to controvert. Unless suitably constructed, the business of the farm, in the winter season, cannot be conducted in the steading in a satisfactory manner to the farmer, or comfortably to the stock. On this account, a farm not having a suitable steading always deters farmers offering the highest rent for it. We regret to say that many farms in all parts of the

country have unsuitable steadings, as regards accommodation for the mode of farming practised upon them. When a farmer finds the accommodation inadequate to the extent of the farm, he is hampered in every kind of work he has to do in it. He would wish it enlarged, but he has not the means himself, and on applying to his landlord, he will probably be told to abide by his bargain. A farmer placed in such a strait is sure to incur loss on many articles of produce, which in better circumstances would probably yield him profit. Even on the supposition that the steading is large enough for the farm, if the arrangement of its apartments is not suited to the kind of farming pursued, inconvenience is felt, and loss incurred. The farmer must then either advance his own capital or must make up his mind to submit to constant loss. See how the matter stands in such circumstances between landlord and tenant: on the one hand, should the farm be rack-rented, and have an unsuitable steading, the landlord is deriving more rent from the farm than he is entitled to receive, and the tenant sustaining a greater loss than he should incur; and, on the other hand, when the steading is suitable to the extent of the farm and the kind of farming practised, the landlord is not only entitled to the highest rent the land is capable of realising, but the tenant, at the same time, is saved the risk of expending capital, which ought rather to be spent in the cultivation of the farm. Is it not therefore

Fig. 19.

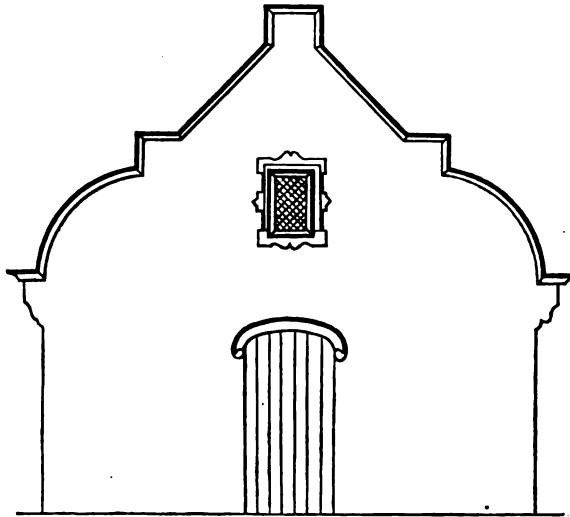

ELEVATION OF A GABLE IN AN ORNAMENTAL ELIZABETHAN STYLE.

desirable, in every case, when a farm is offered to the public, that the most favourable circumstances should be secured both to landlord and tenant? Most

Fig. 20.

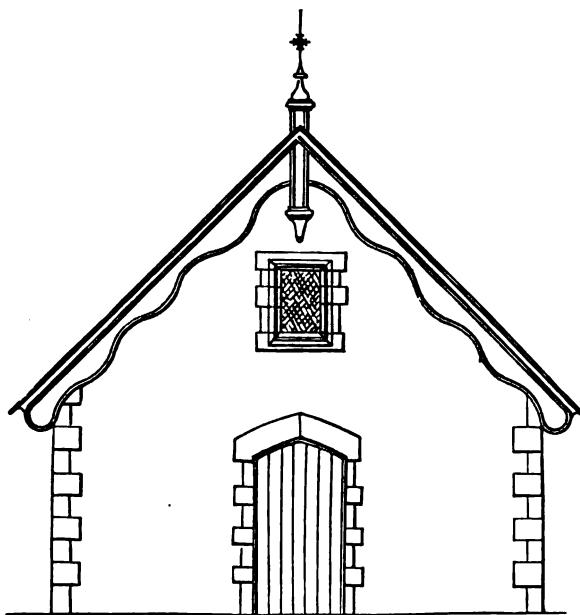

ELEVATION OF A GABLE IN THE GOTHIC STYLE.

certainly; and the most effective, reasonable, and just method of obtaining that security, is for the landlord to make the steading suitable to the size of the farm and its mode of husbandry, because then the tenant would have nothing to do but direct his mind entirely to what is called high farming. Were this understanding acted upon, the kindly feeling betwixt landlord and tenant would remain undisturbed. But, unfortunately, in most cases, steadings are not so complete as to meet the exigencies of the farm, and the tenant, knowing this, and knowing also that he has not the spare capital to expend on buildings, binds himself to pay the landlord six and a half per cent on the amount expended during the course of the lease. By this proceeding it is the tenant and not the landlord who has paid the capital and interest required, whereas the steading ought to have been complete before the farm was offered to the public. It is quite as unreasonable in a landlord to expect the highest rent for a farm with an incomplete steading, as for a farmer to expect as great a price for the same ox in a lean as in a fattened condition. If a per-centage is deemed a fair demand by the landlord on the tenant in those circumstances, it is our opinion that it would be equally fair to demand from the landlord payment of the same per-centage when the tenant expends his capital. And yet how astounded would any proprietor be were such an equitable demand proposed by a farmer when bargaining for a lease, and with what equanimity he would expect the highest rent for his land, however incomplete may be the state of the steading!

DIVISION THIRD.—PLANS OF FARMHOUSES.

281. WE offer a few remarks on the principles which should regulate our choice of the relative position betwixt the farmhouse and steading, and of the site to be occupied by the farmhouse:—

282. *Position of Farmhouse and Steading.*—In regard to the relative positions which the farmhouse and steading should occupy, it has been remarked by a recent writer, that “it is generally advised that the farmhouse should be placed directly in front; to which, however, it may be objected, that it casts a shade over the southern entrance of the yard, if very near; and, if too far off, its distance will be found to be inconvenient. Perhaps the best situation is on one side of the farmyard, with the common parlour and kitchen opening nearly into it: farmers may talk as they like about unhealthy odours arising from the stables and yards, but there never was any one injured by them, and they cannot keep too close an eye upon their servants and stock.”* If farmers “cannot keep too close an eye upon their servants and stock,” and if the position of their houses will enable them to do so, they should do something more than place them “on one side of the farmyard;” they must remain constantly in them, and cause “their servants and stock” to be continually in sight in the farmyard, otherwise their watching will be of no avail; for when the servants come to know that the house has been placed there merely to watch their proceedings, they, at least, if not the stock, can and will easily avoid the particular place constantly overlooked by the house. The truth is, and every farmer knows it, that it is not the spot occupied by his house, whether here or there, that maintains his authority over his servants; he knows that he himself must be “up and doing”

* *British Husbandry*, vol. i. p. 86.

in the fields, in the farmyard—everywhere—ere he can ascertain whether his servants are doing their work well, and his stock thriving apace. Inconvenience to himself in going a great distance betwixt his house and the steading will induce the farmer to place his house *near* rather than at a distance from the steading. He wishes to be within call,—to be able to be on the spot in a few seconds, when his presence is required in the farmyard, the stable, the byre, or the barn; but more than this he does not want, and need not care for. Place the house, therefore, if the choice is given, on some pleasant spot, neither “direct in front,” nor much in the rear, of the steading. If there be no such spot at hand, make one for the house, place it there, and dwell in it, with the comfortable assurance that servants will not regard their master the less, or the stock thrive the worse, because he happens to live beyond the influence of the “unhealthy odours arising from stables and yards,”—odours, by the way, of the unpleasantness of which we never heard a farmer complain. No one of that class but a sloven would place his house beside a dunghill.

283. *Site of Farmhouse.*—With reference to *site*, Mr Allen, in his work entitled *Rural Architecture*, an American work, has some remarks worth quotation: “A fitness to the purpose for which the dwelling is constructed should unquestionably be the governing point in determining its position. The site should be dry and slightly declining, if possible, on every side; but if the surface be level, or where water occasionally flows from contiguous grounds, or on a soil naturally damp, it should be thoroughly drained of all superfluous moisture. That is indispensable to the preservation of the house itself and the health of its inmates. The house should so stand as to present an agreeable aspect from the main points at which it is seen, or the thoroughfares by which it is approached. It should be so arranged as to afford protection from wind and storm to that part most usually occupied, as well as be easy of access to the out-buildings appended to it. It should have an unmistakable front, sides, and rear; and the uses to which its various parts are applied should distinctly appear in its outward character. It should combine all the advantages of soil-cultivation, water, shade, and shelter, which the most liberal gratification, consistent with the circumstances of the owner, may demand. If a site on the estate command a prospect of singular beauty, other things equal, the dwelling should embrace it; if the luxury of a stream or a sheet of water in repose present itself, it should, if possible, be enjoyed; if the shade and protection of a grove be near, its benefits should be included—in fine, every object in itself desirable, and not embarrassing to the main purposes of the dwelling and its appendages, should be turned to the best account, and appropriated in such a manner as to combine all that is desirable both in beauty and effect, as well as in utility, to make up a perfect whole in the family residence.

284. “Attached to the building site should be considered the quality of the soil as affecting cultivation and growth to shrubbery and trees—at once the ornament most effective to all domestic buildings, grateful to the eye always as objects of admiration and beauty—delightful in the repose they offer in hours of lassitude or weariness; and to these, that indispensable feature in a perfect arrangement, the garden, both fruit and vegetable, should be added.”

285. On the subject of trees and shrubs—a due appropriation of which “to an agreeable residence is equal in importance to the style and arrangement of the house itself”—the same author has some remarks worthy of notice. “The proper disposition of trees and shrubbery around, or in the vicinity of buildings, is far too little understood, although tree-planting about our dwellings is a

practice pretty general throughout our country. Nothing is more common than to see a man build a house, perhaps in the most elaborate and expensive style, and then plant a row of trees close upon the front, which, when grown, will shut it almost entirely out of view, while he leaves the rear as bald and unprotected as if it were a barn or a horse-shed—as if in utter ignorance, as he probably is, that his house is more effectively set off by a flanking and background of tree and shrubbery, than in front—and this is called good taste. Let us examine it. Trees near a dwelling are desirable for shade; shelter they do not afford, except in masses, which last is always better given to the house itself by a verandah. Immediately adjoining, or within touching distance of a house, trees create dampness, more or less litter, and frequently vermin. They injure the walls and roof by their continual shade and dampness. They exclude the rays of the sun, and prevent a circulation of air. Therefore, close to the house, trees are absolutely pernicious, to say nothing of excluding all the architectural effect from observation, when, if planted at proper distances, they compose its finest ornaments.”

86. *Working Part of the Farmhouse.*—The principles which should regulate the arrangement of that part of the farmhouse which is exclusively devoted to labour have an intimate connection with the management of the farm. The part we allude to includes the kitchen and dairy, and their accompanying apartments. Now, it may frequently be seen in the plans furnished by architects, that to give the farmhouse a fashionable and airy appearance, the working portion of it is too often contracted and inconveniently arranged. The principle of its construction should be, to make this part of the house thoroughly commodious in itself, and at the same time prevent its giving the least annoyance to the rest from noise or disagreeable effluvia, which cannot at all times be avoided in the labours of the kitchen. Both objects would be accomplished by placing it independent of the main body of the house, and this is best effected by a jamb. Whatever may be the external form given to the

house, the relative positions of its two parts may easily be preserved, whether in the old-fashioned form of a front tenement and back jamb, or the more modern and beauteous form of the Elizabethan style.

287. The ground-plan which we recommend of the kitchen and useful parts of the farmhouse in which work is performed, may be seen in fig. 21, where *a* is the kitchen, 18 feet by 16, and 10 in height, provided with two windows; a door into the interior of the house, another to the kitchen-pantry *k* and dairy *m*, and a third to the scullery *d* and porch *p*. A large kitchen-range, oven, and furnace-pot are at *b*, a commodious lock-up closet *c*, a wall-press *h*, and a dresser and

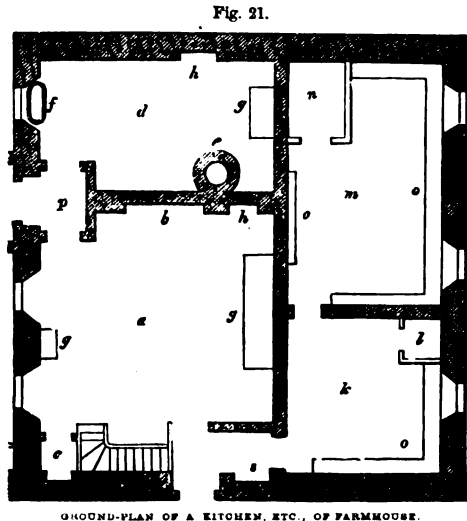

table *g g*. There is a stair at *c* to the servants' and other apartments above, and which also leads to the principal bedrooms in the upper storey of

the house. Beyond the kitchen is the scullery *d*, which contains a large furnace-pot *e*, a sink in the window *f*, a wall-press *h*, and a dresser *g*. This apartment is 18 feet by 10 feet, and 10 in height. A door from it, and another from the kitchen, open on a lobby common to both, and which gives access by another door to the principal kitchen entrance-door through the porch *p*. The porch *p*, 6 feet square, is erected for the purpose of screening both the kitchen and scullery from wind and cold, and it has a window. On going to the right from the kitchen to the kitchen-pantry *k*, is a wall-press in the passage at *s*. The pantry *k* is provided with a door; a window which should look to the east or north; a larder *l*, and abundance of shelving at *o*; it is 12 feet square, having a roof of 10 feet in height. Beyond this pantry is the milk-house or dairy *m*, having two windows also facing to the north or east; a lock-up closet *n*, and shelving *o o* around the walls; it is 18½ feet by 12, and 10 in height.

288. These are the different apartments on the ground-floor, and their relative positions, required for conducting the business of a farm within the house, and in the fitting up of which are many particulars which require attention. The floor of the kitchen should be of *flagged pavement polished*, that it may be cleaned with certainty and ease. The outside walls and ceiling should be lathed, and all the walls and ceiling plastered with the best hair-plaster. Iron hooks, both single and double, should be screwed into the joists of the roof, from which may be suspended hams or other articles. The dressers *g* are best made of plane-tree tops and black American birch frames, the chairs of the latter wood, and the stools of common fir. In case of accidents, or negligence in leaving them unfastened at night, it would be well to have the lower sashes of the windows of the kitchen and scullery fast, and the upper ones only to let down for the occasional admission of fresh and the escape of heated air.

289. In the scullery, the sink *f* should be of polished free-stone, made to fit the window-void, with a proper drain from it, provided with a cesspool. The floor should be of the same material as that of the kitchen, for the sake of cleanliness. The outside wall and ceiling should be lathed, and all the walls and roof plastered. There should be a force-pump in the scullery to fill a cistern with water at the upper part of the house, to contain a constant supply for the sink. A boiler behind the kitchen fire, provided with a small cistern and ball-cock in connection with the upper cistern, for the supply of cold water into the boiler; and a cock from it in the kitchen, and another from it in the scullery, for drawing off warm water when required, could be fitted up at no great cost, and would be found a most serviceable apparatus in a farmhouse.

290. The large furnace-pot *e* should be built in with fire-brick, surrounded with common brick, plastered and protected with cloth on the outside, rubbed hard into the plaster, and the mouth of the pot protected with a 4-inch thick pavement polished. To carry off the superfluous steam, a lead-pipe should be fastened into a narrow immovable portion of the pot-lid, and passed through the wall into the flue. A tin pipe soon rusts and wastes. An iron bar should project from the stone-wall, having a horizontal eye at its end directly over the centre of the furnace-pot, to receive the stick into when making the porridge for the reapers' morning meal in harvest. The dresser *g* should be of the same material as that of the kitchen. There should be iron hooks fastened into the roof for hanging any article on. Shelving is also useful in a scullery.

291. The outside walls and ceiling of the kitchen-pantry *k* should be lathed, and all the walls and ceiling plastered. The flooring should be of the same mate-

rial as that of the kitchen, or of hard brick. The shelving *o* should be of wood of several tiers, the lowest row being 3 feet above the floor. The movable portion of the window should be protected with fly zinc-gauze, and so also the side and door of the larder *l*. A few iron hooks in the roof will be found useful for hanging up game or fowls. A set of steps for reaching above an ordinary height is convenient in a pantry.

292. The outside walls and ceiling of the milk-house *m* should be lathed, and the walls and roof plastered. The flooring should be of polished pavement, for the sake of coolness. The windows should be protected in the movable part with fly zinc-gauze, which is much better than wire-gauze; and the side and door of the lock-up closet *n* should also be lined with zinc-gauze. The best shelving for a milk-house is marble, and though this substance may appear extravagant in a farmhouse, the price of marble is now so much reduced that it is worth the extra expense, the import of foreign marble being now free. Marble is always cool, and easily cleaned and freed of stains. Scottish marble is hard and unequal of texture. The grey-veined marble from Leghorn is therefore preferable, though the black marble of the county of Galway in Ireland is equally good; but the grey colour has a coolness and freshness about it in a dairy which the black does not possess. Polished pavement is the next best material for coolness, but it is very apt to stain with milk or butter, and the stains are difficult of removal. We speak from experience, and know the labour required to keep stone-shelving in a milk-house always sweet and clean; and let us say farther, unless it is so kept, any other material is preferable to it. If marble be rejected on account of expense, we would recommend stout shelving of beech or plane-tree, as being smooth, and hard, and easily kept clean. This shelving should be 2 feet broad, $1\frac{1}{2}$ inch thick, and, to be convenient, should not exceed the height of 3 feet from the floor.

293. It is necessary to make the wall which separates the kitchen and scullery from the milk-house and pantry of brick or stone, to keep the latter apartments more cool, and less likely to be affected by the heat and vapour, which must of necessity sometimes escape from the scullery. It would no doubt be convenient for the removal of the milk dishes to have a door between the scullery and milk-house; but it is much better to avoid every risk of contamination from a place which must at times be filled with vapours injurious to milk—a substance which is at all times delicately susceptible of injury.

294. The windows of all the apartments should be provided with *shutters on the inside*; and it may be a safe precaution against nocturnal intruders to protect those of the milk-house and pantry with iron stancheons on the outside, as their windows should, occasionally at least, be left open even all night.

295. On this side of the kitchen will be observed a stair. It is 4 feet in width, and intended to lead to the storey above the kitchen-floor, as also to the upper storey of the principal part of the house. The storey above the kitchen may be subdivided in this way: let a continuation of the brick or stone wall which separates the kitchen and scullery from the milk-house and kitchen-pantry be carried up, in the form of a partition of lath and plaster, to the roof of the second storey, which may be 9 feet in height, as seen on the right of *g*, fig. 22. The wall of the kitchen-flue *b* should, of course, be carried up to a chimney-stalk above the ridging, containing at least four flues from below, one of the kitchen fire, one of the small furnace-pot of the kitchen, one of the oven, and one of the large furnace-pot in the scullery; but there should also be one from the room above the scullery, and one from one of the rooms above the kitchen; and,

to render both kitchen and scullery as wholesome by ventilation as possible, there should be a small flue from the ceiling of each to carry off heated air and vapour. The kitchen stalk would thus contain six flues from below and two from above.

296. The upper storey should be partitioned off in the way as seen in fig. 22.

Let the apartment *a* above the scullery be fitted up with a fireplace *f* as a bedroom for the female servants, having a closet *c* in the outer wall. After taking off a passage *g* of 3½ feet in width along the whole length of this part of the house, this room will be 14 feet by 10. The space above the kitchen may be divided into two bedrooms, one *b*, 14 feet by 9 feet, and 9 in height, with a fireplace *f* and window, and closet *c*. This might be occupied as a sitting-room and bedroom by the housekeeper, if the services of such a person are required; if not, it might be a large store-room, with a fireplace, which would be useful for various purposes. The room *d*, 14 feet by 8 feet 3 inches,

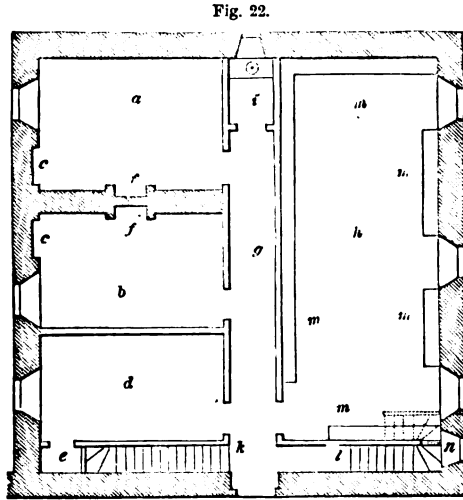

and 9 in height, having a window in it, but no fireplace, might be a bedroom for occasional stranger servants. It has a closet *e* in it, 3 feet by 2 in depth.

297. At the end of the passage is a water-closet *i*, lighted by a window in the gable of the jamb. It is 5 feet 3 inches by 3½ feet. It has water from the same cistern that supplies the sink in the scullery, and its soil-pipe descends in an appropriate recess in the wall. Its window could give light to the passage *g* by a glass window above the door, or light might be obtained by a cupola in the roof, or from the cheese-room *h* by windows in the lath-and-plaster wall.

298. The entire space above the kitchen-pantry and milk-house may be appropriated to a cheese-room *h*, 29 feet 2 inches by 12 feet, and 9 in height, with 3 windows. Besides the floor, proper shelving *m m* would afford accommodation to the cheese, in its various stages towards maturity; and the lower halves of the windows provided with Venetian shutters, outside the glass, to regulate the air into the room when the windows are opened. Except in dairy farms, the milk-house and cheese-room are most conveniently placed within the farmhouse.

299. If there is sufficient room in the roof above these various apartments for a garret, access can be obtained to it by a stair at *l*, which would have to return upon itself in ascending the 9 feet, the height of the storey; and both this stair and the one *k* down to the kitchen could be lighted by a long window at *n*. If there is no garret, then the cheese-room will be 32 feet 3 inches in length, by dispensing with the stair *l*, as also with the window *n*.

300. These dimensions of kitchen and other apartments would be suited to the farmhouse of a farm of from 500 to 1000 acres, under the Mixed husbandry. The milk-house may, perhaps, be large enough for a small dairy-farm; but should it be preferred in the farmhouse, and it be too small for that purpose, it might easily be enlarged by increasing the length and breadth of the building.

301. *Plans, Elevations, and Sections of Farmhouses.*—We now proceed to give illustrations of farmhouses of various sizes and in different styles. In fig. 23 we give a ground-plan of a first-class farmhouse: *a* the entrance steps; *b* the ante-hall, 7 feet wide, with seat *c*; *d* library, office, or study, 12 feet square. There are two doors to this room—one, the public, entering from the ante-hall *b*, the other leading to the hall *e e*, 7 feet wide; *f f* drawing-room, 20 feet by 16; *g g* the dining-room, 20 feet by 16; *h h* store-room, 16 feet by 12; *i i* stairs to second floor, 3 feet 6 inches wide; *k k* kitchen, 16 feet square; *l* kitchen-pantry, 10 feet 6 inches by 8 feet; *m m* milk-house, 25 feet by 16, with closet *n*, 8 feet by 5 feet 6 inches. A lift *o* is placed in this closet, by

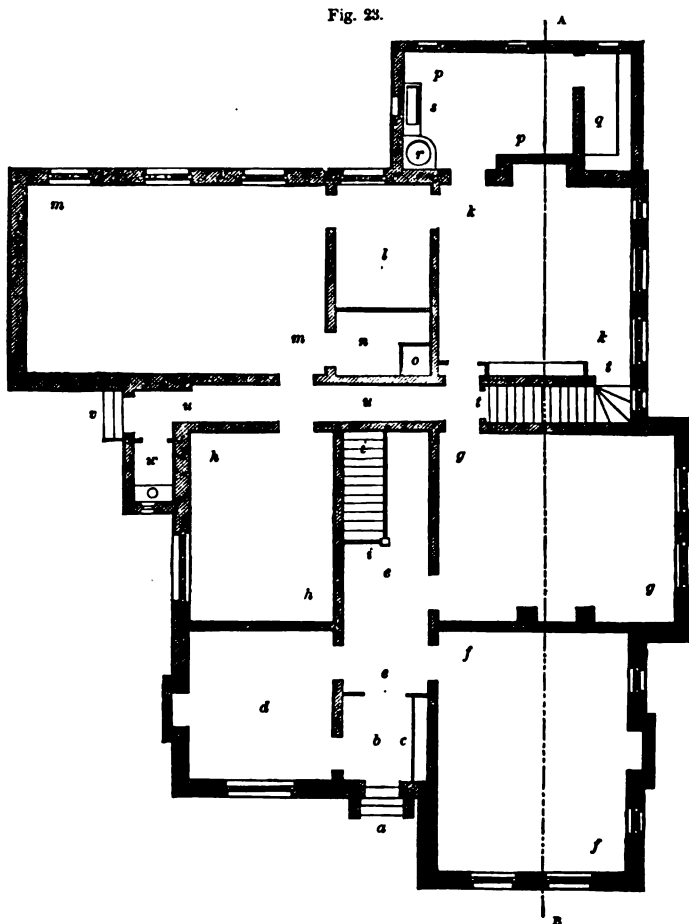

which articles are conveyed to the cheese-room above; *p p* scullery, 14 feet by 8 feet 6 inches, with pantry *q*, wash-boiler *r*, and slop-stone *s*. The back stairs to servants' bedroom are at *t t*; *u u* a passage, 3 feet wide, leading to back-entrance *v*; *w* a water-closet, 3 feet 6 inches wide.

302. In the upper floor, fig. 24, *a a*, *b b* are the principal bedrooms, 20 feet by 16; *c c* small bedroom, 12 feet square; *d d* nursery, 16 feet by 12;

e linen-closet, 7 feet square; *f* water-closet, 3 feet wide; *g g* servants' bedroom, 16 feet square; *h h* cheese-room, 33 feet 9 inches by 16 feet; *i* lift; *k k* roof of scullery.

Fig. 24.

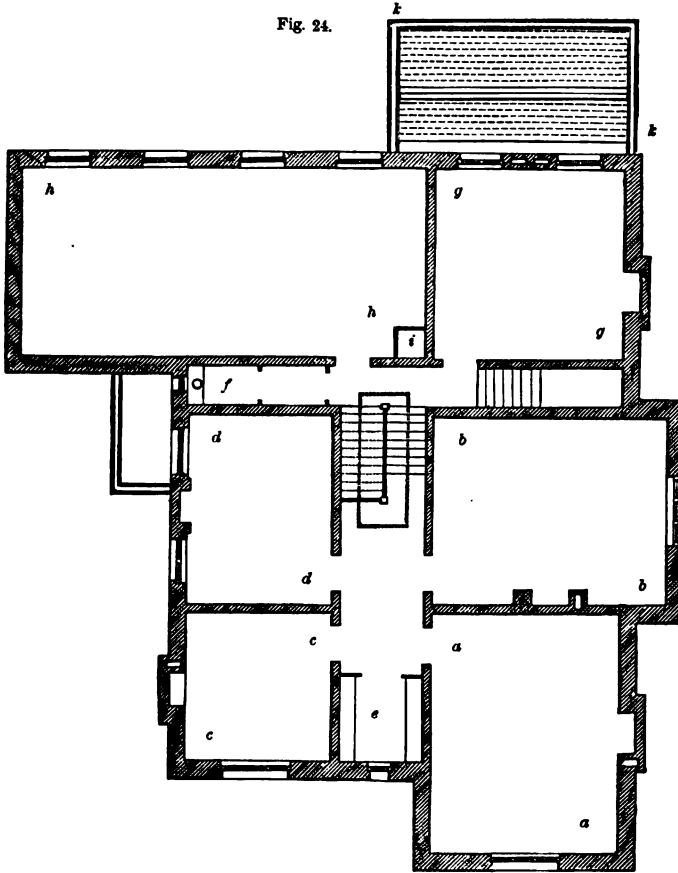

CHAMBER-FLOOR PLAN OF FARMHOUSE—SCALE IN PLATE XVIII.

303. Fig. 25 shows an alternative arrangement of part of chamber-floor storey, in which *a* corresponds with *g g*, fig. 24; a passage *b* being taken off it, to give entrance to a bedroom *c* built over the scullery *k k*, fig. 24, or *p p* and pantry *q*, fig. 23; *d* cheese-room; *e* a room.

Fig. 25.

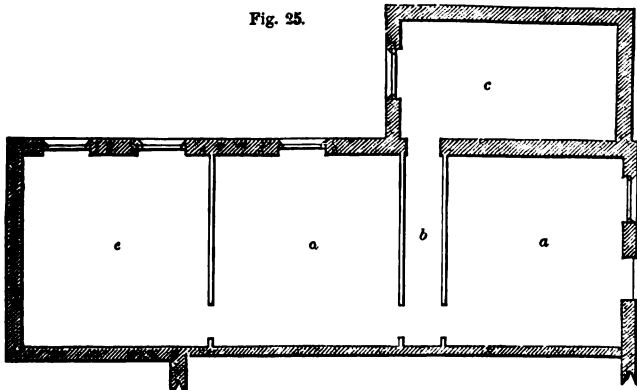

ALTERNATIVE ARRANGEMENT OF PART OF CHAMBER-FLOOR STOREY.

304. In Plate XVIII., fig. 1, we give a drawing of front elevation in the Tudor Gothic style;

fig. 3 being an alternative design in the Italian style; fig. 2 being a second alternative design, adapted for three storeys, in the Tudor Gothic style.

305. In fig. 26 we give a side elevation (left hand in plan fig. 23); in fig. 27 back



SIDE ELEVATION OF FARMHOUSE—SCALE IN PLATE XVIII.

elevation (along the back of the plan, fig. 23); in fig. 28 side elevation (right-hand side of plan in fig. 23), finished to show stone-rubble walling; in fig. 29,

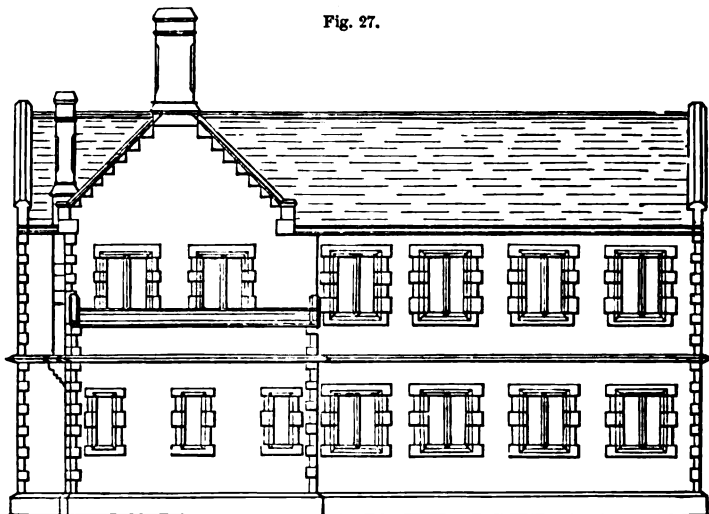

BACK ELEVATION OF FARMHOUSE—SCALE IN PLATE XVIII.

longitudinal section in the line A B, fig. 23; in fig. 30 back elevation of alternative design in same style as fig. 3, Plate XVIII.; in fig. 31 a vertical section of milk-house *m m*, fig. 23, and above it cheese-room *h h*, fig. 24.

Fig. 28.

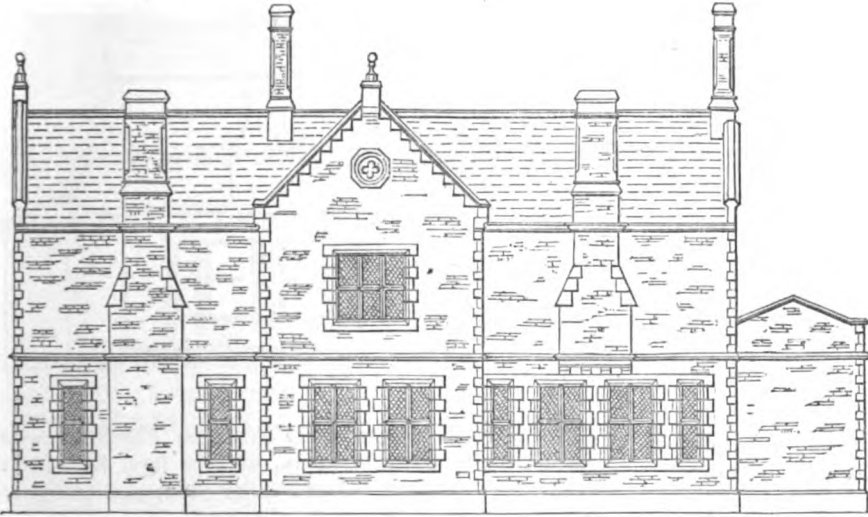

SIDE ELEVATION OF FARMHOUSE, FINISHED TO SHOW STONE-RUBBLE WALLING—SCALE IN PLATE XVIII.

Fig. 29.

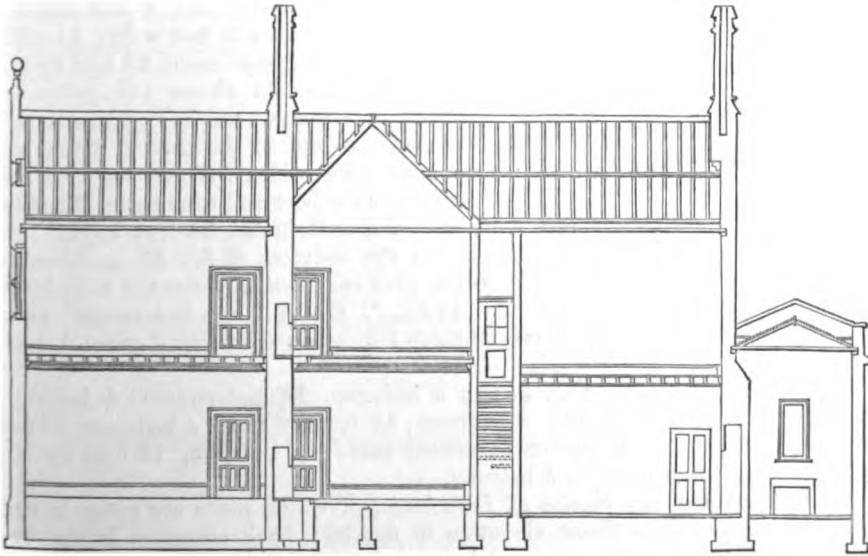

LONGITUDINAL SECTION OF FARMHOUSE IN THE LINE A B, FIG. 23.

PLANS OF FARMHOUSES.

Fig. 30.



BACK ELEVATION OF ALTERNATIVE DESIGN—SCALE IN PLATE XVIII.

Fig. 31.

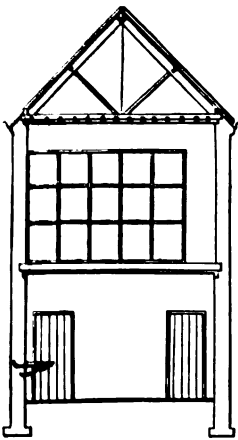

VERTICAL SECTION OF MILK-HOUSE AND CHEESE-ROOM, FIG. 23 AND 24.

306. *Second Design for First-Class Farmhouse.*—In fig. 32 we give ground-plan, and in figs. 33 and 34 cellar plan, and alternative cellar plan, and in fig. 35 chamber or first-floor plan of a farmhouse, designed in the Italian style, with campanile tower.

307. *Ground-Plan.*—In fig. 32, *a* is the entrance-hall, 8 feet square; *b b* drawing-room, 16 feet by 12; *c c* parlour or dining-room, 15 feet by 12; *d d* the kitchen, 15 feet by 12; *e* the scullery, 12 feet by 10; *f* the larder, 6 feet square; *g* the china-pantry, 6 feet square; *h* the central lobby, 4 feet wide; *i i* staircase, 6 feet wide; *k* water-closet and place for hats, 3 feet wide; *l l* milk-house, 25 feet by 12; *m m* cheese-room, 25 feet by 12.

308. *Cellar Plan.*—Fig. 33 shows the cellar arrangement under the kitchen, where the “cheese-room” and “milk-house” are not in the ground floor, and where *a* is the stair, 3 feet wide; *b* the coal-store, 9 feet by 5 feet 6 inches; *c* the beer and wine store, 9 feet by 5 feet 6 inches; *d d* milk-house, 24 feet by 11. In this arrangement the bedroom *d*, fig. 35, is taken as the cheese-room. In fig. 34 the cellar plan is shown as under the milk-house *l l*, and cheese-room *m m*, fig. 32. In fig. 34 the part *a a* is arranged, as in fig. 33, with coal and beer stores, as there indicated; *b b* being a general store-cellar.

309. *Chamber Plan.*—Fig. 35: *a a* bedroom, 12 feet square; *b* balcony; *c c* bedroom, 15 feet by 12; *d* bedroom, 12 feet by 11; *e e* bedroom, 12 feet by 10 at widest, and 6 feet at narrowest part; *f f* bedroom, 12 feet by 10; *g* bath-room, 8 feet square; *h* balcony.

310. *Elevations and Section of Farmhouse*, of which plans are given in figs. 32, 33, 34, and 35.—Front elevation in fig. 36; back elevation in fig. 37; elevation of side towards left hand in ground-plan, fig. 32, is given in fig. 38; the elevation of side towards right hand in plan, fig. 32, is given in fig. 39; a transverse section on the line *A B* in ground-plan, fig. 32, is given in fig. 40. The scale to which these drawings are constructed is given in fig. 32.

Fig. 32.

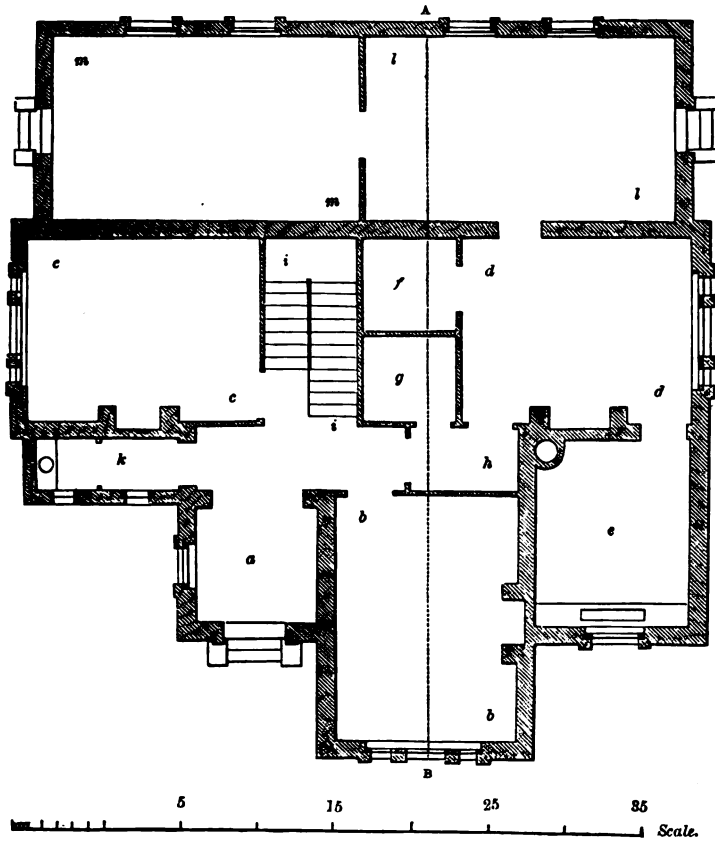

GROUND-PLAN OF FARMHOUSE IN ITALIAN STYLE.

Fig. 33.

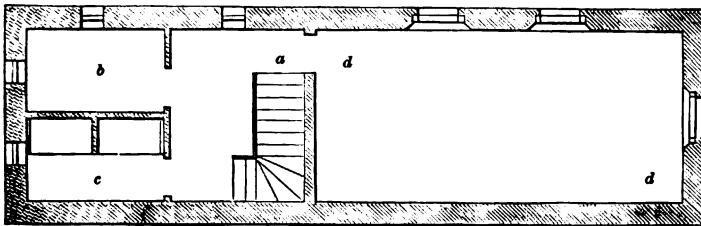

CELLAR PLAN—SCALE IN FIG. 32.

Fig. 34.

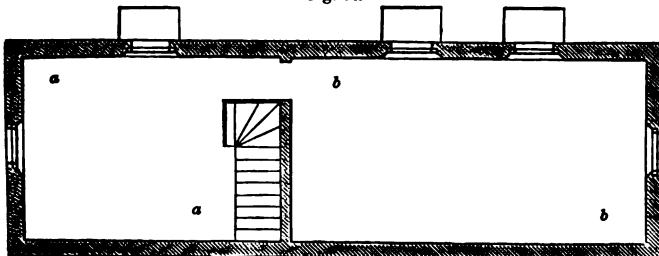

ALTERNATIVE CELLAR PLAN—SCALE IN FIG. 32.

Fig 35.

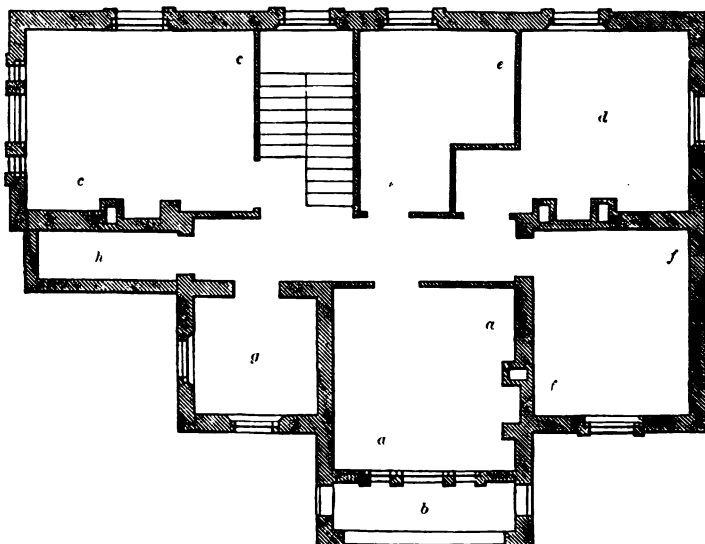

CHAMBER FLOOR PLAN OF FARMHOUSE IN ITALIAN STYLE—SCALE IN FIG. 32.

Fig. 36.



FRONT ELEVATION OF FARMHOUSE IN ITALIAN STYLE—GROUND-PLAN AND SCALE IN FIG. 32.

Fig. 37.

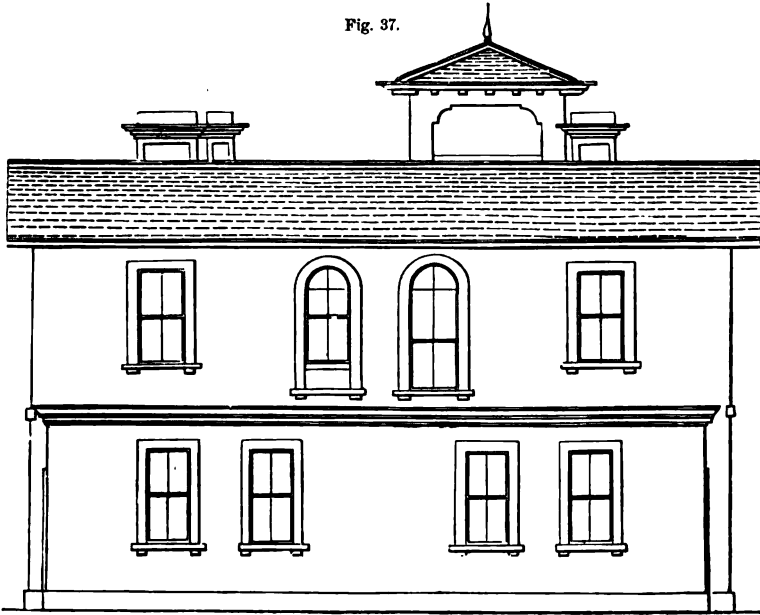

BACK ELEVATION IN THE ITALIAN STYLE—SCALE IN FIG. 32.

Fig. 38.

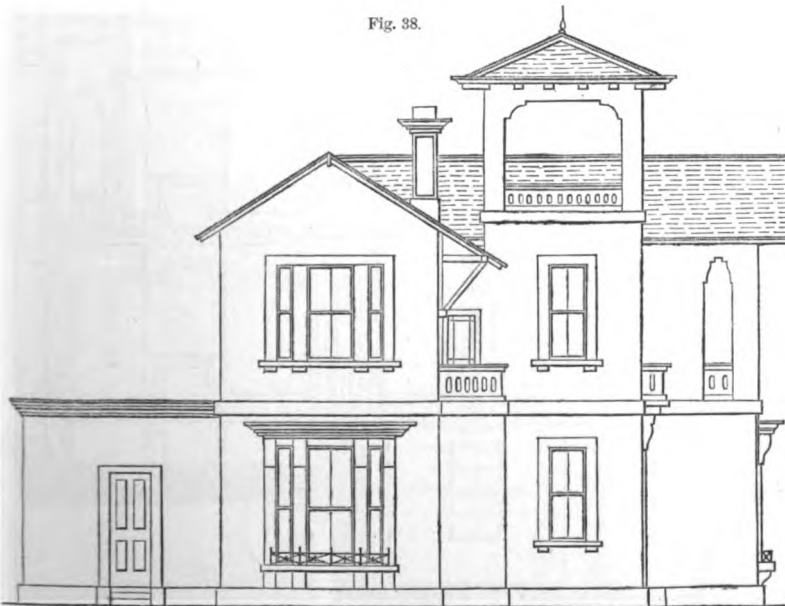

SIDE ELEVATION IN THE ITALIAN STYLE—SCALE IN FIG. 32.

Fig. 39.

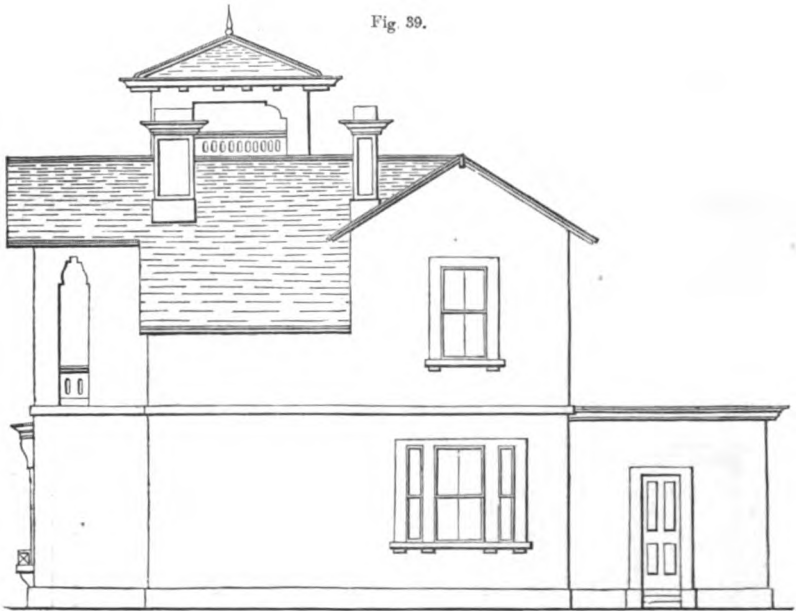

SIDE ELEVATION IN THE ITALIAN STYLE—SCALE IN FIG. 32.

Fig. 40.

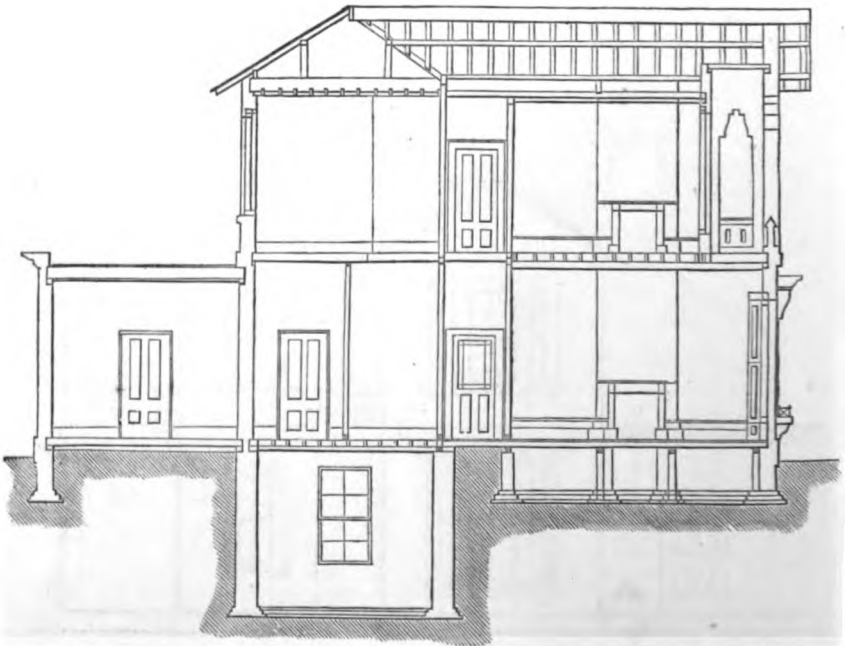

LONGITUDINAL SECTION IN THE LINE A B, FIG. 32—SCALE IN FIG. 32.

311. *Third Design for a First-Class Farmhouse.*—We now present a third set of plans of a farmhouse in the Tudor-Gothic style, the arrangement of the apartments of which present some claims to consideration. The plans are reduced from designs in Mr Scott Burn's work, *Model Designs for Villas*.

312. *Ground-Plan.*—In fig. 41 we give a sketch of the ground-plan, with scale attached, in which *a* is the hall, 7 feet 6 inches wide; *b b* the drawing-room, 16 feet 6 inches square; *c c* the dining-room, 16 feet 6 inches by 12 feet 9 inches; *d d* breakfast-room, 12 feet 9 inches square; *e e* kitchen, 12 feet 9 inches square; *f* scullery, 8 feet 5 inches by 12 feet 9 inches; *g* pantry, 6 feet by 4 feet 9 inches; *h* staircase, 3 feet wide.

Fig. 41.

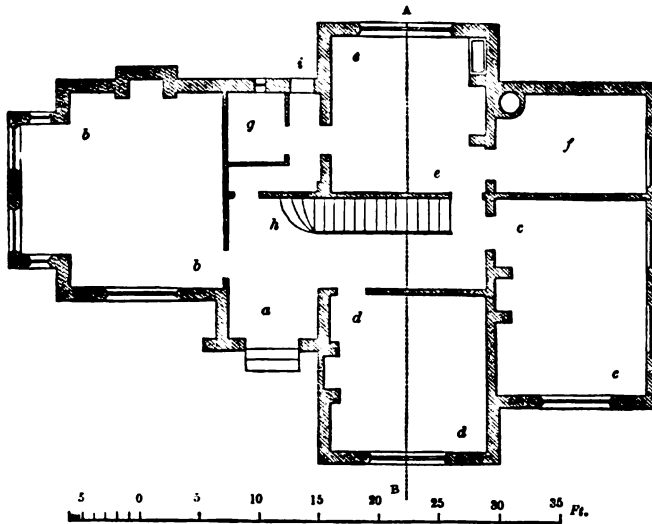

GROUND-PLAN OF FARMHOUSE IN TUDOR-GOTHIC STYLE.

Fig. 42.

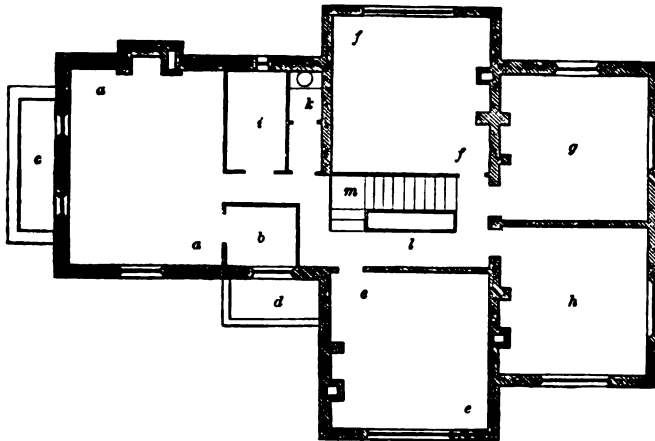

CHAMBER-PLAN OF TUDOR HOUSE—SCALE IN FIG. 41.

313. *Chamber or First Floor Plan*, fig. 42.—*a a* a principal bedroom, 16 feet 6 inches by 12 feet 9 inches, from which is entered the dressing-room *b*, 5 feet 9 inches by 5 feet 3 inches; *c* the flat over window, 4 feet wide; *d* flat over door, 4 feet wide; *e e* front bedroom, 12 feet 9 inches by 12 feet 9 inches; *f f* back bedroom, 12 feet 9 inches by 12 feet 9 inches; *g* bedroom, 12 feet 9 inches by 12 feet 3 inches; *h* bedroom, 12 feet 9 inches by 12 feet 3 inches; *i* bath-room, 8 feet by 5 feet; *k* water-closet, 3 feet wide; *l* well-hole; *m* stairs.

314. *Plan of Attic or Third Storey*, fig. 43.—*a* landing, 6 feet 6 inches wide;

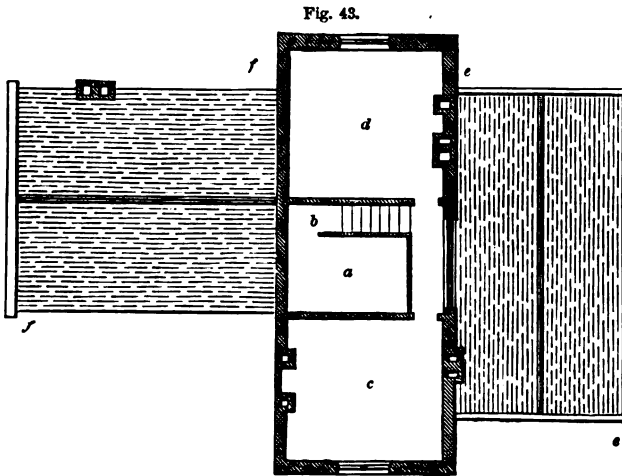

Fig. 43.

ATTIC AND PART ROOF PLAN OF TUDOR HOUSE—SCALE IN FIG. 41.

b stairs, 2 feet 6 inches wide; *c* servants' bedroom, 12 feet 9 inches by 12 feet; *d* second bedroom or store-room, 12 feet 9 inches by 12 feet; *e e* plan of roof over apartments *g* and *h* in fig. 42; *f f* plan of roof over apartments *a a*, *b*, *i*, *k*, in fig. 42.

315. *Cellar Plan*, fig. 44.—The cellar occupies the part under the apartments *d d*, *e e*, *f*, and *c c*, in fig. 41. In fig. 44 *a a* is the staircase,

3 feet wide, entered from the point *i*, in fig. 41; *b* the landing, 5 feet wide; *c* the cellar or store-room, 12 feet 9 inches square; *d* beer-cellar, 12 feet 9 inches by 6 feet; *e* wine-cellar, same dimensions; *f* and *g* milk-rooms, each 12 feet 9 inches by 12 feet.

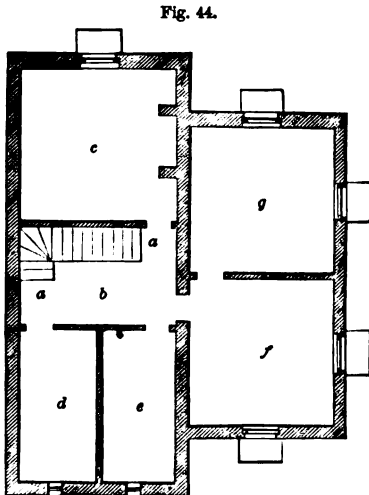

Fig. 44.

CELLAR PLAN OF TUDOR HOUSE—SCALE IN FIG. 41.

316. *Elevations and Sections*.—In fig. 45 we give sketch of front elevation; in fig. 46 back elevation; in fig. 47 end elevation towards apartments *e e* and *f*, fig. 41; in fig. 48 end elevation towards apartments *b b* and *g*, fig. 41; in fig. 49 transverse section on the line A B, fig. 41.

317. *Enlarged Drawings and Details*.—From the small scale to which the elevations now given are drawn, the peculiarities of window and door ornamentation are not observable; to show these, we now give, in fig. 50, enlarged drawings of part of the front entrance-door and window to breakfast-room *d d*, fig. 41. In fig. 51 we give elevation of gable above the apartment *e e* in fig. 42, showing barge-board, attic window, and one chimney-shaft. In fig. 52 we give the elevation of two of the three windows in end elevation, fig. 48, to the apartments *c c* and *f* in fig. 41.

From the small scale to which the elevations now given are drawn, the peculiarities of window and door ornamentation are not observable; to show these, we now give, in fig. 50, enlarged drawings of part of the front entrance-door and window to breakfast-room *d d*, fig. 41. In fig. 51 we give elevation of gable above the apartment *e e* in fig. 42, showing barge-board, attic window, and one chimney-shaft. In fig. 52 we give the elevation of two of the three windows in end elevation, fig. 48, to the apartments *c c* and *f* in fig. 41.

Fig. 45.



FRONT ELEVATION OF TUDOR HOUSE—SCALE IN FIG. 41.

Fig. 46.



BACK ELEVATION OF TUDOR HOUSE—SCALE IN FIG. 41.

318. It may be objected to the designs which we have given for first-class farmhouses that they are too ornate, and would involve in their erection a far greater sum than the ordinary circumstances of farming economy would warrant or justify. While conceiving it to be our duty to give each design complete, with the peculiar ornament fitted to its style—leaving this to be adopted or not as desired—we have endeavoured to meet the above objection by giving plans in which the picturesque effect, which should be striven after in all rural structures, can be obtained by the *outline* of the buildings rather than by the orna-

Fig. 47.

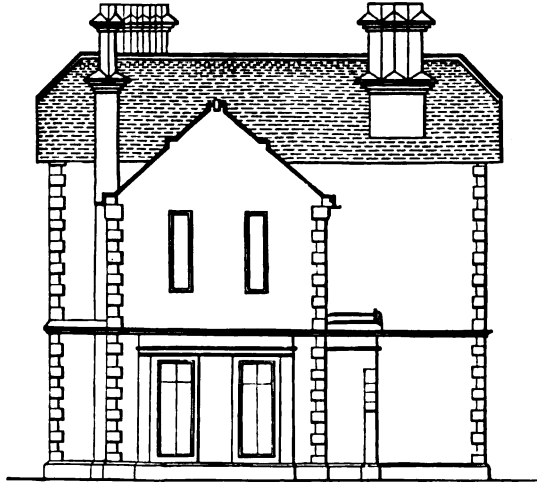

END ELEVATION OF TUDOR HOUSE—SCALE IN FIG. 41.

Fig. 48.

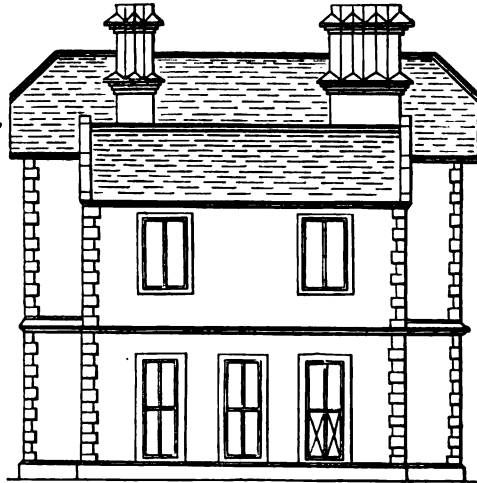

END ELEVATION OF TUDOR HOUSE—SCALE IN FIG. 41.

ments by which their exteriors may be decorated. It is possible, nay, a matter of easy attainment, to erect a house in which large sums may be expended in the exterior decoration of its doors, windows, &c., and yet a bald, tame, and anything but picturesque effect will be produced; while, on the other hand, a house may be erected with its exterior positively destitute of decoration, and yet presenting to the eye of the beholder a pleasing picturesqueness of outline. In the one case, the outline or general design of the building has been bald and tame—tea-box fashion, so to speak—attributes which no amount of external decoration could overcome; while, in the other case, general design has been

Fig. 49.

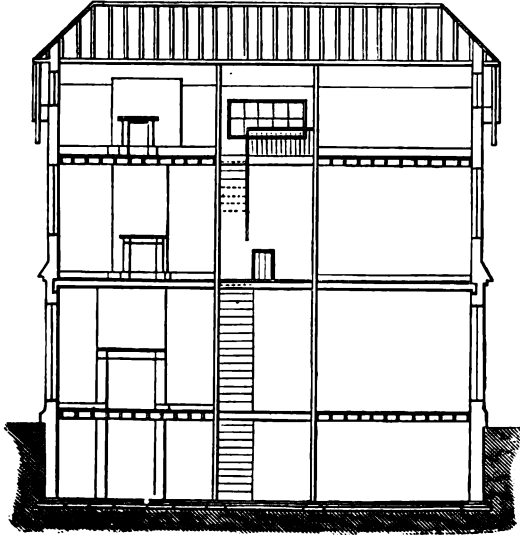

TRANSVERSE SECTION OF TUDOR HOUSE—SCALE IN FIG. 41.

Fig. 50.

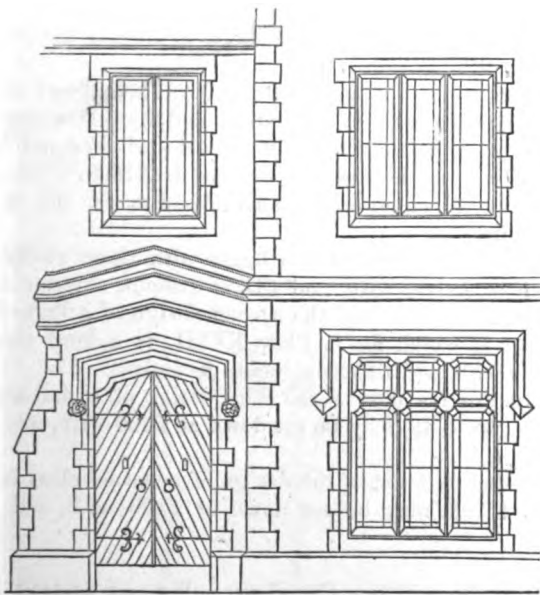

ENLARGED VIEW OF PART OF FRONT ELEVATION IN FIG. 46—SCALE. $\frac{1}{4}$ OF AN INCH TO THE FOOT.

calculated to produce a picturesque effect, by the variety of outline or projection calling into existence the effect of light and shade, and producing an effect, which the lack of ornament does not diminish, and yet, if added thereto, would at the same time be perfectly appropriate, and tend to give it a more perfect because more finished appearance.

319. The scale to which figs. 50, 51, 52 refer is $\frac{1}{8}$ of an inch to the foot.

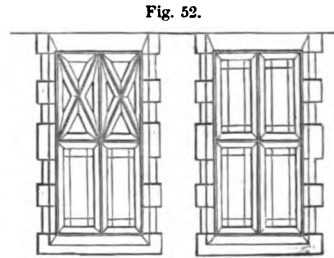
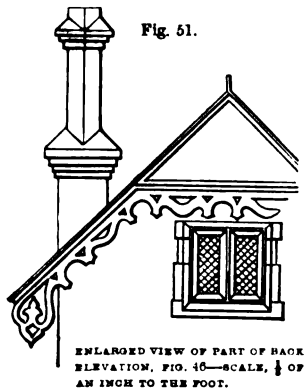

320. The minimum of internal accommodation being determined on, it may be considered as axiomatic that a picturesque outline which will embrace this accommodation will be obtained as cheaply, at least very nearly so, as one which in its tameness will ever be a blot on the landscape and an eyesore to the man of taste. A pleasing building does not depend on its external decoration for effect, but, as we have already said, upon its general design or variety of outline. The external decoration appropriate to the style doubtless gives a finish to the building, but it may be dispensed with without in any degree marring the effect of the structure. We have deemed it best to give the approximative cost with, and without, decoration, leaving the parties interested to decide on its adoption or otherwise.

321. Approximative cost of fig. 1, Plate XVIII, a front elevation in the Tudor-Gothic style, with exterior decoration, and first-class interior fittings, is £1800. Without exterior decoration—that is, the window and door voids, &c., without dressing, &c.—the cost will be reduced to £1600. This again will be lessened by adopting a plainer style than first-class for the interior fittings, grates, paper hangings, &c.

322. The approximative cost of the house with three storeys, as in fig. 2, Plate XVIII, will be £2000 with, and £1800 without, exterior decorations.

323. The approximative cost of the second design of a first-class farmhouse in the Italian style, of which fig. 3, Plate XVIII, is a front elevation, may be set down at £1700 with, and £1600 without, decoration.

324. The approximative cost of the third design of a first-class farmhouse, illustrated by figs. 45 to 49, may be set down at £900 with, and £700 without, decorations.

325. The approximative cost of the design of a second-class farmhouse, illustrated in figs. 56 to 58, may be set down at £800 with, and £660 without, decorations.

326. *Design for a Second-Class Farmhouse.*—We now present a set of drawings illustrative of the arrangements and decoration of a farmhouse, giving less accommodation than those preceding.

327. *Ground-Plan*, fig. 53.—*a* entrance-lobby, 6 feet wide; *b b* dining-room, 16 feet by 14; *c c* parlour, 13 feet by 12 feet 6 inches; *d d* kitchen, 14 feet 6 inches by 12 feet 6 inches; *e* scullery, 10 feet by 9; *f* pantry, or store-room, 9 feet by 5 feet 3 inches; *g* stair, 3 feet wide; *h* back-passage, 3 feet 4 inches wide.

328. *Cellar-Plan*, fig. 54. — *a* stair, 3 feet wide, entered from the back-passage *h*, fig. 53, by a door at the point *i*; *b* the landing-place, 6 feet wide; *c c* beer and wine cellar, 13 feet by 12 feet 6 inches; *d d* store or general cellar, 16 feet by 14 feet.

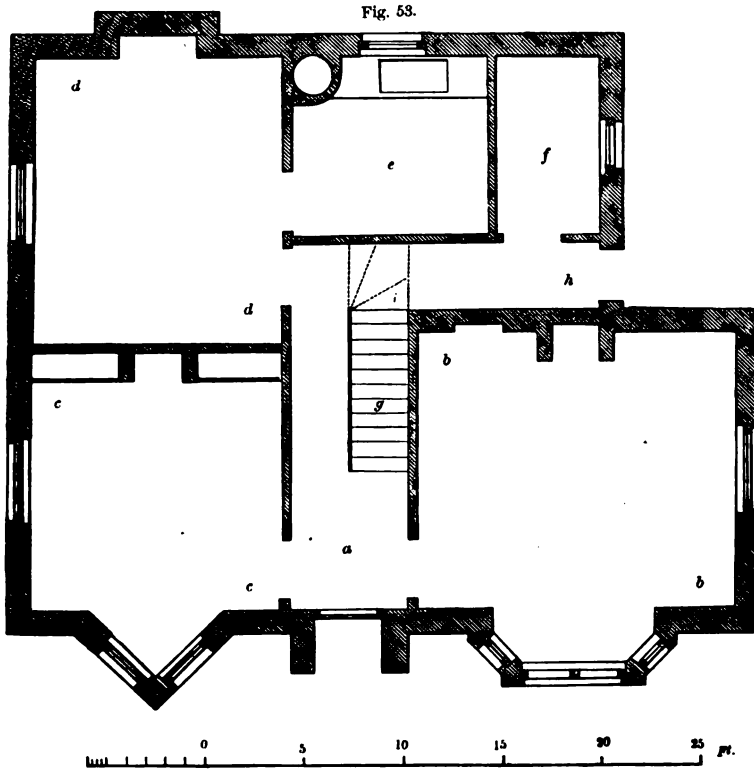

GROUND-PLAN OF A SECOND-CLASS FARMHOUSE.

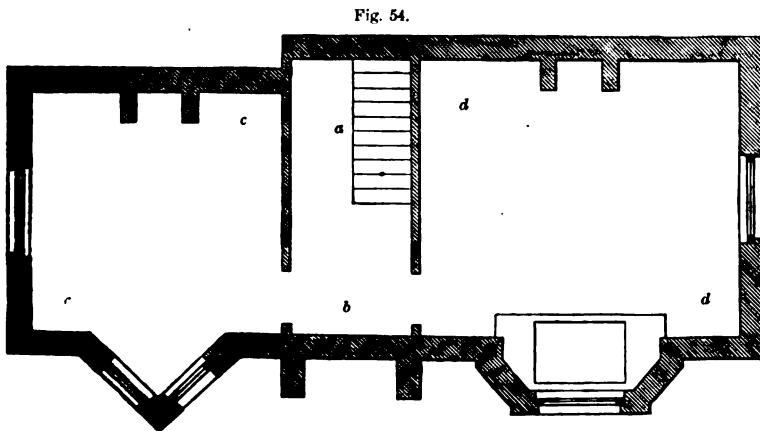

CELLAR-PLAN OF A SECOND-CLASS FARMHOUSE—SCALE IN FIG. 53.

329. *Chamber or First Floor Plan, fig. 55.*—*a* a principal bedroom, 16 feet by 14; *b* *b* bedroom, 13 feet by 12 feet 6 inches; *c* linen-closet, 6 feet by 7 feet 6 inches; *d* *d* nursery or back bedroom, 14 feet 6 inches by 12 feet

Fig. 55.

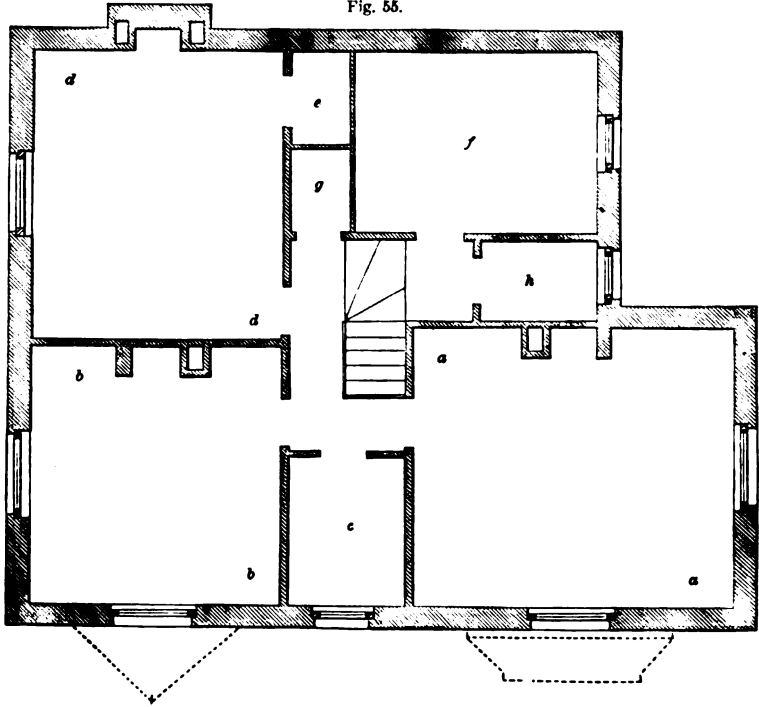

CHAMBER-PLAN OF A SECOND-CLASS FARMHOUSE—SCALE IN FIG. 53.

Fig. 56.



FRONT ELEVATION OF A SECOND-CLASS FARMHOUSE—SCALE IN FIG. 53.

6 inches, with closet *e*, 3 feet by 4 feet 9 inches; *f* servants' bedroom, 12 feet 6 inches by 9 feet; *g* closet, 3 feet by 4 feet 3 inches; *h* water-closet or bath, 6 feet by 3 feet 4 inches.

330. *Elevations*, fig. 56.—Front elevation. Fig. 57, side elevation towards apartments *c* and *d* in fig. 53. Fig. 58, side elevation towards apartments *b*, *h*, and *f* in fig. 53.

Fig. 57.

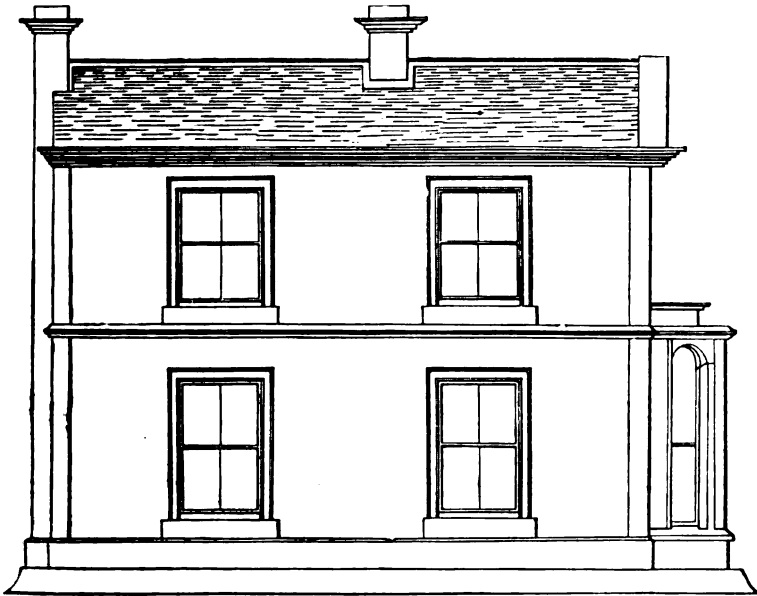

SIDE ELEVATION OF A SECOND-CLASS FARMHOUSE—SCALE IN FIG. 53.

Fig. 58.



SIDE ELEVATION OF A SECOND-CLASS FARMHOUSE—SCALE IN FIG. 53.

331. *First Design for a Third-Class Farmhouse.*—In fig. 59 we give ground-

Fig. 59.

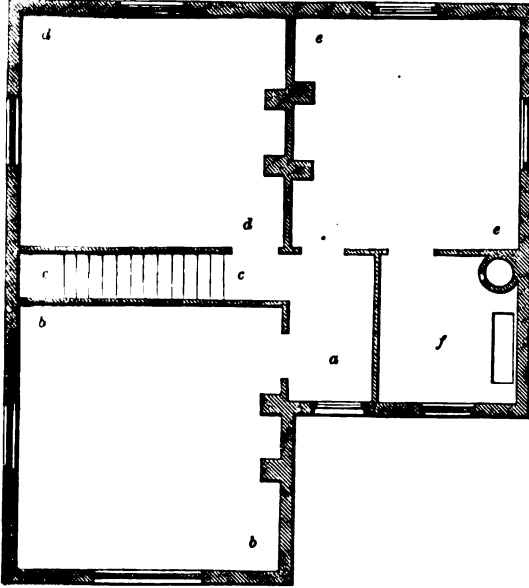

GROUND-PLAN OF A THIRD-CLASS FARMHOUSE—SCALE, $\frac{1}{4}$ OF AN INCH TO THE FOOT.

plan, and in fig. 60 chamber or first floor plan, of a two-storeyed farmhouse. The scale to which these plans are constructed is $\frac{1}{4}$ of an inch to the foot.

332. *Ground-Plan, fig. 59.*—*a* the entrance-passage, 4 feet 3 inches wide; *b* living-room, 14 feet 6 inches by 14 feet 3 inches; *c* staircase, 2 feet 6 inches wide; *d* bedroom, 14 feet 3 inches by 12 feet 6 inches; *e* kitchen, 12 feet 6 inches by 12 feet 3 inches; *f* scullery, 8 feet by 8 feet 6 inches.

Fig. 60.

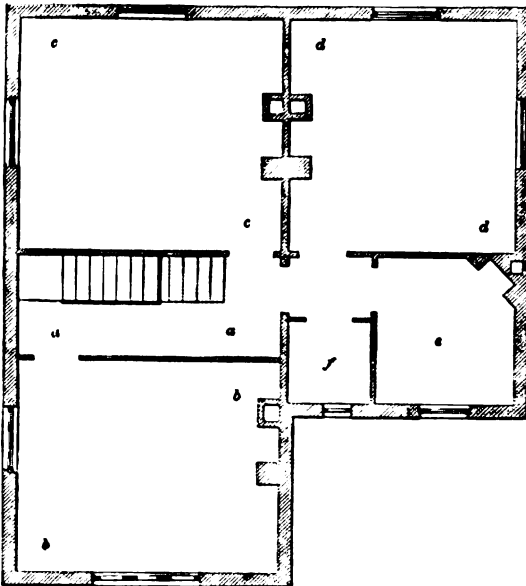

CHAMBER-FLOOR PLAN OF A THIRD-CLASS FARMHOUSE—SCALE, $\frac{1}{4}$ OF AN INCH TO THE FOOT.

333. *Chamber - Plan, fig. 60.*—*a* the landing, 3 feet wide; *b* front bedroom, 14 feet 3 inches by 11 feet 9 inches; *c* nursery or back bedroom, 14 feet 3 inches by 12 feet 6 inches; *d* bedroom, 12 feet 6 inches by 12 feet 3 inches; *e* servants' bedroom, 8 feet by 8 feet 6 inches; *f* linen-closet, 4 feet 3 inches square.

334. Of this house we give the following as the front elevation.

Fig. 61.



FRONT ELEVATION OF A THIRD-CLASS FARMHOUSE.—SCALE, $\frac{1}{8}$ OF AN INCH TO ONE FOOT

335. *Second Design for a Third-Class Farmhouse.*—In fig. 62 we give ground-plan, and in fig. 63 chamber-plan, of another two-storeyed small farmhouse.

Fig. 62.

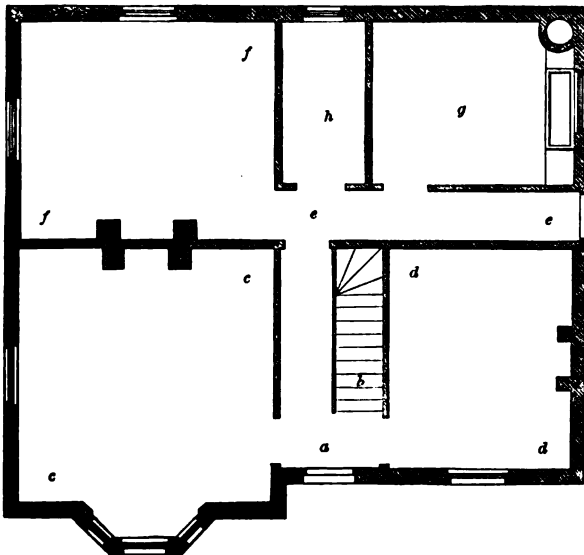

5 10 15 20 Ft.
GROUND-PLAN OF A THIRD-CLASS FARMHOUSE.

336. *Ground-Plan*, fig. 62.—*a* entrance-passage, 5 feet 6 inches wide; *b* staircase, 2 feet 6 inches wide; *c c* living-room, 14 feet square; *d d* office or parlour, 14 feet by 10 feet 3 inches; *e e* back-passage, 2 feet 6 inches wide; *f f* kitchen, 14 feet by 12; *g* scullery, 11 feet by 9; *h* pantry or store-closet, 9 feet by 4 feet 6 inches.

337. *Chamber-Plan*, fig. 63.—*a a* landing-place, 5 feet 6 inches, and 2 feet 6 inches wide; *b b* front bedroom, 14 feet square; *c c* nursery, 14 feet by 12;

Fig. 63.

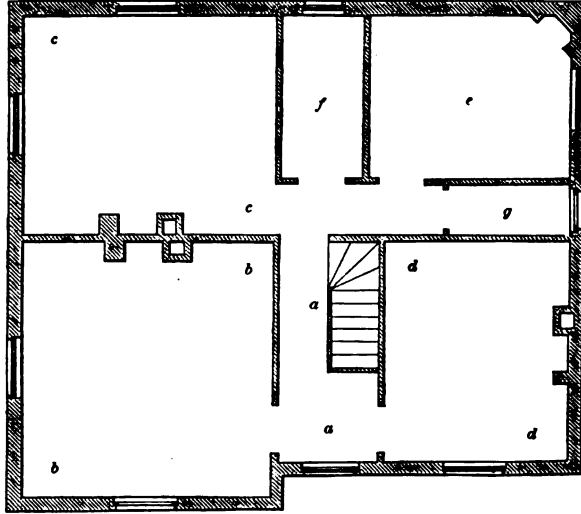

CHAMBER-FLOOR PLAN OF A THIRD-CLASS FARMHOUSE.—SCALE IN FIG. 62.

d d bedroom, 14 feet by 10; *e* servants' bedroom, 11 feet by 9; *f* linen-closet, 9 feet by 4 feet 6 inches; *g* water-closet, 6 feet 9 inches by 2 feet 6 inches.

338. Of this house we give front elevation in fig. 64.

Fig. 64.



FRONT ELEVATION OF A THIRD-CLASS FARMHOUSE.—SCALE IN FIG. 62.

339. *Third Design for a Third-Class Farmhouse.*—In fig. 65 we give ground-plan, and in fig. 66 chamber-plan, of a two-storeyed farmhouse.

340. *Ground-Plan, fig. 65.*—*a* entrance-porch, 5 feet wide ; *b* staircase, 2 feet

Fig. 65.

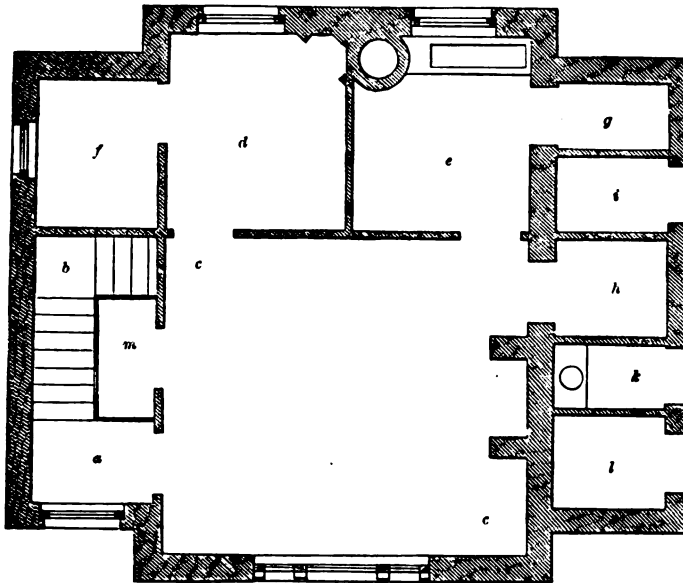

GROUND-PLAN OF A THIRD-CLASS FARMHOUSE—SCALE IN FIG. 67.

6 inches wide ; *c* living-room, 15 feet by 13 ; *e* scullery, 8 feet by 7 feet 6 inches, with boiler and sink ; *d* bedroom, 8 feet by 7 feet 6 inches ; *f* small bed-closet, 8 feet by 5 feet ; *g* pantry, entering from scullery, 4 feet 6 inches by 2 feet 9 inches ; *h* closet, entering from living-room, 4 feet 6 inches by 4 feet ; *i* coal-house, entering from outside, 4 feet 6 inches by 3 feet, and it may also enter from the scullery *e* ; *k* privy or water-closet, 4 feet 6 inches by 2 feet 6 inches ; *l* store-room, 4 feet 6 inches by 3 feet 9 inches, entering better, perhaps, from the living-room *c* than from the outside ; *m* concealed bed.

Fig. 66.

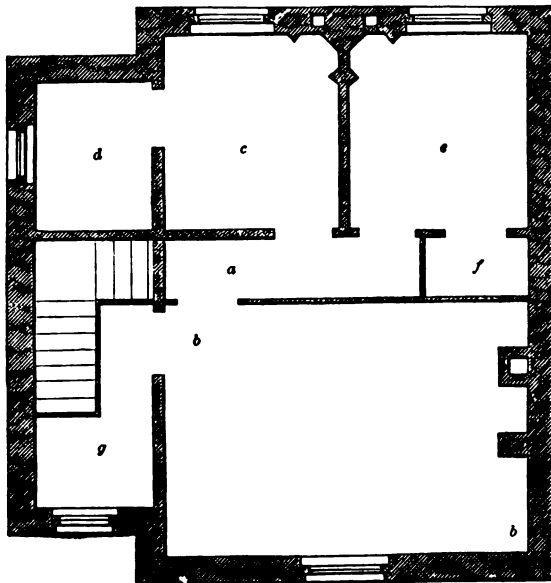

CHAMBER-FLOOR PLAN OF A THIRD-CLASS FARMHOUSE—SCALE IN FIG. 67.

341. *Chamber-Floor, fig. 66.*—*a* landing-place, 2 feet 6 inches wide ; *b* *b*

front bedroom, 15 feet by 10 feet 6 inches; *c* bed-closet, 8 feet by 7 feet 6 inches, with closet *d*, 8 feet by 5; *e* bed-closet, 8 feet by 7 feet 6 inches; *f* closet, 4 feet 3 inches by 2 feet 6 inches; *g* light store-room, 10 feet by 8 at the widest part, or it may be a bed-closet.

342. Of this house we give the front elevation in fig. 67.



343. *Fourth Design for a Third-Class Farmhouse.*—In fig. 68 we give ground-plan, in fig. 69 chamber-plan, and in fig. 70 cellar-plan, of a two-storeyed small farmhouse.

344. *Ground-Plan*, fig. 68.—*a a* passage or lobby, 5 feet wide; *b b* dining-room, 16 feet square; *c c* parlour, 14 feet by 12; *d* stairs, 2 feet 9 inches wide; *e* kitchen, 13 feet by 12; *f* scullery, 9 feet by 6; *g* pantry, 2 feet 9 inches by 2 feet; *h h* bedroom, 16 feet by 14.

345. *Chamber-Plan*, fig. 69.—*a a* landing, 2 feet 6 inches and 5 feet wide; *b b* front bedroom, 16 feet by 14; *c* linen-closet, 9 feet by 5; *d d* bedroom, 14 feet by 12; *e* bedroom, 13 feet by 12; *f* closet, 12 feet by 6; *g g* bedroom or nursery, 16 feet by 14.

346. *Cellar-Plan*, fig. 70.—*a* landing, 2 feet 6 inches wide; the part *b*, 5 feet wide, may be fitted up with shelves for larder; *c c* cellar or store, 14 feet by 12; *d* beer-cellar, 12 feet by 4.

347. Of this house the front elevation is given in fig. 71.

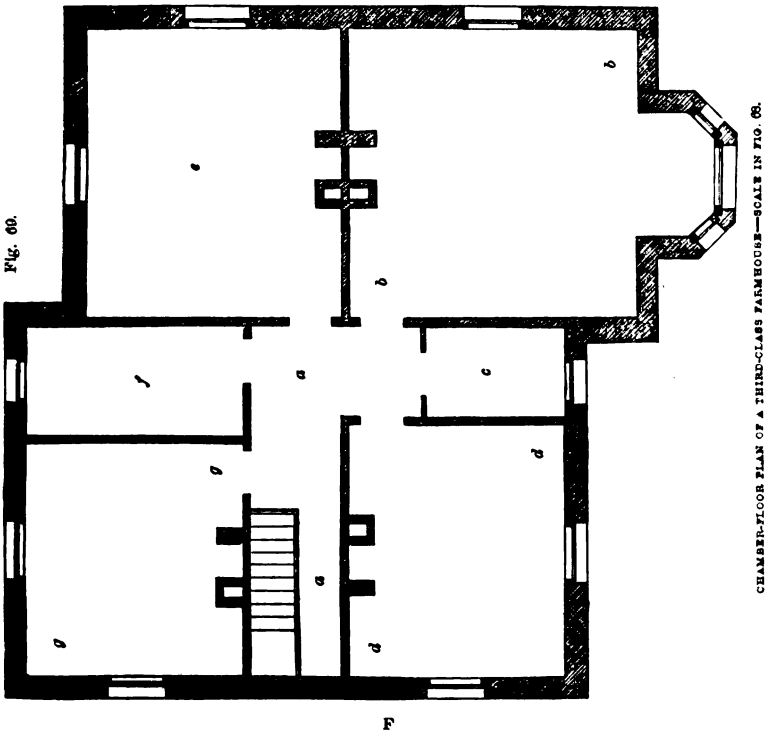
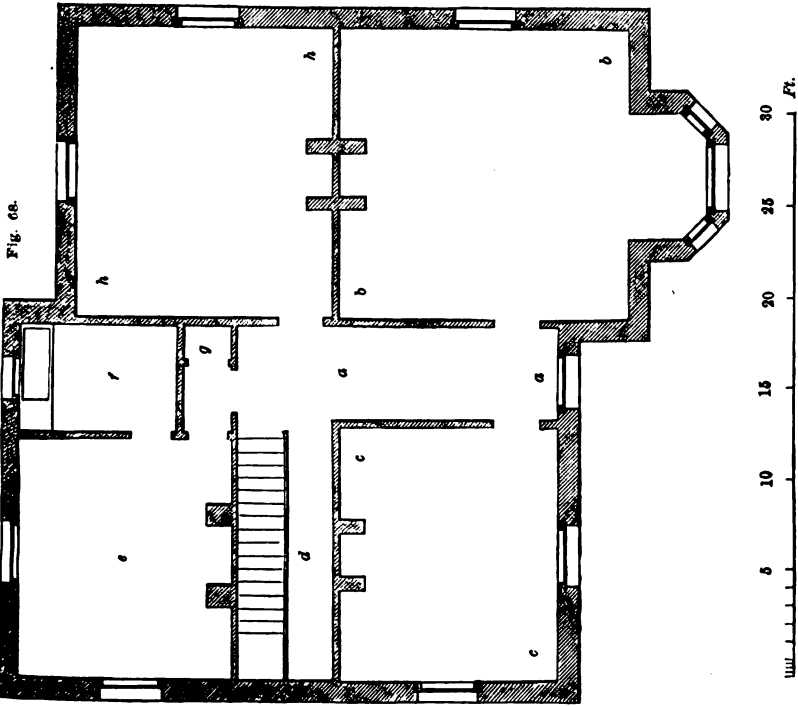
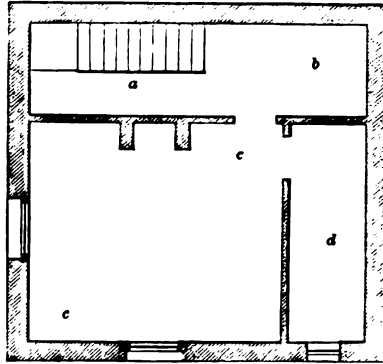

Fig. 70.



CELLAR-PLAN OF A THIRD-CLASS FARMHOUSE—SCALE IN FIG. 68.

Fig. 71.



FRONT ELEVATION OF A THIRD-CLASS FARMHOUSE—SCALE IN FIG. 68.

348. Plans of farmhouses, large and small, could be given in endless variety ; so the above plans are given more as suggestive ones for such structures than as perfect of their respective classes. Convenient arrangement of apartments, and ample room in those of them which are constantly occupied, are requisites as necessary in the farmhouse as in the farm-steading. But how often do we see in the laying-out of a farmhouse the large space sacrificed, and the constant inconvenience in consequence experienced, by making one or two large bedrooms for the accommodation of friends who only pay a visit once a-year, or not so often. It would surely be a wiser plan that a friend who stays only a

few nights, should put up with a moderately-sized bedroom, than that the whole family be inconvenienced for want of adequate room throughout the year.

349. It is a nice adaptation of things to circumstances to see the farmhouse in every respect in keeping with the extent and value of the farm. It would be quite incongruous to find a large, handsome, and ornamental house upon a poor small farm in an obscure part of the country; and it would be equally incongruous to see a mean, tasteless house set down upon a valuable farm in a richly-cultivated district. The former incongruity is seldom, if ever, met with; but the latter is not so rare as it should be. Ample accommodation in his house is due to every farmer; but a large ornate house should only be expected to be occupied by a tenant who pays £1000 of rent and upwards. No farmhouse should consist of less than two storeys, in order to distinguish betwixt the farmer and the farm-steward or bailiff, who, if fulfilling a high position as to management, or having a large family, might justly lay claim to a two-storeyed house, though it should not be as ornate as that occupied by a tenant. In the variety of houses we have given above, and which are still to follow, we hope that no difficulty will arise in choosing one fit for a tenant and another for a bailiff.

DIVISION FOURTH.—PLANS OF FARM COTTAGES.

350. OF the various schemes brought forward during the last fifteen or twenty years—a period fruitful in philanthropic projects—for the improvement of the social condition of our agricultural labourers, none perhaps has met with so much notice, and obtained such general favour, as that having for its object the improvement of their dwelling-houses. The labours of the press, of associated bodies, and of isolated individuals, possessed at once of interest in the question and influence in furthering its practical development, have all aided in placing the subject on a broad and permanent basis; and in a space of time marvellously short in the history of any social movement, have raised it from a position humble in the extreme to one comparatively high in the estimation of the public.

351. But while gladly admitting that much practical advance has been made in this department of social progress, a full and candidly carried out investigation of the agricultural districts of Great Britain shows, nevertheless, that more remains yet to be done. In truth, what has been bears a miserably small proportion to that which has *yet* to be effected, in bringing the house-accommodation of our labouring population into that condition which sanitary science shows us to be needful, before we can secure the full and healthy development of their working capabilities. It needs but a limited inspection to convince us that, as dens in the city street, so hovels in the country hamlet, stare us in the face as of old. The biting blasts of winter blow fiercely through the chinks and crevices of dilapidated dwellings; the rain soaks through the roof-tree and battered wall; green-hued pools and reeking masses of filth pollute the air around; and this not in the close alleys of the city, but in the purer air and brighter skies of the country. While in many districts we yet find that the homes provided for the labourers of the farm may be described by the pithy sentence, “floor, walls, and roof”—and these, too, of the worst materials, put together in the most slovenly of ways—we see on the same farm the utmost attention paid to the housing of the cattle reared on them, as if the bone and sinew of the inferior

animals were of infinitely more importance than the health and comfort of those who were hired to attend upon them. This indifference to the physical wants and moral necessities of the agricultural labourer, strange as it is in its philosophical phases, is unfortunately as deplorable in its social results.

352. The following, although written some years ago, may be taken as a type of the condition of the cottages of the agricultural labourer in many of our farming districts—more particularly perhaps in England—of the cottages of a district of which (Northumberland) one sentence is in fact a description: “The general character of the best of the old-fashioned hinds’ cottages in the neighbourhood is bad at the best. They have to bring everything with them—partitions, window-frames, fixtures of all kinds, grates, and a substitute for ceiling; for they are, as I have already called them, mere sheds. They have no byre for their cows, no sties for their pigs, no pumps or wells, nothing to promote cleanliness or comfort. The average size of these sheds is about 24 feet by 16. They are dark and unwholesome. The windows do not open, and many of them are not larger than 20 inches by 16. Into this space within the shed are crowded eight, ten, and even twelve persons. How they lie down to rest, how they sleep, how they can preserve common decency, how unutterable horrors are avoided, is beyond all conception. The case is aggravated when there is a young woman to be lodged in this confined space, who is not a member of the family, but is hired to do the field-work, for which every hind is bound to provide a female. It shocks every feeling of propriety to think that, in a room, and within such a space as I have been describing, civilised beings should be herding together, without a decent separation of age and sex. So long as the agricultural system in this district requires the hind to find room for a fellow-servant of the other sex in his cabin, the least that morality and decency can demand is, that he should have a second apartment, where the unmarried female, and those of a tender age, should sleep apart from him and his wife.” “If we follow,” says another writer, “the agricultural labourer (in Bedfordshire) into his miserable dwelling, we shall find it consist of two rooms only. The day-room, in addition to the family, contains the cooking utensils, the washing apparatus, agricultural implements, and dirty clothes; the windows broken and stuffed full of rags. In the sleeping apartment, the parents and their children, boys and girls, are indiscriminately mixed, and frequently a lodger sleeping in the same and only room: generally no window—the openings in the half-thatched roof admit light, and expose the family to every vicissitude of the weather. The liability of the children so situated to contagious maladies frequently plunges the family in the greatest misery.”

353. But lest our readers should deem these to be descriptions of the hovels of bygone times, we quote from the description of recent writers accounts of the present condition of the houses of labourers in many of our agricultural districts: “Look,” says a graphic writer*—one who has widely and practically investigated the subject in all its bearings—“at those structures called cottages. They are mere hovels of mud, or of ‘wattle and daub,’ or of rubble stone set in mud, or of rude timber frames filled in with mud, or with brick, or with stone, or with other material. The timber is rotten; the mud, bricks, and stones are damp in wet weather, and dusty in dry weather. Look at the site—probably a hole—not unfrequently a swamp several feet below the adjoining road, the slope being towards the door. If on an elevation, the ground is unformed, rugged, abrupt, uneven, and neglected. Many of these hovels are only one storey in

* Mr R. Rawlinson. *On House Accommodation: its social bearing, individually and nationally.* A Paper read before the Society of Arts, Feb. 3, 1858.

height, the side walls are very low—from three to six feet up to the square—few are vertical, and some are supported by buttresses or by props. Many are half-buried against a hill-side, or against a bank which is wet. Then the roof: this is of thatch, of heather, or of straw; or is formed of sods, of shingle, of tile, or of slate. If of thatch, the material is rotten with age, and green with fungoid vegetation; if of shingle, the timber is decayed; if of slates, they are broken and in holes. Doors and windows match the structure, and the floor is of native mud—the space enclosed being common to bipeds and to quadrupeds alike. The floor is not only very dirty, but the walls, furniture, and roof, are the colour of grimy dirt. Amongst the rafters, spiders and other insects abound. Outside, animal refuse is stored in some hollow where liquid permanently rests, so as to keep up evaporation and an evolution of gases highly injurious to human life; and if this refuse does not actually surround the hovel, it is frequently so situated that the prevailing winds shall drive the gases of decomposition into and through the habitation. The arrangements for disease, misery, and premature death are ample, adequate, and complete. The hovel is crowded by males and by females of all ages without means of separation, so that the arrangements for sin and misery are also complete.”

354. Another well-known philanthropist, the Rev. Harry Stuart, of Oathlaw, in Forfarshire, thus remarks on the present condition of the labourers' houses:—“Very many families get as yet but one damp ill-aired apartment to accommodate them. I have seen such suffering, such ill, and such deaths from this, that I feel I should greatly fail in duty did I lose this opportunity of giving it the greatest condemnation in my power; and even where they have a spare bed-closet for a visitor, the bed in it is always damp. . . . And to what do they owe all their severe sufferings in old age—from rheumatic pains, and rickets, and scrofula, and ringworm, and itch among their children—but to their damp ill-aired hovels.”

355. But if this character is so true of the houses of the married, as bad a one is given by the same writer of those of the unmarried labourers in many districts. The “bothy,” for such is the name given to the shelter—it would almost be a desecration of the sacred name of home to call it such—is “very seldom more than an ill-built small house of one apartment, having no in-door, no lath, no plaster, no floor, hardly a window, and a vent (chimney) that will hardly draw. No chair, no table; an old broken stool or two, two or three rickety bedsteads, one iron pot, and one iron large spoon or ladle, a water-bucket, and a litter of fuel and filth.” This is “all the accommodation and furniture that some half-dozen or a dozen constantly and heavily toiled men have to make themselves comfortable with from one year's end to the other.” “If any man,” says the same author, “is entitled to a comfortable resting-place to recruit his strength, it is the agricultural labourer, by far, according to Dr Adam Smith, the most productive of all labourers. And on the bare question of thews and sinews only—if there be any truth in the principles and findings of animal chemistry, on which you now house, and bed, curry, and feed your cattle—such refreshing places would pay you the best of any.” . . . “Damp, nasty, and unwholesome habitations depress the spirits and enfeeble the exertions not only of man but of brute animals; yet such, I venture to assert, are the habitations of nine-tenths of the ploughmen of Scotland.”

356. Seeing, then, that so much remains yet to be done in combating the indifference and in awakening the interest of those connected with agriculture in this great social question, we may perhaps be permitted to enter somewhat

fully into a consideration of the chief points connected with what may here be called the philosophy of the subject. These resolve themselves into two divisions, the *physical* and the *moral*.

357. And first, as to the physical evils resulting from ill-arranged and badly-constructed houses for the poor. Take, for instance, the damp, defective drainage and bad air as perhaps the most potent influence acting for evil in and around the houses of the poor, and let us trace briefly their effects on the health of the population.

358. As to the first of these, damp, the following is trustworthy evidence:—“When experienced medical officers see rows of houses springing up on a foundation of deep retentive clay, indifferently drained, they foretell the certain appearance among the inhabitants of catarrh, rheumatism, scrofula, and other diseases, the consequence of an excess of damp, which break out more extensively and in severer forms in the cottages of the poor who have insufficient means to purchase the larger quantities of fuel, or to obtain the other appliances by which the rich greatly counteract the effects of dampness.”—(*Report to the Board of Health on Suburban Drainage.*)—The Rev. Mr Stuart, in his well-known pamphlet, which we have already quoted, has some forcible remarks on the evils arising from the damp houses of the agricultural labourers, which space does not permit of us giving here, but of which the following is the concluding portion:—“Oh, it is hard to see, as I have seen, the delicate mother of a numerous young family lingering out a consumption, and blaming, unheeded, the damp of their house for it all, and no way of getting her removed out of it. And I have now in my eye, but mouldering in the dust, some of the finest specimens of country-labourer youths, both as to body and as to mind, that we would wish to see, who blamed nothing else for cutting short their days but their living in some ‘*damp hole*,’ as they called it. A son or daughter comes home sick, and nowhere to put them but into a damp closet.” It is needless here to multiply evidence as to the bad effects of damp cottages on the health of those inhabiting them. Very little consideration, indeed, is necessary to show how potent an influence it is in inciting a variety of diseases, and of that class, too, which rapidly and effectually prevents the labourer from exercising his fullest strength.

359. Turning now our attention to the physical evils resulting from the presence of drainage matters in the immediate neighbourhood of cottages, that which

“Floats a nauseous mass of all obscene, corrupt, offensive things,”

we shall find that they are not less marked in their influence on the health of those subjected to them.

360. “The presence of impurity,” says an able authority, “produced by the decomposition of animal and vegetable matter, is now established as a constant concomitant of the excessive ravages of typhus and other epidemic diseases in towns, and a proportionate exemption from such maladies has marked the removal of the sources of aerial pollution. In proportion as perfect cleanliness has been obtained in prisons, the gaol fever has ceased to exist, and a comparative exemption from the entire class of zymotic diseases has followed the progress of purification in every description of inhabitants.”

361. Dr Southwood Smith says, that he believes the “immediate and direct cause of fevers to be a poison generated by the decomposition of animal and vegetable matters.” Dr Arnott, also, on this point, remarks, that the localities where “fever first breaks out, and in which it becomes prevalent and fatal, are invari-

ably those in the immediate neighbourhood of uncovered sewers, stagnant ditches and ponds, gutters full of putrifying matters, nightmen's yards and privies, the soil of which lies openly exposed, and is seldom or never removed." From malaria produced by these noisome places, too frequently met with in connection with cottages in rural districts, other diseases are induced; "diarrhœa, and a long catalogue of strumous affections, are some of them. The former disease is sometimes very severe in those localities, and in the autumn prevails in the epidemic form. It is now ascertained beyond a doubt that open sewers, stagnant ponds, and masses of vegetable matter, furnish the chief sources of the disease called English cholera."

362. It would be easy to add evidence to evidence in proof of the fact that "dirt makes disease," as it was by some one pithily said, but surely there is little need of it. "History, daily experience alike teach us," as we have elsewhere remarked, "that the haunts of fever have always been amongst the houses of filth;" and that the converse holds equally true, that cleanliness of houses and of persons has always acted as the best preventive of disease. These diseases so caused are not an essential part of our social condition; if so, however much we might deplore their presence amongst us, we could do nothing effectually to remove them, and nothing would remain for us but to cross the hands of patience, and with the Turk in his fatalism exclaim, "Allah el Allah," God is merciful. But things are not so with us. Those maladies, we fear, which come under the influence of filth, are "self-imposed; they are the annoyances of our culpable ignorance, neglect, and folly. It is in our power to avert them, and we know the certain means of doing so. There is no typhus fever where there is absolute cleanliness; but it is in our power to make our villages, towns, and dwellings, absolutely clean; it is therefore in our power to prevent the existence of this plague. Wherever we have drained our marshes, ague or intermittent fever has disappeared, and when we shall have thoroughly purified our towns and houses, typhus fever will equally cease to exist. By enforcing scrupulous cleanliness, we have for some time banished this disease from our union workhouses and from prisons; and now, by giving to the houses of the industrious classes efficient drainage, the ready means of removing solid refuse, a good supply of water, and water-closets instead of cesspools, we have placed a barrier around those dwellings which the mortal pest of our towns and cities has not been able to pass."

363. Glancing for a brief space at the evils of deficient ventilation, we find that they are not less marked than those arising from defective drainage. Indeed, recent experience goes to prove that impure air from the respiratory organs has a more deleterious influence on health than the malaria arising from putrid drainage matters. Thus—"In the Dublin Lying-in Hospital, of 7650 children born within a given period, 2944 died within fourteen days of their birth; but on the hospital being ventilated, the mortality fell to a proportion which proved that 2000 out of the 2944 children who had died had fallen a sacrifice to the poisoned air of the hospital." Dr Simon, medical officer to the Corporation of London, tracing in an elaborate report the evils of deficient ventilation, states it to be "one of the chief causes not only of many definite diseases, but of a general deterioration of health in large numbers of the community. It is the prime agent in the organisation and propagation of that scourge of our clime—consumption—a cause of mortality the more jealously to be guarded against that it perpetuates itself from generation to generation." . . . "The tendency to tubercular disease is one which transmits itself from parent to child; and thus, if in any one generation the disease be artificially engendered or increased, that mis-

PLANS OF FARM COTTAGES.

It does not confine its consequences to the generation which first suffers from it. *It tends to increase tubercular disease among the adult members of the community, and may be regarded as assuredly tending to produce a progressive deterioration of man.*

Sanitary considerations such as those we have briefly laid before our readers are a question of the highest importance to us all. Apart from its humanitarian aspect, it is well to consider the importance of its pecuniary or partly pecuniary one. For it must be obvious to the meanest comprehension, that unnecessary death and disease must be a loss to the community. All the misery which exists by a neglect of sanitary arrangements must be paid for; every death involves the loss of a certain amount of money which must in some shape or other be drawn from the survivors who are able to pay, and this, whether collected in the name of poor-rates or prison-rates, or on any of the numerous modes by which money is obtained either for supporting wretchedness, or endeavouring to prevent or to punish crime. If it is true that "a wrong to the individual is a wrong to the state," it is equally true, "that shortness of life," from whatever cause, "among individuals, is a heavy calamity to the community at large." On this point an able writer has the following: "The more closely the subject of the evils affecting the sanitary condition of the labouring population is investigated, the more widely do their effects appear to be ramified. The pecuniary cost of noxious agencies is measured by data within the province of the actuary, by the charges attendant on the reduced duration of life, and by the reduction of the periods of working ability, or reduction by sickness. The cost would include also much of the public charge of attendant vice and crime, which come within the province of the police, as well as of the destitution which comes within the province of the administration of relief. To whatever extent the probable duration of the life of working men is diminished by noxious agencies, I repeat a truism in stating that, to some extent, so much productive power is lost, and, in the case of destitute widowhood and orphanage, burthens are created and cast either on the industrious survivors belonging to the family, or on the contributors to the poor-rates, during the whole period of the failure of such ability."

365. These considerations are further and ably enforced in the following sentence: "The health of the people is the chief wealth of a nation; for health is life, and without a strong vitality no community can be prosperous or powerful. The vigour of the Anglo-Saxon race is the true source of Britain's greatness, of her freedom and industry at home, of her marvellous success as a coloniser, and of the respect and envy with which she is regarded by other nations. But her advance in power and civilisation is attended with dangers that threaten its very continuance. Emigration drafts off many of the strongest members of the community, wars in various portions of our widespread empire draw away thousands of men in the flower and prime of manhood, of whom large numbers return no more, and at home disease and privation enfeeble vast masses in town and country. And all these causes tend to the deterioration of the parent stock of that extraordinary race to which in this latter day the dominion of the earth seems to have been given. For the prevention of such a result, it becomes the statesman and the moralist, no less than the sanitary reformer, to labour. From the investigations of the latter, it plainly appears that most of the evils which assail the health of the community have their root among the masses living under conditions unfavourable to the development of an average degree of vital vigour. There they are ripened to fatality, and thence they spread through the

entire body social. The conclusion of the poet is equally applicable to physical as to moral health—

“Tis life of which our nerves are scant,
More life, and fuller, that we want.”

366. We have yet to notice the *moral* effects resulting from defective house-arrangement; and but little investigation is required to show that these exercise an amazingly powerful influence for evil. If the arrangements of houses are subversive of what are acknowledged by all as the principles of decency and morality, and are calculated to engender habits of carelessness in personal and household appearances, it is axiomatic that the reflex influence on their inhabitants will be to degrade and lower them in the social scale. The converse of the case needs not to be stated. We can scarcely conceive of a neighbourhood in which there are good, however cheap, convenient and decently-arranged houses, very remarkable either for the depravity of their inhabitants, or the uncleanness of its exterior thoroughfares; at least the experience of the last few years shows that the reverse of this is to be expected. Before the minds and habits of the people can be improved, it is imperatively necessary that their physical amendment should precede all other measures. The physical condition of the labouring classes has been called by Mr Mills “the great economic question of the day,” and “in no other way can it be so efficiently ameliorated as by the improvement of their houses.”

367. “When,” says one who knew the poor well, and the temptations to which they are subjected, “the mind has become habituated to filth, and has lost the taste of a comfortable dwelling, the supply of money goes only to satisfy the appetites that remain. What these are, how gross and debasing, we need not stop to inquire.” “The universal influence of filth and discomfort,” says another authority, “has never been sufficiently attended to. That influence is, in the highest degree, anti-social. The wretched state of a man’s house is one of the most powerful causes which induce a man to spend his money in strictly selfish gratifications. He comes home tired and exhausted; he wants quiet, needs refreshment; filth, squalor, and discomfort in every shape around him, he naturally gets away from it if he can.” One who possessed a wide and intimate acquaintance with the house-condition of the labouring poor, expresses his surprise that the moral evils are not more marked than they really are. “I must confess,” he says, “that the wonder to me is, not that so many of the labouring classes crowd to the gin-shop, but that so many are to be found struggling to make their wretched abodes a home for their families.” This remark, however, applies to the farm-labourer of England, and not to that of Scotland, who is not addicted to go either to the beer or gin shop. Yet even in Scotland we cannot forget that “in these wretched dwellings all ages and all sexes—fathers and daughters, mothers and sons, grown-up brothers and sisters, stranger adult males and females, and swarms of children, the sick, the dying, and the dead—are huddled together with a proximity and a mutual pressure which brutes would resist, where it is physically impossible to preserve the ordinary decencies of life, where all sense of propriety and self-respect must be lost, to be replaced only by a recklessness of demeanour which necessarily results from vitiated minds.” As the houses so the people; with depressing influences we cannot expect to find elevating thoughts—decency with dirt, piety with pollution—the sanctities of privacy with the temptations of publicity. “From a ministerial experience,” says the Rev. J. Puckle, incumbent of St Mary’s, Dover, “of thirteen years, I am perfectly

satisfied of the close connection subsisting between the sanitary and moral condition of our poorer classes. I have found, without any exception, the worst demoralisation in the worst constituted dwellings and neighbourhoods; the one being traceable from the other directly, as effect from cause. To what extent we may succeed in raising the moral tone of our poor people's habits of life, time can only show; but I affirm that, to raise them while they live in such places and under such circumstances is impossible." Another clergyman thus gives his opinion: "The poor man when fatigued cannot be expected to remain in his house if his wearied senses are to be oppressed by noisome stenches and disgusting objects. He naturally seeks the beer-shop as a refuge, and his wife and family are left to seek relief under such circumstances as they may. Thus the domestic bond is loosened, if not severed: he ceases to regard his family, and they cease to respect him; and so a generation of reckless and unprincipled persons is by these means turned out upon society." Strange inconsistency it surely is in those who believe the family tie to be a divine institution, and the influence of the hearth and the home to be potent for good if rightly directed, to do all they can to sever the tie and weaken the influence. Still more inconsistent is it to allow the publichouse-keeper to be the successful caterer for fireside comforts which the poor man cannot obtain at his own home, and which we take special care, or are careless of altogether, not to supply in another and a more innocent direction.

368. We have made bold thus to place some points before the reader in behalf of a class who have not many opportunities to say much for themselves. We are no advocates of that sickly sentimentality which would do all for the labourer, and allow him or ask him to do nothing for himself. There must be a mutuality of effort as well as of interest in all matters of social progress; the labourer must do his part as well as the landlord his. But in some things the labourer is powerless for all action, and this matter of house improvement is one of them. Hence, from the hopelessness of any movement being made by the poor themselves, arises the earnestness of those who ask the assistance of landlords and men of influence to aid this great social movement by practical efforts, and to impress upon those who have property, with its attendant rights and privileges, the importance of taking the initiative in this great question of social reform. As well might we expect a private individual to initiate and carry out a public undertaking, such as a canal or a railway, as expect poor men to build houses, pave streets, lay down pipes to bring in the pure, and drains to carry off the foul, water. Are we who have some legislative influence, and possessed of some pecuniary power, so quick at perceiving the disadvantages of some social abuse, and in getting the remedy applied, that we have any right to expect that the poor, with no influence, shall at once see the disadvantages under which they labour, and, with their lack of pecuniary power, resolve at once to get rid of them? We are a conservative people, truly. But, if property has its privileges, it has its duties also, and these will have, one day or other, to be accounted for. The dictates of the religion we profess, and the impulses of a benevolence we admire, equally demand that we, who have the opportunities of place or power afforded us, shall do all we can to remedy the evils which press so hard upon our labouring poor—evils which, if unremedied, may—nay, assuredly will—bring about a state of matters pregnant with infinite danger to the welfare of the state. Better to go about this question of "remedy" with the grace of a ready compliance, than to allow the evils to increase till the question of "right" shall be mooted. "Why," it has been eloquently asked, "should persons be allowed to erect human habitations in situations and in construction so palpably at variance

with every principle of health or convenience? What right has any man to crowd human beings, poor though they be, into a space utterly incompatible with wholesome, not to say comfortable, existence? Upon what ground does any one presume to confine this less fortunate portion of his species within limits infinitely too small, and obviously insufficient for the maintenance of the healthy functions of vitality? What avail public generosity and private benevolence, our hospitals and dispensaries, if their funds are to be expended and their wards are to be peopled with the inmates of those dens and hovels of infection! It is sacrificing the charity of the many to the cupidity and recklessness of the few; it is catering for the victims of a sordid and unprincipled speculation. If prevention be better than cure, precautionary means wiser than remedial arrangements, the counteraction of existing and immediate mischief more judicious than its subsequent and tardy correction, then it is the duty, as we doubt not it will be the wisdom, of the legislature to enact laws, and rectify, so far as may be, the abuses of the past."

369. An objection commonly made by those who profess to have an interest in the social movement whose claims to the notice of the landlord we have been advocating is, that cottages with improved arrangements do not pay. On this point we are half inclined to say, that those who enter into the matter, careful only as to the paying consideration, had better not enter into it at all. We do not say that the "per-centage" obtained for outlay is not to be considered; on the contrary, it is a fair and legitimate hope, on the part of any capitalist who builds superior houses, that he shall be in fair measure repaid for the outlay. But this matter of repayment is not, we hold, the only point to be considered. What these are cannot be better placed before the reader than in the words of a letter addressed by the Duke of Bedford—a nobleman who has always evinced a high degree of interest in the welfare of his peasantry—to the Earl of Chichester. "Cottage buildings," says his Grace, "except to a cottage speculator, who exacts immoderate rents for scanty and defective habitations, is, we all know, a bad investment of money; but this is not the light in which such a subject should be viewed by landlords, from whom it surely is not too much to expect that, while they are building and improving farmhouses, homesteads, and cattle-sheds, they will also build and improve dwellings for their labourers, in sufficient number to meet the improved and improving cultivation of the land. To improve the dwellings of the labouring class, and afford them the means of greater cleanliness, health, and comfort in their own homes—to extend education, and thus raise the social and moral habits of those most valuable members of the community—are among the first duties, and ought to be amongst the truest pleasures, of every landlord. While he thus cares for those whom Providence has committed to his charge, he will teach them that reliance on the exertion of the faculties with which they are endowed is the surest way to their own independence and the well-being of their families. I shall not dwell, as I might, on the undeniable advantages of making the rural population contented with their condition, and of promoting that mutual goodwill between the landed proprietor and the tenants and labourers on his estate which sound policy and the higher motives of humanity alike recommend."

370. As far as the farm is concerned, the question of the cost of erecting cottages to be occupied by farm-servants is quite irrelevant. A farm can no more be conveniently tenanted without servants' houses than without a farmhouse or a farm-steading. No landlord ever dreams of asking a rent for the farmhouse or the steading separate from that of the farm, and why should any difference

be made in this respect as regards the servants' houses? When a farmer offers for the farm he wishes to occupy, his offer has reference to the state of the farmhouse, the steading, and the servants' houses, as well as to the state of the land. Whichever of the houses he finds in bad order, and is obliged to repair them himself, his offer for the farm is proportionately of less amount than when they are all in good order; or he stipulates for the landlord to undertake the repairs or the rebuilding of them. Whatever may be the case of detached cottages, occupied by other labourers than farm-servants, whether or not they are objects of good or bad investment of money, that consideration should in no case have reference to the necessary dwellings of the servants of the farm. Farm-servants must be accommodated with dwellings suitable to their condition and wants, as well as the farmer himself; and should those dwellings be inadequate for their purposes, the landlord alone must be the loser, in the diminished rent of the farm. Hence the cost of erecting cottages for farm-servants is a question which should never be raised—they being a necessity.

371. Upon this subject the *Quarterly Review* for April 1860, in its article on "Labourers' Houses," quotes with approbation the following remarks of a writer in the Associated Architectural Societies' Reports for 1851: "The landlord proprietor," says the writer, "must be content to look for his return from improved cottages just (only in a higher sense, and I may say, too, in a more direct way) as he does from improved farm-buildings and farmhouses—viz. in the general and permanent amelioration of his estate thereby. Nor does this apply only to our magnates in land: no proprietor would be expected to provide more cottages than his estate will fairly support, any more than he would be expected to build barns and sheds beyond the requirements of his farm; but with less than this he cannot expect either labourer or tenant will be satisfied. The fact is, that it is this very non-remuneration of cottage-building that is the landed proprietor's greatest safeguard. If good cottages could really be built at a paying price, every parish in the country that had an acre of ground, independent of the great proprietor, would soon swarm with them. But the natural constructive faculty which leads every man to build who can afford it—the love of independence of having a house of one's own, and the privileges of a county vote—there would always be on the look-out, as indeed there now is, a herd of small builders ready to invest their capital, if they have it—if not, their labour—in this precarious but most tempting kind of property. I own, then, that the day of well-paying cottages is a day I never wish to see. The present state is one of those 'burdens upon land' which the proprietor may with good heart make up his mind to bear. While I would advocate the strictest economy in cottage building—looking upon all ornament for the sake of ornament as, in this place, the most offensive of all, and the worst of shams—I cannot but rejoice rather than grieve, that the unprofitableness of this kind of building necessarily throws it on the shoulders of those best able to bear it, and thus keeps up that kindly dependence of the labourer upon his master, which I, for one, never wish to see broken up; while at the same time it gives the landlord a fair claim to interfere in the economy of the cottage, and to lay down such rules with respect to lodgers, &c., which, even in the best built cottages, are necessary to protect the poor against themselves, and prevent those crowded bedrooms which are the greatest evil we have now to contend with. If cottages paid as remuneratively as other houses, I don't see how the landlord could prefer this claim."

372. The tendency of these observations leads the reviewer himself to express the opinion that "there can be no doubt in the minds of those who have the welfare of the poor at heart, that there can be no greater blessing to them

than to keep them out of the hands of speculative builders of small capital, the hardest of all landlords, and to make them the tenants neither of shopkeeper or farmer, but of the proprietor of the land." Had the opinion been confined to the propriety of the owner of cottages, occupied by independent labourers, being the landlord, we would readily assent to it. But if the owner is to be the landlord also of the cottages occupied by farm-servants, we must protest against the proposition, because such an arrangement would render farming impracticable; for where would the farmer lodge his new servants, should the old ones, whose services are no longer required, retain possession of their cottages on the plea that they are tenants of the proprietor and not of the farmer? The farmer therefore must be the landlord of his own servants, and his servants' cottages must be as free as the farmhouse and steading, if farming is to be conducted in peace and happiness.

373. Farm-labourers consist of two classes—those who are constantly employed in the daily operations of the farm, and those who occasionally work on a farm, but principally support themselves by independent labour. Farm-servants are stewards or bailiffs, ploughmen, shepherds, cattle-men, hedgers, and field-workers, who are hired by the year or half-year, and are lodged on the farm; at least such is the practice in Scotland, although it is otherwise in many parts of England, where they have to walk long distances to and from their houses in villages, thereby inflicting an undue strain upon their physical powers. The obvious remedy for this strain is to build cottages near the steading. It has often been a source of wonder to us to what cause may be ascribed the practice of placing the dwellings of farm-servants at a distance from the scene of their labours. One should suppose that common sense would fix the lodging of a man who has worked ten hours in the day with a pair of horses upon the farm itself, in which he might rest his wearied body, and from which he might easily tend the animals intrusted to his care, rather than farther to fatigue him by a long journey after the labours of the day had ceased, and at the same time to remove him entirely from the animals under his charge. The payment of weekly money-wages entices the English farm-servant into the beer-shop of the village in which he dwells, rather than spend his leisure hours with his family. The Scotch farm-servant, who is paid greatly from the produce of the farm, and lives upon the spot where his horses are, feels an interest in the welfare of the farm, and has no temptation to waste his hours in imbibing liquor.

374. Independent labourers are hired by the day; and, as the scene of their work may frequently be changed, it is no inconvenience for them to live in villages.

375. The dwellings of both these classes of labourers may be of the same description, although it shall be our special duty to describe such arrangements in the apartments of cottages as shall be most suitable to farm-servants.

376. *Arrangement of Cottages for Farm-Servants having Large or Small Families.*—While deprecating the fault of too limited accommodation, we, on the other hand, conceive it necessary to warn our readers against the fault on the opposite side of giving too much. This caution we deem all the more necessary, inasmuch as we see a desire on the part of many landlords manifesting itself for building *very fine large cottages*. On this point, perhaps, the following considerations will be useful:—

377. A larger house than a hind can well furnish is a burden to him; and

whatever part he cannot furnish, becomes a dirty lumber-room, or is let to some stranger in the capacity of a boarder—a very objectionable class of persons on any farm. A house that will just accommodate the number of persons of his household, is what the hind wants, and the object can only be attained by building cottages of different sizes. The usual practice, when building cottages for farm-servants, is to adopt a uniform plan, upon which all are built. The practice is not founded upon sound principle, nor even on consistency; because it implies that families consisting of very different numbers should, nevertheless, be accommodated with similar spaces. Instead, therefore, of a family accommodating itself to the size of the cottage, the cottage ought to be adapted to the size of the family; and there is no way of fixing the proportions between the cottages and their inmates but by building them with different extents of accommodation, for families of different numbers. This is the only rational course to pursue; and, in pursuance of it, it is as easy to build a given number of cottages on different plans, as on the same plan. Following out this principle, we shall give a number of plans, suited to families of different sizes, taken from practical examples, but modified, in some instances, to suit our own notions of the conveniences, comforts, and means of cleanliness which such dwellings should possess.

378. *Single-Roomed Single-Storeyed Cottages.*—Objections have been made to accommodating a family in one room; but the force of the objections entirely depends upon the number of the family. In some parts of the country the hind's family may consist of himself and wife only, in which case a single room and a single bed will suffice for their accommodation. In other parts the hind is obliged to supply the farmer with a female to work in the fields, when a bed must be procured for her. In this case, at least two beds are required in the house; and even these may be accommodated in one room. Fig. 72 shows

Fig. 72.

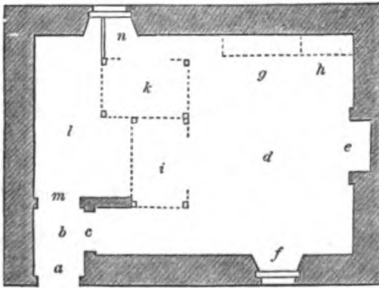

GROUND-PLAN OF A SMALL HINDU'S HOUSE OF ONE ROOM.

the manner of accommodating two beds in one room: *a* is the door of entrance; *b* the porch; *c* the door into the room *d*; *e* is the fireplace; *f* the window of the room; *g* the plate-rack for holding the crockery, &c.; *h* the dresser; *i* and *k* are the two beds, *i* entering from the room *d*, and *k* from the small room *n*, provided with a window, which is divided by a partition between this room and the store-room *l*, which is entered from the porch by the door *m*. The apartment *n* has a door hinged on the corner of the bed *k*, if a box-bed, and on the wall if

not so. If the beds are box-beds, which is the most common form, the inmates at night will be sufficiently separated, the married couple entering the bed *i* from the apartment *d*, and the field-worker *k* from the small chamber *n*. Should the beds be of the tent-bed form, with curtains, farther separation might be effected by a wooden partition between the two beds, and at the ends of *k* next *l* and *d*, and at the back of *i* next *l*. Such a cottage measures 22 feet in length, and 15 in breadth—giving the floor of *d* a space of 15 feet by 11½, which is enough for three adult persons.

379. Even three beds might be accommodated in one room, as shown in fig. 73, where *a* is the entrance-door; *b* the porch; *c* the door of the apartment *d*; *e* the fireplace; *f* the window of the room; *g* the plate-rack; *h* the dresser;

i m n are three beds, so arranged that *m* enters from the room *d*, *i* from the small closet entered by the door *l*, and having the window *k* divided between it and the store-room *o*, which is entered by the passage *p*, where is a door, and has a bed in it, *n*. Box-beds would make a complete separation of their occupants by being so arranged. Tent-beds would require wooden partitions to separate *m* from *n*; and *i* would require one along the back next *p*, and at the end next *o*. If this cottage were of the same size as fig. 72—that is, 22 feet by 15—the room *d* would be equally large, but that the lobby *b* is taken off it, to make up for which the size should be extended 26 feet in length, and 15 in breadth.

380. Box-beds are objected to by medical men, as they are too confined and inconvenient in form when any of the family are sick. Modifications in their form may be effected, chiefly by having the back and ends to open on hinges, and the top made movable, to promote ventilation, as well as to allow freer access to the patient. Curtains suspended from movable rods, made to draw forward in front, instead of sliding panels, have been recommended, to screen the person dressing and undressing, when the beds do not occupy separate apartments; but were the beds arranged in the manner represented in figs. 72 and 73, such a contrivance with the curtains would not be required. It is questionable, however, that box-beds will be voluntarily relinquished by farm-servants, and certainly not so until every cottage is accommodated with fixed beds or separate bedrooms; and if the fixed beds have the alcove form, which most of them have, they are equally inconvenient for a sick patient as the box-bed itself.

381. But it must be owned that, where more than one bed is required in a hind's house, a separate room for it is better than any arrangement that can be made with the beds within one room, and the feeling of security and separation is more satisfactory in the second apartment. Fig. 74 gives the ground-plan of such a cottage, where *a* is the entrance-porch, 3 feet 3 inches by 4 feet 9 inches; *b* the apartment, 15 feet by 14, with a window; *c* the bedroom, 10 feet square, with a window; *d* a light pantry, 4 feet 9 inches by 6 feet 6 inches; *e e* are fireplaces, 4½ feet by 3½ feet; and *f* a wall-press, 3 feet wide. One bed can stand against the back wall of *b* for the hind and his wife, and another if required for two children; and one bed might be put into the room *c*, for the field-worker, and another for two children, if required. Thus three adult persons can well be accommodated in such a house, along with four children, if required.

382. In such a house as fig. 74 tent-beds and curtains would look neat and be appropriate. Iron bedsteads are now quite common, and, for convenience of

Fig. 73.

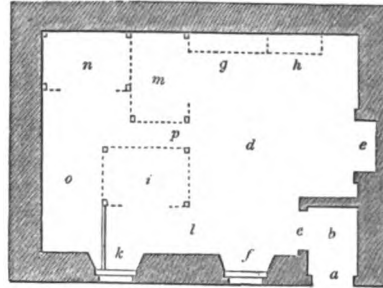

GROUND-PLAN OF A LARGE HIND'S HOUSE OF ONE ROOM.

Fig. 74.

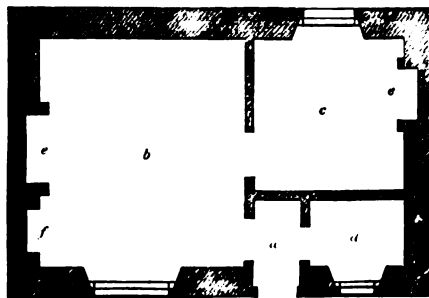

GROUND-PLAN OF A SMALL HIND'S HOUSE WITH TWO ROOMS.

putting up and taking down, and avoiding fracture, they are much better adapted for hinds than wooden ones. They also possess the advantage of giving no shelter to bugs. The curtains of beds ought to be made of wool to resist fire, and not of cotton, which would, in the circumstances, only be a little less dangerous than a covering of tinder.

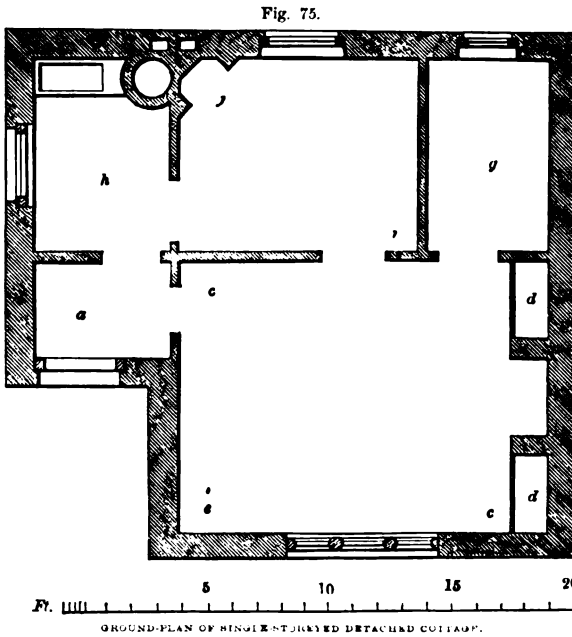

383. *Design for a Single-Storeyed Detached Cottage: Ground-Plan.*—In fig. 75 we give the ground-plan of a single-storeyed detached cottage: *a* the porch, 5 feet 6 inches by 4 feet; *c c* living-room, 15 feet by 11, having a cupboard *d d* at each side of the fireplace.

A bed may be placed at the part *e*; *ff* bedroom (with fireplace), 9 feet 6 inches by 7 feet 9 inches; *g* a bed or store closet, 7 feet 9 inches by 5 feet; *h* scullery, with slop-stone or sink, and boiler, 7 feet 9 inches by 5 feet 6 inches.

384. *Front Elevation.*—In fig. 76 we give a front elevation of the cottage of which, in preceding figure, we have given the ground-plan.

385. *Second Design for a Single-Storeyed Detached Cottage.*—In fig. 77 we give ground-plan of another example of a one-storeyed cottage, in which *a* is the entrance-porch, 4 feet

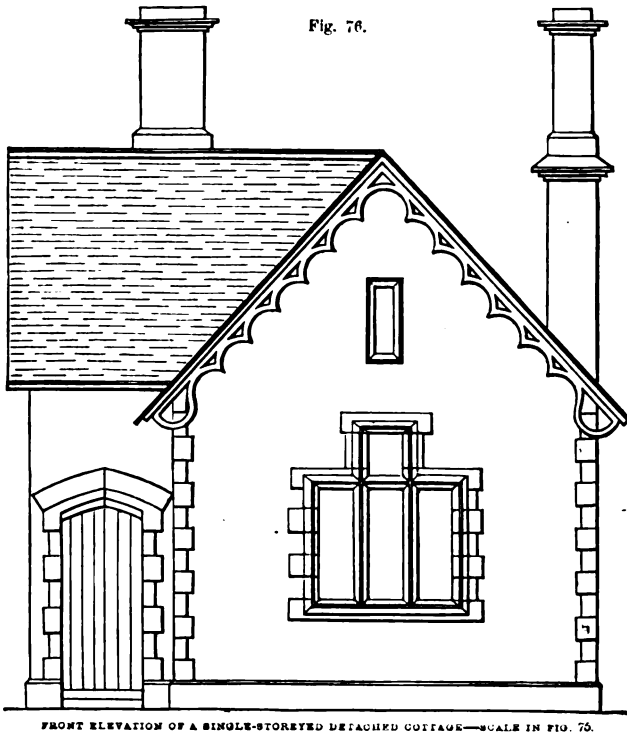

square; *b* a pantry, entering from porch, 4 feet by 3 feet 6 inches; *c c* living-room, 14 feet by 12; *d* pantry entering from living-room, 4 feet 6 inches by 3 feet 9 inches; *e e* bedroom, entering from porch, 10 feet by 8; *f* scullery, 8 feet square, provided with sink and boiler.

Fig. 77.

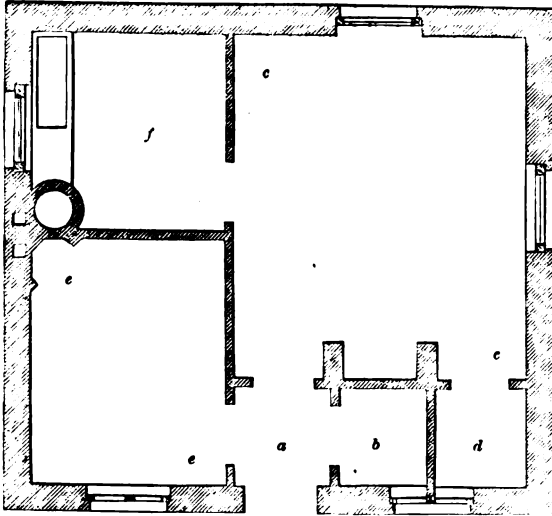

GROUND-PLAN OF A SINGLE-STORYED DETACHED COTTAGE.

386. *Front Elevation.*—In fig. 78 we give front elevation of the cottage of which, in preceding figure, we have given ground-plan. The sketch to the left shows the side elevation of the porch door.

Fig. 78.

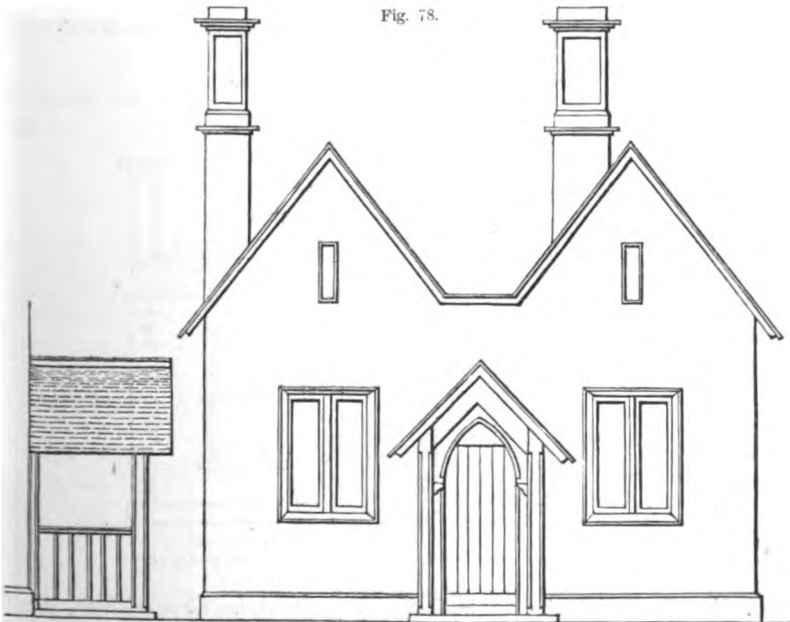

FRONT ELEVATION OF A SINGLE-STORYED DETACHED COTTAGE.

387. *Third Design for a Single-Storeyed Detached Cottage.*—In fig. 79 we give ground-plan of a cottage in which *a* is the entrance-porch, 3 feet 6 inches square; *b b* the lobby or passage, 3 feet 6 inches wide; *c c* bedroom, 13 feet 6 inches by 12 feet; *d d* bedroom, 10 feet 3 inches by 10 feet 6 inches; *e e* nursery or bedroom, 12 feet by 9, with closet *f* off it, 3 feet 6 inches square; *g* store-room or office, 10 feet 6 inches by 6 feet; *h h* living-room, 16 feet 6 inches by 10 feet; *i* scullery, 8 feet by 3 feet 6 inches. This cottage would do for a farm-bailiff or steward.

Fig. 79.

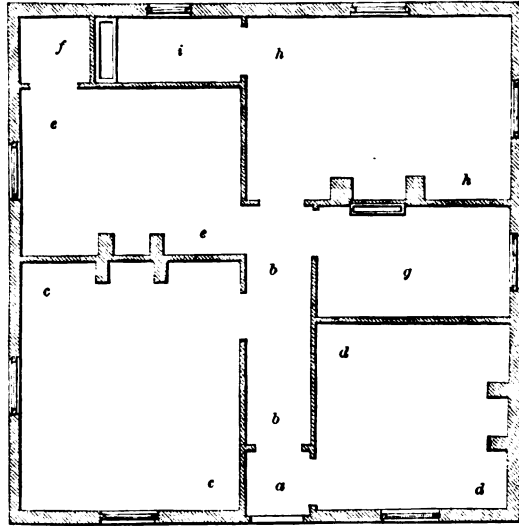

GROUND-PLAN OF A SINGLE-STOREYED DETACHED COTTAGE—SCALE, $\frac{1}{16}$ OF AN INCH TO THE FOOT.

388. Front elevation of this plan is given in fig. 80.

Fig. 80.

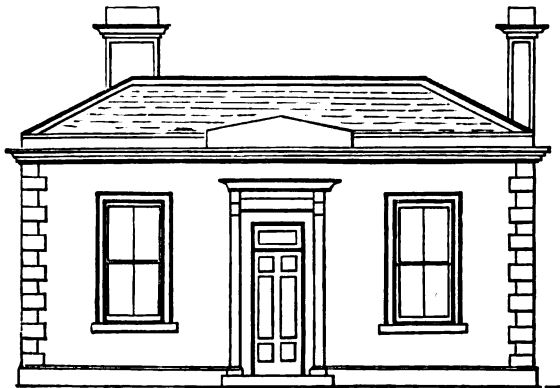

FRONT ELEVATION OF A SINGLE-STOREYED DETACHED COTTAGE—SCALE IN FIG. 79.

389. *Fourth Design for a Single-Storeyed Cottage.* *Ground-Plan, fig. 81.*—*a* the entrance-porch, 5 feet 6 inches by 5 feet 6 inches; *b b* living-room, 15

feet square ; *c c* bedroom, 12 feet by 10 ; *d d* kitchen, 12 feet square ; *e* scullery, 8 feet by 6 feet 9 inches ; *f* closet or store-room, 7 feet by 3 ; *g* stairs to cellars the cellars being under the kitchen *d d*, scullery *e*, and closet *f*. This is a cottage which would accommodate the bailiff of a large farm.

Fig. 81.

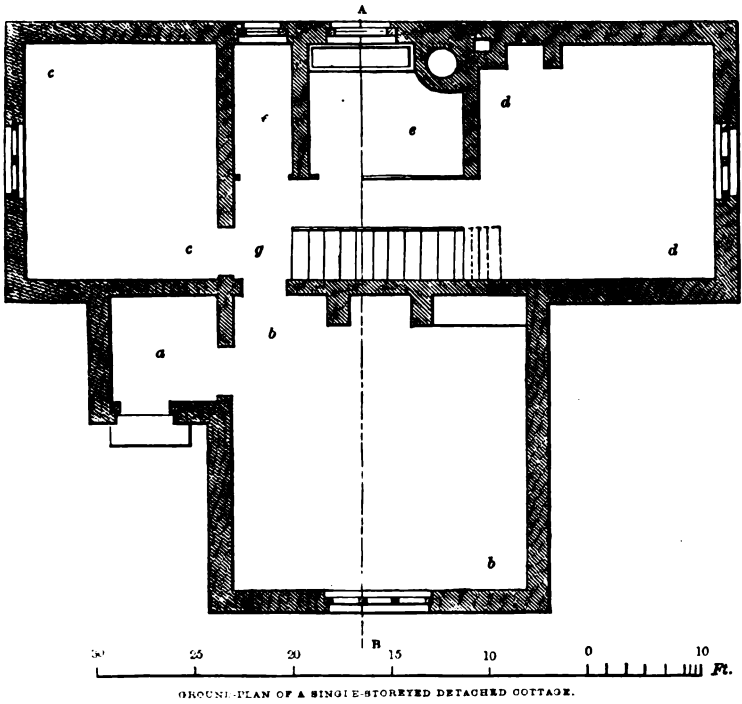

390. In fig. 82 is the front elevation of the cottage, the ground-plan of which is in fig. 81.

Fig. 82.

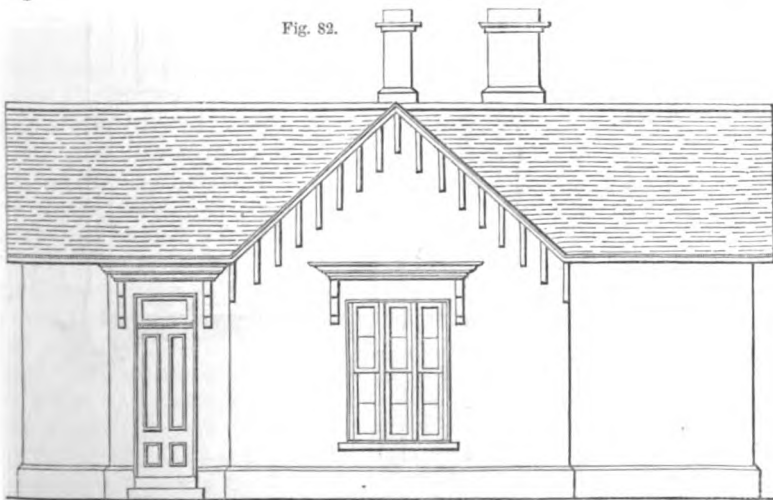

FRONT ELEVATION OF A SINGLE-STOREYED DETACHED COTTAGE—SCALE IN FIG. 81.

391. In fig. 83 is the back elevation of the cottage, the ground-plan of which is in fig. 81.

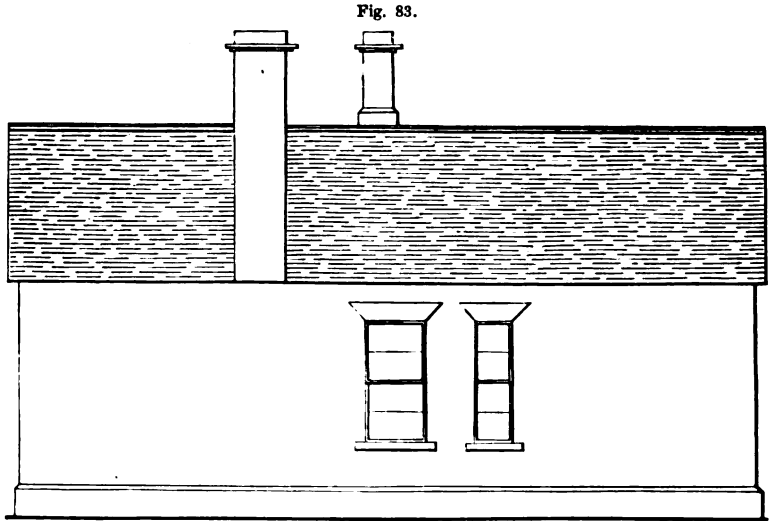

BACK ELEVATION OF A SINGLE-STOREYED DETACHED COTTAGE—SCALE IN FIG. 81.

392. Fig. 84 gives a vertical section of the cottage of which the ground-plan is fig. 81, in the line of A B of fig. 81.

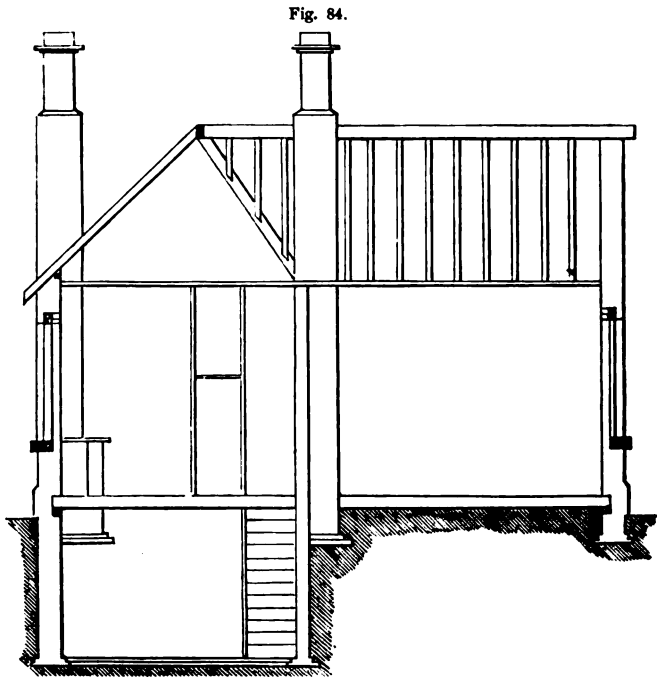

VERTICAL SECTION OF A SINGLE-STOREYED DETACHED COTTAGE—SCALE IN FIG. 81.

393. A more correct idea now prevails in regard to the extent of accommodation absolutely required by a farm-servant and his family. It is deemed proper that a man and his wife should have a bedroom to themselves; and as he is the head of the house, and works harder than any of the family, he should have the principal and most comfortable bedroom in the house. When a separate room from the living-room is offered him for that purpose, he prefers to have his bed near the warm fire, that he may turn into bed with the least trouble and exposure to cold. The girls of the family must have a bedroom for themselves, and so must the boys. Thus three bedrooms at the least are required for a ploughman and his family. If he consent to occupy a separate bedroom, then there must be four rooms in his house. But if he is moreover obliged to supply a field-worker for the farm, then another room is required for her, for such a person is generally a woman. So that in these circumstances five rooms will be required in a hind's house.

394. Such an extent of accommodation in the ground-plan would imply a large and expensive roof, which is the most costly part of house building. A two-storey house is thus necessitated to be made, and many proprietors now prefer that plan for accommodating a large family.

395. It should, however, be held in remembrance that a second sitting-room in a hind's house is an unnecessary appendage to it; it will never be used as such. When in the second storey it will be converted into a sleeping-room: and when on the ground-floor, into a meal or potato store, beside the beds that may be put into it. The fire will never be kindled in it, and it will consequently become damp and cold. It is only when the labourer is a fixed resident, holding directly under the landlord, that he will furnish his second room in the ground-floor comfortably, and warm it by occasional fires.

396. *Design for a Two-Storeyed Detached Cottage.*—In fig. 85 we give ground-plan, and in fig. 86 chamber or bedroom plan of a single two-storeyed cottage.

397. *Ground-Plan.*—*a* entrance-porch, 5 feet by 2 feet 9 inches; *b* a pantry or store-closet, 5 feet 9 inches by 2 feet 3 inches; *c c* stairs to second storey, 2 feet 6 inches wide; *d d* living-room, 12 feet square, with cupboard *e* on one side of fireplace; *f* scullery, 8 feet square; *g* store-closet, 8 feet by 3 feet 6 inches.

398. *Chamber-Plan*, in fig. 86.—*a a* stairs; *b b* landing, 2 feet 6 inches wide; *c c* front bedroom, 12 feet square, with closet *d* off it, 5 feet by 3; *e e* back bedroom, 8 feet by 9 feet 3 inches; *f* linen or clothes closet, 6 feet by 2 feet 6 inches.

399. Front elevation of cottage, of which the preceding are the plans, is given in fig. 87. The scale to which all the figures are drawn of this example is the same as given in fig. 75.

Fig. 85.

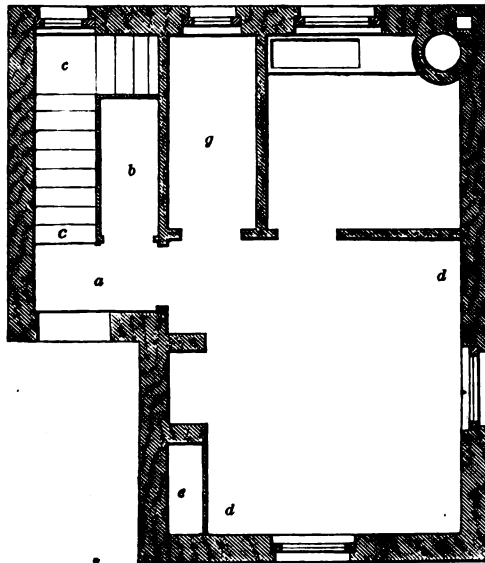

GROUND-PLAN OF A TWO-STOREYED DETACHED COTTAGE—SCALE IN FIG. 75.

Fig. 86.

CHAMBER-FLOOR PLAN OF A TWO-STOREYED DETACHED COTTAGE—SCALE
IN FIG. 75.

Fig. 87.



FRONT ELEVATION OF THE TWO-STOREYED COTTAGE IN FIG. 86.

400. *Double-Detached Cottages.*

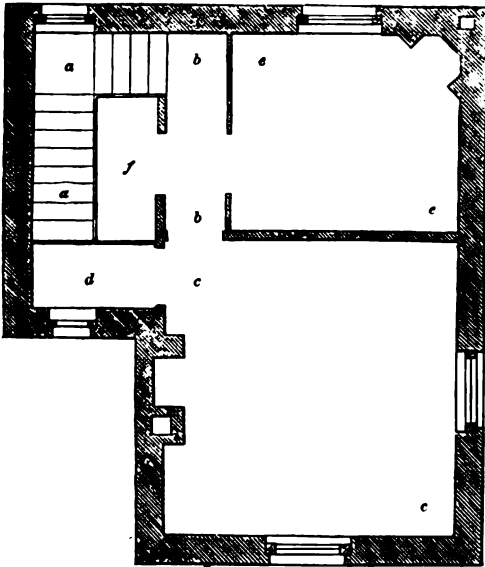
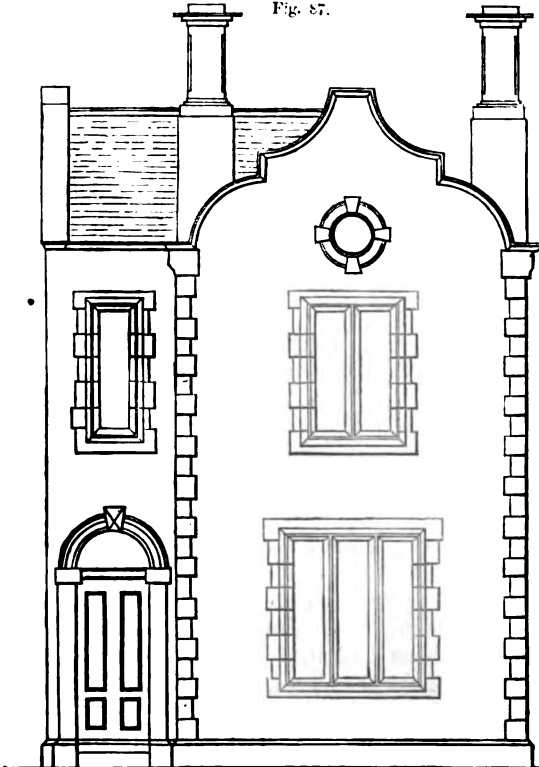
—Labourers' cottages are most commonly built in long rows, and when several are required for a large farm, they frequently assume the form of three sides of a square. When outhouses are afforded, which ought always to be, much inconvenience is experienced by the inhabitants living in long rows of houses, in going to and from them. This row form originated, no doubt, because of a larger number of houses being erected at the same expense, than in any other form, and economy of the ground taken up by them had also entered into the calculation. For comfort and convenience combined, no form is equal to the double-detached house, having entrances at different

parts, and the fireplaces in the centre of the building. Of this class of cottage we now proceed to give examples, dividing them, as in the cases of the single-storeyed detached class of cottages, into single and two-storeyed cottages.

401. *Single-Storeyed Double-Detached Cottage.*

Ground-Plan, fig. 88.—*a a* passage or lobby, 3 feet 6 inches wide; *b b* living-room, 12 feet by 12, with space for bed at *c*; *d* scullery, 7 feet 9 inches by 5 feet 6 inches; *e* pantry, 5 feet 6 inches by 3 feet 6 inches; *f* coal-closet, 5 feet 6 inches by 3 feet; *g* press, 3 feet by 2 feet; *h h* back bedroom, 12 feet by 11 feet 6 inches; *i i* front bedroom, 12 feet by 8 feet 3 inches.

402. *Alternative Plan, fig. 89.*—*a* passage, 3 feet 6 inches wide, with locker

seat *b*; *c c* kitchen, 15 feet by 12 feet 6 inches, with space for bed *d*, 6 feet by 3 feet 9 inches; *e e* back bedroom, 14 feet 9 inches by 8 feet 6 inches; *f f* front

Fig. 88.

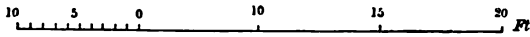
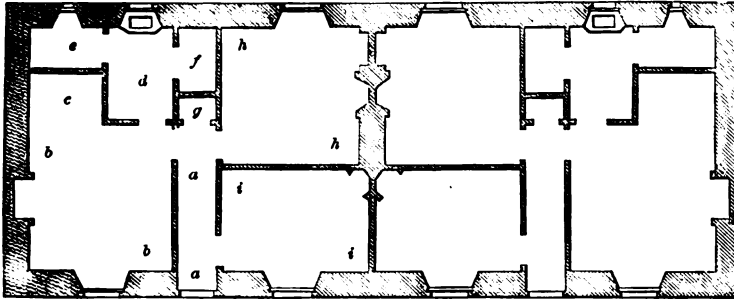

GROUND-PLAN OF SINGLE-STOREYED DOUBLE-DETACHED COTTAGES.

bedroom, 11 feet 6 inches by 11 feet; *g* scullery, 12 feet 6 inches by 5 feet, with coal-bunker *h*.

Fig. 89.

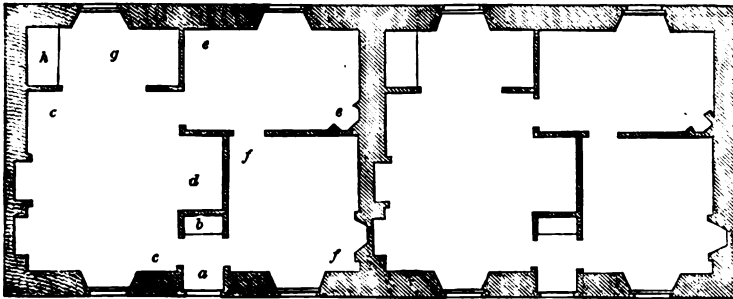

ALTERNATIVE GROUND-PLAN OF SINGLE-STOREYED DOUBLE-DETACHED COTTAGES—SCALE IN FIG. 88.

403. *Front Elevation.*—In fig. 90 we give front elevation for above plans, with an alternative design in fig. 91; the front wall for this having sets-off at the points *a b*, as shown in part of the ground-plan of wall in fig. 91. The scale for all these drawings is given in fig. 88.

Fig. 90.

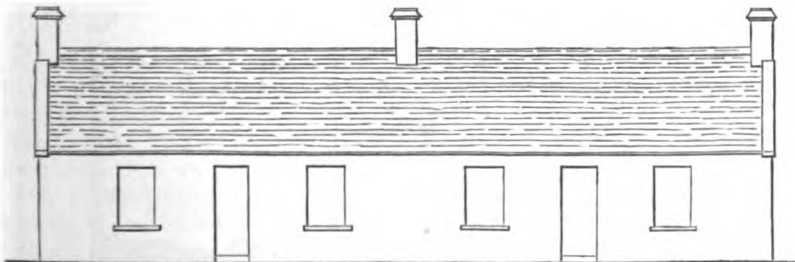

FRONT ELEVATION OF THE DOUBLE-DETACHED COTTAGES IN FIG. 88.

404. In fig. 91 is the alternative front elevation to the front elevation in fig. 90.

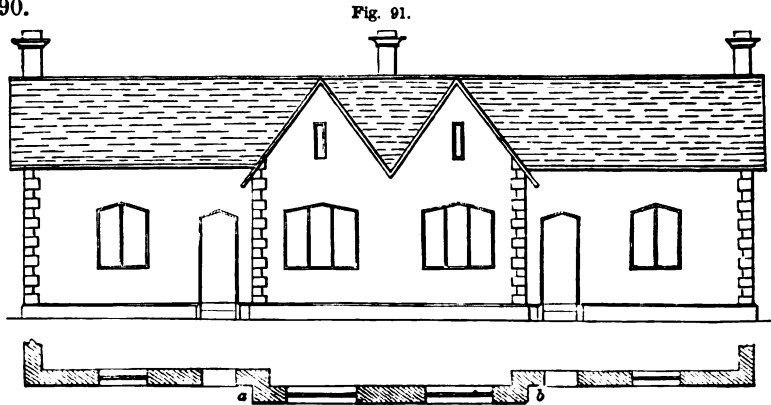

ALTERNATIVE FRONT ELEVATION TO FRONT ELEVATION IN FIG. 90

405. *Alternative Plans.*—In figs. 92, 93, and 94 we give alternative plans of house in fig. 88. In fig. 92 *a a* is the passage, 3 feet 6 inches wide; *b b* living-room, 14 feet by 12; *c c* scullery, 7 feet 6 inches by 6 feet, with pantry *d*, entering off it, 3 feet wide; *e e* bed-closet, 8 feet 6 inches by 7 feet; *f f* back bedroom, 11 feet 6 inches by 11 feet; *g g* front bedroom, 12 feet 6 inches by 8 feet 6 inches.

Fig. 92.

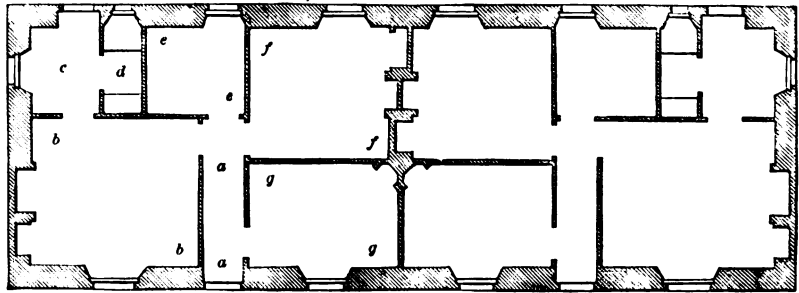

ALTERNATIVE GROUND-PLAN TO GROUND-PLAN IN FIG. 88.

406. In fig. 93, *a a* passage, 3 feet 6 inches wide; *b b* living-room, 14 feet 6 inches by 12 feet 6 inches; *c c* scullery, 7 feet by 6 feet, with pantry *d*, entering from it, 3 feet wide; *e e* bed-closet, 9 feet 3 inches by 7 feet; *f f* bedroom, 12 feet by 11 feet at the broadest, and 9 feet at the narrowest part.

Fig. 93.

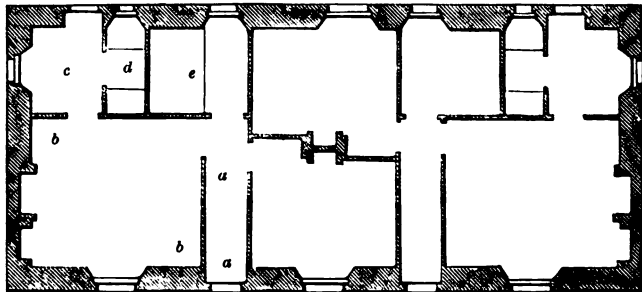

ALTERNATIVE GROUND-PLAN TO GROUND-PLAN IN FIG. 88.

407. In fig. 94, *a a* passage, 3 feet 6 inches wide; *b b* living-room, 14 feet by 12, with *c* space for bed, 6 feet by 4 feet 6 inches; *d* scullery, 8 feet 6 inches by 6 feet; *e* pantry, 6 feet by 3 feet 6 inches; *f* back bedroom, 9 feet 6 inches by 8 feet 6 inches; *g* front bedroom, 12 feet by 11, with space for bed *h*; *i* privy; *k* coal-cellar. The scale to which figs. 92, 93, and 94 are made is given in fig. 94.

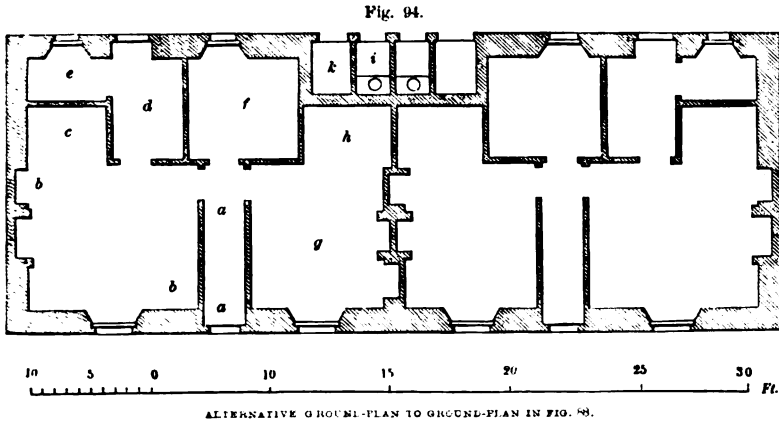

408. We give another example of this class of cottages in figs. 95 to 98.

409. *Ground-Plan.*—Fig. 95, *a a* passage, 3 feet wide, with pantry *b* entering from it; *c c* living-room, 12 feet by 12; *d* bed-closet, 8 feet 6 inches by 7 feet 6 inches; *e* scullery, 8 feet 6 inches by 5 feet, with pantry *h* entering from it, 3 feet by 5; *f f* back bedroom, 12 feet square; *g g* front bedroom, 13 feet by 8 feet 6 inches.

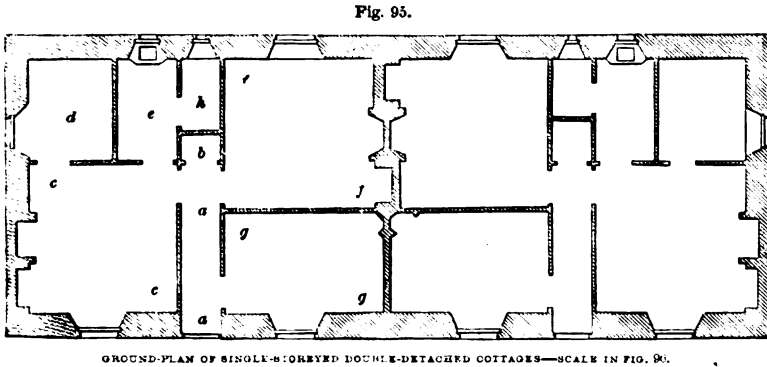

410. *Elevations and Section.*—In fig. 96 we give front elevation, in fig. 97 end elevation, and in fig. 98 transverse section. The scale to which figs. 95 to 98 are drawn, is given in fig. 96.

411. *Two-Storeyed Double-Detached Cottages.*—In figs. 99 to 109 inclusive we give drawings of two-storeyed double-detached cottages.

412. *Ground-Plan.*—In fig. 99, *a a* passage, 3 feet 6 inches wide; *b b* stairs; *c c* living-room, 13 feet by 12; *d* scullery, 9 feet by 7, with back door protected by porch *e*; *f* pantry, entering from scullery, 5 feet by 3 feet 6 inches; *g g* bedroom, 11 feet, and 7 feet wide by 10 feet 6 inches, and 7 feet long; *h* coal-cellar.

413. *Chamber-Plan*, fig. 100.—*a* stairs; *b* landing; *c* front bedroom, 17 feet 4 inches by 9 feet 6 inches; *d* back bedroom, 14 feet 9 inches by 9 feet; *e* bed-closet, 5 feet 6 inches square.

Fig. 96.

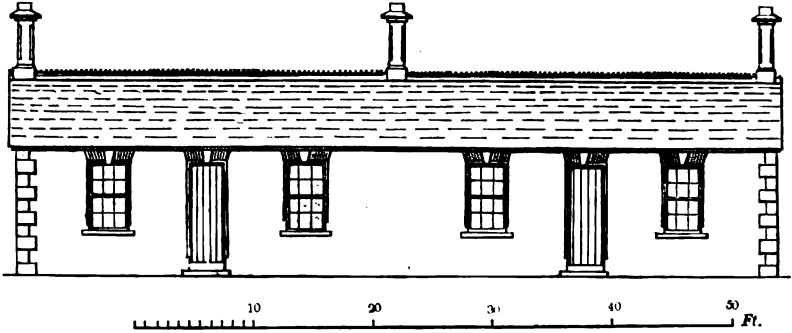

FRONT ELEVATION OF SINGLE-STORYED DOUBLE-DETACHED COTTAGES.

Fig. 97.

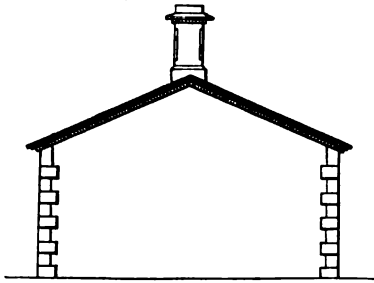

END ELEVATION

Fig. 98.

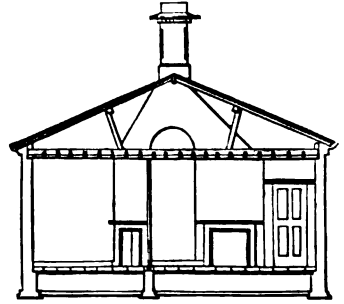

VERTICAL SECTION.

Fig. 99.

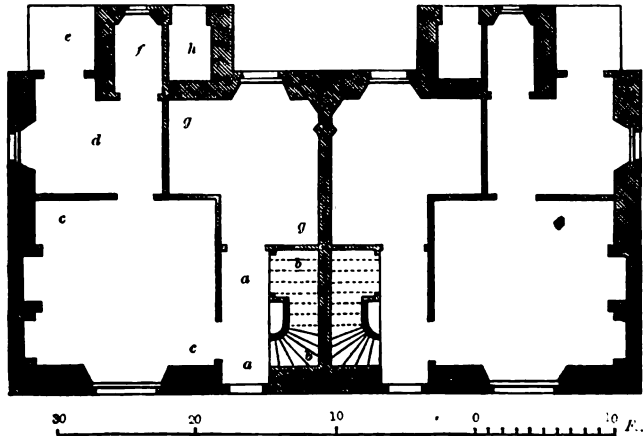

GROUND-PLAN OF TWO-STORYED DOUBLE-DETACHED COTTAGES.

Fig. 100.

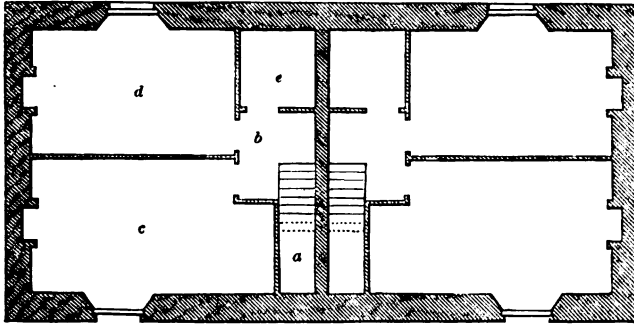

CHAMBER-FLOOR PLAN OF FIG. 99.

414. *Elevations.*—In fig. 101 we give front elevation, and in fig. 102 end elevation—both adapted for brick, and rising two steps from ground-line.

Fig. 101.



FRONT ELEVATION OF THE COTTAGES IN FIG. 99.

Fig. 102.

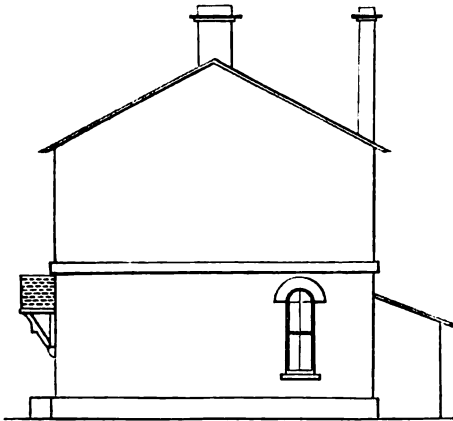

END ELEVATION OF COTTAGES IN FIG. 99.

415. *Ground-Plan*, fig. 103.—*a* porch, 5 feet 6 inches by 5 feet; *b* stairs; *c* living-room, 15 feet by 12 feet 6 inches, with two pantries *d d* entering from it; *e* pantry, entering from scullery; *f* scullery, 7 feet by 5 feet 6 inches; *g* coal-closet; *h* bedroom, 12 feet 6 inches by 11 feet; *i* privy; *k* pig-sty; *l* ash-pit.

Fig. 103.

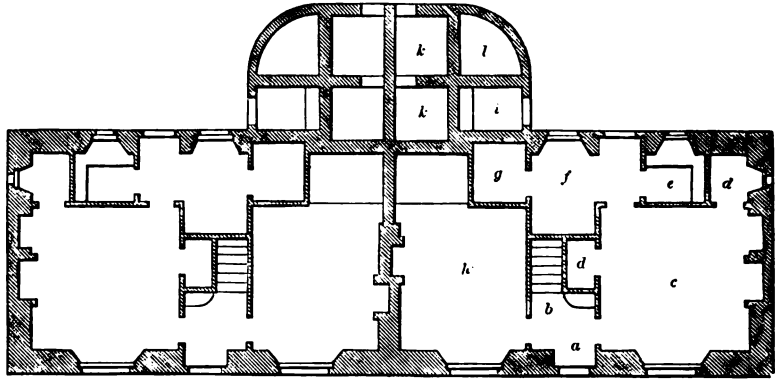

GROUND PLAN OF TWO-STORYED DETACHED COTTAGES.

416. *Chamber-Plan*, fig. 104.—*a* landing; *b b* closets; *c c* bedroom, 13 feet square; *d d* bedroom, 13 feet by 11.

Fig. 104.

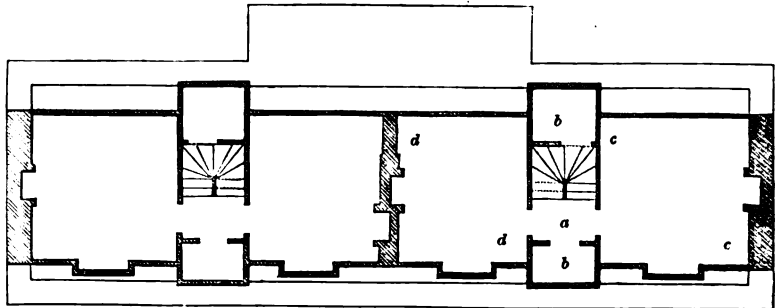

CHAMBER-FLOOR PLAN OF FIG. 103

40 30 20 10 Ft.

417. *Elevation*.—In fig. 105 we give front elevation.

Fig. 105.



FRONT ELEVATION OF COTTAGES IN FIG. 103.

418. *Ground-Plan*, fig. 106.—*a* porch, 6 feet by 5; *b* lobby, 6 feet 4 inches wide; *c* stairs, 3 feet wide; *d d* living-room, 16 feet by 15; *e* scullery, 12 feet by 10; *f f* bedroom, 10 feet by 12; *g* closet, 2 feet 6 inches wide; *h* entrance to cellar under bedroom *f f*; *i* privy, 3 feet wide; *k* ash-pit, 3 feet wide.

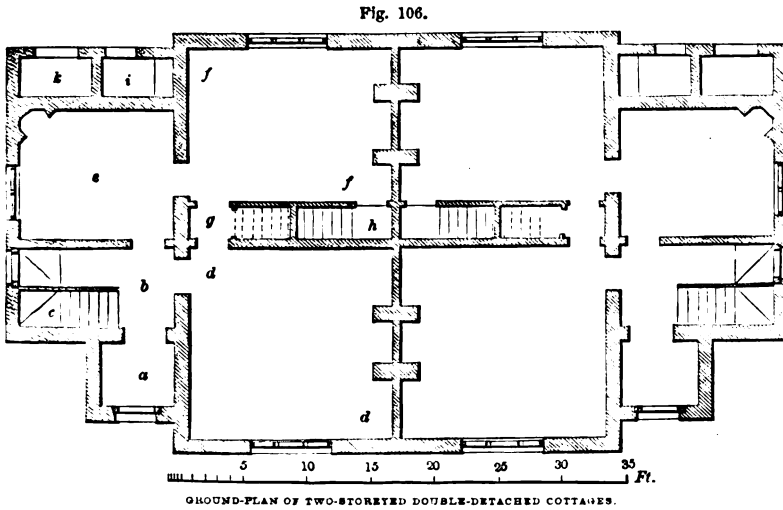

419. *Chamber-Plan*, fig. 107.—*a a* stairs; *b* landing; *c c* front bedroom, 16 feet by 15, with closet *d*, 2 feet 6 inches wide; *e e* back bedroom, 16 feet by 12, with closet *f*, 2 feet 6 inches wide; *g g* small bedroom, 12 feet by 10, less "set-off" to admit of entrance to bedrooms *c c* and *e e* being obtained.

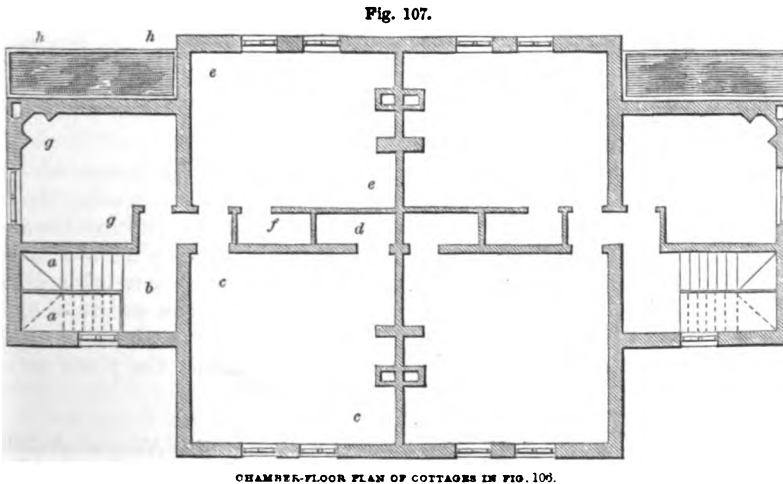

420. *Cellar-Plan*, fig. 108.—*a* stairs, entering at *h* from bedroom *f f*, in fig. 106; *b b* store-cellar, 16 feet by 12. It might be the better arrangement to enter cellar *b b* from living-room *d d*, in fig. 106. In fig. 108 *c* is the stair, entering from lobby *b*, in fig. 106; *d* coal-cellar, 12 feet by 10.

Fig. 108.

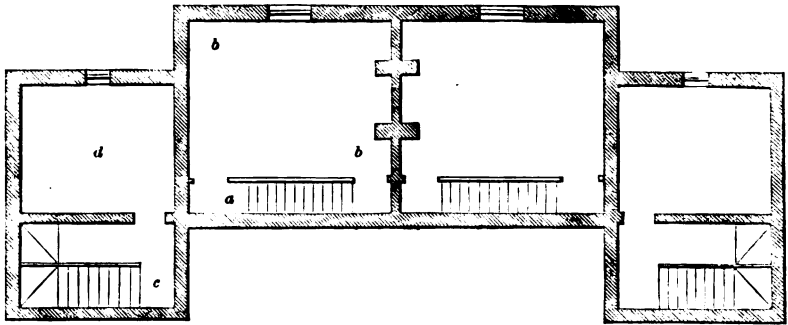

FLOOR-PLAN OF COTTAGES IN FIG. 108.

421. *Elevation.*—In fig. 109 we give a sketch of front elevation.

Fig. 109.

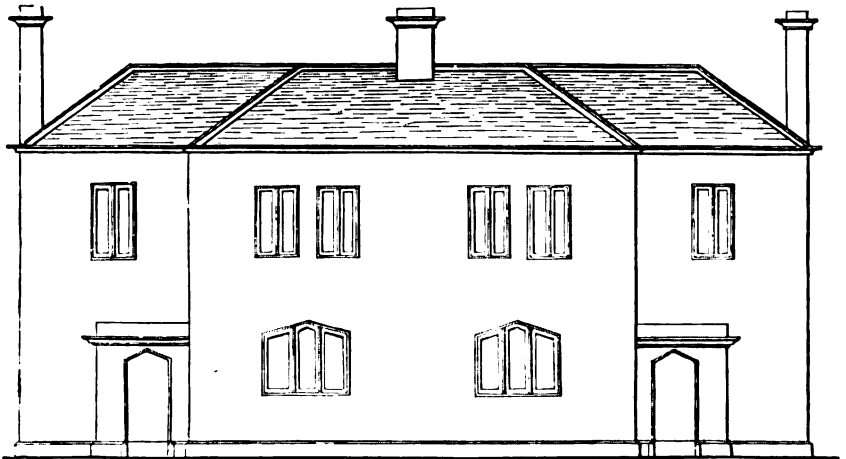

FRONT ELEVATION OF COTTAGES IN FIG. 108

422. In the plans of the double cottages given above, the houses are of the same size, so that families of the same number would have to occupy the same double cottage; but, as we have already said, cottages for work-people should be planned of different sizes, so that a larger or smaller family should have the cottage that best suited their number. With this view we now give plans of double cottages containing houses of different sizes; and as we are of opinion that large families should not be associated together, the numbers of their persons being too many in one cottage, we have arranged the plans so as to unite a large and small house together in each cottage.

423. *Small Single-Storeyed Double-Detached Cottages, with Houses of different sizes.*—In fig. 110 we give a ground-plan of such a cottage, of which on the right hand is the smaller house, where *a* is the entrance-porch, 4 feet wide; *b* the living-room, 17 feet 6 inches by 14 feet; *c* bedroom, 12 feet by 14; *d* scullery, 4 feet by 8; and *e* coal-house, 4 feet by 3.

424. In the larger house on the left hand, *f* is the entrance-porch, 4 feet wide; *g* the living-room, 17 feet 6 inches by 14 feet; *h* front bedroom, 12 feet

by 14; *i* back bedroom, 12 feet by 14; *k* scullery, 4 feet by 8; and coal-house *l*, 4 feet by 3. It would perhaps be more acceptable to the inmates were the bedrooms *c* and *h* to enter from their respective living-rooms instead of from their respective entrance-porches.

Fig. 110.

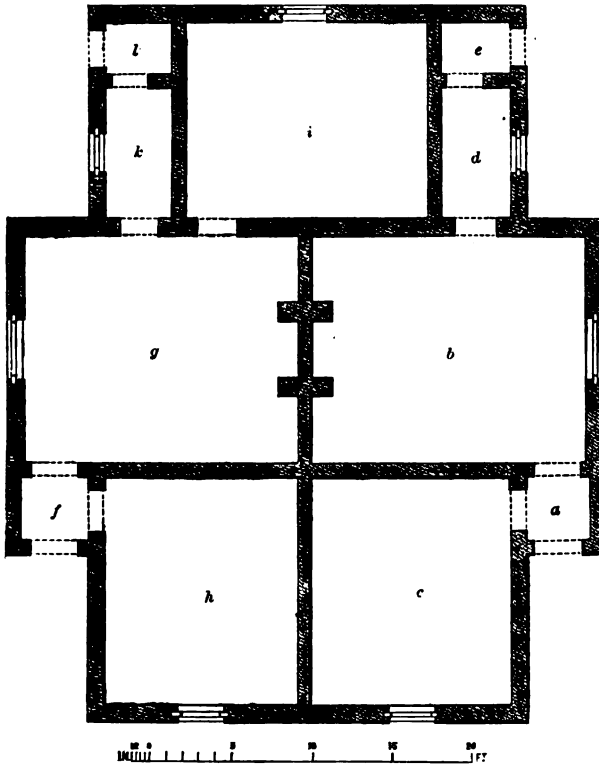

GROUND-PLAN OF SINGLE-STOREYED DOUBLE COTTAGES, CONSISTING OF LARGER AND SMALLER HOUSES.

425. *Small Two-Storeyed Double Cottages Detached, with Houses of different sizes.* Instead of having the sleeping apartments upon the ground-floor, they may be placed in a storey above. Fig. 111 shows such an arrangement, in which *a* is the entrance-porch of a small house; *b* the staircase leading to the upper storey; *c* the living-room, entering from the porch *a*, having a window, a fireplace, and wall-press, and continuing on to a back kitchen *d*, having a window, a boiler, and a back door. This apartment is useful for washing clothes in, and doing such things as to leave the sitting-room *c* always clean and comfortable. One large or two small bedrooms are placed over the sitting-room *c*.

Fig. 111.

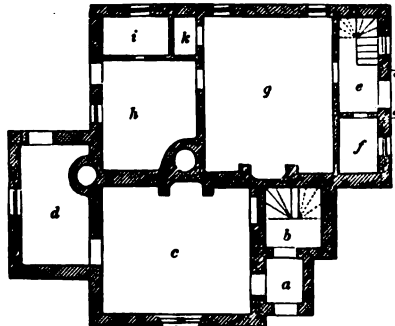

SMALL TWO-STOREYED DOUBLE COTTAGES.

426. A larger house has an entrance-porch *e*, fig. 111, which is also the staircase for the upper storey; *g* is the sitting-room, entering from the porch,



427. Fig. 112 represents the elevation of the houses whose ground-plans are given in fig. 111.

428. *Ground-Plan.*—Fig. 113 gives the ground-plan of a double cottage containing a small house and a large house. Thus, the small house contains an entrance-porch *a*, 4 feet wide; a living-room *b*, 17 feet by 14; a bedroom *c*, 12 feet by 14; a scullery *d*, 4 feet by 7; and a coal-house *e*, 4 feet by 3.

429. The larger house contains the ground-floor and entrance-porch *f*, 4 feet

Fig. 113.

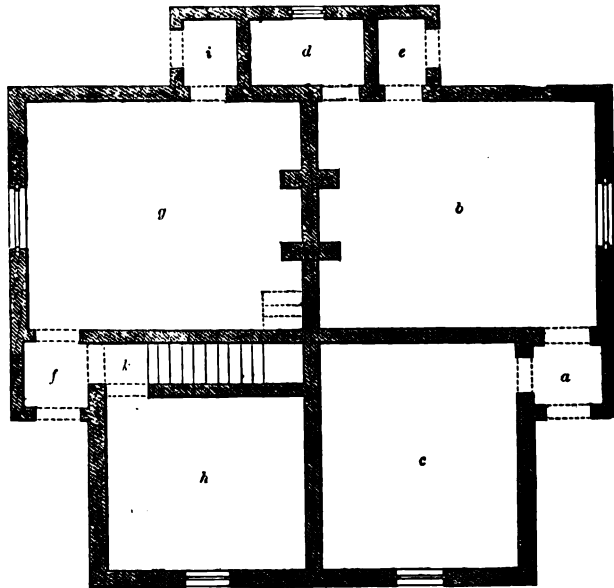

wide; a living-room *g*, 17 feet by 14; *h* the scullery, 12 feet by 10 feet 6 inches; the coal-house *i*, 4 feet by 7, and the staircase *k* leading up to the upper floor.

430. *Chamber-Floor Plan.*—Fig. 114 is the chamber-floor plan of the larger cottage, in which the landing is at *a*, and from it access is had to a small bedroom *b*, 10 feet 6 inches by 12 feet; another bedroom *c*, 14 feet by 12, and to the larger bedrooms *d* and *e*, each 17 feet by 14. This house would contain a man and his wife with a large family, the boys and girls having separate bedrooms, and a separate one for the field-worker; the heads of the family having also a separate bedroom, and the living-room being common to them all.

Fig. 114.

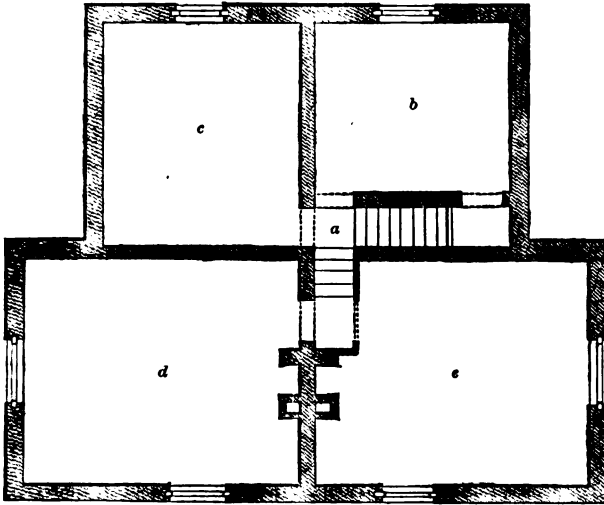

CHAMBER-FLOOR PLAN OF THE COTTAGE IN FIG. 113.

431. *On improving defectively arranged Cottages.*—A few remarks, with illustrative examples, may here be useful, as showing how cottages, when defective or meagre, may be altered to give ampler accommodation.

432. In fig. 115 we give an example of the one-roomed cottage so often met with in agricultural districts, and possessing few or none of those requirements which are indispensable where a family is maintained. Here *a* is the apartment, lighted with one window only, *c*, and entered at once from the open air at *b*, without the intervention of a porch, and with the fireplace *d* at one side. Fig. 116 shows how—still retaining the main part of the building as given in fig.

Fig. 115.

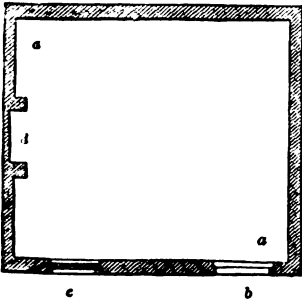

UNIMPROVED SINGLE-ROOMED COTTAGE.

Fig. 116.

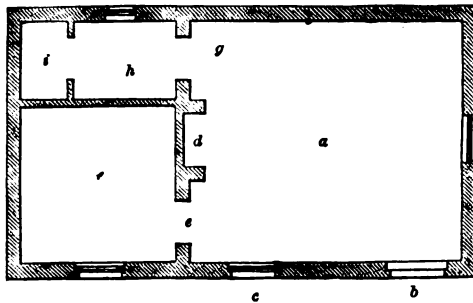

FIRST IMPROVED ARRANGEMENT OF COTTAGE IN FIG. 115.
—SCALE IN FIG. 115.

115—accommodation of a superior quality may be obtained at comparatively small expense. Here *a* is the living-room as before, with window *c*, door *b*, and fireplace *d*; a door *e* gives admission to a bed-closet *f*, while another door *g*, at the opposite side of the fireplace, gives admission to the scullery *h*, from which is entered a pantry *i*; with an additional window opposite the fireplace *d*.

433. Fig. 117 shows how, retaining the old building in fig. 115, still more ample accommodation may be obtained : *a a* is the living-room, as before ; *b* scullery ; *c* bedroom ; *d* bedroom ; *e* pantry.

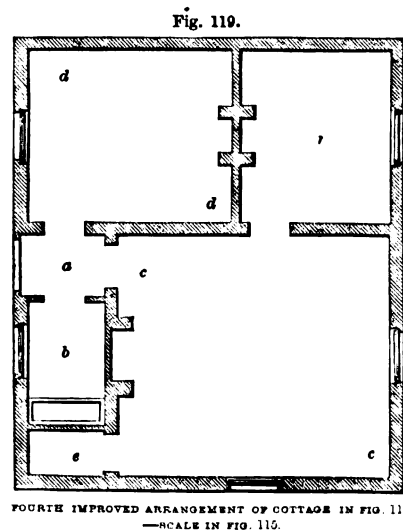
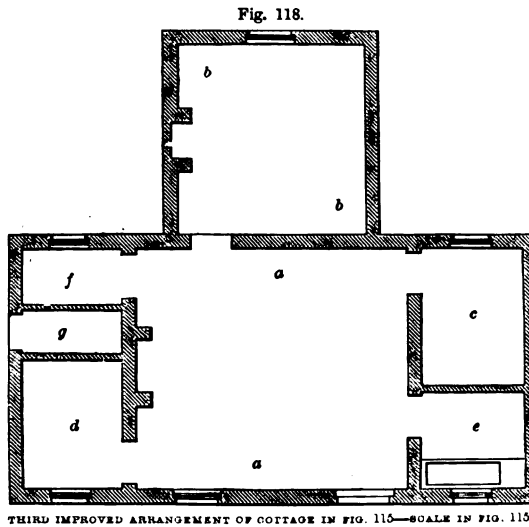
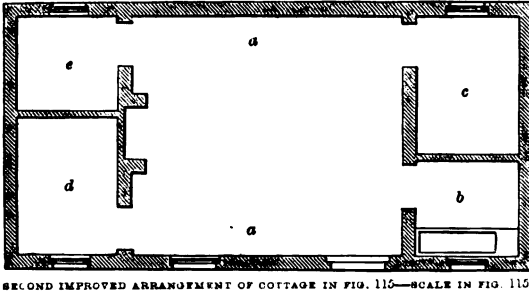

434. Fig. 118 shows further accommodation : *a a* living-room, as before ; *b b* bedroom ; *c* and *d* bed-closets ; *e* scullery ; *f* pantry ; *g* coal-house, entered from outside.

435. Fig. 119 shows another arrangement, in which the entrance-porch is secured at *a*, the scullery *b* being entered from the porch, and independent entrances obtained to the living-room *c c*, and bedroom *d d* ; *e* a pantry entering from living-room ; *f* small bedroom entering from living-room.

436. Fig. 120 illustrates a simple modification of fig. 115, in which an entrance-porch is secured at *a*—the window and door *b c* in fig. 115 being blocked up, and two windows placed at *b* and *c*, as in fig. 120 ; *c c* is the living-room ; *d* is the scullery, entering from living-room *c c* ; *e* a pantry, entering from porch *a* ; *f f* bedroom, with fireplace *g*.

437. *Composite Cottages.*—We deem it likely to be useful to give sketches illustrative of what has been termed composite cottages—that is, two-storeyed cottages, but of which the upper and lower storeys form independent houses with separate entrances, the upper house being generally entered from the back.

438. In fig. 121 we give part plan showing upper house over that given in fig. 81 : *a a* is the entrance-passage, corresponding to the closet or store-room *f*, in fig. 81, reached by the outside stair *b* ; *c* the passage corresponding to cellar-stair *g*, in fig. 81 ; *d* scullery over scullery *e*, in fig. 81 ; *e e* bedroom over bedroom *c c*, in fig. 81 ; *f f* bedroom over bedroom *d d*, in fig. 81 ; *g g* living-room over living-room *b b*, in fig. 81. The other parts of the plan being exactly similar to those in fig. 81,

space is not here taken up by completing the sketch. The scale is in the proportion of $\frac{3}{8}$ of an inch to the foot.

Fig. 120.

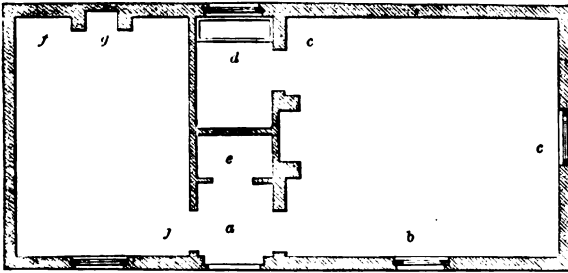

FIFTH IMPROVED ARRANGEMENT OF COTTAGE IN FIG. 115—SCALE IN FIG. 115.

Fig. 121.

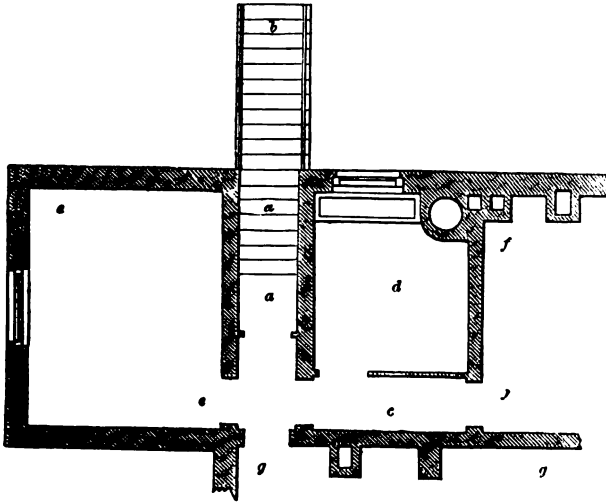

COMPOSITE COTTAGE ADAPTED TO THAT IN FIG. 81.

439. In fig. 122 we give the end elevation of this composite cottage, showing outside stair *a*; *b* is the window of the bedroom *c*, in fig. 81; *c* that of bedroom *e e*, in fig. 121. The porch *a* in fig. 81 is only carried up to the level of second storey; it might, however, be carried up to roof-line, when it would afford space for a small closet, which might enter either from bedroom *e e* or living-room *g g*, fig. 121. Scale $\frac{1}{2}$ of an inch to the foot.

440. In fig. 123 we give sketch of plan of house over that given in fig. 75: *a a* outside stairs; *b* porch, giving entrance to kitchen *c c*—this room corresponding to the apartment marked *f f* in fig. 75. The scullery *d* is entered from kitchen—*d* corresponding to the apartment *h* in fig. 75; the closet *f*, fig. 123, to porch *a* in fig. 75; *e e* living-room corresponding to same apartment *c c* in fig. 75; bed-closet *g g* to that marked *g* in fig. 75.

Fig. 122.

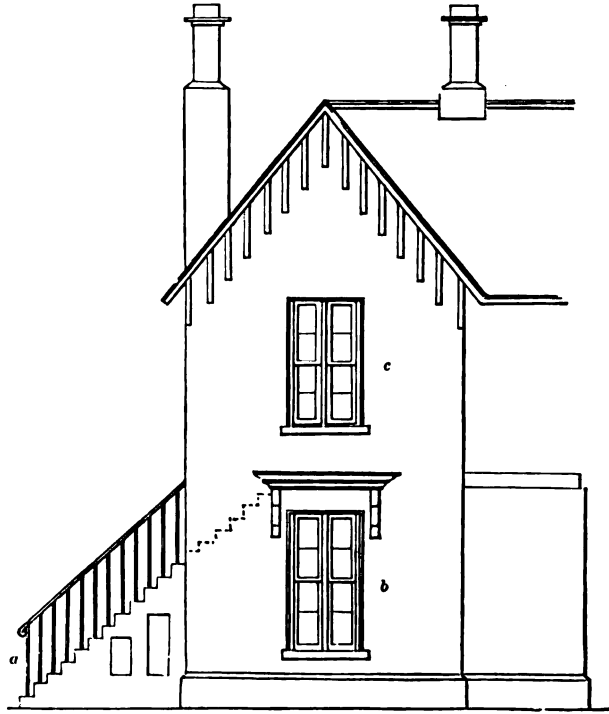

END ELEVATION OF COMPOSITE COTTAGE IN FIGS. 61 AND 121.

Fig. 123.

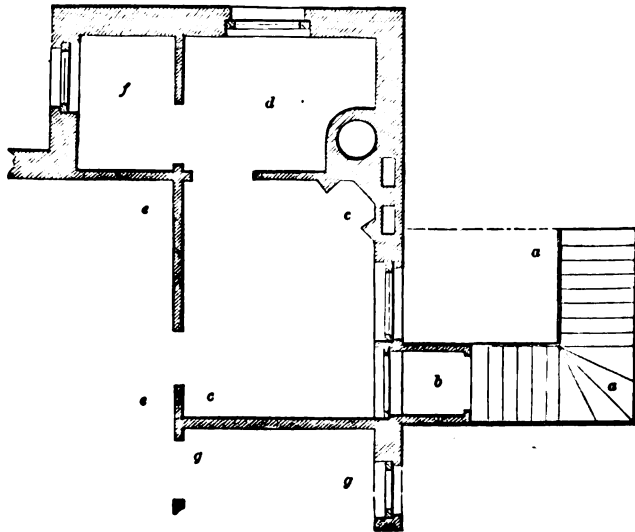

UPPER STOREY OF COMPOSITE COTTAGE APPLIED TO FIG. 75—SCALE IN FIG. 75.

441. In fig. 124 we give plan of house over that in fig. 77: *a a* outside stairs; *b* porch; *c c* living-room over same apartment *c c* in fig. 77; *d* scullery over apartment *f* in fig. 77; *e e* bedroom over same apartment *e e* in fig. 77; *f* pantry or store-closet over the entrance-lobby of fig. 77.

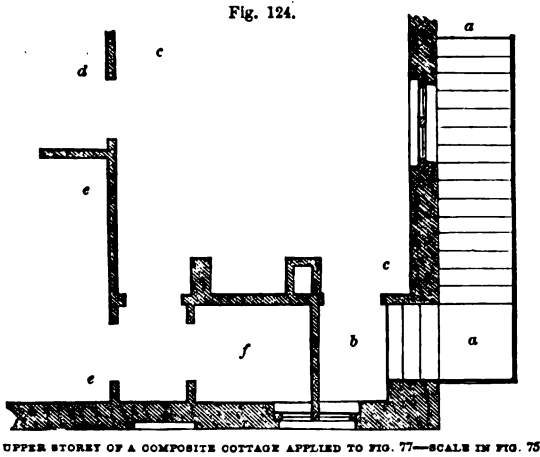

442. In fig. 125 we give part plan of cottage over that in fig. 117: *a a* outside stairs; *b* porch; *c* pantry; *d* bed-closet over *d* in fig. 117; *e e* living-room; the scullery and bed-closet correspond in size and position to apartments marked *b* and *c* in fig. 117.

443. In fig. 126 we give plan of cottage over that in fig. 118: *a a* outside stairs; *b* porch; *c* pantry; *d* coal-closet; *e e* living-room, corresponding to *a a* in fig. 118; *f* bed-closet over the same at *d* in fig. 118. The scullery and second bed-closet are entered from living-room *a a*, as in fig. 118, occupying the same position as *e* and *c* in fig. 118; *g g* is the bedroom corresponding to *b b* in fig. 118.

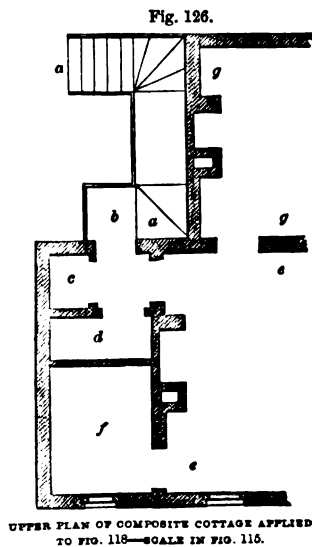
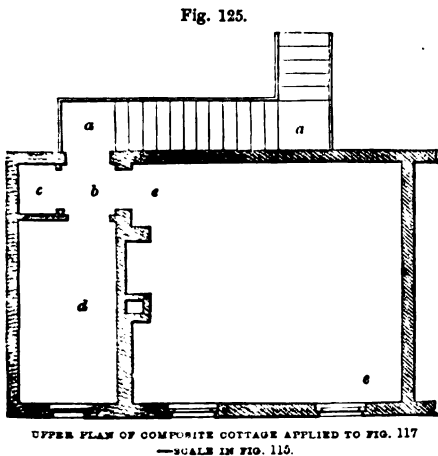

444. In fig. 127 we give plan of cottage over that in fig. 120: *a a* outside stairs; *b* porch; *c* pantry; *d d* living-room; *e* scullery; *f f* bedroom.

445. In fig. 128 we give plan of cottage over that in fig. 119: *a* outside stairs; *b* porch; *c* scullery; *d d* living-room; *e* closet entering from the living-room; *f f* bedroom; *g* bed-closet.

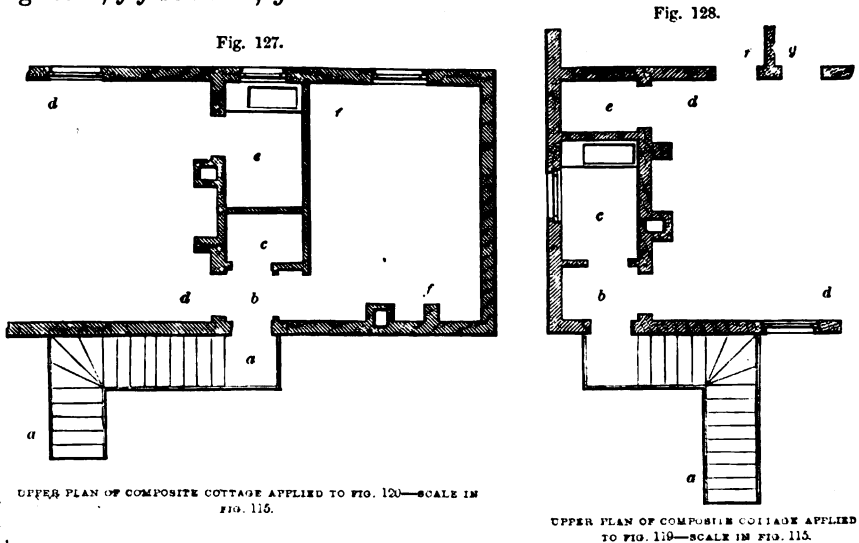

446. *Arrangement of Bothies.*—This structure of the farm has given rise to much discussion—some utterly condemning, others as loudly praising it. Nevertheless, taking the description of their general peculiarities which we have given at the beginning of this section as correct, it will be difficult, we think, for any one to defend the use of a structure of this kind as at all likely to conduce either to the physical or moral well-being of their inhabitants. The Rev. Mr Stuart has made this subject exclusively his own, and to his pamphlet we recommend the reader, where he will find all the evils of the bothy system, unimproved, fully detailed. The same gentleman has been at much pains to devise arrangements which shall give comfort to the inhabitants of the bothy, and enable them to carry out, in some measure, the requirements of decent and orderly living. To avoid the evils of the bothy as generally arranged, Mr Stuart recommends that every one “ought to have a cooking and a sleeping apartment; the one furnished with a strong table and chairs with high backs, well bolted and stayed with iron rods, and the other with small iron bedsteads—one for each man—both these apartments of healthful dimensions and construction. The sleeping apartment floored with wood, well lathed on the walls, quite free of damp, yet well ventilated with ventilating flues. Giving each man his own bed, I am confident, would of itself work a mighty reformation in the habits of ploughmen, as it certainly did in the habits of our soldiers, when each of them wholly got a bed to himself.”

447. In the pamphlet above referred to Mr Stuart gives plans illustrative of an improved arrangement of bothy. We prefer, however, to give those plans containing the results of his whole experience as published in the “Third Annual Report of the Scottish Association for Improving the Dwellings and Domestic Condition of Agricultural Labourers.” Of this the ground-plan is given in fig. 129, and upper floor plan in fig. 130, where *a a* are the beds.

448. The dimensions of the whole structure are 22 feet by 16 ; the side-walls being 14 feet in height, measured from the sole of the outer door. The thickness of the walls is 20 inches, but those of the lower storey are lined with the hollow tiles (hereafter described). A fire-brick sink is placed in the lobby *a*, fig. 129—a foul air flue being carried up from this into the chimney or “vent” of the wash-closet *b*. This has a fire-place in it, so that it can be used as a spare room when any of the men are sick. The dimensions of this apartment are 12 feet by 5. Under the stairs *c* space is obtained for coals. In the kitchen *d* there is space for a resting bed *e*. “The side of the bed next the door, finished and protected from its draught by a low wooden screen rising about 2 feet above the surface of the bed. I have visited this bothy,” says Mr Stuart, “at night, and found several of the men reclining on this bed, and declaring it to be a grand improvement.”

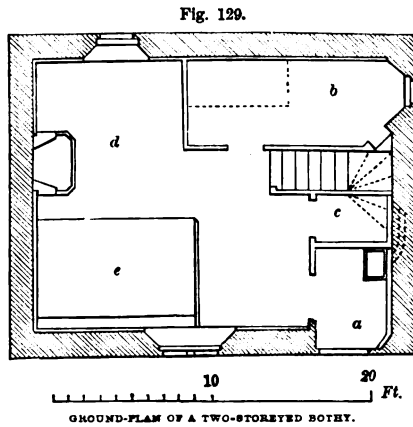

449. “The stair *c* is made to ascend from the living-room, purposely to prevent any man taking to his bed-closet any company his comrades may not see and approve of. For the same reason, when proposed, I objected to locks being put on the bed-closet doors. This would have tended to make the occupant independent of the visits of those who have an interest in seeing that at all times he keeps all right in his own cabin. They can well enough secure all the property they have in their own trunks, and by locking the entry door. Four of the bed-closets on the upper floor average 10½ feet by 5½ feet, or nearly so. It was very difficult to place a stair easy of access,

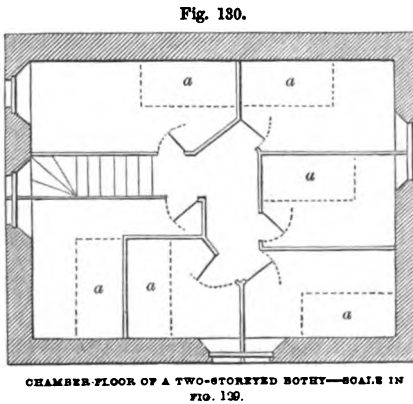

so as not to sacrifice room, and hence one of the closets is of smaller area than the other five, but it has a fine exposure, and is well ventilated. The windows are all sashes, the upper half hung on pulleys, and the smallest of them 1½ by 3½ feet high. At each window a board is placed as a writing-desk. The partitions of the bed-closets are of ¾-inch white wood, grooved and tongued, strongly framed, and carried close up to the ceiling. The closet doors are of the same, also strongly framed. In short, everything is purposely made so as to bear the roughest usage, and need no repairs for generations to come. The beds are strong wooden frames, having a wooden screen about 2 feet high at the head and foot.

450. “To secure the sleeping-closets against severe alternations between cold and heat, lath was put on the upper edge of the baulks, and a coat of plaster between it and them before putting the ceiling lath and plaster on the lower edge.

This cost 10d. a-yard additional, but I considered it a great matter for the health of the occupants; and I cannot too strongly condemn making but small sleeping berths for those hard-wrought men, like so many nests among the couples of the bothy garret only, and all to save a few pounds in raising the walls 5 or 6 feet higher. If such a stunted way of giving each man his own bed and bed-closet is pursued, it will soon bring the movement into disrepute. To form ventilating flues for the bed-closets, the kitchen vent was formed of fire-brick vent-lining; and in the gable-top, around this lining, four fire-brick pipes, each of 4 inches bore, were placed in the kitchen vent-lining, carried some inches above the chimney-top; and, to prevent soot falling into them, a round bonnet of fire-brick was placed in the kitchen vent-lining, carried some 9 inches above the chimney-top. This round screen has of course a round hole in its centre, equal in diameter to that of the vent-lining; and on the upper side a division of vent-lining 1 foot high, to carry off the smoke. These four small pipes, being laid hard on the kitchen vent, will become hot, and thus cause a draught in them upward, and by means of other pipes, made of thin yellow pine deal, the draught of these pipes was thus brought to bear upon the foul air above the beds in the closets, so that, between these and the windows, I should think the ventilation will be good."

451. In fig. 131 we give a plan of bothy for two men, designed also by Mr Stuart: *a* kitchen, 9 feet 6 inches by 9 feet 4 inches, with sink *b*; resting bed *c*; *d* and *e* bed-closets, 6 feet 6 inches by 7 feet; *f f* meal-binns in the kitchen.

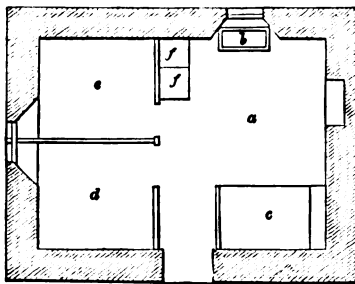

GROUND-PLAN OF A SINGLE-STORIED BOTHY.

452. In some districts the bothy system cannot, under present circumstances, be got rid of, but it behoves the parties having interest in these localities to see that they are improved so far as to secure comfort to their occupants. The advantages obtained in healthier workmen would amply repay the cost incurred in this way. There can be no doubt of the fact that the numbers of comfort-

less bothies throughout the country exercise a most injurious influence on the physical condition of the farm-labourers who live in them. In the words of one who knows the subject well, it is "sad enough to think of the after effects of these on the constitution of the ploughmen compelled to sit in their drenched clothes at night, with no fire to dry at, and again to have them to draw on in the morning, not dry, but merely 'weel dreppit.' The constitutional coughs, and the irremediable rheumatism which prevail among elderly ploughmen, are clearly traceable to such a mode of treatment."

453. A few remarks of our own on the origin of the bothy system, and of the possibility of putting an end to it, may perhaps prove not unacceptable to our readers.

454. No difficulty ever occurred in accommodating married hinds on a farm, for they must have their cottage and garden; but it has been a question in different parts of the country of the best manner of lodging unmarried men. There are just three modes of doing it. One is to lodge them in the farmhouse; another is to provide a house for them to live in together; and the third is to lodge them in the houses of married men.

455. In primitive times the farm lads used to take their meals in the farmer's kitchen, at the table of which the farmer and his wife presided. As far as the quality of the food they received, and their personal comfort during the day

was concerned, they were well fed, and passed their time happily in such an arrangement. But there were drawbacks to it nevertheless. In wet weather the lads could not easily have their clothes dried at the kitchen fire, and at night they had to go to a loft in the work-horse stable to sleep, and to which place they were naturally prohibited taking a light with them, for fear of fire. At length when the farmer preferred his own snug parlour in the company of his family, as the progress of refinement advanced, to the kitchen and its inmates, such an arrangement could not be continued. Left to themselves thus in the kitchen in the evening, all the servants did not conduct themselves with propriety, so that the farmer was glad to purge his house of its unruly inmates. He provided a house for the young men to live in together, near the steading.

456. Such a house was called the *bothy*. The change was an agreeable one to both parties; to the farmer, inasmuch as it restored order and quietness to his house; and to the men, because they were freed from the surveillance of the farmer's wife; and their bed in a bothy was more comfortable than the one in the stable. They had now, however, to cook their own victuals; and to render that task as easy as possible in the circumstances, they were obliged to select articles of food of the simplest description—to live, in short, on oatmeal brose and porridge, while the farmer provided the milk. But, like all cases of compromise, the bothy system has not worked advantageously for either party. The farmer finds idle company congregating in the bothy in the evenings, given to drinking, card-playing, and other evil work. He hears that some of the men wander from home most of the night, and he observes them, in consequence, unable to do their duty next day as it should be done. He is annoyed at their leaving their service every half-year, and it is evident to him, from the general tenor of their conduct, that they feel no interest in the farm or its operations. The men, on the other hand, feel that the farmer takes no interest in their personal comfort. Mated with disagreeable companions, they are induced to visit neighbouring farms in the evening. They complain that their food and fuel are not so good as they should be, and that their bed-clothes are scanty and too long of being changed. They thus believe that a change of place may improve their condition, and after trying many changes, they discover that all places are very much alike.

457. The bothy system has thus proved a failure, and yet where that system is in greatest force, it is believed that it cannot be put down, but has now to be endured as a necessary evil. But in truth no such necessity exists; it can be abolished as completely in every district, as in those parts of the country where the system has never existed. In those parts, the primitive plan of lodging in the farmer's kitchen was also pursued in regard to unmarried men, but when that plan was abandoned, as explained above, the young men were not put into bothies, but continued in their parents' and friends' houses, and took service when so lodged. When a hind finds himself advancing in years, he is glad to have one of his sons to remain with him, and obtain a double-hinding for him from his master; and if the relationship is not so near as that of a father, a young man who has lost his parents may obtain a hinding along with an uncle or a cousin, or he may have a hinding for himself, and occupy the house, with an aunt or a sister. As lodgers in the houses of married men, young men find themselves infinitely more comfortable and enjoyable in every respect than in any bothy.

458. The remedy for the bothy system is thus obvious: Let cottages be built in every farm where the bothy system exists, to be occupied by married men. They will soon be crowded by the bothy men, anxious to marry and

settle in life, or as inmates with their relations. The change from the confused crowd of a bothy to the peaceful quiet of one's own house, will soon work a marked change for the better in the character of the young men. They will then have no desire to change their service. There will then be no loss of time and work every half-year; no hiring-market will then be frequented for a bad purpose, and the outcry against them, and the bothy system itself, will cease for ever. This is no inferential result, but one established from our own experience.

459. *Outhouses of Cottages.*—Although, in some of the examples of cottage arrangement which we have given, we have shown the privy or water-closet connected with the house, we would recommend the space to be used in some other way, as a closet for coals, pantry, &c. This will necessitate having the privy apart from the house, an arrangement which is in every way better. The separate structure should be placed in the garden at a considerable distance from the house, and should also comprise a place for coals and a pig-sty. We now propose to give a few plans suggestive of the arrangements of outhouse structures adapted to the different classes of cottages we have already given.

460. *Outhouses for a Single Cottage.*—In fig. 132 we give plan of the arrange-

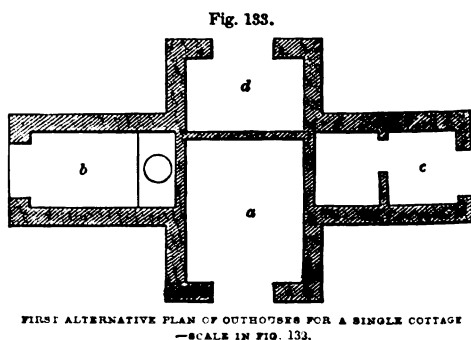
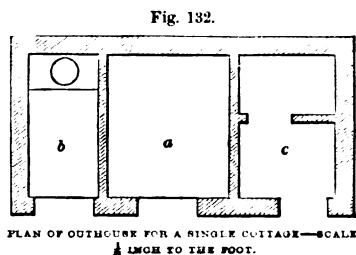

ment suggested, in which *a* is the coal or fuel store, 5 feet by 6 feet; *b* the

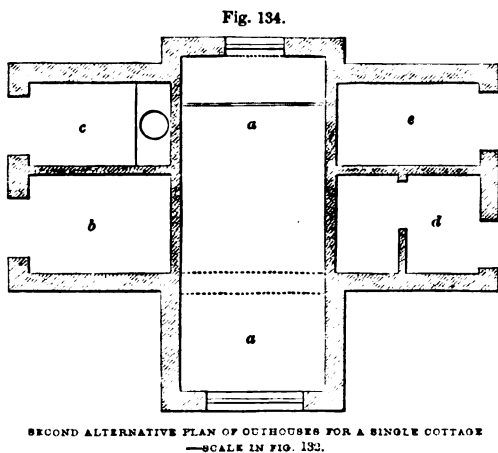

privy or water-closet, 3 feet by 6; *c* pig-sty, 4 feet by 6. *Alternative Plan*, fig. 133, in which *a* is the fuel-store, 5 feet by 6; *b* privy, 3 feet by 6; *c* pig-sty, 4 feet by 6; *d* a food-store, 3 feet by 6. *Second Alternative Plan*, fig. 134, in which the accommodation of cow-byre is given; *a* a the cow-byre, 18 feet by 6; *b* coal-store, 6 feet by 6; *c* water-closet, 3 feet by 6; *d* pig-sty, 4 feet by 6; *e* food-store, 3 feet by 6.

461. *Outhouses for Double-Detached Cottages*, fig. 135, in which *a* and *b* are the two coal-stores, each 3 feet by 6; *c* and *d* the water-closets, same dimensions; *e* and *f*

pig-sties, 4 feet by 6. *Alternative Plan*, fig. 136, in which *a* and *b* are the two coal-stores, 5 feet by 6; *c* and *d* the water-closets, 3 feet by 6; *e* and *f* pig-sties, 4 feet by 6. *Second Alternative Plan*, with cow-byres, fig. 137: *a* and *a* the cow-byres, 18 feet by 6; *b* and *b* privies, 3 feet by 4; *c* and *c* pig-sties, 8 feet by 3; *d* and *d* food-stores, 3 feet by 4. *Third Alternative Plan*, fig. 138: *a* and *a* coal-stores, 7 feet 4½ inches by 6 feet; *b* and *b* pig-sties, 4 feet by 6; *c* and *c* privies, 3 feet by 6; *d* and *d* food-stores, 3 feet by 4.

Fig. 135.

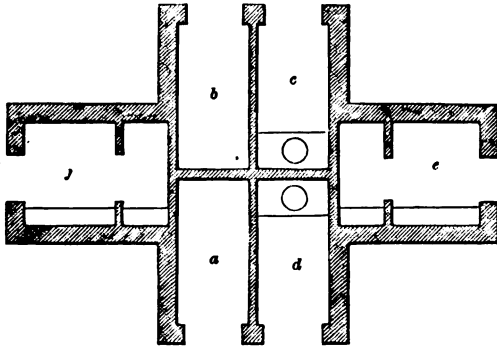

PLAN OF OUTHOUSES FOR DOUBLE-DETACHED COTTAGES—SCALE IN FIG. 133.

Fig. 136.

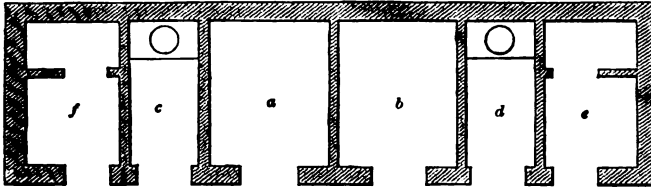

FIRST ALTERNATIVE PLAN OF OUTHOUSES FOR DOUBLE COTTAGES—SCALE IN FIG. 133.

Fig. 137.

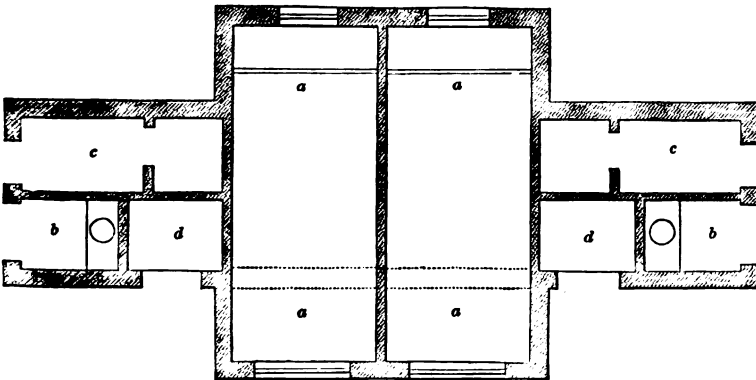

SECOND ALTERNATIVE PLAN OF OUTHOUSES FOR DOUBLE COTTAGES—SCALE IN FIG. 133.

462. *Outhouses for Two Double-Detached Composite Cottages*, fig. 139: *a a, a a* coal-stores, each 4 feet by 6; *b b, b b* privies, each 3 feet by 6; *c c, c c* pig-sties, 4 feet by 6 each. *Alternative Plan*, fig. 140: *a a, a a* privies; *b b, b b* coal-stores, 4 feet square; *c c* pig-sties, two at the ends of the coal-stores *b b*, not shown in the figure, 4 feet by 6.

Fig. 138.

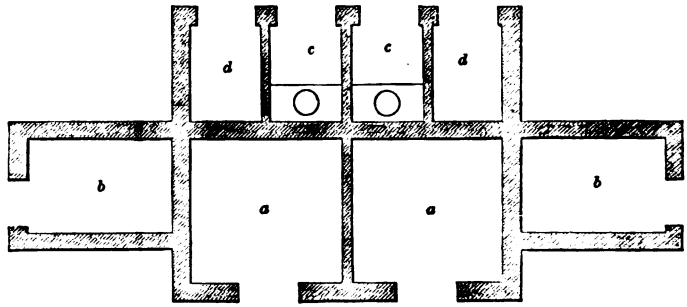

THIRD ALTERNATIVE PLAN OF OUTHOUSES FOR DOUBLE COTTAGES—SCALE IN FIG. 132.

Fig. 139.

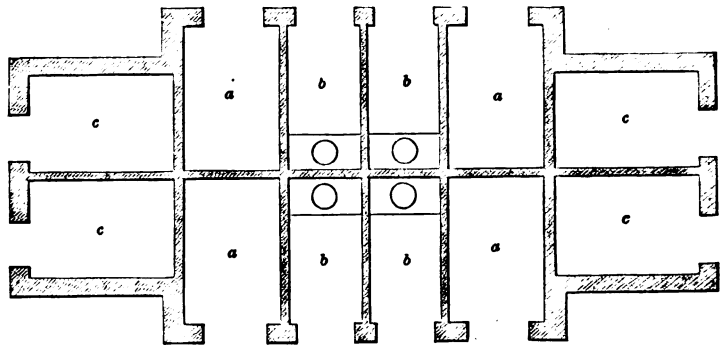

PLAN OF OUTHOUSES FOR FOUR COTTAGES, TWO DOUBLE COMPOSITE COTTAGES—SCALE IN FIG. 132.

Fig. 140.

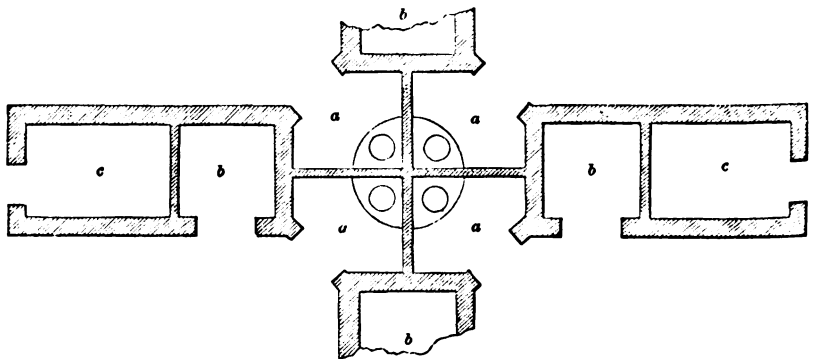

ALTERNATIVE PLAN OF OUTHOUSES FOR FOUR DOUBLE COMPOSITE COTTAGES—SCALE IN FIG. 132.

463. *Doors and Windows.*—Windows and a door for cottages are given in sketches as follow, to larger scale. In fig. 141 we give elevation of front door, showing dressings, &c.; in fig. 142 elevation of three-light window to living-room; in fig. 143 an elevation of two-light window to bedroom; and in fig. 144 an elevation of small two-light window for staircase.

464. The following remarks on windows in the article on Labourers' Homes, which has just appeared in the *Quarterly Review* for April 1860, deserve attention. "It is the windows, however," says the writer, "that give the character to every building, and mark its style; and this to the cottage as much as to the palace. From old association we should regret the substitution of the sash for the casement-window; but, in fact, the latter, if of three lights, and opening outwards in the centre, is also more convenient for the cottage, being much more easily repaired when out of order, and its interior sill serving as a useful shelf. If lead lattice is objected to, the best casement is a wooden frame with square lights. *Large* diamond frames never look well, and are particularly ugly either in wood or cast iron. If the windows are sufficiently large, there can be no objection to small lead lattice, as a cottage window is not wanted to look in or out of, but simply for transmission of light. When near the road, large frames render the interior too public. A single sash-window can never be made proportionate to a low room; for all low buildings the windows should run in horizontal, not vertical length. Good proportion for cottage window-lights are 4 feet high by 18 inches wide, or 2 feet 9 inches by 15 inches."

Fig. 141.

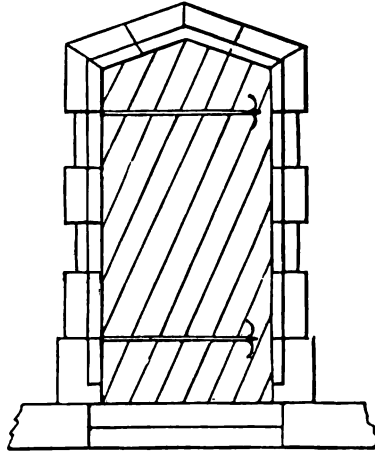

ELEVATION OF FRONT DOOR FOR COTTAGE.

Fig. 142.

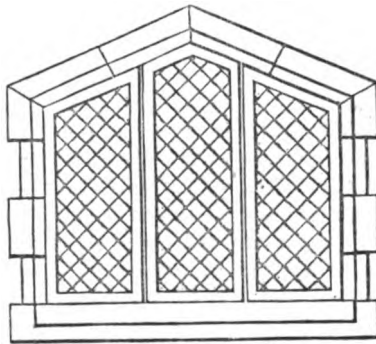

THREE-LIGHT WINDOW FOR THE LIVING-ROOM OF A COTTAGE.

Fig. 143.

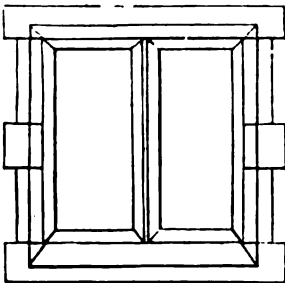

TWO-LIGHT WINDOW FOR BEDROOM OF A COTTAGE.

Fig. 144.

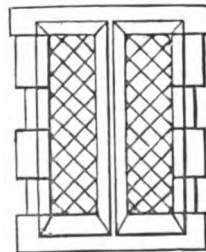

SMALL TWO-LIGHT WINDOW FOR THE STAIRCASE OF A COTTAGE.

465. *Allotments.*—There can be no doubt that a man who has part of his family able to work with him in the field, may live more comfortably, and be better enabled to earn money on a piece of land within the power of their combined labour, and possessed at a moderate rent, than if he were a farm-servant. A piece of land so occupied is called an *allotment*. To render it capable of being occupied by a family, it must have a dwelling-house and a set of offices suited to the extent of the ground occupied.

466. Allotment land must be cultivated with the spade and other hand implements. When the extent of the allotment is less than the occupier and his family can easily cultivate, part of their labouring power is thrown away, and when its extent is beyond their physical power to cultivate it properly, the production of the whole allotment is suppressed. In either case loss is incurred. It is, therefore, of the utmost advantage both to the occupier and the proprietor to have the power of labour and the extent of the ground proportioned to each other.

467. Unfortunately the proportion betwixt labour and the soil cultivated is less attended to than it should be, for commonly the allotment is larger than is the power of the occupier to cultivate it in a proper manner, and the natural consequence is that allotments are not so well cultivated as farms. It is rare to find an allotment in a high state of cultivation. Besides shortcomings in labour, there are shortcomings in capital, and labour alone is not a substitute for capital in the cultivation of the soil. It is then an important consideration for the landlord, when engaging with an occupier, to be assured that both adequate labour and capital are to be brought upon the allotment with the new occupier.

468. But, on the other hand, the occupier should be satisfied that the dwelling-house, the offices, the roads, and the fences are in good order. The house may be a single-storey cottage if the family is small; but if large, a two-storey one will be required. The outhouses should consist of a byre, a barn, a hen-house, and outhouses to contain sundry hand implements, and some light machines. Amongst the many plans of cottages we have given, one may easily be chosen suitable for an allotment.

469. We have nothing more to say on the subject of allotments, and shall conclude by appending the following paragraph by the writer in the *Quarterly Review*, formerly referred to. "There is yet one matter," he says, "in which our landed proprietors might most serviceably aid in cottage improvement. In many parishes the manorial tenure is often the sole obstacle to better dwellings, where encroachments on the waste have given uncertain ownerships, and the parish, the lord of the manor, and the occupier dispute rather whose property it is not than whose it is. This is the most hopeless case, for even repairs are not effected, much less improvement; and too often the tenement, which none think worth an outlay, becomes, when the blood of proprietorship is once up, a bone of contention between parties who can little afford to be at variance. The end is that the poor man is either heartlessly swept away from the home of his fathers, or gains the short-lived and disastrous triumph of retaining the paltry prize in the teeth of those to whom he must look for his bread. Few parishes are without some of this bitter experience, but in many the nature of the soil, and prevalence of copyhold, have made it the rule. These huts and hovels take the place of houses, and, like the mother's pet, are clung to all the more for their weakness and worthlessness. No kinder act could be done to the rural poor than the compulsory commutation of these questionable tenures into freeholds. Often it would be better that the landlord should have them, sometimes it would be fairest to assign them at once to the servant; but as there is no root of

revolution so deep as the agrarian one, it would be well to cut off, before it has too widely spread itself in the social soil, an evil which is daily fostering discontent and defiance among the tillers of the land, and for which they might fairly expect the law to find an easy and equitable remedy. When the work of landed accumulation is going on so fast, a few thousand additional small freeholds would be a political gain, not to the landed interest only, but to the whole state. But the jealousy which is felt towards the cottage freeholder by the farmer, and still more by the steward, can only be appreciated by those who have lived among them. Legislation is not likely to be speeded in this direction. It is a gentleman's question, to be taken into his own hands; and he that can have the heart to abate the jots and tittles of his feudal claims, and not only enfranchise his copyholder, but, if the case requires it, set him up with means to make his new freehold respectable, may be assured that in strengthening the state of his poor neighbour's property he has not weakened his own."

470. *The proportion of power and accommodation to the acreage of the farm.*—The amount of power required to cultivate land depends on the nature of the soil, and the rotation of crops under which it is cultivated. Strong soils require a greater amount of power to cultivate them than weak soils. Strong clays, fitted chiefly to grow wheat, require a greater number of horses to work them than loams, and still more so than gravelly soils. Hence carse clays require a greater force than sharp turnip soils. Perhaps 40 acres of carse clay are as much as a pair of horses can work, whereas 70 acres of turnip soil might be overtaken by the same force. On farms of equal extent, it is thus evident that nearly double the accommodation for horses will be required in the steading of a carse farm than on a farm of gravelly soil.

471. By a parity of reasoning in farms of the same extent and same kind of soil, one rotation of cropping will require a greater number of horses to cultivate it than under another rotation. For example, under a rotation of fours, three-fourths of the land is under arable culture; whereas, in a system of sixes, one half only of the land is under the plough. Less extent, therefore, of accommodation for horses is required in a farm where the six course is pursued, than where is the four course.

472. The difference of force required to cultivate clay soils in comparison with weak soils, is not on account of any difference in the manner of using the implements of culture, but solely on account of the greater physical power required to labour the clay soil in every operation. Not only is a greater force required to work any implement used in clay soils than in light, but a greater variety and heavier class of implements are required to reduce the clay soil to the same degree of pulverisation.

473. From all these considerations, we must come to the conclusion which we have stated at the outset, that the extent and accommodation to be given to farm-buildings must be regulated by the kind of farming to be pursued on the soil which forms the staple of the farm.

474. *State of Farming in Scotland in the Middle Ages.*—Perhaps an appropriate conclusion may be given to this part of our work by taking a glance at the state of agriculture in Scotland in the thirteenth century. In the middle ages the monks were the great promoters of agriculture and gardening, and the breeding and rearing of cattle and sheep. It may prove interesting to our readers to give them a slight sketch of the condition of the farms, farm-buildings, and farm-labourers of that period, and which we can do satisfactorily

from the pages of Mr Cosmo Innes, in his *Scotland in the Middle Ages*, an interesting work which has just recently appeared.

475. Of the condition of pastoral farming Mr Innes says, "The monasteries of Teviotdale had necessarily a great extent of pasture-land; and the minute and careful arrangement of folds on their mountain pastures for sheep, and byres for cattle, and of the lodges and temporary dwellings for their keepers and attendants, shows that they paid the greatest attention to this part of their extensive farming."

476. In regard to arable husbandry, great attention was paid to agriculture from the earliest period of our records. The same corn was grown as is now used. Wheat was grown even in Morayshire in the thirteenth century. We find everywhere strict rules for the protection of growing corns and hay-meadows. "In the reign of Alexander II., the monks of Melrose purchased the right of straightening a stream that bounded their lands of Bele in East Lothian, on account of the frequent injury done by its inundations to the hay-meadows and growing corns of the abbey."

477. "On the estates of the monasteries, water-mills and wind-mills were used for grinding corn in the thirteenth century, and previously, though the rude process of the hand-mill kept its ground in some districts of Scotland to a recent period."

478. "At the end of the thirteenth century (A.D. 1290), and probably always, the monks held a great part of their ample lands and baronies in their own hands, and cultivated them by their villeins from the several granges. The grange itself, the chief house of each of the abbey baronies, must have been a spacious farm-steading. In it were gathered the cattle, implements, and stores needed for the cultivation of their demesne lands or mains, their corn and produce, the serfs or carls who cultivated it, and their women and families."

479. "Adjoining the grange was the mill, with all its pertinents and appearance and reality of comfort, and a hamlet occupied by the cottars, sometimes from thirty to forty families in number. The situation of these was far above the class now known by that name. Under the monks of Kelso, each cottar occupied from 1 to 9 acres of land along with his cottage. Their rents varied from one to six shillings yearly, with services not exceeding nine days' labour. The tenants of twenty-one cottages at Clarilaw, having each 3 acres of land, *minus* a rood, and pasture for two cows, paid each 2 bolls of meal yearly, and were bound to shear the whole corn of the abbey grange of Newton."

480. "Beyond the hamlet or cottar town, were scattered in small groups the farm-steadings of the *husbandi* or husbandmen, the next class of the rural population. Each of these held of the abbey a definite quantity of land, called a husbandland. Each tenant of a husbandland kept two oxen, and six united their oxen to work the common plough. The Scotch plough of the thirteenth century was a ponderous machine, drawn, when the team was complete, by twelve oxen. The husbandland was estimated long ago in the Merse, as 26 acres, 'where scythe and plough may gang.' The husbandmen were bound to keep good neighbourhood, the first point of which consisted in contributing sufficient oxen and service to the common plough."

481. "I have said that, of the inhabitants of the *grange* the lowest in the scale was the *carl*, *bond*, *serf*, or *villein*, who was transferred like the land on which he laboured, and who might be caught and brought back, if he attempted to escape, like a stray ox or sheep. Their legal name of *nativus* or *neyf*, which I have not found but in Britain, seems to point to their origin in the native race, the original possessors of the soil." "We learn of the price of the serf from the

efforts made by the Church for their manumission. . . . The Abbey of Coldingham purchased the freedom of Joseph, the son of Etwald, and all his posterity, for the price of three merks; of Roger Fitz Walker, and all his posterity, for two merks."

482. "Above the class of husbandmen was that of the yeoman or bonnet-laird, as he is now called in primitive parts of Scotland. . . . He no doubt paid for his hereditary right to the lands, and felt himself much above the husbandmen whose little was precarious."

483. "Still higher in the scale were the great Church vassals, who held a place only second to the baronage and freeholders of the crown. These generally had their lands free of all service, and paid only a nominal quit-rent."

484. "No service is imposed on women, except harvest-work, and I believe agriculturists will agree that we have a still more decided proof of advancing civilisation in the fact, that at the period of the rental, the whole *services* were in process of being commuted for money."

485. "As to the rent of land, each husbandland paid 6s. 8d. of money-rent, but to this were added considerable services in harvest and sheep-shearing, in carrying peats and carting wool, and fetching the abbot's commodities. These stipulations are exceedingly precise, fixing even the service in which the husbandman was to have his food from the abbey, and where he was to maintain himself."

486. "Roads appear to have been frequent, and although some are called the green road, *viridis via*, and by other names indicating rather a track for cattle; others, bearing the style of 'high-way,' *alta via*, 'the king's road,' *via regia*, *via regalis*, and still more, the caulsey or *calceia*, must have been of more careful construction, and some of them fit for wheel carriages. A right of way was frequently bargained for, and even purchased at a considerable price. The road leading south of Inverness is called *via Scoticana* in a charter in 1376."

487. "We find agricultural carriages of various names and descriptions during the thirteenth century—*plaustrum*, *quadriga*, *charete*, *carecta*, *biga*—and not only for harvest and for carriage of peats from the moss, but for carrying wool of the monastery to the seaport, and bringing in in exchange, salt, coals, and sea-borne commodities."

488. "The immense number and variety of agricultural transactions," concludes Mr Innes this part of his subject, "the frequent transference of lands, the disputes and settlements regarding marches, the precision and evident care of leases, the very occurrence so frequently of the names of field divisions, and of the boundaries between farms, settled by King David in person, show an enlightened attention and interest in agricultural affairs, that seem to have spread from the monarchy and reached the whole population during that period of natural peace and good government, which was so rudely terminated by the War of the Succession."



BOOK SECOND.—PRACTICE IN CONSTRUCTION.

DIVISION FIRST.—MATERIALS EMPLOYED IN CONSTRUCTION.

489. SECTION FIRST—*Stones*.—Stones useful for the building purposes of the farm may be divided into three great classes—namely, the *Silicious*, the *Calcareous*, and the *Argillaceous*. The silicious are represented by the granites, traps, and sandstones; the calcareous are comprised in the limestones; the argillaceous, being peculiarly liable to atmospheric influences, are by no means durable enough for building purposes, but, being slaty in their structure, they are employed in the construction of roofs.

490. *Granite*.—This, in its several varieties, is the most durable of all the building-stones. Its constituents are—quartz, which is nearly pure silica, and forms the greater part of the rock; felspar, which imparts to granite its peculiarities of character; and mica, which occurs in shining plates of greater or less size. The best granites are obtained in Scotland; they are known as the red and the grey varieties. They are more durable than the granites of the counties of Devon and Cornwall in England.

491. The granular arrangement of felspar, hornblende, and quartz, known as *sienite* or *syenite*, forms a species of granite, the hornblende appearing instead of the mica, and is one of the most durable of the building-stones known. The two substances, hornblende and mica, resemble each other closely in composition—hornblende having, however, a much greater proportion of the black oxide of iron. Syenite is as capable of being worked in large blocks as granite, although, from its hardness, like common granite, it is not easily tooled. The durability of this class of building-stones (the granites), in which felspar is present, depends much on the composition of this ingredient. From the potash contained in it, it is more or less obnoxious to atmospheric influences. Care, therefore, should be taken to ascertain the composition of the stones of this class, where large and important works are to be carried on.

492. *Trap* or *Greenstone* is a very hard and durable stone; it is composed of hornblende and felspar. Although a valuable building-stone, its uses are restricted, from the small size and irregular form of the concretions in which it is frequently found. It is also found in some localities in amorphous masses, when it may be raised in large blocks. For cottages and rural structures, when used in conjunction with white stone-facings or dressings to the windows, doors, and corners, and with white mortar, it is well adapted, and presents a pleasing appearance. *Basalt*, of the same composition as greenstone, but with a larger proportion of iron, is also a durable material as a building-stone; but it

occurs in columnar masses and in still smaller concretions than greenstone, and, being harder, is more difficult of being tooled. Trap-rocks are all liable to what is termed "sweating" in damp weather.

493. *Sandstones*, belonging to the silicious class, are composed of grains derived from the wearing down of the silicious rocks, and bound or cemented together by natural cement of an argillaceous, silicious, or calcareous character. Sandstones present a wide range of character, from a state almost as durable as granite, to that but little better than hardened clay. Where the silicious particles are held together chiefly by an argillaceous cement, they rapidly disintegrate under the influence of the weather.

494. Sandstones are easily worked, and divide readily into convenient blocks. From the ease with which it is worked, indeed, some workmen term it "freestone." The best sandstone is that obtained from Craighleith quarry, near Edinburgh: it is in high repute. The grey-coloured sandstones of Forfarshire are very durable. The Yorkshire sandstones are much esteemed for flagging, being hard, durable, and easily worked. A greenish sandstone, known as Kentish rag, is very durable.

495. In choosing sandstone, preference should be given to that purely silicious; when argillaceous matter is present, the atmosphere will affect its durability. Although generally esteemed from its variegated appearance, sandstone with coloured stripes should be avoided. These coloured parts, arising from the presence of iron, are speedily affected by water, and decay of the stone is thereby hastened. When mica is present in minute quantity, it determines more specifically the stratified character of sandstone, and the stone is then easily worked in blocks.

496. *Limestones*.—This, the last class of stones suitable for the buildings of the farm we have here to notice, is an important one, and presents a large variety of kinds, characterised by as great diversities of composition as the sandstones. The principal constituent of stones of this class is lime. Limestones are impure carbonates, the impurities present giving that diversity of appearance which characterises many varieties, as marble. Any limestone susceptible of a high polish is termed marble, and of this there are many varieties. The oolite limestones, a new formation, afford the limestones chiefly used for building purposes. Magnesian limestones afford some superior building material, as well as the mountain limestone.

497. In determining the qualities of building-stone, its *cohesiveness*, or resistance to a crushing power, and its *absorbent* power, or that which represents its capability to resist atmospheric influences, are the two points principally considered. In the Report of the Royal Commissioners appointed to investigate the qualities of the stone to be used for the Houses of Parliament, a valuable table is given, which we here append. This affords information on the above two points in connection with the most celebrated of the building-stones of the kingdom. In another column the number of grains disintegrated from each specimen is given. The amount of disintegration was ascertained by subjecting all the specimens simultaneously for eight days to Brard's process, which closely resembles the action of the usual atmospheric influences on stone. The absorbent column exhibits the bulk of water absorbed by specimens one cubic inch in size, while the cohesive column exhibits the weight necessary to crush two-inch cubes, or blocks of eight cubic inches. Of the two columns of specific gravities, the first exhibits the ordinary specific gravity, the second shows the specific gravity of the solid particles of which each specimen is com-

posed, on the supposition that the water will take the place of the air which occupied the pores before the atmospheric pressure was removed.

Classes and Names of Stones.	Specific Gravities.		Absorbing Power.	Disintegration.	Cohesive Power.
SANDSTONES.					
Craigleith	2.232	2.646	0.143	0.6	28.033
Darley Dale	2.628	2.993	0.121	0.121	25.300
Heddon	2.229	2.643	0.156	10.1	14.168
Kenton	2.247	2.625	0.143	7.9	17.710
Mansfield	2.338	2.756	0.151	7.1	18.216
Park Spring	2.321	2.615	0.112	5.0	27.071
Morley Moor	2.053	2.687	0.221	0.9	10.879
MAGNESIAN LIMESTONES.					
Bolsover	2.316	2.833	0.182	1.5	29.601
Huddlestone	2.147	2.867	0.239	1.9	15.433
Roche Abbey	2.134	2.840	0.248	0.6	13.915
Park Nook	2.138	2.847	0.249	1.8	15.433
Cadeby	1.951	2.846	0.310	6.4	15.180
Jackdaw Crag	2.070	2.634	0.209	3.1	16.951
Bramham Moor	2.008	2.659	0.244	0.7	22.011
OOLITES.					
Ancaster	2.182	2.687	0.180	7.1	8.349
Bath Box	1.839	2.675	0.312	10.0	5.813
Portland	2.145	2.702	0.206	2.7	7.590
Ketton	2.045	2.706	0.244	3.3	9.108
LIMESTONES.					
Barnack	2.090	2.627	0.204	16.6	6.325
Chilmark	2.481	2.621	0.053	9.8	25.553
Ham Hill	2.260	2.695	0.147	9.5	14.421

498. "If the stones be divided," say Professor Daniell and Wheatstone, who conducted the above experiments, "according to their chemical composition, it will be found that, in all stones of the same class, there exists generally a close relation between their various physical qualities. Thus it will be observed that the specimen which has the greatest specific gravity possesses the greatest cohesive strength, absorbs the least quantity of water, and disintegrates the least by the process which imitates the effects of the weather. A comparison of all the experiments shows this to be the general rule, though it is liable to individual exceptions. But this will not enable us to compare stones of different classes together. The sandstones absorb the least quantity of water, but they disintegrate more than the magnesian limestones, which, considering their compactness, absorb a great deal."

499. In practice stones are chiefly subjected to compression, rarely to a tensile force, or a transverse strain; and as the weight to which they are subjected, in the generality of cases, is far beneath the crushing force, or the point at which the particles part asunder, the principal point to be attended to in the selection of a stone is its capability to resist the influences of the weather. Where, however, it is desirable to know the strength of a stone, or its resistance to a crushing weight, it is the safest plan to institute direct experiment.

500. The following, extracted from the Report which we have already alluded to, will afford some practical information as to the various causes of decay in the different classes of stone: "As regards the sandstones that are usually employed for building purposes, and which are generally composed of either

quartz or silicious grains, cemented by silicious, argillaceous, calcareous, or other matter, their decomposition is effected according to the nature of the cementing substance, the grains being comparatively indestructible. With respect to limestones composed of carbonate of lime, or the carbonate of lime and magnesia, either nearly pure, or mixed with variable proportions of foreign matter, their decomposition depends, under similar circumstances, upon the mode in which their component parts are aggregated; those which are most crystalline being found to be the most durable; while those which partake least of that character suffer most from exposure to atmospheric influences. The varieties of limestone termed oolites (or roestones), composed of oviform bodies cemented by calcareous matter of varied character, will, of necessity, suffer unequal decomposition, unless such oviform bodies, and the cement, be equally coherent, and of the same chemical composition. The limestones which are usually termed *shelly*, from their being formed of broken or perfect fossil shells, cemented by calcareous matter, suffer decomposition in an unequal manner in consequence of the shells, which, being for the most part crystalline, offer the greatest amount of resistance to the decomposing effects of the atmosphere. Sandstones, from the mode of their formation, are very frequently laminated, more especially when micaceous, the plates of mica being generally deposited in planes parallel to their beds. Hence, if such stone be placed in buildings with the planes of lamination in a vertical position, it will decompose in flakes according to the thickness of the laminæ; whereas, if it be placed so that the planes of lamination be horizontal, which is most common in its natural (or *quarry*) bed, the amount of decomposition will be comparatively immaterial. Limestones, such at least as are usually employed for building purposes, are not liable to the kinds of lamination observable in sandstone, nevertheless varieties exist, especially those commonly called *shelly*, which have a coarse laminated structure generally parallel to the planes of their beds; and therefore the same precaution in placing such stone in buildings, so that the planes of lamination be horizontal, is as necessary as with sandstones, above noticed.

501. "The chemical action of the atmosphere produces a change in the entire matter of the limestones, and in the cementing substance of the sandstones, according to the amount of surface exposed to it. The chemical action due to atmospheric causes occasions either a removal or disruption of the exposed particles, the former by means of powerful winds and driving rains, and the latter by the congelation of water forced into, or absorbed by, the external portions of the stone. These effects are reciprocal, chemical action rendering the stone liable to be more easily affected by mechanical action; which latter, by constantly presenting new surfaces, accelerates the disintegrating effects of the former.

502. "Buildings in this climate are generally found to suffer the greatest amount of decomposition on their southern, south-western, and western fronts, arising, doubtless, from the prevalence of winds and rains from these quarters; hence it is desirable that stones of great durability should at least be employed in fronts with such aspects. Buildings situated in the country appear to possess a great advantage over those in populous and smoky towns, owing to lichens, with which they almost invariably become covered in such situations, and which, when firmly established over their entire surface, seem to exercise a protective influence against the ordinary causes of the decomposition of the stone upon which they grow."

503. With regard to the *kind of stone* which should be employed in the building of a steading, it must be determined by the mineral product of the locality

in which it is proposed to erect it. In all localities where stone is accessible, it should be preferred to every other material; but where its carriage is distant, and of course expensive, other materials, such as brick or clay, must be taken. In large flat tracts of country, stone is generally at too great a distance; but in those situations, clay being abundant, brick may be easily made, and it makes an excellent building material for walls, and far superior to the old-fashioned clay walls which were in vogue before brick became so universally used for building. Of stone, any kind may be used that is nearest at hand, though some rocks are much better adapted for building purposes than others.

504. We have already given a description of the most important of these building rocks, and now finally point out that the worst sort of building-stone are land-fast boulders of the primitive and trap-rocks, which, although reducible by gunpowder, and manageable by cleavage into convenient-shaped stones, incur great labour in their preparation for building; and even after the stones are prepared in the best manner they are capable, their beds are frequently very rough, and jointings coarse, and the variety of texture and colour exhibited by them render them at the best unsightly objects in a building. They are equally unsuitable for dry-stone dykes or walls as for buildings; for in the case of dykes, they must be used very nearly in their natural state, as the usual charge for such work will not bear labour being bestowed on the preparation of the material. They form very good *foundation-stones* for dry-stone walls. Still, after all, if no better material for building houses is near at hand than those boulders, they must be taken as the only natural product the country affords. There is a class of boulders composed chiefly of micaceous sandstone, found in banks of gravel, which answer admirably for dry-stone walls, splitting with ease with a hand-pick into thin layers, and exhibiting a rough surface on the bed, very favourable to their adherence together in the wall. This species of building material is abundant in Forfarshire, where specimens of dry-stone building may be seen of a superior order.

505. In the following remarks on the general choice of building-stones by Mr G. Smith, architect in Edinburgh, there is much truth: "The engineer and architect," says he, "go differently to work in choosing their stones. The former, in making his experiments for his piers and bridges, selects the strongest and hardest as most suited to resist great pressure. The latter, for all architectural decorations, chooses not only the most beautiful as to texture and uniformity of colour, but those which may be easily cut into the most delicate mouldings, and which, moreover, will stand the winter's frost and the summer's heat. It may be remarked, that the hardest stones are not always those which hold out the best against the effects of weather."

506. *Preservation of Stone: Kuhlmann's Method.*—Various methods are now adopted to prevent the *decay of stone*. The following is a description of the method used at the Louvre, Notre Dame, and other places in France, with marked success: "Two and a quarter parts of silica (flint or clean sand) are fused with one part of potash; it is then dissolved by boiling under pressure, in from eight to ten times its weight of water. The stonework of old buildings is thoroughly cleansed of all that might prejudice its absorbing qualities. Troughs nugged with clay are placed against the part of the building intended to be silicated, so as to collect the solution, which is applied with a syringe at intervals of three or four hours for about four days, or till the stone (when dry) ceases to absorb. It is considered desirable that this process should be repeated, but to a less extent, the following year. The colour of the stone is not materially changed, provided the absorption is tolerably equal, and the silicalisation effected by a

number of applications of weak solutions, both of which conditions are necessary to success."

507. M. Kuhlmann thus explains the *rationale* of the process of induration thus effected: "The carbonic acid of the atmosphere separates the silica from the potash, leaving it deposited in the pores of the stone, when, should the carbonate of lime be present (as in limestone), it combines with it, and forms the silicate of lime, while the soluble salt—viz. the potash—is removed by the rain or other means." The cost of the process in France is stated by Mr H. H. Burnell to be 1s. 3d. per superficial yard.

508. *Daines' Method*.—Mr Daines, who has devoted considerable attention to the causes of decay in stone, states it to be his opinion that "alkaline efflorescence is the primary cause of decay in stonework. This efflorescence is the result of chemical agency, not the least of which will be found in the cement or mortar employed for 'bedding,' or jointing, the work, as in all cases it may be observed that crystals are found commencing at the angles or joints of the work before the walls are thoroughly dry; and, in the first instance, the disintegration which follows proceeds from the alkaline matter contained in all cements and mortars now in general use. In many cases it is accelerated by the employment of sea or salt sand, which is too often used, as the damp developed on the internal walls of many of our buildings plainly testifies. If pieces of Bath or Caen stone, one inch thick, be set with a layer of Roman cement between, and be exposed to the action of the air, it will be found, in the course of three or four years, that the cement will have so acted upon the stone as to render it incapable of being crushed by pressure between the thumb and finger in consequence of its decomposition by the chemical action of the cement. A proof of the destructive effect of salt upon stonework may be observed in any seaport town. The stone-buildings which are exposed to the sea-breezes show plainly this effect. . . . In certain localities where the atmosphere is comparatively free from that influence, vegetation may be observed as accelerating the progress of decay." The most obvious effect of salt on stones is to be seen on the walls of salt-works situate on the sea-shore.

509. As to the remedy for the decay of stone, Mr Daines states, that he employs a "solution of one part by weight of sublimed sulphur in eight parts of linseed oil, heated in a sand-bath to a temperature of 278° Fahr, by which process the vegetable mucus of the oil is precipitated, and the watery particles evaporated, and their place supplied by the sulphur, which is readily taken up by the oil at the above temperature. The solution is applied with a common painter's brush to the surface of the stone until it will absorb no more. Sulphur is stated by ancient and modern chemists to be insoluble in water, and to suffer no change by exposure to air; and farther, it is known to be a decided foe to vegetation. . . . For these reasons," says Mr Daines, "I have selected it as the basis of the indurating medium. The stone so heated becomes extremely hard, almost equal to granite; and so far as I have been able to test its preserving qualities, a period of four years shows, not only that no decay has taken place, but time actually seems to increase its hardness."

510. *Ransome's Method of Preserving Stone*.—Mr Frederick Ransome, of Ipswich, has introduced a mode of preserving stone by the application of a "wash," or substance applied after the manner of paint, by which he states that "the softest and most friable stone can be rendered impervious and imperishable." The method employed consists in applying to the stone surface a solution of silicate of soda, allowing this to be absorbed, and finally applying a solution of the muriate of lime. These two substances, exercising a chemical reaction, fill

up the pores of the stone with an insoluble substance, the silicate of lime. Objections have been made to this mode of preserving stone, on account of the whitewashed appearance it sometimes gives to stone subjected to the process, and also from the liability of the particles of silicate of lime, which become pulverulent when dried, to be washed out by the action of the rain. Mr Ransome, however, it is right to state, has answered these objections. A very extended trial of the method is, while we write, being made at the Baptist Chapel at Bloomsbury, the result of which will place its capabilities before the public.

511. The following is the method to be adopted, as recommended by the patentee: "The surface of the stone, &c., should be thoroughly cleaned by the removal of any extraneous matter, and the prepared silicate should then be laid on evenly with a brush. As soon as this is properly absorbed, and before it has had time to dry, the prepared calcium, diluted with an equal quantity of water, should be applied and well worked upon the silicate with a stiff brush until all froth has disappeared in the pores of the stone. When dry, a second coating of the prepared calcium should be applied to insure the complete neutralisation of the silicate. Should the stone be of a very absorbent character, it may require a second dressing, in which case it is better to allow the first application to get thoroughly dry, and then proceed in the same manner as before. About four gallons of each solution will be required for every hundred yards of surface." The above solutions can only be obtained of the patentee, Mr Frederick Ransome, Whitehall Wharf, Cannon Row, Westminster, and Patent Stone Works, Ipswich.

512. *Paul's Method of Preserving Stone.*—Mr Paul applies to the surface of the stone to be preserved a solution of aluminate of potash. The action of this is not instantaneous, like that of Mr Ransome's process, but, being gradually decomposed by the carbonic acid of the atmosphere, deposits alumina in the pores of the stone, and creates an insoluble substance, which is not liable to be acted on chemically by atmospheric influences or mechanically washed out by rain.

513. *Szerelmey's Mode of Preserving Stone.*—This method, which, under the auspices of the late Sir Charles Barry, who had, it is said, formed a high opinion of its merits, is being carried out on a large scale at the Houses of Parliament, Westminster, is a secret. We merely mention the fact, to make the reader aware of the existence of such an extended trial as is being afforded to the method, and that he may note the results, which will doubtless be made public hereafter.

514. *Principles of Preservation of Stone.*—In concluding our remarks on the preservation of stone, we may briefly draw attention to the great point to be attended to, namely, the filling of the pores of the stone with some substance incapable of being acted on by atmospheric influences, so that water may not be allowed to permeate the interior pores. Any application which merely surface-paints the pores will not be of service, at least it will not act permanently as a preservative, but will have to be frequently renewed. The pores must be filled up, and that to a considerable extent of their length; and the substance so used for filling up must be indestructible—incapable of being acted on prejudicially either by chemical or mechanical atmospheric influences.

515. *Artificial Stones.*—A few notes on this subject may be useful, as many are now being used in practice.

516. *Ransome's Artificial Stone.*—Of artificial stones, perhaps the most celebrated, and principally used, is that of Messrs Ransome, known as the "Silicious." This is composed of "grains of sand, pebbles, portions of limestone, marble, or granite, or indeed any other material cemented together by a true glass, obtained

by dissolving flint in caustic alkali in a boiler at a high temperature, mixing up the materials with this solution into a paste of the consistence of putty; moulding this paste into any required form; and, after slow air-drying, burning the articles thus manufactured in a kiln, at a bright red heat, maintained for some time. In the course of this process the alkali combines with the free silica and forms a kind of glass, so that the materials become cemented together by a substance which does not admit of the smallest absorption of moisture, and is consequently absolutely unattackable by frost. It also resists every other kind of atmospheric action, and is extremely hard. It possesses, besides, the great advantage of not contracting sensibly during the last process of baking."

517. *Kuhlmann's Artificial Stone*.—M. N. Kuhlmann has discovered a simple process by which he converts blocks of chalk, which in its natural state is easily and cheaply worked into any shape or form, into a hard material resembling stone. It has a smooth appearance, a compact grain, and is susceptible of a high polish; it is also unaffected by damp. The process consists in subjecting the chalk or soft limestone to the action of a solution of silicate of potash, lime having a great affinity for silica dissolved in potash. The quantity of silica taken up by the chalk may be increased by alternately exposing it to the action of the solution and the air. A cement or plaster, which is capable of being applied to soft limestone buildings, may be prepared by mixing some powdered chalk in a solution of silicate of potash. By impregnating the chalk with metallic sulphates, under circumstances of easy attainment, a variety of beautiful shades of colour is produced.

518. *Enamelled Slate*.—This seems a fitting place to notice the enamelled slate of Mr Magnus of Pimlico. The patentee, by a simple process—the nature of which is not publicly known—gives to slabs of slate all the appearance of beautifully grained marbles with highly polished surfaces. In addition to the beauty of the material thus prepared, it possesses the advantage of lightness with a strength equal to about four times that of ordinary stone. This enables long slabs of it to be used for various purposes—the lining of walls, butts, chimney-pieces, wash-stand tops, &c.

519. *Artificial Materials for the production of Architectural Decoration*.—In addition to stucco, a variety of materials are now used for the production of ornaments in relief, such as *carton pierre*, *papier maché*, and *leather*. *Carton pierre* is composed of the pulp of paper, mixed with whiting and glue. This is pressed into moulds of plaster backed with paper, and, when set, dried in a drying-room. From its lightness, strength, and ease of application, this material is now becoming much used for decorative purposes. Messrs Jackson and Sons, Rathbone Place, manufacture it extensively. *Papier maché*, as used for architectural decoration, is prepared by gluing sheets of brown paper together, and pressing them into metal moulds. After receiving the impress of these, it is trimmed, and a composition of paper pulp, rosin, and glue poured into the mould, in which the paper is again inserted; as it is pressed upon the composition, a sharp well-defined ornament is produced. *Leather* is now used to produce ornaments in relief, being stamped by powerful hydraulic pressure, the relieved parts being filled in at the back with a composition. *Vulcanised India-rubber* and *gutta-percha* are also used for the production of decorative ornaments in relief.

520. SECTION SECOND—*Brick*.—If properly made, bricks are little inferior in strength, hardness, and durability, to the building-stones in ordinary use. When broken across, their fracture should present a fine, compact, and uniform texture, of a brownish colour: a whole brick, when struck, should give a clear ringing

sound. In Scotland considerable prejudice exists against the use of bricks, as compared with stone, more especially for domestic structures.

521. The following remarks from the *Report on the Condition of the Labouring Population* are deserving of serious consideration, as showing that, as respects the prevention of damp at all events, stone is not so useful as is generally supposed: "Wood and wattled houses, such as our forefathers built, are the driest and warmest of all; brick is inferior in both these requisites of a comfortable house; but stone, especially the unhewn stone, as it is unnecessarily employed for cottages, is the very worst material possible for the purpose. The evil arises from two causes: the stone is not impervious to water, especially when the rain is accompanied by high winds, and it sucks up the moisture of the ground, and gives it out into the rooms; but principally stone is a good conductor of heat and cold, so that the walls, cooled down by the outer air, are continually condensing the moisture contained in the warmer air of the cottage, just as the windows steam on a frosty morning; besides, the abstraction of heat in stone houses must be a serious inconvenience. . . . Of course I do not attribute all the damp of our cottages to the stone—much of it is due to the wet climate, soil, and building so near the ground; but the stone, as a material of building, must bear a considerable share of the blame."

522. *Advantages of Brick.*—And here we may perhaps be permitted to give a few sentences on this subject which we some time since contributed to the pages of the *Agricultural Gazette*, noting here only that, although the remarks were made more particularly with reference to the advantages of bricks for cottage building, they are obviously applicable to the other buildings of the farm: "Of the various materials employed for walls, none combine so many of the essentials necessary to secure good construction as brick. It is easier set up, admits of good joints being secured, and gives rise to none of the vacuities observable in rubble walls, which harbour mice and rats, so annoying to the farmer, especially in the steading, and is less liable to atmospheric influences than stone. An inspection of a vast number of houses in England and Scotland has gone far to convince us that the employment of brick in Scotland would lessen the number of damp houses there so often met with; for it is a notorious fact, which even a most cursory inspection will show, that there is a much higher proportion of damp houses of stone in Scotland than amongst brick houses in England. Nor is this to be attributed to the difference of the climate. Some districts of Lancashire, not a hundred miles from Manchester, enjoy a far more unenviable reputation for rain and humidity than many parts of Scotland; and yet there is a marvellously small proportion of damp houses met with in those districts—small compared with similarly humid districts in Scotland. . . . Nor need the want of solidity be brought against brick walls; a well-built 9-inch brick wall will compare very favourably with a 24-inch stone wall, built in the wretchedly scrimped honeycomb system—too often passed off as good work in Scotland. Neither in view of the economical features of construction is brick as a building material to be classed as low as it is in Scotland. Estimates for cottages of brick would contrast favourably with those of stone, everything else being equal in both cases. Not seldom have we heard astonishment expressed at the low rate at which good cottages, with ample accommodation and convenient fittings, can be built in England. . . . It is easy to bring vague objections against brick houses as to being cold, and to indulge in jokes at the expense of their solidity; but it should be remembered that the winters of England are little less severe than those of Scotland, and the inhabitants of the former as keenly alive as to what constitutes household comfort as those of

the latter country, and that the apparent thickness of Scotch walls does not always insure dryness or warmth."

523. SECTION THIRD—*Slates—Tiles*.—Blue slate is derived from the primitive rock clay-slate. It occurs in large quantities through the mountainous parts of the kingdom. Good slate should not absorb water, and it should be so compact as to resist the action of the atmosphere. When it imbibes moisture, it becomes covered with moss, and then rapidly decays.

524. The principal blue-slate quarries in Great Britain are in Wales, Lancashire, Westmoreland, Cumberland, Argyll, and Perth shires. The most extensive quarry is in Caernarvonshire, in Wales, near the town of Bangor, on the Penrhyn estate. It employs 1500 men and boys. The Welsh slate is very large and smooth, and much of it is fit for putting into frames for writing-slates. When used very large, being thin, it is apt to warp on change of temperature. The English slates at Ulverstone, in Lancashire, and in the counties of Westmoreland and Cumberland, are not so large as the Welsh, but equally smooth and good. The Easdale slates, in Argyllshire, are small, thick, waved on the surface, and contain many cubical crystals of iron pyrites, but its durability is endless. Being a small and heavy slate, it requires a stout roofing of timber to support it. The Ballachulish slates are rather smoother and lighter than the Easdale, though also small, and containing numerous crystals of iron pyrites, and is equally durable. The slates in Perthshire are of inferior quality to either of these. "The ardesia of Easdale," says Professor Jameson, "was first quarried about a hundred years ago; but was for a long time of little importance, as sandstone flags and tiles were generally used for roofing houses. As the use of slates became more prevalent, the quarries were enlarged, so that 5,000,000 slates are annually shipped from this island. The number of workmen is at present (in 1800) about 300, and they are divided into quarriers and day-labourers. The quarriers are paid annually at a certain rate for every 1000 slates, from 10d. to 15d., I believe, as their work has been attended with more or less difficulty. The day-labourers are employed in opening new quarries, and have from 10d. to 1s. a-day."

525. Slates are assorted into sizes at the quarry. The following are the distinctive names and sizes of slates known in the trade: Doubles, 13 inches by 6; ladies, 15 inches by 8; countesses, 20 inches by 10; duchesses, 24 inches by 12; rags, 36 inches by 24; queens, same size as rags. This size, 3 feet by 2, may be taken as the average size of rags and queens, there being no definite size for these classes. The dimensions of the remaining classes, imperials and patent Wyatts, are 30 inches by 24. Slates are sold by long tale, 1200 for 1000: 100 feet superficial is termed a square. Of doubles, 1000 (1200) will cover $2\frac{1}{2}$ squares; of ladies, $4\frac{1}{2}$ squares; of countesses, $7\frac{1}{2}$ squares; and of duchesses, 10 squares. The weight per square of the three latter classes is nearly 6 cwt. Of rags and queens, a ton will cover nearly 2 squares; of imperials and patent Wyatts, from $2\frac{1}{4}$ to $2\frac{1}{2}$ squares.

526. *Grey Slates* are pretty smooth on the surface, and when so compact in texture as to resist moisture, form a durable though very heavy roof.

527. The cost of grey slating depends on the locality where it is wished to be done. At Edinburgh it costs L.6 a-rood; whereas in Forfarshire, the matrix of the grey slate, it can be done, exclusive of carriage, for L.2, 10s. the rood. In Forfarshire the slates cost L.4 per 1000; 360 are required for a rood; the putting them on, including dressing, holing, pins for the slates, and nails for the lath, costs only 15s.; and with moss for bedding, 1s., and lime for teething, 3s.—

22a. the rood. The droved angular freestone ridging-stone, always accompanying grey slating, including carriage, costs 6d. a lineal foot, or 10s. the rood.

528. Grey slates are obtained in best quality from grey slaty inferior sandstone, belonging to the old red sandstone series. They are derived from the same quarries as the far-famed Arbroath pavement, being, in fact, formed by the action of frost on pavement, set on edge for the purpose. A mild winter is thus unfavourable to the making of slates. From Carmylie to Forfar, in Forfarshire, is the great field for the supply of grey slates; and as blue slates could only be obtained there by sea and long land carriage, before the introduction of railways, and there is little clay fit for tiles, they constituted the chief roofing of cottages and small farmhouses in that part of the country, their aspect being cold and unpicturesque, though snug enough. The easy transit now by railways may effect a material change in that quarter in favour of blue slates.

529. *Of all sorts of slating*, there is none equal to blue slate for appearance, comfort, and even economy in the long-run. When a blue-slate roof is well executed at first, with good materials, it will last a very long time. Tile-roofs are constantly requiring repairs, and the employment of grey slate is a sacrifice of, and a burden upon, timber. Of the blue slates, the Welsh give the cheapest roofing, being larger and much lighter than Scotch or English slates.

530. *Tiles*.—Tiles should be smooth on the surface, compact, and ring freely when struck, when they will resist water. When they imbibe moisture by porosity, they soon decay in winter by the effects of rain and frost.

531. SECTION FOURTH.—*Mortar, Concrete, Beton, Hydraulic Cements, and Cements.*

532. *Mortar* is a combination of lime and sand. Lime, in its ordinary state of carbonate, is useless for building purposes; but, when burnt, a new substance is produced, which has a powerful affinity for water: this new substance is termed an oxide of calcium. When water is added to this, a hydrate is formed, which, when combined with sand, forms a new substance again—namely, a silicate. The office which the sand performs is simply to act as nuclei, round which the crystals of carbonate of lime, and the portions of silicate which are formed, may arrange themselves. Sand, therefore, must not be rotten or friable; moreover, it must contain no salt calculated to make the lime soluble; hence the use of sea-sand must be avoided.

533. The *Sands* used for the preparation of mortar are generally classed as pit, river, and sea sands. Of these, river-sand is generally considered the best, pit-sand being dirty and sometimes friable; while the sea-sand is objectionable for the reason stated in last paragraph, as also from walls built with it being peculiarly liable to atmospheric influences, soon showing damp, arising from the affinity salt has for moisture. A mixture of coarse and fine sand is better than sand of equal fineness. For good mortar, the proportion of lime to sand should be two and a half of sand to one of lime.

534. *Concrete* is a compound of lime finely pulverised, gravel, or broken stones—the more angular the better—and sand. The whole must be mixed up near the spot where the concrete is to be used, as it sets very quickly. The proportions of this compound vary with the locality, and with the practice of engineers. The lime must be fresh burned, and pulverised without slacking. A proportion adopted in London is five parts of gravel and sand to one of lime. The materials are thoroughly mixed up while dry, and a little water is then added to bring the whole to the consistence of mortar; it is then quickly worked up with a shovel,

and applied. In filling in foundations, it is considered by some a good plan to "toss" in the concrete from some height, as it tends to consolidate the mass. A contrary result may, however, be apprehended, as it tends, we think, to separate the constituent parts. When first made, the bulk of concrete is less than the bulk of the materials of which it was composed; but the mass ultimately expands, in the proportion of nearly half an inch in height for every foot of depth.

535. In some instances concrete is applied in blocks as a building material, but both in durability and transverse strength it is very deficient. Away from atmospheric influences, such blocks may be used in the interior of thick walls. As a material for securing a good foundation, and for the prevention of damp, it is exceedingly valuable, and is deservedly in high repute.

536. The term *Beton* is applied to any mixture of hydraulic lime with fragments of brick, stone, or gravel. The most economical mixture, and one which is very good, is broken stone or brick, in fragments of the size of pigeon eggs, with coarse and fine gravel. In preparing beton, the lime is first prepared, with which is next incorporated the finer quality of gravel used. This is then spread out where required to a depth of some 4 or 6 inches, over which the coarse gravel and broken fragments of stone or brick are then strewed, and the whole brought to a well-mixed condition with water by the spade or the lime-hoe. Beton is superior to concrete, especially for foundations under water, or in wet soils.

537. *Hydraulic Cements*.—Pure lime, when reduced to a paste by the addition of water, has no tendency to harden—the lime, after the water has evaporated, returning to its original dry condition. Different effects are produced, however, on different limes by the addition of water: thus, in some, termed "rich or fat limes," the bulk is much increased; in others the bulk is very slightly altered. These last are termed "poor" or "meagre" limes, and are those only which, in combination with silica, alumina, and magnesia, have the power of hardening under water. This combination of poor limes with silica, &c., is called a hydraulic mortar or cement.

538. There are various methods of forming this species of cement. *Smeaton's mortar*, as used at the Eddystone lighthouse, was "composed of equal parts of Aberthaw lime in the state of hydrate of lime in fine powder, and puzzolano also in fine powder, well beaten till it had acquired the utmost degree of toughness." *Puzzolano* is a volcanic concrete thrown up from Vesuvius; it is so named from the town Puzzuoli, where it was first found. An artificial puzzolano is prepared by burning clay. The cement or hydraulic mortar used by the Romans was composed of two parts of puzzolano to one of lime. The facing of the London docks was cemented with an excellent mortar, composed of four parts of lias lime, six of river-sand, one of calcined limestone, and one of puzzolano. A good hydraulic mortar may be composed of two and a half parts of burnt clay to one part of blue lias lime, to be pulverised between rollers, mixed, and used immediately.

539. Many calcareous clays or argillaceous limestones possess the property of hardening under water when made into lime or hydraulic cement. When the proportion of clay is only about 10 or 12 per cent, the hydraulic cement made from these takes about twenty days to set in moist places. The hardening, however, takes place in two or three days, when the proportion of clay reaches to 20 or 25 per cent. A minute division of the clay, and a condition in which part of the silica is given up on the application of caustic potash, is considered to give the best results.

540. *Roman or Parker's Cement* is made in England from nodules of calcareous

matter, found in the London clays of Sheppey and Harwich, and the Oxford and Kimmeridge clays. The *Medina Cement*, so called, is of the same kind, but of lighter colour, and is made from the Hampshire septaria. *Atkinson's Cement* is made from the lias.

541. *Portland Cement*.—The most important of the artificial hydraulic cements is that known as *Portland*. It is "made from carbonate of lime mixed in definite proportions with the argillaceous deposit of some rivers, running over clay and chalk." The whole are pounded together and afterwards dried and burnt. It is called *Portland cement* from its colour, resembling that of the well-known *Portland stone*. It is a cement possessed of extraordinary strength, being four times nearly as great as that of any of the natural hydraulic cements. It forms, when mixed with small or even with broken bricks, a concrete of great strength: the proportion of cement required being so small as a tenth or even a twelfth part.

542. At the Great Exhibition of 1851 a series of interesting and valuable experiments were made to test the cohesive strength of *Portland cement*, as compared with *Parker's* or *Roman*. In one experiment, "a block of neat *Portland cement*, having a sectional area of 16 inches (4 inches square) was suspended from each end, and the weight applied exactly in the centre. The block had been made four months. It broke at 1580 lb. The fracture was perpendicular, even, and good. An exactly similar block of neat *Roman cement*, made from *Harwich stone*, and seven weeks old, broke at 380 lb. This must have been a bad sample of the material."

543. A block of neat *Portland cement*, having a sectional area, measuring $2\frac{3}{4}$ inches by 2 inches, was pulled asunder, with the fracture, as shown at the top, at 2280 lb. A block of *Portland stone*, having the same sectional area, and in all respects resembling the above, broke at 1480 lb. The fracture showed no flaw in the stone, which was of even grain and sound quality.

544. The principal experiment was the breaking of a beam constructed of ten courses of hollow bricks, cemented together, the upper part with three courses on edge and four on the flat, the lower two on edge and one on the flat. They were put together with *Portland cement*, and strengthened with hoop-iron band, $1\frac{1}{4}$ -inch broad and $\frac{1}{16}$ th of an inch thick. Fifteen of these iron hoops were inserted. The following were the dimensions of the beam:—

			Feet.	Inches.
Total length,	24	4
Length between bearings,	21	4
Depth,	4	6
Thickness at bottom,	2	3
Do. at top,	1	6

The total weight of the beam, including 1200 bricks, 32 bushels of cement, and 32 of sand, was 17,150 lb. 672 lb. of stone were placed at the top of the beam. The weight of the attached scale was 1792, and the suspended portion of beam 15,000—making the total suspended weight 17,464. The total sectional area cemented was 700 square inches, and the depth of the beam being $52\frac{1}{2}$ inches, the measure of its strength was $700 \times 52\frac{1}{2} = 36,750$. For some months the beam was unsupported, carrying the weight as above stated, 17,464 lb. A weight of 15,000 lb. was loaded on the beam at the centre; the loading was continued after some days, till it reached the amount of 41,000 lb., which caused a deflection of nearly four-eighths of an inch. 41,600 lb. caused two cracks on each side of the fourth brick from the centre, and not long afterwards a crack exactly in the centre. On the addition of 10,000 lb. to the load the piers were affected, as shown by the breaking of a string which was stretched

from one end to the other, and attached to the piers to measure the deflection. This weight caused the crack to extend through the six lower courses, and increased the deflection to 5-16ths of an inch. The weight being increased to 62,800 lb., which was borne for a short time, all the fissures widened, the centre crack extending vertically alike through cement and bricks; the piers were ultimately thrust a considerable distance out of the "plumb," and the beam broke into two parts.

545. The beam tested with Roman cement was of the ordinary stock-bricks, banded as usual, bedded and jointed with cement composed of equal proportions of best Roman cement and clean Thames sand. In this beam there were nineteen courses, the thirteen upper ones being two bricks deep, and the six lower ones $2\frac{1}{2}$ inches—fifteen bands of hoop-iron being inserted, $1\frac{1}{2}$ -inch broad and 1-16th of an inch thick. The sectional area was 1107 inches, the distance between the bearings being 21 feet 4 inches. After having been built for three months it was loaded with a weight of 11,200 lb., suspended, as usual, from the centre. At the end of another period of three months the weight was increased 24,000 lb.; after twelve months it broke down with a weight of 50,622 lb.

546. "The true comparative strength," says the reporters, "of Roman and Portland cement, is perhaps not so well tested as if the bricks had been of the same kind in the two experiments; but, estimating as nearly as circumstances will admit, it appears that the Portland bears to the Roman a ratio of $2\frac{1}{2}$ to 1, very nearly. It must, however, be remembered that the Roman cement beam had been built seventeen months, and the Portland only five, a fact greatly in favour of the former material."

547. To ascertain the resistance of Portland cement to crushing weights, the following experiments were instituted: "A block of neat Portland cement, manufactured by Messrs Robin, Aspden, & Co., thirty days old, measuring 18 inches by 9×9 , was tested by a Bramah's hydrostatic press, and is said to have withstood a pressure of 41 tons for upwards of a minute, when it broke up with a report. A similar block of one part cement and one sand, twenty-eight days old, cracked at 108 tons. Another, four sand and one cement, at 45 tons; and another, nine sand and one cement, at $4\frac{1}{2}$ tons. A small piece of neat Portland cement, exposing a surface of $1\frac{1}{2}$ inch by 1 inch, and six months old, withstood a pressure of 40,320 lb., while a piece of Portland stone, of the same size, cracked at 2576 lb." For details of other experiments, see the *Jury Report of the Great Exhibition of 1851*, pp. 587-9.

548. Of the cements known as *Martin's*, *Keene's*, and *Parian*, sulphate of lime or gypsum is the base. In these "the plaster in the state of fine powder is thrown into a vessel containing a saturated solution of alum, sulphate of potash or borax. After soaking for some hours it is removed and air-dried, and subsequently rebaked at a brownish-red heat. When taken out of the oven it is once more reduced to a fine powder, and carefully sifted, after which it is fit for use, but when slacked a solution of alum is employed instead of pure water. The cement is called *Parian* when borax is used; *Keene's* when sulphate of potash; and in *Martin's*, pearl-ash as well as alum is employed."

549. *Keene's*, *Parian*, and *Martin's* cements are principally used for decorative purposes, but so far as the Farm Buildings are concerned, a much more practical value is attached to them, from the circumstance of their being peculiarly well adapted for forming skirtings of granaries, barns, &c., uninjured by damp and perfectly *vermin proof*.

550. *Stucco* for decoration is a combination of plaster-of-Paris—calcined gypsum—with a solution of gelatine or strong glue.

551. *Scagliola*.—This material is much used as an economical means of imitating the finer kinds of marble. It consists of a coating of plaster mixed with alum and colour into a paste, and afterwards beaten with fragments of marble. The surface on which it is to be laid is previously prepared with a "key" of lime and hair. In this work, resembling as it does that of the fresco-painter, everything depends upon the skill of the operator.

552. *Marine Cement*.—An excellent marine cement, according to Mr Chalmers, may be artificially obtained by "submitting to a moderate heat a mixture of 70 to 80 parts of pure limestone, and 20 to 25 parts of fine sand or flint; a definite silicate of lime which, in forming a hydrate, takes up six atoms of water. The more intimate the previous mixture of the materials the better." The same authority has the following remarks on marine cements: "Cements which set quickly, and are prepared under moderate heat, are always difficult to manage in marine works, as they contain no free lime, and consequently their hardness is all that preserves them from the influence of the sea-water. They may, however, be improved by adding a certain proportion of lime, and letting the mixture stand a considerable time. Natural or artificial cements, well burnt, and containing only a small portion of quicklime, such as those of Parker, the Medina, or the Portland, owe the great solidity which they acquire under water almost entirely to the presence of the hydro-silicate, as $\text{Si. O}^3 + \text{Ca. O} + \text{H. O}$ contains less water by half than the corresponding silicate produced in the hydraulic lime or cement which is burnt at a lower temperature. These we find to answer best for works which are constantly immersed. They would not probably answer so well for those exposed on each side to the effects of water at varying heights. Artificial puzzolana but seldom gives good results. With natural puzzolana fat lime should be used in preference to hydraulic lime; and it is most important to submit the mixture previously to a long soaking in a small quantity of water. This plan is adopted by the Dutch engineers, and tends to account for their remarkable success."

553. The same authority lays particular stress on the following qualities essential to the formation of good marine cement. The materials to be most thoroughly pulverised before mixing. "Sufficient free lime must be present to allow the carbonic acid in the water to combine with it, and form a protecting coating of carbonate. A long soaking of the materials, in order that the chemical combination necessary for the ultimate stability of the mortar, may take place before it is actually used."

554. *Medina Cement for Farm Structure*.—Labourers' cottages have been constructed by Messrs Francis & Sons, of Vauxhall, of Medina cement concrete. The concrete is made of sea-beach or washed gravel stones, with a small portion of Medina cement, in quantity sufficient to bind the stones together, but without filling the vacuities; a hollow wall is produced which dries instantly, so that the building can be inhabited a week after erection. The concrete is laid between an inner and outer row of planks, which, after the concrete is set, are taken down, and can be used to form the floors, doors, &c., or used in the erection of another building. The chimney-stack is similarly formed, and lined with drain-pipes. The top of the wall is finished with a wooden wall-plate, to receive the roof. A hut 40 feet by 20 can be erected for £100, or if with party-walls, giving two cottages with three rooms each, £140, or £70 each.

555. Two huts were erected at Shorncliff upon this principle, and in connection with which the Inspector-General of Fortifications granted the following certificate: "These buildings give great satisfaction, and have been highly

approved of by the officers and soldiers who inhabit them. They are superior to 9-inch brick work, as that description of wall will not keep out the wet without being plastered; whereas the Medina cement concrete huts are, from the nature of their construction, necessarily plastered, and are therefore warm and dry. They are also very strong and substantial, and as well adapted for two storeys as one. Their great advantage over brick, or indeed wooden huts, is the rapidity and economy with which they can be constructed, combined with a durability little if at all affected by time." This principle of construction is obviously applicable to the erection of various structures of the farm, especially of sheds for stock in the fields.

556. *Cements for Lining Water-Cisterns, Tanks, &c.*, may be easily made by mixing $2\frac{1}{2}$ parts of chalk with 1 of lime, and applying them in the state of a paste, of a consistence easily applied: this will be found useful for lining cisterns, &c.

557. Stone cisterns may be put together with a cement made of boiled linseed-oil, litharge, red and white lead, mixed together till of proper consistence. The proportion of ingredients may be varied, care being taken not to make the cement too thin. This cement is also useful for joining flanges of iron pipes, &c.

558. *Cracks in Iron Boilers* can be stopped up by a cement made by mixing 6 parts of clay and 1 of iron-filings, with as much linseed-oil as will make the cement of a proper consistence.

559. *Pottery, Drain-Tubes, and Articles of Stone*, may be fixed with a cement made of 7 parts of rosin and 1 of bees'-wax, melted and mixed with a small quantity of gypsum, or plaster-of-Paris, or pounded chalk. In cementing such articles as are mentioned, it should be borne in mind that the thinner the stratum of cement between the two surfaces the firmer will be their adherence.

560. *A Cement useful for Joining Glass, &c.*, and metallic surfaces, is made as follows: "To an ounce of mastic add as much highly rectified spirits of wine as will dissolve it. Soak an ounce of isinglass in water until quite soft, then dissolve it in pure rum or brandy, until it form a strong glue, to which add about a quarter of an ounce of gum-ammoniac, well rubbed and mixed. Put the two mixtures together in an earthen vessel over a gentle heat; when well united, the mixture to be put in a phial, and well stopped." In using it, the phial must be placed in warm water to melt the cement; the edges of the glass to be joined should also be warmed. After the cement is put on, the edges should be kept in close contact for at least twelve hours.

561. *A Cement well adapted for Filling up Holes in Roofs, Stone Walls, &c.*, and which hardens by exposure, is made by mixing up white sand and white lead to a consistence rather thicker than that of ordinary paint. It may be used for stopping up leaks in cisterns, &c.

562. *A Cement applicable for the Covering of Exterior Work, Lining of Cisterns, &c.*, may be made as follows: Take 6 parts of burnt clay, 1 part of white lead, 1 part of litharge (red oxide of lead), and 3 parts of linseed-oil. Vauban's cement for lining cisterns is made by slaking 5 or 6 parts of rich lime in linseed-oil, and mixing this up with 2 parts of cement, passed through a fine sieve. The cement should be well incorporated, and allowed to lie for a night, and beaten up and applied next day. It is to be laid on in thin coats, about $\frac{1}{8}$ -inch thick, some days being suffered to elapse before the succeeding coats are put on. Each coat should be scored, to form a key for the succeeding one. The last coat is of course left smooth.

563. SECTION FIFTH. — *Exterior Finishings, Rough-Casting, Stuccoing.*—We purpose giving a few hints on the finishing of external walls, as rough-casting, stuccoing, &c. *The outside walls of pisé houses* are finished in two ways—these are, rough-cast and stucco. Rough-cast consists of a small quantity of mortar diluted with water in a tub; to this a trowelful of pure lime is added, so as to make the whole of the thickness of cream. To finish the walls with greater expedition, the joist-holes may be left not filled up; into these, joists may be inserted, on which to place scaffolding to bear the operatives. The walls are prepared for plastering by indenting them all over from top to bottom with numerous hammer or pick marks: the closer these are to each other the better. The rough-cast is laid on as follows: The indentations in the wall being first carefully swept, the wall being sprinkled with water, the workman takes his brush filled with rough-cast mortar and dashes it against the wall. The indentations in the wall give the appearance of the ordinary rough-cast with pebbles in it. The scaffolding being placed at the top of the wall, he lowers his scaffold, takes out the joists, fills up the holes with bricks, mortar, &c., and, fastening his scaffold lower down, proceeds as before.

564. Stucco for outside work is made with one bushel of unslaked lime to six bushels of clean sharp sand. Stucco-finishing is laid on as follows: The walls being previously indented, swept, and sprinkled with water, the workman places some mortar on a flat piece of board 12 inches square, provided with a handle, and with a plastering-trowel lays this on the wall, pressing it closely between the indentations, and working the surface, finally, fair and level, it being sprinkled at the same time by means of a brush with some of the thin mortar,—the poorer the mortar the better the stucco. Lime-wash is used as a final covering to the stuccoed wall. This is made by dissolving some unslaked lime in clear water, and sprinkling it on the wall before the stucco is dry. When applied in this manner the stucco sets very hard, and the white colour of the wash is so incorporated with it that it will never wash off, although no size or oil is used—indeed, the using of these renders the white dead and less brilliant; whereas, if the lime-wash is alone used, the colour will remain *naturally* as long white as the plaster lasts. All the plastering should be done at one time: new plastering never sets well with old. It is absolutely essential that the walls shall be thoroughly dry before the plaster is laid on. If this is not attended to, the plaster will inevitably scale and blister off, leaving unseemly spots.

565. The method of *Rough-Casting Rubble Stone or Brick Walls* is as follows: First wash the earth from the gravel or coarse sand, and bring it to a uniform size by sifting it, or passing it through a screen; mix the gravel with newly-slaked lime and water, to the consistence of thick cream. Having cleaned the part of the wall to be operated on with a rough brush, a coat of lime and hair is laid on smooth, and, as fast as some two or three square yards are finished, the rough-cast is thrown upon it. Some recommend the first coat of lime and hair to be allowed to dry, and a second coat put on, upon which the rough-cast is finally thrown. Instead of throwing the rough-cast on, small pebbles may be stuck in the mortar while yet in a soft state. This, however, is a tedious process.

566. Mr Downing recommends a strong and durable stucco for the finishing of the outside of rough brick and stone walls, as follows: “Take stone lime fresh from the kiln, and of the best quality, such as is known to make a strong and durable mortar. Slake it by sprinkling or pouring over it just water enough to leave it, when slaked, in the condition of a fine dry powder, and not a paste. Set up a $\frac{1}{2}$ -inch wire-screen at an inclined plane, and throw this powder against

it. What passes through is fit for use; that which remains behind contains the core, which would spoil the stucco, and must be rejected. Having obtained the sharpest sand to be had, and having washed it so that not a particle of the mud and dirt (which destroy the tenacity of most stuccoes) remains, and screened it, to give some uniformity to the size, mix it with the lime in powder, in the proportion of *two parts sand* to one part lime. This is the best proportion of lime stucco. More lime would make a stronger stucco, but one by no means so hard—and hardness and tenacity are both needed. The mortar must now be made by adding water, and working it thoroughly. On the tempering of the mortar greatly depends its tenacity. The wall to be stuccoed should be first prepared by clearing off all loose dirt, mortar, &c., with a stiff broom. Then apply the mortar in two coats: the first a rough coat, to cover the inequalities of the wall, the second as a finishing coat. The latter, however, should be put on before the former is dry, and as soon, indeed, as the first coat is sufficiently firm to receive it: the whole should then be well floated, trowelled, and marked off; and if it is to be coloured in water-colour, the wash should be applied so as to set with the stucco.

567. *Whitewash for External Walls.*—A cheap wash for the outside of wood cottages, outbuildings, &c., is made by slaking fresh quicklime with boiling water, and adding some sulphate of zinc—sufficient water being put in to bring the whole to the consistence of cream. The addition of the sulphate of zinc tends to harden the wash, and make it more durable. The addition of a little sulphate of iron will give the wash a warm tint, which will be much more agreeable to the eye than the pure white resulting from the above.

568. A wash useful for brick and stone walls, rough-casted or stuccoed, is made by mixing equal quantities of clean, sharp, and rather coarse sand, and of fresh-burnt lime, in 6 or 8 gallons of water. This is to be laid on the walls with a brush, care being taken to stir the mixture up each time the brush is dipt into it, so as to mix the sand well up.

569. The following is the recipe for making the celebrated stucco white-wash used in the President's house at Washington, United States: "Take half a bushel of good unslaked lime, slake it with boiling water, covering it during the process to keep in the steam. Strain the liquor through a fine sieve or strainer, and add to it a peck of clean salt previously dissolved in warm water; three pounds of good rice, ground to a thin paste, and stirred in while boiling hot; half-a-pound of powdered Spanish whiting, and a pound of clean glue, which has been previously dissolved by first soaking it well, and then hanging it over a slow fire in a small kettle, within a large one filled with water. Add 5 gallons of hot water to the mixture, stir it well, and let it stand a few days covered from dirt. It should be put on quite hot: for this purpose it can be kept in a kettle on a portable furnace. It is said that one pint of this mixture will cover a square yard upon the outside of a house, if properly applied. . . . It retains its brilliancy for years. Any required tinge can be given to the preparation by the addition of colouring matter."

570. A fawn colour may be made by mixing four parts of amber, one of Indian red, and half a part of lamp-black, previously dissolved in alcohol.

571. SECTION SIXTH.—*Finishing of Interior Walls—Plastering.*—In many cottages, &c., the stucco already described as useful for outside may be adopted for inside walls, partitions, &c. Plaster proper is made of gypsum, or sulphate of lime; this is burned or calcined in a simple rectangular kiln or enclosure, formed of brick walls. The largest lumps or stones of lime are placed on the floor of

the kiln, in such a way as to form, as it were, a series of arches, into the space of which the firewood or fuel used in calcining is put, the smaller stones being placed above. After being calcined, the time for which operation varies according to the quantity of lime to be burnt, the lime is powdered either by hand or a mill, after which it is protected from the atmosphere until ready to be prepared for plaster. This is done by slaking the powder with water, the quantity of water depending on the degree of stiffness required in the plaster.

572. The first coat is laid on the walls in a thinnish state, and left rough to take on the next coat, which must be laid on stiff, and smoothed up with a hand-trowel, the surface being levelled with a flat rule. For ordinary work, a plaster termed "coarse stuff" may be made of common mortar mixed with coarse hair—cattle or horse, from the tanyard—and thoroughly incorporated. In laying this on brick or stone walls, the first coat, which is termed "rendering," is to be crossed or made rough with the trowel, in order to form a key to the next coat. This not done where the work is "two coats" only.

573. In this case the first coat or "rendering" is left smooth; the second coat is then put above this—the material for the second coat being of pure lime slaked with a small quantity of water, more being finally added to bring it to the thickness of cream. After being allowed to settle, the water is poured off, and the lime allowed to remain, till, by the evaporation, it is brought to a proper thickness for working. Where fine stuff is used for ceilings, a little hair is mixed with it, the colour of this being white.

574. Three-coat work is executed by first laying on a coat of coarse stuff, crossing it with the trowel; then above this another coat, smooth and floated with a rule, and then finished with a "set," or smooth coat of fine stuff.

575. In partitions where laths are placed across the timbers, and in ceilings where only one coat of coarse stuff is laid on between the laths, the operation is termed "lath and plaster." A more finished method, where laths are used, is by first laying on a coat (leaving it crossed) of coarse stuff, thereafter a coat of fine stuff; a still higher kind of finish being—first, a coat of rough stuff, crossed; next, a second coat, smoothed; lastly, a coat of fine stuff.

576. The tools used in plastering are simple—a variety of trowels, a small square board on which to place a quantity of plaster while working, a handle being placed on its lower side by which it is held. The float is a rule which may be long enough to be worked by two men—it is used for levelling the surface.

577. *Painting Distemper.*—Plastered walls may be *painted* in distemper—that is, by colours worked up with size instead of oil. The size is formed of a solution of glue. A good substitute for this size can be made by preparing potato-starch, adding some of it to a mixture of whiting and water. This colour has no smell, and makes a beautiful white colouring-wash for ceilings. Where whiting cannot be procured, chalk may be pounded very fine, and washed with pure water. In mixing up whiting and size for this kind of painting, any desired tint may be given by adding the colour finely ground. It must be borne in mind, however, that the colour will dry on the walls of a lighter tint than when mixed up ready to be used. The proper tint can be easily decided on by painting a piece of paper, and allowing it to dry. Two coats must be given in painting distemper.

578. Where old plastered walls become stained, and it is desired to have them painted in distemper, the surface of the wall should be cleaned, and one coat of white lead in oil, with a little turpentine, given to it: after it is dry, the water-colour will be taken on smoothly.

579. *Painting in Oil.*—The basis generally used in preparing colours is *white lead*. The oil used for mixing the colours is *linseed*—the dilution being effected by *spirits of turpentine*. Litharge, sugar of lead, &c., are added to facilitate the drying. The following recipe is for white paint, used for exterior woodwork: seventy-eight parts of white lead, ground in oil, nine parts of boiled oil, nine parts of raw oil, and four parts of spirit of turpentine. For a stone colour for the exteriors of buildings, window and door facings, &c.: white, lamp-black, and a little Venetian red, ground in oil, and mixed with white lead and boiled linseed-oil. For a fawn-colour: white, yellow-ochre, and Spanish brown. For a drab: white, Venetian red, burnt amber, and a little black. A green paint, useful for outside doors, &c., is made with 1 lb. of verdigris, and 2 lb. of white lead, ground and diluted in common linseed-oil—the wood being first painted with white, and the green in two coats.

580. In painting in oil, “when bright colours, as white and grey, are ground and diluted in oil, it is advisable to make use of the oil of walnuts; but if the colours be dark, such as chestnut, or olive, or brown, you must make use of a pure linseed-oil.”

581. In painting wood-work, it is necessary to kill the knots which, in pine especially, are frequently met with. This is effected by covering them with fresh-slaked lime—this being rubbed off after twenty-four hours, and painted over with white or red lead. The knots will also be prepared to take on the colour properly by first giving them a coat of oil mixed with the litharge. The priming coat of white and red lead, well diluted in oil, is next to be put on, previously filling up the nail and other holes with putty, composed of whiting and linseed-oil. The first coat of white is next to be laid on, which, after it is dried, is to be rubbed down with a pumice-stone, to prepare it for the next coat. If the final colour is not to be white, the second coat should have some of the intended colour mixed up with it. The third coat is of the requisite colour.

582. In painting plastered walls, it is absolutely necessary that they should be dry: in no case will the work be satisfactory if this is not attended to. As plaster will take eighteen months or two years to dry, according to circumstances, it will be as well to paint them in distemper first, washing this off whenever the walls are judged sufficiently dry. In painting with oils, the walls must be first primed: this is done by giving two or three coats, to harden the plaster; thereafter lay on two coats of ochre, ground and diluted in linseed-oil; finish with the paint of the desired colour, one or two coats as may be considered desirable.

583. A paint which dries quicker than oil-paint, and has no smell, may be made of milk and lime as follows: “Take of skim-milk nearly 2 quarts, of fresh-slaked lime about 6 ounces, of linseed-oil 4 ounces, and of whiting 3 lb.; put the lime in a stone vessel, and pour upon it a sufficient quantity of milk to form a mixture resembling thin cream; then add the oil, a little at a time, stirring it with a small spatula; the remaining milk is then to be added, and lastly the whiting. The milk must on no account be sour. Slake the lime by dipping the pieces in water, out of which it is to be immediately taken, and left to slake in the air. For fine white paint the oil of carraway is the best, because colourless; but with ochres, the commonest oils may be used. The oil, when mixed with the oil and lime, entirely disappears, and is totally dissolved by the lime forming a calcareous soap. The whiting or ochre is to be gently crumbed on the surface of the fluid, which it gradually imbibes, and at last sinks: at this period it must be well stirred in. This paint may be coloured like distemper or size-colour, with levigated charcoal, yellow-ochre, &c., and used in the same

manner. The quantity here prescribed is sufficient to cover 20 square yards with the first coat, and will cost three halfpence a-yard. The same paint will do for outdoor work, by the addition of 2 ounces of slaked lime, 2 ounces of linseed-oil, and 2 ounces of white Burgundy pitch—the pitch to be melted in a gentle heat with the oil, and then added to the smooth mixture of the milk and lime. In cold weather it must be mixed warm, to facilitate its co-operation with the milk.”—(SMITH'S *Art of House-Painting*.)

584. The following is a very durable paint—more so than the ordinary oil—recommended by Mr Downing for cottage-work—its hardness increasing by time: “Take freshly-burned unslaked lime, and reduce it to powder. To 1 peck or bushel of this add the same quantity of fine white sand, or fine coal-ashes, and twice as much fresh wood-ashes, all these being sifted through a fine sieve. They should then be thoroughly mixed when dry. Afterwards mix them with as much common linseed-oil as will make the whole thin enough to work freely with a painter's brush. This will make a paint of a light-grey stone-colour, nearly white. To make it fawn or drab, add yellow-ochre and Indian red; if drab is desired, add burnt amber, Indian red, and a little black; if dark stone-colour, add lamp-black; or if brown stone, then add Spanish brown. All these colours should of course be mixed in oil, and then added. This paint is very much cheaper than common oil-paint. It is equally well suited to wood, brick, or stone. It is better to apply it in two coats—the first thin, the second thick.”

585. The interior woodwork of cottages may be beautifully stained to resemble oak and walnut, by washing the cleaned surface with diluted sulphuric acid (1 ounce of sulphuric acid to a pint of warm water); this to be washed, when warm, evenly on the surface of the wood to be stained. The next operation is washing over the surface so prepared with a tobacco stain, made by boiling a quantity of tobacco with as much water as will cover it, allowing this to get dissolved to the consistence of a syrup by gentle boiling—this being strained before using. The stain is laid on with a sponge. When the wood is thoroughly dry, it is to be brushed over with 8 ounces of bees'-wax, $\frac{1}{2}$ pint of linseed-oil, and double the quantity of boiled linseed-oil.

586. A varnish for finally covering the surface of the wood thus stained is prepared by dissolving in a pint of spirits of wine a $\frac{1}{2}$ lb. of seed-lac. Varnishes had better be procured ready-made.

587. Outside work may be stained by adopting Mr Wheeler's mode: “Take best rosin tar, or pitch, in the proportion of 1 gallon to every 4 gallons of the following—turpentine $1\frac{1}{2}$ gallon, seed-lac dissolved in alcohol (in the proportion of 1 lb. to 1 quart) 2 quarts, cold linseed-oil $\frac{1}{2}$ gallon, boiled oil $\frac{1}{2}$ gallon, bees'-wax 6 lb., ox-gall 1 lb.; mix all these together, and add the rosin tar first named. Lay it on with a large flat brush.”

588. We would recommend the emigrant to provide himself with a quantity of Stephens' dyes for staining wood: they stain the wood beautifully. The oak, mahogany, and satin-wood colours are 8s. per lb., and are simply dissolved in water: this quantity will make a gallon of stain. Being in powder, they are easily carried. Address—Mr Henry Stephens, 54 Stamford Street, Blackfriars, London.

589. *A Durable Paint for Outdoor Work*.—Any quantity of charcoal powdered, a sufficient quantity of litharge as a drier, to be well levigated with linseed-oil, and when used to be thinned with well-boiled linseed-oil. The above forms a good black paint, and by adding yellow-ochre an excellent green is produced, which is preferable to the bright green used by painters for all garden work, and does not fade with the sun. This composition was first used by Dr Parry of

Bath, on some spouts, which, on being examined fourteen years afterwards, were found to be as perfect as when first put up.

590.—SECTION SEVENTH.—*Timber*.—All the varieties of *Fir timber* imported into the country are employed in the construction of farm-buildings, and those kinds are most used in localities which are obtained from the nearest seaports. For example, along the east coast of this country, Memel logs and Baltic battens are used for all such purposes, while on the west coast no timber is to be seen in the construction of farm-buildings but what is brought from America.

591. Norway and St Petersburg battens, being cut to proper lengths and breadths, form cheap and very durable timber for all farm purposes. The red or white wood battens make excellent floors, and plain deal doors for inside use. Such flooring is beautifully dressed by planing machinery such as at the mills at Leith.

592. Memel logs are admirably fitted for joisting, windows, outside doors, and all outside work, it being composed of strong and durable fibre, surrounded with resinous matter. The greatest objection to its use for small purposes is its knottiness, on which account the Norway battens make handier small scantlings and cleaner door-work.

593. The American red pine is excellent timber, being clean, reedy, and resinous. It is seldom or never of so large dimensions as Memel log. It is fitted for beams, joists, scantlings, windows, and outside doors.

594. American yellow pine is well suited to all inside work, and especially that which requires the highest finish, such as bound-doors, window-fittings, and mantelpieces. There is no wood that receives paint so well. The logs are generally of immense sizes, affording great economy of timber in cutting them up.

595. Swedish 11-inch plank is good and useful timber, but its scantlings are not very suitable for farm-buildings. Stout joists for granaries are made of it, with a $\frac{1}{2}$ draught taken off the side for sarking. It forms excellent planking for wheeling upon, and for gangways.

596. In the interior of the country, at a distance from seaports, *home timber* is much used in farm-buildings. Larch forms good scantlings and joists, and is a durable timber for rough work; and so does well-grown Scotch fir of good age, and cut down in the proper season; but in its ordinary state its durability is not equal to larch or generally any good foreign timber, for rough purposes.*

597. All the timber referred to is derived from the trees belonging to the natural order of *Coniferæ*, or cone-bearing trees. The Scotch fir, *Pinus sylvestris*, is a well-known tree in the forests of this country, and few new plantations are made without its aid, as a nurse for hardwood trees. In favourable situations it grows to a large size, as is evidenced in the Memel log, which is just the produce of the Scotch fir from the forests of Lithuania. Aged Scotch fir cut down at Ardovie, in Forfarshire, was of as good quality and useful sizes as the best Memel.

598. The Swedish plank is of the spruce, *Abies excelsa* or *communis*, a tree which, as it is treated in this country, comes to little value, being rough and full of knots. Inspection of a cargo from Sweden, which arrived at Hull in 1808, convinced Mr Pontey that the white deal, which fetched at that time

* In vol. ix. p. 165, of the *Transactions of the Highland and Agricultural Society* will be found a long account of the larch plantations of Atholl, drawn up from the papers of the late Duke of Atholl; and in vol. xii. p. 122, of the same work, is an account of the native pine forests of the north of Scotland, by Mr John Grigor, Forbes.

from £14 to £15, 10s. the load of 50 cubic feet, was of common spruce, the planks having been recently sawn, and a small branch left attached to one of them.*

599. Whether the Norway pine is the same species as the pine found in some of the forests of the north of Scotland, we do not know. Some writers speak of the Norway batten as of the Norway spruce, called by them *Pinus Abies*. It may be that the white-wood battens are derived from that tree; but the red-wood kind has very probably the same origin as the red-wood of the north of Scotland, which is from a variety of the *Pinus sylvestris* or *horizontalis* of Don.†

600. The red pine of Canada is the *Pinus resinosa*.

601. The yellow pine is the *Pinus variabilis* or *Pinus mitis* of Michaux, which towers in lofty height far above its compeers. It grows to the gigantic height of 150 feet, and must require great labour to square it to the sizes found in the British market, large as these sizes unquestionably are.

602. The larch, *Larix Europæa*, is a native of the ravines of the Alps of the Tyrol and Switzerland, where it shoots up, as straight as a rush, to a great height.

603. Some of the pines of California are highly spoken of as yielding good timber for useful purposes, but as yet we have no experience of them as timber.

604. For agricultural implements two kinds of wood are principally used—oak and ash; oak chiefly in England, ash in Scotland, possibly from ash being cheaper in Scotland than oak. Experiments go to prove the superiority of ash for purposes where sudden shocks and severe strains are given to the implements.

605. *Oak*.—The common English oak, *Quercus robur*, is deemed the best for construction. The grain is straight and fine, and well adapted for purposes where stiffness is required. It splits easily into laths. The Sessile oak is considered, from its elasticity and toughness, best for ship-building purposes, but is somewhat liable to warp and split. It is not so fine-grained as the Robur oak, and is darker in colour. These English oaks take a long period to come to maturity—nearly 100 years. The American oak is of more rapid growth than the English, but is not so durable. The red Canadian oak is deemed of little constructive value.

606. Oak is adapted to a vast variety of purposes, and when kept in a dry situation it may be termed practically imperishable. Even in situations of alternate wetness and dryness, it is more durable than other wood used for construction. The colour of the best quality is a light brown; when it approaches to red, the quality is not so valuable. The heaviest wood is always the strongest, and that grown on clay soil more valuable than that on light.

607. *Ash*.—A hard wood, of compact texture and brownish colour, easily worked when young, but tough and hard when seasoned. Its durability is great when kept dry, but alternations of wetness and dryness cause it to decay. Notwithstanding this defect, it is greatly used for purposes where it is subjected to severe strains and shocks, from its superiority in toughness and elasticity.

608. *The Tree*.—If we examine the transverse section of the trunk of a full-grown tree, we will find it divided into three parts—the heart, which is the

* PONTÉY'S *Profitable Planter*, p. 41, 4th edition, 1814; and at p. 56 he relates an anecdote of a person who, though long accustomed to attend on sawyers, was deceived by some Scotch fir, which he considered excellent foreign plank.

† See *Quarterly Journal of Agriculture*, vol. xi. p. 530.

centre part; the sap-wood, which surrounds the heart; and the bark, which forms the outer covering. Of these the *heart* is the valuable part for constructive purposes, the *sap-wood* having little strength, and being very liable to decay from the amount of fermenting matter contained in it.

609. The tree should not be felled till it has attained its maturity; if cut before, the timber will not be so strong; if cut after decay has set in, it will be less durable and strong than when cut as above mentioned. The commencement of the decline of a tree is indicated by the decay of the top and the topmost branches. There are differences of opinion as to the *period of the year* when timber should be felled—this having reference to the time when the sap is not in circulation. If the tree should be felled while this circulates, the decay of the tree will be hastened from the highly fermentable nature of the sap. The winter months, and the month of July, are considered the best for felling, as the sap is then believed to be dormant. The researches, however, of M. Boucherie, a gentleman who has devoted much time to investigating the properties of timber, point to midsummer and autumn as the time when the sap is least active.

610. *Seasoning of Timber.*—It is impossible to over-estimate the importance of this part of the duties of the machine and implement maker. Unseasoned timber, from shrinking and warping, may cause material injury to important structures and implements. There are a variety of methods now introduced to effect this important purpose. We shall notice three of these: Natural seasoning; Water seasoning; Hot-air desiccation.

611. *Natural Seasoning.*—On felling, the bark and small branches are to be removed, and the timber as soon as possible cut into balks of convenient size of scantling. These are to be removed at once, and piled under drying sheds, where they are subjected to the free circulation of the air, yet protected from the direct action of the sun, wind, and rain. The great object to be attained is uniform drying of the whole timber; all partial and unequal drying only causes warping and shrinking. No timber should be used for constructive purposes until it has been subjected at least two years to this seasoning process. For the usual purposes of the carpenter, timber is considered sufficiently seasoned when it loses about one-fifth of its weight when green.

612. *Water Seasoning.*—This consists in placing the timber in water, with a view to use the latter as a medium to carry off the soluble matter, which is the principal cause of decay. Although much recommended by some, it is considered by good authorities of doubtful utility.

613. *Hot-air Desiccation.*—The best process, and one which has proved itself thoroughly successful, is that introduced by Messrs Davison and Symington. The following is a brief description of it: The timber to be dried is placed in proper positions in a close chamber, into which is forced, by means of fanners, a powerful current of highly heated air. This air is heated by passing through a series of pipes, which are arched over, and form the upper part of the furnace. Some idea may be formed of the complete nature of the process, when we mention that a violin, which had been in use for many years, and was considered thoroughly dry, lost a considerable per-centage of its weight when subjected to the action of the currents of heated air. The same result was obtained in subjecting a piece of wood, which had lain for a great number of years exactly over a smith's forge, which had been in constant use.

614. *Preservation of Wood.*—In regard to the composition of wood, and its chemical properties, "it is considered by chemists that dry timber consists, on an average, of 96 parts of fibrous and 4 of soluble matter in 100, but that their

proportions vary somewhat with the seasons, the soils, and the plant. All kinds of wood sink in water when placed in a basin of it under the exhausted receiver of an air-pump, showing their specific gravity to be greater than 1.000," and varying from 1.46 (*pine*) to 1.53 (*oak*). . . . "Wood becomes snow-white when exposed to the action of chlorine; digested with sulphuric acid it is transformed first into gum, and, by ebullition with water, afterwards into grape sugar. . . . Authenreith stated, some years ago, that he found that fine sawdust, mixed with a sufficient quantity of wheat flour, made a cohesive dough with water, which formed an excellent food for pigs; apparently showing that the digestive organs of this animal could operate the same sort of change upon wood as sulphuric acid does. . . . The composition of wood has been examined by Messrs Gay-Lussac and Thenard, and Dr Prout. According to Dr Prout, the oxygen and hydrogen are in the exact proportions to form pure water; according to the others, the hydrogen is in excess."*

615. "When minutely divided fragments of a trunk or branch of a tree," as M. Raspail observes, "have been treated by cold or boiling water, alcohol, ether, diluted acids and alkalies, there remains a spongy substance, of a snow-white colour when pure, which none of these reagents have acted on, while they have removed the soluble substances that were associated with it. It is this that has been called *woody matter*, a substance which possesses all the physical and chemical properties of cotton, of the fibre of flax, or of hemp."

616. "On observing this vegetable *caput mortuum* with the microscope, it is perceived to be altogether composed of the cells or vessels which formed the basis or skeleton of the living organs of the vegetable. They are either cells which, by pressing against each other, give rise to a network with pentagonal or hexagonal meshes; or cells with square surfaces; or else tubes of greater or less length, more or less flattened or contracted by drying; sometimes free and isolated, at other times agglomerated, and connected to each other by a tissue of elongated, flattened, and equilateral cells; or, lastly, tubes of indefinite length, each containing within it another tube formed of a single filament spirally rolled up against its sides, and capable of being unrolled under the eye of the observer simply by tearing the tube which serves to support it. We find the first in all young organs, in annual and tender stems, in the pith of those vegetables that have a pith, and always in that of the monocotyledons. It is in similar cells that the fecula is contained in the potato. The second is met with in all the trunks and woody branches of trees. The tubes and the spirals (*tracheæ*) are found in all the phanerogamous plants. These are the organs which constitute the fibre of hemp, of flax," &c.

617. "Experiment, in accordance with the testimony of history, proves that, if excluded from the contact of moist air, woody matter, like most of the other organised substances, may be preserved for an indefinite period." The plants found in coal-mines, the wood, linen cloths, bandages, and herbs and seeds found in the coffins of Egyptian mummies, have all their characters undecayed, and yet these tombs are in many cases nearly 3000 years old. "But if the woody matter be not protected against the action of air and moisture, the case is very different. By degrees its hydrogen and oxygen are disengaged, and the carbon predominates more and more. Thus the particles of the texture are disintegrated gradually, their white colour fades, and passes through all the shades till it becomes jet-black; and if this altered woody matter be exposed to heat, it is carbonised without flame, because it does not contain a sufficient quantity of hydrogen. Observe also, that the cells of woody matter contain different sorts

* URE'S *Dictionary of the Arts*—art. "Wood."

of substances tending to organise, and that these are mixed and modified in many different ways." . . . "Woody matter, such as I have defined it, being formed of 1 atom of carbon and 1 atom of water, as soon as it is submitted to the action of a somewhat elevated temperature, *without the contact of air*, experiences an internal reaction, which tends to separate the atom of water from the atom of carbon. The water is vaporised, and the carbon remains in the form of a black and granular residue."*

618. *Kyan's Process*.—Now, if any means could be devised by which the substances in the cells of woody matter could be deprived of their tendency to organise when in contact with common air, wood might be rendered as permanently durable as the grains of wheat which have been found undecayed in Egyptian mummies, and even more so. This discovery seems to have been made by Mr Kyan. In contemplating the probability of the use of home timber being much extended in the construction of steadings, when the young woods at present growing shall have attained their full growth, it may be proper that the growers of wood, and the farmers on the estates on which wood is grown, be made aware of this mode, and of others, of preventing timber being affected by the dry-rot. What the true cause of dry-rot is, has never yet been determined, but it frequently shows itself by a species of mildew which covers the timber, and the action of which apparently causes the wood to decay, and crumble down into powder. The mildew, however, is neither the dry-rot nor its cause, but its effect. It is distinctly seen by the microscope to be a fungus; and as the fungus itself is so minute as to require the aid of the microscope to be distinctly seen, its seeds or spores may be supposed to be so very minute as to be taken up by the spongioles of trees.

619. The principle upon which the chemical action of the corrosive sublimate—the substance used by Mr Kyan—upon vegetable matter preserves the timber, is easily explained. All plants are composed of cellular tissues, whether in the bark, alburnum, or wood. The tissue consists of various-shaped cells; and although they may not pass uninterruptedly along the whole length of the plant, as M. de Candolle maintains, yet air, water, or a solution of anything, may be made to pass through the cells in their longitudinal direction. Experiments with the air-pump have proved this beyond dispute. Those cells, and particularly those of the alburnum, contain the sap of the trees which, in its circulation, reaches the leaves, where its watery particles fly off, and the enlarging matter of the tree, called the albumen, remains. Albumen is the nearest approach in vegetables to animal matter, and is therefore, when by any natural means deprived of vitality, very liable to decomposition, particularly that which is connected with the alburnum or sap-wood. Now, corrosive sublimate has long been known to preserve animal matter from decay, being used to preserve anatomical preparations; and even the delicate texture of the brain is preserved by it in a firm state. The analogy between animal and vegetable albumen being established, there seems no reason to doubt the possibility of corrosive sublimate preserving both substances from decay; and, accordingly, the experiments of Mr Kyan with it on albuminous and saccharine solutions have confirmed the correctness of this conjecture. The prior experiments of Fourcroy, and especially those of Berzelius, in 1813, had established the same conclusions, though neither of these eminent chemists had thought of their practical application to the preservation of timber. Berzelius found that the addition of the *bichloride* (corrosive sublimate) to an albuminous solution, produced a *protochloride* of mercury (calomel), which readily combined with albu-

* RASPAÏL'S *Organic Chemistry*, translated by Henderson, p. 141-164.

men, and produced an insoluble precipitate. This precipitate fills up all the cellular interstices of the wood, and becomes as hard as the fibres.

620. *Ventilation of Timber in Dwellings.*—Even after timber has been subjected to this process, it is requisite to give the air free access to it by means of ventilation, and for that purpose, where timber is covered up, which it is not likely to be in a steading, small openings, covered and protected by cast-iron gratings in frames, should be made through the outside walls.

621. Other plans for preserving timber have been introduced, of which the four most important are known as Burnett's, Bethell's, Payne's, and Boucherie's : of these we offer a short description.

622. *Burnett's Process.*—The process patented in 1842 by Sir William Burnett consists in impregnating the timber with a solution of the chloride of zinc. From recorded experiments, the process seems to be efficient. The solution is prepared in the proportion of 1 pound of chloride of zinc to 10 gallons of water.

623. *Bethell's Process.*—In Bethell's process, oil of tar, and other bituminous matters containing creosote, are used to impregnate the wood. The wood is not only immersed in the solution, but it is forced into the fibres by pressure. The wood to be impregnated is placed in close tanks filled with the solution ; the tanks are then closed up, and the air exhausted from their interior ; more solution is then pumped in for a period of six or seven hours. The wood is finally taken out thoroughly saturated with the solution, and weighing considerably heavier. The process is said to perfectly coagulate "the albumen in the sap, thus preventing its putrefaction." In using the oil of tar it is necessary to deprive it of its ammonia, otherwise the wood becomes brown and soon decays.

624. Timber for farm purposes may be simply Bethellised by painting the surface over with the hot oil of tar, or by immersing it in a tank of the hot solution. This will not give such beneficial results as when impregnated under pressure, but will nevertheless tend to preserve the timber for a considerable time from atmospheric influences. The cost of the oil, as sold by the patentee, is stated at 4d. per gallon.

625. *Payne's Process.*—In Payne's process (patented 1841) the wood is impregnated by pressure with a solution of earthy or metallic substances ; and these substances, by chemical decomposition, preserved within the material in an insoluble state. Thus, if a solution of sulphate of iron is forced into the wood, a second solution is forced in of any of the carbonate alkalies, which "decomposes the salt, and renders the iron insoluble."*

626. *Boucherie's Process.*—This process consists essentially of impregnating the wood with a preservative solution. The solution which is found to answer best is sulphate of copper, or the blue vitriol of commerce, one by weight of which is dissolved in 100 by weight of water. The peculiarity of the process, however, consists in the method of impregnating the wood with a solution—a method which is simple, and easily and inexpensively carried out. The method has two objects in view—one the impregnating of the wood with the salt, and one the driving out of the natural sap—the salt taking the place of the sap. This latter constitutes not the least valuable part of the process ; for in other systems the sap—the fermentation of which is the chief cause of decay in wood—is allowed to remain, while the Boucherie process expells it thoroughly, cleansing the tubes or pores from all fermenting matter. The importance of having the sap of timber expelled, and its place occupied by the preserving solution, has long been recognised ; and attempts have been made to secure the ad-

* See *Transactions of the Highland and Agricultural Society* for 1857, p. 12—art. "The Preservation of Timber."

vantages of this mode of treatment; but the expensiveness of the methods proposed have completely precluded all prospect of their being generally adopted. It has remained for M. Boucherie, as the result of many years' experimenting on the nature of woods, to introduce a mode as simple as it is ingenious and philosophical. The long series of experiments which M. Boucherie instituted resulted in proving that, although the structure of trees is tubular, there is no *lateral* communication between the tubes. To show how completely isolated each tube is from the others surrounding it, and how perfect is the *longitudinal* connection of the tube, M. Boucherie has shut off certain tubes at one end of a tree, leaving these exposed to form a certain word, and, by means of a coloured liquid forced along the tubes, has transferred the word or name from the one end of the tube to the other. And so completely is the flow of the liquid through the tubes carried out that, at whatever part of the tree a section is made, there the name is found. The following is the method of conducting the process: "Soon after the tree is felled a saw-cut is made in the centre, through about 9-10ths of its section. The tree is then slightly raised by a lever or wedge at its centre, and the saw-cut is then partially opened, as in fig. 145. A piece of string is

Fig. 145.



PREPARATION OF THE TIMBER FOR BOCCHERIE'S METHOD OF PRESERVING IT.

then placed round the saw-cut, close to the outer circumference of the tree; the support is then withdrawn, and the saw-cut closes on the string, thereby making a water-tight joint. An auger hole is then bored obliquely into the saw-cut in the direction shown at *a*, fig. 146; a wooden tube *b*, fig. 146, is then driven into the

Fig. 146.

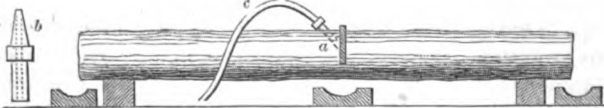

TIMBER PREPARED FOR BOCCHERIE'S METHOD OF PRESERVING IT.

hole, the conical end of which is attached to a flexible pipe *c*, which is in connection with a cistern or reservoir at an elevation of from 30 to 40 feet above the tree

intended to be preserved. In the case of very long trees the foregoing method is slightly modified. When the timber is under operation, the sap runs out from the ends in a clear stream, showing the amazing quantity of this fluid which it contains; in fact, the preserving fluid will traverse a tree 12 feet in length with less pressure than is required to force it laterally through a plank three-quarters of an inch in thickness. As the sap is forced out the preservative fluid follows it, and its presence at the ends of the wood is ascertained by a chemical test. Thus the sap and fermenting juices are completely expelled, and the timber impregnated throughout its length with the preserving fluid."

627. One great advantage possessed by the process, so far as the interest of our readers is concerned, is that the least costly woods are the best for the

operation. Thus woods which at present are the refuse or least valuable may, by the process, be raised to the value of first-class home timbers. From the Reports of the French engineers who investigated the process at the request of the government, the following extract is given: "Those kinds of wood which possess most moisture, and, of the same kind, those which have grown in the dampest soils, are most easily penetrated. It follows that the least esteemed kinds of timber, and consequently the cheapest, are precisely those which afford the best results when injected with the sulphate of copper." They also give the following examples, showing the increase of weight in various woods after impregnation:—

Beech,	increased 209 lb. per 35 ft. cube.
Oak (sappy part only),	" 55 lb. " "
Hornbeam,	" 46 lb. " "
Birch,	" 2 lb. 10 oz. " "
Poplar,	" 70 lb. " "
Alder,	" 50 lb. " "
Ash,	" 156 lb. " "
Scotch Fir,	" 50 lb. " "
White Fir,	" 127 lb. " "
	" 53 lb. " "

628. The sooner the trees are subjected to the process after being cut down the better; no time therefore is lost, or expense incurred, in drying or seasoning the timber. Trees felled any time from November to May may be prepared in May; but if they are cut down in May, or any month from May to November, they ought to be prepared within three weeks from the time of being felled.

629. From statements furnished by the agent of the company, it appears that the cost of the gutta-percha tubing, with every appliance necessary to operate upon fifteen trees at once, is £6; on thirty trees, £11, 5s. Full information as to prices, &c., may be obtained at the office of the Permanent Way Company, 26 Great George Street, Westminster, London.

630. SECTION EIGHTH.—*Metals*.—The metals used in construction are iron, copper, brass, zinc, and lead.

631. *Iron*.—The two varieties of this material are cast-iron and wrought-iron.

632. *Cast-iron* is generally divided into two classes, grey and white, between which there exist very marked differences. When of good quality, grey cast-iron is slightly malleable, and files easily when the skin or outer crust is removed. The fracture presents a granular appearance—grey in colour, and metallic in lustre, as if grains of lead were on the surface. Grey is smoother and tougher than white cast-iron.

633. White cast-iron, when broken, presents a fracture of a distinctly-marked crystalline character, the colour white, and instead of a metallic it possesses a vitreous lustre, or a light somewhat similar to that reflected from a series of small crystals. This quality of iron is hard and brittle.

634. The colour and lustre of iron is usually taken as a test of its strength. Where the colour is dark grey, with a high metallic lustre, the iron is of a valuable quality. Where the lustre is less decided, the softness and weakness are increased. Where the colour is a light grey, with a high metallic lustre, the metal is hard and tenacious. The hardness and brittleness of cast-iron become more marked as the colour becomes whiter, and the lustre changes from metallic to vitreous. The extreme of the grey variety is where the colour is dark and mottled—this gives the softest and weakest iron of this class; and of the white

variety, where the colour is of a dull greyish-white, with a high vitreous lustre—this giving the hardest and most brittle of this class.

635. But while colour and lustre are taken as tests of strength, a good authority does not think them admissible as tests of the chemical constituents of iron; for though dark-coloured iron is usually weak, grey strong, and white brittle, yet black iron, when chilled, becomes white, although it must be supposed to contain the same quantity of carbon. We therefore conclude that the colour of iron indicates the treatment to which it has been subjected, and in some cases only the quantity of carbon.

636. As a general rule, the grey cast-iron is most suitable where strength is requisite, the white where hardness is required. The best test of the quality is to strike the *edge* of a casting with a hammer. If the blow produces fracture, the iron is brittle and comparatively weak; if the blow indents without breaking, the iron is of good quality.

637. The strength of cast-iron depends upon the quantity of carbon which it contains, and its freedom from impurities. In addition to carbon, cast-iron in this country contains silica, lime, magnesia, alumina, and occasionally some of the phosphates and other admixtures. The iron made from the magnetic ores is the best.

638. When cast-iron contains 3 per cent of carbon, it is considered to be of the strongest quality; if it contains more than this amount, it is soft and weak; if less, it is hard and brittle.

639. The quality of iron produced at the iron-works throughout the country varies considerably, although, taking an average of the whole, some approach to a uniform standard is obtained. As a mixture of the various irons is understood to produce the best cast-iron, it is of some practical importance to know the "mixtures" recommended by experienced engineers. The object in mixing the different varieties is to obtain the proportion of carbon which gives the greatest strength with the requisite degree of fluidity; and this proportion is regulated by the appearance of the fracture of the several varieties proposed to be used for the mixture.

640. Mr Fairbairn of Manchester, one of our highest practical authorities, gives the following as the best mixture, independently of price :—

Lowmoor, No. 3.	30 per cent.
Blaina, or Yorkshire, No. 2.	25 "
Shropshire or Derbyshire, No. 3,	25 "
Good old scrap-iron,	20 "
					100

For large and small castings Mr M. Stirling gives the following mixtures: For a heavy casting, several inches in thickness and several hundredweight, a mixture of two proportions of No. 3 to one of No. 1 may be used. When the casting is thin and light (say 2 or 3 cwt.), a larger proportion of No. 1 and a smaller proportion of No. 3 may be used. It is difficult to estimate exactly the quantity of the various irons from their numbers, as these are very arbitrary, the No. 1 of one district differing considerably from the No. 1 of another. Attention should therefore be paid to the appearance of fracture of each quality; and where great nicety is required, it would be advisable to test the strength of each by direct experiment. The London mixture, which by the metropolitan founders is considered to be stronger than country mixtures, is equal proportions, or nearly so, of No. 3 old scrap and No. 1 Scotch hot-blast. Another

mixture recommended is, equal proportions of hot-blast iron, old iron, and Blaenavon Welsh iron.

641. Mr M. Stirling's patented mixture of wrought-iron and cast-iron gives "considerably increased powers of resistance to every description of strain, when compared with the unmixed irons." This process of toughening cast-iron consists in fusing simultaneously wrought-iron and cast-iron in a cupola or air-furnace. The result of a series of experiments made in connection with this toughened iron, showed that the relative value, as regards strength, of the unprepared iron and the prepared was 1 : 1.36—the mean breaking-weight of the unprepared being 38.3, and of the prepared 52.3. Other experiments showed a higher value, however, than this. Mr Fairbairn reports very favourably upon this mixture, and says that, when "judiciously managed and duly proportioned," it "increases the strength about one-third above that of the ordinary cast-iron." With regard to the proportions, Mr Stirling says that "the place from whence the iron comes regulates, to a certain extent, the quality, as a general rule. Scotch iron, generally speaking, requires more, Staffordshire less, and Welsh least of all. The proportions which I should recommend for No. 1 Scotch hot-blast, vary from 24 lb. (of wrought-iron) contained in the cwt., to 40 lb., according to the richness of the iron. No. 2 requires a smaller proportion, say from 20 lb. to 30 lb., also according to its quality. No. 3, generally, I do not recommend for mixture, as it is very often uncertain in itself, and its mixtures are not so certain as the toughened mixtures Nos. 1 and 2. No. 3, Scotch hot-blast, makes an excellent mixture with from 15 to 20 per cent of malleable iron for large castings. The Staffordshire No. 1 will not bear so much as the Scotch, and in the same proportion with Nos. 2 and 3; 20 lb. to 30 lb. would be a high proportion for Welsh No. 1. With Staffordshire No. 2, a small proportion in the same falling ratio as in the Scotch; and with Welsh No. 2, 10 lb. to 15 lb. per cwt. would be sufficient."

642. From the commercial results obtained in the manufacture of cast-iron by the use of the hot-blast, the process is now very generally adopted. The question, therefore, is possessed of considerable interest to the mechanic, Is the strength of cast-iron prepared by the hot-blast less than that prepared by the cold? On this point considerable diversity of opinion exists. An interesting series of experiments was carried out by Messrs Fairbairn and Hodgkinson, to determine the relative strength of hot and cold blast. "From these it was found that the hot-blast irons, when taken collectively from a number of works in England, Scotland, and Wales, gave results rather in favour of the hot-blast; whereas the cold-blast iron, when taken separately, and compared with others, indicated a superior quality of iron to those obtained from the hot-blast." Taking the mean of four kinds of iron experimented upon to ascertain the number of pounds required to tear asunder a bar 1 inch square, it was found that, while the cold took 16,801 lb., the hot-blast took 15,342 lb.; and that, taking the strength of cold-blast as represented by 1000, the ratio of the strength of the hot-blast to it was 928. Again, in ascertaining the force in pounds required to crush a prism an inch square on its base, and $1\frac{1}{2}$ inch high, it was found (taking the mean of four) that while the cold-blast took 99,238 lb., the hot-blast iron took 102,777 lb., the ratio of strength being (cold-blast 1000) as 1000 to 1028. And in the experiments made to ascertain the transverse strength of rectangular bars 1 inch square, laid on supports $4\frac{1}{2}$ feet wide, and broken by a weight in the middle, it was found (taking a mean of eight), that while the cold-blast took 456 lb., the hot-blast took 453 lb., the ratio of strength being as 1000 to 996. "On the whole," says Mr Fairbairn, with reference to the point now

under consideration, "I am of opinion that the hot-blast does not improve the quality of the Welsh and English irons, but, judging from the experiments, and other indications since these experiments were made, that its application to the Scotch furnaces in the reduction of the blackband ores is an improvement. I am the more confirmed in this opinion from the fact, that although the Scotch irons are not injured by the hot-blast, both the English and the Welsh suffer considerably, as may be seen in the case of the Elsicar, Milton, and Buffery irons." As to the effect produced by the hot-blast in the manufacture of iron, the same authority remarks, that "it varies considerably with the quality of the ore and the fuel, and I believe much depends upon the quantity of sulphur present in the coal or coke used. The chemical constituents of the fuel and foreign mixtures in the mine, are considerations of importance in the use and application of the hot-blast; but, generally speaking, I should infer that it has a tendency rather to weaken the iron than otherwise." A large number of experiments were made by the well-known engineer, the late Mr Robert Stephenson, at the High-level Bridge, Newcastle, to test the merits of the various qualities of hot and cold blast iron. The conclusions to which he considered these experiments point were as follows: "(1.) That hot-blast is less certain in its results than cold-blast; (2.) Mixtures of cold-blast are more uniform than those of hot-blast; (3.) Mixture of hot and cold blast give the best results; (4.) Simple samples do not run so solid as mixtures; (5.) Simple samples sometimes run too hard, and sometimes too soft, for practical purposes."

643. The strength of cast-iron objects depends also much upon their size, and in the way in which they are cast. When the object is very large, the iron softens with slow cooling. When the thicknesses of which it is composed are unequal, the unequal cooling of the parts renders some more crystallised and weaker than others. Hence the endeavour of mechanics to have a uniform thickness in the different parts of castings; and hence, also, the rule which should be strictly attended to—namely, never to take the castings out of the sand while red hot, but to allow them to gradually cool, and to become, in fact, annealed in the sand. We are aware that this, in small foundries, cannot under all circumstances be done, from want of space, and also from economical reasons, inasmuch as the portion of the sand in immediate contact with the metal is burnt, and rendered useless; but where sound work to be depended upon is required, it is essential that the castings should be allowed to remain in the sand till cooled, and a "perfect and compact mass of crystallisation" is obtained. Mr Fairbairn says that fireproof beams should be allowed to remain in the sand never less than ten hours, heavy castings thirty or forty hours. Articles, when cast in the direction of their greatest length, are more dense, and are freer from impurity, than when in the direction of their shortest length. Mr Glynn thinks that castings are strongest when the iron is obtained from an air-furnace in dry sand, and that castings in loam are stronger than castings in open sand. The air-furnace is preferred by high authorities before the blast cupola. Mr Fairbairn states that, in one series of experiments, the iron produced in the air-furnace was 2 per cent stronger than that obtained from the cupola.

644. As regards the relative values of Scotch and English iron, the same high authority states, that he "thinks the Scotch weaker, and that it runs more fluid than the English irons. It is, however, equal in strength and superior in quality to some of the Staffordshire irons, but certainly inferior, as respects strength, to the Yorkshire and Welsh cold-blast iron." The Scotch is generally preferred

for the purposes of machinery, as it runs well into the mould, and gives clearly-defined edges.

645. *Malleable Cast-Iron*.—A variety of cast-iron has been introduced by this title, by which all the advantages of a malleability and non-liability to fracture possessed by hammered work, are obtained with the cheapness of cost of moulded work. Various agents are appointed throughout the country to work the patent, which, however, we believe, has not yet been successful as a commercial speculation.

646. *Wrought-Iron*.—The fracture of wrought-iron presents a clear grey colour, with a metallic lustre and granular texture. The appearance of the fracture gives a strong indication of force having been required to tear the fibres asunder. A decided fibrous appearance will be given to the granular fracture, if the fractured bar is drawn out into small bars by means of the hammer. When the fracture presents a crystalline or laminated appearance, the iron is defective. Of defective irons, burnt iron is hard and brittle, of a clear grey colour, and of laminated texture. Cold short iron—so called from its breaking under the hammer when cold—is similar in appearance to burnt iron, the colour, however, being whiter. Hot short iron—so called from its breaking under the hammer while hot—is dark in colour, and has no lustre. This latter defect is indicated by cracks on the edges.

647. Wrought-iron of the best quality is divided into two classes, the hard and the soft. The soft is weaker than the hard, gives easily to the hammer, and presents the fibrous texture in bars of considerable section. The hard is strong and ductile, and only presents the fibrous texture when drawn out into small rods. In testing wrought-iron, bars of not less than 1 inch square or round, and flat bars of not less than $\frac{1}{2}$ -inch thick, should be used. If of less section, the distinctive features of the fracture will not be sufficiently observable.

648. With respect to iron cast and wrought, a question of some importance has arisen as to whether its internal structure is changed by vibration, or by shocks to which the parts may be subjected. On this point a variety of opinions was elicited before the Royal Commission—somewhat contradictory, however, in their nature. Mr Glynn, in his evidence, states that he considers the structure both of wrought and cast iron is altered by a succession of blows—the wrought to a crystalline structure, the cast to larger crystals; and that he has observed this appearance particularly in axles, mill-shafts, tooth-wheels, crowbars, and crane chains. The latter, even when made of strong fibrous iron, require to be annealed every three years. Mr Fox considered that an internal change is produced in wrought-iron by vibration, and points to an instance when the thread of a screw is cut in wrought-iron, and the part broken across at the tapped part and at another point distant from this, the tapped part will present the most crystallised appearance. Mr Fairbairn points out a fact of some importance, that repeatedly making a wrought-iron bar hot, and plunging it into cold water, renders it crystalline, and that annealing is required to restore the fibrous texture. Although percussion renders the fibres more liable to break off short, he thinks that unless it is sufficient to cause a considerable rise in temperature, it does not cause change in the internal structure. Mr Stephenson considered any change in the internal structure to be highly improbable; and cited one instance of a connecting-rod which vibrated 25,000,000 of times and yet remained fibrous. He also pointed to the fact that the iron of an axle may not be in the first instance fibrous; for although the drawing out of bars from one to some twenty feet long necessarily renders the texture fibrous, it

does not follow that it will become so when the bars are drawn out only from 1 to 6 feet. The late Mr Brunel took a still more novel and suggestive view of the matter; and, while doubting the change of internal structure, he thought that the various appearances of different fractures result as much from the mode in which the iron has been broken as from any change of structure. Further, that change of temperature will also produce a variation in the fracture; that iron in a cold state presents a more crystallised fracture than the same iron warmed a little; that wrought-iron does not actually become crystalline and fibrous, but breaks either crystalline or fibrous according to the combination of circumstances under which it is broken. The whole subject, although of great importance to the practical mechanic, is surrounded with difficulties, and all evidence given in connection with it has been more or less conjectural. It is right, however, to state that it is a very general opinion amongst mechanics and philosophers, that iron repeatedly hammered—and by inference subject to repeated vibrations and shocks—becomes completely changed in its internal structure. Numerous instances could be brought forward in proof of this, a most notable one being that of the “monster wrought-iron gun” of Mr Nasmyth, which was fabricated by the agency of the steam hammer, and which burst at the first or second trial, presenting, we believe, all the appearances of cast-iron. Parts of machinery are sometimes cold hammered in order that they may take a higher polish; but if this generally received opinion is correct, the practice is a dangerous one, as they may be much weakened. The same may be said of the practice of repeatedly heating and plunging in cold water, forged parts of machines.

649. As regards the durability of iron, and the influence of the atmosphere and water upon it, Mr Mallet, in his Report to the British Association, gives some valuable remarks. From his close investigation into the nature and properties of iron he deduced a variety of hints, of which the following are the most useful for our purposes.

650. That iron placed in clear fresh river-water corrodes less than under any other immersion, from the absence of highly corrosive matters, and from the coat of oxide which is formed, and which is not so easily washed off as in sea-water; that castings made in dry sand and loam are more durable when immersed in water than those made in green sand; that cast-iron is more durable when the hard crust is allowed to remain, than when it is removed by chipping and filing; that the greater the bulk of bars the less is the corrosion; that to prevent unequal cooling in castings, the ribs should be made of equal thickness.

651. The methods in general use to prevent corrosion and decay of iron-work, consist in the application of paints. These afford, however, little protection; and a better medium, boiled coal-tar laid on while the iron is hot, is highly recommended. It leaves on the surface a bright varnish, capable of resisting for a considerable time corrosive agencies. Painting the surface with the hot solution of the oil of tar—Bethellising—is said to be an efficient preservative of iron surfaces.

652. *Copper*.—For constructive purposes this metal is principally used in form of thin sheets. It is very durable, and it is little affected by atmospheric influences. Brass is an alloy of this metal and zinc, and is composed—when that kind of it known as British brass of a full yellow colour is wished to be made—of 66.18 parts of copper, and 33.82 of zinc. Its specific gravity is 8.299. For purposes where copper is too soft, and a metal less corrosive than iron is required, gun-metal may be used. This is an alloy of copper and tin in the

proportion of 84.29 of copper to 15.71 of tin. To render these alloys easily worked in the various processes of the mechanic, a little lead should be added to the brass, and a little zinc to the gun-metal alloy.

653. The *lead* of commerce is derived from the ore *galena*, which is a sulphuret yielding about 87 per cent of lead and 13 of sulphur. Galena is found in greatest quantity in transition rocks, and of these the blackish transition limestone contains the largest. The ore is more frequent in irregular beds and masses than in veins. The galena lead-mines of Derbyshire, Durham, Cumberland, and Yorkshire, are situate in limestone, while those of the Leadhills, in Scotland, are in greywacke. Great Britain produces the largest quantity of lead of any country in the world, the annual produce being about 32,000 tons, of which the English mines supply 20,000. The rest of Europe does not supply 50,000 tons. The export of lead has fallen off considerably, and its price has experienced a corresponding depression for some years past, on account of the greatly increased production of the lead mines of Adra in Granada, in Spain.

654. Zinc is an ore which occurs in considerable quantity in England. It is found in two geological localities—in the mountain limestone and in the magnesian limestone. It occurs in veins, and almost always associated with galena or lead-glance. It is of the greatest abundance in the shape of a sulphuret or blende, or *black-jack*, as the miners call it. There is also a silicious oxide of zinc, and a carbonate, both called calamine. In North America, the red oxide of zinc is found in abundance in the iron mines of New Jersey. The zinc of commerce is derived, in this country, from the blende and calamine. It is naturally brittle, but a process has been discovered by which it is rendered malleable, and it retains its ductility ever after. It is this assumed ductility which renders the metal useful for domestic purposes. "It is extensively employed for making water-cisterns, baths, spouts, pipes, plates for the zincographer, for voltaic batteries, filings for fireworks, covering roofs, and a variety of architectural purposes, especially in Berlin; because this metal, after it gets covered with a thin film of oxide or carbonate, suffers no further change from long exposure to the weather. One capital objection to zinc as a roofing material is its combustibility."

655. The most malleable zinc is derived from Upper Silesia, under the name of *spelter*, which is sent by inland traffic to Hamburg and Belgium, where it is shipped for this country. The zinc of the Veille Montaigne Company enjoys a high reputation: it is considered the purest spelter. Zinc is much lighter than lead, the density being 7.190, while that of lead is 11.352. The tenacity is also greater; thus, while lead has a tenacity of 27.7, zinc has a tenacity of 109.8.

DIVISION SECOND.—SPECIFICATIONS OF BUILDINGS.

656. SECTION FIRST—*Specifications*.—We shall now treat of specifications, in which the disposition in their respective places of the material employed in the construction of buildings is fully explained, together with the modes in which the work should be executed and finished. But before giving what may be called "model specifications" adapted to stone and brick structures, we deem it advisable to precede them with a list of items which should be con-

sidered in the preparation of all specifications for steadings, dwelling-houses, and cottages:—

657. *Excavating, by the Cubic Yard.*—Dig out and remove surface of ground to depth shown in sections. Dig out for cellars, trenches for footings for walls, cross-walls, chimney-jambs, piers, fenders. Excavate for cesspools in stables, byres, &c., for drains, wells, liquid-manure tanks, and dung-sheds. Clear away rubbish, ram, level, fill in. Concrete to be shot from stage 10 feet high.

658. *Bricklaying, per Rod.*—Walls round the building with footings. Party-walls. Cross-walls. Sleeper-walls and piers for ground joists. Paving, &c. Fenders to fireplaces on lowest storey. Chimney-shaft, extra to sailing-course, continuing walls up gable. Brickwork under steps. Courses of slate to prevent wet rising in cement near ground-line on walls, and sleeper-walls. Bottom of liquid-manure tanks. Wells to have invert arches in cement, with arched crowns in ditto.

659. *Bricklaying, per Yard Superficial.*—Bricknogging. Brickpaving in sand. Invert and relieving arches to openings.

660. *Bricklaying, per Foot Superficial.*—Half-brick trimmer arches to front hearths. Gauged arches set in putty-facings. Yellow malms, white Suffolk, &c. Raking and tuck-pointing.

661. *Bricklaying, per Foot Running.*—Drains, stoneware glazed pipes. Steining. Cuttings. Splays for shutters. Chamfers. Brick on edge. Cutting up gables.

662. *Bricklaying, in Numbers.*—Cement or other chimney-pots, set with tiles in cement. Traps to drains. Brick eyes to drains. Common water-closet, stoneware pan. Bedding and pointing to door and window frames. Making good to sills. Parget and core flues, set copper stoves, range, &c. Sinks on brick piers. Air bricks.

663. *Slating, per Square.*—Slates of fir battens, double nailed, with copper nails, or composition ditto. Allow 10 inches on all the run of eaves to slips, valleys, and gutters. Cement filleting. Saddle slating. Ornamental cruse. Slate cisterns bolted together. Shelves to wine-bins. Pantiling laid dry. Ditto bedded in mortar. Ditto pointed outside. Filleting and heading included. Ditto pointed inside. Plain tiling. Four inches to be allowed for eaves. Six inches for dripping eaves. One foot for valleys. Three inches for all cuttings. In re-tiling, using sound old tiles about 100 new ones are required to one square. Verge per foot-run. Slates in cement breaking point at plinth line of house, to prevent damp rising in walls. Tiles. Eaves tiles.

664. *Masonry.*—Cube stone laid on natural bed. Super-sawing, half ditto. Sunk work, ashlar facing, proper bound stones at intervals. Front and other stone steps. Landings. Sunk-throated and weathered sills, 4 inches longer than opening, project $1\frac{1}{2}$ inch from face of wall. Balcony bottom trusses. Portico, window, and door dressings. Yorkshire tooled or bunched paving to cellars, kitchen, and for travises to byres. Wash-house, areas, &c., laid on brick rubbish. Portland rubbed chimney-pieces to bedrooms, &c. Portland or York tooled or rubbed outer and inner hearths. Outer ditto, 18 inches longer than opening, 18 inches wide. Sinks, sink-stones, and holes cut. Feather-edge coping to walls, &c., throated and set. Rough York stone core for cornices run in cement. Templates to iron columns and storey posts. Hook-stones for gates. Curb for railing. Holes cut. Stone bases for pillars or posts in stable, and byre travises, with upper side chamfered, and hole cut 2 inches deep to receive heel-posts. String-course caps to chimneys. Marble

chimney-pieces. Bath. Pipe-holes cut. Washers let in. Copper cramps, and lead. Feeding-troughs and benches. Court-gate pillars. Cart-shed do. All angles rounded off or splayed. Wall-copings. Causeway for stable and byre floors, &c. Man-hole stone cover for well. Liquid-manure tanks.

665. *Carpentry, Cube*.—Fir in bond, plates, &c. Old oak sleepers and plates, 4 inches by $3\frac{1}{2}$, to basement floor. Templates to beams. Girders. Fir bond all round, with rider to connect at flues. Wood-bricks to doors, windows, skirting, 9 inches by 4 by $2\frac{1}{2}$ inches. Lintels over openings 9 inches hold on wall, each side. Pole-plates.

666. *Carpentry, Cube-framed*.—Ground joists notched and spiked. Trimming joists, fitting in ditto. Common joists. Bridging and ceiling ditto. Girders, bressummers, sawn down, reversed, and bolted together. Storey posts. Ceiling joists and binders to top storey. Dragon piece and angle tie. Principal rafters (pair). Common ditto (pair). Hips and ridge (rolls). Valley-rafters. Tie-beam. King and queen posts. Struts. Purlins. Quartering to form soffit of eaves. Quarter partitions. Head and sill. Braces and quarters. Door-heads. Posts, puncheons. Filling in quarters. Nogging-pieces. Ashlets. Heel-posts, for stables, byres.

667. *Carpentry, per Foot Superficial*.—Gutter-board and bearers. Boarding or Baltic battens to roofs. Eaves boards. Boarding to dormers. Planceer and Facia. Centres and turning pieces to arches, &c. Bracketing. Sound boarding. Boarding for lead-flat. Edges shot. Firrings. Travises for stables, byres.

668. *Carpentry, per Running Foot and Numbers*.—Rounded rolls. Herring-bone strutting. Angle staff. Tilting fillets. Cantilevers. Rebated drips to gutter. Cesspools, &c., ditto.

669. *Joinery, per Square*.—Floors, best rooms, yellow deal, straight-joint, ploughed and tongued headings. Common floors, laid folding.

670. *Joinery, per Foot Superficial*.—Double-moulded skirting. Deal-cased frames, oak sunk weathered sills, double-hung sashes, brass axle-pulleys, lines and weights. Boxing. Shutters, square or splayed. Backs, elbows, and soffits. Shutter front moulded, bead, butt, or square. Framed back-flaps, back linings, elbow-capping, architrave round window. Beaded lining. Rounded window-board. Framed grounds to doors. Double-beaded and rebated door-jamb. Doors, square-framed, four or six panel, moulded one or both sides. Bolection mouldings to entrance-door. Coach-house and stable doors, framed, ledged, and braced. Sash-doors. Marginal squares. Movable shutter. Folding and sliding doors to drawing-rooms. Shutters hung with lines and weights, with proper boxing and frames, beads, &c. Moulding round ditto, deal moulded front, flap to shut over shutters, flush rings, turned knob, lines and weights.

671. *Joinery, per Foot Running*.—Mitred borders to hearths, torus and square skirting, narrow grounds, mouldings, beaded capping. Staircase, dog-legged, or well-hole. Fir-carriages, brackets. Wall-string cut, and mitred inner string, ramped or wreathed. Circular strings. Return hosings. Steps and risers rounded or moulded, glued, blocked, and bracketed, ploughed and feathered-tongued. Curtain step. Hosings to strings. Plain cut brackets. Windows. Landing and joists to ditto. Lining to joists top of well-hole. Working hosing and hollow moulding to landing. Facia. Balusters, turned or square—iron one every fifth step. Iron newel. Turned ditto. Hand-rail rounded or moulded. Ramp, swan's-neck, wreathed, scroll end, raking, moulding to wall-string, sometimes beaded capping. Mitred caps, pendants, fixing iron newel and baluster extra. Joint-screws to hand-rail. Closet fronts, correct to stairs.

Pump casing. Soil-pipe casing to water-closet. Water-cistern dovetailed. Seat and riser. Hole cut and dished. Beaded-handle hole. Clamped flap and beaded frame. Mahogany skirting to ditto. Floor and skirting to water-closet. Dresser. Tongued-drawer bottoms. Dovetailed runs. Beaded drawer-fronts. Dresser-top, ploughed and tongued. Rounded pot-board and bearers. Shelves and standards. Turned legs. Glued sliders. Turned knobs. Flat-rail and pegs. Saddle-brackets, and pins in stable.

672. *Ironmongery.* — Hinges and fastenings. Brass mortice-locks. Iron rim-locks, striking-plates, finger-plates, bolts, latches, turn-buckles. Bolts and screws for shutters, strap-hinges to back flaps. Bolts and screws for doors, brass or iron. Sash-fasteners. Flush-rings. Flush-bolts, barrel-bolts. Draw-back lock and chain. Shutter-bars. Brass shutter-knobs. China-ware or glass, door furniture. Casement stay cross-garnets, cabin-hooks, outside shutter-stays, shutter lifts. Grates, range, copper.

673. *Smith-work and Founding.* — Wrought-iron ties, straps, king-bolts, screws, nuts, bolts, cramps, chimney-bars, saddle-bars. Fitches to strengthen beams. Hoop-iron bond. Tyerman's patent notched ditto. Top rail of railing. Metal bars for skylights, casements, or sashes. Cast-iron girders, columns, rain-water pipes, newel and balusters, heads and shoes, stink-traps, air-bricks, railing, standards, cantilevers, stable-racks and mangers, gates, eaves-shoot, coal-plates, gratings, pumps, balconies, verandahs, knocker, scrapers.

674. *Plumbing.* — Cover lead-flats. Lead-rolls, 4 feet 6 inches apart, of cast-lead; 5 feet of milled ditto. Ten inches extra width to each roll. Cover hips and ridges, valleys, dormers, gutters, gutters behind chimney. Gutters to have one drip every 10 feet; $1\frac{1}{2}$ inch fall in ditto. Raking-step flashing; flash-ink to skylights, chimneys. Line cisterns. Sink to housemaid's closet. Extra soldered angles per foot run. Service and waste-pipes to cisterns, sink, water-closet; water-closet apparatus; lead soil-pipe. D-traps. Lead for mason and smith's work. Brass bell grates, washers and wastes, valves, ferrols, bosses, stop-cocks, square or round water-way, ball-cocks, basin with plug-hole.

675. *Plastering, per Yard Superficial.* — Lath, plaster, float, and set ceilings. Deduct chimney breast. Lath, plaster, float, and set quarter partitions, deduct doors and skirting, unless plaster continued to floors. Lath, plaster, set, soffit of staircase. Render, float, and set walls and bricknogged partitions. Deduct chimney, window, and door openings. Lath, plaster soffit of eaves.

676. *Plastering, per Foot Superficial.* — Cornices, plain or enriched, composition skirting, pugging with lime and hair, and chopped-hay, two coats, or on fir laths with lime, sand, and hair.

677. *Plastering, per Foot Running.* — Cement window and door dressing-strings, reveals, arrises, quirks, &c.

678. *Plastering, per Yard Superficial.* — Washing and stopping. Clearcoling. Whiting, &c., in distemper. Colouring. Ditto in distemper. Centre flowers, trusses, vases, balustrades, ornaments generally.

679. *Painter and Glazier, per Yard Superficial.* — Paint all outside new work four oils. Inside ditto, three oils. Graining and varnishing, two coats. Flating, various tints.

680. *Painter and Glazier, per Foot Running.* — Wire-edges, bars, rails, staff-beads, narrow-skirtings, bands, hand-rail or newel-strings. Rail and pier. Pipe-trunk. Chain. Coping-edge. Cornice (small girt).

681. *Painter and Glazier, Numbers.* — Frames. Venetian ditto. Dormer ditto, squares, per dozen. Small metal ditto. Casements. Sills, 3 feet 6 inches long, each. Reveals, pegs, brackets, saddle-bars, legs, bearers, scrapers,

balusters, newels. Towel-roller and bracket, chain, sets of beads and pulley-pieces. Step and riser each side carpet.

682. *Painter and Glazier, per Foot Superficial.*—Trellis-work, close ditto, ornamental railing, balcony-fronts, glaze-sashes, specify kind of glass, ditto to fanlights, skylights, sash-doors. Measure glass to sashes 3 inches less than width of brickwork, and 7 inches less in height. Glaze dormers and bull's-eye lights.

683. SECTION SECOND—*Specification adapted to a Steading of Stone.*—The example which we shall give of a particular specification applicable to a steading constructed of stone, is that which was drawn up for building the steading of Drumkilbo, in Forfarshire, belonging to Lord Wharnccliffe, and a plan of which is given in Plate XII.

684. *Mason Work.*—The tracks for the foundations of walls are to be dug to the depth of 18 inches below the level of door-sills, and to such a width as there will be 6 inches of a scarcement on each side of the walls. The footings to be of large flat stones, not less than 6 inches in thickness, and to meet in the tails, so as there shall be no small stones between them. The footings to form a scarcement of 6 inches on each side of the walls.

685. The stone walls, unless otherwise described, to be of good common rubble work. The whole of the stones to be fair dressed in face and beds, and to be well banded, bedded, jointed, packed, and pointed with good lime mortar, mixed with a due proportion of clean sharp sand. The lime, after being properly slaked, to be passed through a common sand-riddle, and to be properly mixed with water, and well wrought before being used. Sleeper-walls to be built under all the partitions, and wherever it is necessary; all the gables to be carried up within 3 inches of the sarking, and all the walls, where necessary, to be beam-filled with stone and lime.

686. There is to be a cesspool under each grating in byres and stables. The cesspools to be at least 2 feet 6 inches in depth, and not less than 14 inches square, and to be built and paved with brick; also, at all the junctions of the urine-pipes there are to be eyes of brick at the necessary depths of the pipes 9 inches square. Urine-tank to be of brickwork at the depth shown on the section.

687. All the corners, gate-pillars, and door and window rybats to have 2-inch droved margins, droved breasts, checks to the necessary depths, and pick-dressed in the tail, and the sizes already described, except the following corners and openings, which will be formed of hammer-dressed scuncions, long stones, or brick, viz. :—Cattle-shed, doors, and other openings and corners to be formed of brick; but where there are to be doors hung, two stones of a sufficient size are to be built into the wall, and the crooks sufficiently batted into them. The openings into the two large courts are to be formed with long stones, to be at least 3 feet below the surface of the ground, and to be of such a breadth as cover in the end of the dyke, and not less than 8 inches thick, and to finish with the cope of the dyke, and to be neatly hammer-dressed. Cart-shed pillars to be 22 inches square, two stones to form a course, except the last course, which must be in one stone. The lintels to be at least 13 inches in height, and not less than 9 inches in thickness, and to be built hard together at the ends, to be neatly hammer-dressed, a chamfer to be taken off all round the pillars. All the other openings for doors to have either checks for post or giblet checks. Mill-shed openings to be formed with hammer-dressed scuncions, to be set double and single alternately, and to finish with

a double one at least 18 inches in breadth. The lintels are to be provided by the carpenter. Two stones, 2 feet square by 10 inches in thickness, to be set on wall, at the level of cross-beam, and one of stone, of the same dimensions, set for supporting horse-wheel; also two stones, 18 inches square by 8 inches in thickness, to be built into the wall 6 feet below the top of wall, and a recess made into the wall for an iron rod for fixing down the beam. The position will be pointed out during the progress of the work.

688. *Feeding Troughs Benches.*—The feeding benches in courts are to be built with brick, and covered with faced and jointed pavement, having all the necessary bolt-holes, &c.; those in loose-boxes to be of the same description. Feeding troughs in byres to be as shown on the plan and section, having sides 3 inches in thickness, and not less than 18 inches in depth. All to be dressed straight, and close-jointed; bottoms to be paved with brick, bedded and jointed with lime. Division stones to be from 3 to 4 inches in thickness, and to be 4 feet 6 inches square, having a proper hold of the ground. Thirty-two fixings for cattle to be provided, and fixed to the stones and walls. Fixings to be of 1 inch diameter, and not less than 20 inches in length.

689. *Travise Stones.*—Thirteen stones for horse travises, to be 9 feet by 2 feet 9 inches, and 3 inches in thickness, and to have 6 inches of hold in the ground and 2 in the wall, and chamfered as shown on the section. There will be five stones for supports in cart-shed, 18 inches square by 8 inches in thickness. Also ten stones for partition in straw-barn 12 inches square by 6 inches thick. Six stones for supporting feeding-shed roof, to be 8 feet long, and 12 inches by 9, resting in socket-stones 20 inches by 20, and 9 inches thick, and let into the timber lintel. (See section.) A stone, with a sunk panel, to be set above arch in south elevation, as shown on the plan.

690. *Paving.*—The stables, byres, loose boxes, and turnip-shed are all to be paved with small boulders, bedded in sand, and laid to the proper falls. Stables and byres to have curb-stones, as shown on the section. Ten 8-inch bell-traps to be provided, and fitted into stones 18 by 18 by 6, to be placed above each cesspool. The bell-traps to be strong made, and close fitted on to the stone. The urine-pipes will be provided by the proprietor, but the contractor is to open the trench, and lay them to the proper falls towards the tank, as shown by dotted lines. The passages in byres and feeding-shed passage to be laid with jointed pavement.

691. Bothy, harness-room, gig-house, boiler-house, and passage in straw-barn to be laid with jointed pavement. Riding-stable to be paved where coloured blue, and cut as shown on the plan. Coal-house and privy to be paved, and to have pavement roofs. Privy to have a pavement front for seat. Hen-house, urine-tank, gernal-house, shed, potato-house, workshop, guano store, and chaff-house to be paved with brick on bed, laid on lime, and grosited full in the joints with lime. Urine-tank to be covered with strong covers, a hole 12 inches diameter to be made in the cover for the pump. Also a part of the court dyke coped with flat stones for working the pump, and stone steps for getting up to it.

692. *Cisterns.*—Three stone cisterns to be placed as shown on the plan. The two in shed to be 6 feet by 2, and 1 foot 6 inches; the other to be 14 feet by 2, and by 1 foot 6 inches; or, if the contractor prefers, he can make it in two. They are to be properly checked and jointed with white lead, and bolted together, and made completely water-tight; and scullery to be laid with faced and jointed pavement, bedded on sand and jointed with lime. Dairy shelving to be of polished pavement, and to have at least 2 inches of wall-hold; the pave-

ment under shelving to be laid 2 inches above the floor on section. Coal-house to be paved with brick on bed, laid on lime as aforesaid. The spence to be laid with jointed pavement, bedded on sand and worked with lime.

693. *Jobbing*.—The contractor is to execute all necessary jobbing belonging to his department of the work, such as cutting raglets, bolt-holes, and fitting in crooks for hanging doors, and running them in with lead, sloping for getting in pipes, &c.; but the contractor furnishes no lead except what is wanted for the cattle-fixings—the lead for bolts and crooks being to be all provided by the carpenter.

694. *General Conditions*.—The contractor to get all the materials in the present steading and pigeon-house, belonging to his department of the works, and must take down the walls at such times as the tenant may find it convenient. Brick will be provided by the proprietor for all the work specified to be brick. The contractor will have Kinpurney quarry, free of lordships, for all the stones necessary for the completion of the works shown on the plans and set forth in this specification. The quarry must be well wrought. All rubbish to be removed out of the way, so as not to interfere with the working of the quarry afterwards. The contractor will have the use of the rafters and joisting for scaffolding; but if in any way damaged by him and not fit to be used, he must pay full value for it to the contractor for carpenter and joiner-work. The contractor is to furnish all the materials except brick, as aforesaid; but if sand cannot be got without stripping off the soil, he must do that, and at such times as there will always be as much cleared as allow the tenant free access to the pit. The tenant will perform all necessary carriages. Stones from Kinpurney quarry. Pavement and lime from Meigle Station.

695. The whole is to be finished in a most complete and tradesmanlike manner, and to the entire satisfaction of Christopher Kerr, Esquire, factor on the estate, or any person appointed by him to superintend the works.

696. *Carpentry—Steading Lintels*.—All the doors, windows, and other openings to have safe lintels, as already described. Cart-shed lintels to be in one length. Lintels over mill-shed posts to be 8 inches thick, and of such a breadth as carry the couples. The cross-beams in mill-shed to be 14 inches by 7, to have 18 inches of wall-hold at each end, and to be bolted down to a stone block by a $\frac{3}{4}$ -inch iron rod at least 6 feet in length, to have a good thread and strong nut. The other two beams to be of the same dimensions, to be well secured together by $\frac{3}{4}$ -inch travelling bolts. The beams over pillars for carrying cattle feeding-shed roof to be in one length, and to be 11 inches by 9, having 12 inches of wall-hold at each end.

697. *Joists and Sleepers*.—Granary and sheaf-loft joists to be $10\frac{1}{2}$ inches by $2\frac{1}{2}$, laid on wall-plates 8 inches by $1\frac{1}{2}$. Joists to be set 19 inches apart from centres, and to be properly bridled for machinery. Stair-bridling to be $10\frac{1}{2}$ inches by $4\frac{1}{2}$, to be dovetailed and screwed together with $\frac{3}{4}$ -inch iron bolts, and the whole of the floors to be laid with $1\frac{1}{8}$ -inch white wood ploughed and tongued flooring well nailed down. Corn-room to be laid with sleepers $6\frac{1}{2}$ inches by $2\frac{1}{2}$ on wall-plates 6 feet by 1 inch, and clad with flooring as aforesaid. Bothy bedroom to be laid with sleepers and flooring.

698. *Roofing*.—West and north ranges to be roofed with couples to the sizes marked on the section, and all to be properly checked and well nailed, as aforesaid, and set on wall-plates. Not to be more than 20 inches apart from centres, and to be clad with $\frac{5}{8}$ -inch white wood sarking, as described. Mill-shed roof to be constructed as shown on the section, having ten rafters going to the top. All the rafters to be set on wall-plates sawed to the circle. The wall-plate to

be in two, thickness making 2 inches, to be overlapped and well nailed together, and nailed down to the wood lintels. The other courses of plates to be 6 inches by 3, sawn to the circle, and fitted into a half check in rafters. A deal, 6 inches by $\frac{1}{2}$, to be bent round the outside of each plate. A detailed drawing will be given for this roof during the progress of the work. The rafters to be covered with $\frac{3}{8}$ -inch sarking, as aforesaid. Bothy roof to have couples placed 18 inches apart from centres, and covered with sarking. Stable range to be roofed as described for west and north range. All the byres and cattle-sheds to have couples made as described, and placed 20 inches apart from centres, and clad with lath 2 inches by $\frac{1}{2}$, at the distance to suit the courses of the slates (the slates to be, if they can be got, 14 inches by 8); ridge-battens to be supported on iron spikes on every second couple; fillets to be put on where necessary. Projections to be cleaned, and covered with iron, as described.

699. *Windows*.—The windows in south and west elevations to be sash and case, and primed as aforesaid. Stables and byres to have windows with sparred sliding-shuts, upper half to be glazed. Corn-room to have sash and case windows, as aforesaid. Granary to have twelve opening frames, all to have suitable hinges and fasteners. The proprietor will provide wire-screens for these windows, but the contractor is to fix them. Six skylights to be glazed.

700. *Lathing*.—The bothy ceiling to be lathed in the manner already described for lathing. Two beds to be fitted up in bothy, having forestock and bottom, &c. Granary floor to be supported by a beam running the whole length. Beam to be 6 inches by 6, supported by five uprights the same dimensions, resting into a stone. The beam to have 9 inches of wall-hold at each end. Corn-room partitions to be of standards $4\frac{1}{2}$ inches by 2, and clad with $\frac{3}{8}$ -inch beaded, ploughed, and tongued lining, having doors where necessary. Granary stair to have $1\frac{1}{2}$ -inch treads. Straw-barn to be divided, as shown, by a wood partition, posts to be $6\frac{1}{2}$ inches by $2\frac{1}{2}$, having a runner $6\frac{1}{2}$ inches by $1\frac{1}{2}$ at top and bottom, and clad with rails $3\frac{1}{2}$ inches by $1\frac{1}{4}$, nailed on 12 inches apart. Rails to be of larch.

701. *Cattle-Racks*.—Substantial racks to be fitted up above all the feeding-troughs in byres and loose-boxes. A runner, 3 inches by 3, to be stretched along the top of division-stones the whole length of byres, to be checked down on top of stones at least 1 inch, having all the necessary upright posts for supporting racks, &c. The space between runner and top of feeding-troughs is to be closed in by a door formed of $\frac{3}{4}$ -inch ploughed and tongued deals, with two cross-bars on the back, and will be either hung with hinges or made to slide up and down, having the necessary fixings. Racks to be fitted up in court sheds to the extent of 118 lineal feet.

702. *Feeding-Troughs*.—Troughs in feeding-shed to be formed, as shown on the section, by planks 8 inches by 3, bolted down to the pavement-soles with $\frac{1}{2}$ -inch iron bolts, not more than 6 feet apart. The sides next to passage to have uprights 3 feet by 2, placed not more than 5 feet apart, properly fixed to the side of troughs, and to have a runner 3 inches by 2 at top nailed to the baulks. A sliding door, $2\frac{1}{2}$ feet in height, formed of $\frac{3}{4}$ -inch ploughed and tongued deals, with two cross-bars on the back, to be placed between each upright, and to slide in grooves and into uprights. Each door to have an iron slip-bolt, and two lifters made of hardwood. Privy-seat to be covered with wood.

703. *Travises*.—The stables to be fitted up with travises having high and low racks, heel and shoulder posts, and fire-clay feeding-troughs, having a row

of harness pegs fixed into a plat of wood, to extend the whole length of the stables. Heel-posts to be 7 inches by 7, having a chamfer taken off each corner, and to be set down into stone 2 inches, and well nailed to a runner above 7 feet by 2. Division boards to be 2 inches thick, having two dowels into each joint, and covered on top by $\frac{1}{8}$ -inch hoops of iron, fixed by countersunk screw-nails. The feeding-boxes to be 2 feet 3 inches long by 1 foot 3 inches wide by 1 foot deep, inside measurement. A press to be fitted up in the angle of riding-horse stable, having shelves, and a plain door with a lock and key. The walls of harness-room to be lined on straps with $\frac{1}{2}$ -inch beaded, ploughed, and tongued lining, having a plate of wood round all the house, with all the necessary bridle-pegs and saddletrees fixed into it. The ceiling to be lathed. The hen-house to be fitted up with roost and roosting-poles. Roost to be covered with sarking, close jointed, and nailed down.

704. *Doors.*—There will be ten large doors in two halves, to be formed of 18-inch beaded, ploughed, and tongued deals in narrow pieces, with three cross-bars on the back, and to be hung with strong crook and band hinges, batted into the beds of the stone with lead, and bolted to the doors. Sheaf-loft door to be in two halves; to be 6 feet by 6, to be hung on posts, and to open to the inside, having fourteen cross-tailed hinges, slip-bolt, and stay-band. All the two-leaved doors to have stay-bands, and a hardwood revolving bar outside. All the other outside doors to be formed as already described; the doors having rebates checked inside, to be hung on posts by fourteen cross-tailed hinges, and those doors opening out to be hung with crook and band hinges, as already described. Inside doors to be of $\frac{1}{2}$ -inch wood, and hung with twelve cross-tailed hinges.

705. *Locks and Latches.*—The doors in west, north, and stable ranges all to have stock locks of the best description. The small doors to have good latches, and all the doors opening out to have latches fixed into the stone wall, to keep them back to the wall when open. The keys for stable and byre doors to have a falling ring.

706. *Gates.*—There will be seven 10-foot gates, each gate to be in two halves, having stiles 4 inches by $2\frac{1}{2}$, rails 4 inches by $1\frac{1}{2}$, spars $3\frac{1}{2}$ inches by 1, placed 3 inches apart. Gates to have diagonal or centre rails. Two small gates of a similar description. All to be hung with strong crook and band hinges, as already described. These gates to have suitable slip-bolts, bolted on foot of stiles, and a swivel bar on centres, and all the necessary catches and latches to keep them open or shut, as the case may be.

707. *Skirting.*—Bothy and harness-room to have skirting $4\frac{1}{2}$ inches by $\frac{5}{8}$. Corn-room, sheaf-loft, and granary to have skirting fixed all round the walls and partitions; thus the floor-line to be nailed to dowels driven into the wall. Bothy and harness-room to have plain mantelpieces. The two recesses in bothy to be fitted up with shelves, one of them to get a plain door.

708. *Jobbings.*—The contractor is to execute all jobbing necessary for the completion of his department of the works, also to forward and give all the necessary assistance for the laying and bedding of the beams, &c. All minor parts to be included, and the whole and every department of the works must be finished in strict accordance with the plans, and equal to other works of a similar class. Although everything may not be particularly and minutely described, such must be considered to fall under the contract, as no extras will be allowed unless specially ordered.

709. *Materials.*—All the timber for the carpenter-work to be of the best Swedish fir. The flooring and sarking to be of Baltic white-wood, and the

finishings to be all of the best Quebec or St John's yellow pine. The whole must be the best of their respective kinds, free from softwood, shakes, or large knots, and to stand the sizes when finished.

710. *General Conditions.*—The builder is to get the use of the joists and couples for scaffolding. The contractor is to take the couples and lath of the existing buildings at Drunkilbo, consisting of pigeon-house, stable, byres, barn, cart-shed, and mill-shed. The contractor is to get all the wood in mill-shed, consisting of upright posts and beams, for carrying roof and roofing. All are of new wood, and can be used in the steading. The contractor is to furnish all other materials necessary to complete his department of the works; but the tenant will perform all necessary carriage from Meigle Station, or any similar distance. The whole works must be finished in a most complete and tradesmanlike manner, to the entire satisfaction of Christopher Kerr, Esq., factor on the estate, or any person that may be appointed by him to superintend the works. The factor, as aforesaid, reserves full power to make any additions to or deductions from the foregoing works, without any way affecting the terms of the contract, the value of which will be added to or deducted from the contract price by the architect of the works. No part or portion of the works will be allowed to be sublet without an order from the factor aforesaid.

711. *Slater and Plumber Work.*—The roofs to be covered with dark blue slates. Byres and cattle-sheds to be covered with 14 inch by 8 slates. Byres and sheds to be hung on lath. Cottages and all the other roofs to be covered with slates 13 inches by 7. All to have full and sufficient cover, averaging $2\frac{1}{2}$ inches at bottom, and diminishing regularly to $1\frac{1}{2}$ inches at top; to be square dressed, regularly sized, and hung to the sarking by galvanised iron nails. Every third course to be double nailed. The joints of sarking on house and cottages to be properly filled up with plaster-lime, mixed with hair, and all the raglets to be pointed with mastic.

712. *Plumber-Work.*—All the roans, valleys, ridges, hips, and conductors, to be of 18-inch zinc flashings, to be of 5-lb. lead: $4\frac{1}{2}$ -inch roans to be round all the eaves of farmhouse, and all the roofs falling into the cattle-courts: $3\frac{1}{2}$ -inch roans to be round all the eaves of kitchen and dairy ranges. There will be two 3-inch conductors from farmhouse, one from dairy, and three 2-inch conductors from kitchen-range, and two $1\frac{1}{2}$ -inch ditto from porch, and six $2\frac{1}{2}$ -inch conductors for cattle-courts. A 2-inch roan to be round eaves of porch. The roans to be supported by strong iron hooks, well nailed to the sarking or lath, not to be more than 27 inches apart from centres, all to be laid to the proper falls. Each conductor to have a 6-foot cast-iron length to enter the drains 12 inches below the surface. Ridges, hips, and valleys to be 12 inches in breadth, all to fit their respective places. Lead flashings, 8 inches broad, to be properly ragleted on porch roof. All the chimney-tops to have lead flashings 8 inches broad.

713. *Skylights.*—There will be six cast-iron skylights; two to open, the others to be dead. All to have zinc soles—two skylights No. 4, and four No. 3.

714. *Ventilators.*—There will be twenty double ventilators of zinc. The position of them will be pointed out during the progress of the work. (See north elevation in Plate XII. for sketch of ventilators.) A spire to be fixed on top of mill-shed roof with a weathercock, to be of sheet copper. The spire to be a rod of 1-inch round iron, to be fixed 3 feet below the top of roof, having a shoulder and a nut properly screwed, and to be firmly braced up. The cock to

be 5 feet above roof. The whole to be finished in a most complete and tradesman-like manner, to the entire satisfaction of Christopher Kerr, Esq., or any person appointed to superintend the works. The contractor is to uphold the roofs against wind and weather, and keep them completely water-tight, for twelve months after the completion of the whole works, and leave them in good condition at that period. The contractor is to take the slates off the present steading-house and pigeon-house, and put them carefully aside, so as to be entirely clear of all the buildings, &c., having no further claim on them. The contractor is to furnish all materials necessary for the completion of his department of the works; but the tenant will perform all carriages from Meigle Station, or any similar distance. All minor parts to be included; and the whole and every department of the works must be finished in strict accordance with the plans, and equal to other works of a similar class. Although everything may not be particularly and minutely described, such must be considered to fall under the contract, as no extras will be allowed unless specially ordered.

715. *Plaster-Work.*—Bothy walls, partitions, and ceiling, to receive two coats of plaster. Ceiling of harness-room to get two coats of plaster. Granary, sheaf-loft, and corn-room walls to receive one coat of plaster. The windows to be bedded and pointed with lime. The plaster is to consist of lime and clean sharp sand, mixed with a due proportion of good fresh hair, to be well mixed and properly wrought, and the whole to be of the best description when finished, free from cracks, blisters, or water-marks of every description. The contractor is to provide all materials necessary for the completion of the works; but the tenant will perform all carriages of lime from Meigle Station, and sand from the pit. The whole to be finished to the entire satisfaction of Christopher Kerr, Esq., factor on the estate, or any person appointed to superintend the works. All minor parts to be included, and the whole and every department of the works must be finished in strict accordance with the plans, and equal to other works of a similar class. Although everything may not be particularly and minutely described, such must be considered to fall under the contract, as no extras will be allowed unless specially ordered.

716. What is contained on this and preceding pages are the specifications referred to in a minute of agreement, executed of equal date herewith, between Christopher Kerr, conjunct town-clerk of Dundee, as factor and commissioner for the Right Hon. Lord Wharncliffe, of the first part, and David Milne, mason, Kirriemuir; Robert Dow, wright, Blairgowrie; Andrew Anderson, slater, Coupar-Angus; and Alexander Mitchell, plasterer, Alyth; and David Smith, manufacturer, Alyth, as cautioner for and with the said Alexander Mitchell, all of the second part.—In witness whereof, this docquet, written upon this page by James Moir, clerk to Christopher Kerr and Company, writers in Dundee, by whom the said specifications are also written, are subscribed, along with the said specifications, by all the parties, as follows—viz., by the said David Milne, Andrew Anderson, Alexander Mitchell, and David Smith, all at Dundee, on the twentieth day of March eighteen hundred and fifty-seven, before these witnesses—Christopher Webster Kerr, residing in Dundee, and Andrew Hutton, clerk to the said Christopher Kerr and Company; by the said Robert Dow, on the twenty-seventh day of the said month of March, before these witnesses—the said Christopher Webster Kerr and Andrew Hutton; and by the said Christopher Kerr, also at Dundee, on the said twenty-seventh day of the said month of March, before these witnesses—the said Christopher Webster Kerr and the said Andrew Hutton.

717. *Specification adapted to a Steading of Brick.*—The following is an example of a specification for a brick-built farm-steading:—

718. *General Conditions.*—The several contractors for the farm-buildings are required to provide all materials, tools, tackle, and all other requisites necessary for completing the work. The whole of the materials to be the very best of their several kinds, sound and well seasoned, and to be applied in the most workmanlike and substantial manner, under the direction and to the complete satisfaction of the architect, or the clerk of works, duly appointed to superintend the erection of the building.

719. The drawings are strictly to be adhered to, and to be considered equally binding with the specification. Should anything appear to have been omitted in either the drawings or the specification which is usually inserted in these, or which may reasonably be inferred from the said drawings and specification, the contractors shall not be free to obtain any advantage from these omissions. On the contrary, it is clearly understood that they shall provide and apply whatever material or labour, or both, which may be wanting to complete the works in accordance with the true intent and meaning of the said drawings and specification, and with the general conditions; and the directions for their correct performance, as given from time to time by the architect or clerk of the works, are strictly to be adhered to.

720. Where any ambiguity exists with reference to the measurements shown in, or taken from, the drawing from the scale attached thereto, figures are in all cases to be preferred to the drawings. Any doubtful or disputed point, or question arising on this or any other subject, is to be decided by the architect, whose decision in writing shall be final and without appeal.

721. Any dispute or disputes that may arise in connection with the work, whether on account of extra or unfinished works of the drawings or specification, or otherwise, of whatever kind, shall be referred to the architect, whose decision or valuation, as the case may be, shall be final, and binding upon all parties.

722. Any extra work which is required to be done, is to be contracted for before the same is commenced to; and should any of the contractors omit to make such previous agreement or contract, the architect, or person appointed by him, shall measure the work done, and value the same, and this valuation is to be final and binding.

723. Should any of the several works herein specified or shown on the drawings be ordered to be omitted and not carried out, then the architect, or person appointed by him, shall measure the portions so ordered to be omitted, and value them according to the rates or prices at which he considers the contractor or contractors to have founded his or their contracts; and the amount so valued shall be deducted from the sum due to the contractor.

724. The payments to the bricklayer, mason, and carpenter, to be made in three instalments, in sums not less than 20 per cent upon the amount of the respective contracts—upon producing a certificate from the architect that the amount of the sums applied for do not exceed three-fourths of the value of the works then executed and performed. The value to be computed after the same ratio at which the architect conceives each contractor's estimate or tender has been formed.

725. The plasterer, slater, plumber, painter, and paperhanger to be paid when the whole of their work is completed to the satisfaction of the architect or clerk of works.

726. The proprietor, through his architect, reserves to himself the power of making any alterations or additions to the several works as they proceed, with-

out multiplying or invalidating the contracts; but the architect will not feel himself bound by any order given, or which may be said to have been given, verbally for any such alterations and additions; consequently no allowances will be made for such work, except the contractor or contractors can and do produce a written order authorising the addition or alterations, signed by the architect. No deviations, therefore, are to be made from the drawings, without a written order from the architect.

727. The building, the ground attached, and materials placed thereon, from the commencement to the finishing thereof, are to be considered in the possession of the proprietor, without tending to make void or to invalidate any of the foregoing conditions, or to make him liable for any accident, risk, or damage whatsoever, that may occur to the same. None of the materials to be removed without the permission of the architect.

728. Should any of the contractors perform any improper and untradesman-like workmanship, or provide any improper materials, they shall be immediately replaced by good workmanship and materials, upon the architect requiring the same to be done. And should any of the contractors in such case refuse to carry out the requirements of the architect within the space of twenty-four hours after a written notice has been given of the same, it shall be lawful for the architect to re-let the work to other contractors, and cause to be replaced by good workmanship and materials the said defective workmanship and materials, according to the terms of this specification; and this at the cost of the original contractor or contractors whom it may concern.

729. From the commencement to the finishing of every part of the respective works, the care of the same, and whatsoever appertains thereto, is to be with the several contractors, who are in each of their respective departments to protect and preserve the same; and in case of any damage or injury happening to any portion of the said works by the artificers employed—by the inclemency of the weather, by fire, or by any accident whatever—the contractor or contractors whom it may concern shall repair the same at his or their costs, so that at the conclusion of the several works every part may be complete and perfect.

730. No portion of the works will be allowed to be sublet on any account, unless the architect shall fully approve of the same.

731. The buildings are to be erected ready for the slater and plumber in weeks from the date of an order from the architect to commence the works; in default of which the bricklayer, mason, and carpenter are all and each of them severally to perfect and pay to the proprietor the sum of per week, for each and every week, until the work shall be so built up, from the aforesaid date; anything whatsoever to the contrary notwithstanding to be recovered from them as and for liquidated damages, or to be deducted from the amount due to the said contractors.

732. The whole of the slating and plumbing to the roofs, cisterns, and gutters are to be thoroughly finished in days after an order has been given by the architect to commence; in default of which the plumber and slater shall each and both pay the sum of per day to the proprietor, for each and every day, until the said work shall be completed, from the aforesaid date, to be deducted from the amount due to the said contractor.

733. The whole of the works to be entirely completed, to the full extent herein specified, in weeks after the roof is covered in; in default of which the contractors are all and each severally (with the exception of the slater) to forfeit and pay to the aforesaid proprietor the sum of for each and every week, until the aforesaid work shall be so completed, from the

aforesaid date; the amount thus forfeited to be deducted from the amount due to the said contractors.

734. Each contractor to clear and cart away all rubbish accumulated from time to time in connection with his work as the architect shall direct.

735. The several contractors are to be prepared with the names and residences of two respectable sureties each at the signing of the contract.

736. *Excavator*.—Make all the necessary excavations for footings, drains, wells, liquid-manure tanks, and dung-stances, to the depth and in the position shown in the drawings. All water, soil, &c., settling in these trenches, to be drawn off, and this drainage to be effectually completed before the brick-work is commenced. Level and ram down hard the beds of all footings, and consolidate the earth about the same, and also against all walls, drains, &c., if the nature of the foundation soil requires it.—(See Section on Foundations, Book Second.) Lay under the external walls round building a course of good lime concrete (see Concrete); the depth of this to be 18 inches, and width 1 foot wider than the width of lower course of footings. The concrete to be thrown into the trenches from a stage at least 6 feet above their level. Any other work upon the site of the whole building which may be required to level and render it complete to be duly executed; and all rubbish and superfluous soil that may accumulate during the progress of the work to be removed, and all left clean and perfect, to the satisfaction of the architect or the clerk of works.

737. *Bricklayer*.—The brick-work to commence on the concrete (if used), the first course to be laid and well bedded in mortar.

738. All the walls to have two to three courses of footing, and to be constructed of the several thicknesses shown upon the drawings, of the best hard well-burnt, sound stock-bricks, to be laid in old English bond, and to be carried up regularly. No four courses of brick to rise more than $\frac{3}{4}$ inch beyond the collected height of the bricks; every course to be filled in and fully flushed up with mortar, and well grouted with liquid mortar of hot lime and sand every second course up to level of ground line, and every fourth course above this. No variation to be made between the inside and outside work. The joints inside of the apartments which are required to be plastered to be left rough. Where plastering is not required, the inside joints to be finished with a neat ruled joint in putty or cement. To prevent damp rising, lay all round the walls, at ground level, a course of countess slates, laid in cement, or a layer of a composition formed of coal-tar and sand, to be carefully laid on with a hard brush, and well worked into the joints before flushing. 9-inch relieving arches to be turned over all voids, window, door, and chimney openings. Turn arches in brick-and-half work to liquid-manure tanks. Drains to be laid down in drain tubes or in brick drains as directed. (Here fill in description of drains to be employed.—See Drains.) Bed in mortar all bond timber, plates, lintels, wood-bricks, templates, and other wood-work required to be set in the brick-work. Bed and point round all window and door frames with lime-and-hair mortar, and bed the sash-sills with white lead. Cut all splays, chamfers, &c., where required. Set the boilers in boiling-houses with seconds bricks, and with bull-nose corners—the fireplaces to be set with fire-bricks of the best quality. The flues to be 14 inches by 9 for fireplaces in wool-room, and 9 inches square for single boilers in boiling-houses, the inside to be pargeted with well-made cow-dung pargeting.

739. The floors of the several apartments (here name them) to be laid with brick on edge, or Minton's encaustic tiles, as directed.—(See Section on Floors.) Make good all necessary openings to drains. Build cesspools in 9-inch work

laid in cement in cow-house, stables, feeding-boxes, &c., where required. Build foundation to mangers in byres, and to feeding-troughs in cattle-courts. Set in brick-work, where required, water-troughs for cattle. All the angles of doors and gates to be splayed or made bull-nosed. Provide all necessary scaffolding, and appurtenances to carry on the work, and to attend on the masons, plumbers, carpenters, and smiths, aiding and making good after them; and to perform all jobbing necessary to carry out the works; and to leave all in a perfect state of completion, to the full satisfaction of the architect or the clerk of works. To set in brick-work, where required, all parts of the steam-engine and boiler-house, and the steam-boiler chimney, according to the plans specially provided for this department by the engineer. To set foundation, &c., where required, for all machines, as directed by the engineer.

740. *Mason.*—Provide and fix to the windows throughout stone sills, weathered and throated, 4 inches deep on face, $4\frac{1}{2}$ inches on back, $8\frac{1}{2}$ inches wide, and 4 inches longer than the width of window-opening. Provide and fix to each door two stone blocks, width of thickness of brick-work, and 6 inches deep, and to mortise the same for the leading of iron bends to receive doors; also to each door a stone block with mortise-hole to receive fastening of door. Provide and fix to all the doors of all apartments named stone sills, 9 inches by 3, with mortise-holes to receive door-posts. Provide and fix coping to all the walls of courtyards, and jambs to gates of the same. Provide coping for steam-engine chimney-shaft, and all stone-work required by the engineer for the fitting up of the machinery department, according to drawings and directions furnished by the same. Provide and fix stone blocks to the number required, as shown in the drawings, to fix stall-posts in stable, travise-posts in cow-house, and pillars of shelter-sheds in courtyards, each block to be 9 inches square and 6 inches deep, and properly mortised and chamfered at top. Provide and fix curb-stones between stall divisions of stable and cow-house, with groove on upper surface to receive travis-boards. Provide and fix stone blocks 12 inches square and 9 inches deep; cut on upper surface to receive gratings and stench-traps. (Where the byres are to be fitted up with stone travises.)—Provide and fix stone travises to cow-byre, 6 feet long, 4 feet wide, and 3 inches thick; to be 12 inches sunk below the floors. The angles to be rounded off, to prevent injury to the cattle. Pavement to be provided for all apartments named (here name apartments), to be faced and jointed, and tool-dressed on upper surface, and laid in sand with cemented joints. (Where a horse-wheel is used as the motive power).—To provide for horse-wheel-house lintels with a 12-inch hold on the walls, also two stones 14 inches square and 9 inches thick, to place centre-beam upon; each stone to have $1\frac{1}{2}$ -inch bolt-hole in centre (see mode of fixing beam in Section treating of iron and woodwork combined). To provide and fix feeding-bench bottoms 3 inches thick, with holes cut along the front-edge, at intervals of 6 feet, to receive posts to retain wood front. To provide and fix in apartments named (here name them) causeway of small stone boulders laid in sand. To provide and fix man-hole-door pavements and covers to liquid-manure tanks; the latter to have a 4-inch hole cut to receive barrel of pump. To cut all holes and notchings, and to provide all cramps, lead, cement, &c.; to attend smith, and to clean down all stone-work at finish, to the complete satisfaction of the architect or clerk of works.

741. *Carpenter and Joiner.*—The whole of the timber to be used to be of good (here name the quality or qualities to be used)—all of approved quality, well seasoned, free from all sap, shakes, large or unsound knots; all to be cut die-square, and true to the several dimensions shown on the drawings, and herein

described. None of the timber to be set more than 14 inches apart, and to have bearings not less than 6 inches on the wall.

742. Provide and fix all necessary centring, and turning-pieces, stops, fillets, backings, blocks, firings, &c., and all other articles necessary to the perfect and efficient completion of the various works described under the various heads of bricklayer, mason, carpenter, joiner, slater, and plumber. The centring to be eased, and finally struck when directed by the architect.

743. Provide all necessary wood-bricks, with every required preparation for firing grounds, battens, and joinery.

744. Provide and fix good and sound lintels of timber over all doors, windows, and openings generally. The lintels to have a vertical depth of 1 inch for each foot of opening, and to have a bearing on the walls at each end of not less than 9 inches. The beam over cart-shed posts to be in one length, 12 inches by 8, and to have a bearing on wall of 12 inches at each end.

745. The flooring-joists, in apartments where boarded floors are required, to be 5 inches by $2\frac{1}{2}$, laid on cross sleeper-walls, carried up from footings. The joists of granaries over cart-sheds and barn to be 9 inches by 3, placed 14 inches apart from centre to centre. Trimmer-joists for thrashing-mill machinery to be 12 inches by 6. Flooring to be inch red pine, properly tongued and grooved.—(See Section on Floors.)

746. The roofs to be turned as shown in drawings, and of the following scantlings.—(See Section on Roofs for scantlings of various dimensions.)

747. Form hatches as shown in upper barn-floor. Staircases to have 9-inch treads, and $7\frac{1}{2}$ -inch risers, formed of inch red pine, with inch square balusters, and deal handrail. The partitions to chaff-room, &c., to be made as directed.—(See Section on Partitions.)

748. The stable travises to be fitted up as shown in drawings, with heel-posts 6 inches by 6, with runner at top, 6 inches by 3. The heel-posts to be chamfered at corners, and let in to the stone blocks at least 2 inches. Travis or division boards to be 2 inches thick, tongued, or grooved, or dowelled; the upper board to be finished on edge with $\frac{3}{8}$ -inch hoop-iron, screwed on with countersunk screw-nails. To provide racks, mangers, &c., as described.—(See Section on Wood Fittings of the Farm-Steading.)

749. To provide and fix doors and windows as described.—(See Wood Fittings of the Farm-Steading.)

750. *Slater*.—All the roofs to be covered with duchess slates, laid on battens, with proper lap, and secured with two copper or galvanised iron nails to each slate. The whole to be left perfectly water-tight at completion.

751. *Plumber*.—Cover the ridge and hips with 5-lb. lead, secured with lead-headed nails. Flashings to be of 5-lb. lead. Cast-iron spouting and down-pipes leading to drains, carrying rain-water to horse-pond, or rain-water tank for dairy purposes, to be provided to all the roof. Ventilators of zinc to be provided and fixed in roof of stable and cow-byres where directed.

752. *Plasterer*.—To plaster with lime-and-hair plaster the walls of granary; and provide a solid skirting of cement, 9 inches deep all round, to prevent entrance of rats. Walls of riding-horse stable and of harness-room to be plastered.

753. *Smith*.—To provide boilers to boiling-house, and all locks, hinges, staples, &c.

754. *Painter*.—To give three coats of good colour to all outside work, and to inside work where directed.

755. *Glazier*.—To provide and fix to all windows, as directed, squares of the best glass. The whole to be left clean on completion.

756. *Specifications adapted to a Farmhouse of Brick*.—The following are specifications of the various works to be executed in erecting a farmhouse of brick of the first class.

757. *Excavator*.—Dig out the ground where necessary for the several walls, cellars, drains, cisterns, &c., as shown in plans, and fill in and well-ram the same as the different works are brought up. Cart away all superfluous earth, and deposit it upon any portion of the ground as may be directed from time to time. The whole of the surface earth (if suitable) to be reserved, and afterwards spread uniformly and evenly over garden.

758. All water that may rise from springs, rain, or other cause, must be pumped out or baled as soon as discovered. The *concrete* under all walls to be in no part less than 1 foot thick, and double the width of the lowest course of footings. The concrete to consist of perfectly clean gravel, with a proper proportion of large and small stones (none of these, however, to be larger than will pass through a ring $1\frac{1}{2}$ inch in diameter), and fresh-burnt grey-stone lime, in the proportion of five parts of gravel and stones to one of lime. The whole to be thoroughly incorporated in a dry state; the water to be added by degrees, and not at once.

759. The concrete thus made to be lifted from the highest possible point into the trenches.

760. *Bricklayer*.—The whole of the *bricks* used throughout the building to be of the best description of *grey stock-bricks*, sound, hard, and well burnt; no *pluce* or soft unsound bricks to be used in any part of the building. The *mortar* to consist of *grey-stone lime*, and clean, sharp, screened *river sand*, free from all impurities, in the proportion of three parts of sand to one of lime. The lime and sand to be well mixed together, in the first place, in the dry state, and afterwards passed through a pug-mill two or three times, in order that the ingredients may be thoroughly incorporated.

761. The *walls* are to be built in regular courses, *Flemish bond*, and of the different lengths and thicknesses shown upon the drawings. No four of the courses to exceed 13 inches in height. The whole to be carried up in a regular manner. The mortar used throughout to be of such consistency that the workmen may be able to flush up each joint full and sound, course by course. No tothing to connect the walls to be left; but the walls are to be racked back and properly bonded. The *footings* are to be in three courses; the bottom one must be twice the thickness of the wall to be built over it. The bricks to be used in the construction of the footings to be selected from the hardest and best burnt; no unsound bricks to be used in any case.

762. The *window splays* to be neatly cut, and all *quoins* accurately formed; the walls on top floor to be splayed back to receive the timber of roof. All *putty holes* to be filled in; and if, after the completion of the works, any efflorescence be discovered, the defective bricks displaying such efflorescence to be removed and sound bricks substituted.

763. Form all projections for *strings*, *plinths*, and *cement runnings*, and securely tie in the same; bring out all *corbellings* for fireplaces, and *bearings of timber*; properly bed and secure all *lintels*, *wall-plates*, and *templates*.

764. Turn 9-inch arches over all *lintels* and openings, in $\frac{1}{2}$ -inch rings, with joints properly broken. Turn 9-inch arches in cement over cellars and cisterns, and fill in spandrils with hard dry rubble. Properly form, cover, and

carefully parget all flues; the sizes of the same to be not less than 14 inches by 9, all of one uniform size. $4\frac{1}{2}$ -inch arches to be turned to all fireplaces, and trimmer arches to all hearth-stones, except those in basement floor. Fix boiler and furnace in scullery with all necessary fire-bricks, the external face to be carried up with hard sound bricks neatly pointed. Fix all grates throughout the house, finding and setting in loam all necessary lumps and fire-bricks. Provide and lay from water-closet 6-inch glazed stoneware drain-pipes, properly jointed in cement and well puddled in clay bed. The fall throughout length of pipes to be 2 inches in every 10 feet. The termination to be securely connected with liquid-manure tank. The remainder of the drain-pipes employed to be of 4 inches diameter. All necessary bends, junction, syphons, &c., to be provided and properly fixed and laid. The cellar to be paved with hard dry bricks laid in mortar, on a properly prepared bed of hard dry rubble.

765. *Mason*.—All stone used throughout the building to be of the best description of its kind, sound, and free from all sand-holes, vents, veins, or other defects. The steps leading to cellar to be of tooled York stone, 2 inches thick, set on brick risers and properly bedded in mortar. The steps to front entrance to be of Portland stone, 11 inches in the tread, 7-inch risers, with moulded risings, and properly weathered. Tooled Yorkshire stone steps to be placed at back-door leading from milk-house and cheese-room to garden, with 10-inch treads and 7-inch risers. The kitchen, scullery, larder, milk-house, and cheese-room, to be laid with Yorkshire stone paving, tooled on one face, and properly jointed and bedded in mortar; no stone to be less than 9 feet in superficies.

766. 2-inch rubbed Portland stone hearth-slabs to be laid in drawing-room and parlour and dining-room fireplaces, of the requisite length and width. Tooled slabs and inner hearths to be provided to kitchen and bedrooms, firmly bedded in mortar. Provide and fix in scullery a York stone sink, 4 feet long, 1 foot 6 inches wide, and 6 inches deep, with hole cut at one corner for bell-trap. The larder and milk-house to have 1-inch tooled slate shelves, supported on iron brackets.

767. A Portland stone chimney-piece to be provided and fixed in kitchen, with 12-inch jambs and mantel, and 9-inch shelf. The chimney-piece in drawing-room to be of marble—say of the value of £8; that in the parlour or dining-room of enamelled slate—say of the value of £3. The chimney-pieces in bedrooms to be of Portland stone, with 7-inch jambs, and moulded trusses and plinths. Yorkshire stone sills, rebated, weathered, and throated, to be placed to all window openings, 12 inches wide, $4\frac{1}{2}$ inches thick at heel edge, and 3 inches at nose; the whole to be firmly bedded in mortar. Provide and fix a York stone barb, with hole cut in centre to receive coal-plate or grid.

768. *Carpenter and Joiner*.—The timber (except where otherwise particularly specified) is to be of red pine, of the best quality, free from sap, shakes, large or dead knots, and all other defects.

769. All joists or other timbers bearing on the walls are to rest upon plates 4 by 3, with templates 2 feet 6 inches long where necessary, the plates to be in long lengths, halved together, with an overlap of 12 inches, and securely nailed.

770. Lintels to all door-ways and windows 4 inches thick at least, and bearing 9 inches on each quoin.

771. The joists of ground floor are to be 6 by 2 inches, laid on sleepers 4 by 3 inches, those of upper floor 9 by 2 inches, except to cheese-room, which are to be 11 by 2 inches. The whole to be securely nailed to the plates, and strengthened with cross-braced strainers, one row to each room on chamber floor.

772. The joists are to be trimmed round the fireplaces and stairs; the trimmers and trimming-joists to have an extra thickness of 1 inch.

773. The joists, generally, rafters, &c., are not to be placed more than 12 inches apart.

774. The bedrooms, passage, and nursery are to be floored with best 1-inch spruce prepared boards 7 inches wide.

775. The dining and drawing rooms, office, store-room, and water-closet, to be floored with $1\frac{1}{4}$ -inch prepared red floors, $5\frac{1}{2}$ inches wide.

776. The cheese-room to be laid with $1\frac{1}{2}$ -inch rough spruce flooring. The whole to be straight jointed and well nailed.

777. The sashes throughout, where practicable, are to be double hung; they are to be 2 inches astragal and hollow, well dowelled and mitred, hung in proper boxed frames, with mullions and transom, behind freestone ditto, with pitchpine sills rebated to lie on freestone sill, brass-faced axle-pulleys, patent lines, and iron weights complete.

778. Angle-staves to be put to all external angles on the several floors.

779. The door-frames are to be properly built into the walls, with horns and side arms, and secured to stone plinths by iron strap tenons.

780. *Ground Floor.*—The inside doors to offices to be $1\frac{1}{4}$ inch thick, square framed, six panelled (7 feet by 3) hung by $3\frac{1}{2}$ -inch butts to $1\frac{3}{8}$ -inch rebated and rounded recesses, grooved to receive plastering.

781. The external door at back to be 2-inch bead and flush, 7 feet by 3, hung by 4-inch butts and screws to 4 by 3 inch red deal rebated and beaded frame.

782. The doors to sitting-rooms and office to be $1\frac{5}{8}$ -inch thick (7 feet by 3), in six panels, double-worked, moulded, and filleted, hung to $1\frac{3}{8}$ -inch rebated jamb-linings by $3\frac{1}{2}$ -inch butts and screws, with 7-inch double-sunk architraves and grounds.

783. 2-inch moulded glazed screen in entrance-hall, to correspond with best doors.

784. Provide and fix to the doors of offices 7-inch three-bolt iron rim-locks—to the back-door approved spring-latch and two 12-inch bolts. The sitting-room and office doors and screen to have best mortise-locks, and plain china furniture.

785. The front entrance-door to be $2\frac{1}{2}$ inches thick, moulded and raised outside, and bead and flush inside, hung by 4-inch butts, to 4 by 3 inch rebated and beaded frame, with transom curved head, as shown on elevation, and 2-inch fanlight. To provide and fix to this door Chubb's patent latch, and two 12-inch bolts.

786. The dresser in kitchen to have $1\frac{1}{2}$ -inch rounded and sunk top, and bearers, with $1\frac{1}{8}$ -inch deal cupboard and $\frac{7}{8}$ -inch drawer fronts, the drawers to have $\frac{3}{8}$ -inch dovetailed rims and bottoms. No. 3, $\frac{7}{8}$ -inch shelves, small cornice, turned uprights, &c., complete.

787. Double pinned cover, and handle to boiler with elm curb.

788. The windows of sitting-rooms and office to have $1\frac{3}{8}$ -inch moulded, square framed, panelled shutters, with $\frac{7}{8}$ -inch square framed back-flaps, and $1\frac{1}{8}$ -inch framed soffits, plain $\frac{3}{4}$ -inch back linings, $1\frac{1}{4}$ -inch framed, and moulded backs and elbows, with beaded capping, and 7-inch architraves to match doors.

789. $1\frac{1}{4}$ -inch square framed shutters to offices, with square framed back-flaps, soffit, &c., and $\frac{7}{8}$ -inch rounded window-boards on proper bearers.

790. Hang the shutters with 3-inch butts, and the back-flaps with $1\frac{1}{2}$ -inch back-flap hinges.

791. $1\frac{1}{2}$ -inch moulded steps and 1-inch tongued risers of red deal to stair-cases, with two rows of 5 by 3 inch carriages. Principal stairs to have $1\frac{1}{4}$ -inch moulded steps and risers, housed into $1\frac{1}{4}$ -inch. Sunk and moulded outer storey, 12 inches wide, deal chamfered balusters 2 by 1 inch, moulded oak hand-rail, 4 by 3 inches, chamfered newel, 5 by 5 inches, with raised lozenge and trenail, and raking moulded skirting complete.

792. The water-closets to be fitted up with 1-inch moulded mahogany seat and riser, with back and returns, 18 inches high, and $2\frac{1}{2}$ -inch moulded capping, $\frac{7}{8}$ -inch clean white deal under seat, paper box, flush ring, and brass hinges complete, $1\frac{1}{2}$ -inch deal cistern, over upper water-closet, 3 by 2 feet 6 inches, and 2 feet deep, on 5 by 3 inch bearers, $\frac{1}{2}$ -inch beaded pipe-casing where necessary.

793. The flat over water-closets and brick door to be covered with 1-inch rough boarding, on 4 by 2 inch bearers, to receive zinc.

794. Form the "lift" to cheese-room in position shown in drawing, with 3 by 2 inch framing, cased with $\frac{3}{4}$ -inch wrought and beaded boarding, and provide all necessary guide pieces, lines, weights, hooks, &c., complete. Provide and fix 100 feet, run 1-inch shelves, 12 inches wide, and bearers to store-room and linen-closet.

795. *Chamber Floor.*—The doors are to be $1\frac{1}{2}$ -inch thick (7 by 3 feet), double worked in six panels, hung to $1\frac{3}{8}$ -inch rebated jamb linings, by $3\frac{1}{4}$ -inch butts and screws, with 6-inch double sunk architraves and grounds; 6-inch rim-locks to these doors.

796. The partitions on false bearings to be 4 by 2 inches, trussed with head 4 by 4 inches, and sill 5 by 4 inches, and filled in with quarters, not exceeding 12 inches apart.

797. Form a trap-door to gain access to roofs, with $\frac{7}{8}$ -inch beaded casing, hung with 2-inch butts and screws, and two 4-inch flush-bolts.

798. The window-sashes and frames to be as described for ground floor.

799. Window boards to be provided and fixed where required, and chamber windows to have 3-inch band moulding round same.

800. The skylight to be formed of the size shown on plan, with 8 by 4 inch curb, and to have 2-inch moulded lights, one compartment hinged, with pulley and line to open, $\frac{7}{8}$ -inch beaded casing to ditto.

801. The cheese-room to be fitted up with shelves and divisions, the uprights, back, and front, and cross bearer, to be 3 by 2 inches wrought and beaded. The shelves to be in two tiers $1\frac{1}{2}$ -inch thick, planed both sides, and with rounded edge.

802. The roofs are to be framed, and with timbers of the following dimensions, of Memel or Riga timber, well seasoned, and free from all defects :—

Tie-beams, . 7 by 3 inches.	Rafters, . 4 by 2 inches.	Struts, . 4 by 3 inches.
Purlins, . 6 by 4 "	Ceiling joists, 3 by 2 "	Ridge, . 7 by $1\frac{1}{4}$ "
Hips and valleys, 8 by 2 "	Principals, . $5\frac{1}{2}$ by 3 "	Wall-plate, . 4 by 3 "

803. Provide and fix 1-inch deal gutter and valley boards on 3 by 2 inch bearers, with $\frac{5}{8}$ -inch side boards, 7 inches wide, laid with a current of 2 inches in 12 feet, and $1\frac{1}{2}$ inch drips.

804. *Tiler and Plasterer.*—The roofs are to be covered with dun-coloured plain tiles, having alternate courses laid ornamentally, to be secured to Baltic deal battens, 2 by 1 inch.

805. Ornamental creese to be put to the ridges, carefully set in cement.

806. The gables, and where else the roofs abutt against walls, are to have neat tile in cement filletting.

807. The ceilings, partitions, and soffits of stairs to be lathed with Baltic laths, once and a-half the usual thickness, each lath separately nailed and not lapping, and the bond broken every 18 inches, to be rendered and floated in good hair mortar, and set in fine stuff.

808. The walls of the whole of the rooms to be rendered and floated in hair mortar and set in fine stuff, except to offices, cheese-room, and milk-houses, which are to be plastered one coat in hair mortar, and set in fine stuff.

809. Plaster cornices, 12 inches girt with two enrichments, to be run round office, hall, and staircase. Ditto, 18 inches girt with 3 enrichments, to dining and drawing rooms, and 6-inch plain cornices to the whole of the bedrooms.

810. Enriched flowers, 3 feet in diameter, to the two principal rooms, with 4 corner flowers to the drawing-room, value 10s. each.

811. The three sitting-rooms, hall, and office, are to be skirted with moulded base and plinth, 15 inches high, executed in Keene's cement, the bedrooms and chamber floor throughout to have moulded skirting 9 inches high in same material, and all other floors to have chamfered cement skirting 6 inches high, in Portland cement.

812. The cement floors are described in mason's specification.

813. *Painter.*—The whole of the wood, iron, and other work usually painted, is to have four coats of good oil colour, properly knotted, stopped, and rubbed down between the coats. The shelves in cheese-room are not to be painted. The external wood-work to be grained, branched, and twice varnished, in imitation of oak in the best manner.

814. Clean off with fine sandpaper, and French polish the seats of water-closets and hand-rail of stairs.

815. *Plumber.*—The gutters and valleys are to be laid with the best milled lead, weighing 6 pounds per foot superficial, not less than 8 inches in the narrowest part, turning 8 inches up the rafters, with drips and cesspools where necessary, and flashings of lead, 5 pounds to the foot. Similar flashings, 12 inches wide, to chimney-stacks and round skylight, also where roofs abut against walls, forming concealed gutters under tiles.

816. Line the cistern over water-closet with 6-pound lead, properly soldered and rounded at the angles.

817. The water-closets to be fitted up with the best apparatus, ivory handle, blue basin, copper pan, iron container, &c., complete, with $\frac{3}{4}$ -inch lead supply-pipe and service-box to the same, 4-inch soil-pipe, weighing 7 pounds per foot superficial, with lead eject shoe, and necessary bends from water-closets to drain.

818. Lay the flat over water-closet with zinc, 16 ounces to the foot superficial.

819. Provide and fix 5-inches semicircular eaves gutters, as shown on elevations, with clip stays turning over edge of shutes. Cast-iron down-pipes fixed with ring stays where required, having cast-iron cistern-heads and snow-boxes complete, and connected at foot with drain.

820. *Glazier.*—The sashes of main fronts are to be glazed with the best crown glass, securely fixed and made water-tight, that in the sitting-rooms being fluted; the remainder to be glazed with the best seconds crown glass, well bedded in putty and neatly back-puttied. The screen in hall and skylight to be glazed with ribbed glass. The whole of the glass to be cleaned down on completion, and all damages made good.

821. *Paperhanger.*—Prepare the walls, and provide and hang the dining and drawing rooms with paper of the value of 4s. per piece, the hall and office with ditto, value 2s. 6d. per piece; and the bedrooms, landing, passages, &c., with paper of the value of 1s. 6d. per piece. The hall to be twice varnished.

822. *Bellhanger*.—Hang the following bells, of the best bright metal and of different sounds, with pendulums—to have proper wires in concealed tubes, with all necessary cranks, &c., complete: front door, 1 bronzed handle, with bell in kitchen; back door, ditto; office, 1 lever, value 2s. 6d., with bell to kitchen; drawing-room, 2 levers, value 5s. each, with bell to ditto; dining-room, ditto; nursery and four bedrooms, 1 pull each, with bell to ditto. Provide and fix $1\frac{1}{2}$ -inch wrought and beaded bell-board for the above.

823. *Chimney-pieces* of the following values to be provided and fixed: bedrooms, £1 each; nursery, 15s.; kitchen, £2; drawing-room, £6; dining-room, £4; office, £2, 10s.

824. *Grates* of the following values to be provided and fixed: bedrooms and nursery, 10s. each; drawing-room, £4; dining-room, £3; office, £1, 10s.; kitchen-range, £8; a 20-gallon boiler to be fixed in scullery.

825. Where the house is to be built of *stone*, the specification will be as follows; all the portions relating to the carpenter, joiner, slater, &c., being the same as already given above:—

826. *Excavator*.—The ground is to be excavated to the extent and depth necessary for carrying the proposed plans into execution; the trenches for foundations and drains being made sufficiently wide for the mason to build therein, and afterwards properly filled in with dry screenings, well rammed, and levelled. The whole of the earth excavated, together with all rubble created by the building, is to be deposited on the ground where directed.

827. *Mason*.—The walls are to be built of the several depths, heights, and thicknesses, shown on the plans, such as are more than 9 inches thick are to be of stone, well bonded, true, and perpendicular, and those less are to be of brick. The walls are to be carried up in a regular manner, and made level every 4 feet in height.

828. The wall-stones are to be good, fluted, bedded, large size stones of the district, not being mountain limestone or lias; the external faces to be neatly polled, and laid in regular courses, to be pointed on completion with a narrow tuck joint of properly prepared pointing mortar.

829. The bricks are to be the best hard burnt Stocks.

830. The mortar is to be made from fresh slaked lime and well screened coal-ashes, properly mixed and tempered together, in the proportion of three bushels of lime to five of ashes or sand, mixed in a pug-mill, and no more made at one time than a day's consumption.

831. The foundation and cellar walls to be built of brown lime, to the level of plinth-course.

832. Lay a course of $\frac{1}{2}$ -inch slate slabs between two beds of cement, all round house, the whole width of walls at level of plinth-course.

833. Brick trimmer arches to be turned, to receive all slabs in front of fire-places, on boarded floors.

834. The said slabs are to be of planed slate, 2 inches thick, and 18 inches wider than the several openings, and projecting before the same 2 feet at least.

835. The flues are to be built of equal sizes throughout, not less than 12 by 9 inches, smoothly pargeted with cow-dung mortar. They must be properly cored after the building is completed, and left in a perfect state, free from every obstruction.

836. Stone or 9-inch brick arches are to be turned over all openings, whether with lintels or otherwise, through the whole thickness of the several walls, where the plan will admit of it.

837. The sills, jambs, heads, mullions, &c., of windows and doors, the coping to gables, string courses, corbels, tablings, and chimney-stalks, are to be executed in freestone from approved quarries, free from all defects, and laid in its natural bed, and to be cleaned off with a fine drag upon completion—to be cramped where necessary with galvanised wrought-iron cramps, run in with lead, and grooves for flashings to be made where required.

838. All plates, bond or other timbers, door-frames, window-frames, and blocks, to receive joiner's work, are to be properly bedded in the walls, at the levels required.

839. The grates, range, and boiler (of the values hereafter named), are to be provided and fixed with all necessary slips and coves. Also fix chimney-pieces as hereafter specified.

840. Put solid, benched, square-nosed, hard-stone steps, to front and back doors.

841. Erect in scullery, on solid stalk, a Yorkshire stone sink, of the size shown, and 6 inches deep, with 6 inches iron grating, and bell-trap, and properly trunked into drain.

842. Provide and fix approved glazed earthenware pipes 6 inches diameter from soil-pipes and sink, and 4 inches diameter from down-pipes, with all necessary bends, junctions, &c.; the whole well bedded in brown lime mortar, and the joints cemented.

843. The kitchen, scullery and larder, passage, milk-house, and pantry, to be paved with paving-stone, not less than 2½ inches thick, and no stone less than 3 feet superficial; the whole to be close-jointed, and well bedded in brown lime mortar.

844. The hall floor and entrance lobby, to be laid with 1½-inch Portland cement and rough sand, finished with Keene's cement ¼ inch thick, marked in squares with black dots at the intersections.

845. The larder and milk-house to have 1-inch tooled slate shelves, in position shown on plan, supported on iron brackets.

846. Provide and fix No. 6 cast-iron gratings, 12 by 4, for ventilation under floors, neatly let into plinth.

847. Build in copper where shown on plan, forming flue, and providing furnace-door and bars complete.

848. The following is a Schedule of Measurements, or Bills of Quantities, for a Farmhouse, of which we have given the specifications for stone:—

Yards.	Feet.	EXCAVATOR.	£	s.	d.
203		Cube excavating surface of ground and trenches, ramming and filling into ditto, and removing surplus earth,			
		Carried to summary,	£		
		MASON.			
732		Cube of rubble walling in random courses in mortar,	£		
	227	Run flues, cored and pargeted,			
	81	Superficial 18-inch discharging bricks,			
	34	" 4½-inch trimmer walls,			
	370	" ½-inch slate slabs, set in cement and bedded in walls,			
	108	" 2-inch planed slate-hearths and brick-hearths,			
671		" Polling and pointing walls with blue ash mortar,			
		Carry forward,	£		

Yards.	Feet.		Brought forward,	£
140		Superficial Hardstone paving, 1½ inch thick, Building stack for sink in scullery, do. for copper or boiler, and setting same, with all necessary fire- bricks, burrs, &c.,	.	.
21		Run 12 by 6 inches solid square-nosed stepping, well bedded, No. 1 solid sunk Yorkshire sink, 4 feet by 2, 8 inches thick, with "Bell-trap," grating, &c., complete,	.	.
70		Run 6-inch glazed earthenware pipe and joints cemented, and includ- ing digging of trench for same, and well puddling with clay,	.	.
170		" 4-inch do. do. do., No. 3, 4-inch bends, No. 5, 4-inch junction,	.	.
84		Superficial 1-inch tooled slate shelves, No. 6 cast-iron gratings, let into plinth course for ventilation of timbers, No. 2 scrapers, let into stone-work and run with lead, one at front and one at back entrance,	.	.
1081		Cube freestone, from approved quarry, free from all defects, includ- ing sunk and splayed labour thereon as to windows, &c., and with proper beds and joints,	.	.
399		" Do. do. including moulded labour thereon, as to strings, courses, chimney, &c., as per detail drawings, and with proper beds and joints, Extra to turning two finials, Setting No. 9 chimney-pieces, " No. 8 grates, and one range, Finding all necessary slips, cover, and fire-bricks, &c., to the same,	.	.
			Carried to summary,	£

Squares.	Feet.			£
			CARPENTER AND JOINER.	
332		Cube fir in lintels, wall-plates, and joists,	.	.
237		" Fir framed in roof,	.	.
27½		Superficial labour and nails to roof, " Quarter partitions,	.	.
70		Run herring-bone strainers,	.	.
7		Superficial 1½-inch red flooring, well nailed,	.	.
5		" 1½-inch spruce flooring, rough,	.	.
13		" 1-inch prepared do. do.,	.	.
63		" 1-inch rough boarding to trough gutter,	.	.
168		" ½-inch valley boards,	.	.
871		" 2-inch astragal and hollow sashes in deal-cased frames, with pitchpine sills, brass-faced axle-pulleys, patent lines, and iron weights, complete,	.	.
224		" 1½-inch square-framed, moulded, and chamfered shutter- fronts, and ¾-inch square-framed back-flaps,	.	.
245		" 1½-inch square-framed shutters,	.	.
82		" 1½-inch do. do. chamfered and moulded backs and elbows,	.	.
34½		" 1½-inch framed, chamfered, and splayed soffits,	.	.
101½		" ¾-inch plain back-linings,	.	.
61½		" 1-inch rounded window-boards and bearers,	.	.
476		Run 3-inch band mouldings,	.	.
328		" 6-inch double-sash moulded architraves and grounds,	.	.
288		" ¾-inch angle bead,	.	.
170		" 4 by 3 inches solid, rebated, and beaded door-frames,	.	.
238		" 1½-inch double, rebated, and beaded jamb-linings,	.	.
26		" 2½-inch moulded outside, and bead-flush inside front door, with transom and fanlight over,	.	.
22½		Superficial 2-inch framed, ledged, and beaded door,	.	.
105		" 1½-inch 6-panel double-worked, moulded, and filleted doors,	.	.
189		" 1½-inch 4-panel square-framed doors,	.	.
210		" 1½-inch 4-panel moulded do. do., No. 1 Beaded bell-board, 6 by 9 inches,	.	.
			Carry forward,	£

SCHEDULE OF MEASUREMENTS.

189

Squares. Feet.		Brought forward, £
	No. 1 Dresser in kitchen, 8 feet long, with 1½-inch rounded sunk top, with 1½-inch deal cupboard front; and ¾-inch chamfered fronts, with ¾-inch dovetailed runs and bottom,	
	No. 3 ¾-inch shelves, small cornice, and turned uprights, &c., complete,	
	No. 1 Vent to copper,	
	No. 1 Double cover to do.,	
77	Superficial 2-inch moulded glazed screen, to correspond with best doors,	
35	1-inch risers to stair, housed into wall-strings,	
60	Moulded deal treads, housed to strings,	
28	1½-inch boldly moulded, sunk, and beaded into string,	
20	1½-inch beaded inner string,	
53	Run chamfered bar balusters, 2 by 1 inch,	
19	Gothic moulded mahogany hand-rail, 5 by 3 inches,	
16	6 by 6 inches moulded, chamfered, stopped, and newels, with raised lozenge, and ornamental caps and pendants,	
20	1½-inch deal string-board,	
56	1-inch deal steps and risers, with rounded nosing, housed into string,	
	Fitting up two water-closets, with 1-inch mahogany seat and riser, clamped flap, and beaded frame, with backs and returns, 18 inches high; ¾-inch clean deal white underseat, paper box, flush ring, and hinges complete,	
	No. 2 small cistern over ditto, 3 feet by 2 feet 6 inches, 2 feet deep,	
16	Run 1½-inch framed and ledged trap-door to roof,	
28	¾-inch beaded boxing,	
37½	2-inch moulded skylight,	
320	3 by 2 inch moulded and beaded standards, and cross-ties to cheese-room,	
126	Superficial 1½-inch shelves, wrought both sides, shelves with rounded edges,	
84	1-inch shelves, on proper bearers, to linen-room,	
	Constructing "lift," as shown in plan in cheese-room, with 3 by 2 inch studding, ¾ inch beaded and matched,	
	Casing, with lines, guides, and counterbalancing weights, complete,	

Carried to Summary, £

IRONMONGER.

	No. 8 Cast-iron buckets, 2 feet long,	£
	6 inches deep tailing, 9 inches into wall, with caulking at end,	
	2 pairs 4-inch butts,	
23	pairs 3-inch do.,	
18	2½-inch do.,	
28	back-flaps,	
	2 shutter-bars, 6 feet long,	
10	4½ feet long,	
8	3 feet long,	
56	sash-fasteners,	
	5 mortise-locks,	
15	rim-locks,	
2	patent latches,	
4	10-inch barrel-bolts,	
	1 chimney-bar of wrought-iron to kitchen, 10 feet by ¾ inch,	
	1 furnace-door, and bars to boiler,	
	2 door-scrapers,	

Carried to Summary, £

TILER AND PLASTERER.

27½	Dun-colour plain tiles, on 2 by 1 inch batting,	£
144	Run batting to valleys,	
147	creese set in cement,	
404	Superficial lath plaster, float and set ceilings,	
768	binder float and set walls,	

Carry forward, £

	Brought forward,	£
No. 1 bell in dining-room, with two levers or "pulls,"	.	
No. 1 do. library, and No. 1 lever,	.	
No. 5 do. bedrooms, and No. 5 pulls,	.	
	Carried to Summary,	£

SUMMARY.

EXCAVATOR,	£
MASON,	
CARPENTER AND JOINER,	
IRONMONGER,	
TILER AND PLASTERER,	
PLUMBER AND SMITH,	
GLAZIER,	
PAINTER,	
Chimney-pieces,	
Grates,	
BELLHANGER,	
				Estimate,	£

849. *Specifications adapted to a Farmhouse of Stone.*—The following are specifications adapted to a farmhouse built of stone, after the Scotch building customs; the last specification in brick given being adapted to English customs:—

850. *Mason Work : Digging.*—The tracks for the foundations of walls to be dug at least 15 inches below the present surface of the ground or deeper if necessary to obtain a good foundation.

851. *Building.*—The walls to be founded with large flat bedded stones, at least 6 inches thick, and brought up to the thickness shown in the drawings. The whole of the walls to be of good common rubble work, the stones to be well dressed, bedded, and bonded, and laid on their flat; to be well bedded, jointed, packed, and pointed with good lime mortar.

852. *Mortar.*—The mortar to consist of lime, mixed with a due proportion of clean sharp pit or fresh-water sand, to be well mixed together.

853. All the corners, door and window rebates, to have 4-inch droved margins, and to be neatly pick-dressed in the tail; rebates to have droved breasts and cheeks to the necessary depths. Sills of windows to project 1½ inch over face of wall. Corners and rebates to be 2 feet in length, 8 inches in thickness, and not less than 11 inches in height or more than 13.

854. Kitchen jambs to be 4 feet in height, and set 4 feet 6 inches apart. Parlour and dining-room jambs to be 3 feet 2 inches in height, and set 3 feet 2 inches apart. All the bedroom jams to be 3 feet in height, and set 2 feet 9 inches apart. All the vents to be regularly taken into the dimensions before mentioned, as no quick bends or turns will be allowed. A brick arch to be over each jamb lintel, and under each hearth-stone in upper flat. Chimney-heads to be formed of droved ashlar, having a base course and projecting cope. The brigs to be of brick on bed, and to be ragleted into the chimney-head; ashlar on both sides, at least 2 inches. Chimney-head cope to be firmly battled together with iron batts run in with lead.

855. All the vents must be properly swept after the chimney-heads are finished, so as all the lime that may have collected in them during the progress of the work may be dislodged.

856. Jambs to be set 3 feet 2 inches apart, and not less than 3 feet 2 inches in height. Door and window sills, and lintels, and chimney-head cope to be of

stone and to be droved. Chimneys to be carried up as aforesaid, and to have droved hearths of Glammiss or Forfar pavement. Kitchen to have a faced hearth. Dining-room, parlour, and bedrooms to have polished hearths, and all to be of such a length as cover in the jambs and mantel-pieces, and of such a breadth as be 1 foot 10 inches beyond the finished wall, having back hearths the necessary breadths.

857. Floor of porch and door flat to be of polished pavement. Dairy passage, kitchen, and scullery to be laid with faced and jointed pavement, laid in sand and jointed with cement.

858. *Carpenter and Joiner Work*.—All the doors, windows, and other openings to have safe lintels, to be 1 inch in thickness for every foot of span, and to fit close to the back of stone lintels, having 9 inches of wall hold at each end.

859. *Bond Timber*.—Bond timber to be provided for all the stone walls in house, except store-room and kitchen-range. Bond timber to be 4 inches by $1\frac{1}{4}$, placed not more than 22 inches apart from centres, and all the height to suit the foot base. Wall-plates for sleepers to be 6 inches by 1, for joists 8 inches by 1, and for couples 6 inches by $1\frac{1}{4}$.

860. *Joists and Sleepers*.—Sleepers to be $6\frac{1}{2}$ inches by $2\frac{1}{2}$, joists to be $10\frac{1}{2}$ inches by $2\frac{1}{4}$, and to be properly bridled for the stair. Kitchen-range joists to be 8 inches by $2\frac{1}{4}$, placed not more than 18 inches apart from centres, and all to be clad with $1\frac{1}{2}$ inch white wood, ploughed and tongued flooring, well nailed down, all by wood to be dressed off.

861. *Deafening*.—All the upper flat to be deafened with billet wood, resting on fillets $1\frac{1}{2}$ inch by 1, and to have two rows of cross dwangs properly keyed up the whole length of the house.

862. *Roofing*.—The couples to be made of scantlings, to the sizes marked on section, and to be properly checked to fit the wall-plates, and well nailed together with long wrought-iron nails, and set not more than 18 inches apart from centres (to be dressed and set as shown in west elevation); all the projections to be clad with flooring, laid with the dressed side down. The couples to be clad with $\frac{5}{8}$ -inch sarking, not more than 9 inches in breadth. Each sarking board to have three nails in each couple, all to be close jointed in ends and edges. Ridge battens to be $1\frac{1}{2}$ feet diameter, supported on iron spikes every 3 feet. Fillets to be put on for the slates where necessary.

863. *Partitions*.—The house to be divided as shown in the plan. The partitions coloured yellow are to be formed of standards $3\frac{1}{2}$ inches by 2, placed 15 inches apart from centres, having runners the same dimensions at top and bottom. Warpings are to be provided for brick partitions, to be placed not more than 2 feet 6 inches apart, and at the height of the foot base, and to be nailed to the door-posts. Door-posts to be 5 inches by $2\frac{1}{4}$, to go to the ceiling.

864. *Strapping*.—All the stone walls in house to be strapped, except store-room and kitchen-range. Straps to be $1\frac{1}{2}$ inch by $\frac{3}{4}$, placed not more than 15 inches apart from centres.

865. *Stairs*.—Main stair to have $1\frac{1}{2}$ -inch treads and 1-inch breasts—treads to project over breasts, and ends forming a bottle and fillet. Width of stair when finished to be 3 feet 10 inches. Stair to have ornamented cast-iron balusters, and a solid mahogany hand-rail. Kitchen to have a common stair, with treads and risers.

866. *Lathing*.—All the strapped walls, wood partitions, back of main stair, ceiling and servants' beds, window-soffits and ingoes, to be lathed with the best Baltic split-lath; not to be more than $1\frac{1}{2}$ inch in breadth, or less than 3-16ths in thickness, and fixed with cast-iron nails; the bond to be broken every two

feet on all the ceilings, and on both sides of the partitions; the lath all to meet in the ends, or to be overlapped; two beds to be fitted up in servants' bedroom, with standards to go to the ceiling, all to be complete.

867. *Windows.*—The window-sashes to be framed 2 inches thick, having $\frac{5}{8}$ astragals, to be hung in cases made of $1\frac{1}{4}$ -inch wood; all the windows in main house to be double-hung, kitchen windows to be single-hung—all to be hung with bleached sash-cord line, having brass-faced axle-pulley boxes and metal weights, and all the necessary facings, beads, and batten-rods, sash-lifters, and counter check-fasteners; dairy and coal-house windows to be opening frames.

868. *Struts.*—Parlour and dining-room windows to have bound struts, breasts, elbows, and soffits, with raised planted mouldings; bedroom and other windows to have bound struts, breasts, elbows, and soffits, with sunk mouldings—all to have shutter-knobs, &c.; struts to be framed $1\frac{3}{8}$ inch, back folds, $\frac{7}{8}$; kitchen-range windows to have plain deal struts, with cross heads.

869. *Doors.*—Front-door to be margin style, framed, $2\frac{1}{4}$ inches thick, having raised planted mouldings outside—inside to be sunk; lobby-door to be framed, 2 inches thick, having raised planted mouldings on both sides—upper half to be glazed with plate glass; the doors in lobby of first floor to be framed $1\frac{3}{4}$ inch thick, having raised planted mouldings on both sides; the other doors to be framed, 12 inches thick, having sunk mouldings; kitchen outside door to be in two halves, framed, $1\frac{1}{4}$ inch thick, and clad with $\frac{3}{4}$ -inch bedded, ploughed, and tongued lining in narrow pieces; dairy and kitchen inside doors to be formed of $2\frac{1}{4}$ -inch beaded, ploughed, and tongued deals, with three cross bars on the back; kitchen outside door to have a stay-band, and all the necessary slip-bolts.

870. *Presses.*—Dining-room to have two presses, as shown; parlour to have one, the doors to be framed, $1\frac{1}{2}$ inch thick, having raised planted mouldings outside—inside to be sunk; bedroom press-doors to have sunk mouldings; all the presses to be lined with wood inside, and to have four heights of shelving as described.

871. *Shelving.*—One course of shelving to be fitted up all round dairy, supported on brackets, and forty feet of shelving to be fitted up in kitchen and scullery; dairy shelving to be 14 inches by $1\frac{1}{2}$; kitchen and scullery shelving to be 12 inches by 1.

872. *Water-closet.*—A water-closet to be fitted up as shown, having seat, and breast, and hinge-flap; the closet walls to be lined round with $\frac{5}{8}$ -inch lining, not less than 5 feet in height; cistern to be 3 feet by 2, by 2 within, made of $1\frac{1}{2}$ -inch wood.

873. *Foot-base.*—Dining-room, parlour, and lobby, to have a foot-base plate 9 inches, with a $1\frac{1}{2}$ -inch moulding on top; the other rooms and upper lobby to have a foot-base plate 6 inches by $\frac{3}{4}$, with a moulding on the top; kitchen-range and dairy to have skirting $4\frac{1}{2}$ inches by $\frac{5}{8}$, with a moulding on the top; skirting to be round all the floor and shelving in dairy, and all to be properly fixed to hooks driven into the walls.

874. *Architraves.*—All the doors and windows in main house to have architraves set on blocks; window architraves $6\frac{1}{2}$ inches, door architraves $5\frac{1}{2}$ inches; parlour and dining-room to be double-faced on both sides; the other doors to be single; kitchen and dairy range all to have facings $4\frac{1}{2}$ inches by $\frac{5}{8}$, with a moulding on both sides; corner beads to be put up where necessary.

875. *Mantelpieces.*—Dining-room and parlour to have marble-pattern mantelpieces; the other rooms to have jamb moulds, with frieze and shelf; kitchen to have a plain mantelpiece; closet in second flat to have 15 feet of shelving

fitted up, 15 inches by 1½, and one row of pegs fixed into a plate of wood on the opposite side.

876. *Glazing*.—All the windows to be primed with lead, mixed with linseed oil, glazed with the best crown glass, puttied and back puttied.

877. *Ironmongery*.—The front-door to be hung with 7-inch double-jointed edge hinges, having a 9-inch rim-lock of the best quality; the inside bound doors to be hung with 6-inch double-jointed edge hinges, and to have 7-inch rim-locks of the best quality; lobby-door to have a mortise-lock; parlour and dining-room doors to have 7-inch mortise-locks; kitchen outside door to be hung with double-jointed edge hinges, having a good stock-lock and strong thumb-latch and stay-band; the plain doors to have 12-inch cross-tailed hinges, and good pull-back locks, and strong thumb-latches; press-doors and window-struts to have suitable hinges, and all the presses to have locks; water-closet door to have a spring latch.

878. We conclude this department by giving specifications suitable to the different classes of Cottages we have illustrated.

879. *Specifications adapted to Single-Storeyed Detached Cottages of Brick*.—In single-storeyed detached cottages, built of brick, the following specifications will serve as an example:—

880. *Excavator*.—Dig out the ground for the several footings, drains, &c. Dig out the earth to the depth of 18 inches under the whole of the floors. Fill in and ram around foundations, and remove all superfluous rubbish.

881. *Bricklayer*.—The whole of the brick to be of the best hard burnt stocks laid in mortar. The mortar to be composed of one-third stone lime and two-thirds clean sharp river sand. The fronts to be finished with a neat rule joint. A course of slate, bedded in cement, to be laid round external walls at level of joists. All openings over fireplaces to be formed with counter-arches over the same. All the flues to be carried up, of diameter not less than 9 inches of circular, and 14 feet by 9 of rectangular. The interior of all flues to be properly cored and finished. All plates, lintels, wood-bricks, stone, or other work requiring to be set in the brick-work, to be well bedded in mortar, and pointed with hair-lime. All door and window frames to be mortared. Boiler in scullery, and all grates, to be properly set with fire-brick. Build dwarf walls, piers, &c., to receive sills of partitions and joists for floors. Build brick piers in scullery to support sink or slop-stone. 5-inch drain-pipes to be laid from sink in sculleries and water-closets in yard to liquid-manure tank in garden.

882. *Mason*.—Provide and fix to all chimney openings rubbed York mantel-pieces, jambs, shelves, tooled back hearths, and rubbed front hearths to same. Pave porches and sculleries with 1½-inch paving, or fire-bricks set on edge. Provide 3-inch step treads to all front-doors, with mortises for door-posts. Sculleries to be provided with a 6-inch York slop-stone or sink.

883. *Carpenter and Joiner*.—The whole of the timbers used to be of the best Memel, Riga, or Danzig fir, well seasoned, and free from knots, shakes, or other defects. The floors of living-rooms and bedrooms to be laid with 1-inch white deal flooring on joists 4 inches by 2, or oak sleepers 4 inches by 2. The partitions to have heads and sills 4 inches by 3, posts 4 inches by 4, quarters and braces 4 inches by 2. The roof to have ceiling joists 3 inches by 2, rafters 4 inches by 2, wall-plates 4 inches by 4. The whole of the floors to be laid with 1-inch white deal, straight jointed. The whole of the windows to be deal, solid, moulded, and rebated sashes, prepared to receive zinc casements, and to be fitted with 1½-inch deal bead butt shutters, hung with hinges, and

fastened with bow latch sash-fasteners complete. The external doors to be $1\frac{1}{4}$ -inch deal, four-panel, square framed, moulded on one side, and hung with $3\frac{1}{2}$ -inch butts to solid, rebated, and beaded frame. Back-doors (where used) to be fitted with a $1\frac{1}{2}$ -inch proper beaded and ledged door, hung to solid frame. External doors to have thumb-latches and barrel-bolts. The internal doors to rooms to be of $1\frac{1}{2}$ -inch deal, four panel, square framed, hung with 3-inch butts to $1\frac{1}{4}$ -inch wrought, rounded, and rebated linings, and to be fastened with rim-locks. Cupboards to be fitted to recesses at sides of fireplaces in living-rooms; to have $1\frac{1}{4}$ -inch deal beaded cupboard front, with $1\frac{1}{4}$ -inch four-panel square framed door, hung with $2\frac{1}{2}$ -inch butts, and fastened with turn-buckle fastener. Provide and fix round living-rooms a truss skirting, moulded 7 inches high, and round bedrooms a square skirting 6 inches high. The privy-seat and riser to have proper bearers, seat-hole cut and dished, with movable cover. The doors to all outhouses to be $1\frac{1}{4}$ -inch deal beaded and ledged, hung to $1\frac{1}{2}$ -inch linings. Doors to coal-stores and food-stores to be provided with locks.

884. *Plasterer*.—Render two coats, float, set, and white the walls and lath; float, set, and white the partitions throughout; and lath, plaster, and twice white the ceilings.

885. *Slater*.—The whole of the roof to be covered with countess slates (or tiles), laid to a proper gauge, on 3-inch battens, nailed with zinc nails.

886. *Plumber*.—The sinks in sculleries to have 3-inch iron waste-pipes, with grating and trap; and to have $\frac{3}{4}$ -inch service-pipe, with bib-cock, led from rain-water butt or cistern; the whole well secured with wall-hooks. The ridges to be covered with 5-lb. lead, 12 inches wide, well dressed down, and fastened to proper deal ridge-rolls. Valleys to be laid with 5-lb. lead, turned up at least 7 inches under slates on each side, and properly secured. Provide proper flashings of 5-lb. lead to chimney-shafts. Lead and labour to be found for fixing all stone and iron-work where required.

887. *Painter*.—All the wood-work required to be done to be painted four coats in good colour. Entrance-doors to be grained wainscoat, and varnished.

888. *Specifications for Detached Single-Storeyed Double Cottages of Brick*, The following specifications may be taken as an example:—

889. *Bricklayer*.—To excavate the ground for foundations to the depths and widths shown in the drawings, also for all drains, and all other digging and removal of earth is to be done as required. The ground beneath stone floors to be made hard and firm; and, after the foundations are laid, the earth to be filled in and around the same, and well rammed. The whole of the walls and partitions shown in plans are to be built of good hard burnt stock-bricks; the fronts of a bright and uniform colour, carried up regularly, and no four courses to rise more than $1\frac{1}{4}$ inch above the height of four courses laid dry. All work to be done in English bond, with the vertical joints neatly drawn, and pointed with dark mortar. The angle-groins and arches to doors and windows to be executed in red bricks; and the chimney-headings, eaves course, and along gable-ends, to be executed in the same set in angle, as shown in elevation. All the flues are to be carried up separately, and to be cored and pargeted. All the mortar used to be compounded of one-third part fresh burnt stone-lime and two-thirds clean sharp river sand. Provide and fix in entrance-door tooled York stone steps, 12 inches by 8. The windows to have freestone sills, 9 inches by 4, weathered and throated, and freestone keystone to window-arch, also to arch of doorway. The living-room and scullery to be paved with large Yorkshire tooled paving, well bedded in brown lime-mortar. Fix in scul-

lery solid sink on brick stack, with 4-inch trap trunked into drain. Provide and fix chamfered freestone chimney-pieces and shelves to all fireplaces, with 2-inch tooled hearthstones. The drain from sink to liquid-manure tank to be 4-inch earthenware, laid where directed, with bends and junctions wherever necessary.

890. *Carpenter and Joiner*.—The timber employed throughout to be good American or Baltic, free from all defects. The joists, rafters, and quarters in partitions to be placed not more than 13 inches apart from centre to centre. 3½-inch lintels to be provided for all doors and windows, bearing not less than 9 inches on each groin, the full thickness of the wall. Wood-bricks, 4 inches by 3, and 9 inches long, to be built into the walls at proper intervals to receive joiner's work. The roof to be framed according to section, the rafters being notched down upon the plates; and purlins and ceiling-joists to be notched up to the beam, and well nailed. The sleeping-room to have joists, 6 inches by 2, resting on oak sleepers, 4 inches by 3, and to be laid with 1-inch spruce flooring boards, 7 inches wide, and to have ⅝-inch truss skirting round room, 6 inches high. The front-door to be of red deal, 1½ inch thick, rebated, beaded, and ledged, hung with 18-inch hinges to 4 inches by 3 rebated and beaded frame, with ⅞-inch drawback-lock and two strong bolts. The internal doors to be ⅞-inch rebated, beaded, and ledged, hung to 1-inch plain jamb linings, with fillet, 2 inches by ½ inch, nailed to same, to form rebate, and to be hung with 3-inch butts, and to have 6-inch iron rim-locks. The windows to be 1½ inch thick, double-hung, with fir sills, iron pulleys, lines, weights, and fastenings complete; glazed with 16 oz. crown glass; to have ⅞-inch bead round sash-frame inside, to stop the plastering, and 1½-inch rounded window-board on proper bearers. Provide and fix to the front windows 1-inch beaded and ledged outside shutters, with 8-inch barrel-bolt to fasten the same, hung with parliament hinges. Fit up the closets, where shown, with three tier of 1-inch shelves, and the pantry with ditto, 9 inches wide, and 6 feet of meat-rail with turned hooks.

891. *Slater, Plasterer, and Painter*.—The roof to be covered with duchess slates on deal battens, 1½ inch by ¾ inch, secured with zinc nails. 5-lb. lead flashings to chimney-stacks, and cement verge to gable-ends. The ridge to be covered with ornamental creese, set in cement. The ceilings and partitions to be lathed with single laths, separately nailed and not lapping, and plastered one coat in good hair mortar, and set in fine stuff. The walls to be plastered two coats, finished in fine stuff. 4-inch cast-iron skirting to eaves, and 2½-inch iron drain-pipes and cistern-heads where necessary. Chamfered cement skirting, 7 inches high, to be run round living-room and passage. All the wood-work usually painted to have four coats of good oil-colour. Lancashire grate or oven in kitchen, sham register-grate in bedrooms.

892. *Specifications for Detached Two-Storeyed Cottages in Brick*.—For two-storeyed detached cottages built of brick, the following specifications will serve as an example:—

893. *Excavator*.—Dig out and cart away ground for the foundations, to the depth from ground-line as in the section; also for drains, liquid-manure tank, &c. The excavations for drains to be made with a sufficient fall to liquid-manure tank. To dig out the ground under front living-room and lobby for cellar, to the depth shown in section; also under floors of kitchen and scullery, to the depth of 1 foot below floors. Fill in and ram all the foundations and other walls, and cart away all superfluous earth and rubbish.

894. *Bricklayer*.—Carry up all the walls, external and party, 9 inches in

thickness, to the several heights shown in the section; the mortar to be well mixed and tempered together, in the proportion of 1 bushel of good stone-lime to 2 of good, clean, sharp river or other approved sand. The bricks to be of quality and kind as decided by the landlord, or easiest obtainable in the neighbourhood. Lay the whole of the brick-work in old English bond—the exterior to be worked fair, and finished with a flat-ruled joint; the interior to be left rough for plastering. Turn half-brick trimmer-arches to all the openings of fireplaces, and carefully carry up same at a proper angle. Make air-chamber at back of fireplaces in living-room and kitchen; make circular openings, 9 inches in diameter, communicating with same, above skirting in room, and close to fireplace jamb. Provide and lay in 4-inch drain-tube, glazed, communicating with the interior of air-chamber at back of fireplace and the external atmosphere. Provide, in like manner, a 2-inch pipe leading to cavity beneath hearthstone, to supply fireplace with air. Run up at back of fireplaces pipes to serve as “dust draughts;” or build in brickwork a 2-inch drain tube, communicating with ash-pit and chimney. Carry up 9-inch circular chimney-tubes for flues, or ventilating chimney-tubes. If the flues are preferred to be run up in the brick-work, they should be made oblong, with the corners rounded off. The chimney-bearer in all the fireplaces to be of wrought-iron. If ventilating chimney-tubes are *not* used, air-flues, 4 inches broad by width of flue, to be run up alongside of chimney-flues, opening below ceiling to communicate therewith. If circular tubes are used for the chimney-flues, provide and run up alongside of these 3-inch drain-tubes, properly jointed, to serve as ventilating tubes. If the air-siphon ventilation is used, provide a flat zinc pipe, 3 inches by 2½, and let same into brick-work in chimney-breast—one end communicating with the flue by a circular bend, the other with an aperture near ceiling. The same to be provided to the front and back bedrooms. The children’s bedrooms to have air-flues in wall leading to space between ceiling of bedrooms and external roof, formed of 3-inch drain-tube—the opening in room to be beneath the ceiling. The chimney-shafts to be set angularly, and carried up as in elevation and detail drawings, and to be finished externally with a neat trowel joint. Construct two liquid-manure tanks behind fence wall, at the points of the division wall of yards, with filtering divisions; size, 6 feet square by 6 feet deep (internal dimensions); face inside with 4-inch brickwork set in Roman cement, and done over with half-brick arch; provide man-hole, and cover same with stone slab, to be luted at the edges with clay to prevent escape of gas—or a rebated edge, 1 inch deep and 2 broad, may be cut round the man-hole, in which to lay slab cover. If preferred, the interior of tank to be formed of strong deal boarding lined with gutta-percha. Construct over privy and ash-pit to right and left hand corner houses, cisterns in 9-inch brick-work, external dimensions 9 feet by 5, and 4 feet deep, lined with slate slab, or glazed flat tiles, to hold rain water; or, if preferred, internally deal-boarded, and lined with gutta-percha. Construct above privies and ash-pits to *centre-houses*, a rain-water tank as above—external dimensions 9 feet by 9, and 4 feet deep. Provide and fix with proper fall 4-inch drain-tubes with *conical* joints, leading from sink in scullery and from privies to cesspools. Where bends or junctions are required, provide and lay *circular* ones. Provide a soil-pan with trap to privies, connected with tube leading to cesspool. All grates and ranges provided by the smith to be properly set and fixed. Bed in mortar all wood, bricks, bond-timbers, and point well with lime-and-hair mortar all door and window frames. Pave the privies with hard and well-burnt bricks set on edge in mortar laid on dry ashes or smiths’ cinders. Pave kitchen and scullery with

flat paving-tiles in mortar or dry ashes. Pave lobby with flat tiles parti-coloured, in simple pattern or lozenge shape.

895. *Mason*.—The whole of the stone-work in external walls, consisting of heads, jambs, and sills to doorways and windows, to be of the best (here describe *stone* most conveniently obtained in the neighbourhood), properly worked in beds, joints, and faces, and set with chamfered angles and stopped ends, as shown in the drawings. (If the lobby is preferred paved instead of flat-tiled as above, pave all entrance passages with 2-inch paving laid to a close joint on brick sleeper-walls, well stopped in composition.) Provide and fix 3-inch treads to doors, and properly mortise the same to receive the door-posts. Provide and fix rubbed stone-slabs and back hearths to all the fireplaces; the slabs to project 20 inches from the face of the chimney-breast. The fireplaces throughout to be fitted up with 1½-inch rubbed Portland jambs (or slate or other suitable material easily obtained in the neighbourhood); mantels and shelf with rounded corners, each 6 inches in width, well cramped and secured together. Cut in centre of hearthstone above cavity communicating with the air-flue to supply fireplace, an aperture, 4 inches by 2, with rebated edge to lay grating in; the inner edge to be not more than 3 inches from line of fireplace bars. Provide and fix in scullery a stone sink or slop-stone on brick bearers, of the size shown in plans, 6 inches in depth; and cut hole in same to receive waste-pipe (leading to drains) and trap. Provide a slab of stone, 2 inches in thickness and 2 feet square, to cover man-hole of liquid-manure tank. Provide and fix in cellar, close up to wall opposite window, a stone slab 4 feet by 2 feet, 2 inches thick, on which to place meat, milk, &c., to keep cool, on brick bearers 30 inches high. Cut all holes, &c., for iron and other works, where required.

896. *Carpenter*.—All the timber to be used to be good, sound, well-grown Baltic, Danzig, or Riga fir, well seasoned, and free from sap-shakes, or large and unsound knots, cut square and true to the several dimensions and lengths required; and no timbers to be fixed more than 12 inches apart, or to have a less bearing than clear 4 inches on the plates, &c. Provide a sufficiency of wood-bricks for joinery, to be inserted where required; also all centerings and turning-pieces for chimney openings. The quarter partitions throughout to consist of heads and sills 4 inches by 7; posts 4 inches by 4; door heads, quarters, and braces, 4 inches by 2, with the exception of the centre partition, which is to be as follows: heads and sills, 5 inches by 4, quarters and braces 5 inches by 3. The interstices to be filled in with brick-work in mortar. The joists in living-room ground-floor to be 7½ inches by 2½, 12 inches apart, having a clear bearing of 4 inches in walls. The whole of the joists in first or chamber floor to be 7½ inches by 1½; trimmers, 7½ inches by 2½; wall-plates, 4 inches by 2½. The joists on this floor, when truly fixed, to have (if desirable) a row of herring-bone strutting, and to be properly fixed underneath for lathing. The roof timbers to be 12 inches apart, and to consist of rafters 3½ inches by 2, ceiling joists 3 inches by 2, wall-plate 4 inches by 2½, ridge 6 inches by 2, valley rafters 7 inches by 2. Prepare the whole of the roofs for slates with 2½-inch by ¾-inch battens, well nailed to rafters. If zinc roofing is preferred, provide and nail to rafters single slabs to lay zinc plates on.

897. *Joiner*.—Lay the floors of living-room on ground floor, and of all the bedrooms, with 1-inch yellow Christiana deals, not more than 9 inches wide, with close joints, and well nailed, and bordered to slabs or hearthstone; the whole to finish clean up to the brick faces. Provide and fix ¾-inch skirting 6 inches high, with proper grounds to receive the same in all the rooms. The whole of the sashes to be 2½-inch deal, chamfer moulded and rebated to receive

casements; 1-inch deal rounded linings and window-board ploughed to receive plastering. The shutters in lower storey to be $1\frac{1}{4}$ -inch deal, bead, butt, and square, hung with hinges in two leaves, and folding back against wall on the inside, and fastened with bow-latch spring fastening complete. Provide and fix to all external doors a proper fir door-frame, mortised to heads of steps, and fitted with $1\frac{1}{2}$ -inch deal ledged door, hung with 3-inch butts, and to have two 1-inch rod bolts and iron rim drawback-lock and key. The inner doors to be $1\frac{1}{4}$ -inch deal, square-framed, hung with $2\frac{1}{2}$ -inch butts and rounded linings, with stop grooved for plastering, and to be fitted with a 6-inch iron rim-lock. Provide and fix in recess on side of fireplace in living-room nearest the window a tier of 1-inch deal shelves on proper bearers, for books, &c.; and at other recess, a small cupboard 30 inches high, with flat deal top moulded at edge. Provide and fix between chimney-breasts and walls in kitchen a small dresser with $1\frac{1}{2}$ -inch deal top, with sliders and runners for drawers, with 1-inch deal fronts, return beaded $\frac{5}{8}$ -inch deal rims and $\frac{1}{2}$ -inch bottoms. Provide and fix above this three tier of 1-inch deal shelves on proper bearers, with plate fillet attached; also a $\frac{3}{4}$ -inch deal pot-board and skirting complete. The drawers to be fitted with common black handles fixed with screws, and good drawer locks and keys. Provide and fix to closet on the other side of fireplace $1\frac{1}{4}$ -inch beaded closet fronts, with 1-inch deal, two-panel, square-framed doors, hung with $2\frac{1}{2}$ -inch butts, and fastened with turn-buckle fastening and cupboard locks complete; to have $\frac{3}{4}$ -inch deal tops, 1-inch deal rounded tops, and three tier of 1-inch deal shelves inside. The stairs to have 1-inch deal treads and deal risers, framed into $1\frac{1}{2}$ -inch strings, with proper carriages, and blocked with rounded end to bottom step; deal framed and turned newels, with deal elliptical hand-rail, and square bar balusters. The spandril to be filled in with $1\frac{1}{4}$ -inch deal framing. Provide and fix in recess in side of fireplace next window, in front bedrooms, a two-basined wash-stand; basins to be fixtures, and communicate with drains by 1-inch pipes. Fix one-basined stand in back bedroom. Provide and fix in other recess a neat plain wardrobe with folding doors, and fitted with shelves as desired. Provide and fix to cellars sash or French windows, opening inwards, as may be desired. Provide and fix to privies $1\frac{1}{4}$ -inch deal proper ledged doors, with stop and rounded linings, hung with 3-inch butts, and fitted with thumb-latch and bolt complete. Provide and fix in privies 1-inch deal seat and riser, with clamped flap and beaded frame. Provide and fix $\frac{1}{2}$ -inch deal skirting round seat, 4 inches wide; cut hole in seat for handle in cock for supply of water to soil-pan. Provide and fix a hinged door to ash-pit hole, 2 feet square. Provide and fix in gable of roof a proper oak frame, grooved at 45 deg. angle, to receive luffer boarding fitted in ditto, and ornamented with a wave line. Provide and fix in bedroom ceiling a small sliding trap-door, with frame rounded and grooved to receive the same, to facilitate ventilation.

898. *Plasterer*.—Render two coats, float and set all the walls internally, and lath-plaster two coats; float and set the partitions throughout, and colour the same in kitchen and scullery. Lath-plaster, float, and set all the ceiling, and twice lime-white the same.

899. *Paperhanger*.—Query—(A neat light paper in sitting-rooms and bedrooms much recommended.)

900. *Painter*.—Stain and varnish the whole of the wood-work, except in living-room, to be painted of a suitable light colour. The back-door to yard, and door to ash-pit and privy, to be painted a light green internally and externally.

901. *Glazier*.—The whole of the sashes to be glazed with diamond-shaped quarries of the best Newcastle crown glass. Provide and fix in window of bed-

room and children's room Lothead's perforated glass near top, to admit fresh air, the perforations to be angular, and so placed as to throw the air towards ceiling. Provide and fix the same to top of cellar window.

902. *Plumber*.—Provide to sink in scullery a 2-inch iron waste-pipe into drain, with proper trap and grating complete. Lead a 1-inch pipe from bottom of rain-water tank filtering department to scullery, near end of slop-stone of sink, and 15 inches above it, to allow utensil to be placed beneath to withdraw water. Also same size pipe from unfiltered department of cistern to seat of water-closet, and provided with stop-cock to flush soil-pan with. Lead a 1-inch pipe from wash-stand basins in bedrooms to back of soil-pan in water-closet, using at each stand, beneath basin, a simple trap to prevent ascent of foul air. Lay the valleys of roof with 5-lb. lead, to turn up at least 7 inches under the slates on each side, and properly secured. Provide and fix 5-lb. lead flashing to chimneys and gables wherever requisite. Provide and fix to roof proper zinc gutters on iron brackets, with cistern heads of neat design, and pipes complete, leading to unfiltered department of rain-water tank. Provide and fix ventilating zinc siphon tubes for ventilation of rooms where required. Provide and fix circular valves to apertures in living-room and kitchen, for regulating supply of air from warm-air chambers. Provide and fix perforated zinc plate with moulded edge to all ventilating apertures near ceiling. Provide and fix iron wash-hand basins, lined with glass, with stopper and chain complete, with trap connected with pipe leading to water-closet soil-pan.

903. *Smith*.—Provide and fix wrought-iron chimney-bars $2\frac{1}{2}$ by $\frac{1}{2}$ inch, 1-inch camber running through all the jambs to fireplaces on basement. Provide grating to cellar-windows, also to all air-flues at external walls. Provide bow-latch spring shutter bars to all the shutters. Provide and fix, if required, a boiler at back of fireplace in kitchen, to supply neat pedestal tube in bedrooms with warm water, with feed and return pipes complete.

904. *Specifications adapted to Cottages of Stone*.—For cottages built of stone, the following specifications, taken from the "First Annual Report of the Association for promoting Improvement in the Dwellings and Domestic Condition of Agricultural Labourers in Scotland," will serve as an example for practice:—

905. *Mason-Work*.—The depth of foundations is shown on the section; and the whole area of building, with a space 18 inches wide beyond the face of walls, will be excavated to that depth, or further if necessary, to secure a solid and equal bearing for the walls. The 18-inch space will be afterwards filled in with dry stone. A drain will be formed, from 3 to 4 feet from outside face of walls all round, with two cross drains running into it. These drains will be at least 12 inches below the foundations, executed with large drain-tiles, covered with loose stones to within 10 inches of the surface. Where sinks are used in sculleries, a drain will be formed at the back of the cottages, with 6-inch clay tubes, having spigot and faucit, or saddle joints, with a fall of 2 inches in every 10 feet, jointed with Roman cement, and have junctions and bends where necessary. The rain-water pipes will be led into this drain (unless in those cases where tanks are constructed for collecting either the rain-water or liquid-manure, or both), and also the subsoil-drain already described. Where there are no sinks in sculleries, the drain may be in front; and at each end of cottage an iron grating and cesspool, 9 to 10 inches diameter, will be placed, communicating with the drain, and fitted into a stone hollowed out for the purpose. The foundations will be laid with large flat-bedded stones, having the joints packed with

stone shivers and grouted, forming a 6-inch scarcement on each side. The whole of the walls will be of the best rubble-work, carried regularly up, with headers in every foot of height, and 5 to 6 feet apart; the beds and joints well squared, and the whole exterior face of walls square hammer-dressed, having the joints carefully pointed and drawn in. The inside of walls will also be carefully pointed. The vents will be executed with hammer-dressed stone, free of pinnings on the joints, carefully contracted over fireplaces, and plastered with fine lime. Those for kitchens will be 11 inches square, and for bedrooms 10 inches square. If executed with fire-clay vent linings, they will be carefully jointed with fine lime, closely packed all round, and the joints cleaned off. A ventilating flue, 8 inches square, will be formed close to the kitchen-flue, commencing about 12 inches below kitchen ceiling, and terminating in an opening, 12 by 8 inches, under cope of chimney-stalk, covered with a cast-iron grating. The partitions on ground-floor will be of $4\frac{1}{2}$ -inch brick on bed, on 12-inch stone footings. Ventilating openings, from 8 to 10 inches square, will be left in the outside walls, under floors of bedrooms, on the ground-floor, covered with cast-iron gratings. The chimney-stalks will be executed with hammer-dressed stone, well squared on the beds. The corners of building and chimney-stalks will not be less than 20 inches long, and 9 to 10 inches on the head. The rebates of doors and windows will be of similar dimensions, the inbands extending through the walls, and neither rebates nor corners will exceed 14 inches in height. A 2-inch droved margin will be worked on corners, rebates, sills, and lintels, the parts beyond being made to correspond with the rubble. The ingoings of rebates and lintels, the whole of projecting sills, skewes of gables and attic windows, jambs, hearths, and door-steps, will also be clean droved. The floors of kitchen, scullery, pantry, and lobby, will be laid with well-burned fire-clay paving tiles,* 9 inches square, on a layer of broken stone at least 9 inches deep, hard beat down, bedded with lime, and the joints afterwards grouted with thin lime. The scarcements of walls in bedrooms on ground-floor will be brought up to the level of under side of sleeper joists. The hearths in kitchens will be 3 feet, and in bedrooms 1 foot 6 inches in front of jambs, all extending to the back of fireplaces, of Arbroath stone, not less than $2\frac{1}{2}$ inches thick, bedded on lime. The stone required for the building will be quarried by the contractor from the ——— quarry, free of lordship. It must be worked in a regular manner, to the satisfaction of the proprietor, or the person appointed to superintend the work, and left in a proper working state and clear of rubbish when the work is finished. All the stones will be laid on their natural beds. The lime will be mixed with a due proportion of clean sharp pit or river sand, and properly worked together. The mason will cut all bat-holes, raglets for slates, &c., and do all jobbings required by the other tradesmen in carrying on the work. The contractor will provide all the materials except that above-mentioned, also all tressels, scaffolding, &c.; but the carriages will be performed by the tenant, the contractor paying the tolls.

906. "*Carpenter and Joiner Work.*—The safe lintels will be 4 inches thick, and of the requisite breadth, having 9 inches of wall-hold at each end. The rafters and baulks of roof will be $6\frac{1}{2}$ inches by $2\frac{1}{2}$; those for roofs of scullery and attic windows will be 5 inches by 2, all placed 20 inches apart from centre to centre, on wall-plates 7 inches by $1\frac{1}{2}$; and the whole will be strongly put together, well secured to the wall-plates, and covered with $\frac{3}{4}$ -inch deal

* In those parts of the country where Arbroath or Caithness pavement can be had at the same price as the above, it will be preferred; it will be square jointed, and laid in a similar manner, and not be less than $2\frac{1}{2}$ inches thick.

sarking closely jointed—the ridge batten will be 2 inches diameter, secured to the rafters with strong spikes. The sleeper joists will be $6\frac{1}{2}$ inches by $2\frac{1}{2}$, and 20 inches apart from centre to centre, laid on dwarf walls. The joists of upper floor will be 7 inches by $2\frac{1}{2}$, 18 inches apart from centre to centre, on wall-plates 7 inches by $1\frac{1}{2}$, having 9 inches of wall-hold at each end. None of the timbers will be placed within 9 inches of any of the smoke-flues. All the bedroom floors will be laid with $1\frac{1}{8}$ -inch deal, grooved and tongued on the edges. The inside of all the exterior walls will be prepared for lath, the straps being 1 inch square and 14 inches apart from centre to centre, fixed to the walls by malleable iron holdfasts, not exceeding 2 feet apart; and these walls, and also standard partitions, ceilings, &c., will be covered with the best Baltic split lath, not more than $1\frac{1}{4}$ inches broad, nor less than 3-16ths of an inch thick, each split.* The door-standards will be 6 inches by 2; those for outside doors will be fixed to the stone by strong split bats. The partition-standards in upper floors will be $3\frac{1}{2}$ inches by $1\frac{1}{2}$, placed 16 inches apart from centre to centre, having sill and runtree of similar dimensions. The outside doors will be framed,† the styles being 4 inches by 2, the top-rail 4 inches by $1\frac{1}{4}$, and the other two 7 inches by $1\frac{1}{4}$, lined on the outside with $\frac{3}{4}$ -inch grooved, tongued, and beaded deal, not more than 4 inches broad, hung with strong cross-tail hinges, and have a strong thumb-latch, also a strong stock-lock, of the value of 4s.; and each of these doors will have a fanlight placed over it. The inside doors will be of plain deal, 7-8ths of an inch thick, with three strong back-bars, hung with 14-inch cross-tailed hinges, and have good thumb-latches; the pantry and press doors will have good press-locks. All the doors will have facings and stops 5-8ths of an inch thick—the latter will be 4 inches broad, and beaded, and each apartment will have a $4\frac{1}{2}$ -inch skirting, also 5-8ths of an inch thick. The window-cases will be of 7-8th inch wood, with a 4-inch sill, and the sashes of 2-inch wood, and 5-8th inch astragals, the latter put together with a mixture of white lead and glue well boiled. All the windows will be single-hung, with iron-faced axle-pulleys, cast-iron weights, and the best sash-line, and glazed with third crown glass; those on the ground-floor having strong sash fasteners.‡ All the exterior timber-work will receive three coats of oil-paint, and the windows will be primed before being glazed. The pantry and press in kitchen will have three shelves of 1-inch deal, supported in the former on framed brackets. A shelf, 8 inches broad and $1\frac{1}{4}$ inch thick, will be fixed over the lintel of jambs in each bedroom. The breasts and elbows of windows in kitchen and bedrooms will be lined with $\frac{3}{4}$ -inch deal, grooved, tongued, and beaded on the joints; and the angles of all the windows, and other angles where necessary, will have 7-8th inch corner beads. Each window will have a blind-roller, fitted with the best common mounting. The treads of stair will be $1\frac{1}{4}$ inch, and the breasts $\frac{3}{4}$ of an inch thick, strongly secured to the string-boards, which will be 1 inch thick. The skylights will be of cast-iron or zinc, with strong hinges and quadrant, and glazed with strong sheet glass. A box about 6 inches square will be fitted into the ceiling, or into the wall close to the ceiling of each bedroom, open on the under side, and covered with a perforated zinc or metal grating; and a tube, 6 by 3 inches,

* Hollow tiles are recommended for kitchens, &c., instead of lath and plaster, not being liable to be broken.

† In some cases, where the entrance-lobby is small, it will be found more convenient to make these doors in two leaves.

‡ If shutters are preferred on ground-floor windows, they may be of plain deal $\frac{3}{4}$ ths of an inch thick, having cross-heads, hung with 3-inch edge hinges, and finished with facings similar to the doors.

will be fitted into it, extending to the ventilating flue, formed as already described, beside the kitchen chimney. These tubes will be framed of $\frac{1}{2}$ -inch wood, and made perfectly air-tight.* The whole of the timber must be of the very best description, free from all defects, and thoroughly seasoned before being used. That for roofing, joisting, safe-lintels, wall-straps, windows, and exterior doors, will be of Memel, or red wood Baltic plank, or battens:† the interior doors, flooring deals, lining, and stair, may be of red or white wood Baltic plank or battens, and the other finishings of American yellow pine. The carpenter will allow the other tradesmen the use of part of the roof-timbers and sleepers for scaffolding, provide moulds, and do all jobbing required during the execution of the work. The contractor will provide all materials, and the carriages will be performed by the tenant, the contractor paying the tolls.

907. "*Plumber-Work.*—A 4-inch cast-iron roan will be carried along the eaves of roof, supported on malleable-iron straps placed 3 feet apart; the rain-water pipes will also be of cast-iron, 3 inches diameter, having cast-iron waste-heads, and all will be well lacquered before being put up. The small valleys at attic windows will be executed with zinc, 8 inches broad, turned over a round on each edge; the ridge of roof will be covered with zinc 14 inches broad, over a roll 2 inches diameter.‡ The zinc will weigh 18 oz. to the superficial foot. The sinks in sculleries may be of cast-iron or Welsh slate, having cesspool, table-washer, and chain complete. The contractor will provide all materials and scaffolding, and the carriages will be performed by the tenant, as before mentioned.

908. "*Slater-Work.*—The roofs will be covered with the best Easdale or Ballachulish, Birnam, Glenalmond, or Welsh slates, having 3 inches of cover, laid in good bond, shouldered with haired lime, and hung with malleable iron nails, weighing 10 lb. per thousand, steeped in linseed oil when red-hot. The slates will be ragleted into the stone where they come in contact, and all the skews will be carefully pointed with Roman cement. The contractor will provide all materials and scaffolding, and the carriages will be performed by the tenant, as before mentioned.

909. "*Plaster-Work.*—All the walls, ceilings, and partitions will be finished with the best two-coat plaster hard rubbed in, and free of cracks and blisters. The whole of the windows will be bedded with plaster lime, and pointed with mastic after being hung. All broken plaster must be mended after the other tradesmen are finished. All the carriages required by the several contractors will be performed by the tenant, the contractors paying the tolls; and such materials as require to be brought from a distance, will be laid down by the contractors at the ——— railway-station. The whole of the works herein described will be executed in the most perfect, substantial, and tradesmanlike manner, in strict accordance with the plans and specification, and to the satisfaction of the proprietor, or the person who may be appointed to inspect the work, either during its progress or after it has been completed. Contractors will be bound to maintain their respective departments of work in a state of

* In one-storey cottages, and on upper floors of two-storey ones, these tubes may be placed on the top of ceiling joists; on the ground-floor of two-storey cottages they will be conveyed across the ceiling where most convenient.

† This is recommended as the best; but from the difference in price of home and foreign wood in some parts of the country, it will be found necessary in some cases to use the home for many purposes which are here described to be executed with foreign.

‡ The ridges of roofs are also frequently covered with stone; fire-clay, both plain and ornamental, has also been used for the same purpose.

efficiency for a period of three years after the work has been taken off their hands. Separate estimates will be given in for each department of work, as follows: first, the Mason-work; second, the Carpenter and Joiner-work; third, the Plumber-work; fourth, the Slater-work; and fifth, the Plaster-work. The proprietor does not bind himself to accept the lowest, or any of the offers given in, unless in other respects satisfactory."

910. *Contracts.*—Specifications must form the basis of all contracts for the construction of buildings.

911. There are just three forms of contracts in which the construction of buildings founded on specifications must be based. One is, that one party contracts for the construction of the entire buildings for a slump sum, and on a fixed plan.

912. The advantages of contracting for a slump sum are, that the employer has to do business with, and make payment only to, one party; that the probability is, that the entire contract, having been undertaken by one party, will be done at a smaller sum than if it had been undertaken by several parties, because it is reasonable to expect that the different classes of mechanics, in doing their respective parts, will work into one another's hands more cordially in a common contract than if they had separate interests.

913. One of the disadvantages of contracting for a slump sum is, that one part of the work may be done in an inferior manner to another: for example, the masonry, which is so palpable to every observer, may be done in a superior manner, and at greater cost than the contractor has calculated to do it, but that the carpentry, the bulk of which is out of sight, may be executed in such an inferior manner, and with so much less amount of material than the specifications direct, as to make up for the loss sustained, and even more, by the superior masonry. Another disadvantage is, that it renders any improvement of the plan, while the work is proceeding, nugatory, for wherever a change is insisted on by the employer, in the plan supplied by himself, the contractor considers that his agreement is abandoned to that extent; and the employer is thus so far placed at the mercy of the contractor, who may charge for the altered portion of the plan whatever he may choose to demand.

914. Another form of contract is of a separate contractor executing each department of the work—for example, one contractor for the masonry, another for the carpentry, and so on for the slater-work, the plumber-work, the glazier and painter work.

915. The advantages of separate contracts is, that as each contractor has to do only his part of the work, he will do it to the best of his ability for the sake of his own character as a tradesman; and hence each sort of work may be well done, and better done than when undertaken for a slump sum.

916. The disadvantages of separate contracts are, that having separate interests, the contractors will not work into one another's hands for the benefit of the entire work; that the separate contracts will not be undertaken at so low a sum as in one contract for a slump sum; that the plan being a fixed one, no alteration can take place in it without an abandonment of the contract so far, and a consequent obligation of payment by the employer to the contractor to whatever extent the contractor may choose to demand.

917. A third form of contract is by measurement. The rate per foot or yard, running or superficial, is fixed between the employer and contractor, and after its execution the work is measured by an ordained surveyor, and the entire cost is calculated according to the rates fixed on in each department of the work.

918. The advantages of this form of contract are, that the work is specially surveyed after its execution, and its quality tested in terms of the specifications; that the plan is not so fixed and absolute but that alterations may be made in it as the work proceeds, according to the matured wishes of the employer; that the contract may be undertaken by one party for the entire work, or by a party for one or more parts of the work, with equal advantage to the work itself; that it is the most equitable form of agreement both for employer and contractor; and that it affords the most satisfaction of any to the employer in the end.

919. There are no disadvantages attending this form of contract that we are aware of; the contractor receiving the value of the work he has executed at the rates he himself had agreed to accept, and the employer having the option of change in the plan.

920. A superintendent should be appointed by the employer to inspect the work in its progress, and to see that the terms of the specifications are strictly attended to by the contractor.

921. Payments are made by the employer to the contractor at periods agreed on, but which are generally never equal to the value of the work done by 20 or 25 per cent until the final settlement.

DIVISION THIRD.—PRACTICAL CONSTRUCTION.

922. SECTION FIRST—*Foundations*.—It is impossible to over-estimate the importance of a good foundation, for on its being carried out in a proper manner depends obviously the stability of the superstructure. The term "foundation" has a twofold meaning, having reference, first—to the preparation of the ground on which the materials rest; and, secondly, to the arrangement of the materials forming the lower part of the substructure resting on the ground so prepared. Our remarks, therefore, are naturally divided into two classes—1. The choice and preparation of the ground; 2. The arrangement and construction of the "footings," by which name the lower part of walls is designated.

923. *Choice and Preparation of the Ground*.—The best foundations are in compact gravelly soils. This soil is incompressible, dry, little affected by the atmospheric influences, and yields very little laterally. In a soil of this kind the foundation is easily formed; all that is necessary is to dig a trench considerably wider than the width of the walls of the building, and of depth not less than 3 feet. In some instances, a soil of this kind may not be uniformly good, but may present places where the soil is defective, being soft and yielding. When these parts are met with, a simple method to secure a good foundation for structures of no great weight is to dig out the bad earth till good is met with, filling up the holes so made with sand; or the patches of yielding soil may be rammed well up with layers of small broken stones, as angular in their form as obtainable. The more firmly these patches are rammed the better.

924. In the preparation of foundations in compact clayey soils, great care must be taken, as they form treacherous foundations, in consequence of their being so subject to atmospheric influences. Thus a blue shale may be so difficult to work as in some cases to require blasting with gunpowder, yet so susceptible that in a short time the influence of the atmosphere may reduce it to a thin sludge. In soils, therefore, of this nature, it is essentially requisite to secure

the foundation from the action of the air. To attain this the trenches should be dug deep, if possible, to reach the sound compact substratum; the depth should not be less than 30 inches. Before commencing to lay the bottom-courses of the walls, a layer of concrete should be laid along the trenches. The preparation of this material, and the advantages obtained by its use, has been described in par. 534.

925. Firm compact beds of sand form good foundations, but only in circumstances where the sand has no tendency to move laterally—that is, slide from under the foundation. As this lateral tendency cannot in all cases be traced, and as, however firm an examination may show the soil to be, the action of springs, or even of surface water, may give at any time this lateral tendency, it is deemed advisable, in the majority of cases where sand is met with, to adopt special arrangements. These are as follows:—

926. First, simply extend the bearing surfaces on which the walls rest. This is easiest done by making the trenches considerably wider than the width of intended wall, and laying broad and thick flagstones on the surface of the trenches. The width of the stone for a single-storeyed building should be such as to project a foot beyond the lowest course of the wall—the thickness of the flagstone 3 inches. If the building is to have two storeys, add 3 inches to the above breadth and 1 inch to the thickness. It is of essential importance that the stones should have a fair and flat bedding, to prevent unequal settlement. In some cases this extension of bearing surface is given by laying a platform of wood on the sand forming the foundation, this being confined with walls of masonry or brickwork. A much better plan, however, is to dig subsidiary trenches, completely surrounding the main trenches. The main trenches are filled up to the level with concrete, and the subsidiary trenches also. These subsidiary trenches should be deeper than the main trenches. By this arrangement the sand is greatly prevented from sliding laterally from under the foundation-courses. In some cases a firm unyielding soil is found below the bed of sand on which it is proposed to build. In this case piles may be driven down to the solid soil, and the whole of the piles sawn off level. A timber platform may then be put on the piles, on which to rest the superstructure. If possible to be carried out, the better plan will be to dig out the sand, filling up the spaces with concrete or beton (par. 536).

927. To secure a good foundation in soils of a very soft, yielding character, having a tendency to lateral displacement in almost every direction, it will be necessary to surround the whole area of the foundations with a row of piles driven close together, the heads of the piles sawn off at a level, and to spread over the surface of the soil enclosed by the piles, and over the soil, to some distance beyond the piles, a layer of concrete or beton.

928. In some of the constructions of the farm it may be necessary—as in the case of throwing a bridge across a stream—to make a foundation under or on a space surrounded by water. In many cases this species of foundation demands the exertion of the utmost degree of skill on the part of the architect and engineer; but in the majority of cases, in farm operations, the simplest methods of carrying out and constructing foundations of this class may be available.

929. Where the water is shallow, and is either stagnant or its velocity of flow of small amount, a foundation useful enough for many structures will be obtained by throwing in heavy stones, leaving them to settle into a mass of their own accord. Where the soil or river-bottom is soft and yielding, this method will not be eligible, as the action of the water will carry off the soil from under the stones, and cause unequal settlement in the mass. In this case,

if the circumstances will admit of it, a space surrounding the spot on which the foundation is required should be enclosed with a dam or wall of clay well rammed together; the water should be pumped out of this enclosed space, and the foundation-trench dug, and the lower courses built up. After this is done, the dam should be removed, and in order to prevent as much as possible the action of the water on the foundation-courses, a mass of stones should be placed against them, sloping downwards from the pier to the water.

930. Where the velocity of the stream is considerable, the space on which the foundation is to be built will require to be enclosed by more permanent materials than the clay mentioned in last paragraph. A suitable form of "coffer-dam" may be erected by driving in piles on each side of the enclosed space, giving these a hold of the ground according to the nature of the soil. The piles should project some distance above the highest flood water-mark. The strong planking should be nailed closely on the outside and inside of the piles, and the space between them well "puddled"—that is, rammed up with clay and sand. The water should then be pumped out, and the foundation

prepared according to the nature of the soil met with. On the removal of the coffer-dam, the "apron" of stones, as described in last paragraph, should surround the pier. In cases where the action of the water is rapid to a more than usual degree in small rivulets, it will be advisable to construct this "apron" as in fig. 147, where *a a* is the pier; *d d*, *c c* short piles driven in obliquely, between and surrounding which the stones are thrown in. It may be useful here to append a sketch showing a form of "coffer-dam" adapted to cases presenting greater difficulties of execution than those referred to in preceding paragraphs. In fig. 148, *a a* and *a a* are the main piles, the distance between them laterally from centre to centre being 4 feet. The piles are connected by horizontal pieces called "string-pieces," or "wales," *e e*, *c c*, and these again by cross pieces, *b b*, notched on to the wales. These prevent the piles from spreading out laterally. The smaller piles driven in juxtaposition with the larger ones, as *d d*, are termed "sheeting piles." Interior "wales" are placed inside the piles *a a*, which support the sheeting piles *d d*. The flooring is supported by the cross pieces *b b*.

The puddling is rammed into the spaces *h h*, *h h*; the water-level is at *i i*; *o* represents the mass of concrete or beton on which the pier is built. When the depth does not exceed 10 feet, a width or thickness of equal extent is given to the dam; as the depth is increased, a foot of additional thickness should be given for every addition of 3 feet to the depth. When the interior excavated space is completed, a pressure is exerted on the sheeting-piles *d d*, tending to drive them inwards; to prevent this, cross pieces may be stretched across the dam from string-piece to string-piece, *e* to *e*; *g* is the footing and base of the pier of the bridge.

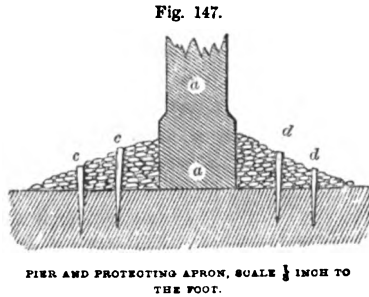

PIER AND PROTECTING APRON, SCALE $\frac{1}{2}$ INCH TO THE FOOT.

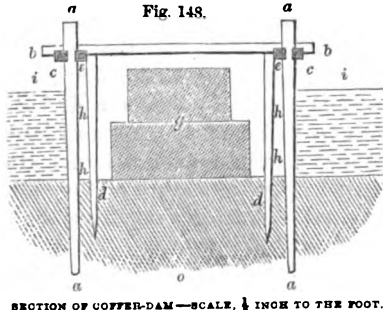

SECTION OF COFFER-DAM—SCALE $\frac{1}{2}$ INCH TO THE FOOT.

931. In commencing work on the most secure, yet the most difficult class of foundations to work—namely, rock—care should be taken to level all the trenches perfectly throughout, to fill up all rents either with concrete or masonry, and specially to note that the trenches are deep enough to get rid of all portions which have been subjected to the influence of the weather. Where the ground is unequal, the foundation will require to be “benched out,” or cut into a terrace form, as it were. Where the level of these benches varies much, to insure equal settlement of the superstructure, it is recommended to have the whole built up to the same level by courses of masonry.

932. In digging foundations the material should be economically dealt with; that is, the “sod” should be cut carefully off, and removed to some distance; the same with the surface-soil or mould. Sand, if met with, should be retained for mortar, gravel to make concrete with, and clay for puddling purposes. The digging should commence and be carried out, so that, when the excavation is finished, the floor may be as uniform and undisturbed as possible. The whole should then be carefully gone over with a rammer, and the unsound parts excavated, and filled up with concrete or sand. The sand used in this way possesses many advantages, in cases where it is not allowed to slide laterally. Indeed, where this lateral movement can be prevented, sand is recommended in preference to wood for piles, inasmuch as it is capable of yielding and assuming new positions according to the pressure—the lateral pressure which it exerts tending to relieve the vertical on the bottom of the trench.

933. Fig. 149 gives a section of the manner in which the foundation of hinds' houses ought to be constructed, where *a* is the pavement

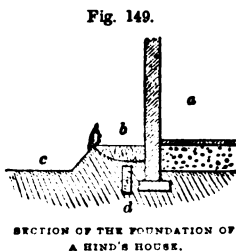

of the floor of the room resting upon broken stones to keep it dry; *b* the broad gravelled footpath along the front of the wall; *c* the surface of the ground on the road, some inches below the level of the footpath; and *d* the drain to carry away the water that may chance to fall upon the footpath. A border of earth may be made along the front of the house, and a fence of low hedging placed between it and the footpath, which in that case would be made where the road *c* is.

934. *Stone Construction—Stone Footings.*—In the construction of footings, the great object is to give a wide base, to which the vertical pressure of the walls is to be transferred, greater stability being thus given to the structure by diffusing its weight over a larger surface. The width of the base will obviously depend upon the nature of the soil in which the foundation is made—rock of a firm stable character requiring the minimum, soil of a loose and yielding nature, the maximum breadth.

935. The proper thickness of the wall begins usually at the ground-level, the space below, in the foundation-trench, being devoted to the footings, which spread out the farther they proceed from the ground-level line. Two methods are in use for forming the footings of stone constructions, as exemplified in fig. 150. In one method, the lower courses are so made as to form what is called a “set off,” this being formed by one course, as *c*, being narrower than *d*, and *b* narrower than *c*, the wall *a* narrower than *b*. The other method consists in giving a uniform slope or batter, from *g* to *f*, to the footings,

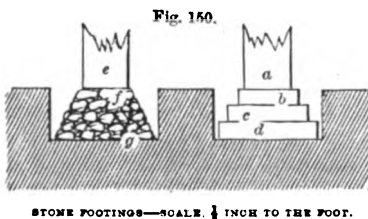

upon which the wall *e* is raised. This employs a smaller volume of material than the method at *b c d*, with an equal stability. The breadth of each set-off, where used, should not exceed 4 inches.

936. The largest sized stones are used for the bottom course; and the thickness of stones used for any course should be uniform. The more perfectly levelled the surfaces are the better. If obtainable, stones of size sufficient to go across the foundation should be used. When, for thick walls, all the stones cannot be obtained of breadth sufficient to reach across, the place of every second stone should be taken up with two shorter blocks of the same width and thickness. Thus in fig. 151, let *a, b,* and *c* represent the longest, and *d e f g*

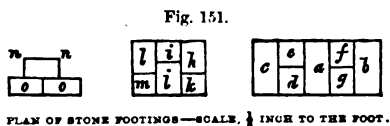

the shortest blocks. Another method is also illustrated in fig. 151, where the longest stones, as *h j l*, are two-thirds of the thickness of the wall; and the shortest stones, as *i k m*, one-third. The method of disposition is shown in the diagram. The joints of all the stones should be so disposed that the joints of one course will fall upon the solid parts of the course below, as the joints of *n n*, fig. 151, rest on the solid parts of the stones *o* and *o*. This is called "breaking joint."

937. Where the soil is somewhat compressible, and the stones cannot be obtained with straight surfaces, a plan of forming the foundation is thus recommended: Make the first course with the smaller blocks, well bedding them into the soil or on the concrete; form the next course with the large blocks, binding the smaller stones together, and spreading the weight uniformly over them.

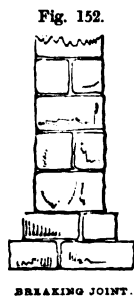

938. The largest stones should be used for the angles of the foundations, particular care being taken in bedding them; and wherever the soil is liable to moisture, hydraulic cement should be used for the joints. As in walls the pressure is nearly always vertical, the surfaces of the stones upon which the walls are to rest should be horizontal, carefully levelled, and presenting no angular points. The stones of the upper course, as *b*, fig. 150, should be so arranged that the first course of the wall *a* shall rest on the outer stones.

939. Where solid foundations are required for pillars, as in the case of a large roof covering a stackyard, &c., and where the ground is of a soft yielding character, the plan of turning inverted arches might be adopted with advantage, as shown in fig. 153, where *c* and *d* are the bottom blocks for supporting the pillars or columns *a* and *b*, and *e f* is one of the inverted arches.

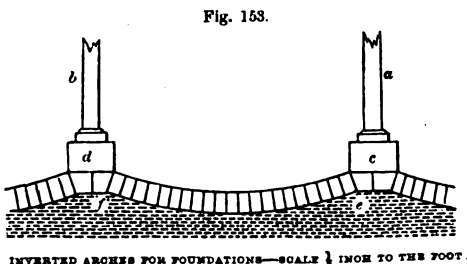

SUBDIVISION FIRST—*Stone Construction.*

940. SECTION SECOND—*Stone Masonry.*—The two principal kinds of stone masonry are "ashlar" and "rubble." Ashlar consists of stones cut and dressed to specific sizes; it is the strongest method of building, although, from the expense of dressing the stones, it is not so often followed. The front or outside of an ashlar wall is termed the face, as the inside is termed the back: the stones

composing these are, therefore, styled the facing and the backing. Where the courses—that is, the horizontal layers of the stones—are of regular and equal thicknesses, the style of building is called regular coursing; if of unequal thicknesses, irregular or random. The upper surface of each stone, as it lies on the course, is called the “bed;” and the method by which the connection is made between the different stones is called the “bond.”

941. For *ashlar-work* the stones are generally from 28 to 30 inches long, 12 to 18 wide, and 5 to 9 thick. The sizes will depend upon a variety of circumstances; but, as a general rule, the breadth should never be less than the thickness, and never exceed twice this dimension—the length of the stone not exceeding three times its thickness. Every care should be taken to have the stones well dressed; the closer they fit together, the better the work: unequal settling will certainly result from unequal surfaces, if not actual fracture of the stone from the unequal pressure on the different points. All the surfaces should be at right angles to the direction of the pressure. The practice so often adopted by *scamping* workmen, of dressing the stones a few inches from the face, should be carefully avoided. When this plan is followed, voids or empty spaces will be left, as *a b* in fig. 154; and unequal settling, and possibly fracture of the stones at the joints, will be the result. Where the backing of an ashlar front is of rubble, this tapering-off of the blocks to the back may be tolerated as affording a good bond between the facing and the small stones composing the rubble backing; but even in this case the stones should be dressed as far back from the face at least as a foot.



942. Rubble-work is sometimes used as a backing for ashlar facing. This is by no means a good plan, for, the modes of building being so dissimilar, unequal settlement is likely to take place, and the backing to be separated from the facing. The method illustrated in fig. 155 is a good one, and will be cheaper than solid ashlar-work, and, if carefully built, nearly as strong: *a b* and *c d* are through-band stones across the breadth of the wall, while the smallest stones forming the front and back of the wall, and the smallest stones of rubble-work fill up the spaces between them.

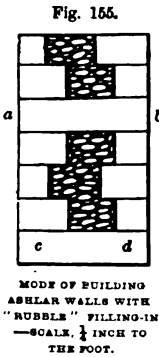

943. The bed should now be carefully cleansed from dust and stone-chippings, and moistened with water; the mortar should next be laid on the bed, and the block, with its under-side cleansed and moistened, lowered, and settled in its place by blows of the mallet. The joint which goes up against the joint of another block, in the same course, must be as carefully made.

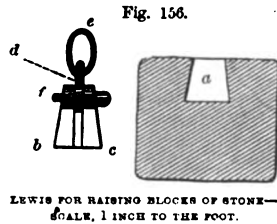

The vertical joints must be at right angles to the horizontal ones, and also at right angles to the facing; by this arrangement of the horizontal and vertical joints, the greatest strength possible is given to each block.

944. Heavy blocks are raised and lowered by what is called a “*lewis*,” as illustrated in fig. 156. An aperture, as *a*, is made in the upper surface of the stone; two wedges, as *b c*, of wrought-iron, are made with a slope to correspond to the slope of the aperture *a*; a flat piece *d* goes between them, and the whole are united by the bolt *f*. In using a lewis the bolt *f* is taken out, and one of the tapered wedges, as *b*, inserted in the

hole *a*; the other, as *c*, is next inserted; lastly, the flat piece *d*; the bolt *f* is then passed through them. The chain is attached to the ring *e* passing through *d*, and the tendency of the weight of the stone is only to tighten the wedges *b c* in the hole *a*. Fig. 157 shows a lewis fixed in the stone.

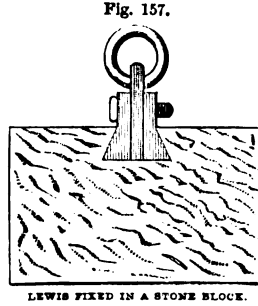

945. In ashlar-work, the stones in particular constructions, as embankment walls, &c., are often required to be joined together, as well as one course to those above and below it. To effect this junction, "dowels" or "joggles" are sometimes used, as at *a* in fig. 158, or as at *b*. These dowels or joggles are made of copper or of slate, or hard stone. Iron "cramps" of various shapes are also used; the object being to give them as complete a hold of the stones as possible. These are let into similarly-shaped indentations made in the stone, and run with lead; two of which cramps are shown at *c* and *c*. The connection of the course with another above or below it is also made by means of cramps, as at *d* and *e*. Projections are sometimes made in the bed of one block, and corresponding indentations on the under-side of the other. Fig. 159 shows another form of joggled joint.

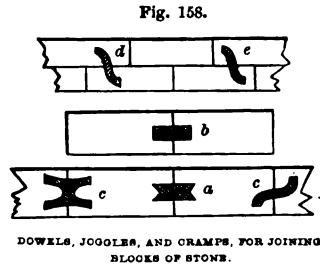

946. Rubble-work is of two kinds, coursed and uncoursed, or regular and irregular. In the coursed work the stones are hammer-dressed to sizes nearly uniform; the courses may be of unequal thicknesses. In uncoursed rubble, the stones are prepared by knocking off all the sharp angles. The bedding should be carefully prepared, and the interstices filled in with smaller pieces or chippings pressed into the mortar. As each course is finished, *grout* or thin mortar should be applied to the surface, in order completely to fill up all the interstices.

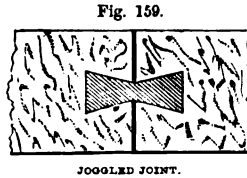

Due care should be taken to place the stones in their natural or quarry-bed position, which is indicated by the laminæ of the stone. The great art in building rubble-work uncoursed, is to place the stones of different sizes in such a way as to interweave with each other, the interstices being well filled up with mortar. To test if rubble-masonry is well built, step upon a levelled portion of any course, and, on setting the feet a little asunder, try, by a searching motion of the legs and feet, whether any of the stones ride upon others. When the stones ride, they have not been properly bedded in mortar. To ascertain if there are any hollows, pour out a bucketful of water on the wall, and those places which have not been sufficiently packed or hearted with small stones will immediately absorb the water.

947. Stone Details of House in Plate XVIII.—In fig. 160 we give elevation of stone finial to house in fig. 1, Plate XVIII.; in fig. 161, section of moulding of corbel to chimney; in fig. 162, section of mouldings of chimney cap; in fig. 163, section of mouldings of string-course; in fig. 164, section of mouldings of summer-stone; and in fig. 165, section of mouldings of jamb and mul-lion of doorway. In fig. 166 we give elevation of finial for house, the elevation of which is in fig. 2, Plate XVIII.

Fig. 160.

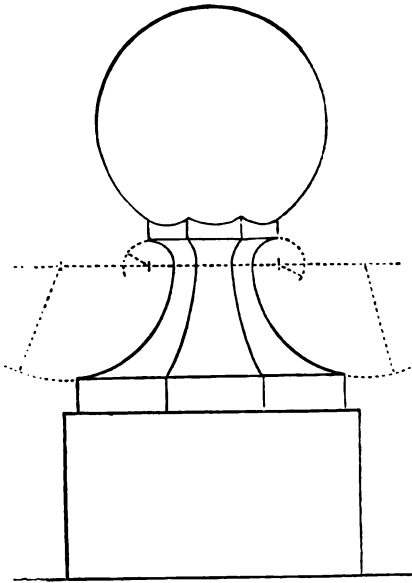

ELEVATION OF STONE FINIAL—SCALE, $\frac{1}{2}$ FULL SIZE.

Fig. 161.

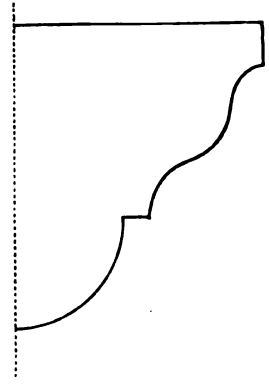

MOULDING OF CORBEL TO CHIMNEY.

Fig. 164.

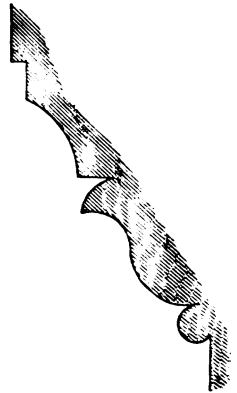

SUMMER-STONE—SCALE, $\frac{1}{2}$ FULL SIZE.

Fig. 162.

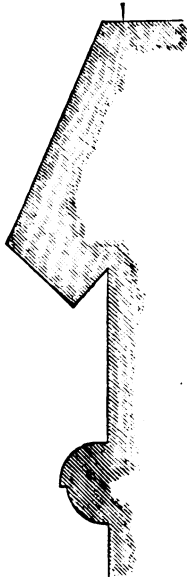

MOULDING OF CHIMNEY-CAP—SCALE, $\frac{1}{2}$ FULL SIZE.

Fig. 163.

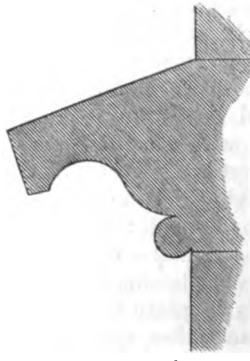

STRING-COURSE—SCALE, $\frac{1}{2}$ FULL SIZE.

Fig. 165.

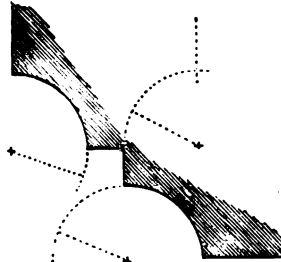

MOULDINGS OF JAMB AND MULLION OF DOORWAY—SCALE, $\frac{1}{2}$ FULL SIZE.

Fig. 166.

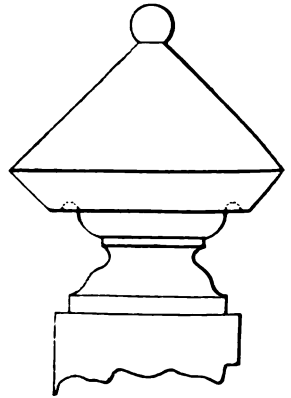

FINIAL—SCALE, $\frac{1}{2}$ FULL SIZE.

948. *Stone Details of House in Fig. 36 in the Italian Style.*—In fig. 167 we give mouldings of “capping;” in fig. 168, mouldings of window cornice; in figs. 169 and 170, suggestions for stone balcony fronts.

Fig. 167.

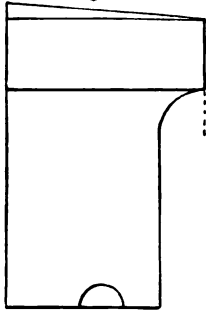

MOULDINGS OF CAPPING—
SCALE, $\frac{1}{2}$ FULL SIZE.

Fig. 169.

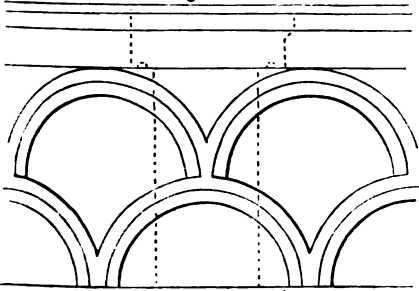

STONE BALCONY FRONT—SCALE, 1 INCH TO THE FOOT.

Fig. 171.

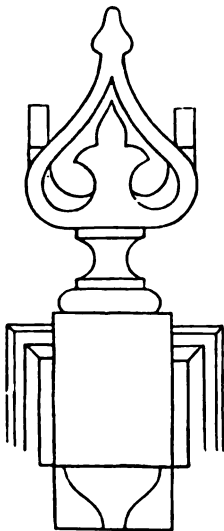

STONE FINIAL.

Fig. 168.

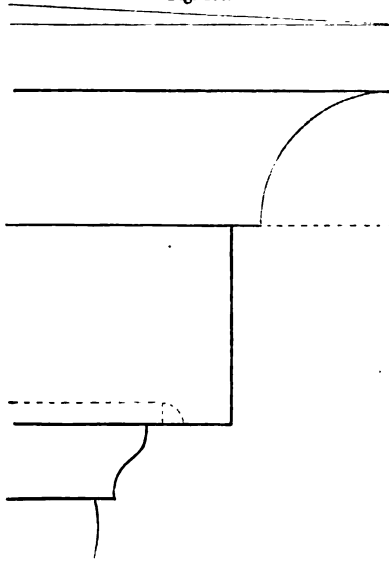

MOULDINGS OF WINDOW CORNICE—SCALE, $\frac{1}{2}$ FULL SIZE.

Fig. 170.

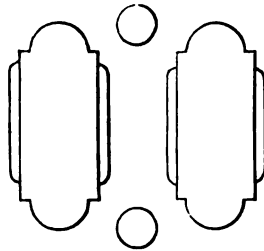

STONE BALCONY FRONT—SCALE, 1 INCH
TO THE FOOT.

Fig. 172.

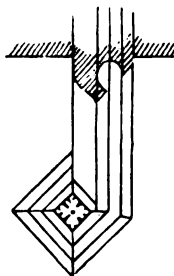

DRIP-STONE.

Fig. 73.



STRING-COURSE.

949. *Stone Details of House in Fig. 45 in the Tudor-Gothic Style.*—In fig. 171 we give an enlarged drawing of “finial” to apex of gable; in fig. 172, drawing of “drip-stone” to breakfast-room window, of which, in fig. 45, we give an elevation (and in plan at *d d*, fig. 41); and in fig. 173, section of mouldings of “string-course.”

950. In fig. 174 we give mouldings of cornice to window of house in fig. 64; and in fig. 175, mouldings of chimney-cap to house in fig. 67.

Fig. 174.

STONE WINDOW CORNICE.—SCALE. $1\frac{1}{4}$ INCH TO THE FOOT.

Fig. 175.



MOULDINGS TO CHIMNEY-CAP.

951. SECTION THIRD—*Brick Construction.*—*Brick Footings.*—In brick-work, when a brick is placed with its side parallel to the length of the wall, as *a*, fig. 176, it is called a “stretcher;” when its end is parallel, or its side at right angles to the length of the wall, as *b*, it is termed a “header.”

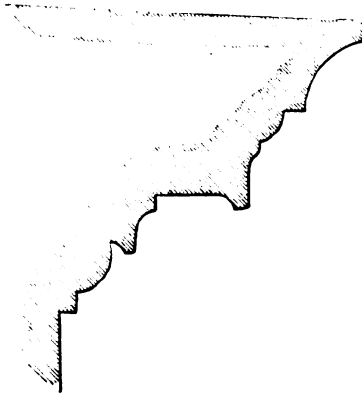
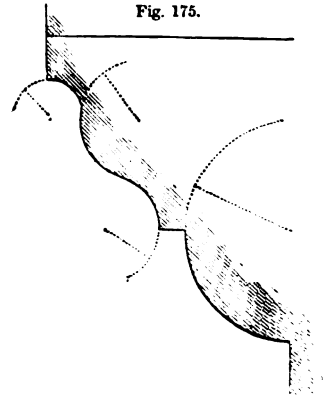
Fig. 176.

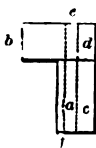

HEADER AND STRETCHER (BRICKS)

In forming brick-work footings, it is advisable to have all the outside courses headers, as *b*. The benefit derived from attending to this is obvious enough on examining the diagram in fig. 176. For, let the line *c d* represent the outside line of the succeeding course, then it is obvious that the brick *a* (stretcher) sustains the pressure of the superstructure over half of its surface only; while the brick *b* (header) sustains it over nearly three-fourths of its surface. We have, in the *Book of Farm Implements and Machines*, shown that the more uniformly (*Strength of Materials*) a weight or pressure is distributed over a material, the greater the weight which it can support. Thus by increasing the width of the offset of the footing, as say to the line *e f*, the bearing surface of each brick *b* and *a* is much reduced.

952. In fig. 177 we give a sketch showing the arrangement of brick footings adapted for a 14-inch wall *a b*, with the footings *c d, e f g, h i j*. In fig. 178 we give the plan of the footing *h i j* in fig. 177, *f e* being the breadth or thickness of the wall, the length being in the direction *e g*. Make the set-off equal to half the width of a brick, or $2\frac{1}{4}$ inches, this will give the lines *a d, a b*, and *d c*; these two last being, of course, continued as long as the wall. Fig. 179 shows the arrangement of the course *e f g* in fig. 177, the width of which *b d* corresponds to the width *a d* in fig. 178. This course is made up of two rows of headers *g* and *h*, fig. 179, placed on each side of stretchers *e* and *f*. Setting-off as before the distance of half a brick breadth,

the lines jk , ji , and kl will be obtained, ji and kl stretching along the wall. Fig. 180 is the plan of the course cd in fig. 177, the line jk corresponding to jk in fig. 179. In this course there are two rows of headers, placed end to end. Set-off as before, $2\frac{1}{4}$ inches, and the lines bd , ba , dc , will be obtained, giving the space for the wall as ab in fig. 177. Of this course $abcd$, fig. 181, is the plan composed of headers and two stretchers. If the reader would take tracings of all these sketches, figs. 178 to 181 inclusive, and superpose fig. 179 on fig. 178, and fig. 180 on fig. 179, and fig. 181 on fig. 180, he would find that the joints of all the bricks of each course would lie against the solid parts

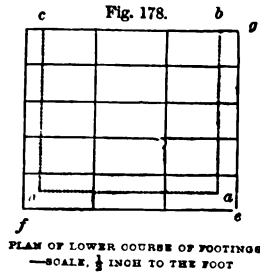
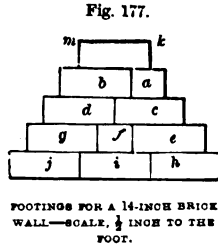

Fig. 179.

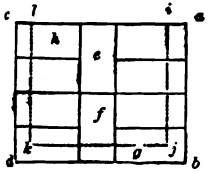

Fig. 180.

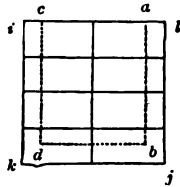
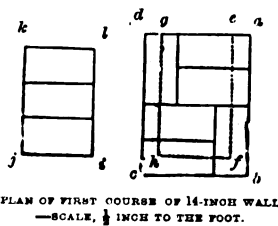

Fig. 181.



of the bricks in the course immediately beneath, just as shown in the section in fig. 177. Should a 9-inch wall be required, as shown by the dotted lines km in fig. 177, the bricks will be laid as in plan $ijkl$, fig. 181; ji will correspond with hf , il with fe , and jk with hg .

953. *Brick Walls.*—Since the repeal of the duty on bricks, they are made of all sizes and shapes; but the dimensions of ordinary building-bricks remain still as before—namely, 9 inches long, $4\frac{1}{2}$ inches wide, and 3 inches thick. Each course is thus of the same depth, being regulated by the thickness of the bricks. The facing of brick walls is “set” up in two ways—“old English” and “Flemish” “bond.” The English is illustrated in fig. 182; in this the courses are made up of alternate rows of headers and stretchers: aa , bb are stretchers, cc are headers. The “Flemish” bond is illustrated in fig. 183; in this, each course is made up of headers and stretchers alternately: aa are stretchers, bb are headers.

Fig. 182.

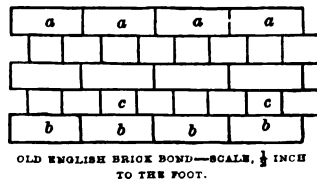
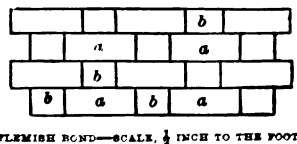

Fig. 183.



954. The Flemish bond is considered to look the best, but the old English is undoubtedly the strongest. In the Flemish there is comparatively little lateral tie, as the length of the stretchers predominates over that of the headers. In the old English, on the contrary, the bond or connection between the various parts is very complete, the headers giving

good bond across the wall, the stretchers along it. As brick walls are apt to split or rupture transversely, or in the direction of their thickness, and laterally in the direction of their length, every attention should be paid to avoid this tendency. Old English bond is preferable to Flemish, on this account chiefly, that the frequency of the headers gives strong lateral bond. To afford the mortar a secure hold of, or to enable it to "key" to the brick, bricks are now sometimes moulded with shallow rectangular indentations on the upper and under sides; into these the mortar is pressed, forming a "key" or hold.

955. Still further to secure the advantages of a good "bond" in the structure, "bond-timber" is often used to connect the wall longitudinally. This consists of timber of some 3 or 4 inches square, or of such dimensions as the builder thinks fit, built into the centre of the thickness of the wall, and running along in the direction of its length.

956. Bond-timber is, however, fast falling into disuse, in view of the superior advantages of hoop-iron for binding purposes. Timber is apt to rot when imbedded in the wall, and no external evidence is given of its decay; but this objection does not hold against the use of hoop-iron. Sir I. K. Brunel was the first who introduced this material for binding purposes, and its use has gradually extended, till it is all but universal in good constructions. Experiments have proved that brick beams have been strengthened ten times with the use of cement and iron-hoop bonds. The hoop-iron should be slightly rusted before being built in, as the adhesion of the mortar is thereby better secured. Two strips of the iron should be laid along the length of each course; where economy, however, is more consulted than efficient workmanship, one only may be used. It should be remembered that the strain the hoop-iron bond has to sustain is that of tension.

957. *Tyermann's Hoop Bond.*—In fig. 184 we give a sketch of Tyermann's



hoop-iron bond, which is prepared from the ordinary hoop-iron by notching it at intervals of $11\frac{1}{2}$ inches, on both sides alternately, and turning one

side of each notch in succession in contrary directions on the reverse sides of the iron, thus forming reversed claws, which are so bent that a direct end abutment of the iron is presented longitudinally, offering a most powerful and effectual resistance in both directions, and which become, when built into the brickwork, imbedded in the structure, an effectual means of preventing the possibility of a longitudinal slip, and affording thereby a complete and permanent bonding together of the whole building. Manufacturers, J. Perry & Sons, Highfield Works, Bilston.

958. In carrying up walls in old English bond, the "quoins," or corners, must be commenced with a half-brick, termed a "closure" or "closer." The same must also be attended to in Flemish bond walls; the object of this being that the bricks, as they are laid down, shall "break joint." For instance, in an old English 9-inch bond wall, in the course of stretchers, it is obvious that if the second line of stretchers, making up the thickness of the wall, started fair with the first line, all the joints would lie against each other; but by putting in a half of a brick at the end, and starting with a whole brick, all the joints of the second row, in the direction of the breadth of the course, will lie against the solid parts of the facing bricks. In fig. 185 we give the plan of the first course of a 9-inch wall in old English bond; and in fig. 186, the plan of the

second course. In fig. 186, the position of the stretchers *a a a* in fig. 185 is taken by the headers *a a*; while in fig. 185, the position of the stretchers *c e d*, fig. 186, is taken by the headers *b b*. In fig. 185, by inserting the closer *c*, the joints of the second header *d* are carried to the solid parts of the first and second stretchers *a a*. If the closer had not been inserted, one of the joints of *d* would obviously have come to the joint of *a a*. The same effect is produced by inserting the closer *b* in fig. 186. Corresponding plans of Flemish bond are shown in figs. 187 and 188; *c* and *c* being closers.

959. In Flemish bond the facing is generally made of a superior quality of brick, and to serve this the headers are not whole-length bricks, but are cut through. This is a practice utterly wrong; for the headers, on which depends, or should depend, the transverse strength of the wall, have no hold of the back part of the wall. The consequence is that the "backing" and "facing" separate from each other, and the whole structure becomes endangered.

960. *Walls.*—In carrying up walls, the courses are should be taken up as uniformly as possible, in order to insure regular and equal settlement. If this is not attended to, and one part *a* is carried up much higher than *b*, fig. 189, the wall will likely crack. All buildings settle or shrink; and those parts which are built up first, and allowed to settle first, will remain stationary, so that when the succeeding part is built up, its settlement will cause it to be separated from the first-built portion. All agreements should specify that no particular part is to be built up exceeding 4 feet in height. As each part is thus built up, its ends should not be made square, but the courses should terminate so as to afford a series of step-like projections, as from *b* to *c*, fig. 189, which will afford a good bond to the next-built-up portion. The layer of mortar between the bricks should not exceed a quarter of an inch in thickness; it is a sign of bad construction when thick patches of mortar are seen between the bricks. The brick should be well wetted before setting, to free it from all matter likely to prevent adhesion of the mortar. The mortar should be carefully spread over the brick, and the one to be bedded well rammed down with the trowel, or, what is better, pressed down with a rubbing motion. The joints in the face of the work should be finished off with what is called a "straight-ruled joint."

961. In carrying up walls, small piers,

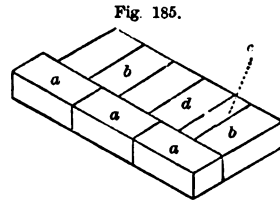

Fig. 185.
PLAN OF FIRST COURSE OF 9-INCH WALL
IN OLD ENGLISH BOND—SCALE,
½ INCH TO THE FOOT.

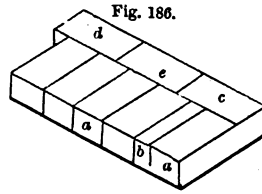

Fig. 186.
PLAN OF SECOND COURSE OF 9-INCH WALL
—SCALE, ½ INCH TO THE FOOT.

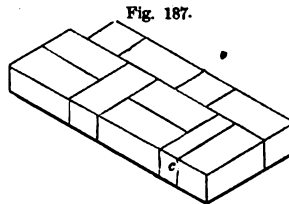

Fig. 187.
PLAN OF FIRST COURSE OF 9-INCH WALL
IN FLEMISH BOND—SCALE, ½ INCH
TO THE FOOT

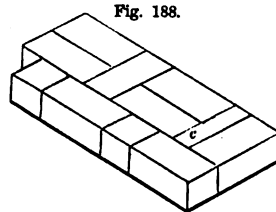

Fig. 188.
PLAN OF SECOND COURSE OF 9-INCH WALL,
FLEMISH BOND—SCALE, ½ INCH
TO THE FOOT

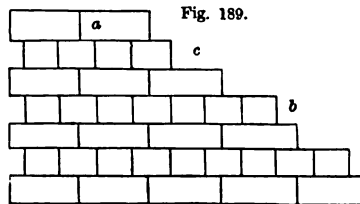
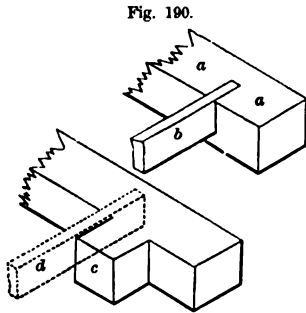

Fig. 189.
MODE OF CARRYING UP BRICK COURSES—
SCALE, ½ INCH TO THE FOOT.

as *c*, fig. 190, should be carried up from the footings, on which to lay the flooring-joists *d*. This allows the air to circulate round the end of the joist,



GOOD AND BAD METHODS OF SETTING FLOORING-JOISTS—SCALE, $\frac{1}{4}$ INCH TO THE FOOT.

and tends greatly to preserve the timber. The plan of building in the ends of the joists, as the joist *b* in the wall *a*, fig. 190, is greatly to be reprehended: the decay of the timber is hastened, and, as it decays, irregular settlement of the walls is likely to ensue. In the upper walls, as piers cannot conveniently be built, the plan illustrated in fig. 191 should be adopted, to secure the advantages of a circulation of air round the ends of the joists. In this illustration the end of the joist or beam *a* rests in an aperture or wall-box, formed by two stone or wooden slabs *b* and *b*. The width of this aperture should be greater than the breadth of the beam, so as to

enable the air to circulate round its sides as well as round its end and top, as at *c*, fig. 191. For securing the ends of large girders, wall-boxes or shoes of cast-iron are built into the wall in which the ends of the girders are inserted. Fig. 192 shows a bearing wall in which the joist *a* rests on a wall-plate *b*.

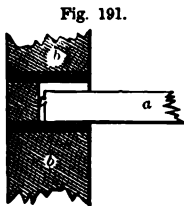

MODE OF FIXING BEAMS OF UPPER FLOORS—SCALE, $\frac{1}{4}$ INCH TO THE FOOT.

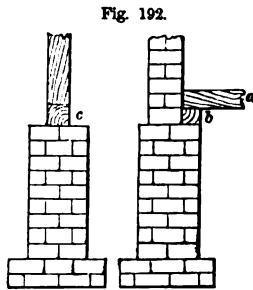

BEARING WALLS.

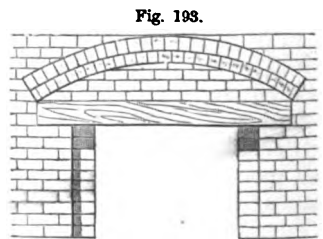

CURVED ARCH AND LINTEL.

962. In the case of openings—as doors and windows—in walls, it is essential, in sound construction, to arch them over, as in fig. 193. Where the opening is narrow, good construction may, to a certain extent, be insured by the use of strong and sound timber lintels, fig. 193. For openings of doors and windows of the ordinary extent, the size of this lintel may be 5 inches by 4 inches, a bearing of at least 14 inches on the walls being given to it, as from *b* to *c*, fig. 194. A flat arch may be substituted for the lintel, as fig. 194. If this is used, as the whole strength depends on the mortar, it will be advisable to use cement of a good quality and hoop-iron bond. As evidence of the amazing increase of transverse strength obtained by the use of cement and hoop-iron bond, we here cite an experiment of Colonel Pasley. Brick beams were made 10 feet long, 18 inches wide, 12 inches thick, of four courses, and made to rest on brick piers. The first beam was built with pure cement only; the second with pure cement

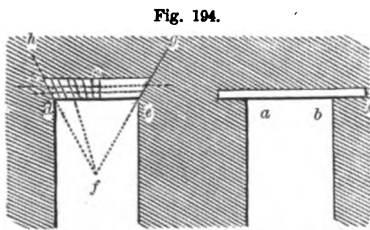

FLAT ARCH AND LINTEL—SCALE, $\frac{1}{4}$ INCH TO THE FOOT.

and hoop-iron bond, two pieces being placed at the upper and lower joints, and one in the centre, thus $\text{—} \text{—} \text{—}$; the third beam was built with mortar only. The

breaking-weight was placed in the centre of the beams, between the two pieces. No. 1 (pure cement) was broken across with 498 lb.; No. 2 (pure cement and hoop-iron bond) was broken with 4723 lb.; No. 3 (mortar only) took a weight of 459 lb. only to break it.

963. *Arches*.—To enter fully into the “theory of equilibrium” of arches, would be beyond the scope, and exceed the limits of this work; we shall therefore only refer to a few forms of arches of ordinary occurrence.

964. An arch is the disposition of the building materials in a curved form, the mutual pressure of which enables them to support large weights pressing upon them. In fig. 195 the wedge-shaped blocks *a* to *a* are termed the *voussoirs*; the central *b* are the *key-stones*; the line formed by the external surface of the blocks *c* to *c*, the *extrados*; the line formed by their internal surface, *d* to *d*, the *intrados*, or *soffit*. The distance from *d* to *d* is called the *span*, that from *f* to *b* the *rise* of the arch. The parts receiving the thrust of the arch *c* and *c*, or those from which the voussoirs, *a* to *a*, spring, are called the *abutments*.

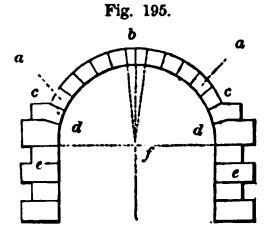

DISPOSITION OF THE PARTS OF AN ARCH
—SCALE, $\frac{1}{4}$ INCH TO THE FOOT.

965. The flat arch illustrated in fig. 194 is applicable to narrow openings, where the weight of materials over them is not great. Great care, however, should be taken to get a proper slope or bevel to the bricks, or a “skew-back,” as it is termed. To proportion this, let *d e*, fig. 194, be the width of opening; from *d* and *e*, with *d e* as radius, describe arcs cutting in *f*. From *f* draw lines *f d*, *f e*, forming an equilateral triangle with *d e*; and continue them to *g* and *h*. All the joints of the bricks should converge to the point *f*. To insure good construction, the use of parallel bricks should be carefully avoided. The bricks should be rubbed to the proper shape, so that, when placed in their respective situations, the whole joints will lie close to each other. If parallel bricks are used, their upper joints naturally open. If cement is used, the work should be quickly done, as it sets rapidly; possibly the better way will be to use blue lias mortar. Arch bricks of the proper bevel and curvature are now made to suit arches of all sizes.

966. In all cases where the opening is wide, or a large amount of material is resting above it, as in the case of openings near the ground-level, circular, elliptic, or segmental arches must be constructed. In fig. 196, a segmental arch is illustrated at *a b*, a semicircular arch at *c d*. The bricks, to insure good construction, should be carefully rubbed; but to lessen the amount of the opening of the joints at the upper ends, it is considered a good plan to divide the depth of arch into two concentric circles or arcs. Thus, a 9-inch arch may be made up of two rings of half-bricks, as from *a* and *d*, fig. 196.

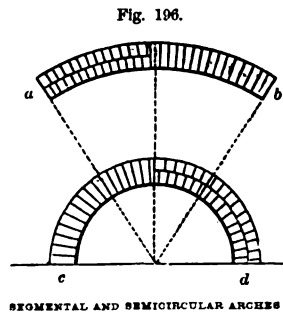

SEGMENTAL AND SEMICIRCULAR ARCHES

967. *Hollow Walls of Brick*.—We now, in concluding our remarks on brick-work, present a few notes on the construction of hollow walls. These may be constructed of the ordinary solid bricks, so arranged as to present cavities in the direction of their length, or the bricks themselves may be hollow. In whatever way constructed, the “principle” is so good, that it should be adopted in all cases where the important advantages of security from damp and the saving of

material are desired. To the agriculturist the prevention of damp, which hollow walls insure, is alone of great importance.

968. We shall first notice the methods adopted to construct hollow walls with the ordinary solid bricks. In fig. 197 we illustrate Dearn's method of building 9-inch hollow walls. In this method the courses, up to the ground-level, are built in old English bond. The next course immediately above is formed of two rows of stretchers *a b* laid on edge. The next course above this of a row of headers, *c d*, laid on their flat side, edge to edge. The saving of material by this arrangement is considerable, and the saving of mortar also; for it is evident that the spaces between the edges of the row headers, as *c d*, which lie over the hollow beneath, have no mortar between them; so that, in fact, a hollow wall from top to bottom is secured. In fig. 198 we give an illustration of a method of building an 11-inch hollow wall. By driving in wood

Fig. 197.

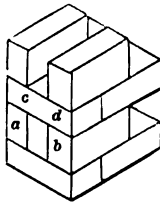

DEARN'S HOLLOW 9-INCH WALL—SCALE, $\frac{1}{4}$ INCH TO THE FOOT.

Fig. 198.

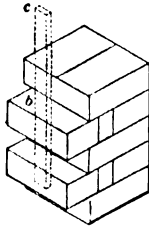

11-INCH HOLLOW WALL—SCALE, $\frac{1}{4}$ INCH TO THE FOOT.

nailing vertical battens, as *c*, on which to nail boarding laths, the advantages of a double hollow wall may be obtained. If this is not adopted, and the inside is wished to be plastered, the expense of laths may be saved in this form of hollow wall, as the hollow spaces will afford excellent "keys" for the plaster to be secured to the walls. In fig. 199, we illustrate a method of building a 14-inch hollow wall, constructed by placing a row of two stretchers and a header on opposite sides of the wall.

Fig. 199.

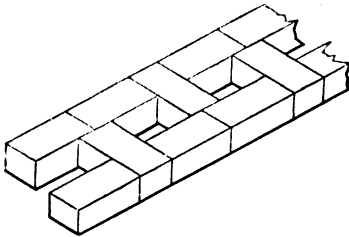

14-INCH HOLLOW WALL—SCALE, $\frac{1}{4}$ INCH TO THE FOOT.

969. Another, and, since the introduction of improved machinery, a more generally adopted method of forming hollow walls, is to use hollow bricks. A great many forms of this species of brick have been introduced. In figs. 200 to 211 we give various views of Roberts' patent bonded hollow bricks. "By the forms adopted in the patent hollow brick-work, a perfect bond, running longitudinally through the centre of the wall, is secured; all headers and vertical joints passing through it are avoided; internal as well as external strength is obtained, and every facility given for fixing the floor-plates and other timbers; whilst, by the parallel longitudinal cavities, ample security for dryness is afforded, and great facility is presented for ventilation, as well as for the conveyance of artificial heat, the transmission of pipes, &c." The size adopted by the patentees makes the work look bolder than ordinary brick, three courses rising 1 foot in height, the length being 12 inches. The number of joints is thus reduced one-third. Nine of the hollow bricks go as far as sixteen ordinary bricks. Not the least advantage of this and other forms is the extreme lightness, insuring a large saving in the cost of carriage.

970. We now present a few illustrations of this important system. In fig. 200, we give the representation of an elevation of dwarf wall, of which, in fig. 201, we give a section. The section of a 14-inch hollow wall is shown in fig. 202. 9-inch walls can be built by the use of the "external patent bricks," one of which is shown to the right of fig. 203, along with the "quoin

970. We now present a few illustrations of this important system. In fig. 200, we give the representation of an elevation of dwarf wall, of which, in fig. 201, we give a section. The section of a 14-inch hollow wall is shown in fig. 202. 9-inch walls can be built by the use of the "external patent bricks," one of which is shown to the right of fig. 203, along with the "quoin

brick," shown to the left of same figure; and the "jamb brick" to the right of the following fig. 204. Where walls thicker than 9 inches are required, the form of brick shown in the centre of fig. 203 is used in conjunction with the

Fig. 200.

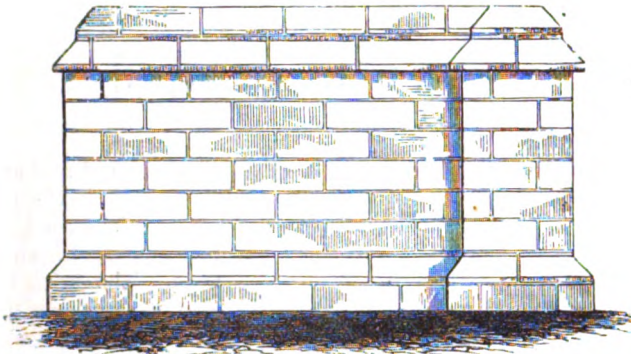

ELEVATION OF DWARF WALL IN ROMAN'S HOLLOW BRICK.

Fig. 201.

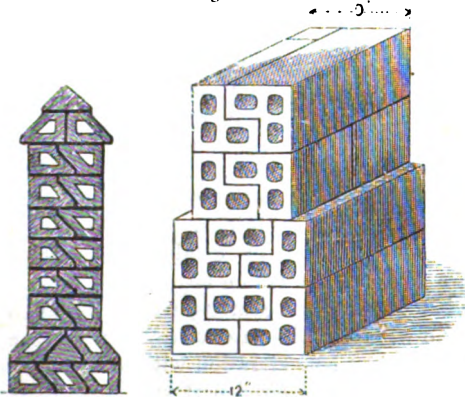

SECTIONS OF 12-INCH HOLLOW WALL.

Fig. 202.

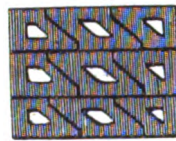

SECTION OF 14-INCH WALL.

Fig. 203.



VIEWS OF "EXTERNAL JAMB" AND "CENTRE" HOLLOW BRICKS.

Fig. 204.



VIEWS OF JAMB AND CHIMNEY HOLLOW BRICKS

others just described. The form of brick shown to the right of fig. 204 is used for internal jambs and chimneys, and is $8\frac{3}{4}$ inches long. The two other stretchers in this figure show how one or two angles may be chamfered in the process

of making by the same die. The form of brick seen to the right of fig. 205 is used for 4½-inch partitions, of which fig. 206 is a sectional elevation.

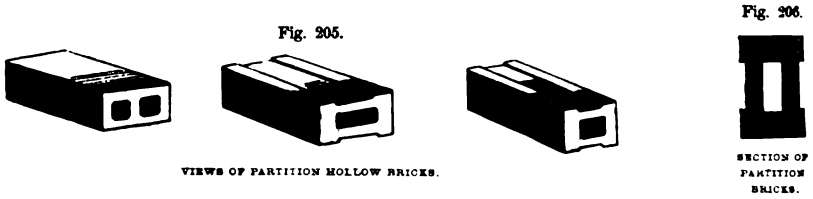

VIEWS OF PARTITION HOLLOW BRICKS.

SECTION OF PARTITION BRICKS.

These bond with the splayed bricks, and answer for floor and roof arches where the span does not exceed 7 feet. The form of brick shown in the centre of fig. 205, is used for 5½-inch partition walls, also for arch bricks used for floor and

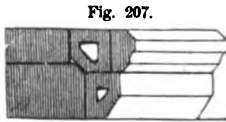

HOLLOW BRICK FOR DOOR JAMBS IN ALTERNATE COURSES

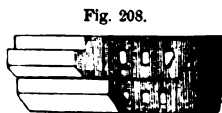

HOLLOW BRICK FOR DOOR JAMBS IN ALTERNATE COURSES.

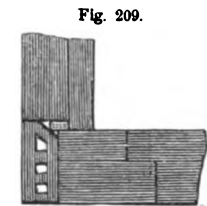

PLAN OF ANGLES FOR DOOR JAMBS IN ALTERNATE COURSES.

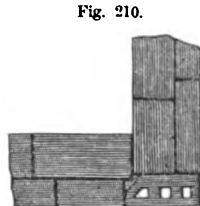

PLAN OF ANGLES FOR DOOR JAMBS IN ALTERNATE COURSES.

roof arches, of from 7 to 10 feet span. The brick to the left is also used for partition or internal walls, with web to give extra strength, and to adapt them for using on edge in partitions of 3¼ inches thick, to rise

in 6-inch courses. The method of setting these hollow bricks for window and door jambs on alternate courses is shown in figs. 207 and 208, and the plans of angles on alternate courses in figs. 209 and 210. Much economy is said to result from the use of these patent bricks. The inventor, an architect of established reputation, states

that 9 patent hollow bricks of the size before described—viz., 12 inches in length, and calculated to rise 1 foot in three courses, will do as much walling as 16 ordinary bricks; whilst the weight of the patent bricks but little exceeds that of the ordinary bricks—an important consideration with reference to carriage, and ease of handling. If niched at any desired part with a sharp-pointed hammer, they will break off easily, and the angles may be taken off with a trowel as readily as those of a common brick. The bricks for the quoins and jambs may be perforated for ventilating purposes, with perpendicular holes, either square, circular, or octagonal. As to the saving effected by their use, the following comparative statement of a rod of ordinary bricks, and a rod of the patent, will afford some information:—

4000 ordinary bricks at 20s.,	£4 6 0
2450 patent bricks at 25s.,	3 1 3
Saving in bricks per rod,					<u>£1 4 9</u>
4000 ordinary bricks at 24s.,	£5 3 3
2450 patent bricks at 30s.,	3 13 6
Saving,					<u>£1 9 9</u>
4000 ordinary bricks at 28s.,	£6 0 5
2450 patent bricks at 35s.,	4 5 9
Saving,					<u>£1 14 8</u>

Being about 29 per cent in favour of the patent bricks, and of 25 per cent in mortar and labour. The following test as to the strength of the hollow bricks may be interesting: six bricks of good quality were put together so as to form a pier 1 foot long, 1 foot high, and 9 inches wide; the external sides being $\frac{3}{4}$ ths of an inch thick, the internal $\frac{1}{2}$ ths of an inch thick, it was found that a weight of $6\frac{1}{2}$ tons caused a slight crack, only perceptible by sound, which did not increase until $8\frac{1}{2}$ tons were placed on them. With 9 tons the horizontal beds gave way, the perpendicular sides remaining unbroken, and without any tendency in the bricks to separate. This experiment was made at the eminent architects and builders, Messrs Cubitt, of Gray's Inn Road, London. Roberts' patent bonded hollow bricks are also well adapted for partitions, as also for forming fireproof ceilings and floors, as shown in fig. 211. The external springers are of cast-iron, connected by wrought-iron tie-rolls. The space above the arch, as at *c*, is filled in with concrete, and finished with a boarded floor *b b*, resting on narrow fillets; or tiles may be used, or the patent bonded bricks.

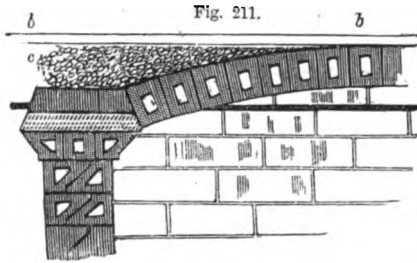

FIRE-PROOF FLOORS AND CEILINGS IN ROBERTS' HOLLOW BRICKS.

971. *Grooved Bricks.*—In order to secure a better bond in brick-work, bricks are now often made with a depressed or hollow part in the flat side, as at *a*, fig. 212, or grooved, as at *b b*. The depressed portions afford keys for the mortar.

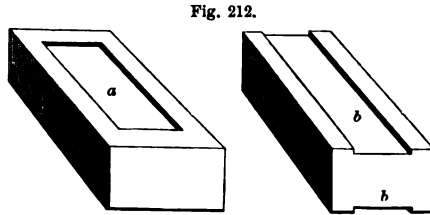

Fig. 212.

GROOVED BRICKS.

972. *Large-sized Bricks* are now frequently used. They save mortar, and a building is quicker erected.

973. In fig. 213 we illustrate Norton and Borrie's hollow brick, *a*

Fig. 213.

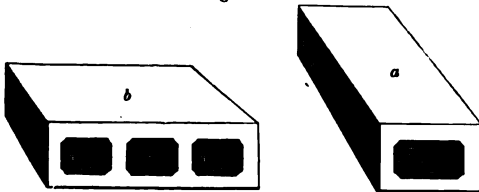

NORTON AND BORRIE'S HOLLOW BRICKS.

Fig. 214.

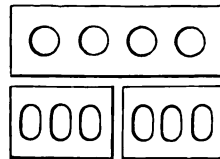

DEAN'S HOLLOW BRICKS.

being a stretcher, and *b* a header. These are rectangular, and can be built in the ordinary way, or hollow, as by any of the methods illustrated in figs. 204, 205, or 206.

974. In fig. 214 we give a section one-fourth of full size of hollow bricks made by Thomas Dean, Wishaw and Coltness Brick-works. The header is perforated in a different manner from the stretchers. In fig. 215 we give a section of a hollow tile for lining walls or for making partitions. They are recommended by the Association for promoting Improvement in the Dwellings and Domestic Condition of Agricultural Labourers in Scotland.

Fig. 215.

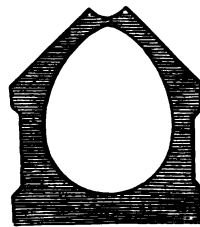

STEWART'S PARTITION TILE.

975. SECTION FOURTH—*Embankments—Dams—Weirs.*—Our remarks on the subject of embankments will be confined to the consideration of those constructions of comparatively minor importance—as those for rivulets, the protection of river banks, and of parts exposed to the action of the sea—premising that much of the information already given on the subject of “Foundations,” and that which is to follow on “Footings,” will be applicable to the construction of embankments.

976. In order to determine the dimensions of an embankment adapted to the peculiarities of a locality, the *highest point* to which the water of the rivulet had ever reached should be ascertained from the best evidence which can be obtained; and if the embankment is made 1 or 2 feet higher than that point, the land may be considered as being placed in safety. The next consideration is the distance of the site of the embankment from the brink of the water. In every place where the bed of the stream is narrow, and where, of course, the flooded current will attain the greatest height, the embankment should not only be higher, but farther removed from the edge of the stream. Where the bed of the stream, on the other hand, is broad, and there is ample space for a slow though deep current, the embankment may be safely placed nearer the water's edge. But the safest plan in all cases is to afford sufficient room for the water, as much loss has been occasioned by overflowings of rivers, even when embanked, by contracting the channel between the embankments on opposite sides of rivers too much, from a mistaken desire to reclaim a piece of land from the river-bank; forgetting that, in proportion as the river increases in depth, by confinement between the embankments on both sides, its power to do mischief is greatly increased; and it may even overcome the strength of the embankment, when the injury committed will be more serious than if there had been no embankment at all. The best policy, therefore, is to give the river sufficient room to flow, and also to remove all sudden turns in its course against which the water may strike with force, or be reflected with violence against the opposite bank. Let all curves of embankments, whether concave or convex to the river, present surfaces along which the water will flow in unbroken sweeps, not in all places conformably, perhaps, to the *natural* form of its channel, but the form of the channel should be made with easy sweeps, by taking away portions of the bank on one side, and filling up deep bends on the other.

977. Fig. 216 gives a vertical section of such an embankment as may suffice to keep off the swollen water of a small rivulet. It is formed of turf derived

Fig. 216.

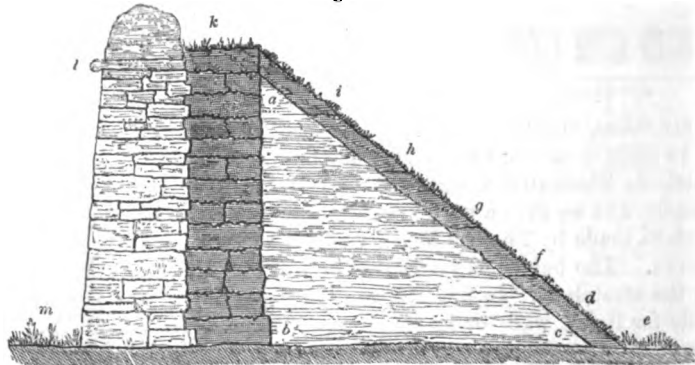

EMBANKMENT AND FACE-DIKE AGAINST A RIVULET.

from the river's bank, and faced with a stone dyke to prevent its being injured by stock on the side of the field, where the dyke answers the purpose of an efficient fence. The line of the embankment should be marked off with pins, and the turf raised along the breadth of ground to be occupied by the embankment. In raising the turf, that intended to cover the *face* of the embankment next the stream should be at least one foot square, unbroken, and tough; and if the river-bank does not afford turf of this description, it must be obtained elsewhere, and brought to the spot. The turf to build the face-wall may be of any description possessing tenacity at all. The turf for the sloping bank should be cut with beveled edges, so that each turf may overlap two lower turfs with two of its edges—the one edge, the lowest, overlapping in the direction of the slope of the bank, the other overlapping in the direction of the flow of the water of the river. These circumstances settling the proper and relative position of the turfs, the embankment should begin to be constructed at the lowest point down the stream, and carried upwards; and it should also be begun at the water's edge, and carried upward to the top of the slope.

978. Suppose the turf wall *a b*, fig. 216, to be 4 feet in height, then a breadth of 5 feet from *b* to *c*, being the base of the slope of the embankment, may give sufficient stability to the structure, and slope to the face. The line *b c*, however, will vary according to the nature of the ground on the river-bank. In a steep part it may be less than 5 feet, in a gentle slope it will retain its proper length, and in a sudden and narrow hollow it may be necessary to fill up the hollow altogether, in order to make the bank uniformly even, in which case the slope may have to be built up from the very edge of the water. The first operation in the actual *construction* of the embankment is building the turf-wall *a b*, the sods of which are laid with the grassy face downwards, on the same principle as breaking joints in masonry. As the wall proceeds, earth is taken from the field in spadefuls to pack behind it, and to fill up the entire contents of the embankment included within *a b c*. This earth should be free of stones, and if disposed to rise in lumps, should be chopped small with the spade, and beaten firmly with a wooden beater. After a sufficient quantity of earth has been placed behind the turf wall, the turfs of the slope *c a* are then begun to be laid at the lowest point *c*, where the first turf *d*, with the grass side upmost, is made to grip under and abut against the sward *e* of the river-bank by a notch cut out of the latter with the spade, the object of the notch being to plant the edge of the turf *through* the sward, to prevent the water getting hold of it and carrying it away. Another turf *f* is made to overlap with its lower edge the upper edge of the turf *d* just laid, and the earth is brought behind it with a trowel, or with the hand, to the shape of the slope *c a*. In like manner, the turfs *g*, *h*, and *i* are laid one after the other, till the top of the turf wall *b a*, and the top of the slope *c a*, are reached at the same time, when a thick turf *k*, with the grass upmost, covers the top of the wall, and finishes the slope. When the turfs are cut square, and all of the same size, which they should scrupulously be, they are quickly and evenly laid. The whole of the turfs are then beaten firmly down with the back of the spade. It will be concluded from this description that the building of the turf wall should proceed in advance of the laying of the turf upon the slope. In conjunction with the turf work, the building of the stone dyke *l m* may proceed, and finish the whole embankment at once. Such a dyke as is here required is called the *single-faced* dyke, having only one finished face, towards the field, with broad projecting covers and a strong cope.

979. The cost of making an embankment, 4 feet high in the wall, 5 feet

broad in the base, and casting the turf for it, the materials being all at hand, is 1s. 4d. per rood of 6 yards. If the turf has to be brought from a distance, the cost of its carriage, and casting, of course, involves a greater expense. The cost of building the face-dyke five quarters high will be 8s. per rood of 30 lineal yards, and the quarrying and carriage of the stones will be as much, or $9\frac{1}{2}$ d. per lineal yard.

980. Such an embankment should be constructed at as early a period of the season as possible, to give the turf time to grow together before the occurrence of the earliest flood. In a very dry summer the turf may become brown, when water should occasionally be thrown upon it with a scoop from the rivulet; and in any kind of season it is possible that a turf will die here and there, when it should be removed, and a fresh one substituted. Until the turving becomes converted into a thick and tough sward, it should be frequently inspected, and every gap in it plugged up, whether occasioned by accident, such as the feet of cattle trespassing from the opposite side, or the burrowing of animals, such as rabbits or water-rats. In the succeeding season the grass will grow luxuriantly upon the embankment, when it may be mown early in summer, to give it time to grow to a thick sward before winter. After this period the earth will become quite firm, and the embankment require nothing more than a general supervision every year.

981. In fig. 217 we give a section of a form of embankment recommended

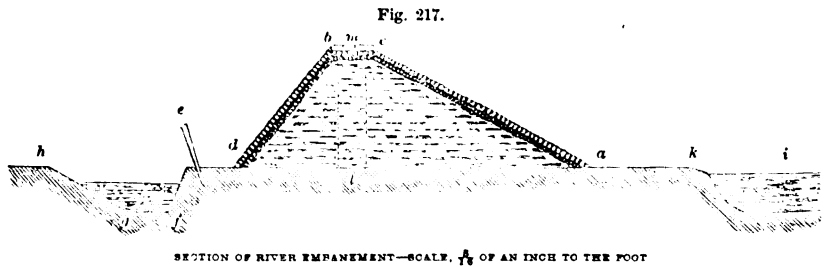

by Mr Johnstone, for low ground on the side of rivers. The slope of the embankment towards the river from *a* to *c* should be longer than that of the land side, as from *b* to *d*. The base of an embankment, as *ad*, should be three times its height, as *lm*; the width *bc* at top one-third of the height *lm*. The distance of the foot *a* of embankment from the river, as the distance *ak*, is shown in the figure at 10 feet; and all trees, brushwood, &c., should be removed from the space, as these may shake the earth and render it loose, and give admission to the water. The earth to form the embankment should be taken from the land side, none from the river; this obviates the necessity of breaking and loosening the surface next the river. The earth may be taken from adjoining heights, or from the ditch *hg*; which is formed at the back of the embankment, to lead the surface-water from the field. A paling or fence *e* should be put up at the outer side of the scarcement *de*, to prevent cattle from going up and trampling upon the embankment, until it be consolidated and well swarded. The slope of the embankment in this case is supposed to be covered with grass turf; but, in the absence of this, a stone facing may be adopted.

982. The body of the embankment may be formed of the earth in the immediate neighbourhood, care being taken to beat it well down; but for better security, and to prevent all leakage—which, in time, endangers the stability of

the embankment—a puddle-wall should be placed in the centre, as shown by the dotted lines from *l* to *m* in fig. 217.

983. Some writers state that, in founding the embankment, all that is necessary is to remove the turf from its site; it is obvious, however, that this only holds where the subsoil is impervious and retentive. If it is light and porous, admitting the water easily beneath the embankment, it is absolutely essential to make a complete union between the subsoil and the lower courses of the embankment. This will best be effected by sinking a trench as broad as the embankment, the trench being deep enough to reach the retentive soil. Should a central puddle-wall, as represented by *m l* in fig. 217, be used, it will only be necessary to make the trench wide enough for the wall, the embankment on either side resting on the unturfed soil.

984. As the stability of the embankment depends upon the thorough incorporation of the mass of earth which forms it, no pains should be spared to secure this. The materials should be placed down in thin layers, and each well rammed down before the next is superimposed. Mr Thom, the well-known engineer of the Shaws Waterworks, Greenock, recommends embankments to be formed of alternate layers of earth, clay, or other soil, with small stones or gravel, forming a species of artificial puddingstone. The great point to attend to is securing the materials from the attacks of rats and other vermin; once these effect a lodgment, the deterioration of the embankment commences; holes are rapidly formed, into which the water enters gradually, washing away all soft material it meets with. Care also should be taken to preserve throughout the embankment the proper slope or angle of its sides; to insure this, a wooden template or mould should be made to guide the workmen in laying down the materials.

985. We have hitherto referred only to turf as the material for facing the slopes of embankments; but in exposed situations the river-side will be most effectually protected when a stone facing is employed. This facing may be made thus: over the whole of the river-slope place a layer of broken stones, not less than 8 inches deep; ram these well down. Over this rubble-stones are laid, and continued upwards beyond the line where the waves dash at their highest: if carried over the top and down the land side, the embankment will be secured from the ravages of vermin. This, however, will be so expensive, that it will be sufficient to stop the stone facing near the top of the river-slope. To secure a good bond between the stones of the facing, piles or short stakes are driven into the face of the slope at intervals, and a row close together at the bottom line.

986. "When the surface and subsoil are both of a gravelly nature," says Mr Sutter, C.E., in his Prize Essay on "River Embankments," in the *Transactions of the Highland and Agricultural Society* for 1858, p. 317, "the work of embanking becomes then very unsatisfactory, and the water will filter through, should the flood continue for any length of time, or else bubble up from below. Many methods have been adopted to prevent this, but all attended with considerable expense. I have used the following method, and it has been attended with success. A drain *a*, fig. 218, was cut behind and alongside the embankment 4 feet deep, and filled with clay from an adjoining hill. Clay, however, is very expensive when it has to be used in large quantities, and may not readily be procured; and even this method would fail after a time, as the water would still percolate below this trench. Again, the most effectual way would have been a wall of clay *b c*, fig. 218, from the top of the embankment. . . . If no clay can be procured, then take as much of the

soil as will at least cover the face of the embankment from *d* to *e*, even though it should have to be made up with gravel. The whole face will

Fig. 218.

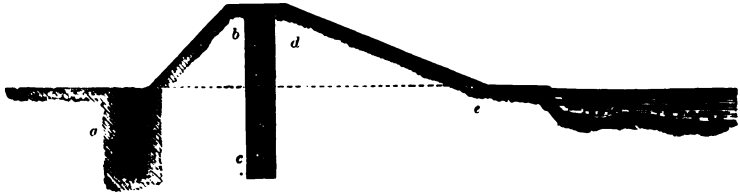

THE MOST EFFECTUAL EMBANKMENT ON A GRAVELLY BOTTOM.

require to be turfed; for, should any breakage take place on the face, the gravel forms such a bad element that it will all go by the run. A ditch is sometimes formed behind the embankment for leakage water; this, however, unless under certain circumstances, should not be formed, it merely weakening the stability of the whole by breaking the surface, and causing the water to leak more readily from the bottom of the ditch."

987. Where the banks of a river are perpendicular, and composed of loose or friable earth, the best plan to prevent the continual washing away by the action of the river, is to slope the bank, as shown in fig. 219, from *a* to *b* to the

Fig. 219.

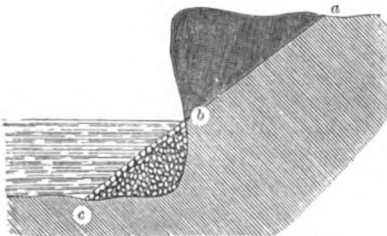

CUTTING OF RIVER-BANKS TO PREVENT WASHING AWAY.

surface of the water. This should be done early in spring, and the slope covered with turf, or sown "very thick with the seeds of some small mat-rooted grass: the creeping meadow-grass (*Poa reptans*) is a proper grass for this purpose." The breast of the bank, from *b* to *c*, is formed by throwing in small stones about the size of a man's hand, the slope being a continuation of that from *a* to *b*. These stones will be best suited for the purpose if taken off cultivable land, and great

care should be taken to make the slope or face of the heap as smooth as possible.

988. On the use of stones for the protection of river-sides, Mr George Stephens, in his work on *Irrigation and Draining*, has the following: "The sheathing or protecting of river-sides with small stones is so very simple in itself, that, where stones are to be had, there is not the least difficulty in preserving their banks at a trifling expense, provided the injured part be immediately filled. Instead of putting a few cartloads in heaps at random along the affected part, they ought to be laid regularly along the affected part; for, in the first case, they only serve to break the cement, forming partial waterfalls where there were none, whereby the injury is increased instead of diminished; but in the latter case the bank will be secured. Even in districts where stones cannot be had, half the ravages committed by watercourses winding through low grounds might be prevented by timely and judiciously keeping down the perpendicular banks, and sowing or planting the slopes with small-rooted aquatic plants, such as bog-reeds, sedges, water spiderwort, rushes, and seeds of any kind of plants which are known to thrive in and near water."

989. Where the tendency of a river is to scoop out a place, as at *a*, fig. 220, a jetty may be placed obliquely, as at *b*, which will have a tendency to direct the current towards *c*, and prevent it acting on *a*. Care should be taken to place the jetty obliquely to the course of the stream, as at *b*; if thrown out nearly at right angles, as at *d*, the result will be that the water is projected with considerable force against the opposite point *e*, and be reflected with increased force towards *a*. A jetty, thrown out as at *d*, will require, moreover, to be made much stronger than when sloping as at *b*. Jetties, in slow-moving streams, will be best when constructed of stones loosely thrown in, so as to form a bank sloping on either side. Where stones cannot be had, stakes may be driven in some 2 or 3 feet, and closely wattled with brushwood, or fascines, or bundles of faggots. These will gradually arrest silt, floating materials, &c., and in time a bank will be formed.

990. As to this method of placing jetties, Mr Sutter has the following remarks, which demand attention, all the more from his opinions being at variance with other authorities. "A common way of attempting the saving of a side, such as *a a*, fig. 221, from a current, is by placing weirs as in fig. 222, in the

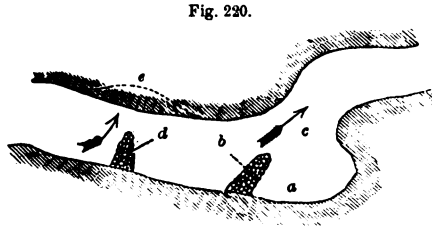

PROTECTION OF RIVER-BANKS BY MEANS OF BREAKWATERS.

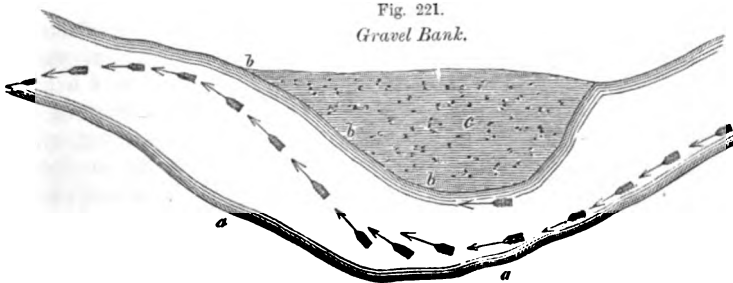

PLAN OF RIVER-BANKS REQUIRING PROTECTION.

hope of directing the current against the opposite side. The water acts upon these weirs, as shown by arrows, merely keeping outside the points, and for the most part turning round in the shape of eddies and undermining them. If the bottoms of these weirs are placed right across the river, say, by laying a tree across, from the weir to *a* as in fig. 223, then the current is thrown as from a dam to the other side, but not without some such means. This latter manner of saving land is far from proper, and, should the stream form a march, often leads to lawsuits; in fact, it ought never to be allowed. The adjoining proprietor should either allow the removal of the sand or gravel bank *c*, supposed



WEIRS FOR PROTECTING RIVER-BANKS.

to be as in fig. 223, or the proprietors at the concave side protect themselves without injuring their neighbours; for, be it observed, the proprietor having the



MINUTE OF A TREE IN THE PROTECTION OF RIVER-BANKS.

gravel bed is always safe—he has a natural advantage which nothing can take away. The current *never* does set towards the side *b b b* of the gravel bank *c*, fig. 221, like the arrows, and it is in general at those places without a current.”

991. Where a rock obstructs the passage of the stream—lying, we shall suppose, in the position shown at *d*, fig. 220—and causes the river to act on the opposite bank *e*, it will be necessary, if this is of a soft and yielding nature, to protect it by throwing in stones, or facing it with fascines or a stone wall. To face with fascines, the brushwood is tied up into bundles, piles or stakes driven in at intervals, and the fascines laid between, and secured to the piles by wattling; or if two or more layers of fascines are used, they should be placed in opposite directions. Thus, if the first row is placed at right angles to the slope, the second should be parallel.

992. *Piling*.—Common piling, for repairing embankments or protecting the sides of rivers, is performed by driving in rows of piles some 2 feet into the river bottom, fig. 224. The top is secured by means of a rail, and the back filled up

Fig. 224.

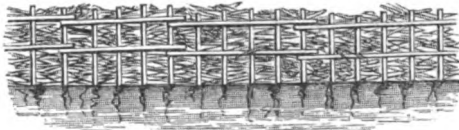

COMMON PILING FOR THE PROTECTION OF RIVER-BANKS.

with boughs and stones. Even when this kind of piling is carelessly done it lasts a long time, especially after it gets silted up. Mr Sutter does not recommend piling at all, but in its place an extremely flat slope, with a rise of 4 to 1, or so, with a flat space, 2 or 3 feet wide, next the river. Should “the whole strength of a river run upon a point, it then becomes necessary,” says Mr Sutter, “to have it protected; and if expense of masonry be too great, piling may be resorted to in the following manner: A good slope having been given the embankment, the piling should be double, and driven, that they be not more than 4 inches between the sides, and having two or more rails upon the face, say 6 inches broad; at least every 5 feet should have a stay, connecting the whole with the face of the embankment, fig. 225, firmly nailed or bolted to all these piles.

Fig. 225.

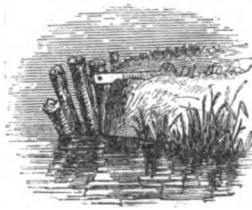

IMPROVED PILING FOR RIVER-BANKS.

This will prevent the piles leaning outward; the space between the piles filled with stones not above 6 inches square, or such a size as will prevent them passing through the piles. If larger stones can be procured, they might be with great advantage placed outside, but never inside (unless the piling be very strong), as they force the piling out in spite of the resistance of the stay. The whole space being thus completed, will resist almost any amount of wear from water, as it gradually fills with sand until it becomes as solid as a wall. When piling is single and

without stays (a very common practice), the water, in my experience, seems to shake the pile until it loses all hold of the bottom; and in gradually shaking the

earth, undermines the ground behind. When packed with brushwood behind, the pile is forced forward, and gradually falls away, leaving the earth bare the whole height of the pile; whereas, had no pile been there, the grass would have grown, and thus naturally have formed one of the best defences against a current: for this reason I object to all piling, except at sharp corners; and even there, with proper construction of embankment, it is unnecessary."

993. *Sea Embankments.*—On the subject of embanking lands from the sea, we now propose to offer a few remarks. In cases where the banks near the sea are perpendicular, and composed of loose or penetrable mould mixed with loose stones, much valuable land above the sea-level will speedily be lost by the continued action of the waves below undermining the soil, and allowing the superposed material to fall in. In cases where the tidal force or the exposure is not great, a sufficient bulwark may be made by giving the face of the bank a considerable slope, as from *a* to *b*, fig. 226, the earth taken from *c* being used to make up the part *d*. This slope may be faced by any of the means already described for river embankments. Where the action of the tide is considerable, stone facing may be used, piles being driven in at intervals to secure a bend; and further to reduce the action of the waves, it will be found beneficial to drive in a

row of piles at the foot of the bulwark, as shown at *e* in fig. 226. This expedient has been found to be highly beneficial in moderating the action of the waves on the face of the bulwark.

994. For reclaiming or protecting low-lying lands from the sea, embankments are raised; in fig. 227 we give a section of one form of embankment for this purpose. Before proceeding to form the embankment, the exact level of the highest tides should be ascertained, and the height of the embankment should exceed this by 2 feet. Stakes of the proper height should then be driven in along the whole line of embankment. Two frames of timber should then be constructed of the exact form of section of the embankment, and set up some 20 or 30 feet distant from each other. As the whole surface of the sea is on a level, it is essential that the upper line of embankment present a true level parallel to the horizon; to insure this, the two frames above mentioned should be set on

a level. The construction of the embankment should then be begun. As on many shores, sand, debris of various kinds, collect very rapidly, it is recommended by some

authorities to drive in stakes in the line of embankment, to fix fascines to; the mud, sand, debris, are

Fig. 226.

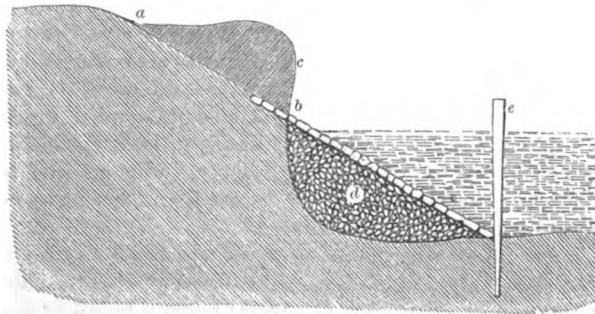

PROTECTION OF SEA-BANKS.

Fig. 227.

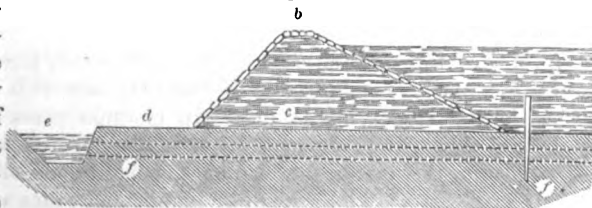

PROTECTION BY SEA EMBANKMENT.

soon collected, and tend to form a species of embankment, which can be finished in due time, in the usual way. Indeed, an extension of this system will sometimes suffice to form a permanent embankment. This is done by forming rows of wicker-work, well staked down, and by filling up the intervals with brushwood, &c., so as to form as regular a slope as possible from the water. As the tide passes through these materials, they collect and arrest the sand, mud, &c., and as they accumulate, the embankment will rise, so as ultimately to exclude the tide at all times.—(JOHNSTONE'S *Draining*, p. 171.)

995. "As the pressure of water," says the above authority, "upon an embankment against the tide, is different from that in the current of a river, it is not necessary to have it so straight, or of that uniform smoothness which is requisite where a running stream is to glide along the side of it. It is unnecessary, however, to give it such turns and windings, or to embrace all the points and indentures of the verge next the water, which would lengthen its course, and increase the expense; but it may be carried as near the edge of the land as it is possible to obtain a safe and permanent foundation. In forming the bank, the breadth, height, and strength, must be made in proportion to the depth and weight of water it may have to resist; and in order to obviate resistance, and to lessen the pressure, the more the slope towards the water approaches to a degree of flatness, the greater will be the firmness and durability of the structure. In difficult cases, it is advisable that the surface next the water should form an angle to a perpendicular line of from 40 to 60 degrees, according to the force to be opposed, and the nature of the materials of which the mound is to be constructed."

996. As regards the materials of which sea embankments may be constructed, Mr John Wiggins, a first-rate authority on this subject, after reviewing the nature and constituents of several usually found in sea-districts, says, "On the whole, it must be concluded, that of the materials for a sea-bank, tenacious clay is the best, and loose sand the very worst. All the intermediate modifications of soil will have their respective merits or demerits, but they will be eligible in proportion to their ponderosity, their cohesiveness, and their power of resisting the action of water, either in penetrating or dissolving them; and these soils will be ineligible in proportion to their lightness, their looseness, and their aptitude to run or to blow away when dry, or to melt when wet. A mixture of materials, bad and good together, when in a wet state, would probably reduce the whole mass to an eligible condition; and although the expense might be thought too great at first, it might be found economy in the end, and the mixture might be effected by the tread of horses without much labour, previously to the material being laid up on the bank. In cases, also, where the material is not very trustworthy, an artificial dyke of concrete or common puddling might be carried up in the centre of the bank, of such width, and commencing at such depth below the shore-level, as the case might require."—(*The Practice of Embanking Lands from the Sea*. By JOHN WIGGINS, F.G.S. Weale, London. 2s.)

997. Where the embankment is much exposed, the safest facing is stone. When this is used, it is advisable to finish the face with a layer of well-puddled clay before the stones are laid on. In medium cases of exposure, after the clay is laid down, the face may be carefully covered with turf. In cases of least exposure, the material of which the main body of the bank is made will answer for the face. The growth of plants and grass which have a tendency to bind the soil on which they grow, may be encouraged. The ordinary couch-grass will be found admirably adapted for this purpose.

998. Stones should be carefully removed from the foot of the embankment, as they cause eddies, which tend to undermine the base. A "footing" of gravel laid along the base-line, more especially if subjected to pressing action, as when used for a road, is recommended by Mr Wiggins as an effectual means of preventing the sea undermining or "pecking" the bank. When the bank is constructed of sand, this gravel footing consolidates it, "and checks the soakage under the bank—a service of the very utmost importance for the purpose of preventing its blowing up."

999. To maintain a good breadth of what is called "foreland"—that is, the portion of shore before the embankment—is a point of importance. "There is certainly," says Mr Wiggins, "no feature appertaining to a sea-bank of greater importance than this, since it acts against, as the advanced guard to the bank itself receives, the first shocks of the sea, and deadens its force upon the bank by decreasing the depth and bulk of the wave. The broader, therefore, the foreland, and the higher the shore above the low-water mark, the greater its protection to the bank. In Essex, a county so famous for its sea-walls, the foreland generally stands several feet above low-water mark, and some hundreds of yards outside the bank; and where it wears away, its edges are scarped and stoned, to prevent the loss of so valuable a defence to the sea-wall."

1000. The drain *e*, fig. 227, should not be too near the foot of the inner slope, as the water continually resting against the soil is apt to percolate through and undermine the embankment. The distance *d*, from the foot of the embankment *b c*, Mr Wiggins recommends to be 12 yards, the depth of the drain *e* 4 or 5 feet, the width at top 12, and at bottom 6 feet—the water to stand 2 feet below the surface. In very loose sandy soils it is not advisable to have a drain cut as a substitute for it. A slight rill may be allowed to "carry off the soakage from the bank, which, in such a soil, must be considered as inevitable."

1001. It does not form part of the plan of this work to give descriptions of drainage or irrigation works, further than of those parts which come under the head of construction, as culverts, sluices, &c. We have therefore little more, under the head of drainage of the "intake" of reclaimed or embanked lands, to say, than that the discharge of the land-water to the sea is effected by drains or culverts passed through the bank, as shown by the dotted line *f f*, fig. 227. For the construction of these, see remarks on culverts, &c., in the succeeding Section; and for notes on valves or flood-gates, see Section on "Timber Construction."

1002. *Dams—Weirs.*—As a conclusion to this department, we now propose to consider briefly the construction of dams and weirs. In cases where water is to be led off directly from a river to the mill-race, the supply of water being at all times considerable, the velocity slow, and the stream liable to few sudden torrents, a dyke of timber thrown across the stream obliquely will in many cases be all that is necessary. This dyke may be constructed after the manner recommended by Mr Findlater, and described in his prize essay on the "Construction of Reservoirs of Water for Agricultural Purposes," published in vol. xii. of the *Transactions of the Highland and Agricultural Society*, p. 314. Figs. 228 and 229 will illustrate the method: *a*, fig. 228, shows the oblique position of the dyke, *b b* the mill-race; *c*, fig. 229, the piles or stakes driven into the bed of the river, and placed at a distance of 5 or 6 feet apart. A strong or cross piece *d* unites the heads of the piles. A facing of wood planks, 2½ inches thick, is nailed closely to the piles. This planking faces up the stream, and is opposed to the direction of the current, as shown by the arrow. The timber-work thus made is backed up with rubble *f f*, having a slope of not less than 45

degrees. The face *ee* of this rubble backing should be formed of stones set on edge, and close laid. The rubble backing *ff* should be started at least 2 feet

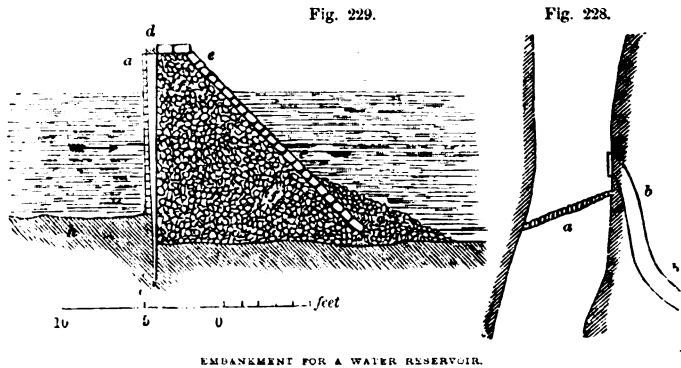

below the line *h* of the natural bed of the river. A complete junction with the ends of the dyke and the sides or banks of the stream should be secured; this will be effected by cutting out parts, and carrying in the piles and backing for some distance. A not uncommon practice is to place the mill-race *b b*, fig. 228, at the acute angle of the dyke *a*, whereby all the refuse that floats in the water finds its way to the sluice of the mill-race, and of course entails the trouble of having it to remove frequently.

1003. Where the stream is rapid and liable to torrents, the dyke or dam must be constructed in a more substantial form, entirely of stone. The worst way in which to construct this, is to lead directly across the stream at right angles, and in a straight line; the section at the same time answering the form of a triangle, the two sides sloping to a point. "A dyke of this form and structure," says Mr Johnstone, "must be very insufficient, and liable to be disarranged and thrown down by the force of running water pressing upon and falling over it. The upper stones are first lowered and carried down, and the water, striking with velocity on the whole face of the dyke, precipitates itself with violence against those at the bottom, and displacing them, the whole structure is soon demolished. Dams that are erected at still greater expense, of hewn stone, but of a similar construction, are also liable to be destroyed (although in a lesser degree), if the lower side is formed with a slope or inclined plane. The water in this case does not insinuate itself in such a body among the stones that are joined as it does when they are loosely laid together, as in the first-mentioned case; but still the force of the falling water has such effect upon the undermost layers of stone, that in time it cannot fail to undermine and displace them. The first error in all these kinds of stone weirs is the carrying them in a straight line across the river or stream. They should be constructed so as to form an arch across the bed of the stream, with the convex side upwards, the ends resting on strong abutments placed in the bank on both sides, fig. 231. By this means the force of any body of water, however great, will be effectually resisted, and the structure be perfectly firm and secure. The greater the slope towards the upper side the better, but the lower side should be nearly perpendicular, that the water may fall over it like a cascade, without coming in contact with the face of the building." A pavement of considerable breadth, and well laid, should be placed before the under-side; this will receive the falling water, and

will prevent its action in undermining the wall. In fig. 230 we give a section, and in fig. 231 a plan of this form of dyke or weir, as recommended by Mr Johnstone.

1004. Great care must be taken to secure a good foundation for the wall. (See our remarks on Foundations in a preceding Section.)

The dimensions of the wall *a*, fig. 230, will be regulated by circumstances: if the height is 12 feet, the breadth at bottom should be 6, and at top 2. Every care should be taken to well-bed the stones, and hydraulic cement should be used to make good the joints. The top of the wall must be exactly level throughout its whole extent, so that the water, in times of flood, shall go over the weir in a stratum of equal thickness, and so prevent any undue action on one part more than another, which would be the case if this precaution was not taken. The top should be provided with a coping of flat stones, projecting slightly over the face of the wall: if stone cannot be had, planking may be substituted; in either case it is essential to have the coping as smooth as possible, free from all irregularities of surface.

1005. To prevent the action of the water on the upper face of the wall, a layer of clay *b* should be well rammed down against its whole height and length. This clay should extend lower than the foot of the breastwork. An apron of gravel *c* thrown down before the clay, presenting as great a slope as possible, will still further prevent the action of the water on the dyke.

1006. Where the water of a small rivulet, or that of drainage, passing through a valley or gorge, is desired to be retained for ornamental or domestic purposes, an embankment of the form shown in fig. 217 may be constructed. The points noted relative to the construction of embankments already described will be applicable to this. Every care should be taken to consolidate the successive layers of soil as they are laid down, and the embankment should stand for some months after it is finished before the water is let in.

1007. In fig. 232 we give at *a* a section of a dam or weir, and at *b* a section of a protective groin for a river-side, as used in Italian irrigation. We are indebted for these illustrations to Captain Baird Smith's work on this subject.

1008. During a recent visit to the Orkneys, we noticed a curious specimen of a sea-wall in the harbour of Wick. In this the stones—of the flagstone series—instead of being placed on their flat sides, or "broad-bed," are raised on end "like staves in a pail or barrel, so that at some little distance the work looks like as if formed of upright piles or beams jammed fast together." Mr Hugh Miller, who thus describes it in his *Rambles of a Geologist*, gives the reasoning on which Mr Bremner, the engineer who carried out this style of work, founded the principle of operation. Referring to the standard rule of masonry, that the

Fig. 230.

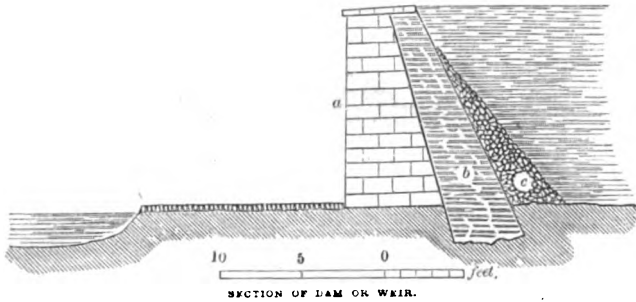
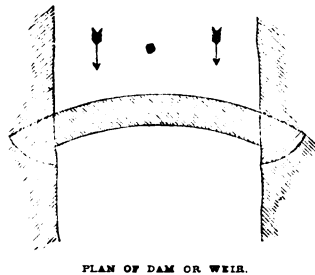
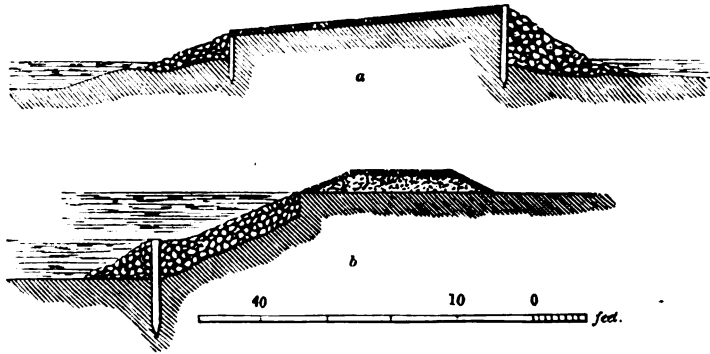

Fig. 231.



“broad-bed of a stone being the best, should always be laid below,” Mr Bremner says, “A good rule for the land, but no good rule for the sea. The greatest

Fig. 232.



SECTION OF GROIN (b) AND DAM (a) FOR PROTECTING A RIVER-SIDE.

blunders are almost always perpetrated through the misapplication of good rules.” “In a coast like ours,” he continues, “where boulders of a ton weight are rolled about with every storm like pebbles, these stones, if placed on what a workman would term their ‘vert beds,’ would be scattered along the shore like sea-wrack by the gales of a single winter.” “In setting aside the prejudice that what is indisputably the best bed for a stone on dry land, is also the best bed in the water or an exposed coast, I reasoned,” says Mr Bremner, “thus :—The surf that dashes along the beach in times of tempest, and that forms the enemy with which I have to contend, is not simply water, with an onward impetus communicated to it by the wind and tide, and a reactive impetus in the opposite direction—the effect of the backward rebound, and of its own weight, when raised by the propelling forces above its average level of surface. True, it is all this; but it is also something more. As its white breadth of foam indicates, it is a subtle mixture of water and *air*, with a powerful upward action—a consequence of the air struggling to effect its escape; and this upward action must be taken into account in our calculations as certainly as the other and more generally recognised action. In striking against a piece of building, this subtle mixture dashes through the interstices into the interior of the masonry, and, filling up all its cavities, has, by its upward action, a tendency to *set the work afloat*; and the broader the ends of the stones, of course the more extensive are the surfaces which it has to act upon. One of these flat flags, 10 feet by 4, and 1 foot in thickness, would present to this upheaving force, if placed on end, a superficies of but *four* square feet; whereas, if placed on its broader base, it would present to it a superficies of *forty* square feet. Obviously, then, with regard to this aerial upheaving force, that acts upon the masonry in which no precautions are usually adopted to bind it fast—for the existence of the force itself is not taken into account—the greater bed of the stone must be just ten times worse over a worse bed than its lesser one; and, in a tempestuous foam-encircled coast such as ours, this aerial upheaving force is, in reality, though the builder may not know it, one of the most formidable forces with which he has to deal. And so,” concludes Mr Bremner, “on these principles I ventured to set my stones on end—on what was deemed their *worst*, not their *best*, beds—wedging them all together like staves in an anker, and there, to the scandal of all old rules, are they wedged fast still, firm as a rock.”—*Rambles of a Geologist*, p. 384.

1009. SECTION FIFTH—*Culverts—Drains.*—We shall now offer a few remarks on the form and construction of culverts and drains. In many cases, such as in the sluices of sea embankments, the culverts are made of wood, elm being generally chosen for this purpose; in constant wet it lasts a long time. In Essex the sluices are generally made of 2 or 3 inch plank, the usual dimensions being 2 feet high by 1½ wide.

1010. In districts where stone is easily obtained, the culverts may be made of the form as shown in fig. 233. Culverts of this form should not be made of greater dimensions than 18 inches in the clear. If a larger size is required, a brick arch may be thrown over the top, as shown by the dotted lines. A brick drain with angular bottom, as in fig. 234, may be made at an expense of 2s. per lineal foot, or thereabouts. The cover is of rough slab.

1011. Culverts of the form and dimensions shown in fig. 235 may be constructed at the rate of 14s. per lineal foot; this includes brickwork only, not excavation. -

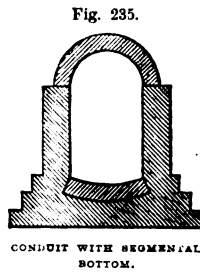
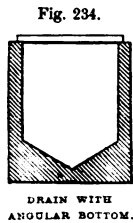
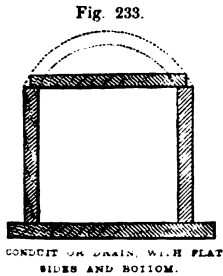

1012. *Form of Section of Conduits or Culverts.*—All conduits through which water has to flow, should possess a form calculated to increase the rapidity of that flow, and to reduce the friction. For this purpose, a drain with a right-lined section is infinitely inferior to one with a curved-lined section. A curve encloses a greater space within its perimeter than can be obtained by the same length of right lines, so that a circular or curved drain will present less surface to any given amount of liquid flowing through it, than will be presented by a drain rectangular in section. Thus the friction of a circular tube 2 feet 3 inches

in diameter being represented by 7, the friction of a rectangular opening 2 feet by 2 is represented by 8, while an opening of 4 feet by 1 is represented by 10—the area of opening in all cases being the same. Again, in all conduits in which the quantity of water flowing through varies, it is necessary to preserve at all times the greatest possible depth of fluid. This depth cannot be obtained in a flat-bottomed drain, as in fig. 233, to a like extent with the form in fig. 236, the same quantity being spread over a much greater extent of surface in fig. 233 than in fig. 236. Moreover, as all conduits have to sustain the pressure of the surrounding earth, those of

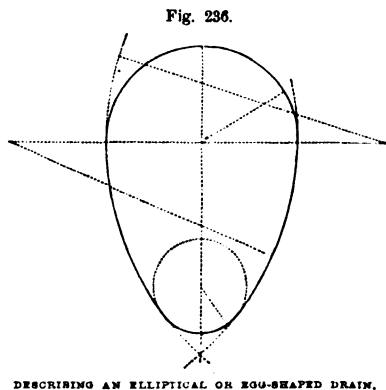

circular or curved sections are better capable of resisting this pressure than those of flat or rectilinear sections.

1013. Taking as the theoretical requirements of conduits the three points:— (1.) The least possible interior surface with the greatest possible area; (2.) Preservation of the greatest depth of flowing water with the least quantity; and (3.) The capability to resist the pressure of the surrounding earth with the least amount of constructive material;—the form known as the “egg-shaped” or “elliptical,” has been found in practice to be the most economical and efficient, and that which very closely possesses those three requisites noted above.

1014. We are indebted to Weale’s *Engineer’s Pocket-Book for 1855–6*, p. 147, for the following method of setting out this form of conduit:—

“ If the diameter of top arch	=	.1
Let the diameter of invert ditto	=	0.5
And the total depth = the sum of two diameters, or	=	1.5
Then the radius of the arcs which are tangential to the top arch, and the invert will also be		1.5

From this formula any two of the elements can be deduced from one being known. Thus, if the total depth is intended to be 6 feet, then the diameter of top arch will be 4 feet, and that of the invert will be 2 feet, and the radius for the side connecting area will also be 6 feet.” Assuming the cost, as before stated, of the form of sewer illustrated in fig. 235 to be 14s. per lineal foot, the cost of an egg-shaped sewer, as in fig. 236, of equal capacity, will be 10s. only, the thickness being equal to one brick length.

1015. The objection urged against conduits of curved section is, that unequal and open joints are caused by the manner in which the bricks have to be laid. Much of this objection can be met by taking the precautions we have

Fig. 237.

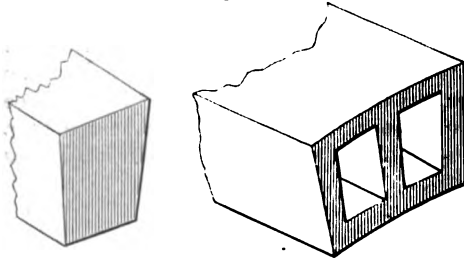

SEGMENTAL BRICKS FOR DRAINS.

already pointed out, in Section Third, as necessary to be attended to in constructing arched work. The objection is, however, wholly met by the use of the radiated bricks, of which, in fig. 237, we illustrate one or two forms. These are now manufactured at a price very little above that of ordinary bricks, and suited for conduits of various sizes. These bricks require less cement than ordinary ones, and give perfectly

parallel joints. In fig. 238 we give a section of a “patent junction block,” manufactured by Doulton & Co., Lambeth Pottery, London. Each block is made to bond with the brickwork of the culvert or sewer, the inner surface corresponding to the curve. A socket is provided, either within the thickness of the block, or projecting a little beyond it. This socket is so constructed as to receive a junction-pipe, either straight or oblique to the line of culvert. In fig. 239 we give a view of an “invert block” made by the same firm. This is made of glazed stoneware, and forms an excellent foundation for the culverts, figs. 234, 235.

1016. For conduits from 9 to 18 inches, stoneware tubes may be used with advantage. Every care should be taken to secure a good bedding for the tubes, and to make good the joints. For these purposes nothing exceeds well-puddled clay. Cast-iron pipes will in many cases be found eligible.

1017. In laying down culverts a proper fall should be given to them of not less than half an inch in every 10 feet—this being increased in the case of junctions. All junctions should be curved, never made at right angles. In our remarks on foundations and footings will be found all necessary information applicable to the construction of culverts, the digging of the trenches, and the setting of the materials, use of cement, &c. We are therefore spared the necessity of entering further into the subject here.

1018. *Liquid-Manure Conduits* should be built with stone and lime walls, 9 inches high and 6 asunder, flagged smoothly in the bottom, and covered with single stones. Fig. 240 shows the form of this sort of drain, and sufficiently explains its structure. As liquid manure is sluggish in its motion, the drains require a much greater fall in their course than rain-water drains. They should also run in direct lines, and have as few turnings as possible in their way to the tank. The same remark (1012) as to the superiority of the curved form over that of the right-lined, applies to these conduits as to those for other purposes.

1019. *House Drains*.—In fig. 241 we give an illustration of the spigot and faucet, or socket drain-pipes, where *a a* is the spigot-tube, and *c c* the faucet of the tube *b b*. Although this form is the most generally adopted, it is open to serious objections. The cement or clay used to make good the joint is very frequently pushed into the inside of the pipe when the two lengths are laid together; this causes ridges to be formed in the interior of the drain, making a permanent obstruction, or forming a nucleus at each joint, around which the solid sewage-matter soon accumulates. In the *Minutes of Information on House Drainage*, issued by the Board of Health, containing practical information for the guidance of builders, &c., it is stated that well-mixed clay has been found to be a better material for making the joints good than cement—an opinion which we have long entertained. In laying socket-jointed pipes, care should be taken to pass down a wooden plug nearly the diameter of inside of drain, the plug being attached to an iron rod. This operation, performed as every three or four lengths are laid, will clear the interior of any cement or clay. It is also necessary that the pipes should have each a full bearing given them, and not to allow the plain ends to “bond,” or rest entirely on the socket, as, by doing so, the pipes are exceedingly apt to be broken. To obviate the inconveniences arising from the use of socket-jointed drain-pipes,

Fig. 238.

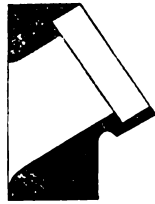

DOULTON'S PATENT JUNCTION BLOCK FOR DRAINS.

Fig. 239.

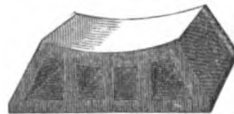

DOULTON'S "INVERT BLOCK."

Fig. 240.

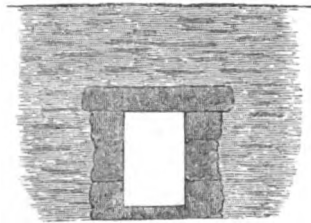

LIQUID-MANURE CONDUIT.

Fig. 241.

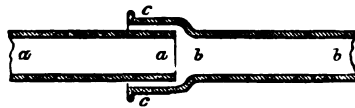

SPIGOT AND FAUCET DRAIN-TUBE.

Mr Austin has proposed a half-socket joint, to be manufactured either with a half socket at one end only of each length, or at the lower half of both ends; to be used alternately with a length without any socket. This form is shown in fig.

Fig. 242.



242. The advantage to be derived from this arrangement, is that the half sockets form a bed or foundation in which the plain pipes are laid, not pushed in, as in the full socket-pipe; thus every joint, as it is made, is open to inspection; and, in case of accident or faulty joint-making, any one length of pipe can be taken up without disturbing the others. One objection, however, to all socket-jointed pipes is, that the projection of the socket acts as a species of fulcrum for the lever formed by the adjoining length of pipe, which may be subjected to disturbance by the passage of heavy carts over the ground above it. This displacement is, however, obviated, by using what is termed the "conical-jointed pipe." These are laid down in alternate lengths, the small end of one being inserted in the large end of the other. When these are smoothly made, they form excellent drain-tubes. Constructed of the durable material known as Peake's "Terro Metallic," they will give much satisfaction. Drain-tubes with the "rabbet joint," as in fig. 243, form a very tight, and not

Fig. 243.

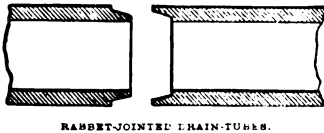

easily disturbed, line of drain. Forming one continuous line, they lie evenly in the bed. In order to give sufficient thickness to admit of the "rabbet" being formed, more clay is required than in the socket-jointed pipe, but they are more easily made. A form of drain-tube joint has been recently introduced by Mr Clayton, a view of which is given in fig. 244, by which it will be seen that one end of the pipe is cored out, whilst the other end is turned down to suit.

Fig. 244.

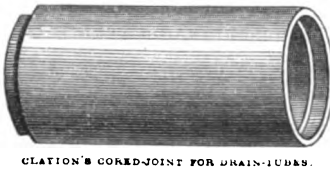

These pipes, when laid together, form a perfectly flush joint. The address of the patentee is, Atlas Works, 21 Upper Park Place, Dorset Square, London. Where it is a desideratum to have the range of drain-tubes as absolutely water-tight as possible, the tubes should be gently pushed down upon a bed of well-puddled clay; the space on each side, and to a height of at least 6 inches above the crown of the tube, should next be filled in with the same material forming the bed. The tubes, thus completely embedded, will remain very satisfactorily placed, even in circumstances where heavy vehicles may pass frequently over the line of tubes. Where the strata through which the tubes are to be laid are irregular, they may be much straightened by the use of collars, where the tubes are what are called "butt-joints"—that is, each length of tube similar to its neighbour, and the ends squared off. These "collars" are also very useful in repairing breakages of tubes, when these happen between the joints.

1020. *Lidded Drain-Tubes.*—By far the best method yet introduced for enabling the interior of drains to be examined and cleansed, at any one point, without disturbing the series, or any part of the invert of the tubes, is that in which they are provided with movable lids or covers. Several parties have introduced tubes of this description. We select the plans of Messrs Doulton & Co.,

and Mr Cooper. In fig. 245 we give a section, and in fig. 246 a perspective sketch, of Messrs Doulton's (High Street, Lambeth) lidded pipes.

Fig. 245.

SECTION OF DOULTON'S LIDDED
DRAIN-TUBES.

Fig. 246.



PERSPECTIVE VIEW OF DOULTON'S LIDDED DRAIN-TUBES.

1021. The thickness and strength of the pipes are increased by two ribs running lengthways, through which a partial division is effected in the process of manufacture, both internally and externally, leaving sufficient material to preserve strength and soundness. The pipes are thus fired in one piece, and perfect accuracy of form is secured. By the insertion of a chisel at the ends, the upper pieces may, at any time, be detached without the slightest risk, and afterwards replaced, so as to form a perfect and accurately fitting cover; or the lids can be removed when the pipes are laid, and the drain tested as to its fall and the accuracy of the joints before they are replaced. The following may be stated as the advantages possessed by pipes of this sort:—"These pipes may be laid whole as ordinary socket pipes, and the covers need only be removed should necessity arise. On the removal of the lids the drain is laid open throughout its entire length, and may be cleaned without disturbing any part of the invert. The advantages of inspection are obtainable without any imperfect joints or other complication, which would allow either the escape of the liquid contents of the drain, or the entry of the surrounding soil. The capacity of the drain is not lessened when under examination, as is shown by the cross section, fig. 245. The introduction of junctions is facilitated. The upper part or cover being fired in one piece with the pipe, fits with a perfection and accuracy only possible by this peculiar mode of manufacture, and it cannot shift laterally. Perfect truth of form is secured, and increased strength obtained."

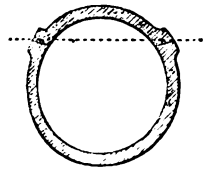
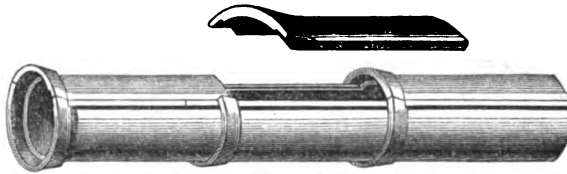
1022. In fig. 247 we give a sketch of the method of laying Mr Cooper's (Fac-

Fig. 247.

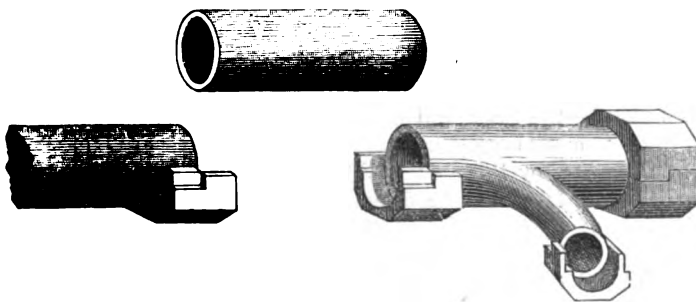

PERSPECTIVE VIEW OF COOPER'S LIDDED DRAIN-TUBES AND SADDLES.

tory, Wootton, Isle of Wight, or 150 Leadenhall Street, London) pipes, which are of the "butt joint" kind; "chairs" being used to connect the length of pipes. In fig. 248 we give views of the "chair." Mr Cooper states the advantages of his system to be as follows:—"They provide ready access to any part of the

drain, for examination, without disturbing any other part, or point of the invert, of the drain. The pipe, being laid on the under connection, butts the adjoining

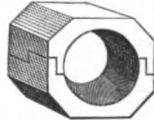

FIG. 248.
PERSPECTIVE VIEWS OF SADDLES FOR COOPER'S LIPPED DRAIN-TUBES.

pipe at the middle of the connection; the pipes are therefore kept perfectly straight in the drain. Should any pipes be not quite exact in size, arising from the difference of the shrink in burning (which is often the case), their being joined on an even surface at the middle of the under connection, will necessarily throw any irregularity to the top of the drain, thereby obviating the necessity of the use of the mop, and making the invert perfectly fair and even, not liable to be obstructed or injured by running sand, sinking of the earth, or the action of external water. By the use of the under connection singly, the full advantage that half sockets, single or double, may be considered to be, is secured to every pipe."

1023. SECTION SIXTH—*Construction of Dry-Stone Dykes.*—Very many dry-stone dykes in this country are constructed on erroneous principles, the stones being laid promiscuously, and more with a view to give a smooth face than a substantial hearting to the wall. The coping, too, is often disproportionately large for the body of the wall, which is not unfrequently too narrow for its height. We suspect that many dry-stone dykes are built by ordinary masons, who, being accustomed to the use of lime-mortar, are not acquainted with the bedding of the loose stones of a dry dyke as firmly as they should be, and therefore are unfitted to build such a dyke. A builder of dry-stone dykes should be brought up to the profession; and when he has acquired skill he will build a substantial one, at a moderate cost, which will stand upright for many years. A proper sort of stone is a great assistance to the builder of stone dykes, flat thin ones being the best: but flatness and thinness are not the only requisites; they should also have a rough surface by which to adhere to one another in the wall; and no material, on this account, is so well adapted for the purpose as the stones derived from sandstone boulders of gravel deposits, when split with the pick into flat pieces of the requisite thickness on being taken out of the ground, and which, on being exposed to the air for a short time, become dry and hard.

1024. Dry-stone dykes are measured in height by quarters—that is, quarters of a yard, of 9 inches each. A 5-quarter dyke is the usual measure of a field-fence; that is, 45 inches, or 3 feet 9 inches, to the under side of the cover upon which the cope-stones stand—the cover and cope-stones usually measuring 12 inches, so that the dyke stands altogether 4 feet 9 inches in height. The dyke, when finished, is measured by the rood of 36 square yards upon its face under the cover, so that every 30 yards of a 5-quarter dyke will be 1 rood in length. The usual thickness of such a dyke is 2 feet at the base, and 15 inches under the cover.

1025. A dyke that has two plain faces is called a double-faced dyke, and a dyke with one face, as one built against a sunk fence, is called a single-faced dyke. A double-faced 5-quarter dyke requires 1 ton of stones for every square yard of its face, so that 36 tons of stones are required for every rood of 30 yards long. The expense of quarrying that quantity of stones is about 10s. the rood; the carriage of them at a reasonable distance beyond one mile is also 10s.; and the building is commonly undertaken, when the stones are good, at 10s.

also; so that such a dyke costs 30s. the 30 yards, or 1s. for every yard in length, or £6, 9s. 6d. per cubic rood, or 3s. 7d. per cubic yard. The best way to contract for the erection of stone dykes is by the rood of 36 cubic yards, when every temptation on the part of the builder to lessen the breadth, and make the heart of the dyke hollow, will be removed.

1026. The tools of a dry-stone dyker are few and inexpensive, consisting only of a mason's hammer, a frame as a gauge for the size of the dyke, and cords as guides for the straightness and thickness of the dyke. A ditcher's shovel is also useful to him in putting the shivers of the stones together into heaps, to be the more easily removed by carts.

1027. A dyker cannot work in wet or in very cold weather, as handling stones in a state of wetness is hurtful to the bare hand; on which accounts, dry-stone dykes are commonly built in summer.

1028. The line of fence being determined on, it is marked off with a row of stakes driven firmly into the ground. The upper soil, to the depth it has been ploughed, is removed from the line to form the foundation of the dyke; and it may be driven away immediately, and not lie in the builder's way, or it should be formed into a compost with lime, near the spot, for top-dressing grass. When the surface consists of old firm thick sward, the dyke may be founded upon it; but in forming foundations, it should be borne in mind that dykes are apt to sink in soft earth of every kind, to its injury—not merely by curtailing its height as a fence, but by twisting its structure and causing it ultimately to fall. When the soil consists of vegetable mould, it should therefore be removed altogether, and its intrinsic value in a compost will amply repay the trouble of removing it.

1029. After the foundation has been formed by the removal of the earth, the stones should be laid down on both sides as near the line of foundation as practicable, for it is of considerable importance to the builder that the stones be near at hand. When the stones are laid even as far off as two yards from the foundation, the builder loses time in throwing them nearer; but, on the other hand, no stones should be emptied from the cart into the foundation, as they will have to be removed by the builder before he commences his work. Large boulder-stones form excellent material for the foundation of stone dykes, and should be laid close to the foundation before the building stones are brought. In laying down the stones, the carters should be instructed to put down 18 tons on each side of 30 yards length of the foundation; and when boulders are also put down, allowance should be made for them out of the building stones. These particulars are worth attending to, to save unnecessary trouble afterwards in removing or bringing stones, to the annoyance alike of the dyker and the farmer.

1030. The simplest mode of conveying large boulders is upon a sledge, shod with iron, which is better than putting them in and taking them out of a common cart, the bottom and sides of which are apt to be broken by boulders. A pair of horses, yoked as in a plough, will draw a very heavy boulder upon such a sledge, on the ordinary surface of the ground. When many ordinary stones are driven for buildings, of any kind, the carts should receive an extra bottoming and lining with deals of common Scots fir, or of willow, which is better than any other sort of wood, as being softer and less liable to split.

1031. Every preparation being thus made, two builders proceed to the work, one opposite the other—the best number to make the best work, and they assist each other with stones which one would not be able to manage.

1032. They begin by setting up the frame, fig. 249, at one end of the dyke,

whether it commences against another fence, or at a gateway into the field which the figure is supposed to represent, in the foundation of the proposed

Fig. 249.



THE BUILDING A DRY-STONE DYKE.

line of dyke. The frame is made of the breadth and height of the proposed dyke under the cover; and is set perpendicularly by the plummet attached to it. A corresponding frame should be placed beyond the point which is fixed for one stretch of building, or two stakes driven into the ground, having the same inclination as the sides of the frame, to answer the purpose of a temporary one. On undulating ground, a space of half a rood, or 15 yards, between the frames, is a sufficient stretch of building at one time; but on level ground a rood may safely be taken in. The cords are then stretched along the space, and fastened to the outside of each frame, to guide, as lines, the building of the side of the dyke straight, and to gauge its breadth. The frame is held upright and steady by a stiff rail, having a nail driven through one of its ends, hooked on to the top-bar of the frame, and the other end with a stone laid upon it, or pushed into the ground.

1033. When the dyke begins with a scuncheon, as in this case, a large boulder should be chosen for its foundation stone; and if there are no boulders, a large stone should be selected and dressed for the purpose, as no better protection can be given to the end of a dyke—and especially so when the scuncheon forms one side of a gateway to a field. Another boulder, or large stone, should be placed at a little distance from the first, and smaller stones used to fill up the space between them, until the building is raised to the height of the boulders.

1034. Great art is required in laying the small stones, and it is this art in dyke-building which detects the good from the bad builder. In good dry building, the stones are laid with a slight inclination downwards, from the centre of the dyke, towards each face, and to break band with one another; and to support their inclination, small stones should be wedged firmly under them in the heart of the dyke; whereas stones that are laid flat admit of no wedging to

heart them, and receive none, to the risk of the dyke bulging out in both faces. The inclination causes the rain which may have found its way down through the top of the dyke to be thrown off by both sides.

1035. The stability of a dyke is much assisted by having what is called a *thorough-band* stone, placed across it at about half-way up the building. The cover also acts as a thorough-band at the top of the dyke; but in laying the cover, the levelling of the dyke to form its bed should not be made of very small and very thin stones, as is too often the case, as neither have stability, are easily broken, and are constantly in danger of slipping out from under the cover and cope. Thorough-band stones are frequently left projecting from one or both sides of the dyke by some builders, merely to indicate that they are thorough-bands; but the practice is objectionable, inasmuch as such projections serve only as stepping-stones for trespassers to climb over the dyke.

1036. A scuncheon should be formed of in-band and out-band stones, hammer-dressed, and firmly bedded upon one another.

1037. The covers should project an inch or two beyond the face of the dyke, to protect the top. They should be 2 inches thick, and without a flaw throughout their length, which should be 2 feet at least, that their weight may keep them firm and their size cover a large space of building.

1038. In forming the cope, a large stone should be placed at the end of the scuncheon to keep down the cover, and act as an abutment for resisting the wedging down of the smaller cope-stones. Another large cope-stone should be set at a short distance from it upon the joining of two covers, to keep them secure. Thinner stones should then be placed on edge between these—and wherever they meet, a stone should be wedged in by strokes of the hammer; but the wedging should be delayed until a considerable length of coping is finished, the better to resist its force. The cope-stones should be nearly all of the same height. On finishing the face of a dyke, small stones should be firmly wedged in with the hammer, where room can be found, between the beds and the ends of the larger ones.

1039. In building a stretch of dyke, such as the rood above referred to, it is customary to carry up the building at both ends, as well as at the middle of the stretch, to the levelling of the top, before the intermediate spaces are built up, because those primary parts, being built thus independently, act as pillars in the dyke to support the intermediate building plumb; and they are also convenient for pinning the cords against while the intermediate spaces are being built.

1040. When a few stretches of dyke have thus been finished, the surplus stones, if any, should be removed, and laid where they are wanted; and should there be a deficiency, stones should be immediately brought, to allow the builders to finish one stretch before they proceed to another. The debris of stones caused by the hammer should be taken to repair roads.

1041. These are all the particulars to be attended to in building dykes for ordinary fencing; but modifications are sometimes introduced into their form to serve a convenient purpose. For example, an opening should be left under the cover of a dyke, of a sufficient width and height to allow sheep to pass from one field into another, when the passage between them by road may be a considerable distance. Where a passage exists between the fields by means of a gate, no such opening should be made, but only when the two fields are entered by different farm-roads. When the opening is not used, it should be stopped up with thorns or a wooden board. An opening of $3\frac{1}{2}$ feet wide and 3 feet high will suffice.

1042. Another convenience is to leave a gap at the top of the dyke by lowering its cover and removing the cope at a place where a passage is occasionally required for foot-passengers. By doing this the dyke may be saved from much injury. A gap near the top of the dyke may be useful as a stile in the line of a footpath, or at the side of a cover, for hounds and huntsmen to pass with ease; and here the whipper-in may stand on the outlook for a break-cover. When not constantly in use, the gap is easily fenced with a bunch of thorns or whins.

1043. Such dykes as we have been describing, of 5 quarters in height, will fence horses and cattle and Leicester sheep, but will not confine blackfaced sheep, and scarcely Cheviots. For these, higher walls must be built, or expedients used to make ordinary ones confine them. Some of these expedients are shown in fig. 250, where part of an ordinary dyke with its cope is

Fig. 250.

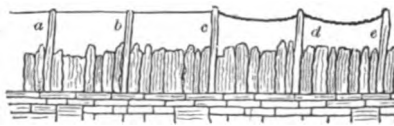

seen; and they consist of occasional cope-stones *a b c d e*, set on edge to a considerable height, say 12 inches, above the ordinary ones, and 4 feet apart. Upon these are placed either fillets of wood along notches made on the top of the stones, and wedged into them, as at *a b c*, or a strong rope of straw is laid somewhat

loosely over the notches to dangle in the wind, and to form a scare to the sheep, as at *c d e*. Another expedient is, where a single-faced dyke is built against rising ground, consisting of plantation or of cultivated land, to sow a few seeds of whin or broom in the soil behind the dyke, and the plants in time spread over the cope-stones. Where good stones for covers are scarce, and turf is tough and heathery, thick turfs, cut of the breadth of the top of the dyke, and laid with the grass side uppermost, firmly and neatly on with cope-stones upon the turfs, which thus afford them a firm bed, will raise a dyke a sufficient height. A more permanent expedient than either of these, where the dyke is built of large strong stones from a quarry, is to erect a wire fence upon the dyke, by batting upright wrought-iron standards into the covers, and stretching three rows of wire through them. Such an addition costs from 8d. to 1s. 4d. per lineal yard. Or stakes might be driven along and close to one face of the dyke, of sufficient length to reach above its covers to receive three rows of wires. Where thinnings of plantations are abundant, this is the cheaper, though less durable plan, than the preceding one with the iron standards.

1044. When dykes run at right angles to one another, and are erected simultaneously, they should be built in connection; but where a new dyke comes against another, the old one should not be touched, and the new built firmly beside it.

1045. Where two dykes cross, and the place is naturally wet, or water may be easily brought to it, a watering-pool there would serve four fields, and the basin for the pools should be formed before the dykes are built. The two dykes cross at the centre of the pond, as in fig. 251, having holes in them to allow the water to pass through, forming a watering-pool in each field, as at *a b c d*.

1046. Where a pond already exists, and its water is too deep for dykes to traverse, the dykes must terminate within its edge, and convert the pond into a watering-pool common to four fields. When the pond *c*, fig. 252, is used by only one field at a time, it should be fenced from the other three fields by means of hurdles or paling, at *f g h*; and when the pond happens to be used by more

than one field at a time, a paling should be run across it from dyke to dyke, besides the fences to the fields not occupied by the stock.

1047. Where the ground is firm, and there is no prospect of obtaining a watering-pool, the dykes should be made to cross, and a well sunk in a corner of one of the fields, with a pump in it of such height as to supply all the fields with water from it by means of a spout into a trough in each field. This expedient we have successfully used.

1048. Where the ground is firm, and no water but shelter is wanted at that spot, the dyke should be built curved, to enclose a space between them to be planted with trees for ornament and shelter. The land here will not be wasted, even should it be of the highest value; because the corners of four adjoining fields always have ground that cannot be reached by the plough, as may be seen between *i k l m*, fig. 253, while the plough can pass along such curves as near as to a straight fence. In building curvatures in dykes, builders charge a half more per rood than for plain work. Such curves in dykes are easily drawn by setting off an equidistant centre for each.

1049. A stone dyke is in the highest state of perfection as a fence immediately from the hands of the builders; but every day thereafter the effect of the atmosphere upon the stones, at all seasons, and the accidents to which they are liable by trespasses of individuals and the fretting of stock, render it necessary to uphold their repairs frequently; and this consideration should cause the best materials and workmanship to be selected for their original construction.

1050. SECTION SEVENTH—*Farm-Roads*.—We do not deem it at all necessary to go into detail as to the methods adopted for laying out a road, so as to secure the most beneficial level, and the nearest route between any two desired points; for all purposes of the farm, the farmer will at once be able to distinguish at what points a hollow place may be filled up, and embankments made from the material obtained from cuttings, and the cases in which the trouble and cost of performing these operations would be repaid by the extra perfection of the road. We shall merely content ourselves with a few hints as to the forms of roads, and the kind of materials which may be employed, leaving the reader to decide, according as circumstances or his own opinions may dictate, as to which of these he may carry out in practice.

1051. Convex roads—that is, roads highest in the centre—have been much recommended, from the facilities which the form presents to the thorough drainage of the surface; the water, it is said, freely running from the centre to the sides. Authorities, however, seem to agree in thinking that the advantages of this have been much over-rated. The principal objection made to it is, that as the centre of the road is the only place at which the vehicles passing over it

Fig. 251.

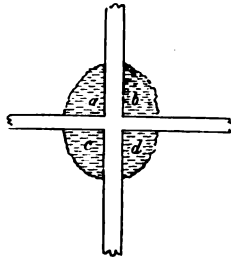

FOUR WATERING-POOLS FORMED BY TWO DYKES CROSSING.

Fig. 252.

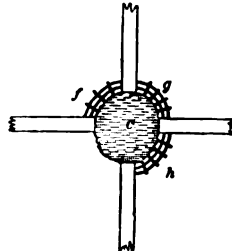

ONE WATERING-POOL COMMON TO FOUR FIELDS.

Fig. 253.

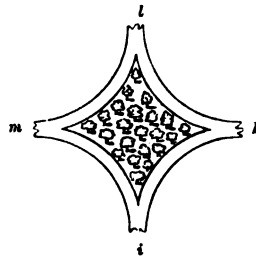

A CLUMP OF TREES WITHIN THE MEETING OF DYKES

can be kept vertical, it is most frequently used, and hence the centre part becomes hollow, affording a receptacle, as it were, for rains to lodge in, and from which it is difficult to run off. Upon the whole, we would recommend the farmer to form the road with a comparatively slight rise in the centre. The materials of which to make a good road-surface may be broken stones, of a size sufficient to pass through a ring 2 inches diameter. These are placed in layers on the road, and well rammed down; the upper surface soon becomes smooth and consolidated by the action of the passing vehicles. Some recommend the depth of materials to be greater in the centre than at the sides of the road; this, however, should not be attended to; on the contrary, care should be taken to make all portions of the road equal in construction and solidity—the aim in a well-laid-out road being to make it serviceable on all parts of its surface for the passage of vehicles. When footpaths are required, they may be formed of a layer of broken stones of size sufficient to pass through a ring 1 inch diameter, with two layers of gravel well rammed down: the surface should slope towards the side drain. In place of ramming the broken stones on the soil which forms the basis of the principal road, blocks of rough stones may first be laid down, and the layers of smaller stones above these. Good gravel is a good material for road surfaces.

1052. In all cases drains should be made at the side (or both sides, if possible), by which to carry off the surface-water. These drains are formed by ditches of sufficient depth to carry away the water, and having a proper fall throughout their length. Where a footpath is made, the surface-water of the main road, and that of the footpath, is taken off by a small gutter formed at the inner edge of footpath, and constructed of blocks of stones: small outlets are made at intervals by which the water is led off through drains placed beneath the footpath to the large side-drain or ditch. Where the side-ditch or drain is of sufficient depth, the soil beneath the road surface will also be drained by it. Beside the side-ditches, a covered drain should run along the middle of the road where the subsoil is of clay, and where there is a burst of water.

1053. In excavating roads, the sides of the excavation should have 2 feet of a slope outwards for 1 foot perpendicular of its height. Where the soil is sandy or gravelly, a greater degree of slope must be given to the sides of the excavation. In forming embankments, each layer, of some 4 feet, should be well rammed: this tends to consolidate the road. The slope given to the sides should be less than that which the materials would naturally assume if left to themselves. The side slopes can be very efficiently protected by encouraging the growth of grass on them. The surface-water from the road must not be allowed to run down the sides, but be carefully let off by properly-constructed side-drains.

1054. Where a road is formed over a sandy soil, the sand may be in a great measure prevented from shifting laterally by digging, at each side of the road, ditches some 30 inches deep, and the same width—filling these up with turf or clay, and well ramming them. This precaution need not be taken where an excavation and strong embankments are made in the sides.

1055. *Construction of Roads on Strong Soils.*—Perhaps the most practical authority on this department of road-making is Mr Bailey Denton, who published the result of his experience in the *Journal of the Royal Agricultural Society of England*, vol. xviii., from which we extract the following points to be attended to in practice: “1st, The road should be perfectly drained by means of surface-ditches, as *a a*, fig. 254, on each side of the formation, and of under-drains, as *d d*, on each side of the metalling. 2d, The formation should be 18 feet wide

at least between the inner edges of the surface-ditches, *i. e.*, from *b* to *c*. 3d, The surface-ditches *a a* should be at least 18 inches deep, with good and suffi-

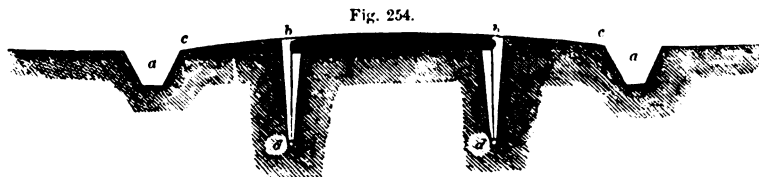

SECTION OF ROAD ON STRONG CLAY SOILS—SCALE, $\frac{1}{4}$ INCH TO THE FOOT.

cient batter or side slopes. They should have a sufficient fall towards existing watercourses, to discharge freely all water that may be run into them, and pipe-culverts protected by end-gratings should be provided at all gateways opening to the road. 4th, The metalling should be 9 feet wide at least, that is, from *b* to *b*. 5th, The under-drains *d d*, should be dug 4 feet deep at least on each side of the metalling, laid with 2-inch pipes, and connected with the culverts or drains crossing the road at every fence and every hollow in the ground; and these cross-culverts or drains should be laid so low in connection with existing ditches (to be deepened, if necessary, for the purpose), that the crown of the cross-culvert or drain shall be no higher than the bottom of under-drain; thus, in fig. 255 *a* is a cross-culvert, *b b* under-drains. At the ends of each cross-culvert

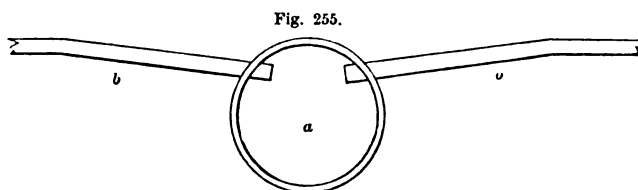

SECTION OF CROSS-CULVERT AND UNDER-DRAINS

there should be an iron grating to prevent the passage of vermin. The under-drains should be carefully filled to the height of the metal bed, with the earth taken out of the drains. 6th, The surface of the road for its entire breadth of 18 feet or more, from *c* to *c*, fig. 254, should be raised above the ground surface in a convex shape. 7th, The height of the centre of the road above the ground surface, should be as near as possible the thickness of the metalling, whatever it be. It is necessary, however, that the ground or base upon which the metalling is placed should be perfectly solid, and, if possible, unbroken. It should be convex, and accord in form with the intended convex shape of the surface of the road itself. 8th, The metalling may consist of two or more layers or strata which, together, should be 9 inches deep at least. This depth will suffice where the materials are of the best sort, but they should be proportionately deeper in cases where the materials are softer and less durable. 9th, The metalling should be of uniform depth for its entire width. 10th, The under stratum or foundation of metalling may consist of any durable, porous, or non-absorbent material, of the depth of $4\frac{1}{2}$ inches at least. It may be judiciously increased where the material required for the upper stratum or covering is very costly, when the depth of the covering may be reduced accordingly. It is not essential that the material for the foundation shall be of uniform size, as long as it lies compact, is well banded, and its surface is even and regular to receive the upper stratum. 11th, The upper stratum or covering should be of the best description of clean stone, or sifted gravel or pebbles, the country will afford. If gravel, it should be screened, to get rid of sand and dirt; and the

larger stones should be broken, so that no particle shall be left on the road exceeding $2\frac{1}{2}$ inches in the largest diagonal line. The depth should be $4\frac{1}{2}$ inches, and should, if possible, be placed on the road in two courses. 12th, The side spaces, 4 feet 6 inches each at least—from *b* to *c*, fig. 254—should be carefully finished off in close conformity with the metalling. The fall thus given from the centre to the sides of the road will insure a perfect drainage of the surface into the side ditches. The side spaces should be seeded and rolled, or beaten down firmly. 13th, There should be no fence that will throw a shadow on the road. 14th, The road, after its completion, should be most rigidly maintained in its convex form; any unevenness should be overcome by the rake, and all ruts and hollows should be kept filled in at once with fresh material, properly broken to the same size as the original metalling; and the side ditches should be kept open and free to discharge the water flowing into them. No water should be allowed to stand on either the metalling or the side spaces, but the water should be got rid of, not by making grips or channels into the side-ditches, but by filling up hollows and ruts, and keeping the whole in its original form."

1056. It will be observed that in these rules, very great stress has been laid upon both surface and under draining. All engineers have acknowledged the advantage of rendering roads dry and unyielding, and considerable attention has been paid to surface-draining; but the importance of under-draining roads by means of longitudinal pipe drains, laid sufficiently deep and near each other to remove soak or bottom water, and overcome as far as possible capillary attraction and suction in the soil, has been overlooked until very recently. A shallow centre drain, called a mitre-drain, was often adopted with good effect, but it failed to render the subsoil dry, and increased the cost of the road considerably. There is but little doubt, however, that the advantages arising from the act of adequately deep under-draining, both in economising materials and in reducing the cost of maintenance, surpass any single appliance of either Telford or Macadam in the practice of road-making. The effect of deep under-drains on each side of the metalling is to render the mass of soil between them perfectly solid and inflexible, so that any metalling, let it be either loose gravel or a close pavement, rides upon it without sinking into it.

1057. "The solid and firm base thus obtained is equivalent to at least one-fourth of the metalling ordinarily put on roads. That proportion which is so frequently sunk and buried in the clay base, is saved; and it has been found that roads carefully formed and under-drained, with 9 inches of metalling, will better preserve their shape, and a hard and firm surface, than roads with 12 inches of metalling without under-draining.

1058. "The practice, too, of laying faggots as a foundation is superseded by under-draining, except in cases of peat-bogs and deep spongy soils, where a layer of faggots is essential as a platform for the materials. In dealing with homogeneous clays, the use of faggots is much to be reprehended. Their elasticity keeps the base of the road in a constant fret and soft state, causing the clay to rise, and the metalling to sink between the branches and twigs of which the faggots are composed."

1059. For other information as to details of construction, cost, &c., the reader is referred to Mr Denton's paper, which abounds in practical information on the subject.

1060. SECTION EIGHTH—*Well-Sinking—Liquid-Manure Tanks—Horse Pond.*
—In well-sinking we confine ourselves to explaining the easiest method of sink-

ing shafts for wells in various soils, refraining from noticing the method of obtaining water by boring through the surface and the various strata, this involving the use of instruments and appliances not easily attainable by the farmer. It is somewhat difficult to decide as to the localities most suitable for sinking a well so as to insure a regular supply of water at a reasonable depth. Mr Swindell (*Rudimentary Treatise on Well-Digging and Boring*. 1s. Weale, London) gives the following as a few simple directions on this point:—"In the early part of the year, if the grass assume a brighter colour in one particular part of a field than in the remainder, or, when the latter is ploughed, if a part be darker than the rest, it may be suspected that water will be found beneath it. In summer the gnats hover in a column, and remain always at a certain height above the ground, over the spots where springs are concealed. In all seasons of the year more dense vapours arise from these portions of the surface, from which, owing to the existence of subterranean springs, a greater degree of humidity gives rise to more copious exhalations, especially in the morning or evening. The springs to which these rules apply are such as are only near the surface." In trap-rock, water is not likely to be found; and in gravel, sand, or rich unctuous clay, digging to a considerable depth will likely be required before water is obtained. Water is most certain to be found in diluvial clay; this, although impervious to water, is here and there intersected with veins of sand, interspersed with small stones, on removing which water is found to ooze, and which may be collected in a pit formed in the clay. The following is the method of digging a well in such a soil: "Let a circle of 8 feet in diameter be described on the surface of the ground, from whose area let the surface-soil be removed to be used elsewhere as compost. After throwing out a depth of 8 or 9 feet with the spade, let a winch and rope and bucket be set up to draw the earth out of the well. While the digging is proceeding, let a sufficient quantity of flat stones be laid down near the winch, by which to let them down to build the ring. A depth of 16 feet will most probably suffice; but if no water is found, let the digging proceed to the requisite depth. A ring of 3 feet in diameter will be a large enough bore for the well: the rest of the space should be filled up with dry rubble masonry, and drawn in at the top to 2 feet in diameter. Whenever the building is finished, the water should be removed from the well with buckets if the quantity is small, and with a pump if it be large, to allow the bottom to be cleared of mud and stones. A thick flat stone, reaching from the side of the ring to beyond the centre, should be firmly placed on the ground at the bottom of the well for the wooden pump to stand upon, or for the lead pipe to rest on. If a wooden pump is used, a large flat stone, having a hole in it to embrace the pump, should be laid on a level with the ground upon the ring of the well; but if a lead pipe is preferred, the flat stone should be entire and cover the ring, and the *clayey* earth thrown over it."

1061. In cases where the well has to be sunk in loose gravel or sand, a different plan has to be adopted. The following is a specification of a method carried out by Mr Wilson, Dumbartonshire: "The diameter of the well to be 3 feet 6 inches inside of the building, and the building, instead of rubble, to be of droved ashlar, each stone 8 inches broad in the bed, 12 inches deep, about 21½ inches long, in the chord of the arc of a circle on the one side, and 17 inches long in a straight line on the other side. The outside of the stones to be formed neatly to a circle, and their inside into an octagon. Beds to be square; ends properly bevelled and wrought correctly to a mould; each course to contain 8 stones of equal size; a ring-board to be formed of willow, not to taste the

water, $8\frac{1}{2}$ inches broad, $1\frac{1}{2}$ or 2 inches thick, and $\frac{1}{2}$ inch larger than the outside circle of the stones. The ring-board could be made stronger in two courses of four pieces of equal size. In building upon the ring-board, the first course of stones to have the centres of their face raised perpendicular to the inside of the ring-board. The centres of each stone of the second course to be placed over the joints of the preceding course, and also perpendicular to the inside of the ring-board. The inside face of each stone being a straight line, the inside diameter of the well being $3\frac{1}{2}$ feet, and the ring-board being correctly made, the inside ends of each stone will be back $1\frac{3}{8}$ inch from the centre of the face of each stone in the course immediately above it, and so on with every course. A small stick, made as a gauge at one end, of $1\frac{3}{8}$ inch length, will be found handy for setting the stones. The outside circle must be most carefully made. The upper course to form a square instead of an octagon for the covers to rest on, and to slope to one side, to carry the water off the top of the well. The covers to be drowed, and in three pieces, one of which to cover the building on one side and half of the well, and to be half-checked where the other two stones meet it in the middle, and they are to be half-checked into it, also half-checked into each other where they meet in the middle, and to cover the other side of the building. One of the stones covering a portion of the well to have an iron ring in it, by which to lift it freely out of the checks of the other two stones. The joints of the covers to be filled with putty well mixed with whitelead, to prevent water from the surface getting into the well."

1062. The method of sinking the well is thus described by Mr Wilson: "I had the stones dressed, drowed to a mould as specified, and all ready before breaking ground, when I made a rod 2 inches longer than the extreme diameter of the ring-board; described the circle on the surface with it, and gave it to the labourer as a gauge, that he might not take out any more sand and gravel than was necessary to let the ring-board in with ease. I had about 5 feet of gravel, which I should always like to go through before laying in the ring-board. There were then 2 feet of fine sand, when water appeared by taking a shovelful out of the centre. I then ordered the ring-board to be put in and levelled, and built upon to the top of seven courses, filling up as it was built the back of each course with fine sand, loosely put in with a shovel, to steady the building when sinking. I then commenced taking gravel out of the centre with a short shovel, and a bucket with a rope attached to it to be drawn up with a winch and handle. In about three hours of an afternoon there was about a foot of water. Next day I commenced taking out a barrowful of sand, and two or three bucketfuls of water alternately, till in other three hours I had got down altogether about 11 feet 6 inches, when the water flowed in so much that I could not proceed further, and it rose to its level of 3 feet 8 inches. The building went down steadily, and did not seem to be an eighth of an inch off the level at which it was first set. Other four courses were then built, and the covers put on, and the pump-frame erected several feet from the side of the well, where an inclined plane and gutter had been formed to carry off the water. The pump I use is a copper chamber, 4 inches in diameter, with brass boxes, and a 2-inch lead pipe attached to the chamber, and laid into the well through the side of the building about 2 feet below the surface."

1063. Where the interior of the wall is faced with bricks—"steined," as it is termed—a simple method of proceeding is as follows: A drum-curb is provided, being a circular frame of wood, with a strong flat ring, of the same diameter as the intended well at top and bottom, the breadth of the ring being equal to the breadth of a brick; the depth of curb is 5 feet or so. The ground being exca-

vated to a depth equal to that of the curb, this is lowered into the excavation. The operation of digging is continued, the curb gradually descending—the excavated earth being removed by buckets lifted by tackle supported above the excavation by a triangular frame. The steining or brickwork is then built on the upper ring of the curb; the bricks are laid without mortar, care being taken to arrange them so as to keep the form of the circle as perfect as possible, each course breaking joint with the one under it. As the sinking of the curb goes on, the laying of the bricks is proceeded with, until the necessary depth is obtained. It is scarcely requisite to point out the absolute necessity of making all wells circular;—the sides of square ones would inevitably be forced in.

1064. Of all the methods in use for raising the water from wells that are of greater depth than when the common pump can be used—namely, 30 feet—that of the ascending and descending buckets (the empty one descending as the full one is being pulled up) forms the simplest. The buckets must be comparatively heavy to allow of their sinking into the water on being let down. The rope to which the buckets are attached is wound round a wooden barrel, revolving on two uprights at each side of the well mouth, and turned by a winch or handle. The well-covering should be made in two halves, opening upwards, and hinged at the outer edges to a wooden frame placed round the mouth of the well. A small space should be left between the edges of the flaps, to admit of the rope passing freely. A small curb-wall should be made round the mouth, in order to prevent surface-water running into the well; and a railing, some 3 or 4 feet high, to prevent children having access.

1065. *Liquid-Manure Tanks.*—Tanks are not required on every kind of farm. On *carse farms*, where much straw and little green food is used, there can be no liquid manure; and on *pastoral farms*, the stock confined in winter in the steading are too limited in number to afford much of that material. On *dairy farms*, on the other hand, where many cows are maintained, and much green food consumed by them in byres, tanks should be constructed for the advantage of the pastureland. The practice of the farmers of Flanders might be usefully followed on all small dairy farms, by constructing a small tank under ground in every byre, the contents of which might be enriched with rape-cake and other valuable ingredients. These enriched contents, employed as a top-dressing on pasture and forage land, would increase their produce, for the support of the cows, very considerably. A tank to a dairy farm seems, therefore, indispensable, and it should be of large dimensions, to meet any enlargement of the dairy. On *farms of mixed husbandry*, if the steading is furnished with rain-water spouts, and the stock well supplied with litter, much liquid manure cannot be collected. Under that system we had a circular tank of 12 feet in diameter and 4 deep, connected with well-planned courts by neatly-built drains provided with good gratings, and the courts were defended from being deluged with rain-water by capacious rain-water spouts, and care taken that the cattle were always provided with a sufficient quantity of litter—with all which accommodations every well-appointed steading should be supplied. The tank was not filled in the course of the season above three times—a quantity not worth while providing a liquid-manure cart to take it to the field; and even this small quantity was solely derivable from heavy rains and melting snows for a few days falling directly into the courts, and causing a surplus of water, which was readily conveyed into the tank by the drains. The ordinary supply of the liquid manure was merely a few drops from the sole of the drain into which all the other drains merged. The sole of this drain was only 4 feet above the bottom of the tank, and, except after rain or snow, the liquid manure never reached that height. Still, wher-

ever cattle are housed and fed in large numbers on turnips, a tank should be constructed with drains, to keep the courts comfortably dry.

1066. There are several circumstances to be taken into consideration, before proceeding to construct a tank for liquid manure. When a tank is made deep, such as a well, the building of the lower part, as well as of the sides, will require to be particularly strong, to resist the equal hydrostatic pressure of the fluid on all sides within it, and, of course, will be so much the more expensive in construction. A tank should therefore be shallow, to be economical in construction, and not deeper than 6 feet below the drains which bring the liquid manure. It is very desirable to have the tank covered, for the sake of protection against accidents, and against undue action of the atmosphere upon the liquid. The most durable covering is an arch; and, to keep the cost of that within bounds, the tank should be narrow, not exceeding six feet. The desired capacity of a tank will thus be attainable by extending its length. A tank should neither let in nor let out liquid. To prevent its letting in water, a drain should be formed where there is the slightest appearance of it in ooings or a spring; and to prevent the liquid getting out, a puddling of clay should be used, where the subsoil does not consist of tenacious boulder clay. The clay for puddling should be well pugged, or beaten into the consistency of putty.

1067. A considerable fall is required along the floor of a liquid-manure tank; and a roomy man-hole should be made in the arch of the roof at each end, and at the deepest end a third opening for a pump.

1068. To know the size of tank required for any particular case, an allowance of 1000 gallons for every cow is a good criterion on a dairy farm, and that number of gallons occupies 162 cubic feet. When enlarged tanks are desired, it is better, because cheaper, to have parallel rows of narrow tanks contiguous to each other, than to extend the breadth or length and increase the depth of the dimensions given above (1066). In a series of parallel tanks, the common walls support the arches on both sides.

1069. A tank of 72 feet in length, 6 feet wide inside, and 6 feet deep below the soles of the drains, contains about 2600 cubic feet, and, with a pump and the carriage of materials, would cost about £24.*

1070. Mr Milburn, Sowerby, by Thirsk, gives the cost of constructing a liquid-manure tank, $13\frac{1}{2}$ feet in length, $6\frac{1}{2}$ feet in width, and 6 feet deep, inside measure, with brick in length, and plastered with Roman cement—a size suitable to small holdings—in these terms:—

	Ft. in.	
Length within,	13 6	
Width,	6 6	
Depth,	6 0	= 19½ cubic yards.
Cutting over all, at 3d. per yard,		£0 7 9
Walling, including bricks in length, and mortar around them, at 4s. per yard,		6 8 0
Plastering and cement,		0 16 0
Covering and flags,		2 15 0
		£10 6 9†

1071. A simple and convenient mode of collecting the liquid manure of a dairy farm—of from 130 to 170 acres, with a stock of cows from 14 to 24, with young beasts and horses—has been practised by Mr M'Lean, Braidwood, and Mr Wilson, Eastfield, both near Penicuik, Mid-Lothian. Drains are formed from

* *Transactions of the Highland and Agricultural Society for March 1846*, p. 292-8.

† *Ibid.*, vol. xiv. p. 280.

the byres and stables into one main drain, the mouth of which happens to be elevated as high above the ground below it as to admit a liquid-manure barrel—a common butt, mounted on its cart—to stand under it, and receive the liquid direct into the bung-hole; and as the barrel becomes full, it is carted away, and its contents emptied on the field. The barrel contains 150 gallons, and is usually filled three times a-week. When there is an excess of liquid, in consequence of much rain, it is allowed to run into the dunghills below the drain, and, after saturating them, flows into an open shallow tank, from which it irrigates at pleasure a drained mossy field laid down to perpetual grass.

1072. The cost of these drains is thus given by Mr Wilson:—

In under-byre, including cover of the main drain,	£2 2 6
In upper-byre,	1 6 0
Stable pavement, grates, and cost of putting them in,	2 0 0
Drains from dwelling-house and scullery, including grates,	0 15 0
Expense of cutting a road, to allow the bung-hole of the barrel to be placed lower than the main drain,	0 10 6
	<hr/>
	£6 14 0
	<hr/>

1073. A common butt, of the above capacity of 150 gallons, sunk into the ground, forms a good and convenient tank for the use of a labourer's cottage, and, retaining all the liquid refuse from the house, would afford ready means of manuring a portion of the garden.

1074. The rationale of the construction of liquid-manure tanks is this:—The cistern for collecting liquid manure in the farmstead, though apparently simple in its construction, being merely a covered pond or a well, yet serious errors are frequently committed in its formation. The first and most important consideration for the formation of the cistern, is the effect of hydrostatic pressure; inattention to this has caused the failure of many such cisterns. The liquid we have here to deal with, like all other fluids, acts on the bottom and sides of the vessel or body that contains it, with a pressure directly in proportion to the depth at which the fluid stands, without reference to either length or breadth; that is to say, suppose a cistern, whose bottom is 12 inches square, and its depth 10 feet, filled with water, every square inch in the bottom will suffer a pressure equal to the height of a column of water whose base is one inch square and 10 feet, or 120 inches, in height. The weight of such a column will be $4\frac{1}{2}$ lb. nearly, and this would be exerted on every square inch on the bottom, or the whole pressure on the bottom would be 625 lb., the weight of 10 cubic feet of water. There is a natural law that governs the pressure of fluids, which shows us that they press equally in all directions, downward, horizontally, and even upwards, the last arising from the general statical law, that "action and reaction are equal, and in opposite directions." It follows, from these hydrostatical laws, that the lowermost portion of each side of our supposed cistern will suffer a pressure from the water equal to that which acts upon the bottom—hence, taking the lowermost inch in the height of the sides of this cistern, it will be pressed with a force of $52\frac{1}{2}$ lb. or thereby, or $4\frac{1}{2}$ lb. on the square inch, and each of the four sides will suffer the same pressure. Suppose, now, that the cistern is elongated in one direction to any number of feet, and again filled to the depth of 10 feet, the pressure on each square foot of the bottom remains the same as before, and so in like manner does it remain the same upon the sides; for the pressure is not altered in any direction, although the proportion of the cistern has been changed. Keeping this in view, it will be seen that length and breadth produce no effect on the pressures

that a fluid exerts against the vessel or body that retains it; and that, in calculating the resistance to sustain such pressures, depth is the only element requiring to be taken into account. It is also to be kept in view, that pressure on the bottom or sides is directly as the depth; thus, if our supposed cistern were reduced to 5 feet in depth, the pressure on the bottom would only be one-half, or $2\frac{1}{2}$ lb. on each square inch.

1075. The conclusion to be drawn from these remarks is, that a cistern, in the form of a pit or well, should be always avoided, unless it can be formed in a natural bed of impervious clay. When such a substratum can be attained, a pit may be adopted, but not otherwise. If such has been found, and the pit dug out, it should be lined with brick, or with stone built in mortar, the bottom being first lined with the same material. When the building approaches to the surface, the wall can be gradually reduced in diameter to a small compass, leaving only an opening of 2 to 3 feet square, which is covered in at small expense; and the saving in this last item is the only apparent advantage that seems to attend the practice of pit cisterns. Deep cisterns are liable to another inconvenience—of their becoming recipients of spring or of drainage water; and it is sometimes more difficult to keep such water out than to keep the proper liquid in; for if springs and their origin lie at considerable heights, their hydrostatic pressure may be so great as to render the prevention of access to their products a process of great difficulty.

1076. A cistern of moderate depth, not exceeding 4 feet below the outfall of the drains, may be constructed in any situation, whether in gravel or in clay, and its length can be extended so as to afford any required capacity; the breadth being restricted to that for which materials for covering it can be most easily obtained, which may be from 3 to 4 feet, or, if arched, it may be 6 feet. Whatever be the stratum in which such a cistern is to be formed (unless it be perfectly impervious clay), it should be puddled to the thickness of at least 1 foot with the best clay that can be procured. For this purpose, the earthy matters are to be dug out to a depth of $1\frac{1}{2}$ foot lower than the intended sole, and to a width of 4 feet more than that proposed for the cistern. Two or three thin layers of the prepared clay are then to be compactly laid over the whole breadth of the excavation, and beaten firmly together at all points, making up the depth to 1 foot, and the surface of it brought to a uniform level. Upon this the side walls are to be founded, and these may be of brick 9 inches in thickness, or of flat bedded rubble stones 14 inches. The wall should be built in successive courses of about 1 foot in height, the whole being bedded in mortar; and, as each course is completed, the puddle is to be carefully laid and beaten in behind, in layers of 6 inches or thereby, the first layer being properly incorporated with the foundation puddle, and each succeeding layer with the one immediately preceding it. To prevent the side-walls from being pushed inward by the pressure of the puddle or of the bank, tie-walls of brick or of stone should be formed at every 5 feet of the length of the cistern. These may be 9 inches of brick, or 14 inches of stone, and they must have conduits formed at the level of the sole, to allow the liquid to run towards the pump. The sole should be laid all over with brick set on edge, or with strong pavement jointed, the whole having a slight declivity towards one end, where a small well-hole of 9 inches in depth is to be formed to receive the bottom of the pump. The brick or pavement, as the case may be, is to be bedded on the puddle, and grouted flush in the joints with mortar; and when the walls and sole are built up, they should then be pointed in every joint with Roman cement. The covering may be effected with strong pavement, of length sufficient to rest on

the side-walls, laid and jointed with mortar; or with rough found-stones, where such can be procured; and if neither can conveniently be found, a beam of sound Memel fir may be laid along the middle of the cistern, resting on the tie-walls, and, with this bearer, stones of half the length will be sufficient to form a cover. A thin layer of clay may be laid over the stone covers, and upon that a coat of gravel. To prevent accident, it is always desirable to construct the cistern in a situation where it will be as little as possible exposed to the transit of carts; and this may be always obtained at a small additional expense of covered drain to convey the manure from the dunghills to the cistern. The best and most secure plan, no doubt, though the most expensive, is to cover the cistern with an arch of stone or brick.

1077. The pump for lifting the liquid from the cistern to the cart may be either of wood or cast-iron, but the latter is preferable. A common sucking-pump of $3\frac{1}{2}$ inches chamber is quite sufficient; the chamber should be bored out, and the pump-boxes, for durability, should be also of metal, with leathern flap-valves. The height of the pump should be such as to deliver the liquid freely into the funnel of the barrel or tank; but if this height is found to raise the pump-lever above the reach of a man's hand, it is only necessary to joint a light connecting-rod to the lever, its lower end being furnished with a cross handle, and by these means the pump-man will be able to work the pump in the same manner as the lower end of the common pit-saw.

1078. Forcing and lifting pumps have been proposed, and even employed, for the purpose we have here in view, though with questionable propriety; and here it may be proper to explain, that by the term force-pump is to be understood a pump that raises water to any height above the point where the power is applied, by the descent of a solid piston acting in the chamber of the pump, sending the liquid into an ascending pipe, which springs from below the piston.

1079. The lifting-pump differs from this in having a valved piston through which the liquid passes, as in the sucking-pump, on the descent of the piston; and, on its ascent, the valve being now closed, the liquid is lifted and forced into the ascending pipe, which, in this case, springs from above the piston, the chamber being closed at top with a water-tight stuffing-box. From this brief description, the simplicity, both in construction and in management, of the sucking or common pump, as compared with the other two, will be obvious, the cost being also in favour of the first.

1080. *Construction of Tank for the Waste Urine from a Dunghill.*—Mr James Porter, in his prize essay ("Report on the Saving and Application of the Liquid Manure of a Farm"—*Transactions of the Highland and Agricultural Society*, January 1857), gives the following description of a cheaply-formed tank, erected in a circular form, 10 feet diameter and 7 deep = 550 cubic feet, capable of containing 3427 gallons, or about $18\frac{1}{2}$ tons weight. "When the pit was excavated, a puddle of clay was laid on its bottom about 12 inches deep, firmly beaten down and causewayed over with pebble-stones. The sides were then built round with a rough stone-and-lime wall 18 inches thick; and as the building advanced, a puddle of clay the same thickness was carried up between it and the back. The pump was then set in the side next the dung-pit, in a hollow in the bottom left for receiving it. The tank had then a close covering of strong rough wood, as far below the adjoining ground as admitted of 6 inches depth of gravel being laid over it. As more sediment was expected to collect in this than the other tanks, a trap-door was put in to allow its being cleared out. The tank of itself is perfectly close, and as suitable for the purpose as could be desired. The wooden covering is no doubt perishable, and will

at times cost some expense in renewing it, but which will only happen at considerable intervals, as wood lasts for a long time below ground. I have constructed several oblong tanks in this way, and always found them to answer the purpose well; with plenty of good clay well puddled in, it is quite practicable to make them perfectly water-tight, and as suitable for preserving urine as cemented tanks constructed of pavement or the best ashlar work. . . . Where the ground is wet and spongy, it ought always to be deeply drained around all dunghills and urine-tanks."

1081. *Flemish Liquid-Manure Tanks*.—The tank is frequently constructed underneath the stable and cattle-house, the liquid being led to it by open gutters running along in front of the stalls. Part of it projects beyond the wall, as in fig. 256 at *a*, and is provided with a well-hole *b*, through which the liquid is taken when required for use by means of a pump, or long-handled ladle. The aperture is closed at other times by a wooden or stone cover *c*, as shown. Brick is used in its construction, and the bottom and sides are well cemented, to make the whole water-proof. Sometimes the tank is divided into various compartments, as in fig. 257, at *a b c d e* and *f*, these being designed to hold the liquid manure collected at different periods.

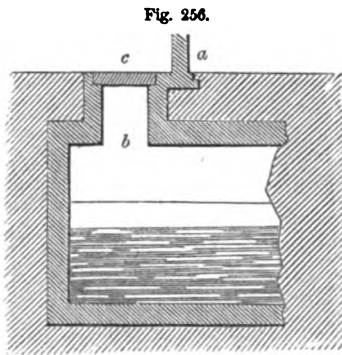

FLEMISH LIQUID-MANURE TANK.

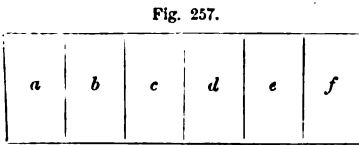
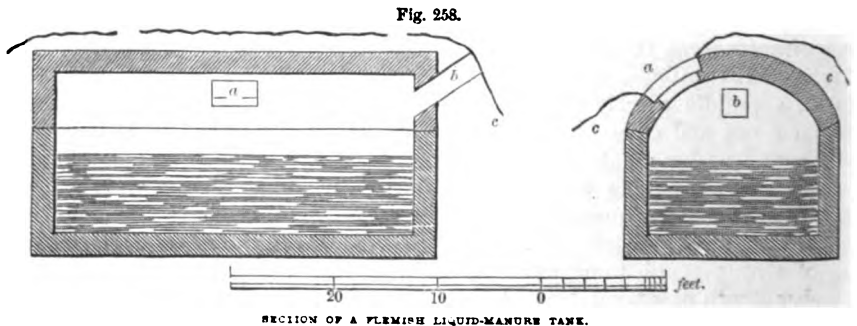

Fig. 257.

1082. But not only are tanks provided at the steadings: in many districts, as in the flax-growing district of Courtray, they are built at the roadside, at the edges of the fields, in order to facilitate its application. These are usually made to contain the *vidanges*—by which term is meant human excretæ—which are collected from time to time in the towns, and carted out to the rural districts. In fig. 258 we give a transverse and a longitudinal section of a roadside tank.

The manure is supplied to and taken out of the tank through the man-hole door *a*, shown in the transverse section to the left: this is usually kept closed by means of a stone or wooden cover. But a second aperture *b*,



SECTION OF A FLEMISH LIQUID-MANURE TANK.

is provided at the end of the tank, which is always kept open, to allow of the ingress of air and the egress of the foul emanations. The crown of the arch

rises a considerable height above the level of the surrounding ground, and the whole is covered with earth or turf, *c c*, so that in process of time the structure is grown over with grass, presenting the appearance of a verdant semicircular mound with rounded ends.

1083. *Horse-Pond*.—The most convenient form of the horse-pond, at the stead-ing, is open at the one side and fenced at the other, of considerable width, and the clear water to come in at the upper end, and flow away at the lower.

1084. The pond should have a hard bottom to resist the action of the horses' feet, and it should not exceed a depth beyond the horses' knees. When on clay, small gravel is beaten into it, and upon this should be made a causewaying of small round stones imbedded in sand and beaten down with a rammer. When the bottom is gravel, it should be puddled with clay first beaten smooth with a wooden rammer, and mixed with a fourth part of its bulk of slaked lime, to prevent injury from worms. After the mass has soured for a time, let large balls be formed of it, and forcibly thrown upon the prepared bottom of the pond, and beaten down with a rammer until a coating of 6 or 7 inches or more in thickness is formed. The gravel and causewaying are placed above the clay. The water should not be let on until the paving and clay have consolidated a little, and it should be brought on and off the pond without a fall. At such a pond a number of horses can drink at once, and pass one another in washing their feet.

1085. SECTION NINTH—*Fittings of the Farmhouse, Cottage, and Steading.*

1086. *Paving-Bricks—Floors—Peake's Terro-Metallic Paving-Bricks*.—In fig. 259 we give a diagram of oblong, in fig. 260 diamond or lozenge-shaped, and

in fig. 261 square-shaped bricks of this material. The price of fig. 259, 9 inches by 4½, blue or red for intersection, £4, 10s. per 1000, or about 2s. 10½d. per square yard. The price per 1000 of those in fig. 260, 5 inches by 5, and 1 inch thick, red or blue, with cut ones to divide, is £3, 13s. 6d., or 4s. 6d. per square yard. The price per 1000 of those in fig. 261, 6 inches square, £4, 5s., or 2s. 10½d. per square yard. The address of the manufacturer is, Thomas Peake, Tunstle, Staffordshire Potteries.

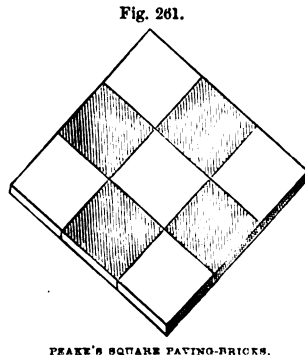
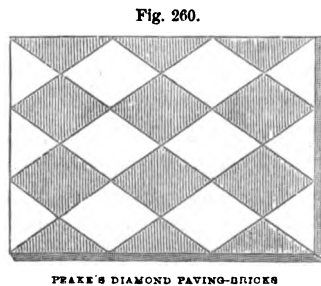
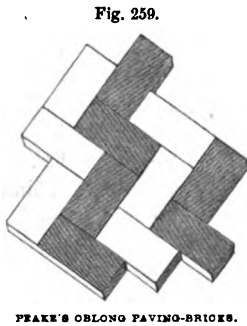

1087. *Hexagonal Paving-Tiles—Hollow Bricks*.

—Hexagonal, or six-sided tiles, would bind well in with one another. The best mode of making floors with the top covering of tiles would be thus: Well beat the bottom of the foundation; place a layer of stones on this, of sufficient size to pass through a ring 1½ inches diameter; pour over this a mixture of coal-tar and clean sharp sand—three parts of the latter to one of the former; press this closely down;

when partly consolidated, throw on another layer of stones, and above this another of the tar and sand. When the upper is nearly consolidated, but not hardened, place the flat tiles, beginning at one end, and advancing in such a manner as to leave no footsteps on the soft material. Instead of tar and sand,

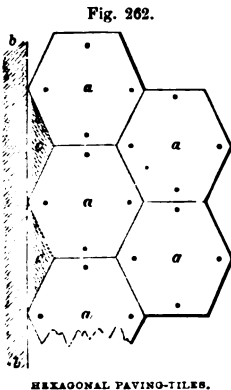

HEXAGONAL PAVING-TILES.

consistent clay, in a partly fluid state, may be used, and allowed to consolidate before the tiles are laid on. The tiles should have projecting knobs or snugs on their under side, which would, when pressed into the soft materials beneath, keep them in their places. If, however, the tiles were hexagonal, there would be sufficient bond to keep them in their places. Fig. 262 represents the position of the hexagonal tiles: the round dots represent the position of the projecting knobs or snugs on the under side; *a a* the tiles, *b b* the line of wall; as the tiles, from their shape, will leave in some places triangular spaces, as *c c*, these may be filled up with cement or asphalt, or pieces of tile might be made of the shape: this will be the same size at all places, the angles being invariably equal.

Fig. 263 represents the position of square tiles laid angularly, having projections or tongues on one side, with corresponding grooves to fit into them; *a a* the tiles, *b b* the tongues and grooves. Hollow bricks are admirably adapted for ground floors. Fig. 264 shows

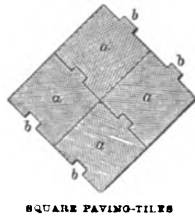

SQUARE PAVING-TILES

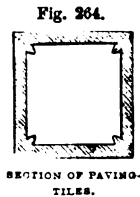

SECTION OF PAVING-TILES.

Mr Rawlinson's improved form of hollow brick. The following is Mr Roberts's plan of forming hard, cheap, and durable floors: A foundation or substratum should be prepared about 6 inches thick, with coarse gravel, or brickbats and lime-core, well beaten to a level surface. In damp situations, tar may be added to the concrete on

which the ash-floor is to be laid, thus prepared: Take good washed sand, free from all earth and stones, together with the ashes of lime fresh from the kiln, in the proportion of two-thirds of sand and one-third of lime-ashes (where obtainable, the substitution of one-third of smiths' ashes or pounded coke for one-half of the sand increases the durability and hardness of the floor); mix the sand and lime-ashes well together, and let them remain in a body for a fortnight, in order that the lime may be thoroughly slaked; then temper the mortar, and form the floor with it 3 inches thick, well floated, and so worked that it be not trodden till it has lain for three days, or according to the dampness of the weather, when it should be well rammed for several successive days, until it becomes hard—taking care to keep the surface level; then use a little water, and smooth it with a trowel; after this keep the floor free of dirt, and when perfectly dry it may be rubbed over twice with linseed-oil, which gives the appearance of stone instead of sand. The price paid for such floors is about 6d. per yard for labour, and 8d. for material. In cases where cottages are built on the fireproof principle adopted by Mr Roberts, or on the patent system of Mr Barrett, the floors in the upper rooms, if any, may be made in the same economical way as those on the ground.

1088. *Asphalt Floor*.—As a cheap and excellent floor, we would recommend asphaltum to be used. It has been adopted in similar cases with marked success, and we are not aware of any valid objection against its use. It is preferable, in every point of view, to stone or porous brick. An asphalt can be made by mixing boiled coal-tar with powdered chalk or bricks. Dr Ure, a high

authority, says it is equal to the natural kind. The mode of laying asphalt floors is simple. Place a layer of small gravel-stones, about $6\frac{1}{2}$ inches deep, in a dry and well-beaten foundation; pour the asphaltum (which must previously be melted in a caldron), when boiling, over this to any convenient thickness; spread it smoothly and press it down; sift some very small powdered stones over the surface, press them down with a flat wooden trowel, and, when hardened, the operation is finished. The best material—after wooden boarding, which we look upon as the “standard” material for all floors of living-rooms—that can be used for the laying of ground-floors is hard glazed earthenware tiles or slabs; these would imbibe no moisture, be easily kept clean, and may be looked upon as nearly indestructible.

1089. *Roof-Tiles*.—In fig. 265 we give a diagram of Peake’s plain, and in fig. 266 a diagram of ornamental, tiles. Size of fig. 265, $10\frac{1}{2}$ inches by 7; price per 1000, £3, 5s.—about £1, 12s. 6d. per square of 8-inch gauge. Size of fig. 266, $10\frac{1}{2}$ inches by 7; price per 1000, £3, 17s. 6d.—about £1, 13s. 9d. per square. In fig. 267 we give a diagram of Peake’s ridge-tiles;

Fig. 265.

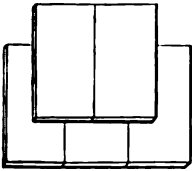

PEAKE'S OBLONG ROOF-TILES.

Fig. 266.

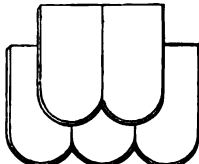

PEAKE'S ROOF-TILES WITH ROUNDED ENDS.

Fig. 267.

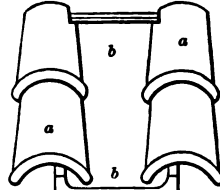

PEAKE'S RIDGE-TILES.

a to cover the joints of the flat tiles *b*; price of *a*, 9d. per pair; price of *b*, £10 per 1000. In fig. 268 we give a diagram of Peake’s quoin’d valley, and in fig. 269 of hip-tiles. Price of fig. 268, $3\frac{3}{4}$ d. each; of fig. 269, $4\frac{1}{2}$ d. each. In fig. 270 we give a diagram of ridge-tiles, and in fig. 271 grooved ridge-tiles, in the groove *a* of which the ornamental tiles shown in fig. 272 are fitted.

Fig. 268.

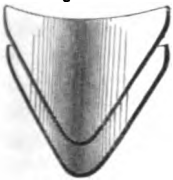

QUOIN'D VALLEY-TILES.

Fig. 269.

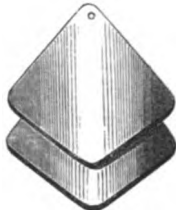

HIP-TILES.

Fig. 270.

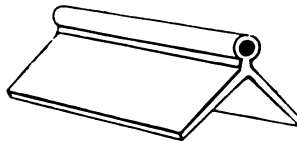

RIDGE-TILES.

Fig. 271.

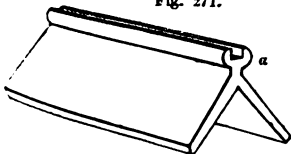

GROOVED RIDGE-TILES.

Fig. 272.

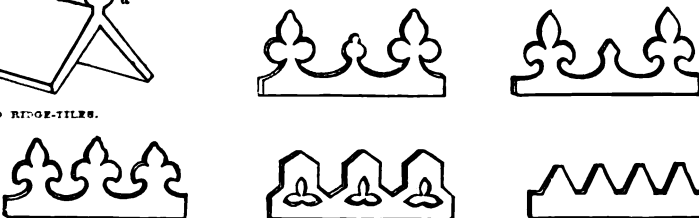

ORNAMENTAL TILES TO FIT IN GROOVES OF RIDGE TILES, AS IN FIG. 271.

1090. *Corrugated Roof-Tile*.—In fig. 273 we give a drawing of this tile, manufactured by Messrs Norton & Borrie, and in fig. 274 a hollow roof-tile by the same firm.

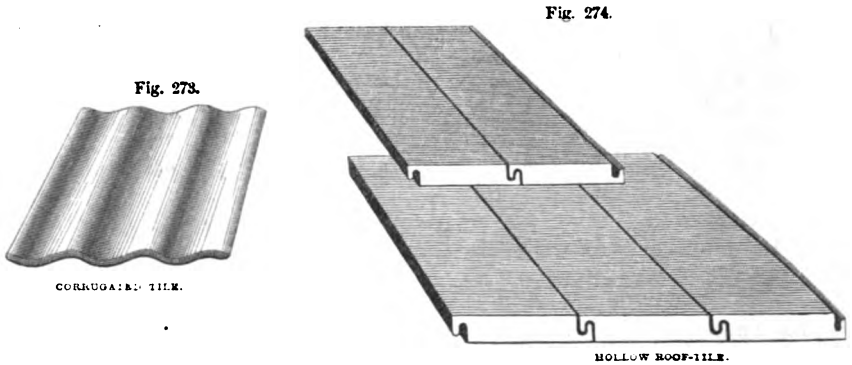

1091. *Beadon's Eave or Gutter-Tile*.—In fig. 275 we illustrate this tile in three forms, *a c b*. It is simply a tile with its end turned up at right angles. Each tile is cemented to the next adjoining, forming a water-tight joint.

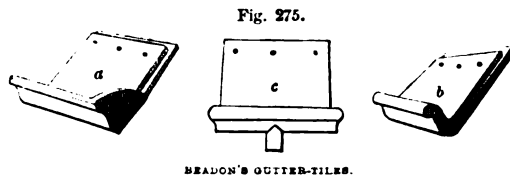

1092. *Asphalted Felt Roof-Covering*.—A species of covering for boarded roofs, whether of iron or timber trusses, much used, especially for temporary agricultural erections, is the "asphalted felt" manufactured by Messrs M'Neil & Co., Bunhill Row, London. It is also well adapted for placing underneath rafters, as, from its non-conducting powers, it tends to exclude the heat of the sun and the frost of winter. It is also used for lining damp walls, &c. The materials of which it is composed are strong and durable fibres, with a mixture of hair, thoroughly saturated with the best bitumen or asphalt. It unrolls as easily as any other ordinary cloth, and is manufactured in any given lengths, to suit the buildings proposed to be covered with it. The width—namely, 32 inches—is the same for any length. The manufacturers, whose address we have given, present purchasers, or parties applying, with a book so full of practical instructions as to its use, and with diagrams showing every species of roof-construction, &c., for which it is adapted, that we deem it unnecessary to go further into the matter, save than by giving comparative estimates, furnished by the manufacturers, of the cost of roofs on which the material and the ordinary slate and timber are used:—

SLATE COVERING FOR A ROOF 40 FEET LONG AND 24 FEET WIDE, ADAPTED FOR A SHED, ETC.

	Inches.		
3 tie-bearers, 24 feet 6 inches long, . . .	4 by 6	} 104 cubic feet, at 3s. per cube, including labour and fixing.	£15 12 0
6 principals, 16 " 6 " " . . .	4 by 5		
3 king-posts, 11 " 6 " " . . .	4 by 4		
6 struts, 8 " 6 " " . . .	4 by 4		
8 purlins, 10 " 6 " " . . .	3 by 4½		
60 rafters, 17 " 6 " " . . .	4 by 2½		
Ridge-piece, 40 " 6 " " . . .	7 by 1½		
Battening for slates,			2 10 0
15 squares of slating, with metal nails, &c., at 28s., . . .			21 0 0
			£39 2 0

SAME ROOF, WITH ASPHALT FELT.

	Inches.		
6 principals, each 15 feet long, . . .	3 by 5	} 49 cubic ft. at 3s.	£7 7 0
3 ties, 18 " " " . . .	3 by 5		
24 purlins, 10 " " " . . .	2½ by 4½		
Ridge-piece, 40 " " " . . .	6 by 1½		
1160 square feet of ¾-inch or ⅝-inch boarding, including fixing, . . .			7 5 0
The necessary felt, including everything,			6 10 0
			£21 2 0

1093. The price per square foot of the felt is 1d., the width of the pieces being invariably 32 inches. The length as desired.

1094. *Blue and Grey Slates for Roofs.*—We now propose to add a few remarks on the mode of laying on blue and grey slates as a covering for roofs. The blue or ordinary slates are laid either upon close boarding or upon battens, the width of which varies from 2 to 3 inches. The use of battens is more general than close boarding, as it is cheaper. Before laying the slates, the sides and the under edge are trimmed. The under surface of a slate is called the *bed*, the upper the *back*, its upper edge the *head*, and its lower edge the *tail*. By the term *margin* is meant that part of the slate which, on the finished roof, is exposed to view—the width of this being termed the *gauge*. The *lap* of a slate is the distance which its lower edge overlaps, when laid in its place, the course of slate immediately beneath; this lap should never exceed 3, nor be less than 2, inches. When battens are used, the distance between them will of course be regulated by the sizes of the slates. The holes through which the nails are driven to secure the slates to the batten, are punched as near the *head* as possible—the holes being equidistant from the lower edge or tail. The duchess slate, the size of which is 24 inches by 12, will give a gauge, or exposed surface of 8 inches, the lap being 2 inches; with a lap of 3 inches, the gauge will be only 6 inches. Each slate should be fastened with two nails, these being best of copper; zinc or iron nails may be used; if of iron, to prevent them rusting they may be put in boiled oil, or steeped in a hot solution of coal-tar. Slating is well executed when the tails lie very close to the backs of the course below. In slated roofs, the hips and ridges are generally finished with lead. A cheap method of finishing is sometimes executed, in which fillets of slate are made to cover the ridge-boards and hips—the whole being well bedded in putty, and nailed down with a nail at each end. Ornamental ridge-tiles and slates are now much used. A cheap plan of covering roofs with slates has been recently introduced, which requires no battens. To the upper surface of the rafters a fillet of wood is nailed, this being about 1 inch thick, ¾ inch broad at the bottom, where it is nailed on to the rafter, and 1 inch broad at the upper surface; the taper is thus

the wrong way. The edges of the slates are brought up to the fillets, and the joint well made with putty. A neat joint may be made by nailing a roll over the two slates—this roll being nailed to the central fillet. Slates for the roofs of steadings are sometimes set with battens after the manner of tiles, the under surfaces being made good with mortar worked into curves.

1095. *Grey Slates* require the roof to be lathed in the same manner as tile, but, not being of a uniform size like tiles, they are assorted to sizes in the quarry. The larger and heavier slates are put next the eaves, and gradually diminish in size to the ridge. The course at the eaves is laid double, slate above slate. Every slate is hung upon the lath by a wooden pin being passed through a hole at the upper end, and, on being laid on, the slates are made to overlap at least one-third. Grey slates should either be bedded and shouldered in plaster-lime, or laid on moss, the latter making the warmer roof.

1096. The flanks are made of slate, but the ridge is covered with drowed angular ridge-stones of freestone. As this species of roofing is not adapted to pavilion roofs, the peands should be covered with lead; but the safest form of roof with grey slates is with upright gables.

1097. Flat tiles are simply fastened to the battens by pegs passing through holes in the upper part. In the ordinary-shaped tile, or pantile, projecting parts are provided at the back of each tile, by which it is attached to the lath. In fig. 274, we have illustrated a form of hollow roofing tile.

Fig. 276.

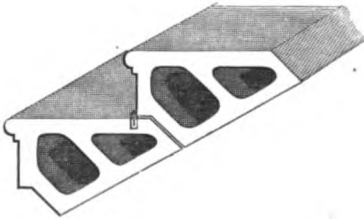

SECTION OF EARTHENWARE BLOCKS FOR STAIRCASES.

1098. *Earthenware Staircase*.—In fig. 276 we give a view of Norton & Borrie's fireproof staircase.

1099. *Heating of Apartments, Grates, &c.*—Figs. 277 and 279 are a section and plan showing method of heating upper rooms from the kitchen fire. The hot-air chamber *a* is formed of cast-iron, of the same width as the fire, and extending from the bottom of the grate to a few inches over the top of it. The cold air is brought

in by the flue *b*, formed in the thickness of the wall, and after circulating through the cells into which the chamber is divided, and being thereby warmed, it is conveyed to the floor above by the flue *c*, and thrown into the room at an opening in the skirting, fitted with a valve. *d* is a ventilator in connection with a ventilating flue, shown by the dotted lines above: it is formed as close as possible to the kitchen flue *g*, the heat of which, being by this means communicated to the ventilating flue, produces an upward current, and thus promotes ventilation. By connecting the hot-air flue with the ventilating flue, as shown at *f*, the hot air, when not required, as in summer, may be allowed to escape, and in this way it will also assist ventilation. Thus might an iron kiln floor, placed over the engine-boiler in the steading, form a convenient chamber for drying, by means of heated air, grain, sacks, and barn-cloths.

1100. When vent-linings are used, the ventilating and smoke flues may be formed in one piece, as shown in fig. 278, the large opening being the smoke-flue, and the small one the ventilating flue. In those parts of the country where fireclay is expensive from the long carriage, vent-linings of well-burnt common clay may be used: the first 3 or 4 feet should be of fireclay.

1101. With a view to prevent smoke, a small flue is formed of 2-inch drain-tiles, built into the wall as at *e*, figs. 277 and 279 (it may also be brought in under the floor of houses already built), extending from the outside of wall to

Fig. 277.

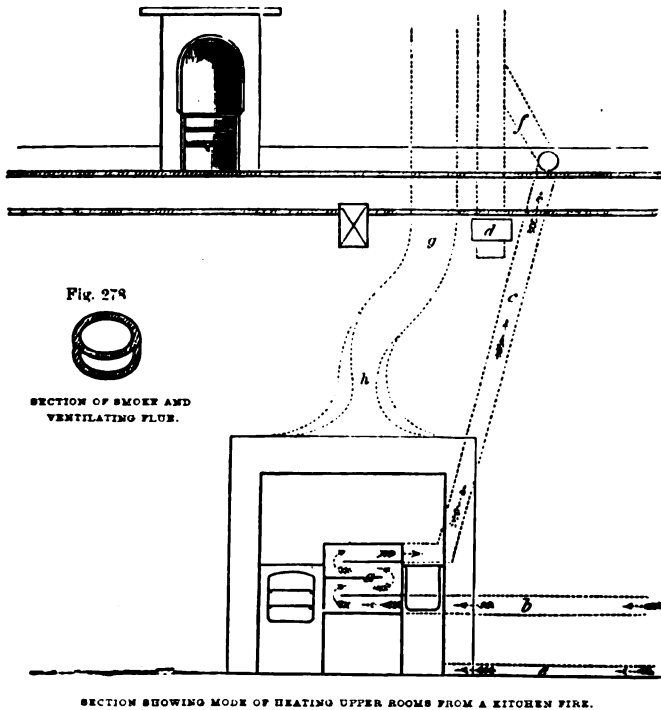
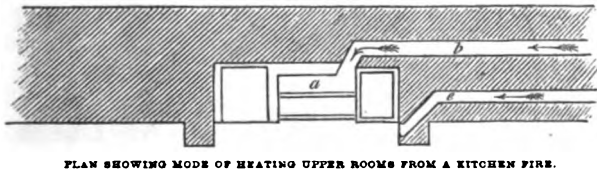

Fig. 278

SECTION OF SMOKE AND VENTILATING FLUE.

Fig. 279.



the inside of jamb, covered at both ends by a grating, thus providing a supply of air for the fire, and thereby preventing draughts. The smoke-flue should be carefully contracted over the lintel, as shown by the dotted lines in the left-hand diagram in fig. 280. In many instances it has been found an effectual preventive of smoke to contract the flue, as shown by the inner dotted lines *h*, fig. 277, widening gradually to the full size above.

1102. *Pierce's Fire-Lump Stove-Grates*.—In fig. 280 we illustrate a form of ventilating stove which enjoys a high reputation for efficiency: *a, a* is the fresh-air channel, *b* warm-air chamber, *c c* valves for admitting warm air to interior of apartment; *d* is the plan. In fig. 281 we give *Pierce's Fresh-air Cottager's Grate* for warming two rooms with one fire.

1103. "This grate is made of the best fireclay, having the back part hollow to form an air-chamber for the admission of fresh air introduced from the outside by means of earthen pipes; this fresh air passing through the back of the grate becomes warmed, and will thus supply a bedroom over the living-room

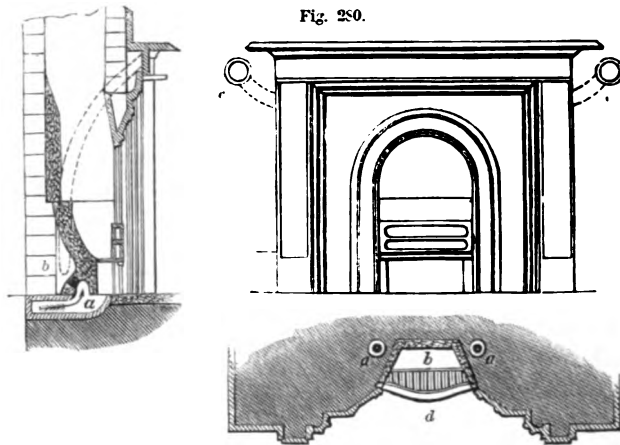

PLAN, ELEVATION, AND SECTION OF PIERCE'S FIRE-LUMP SLOVE-GRATE.

(or a room adjoining) with a large quantity of pure, warm air, without any additional fire. The great economy of this grate consists in the peculiar construction of the back (which is made out of the solid mass), supplying sufficient air to warm another room, in addition to the radiant heat produced by the fire. It also has the additional advantage of a table bar at the bottom, and a large trivet at the top."

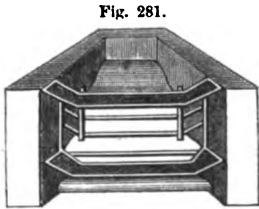

PERSPECTIVE VIEW OF PIERCE'S COIL-TAGE FIRE-LUMP GRATE.

iamb. Fig. 283 is a section of the hearth.

1104. *Fireclay Hearth.* — In fig. 282 we give plan of fireclay hearth and fender: *a* is the hearth, *b b* the hollow tiles lining walls, *c c* the

Fig. 282.

Fig. 283.

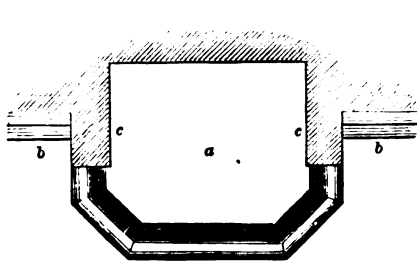

PLAN OF FIRECLAY HEARTH

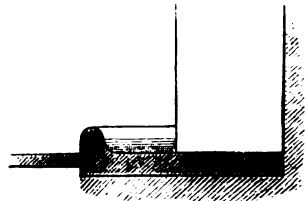

SECTION OF FIRECLAY HEARTH.

1105. *Ventilating Chimney-Tubes.* — These contrivances, recently introduced, are admirably adapted to promote the ventilation of apartments. The heat of the chimney is communicated to the air in the flue near it; and if the air in the room is admitted to this smaller flue, the upward current created will carry off the vitiated air from the apartment—that is, if the communications required are made in a proper place and way. Thus, in fig. 284, if *a a* is a chimney-flue, and *b b* a smaller one alongside of it, divided by a partition of brick or stone, the heat of the smoke in the chimney *a a* will be communicated through the partition to the air in *b b*, and an upward current therein will be produced. Now, suppose *a a*, fig. 285, to be the cornice at the

ceiling of a room, *b b* the chimney-breast, the dotted lines representing the course of the chimney-flue and that of the ventilator, the latter beginning somewhere about *d*, a short distance beneath the cornice *a a*. Now, if an aperture

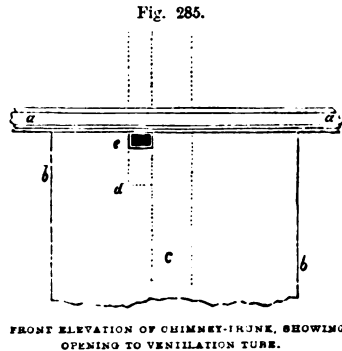
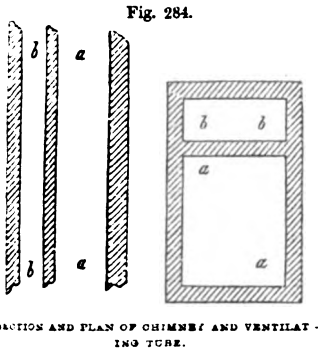

is made at *e*, communicating with the interior of the ventilating flue, the upward current therein will withdraw the vitiated air from the room through the aperture *e*, which may be covered with an ornamental grating, as in fig. 286. This is a very simple and efficacious method of withdrawing vitiated air from apartments; it is constantly in action, and, from having no movable parts about it, it is never likely to be disused through getting out of repair. There are numerous ways of carrying out this principle. In figs. 287, 288, we give a "registered" form which has been much introduced recently: the large flue is the chimney, the small one the ventilator. With this construction the ventilating flue can be placed nearest the room, or outside of the chimney-breast, as in fig. 288, thus enabling the aperture for admitting the vitiated air to be made in the centre of the chimney-breast, which would look better than if placed at one side, as at *e*, fig. 285. From the square outline of this frame of double tube, the flues from a good number of apartments may be joined and run up in one central stack. "In a dwelling

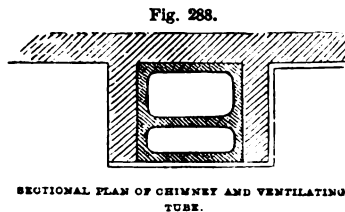
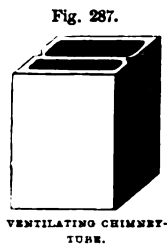
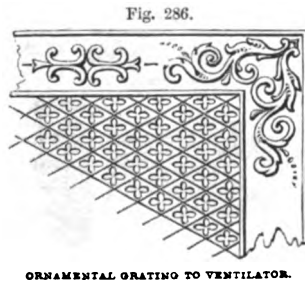

three storeys high, for instance, consisting of six rooms, or two dwellings of three rooms each, the whole of the six chimney-tubes and ventilating flues may be carried up in one tubular stalk: the tubes, as they proceed upwards, would be firmly tied together, and secured by the floors; and at the top, outside the building, might be held together by an iron hoop concealed by an ornamental moulding. In the two lower storeys, the egress openings would not be in the centres of their respective chimney-breasts; but as they would require a valve, or sliding plate, with a frame of iron or brass, another and similar frame might be fixed at an equal distance on the other side of the centre line. The

hollow space that would be left under the elbows should be filled in with brick-work, and the front and sides of the whole mass plastered, which completes the chimney-breast all the way up." These tubes, which are much to be recommended, may be had of the registree, Mr William Walker, engineer, Lower

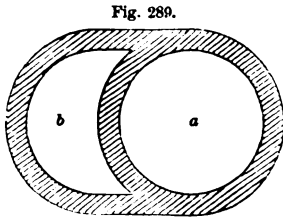

SECTIONAL PLAN OF CHIMNEY AND VENTILATING TUBE.

King Street, Manchester. By the use of these double tubes, much brickwork in the chimney-breasts is saved; and where this is of importance, as in brick buildings, the projection being less, a little extra space is added to the room. Where single chimney-flues are run up separately, double tubes of an elliptical form, as in fig. 289, might be used. The chimney-flue would thus be completely circular; the shape of the ventilating flue would be slightly irregular, but in nowise calculated to

retard the ascent of the vitiated air: *a* is the chimney, *b* the ventilating shaft. In fig. 290 we give a perspective view of Doulton's Ventilating Chimney-Tube in the circular form, and in fig. 291 various sections. In fig. 290, *a* is

Fig. 290.

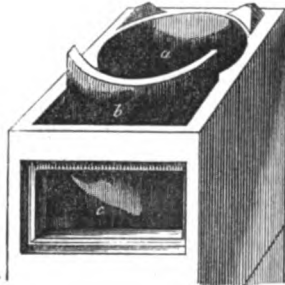

PERSPECTIVE VIEW OF DOULTON'S VENTILATING CHIMNEY-TUBE.

Fig. 291.

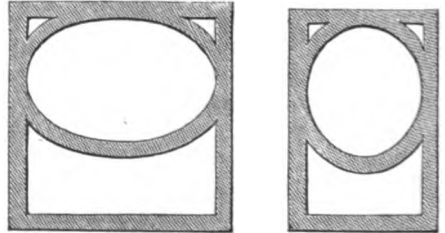

SECTIONS OF DOULTON'S VENTILATING CHIMNEY-TUBE.

the smoke-tube, *b* the ventilating pipe; the air from the room to be ventilated, passing into it by the aperture *c*.

1106. *Looker's Tubular Ventilator*.—This contrivance, illustrated in fig. 292,

Fig. 292.

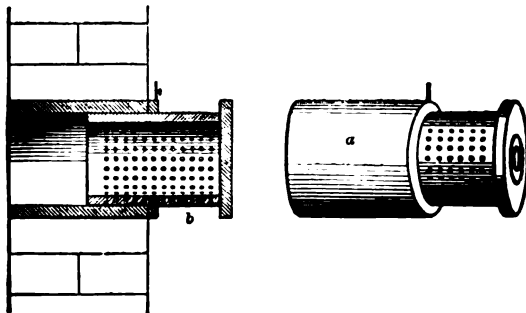

LOOKER'S TUBULAR VENTILATOR.

consists of a tubular piece of pottery, of any size or shape, fixed in the wall of a building in which, in the inside, another piece with closed end is made to slide—the latter having its periphery perforated with small holes. In proportion as the sliding piece is withdrawn, the air is admitted through the tube to the apart-

ment with which it is connected ; *a* is the tubular ventilator in perspective, and *b* is the same in section in connection with the wall.

1107. *Stench-Trap—Scullery Sink and Trap.*—In fig. 293 we illustrate a form made entirely of clay. It is formed in two pieces, the sink and upper part of trap being in one piece, the lower part of trap and pipe to drain forming the other. It requires no plumber-work whatever, is jointed with Roman or Portland cement, and fitted up by the mason. It is salt-glazed, and is thus easily kept clean. It may also be used as a washing-tub. It is made by Mr T. Grieve, Prestonpans, near Edinburgh.

1108. Fig. 294 is a section of a syphon-trap, of the same diameter as the drain-tubes, with an opening for cleansing when required. This opening will be covered with a slate or flat stone bedded in cement. All these pipes should be salt-glazed, which is greatly superior to the common glaze.

Fig. 293.

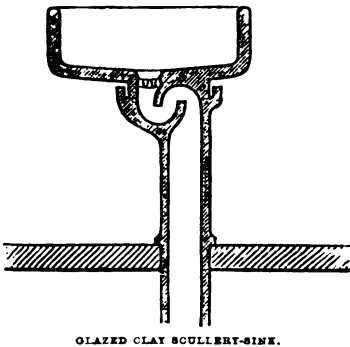

Fig. 294.



1109. Fig. 295 shows form of syphon-trap adapted for sinks and sculleries ; and in fig. 296 a trap or cesspool for house-yards.

Fig. 295.



Fig. 296.

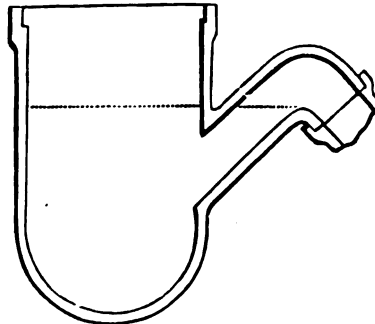

COURT CESSPOOL-TRAP.

1110. *Rain-water Cistern.*—Rain-water for domestic purposes is collected in cisterns. The form of a rain-water cistern, represented by fig. 297, we have found useful for allowing the undisturbed deposition of impurities, and at the same time the quick flowing off of the purer water without disturbing the deposition. Let *a b c b* be a cistern of stone or wood, placed at a convenient spot of the steading or farmhouse, for the reception of rain-water. We have found that such a cistern, of the capacity of 12 cubic feet, holds a sufficient quantity of

rain-water for the domestic purposes of an ordinary family. A cistern of 2 feet square at the base, and 3 feet in height, will just contain that quantity; but as the size of an ordinary wash-tub is 2 feet in diameter, the space between *d* and *d* must be made 2 feet 6 inches at least, and the height of the cistern *b* would be 2 feet; but if more water is required than 12 cubic feet, then the

Fig. 297.

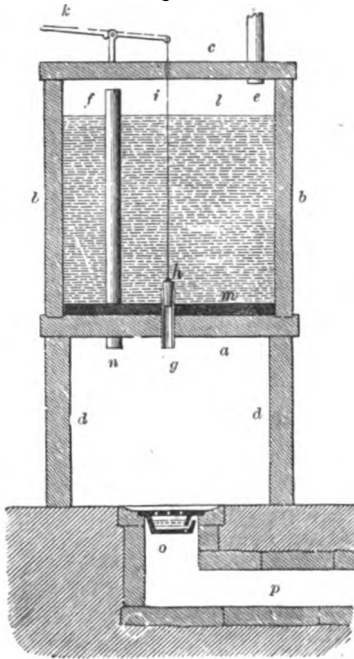

A RAIN-WATER CISTERNS.

height should be 3 feet, which gives a capacity to the cistern of 18 cubic feet. Suppose the cistern represented in the figure to contain 18 cubic feet, then the area of *a* will be $2\frac{1}{2}$ feet square, and *b* 3 feet in height, supported on two upright stones *d d* of the breadth of the cistern, and 2 feet high. The cistern may either be made of a block of freestone hewn out to the dimensions, or of flags, of which the sides are let into grooves in the bottom, and into each other, and imbedded in whitelead, and fastened together with iron clamps, having a movable stone cover *c*. Or it may be formed of a box of wood, securely fastened at the corners to be water-tight, with a cover of wood, and resting on the stone supports *d d*. Stone, being more durable, is of course preferable to wood for a cistern that stands out in the open air.

1111. A hollow copper cylinder *g* is fastened perpendicularly into the bottom *a*, having its lower end projecting 1 inch below, and its upper 3 inches above, the respective surfaces of the bottom. The upper end of the copper cylinder is formed to receive a ground truncated cone of copper *h*, called a plug or stopper, which is moved up and down with a lever *k*, by means of the copper rod *i*. The plug *h* must be made water-tight with grease, the rod of which passes through a hole in the cover, to be connected with the lever *k*, whose support or fulcrum is fixed on the cover. These parts are all made of copper, to withstand rusting from the water, with the exception of the lever, which may be of iron painted. The rain-water is supplied to the cistern by the pipe *e*, which descends from the rain-water conductor, and is let through a hole in the cover. The water is represented standing as high as *l*; but in case it should rise to overflow, it can pass off by the lead waste-pipe *f*, which is secured and movable at pleasure in a ground washer *n*, whose upper end is made flush with the upper surface of the bottom *a*. After the water has entered the cistern, it gets leave to settle its sediment, which it may do to the height of the upper end of *g*. The sediment is represented by *m*, and when it accumulates to *h*, the cover *c* should be taken off, and the waste-pipe *f* removed, and the cistern cleaned completely out by the washer *n*. The waste water runs away through the air-trap *o*, and along the drain *p*. It is more convenient to have two small than one large cistern, as, while the water is rising in the one, that in the other gets leave to settle. The cost of such a cistern, with droved stones, and to contain 18 cubic feet, with the proper mountings, may be about £5. We think it right to say, in commendation of this form of water-cistern, that in no case have we known the

water about the plug to be frozen, in consequence, perhaps, of the non-conducting power of the mud in the bottom of the cistern. The rod *i* has sometimes become fast to the ice on the top of the water at *l*, but a little boiling water poured down by the side of the rod through the hole in the cover, by means of a funnel, soon freed it from restraint.

1112. *Carbon Filter*.—In fig. 298 we give an elevation of a very simple and efficient form of filtering medium. It is composed of a ball of moulded carbon, or porous charcoal, manufactured after a process recently patented. (Depot, 62 Fleet Street, London.)

1113. *Wash-Basins and Lavatories*.—As a cognate branch of this department of our subject, we may here notice those contrivances now adopted in the most improved constructions, for the convenience of hand-washing, &c., in bedrooms and sculleries. Those introduced by Ridgway, and termed the “pottery fountain hand-basins,” are very cheap, and even elegant in design. The sectional sketch in fig. 299, will convey an idea of this “convenience:” *a* is the pipe leading from the rain-water cistern; *b b* the basin, supplied with a plug which fits into the top of the pipe at *c*, thus retaining the water at pleasure; this plug should be attached by a chain to the side of the basin, to prevent its being lost; *d d* the pipe leading to the drain by the exit *e*, and it should be trapped at the junction. This form is adapted to cases where the supply of water can be obtained from a cistern above the level of the basin. In cases where there is no provision of this nature, another form is required; at least a subsidiary contrivance has to be adopted to supply the defect, which is attained by having a small pottery cistern hung at a short distance above the basin, where it is filled with water when required; and the water is withdrawn by means of a small stop-crane. In fig. 300 we give perspective views of the forms just noted.

Fig. 298.



VIEW OF CARBON FILTER.

Fig. 299.

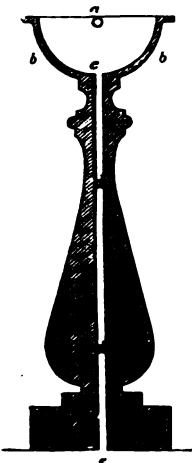

SECTION OF WASH-HAND
PORCELAIN BASIN.

Fig. 300.

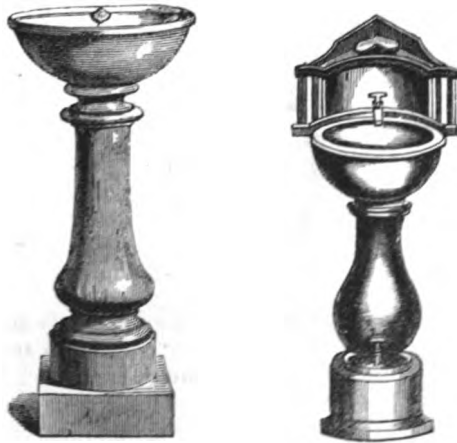

WASH-HAND BASINS AND FOUNTAINS

1114. In fig. 301 we give a sketch of the apparatus adopted in the form of a lavatory for bedrooms, introduced by Mr Jennings, of Great Charlotte Street, Blackfriars Road, London, in which "hot" and "cold" water and "waste-pipe" cocks are acted on by handles or knobs.

Fig. 301.

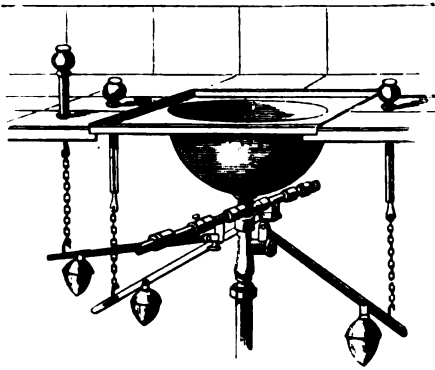

JENNINGS'S LAVATORY.

Fig. 302.

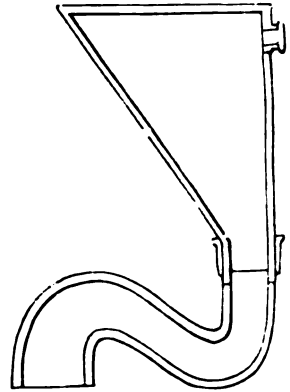

CLOSET SOIL-PAN AND TRAP.

1115. *Water-Closets.*—If the water-closet is placed within the house—a matter which we leave to the dictation of personal opinion, although ours is decidedly in favour of exterior arrangements, or at least, if they are interior, that they must be well ventilated—the soil-pan should at once communicate with the drain leading to the manure-tank. In fig. 302 a section is given of a soil-pan combining a water-trap, up which the foul air cannot ascend, as may be seen in the figure. The whole is made of earthenware, and the cost varies from 4s. to 7s. 6d. The pottery water-closet, shown in perspective in fig. 303, manufactured by John Ridgway & Co., Cauldon Place, Staffordshire Potteries, may also be used. They are neat, and made of the hard vitreous pottery, which is an admirable non-absorbent material.

Fig. 303.



RIDGWAY'S POTTERY WATER-CLOSET.

Fig. 304.



CLOSET-PAN TRAP.

1116. Fig. 304 illustrates a very simple and cheap form of closet-pan. Fig. 305 represents a form of water-closet pan and trap formed in one piece, wholly of earthenware, so as to require no woodwork for its support. The top is spread out about four or five inches, so as to form a self-sustaining seat. The entrance of the pipe for carrying off the effluvia to a ventilating tube or chimney is shown at *a*. This form, when properly constructed, and with an ordinary service-pipe

for water constantly on, and under pressure, is found to answer completely

In fig. 306 we give a section of Jennings's water-closet pan, in which an india-rubber tube *a*, is employed to communicate with the drain by raising the handle *b*; the lever *c c* nips the tube *a*, and closes it perfectly water-tight, as shown in fig. 307. This is perhaps the best and most efficient form of water-closet yet introduced. It is peculiarly free from the liability to get out of order, which characterises those apparatus with cranks, levers, &c.

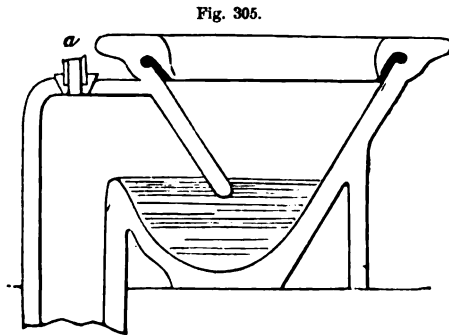

EARTHENWARE CLOSET-PAN WITH TRAP

Fig. 306.

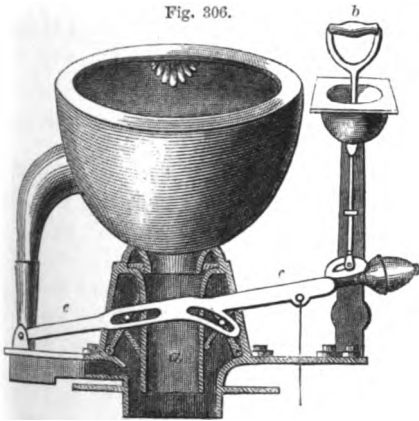

SECTION OF JENNINGS'S WATER-CLOSET—TUBE OPEN.

Fig. 307.

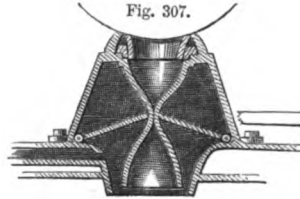

JENNINGS'S WATER-CLOSET—TUBE CLOSED.

1117. SECTION TENTH—*Fittings of the Farm-steading.*—A fixed milk-cooler is represented by fig. 308, made of stone—sandstone, slate, or marble—the last being the best material, being cool, cleanly, and handsome. An orifice is made in the bottom, at the near side, through which the milk runs out of the cooler, as also the water which has been used to wash it clean. The dimensions may be made at pleasure, 3 feet long and 2 broad being a good size; but the depth should not exceed 4 inches, to contain from 2 to 3 inches of milk. When made of wood lined with zinc, block-tin, tin, or lead, the form is the same as this. The sandstone and marble ones, as *a*, fig. 308, are each hewn out of single blocks and polished, and placed upon upright slabs;

Fig. 308.

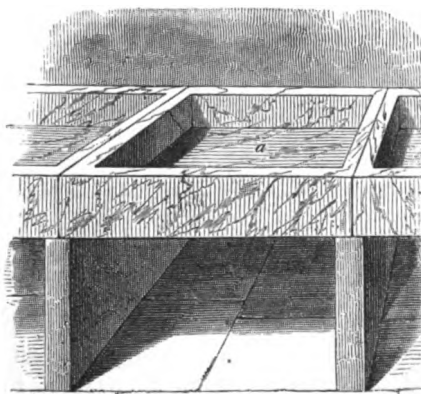

A FIXED MILK-COOLER OF MARBLE, OR OF WOOD LINED WITH METAL.

and the wooden ones, which support the metallic lining, are framed along the walls of the milk-house, and subdivided into separate coolers. It is only in large dairies that these fixed coolers are used.

1118. *Drainage Pavement-Bricks.*—In fig. 309 we give views of Forbes's patent

Fig. 309.

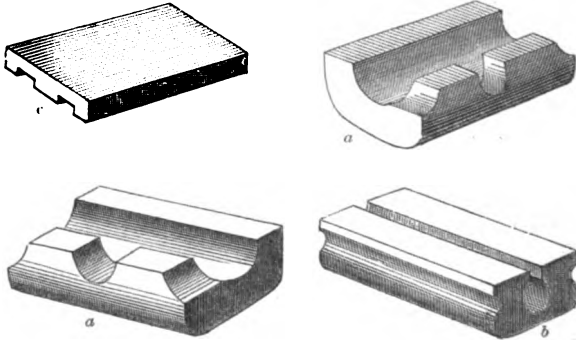

PERSPECTIVE VIEW OF FORBES'S DRAINAGE PAVEMENT-BRICKS.

drainage bricks for the floor of stables, byres, &c., manufactured by H. Clayton, Aslar Works, Dorset Square, London. In fig. 309 *a* and *a* are gutter bricks, *b* a drain brick, and *c* a cover for gutter. In fig. 310 we give a diagram showing the floor of flushed pavement, with the gutter partly uncovered, to show its connection with the pavement.

Fig. 310.

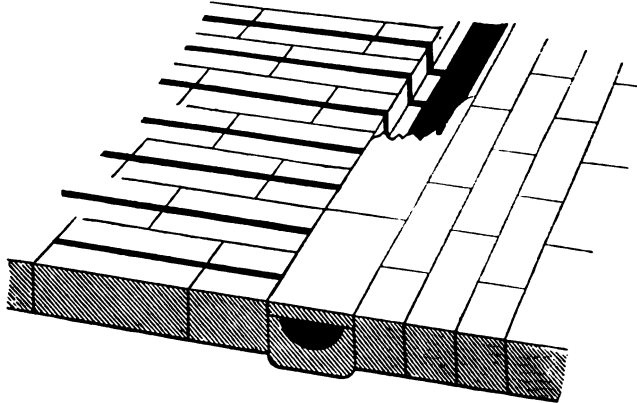

DRAINAGE PAVEMENT-BRICKS IN PERSPECTIVE, WITH GUTTER PARTLY UNCOVERED TO SHOW ITS CONNECTION WITH PAVEMENT.

1119. *Water-Troughs for Courts.*—The supply of water to cattle-courts is of paramount consideration. The troughs may be supplied with water either directly from pump-wells, or by pipes from a fountain at a little distance, the former being the most common plan. As a pump cannot conveniently be placed at each trough, we have found a plan of supplying any number of troughs from one pump, to answer well, provided the surface of the ground will allow the troughs being placed nearly on the same level.

1120. Were the trough which receives the water placed a few inches below the top of the one supplying it, and a lead pipe to come from the bottom of the supply trough over the top of the edge of the receiving one, the water might entirely be emptied, by drinking, without affecting the quantity in any of the others. Let *a*, fig. 311, be the supply trough immediately beside the pump; let *b* be the trough in any other court to be supplied with water from *a*, and let it be 3 inches below the level of *a*. Let a lead pipe *d*, be fastened to the bottom of *a*, the orifice looking upwards, and protected by the hemi-

spherical drainer *c*. Let the lead pipe *d*, be passed under ground to the trough *b*, and emerge from the ground by the side of and over the top of *b* at

Fig. 311.

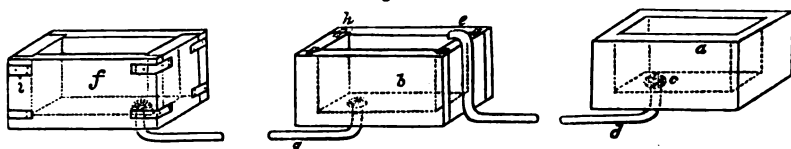

WATER-TROUGHS.

e. When *a* is filling with water from the pump, the moment the water rises in *a* to the level of the end of the pipe at *e*, it will commence to flow into *b*, and will continue to do so until *b* is filled, if the pumping be continued. The water in *a*, below the level of the end of the pipe at *e*, may be used in *a* without affecting *b*, and the water in *b* may be entirely used without affecting *a*.

1121. Water-troughs may be made of various materials: *a* is hewn out of a solid block of freestone, which makes the closest, most durable, and best trough.

1122. If of flag-stones, as *b*, the sides are sunk into the edges of the bottom in grooves luted with whitelead, and held together with iron clamps *h*, at the corners. This makes a good trough, but is apt to leak at the joints.

1123. Trough *f* is made of wood dovetailed at the corners, which are held together by clamps of iron *i*. When made of good timber, and painted, they last many years.

1124. Water-troughs are sometimes supplied from a large cistern, somewhat elevated above their level, and filled from a well with a common or force pump. In this case a cock, or ball-and-cock, is required at each trough: if a cock, the supply must depend on the cock being turned in due time; and if a ball-and-cock, the supply depends on the cistern always having water in it; but this method is expensive, and liable to go out of order.

1125. In an abundant supply of water from natural springs, accessible without the means of a pump, lead pipes may be made to emit a constant stream of water into each trough, and the surplus conveyed away in drains to the horse-pond, or to any other useful purpose.

1126. Still another mode may be adopted where the supply of water is plentiful, and it flows constantly into a supply-cistern. Let the supply-cistern be 2 feet in length, 1 foot wide, and 18 inches in depth, provided with a ball-and-cock, and let a pipe proceed from its bottom to a trough of dimensions fit for the use of cattle, into which let the pipe enter by the end or side a little way, say 3 inches, below the mouth of the trough. Let a pipe proceed from this trough, as from the lower bend of the pipe *e*, at the bottom of the trough *b*, fig. 311, into the end of another trough, and so on, from trough to trough, into the ends of as many succeeding troughs, on the same level, as are required, and the water will rise in each as high as the mouth of the pipe, and, when withdrawn by drinking from any one trough, the ball-and-cock will replenish it direct from the supply-cistern; but the objection to the ball-and-cock applies as strongly in this as in the other case, although economy of pipe attends this method.

1127. *Stone Trough for a Byre*.—To keep the stone troughs of byres always sweet and clean, they should be washed out and scrubbed with a heather rinse once a-day; and, that the water may be conveniently got rid of, the troughs should be formed as in fig. 312, with the bottom sloping both along it from *b* to *d*, and across it from *d* to *e*, where is a metallic sucker and stopper, to allow

the water to escape to the drain underneath; and this drain, of course, communicates with the other drains.

Fig. 312.

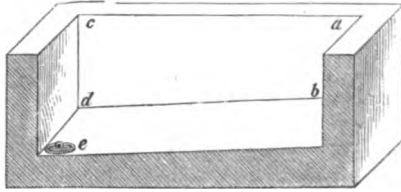

SECTION OF A STONE TROUGH FOR A BYRE.

A convenient form and size of trough is 27 inches in length, 16 in width, and 8 in depth at *a*, increasing to 9 at *c*, and to 10 inches at *e*, the lowest point.

1128. A hydraulic apparatus is sometimes provided to such byres, for the supply and removal of cold water from the troughs, by means of the action of

a lever operating at each trough; and as long as the apparatus works well, its convenience is certainly great, but it is apt to get out of proper action, when its presence becomes a continual source of annoyance.

1129. The floors of work-horse stable, riding-stable, cow-byres, calves'-house, and hay-house should be paved with small stones embedded in sand and beaten down firm with a rammer. Round stones may be gathered from the land or sea-shore, and square-dressed ones from a quarry. The floors of straw-barn, outhouses, and turnip-stores may be of earth rammed hard. Pig-sties should have a flooring of flag pavement, to prevent the propensity of pigs to grub up small stones. The floors of corn-barns are often laid of flag pavement or asphalt, but we would always prefer them of wood.

1130. SECTION ELEVENTH—*Pisé Walls*.—Brick earths are well adapted for *pisé*; but, owing to the capacity for retaining moisture, they are apt to crack, unless carefully shielded from the wet during the process of drying the walls. All kinds of earth, however, may be used, with the exception of light poor lands and strong clays; these, however, will do if judiciously mixed with other better-fitted soil. To show how this mixing may be most successfully carried out, a few sentences may be useful: the principle of mixing is simply to blend a light earth with a strong, a clayey with a sandy or gravelly kind. Where the best kind of soil—that is, gravelly—cannot be obtained, small round pebbles, &c., may be mixed with it. All animal or vegetable substances that are apt soon to decay must be carefully kept out of the soil to be used. The following indications, which may be observed in order to judge of the fitness of the soil for *pisé* in any district, may be useful. In digging, if the spade brings up large lumps at a time, the soil is well adapted for the work; this holds also where the soil lies on arable land in large clods, and binds after a heavy shower and a hot sun. Where vermin holes are smooth in the inside and firm, or where the small lumps generally found in plenty in all fields are difficult to be crumbled between the fingers, the soil is good. Soil of good quality is generally found at the bottom of slopes that are in cultivation, and on the banks of rivers. In preparing the earth for building, the first operation is breaking the clods or lumps, and thereafter placing the soil in a conical heap; this form facilitates the removal of large, flat, and circular stones, which, falling to the bottom, are easily removed from the mass by means of a rake. The teeth of the rake should be placed at intervals of 1 inch or thereabouts, so that only stones exceeding this in size may be withdrawn; or what would be better and quicker, a bricklayer's sieve or "screen" might be used, having the meshes about an inch square. Where two varieties of soil are to be mixed, the operation should be done at this stage. Enough of soil should only be prepared to last a day's working. Care must be taken to prevent rain saturating the earth

with water, as in this state it will form mere mud in the mould. It is necessary to note that the soil is in best condition for working when neither too dry nor too wet. It is very evident that less time will be lost in slightly wetting the soil when too dry, than in waiting for it to dry should it get saturated with rain by a careless exposure.

1131. The next point we have to explain is the construction of the "mould." This should be made of clean thin planks of pine, or other light wood, well seasoned, to lessen the chances of their warping. Their thickness should be about 1 inch, well planed on both sides. The length should be from 12 to 14 feet for ordinary work; but shorter moulds, as 7 feet, will be at times useful. The depth of the mould should be 14 inches—some recommend 2 feet 9 inches; but a practical experiment, where the former depth was adopted, showed that it was more convenient than the latter, giving at the same time greater facilities for detecting error in carrying up the walls. The two sides of the mould, of whatever depth, are formed by the requisite number of planks laid edge to edge, and tongued and grooved as in fig. 313 at *a*, or held together by pins as at *b*, placed at a distance of from 4 to 6 inches. Battens, as in fig. 314,

Fig. 313.

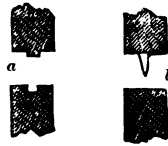

SECTION OF PLANKS FOR MOULD FOR PISE WALLS.

should be nailed on the outside of the side of the frame, at intervals of 30 inches, or thereabouts. Iron handles may be placed at each end of the upper edge of frame, to facilitate its removal. It is necessary to have the boards forming the side of frame, and the battens, of one uniform thickness. In forming the angles, a separate frame is required; this should be of same depth as the other, but having battens at each end only, and these in the inside. These should be put firmly on with screw-nails, as the ordinary ones are apt to start. The use of these battens is to prevent the head of the mould from springing out when forming the ends of the wall. The pressure being outwards, the head of the mould must evidently be of the same depth as the mould, and its width equal to the intended width of wall. This is shown in fig. 315, where *a a* are the sides of the mould, *b b* the inside battens, *c* the head. The next point to be attended to is the "joists." These are to be made of hard timber, 4 inches broad and 2½ deep. Suppose the thickness of the wall to be 14 inches, the sides of the mould or frame being each 1 inch thick, mortises must be cut at each end of the joist, as at *a a*, fig. 317, the distance between the inner ends of which must be 16 inches. This will give a width between the inside faces of the mould of 14 inches, equal to the intended thickness of wall. Fig. 316 shows the plan of the joists and sides of the mould when laid on the wall. The mortises should be 1½ inch wide, and some 4 or 5

Fig. 314.

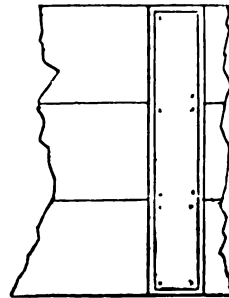

SIDE OF MOULD FOR PISE WALLS.

Fig. 315.

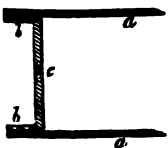

SECTION OF MOULD.

Fig. 316.

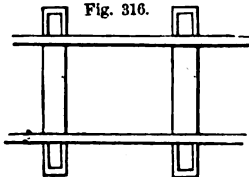

PLAN OF JOISTS OF MOULD

Fig. 317.

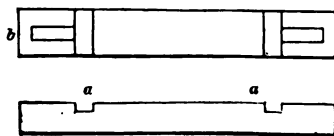

PLAN AND SECTION OF A JOIST.

inches long ; and in order still further to facilitate the placing of the sides of the mould, a groove *b b*, fig. 317, some $\frac{1}{2}$ inch deep, and 1 inch wide (the thickness of the sides), may be made in the upper sides of the joists, close up to one end of the mortise. "Posts" are next to be provided, 4 inches square, and equal in length to about twice the depth of mould. Tenons will be made at one end to fit into the mortise in the joists. The outer sides of the mould will thus press closely against the inside face of each post. It is essentially requisite that all the posts shall be of uniform scantling, and the tenons all of the same size : this will prevent numbering being necessary, and facilitate operations. The foot of the posts *a a*, showing tenons *b b*, is shown in fig. 318. "Caps" are next to be described. These consist of pieces of hard

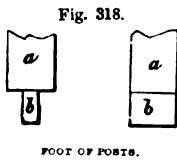

wood *a a*, fig. 319, 4 inches broad, and $2\frac{1}{2}$ or 3 inches thick, having snugs *b b* same breadth, and $2\frac{1}{2}$ inches thick, dove-tailed at each end. The distance in the inside of these snugs should be 25 inches, so that space may be afforded on each side to drive thin wedges between the inside face of snugs and outside face of posts. The method of using the apparatus may now be briefly described. The foundation of the

building to be erected is to be of stone or brick at least 18 inches above the level of ground. The joists, figs. 316, 317, are next to be laid on the wall, at distances corresponding to the length

Fig. 319.

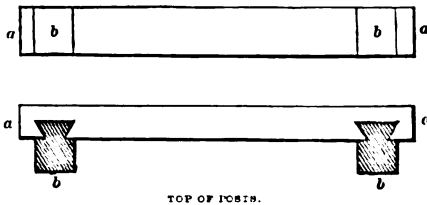

of boards forming the sides of mould. The joists should be so laid that the inside and outside line of foundation-wall shall correspond with the inside line of mortises cut in joists, fig. 316. Having adjusted the joists, the foundation-wall, in stone or brick, must be increased in height a course or two, so as to enclose the

joists in the body of the wall. The posts with tenoned ends are next to be inserted in the mortises of the joists, the sides of the mould placed in the grooves, the outside end filled in with the prepared board, and the caps finally adjusted over the upper ends of posts, and driven hard up by means of the wedges. The mould sides will, by this means, be able to resist the force of compression used in ramming the earth ; while the end nearest the extremity of wall will be prevented from flying out by means of the battens placed at the ends of each side forming the mould, as before described. In fig. 320 the arrangement of the various parts may be seen : *a a* is the brick or stone wall, *b b* the joists, *c c* the posts, *d d* sides of mould, *e* the cap, *f f* the wedges to drive up the same. It should be here noted that, as the foundation in stone or brick is worked round, the joists used at one part of the building should be driven out (to facilitate their removal,

Fig. 320.

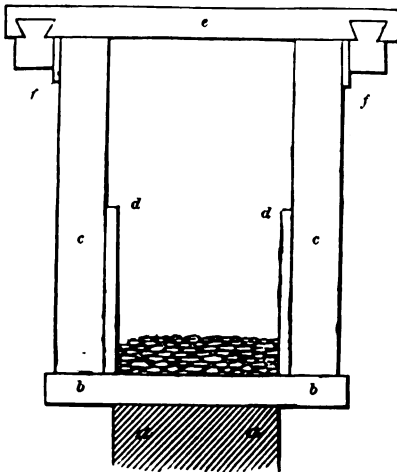

SECTION SHOWING ARRANGEMENT OF PARTS OF MOULD.

used at one part of the building should be driven out (to facilitate their removal,

they are made slightly narrower at one end than at the other), and placed as before; thus, when the foundation is finished, it will present the appearance of a wall from 20 to 24 inches high, having all round it square or oblong holes, in which the joists can be placed. Before commencing to ram the earth in the mould, it will be necessary to try it by means of the plumb-line and square, to ascertain that it is properly levelled. The operations must be commenced at one angle of the wall, the head of the mould being at the outer extremity of wall, within 14 inches of it, the joints being at that distance from the outer extremity in consequence of the thickness of return wall. The labourers appointed to prepare the mould, hand it up to those engaged in the mould in ramming; these take the earth and lay it out at the bottom of the mould to the depth of 3 or 4 inches: more than this depth should not be put in at one time. The first strokes of the rammer should be made close to the edges of the mould, thereafter going over the whole surface in regular succession, from the head of the mould downwards; then crossing these first blows or indents by another succession. Care should be taken to give to each layer as equal a compactness as possible, which is easily attainable; the parts under the caps must be carefully looked to, as, from their position, the rammer must be used obliquely. The mould being thus filled by successive layers, each equally well rammed, the wedges holding the caps must be withdrawn, the caps taken off, the sides thus released taken out, and the joists finally drawn out of their holes in the wall, which should be filled up by proper means. In filling up the mould, the inner end should not be filled up to the same height as the other parts, but should be made to slope gradually down. This is shown in fig. 321.

The joists are next to be placed in the adjoining holes, the sides of the moulds being without battens at the ends—these not being required, as no end to the mould is needed. The outer end of the sides should be so adjusted that they are on a line with the top of the slope of the first course of rammed earth. By this means, when the earth is filled in to the second mould, one end of it will lie upon the sloping end of the first course, thus forming a species of bond. The foundation-wall being, by a succession of moulds, covered with a wall of rammed earth, the height being equal to the depth of the mould, holes or slits are cut in the upper surface in which to lay the joists. These being prepared, the mould is to be set up as before at an angle of the wall, the sides having the battens at one end against which to fix the end; but the operation is to be begun at the opposite end of the wall to that originally started with. By this means, as each end of the mould is left sloping off as before, the sloped surfaces in the second course will lie the contrary way to those in the first; the bond between the several courses will thus be increased in efficiency. It should be borne in mind that the holes for the

joists cut in the upper surfaces of the successive layers, should be so placed as not to be exactly above one another in all the courses, but each succeeding series between those of the series below. These recommendations will be seen exemplified in fig. 322. The gables of a house can easily be made by making the successive layers each shorter than the one immediately below it; the requisite slope will thus be obtained. When a day's work is finished, the walls should be covered with boarding, so that they may be covered in the

Fig. 321.

MODE OF FILLING UP
THE MOULD.

Fig. 322.



COURSES OF A PISE WALL.

event of rain ; and the roof should be placed as soon after the walls are completed as possible. The roof should overhang at least 12 inches, to protect the vertical walls from the effect of rain. Where the building consists of two storeys, the walls of the upper storey may be made thinner than the lower, by setting at the level of first floor a depth of 2 or more inches from the inside, the outside being flush with the outside of lower wall. The rammer may be made of hardwood or cast-iron ; if of the latter material, its weight may be 14 lb. or thereabouts. Bond timbers may be used with advantage in *pisé* walls ; they should be of the length of the mould, and in breadth equal to one-third the thickness of wall. As they are completely embedded in the earth, they last for a great length of time. If considered necessary or more economical, the inside faces of the bond timbers may be made to lie flush with the inside wall of house. In this case they will serve as battens in which to drive nails or holdfasts for many convenient purposes. The openings for doors and windows should be left a little less than required ; they may be dressed after the building is finished to the proper dimensions. Wood bricks should be built in here and there to which to fasten the dressings and frames. The openings are made by placing heads or a head in the mould at the place where the wall is to terminate and the opening begin. We have next to notice the method of constructing the walls of houses of

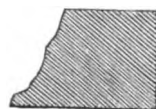
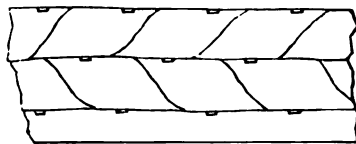
1132. *Unburnt Bricks*.—Unburnt bricks form a much drier wall than ordinary burnt bricks, inasmuch as they are not so absorbent of wet or damp. To make these, any ordinary clay will answer. If dry when obtained, it must first be moistened and thoroughly worked by the feet of cattle, or pounded by hand. Cut some straw into pieces about 6 inches in length. After being duly mixed, the clay is ready to be made into bricks. A mould of any size must be made ; a convenient size is 12 inches long, 6 wide, and 5 deep : this mould should have a bottom, but not air-tight, in order to prevent the brick from sticking in the mould. The clay is put in this mould, and the brick formed much in the same way as ordinary bricks. Should the clay be very tenacious, a little sand sprinkled in the mould will enable the brick to leave it freely. The bricks are placed upon level ground to dry, turning them on their edges on the second day ; thereafter left in piles, protected from the rain, for ten or twelve days. The foundation must be formed of stone or burnt brick ; and, to prevent damp rising, a course of slate should be laid above the footings in hydraulic cement. The walls formed of these bricks will be exactly 12 inches in thickness—that is, the length of the mould ; the partitions are formed by laying the bricks lengthwise, thus giving a thickness of 6 inches, the breadth of the mould. To obtain the necessary bond in the walls, the work is carried up in alternate courses of headers and stretchers—one course having the bricks laid across the wall, the next course having them side by side. A good ordinary brick-mortar is to be preferred, although a weak mortar of lime and sand will do for laying the bricks. The doors and window-frames should be previously made to be ready to insert when required. These frames should be of stout plank, the exact width of the thickness of walls ; they will thus help to cover the joints and strengthen the walls. Lintels and sills of stone, when easily had, will much improve the appearance of the structure : pieces of timber 3 inches thick, width equal to thickness of walls, may be used in place of stone ; these should have a clear bearing of at least 12 inches on each side of the opening. Of whatever kind the roof is, it is essential, in this form of material for external walls, that it should be an overhanging one, in order to guard the walls from vertical rains. The outside of the walls is plastered with good lime-mortar mixed with hair,

and then with a second coat pebble-dashed as in roughcast. The inside walls are finished in the usual way. A cottage may be built in this way for an incredibly small sum—warm, dry, and of course comfortable. As to its durability, it is only necessary to state, that it is by no means a difficult matter to adduce instances where such structures have existed in thorough efficiency for a great length of time; in some, for upwards of two hundred years. The method of forming the unburnt bricks will be found described under the head of BRICK-MAKING, in the *Handbook of the Mechanical Arts*, by R. Scott Burn. Blackwood & Sons.

SUBDIVISION SECOND—*Timber Construction.*

1133. SECTION FIRST—*Joining, or Joints of Timber.*—When framing is constructed of wood, the modes of joining and fitting the various parts together constitute the Practice of Carpentry. It is to the various forms of joints used in carpentry that we now direct the attention of our readers.

1134. *Fished Joints.*—*Joining Timbers in the direction of their Length.*—When timbers are to be joined in the direction of their length, when subjected to tension, the method illustrated in fig. 323 may be adopted; thus the ends of the beams *a* and *b* are squared up, and made to abut against each other; they are secured in this position by bolting together the two pieces *c* and *d*, the bolts passing through the beams *a* and *b*. This is a strong, if not the strongest, method of joining timbers under this head, although it is objected to on account of its clumsy appearance. In fig. 324 we show another method of “fishing” beams;

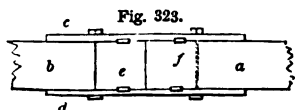

Fig. 323.
JOINING TIMBERS IN THE DIRECTION OF THEIR LENGTH—SCALE, $\frac{1}{4}$ INCH TO THE FOOT.

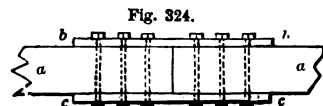

Fig. 324.
JOINING TIMBERS IN THE DIRECTION OF THEIR LENGTH—SCALE, $\frac{1}{4}$ INCH TO THE FOOT.

a a the two beams to be joined, *b b, c c*, the upper and lower pieces secured together by the bolts and nuts. The joint may be made stronger by notching the pieces *f f* and *g g*, as in fig. 325, or inserting flat keys into apertures made partly in the beams and partly in the pieces, as shown at *e* and *f*, fig. 323. In fig. 325, *b d* are the two beams to be joined, butting at *c*; *f f* and *g g* the two pieces notched in; *h* and *i* showing the plan or upper side of the notches. Another form is given in fig. 326, where *a b* are the two beams, butting at *c*; *d d* the lower, and *e e* the upper pieces notched into the upper and lower sides of the beams, and kept together by the straps *f f*, or bolts and nuts may be used.

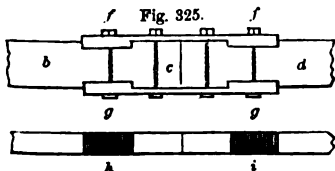

Fig. 325.
JOINING TIMBERS IN THE DIRECTION OF THEIR LENGTH—SCALE, $\frac{1}{4}$ INCH TO THE FOOT.

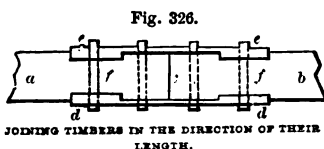
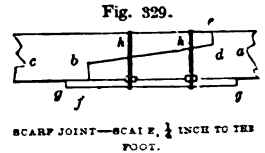
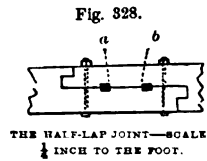
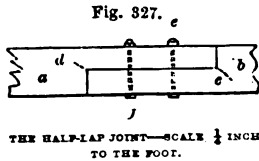

Fig. 326.
JOINING TIMBERS IN THE DIRECTION OF THEIR LENGTH.

1135. *Scarf Joints.*—When the joint is so constructed that the surfaces of the two beams are flush with each other, the united beams presenting the appearance of one only, the joint is called a “scarf” joint. The simplest and the

strongest form of this, known as the "half-lap joint," is shown in fig. 327; the beams to be joined being shown at *a b*, the abutting ends *c d* being square; bolts *e f* are used to keep the parts together. Fig. 328 shows another form of "half-lap" scarf joint, *a b* being hardwood keys. These keys should not be driven in too tightly, so as to produce any strain on the parts; all that is necessary is to bring the joints together, and then bolt together the beams firmly. When the jointed beams are subjected to a cross strain, the form of "scarf" shown in fig. 329 will be found a good one. The two beams to be joined



are represented by *a c*; the portion *d b* is oblique, not parallel to the surfaces of the timber as in fig. 327. The end *b f* is at right angles to the surface of the beam, and the end *d e* oblique. A piece of timber *g g* is secured to the under-side by hardwood keys, and the whole secured by iron hoops or bands *h h*. Fig. 330 shows another form of scarf joint, in which *a b* are the two beams; the abutting surfaces or tables are notched, as shown. Wooden keys are driven in at the parts marked *c c c*; *d d* are straps, or bolts and nuts, which embrace the iron plates *e e*, and bind the whole together. This example is here given as one rather to be avoided than used. Fig. 331 shows another form, in which *a b* are

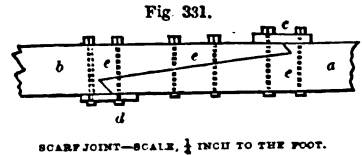
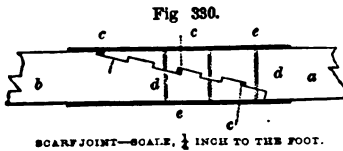

the two beams; *c d* iron plates secured by bolts and nuts *e e e*. Fig. 332 shows another form, in which the half-lap joint is employed in conjunction with two iron plates; *a b* are the two beams; *c d* the two plates, secured by bolts and nuts *e e e*. This method of using plates does not give so strong a joint as where the plates are arranged as at *a a*, *b b*, fig. 333, extending along the whole joint

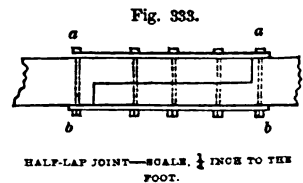
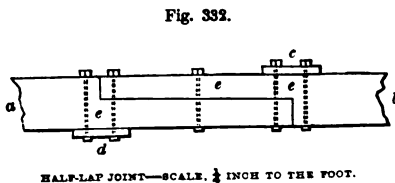

In some scarf joints the plates are placed at the sides, as at *a a* in fig. 334. This should be avoided, as it tends to weaken the joint. In fig. 335 we give an excellent form of a step scarf, with keys at *a b c*—if placed at the points *d* and *e* the joint would be weakened—*f f*, *g g*, lower and upper iron plates, are secured together with the bolts and nuts *g f*, *g f*.

1136. Where the jointed beams are subjected to compression and extension at the same time, the form of joint should be designed to meet those strains. Fig. 336 shows a form adapted to these circumstances; *a b* are the two beams

to be joined; the folding wedge or double keys *c d* serve to bring the parts together. A plate of wrought-iron *g g* is placed at the under-side, and secured by bolts *e e*.



1137. *Scarf Joints for Perpendicular Timbers.*—Many of the joints used to increase the length of timbers laid horizontally are obviously useful to lengthen beams placed perpendicularly. Thus, the joint in fig. 337 is well adapted for lengthening a post or pillar, and is better calculated for this purpose than the joints illustrated in figs. 338 or 339. The following joints are useful in building up or lengthening posts or pillars. When two pieces of timber are to be joined vertically together

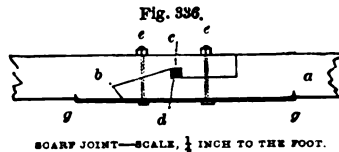
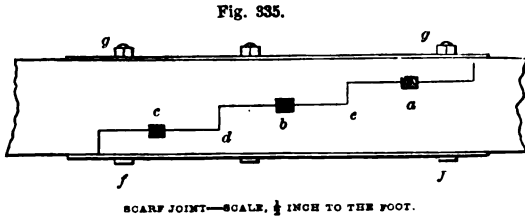

in the direction of their length, to resist compression, joints, as in figs. 337 and 338, may be used. In fig. 337 let *a b c d* be the end of the lower part of the beam; two square pieces are cut out at opposite corners. Let the end of the upper part of the beam be similarly cut, as at *e*, and the two placed together, so that the solid parts of the upper beam may fit into the hollow spaces of the lower beam. In fig. 338, *a b d c*, *e f g h*, represent the ends of the beams

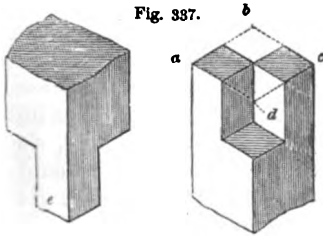

JOINT TO RESIST VERTICAL COMPRESSION—
SCALE, 1 INCH TO THE FOOT.

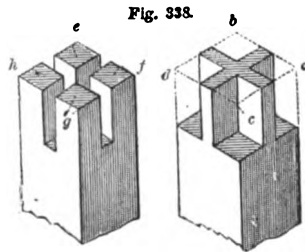

JOINT TO RESIST VERTICAL COMPRESSION—
SCALE, 1 INCH TO THE FOOT.

to be joined. From the lower beam parts are cut at each corner, as at *a b c d*, of any depth required. The method of cutting the end of the upper beam is shown at *e f g h*; the corners being left solid, the solid parts of the lower beam go into the hollow parts in the upper beam. If there is any chance of the beams thus joined being subjected to a cross strain, plates of iron may be put at the sides, extending some distance on either side of the joints, and secured together by bolts passing through the beams, or, what will be better, by hoops passing outside.

1138. In fig. 339 we give other forms of joints for perpendicular beams. In the figure to the right, the part *a a* is cut out of the lower beam, the part *b* of the upper beam being passed into *a*. In the figure to the left, the part *c* is cut at right angles to *d*, the depth being equal to *e*. The part *f* of the upper beam enters the part *c* of the lower, *g* the part *d*.

1139. As regards the proportions of scarf joints, of which we have given illustrations, Tredgold, in his valuable work on Carpentry, has given some valuable notes: these we here append. "The length of the scarf should be, if bolts are not used, in oak, ash, or elm, six times the depth of the beam; in fir twelve times the depth of the beam. If bolts and indents are combined, the length of the scarf should be, in oak, ash, or elm, twice the depth of the beam; in fir, four times the depth. In scarfing beams to resist transverse strains, straps drawn on tight are better than bolts. The sum of the area of the bolts should not be less than one-fifth the area of the beams when a longitudinal strain is to be borne. No joint should be used in which shrinkage or expansion can tear the timbers."

Fig. 339.

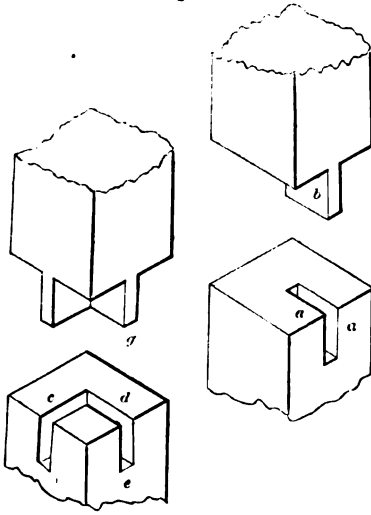

JOINT TO RESIST VERTICAL COMPRESSION—
SCALE, 1 INCH TO THE FOOT.

1140. In joining timbers, all the bearing surfaces should be made with great accuracy, all inequalities tending to increase the strain more upon one part than another, and thus to cause rupture. The simpler the parts are the better.

1141. As the bolts and keys of scarfed timbers are apt to work loose and become shaky in situations where subjected to vibration, as in engine-rooms, &c., scarfed beams should not be employed under such circumstances—trussed beams of wood being employed, or iron, cast or wrought.

1142. *Joints employed when the Timbers are at right angles to each other.*—When the piece *c*, fig. 340, is to abut vertically upon a horizontal piece *a*, the joint is made by what is called a mortise-and-tenon joint.

Fig. 340.

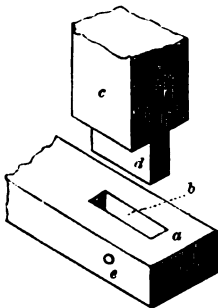

MORTISE-AND-TENON JOINT—
SCALE, 1 INCH TO THE FOOT.

The projecting piece or tongue *d* is called the tenon, and the slot or aperture *b* which receives it is called the mortise. When the piece *d* is inserted into *b*, the two are generally connected by an oak pin driven through at *e*. To secure permanence in this joint, the tenon must fit with great accuracy into the mortise, to keep the strain equally on the whole parts; if the strain is thrown on the tenon only, through inaccuracy of the parts fitting, the joint is much weakened. To prevent this, the joint is sometimes made with the sides at an angle, as at *a b*, *b c*, fig. 341, on the part *d*. The acute angle *e f g* does not secure so good a joint as the obtuse one at *a b c*, especially where the lower beams are of the same depth. The king-post of a roof, as *a a*, fig. 342, is connected with the tie-beam *b b* by the tenon *c*. *d d* is a plan of the lower edge of tie-beam, with the mortise-hole *e*; *f f* are the struts. Wedges may be driven up from the under-side of tenon *c*, as at *g*.

1143. In figs. 343, 344, and 345, we give other methods of connecting the king-post of a roof with the tie-beam.

1144. In fig. 343 we illustrate a method of connecting king-post *b* with tie-beam *a a*; a mortise is cut in the beam, in which the tenon *c* is inserted—*d*

being a wedge to drive the whole tight up. In fig. 344 we illustrate another method, where the king-post *b* is let into the upper edge of the beam *a*, as shown in the section *e f g*, to the right hand of the diagram. A bolt *d* passes through both of them, and is secured by the nut *c*. In fig. 345 the connec-

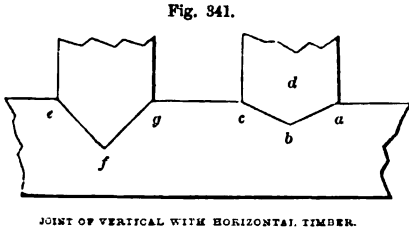

JOINT OF VERTICAL WITH HORIZONTAL TIMBER.

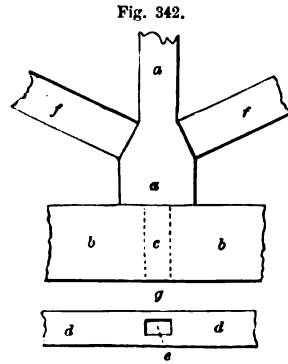

CONNECTION OF KING-POST WITH TIE-BEAM
—SCALE, 1/2 INCH TO THE FOOT.

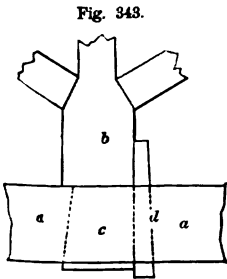

SECTION OF KING-POST WITH TIE-BEAM,
WITH WEDGE—SCALE, 1/2 INCH TO THE FOOT.

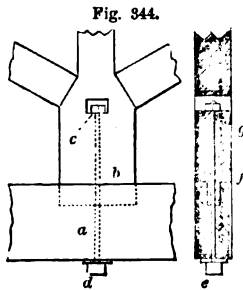

CONNECTION OF KING-POST WITH TIE-BEAM,
WITH BOLT—SCALE, 1/2 INCH TO THE FOOT.

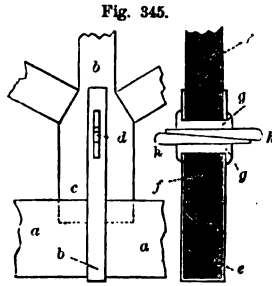

CONNECTION OF KING-POST WITH TIE-BEAM,
WITH JOBS AND COLLARS—SCALE,
1/2 INCH TO THE FOOT.

tion is made by passing an iron strap *b b*, round the tie-beam *a a*, and connecting it to the king-post *c d* by the keys *h h*, and cottars *g g*—these passing through an aperture cut in the king-post and slots in the sides of the strap *b b*. In the section, *f f* is the king-post, *e* the tie-beam.

1145. Fig. 346 shows a method of joining at right angles a horizontal beam *a a*, to a vertical one *b b*, by what is called a "dovetail joint," the tenon *c* passing into the mortise *d*.

1146. If the tenon is to be inserted in the beam *a*, in its centre as at *c*, fig. 347, the tenon is made of the form as at *b*, and small oak wedges *f f* are inserted in the end of *b*; and as the tenon is driven in the mortise, the wedges *f f* are forced into and cause the tenon to expand, filling up the mortise *c*. This species of joint is called "fox-tail dovetailing." In section, *d* is the mortise and *e* the tenon.

1147. Fig. 348 illustrates three methods of joining horizontal to vertical timbers, given by Emy in his celebrated *Treatise on Carpentry*.

1148. In cases of double-flooring, the binding joists are mortised into the "girders" in the manner shown in fig. 349. The best place to make the mortise in the girder *e* is in its neutral line, or the middle of its depth, as at *f*. The tenon *d* of the joist which is to be supported by the girder *e* should be somewhat

near the bottom line of the joist, as at *g*. Where the beam is subjected to a great strain, tending to draw the tenon *d* out of the mortise in the girder *e*, an

Fig. 346.

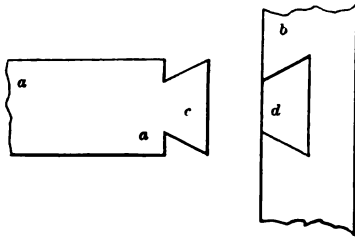

DOVETAIL JOINT—SCALE $\frac{1}{2}$ INCH TO THE FOOT.

Fig. 347.

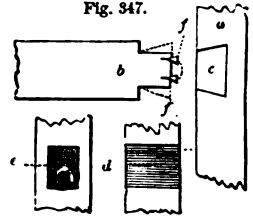

DOVETAIL JOINT—SCALE $\frac{1}{2}$ INCH TO THE FOOT.

oak trenail, or pin, or an iron bolt, should be passed through. In the case of a

Fig. 348.

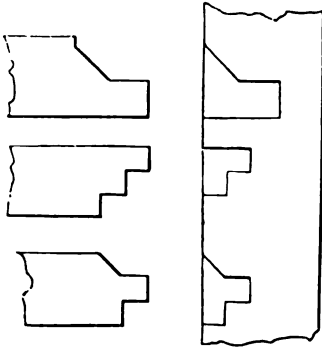

TUBE JOINTS—SCALE, $\frac{1}{2}$ INCH TO THE FOOT.

Fig. 349.

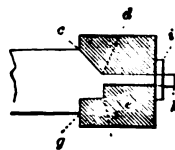

JOINING OF GIRDERS AND BINDING JOISTS—SCALE, $\frac{1}{2}$ INCH TO THE FOOT.

joist mortised through a beam, the tenon may be fastened as at *h*, and a pin *i* inserted.

1149. In joists, as in fig. 349, the mortises should be sunk near the top of the girder, as at *c*, gradually deepening towards the central or neutral axis

of the girder, where the strain is least. The length of the tenon may be about one-sixth of the depth of the girder.

1150. *Wall-plates* are joined at the corners by methods shown in fig. 350, half notched at the end as at *a* and *b*, or a little from the

end of each, as at *c* and *d*. By this method of joining, the tendency to disconnect in either direction is prevented. A dovetail joint is sometimes used as at *e*, a corresponding tenon being made at the extremity of the other wall-plate. The joint shown at *c* and *d* is perhaps the best.

1151. *Tie-beams* are joined to the wall-plates, as *a a* to *b b*, fig. 351, by the

Fig. 350.

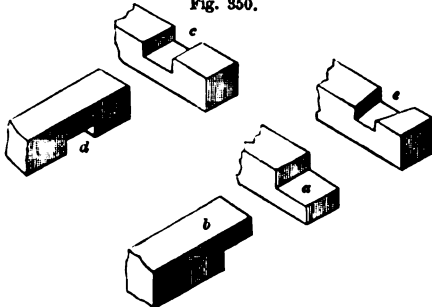

METHOD OF NOTCHING "WALL-PLATES" TOGETHER—SCALE, $\frac{1}{2}$ INCH TO THE FOOT.

Fig. 351.

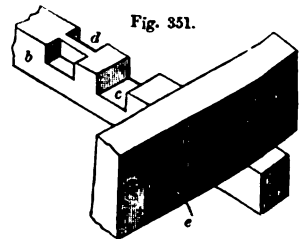

JOINING OF "TIE-BEAM" WITH WALL-PLATE—SCALE, $\frac{1}{2}$ INCH TO THE FOOT.

joint at *c*, the tie-beam being simply let into this. A better and more secure joint is shown at *d*, which is similar to that at *c*, with this exception, that the

wood is not cut across, but a piece or feather is left in the middle: a corresponding piece *e* is cut out of the lower edge of the tie-beam *a*, into which the feather goes.

1152. In fig. 352 we show at *a b* a method of joining the tie-beam *c c* with the wall-plate *d*: where a dovetail joint, as at *e f* in the lower figure, is employed, the tenon is apt to work loose. In fig. 350 we gave at *a b* a form of joint suitable for joining timbers at right angles to each other at the corners or angles.

1153. In fig. 353 we give two illustrations showing other forms. The beam *a* is joined to *b* by the mitre-joint at *c*; the beam *d* is notched into the beam *e*. Where beams cross each other, as in fig. 354, the beam *a a* crossing

Fig. 352.

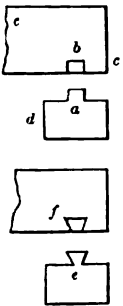

JOINING OF TIE-BEAMS WITH WALL-PLATES—SCALE. 1/2 INCH TO THE FOOT.

Fig. 353.

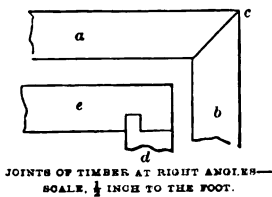

JOINTS OF TIMBER AT RIGHT ANGLES—SCALE. 1/2 INCH TO THE FOOT.

Fig. 354.

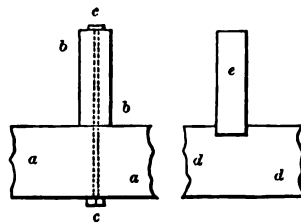

JOINING OF BEAMS CROSSING EACH OTHER AT RIGHT ANGLES—SCALE. 1/2 INCH TO THE FOOT.

the beam *b b*, the upper beam may simply be placed on the lower, being secured by a strap, or by bolt and nut *c c*; or the lower one *d d* may be notched into the upper one *e*.

1154. *Joining of Timbers at angles other than a right angle.*—We give a few illustrations of joints for such cases. In fig. 355 the beam *a* is joined to the beam *b b* by being let into the notch *c*. The obtuse angles *d d* of the beam *a* give a stronger joint than when they are more acute, as at *e e* in the beam *f*.

Fig. 355.

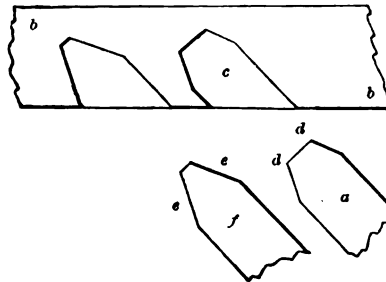

JOINING OF TIMBERS AT OBTUSE ANGLES—SCALE. 1 INCH TO THE FOOT.

1155. In fig. 356 the beam *a* is secured to the beam *b* by the tenon *c* being inserted in the notch *d*. As good a joint for cases now under consideration as can be made, is perhaps that shown to the left hand of fig. 356, where a notch is cut across of the full breadth of the beam *f*; the two beams *f* and *e e* being secured together by a rib or tenon *g* going into the notch or mortise in the under-side of the beam *f*; *i* is a continuation of the beam *f*. An objectionable form of joint of this kind is shown in the right hand of fig. 357, where the beam *a* is joined to the beam *b b* by the tenon *c* passing into the mortise *d*.

1156. Beams crossing each other at other than right angles, may be secured by the form of joint shown in fig. 357, the diagram to the left; the beam *a a* crossing the beam *b b*, the part *c* being inserted in the notch *d*; *e e* in the lower figure shows the beam *b b* in continuation on each side of the beam *a a*.

1157. *Joining of Timbers placed at angles to horizontal Timbers.*—Of this class of joints the most important refer to the joining of the feet of rafters with the tie-beams of roofs. Fig. 358

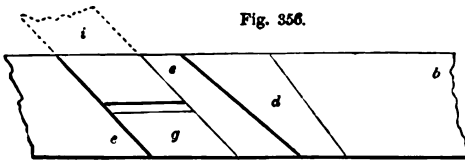
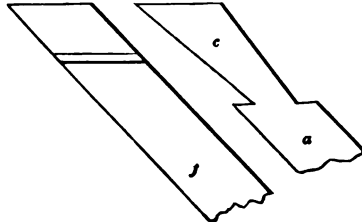

Fig. 356.



JOINING OF TIMBERS CROSSING EACH OTHER AT RIGHT ANGLES—SCALE, 1 INCH TO THE FOOT.

Fig. 358 shows a simple form of connecting the foot of a rafter *a* with the tie-beam *b b*. By forming the joint as *c d e f*, and giving a tenon *d e f g*, a much stronger joint will be secured. A better form of joint, as in fig. 359, may be adopted; *a* is the rafter, *b* the tie-beam. The butting end *c* is at right angles to the line *e f* of the rafter. The part *d e f* is not cut out across the upper edge of the tie-beam, but a piece forming a feather is left as at *g*;

a corresponding mortise is cut out at the lower edge of the rafter *a*, into which *g* fits. The tenon may be formed on the end of the rafter, and the mortise in the tie-beam; this is the usual way.

Fig. 357.

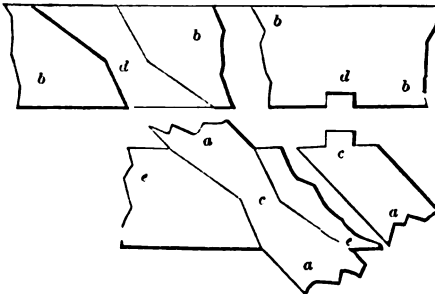

JOINING OF TIMBERS AT RIGHT ANGLES—SCALE, 1 INCH TO THE FOOT.

Fig. 358.

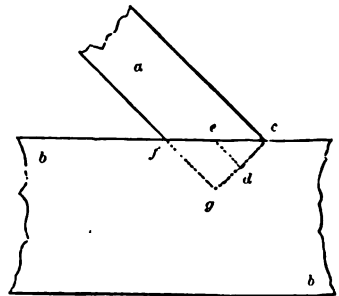

JOINT OF FOOT OF RAFTER WITH TIE-BEAM—SCALE, 1 INCH TO THE FOOT.

1158. A still better form for the same joint is illustrated in fig. 360: *a* the

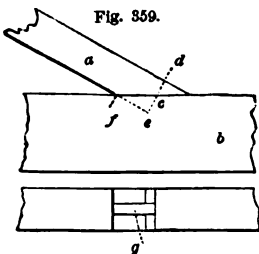

Fig. 359.

JOINING OF AN INCLINED WITH A HORIZONTAL BEAM—SCALE, 1/2 INCH TO THE FOOT.

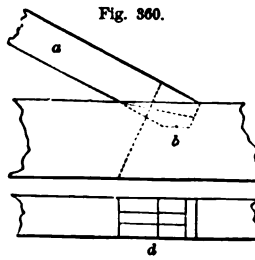

Fig. 360.

JOINING OF INCLINED BEAM WITH A HORIZONTAL BEAM—SCALE, 1/2 INCH TO THE FOOT.

rafter, *b* the tie-beam, and *d* plan of the upper edge of the tie-beam, with the mortise cut to receive the tenon *b*, formed on the end of the rafter *a*. An easily-formed and strong joint is shown in fig. 361; where *a* is the rafter, *b b* the tie-beam, *c* the dotted lines showing the form of the tenon.

1159. Collar or horizontal timbers are joined to angular timbers, or "principals," by a variety of joints, of which we give a few examples.

1160. In fig. 362 the "collar" *a* is joined to the "principal" or "rafter" *b b*, by inserting the termination *a* into the notch *c*. To bring the surface of *a* flush with that of *b b*, the end of *a* is half-notched, as shown at *d*.

Fig. 361.

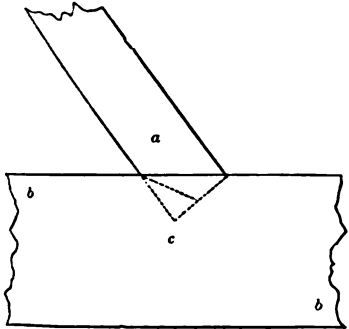

JOINT OF RAFTER WITH TIE-BEAM—SCALE, 1 INCH TO THE FOOT.

Fig. 362.

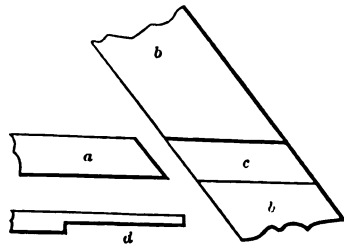

JOINT OF BOTTOM BEAM WITH RAFTER—SCALE, 1/2 INCH TO THE FOOT.

1161. The dovetail joint, fig. 363, is a good form. An end *a* of the collar *b* is inserted into the notch *c* of the rafter *d d*.

1162. Fig. 364 shows another form of joint. In all these joints trenails or spikes are used to secure the timber together.

Fig. 363.

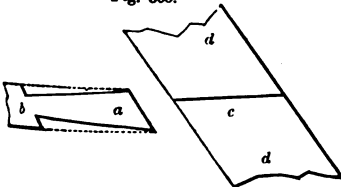

JOINT OF COLLAR-BEAM WITH RAFTER—SCALE, 1/2 INCH TO THE FOOT.

Fig. 364.

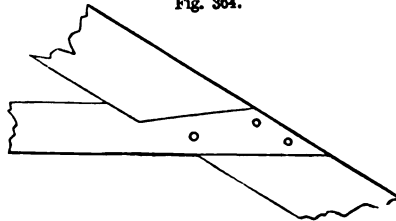

JOINT OF COLLAR WITH RAFTER—SCALE, 1/2 INCH TO THE FOOT.

1163. Struts are made to abut against king-posts in a variety of ways. The best method, however, is where the face of the joint is at right angles to the direction of the thrust of struts, as the faces *a b*, fig. 365, to the line of struts *c d*, or the faces *e f* to the struts *g h*. The forms of joint shown at *i* and *k* are objectionable.

1164. In fig. 366 we show the method of forming the joint with a tenon: *a b* the front view of head of king-post; *c* the bearing of the rafter end; the dotted line shows the tenon cut to receive the mortise *e* of the rafter *d*; *f* shows an edge view of the king-post head, with mortise. The ends of struts are joined to the foot of king-post by mortise and tenon. This is illustrated in fig. 367: *a* is end of king-post, mortised to the tie-beam *b*; *c* is the part against which the strut abuts, with the mortise to receive the tenon of the strut—an end view of which is seen at *d*.

Fig. 365.

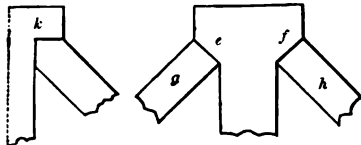
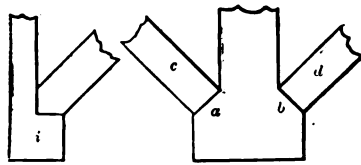

JOINTS OF STRUTS AND RAFTERS WITH HEADS AND FEET OF KING-POSTS AND QUEEN-POSTS—SCALE, 1/2 INCH TO THE FOOT.

1165. A better way to join the rafters with the king-posts, or the straining beam with the queen-posts and principal rafters, is to make the ends abut against each other—a piece of sheet-lead being only placed between them. As there is no compressible material as the wood of the king-post, the form of the framing is less liable to change. This is illustrated in fig. 368, where the

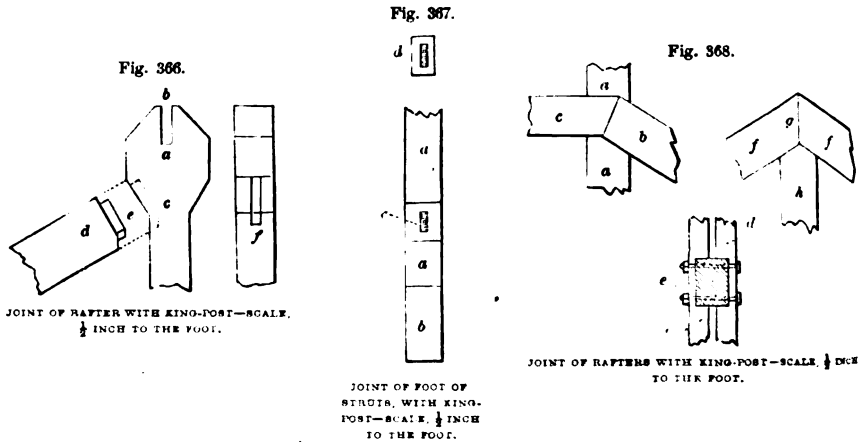

straining beam *c* butts immediately against the principal rafter *b*; the queen-post *a a* being bolted in two halves on *d* and *d*, embracing the beam *c*, and secured by bolts and nuts. In the same figure, *f f* represents the principal rafters butting at *g*; the king-post *h* being bolted in two halves as at *d* and *d*.

1166. In fig. 369 we show the method of joining the straining-beam with the queen-post *b*, side view of post, with indent cut out of it; *a* the edge view of ditto, showing the mortise to receive the tenon *e* of the straining-beam *d*, of which an end view is at *c*.

1167. The purlins of a roof are notched into the rafters by joints similar to those used to join the tie-beam to the wall-plate. In fig. 370 *a* is the section of purlin, notched into the principal rafter *b*, and at its upper end to the common rafter *c*. The purlin butts against a piece *d*, nailed to, or mortised into, the principal rafter *b*.

1168. In the case of "lean-to" roofs, the rafters should butt in the wall-plates with a horizontal joint, as in fig. 371, at *a* and *b*, shown in section.

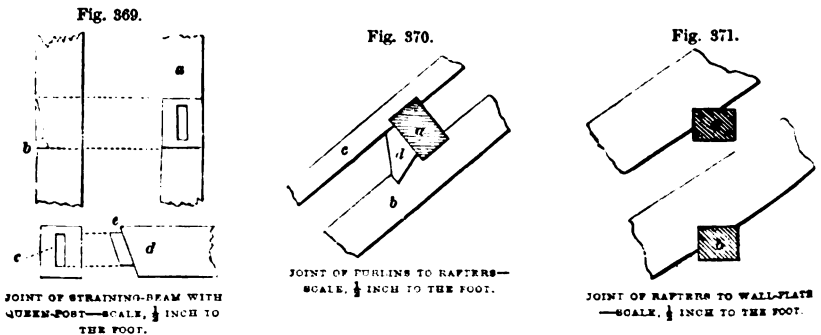

1169. *Trussed Beam*.—In the Section treating of parts of structures in which

wood and iron are combined, the reader will find various methods illustrated and described of trussing beams.

1170. We here give in fig. 372 an exceedingly simple and effective form of flat roof truss, the invention of Mr Smart, by whom it was communicated to the Society of Arts, and named by him "the bow-and-string rafter." "In this communication," he says, "I take a span of the usual size for a rafter, and, by means of a circular saw, make an incision in it, as shown at *a a*, fig. 372.

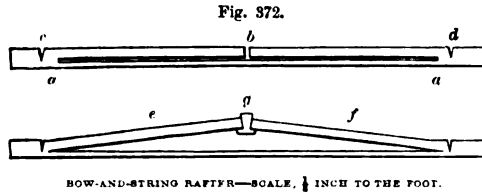

BOW-AND-STRING RAFTER—SCALE, 1/4 INCH TO THE FOOT.

I then make a cut *b*, at right angles to the former, and equidistant from the two ends. Lastly, I make two cuts *c d*, taking out a thin wedge from each piece. The two pieces *e f* are then to be gently raised up till they form an angle of 10° or 12° with the piece *a a*, and are secured in their place by the oak key-wedge *g*. It is obvious that a weight pressing on the key-wedge of this rafter (the ends being properly supported) will be sustained, either till the fibres of the wood forming the string are torn asunder, or till the lateral cohesion of the wood forming the butt end of the rafters be destroyed; at the same time, there is no lateral pressure on the wall."

1171. In fig. 373 we give sketch to a larger scale of the end of the rafter so treated, where *a a* is the rafter, *b b* the horizontal saw-cut, *c* the wedge.

1172. In fig. 374 we give a sketch of the centre of the rafter above formed;

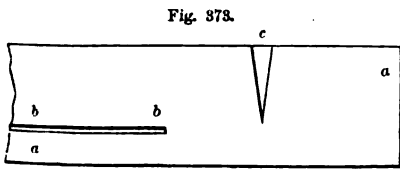

END OF BOW-AND-STRING RAFTER—SCALE, 1/2 INCH TO THE FOOT.

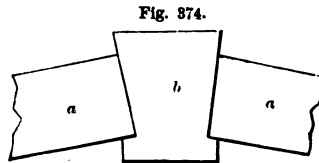

CENTRE OF BOW-AND-STRING RAFTER—SCALE, 1/2 INCH TO THE FOOT.

a a are the two ends, corresponding to the ends of the pieces *e f*, fig. 372, *b* the oak key-wedge.

1173. In fig. 375 we give a drawing of a rafter for a 56-foot span, the scantling of the rafter being 10 inches by 4. In this form Mr Smart inserted vertical pieces *a a* between the upper and lower parts of the beam, securing these by iron straps.

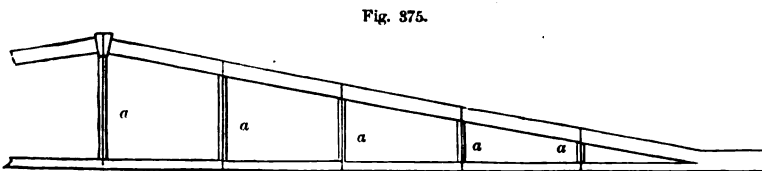

BOW-AND-STRING RAFTER—SCALE, 1/4 INCH TO THE FOOT.

1174. *Increasing Depth of Beams.*—A method to obtain depth in a girder, and to avoid deflection or bending, is illustrated in fig. 376, and is recommended by some as preferable to the trussed girder. Two beams of equal scantling are laid edge on, as *a b, c d*, and secured together by keys *e e e*, the whole being secured together by hoops of iron *f f f* driven tightly on. In place of hoops,

bolts may be used, as shown at *g*, but hoops are preferable. The thickness of

the keys should be equal to about half of the breadth—the total thickness of all the keys, when laid on each other, being equal to one-third of the depth of the beam.

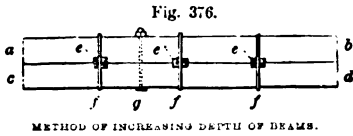

METHOD OF INCREASING DEPTH OF BEAMS.

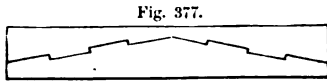

METHOD OF INCREASING DEPTH OF BEAMS.

1175. In fig. 377 we illustrate another method of deepening a beam, the surfaces in contact being provided with indentations and corresponding projections, the two being well secured by bolts and nuts.

1176. SECTION SECOND—Floors.—The simplest form of floor is illustrated in fig. 378, and is called the “single flooring.” Where *a a a* are the joists laid on the wall *c c c*, parallel to one another, the distance should not in any case exceed 12 inches from centre to centre of joists. The flooring-planks *b b* are laid on the joists *a a a*.

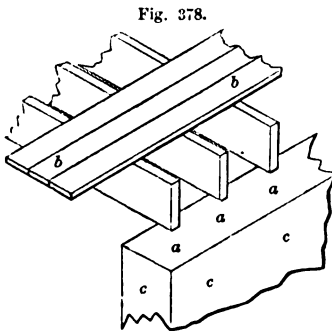

SINGLE FLOORING—SCALE. 1/4 INCH TO THE FOOT.

1177. When the walls, as *a a* and *b b*, fig. 379, are separated more than 8 feet, the joists are apt, under sudden strains—as weights hauled over the floor, people walking quickly, &c.—to bend laterally. To prevent this, struts are placed between the joists, as *c c* between the joists *d d d*. When the span of floor is wide, these struts should be placed at distances of not less than 4 feet apart. One row will do for joists, with a bearing exceeding the 8 feet; for every 4 feet of extra bearing, one row of strutting should be given. They may be formed either of pieces of thin wood, as at *e*, fig. 379, the same depth of the joists, or of two pieces crossed, as at *f*.

1178. When the course of the joists is to be interrupted, as in fig. 380—

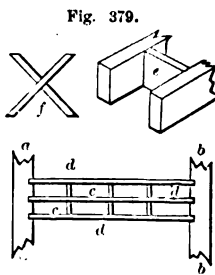

TRUSSING OF FLOORING BEAMS—SCALE. 1/4 INCH TO THE FOOT.

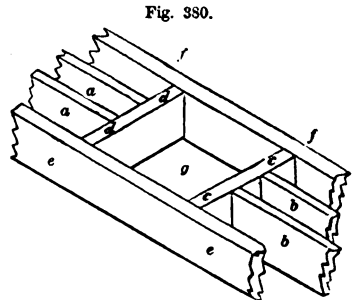

TRIMMING-JOISTS—SCALE 1/4 INCH TO THE FOOT.

where, for instance, a well-hole *g* is to be made, as in the floor of a barn or granary, to admit of passage from one floor to another by means of trap-stairs—the joists, as *a a*, *b b*, are supported by cross pieces *c c*, *d d*, called “trimmers” or “bridles.” These again are supported by larger joists *e e*, *f f*, which run parallel to the ordinary joists *a a*, *b b*; these larger joists are called “trimming-joists,” or “carriage-beams.” The trimmers *c c*, *d d* must be made strong in proportion to the number of joists which they have to carry, and

the scantling of the carriage-beams is proportioned to the weight which the trimmers carry.

1179. For floors of a wide span, and where more perfect work is required, as in the supporting of heavy weights, what is called "double flooring" is used. This is illustrated in fig. 381, where *b b b* represent two large joists, termed "binding-joists," which are laid on the wall *a a* at each end, at distances of 10 feet apart from centre to centre. These joists support other joists, termed "bridging-joists," *c c c*, laid at right angles to *b b*. These bridging-joists are laid at distances of from 12 to 20 inches apart, and support the flooring-planks *d d*, which run parallel to the "binding-joists" *b b*. Where it is deemed necessary in the apartments of the steading to have a "ceiling" on the under-side of the floor, what are called "ceiling-joists" should be notched into the under-side of the binding-joists, as at *e e*. The distance between these is usually set off at 12 inches.

1180. A still more complicated form of flooring, and one usually adopted where the bearing is great, is illustrated in fig. 382, and is known as the

Fig. 381.

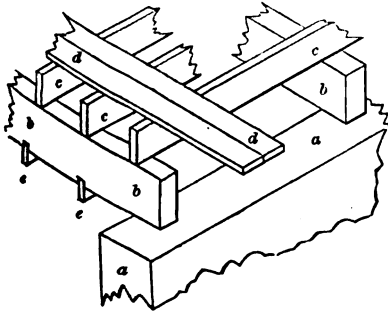

DOUBLE FLOORING—SCALE. 1/4 INCH TO THE FOOT.

Fig. 382.

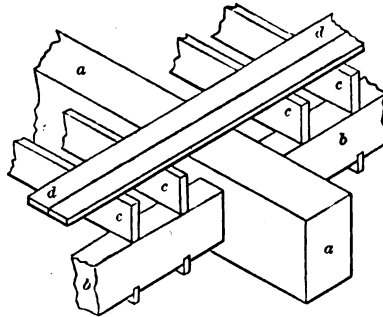

DOUBLE-FRAMED FLOORING—SCALE. 1/4 INCH TO THE FOOT

"girder" or "double-framed flooring." In this case the binding-joists *b b* are not supported at the ends by the walls, but are supported by "girders," as *a a*, which rest on the walls, and are placed generally at a distance of 10 feet apart; on the "binding-joists" *b b*, the bridging-joists *c c c c* are placed, these supporting the flooring-planks *d d*.

Span or Bearing.	CLASS I.	CLASS II.	CLASS III.	Ceiling-Joists.	Distance apart of Girders.	Distance apart of Binding-Joists.	Distance apart of Bridging-Joists.
	Joists.	Binders.	Girders.				
6	W. D.	W. D.	W. D.	W. D.	CLASS I.	CLASS II.	CLASS III.
8	2 1/2 x 7	6 x 4 in.	...	3 1/2 x 2 in.	10 feet apart. The bearings on wall 9 to 12 in.	4 to 6 feet apart. Bearing 4 to 6 in. on walls.	12 to 14 in. 4 to 6 in. bearing on walls.
10	2 1/2 x 7 1/2	7 4 1/2	...	4 2 1/2			
12	2 1/2 x 8	8 5	9 x 7 in.	5 2 1/2			
14	2 1/2 x 9	9 5 1/2	10 8	...			
16	...	10 6	11 9	...			
20	3 x 12	11 6 1/2	12 10	...			
24	...	13 7 1/2	13 11	...			
28	15 12	...			
	16 13	...			

1181. Taking fig. 378 as representative of the "first class" of floors, fig. 381 of the "second," and fig. 382 of the "third," the preceding table, compiled from data given by the eminent authority Tredgold, will be useful, as showing

the scantling of floors for various spans. *W* represents the width, and *D* the depth of the joists, binders, and girders.

1182. The following remarks on flooring by Mr Gwilt will, we trust, be of use:—"First, the wall-plates—that is, the timbers which lie on the walls to receive the ends of the girders or joists—should be sufficiently strong, and of sufficient length to throw the weight upon the piers. Secondly, if it can be avoided, girders should not lie with their ends over openings, as doors or windows; but when they do, the strength of the wall-plates must be increased. To avoid the occurrence in question, it was formerly very much the practice in this country, and indeed is still partially so, to lay girders obliquely across rooms, so as to avoid openings and chimneys, the latter whereof must always be attended to. Thirdly, wall-plates and templates must be proportionately longer, as their length and the weight of the floor increase. Their scantlings will in this respect vary from $4\frac{1}{2}$ inches by 3, up to $7\frac{1}{2}$ inches by 5. Fourthly, the timbers should always be kept rather higher—say half to three-quarters of an inch—in the middle than at the sides of an apartment, when first framed, so that the natural shrinkings and the settlements which occur in all buildings may not ultimately appear after the building is finished. Lastly, when the ends of joists or girders are supported by external walls whose height is great, the middles of such walls ought not at first to rest upon any partition-wall that does not rest higher than the floor, 'but a space should (says Vitruvius, lib. vii. 1) be rather left between them, though, when all has settled, they may be brought to a bearing upon it. Neglect of this precaution will induce unequal settlements, and, besides causing the floor to be thrown out of a level, will most probably fracture the corners of the room below.'"

1183. SECTION THIRD—*Partitions*.—In designing partitions, care should be taken to transfer the weight to the points of support—the walls. This is best done by placing two struts or braces, butting against a central post. The best angle for the braces is 40 degrees. Where partitions have to support their own weight merely, the principal timbers for a span of 20 feet may be 3 inches by 4; for a span of 25 feet, $3\frac{1}{2}$ inches by 5; and for a span of 30 feet, 4 inches by 6. Where partitions have to bear other weights, then the dimensions of their parts may be calculated according to the rules to be given hereafter.

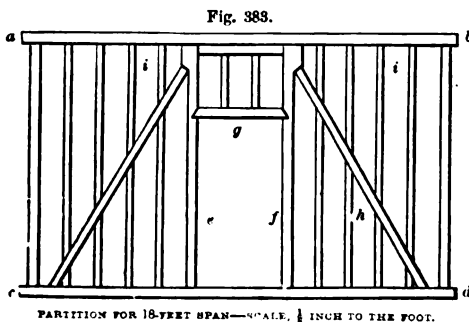

1184. In fig. 383 we give a drawing of a partition adapted to an 18-foot span, with one door in the centre. The head *a b* is 5 inches by 4; the sill *c d*, same scantling; the posts *a c*, *b d*, *e f*, 5 inches by 4; the straining-beam *g*, 5 inches by 3; the struts or braces *h h*, 5 inches by 4; the filling-in pieces *i i i i*, 5 inches by $2\frac{1}{2}$.

1185. In fig. 384 we give the drawing of a partition adapted to a 28-foot or 30-foot span, with spaces for a door at each end. The scantlings are as follows: the head *a b*, 6 inches by 6; the sill *c d* the same; the posts *a c*, *b d*, *e f*, 6 inches by 6; the king-post *k* same size; the straining-pieces *g g*, 6 inches by 4; the struts or braces *h h*, *h h*, 6 inches by 5; the filling-in pieces *i i*, 6 inches by 3.

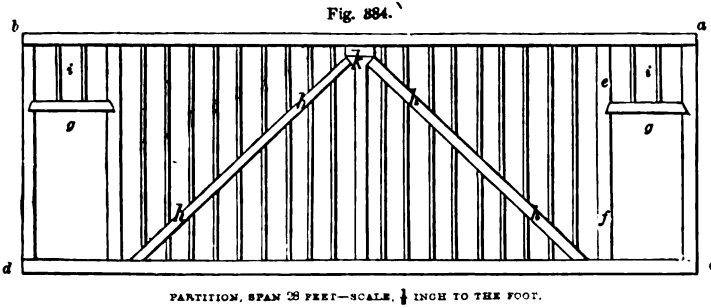

1186. In fig. 385 the partition is adapted to a 22-foot span: the head *a b*, 6 inches by 6; the sill *c d*, 6 inches by 4; the tie-beam *e e*, 6 inches by 5;

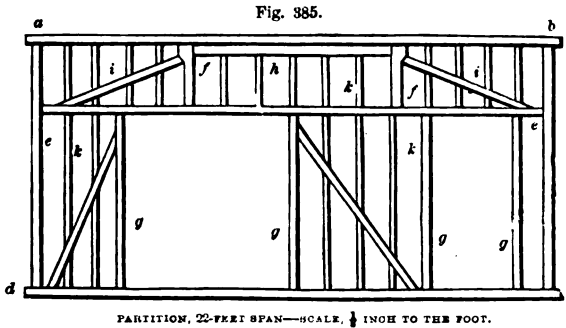

the king-posts *f f*, 6 inches by 6; the posts *b c*, *a d*, *g*, *g*, *g*, *g*, 6 inches by 6; the straining-piece *h*, 6 inches by 4; the braces or struts *i i*, 6 inches by 4; the filling-in pieces *k k*, 6 inches by 3. There are here a wide and narrow door.

1187. In fig. 386 we give a drawing of a partition without door spaces for a span of 16 to 18 feet, of which the scantlings are as follows: *a a* sill, 5 inches by 4; *b b* head, also 5 inches by 4; *c* post, 6 inches by 4; *d d* braces or struts, 10 inches by 2; *e e* quarters, 4 inches by 2.

Fig. 386.

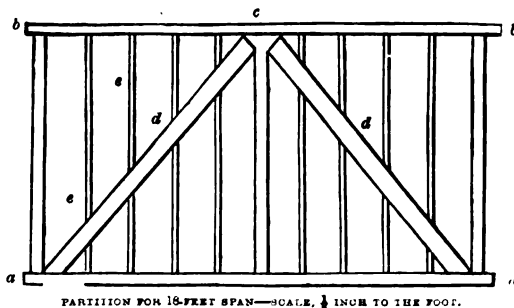

1188. In fig. 387 we give the drawings of a partition with large door in centre and small door at side, adapted to an 18-foot span. The sill *a a* 4 inches by 4; head *b b*, 4 inches by 4; the tie-beam *c c c*, 4 inches by 3; the posts *d d d d*, 4 inches by 3; straining-beam *e*, 4 inches by 4; struts or braces *f f*, 4 inches by 3; *g* filling-in pieces, 4 inches by 2.

1189. In fig. 388 we give the drawing of a trussed partition for a wide span, with large door at one side and small door at the other.

1190. In fig. 389 we give a drawing of a partition adapted for an 18-foot

span, with large door in the centre only. The scantlings the same as in fig. 388, just above.

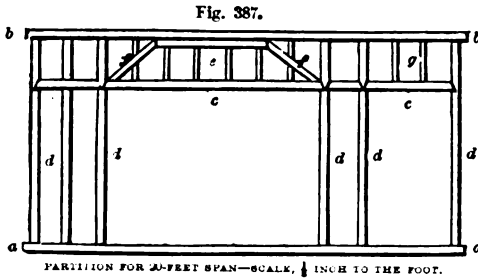
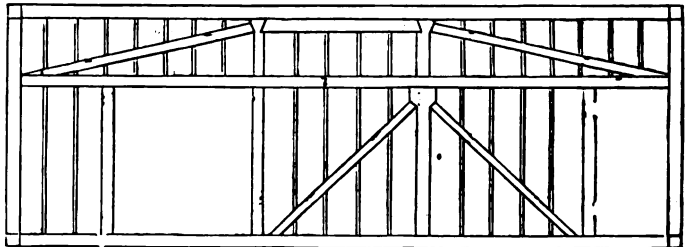
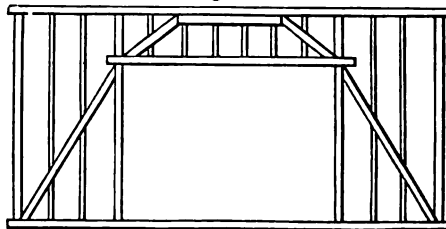

Fig. 388.



TRUSSED PARTITION—SCALE, $\frac{1}{4}$ INCH TO THE FOOT.

Fig. 389.



PARTITION FOR 18-FOOT SPAN—SCALE, $\frac{1}{4}$ INCH TO THE FOOT.

Fig. 390.

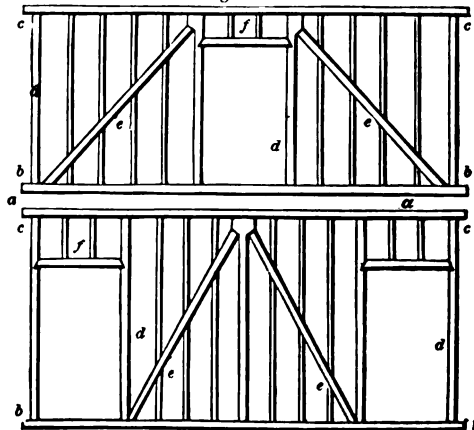

DOUBLE PARTITION—SCALE, $\frac{1}{4}$ INCH TO THE FOOT.

1191. In fig. 390 we give a drawing of the partitions in first and second storeys, in which the span is 18 feet. The beam *a a* is 18 inches by 3; the sills *b b*, *b b*, 4 inches by 4; the heads *c c*, *c c*, 4 inches by 4; posts *d d d*, 4 inches by 3; struts or braces *e e*, *e e*, 4 inches by 3; puncheons *f f*, 4 inches by 2.

1192. SECTION FOURTH — *Roofs*.—Before illustrating the construction of the trusses for roofs, we shall give a few diagrams showing the forms as used in the more simple constructions of the farm.

1193. *Lean-to and Ridge Roofs*.—Where the plan of building is rectangular, as $a b c d$, in fig. 391, and one wall higher than the other, as $e f$, the form of roof employed, sloping from f to g , is termed a "lean-to." Where the walls are of equal height, as $h i, k l$, the slopes of the roof, as $h m, m k$, are equal; the point at which they meet, as at m , being termed the "ridge," and the angle $h m k$, the "gable." The ridge divides the building into two parts by a line, as $n o$.

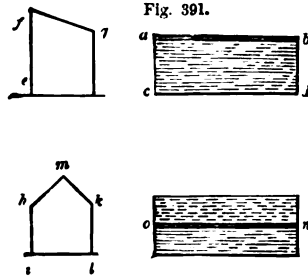

LEAN-TO AND RIDGE ROOFS.

1194. *Hipped Roofs*.—Where the plan is rectangular, in place of the ridged roof, as in last figure, the form in fig. 392 may be used; $a b$ is the ridge, the ends $c d, e f$, sloping at the same angle as the sides $d e, c f$. The ridges $a b, b d, b c$, are termed hips, and the whole arrangement a hipped roof; g is an end, and h a side elevation of roof.

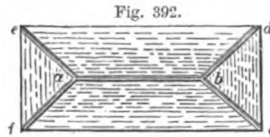

HIPPED ROOFS.

1195. *Pavilion Roof*.—Where the plan of the building is a square, as at $a b c d$, fig. 393, all the sides of the roof may be made to slope at an equal angle, and to meet in the point. All the elevations present the same appearance as at e . Where the length $f h$ of the building does not much exceed the breadth $f g$, it may be roofed with a pavilion roof, as shown.

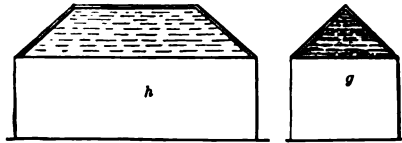
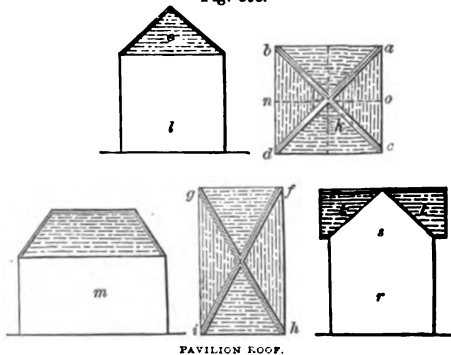

Fig. 393.

Where the building is square, the pavilion roof may be truncated by a plane, as shown by the dotted lines in square above, k , parallel to the base l . In this case the side elevation will be as at m . Where the square building is desired to have gables at all the sides, there will be two ridges, as shown by the dotted lines $n o$ and k , at right angles to each other—the elevation being as at r ; s being one gable, $t t$ the two gables of the sides at right angles to the side r .



PAVILION ROOF.

1196. *Conical Roof*.—This form of roof, generally used for the roof of thrashing-mills, is shown in fig. 394, in plan at a , and elevation at b .

1197. *Ridged Roof meeting at Right Angles*.—Where the building $a b c d$, fig. 395, is at right angles to the building $e f g h$, the plan of roof is as shown in the drawing; $i k, l m$ being the ridges, $e l, l f$ being termed the valleys.

1198. *M Roofs—Ridge-and-Valley Roofs*.—Where the building is wide, and the roof is to be kept low to correspond in height with the other parts of the building, the width is divided into two parts l and m , fig. 396. Where more than

two divisions are made, as at *n n*, the arrangement is termed a "ridge-and-valley roof," *g h i k* being the ridges, *o o o* the valleys.

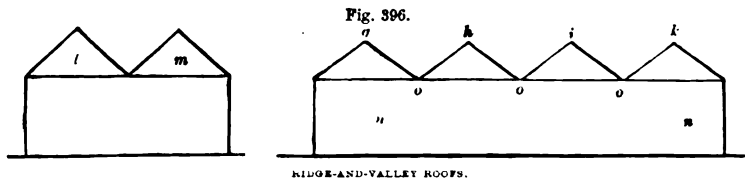
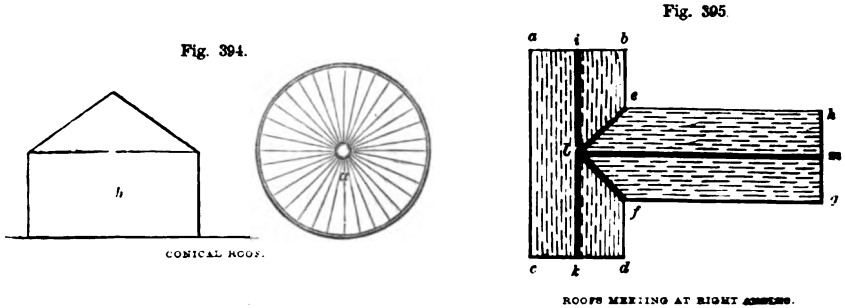

1199. *Roof Trusses.*—In fig. 397 we give an illustration of the simplest form of roof; this is called a "lean-to," and is adapted for covering cart-sheds, &c. The form in fig. 397 is calculated for spans of from 10 to 12 feet. The scantling of the rafter or beam *b c* is 105 inches by 2½; the wall-plate *b*, 4 inches by 3. The joists should project 18 or 20 inches beyond the lower wall *d*, as at *f*, and should be placed on the walls at distances of 4 feet from each other. The roofing-boards are nailed on the joists parallel to the walls *a* and *d*.

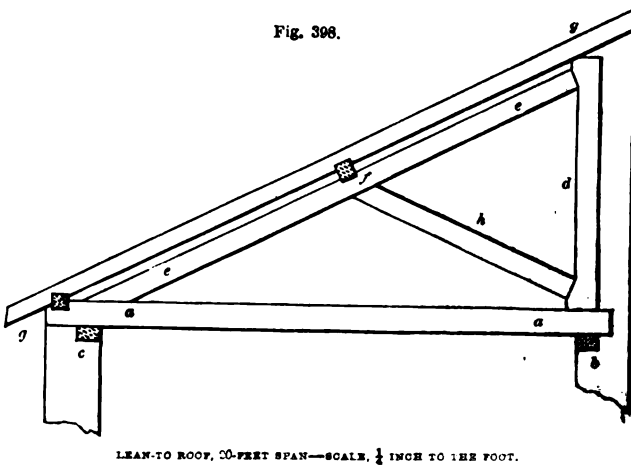
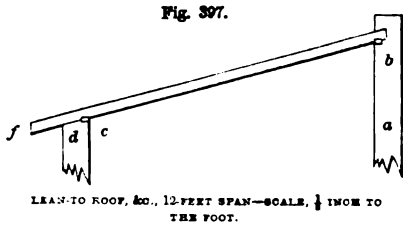

1200. Where the distance or span is from 10 to 14 feet, and a lean-to roof required, the "truss" shown in fig. 398 may be adopted. In this a "tie-beam" *a a* is used, which rests upon the wall-plates *b* and *c*. An upright post *d* is notched into the end of the tie-beam *a a*, and is let into the wall. The

notched into the end of the tie-beam *a a*, and is let into the wall. The

rafter *e e* is notched at its upper end to the post *d*, and to the tie-beam *a a* at its lower end; *f* is the purlin; *g g* the common rafter, 4 inches by 2½. The scantling of the tie-beam *a a* is 6 inches by 4; the wall-plates *b c*, 6 inches by 4; the rafter *e e*, 5½ inches by 4; the post *d*, 4 inches by 3. The post *d* may be dispensed with, and the upper end of the rafter *e e* abut on a wall-plate, as *b*, fig. 397; *h*, fig. 398, is a strut.

1201. An arrangement adapted to the most usual form of roof—namely, one having an equal slope on both sides—is shown at fig. 399. The rafters *a a*, *d d* are notched at their lower extremities to the wall-plates *b c*. As the weight of the roof-covering which would rest upon those rafters would give them a tendency to separate at their feet, and thrust out the walls, a "collar" or "tie" *e* connects the two. The scantlings of the parts are as follows: rafters *a a*, *d d*, 9 inches by 3; wall-plates, 4 inches by 3; collar or tie, 5 inches by 3.

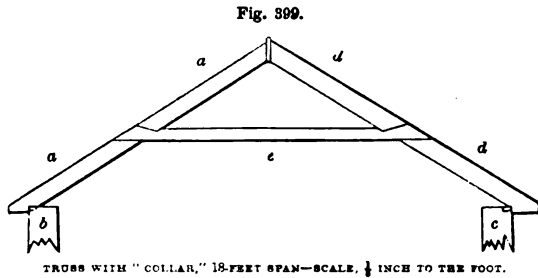

1202. Fig. 400 shows a truss of this kind with two collars. For a span of 16 feet the scantlings are as follows: rafters or principals *a a*, *b b*, 6 inches by 2½; collars *c c*, 6 inches by 2; *d*, 5 inches by 2.

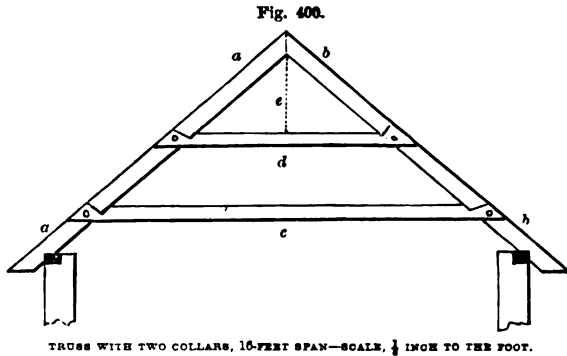

1203. *Truss for a Collar-Beam Roof.*—Roofs with a collar-beam may be strengthened by a longitudinal truss placed at the point shown by the dotted line *e* in fig. 400, the ends of the truss being inserted in the gables. A side elevation of the truss is given in fig. 401; *a b* the sill, *c d* the head, *e f g h* the posts, *i* the straining-piece, *j k* struts or braces.

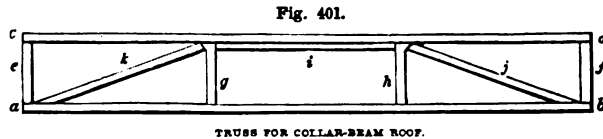

1204. In fig. 402 we give a truss for a porch or building of small span, say from 6 to 8 feet: *a a* the 9-inch walls; *b b* the wall-plates, 5 inches by 3; *c e* the rafters, 3 inches by 2; *d d* the struts or braces, 2½ inches by 2.

1205. As the tie-beam or collar *e* in the illustration, fig. 399, is too high up to act in the best way, the tie should be placed as at *b b*, fig. 403, resting on the wall-plates *c c*, 4 inches by 3. The rafters *d d*, 6 inches by 4, abut on the tie-beam *b b*, 8 inches by 4. This truss is strengthened by the struts *e e*, 4 inches by 3, abutting on the "straining-sill" *f*, 3 inches

square, let into the face of the tie-beam. This truss is adapted to spans from 19 to 24 feet. In these illustrations, fig. 397 is for a 12-foot span,

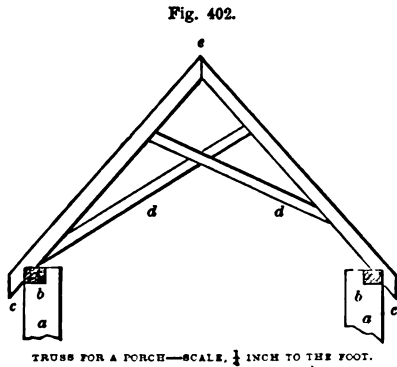
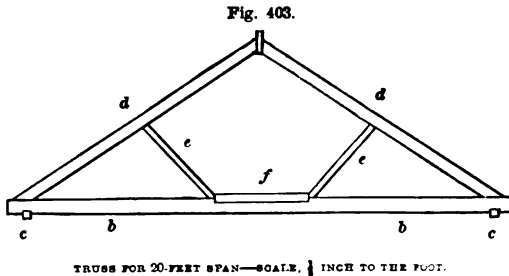

fig. 398 for 20, fig. 399 for 18, and fig. 402 for a 6-foot span. Fig. 404 is a roof on the principle of fig. 403, with a suspension-rod *a* of iron, *b b* struts, *c c* tie-beam, *d* wall-plate, *e* pole-plate, *f f* common rafters.

1206. The truss in fig. 405 is calculated for a 30-foot span; *a* the rafter-box or shoe, of cast-iron; *b* the suspension-rod of wrought-iron, 2 inches diameter; *c c* struts, 5 inches square; *d d* wall-plates, 6 inches by 4; *e e* pole-plate, 5 inches by 3; *f f* principal rafters, 10 inches by 5; *g g* common rafters, 4 inches by $2\frac{1}{2}$; *h h* tie-beam, 12 inches by 5; *i* nut for securing tie-bolt *b*; *m* ridge-pole, 8 inches by $1\frac{1}{2}$; *n* purlins, 6 inches by 4.



1207. *King-post Truss*—Fig. 406.—The truss in this sketch is adapted for a span of 25 feet between the walls *a a*; *b b* the wall-plates—which run longitudinally along the walls—5 inches square; these support the tie-beam *c c*, 10 inches by 5; *d d* pole-

plates, 5 inches square; *e e* king-post, 5 inches square; *f f* principal

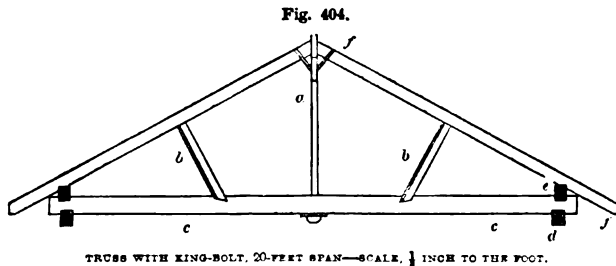

rafters, 5 inches by 4; *g g* struts, 5 inches by 3; *h h* purlins, 6 inches by 4; *i i* common rafters, 4 inches by $2\frac{1}{2}$. The various parts now described as the tie-beam *c c*, the principal rafters *f f*, the king-post *e e*,

and the struts *g g*, constitute what is called "the truss." The trusses are placed at distances apart from 6 to 10 feet. The roof materials, boarding and slating, are supported by the common rafters *i i*, abutting at the upper end on the ridge-pole *j*, and at the lower on the pole-plate *d d*, notched into the tie-beam *c c* above and near the wall-plates *b b*. The common rafters also rest on the purlins *h h*. These rest on the principal rafters *f f*, and are continued from truss to truss. The ridge-pole *j* is let into a notch in the head of the king-post *e e*, and is continued from truss to truss, like the purlins. The ridge-pole *j*, the purlins *h h*, the pole-plates *d d*, are all parallel to the walls *a a*, as also the wall-plates *b b*; while the tie-beam *c c*, the common rafters *i i*, the principal rafters *f f*, the king-post *e e*, and the struts *g g*, are all at right angles to the walls *a a*. Properly the "king-

post" *ee*, does not act as a post—which involves the idea of compression—but as a tie, as the tie-beam *cc* is suspended at the centre by it. A better name would perhaps be the "king-bolt," or "suspender."

1208. Where space is required above the line of the tie-beam, a form of truss, known as the "queen-post," is used. It is also adapted to greater spans than the king-post truss. This is illustrated in fig. 407, which is a queen-post

Fig. 405.

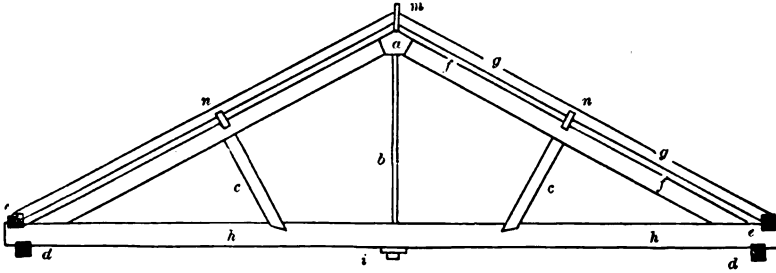

TRUSS FOR A 30-FOOT SPAN—SCALE, $\frac{1}{4}$ INCH TO THE FOOT.

Fig. 406.

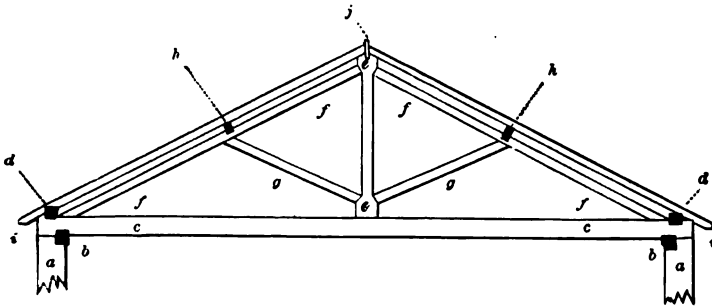

KING-POST TRUSS FOR 25-FOOT SPAN—SCALE, $\frac{1}{4}$ INCH TO THE FOOT.

Fig. 407.

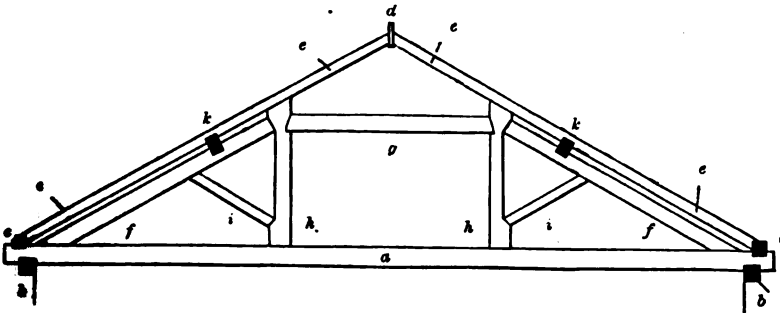

QUEEN-POST TRUSS FOR 30 TO 45 FEET SPAN—SCALE, $\frac{1}{4}$ INCH TO THE FOOT.

truss for a 30-foot span, but is adapted to spans from this extent up to 45 feet. The tie-beam is at *a*, 10 inches by 5; *bb* wall-plates, 6 inches square; *cc* pole-plates, 5 inches square; *d* ridge-pole, 8 inches by $1\frac{1}{2}$; *ee* common rafters, 4 inches by $2\frac{1}{2}$; *ff* principal rafters, 9 inches by 5; *g* straining-beam, 9 inches by 5; *hh* queen-posts, 7 inches by 5; *ii* struts, 5 inches square;

k k purlins, 6 inches by 4. A straining-sill, formed of a flat piece of wood, is sometimes placed on the tie-beam, against which the feet of the queen-posts *h h* abut, serving the same purpose as the straining beam *g*.

1209. In fig. 408 we give a drawing of a roof truss for a 30-foot span, on the principle of the queen-post truss, but modified with a king-post *a*, and struts or braces *b b*, *c c*.

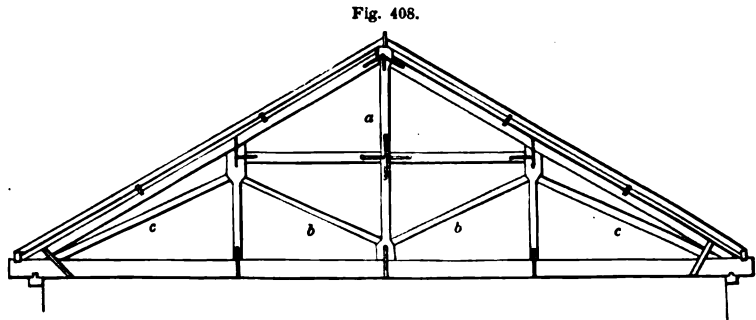

TRUSS FOR A 30-FOOT SPAN—SCALE, $\frac{1}{4}$ INCH TO THE FOOT.

1210. In fig. 409 we give a sketch of half of a truss calculated for 47-foot span,

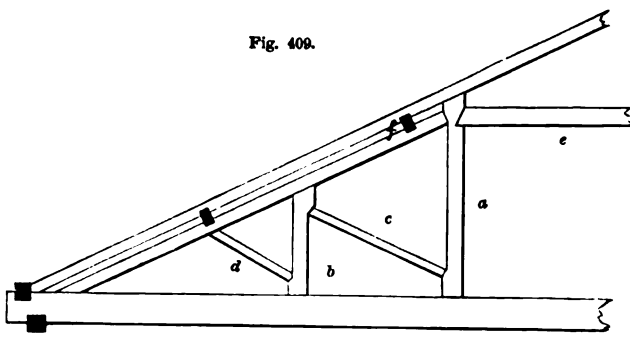

Fig. 409.

TRUSS WITH TWO QUEEN-POSTS FOR 47-FOOT SPAN—SCALE, $\frac{1}{4}$ INCH TO THE FOOT.

but also adapted to spans between 45 and 60 feet. In this there are two queen-posts *a b*, with a strut *c* between them, and a second strut *d* supporting the principal rafter. The following are the sizes or scantlings of the various parts: the wall-plates, 6 inches square; tie-beam, 13 inches by 8; queen-posts *a*, 8 inches square; small queen-posts *b*, 8 inches by 4; principal rafters, 8 inches by 6; straining-beam *e*, 9 inches by 6; struts *c d*, 5 inches by 3; purlins *f*, for 8-foot bearings, 7 inches by 5; pole-plates, 6 inches square.

inches by 8; queen-posts *a*, 8 inches square; small queen-posts *b*, 8 inches by 4; principal rafters, 8 inches by 6; straining-beam *e*, 9 inches by 6; struts *c d*, 5 inches by 3; purlins *f*, for 8-foot bearings, 7 inches by 5; pole-plates, 6 inches square.

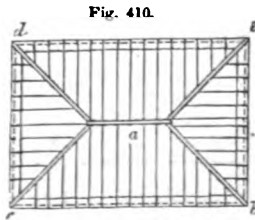

Fig. 410.

ROOF WITH HIP-RAFTER—SCALE, $\frac{1}{4}$ INCH TO THE FOOT.

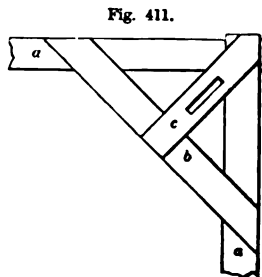

Fig. 411.

DRAGON-PIECE AND DRAGONAL TIE TO SUPPORT HIP-RAFTERS.

1211. *Hip Roof*.—In small roofs the lower ends of the hip-rafters rest on the walls at the corners *b c d e* of the building, the upper end being fitted to the ridge-pole *a*, as in fig. 410.

1212. Another method is to form a frame as *a a b c*, fig. 411, which is placed at the corner of the walls. Upon this framing the lower termination of the hip-rafter is fixed, the upper resting on the king-post. Where a tie-beam is introduced, the

outer end rests on the angle of the wall, the inner being fixed to the principal tie-beam. A strut fitted to the smaller tie-beam supports the middle of the hip-rafter. The short rafters between the hip-rafters are called "jack-rafters."

1213. Fig. 412 illustrates the plan of a hipped roof: *a a a* the walls, *b b b* the wall-plate, *c c* hip-rafters, *d d* angle-pieces to support end of rafters, *e e* principals, *f f* purlins, *g* ridge-pole. The part to the left shows the roof slated.

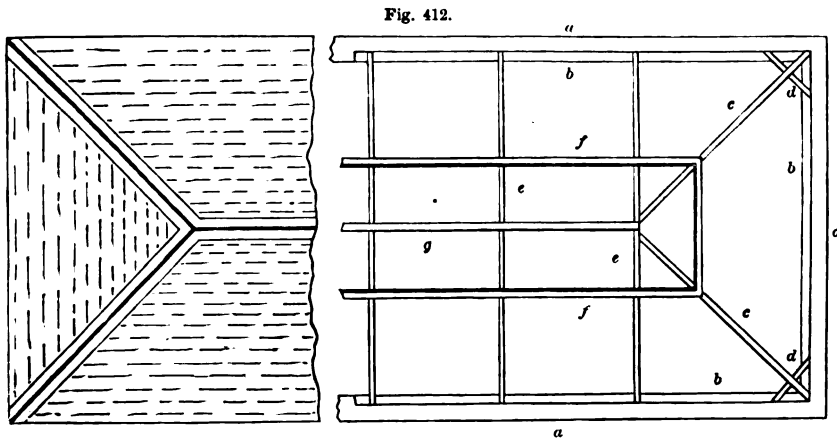

PLAN OF HIPPED-ROOF.

1214. *Scantlings of Roofs of various Classes and Spans.*—Taking fig. 406 as an illustration of the "first class" of "roof-trusses," fig. 407 as an illustration of the "second," and fig. 408 as of the "third class," the following may be taken as tables of the sizes of useful spans of roofs:—

CLASS I. (Fig. 406.)

Span.	Tie-beam.	Principal Rafters.	COMMON RAFTERS.		Struts.	King-post.	PURLINS.	
			Bearing—				8 Feet.	10 Feet.
			8 Feet.	10 Feet.				
20 ft.	10 × 4 in.	4 × 4 in.	4 × 2½ in.	6 × 3 in.	4 × 3 in.	4 × 4 in.	6 × 4 in.	7 × 5 in.
25	10 5	5 4	5 3	5 5
30	11 6	6 4	6 3	5 5

CLASS II. (Fig. 407.)

Span.	Tie-beam.	Principal Rafters.	Queen-posts.	Straining-beam.	Struts.
35 ft.	11 × 4 in.	5 × 4 in.	4 × 4 in.	7 × 4 in.	4 × 2 in.
40	12 5	6 4	5 5	8 5	5 3
45	13 6	7 5	6 6	9 5	5 5

CLASS III. (Fig. 408.)

Span.	Tie-beam.	Principal Queen-posts a.	Small Queen-posts b.	Struts.	Straining-pieces.	Principal Rafters.
50 ft.	13 × 8 in.	8 × 8 in.	8 × 4 in.	5 × 3 in.	9 × 6 in.	8 × 6 in.
55	14 9	9 8	9 4	5½ 3	10 6	8 7
60	15 10	10 8	10 4	6 3	11 6	8 8

1215. In fig. 413 we give a plan of the roof-timbers of a building where one part is at right angles to the other: *a a a a* the walls; *b b b* the wall-

Fig. 413.

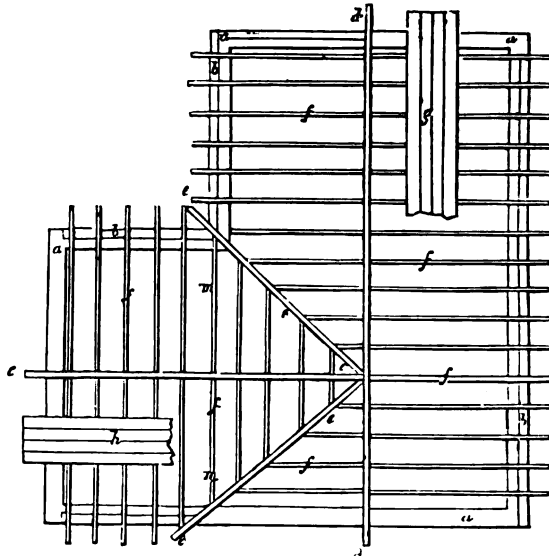

TIMBER OF A ROOF MEETING AT RIGHT ANGLES (PLAN)—SCALE, $\frac{1}{2}$ INCH TO THE FOOT.

plates, 4 inches by 2; *d d* the ridge-pole, $7\frac{1}{2}$ inches by $2\frac{1}{2}$, of the longest part of the roof; *c c* the ridge-pole, 7 inches by $1\frac{1}{2}$, of the shortest part; *e e* the hip-rafters, 6 inches by 2; *f f* the rafters, 6 inches by 2; *g h* part of the slate-boarding on the two roofs. In fig. 414 we give an end elevation of the same roof; *h h* is the ridge-pole corresponding to *c c*, fig. 413, the end of which butts on the ridge-pole corresponding to *d d*, fig. 413, the other end resting on the gable of the short projection of the building *m m*, fig. 413; *f* the rafters of the longest portion of building; *d* the ceiling joists, 4 inches by 2; *g* the hip-rafter corresponding to *e*, fig. 413; *n n* the common rafters. In fig. 415 we give the side elevation of roof; *o o* is the ridge-pole corresponding to *d d* in fig. 413; *b b* the rafters corresponding to *n n*, fig. 414; *n n* the rafters corresponding to those marked *f f* in fig. 413. In fig. 416 is the arrangement of timbers at *c c*, fig. 413, drawn to a larger scale; *a a* part

Fig. 414.

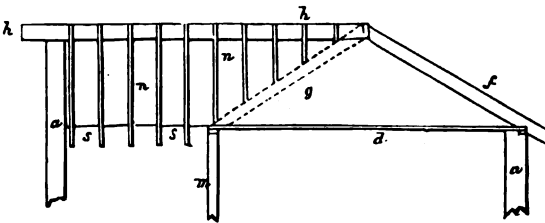

ELEVATION OF ROOF IN FIG. 413—SCALE, $\frac{1}{2}$ INCH TO THE FOOT.

Fig. 415.

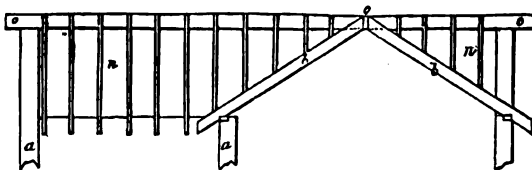

SIDE ELEVATION OF ROOF IN FIG. 413.

n n the rafters corresponding to those marked *f f* in fig. 413. In fig. 416 is the arrangement of timbers at *c c*, fig. 413, drawn to a larger scale; *a a* part

of the ridge-pole, corresponding to *d d*, fig. 413, and *b* the ridge-pole, corresponding to *c c* in the same figure, *c c* the hip-rafters, corresponding to *e e*, fig. 413.

1216. In some roofs the ends terminate at the same angle of inclination as that of the sides. This is effected by introducing hip-rafters, as *a a*, fig. 417.

1217. In smaller roofs the lower ends of the rafters rest on the walls at the corners of the building *a a*, the upper end being fitted to the ridge-pole *b*, as in fig. 417.

1218. Fig. 418 shows the "jack-rafters" of a hip-roof, being the short timbers filling up the slope.

Fig. 416.

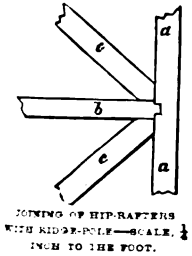

Fig. 417.

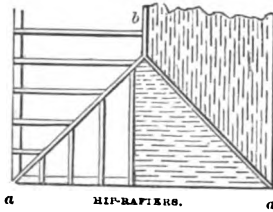
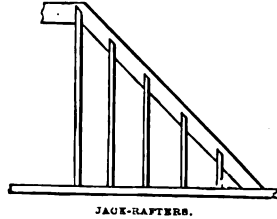
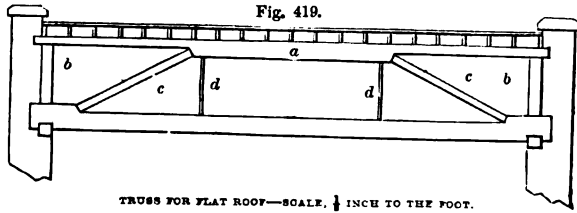

Fig. 418.



1219. In fig. 419 we give the elevation of a truss adapted for a flat roof; *a* the straining-beam, part of which is cut away at either end, as at *b b*, to form the butting ends, against which the rafters *c c* rest. These rafters are made of the pieces cut out of *b b*. Suspension or tie-bolts *d d* are placed near the ends of the beam *a* to prevent deflection.



1220. In fig. 420 we give a drawing of another form of truss for a flat roof, for a 35-feet span: *a* wall-plate, 6 inches square; *b b* tie-beam, 13 inches by 5; *c* queen-post, 12 inches by 6; *d* straining-beam, 12 inches by 6; *e* strut or brace, 5½ inches by 5½; *f f* principal, 8 inches by 6; *g* pole-plate, 6 inches by 4; *h h* common rafter, 7 inches by 6; *i i* joists supporting the lead flat.

Fig. 420.

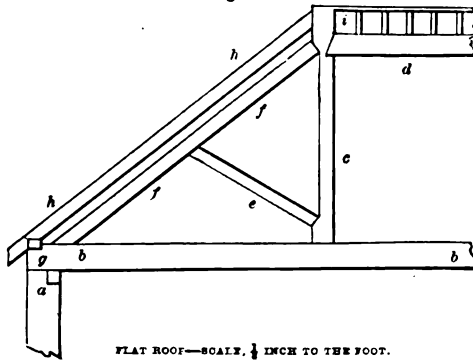

1221. *Mansard or Curb Roof.*—In cases where space is desired above the tie-beam, a form of truss known as the "mansard" is adopted; an illustration of which we give in fig. 421; *a a*, 10 inches by 4; *b b*, 6 inches by 4; *c c*, 5 inches by 4; *d d*, 4 inches by 4; *e e*, 5 inches by 4; *f*, 5 inches by 4; *g g*, 5 inches by 2.

Fig. 421.

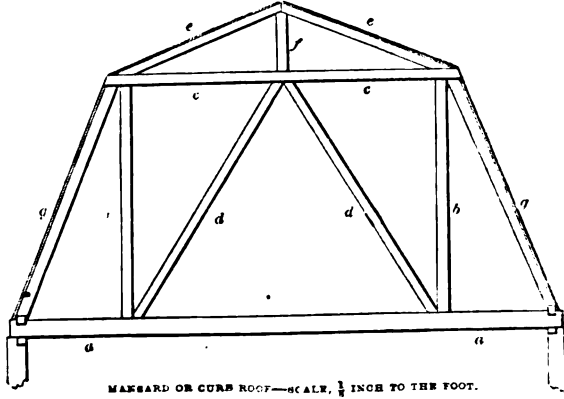

Fig. 422.

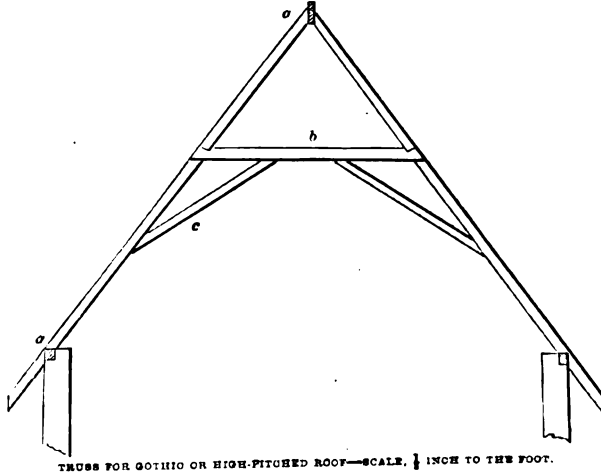
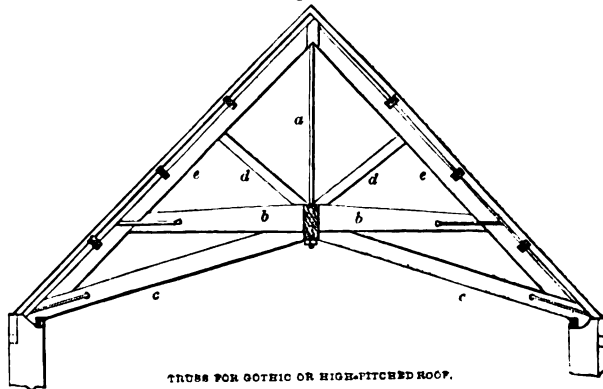

Fig. 423.



1222. *High-pitched or Gothic Roofs.*—In fig. 422 we give a truss for a high-pitched roof for a 20-foot span; *a a*, 4 inches by 3½; *b*, 5 inches by 4; *c*, 3½ inches by 4.

1223. In fig. 423 is another form of a truss for a high-pitched roof, in which the tie-bolt *a* is of wrought-iron. The tie-beam *b b* is 12 inches deep at the centre and 9 at the ends, the thickness being 5 inches; *c c* lower braces, 9 inches by 5; *d d* upper braces, 6 inches by 5; *e e* principals, 9 inches by 5.

1224. Height in a high-pitched roof may be obtained by cambering up the tie-beam, as shown in fig. 424, which may be adapted for a thrashing-mill. The king-post will require to have as many faces as there are sides in the polygon to be roofed. The whole strength of the arrangement depends upon the strength of the straps used to join the ends of braces *b b* to the foot of the king-post *a*.

1225. *Curved Rib-Truss.*—Fig. 425 illustrates a form of roof invented by Mr Holdsworth, and for which the Society of Arts gave a reward. In this form, the space usually taken up by king-posts, &c., is left

clear, so as to be available for several useful purposes, while the truss is

Fig. 424.

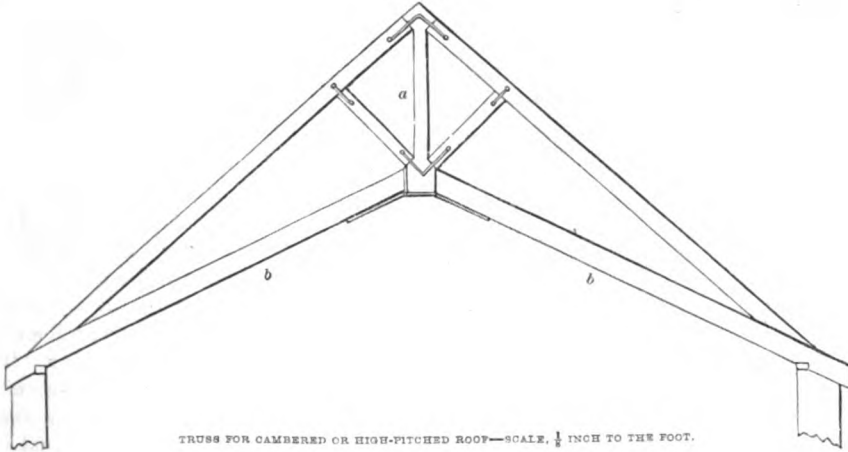

not only lighter, but a considerable saving of timber is effected. The principal feature is the employment of a curved rib, as *a a a*; this may be made of thin half-inch boards bolted together at intervals, firmly fixed into the tie-beam *b b*; the principal rafters *c c* rest on these ribs, the lower ends abutting upon pieces *d* resting on the wall, and firmly connected by iron straps to the rib, so as to be able to counteract the outward thrust of the rafters; *e e* are the common rafters, *f f f* the purlins, *g* the wall-plate.

Fig. 425.

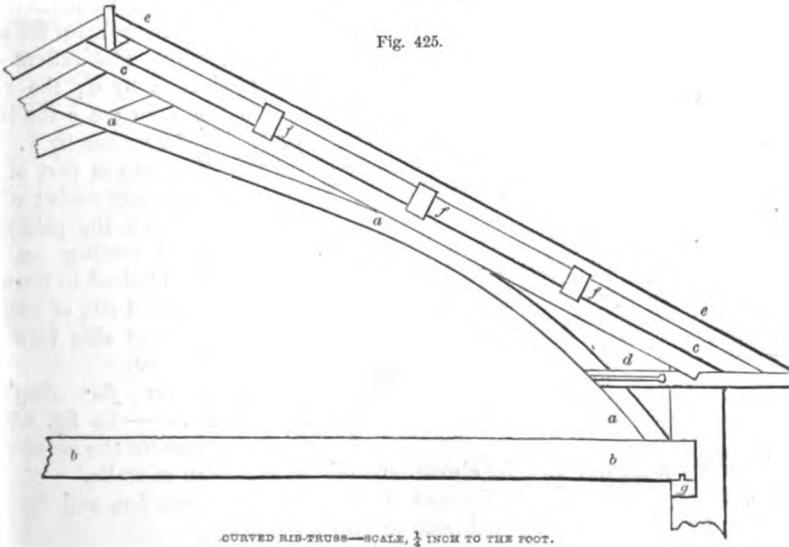

1226. Mr Tredgold describes a method of making curved ribs of short pieces of wood, which we illustrate in fig. 426. The pieces break joint, as shown in plan, the bolts being placed at each side of the joint, passing through the solid parts of the wood. Timber for small roofs may be bent into the required form; the elasticity of a piece of timber not being impaired by thus bending, when

its thickness does not exceed the one-hundred and twentieth part of its length. The best mode, however, of making a bent rib is on the "laminated" principle,

Fig. 426.

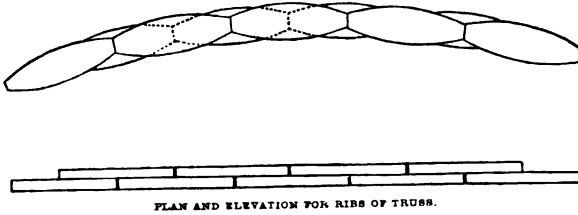

PLAN AND ELEVATION FOR RIBS OF TRUSS.

now much adopted in railway-station roofs—a fine example being met with in the Carstairs Junction Station of the Caledonian Railway. Flat half-inch boards may be laid together till the thickness desired is attained.

The two ribs may then be placed, and the ends brought down with a rope till the curve is got, when the two should be bolted together. On the release of the rope they will not spring back more than one-fourth or so of the amount of curve. The original curve given them, therefore, should be about 25 per cent greater than the curve required, to compensate for this spring or return, which taking place will bring the ribs to their true position.

Fig. 427.

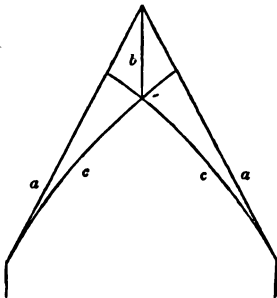

SKELTON OF TRUSS FOR A LAMINATED RIB ROOF, 32-FOOT SPAN.

Fig. 428.

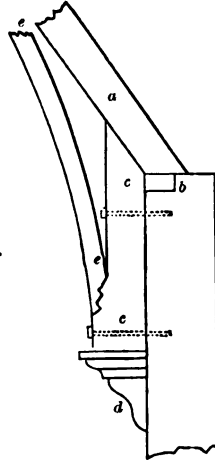

DETAIL OF PART OF ROOF-TRUSS
—SCALE. 1/2 INCH TO THE FOOT.

1227. *Laminated Rib-Roof.*—In fig. 427 we give a sketch of a truss of 32-foot span for a laminated rib. The rafters *a a* are 10 inches by 6; the king-post *b* the same; *c c* the laminated ribs, 10 inches by 6.

1228. Fig. 428 is part of the truss on a larger scale; *a* the rafter resting on the pole-plate *b*, *c c* post resting on the bracket *d*, and bolted to the wall, *e e* the laminated rib, of which a section and part side view are given in fig. 429.

1229. *Truss for Roof in Thrashing-Mill.*—In fig. 430 is plan of a truss for the horse-walk

of a thrashing-mill, fig. 431 the elevation, and fig. 432 plan of walls.

1230. *Hexagonal Roof.*—In fig. 433 is plan, fig. 434 elevation, and fig. 435 section of hexagonal roof for a thrashing-mill horse-walk.

1231. *Timber for Dormer Windows.*—Where windows project from the angle of a roof they are termed "dormer," as at *a b*, fig. 436. In same figure we give a section showing the arrangement of timbers; *c c* the rafter of the roof, *d* the ridge-pole of the window, *e e* upright for supporting the window-frame, *f* filling-in pieces.

Fig. 429.

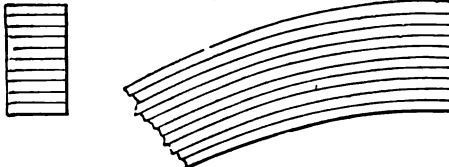

DETAIL OF RIB OF ROOF—SCALE. 1/2 INCH TO THE FOOT.

Fig. 430.

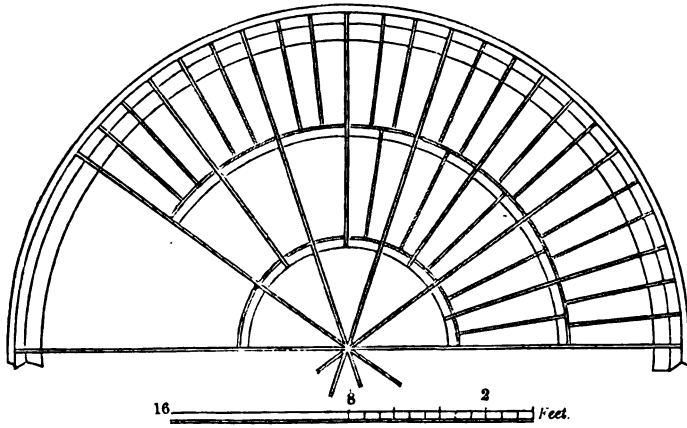

PART PLAN OF TRUSS OF ROOF FOR THRASHING-MILL HORSE-WALK.

Fig. 431.

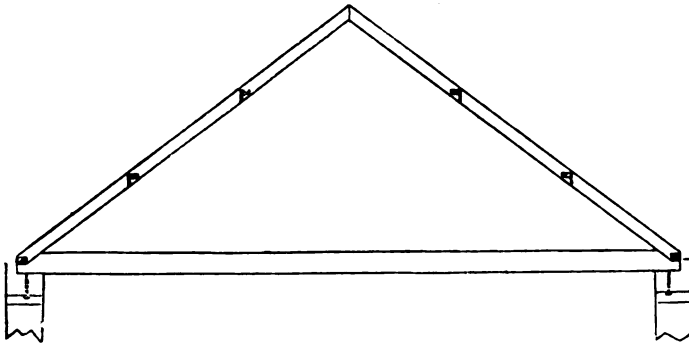

ELEVATION OF TRUSS FOR THRASHING-MILL HORSE-WALK—SCALE IN FIG. 430.

Fig. 432.

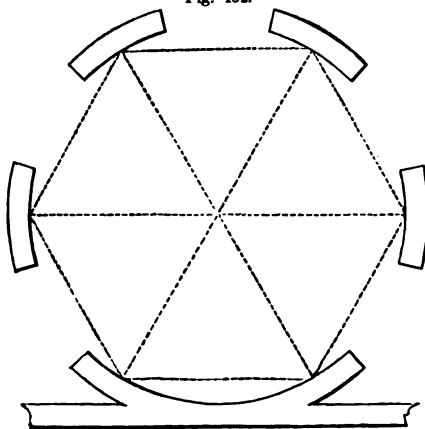

PLAN OF WALLS OF HORSE-WALK.

Fig. 433.

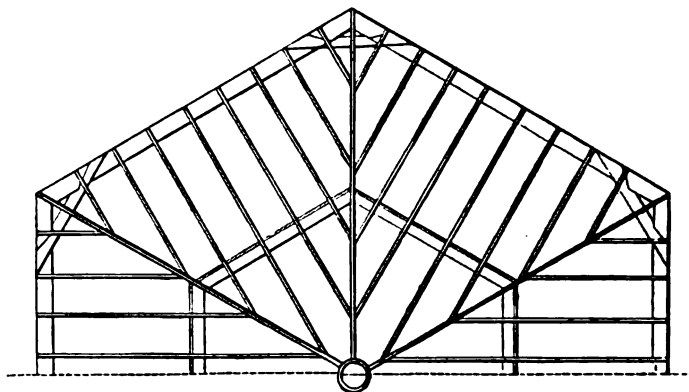

PLAN OF HEXAGONAL TRUSS—SCALE, $\frac{1}{4}$ INCH TO THE FOOT.

Fig. 434.

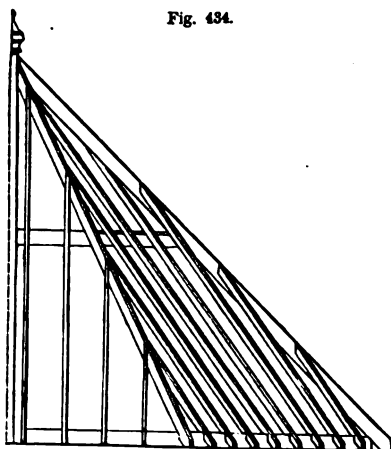

ELEVATION OF HEXAGONAL ROOF—SCALE, $\frac{1}{4}$ INCH TO THE FOOT

Fig. 435.

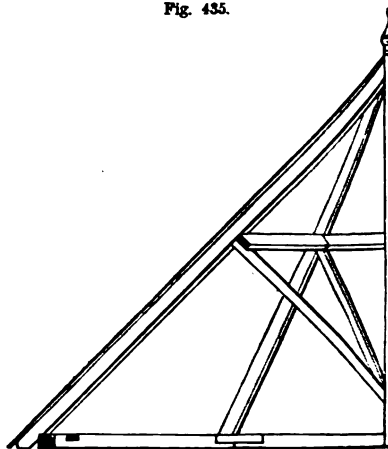

SECTION OF HEXAGONAL ROOF—SCALE, $\frac{1}{4}$ INCH TO THE FOOT.

Fig. 436.

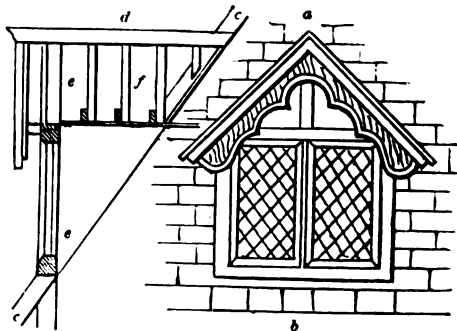

ELEVATION AND SECTION OF DORMER WINDOW—SCALE, $\frac{1}{4}$ INCH TO THE FOOT.

1232. *Gutters*.—Where the rafters project over the wall—which in the majority of the simpler constructions will be the case—the manner of making the gutters in a variety of ways is shown in the following figures: In fig. 437, *d* is the rafter; *c* the gutter, formed by bending thin iron or zinc into the shape required, and nailing it to the end of the rafter. Care must be taken to give the gutter a gentle slope throughout its length, to prevent the water stagnating in any part, and to lead it as quickly as possible to the “down pipe,” carrying it to the rain-water tank or barrel. This slope is given to it by marking off on the end of the first and last rafter, between which the length of gutter is fastened, a line at the same distance from the under side—say this, 4 inches: the upper edge of the gutter, as *a*, is nailed at the mark; and the other end of the gutter at the other rafter, at a short distance below the mark, as *b*: this will give the proper fall. The inclination may be, for every 15 feet in length, a fall of 1 inch. In fig. 438 the gutter *b* may be made of wood 3 inches square in the inside, and nailed to the rafter *a*, as shown. Mr Downing, in his work on *Country Houses*, figures two simple methods of forming gutters at the end of rafters; these are shown in figs. 439, 440. In fig. 439, *a* is the wall, *b b* the rafter, *c* a trian-

Fig. 437.

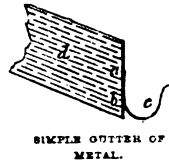

SIMPLE GUTTER OF METAL.

Fig. 438.

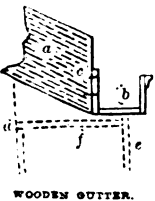

WOODEN GUTTER.

Fig. 439.

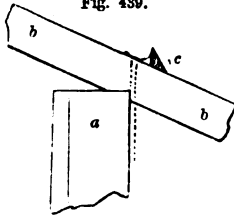
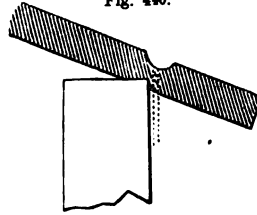

Fig. 440.



GUTTERS AT ENDS OF RAFTERS.

gular piece of wood nailed to the rafter, giving a support to a curved half pipe of zinc or iron, as shown in the diagram. In fig. 440 the half-circular bed for the pipe-gutter is cut out of the rafter: this looks well from the exterior, as no projection is seen. In both these plans the down-pipes, for leading the rain-water to the lower level, can be at once taken from the gutters, flush or level with the outside line of wall, as shown by the dotted lines. In the other forms of gutter described, if the down-pipe is wished to be taken along the wall, bends or turns must be made to bring it from the projecting gutter to the face of wall. Thus, in fig. 438, the simplest method of leading the rain-water from the gutter *b*, would be to take a pipe, shown by the dotted line *c*, to the barrel or drain beneath. This, however, would be unsightly; to obviate which, a return or bend *f* might be made to the wall *d*, and the pipe led down its face, as is usually done. In fig. 441 the gutter is supported by pieces of timber *a*, placed beneath the wall-plate *b*, at intervals corresponding to the rafters *e*. The front face of the gutter *d* may be ornamented with a moulded piece *f* nailed to it. The size of projecting piece *e*, or “cantaliver” as it is termed, may be, for roofs of ordinary size, 4 inches wide by 1 thick; the size of gutter inside may be from 3 to 4 inches wide and deep, inside measurement.

Fig. 441.

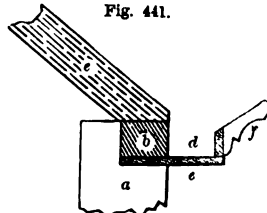

GUTTER WITH CANTALIVER.

1233. In fig. 442 we give a section of a wall of house showing formation of gutter, in which *a* is the wall, *b* the cantaliver, supported by the bracket *c*, secured to the nog *d*; *e* an ornamental bracket; *f* the gutter. Of the remaining part of this figure, *g* is the pole-plate, *h h* the rafter, *i* the ceiling-joint, *k* the cornice, *l* head of window, and *m* upper part of sash.

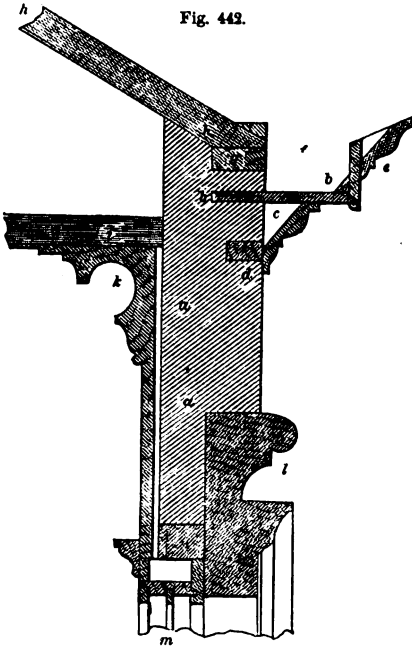

Fig. 442.

SECTION OF WALL SHOWING GUTTER WITH CANTALIVER—SCALE, 1/2 INCH TO THE FOOT.

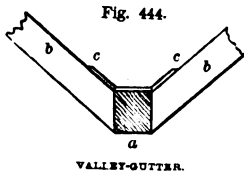

Fig. 444.

VALLEY-GUTTER.

1236. In fig. 445 is another method of forming a valley-gutter: *a a* the beams, 10 inches by 2 1/2, against which the rafters *b b*, 4 inches by 2 1/2, abut; *c c* the boarding forming the gutter.

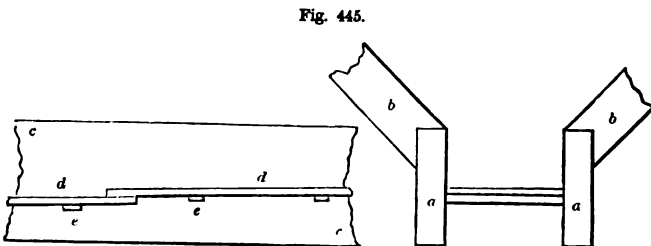

Fig. 445.

SECTION AND ELEVATION OF VALLEY-GUTTER—SCALE, 1/2 INCH TO THE FOOT.

1234. *Bridged Gutter.*—Where the wall is continued in front to form a parapet, as *a a*, fig. 443, the bridged gutter is used; *b b* the rafter, butting by a bird's-nose joint on the wall-plate *c*; *d* the gutter-beam, supported by *e*.

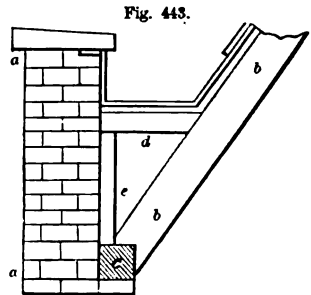

Fig. 443.

BRIDGED GUTTER—SCALE, 1/2 INCH TO THE FOOT.

1235. *Valley-Gutter.*—Fig. 444 shows a simple method of forming a valley-gutter, in which *a* is the beam on which the rafters *b b* abut; *c c* the boarding forming the gutter.

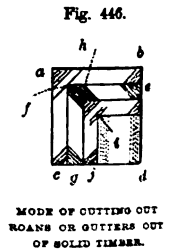

Fig. 446.

MODE OF CUTTING OUT ROANS OR GUTTERS OUT OF SOLID TIMBER.

1237. *Roans or Gutters cut out of a Solid Block of Wood.*—Fig. 446 represents a

method of cutting out triangular "roans" out of a solid balk, as recommended by the architect of the Scottish Association for Improving the Cottages of Agricultural Labourers. Let $abcd$ be the section of balk; by means of a circular saw, make a cut from e to f , and from f to g ; the part $efgd$ will thus be cut out, leaving a roan or gutter $abefgc$. Out of the part $gfed$ another gutter may be cut, as shown by the lines jh ; and out of the square piece cut i , a third may be obtained, leaving, finally, a spar, which may be used for a variety of purposes.

Fig. 447.

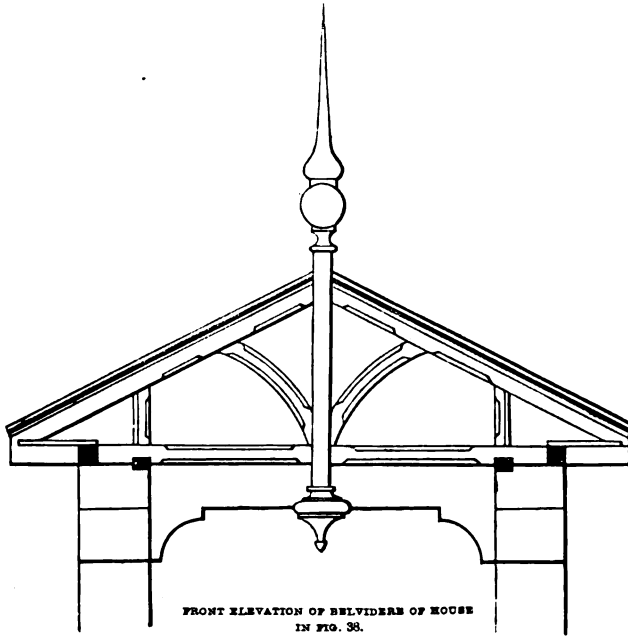

1238. *Belvidere of House in Fig. 38.*—Of this we give in fig. 447 a section, and in fig. 448 a side elevation of brackets supporting rafters.

Fig. 448.

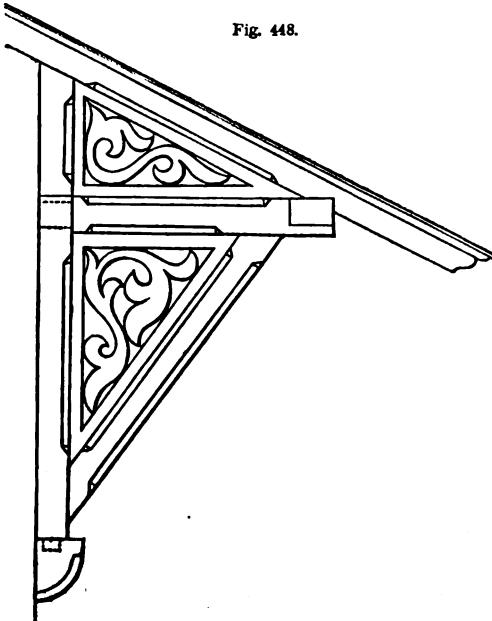

SIDE ELEVATION OF WOODEN BRACKET OF HOUSE IN FIG. 38.

1239. SECTION FIFTH—*Stairs*.—There are two limits of space to be considered in the laying out of stairs—these are, the height from the upper surface of the lowest floor to that of the upper, as the height from *b* to *a*, fig. 449; next, the horizontal distance between the outer edge of the step at the top, as *a* to that of the lower one at *c*. The part of a step on which the foot rests in ascending or descending is termed the “tread,” *a*, fig. 450, and a generally received breadth for this is 9 inches; the vertical part of a step, as *b*, *b*, fig. 450, is

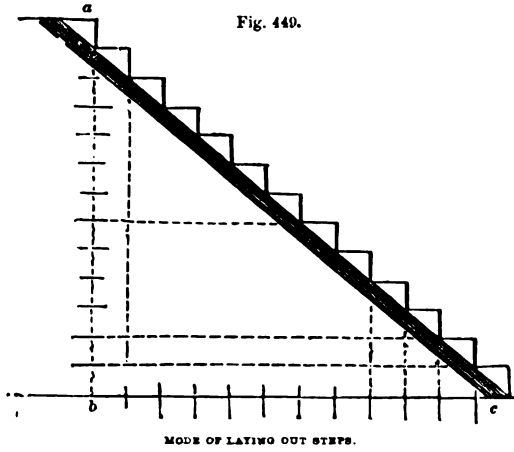

Fig. 449.

MODE OF LAYING OUT STEPS.

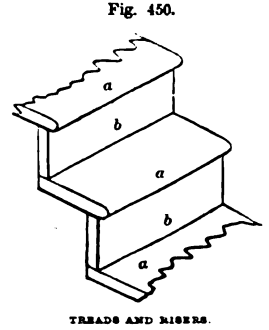

Fig. 450.

TREADS AND RISERS.

called the “riser,” and the height may be averaged at $7\frac{1}{2}$ inches. The vertical height *a b*, fig. 449, from one floor to another, being carefully ascertained—suppose it to be $97\frac{1}{2}$ inches, or 8 feet $1\frac{1}{2}$ inch, and the height of riser to be $7\frac{1}{2}$ — $97\frac{1}{2}$ divided by $7\frac{1}{2}$ lengths will give 13, the number of risers in the stair as in fig. 449. Now, supposing the horizontal distance *b c* to be accurately ascertained to be 9 feet or 108 inches, the tread being 9 inches, this will give 12 treads; the number of treads in a stair is always one less than the number of risers, as the floor of the upper storey forms the last tread.

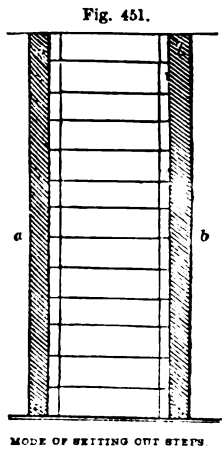

Fig. 451.

MODE OF SETTING OUT STEPS

1240. Fig. 451 is an elevation of the stairs laid out in fig. 449, and which forms the simplest method of reaching an upper floor.

1241. In fig. 452 we give the plan of a “platform staircase,” in which there is first a flight of eleven

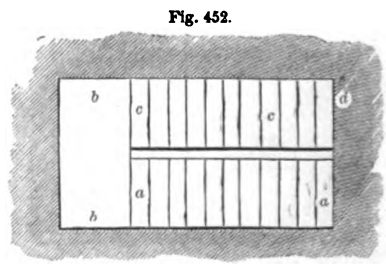

Fig. 452.

PLAN OF PLATFORM STAIRS—SCALE, 1/4 INCH TO THE FOOT

steps *a a*, leading to the platform *b b*, which forms the twelfth step. A second, or “return” flight, of eleven steps, *c c*, leads to the floor *d d* of second storey, which forms the twenty-fourth step.

1242. In fig. 453 we give a section of this; $a b$ being the height from first to second floor; c the twelfth landing-place.

1243. In fig. 454 we give the plan, and in fig. 455 the section, of a staircase, with return steps $a a$.

1244. *Notch-Board.—String-Board.*—The “treads” and “risers” of a staircase are notched into, or housed into, two inclined boards, which are termed “notch-boards.” The “carriage-board,” fig. 456, is the board next the open side of the well-hole of a staircase, which encloses or terminates the ends of the steps.

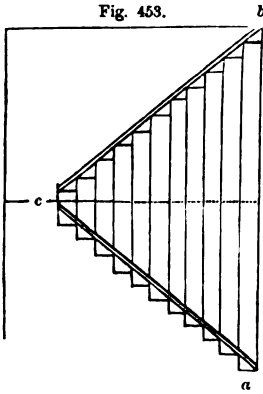

SECTION OF PLATFORM STAIRCASE—
SCALE $\frac{1}{2}$ INCH TO THE FOOT.

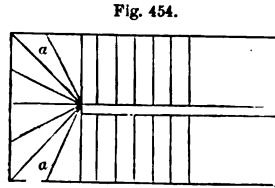

PLAN OF STAIRCASE WITH RETURN.

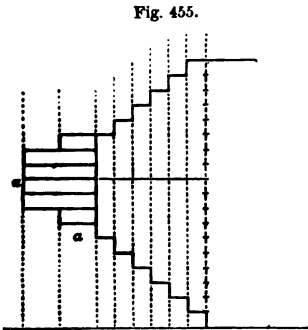

SECTION OF RETURN STAIRS.

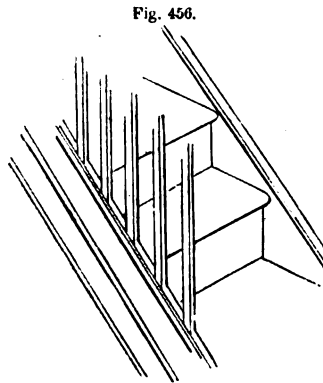

CARRIAGE-BOARD OF A STAIRCASE.

1245. *Laying out of the Steps on the Notch-Board.*—We now proceed to explain another way of laying out the positions of the treads and risers, on what are termed “string” or “carriage boards”—as $a b c d$, fig. 457, where $e f, g h$ represents the mortises made in the face of the board $a b c d$, and $e g, h i$ those for the treads, and into which the ends of the boards, 1 inch thick, are passed, forming the “risers” and “treads” respectively. Instead of mortising them, the risers may be merely nailed at each end to the carriage-boards, the treads being nailed on the risers. The dimensions of the carriage-board, where the “risers” are $7\frac{1}{2}$ and the treads 9 inches, may be 9 by $1\frac{1}{4}$ inches. If the under side of steps is to be covered in with lath and plaster, 4 inches should be added to the

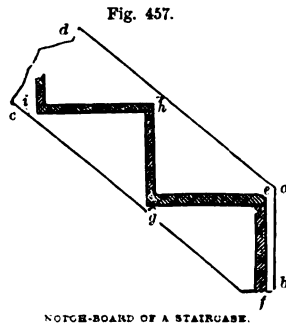

NOTCH-BOARD OF A STAIRCASE.

above breadth. Having duly ascertained the vertical and horizontal heights, proportioned the rise and tread, and ascertained their number, procure a triangular board *a b c*, fig. 458—the sides *a b*, *b c*, each 12 inches or so, and about $\frac{7}{8}$ thick—from *b* mark off on *b a*, an extent of $7\frac{1}{2}$ inches *d* (or whatever dimensions the “riser” is to be), and from *b* to *e* on *b c*, equal to 9 inches (or the size of tread). Procure a piece of timber *a b c d*, fig. 459, about 1 inch thick, and

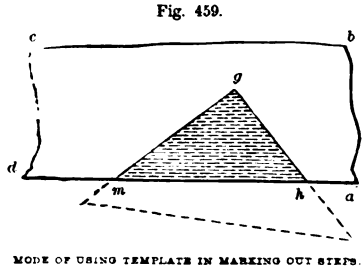
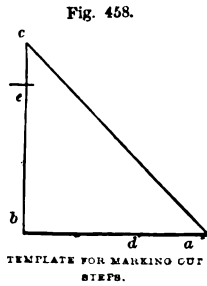

square up one side *a d*; take the triangular piece *a b c*, in fig. 458, and placing the point *d* (denoting the extent of $7\frac{1}{2}$ inches from *b*) at any point in the side *a d*, as at *h*, fig. 459, and the point *e* (denoting the extent of 9 inches from *b*) to meet the same line *a d*, mark round, with a sharp point or pencil, *h g*, *g m*, and cut out the piece *h g m*, as shown by the notched lines; square the edges of this—it will form the “pitch-board” by which to mark the position of treads and risers on

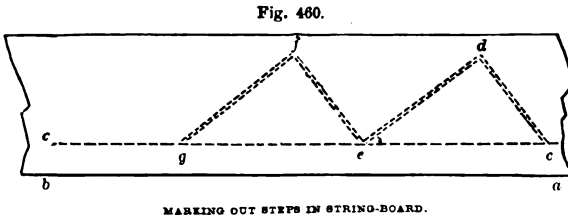

the string-board. Having obtained the timber for the string-board of proper dimensions, place the “pitch-board” *h g m*, fig. 459, with the point *h* at *c*, fig. 460 (having previously drawn a gauge line *c c* from the squared-

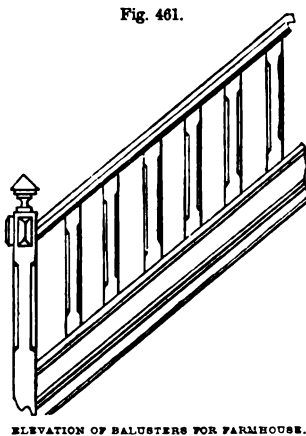

up side *a b*, of breadth sufficient for plastering 4 or 5 inches, or 2 to 3 if left open), and the point *m* at *e*; draw in the face of the string-board *c d e*; next place the end *h* at *e*, and *m* at *g*, and draw *e f g*, and so on until the requisite number of treads and risers are laid

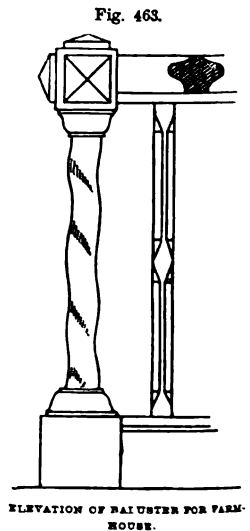
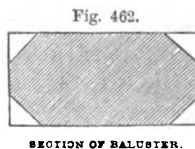

down. The two string-boards thus treated (one on each side of the staircase) are to be placed as far

apart as the width of stair; and the boards forming treads, 9 inches wide, and those forming risers, $7\frac{1}{2}$ inches deep, are to be nailed at the ends or mortised, as described in fig. 457—the risers being nailed, &c. to the lines corresponding to *c d, e f*, and the treads on the lines *d e, f g*, fig. 460. When the stairs, thus formed, are placed in their position between the walls *a* and *b*, in fig. 451, the treads *d e, f g*, fig. 460, will be horizontal, and the risers *c d, e f* vertical.

1246. In fig. 461 we give elevation of balusters for house in fig. 23, and in fig. 462 a section of one of the balusters; and in fig. 463 an elevation of the baluster for house in fig. 41; both for a first-class farmhouse.

1247. SECTION SIXTH — *Wooden Fittings of the Farmhouse and Cottage* — *Doors—Windows, &c.*

1248. *Ledged Doors.*—A ledged door is constructed of a number of boards, *a a*, fig. 464, of length equal to that of doorway. They are tongued and grooved, and secured by cross pieces or ledges *b b*.

1249. *Ledged and Braced Doors.*—In this form, in addition to the ledges *a a a*, fig. 465, braces *b b*, are added.

1250. *Framed and Braced Doors.*—In this form the longitudinal boards are kept together by the frame *a a a a*, fig. 466, and farther strengthened by the braces *b b*. Doors of this kind, when circular headed, may be finished in the interior, as shown in fig. 467. The exterior being kept quite plain.

Fig. 467.

Fig. 464.

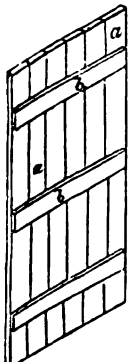

LEDGED DOOR.

Fig. 465.

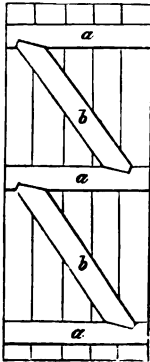

LEDGED AND BRACED DOOR.

Fig. 466.

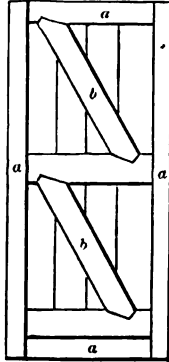

FRAMED AND BRACED DOOR.



CIRCULAR-HEADED DOOR.

1251. *Sash Door.*—In fig. 468 we give the elevation of a sash door, the lower part being furnished with two panels *a b*, the upper with a sash *c*, framed and glazed.

1252. *Framed Doors.*—The doors of rooms of a superior class, furnished with panels, are termed "framed doors." In fig. 469, *a a* shows a four-panelled, and *b b* a six-panelled door. In the

Fig. 468.

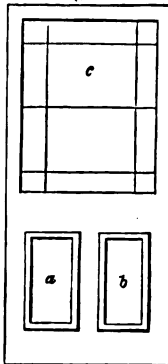

SASH DOOR.

Fig. 469.

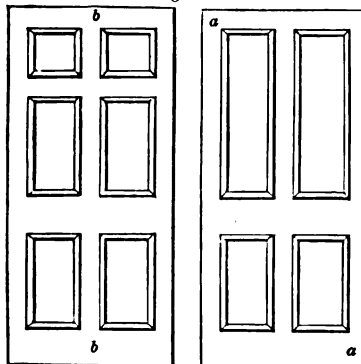

FOUR-PANEL AND SIX-PANEL DOORS.

frame of a panelled door, the side parts *a a*, fig. 470, are called "styles." The "rails," fig. 471, are the horizontal pieces containing the tenon mortised into the styles, and into which the panels are inserted. In fig. 472 *a* is the

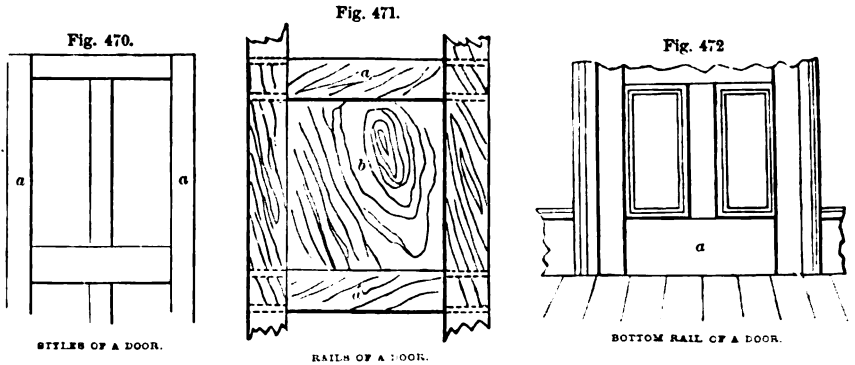

"bottom rail;" in fig. 473 *a* is the "middle rail." The vertical pieces *a a*, fig. 474, between the styles *b b* and rails *c c*, are called "muntins."

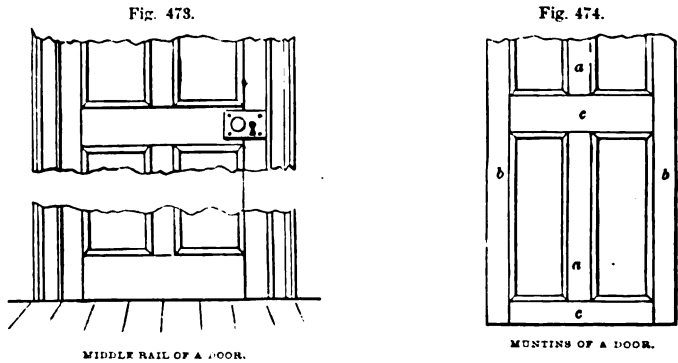

1253. *Panels.*—In fig. 475 we give at *a* the elevation of a sunk panel, and at *b* a raised lozenge. A panel is said to be "bead butt," as at *a*, fig. 476, when the bead is worked on the edge of the panel, and so butts against the "rails." It is said to be "bead flush," as at *b*, fig. 476, when the bead is worked all round on the edge of the frame.

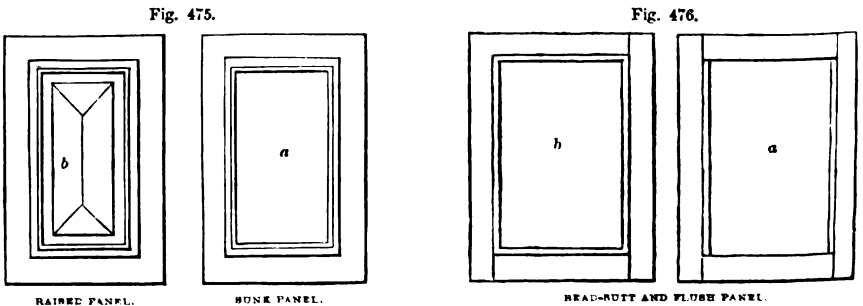

1254. In fig. 477 we give suggestions for panelled work for house in fig. 23, and in fig. 478 for the panel of drawing-room door of house in fig. 41.

Fig. 477.

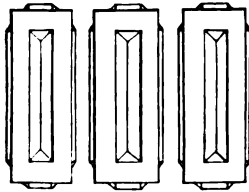
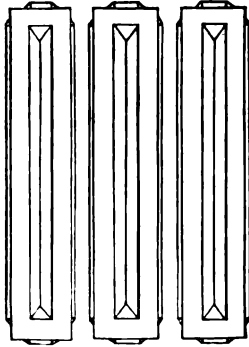

PANELS OF DOOR OF FARMHOUSE.

1255. *Gothic Door*, fig. 479.

1256. *Raised Panel Door*.—*Bolection Moulded*, fig. 480.

1257. *Folding Door*, fig. 481.

1258. *Sliding Door*, fig. 482.

Fig. 478.

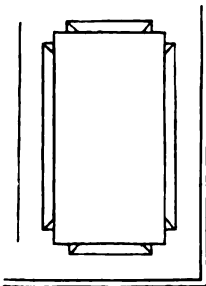

PANEL FOR DOOR OF FARMHOUSE.

Fig. 479.

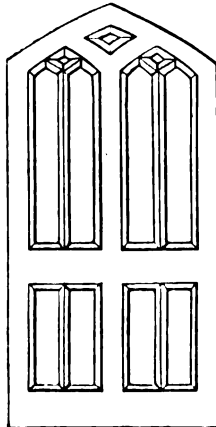

GOTHIC DOOR.

Fig. 480.

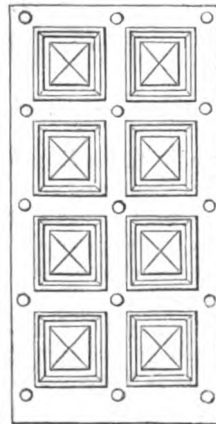

RIGHT-PANEL RAISED DOOR.

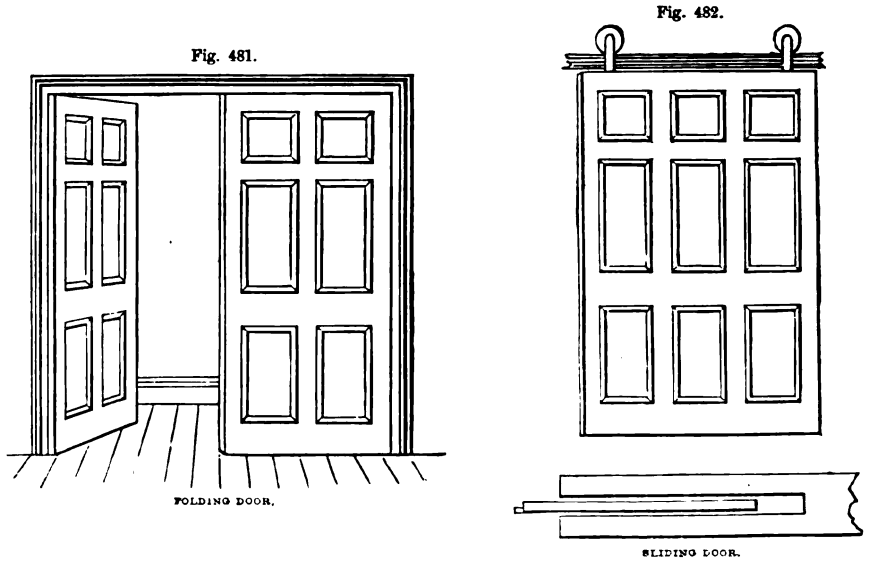

1259. *Door Stops for the Prevention of Draughts.*—In fig. 483 we give a drawing of a left-hand door closed, and in fig. 484 a right-hand door opening,

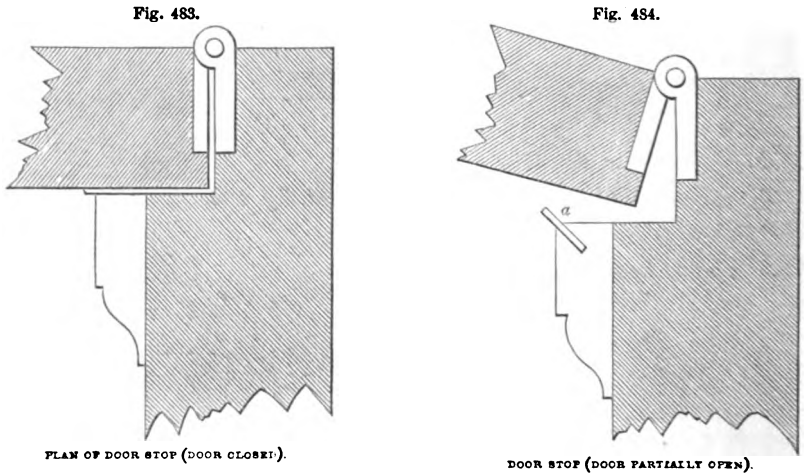

fitted with the india-rubber stops. The appliance consists of a small beading, nailed or screwed round the door frame, with a narrow strip or ribbon of thin vulcanised india-rubber, which is fixed at an angle, as at *a*, fig. 484, in a groove. The whole forms a species of spring, which presses against the door when closed, and forms an air-tight joint all round. In fig. 485 we illustrate the stop for the bottom of a door—an admirable substitute for weatherboards in outside-doors. The beading which supports the strip of vulcanised india-rubber is hinged to the door itself, so that it opens like a parallel ruler. A spring is provided between the two pieces, so that, as the door closes, the heel of the bead is caught by the frame and pressed so as to open the parallel slip, and cause the lower edge, provided with the india-rubber, to press upon the

floor or carpet. The address of the patentee is, Mr J. Greenwood, 10 Arthur Street West, London Bridge, London.

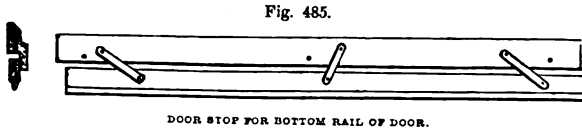

1260. *Windows.*—In fig. 486 we give a diagram of the framing for a window 4 feet high—that is, between upper and under side of lintels *a a, a a*—and 2 feet broad between inner side of side-posts *b b*. Part of the length of side-posts are broken off to save room. The lintels *a a, a a* are 4 inches by 3; the side-posts, same size, are attached to these by any of the joints already described; a centre rail *c c*, 4 by 2, divides the window into two. Fig. 487 shows the plan of this, where the angular form of wall *o o* is shown, commencing at upper side of lower lintel *a a*, fig. 486, and terminating at under side of upper lintel *a a*. The window-sill, in the inside of room, is formed by placing a piece of boarding, inch thick,

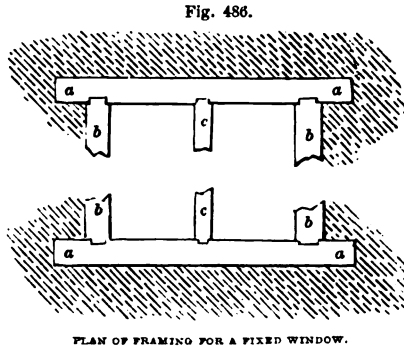

and projecting over inside wall about $\frac{3}{4}$ inch. An exterior sill may be made by nailing to outside of under lintel *a a*, fig. 487, a piece of timber 3 inches square—the upper side sloping, and under side throated: *c* is section of the corresponding centre rail *c*, fig. 486. In fig. 488 we give the drawing of a sash window, the upper half *c* of which is fixed, the lower *d* being movable—that is, capable of being lifted up. The lower movable sash is, however, not balanced by sash-weights, but is retained in its place by a simple catch, or a piece of wood, at any desired height. The construction of a balanced sash is of too complicated a kind to be attempted by any but an experienced workman. The left figure is a section (vertical), that to the right being an elevation: *a a a a* is the framing, 5 inches by 3, the wall *f f* being 14 inches thick; *c* the upper sash, firmly nailed to the framing; *d* the lower movable sash, which slides up

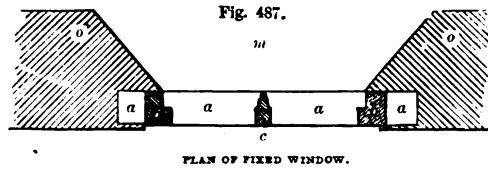

and projecting over inside wall about $\frac{3}{4}$ inch. An exterior sill may be made by nailing to outside of under lintel *a a*, fig. 487, a piece of timber 3 inches square—the upper side sloping, and under side throated: *c* is section of the corresponding centre rail *c*, fig. 486. In fig. 488 we give the drawing of a sash window, the upper half *c* of which is fixed, the lower *d* being movable—that is, capable of being lifted up. The lower movable sash is, however, not balanced by sash-weights, but is retained in its place by a simple catch, or a piece of wood, at any desired height. The construction of a balanced sash is of too complicated a kind to be attempted by any but an experienced workman. The left figure is a section (vertical), that to the right being an elevation: *a a a a* is the framing, 5 inches by 3, the wall *f f* being 14 inches thick; *c* the upper sash, firmly nailed to the framing; *d* the lower movable sash, which slides up

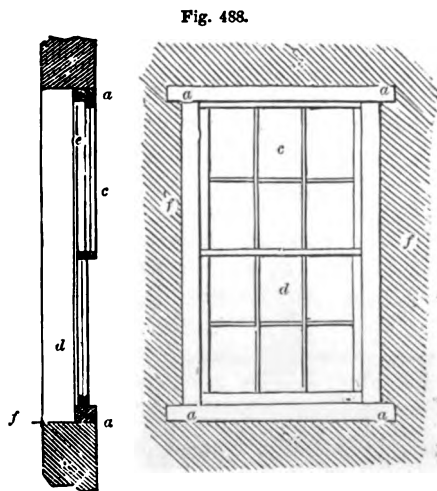

ELEVATION AND SECTION OF FRAME OF FIXED WINDOW.

into the space *e*. The lower sash *d* is prevented from coming out of its place by two bars *c c*, fig. 489, $\frac{1}{2}$ inch thick, and inch wide, nailed to the inside and outside of side-posts *a a*.

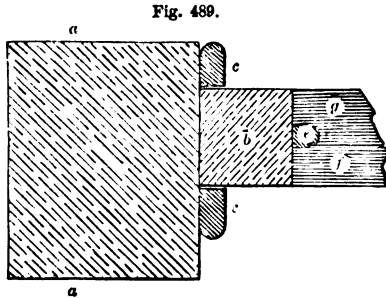

PART SECTION OF SASH-FRAME.

The outer one is only continued from bottom lintel up to the under side of upper sash; the inner one being carried up to the under side of upper lintel. In fig. 489, *b* is the side of sash-frame *c*, fig. 488, *e* the rebated astragal, *f* the glass, *g* the bottom rail of sash-frame *c*, fig. 488. The dimensions of this window is 3 feet 4 by 6 feet 5; each sash is divided into six panes, 12 inches by 17.

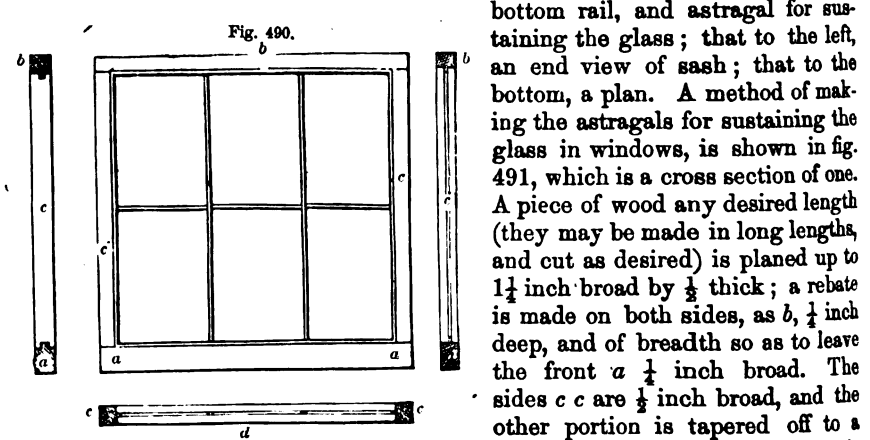

ELEVATION AND SECTION OF SASH-FRAME OF WINDOW.

In fig. 490 we give drawings of the lower sash, drawn to a scale of $\frac{1}{2}$ inch to the foot. The lower rail *a a*, is 3 inches by 2; the upper, *b*, 2 inches by 2, as also the side ones *c c*. The section to the right shows position of top and bottom rail, and astragal for sustaining the glass; that to the left, an end view of sash; that to the bottom, a plan. A method of making the astragals for sustaining the glass in windows, is shown in fig. 491, which is a cross section of one.

A piece of wood any desired length (they may be made in long lengths, and cut as desired) is planed up to $1\frac{1}{4}$ inch broad by $\frac{1}{2}$ inch thick; a rebate is made on both sides, as *b*, $\frac{1}{4}$ inch deep, and of breadth so as to leave the front *a* $\frac{1}{4}$ inch broad. The sides *c c* are $\frac{1}{2}$ inch broad, and the other portion is tapered off to a little more than $\frac{1}{8}$. The glass is fastened in the rebates *b*, and secured with putty, filling up the angle. The part *a* is outside, *d* in the interior of the room. In fig. 492 the manner of joining the astragals together is shown: *a a* corresponds to the vertical lengths in fig. 490, *b b* to the cross ones. They may be joined by a dovetail or other joint, or nailed together. The dotted lines in fig. 491 show the position of an astragal at right angles to *a d*. In fig. 493 we give a diagram illustrative of the arrangement of another form of sliding window: in this instance the window is moved from side to side laterally, instead of vertically, as in fig. 488. Let *a b c d* be the opening of window in inside of frame, or in the wall; *h h* the wall of room; below the window fix (to wood bricks fixed in the wall) a horizontal timber *e e*,

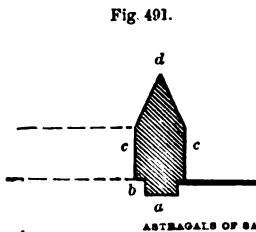

ASTRAGALS OF SASH WINDOW.

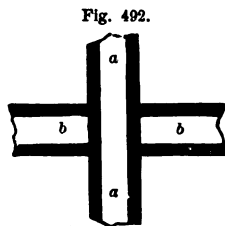
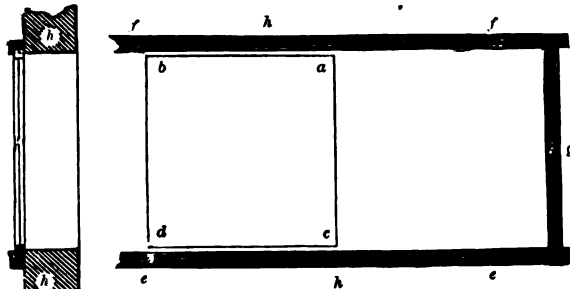

Fig. 492.

below the window fix (to wood bricks fixed in the wall) a horizontal timber *e e*,

4½ inches by 4 feet, having nailed on its upper side a piece *c*, fig. 494, ½ inch square; similar to this, fix above the window another horizontal slide *f f*, but having its piece, as *c*, fig. 494, fixed on the lower edge; there will thus be at upper and under sides of window, and extending beyond it on both sides (or one, as the window is desired to be moved on both sides or one only), two slides, in which the sash-frame *a b c d*, fig. 493, can be moved or pushed along.

Fig. 493.



SECTION AND ELEVATION OF FRAME OF SLIDING WINDOW.

To facilitate its being moved along, two projecting handles may be attached to the sash-frame inside. The upright *g*, fig. 493, limits the extent to which the window can be opened, or slid along *e e* and *f f*. In the diagram we have represented the horizontal bars *e e*, *f f* as being broken off. If the window is required to be capable of moving either to right or left of window-opening, they will extend to an equal distance on both sides: if the window

Fig. 494.

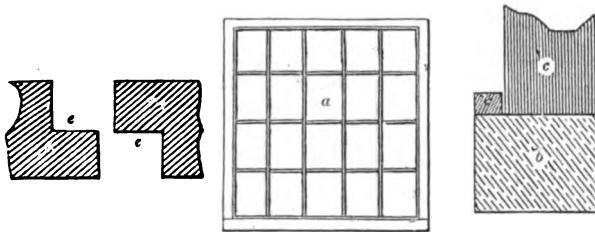

DETAILS OF SLIDING WINDOW.

is to move only to one side, a vertical post similar to *g* will be placed close to the edge of window, at side opposite to that at which *g* in the figure is placed. The figure to the left, fig. 493, is a section. In fig. 494, *a* is the sash-frame, 4 feet square, inside measurement, the scantling being the same as in fig. 490. It is divided into 20 squares, 11 inches by 9. The section *b* to the right represents the under rail *e e* in fig. 493, to a scale of ½ inch to the inch; *c* is the bottom rail of the sash. Instead of making the window in one part, it may be divided into two—the inner rails of sash-frame being rebated, as in section *e e* to the left, so that, when closed together, they will form a water-tight joint.

1261. As a good window is an essential article in the cottages of labourers, it may be worth while to give a description of one made by Messrs M'Culloch & Co., Gallowgate, Glasgow, and for which they received a premium from the Highland and Agricultural Society. "This window is extremely simple in its construction, and may with safety be pronounced efficient in point of comfort and utility, while the price, it is believed, will not be higher than the cheapest description of iron windows now in use, and, for durability, will be preferable to those of any other material. The dimensions that have been recommended for the windows of ordinary cottages are, 39 inches for the height, and 24 inches for the width, within the wooden frames. The size of glass required for these frames is 7½ inches by 5½. The sash is divided into two unequal parts, the lower part having 3 squares in height, and the upper part 2. The lower part is per-

manently fixed, while the upper part is constructed to turn in the vertical direction on pivots, which are situate in the line of its middle astragal; and both parts are set in a substantial wooden frame, which may either be built in while the wall is erecting, or set in afterwards in the ordinary way, with or without checked rebats, according to the taste of the proprietor. The window and its arrangements will be better understood by reference to the annexed cuts, fig. 495 showing an inside elevation, fig. 496 a plan, and fig. 497 a ver-

Fig. 495.

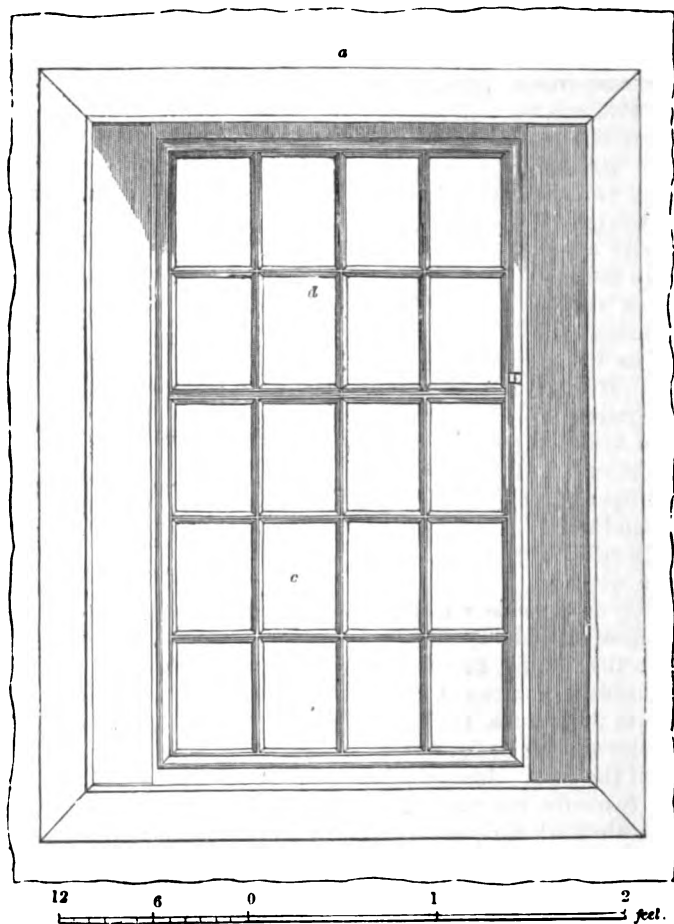

THE INSIDE ELEVATION OF AN IMPROVED WINDOW SUITED FOR COTTAGES.

tical section, in each of which a portion of the wall is exhibited, and the same letters refer to the corresponding parts of each figure; *a* is a portion of the surrounding wall; *b b* the wooden frame of the window; *c* the lower sash, which is dormant; and *d* the upper and movable sash. In fig. 497, the upper sash is represented as open for ventilation. When shut, the parts of the opening sash cover and overlap the fixed parts in such a manner as to exclude wind and water; but when ventilation is required, the arrangement of the parts which

produce this, is such as to enable the housekeeper to admit air to any extent. For this purpose, the notched latch *e* is jointed to a stud in the edge of the

Fig. 496.

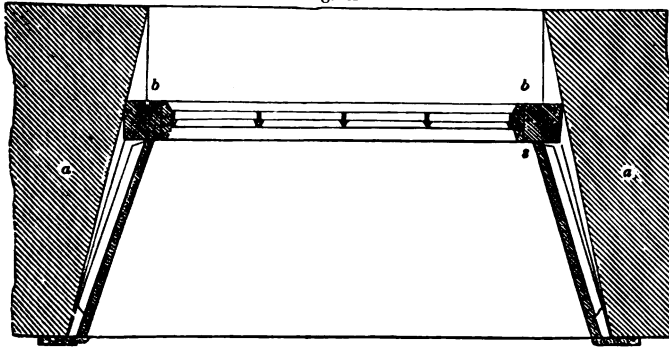

THE PLAN OF AN IMPROVED WINDOW FOR COTTAGES.

sash; a simple iron pin or stud is also fixed in the wooden frame at *s*, and the notches of the latch being made to fall upon this stud at any required distance, the requisite degree of opening is secured; and when the sash is again closed, the latch falls down parallel with, and close to, the sash. To secure the sashes when shut, the T bolt *f*, in the middle of the meeting bars, has only to be turned $\frac{1}{4}$ round, and the movable sash is held fast in close contact with the other. Fig. 495 represents the windows as finished with simple dressings—namely, plain deal shutters, facings, and sole—which, at a small expense, would give an air of neatness and comfort to the apartment, and promote a corresponding taste in the other parts of the cottage. Though the dimensions of the window here stated may be conceived sufficient for lighting an apartment of ordinary size, they can, nevertheless, be varied to suit every purpose. This may be done either by employing two such windows as above described, with a mullion of wood or of stone between them, or the single window may be enlarged by 1 or 2 squares in width, or in height, or in both directions."

Fig. 497.

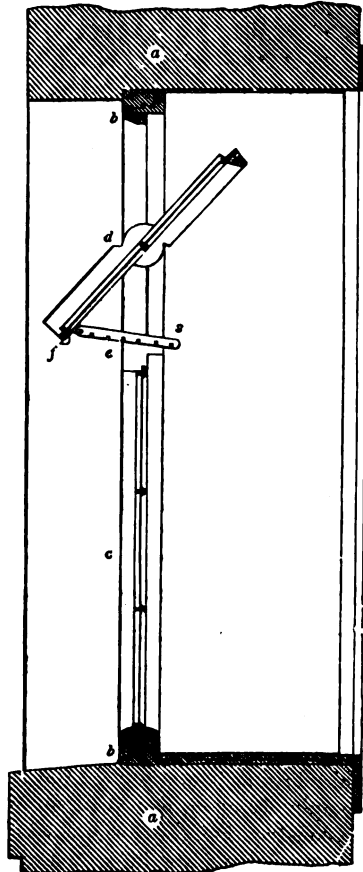

THE VERTICAL SECTION OF AN IMPROVED WINDOW FOR COTTAGES.

1262. It is proper to mention that zinc, in the opinion of tradesmen, is too weak for window-sashes to admit of repair by an unpractised hand. Wood and lead are, for the same reasons, equally unsuitable. Malleable iron, even so thin as to impede the light but little, if the astragals are not provided with flanges for the glass to rest against, the re-

pair must also be a work of some difficulty, and is also deemed unfit for the purpose. Cast-iron, therefore, appears to be the material least liable to objection; but astragals of cast-iron must be of considerable thickness, and such frames, consequently, could not be adapted to a very small size of glass, without materially obscuring the light. The iron sashes, as shown above, without the wooden frames, cost 5s.; and glass for such windows may be purchased at 2 $\frac{3}{4}$ d. per square.

Fig. 498.

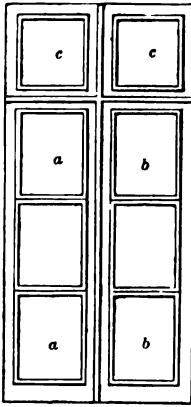

ELEVATION OF A FRENCH OR CASEMENT WINDOW.

1263. *French Casement Window*.—In fig. 498 we give an elevation of this form of window, the peculiarity of which is, that the sashes *a a*, *b b* open longitudinally, like folding-doors. The leaves may open up the whole length of window, or the sashes *c c* may be fixed. Objections to this form of window—the difficulty of regulating the amount of opening, so as to secure less or more ventilation, the expensiveness of the fastenings, and their liability to shake and rattle, and to admit draughts through the central joining—are all obviated in the ingenious form of window now to be described.

1264. *West & Habbell's Patent "Oak-Hall" Window*.—In fig. 499 we give an elevation of this window closed, and in fig. 500 an elevation open. From fig. 500, it will be seen that the sashes are capable of

Fig. 499.

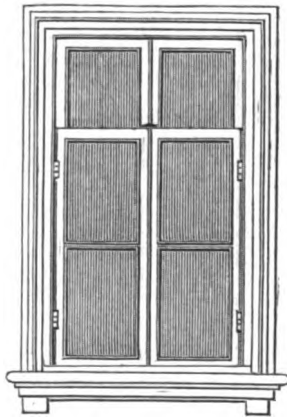

OAK-HALL WINDOW, CLOSED

Fig. 500.

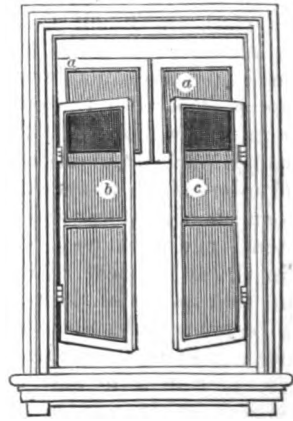

OAK-HALL WINDOW, OPEN.

being opened several ways at once. The top sashes *a a* can be lowered, so as to permit of the escape of the foul air of the room, while the lower sashes *b* and *c* can be opened not only in the direction of their length, but can be raised in the frame. The upper panes *a a* can be lowered to the bottom of the frame, so as to be within easy reach when requiring to be cleaned or repaired; and being kept in the lower position while the two swinging sashes are completely open, they will serve as a protection when children are in the room. In construction, this form of window is cheaper than French casements, requires no expensive fastenings, and does not interfere with inside blinds, which can be used whether the window is open or shut. Amongst other advantages this window possesses, is that which enables one-half of the lower sash, as the

part *b*, to be opened or drawn up independently of the other half *c*. By this arrangement, the draught of air entering the apartment can be directed as desired. The centre mullions of the lower sashes *b*, *c* are tongued and grooved like the boards of a floor, so that the sashes do not shake or rattle, and are perfectly weather-tight when closed. From the vertical movement of the lower sashes, the stop bead at the bottom of the frame acts also as a medium to exclude the weather—the drip being on the outside. In fig. 501 we give a longitudinal, and in fig. 502 a horizontal, section of this window.

Fig. 501.

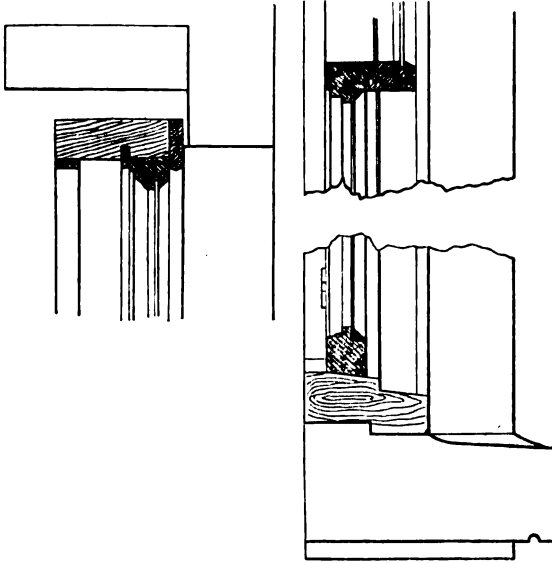

PART LONGITUDINAL AND VERTICAL SECTION OF OAK-HALL WINDOW.

Fig. 502.

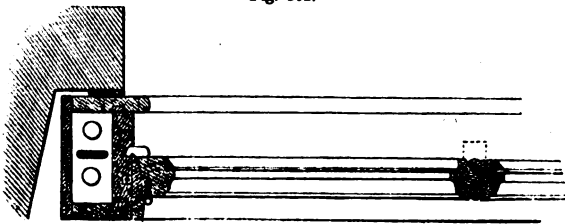

PART HORIZONTAL PLAN OF OAK-HALL WINDOW.

1265. *Shaw's Patent Sash-Frame*.—In fig. 503 we give a drawing of part elevation, in fig. 504 a horizontal section, and in fig. 505 a vertical section, of this window, which is rapidly coming into use, affording great facilities for cleaning and repairing. The sashes are fixed upon centres, so that they are capable of making a semi-revolution—presenting the outside of the window to the inside of the room. In fig. 505 the sash-cords *a* are attached to strips or loose pieces *b*, sliding in the recess of the window-frame; the sashes *d* *d* have on either side a projecting pin or centre *e* *e*, as seen also in fig. 503

on the lower sash only. The centres *e* are nearly in the centre of the length of sash, and they engage in the bearings *f*, in the loose strips *b*. To preserve the sashes in a vertical direction, screws *g g*, fig. 504, are passed through the sash stile, and engage in pieces *h h*, fixed in the strips *b*. The sash is thus made to form vertically one piece with the strips *b*, so that it can be raised or lowered as an ordinary sash. By withdrawing the pins *g*, the sash may be turned on its centre, as in fig. 505. The sashes, when restored to their vertical position, are secured in their places by the screws *g g*—these entering the window in an oblique direction, as in fig. 504. The address of the patentee is, Benjamin Shaw, Wellington, Salop.

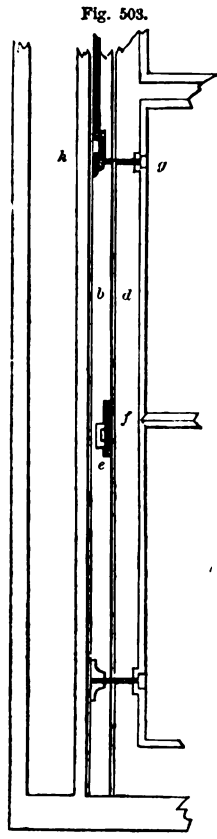

PART ELEVATION OF SHAW'S PATENT WINDOW.

Fig. 504.

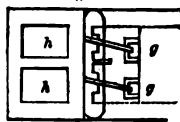

PART PLAN OF SHAW'S PATENT WINDOW.

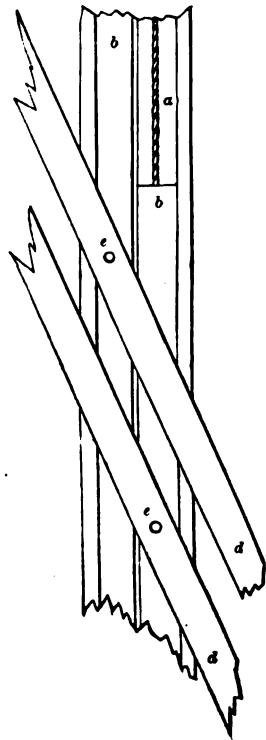
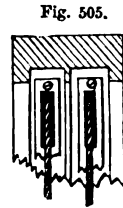

LONGITUDINAL SECTION OF SHAW'S PATENT WINDOW.

1266. *Details of Windows of Farmhouses.*—Of the windows of houses given from pages 58 to 83, we now propose to give detail drawings. In fig. 506

we give half plan of main window, of which we have given the front elevation in fig. 56.

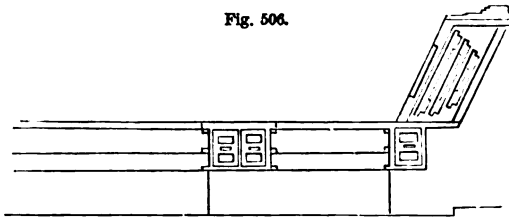

HALF PLAN OF MAIN WINDOW OF HOUSE IN FIG. 56.

1267. In fig. 507 we give an enlarged sketch—to a scale of $\frac{3}{16}$ inch to the foot—showing half elevation of bay window to sitting-room *a a* in ground plan, fig. 55, and elevation in fig. 56.

1268. In fig. 508 we give part plan of this window, at the corner where the

Fig. 507.

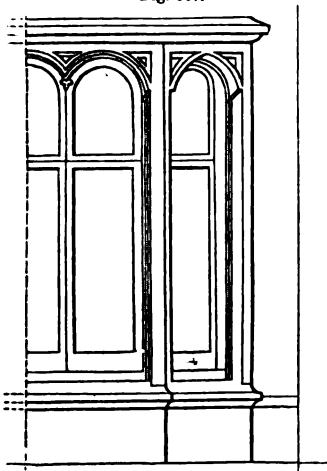

ENLARGED PLAN OF VIEW OF BAY WINDOW OF HOUSE AS SEEN IN FIG. 56.

Fig. 508.

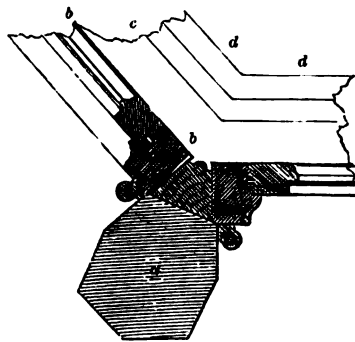

PART PLAN OF BAY WINDOW—SCALE, 1 INCH TO THE FOOT.

front and side lights meet; *a* the corner jamb or mullion, *b b* space for sun blinds, *c* space for shutters, *d* skirting.

1269. In fig. 509 we give the plan of shutter of one side of this window, where *a a* is line of sill, *b* jamb or mullion, *c c* space for sun blinds, *d d* space for shutters, *e e* face of skirting, *f f* shutter-box and shutters.

1270. In fig. 510 we give part vertical section of this bay window; *a a* a cornice, *b* sash-frame.

1271. In fig. 511 we give part vertical section of base of the same bay window; *a* the sill, *b* sash-frame, *c* skirting in room.

1272. In fig. 512 we give a side elevation of the V window in fig. 56, and in parlour, *b b*, fig. 55, of which fig. 513 is part plan, showing mullion *a*, sash-framing *b b*.

1273. In fig. 514 we give section of inner part of same window, with jamb *a*, and shutter-box and shutters *b* and *c*. In figs. 513 and 514 the numbers 1 1 1, 2 2, and 3 3, denote the same lines. The scale to which these drawings are made, is 1 inch to the foot.

Fig. 509.

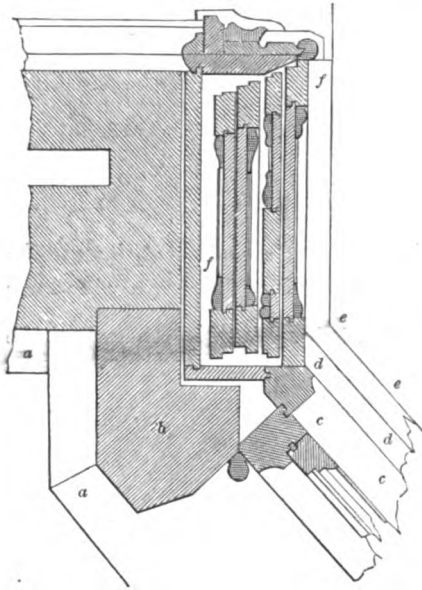

PLAN OF SHUTTERS—SCALE, 1 INCH TO THE FOOT.

Fig. 510.

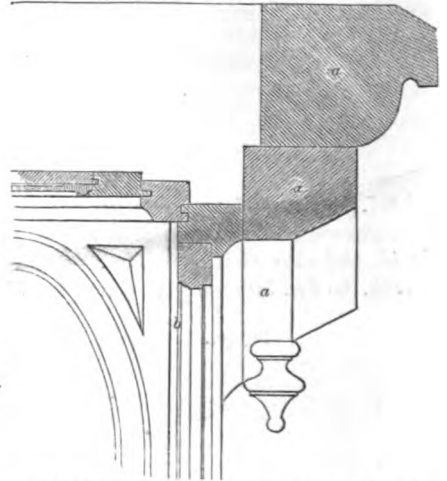

PART VERTICAL SECTION OF BAY WINDOW—SCALE, 1 INCH TO THE FOOT.

Fig. 511.

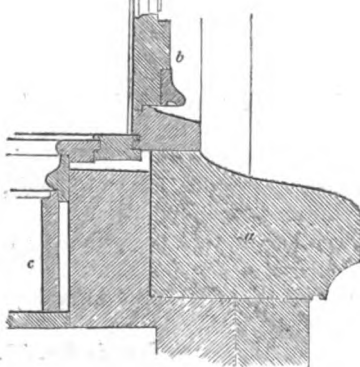

PART SECTION OF BASE OF BAY WINDOW—SCALE, 1 INCH TO THE FOOT.

Fig. 512.

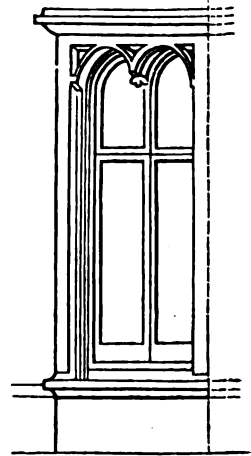

SIDE ELEVATION OF WINDOW
IN FIG. 50.

Fig. 513.

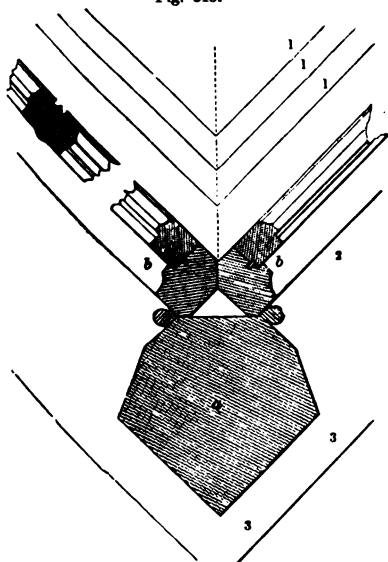

PART SECTIONAL PLAN OF V WINDOW—SCALE, 1 INCH TO THE FOOT.

Fig. 514.

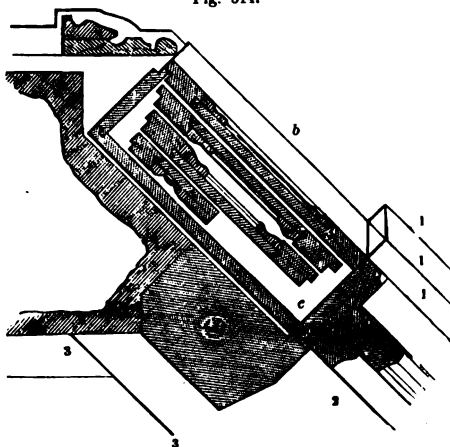

PLAN OF V WINDOW-SHUTTERS—SCALE, 1 INCH TO THE FOOT.

1274. In fig. 515 we give plan of shutters of principal window of room *c c*, in house in fig. 65 (and in elevation, in fig. 67), of which *a a* is the brick wall, *b b* cavity of do., *c* bracket, *d* stone mullion, *e* sash, *f f* shutter. Scale, 1 inch to the foot.

Fig. 515.

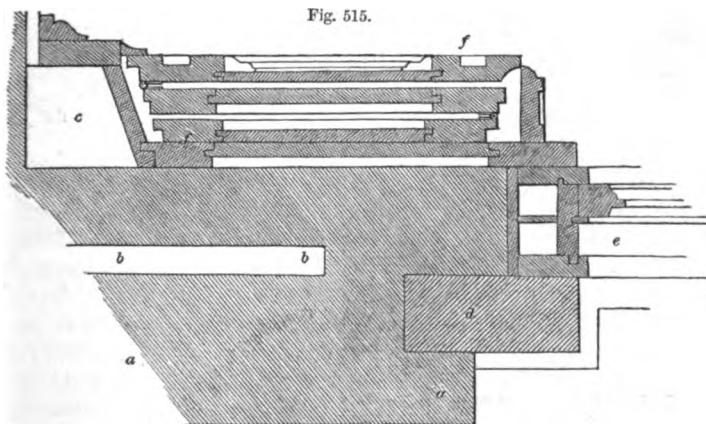

PLAN OF SHUTTERS OF WINDOW OF HOUSE IN FIG. 65—SCALE, 1 INCH TO THE FOOT.

1275. In fig. 516 we give part plan of bay window in apartment *b b*, fig. 68; *a* stone mullion, *b b* brickwork, *c* sash-frame.

1276. In fig. 517 *a* part of sash-frame, *b b* brickwork, *c c* shutters.

1277. In fig. 518 we give half plan of bay window in chamber floor *b b*, fig. 69, and in the elevation in fig. 71; *a* stone mullion, *b b* brickwork, *c d e* sash-frames and sashes. The scale to which figs. 516, 517, and 518 are constructed, is given in fig. 516.

Fig. 516.

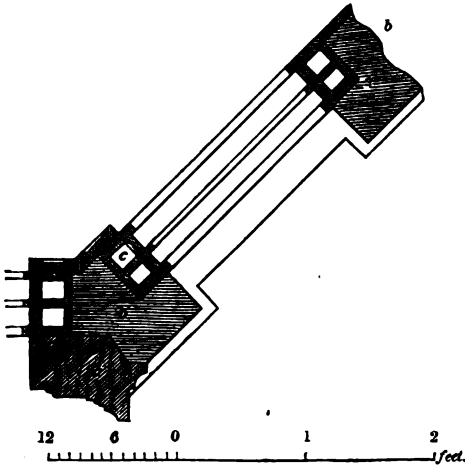

PART PLAN OF BAY WINDOW OF HOUSE IN FIG. 68—SCALE, 1 INCH TO THE FOOT.

Fig. 517.

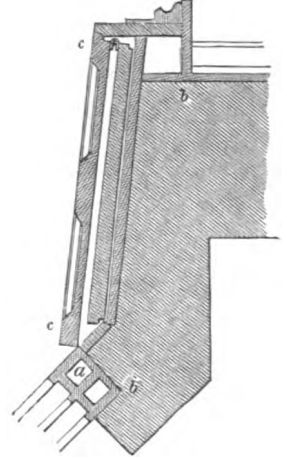

PLAN OF BAY WINDOW SHUTTERS—SCALE IN FIG. 516.

Fig. 518.

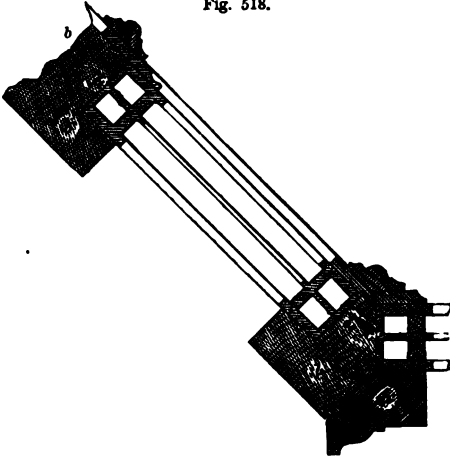

PLAN OF BAY WINDOW, CHAMBER FLOOR, IN FIG. 68—SCALE IN FIG. 516.

Fig. 519.

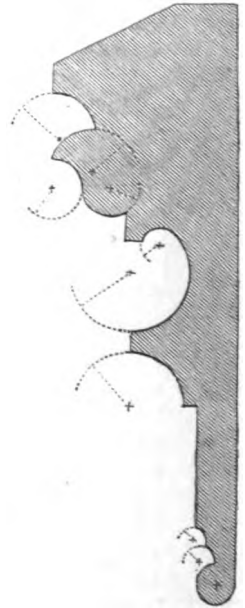

SECTION OF ARCHITRAVES OF HOUSE IN FIG. 23.

1278. *Architrave*.—In fig. 519 we give section of mouldings of architrave for house in fig. 23.

1279. *Skirting and Cornice*.—In fig. 520 we give section of skirting and cornice for dining-room of house in fig. 41. In fig. 521 skirting, and in fig. 522

cornice for drawing-room of same house. For many of these details we are indebted to Mr Burns' work, *Model Designs for Mansions, Villas, &c.*

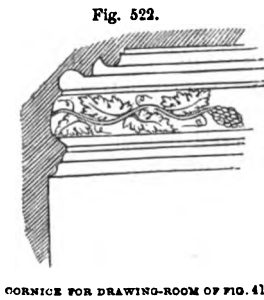
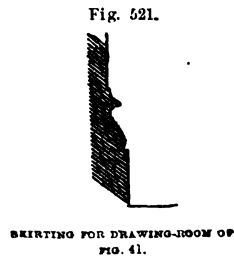
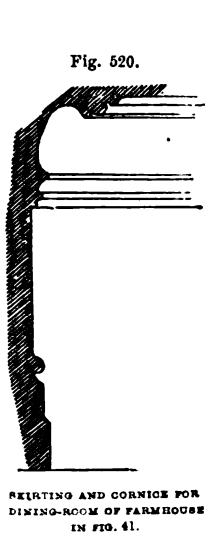

1280. SECTION SEVENTH—*Fittings of the Steading, Stable, Byre, Barn, Courtyard, &c.*—The length of a work-horse stable, of course, depends on the number of horses employed on the farm; but in no instance should its width be less than 18 feet, for comfort to the horses themselves, and convenience to the men who take charge of them. Few stables for work-horses are made wider than 16 feet, and hence few are otherwise than hampered for room. A glance at the particulars which should be accommodated in the width of a work-horse stable, will show at once the inconvenience of this narrow breadth. The length of a work-horse is seldom less than 8 feet; the width of a hay-rack is about 2 feet; the harness hanging loosely against the wall occupies about 2 feet; and the gutter occupies 1 foot; so that in a width of 16 feet there is only a space of 3 feet left from the heels of the horses to the harness, to pass backward and forward, and wheel a barrow and use the shovel and broom. No wonder, when so little room is given to work in, that cleanliness is so much neglected in farm-stables, and that much of the dung and urine are left to be decomposed and dissipated by heat in the shape of ammoniacal gas, to the probable injury of the breathing and eyesight of the horses, when shut up at night. To aggravate the evil, there is very seldom a ventilator in the roof; and the windows are generally too small for the admission of light and air; and what is still worse, a hay-loft is placed immediately above the horses' heads; and, to render the condition of the stable as bad as possible, as regards cleanliness, its walls are never plastered, and their rough stones form receptacles of dust and cobwebs.

1281. Another particular in which most stables are improperly fitted up, is the narrowness of the stalls, 5 feet 3 inches being the largest space allowed for an ordinary-sized work-horse. A narrow stall is not only injurious to the horse himself, by confining him peremptorily to one position, in which he has no liberty to bite or scratch himself, should he feel so inclined, but it materially

obstructs the ploughmen in the grooming and supplying the horse with food. No work-horse, in our opinion, should have a narrower stall than 6 feet from centre to centre of the travis, in order that he may stand at ease, or lie down at pleasure with comfort.

1282. It is a disputed point of what form the hay-racks in a work-horse stable should be. The prevailing opinion may be learned from the general practice, which is to place them as high as the horses' heads, because, as it is alleged, the horse is thereby obliged to hold up his head, and he cannot then breathe upon his food. Many better reasons, as we conceive, may be adduced for placing the racks low down. A work-horse does not require to hold his head up at any time, and much less in the stable, where he should rest as much as he can. A low rack permits the neck and head, in the act of eating, to be held in the usual position. He is not so liable to put the hay among his feet from a low as from a high rack. His breath cannot contaminate his food so much in a low as in a high rack, inasmuch as the breath naturally ascends; and as the sense of smell is employed by the horse in choosing his food, he chooses it at leisure from a low rack, whereas from a high one he is first obliged to pull it out before he knows he is to like what he pulls. He is less fatigued eating out of a low than from a high rack, every mouthful having to be pulled out of the latter, from its sloping position, by the side of the mouth turned upwards. For this reason mown grass is much more easily eaten out of a low than a high rack. And, lastly, we have heard of peas falling out of the straw, when pulled out of a high rack, into the ear of a horse, and therein setting up a serious degree of inflammation.

1283. The front rail of the low rack should be made of strong hardwood, in case the horse should at any time playfully put his foot on it, or bite it when groomed. The front of the rack should be sparred, for the admission of fresh air among the food, and incline inwards at the lower end, to be out of the way of the horses' fore-feet. The bottom should also be sparred, and raised at least 6 inches above the floor, for the easy removal of the hay-seeds that may have passed through the spars. The manger should be placed at the near end of the rack, for the greater convenience of supplying the corn. A spar of wood should be fixed across the rack from the front rail to the back wall, midway between the travis and the manger, to prevent the horse tossing out the fodder with the side of his mouth, which he will sometimes be inclined to do when not hungry. The ring through which the stall collar-shank passes, is fastened by a staple to the hardwood front rail. We have seen the manger, in some new steadings, made of stone, on the alleged plea that stone is more easily cleaned than wood after prepared food. We do not think wood more difficult of being cleaned than stone, when cleaned in a proper time after being used. As ploughmen are proverbially careless, the stone manger has perhaps been substituted on the supposition that it will bear much harder usage than wood; or perhaps the proprietors could obtain stone cheaper from their own quarries than good timber from abroad: but whatever may have been the reasons for preferring stone in such a situation, it has a clumsy appearance and feels uncomfortable, and is injurious to the horses' teeth when they seize it suddenly in grooming, and even work-horses will bite any object when groomed; and we suppose that stone would also prove hurtful to their lips when collecting their food at the bottom of the manger.

1284. When hind-posts of travises are made of wood, they are fastened at the upper ends to battens stretching across the stable from the ends of the couple legs where there is no hay-loft, and from the joists of the flooring where

there is, and sunk at the lower ends in stone blocks placed in the ground. The head-posts are divided into two parts, which clasp the travis-boards between them, and are kept together with screw-bolts and nuts, and their lower ends are also sunk into stone blocks. Their upper ends are fastened to the battens or joists when the hind-posts are of wood. The travis-boards are put endways into the groove of the hind-post, and pass between the two divisions of the head-post to the wall before the horses' heads; and are there raised with a sweep so high as to prevent the horses putting their heads over it.

1285. Fig. 523 gives a view of the particulars of a stall for work-horses, fitted up with wooden travis-posts, which is yet the common method :

Fig. 523.

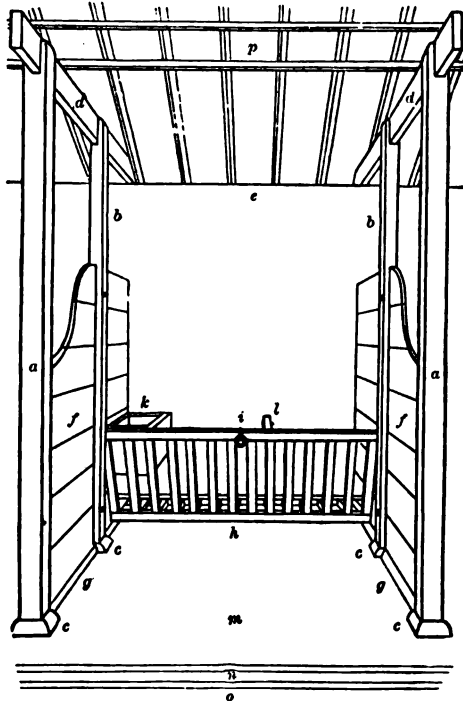

A STALL FOR A WORK-HORSE STABLE.

a a are the strong hind-posts; *b b*, the head-posts, both sunk into the stone blocks *c c c c*, and fastened to the battens *d d*, stretching across the stable from the wall *e* to the opposite wall; *f f*, the travis-boards, let into the posts *a a* by grooves, and passing between the two divisions of the posts *b b*; the boards are represented high enough to prevent the horses annoying each other; *g g* are curb-stones set between the hind and fore posts *a* and *b*, to receive the side of the travis-boards in grooves, and thereby secure them from decay by keeping them above the action of the litter; *h* is the sparred bottom of the hay-rack, the upper rail of which holds the ring *i* for the stall collar-shank; *k* the corn-manger or trough; *l* the bar across the rack, to prevent the horse tossing out the fodder; *m* the pavement within the stall; *n* the freestone gutter for conveying away the urine to one end of the stable; *o* the pavement of the passage behind the horses' heels; *p* are two parallel spars fastened over and across the battens, when there is no hay-loft, to support trusses of straw or hay, to be given as fodder to the horses in the evenings of winter, to save the risk of fire in going at night to the straw-barn or hay-house with a light.

1286. A new method of arranging the stalls in stables has recently been advocated—namely, giving feeding passage at the head, in place of terminating them at a dead wall. Morton, in his prize essay on *Fittings for Stables and Byres*,* has, we think, exhausted all the reasons which can be urged in favour of the scheme, and very pertinently finishes his remarks with the following:—“ If cow-stalls, having a front feeding passage, are found of advantage, in facilitating labour, in supplying the animals with food, and in some degree promoting ventilation, the same arrangement ought surely to be adopted in

* *Transactions of the Highland and Agricultural Society, 1857.*

stables where these advantages are of still greater importance." But with such a passage the stable would require to be made proportionately wider.

1287. In the same essay Morton describes a method of fitting up the

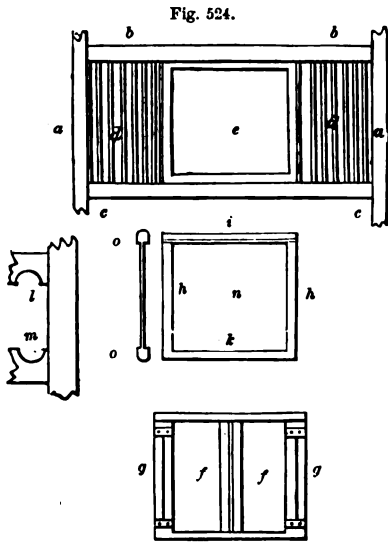

FITTINGS OF HEAD OF STALL WITH FEEDING-PASSAGE—SCALE, 1/4 INCH TO THE FOOT.

screwed to the face of the upper and lower bars *b b* and *c c*. The sliding gate *h h* may be fitted in at the centre *n*, either with vertical spars or with boarding.

Fig. 525.

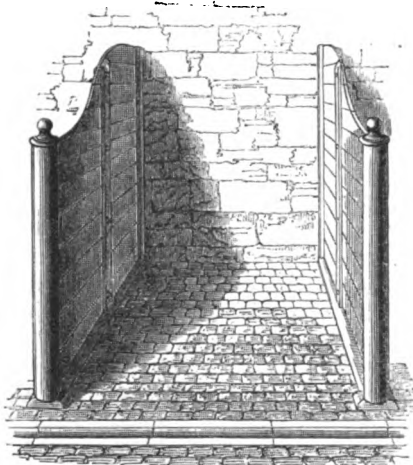

STALL WITH CAST-IRON HEEL-POSTS.

front of the stalls to which we refer the reader. The following illustration which we have prepared, embraces the particulars there given, with some modifications. In fig. 524, *a a* are the head-posts of the stall, into which the cross-bars *b b*, *c c* are mortised—the bar *c c* being just above the top edge of manger. These bars, *b b*, *c c*, support a range of vertical spars *d d*, or have boarding nailed to them, according as an open or a closed space is required. In the centre of the stall a space *e* 30 inches wide is left, through which to supply food to the manger. This is closed when required by folding-doors *f f*, hinged to the upright bars *g g*, which are mortised into the bars *b b*, *c c* at their upper and lower ends. In place of these folding-doors a sliding gate may be adopted. This is shown at *h h*—the upper and lower bars of which, *i i*, *k k*, being rounded at their outer edges *o o*, and running in grooves, made in bars *l m*,

1288. Fig. 525 is a specimen of a stall for a work-horse stable, with cast-iron heel-posts.

1289. The roof of a work-stable should always be open to the slates, and not only so, but have openings in its ridge, protected by ventilators; and such are absolutely necessary for a work-horse stable. It is distressing to the feelings to inhale the air in some farm stables at night, particularly in old steadings economically fitted up, which is not only warm from confinement, moist from breathing, and stifling from sudorific odours, but cutting to the breath, and pungent to the eyes, from the volatilisation of ammonia. The windows are seldom opened, and can scarcely be so by disuse. The roof in such a stable is like a suspended extinguisher over the half-stifled

horses. This evil is still further aggravated by a hay-loft, the floor of which is extended over and within a foot or less of the horses' heads. Besides its inconvenience to the horses, the hay in it, through nightly roasting and fumigation,

soon becomes dry and brittle, and contracts a disagreeable odour. The only remedy for all these inconveniences is complete ventilation.

1290. *Ventilation*.—The object of ventilation, to any apartment which constitutes the abode of animals, is to procure a constant supply of air in sufficient purity to meet the demands of the animal economy. The practice that has long prevailed, as regards ventilation, seems to deny its utility, and to doubt the injury accompanying its neglect. "It is upwards of eight-and-forty years," says Stewart, "since James Clarke of Edinburgh protested against close stables. He insisted they were hot and foul, to a degree incompatible with health, and he strongly recommended that they should be aired in such a manner as to have them always cool and sweet. Previous to the publication of Clarke's work, people never thought of admitting fresh air into a stable; they had no notion of its use. In fact, they regarded it as highly pernicious, and did all they could to exclude it. In those times the groom shut up his stable at night, and was careful to close every aperture by which a breath of fresh air might find admission. The keyhole and the threshold of the door were not forgotten. The horse was confined all night in a sort of hot-house; and, in the morning, the groom was delighted to find his stable warm as an oven. He did not perceive, or did not notice, that the air was bad, charged with moisture, and with vapours more pernicious than moisture. It was oppressively warm, and that was enough for him. He knew nothing about its vitiation, or about its influence upon the horses' health. In a large crowded stable, where the horses were in constant and laborious work, there would be much disease—glanders, grease, mange, blindness, coughs, and broken wind would prevail, varied occasionally by fatal inflammation. In another stable, containing fewer horses, and those doing little work, the principal diseases would be sore throats, bad eyes, swelled legs, and inflamed lungs, or frequent invasions of the influenza. But everything on earth would be blamed for them before a close stable." Moreover, he observes, "The evils of an impure atmosphere vary according to several circumstances. The ammoniacal vapour is injurious to the eyes, to the nostrils, and the throat. Stables that are both close and filthy are notorious for producing blindness, coughs, and inflammation of the nostrils; these arise from acrid vapours alone. They are most common in those dirty hovels where the dung and urine are allowed to accumulate for weeks together. The air of a stable may be contaminated by union with ammoniacal vapour, and yet be tolerably pure in other respects. It may never be greatly deficient in oxygen; but when the stable is so close that the supply of oxygen is deficient, other evils are added to those arising from acrid vapours. Disease, in a visible form, may not be the immediate result. The horses may perform their work and take their food, but they do not look well, and they have not the vigour of robust health;—some are lean, hide-bound, having a dead dry coat,—some have swelled legs, some mange, and some grease. All are spiritless, lazy at work, and soon fatigued. They may have the best of food, and plenty of it, and their work may not be very laborious, yet they always look as if half starved, or shamefully overwrought. When the influenza comes among them, it spreads fast, and is difficult to treat. Every now and then one or two of the horses become glandered and farcied."

1291. In order to show in a striking light the necessity there exists of using means to promote ventilation in all places occupied by animals, it may perhaps be done in the best manner by stating the estimated quantity of air which is vitiated every day by a cow of ordinary size. Dr Robert D. Thomson, after showing that the large quantity of carbon, 6.172 lb., daily taken by a cow in

its food, is employed for a purpose totally distinct from proper nutrition, proceeds to say—"We are at present acquainted with only one other purpose for which the carbon of the food can be employed—viz., the generation of animal heat throughout the body, a function undoubtedly carried on, not only in the lungs, but also throughout the entire capillary system of the skin, at least in man and perspiring animals. If this view be correct, then it follows that upwards of 6 lb. of carbon are expended by a cow daily in the production of animal heat. And as 1 lb. of carbon, when combined with the necessary amount of oxygen to form carbonic acid, gives out as much heat as would melt 104.2 lb. of ice, it is evident that the quantity of ice capable of being melted by the heat generated by a cow, in one day, would amount to upwards of 625 lb., or it would heat 1 lb. of water, 87,528 degrees. It would consume, at the same time, the enormous quantity of 330,429 cubic inches of oxygen, or $191\frac{1}{4}$ cubic feet of this gas; and as this amounts to one-fifth of the atmospheric air, we find that a cow, consuming 6 lb. of carbon for respiratory purposes, would require $956\frac{1}{4}$ cubic feet of atmospheric air, a sufficient indication of the immense importance of a free ventilation in cow-houses, and of the danger of over-crowding, if the animals are expected to retain a healthy condition."*

1292. Here are data furnished of the quantity of air required to be admitted into a byre, for the necessary use, daily, of a single cow of ordinary size. How, then, is this large quantity of fresh air to be admitted into a byre, when all the doors and windows are shut? This question involves and presupposes another, namely, How is as large a quantity of vitiated air to be expelled from the byre?—for this must first take place ere a ventilation through the byre can be maintained. The popular notions, however, regarding ventilation are very indefinite, as Mr Stewart observes: "Most people do not imagine that one set of apertures is required to carry away the foul, and another to admit the pure air. Even those who know that one set cannot answer both purposes in a perfect manner, are apt to disregard any provision for admitting fresh air. They say there is no fear but sufficient will find its way in somehow, and the bottom of the door is usually pointed to as a very good inlet. It is clear enough, that while air is going out, some also must be coming in; and that if none go in, little or none can go out. To make an outlet without any inlet betrays ignorance of the circumstances which produce motion in the air. To leave the inlet to chance, is just as much as to say that it is of no consequence in what direction the fresh air is admitted, or whether any be admitted. The outlets may also serve as inlets; but then they must be much larger than when they serve only one purpose; and the stable, without having purer air, must be cool or cold. When the external atmosphere is colder than that in the stable, it enters at the bottom of the door, or it passes through the lowest apertures, to supply and fill the place of that which is escaping from the high apertures. If there be no low openings, the cooler air will enter from above—it will form a current inwards at the one side, while the warmer air forms another current, setting outwards at the other side. But when the upper apertures are of small size, this will not take place till the air inside becomes very warm or hot."† So little do many people see the necessity of ventilation, that they cannot distinguish between the warm air and the foul air of a stable; and, consequently, if the admission of fresh air is wanted to expel the foul, they immediately conclude it must be cold, and do harm. Now, it is the proper action of ventilation to let away all, and no more of the warm air of a stable, than what is foul,

* THOMSON'S *Researches into the Food of Animals*, pp. 113, 114.

† STEWART'S *Stable Economy*, pp. 35, 43, and 51.

and then, of course, no more than the same quantity of fresh air can find its way into it.

1293. As doors and windows are usually situated in farm-stables, the fresh air should not be allowed to enter by them through the night; they should therefore be made tight. Fresh air coming directly from the doors or windows towards the nostrils of a horse, must pass either over his body, or first strike against his limbs—in either case doing more injury than good. The fresh air should come in near the horses' nostrils, where it is really required to be breathed in. An opening through the head wall of the stable, a few feet above the horse's head, seems the most convenient and proper place for the air to find its way. For the supply of every horse alike, an opening should be made above the head of each horse; and being so numerous, they should be small. We cannot particularise the size, as that must depend on many circumstances—the number of horses, contents of the stable, tightness of the doors and windows, and such-like. The air, on entering, being colder than that in the stable, will fall downwards, and to retard the velocity of its entrance the openings should be provided with a covering of perforated plates of zinc; and should the current be still too strong, let it strike against a board or plate of iron fixed to the wall, and so placed as to cause the air to be reflected upwards before it descends. Experience will soon adjust the various parts of the means of ventilation to their proper relative proportions.

1294. It greatly promotes the comfort and health of animals confined for many hours every day in one apartment to have the fresh air admitted to them without the creation of draughts, and no means of obtaining this object is so much in our power, as placing ventilators in the roof of the part of the steading so occupied by the animals.

1295. *Ferguson's Improved Ventilator for Stables, &c.*—In fig. 526 we give an elevation, and in fig. 527 a section, of a ventilator invented by Mr James Ferguson, agent to W. B. Beaumont, Esq., M.P. In fig. 527, the section, the

Fig. 526.

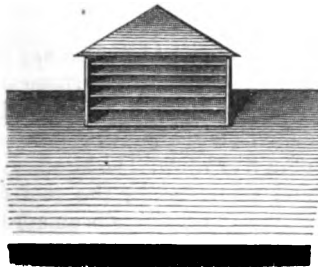

ELEVATION OF FERGUSON'S VENTILATOR.

Fig. 527.

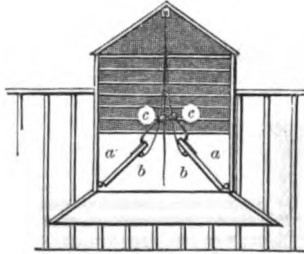

SECTION OF FERGUSON'S VENTILATOR.

dimensions are about 3 feet by 2, and 3 feet high. A continuation of the void of the ventilator is carried downward with light close boarding, forming a chamber *a a*, in which the regulator operates—its interior dimensions being as above stated. At bottom the chamber spreads out, so as to assume the form of an inverted funnel. At the point where the chamber expands, two valves or light doors are hinged, as at *b b*; these, when let down in a horizontal position, fill up the area of the chamber so completely as to prevent all egress of the foul air. The descent of the valves is secured by the action of the loaded levers *c c*. To open the valves, cords are attached, as shown in the diagram, and, joined into one, are carried down to a point within easy reach of the attendant.

1296. *Other forms of Ventilators.*—In figs. 528 and 529 we give forms of ventilators, in which the egress of the foul air is easily regulated, and which we have used with success. In fig. 528 *a a* is the box of the ventilator, which passes through, and is continued at least 2 feet above the ridge of the roof. A valve *b* is hinged at one side *c*, and rests on the batten or piece *d*, secured to the side of the ventilator. This is lifted up to any desired extent by the chain or string *e e*, which passes through an aperture in the box *a*, and is led over a pulley *f*, working in a small bracket secured to the box. The cord is carried over another pulley, and terminates within easy reach of the attendant. An-

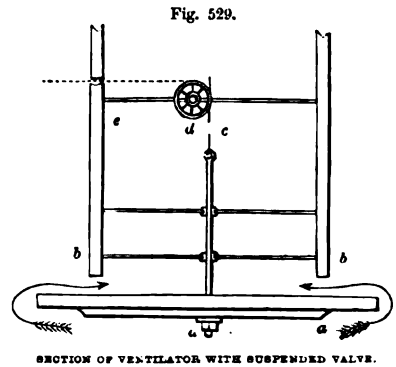
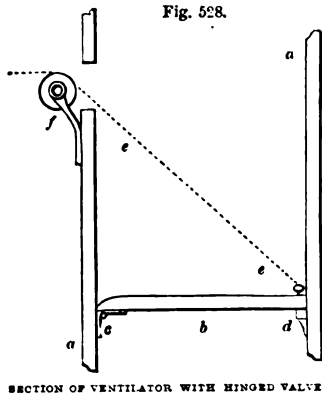

other form is shown in fig. 529. In this the valve *a a* is suspended beneath the ventilator *b b*. The dimensions of the valve *a a* exceed the area of the aperture of the ventilator. By this arrangement the foul air is compelled to take the course of the arrows, thus creating a more widely-extended current from the parts surrounding the aperture of the ventilator. The valve is worked by a cord *c* passing over the pulley *d*, which works on a bar *e*, passing across the ventilator.

1297. Fig. 530 is a ventilator, in which the Venetian blinds *a* are fixed, and

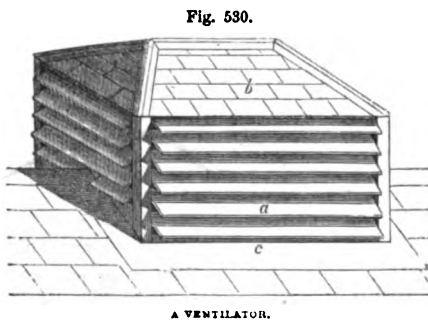

answer the double purpose of permitting the escape of heated air and effluvia, and of preventing the entrance of rain or snow. The blinds are covered and protected by the roof *b*, made of slates and lead; *c* is an apron of lead. Such a ventilator would be more ornamental to the steading than fig. 530 is, and more protective to the blinds, if its roof projected 12 inches over. One ventilator 6 feet in length, 3 feet in height in front, and 2 feet above the ridging of the roof, for every six

horses or cows, might suffice to maintain a complete ventilation. But such openings in the roof will not of themselves constitute ventilation, unless an adequate supply of fresh air is admitted below; and the supply might be obtained from small openings in the walls, including the chinks of doors and windows when shut, whose gross areas should be nearly equal to those of the ventilators. The openings should be in such situations and numbers as

to cause no draught of air upon the animals; and might be conveniently placed, protected by iron gratings on the outside to prevent the entrance of vermin, in the wall behind or before the animals, of such a form as to deflect the air upwards against a board or plate of iron, to spread it about as much as possible. Other forms of ventilators are in use, consisting of a large curve of lead or zinc pipe projected through the roof and bent downwards; or simply a few of the slates or tiles raised up a little, either of which is better than no ventilator at all, but neither so effectual for the purpose of ventilation as the one we have described. (Other forms of ventilators for withdrawing foul air will be found described in a future Section, when treating of Iron Construction.)

1298. *Stable Windows.*—The windows of steadings should be of the form for the purpose they are intended to be used. On this account the windows of stables, and of other apartments, should be of different forms. Fig. 531 re-

presents a window for a stable. The opening is $4\frac{1}{2}$ feet in height by 3 in width. The framework is composed of a dead part *a*, of 1 foot in depth, 2 shutters *b b* to open on hinges, and fasten inside with a thumb-catch, and *c* a glazed sash 2 feet in height, with three rows of panes. The object of this form of window is, that it may easily be opened, although a number of small articles are thrown upon the sole of a work-horse stable window, such as short-ends, straps, &c., which are only used occasionally, and intended to be at hand when wanted. The consequence of this confused mixture of things, which it is not easy for the farmer to prevent, especially

in a busy season, is, that when the shutters are desired to be opened, it is scarcely possible to do it without first clearing the sole of everything; and, rather than find another place for them, the window remains shut. A cupboard in a wall suggests itself for containing such small articles; but in the only wall—namely, the front one of the stable—in which it would be convenient to make such a cupboard, its surface is occupied by the harness hanging against it; and besides, no orders, however peremptory, will prevent such articles being at busy times thrown upon the window-soles; and where is the harm of their lying there at hand, provided the windows are so constructed as to admit of being opened when desired? When a dead piece of wood, as *a*, is put into such windows, small things may remain on the sole, while the shutters *b b* may be easily opened and shut over them.

1299. *Harness-Pins.*—The harness should all be hung against the wall behind the horses, and none on the posts of the stalls, against which it is too frequently placed, to its great injury, in being constantly kept in a damp state by the horses' breath and perspiration, and apt to be knocked down among their feet. A good way is to suspend harness upon stout hardwood pins driven into a strong narrow board, fastened to the wall with iron holdfasts; but perhaps the most substantial way is to build the pins into the wall, when a new stable is building. The harness belonging to each pair of horses should just cover a space of the wall equal to the breadth of the two stalls which they occupy, and when windows and doors intervene, and which of course must be left free, this arrangement requires some consideration. We have found this a convenient one: A spar of hardwood nailed firmly, immediately over the passage, across the upper edge of the batten *d*, fig. 523, that supports both posts of the stall, will suspend a collar on each end, high enough above a person's head. One pin on the wall is sufficient for each of the cart-saddles, one will support both the bridles, while

Fig. 531.

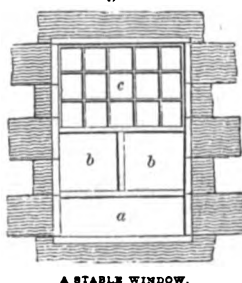

A STABLE WINDOW.

a fourth will suffice for the plough, and a fifth for the trace harness. Thus 5 pins or 6 spaces will be required for each pair of stalls; and in a stable of 12 stalls—deducting a space of 13 feet for 2 doors and 2 windows in such a stable—there will still be left, according to this arrangement, a space for the harness of about 18 inches between the pins. Iron hooks driven into the board betwixt the pins will keep the cart-ropes and plough-reins by themselves. The curry-comb, hair-brush, and foot-picker, may be conveniently enough hung up high on the hind-post, betwixt the pair of horses to which they belong, and the mane-comb is usually carried in the ploughman's pocket. When the hind-posts are of cast-iron, these small articles cannot be hung upon them; and in such a case, there being no batten to suspend the collars from, hooks must be driven into the couple-legs to hang them upon.

1300. Each horse should be bound to his stall with a leather stall-collar, having an iron-chain collar-shank to play through the ring *i* of the hay-rack, fig. 523, with a turned wooden sinker at its end, to weigh it to the ground. Iron chains make the strongest stall collar-shanks, though certainly noisy when in use; yet work-horses are not to be trusted with the best hempen cords, which often become affected with dry rot, and are, at all events, soon apt to wear out in running through the smoothest stall-rings. A simple stall-collar with a nose-band, and strap over the head, is sufficient to secure most horses; but as some acquire the trick of slipping the strap over their ears, it is necessary to have either a throat-lash in addition, or a simple broad belt around the neck. Others are apt, when scratching their neck with the hind-foot, to pass the fetlock joint over the stall collar-shank, and, finding themselves entangled, to throw themselves down in the stalls, bound neck and heel—there to remain unreleased until the morning, when the men come to the *stablé*. By this accident we have seen horses get injured in the head and leg for some time. A short stall collar-shank is the only preventive against such an accident, and a low rack admits of its being made short.

1301. *Loose-Box*.—Besides the ordinary stalls, a loose-box will be found a useful adjunct to a work-horse stable. A space equal to two stalls should be railed off at one end of the stable. It is a convenient place into which to put a work-mare when expected to foal. Some mares indicate so very faint symptoms of foaling, that they frequently are known to drop their foals under night in the stable—to the great risk of the foal's life—where requisite attention is not directed to the state of the mare, or where there is no spare apartment to put her in. It is also suitable for a young stallion, when first taken up and preparing for travelling the road; as also for any young draught-horse, taken up to be broke for work, until he become accustomed to the stable. It might also be, when unfortunately so required, converted into a temporary hospital for a horse, which, when seized with complaint, might be put into it until it is ascertained whether or not the disease is infectious, and if so, removed to a proper hospital. Some people object to having a loose-box in the stable, and would rather have it out of it; but the social disposition of the horse renders such a place useful on such occasions. It is, besides, an excellent place to rest a fatigued horse for a few days. It is also a good place for a foal when its mother is obliged to be absent at work in the fields, until both are turned out to grass.

1302. *Hay-House*.—The hay-house should be adjoining the work-horse stable. Its floor should be flagged on a considerable quantity of sand to keep it dry, or with asphaltum. It should have a gible-checked door to open outwards, with a hand-bar to fasten it on the inside; it should also have a

partly glazed window, with shutters, to afford light when taking out the hay to the horses, and air to keep it sweet. As the hay-house communicates immediately with the work-horse stable by a door, it may find room for the work-horse corn-chest, which may there be conveniently supplied with corn from the granary above, by means of a spout let into the fixed part of the lid. For facilitating the taking out of the corn, the end of the chest should be placed against the wall at the side of the door which opens into the stable, and its back part boarded with thin deals up to the floor above, if there be one, or sufficiently high to prevent the hay coming upon the lid of the chest. The walls of the hay-house should be plastered.

1303. *Corn-Chest*.—The form of the corn-chest is more convenient, and takes up less room on the floor, when high and narrow than when low and broad, as in fig. 532, which is 5 feet long and $4\frac{1}{2}$ high at the back above the feet. A part

Fig. 532.

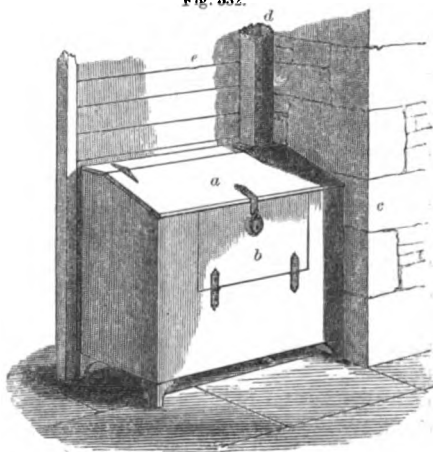

CORN-CHEST FOR WORK-HORSES.

of the front *b* folds down with hinges, to give easier access to the corn as it gets low in the chest. Part of the lid is made fast, to receive the spout *d*, for conveying the corn into it from the granary or lop, if there be one, and also to render its movable part *a* lighter, and this is fastened with a heep and padlock, the key of which should be constantly in the custody of the farm-steward, or of the person who gives out the corn to the ploughmen where no farm-steward is kept: *c* is the corner of the doorway into the work-horse stable, and *e* is the boarding behind to prevent the hay falling on the lid. A fourth part of a peck measure is always kept in the chest for measuring out the corn to the horses. It must not be imagined that when the spout supplies corn from the granary as required, it supplies it without measure. The corn appropriated for the horses is previously measured off on the granary floor, in any convenient quantity, and then shovelled down the spout at times to fill the chest. A way to ascertain the quantity of corn at any time in the chest is to mark lines on the inside of the chest indicative of every quarter of corn which it contains.

1304. *Byres*.—The cow-house or byre is occupied by the cows, and in some districts by the fattening oxen also, and is fitted up in a peculiar manner. The cows stand in stalls: the stalls, to be easy for the cows to lie down and rise up, in our opinion, for a large kind of cattle, should never be less than 5 feet in width. Four feet is a more common width, but is too narrow for a large cow, and even 7 feet is considered in the dairy districts a fair-sized double stall for two cows. Our opinion is, that every cow should have a stall for her own use, lying, standing, or eating her food, of sufficient length and breadth that she may lie at ease betwixt the manger and the gutter. The width of the byre should be 18 feet, the manger 2 feet in width, the length of a large cow about 8 feet, the gutter 1 foot broad, leaves 7 feet behind the gutter for a passage for containing the different vessels used in milking the cows and feeding the calves. The ceiling should be quite open to the slates, and a ventilator for every four or five cows in the roof, for regulating the temperature and supplying the byre

with fresh air. A door, divided into upper and lower halves, should open outwards to the court on a giblet-check, for the easy passage of the cows to and from the court, and each half fastened on the inside with a hand-bar. Two windows with glass panes, with the lower parts furnished with shutters to open, will give sufficient light, as also air, with the half-door. The walls should be plastered for comfort and cleanliness.

1305. The stalls are most comfortably made of wood, though some recommend stone, which always feels hard and cold. Their height should be 3 feet, and length no farther than to reach the flank of the cow, or about 6 feet from the wall. When of wood, a strong hardwood hind-post is sunk into the ground, and built in masonry. Between this post and the manger should be laid a curb-stone, grooved on the upper edge to let in the ends of the travis-boards. The deals are held in their places at the upper ends by means of a hardwood rail, grooved on the under side, into which the edge of the deals are let; and the rail is fixed to the back of the hind-post at one end, and let into the wall at the other, and there fastened with iron holdfasts. Stone travises are no doubt more durable, and in the end perhaps more economical, where flag-stones are plentiful; but we would in all cases prefer wood, as feeling warmer, being more dry in damp weather, and less liable to injure the cows coming against them, and within doors will last a long time.

1306. The mangers of byres are usually placed on a level with the floor, with a curb-stone in front to keep in the food, and paved in the bottom. Such a position we conceive highly objectionable, as, on breaking the turnips, the head of the animal is so depressed that an undue weight is thrown upon the fore-legs, and an injurious strain induced on the muscles of the lower jaw. A better manger is made of flag-stones or wood, resting on a building of stone and mortar, raised about 20 inches from the ground, and a plank set on edge in front to keep in the food. This front should be secured in its position with iron rods batted into the wall at one end, and the other end passed through the plank against a shoulder, which is pressed home by means of a nut and screw. Out of such a manger the cow will eat with ease any kind of food, whether whole or cut; and all feeding byres for oxen should be fitted up with mangers of this construction. Mangers are generally made too narrow for cattle with horns, and the consequence is the rubbing away of the points of the horns against the wall.

1307. The supply of green food to cattle in byres may be effected from the outside through holes in the wall at the back of the manger. This is a convenient mode for the cattle-man, but is costly in the outfit, and allows the wind to blow forcibly upon the heads of the cows. Fig. 533 is a door in the opening of the wall, shut on the outside. We prefer giving the food by the stall, when it is 5 feet wide, and no cold air can come upon the cows. But when the stalls are narrow, a passage of $2\frac{1}{2}$ feet in width, betwixt the stalls and the wall, would allow the cattle-man to supply turnips and fodder. In such a case the space

Fig. 533.

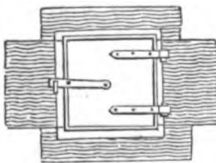

DOOR THROUGH WHICH TO
SUPPLY MANAGERS WITH
TURNIPS.

behind the cows is reduced to $4\frac{1}{4}$ feet in width.

1308. A wide single stall is not only useful in supplying the food from within the byre, but admits of the cows being more easily and conveniently milked. A double stall is objectionable for several reasons: a cow is a capricious creature, and not always friendly to her neighbour, and one of them in a double stall must be bound to the stake on the same side as she is milked from; and, to avoid the inconvenience, the dairy-maid either puts the cow aside nearer her

neighbour, in the same stall—which may prove unpleasant to both parties—or the cow in the adjoining stall nearer her neighbour, which may prove equally inconvenient. Neither is it a matter of indifference to the cow from which side she is milked, for many will not let down their milk if the milk-maid sits down to the unaccustomed side. The best plan in all respects is, for each cow to have a roomy stall to herself.

1309. Fig. 534 is a section of a travis and manger of a byre, as just described,

where *a* is the wall, *b* the building which supports the manger *c*, having a front of wood, and bottomed with either flags or wood; *d* the hardwood hind-post, sunk into the ground, and built in with stones and mortar; *e* the hardwood top-rail, secured behind the post *d*, and let into and fixed in the wall *a* with iron hold-fasts; *f* the stone curb-stone into which the ends of the travis-boards are let; *g* the travis-boards let endways into

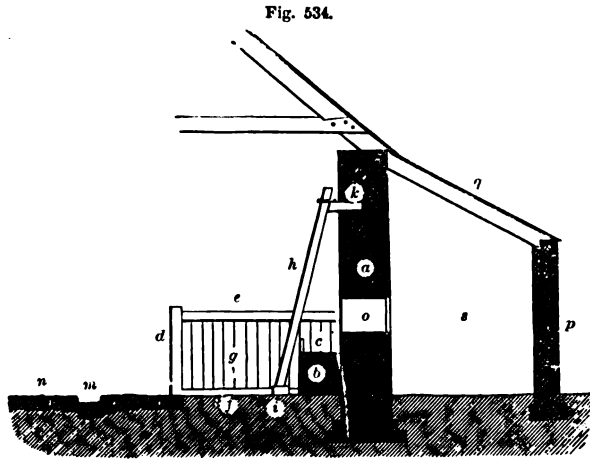

BYRE TRAVIS, MANGER, STAKE, AND TURNIP-STORE.

the curb-stone below, and into the top-rail above, by a groove in each; *h* a hardwood stake, to which the cattle are fastened by binders, the lower end of which is let into a hole in the block of stone *i*, and the upper fastened by a strap of iron to a block of wood *k*, built into the wall *a*; *m* is the gutter for the dung, having a bottom of flag-stones and sides of curb-stones; *n* the paved floor; *o* the opening through the wall *a* by which the food is supplied into the manger *c* to the cattle, from the shed *s* behind. This shed is 8 feet wide, *p* being the pillars, 6 feet in height, which support its roof *q*, which is a continuation of the slating of the byre roof, the wall *a* of which is 9 feet high. But where these small doors are not used, the shed *s*, pillars *p*, and roof *q*, are not required, but they might form a convenient turnip-store, to which access might be obtained from the byre by a back door.

1310. *Cattle-Bindings*.—Cows are bound to a stake in the stall by means of a ligature which goes round the neck behind the horns. One method of binding is with the *baikie*, which is made of a piece of hardwood, *e* fig. 535, standing upright, and flat to the neck of the cow. A rope *g* fastens the lower end of it to the stake, upon which it slides up and down by means of a loop which the rope forms round the stake. This rope passes under the neck of the animal, and is never loosened. Another rope *k* is fastened at the upper end of the piece of wood *e*, and, passing over the neck of the animal and round the stake, is made fast to itself by a knot and eye, and serves the purpose of fastening and loosening.

Fig. 535.

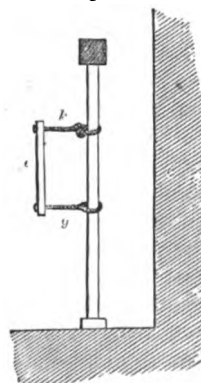

A BAIKIE.

ing the animal. The neck, being embraced between the two ropes, moves up and down, carrying the baikle along with it. This method of binding, though quite easy to the animals themselves, is objectionable in preventing them turning their heads round to lick their bodies; and, the stake being in a perpendicular position, the animals can only move their heads up and down, and are obliged to hold them always over the mangers.

Fig. 536.

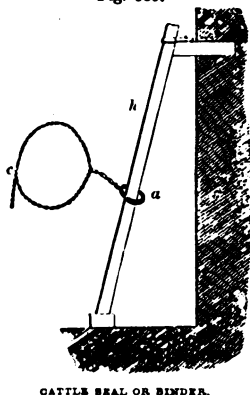

CATTLE SEAL OR BINDER.

1311. A much better mode of binding cattle is with the *seal*, which consists of an iron chain, fig. 536, where *a* is the large ring of the binder, which slides up and down the stake *h*, which is here shown in the same position as is *h* in the section of the stall in fig. 534. The iron chain, being put round the neck of the cow, is fastened together by a broad-tongued hook at *c*, which is put into any link of the chain that forms the gauge of the neck, and it cannot come out until turned on purpose edgeways to the link of which it has a hold. It is the most durable form of binder, and gives the animal liberty not only to lick itself, but to turn its head in any direction it pleases; and the inclination of the stakes gives the animal the farther liberty of lying down or standing back quite free of the manger.

1312. *Byre Windows*.—A convenient form of window for a byre consists of

Fig. 537.

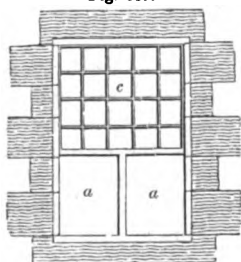

BYRE WINDOW.

two shutters, *a a*, fig. 537, 2 feet in height, which open by cross-tailed hinges, and are kept shut with thumb-catches. The window-frame is made of wood, and glazed with four rows of panes *c*, $2\frac{1}{2}$ feet in height, and 5 in number to the width—the opening of the window being $4\frac{1}{2}$ feet in height and 3 in width. There being no small articles in a byre to lay upon the window-sole, as in stables, the dead piece of wood below the shutter is not here required.

1313. The construction of byres for the accommodation of *fattening* oxen and milk cows is quite the same, but feeding-byres are usually made much too small for the number of oxen confined in them. When stalls are put up, they seldom exceed 4 feet in width; more frequently two oxen are put into a double stall of 7 feet, and not unfrequently travises are dispensed with altogether, and simply a triangular piece of boarding placed across the manger against the wall, to divide the food betwixt each pair of oxen. In double stalls, and where no stalls are used, even small oxen, as they increase in size, cannot all lie down at one time to chew their cud and rest; and as they require more room and rest the fatter they become, the larger the oxen become they are hampered the more. In such confined byres, the gutter is placed too near the heels of the oxen, and prevents them standing back when they desire. Short stalls, it is true, save the litter being dirtied by the dung dropping from the cattle directly into the gutter, and the arrangement saves the cattle-man trouble; but the saving of litter in such a case is at the sacrifice of comfort to the animals.

1314. *On the Construction of Cattle-Boxes*.—Mr Ewart, a well-known practical writer on agricultural construction, and author of a prize essay on "Farm Buildings," has the following remarks:—"The boxes should be sunk 1 foot below

the surface of the ground, and be separated from each other by a wall one brick thick, and 2 feet high from their bottom or floor. They should also have a similar wall in front, upon both of which there should be a wall-plate of deal 9 inches wide and 3 inches thick, bringing the entire height of the division walls to 2 feet 3 inches above the level of the floor, and that of the front to 1 foot 3 inches above the level of the passages. At the intersection of the front wall of the boxes by the division walls, should be cast-iron pillars 6 feet long and $4\frac{1}{2}$ inches outside diameter, supporting a deal, similar to the wall-plates described, to carry the roof; and at each end of the range of boxes should be an upright jamb of 9 inches deal, laid flat to the inside of the north wall; . . . such jamb being framed to the wall-plate, and the deal supported by the pillars. The cast-iron pillars should have grooves formed on each of their sides in the direction of the length of the range, and also another groove on the side in the direction of the division walls, between the boxes, the grooves being formed of flanges $2\frac{1}{2}$ inches apart and 2 inches deep. The upright deals against the walls, at the ends of the range of boxes, should have half the breadth of a Norway batten nailed firmly on the face at $2\frac{1}{2}$ inches apart, thus forming a groove in the middle of the breadth of the deals throughout their length $2\frac{1}{2}$ inches wide and $2\frac{1}{2}$ deep. On the deal supporting the front of the roof, and immediately above each cast-iron pillar, should be firmly spiked one end of a Norway batten, which should extend across the range of boxes to the back wall, on which it should rest firmly, spiked to a continuous wall-plate of deal $4\frac{1}{2}$ inches wide. Against the back wall of the boxes should be upright deals framed to the wall-plates on the division walls, between the boxes, and receiving the cross-beam spoken of above in a notch. The upright deal just mentioned should have a groove formed in its face similar to those previously described, on the upright deals at each end of the range at the front of the boxes. Midway, in the length of the division between the boxes, should be two upright pieces, half the breadth of the Norway batten, opposite to each other, at $2\frac{1}{2}$ inches apart, the lower ends of which should be framed to the wall-plate in the division wall between the boxes, and the upper end secured to the cross-beam by a screw bolt. The fronts of the boxes should be enclosed to a height of about 4 feet above the walls, first by an 11-inch deal, and then by Norway battens in succession, fitting rather loosely in the grooves on the sides of the pillars in the direction of the length of the range. The fences between the boxes may be formed also of battens, one end of which being fitted into the groove in the pillar, in the direction of the breadth of the boxes, the other in the groove formed upon the upright deal on the back wall, passing between the half-battens at the mid-length of the division walls, and should be held 1 foot apart from each other by cotter bolts, on holes made for the purpose in the flanges of the grooves."

1315. *Laycock's Fittings for Cattle-Boxes.*—Mr Laycock of Lintz Hall has designed a variety of farm-building fittings, of which those for cattle-boxes may be selected for description. "The front of the box is furnished with horizontal bars from one pillar to another—their ends fitting rather loosely into the grooves. The lowest is formed of a deal 11 inches wide, with chocks $3\frac{1}{2}$ inches wide, fixed on the lower edge near the ends. On the upper edge is hung, by means of hooks formed of flat iron, fitting the thickness of the deal, a short iron feeding-pan or manger, 2 feet 6 inches in length, 15 inches wide at top, and 8 inches wide at the bottom; 14 inches deep at the back, and 10 inches of perpendicular depth at the front. The hooks are riveted to the backs of the pans near to the ends. On the same deal is a rack, the bars of which are $\frac{3}{8}$ round iron, 2 feet 6 inches long, somewhat curved, and each end riveted into a piece of flat

iron 1 inch broad and 2 feet 6 inches long, forming a rack about 2 feet high, which is attached to the deal near the lower edge by means of hook-and-eye hinges near the extreme ties, and supported in a sloping position by a piece of small chain at each end, 2 feet long, linked to any desired length to hooks near to the upper edge of the deal. Fig. 538 is a section of the manger, and fig. 539 that of the rack, described on a scale of $\frac{1}{4}$ inch to the foot.

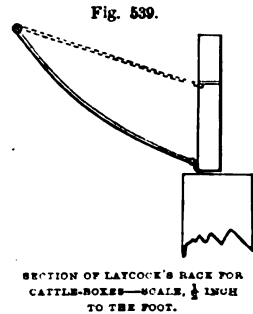
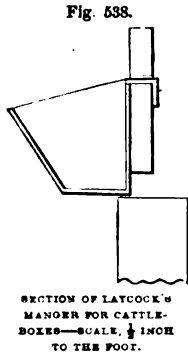

1316. "Above the deal just described are two other bars, formed of Norway battens; the upper one held in its position, about 4 feet above the wall-plate, by means of iron pins or small cotteril bolts passing through holes in the sides of the grooves, and at the ends of the bars. It will be perceived that the racks and mangers can be raised as the box becomes filled with manure, by placing bars under the deal to which they are attached."—Prize Essay on the Construction of Farm Buildings, in vol. xi., *Journal of the Royal Agricultural Society of England*, pp. 245, 246.

1317. *Calves' House.*—For convenience, the calves' house should be placed immediately adjoining the cow-byre. Calves are either suckled by their mothers, or brought up on milk by the hand. When they are suckled, if the byre be roomy enough—that is, 18 feet in width—stalls are erected for them against the wall behind the cows, in which they are usually tied up immediately behind their mothers; or, what is a less restrictive plan, put in numbers together in large loose-boxes at the ends of the byre, and let loose from both places at stated times to be suckled. When brought up by the hand, they are put into a separate apartment from their mothers, and each confined in a crib, where the milk is given them. The superiority of separating calves to having a number together is, that it prevents them sucking one another, after having had their allowance of milk, by the ears, teats, scrotum, or navel, by which mal-practice certain diseases may be engendered.

1318. The crib is large enough for one calf at 4 feet square, and 4 feet in height, sparred with slips of tile-lath, and having a small wooden wicket to afford access to the calf. The floor of the cribs may be of earth; but the passage between them should be flagged, or of asphalt. Abundance of light should be admitted, either by windows in the walls or skylights in the roof; and fresh air is essential to the health of calves, the supply of which would be best secured by a ventilator in the roof, such as fig. 530. A door should communicate with the cow-house, and another, having upper and lower divisions, with a court furnished with a shed. The crib should be fitted up with a manger to contain cut turnips or carrots, and a high rack for hay, the top of which should be as much

elevated above the litter as to preclude the possibility of the calf getting its feet over it. The general fault in the construction of calves' houses is the want of both light and air, light being cheerful to animals in confinement, and air essential to the good health of all young animals. When desired, both may be excluded. The walls of the calves' house should be plastered, to be neat and clean. Some people are of opinion that the calves' house should not only have no door of communication with the cow-house, but should be placed at a distance from it, that the cows may be beyond the reach of hearing the calves. Such an objection could only have originated from an imperfect acquaintance with the character of these animals. A cow that is prevented smelling and suckling her calf, does not know its voice, and will express no uneasiness about it a few minutes after they are separated, and after the first portion of milk has been drawn from her by the hand.

1319. The front and door of a calf's crib is represented by fig. 540, in which *a* is the wicket door which gives access to it, *b b* are the hinges, and *c* is a thumb-catch to keep it shut. This sort of hinge is very simple and economical. It consists of those rails of the wicket intended for the hinges being elongated towards *b*, where they are rounded off; and their lower face is shaped into a round pin, which fills and rotates in a round hole made in a billet of wood, seen at the lower hinge at *b*, securely screwed to the upright door-post of the crib. Another billet *d* is screwed immediately above the lower rail *b*, to prevent the door being thrown off the hinges by any accident. Cross-tailed iron hinges, of the lightness suited to such doors, would soon break, by rusting in the dampness usually occasioned by the breath of a number of calves confined within the same apartment.

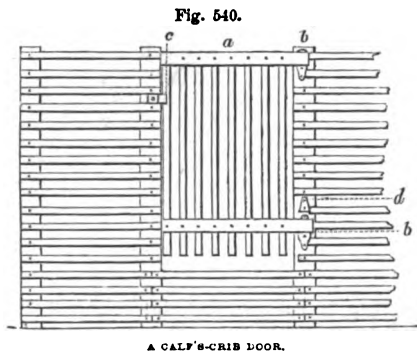

1320. A court should be attached to the calves' house, and there should be erected in it, for shelter to the calves in cold weather, or at night before they are turned out to pasture, or for the night for a few weeks before they are put into the larger court when at pasture, a shed fitted up with mangers for turnips and racks for hay. A trough of water is also requisite in this court, as well as a gateway for carts, by which the dung may be removed, and a liquid-manure grating to keep the court dry.

1321. *Fittings for Courts—Turnip-Troughs.*—The troughs for turnips are placed against the walls, as in fig. 541, where *a* is the wall against which the trough is built, and *b* a building of stone and lime 2 feet thick, to support the bottom of the trough, of which the lime need not be used for more than 9 inches in the front and sides of the wall, and the remaining 15 inches may be filled up with any hard material; *c* is the flagging placed on the top of this wall, to form the bottom of the trough. Some board the bottom with wood; and, where wood is plentiful, it is cheap, and answers the purpose, and is pleasanter for the cattle in wet and frosty weather; but where flags can be easily procured, they are more durable in the open air: *d* is a plank, 3 inches thick and 9 in depth, to keep in the turnips. Oak planking from wrecks, and old spruce trees, however knotty, we have found a cheap and durable front for turnip-troughs. The planks are spliced together at their ends, and held on edge by

rods of iron *e* battled with lead into the wall, and with a shoulder and nut and screw in front. The height in front should not exceed 2 feet 9 inches for

Fig. 541.

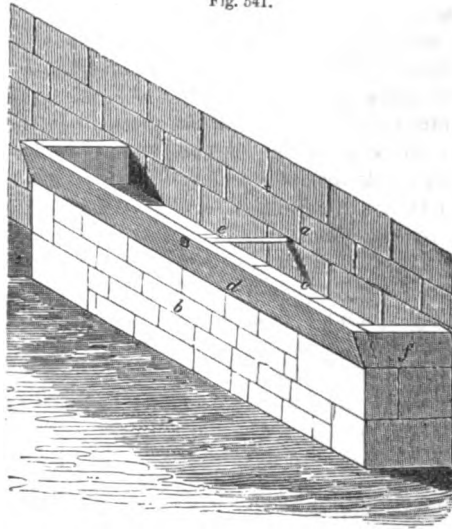

TURNIP-TROUGH FOR COURTS.

calves, and 3 feet for the other cattle; and it will become less as the straw daily accumulates. The trough, here shown short, may extend to any length along the side-wall of a court.

1322. *Straw-Racks*. — The straw-racks for courts are made of various forms. A common kind of wooden rack is in fig. 542, of a square form, sparred round the sides and bottom to keep in the straw. The cattle draw the straw through the spars as long as its top is too high for them to reach over it, but after the dung accumulates, and the rack thereby becomes low, the cattle get at the straw over the top. It is made of wood, 5 feet square and 4 in height. These racks may be pulled up

Fig. 542.

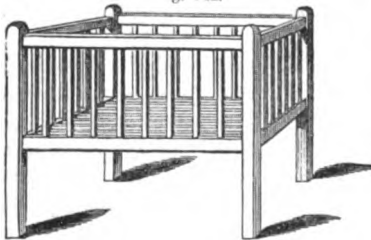

WOODEN STRAW-RACK FOR COURTS.

higher when the dung accumulates much.

Fig. 543.

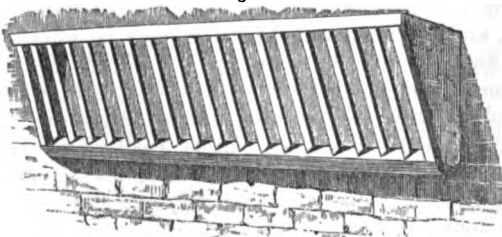

STRAW-RACK FOR SHEDS.

1323.—Fig. 543 is a form of wooden rack adapted to supply fodder to cattle under cover in sheds. It consists of an upper and a lower bar of wood, parallel to each other, and into which are notched behind a series of rails as far asunder as to allow of the straw being pulled through between them by the cattle.

The rack has an inclination of about 2 feet forward at the top, which affords the capacity of holding the food, both its rails being battened to the wall.

1324. *Pig-sty Door*.—As swine have very powerful necks, and are apt to push open doors of ordinary construction, a form of door such as is represented in fig. 544 is very secure. The door, of double plank-wood, slips up and down a groove formed in the masonry on each side, and this contrivance is such as to elude the arts of the most cunning brood-sow to escape out of its sty.

Fig. 544.

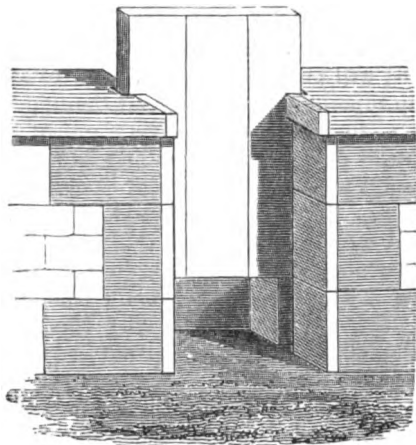

FIG-STY DOOR.

1325. *On the Accommodation of the Grain Crops in the Steading*.—On looking at the plans of steadings in the Plates, it will be observed that the thrashing-machine, placed in the upper barn above the corn-barn, is in the middle of the great range of the steading, ready to receive the unthrashed crop from the stackyard behind it, and as ready to deliver the straw thrashed into the straw-barn, and the grain into the corn-barn below.

1326. *Straw-Barn*.—The straw-barn is purposely made of the height of the upper barn, to contain a large quantity of straw, as it is often convenient in bad weather to thrash out a considerable quantity of corn, when no other work can be proceeded with, or when high market-prices induce farmers to take advantage of them. There is another good reason for giving ample room to the straw-barn. Every sort of straw is not suited to every purpose, one sort being best suited for litter, and another for fodder. This being the case, it is desirable to have always both kinds in the barn, that the fodder-straw may not be wasted in litter, and the litter-straw given as fodder, to the injury of the animals. Besides, the same sort of straw is not alike acceptable as fodder to every class of animals. Thus wheat-straw is a favourite fodder with horses, as well as oat-straw, whilst the latter only is acceptable to cattle. Barley-straw is only fit for litter. To give access to litter and fodder straw at the same time, it is necessary to have a door from each kind into each court. Thus four doors, two at each side near the ends, are required in a large straw-barn. Slit-like openings should be made in its side-walls, to admit air and promote ventilation through the straw. A skylight in the roof, at the end nearest the thrashing-machine, is useful in giving light to those who take away and store up the

straw from the thrashing-machine when the doors are shut, which they should be whenever the wind happens to blow too strongly through them into the machine against the straw. Instead of dividing straw-barn doors into two vertical leaves, as is usually done, they should be divided horizontally into an upper and lower leaf, so that the lower may always be kept shut against intruders, such as pigs, whilst the upper admits both light and air into the barn. One of the doors at each end should be furnished with a good stock-lock and key, and thumb-latch, and the other two fastened with a wooden hand-bar from the inside. The floor of the straw-barn is seldom or never flagged or causewayed, though it is desirable it should be. If it were not so expensive, the asphaltum pavement would make a good floor for a straw-barn; but the most effective floor is made of small broken stones to the depth of 15 inches, and blended with gravel. It will prevent moulding, and resist rats. Mouldy straw at the bottom of a heap superinduces throughout the upper mass a disagreeable odour, and imparts a taste repugnant to every animal. That portion of the floor upon which the straw first alights on sliding down the straw-screen of the thrashing-machine, should be strongly boarded, to resist the action of the forks when removing the straw. Blocks of hardwood, such as the stools of hardwood trees, set on end causewaywise, and sunk into the earth, form a very durable flooring for this purpose. Stone flagging in this place destroys the prongs of the pitchforks. The straw-barn should communicate with the chaff-house by a shutting door, to enable those who take away the straw to see whether the chaff accumulates too high against the end of the winnowing-machine.

1327. *The Corn-Barn.*—Its roof is formed of the floor of the upper barn, and its height is generally made too low. The higher the roof is, the more easily will the corn descend to be cleaned from the thrashing-machine down the hopper to the winnowing-machine. Nine feet is the least height it should be in any instance. The corn-barn should have in it at least two glazed windows, to admit plenty of light in the short days of winter, and they should be guarded outside with iron stanchions. If one window cannot be got to the south, the door when open will answer for the admission of sunshine to keep the apartment comfortably dry for the workpeople and the grain.

1328. The door is generally divided into upper and lower halves, which, as usually placed, are always in the way when the winnowing-machine is used at the door. A more convenient method is to have the door in a whole piece, and when opened, to fold back into a recess in the outer wall, over the top of which a plinth might project to throw off the rain. In this case the rebats and lintel must be giblet-checked as deep as the thickness of the door, into which it should close flush, and be fastened with a good lock and key, and provided with a thumb-latch. The object of making the corn-barn door of this form is to avoid the inconvenience of its opening into the barn, where, unless it folds wholly back on a wall, it is frequently in the way of work, particularly when winnowing roughs, and taking out sacks of corn on men's backs. As to size, it should not be less in the opening than $7\frac{1}{2}$ feet in height and $3\frac{1}{2}$ in width. A light half-door can be hooked on, when work is going on, to prevent the intrusion of animals, and the wind sweeping along the floor.

1329. The floor of the corn-barn is frequently made of clay, or of a composition of ashes and lime; the asphaltic composition would be better than either; but in every instance it should be made of wood—of sound hard red-wood Drahm battens, ploughed and feathered, and fastened down to stout joists

with Scotch flooring sprigs driven through the feather-edge. A wooden floor is the only one that can be depended on being constantly dry in a corn-barn; and in a barn for the use of corn, a dry floor is indispensable. It has been suggested to us that a stone pavement, square-jointed, and laid on a bed of lime over 9 inches of broken stones—or an asphaltum pavement, laid on a body of 6 inches of broken stones, covered with a bed of grout on the top of the stones, would make as dry and a more durable barn-floor than wood, and which will not rot. No doubt stone or asphaltum pavement is durable, and not liable to rot; but there are objections to both, in a corn-barn, of a practical nature, and it is certain that the best stone pavement is not proof against the undermining powers of the brown rat: whilst a wooden floor is durable enough, and certainly will not rot, if kept dry in the manner we shall recommend. The objections to all stone pavements as a barn-floor are, that the scoops for shovelling the corn pass very harshly over them—the iron nails in the shoes of the work-people wear them down, raise a dust upon them, and crush the grain—and they are hurtful to the bare hands and light implements, when used in taking up the corn from, or in cleaning the floor. For true comfort in all these respects, there is nothing like wood. The walls of this barn should be made smooth with hair-plaster, and the joists and flooring forming its roof cleaned with the plane, as dust adheres much more readily to a rough than to a smooth surface. The stairs to the granaries should enter from the corn-barn, and a stout plain deal door with lock and key placed at the bottom of each. And at the side of one of the stairs may be enclosed on the floor of the barn, a space to contain light corn to be given to the fowls and pigs in summer, when this sort of food becomes scarce.

1330. As the method of hanging doors on a giblet-check should be adopted in all cases in steadings where doors on outside walls are likely to meet with obstructions on opening inwards, or themselves becoming obstructive to things passing outwards, the subject deserves a special illustration. In fig. 545, *a* is the inside form of a strong door, mounted on crooks and bands, fully open, and thrown back into the recess of the wall *b*, the projecting part of the lintel *c* protecting it effectually from the rain; *d* is the giblet-check in the lintel, and *e* that in the ribats, into which the door shuts flush; *f* is the light movable door used when work is going on in the corn-barn.

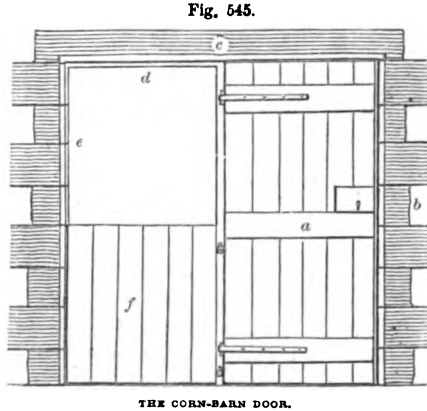

1331. The wooden floor of the corn-barn is liable to decay unless precautions are used to prevent it; but a much too common cause of its destruction is vermin—such as rats and mice. We used a most effectual method of preventing the destructive ravages of either vermin or damp, by supporting the floor in the particular manner represented in fig. 546. The earth, in the first instance, was dug out of the barn to the depth of the foundation walls, which should be two feet below the door-soles, and in the case of the building of a new steading this can be done when the foundations of the walls are taken out. The ground is then spread over with a layer of sand, sufficient to preserve steadiness in the stout broad flags *b b* which are laid upon it and jointed in strong mortar. Twelve-inch thick sleeper walls *a a*, of stone and lime, are then built on the flags, to

support the ends of the joists of the floor. The ends of the joists *c*, formed of 10 inches by 2½-inch plank, are then laid on edge upon the walls 16 inches apart,

Fig. 546.

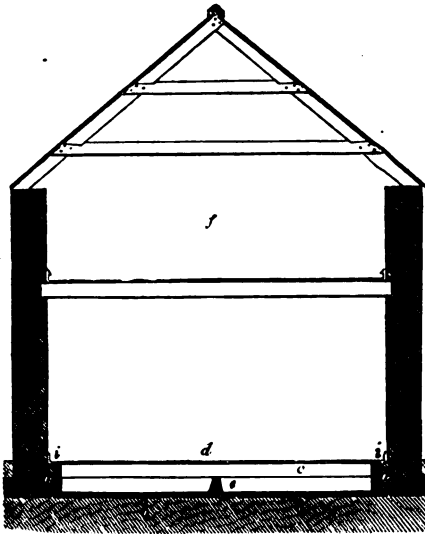

SECTION OF THE CORN-BARN FLOOR.

and the spaces between them filled up to the top of the joists with stone and lime. The building between the joists requires to be done in a peculiar way. It should be done with squared rubble stones, and on no account should the mortar come in contact with the joists, as nothing destroys timber, by superinducing the dry rot, more readily than the action of mortar upon timber above ground. For the same reason care should be observed in building all the joists into the walls; in placing the safe-lintels over the doors and windows dry-bedded, and in beam filling between the couple-legs. The floor *d* is then laid on a level with the door-sole, and finished with a neat skirting board *i* round the walls of the barn. By this contrivance the vermin cannot possibly reach the floor but from the flags *b*, which are nearly 2 feet

under it. A hewn stone pillar *e*, or even two, are placed on the flags under each joist to support and strengthen the floor. This construction of floor freely admits the air above and below to preserve it, and affords room under it for cats and dogs to hunt after the vermin. The figure also gives a section of the building above the corn-barn, constituting the upper barn *f*, having similar outside walls, coupling, slating, and ridging of the roof to the middle range of the building.

1332. Immediately in connection with the upper barn may be a gangway to give access to the stackyard. It is used as an inclined plane, upon which to wheel the corn-barrows, and forms a road for the carriers of sheaves from the stackyard. This road should at all times be kept hard and smooth with small broken stones, and sufficiently strong to endure the action of barrow-wheels. Either asphaltum or wood pavement would answer this purpose well. To prevent the gangway affecting the wall of the corn-barn with dampness, it should be supported on a semicircular arch of masonry. Some farmers prefer taking in the corn on carts instead of by a gangway, and the carts in that case are placed alongside the large door of the upper barn, and emptied of their contents by means of a fork. We prefer a gangway for this reason, because it enables the farmer to dispense with horse-labour in bringing in the stacks if they are near at hand, and they should always be built near the upper barn for convenience. It is suggested to have a railway to convey the stacks on their stathels to the upper barn-door, and thence cast the sheaves into the barn at once. This would require the ground of the stackyard and the barn to be on the same level.

1333. *Granary Windows.*—These windows should be formed to admit light and air freely; and we know of no form so capable of affording both as fig. 547. The opening is 4½ feet in length and 3 in height. In the frame *a* are a glazed sash 1 foot in height, composed of two rows of panes, and *b* Venetian

shutters, which may be opened more or less at pleasure: *c d* shows in section the manner in which these shutters operate. They revolve by their ends, a round pin, in holes in the side-posts of the frame *d*, and are kept in a parallel position to each other by the bar *c*, which is attached to them by an eye of iron, moving stiff on an iron pin passing through both the eye and bar *c*.

1334. *Stackyard*.—As most of the stacks must stand on the ground, it should receive that form which will allow the rain-water to run off and not injure their bottoms. This is done by forming the ground into ridges. The minimum breadth of these ridges may be determined in this way: The usual length of the straw of the grain crops

can be conveniently packed in stacks of 15 feet diameter; and as 3 feet is little enough space to be left on the ground between the stacks, the ridges should not be of less width than 18 feet. The stackyard should be enclosed with a substantial stone and lime wall of $4\frac{1}{2}$ feet in height. In too many instances the stackyard is entirely unenclosed, and left exposed to the trespass of every animal. The stackyard should have gateways of not less than 10 feet in width clear, with a stout gate hung on crook and band, and fastened with a short chain and hook. In carse farming the stacks require to be 24 feet in diameter.

1335. *Stathels*.—It is desirable to place the outside rows of the stacks next the wall on stools or stathels, which will not only keep them off the wet ground, should they remain a long time in the stackyard, but in a great measure prevent vermin getting into the stacks. These stathels are usually and most economically made of stone supports and a wooden frame. The frame is of the form of an octagon, and under its centre and each angle is placed a support. The framework consists of a plank *a a*, fig. 548, 15 feet in

Fig. 547.

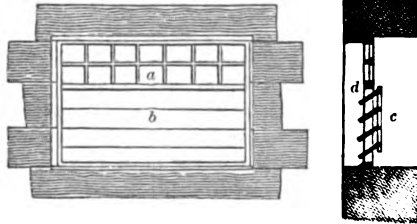

ORDINARY WINDOW AND SECTION OF SHUTTERS.

Fig. 548.

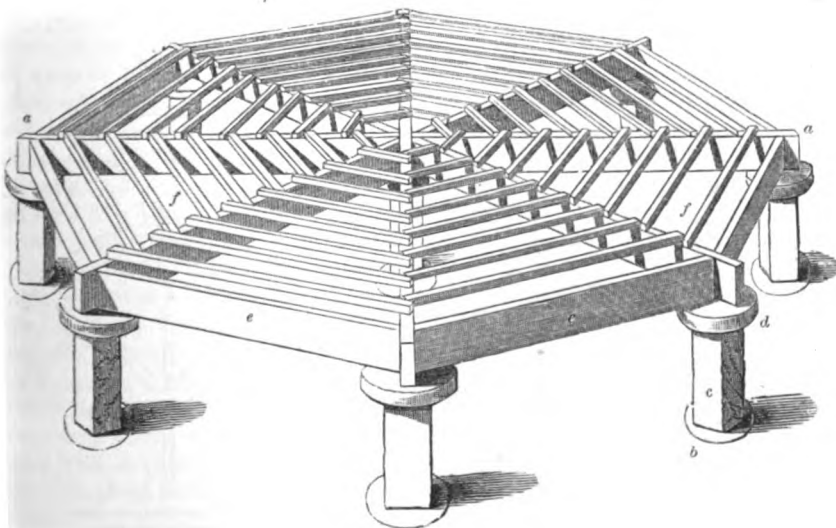

A WOODEN STATHEL FOR STACKS, WITH STONE SUPPORTS.

length, and of others $7\frac{1}{2}$ feet in length, 9 inches in depth, and $2\frac{1}{2}$ inches in thickness, if made of Scots fir, but less will suffice of larch. The supports consist of a stone *b*, sunk to the level of the ground, to form a solid foundation for the pillar *c*, 18 inches in height and 8 square, to stand upon, and on the top of this is placed a flat rounded stone or bonnet *d*, of at least 2 inches in thickness. The pillar is bedded in lime, both with the found stone and bonnet. The tops of these stone-supports must be on the same level. Upon them are placed on edge the scantlings *a a*, to the outer end of which are fastened with strong nails the bearers *e e*, also 9 inches in depth and 2 in thickness. The spaces between the scantlings *a* are filled up with fillets of wood *f f*, nailed upon them. If the wood of the framework were previously preserved by Kyan's or Burnett's process, it would last perhaps twenty years, even if made of any kind of home timber, such as larch or Scots fir.

1336. SECTION EIGHTH—Centres for Arches—Bridges—Sluices.

1337. *Centres for Arches.*—In fig. 549 we illustrate a simple centering for a semicircular arch; *a b* the arch timbers, or ribs, resting on the posts *c c*, as shown. Wedges are driven in between the top of posts and under side of ribs *a b*. When the arch is turned and set, by driving out these wedges, the ribs are gradually lowered, and the arch allowed slowly to settle before the centering is finally removed. Bolster-pieces, as shown at *d*, are laid across the ribs, and on these the brick or stone work rests. Two of these ribs are generally used—one at each side of the thickness of the wall—the bolster-pieces *d* stretching between them. When the wall on which the arch is to be turned is of more than ordinary thickness, three ribs may be used, placed parallel to, and at equal distances from, each other.

1338. In fig. 550 we give other forms of centres, in which the ribs *a* are supported by ties *b*, and struts or braces *c c*. The centering for a Gothic or pointed arch is shown at *d e* in the same figure.

1339. In fig. 551 we show how the ribs for centering may be strengthened

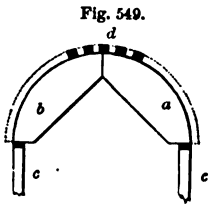

Fig. 549.
CENTRE FOR A DOOR ARCH—
SCALE, $\frac{1}{2}$ INCH TO THE FOOT.

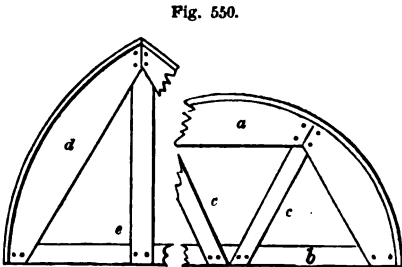

Fig. 550.
CENTERINGS FOR GOTHIC AND SEMICIRCULAR ARCHES—
SCALE, $\frac{1}{2}$ INCH TO THE FOOT.

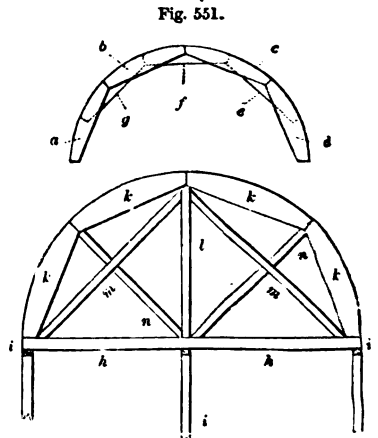
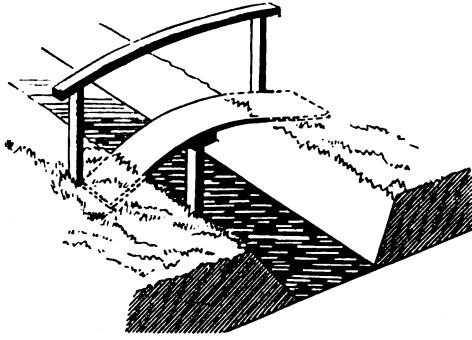

Fig. 551.
CENTRES FOR STONE CIRCULAR ARCHES—SCALE,
 $\frac{1}{2}$ INCH TO THE FOOT.

by being formed of two thicknesses—the parts *a b c d* having similarly cut pieces *e f g* placed behind, and secured to them in such a way that their solid parts shall be placed at the back of the joints of the front pieces *a b c d*. In the lower part of the same figure, a centre for a larger arch or a small bridge is shown. The tie-beam *h h* is supported on the posts *i i i*, and carries the ribs *k k k*. These are supported by the king-post *l*, and braced by the struts *m m*, and *n n*.

1340. *Bridges*.—As a useful addition to the present section, we here give a few designs for simple wooden bridges, adapted for the short spans usually met with in farms. For the construction of more complicated forms we would advise the professional aid of a competent engineer to be called in. Our notes, however, will apply to the majority of instances where small erections, not subjected to unusual strains, are required. Fig. 552 shows a form of simple foot-bridge used in Flanders for crossing ditches.

Fig. 552.



FOOT-BRIDGE FOR SPANNING DITCHES.

1341. Fig. 553 illustrates the simplest form of bridge which can be erected.

It is composed of girders *b b*, resting on wall-plates *c c*, on the walls *a a*. The span is 15 feet, the breadth 10 to 12 feet. Three girders are placed at equal distances on the wall-plates. The flooring is made with flooring-boards or planking, spiked on to the girders. The timbers should be Kyanised before being laid down, or well painted with coal-tar. The girders, 9 inches by 4, are calculated to sustain ordinary cart-load pressure. The scantling of the flooring-boards *d d d*, 6 inches by 2. The hand-rail *f f*, 3 inches by 2 (laid flat), is supported by posts *e e e e*, 3 inches by 2, mortised into the girder *b b*. Diagonal struts *g g g* are inserted between the posts, their scantling, 3 inches by 1½. The bridge illustrated in fig. 553 will be strengthened by using two struts *c c*, abutting at their lower ends on stone corbels *d d*, as in fig. 554,

Fig. 553.

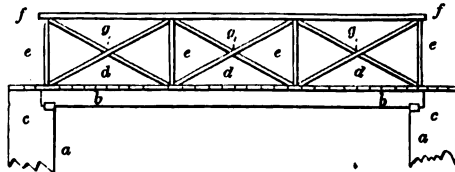

BEAM-BRIDGE FOR 15-FOOT SPAN—SCALE, ¼ INCH TO THE FOOT.

built into the piers or abutments *a a*, and at their upper ends against the "straining beam" *b*. These two forms of bridges are well adapted for farm purposes, where a rivulet has to be crossed. Of the two forms, fig. 554 presents the simplest construction of rail. The whole structure may be formed of rough trees in the bark, the girders of Scots fir, and the rails of weedings of larch.

Fig. 554.

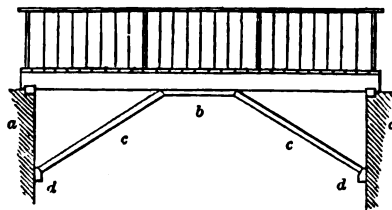

BRIDGE FOR 14-FOOT SPAN, WITH STRUTS—SCALE, ¼ INCH TO THE FOOT.

1342. *Trussed-Girder Bridges*.—In fig. 555 we give an elevation of a girder bridge for a span of 8 feet.

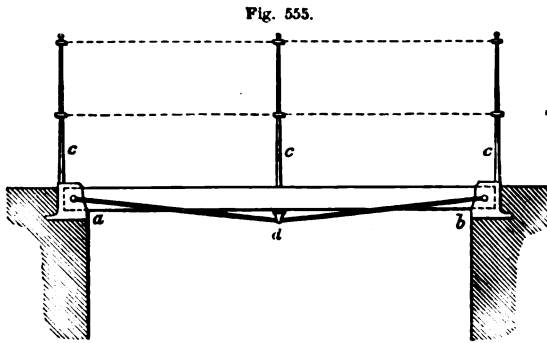

TRUSSED-BEAM BRIDGE, SPAN 8 FEET—SCALE, $\frac{1}{4}$ INCH TO THE FOOT.

The beam rests in cast-iron shoes *a b*; *c c c* are the hand-rails, and *a d b* is the malleable-iron truss. In fig. 556 is a sketch showing the arrangement of trussed beams for a span of 32 feet, divided into two spans of 16 feet each. The beams *a a*, 12 inches by 8, rest at the ends *b b* on the retaining walls; the other ends being secured by cast-iron shoes to the cap of the iron pillar *c c*. Bolster-pieces *d d* rest on the beams, and upon these the flooring or planking *e e* is laid.

Fig. 556.

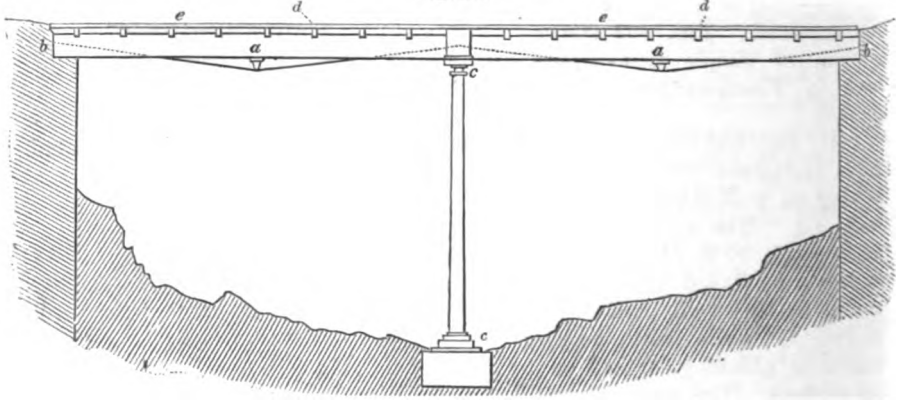

TRUSSED-GIRDER BRIDGE FOR A SPAN OF 32 FEET—SCALE, $\frac{1}{4}$ INCH TO THE FOOT.

1343. In fig. 557 we illustrate another method of trussing beams to be thrown across an opening, on the principle of the king-post truss; *a a* the tie-beam, *b b* the king-post, *c c* the struts. The hand-rail *d d* passes through the cap of the king-post after the manner of a ridge-pole in a roof, and the ends are supported by posts or uprights *e e*.

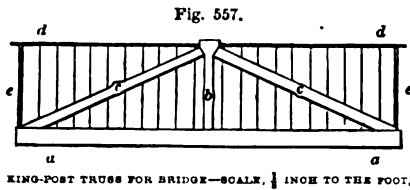

KING-POST TRUSS FOR BRIDGE—SCALE, $\frac{1}{4}$ INCH TO THE FOOT.

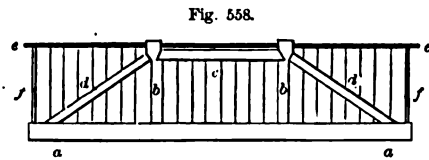

QUEEN-POST TRUSS FOR BRIDGE—SCALE, $\frac{1}{4}$ INCH TO THE FOOT.

1345. In fig. 559 we illustrate another form of trussed bridge girder for a 30-foot span; *a a*, 13 inches by 4; *b b*, 7 by 4; *c c*, 8 by 4; *d d*, 8 by 4; *e e*, 6 by 4;

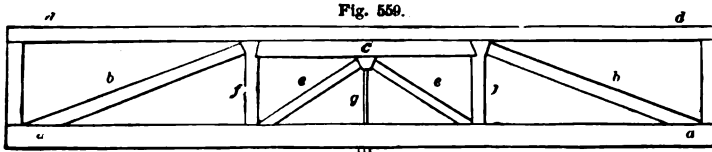

TRUSSED BRIDGE GIRDER—SCALE, $\frac{1}{4}$ INCH TO THE FOOT.

f f, 8 by 4; *g*, wrought-iron king-bolt $1\frac{1}{2}$ inch diameter. If the span is increased, say to 32 feet, or double that of fig. 553, as in fig. 560, two girders—same length as in fig. 553—may be scarf-jointed to form one beam and supported by an upright *b*, 4 inches by 6. At the upper end of this is a transverse beam *a*, 4 inches by 6, the ends of which rest on wall-plates *d d*. Struts *c c*, 4 inches by 3.

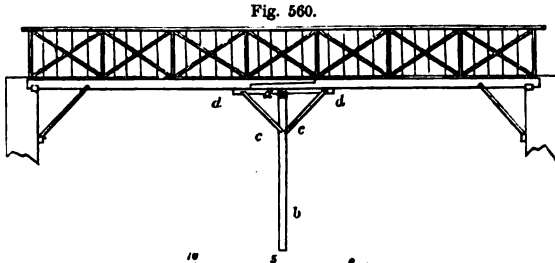

ELEVATION OF BRIDGE OF 32-FOOT SPAN.

1346. In fig. 561 we illustrate the method which may be adopted to support the post *b*, fig. 560: *a a* are piles driven into the bed of the river, or the centre of the ravine over which the bridge may be supposed to cross. These piles are driven at a distance of 2 feet apart; *b b* is a "capping-beam," connecting the heads of the piles together. Into this beam the upright posts *c c c* are mortised, or secured

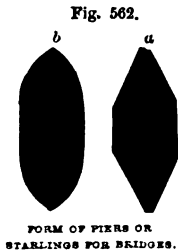

FORM OF PIERS OR STARLINGS FOR BRIDGES.

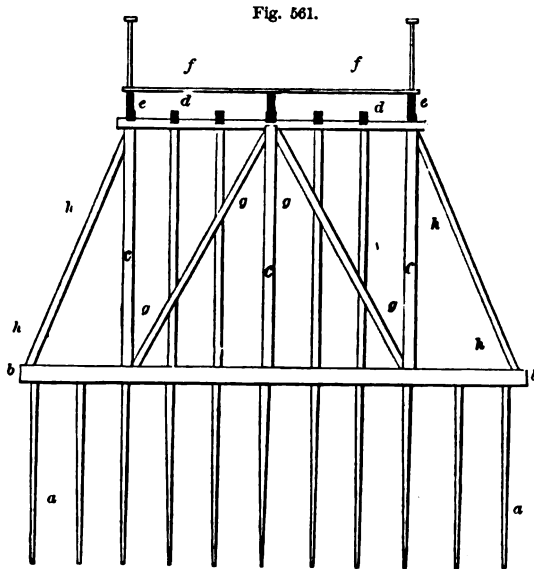

ELEVATION OF MID-PIER FOR BRIDGE IN FIG. 560.

by straps, bolts, and nuts; *d d* is the transverse beam, represented by the letter *a*, fig. 560, on which the piles *d d* and the beams *e e*, fig. 561, are supported; *f f* are the flooring timbers, *g g* struts or braces, *h h* outside struts, will act as fenders to protect the posts from ice, &c. The end of the beam *b*, pointing up stream, should be tapered, or nose-pointed, as at *a* or *b*, fig. 562.

1347. In fig. 563 we illustrate a simple method of forming a central support, which may be used

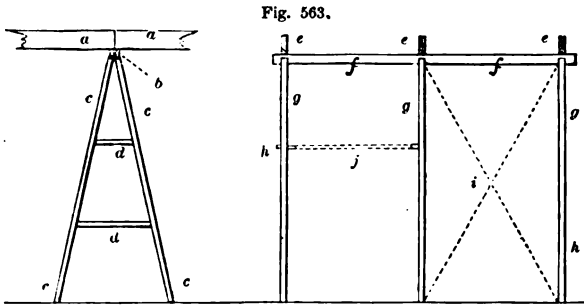

END AND SIDE ELEVATION OF CENTRAL SUPPORT FOR BRIDGE, IN FIG. 560.—
SCALE IN FIG. 560.

where the bridge, as in fig. 560, has not much pressure to support—as in the case of a foot-bridge—*a a*, *e e e* is the beam, corresponding to *e e* in fig. 561, resting on the cross-beam *f f* or *b*. This is supported by the stays *c c c* at three points *g g g*. The stays *c c, c c* are

strengthened by collars *d d*, transversely, and by others longitudinally, as shown by the dotted lines *j*; cross stays, as shown by the dotted lines *i*, may also be put in.

1348. *Wooden Aqueduct*.—In fig. 564 we illustrate a form of bridge to lead the water of irrigation across a ravine. We are indebted for this illustration to Captain Baird Smith's work on *Italian Irrigation*: *a a* is a plan of the aqueduct, with the leaders of irrigation *c c, c c* diverging from it; and *b b* is an elevation of the aqueduct.

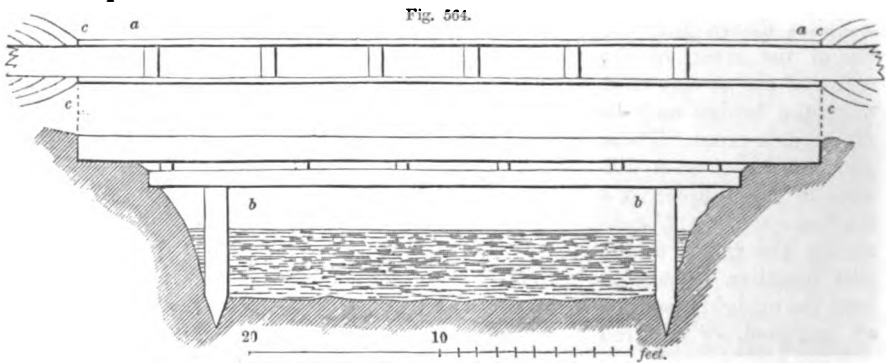

ITALIAN WOODEN AQUEDUCT FOR CONDUCTING WATER OF IRRIGATION OVER RIVERS, RAVINES, &c.

1349. *Sluices*.—We now propose to illustrate a few simple forms of sluices. In fig. 565 we give a sketch of one constructed entirely of timber; *a a* the gate, composed of three pieces, strengthened with battens, as shown by the dotted lines; *b b* the gate in plan. The two uprights *c c* are mortised into the sill *d d*; two cheeks *e e, f f* (*g g* in elevation) are fastened to the uprights, forming a groove in which the sluice-gate *a a* works up and down. The gate is lifted by *h*, which passes through a slot in the cross-beam *i i*. Apertures are provided in *h*, through which a pin can be passed to retain the gate at any desired elevation. In fixing the timbers in the water-way, care should be taken to bed the sill and uprights in good puddle, to prevent all side and bottom leakage. The sluice-gate may be lifted by means of a screw *a*, right hand fig. 566, passing through an aperture in the cross-beam *d*, the nut *e* provided with handles. The screw may be terminated by iron straps *b b*, which will enable it to be firmly fixed to the gate. The left-hand fig. 566 illustrates a method of lifting gates used in Italian irrigation; *f* the gate; *g g* uprights, between which wooden or iron

rungs or rods *h* are placed, and which serve as handles to lift the gate. This is supported at any desired elevation by a stick or pin passed between one of the rods and the top of the cross-beam *i i*.

Fig. 565.

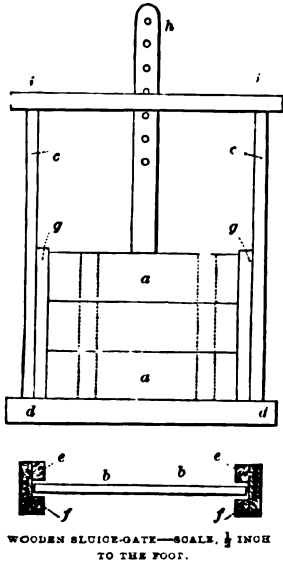
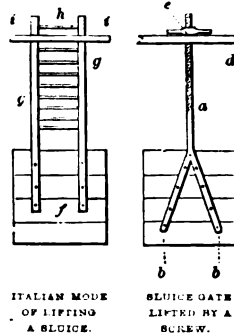
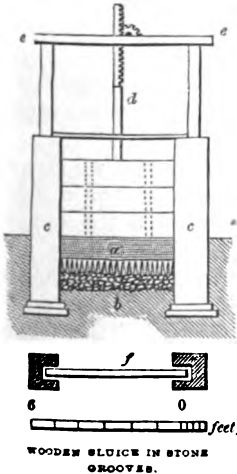

Fig. 566.



1350. Where perfect work is desired, the gates should work in contact with stone or brick facing; the sill *a*, fig. 567, being carefully set in a good foundation *b*, and the retaining walls *c c* well puddled. The foundations of the walls *c c* should be carried down some distance below the bed of the water-channel. In this form of sluice the gate is raised or lowered by means of a rack fixed to the tail *d*, and a pinion working in bearings fixed to the cross-beam *e e*. A pawl should be provided, which, entering the teeth of the rack, will sustain the sluice at any desired elevation; *f* is the sluice-gate and walls in plan.

Fig. 567.



1351. *Self-acting Sluice*.—In fig. 568 we give the longitudinal section, in fig. 569 plan, and in

Fig. 568.

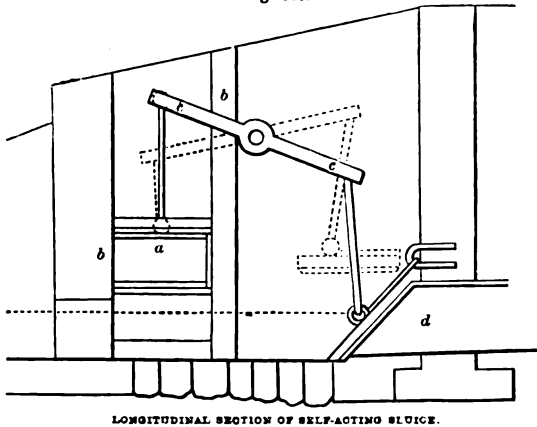
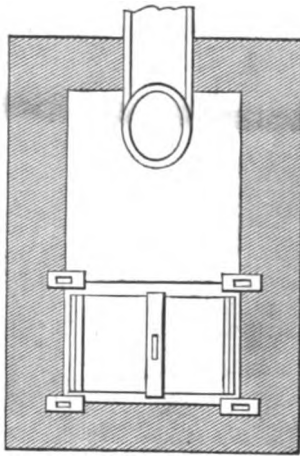

fig. 570 a transverse section of a self-acting sluice, designed by Mr Archibald Sutter, C.E., Edinburgh, and described by him in his valuable paper on

Fig. 569.



PLAN OF SELF-ACTING SLUICE.

Fig. 570.

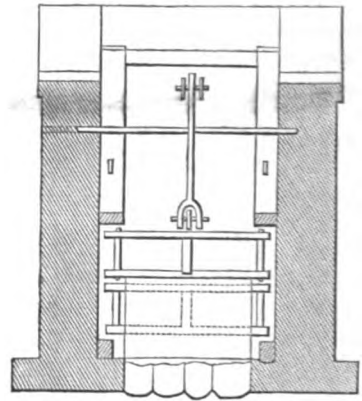

TRANSVERSE SECTION OF SELF-ACTING SLUICE.

“River Embankments,” in the *Transactions of the Highland and Agricultural Society*, July 1858. It consists of a chamber built of masonry in the centre of the embankment, as shown in fig. 568. The float *a* is kept in position by the guides *b b*. When the river begins to rise, the working beam *c c* is raised, consequently holding down the cover or valve of the pipe *d*, and upon the fall of the river again, opening the same, as shown by the dotted lines. A wooden door should be provided at the top to prevent people interfering with its working. “It will be apparent,” says Mr Sutter, “that sluices of this nature would be more applicable to tidal-waters than others, the regularity of the tides preventing them getting out of order for want of work. In rivers, unless some examination takes place, grass may grow, say outside the valve hinge; a stone gets washed down the pipe and sticks below the valve, or something of that sort takes place, and unless remedied, spoils all.”

1352. *Sluice-Pipe Valves*.—Valves for this purpose are hung outside the box which terminates the sluice-pipe or culvert. The valve is hung obliquely to the line of box, so that it has always a tendency to keep closed. In ordinary circumstances the water passes freely out, but in times of flood or tidal flow, the valve is kept close by the pressure outside, and the efflux of the drainage-water prevented.

Fig. 571.

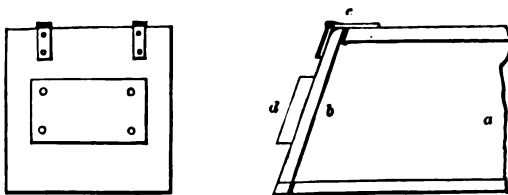

SLUICE-PIPE VALVE.

1353. In fig. 571 we give a sketch illustrative of a form of sluice-valve; *a* the box, *b* the valve, hinged at *c*. A piece of iron *d*, may be bolted to the back of the valve to keep it closed. The figure to the left is a front view of valve. An iron sluice-valve will be found illustrated in

Section on Bridges and Sluices, in Iron Construction.

1354. SECTION NINTH—*Gates*—The reader, desirous to discuss the principles on which gates ought to be constructed, is referred to the *Book of Farm Implements and Machines*, where he will find the subject fully entered into. We proceed at once, therefore, to illustrate examples for practice.

1355. Fig. 572 represents field-gate with diagonal strut, without the upfilings, where $a c$ is the heel-post, $b d$ the head-post, and $c b$ and $a d$ the top and bottom rails of the rectangular frame of a field-gate; and $a b$ is the diagonal, which converts the rectangle $a c b d$ into two triangles $a c b$ and $b a d$.

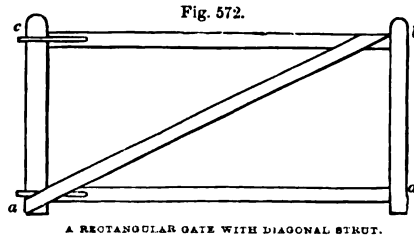

1356. In field-gates constituted entirely of wood, the diagonal should invariably be applied as a strut, to rise from the foot of the heel at a , and terminate at the top of the head-post at b . Placed in this position, the diagonal $a b$ supports the swinging end of the gate $b d$, by its resistance to compression; which it is well adapted to perform by the area of its cross section being considerable, and hence capable of resisting lateral flexure.

1357. But a field-gate is liable from various causes to be forced up at the head-post $b d$, however well the diagonal is adapted to prevent the upper rail from being depressed by any undue weight exerted upon its end at b . The advantages of a tie are the converse of a strut. If a tie, therefore, is placed from c to the opposite angle d , crossing the strut $a b$ in its centre—and an iron bar makes a perfect tie, the cohesion of which is such that a very small sectional area is sufficient for the purpose—the two antagonistic forces of the wooden strut and the iron tie, acting each in its own sphere, preserve within the whole structure the most perfect equilibrium.

1358. *Defective Field-Gate*.—A very common form of field-gate to be seen in this country is shown in fig. 573, and applying correct principles to it, we shall find it defective in several most essential particulars. It has a strut $a b$, but instead of extending across the entire diagonal to c , it stops short at the centre of the gate at b . The part of the top $b c$ is liable to be broken off by any undue force being exerted upon it at c when it is converted into a lever, whose fulcrum is supported at b by the end of the strut $a b$. It has also a tie $b d$, which is not only made of a wooden rail, but it does not extend across the rectangle to e , and in no part does it cross the strut $a b$, so as to act with it in maintaining an equilibrium of forces. The consequence in practice is, that this form of gate is very frequently fractured at the head-post $c d$, and falls to the ground at d .

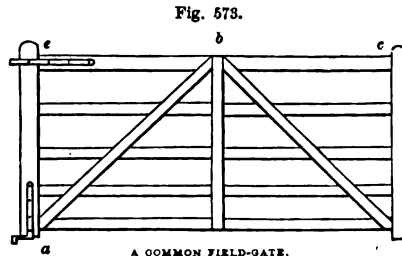

1359. *Trussed Gate*.—The principle of trussing has been successfully introduced into the wooden field-gate by Sir John Orde of Kilmory in Argyllshire. Fig. 574 shows the rectangular form trussed, so as to make a compact firm structure. The heel-post $a b$, the head-post $c d$, and the upper and lower rails $a c$ and $b d$, form the rectangular frame. The truss consists of four bars of wood, $a e$, $b e$, $c e$, and $d e$, each of which abuts into an angle of the rectangle,

and all meet at the centre of the gate *e*; where, each bar being longer than the half of a diagonal of the rectangle *a d*, they become elevated in the form of a pavilion roof. A similar truss is formed for the other face of the gate,

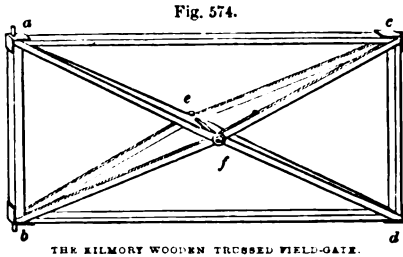

whose apex is at *f*. Through the points *e* and *f*, the apices of the trusses, passes the iron bolt *e f*, the head of which holds the bars at *f*; and a screw and nut upon a plate hold those at *e*; and when the screw is tightened, the trusses are brought nearer together in the centre, and their ends abut with great force against the angles of the rectangular frame at *b*, *a*, *c* and *d*. To resist this pressure, it is necessary to connect the posts and rails with an iron clamp at each angle of the frame. We believe that this construction of gate will admit the frame neither to bend nor twist, and it will bear any pressure of stock against its sides; but its peculiar form is attended, we think, with a practical inconvenience. The trusses rising on each side of the gate $9\frac{3}{4}$ inches above the plane of the frame, the projecting parts at *e* and *f* present an easy and ready hold for the foot of a colt, should he be disposed to amuse himself about the gate—a recreation which young horses are apt to indulge in; and the same projection will likely graze against the sides of cattle, and lay hold of the harness of horses when passing through the gate. We are therefore doubtful of its utility as a common field-gate. The interior of the frame can be filled up with any light material, as wire or spars of wood. When fitted up with wooden spars, the frame costs 13s. 6d., and the posts suited for it, 13s. 6d. more.

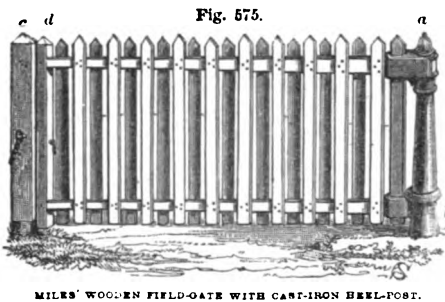

1360. A gate constructed by Mr Charles Miles, architect, London, which seems well adapted for fields, is illustrated in fig. 575. It consists of both iron and wood. It has a strong cast-iron heel-post, *a b*, which is round, tapering to the top, and is batted into a large stone in the ground. At *a* is a collar of iron embracing and revolving round upon a projecting bead encircling the post. To one side of this collar is attached a socket of considerable depth, and of a form to receive into it the upper rail of the gate, which, when properly seated, the socket prevents from drooping at the head *d*. The under-rail style at *b* is in every respect fitted up in the same manner as the upper one. The head-style *d* is light, and completes the framing. The filling-up of the frame is left to choice, either in iron or wood. In the figure the filling-up consists of light wooden spars, nailed on alternately upon both sides of the upper and lower bars. Were a wooden strut introduced into the frame from the bottom rail *b* to the opposite angle at *d*, the gate would be much strengthened, though the deep hold of the sockets makes the rails much more rigid than might be expected. The receiving-post *c* is made of wood fitted into an iron socket, which is batted into a stone. The cost of the gate, without the receiving-post, is 37s. 6d.; with the post, 45s.

1361. We have hitherto alluded only to the simplest efficient form of wooden field-gates, in the construction of which cheapness is always an object, and we have, in order to avoid confusion of ideas, restricted the description to the essential parts; the number of bars, or other means of rendering the gate a sufficient fence, is left to be filled up at discretion. In making these upfillings, the maker should studiously keep in mind that no curved bars or timbers of any description should enter into the construction either for ornament, or ostensibly for use.

1362. In the construction of wooden gates for drives or approaches, where utility is the chief object, strict attention should still be paid to the principles of construction, but a little more latitude may be admissible in point of finish and expense. For such purposes, the rails and posts of the gate should be all of one thickness, or at most, the only difference should be a gradual diminution in thickness towards the head, to lessen the effect of gravity on the hinges and gate-post; for pleasant effect, there should not be more than three horizontal rails, with two diagonals; and if it is necessary to have a closer upfilling, it should be of an upright light balustrade form. Fig. 576 is an

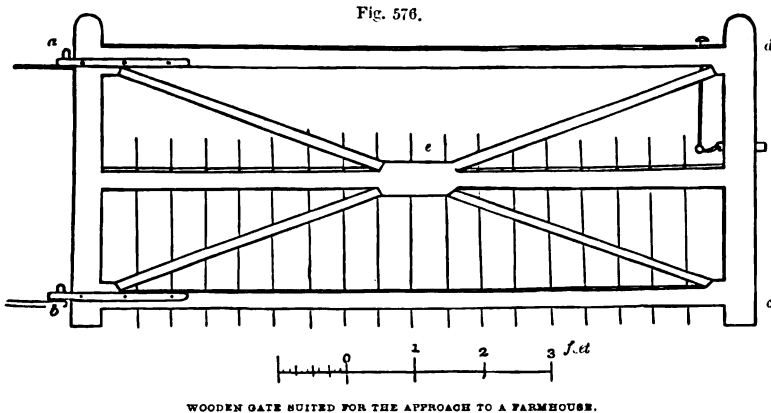

example of this form of gate, adopted many years ago, and the originals then constructed are still good and serviceable, but it is considerably more expensive than the common field-gate. The heel-post *a b* is 5 inches broad and $\frac{3}{4}$ thick, while the head-post *c d* may be reduced to $2\frac{1}{4}$ inches if thought advisable. The top and bottom bars are formed with abutment pieces at both ends, which are 5 inches broad, the intermediate parts being reduced to $3\frac{1}{2}$ inches; the middle bar has the same breadth, but is made up in the middle with corresponding abutments as at *e*, and the two diagonals, of 2 inches in breadth, are inserted in four pieces, exactly fitted between the abutments of the bars. The hinges are of the common double-tailed crook-and-band form, binding the top and bottom rails firmly to the heel-post, and the gate may be hung upon pillars of stone, or of wood well secured. The best balustrade for a gate of this kind is rods of iron $\frac{1}{2}$ inch diameter, as in the figure, passed up through the bottom and middle bars and the diagonals, the holes for these being easily bored with an auger after the gate is formed; but a simple and cheaper balustrade is formed of light wooden spars sunk into the bars and diagonals.

1363. For all wooden gates, the method of bracing with light iron diagonals is to be preferred to wooden struts, but to be effective, two diagonals must always be applied. In some cases they may pass from one angle to its opposite in one length, but in others they may be applied in four pieces, the con-

nection at the centre of the gate being effected either by a ring of iron, in which the four ends are screwed, or by bolting the palmated ends of the four parts, two and two together, through the middle bar, as at *e*, fig. 576, one bolt securing the four ends; and in either case the rods pass through the top and bottom of the heel and head-posts of the gate, and are there secured by screw-nuts. It is obvious that iron diagonals would apply in this manner to the gate, fig. 576, instead of the wooden braces from *e*.

1364. Field-gates should always be made to fold back upon a fence, to open beyond the square, and not to shut of themselves. When they shut of themselves, and are not far enough pushed back when opened, they are apt to catch the wheel of a cart when passing, and to be broken, or the post to be snapped asunder by the concussion; and as self-shutting gates are all apt to be left unfastened by people who pass through them, requiring greater attention than is usually bestowed on such matters, the stock, particularly young horses, which seem to take delight to loiter about gates, might then escape from the field. Young horses are fond of rubbing their rumps against gates, to prevent which, when they do, it is necessary to wattle thorns into the bars.

1365. An excellent plan of fixing a hanging-post is to dig as narrow a hole as is practicable for the purpose, 3 feet deep, and at the bottom lay a flat stone of about 15 inches square and 7 or 8 thick, in the centre of which is cut through a hole of 8 or 9 inches in diameter, to take in the lower end of the post, dressed with the axe to fit the hole. Earth alone is then put in spadefuls into the hole, and made firm around the post with a rammer, up to the surface of the ground, in which is sunk a stone, at the edge of the upper square face of which

Fig. 577.

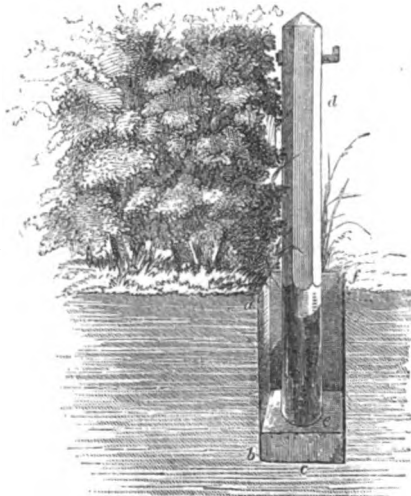

SECURE MODE OF FASTENING THE HANGING-POST OF A FIELD-GATE.

the iron-shod heel-post of the gate is made to rotate in a shallow hollow made to fit it. Fig. 577 shows the different parts of this mode of fastening the hanging-posts of field-gates; where *a b* is the hole into the bottom of which the stone *c* is sunk, and into this stone the end of the post *d* is inserted and secured, as at *e*. Water passing through the hole in the stone, the lower end of the post will be preserved; and more so by being charred or in the bark, and smeared with coal-tar: the upper part of the post at *d* will be best preserved by being planed and painted. The top of the post should always be semispherical, or pyramidal, to prevent the lodgment of water upon it. The earth is rammed hard into the pit *a b* to the surface of the ground, in which is sunk at *f* a stone, on which the heel-post of the gate rotates. Part of the hedge-fence of the field in which the gate is placed is shown, as also the crook above *d* on which the gate is hung.

1366. Another method is in digging a hole $2\frac{1}{2}$ feet square and of 3 in depth; and the post being set into it, the pit is filled with rubble masonry in mortar, packed firmly, and grouted round the post. This is no doubt a very effectual mode of fastening gate-posts—a matter not so well attended to on a farm as it

ought to be; and the lime may tend to preserve the wood under ground a longer time than it would be without it; but it is expensive, and when the post has to be renewed, the masonry will have to be removed, as no new post can again be fixed so firmly in the pit as when both were put in together.

1367. There is no better mode of hanging a field-gate than by crook-and-band hinge at the upper rail, and a heel-crook at the bottom of the heel-post. Both the band-hinge and the heel-crook ought to be double-tailed, to embrace both sides of the heel-post and of the upper rail. The upper crook keeps the gate close to the upper part of the hanging-post, while the heel-crook, perpendicularly below it, resting on and working in a hole made in a hard stone, supports the entire weight of the gate, and thereby relieves the hanging-post. A gate-post of whatever kind, which has to support the entire weight of a gate, requires to be very securely fixed into the ground; but when the gate is supported by a heel-crook, the post may be of more slender form.

1368. The simplest mode of fastening field-gates to the head-posts is to hook on a small linked chain from the stile-head of the gate to a hook in the receiving-post. No animal is able to unloosen this simple sort of fastening; but horses soon learn to unfasten almost every other sort.

1369. Field-gates ought to be painted before being put to use, and they ought to receive a new coat every year, as without it they will rot in a comparatively short period of time. The iron part of gates must of necessity be painted, to keep them from rusting. Coal-tar does not look well as a paint, and is apt to blacken the hands and clothes after exposure for a time to the air. Many compositions are presented to the public notice as suitable for painting outside work, amongst which we have seen a thick black varnish; but there is nothing better than good whitelead and oil. Field-gates painted white have a lively appearance amongst the dark-green foliage of thorn hedges, and they harmonise well even with the colour of dry-stone walls.

1370. *Sliding Door.*—In fig. 578 we give a drawing of a sliding door for the stable of the Coleshill Farm, Plate XIV.; *a a* the wooden gate, the upper rail *a* of which is embraced at points near each end by double straps *b b*, which support wheels *c c*, running on the bar of iron *d d*, $1\frac{1}{2}$ inch by $\frac{1}{2}$. This is bent at each end so as to project $1\frac{1}{2}$ inch from the face of plate or lintel, to which it is bolted by three bolts; *e e* are blocks of wood placed in the ground, with a groove in each to keep the door in its place; *f f* an upright post, against which the door *a a* shuts. A sliding door or gate may be double, opening right and left, and shutting against their two edges.

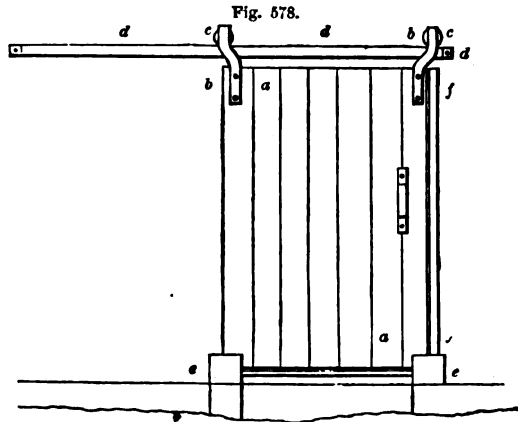

1371. *Suspended or Hanging Gate.*—In cases where a wall, as *a a*, fig. 579, divides two courtyards, the narrowness in which prevents the gate of an ordinary construction opening laterally, it may be suspended as shown; *b b* the gate, hung by the chains *c c*, passing over the pulleys *d d*, and counterbalanced by the

weights *e e*; *f f* the diagonal stays, to support the uprights, which carry the wheels or pulleys *d d*.

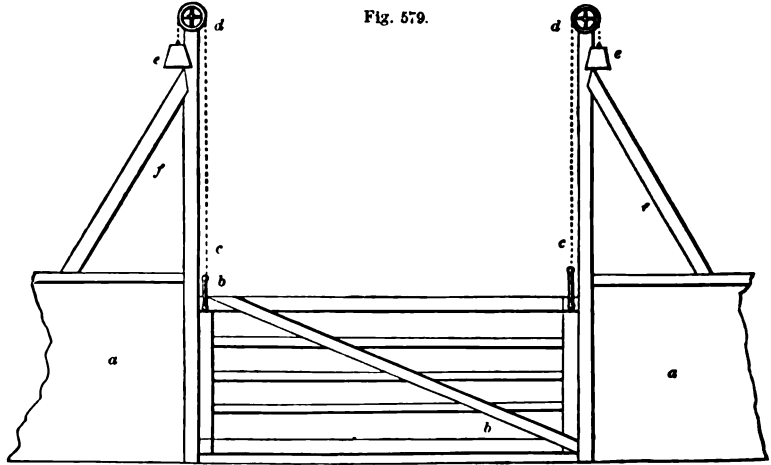

SUSPENDED OR HANGING GATE FOR COURTYARDS—SCALE, $\frac{1}{4}$ INCH TO THE FOOT.

1372. *Gate for Centre of Bridge.*—Where two pasture fields *a a*, fig. 580, are divided by a rivulet *b b*, crossed by a bridge *c c*, the cattle may be prevented from passing from one field to the other by a gate placed in the centre of the bridge, as at *d d*, in place of having two gates, one at each side at *a*. This is a plan adopted in Holland. An illustration of a swivel-gate for centre of bridge used in Belgium, is given in fig. 581: *a d* banks of the rivulet; *b b* the bridge; *c c* the swivel-gates, which are shown closed at *e e*.

Fig. 580.

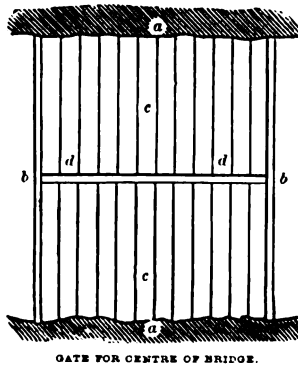

GATE FOR CENTRE OF BRIDGE.

Fig. 581.

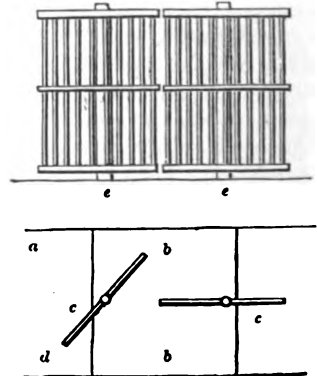

SWIVEL-GATE FOR CENTRE OF BRIDGE.

1373. SECTION TENTH—*Timber Houses and Sheds.*

1374. *Construction of Frame-Houses.*—The simplest frame-house which can be erected is by driving posts into the ground, and nailing what are termed slabs—that is, the outsides of logs sawn off, as in *a*, fig. 582—on the inside and outside faces *b* of posts *c c*, the space between them, *d*, being filled up with some non-conducting material, as clay or earth, which will keep the interior much warmer than if

Fig. 582.

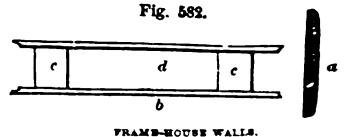

FRAME-HOUSE WALLS.

the space is left hollow. The foundations of a good frame-house should be constructed of brick or stone, and carried all round to a height of at least 18 inches above the ground—in this foundation the upright posts constituting the framing are built. In the event, however, of brick or stone work for this purpose not being available, we think it best to explain, also, how a good balk foundation may be made, which will last many years—premising that the after operations to be described are to be carried out in any case, whether the foundations be of wood, or of brick or stone. Having procured balks of from 12 to 16 inches diameter, partly square them on opposite sides; next mark out the outline of house on the ground, and make a frame of logs corresponding to this. Having previously decided on the plan, ascertain the measurements of the distance of window and door openings from any angle, as at *b*, fig. 583, and mark them off on the log foundation, or frame, as to *c c*, and at these places cut mortise holes, to admit the mortised ends of the upright posts.

After all these holes have been marked and cut, the foundation frame, as lying on the ground, will present the appearance of fig. 584, which is a ground-plan. Having provided the upright posts of requisite length, 4 inches square and tenoned at the ends, they are to be placed in the respective mortises in the log foundation. When thus placed they will present the appearance, when viewed from the front of the house, as in figs. 585 and 586. The upper timbers *h h*, 9 inches square, must be placed on

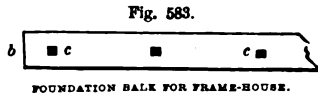
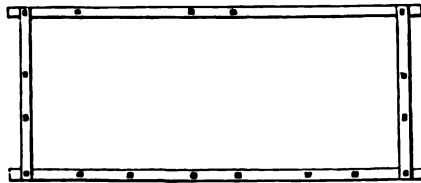
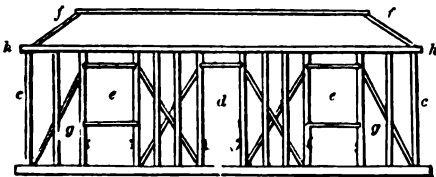

Fig. 584.



PLAN OF FOUNDATION BALKS FOR TIMBER SHED—SCALE, 1/4 INCH TO THE FOOT.

Fig. 585.



SIDE ELEVATION OF SHED—SCALE, 1/4 INCH TO THE FOOT.

Fig. 586.

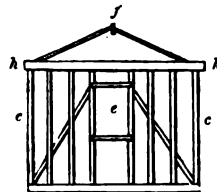

ELEVATION OF SHED—SCALE, 1/4 INCH TO THE FOOT.

the top of the posts *c c*, the tenons of these going into mortise holes in the timber; or notches may be made on the under side of *h h*, and spiked to the posts: the office of these timbers *c c* is to support the spars forming the roof *f f*. The upper part of the door-frame *d*, and the upper and lower parts of the window-frames *e e*, must next be put in between the posts, and struts *g g*, 2 inches broad by 1 thick, placed as in the figures. The spars forming roof are next to be laid down, and properly secured; and finally, the shingles, slates, tiles, &c., used for the roof-covering laid carefully on. The outside covering of walls comes next under consideration. This is generally effected by nailing planks some 6 or 9 inches broad by 1 thick, either vertically or horizontally, as exemplified in fig. 587.

Fig. 587.

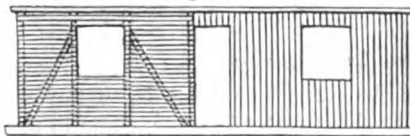

EXTERIOR FURNISHING OF SHED.

We prefer to place them vertically, as on the left of the figure: where they are laid horizontally, they overlap one another in the manner shown in figs. 588 and 589. Fig. 588 is a front view, the left figure representing it in section. Fig. 589 is the outside of the post to which the boards are nailed. In securing these, the one nearest the ground is nailed first, the second is placed so as to overlap this, the third to overlap the second, and so on: by this arrangement all the joints are secured from the effects of the weather. Where the boarding is secured to the posts vertically, the planks are nailed to the top and bottom timbers, between the posts, edge to edge. In first-class work they are tongued and grooved, but in ordinary work they may be merely planed, or, if preferred, left rough. The joints between the boards *a a*, fig. 590, are covered by narrow strips

Fig. 589.

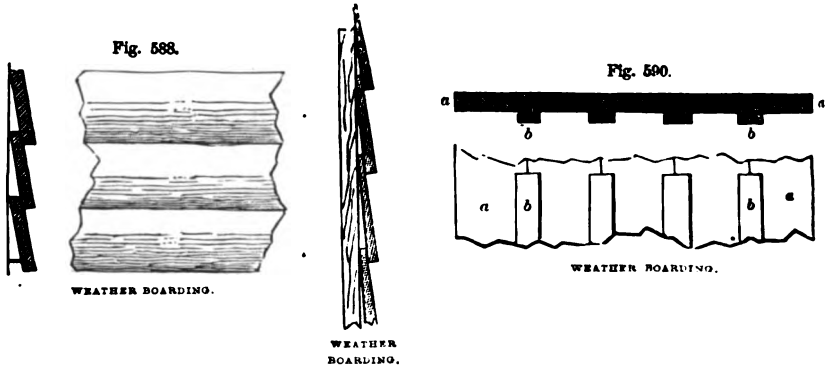

or battens *b b*, some 2 inches broad and 1 thick, and secured by nails. The form of these battens may be varied according to taste: in fig. 591 a few are given. Messrs Eassie & Son, Gloucester, have patented a method of joining boards for roofing and sides of timber houses; this we illustrate in fig. 592, in elevation, and in section at bottom. This makes a neat water-tight joint. In well-constructed frame-houses, the interior facings are built up with brick, and plastered. Where this is objected to, the inner face of the posts may be rebated as in fig.

Fig. 592.

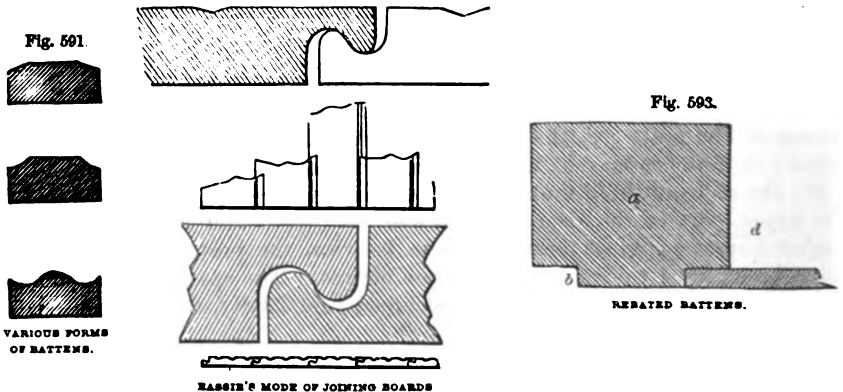

593, where *a* is the post, with rebates as *b* on the inner face. Boarding, planed on the outer face—that is, to the side to be presented to the room—may be placed between the posts, going in at each end into the rebates of the posts, and there secured. If the thickness of the boarding is equal to the depth of rebate *b*, the face will be flush with that of the post *a*. The paper or paint may be

placed at once on the face of the boarding. The space between the inner face and the exterior weather boarding, as at *d*, may be filled in with some non-conducting material. A method of making the exterior and interior finishings for walls of timber, almost universally adopted in Sweden, may be noticed here: *a a*, fig. 594, are the upright posts; *c c* a range of boarding laid horizontally; an outer range, *d d*, is placed above this vertically, secured by battens as in fig. 590; the inner boarding *b b* is horizontal. The space between the posts and boarding is filled with non-conducting material.

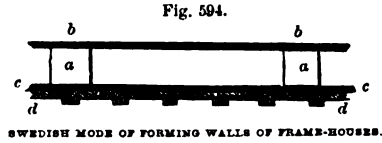

1375. There is one decided objection to frame-houses—that is, their extreme liability to fire. We think that a method of combining the rapidity with which a house of this description may be built, its economy where wood is plentiful, its durability—and at the same time securing to it an almost absolute fireproof condition—will be useful and acceptable. The method we have to propose is amazingly simple—it is an adaptation of a plan much used in Paris for making fireproof partitions. The upright posts are to be placed in the horizontal foundation, at distances not greater than 2 feet; where window and door openings occur, they must necessarily be placed wider apart. Let *a a*, fig. 595, be the foundation; *b b* two of the posts; to the inside of these nail firmly flat boards *c c*, 1 inch thick, and of the breadth of the intended thickness of wall. Provide struts *e e e*, 2½ inches wide by 1 thick, and place them between the posts in the manner shown in the figure, one at each side; secure them to the boarding *c c*. Having provided a hard setting mortar, or mixture of gypsum and sand, or other easily made cement, fasten a board, of dimensions sufficient to cover one at least of the large diamond-formed openings, temporarily, yet firmly, either to the outside or inside of the posts; next procure a number of pieces of broken and angular stones of all sizes, not exceeding, however, that which could pass through a ring 3 inches diameter; place these within the interstices formed by the struts *e*,

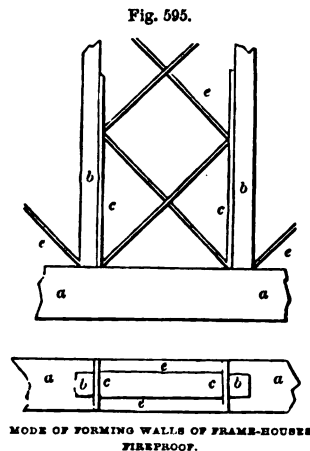

placing them as carefully as possible, so as to be flush, or nearly so, with the outside and inside face of posts. Having thus well fitted the spaces, proceed to press well in, from the side opposite to that on which the flat board is temporarily fastened, the thin mortar or cement—taking care that it shall thoroughly mix and permeate through the interstices of the stones packed up between the timbers. Having thus carefully filled in one portion with the stones and cement, remove the flat board to another portion, and proceed as before. The rough places afforded on each side of the wall by the projecting portions of small stones, will afford an excellent hold for the outside finishing and interior plastering. The roof can be made in exactly the same way, care being taken to place the flat boards on the under side of the timber, and allowing the cement a longer time to set. A house made on this principle will be dry, economical, quickly constructed, and almost absolutely fireproof.

1376. *Shelter-Sheds*.—In fig. 596 we give the plan of a shelter-shed to be placed at the corner of four fields, from each of which a door leads to interior of shed. In case two of the four fields be in grass at the same time, a fence

Fig. 596.

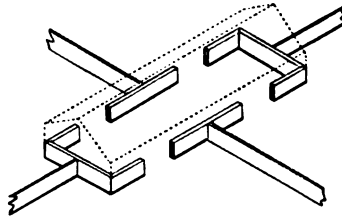

0 20 40 20 10 0
SHELTER-SHED AT THE CORNER OF FOUR FIELDS.

Fig. 597.

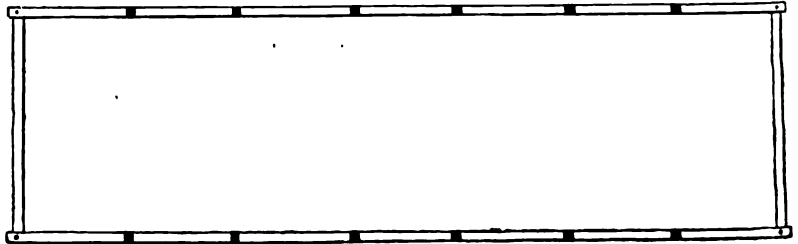

0 10 30 50 } feet.

PLAN OF BALK FOUNDATIONS OF SHELTER-SHED.

Fig. 598.

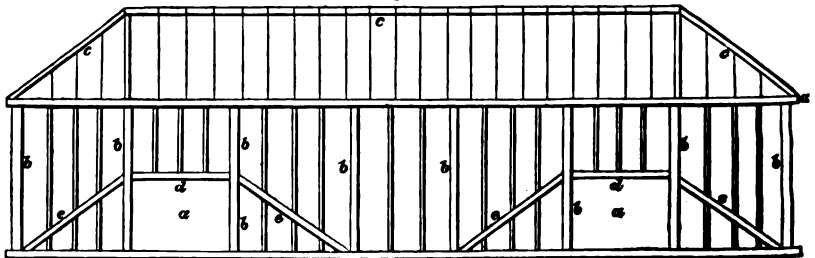

SIDE ELEVATION OF TIMBERS OF SHELTER-SHED.

could be put across the middle of the shed. Of such sheds there are too few in our pasture-fields. In fig. 597 we give plan of balk foundation for the shed.

In fig. 598 side elevation, showing arrangement of timbers: *a a* door-spaces; *b b* upright posts and cheek-posts of door-spaces; *c c* roof-timbers; *d d, e e* braces. In fig. 599 we give end elevation. These walls are 12 feet high, but they would be sufficiently high at 9 feet.

1377. *Covered Dung-Shed.*—In fig. 600 we give plan of covered dung-shed as introduced in Belgian farm-practice by Baron Peers, at Oostcamp, near Bruges. In fig. 601 we give an end elevation and section; and in fig. 602 a side elevation. In the plan, fig. 600, are two double gates *d d* on each side of the shed, for the ingress and egress of the dung, as *e e* are one double gate at each end. The shed is 60 feet long outside walls, and 27 in width. In the end elevation, fig. 601, *a a* is a pit, dug 4 feet below the ground *b b*, with a

Fig. 599.

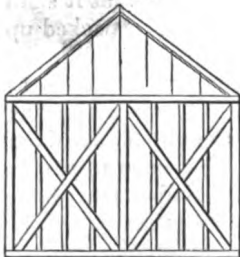

END ELEVATION OF SHED.

parapet of brickwork 3 feet above the ground, and the bottom is paved with brick; *c c c* are posts 7 feet high above the parapet; *d* is the roof, and *e e a* a double gate. In fig. 602, *a a* is the parapet, *b b* the roof, *c c* double gates, and *d d* the side-posts.

Fig. 600.

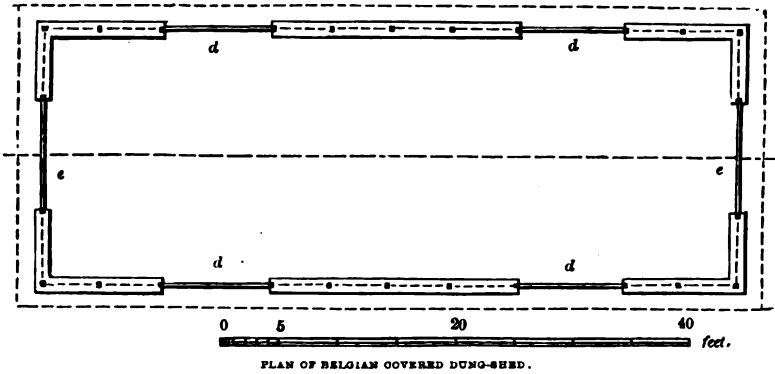

Fig. 601.

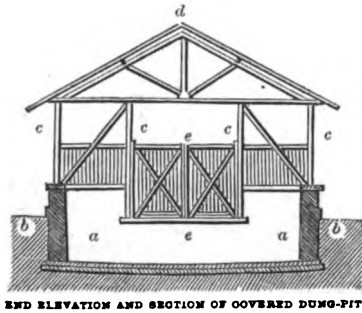
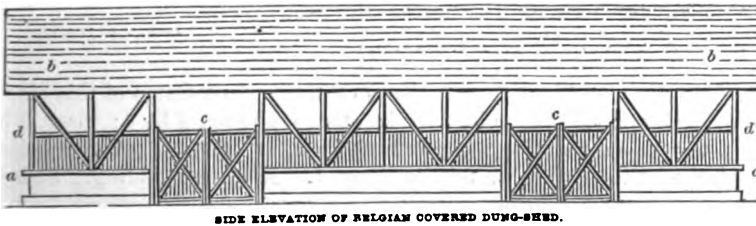

Fig. 602.



1378. The Americans are justly celebrated for their timber constructions. In fig. 603 we give a section of a barn 48 feet wide—the central portion being the barn floor, 24 feet by 42; the right and left hand divisions being the cow-stables, each 12 feet wide. The length of the posts is 18 feet, the pitch of the roof $\frac{1}{2}$; the projection of rafters over sides 2 feet. The dotted lines show the windows. In a future section, the internal arrangement of American barns or farm buildings will be fully illustrated.

1379. A style of framing known as "balloon" is now being rapidly introduced in the United

Fig. 603.



States; with extreme lightness it possesses great strength. All mortise holes, tenons, auger holes are avoided in the construction, thus insuring the perfect integrity of the timbers. Nails alone are used in the manner hereafter illustrated, and advantage taken of the full tensile and compressible strength of the timber. For the following illustrations and descriptions, we are indebted to the *American Cultivator*.

1380. Fig. 604 shows a portion of a balloon frame, drawn in isometrical perspective. This is sufficient to show the whole manner of construction, the other parts of the building being a repetition. The manner of securing the different timbers is shown in figs. 605 and 606—the nails being driven diagonally, as in fig. 605, and in a manner to secure the greatest amount of strength. In fig. 605, *a* is the corner stud, 4 inches by 4; *b b* joists, 5 by 3; *c*, 2 by 4. In fig. 606, *d* is the joist, *e* stud.

Fig. 604.

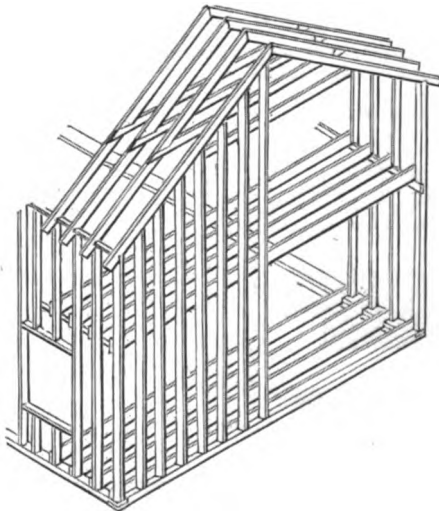

ISOMETRICAL PERSPECTIVE VIEW OF THE BALLOON FRAME.

Fig. 605.

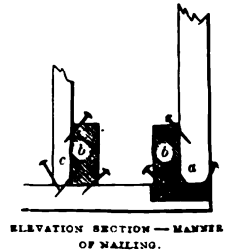

ELEVATION SECTION — MANNER OF NAILING.

Fig. 606.

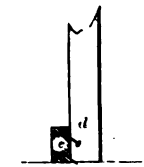

UPPER EDGE OF JOIST.

1381. The sizes of the different pieces of timber in a frame of this size are: sills, 3 inches by 8; corner studs, 4 by 4; other studding, 2 by 4; plate, 1 by 4; side strips, or side girts, 1 by 4; rafters, 3 by 6, or $2\frac{1}{2}$ by 5 will do; collars, 1 by 4; floor joists, 3 by 8, or maybe 2 by 7. Rafters, studdings, and joists are 16 inches between centres.

1382. Small buildings of this character, not calculated for heavy storage, may have all timbers 2 feet between centres. Small buildings of one storey, as tool-houses, granaries, cottages, &c., will be perfectly strong and secure, if all the timbers above the first floor joists are ripped from common $1\frac{1}{2}$ -inch floor plank—thus make studdings, ceiling joists, and rafters, $1\frac{1}{2}$ inch by 5.

1383. For large barns, storehouses, &c., larger sizes will be required. The weight and power necessary to injure a building with 3 by 8 studding, with a double row of bridging, is more than is ever practically applied to any store-house.

1384. The lining of a balloon frame adds immensely to its strength, particularly so if put on diagonally; it may be done outside or inside, though on the whole the inside is preferable. If done outside, it should be carried over the

sill and nailed to it; the sill being wider than the studding, in order to get a larger bearing on the masonry, and the floor joists being in the way, does not admit of inside lining being put on in the same manner. Close or continuous lining is not necessary for strength, but for dwelling-houses adds much to the warmth. Large buildings, not used as dwelling-houses, can be sufficiently well braced by diagonal strips of 1-inch board, 6 inches wide, nailed to the studding inside, 6 feet apart. Where vertical siding is used, these same strips can be put on in the same manner outside the studding. Let the strips run over the sill and be nailed to it. Between the strips on the sill, nail an inch board, and it is then ready for upright or battened siding. Small out-buildings, barns, &c., do not require any diagonal bracing.

1385. This kind of framing possesses many advantages — the labour of making mortise holes, &c., is dispensed with; and as any one timber can be removed without detriment to the structure, repairs are easily made — the whole indeed may be renewed timber by timber. Those requiring full information as to the system, may apply to Mr George E. Woodward, architect, 335 Broadway, New York, United States.

SUBDIVISION THIRD—*Iron Construction.*

1386. SECTION FIRST—*Beams.*—In fig. 607 we give a section of the best form of a cast-iron beam; in fig. 608 a plan; and in fig. 609 an elevation. It will be observed from fig. 608, that in plan the shape of the flanges is not rectangular, but that it tapers from the middle towards the ends *a a* in the form of double parabolas, with the vertex at the middle. By this arrangement the quantity of metal in the bottom flange is reduced without deteriorating the strength of the beam. The ratio of the strength of this beam, and that with the equal flanges, as in fig. 610, is as 4075 to 2368, which was long considered, and is now by some still considered, the best form of cast-iron beam.

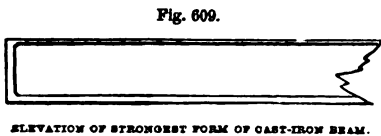
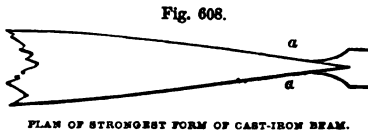

1387. In fig. 611 we give at *b b* an elevation of a cast-iron girder, calculated for a span of 18 to 20 feet between the bearings. In the plan, fig. 608, it will be observed that the shape of the lower flange is parabolic; but as the extremities of this are too narrow for bricks or beams to lie on, the plan of the beam in fig. 611 is modified, so that

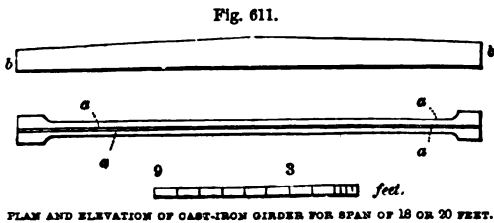

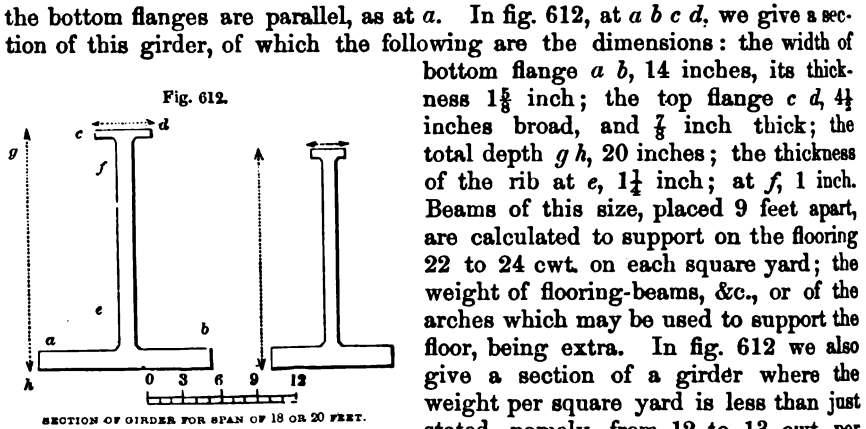

1388. In fig. 613 we illustrate a method of filling in the spaces between the girders with the binding-joists *a a*, 8 inches by 5; the bridging-joists *b b*, 6 inches by 2; and the flooring-planks *c c*. Another method is shown in fig. 614, where shoes, as *a*, are cast in the side of the girder, in which the joists *b* are laid; *c* is a front view of the shoe. Ceiling-joists, as *d*, may be suspended from the under side of the girder by bolts and nuts, in passing through projecting snags *e* cast into the bottom flange, as is the snag *g* in fig. 613.

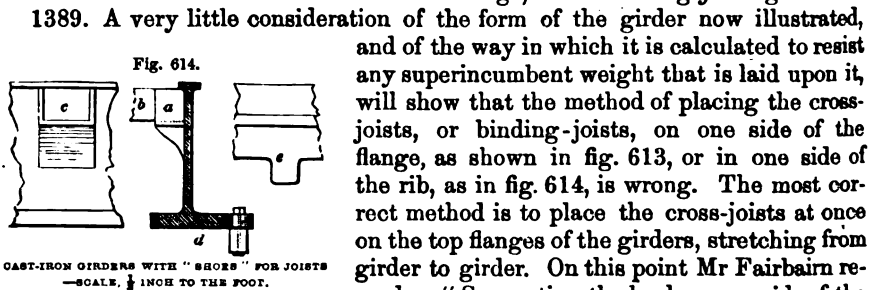
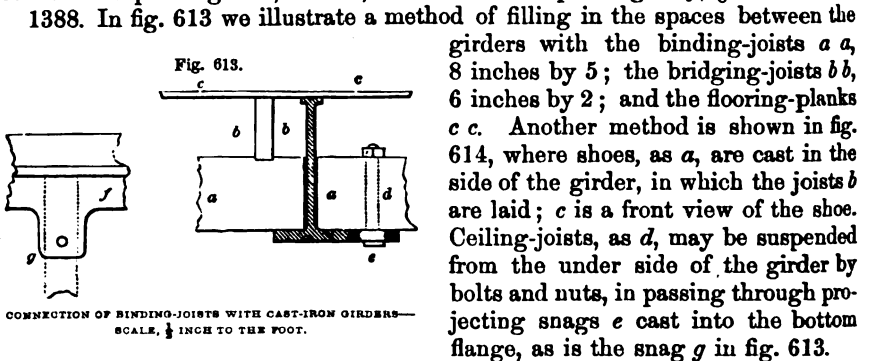

bolt-holes are made in these, by which the cross-beam *d* is bolted to the flange. By this method the whole of the cross-beams and girders are united together, and the "girder will be prevented from 'canting,' as the strain has a tendency to bring the top flange inwards, and to force the top flange outwards, thus producing a lateral strain upon the girder, which would in a great measure be resisted by the bolts in the cross-beams. The best security for girders loaded in this way will, however, be good broad flanges, cast upon the top and bottom sides, in order to resist the lateral thrust of the cross-beams."

1390. When the cross-beam or binding-joint is of cast-iron, and of the same section as the girder, Mr Fairbairn recommends an arrangement to be adopted, illustrated in fig. 615, a narrow shelf *a* being cast on the side of the flange, from one end of the girder to the other (not merely, it is to be noted, at the places where the cross-beams occur); "this would give a sufficient bearing for the cross-beam by forming the ends, as shown in the figure at *d*; and the bolt-holes *c* should perforate the vertical rib as near as possible to the neutral axis of the girder." The cross-beam is shown at *b*.

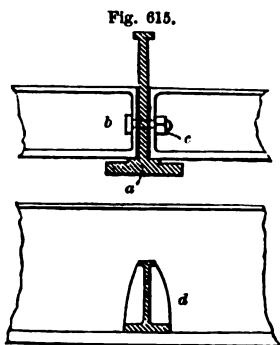

CONNECTION OF CROSS-BEAMS WITH GIRDERS—SCALE, $\frac{1}{4}$ INCH TO THE FOOT.

1391. With reference to this plan of perforating the girder, and also of making perforations for passing through the tie-bolts, often used in trussing cast-iron girders, Mr Fairbairn says, that in "cast-iron girders," even where the hole, or rather the metal immediately surrounding the aperture, is greatly strengthened, "such a process, if not fatal, would be, to say the least of it, exceedingly injurious. I have," he continues, "decided objections to anything like perforations in cast-iron girders; and it is even with some reluctance I would have a bolt-hole through the neutral axis, unless thickened so as to compensate for the part taken out; besides, it is exceedingly objectionable to cut off the connection between the two resisting flanges of a girder, or to damage in any other way a casting of this description. There is nothing I should be more tenacious about than the cutting or boring of any part of a well-proportioned girder; and I believe there is nothing so dangerous in the hands of persons unacquainted with the laws which govern the strength of these important structures."

1392. Mr Fairbairn remedies the evil arising from the use of perforated girders by the plan illustrated in fig. 616. It is of essential importance that the bottom flange shall not be perforated, the cross-beam being supported only by hook-bolts. The other method is to lay the cross-beams at once upon the girders.

1393. Where tie-rods are used to truss the girders and prevent their lateral movement, it is important that they should be placed in the proper position. This practically is at the soffit of the arch, in which position the tie-rods will perforate the "neutral axis" of the beam. The maximum point of tension of the tie-rods is at the bottom of the flange; but this, although the safest, is not the most convenient position in practice, as the tie-rod would then stretch across the chord of the arc. Tie-rods should never be placed above the arch near the top of the girder. For cases where the weight to

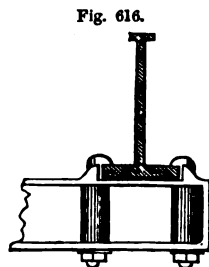

SUSPENSION OF CROSS-BEAMS FROM GIRDERS—SCALE, $\frac{1}{4}$ INCH TO THE FOOT.

be supported is equal to 13 cwt. per square yard, the sectional area of the tie-rods should not be less than 3 square inches for every 20 feet in width of the building; where the weight to be supported is equal to 24 cwt. per square yard, the area should be increased to nearly 5 square inches.

1394. As already noticed, par. 1391, Mr Fairbairn objects to all perforations in girders, as in cases where tie-rods are used; he, however, has objections to the use of tie-rods on other grounds, which we here give: "In trussing a cast-iron girder, I would much rather give the strength to the girder itself than depend upon a malleable-iron truss. The two materials are widely different in character, the one being ductile, and subject to elongation under a severe tensile strain, and the other rigid and firm under compression: they seldom, if ever, agree (if I may use the expression) well together; and during the whole of my experience, I have found it safer and better to keep them separate. Besides, the effect of tightening or screwing up the truss-rods has a tendency to throw increased strain upon the girder, or, *vice versa*, upon the rods themselves; in fact, an ignorant person screwing up the trusses might do serious injury without ever being aware of having done so. Altogether, I have now, and always had, an objection to trussed girders, whether composed of chains or rods: I have, therefore, no hesitation in recommending a perfectly simple and well-proportioned girder, free from encumbrances of all kinds."

1395. Where truss-rods are used, Mr Fairbairn, in his work *On the Application of Iron to Construction*, recommends, at p. 150,

the following method:—*a*, fig. 617, represents the flange of beam in plan, *b* the rib, which is thickened at the part *c*, through which the tie-rods pass. A rectangular hole is made in this part, through which the tie-rods *d e* are passed in opposite directions, the ends *f* catching on the rib of the beam, and the whole secured by a cotter *g*. The diameter of the rods—if wrought-iron—*d* and *e*, may be $\frac{3}{4}$ or $\frac{1}{2}$ of an inch. "This connection is probably the best, as the rods are not weakened by cotter holes, and are simply formed into single gibs, with shoulders pulling against the beams, on each side, and a key between."

Fig. 617.

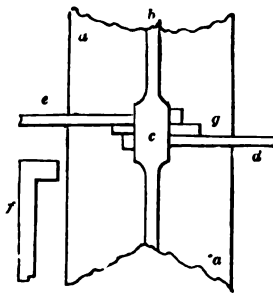

FIXING OF TRUSS-RODS OF CAST-IRON BEAMS—SCALE, $\frac{1}{2}$ INCH TO THE FOOT.

1396. *Defects of Cast-Iron as compared with Wrought-Iron Beams.*—With the pillars, cast-iron girders, and brick arches, buildings are not so safe or strong as might be expected. "Cast-iron cannot," remarks Mr Fairbairn, "be depended upon, even in the best form, and for several reasons—viz., unequal contraction in the cooling of the metal; the brittle nature of the material; imperfections and flaws in the castings; and its liability to break without warning. As regards the first point, we labour under great uncertainty in consequence of the 'shrinkage' or contraction of the metals during the process of cooling. A casting, even when well proportioned, will suddenly 'snap,' without any apparent cause. Exposure to rain, or intense frost during the night, not unfrequently produces fracture; and on these occasions, rupture takes place with a loud noise like the report of a pistol. On minute examination, the injury is at once seen to have arisen from the presence of an immense tensile strain in the immediate vicinity of the fracture, which is generally found to be greatly enlarged, and an enormous force is required to bring the parts again into contact. This unequal and dangerous force of tension, existing within the

casting itself, appears to me to be produced by one of two causes, either from unequal rates in the time of cooling, whereby the crystalline process is seriously damaged, or from imperfect mixture of the metals, whence the shrinkage is greater in one part than in another, and from which would follow unequal degrees of tension of the parts. Great care, therefore, should be observed in castings. It should be seen that the metals are well mixed, and that the moulds or patterns are so proportioned as to insure uniformity in the rate of cooling. These are practical operations of some importance, and the moulds, after running, should be covered closely up, and as much time as possible given for attaining, by a slow rate of cooling, a greater degree of perfection in crystalline structure. The second cause of danger is, that all crystalline bodies are of a more brittle and uncertain character than those which are of a fibrous structure; and as wrought-iron possesses more ductility, and partakes in a greater degree of the latter quality, it is better qualified to sustain heavy weights and shocks than cast-iron; and its high powers of resistance to a tensile strain render its application in the constructive arts an object of primary importance to all those connected professionally or otherwise with the erection of buildings. The superiority of its resistance to tension is not, however, its only recommendation, as the new forms and conditions under which it can be manufactured and applied, in position and distribution, to resist compression, is another powerful recommendation of it as a safer and lighter substitute for cast-iron. Another defect of cast-iron is the impossibility of discovering imperfections which may lie concealed under the surface of a casting, and which frequently baffle the scrutiny of the keenest observer. These defects are by no means uncommon; and repeated instances have occurred wherein castings, presenting every appearance of perfection, have been found to contain the elements of destruction, either in concealed air-bubbles, or in the infusion of scoriæ which had been run into the moulds, and skinned over by a smooth covering of apparently sound iron. Now, this can never occur in the wrought-iron beams; as the different processes of manufacture, such as puddling, forging, piling, and rolling, are sufficient to cause any imperfection calculated to endanger the soundness of the plates to be detected. It will, however, sometimes occur, that minute particles of scoriæ will be inserted between the laminæ or bars from which the plates are rolled; but this does not materially affect the strength, excepting only in the case of boilers, where they form blisters when exposed to intense heat. In the formation of bearers, these defects are of less consequence, as they do not seriously impair their strength."—*On the Application of Iron to Building Purposes*, pp. 48, 49. Weale, London.

1397. In view of these and other defects of cast-iron fireproof constructions, and the great weight of the girder, wrought-iron beams have been introduced with marked success. Mr Fairbairn, than whom no more practical authority on all matters connected with construction can be cited, thus remarks on their use:—"From the increased safety and greatly increased strength of the wrought-iron beam, it appears to me to be in every respect adapted to the construction of fireproof buildings. It offers much greater security, and is free from the risk of those accidents which not unfrequently occur with cast-iron beams, and which have created so much alarm in the public mind. . . . It now becomes a consideration of some importance to exhibit the advantages which may be gained by its introduction on a large scale into the building of warehouses, cotton and flax mills, and dwelling-houses, which require protection from risk, whether arising from weakness, from the employment of a dan-

gerous material, or from fire. In these erections, it will be found exceedingly valuable, irrespectively of the sense of security which the nature of the material is sure to establish in the public mind. Impressed with these convictions, I unhesitatingly recommend its adoption to the architect and engineer; and provided the laws which govern its strength be carefully attended to, I have every reason to believe that a few examples will not only give entire confidence in its powers, but that increased experience will elicit improved conditions, and probably better forms for its application."

1398. In fig. 618 we give a section of the "plate beam" which Mr Fairbairn most approves of. The length between the bearings for this example is 30 feet, and the breaking weight at the centre is 27.5 tons, uniformly distributed over its surface 55 times: one-fourth or one-third of this should be the amount laid upon it. The total depth is 22 inches; the breadth of bottom flange $5\frac{1}{2}$ inches; its thickness $\frac{3}{8}$ inch; the breadth of upper flange $7\frac{1}{2}$ inches; and thickness $\frac{1}{4}$ inch. The thickness of the middle plate is $\frac{1}{16}$ of an inch. As will be seen from the sketch, the beam is composed of a central plate, with angle irons riveted on each side at the upper and lower edges. There is very little difference between the cost of a girder of this kind and that of a cast-iron girder

calculated to bear the same weight; but the wrought-iron girder is only one-third of the weight of the cast-iron, and therefore costs less for carriage, and is easier erected and put in its place, besides possessing, as we have shown, the advantages of increased safety.

1399. In fig. 619 we give a section of a rolled beam, after the manner of

rails, adapted for wrought-iron fireproof construction; the length $a b$ being 20 feet. The width of bottom flange is 4 inches, and thickness $\frac{1}{2}$ an inch; of top flange, 4 inches, and thickness $\frac{3}{4}$ inch; the thickness of rib c $\frac{3}{8}$; total depth of beam 15 inches.

1400. In fig. 620 we show the method of fixing the tie-rods to wrought-iron beams; $a a$ the upper flange of beam, $b b$ the tie-rod, $\frac{3}{4}$ inch broad and $\frac{3}{8}$ thick; c is

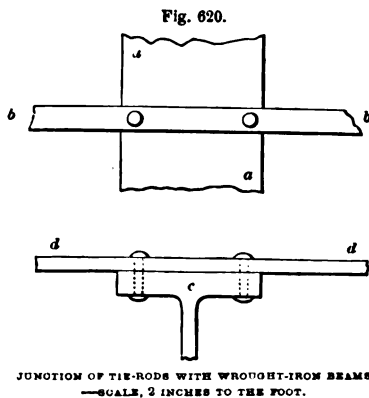
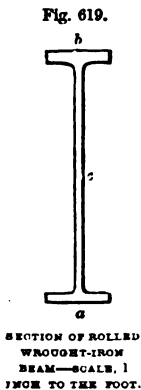
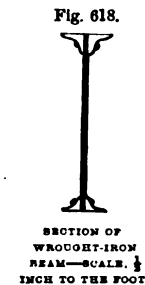

a part cross section of beam, $d d$ tie-rod.

1401. We here append the dimensions of cast-iron girders, and joists or binders, for a few of the most useful spans, calculated for loads of 280 lb. per square foot of floor, this including the material resting upon the floor, as grain or machinery, and the weight of the joists and the flooring materials. Fig. 612 will illustrate the different measurements: thus, $a b$ is the bottom flange; $c d$ the top flange; e the "thickness of rib" at the bottom; f the thickness at top; $g h$ total depth of girder.

1402. The following are the sizes of main girders adapted to support $2\frac{1}{2}$ cwt. per square foot. A floor of 30 feet square, 900 superficial feet, supports a load of 111 tons 5 cwt. The dimensions of the girder are as follows: length, 32 feet;

extreme depth, from g to h , fig. 612, 30 inches; bottom flange $a b$, 2.4 inches in breadth, $4\frac{1}{2}$ inches thick; top flange $c d$, 8 inches broad, $4\frac{3}{8}$ inches thick; thickness of rib at e , $3\frac{1}{4}$ inches; at f , 2 inches. For a room of 25 feet square, the floor of which, 625 feet superficial, supports nearly 81 tons: length of girder, 27 feet; breadth of bottom flange $a b$, 21 inches, thickness $4\frac{3}{8}$ inches; breadth of top flange $c d$, $6\frac{1}{4}$ inches, thickness $2\frac{1}{2}$ inches; depth of girder $g h$, 24 inches; thickness of rib at e , $2\frac{7}{8}$; at f , $1\frac{3}{4}$. For a room 20 feet square, the floor of which, 400 feet superficial, supports a weight of 50 tons: length of girder, 22 feet; breadth of bottom flange $a b$, 15 inches, thickness 3 inches; breadth of top flange $c d$, $5\frac{1}{2}$ inches, thickness $1\frac{1}{2}$ inches; depth of girder $g h$, 24 inches; thickness of rib at e , 2 inches; at f , $1\frac{1}{4}$ inch. For a room of 16 feet square, the floor of which, 256 square feet, supports 28 tons, the length of the girder is 18 feet; the breadth of bottom flange $a b$, 14 inches, its thickness 2 inches; breadth of top flange $c d$, $4\frac{1}{2}$ inches, its thickness $\frac{1}{2}$ inch; depth of beam, $g h$, 18 inches; thickness of rib at e , $1\frac{3}{4}$ inch; and at f , 1 inch.

1403. The following are the dimensions of binders or joists adapted for the foregoing cases, and still illustrated by fig. 612: For a bearing of 30 feet, with a distance of 6 feet from centre to centre of joists, the weight supported is $22\frac{1}{2}$ tons, at $2\frac{1}{2}$ cwt. per square foot. Length of joist 25 feet, breadth of bottom flange $a b$, 18 inches, thickness $2\frac{1}{4}$ inches; breadth of top flange, 6 inches, thickness $1\frac{1}{8}$ inch; depth of joist $g h$, 18 inches; thickness of rib at e , $1\frac{5}{8}$; at f , $1\frac{1}{4}$. For a bearing of 25 feet, the distance from centre to centre of joists being 6 feet, the weight supported is nearly 19 tons. Length of joist 25 feet; breadth of bottom flange, $a b$, 18 inches, thickness $2\frac{1}{4}$; breadth of top flange $c d$, $5\frac{3}{4}$, thickness $1\frac{1}{2}$ inch; depth of joist $g h$, 12 inches; thickness at e , $1\frac{5}{8}$ inch; at f , $1\frac{1}{4}$. For a bearing of 16 feet, with the joists 6 feet apart from centre to centre, the weight supported is 12 tons. The length of joist is 16 feet, the breadth of flange $a b$, 8 inches, its thickness 2 inches; the breadth of flange $c d$, 3 inches, thickness 1 inch; depth of joist $g h$, 12 inches; thickness of rib at e , $1\frac{1}{4}$; at f , 1 inch. For a very full table of the sizes of girders and joists for a variety of spans and depths, we would recommend the reader to Weale's *Engineer's Pocket-Book for 1855-56* (6s.)

1404. SECTION SECOND—Columns.

1405. *Cast-Iron Columns, and Junctions with Girders or Beams.*—Where the foundation on which the column rests is good hard stone, the simplest method of fixing or bedding is shown in fig. 621, where a is the foundation-stone, with a socket cut into it to receive the neck b of the column c . Care must be taken to have the end of the neck perfectly flat.

1406. Where the foundation is of brick or soft stone, a cast-iron plate $g g$, fig. 622, should be let into the top of the stone a ; the plate has a collar or projection b , which passes into the aperture of the pipe of the column; the solid parts of the column fit into the parts $c c$; d shows the pillar connected with the base.

1407. Fig. 623 represents the method of fixing the column at foundation in cotton factories; $a a$ the stone-bed, resting on two or three brick courses; $b b$ a cast-iron plate, bolted to the stone, and provided with a circular projection c —the hollow end of the column d passes over this; $e e$ shows a plan of the whole. For supporting beams of 20 to 25 feet span, the diameter of column

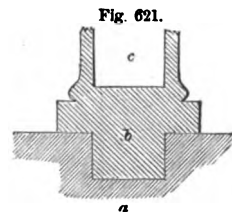

FIXING OF CAST-IRON PILLAR—
SCALE, 1 INCH TO THE FOOT.

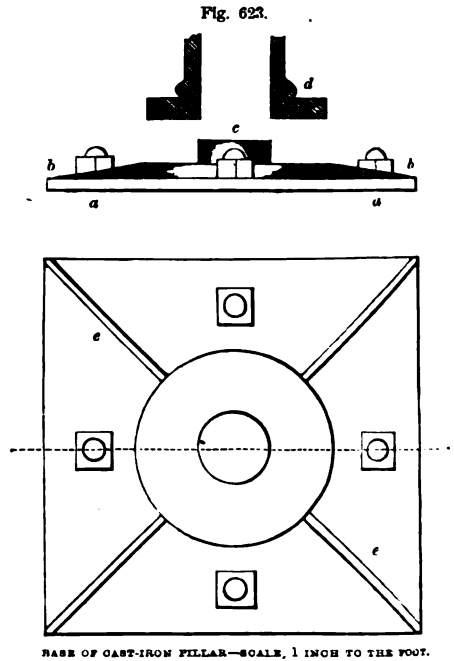
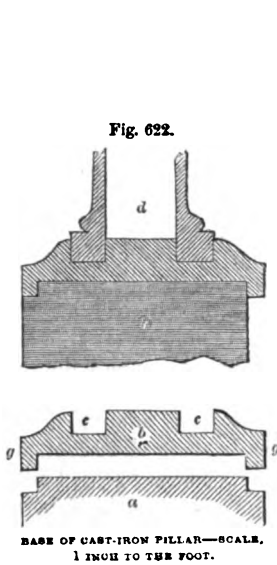

should be 8 inches; the thickness of metal at the bottom of $1\frac{3}{8}$ inch, and $\frac{5}{8}$ at the top. For beams of 18-feet span, the diameter may be reduced to 7 or $6\frac{1}{2}$ inches; the size of base-plate *e e* or *b*, fig. 623, being from 2 to $2\frac{1}{2}$ feet square. Mr Fairbairn states, "that the base of the lower columns should, in every case, be considerably enlarged, and the ends faced in the lathe; the base-plate, which receives it, should also be faced. This is the more necessary, as it gives an even surface for the purpose of levelling the plate, and maintaining the vertical position of the column."

1408. The top of the pillar or column must be specially adapted to receive

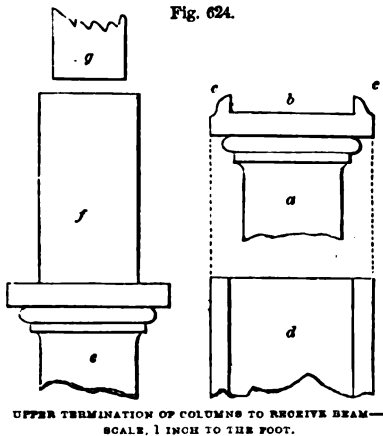

the girders or joists which rest upon it. A method of doing this is shown in fig. 624, where the top-plate *b* is left square, and has along two of its edges snags or projections *c c*; the space between these should be wide enough to allow the girder to be inserted easily, with a little on each side to allow of expansion; *d* shows the plan of top-plate. Where there are two storeys to the building, and one row of columns has to rest upon the other immediately beneath, the best method to adopt is to have the neck *f* of the lower pillar *e* prolonged, and made hollow, to receive the end *g* of the upper pillar. The neck *f* must be long enough to be flush with or a little above the top

edge of the girder, when it is laid upon the cap of the lower pillar *e*.

1409. Fig. 625 shows another method of connecting one base of upper column with the cap of lower one, of which the upper part *a* receives the lower part *b* of column. The socket *a* and part *b* should both be carefully faced in the lathe to insure accurate fitting.

1410. Where the caps of columns in rows are tied together by truss-rods—which run at right angles to the line of beams—as the ties *a a*, fig. 626, connecting the columns *b b b* placed opposite each other—the method recommended by Mr Fairbairn is the best which can be adopted to secure the tie-rods.

1411. In fig. 626 *c c* is part of cap of column, with slot holes in each side, as *d*. The tie-rods *e e* are terminated with

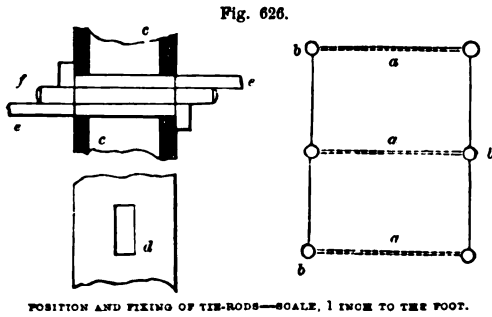
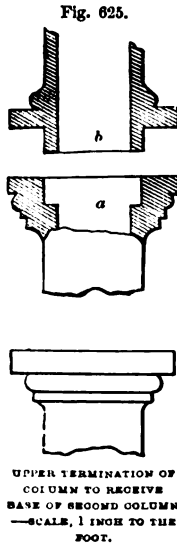

catches or bent points, which grasp the cap of the column, and are secured together by driving in the key *f*.

1412. There are various methods in use to join girders together, lying on the caps of columns. The simplest is illustrated in fig. 627, which represents a plan of the top of two girders, the ends *a c* and *b d* of which are expanded into flanges, to allow of bolt-holes to be made. The side view is seen at *e*.

1413. The method adopted where a circular neck is made to the cap of the column, as *f* in fig. 624, is illustrated in fig. 628. In this form of joint the ends of the girders *b b* and *c c* are expanded into semicircular flanges, which embrace

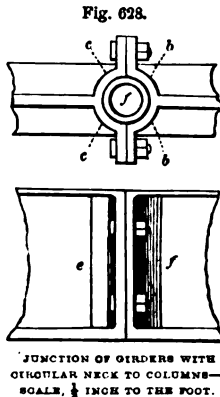
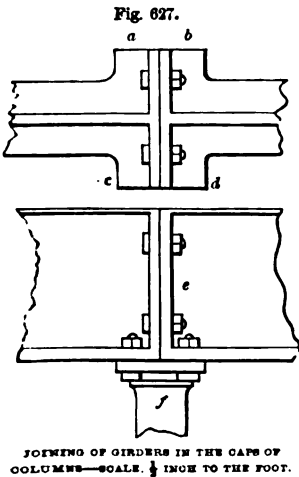

the neck *f*, as *f* and *f* in figs. 624 and 627, and are secured by bolts and nuts. The side view is shown at *e f*, fig. 628.

1414. In place of joining the two beams with bolts and nuts, as shown in fig. 629, projecting horns *a b* may be cast in the ends of the beams *c d*, which embrace the cap *e*; these two horns being secured by wrought-iron clasps or clips *f g*.

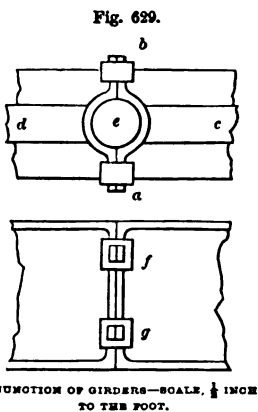

JUNCTION OF GIRDEES—SCALE, $\frac{1}{2}$ INCH TO THE FOOT.

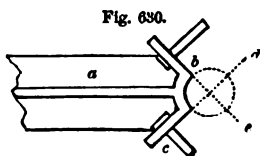

JUNCTION OF FOUR GIRDEES ON CAP OF COLUMN—SCALE, $\frac{1}{2}$ INCH TO THE FOOT.

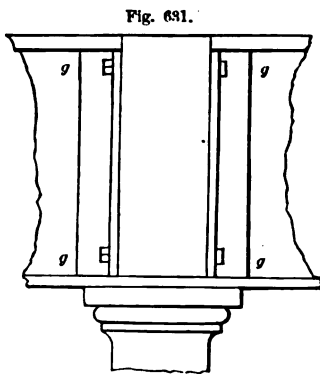
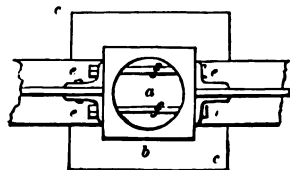

Fig. 631.



JUNCTION OF WROUGHT-IRON BEAMS IN CAP OF COLUMN—SCALE, 1 INCH TO THE FOOT.

1415. Where four girders meet on the cap of a column with neck, as at *f*, fig. 627, the ends of the girders are expanded into flanges of the form as shown in fig. 630, at *b* and *c*. Where four of these are put together, the ends form a figure as shown by the dotted lines *b e, c d*.

1416. *Junction of Wrought-Iron Beams with Cast-Iron Columns.*—In fig. 631 we show how this is effected: *a* the central hollow of column; *b* the square

part of the cap *c c*, against which the ends of the two beams abut; angle-irons *e e, e e* are secured to the neck of column by the bolts *f f*, which pass through the part *a*, and are secured by nuts. The angle-irons *e e, e e* are riveted to the beams, as shown in the front elevation at *g g, g g*.

1417. SECTION THIRD—*Roofs.*—In fig. 632 we give a skeleton diagram of a roof adapted for a span of 18 feet, and in which the principals are placed at a distance of 7 feet apart. The following are the dimensions of parts:—The rise or camber of tie-rods from *a* to *b* = 6 inches; from *a* to *c*, 4 feet; diameter of tie-rods *a d*, $\frac{3}{4}$ inch; diameter of king-bolt *b c*, $\frac{5}{8}$ inch. The following are the dimensions of the rafters *c d, c g*, of which the right hand of fig. 633 is a section: Width of table *a b*, fig. 633, 2 inches; thickness of do., $\frac{1}{4}$ inch; total depth

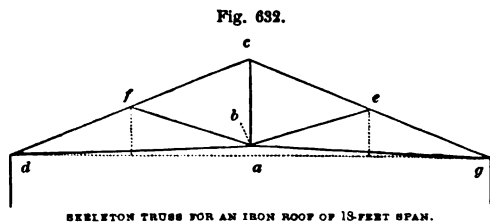

SKELTON TRUSS FOR AN IRON ROOF OF 18-FOOT SPAN.

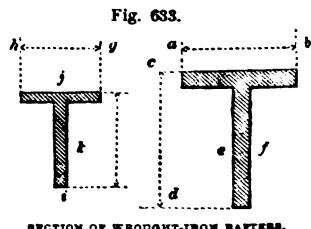

SECTION OF WROUGHT-IRON RAFTERS.

from *c* to *d*, $2\frac{1}{2}$ inches; thickness of rib *e f*, $\frac{3}{8}$ inch. The following are the dimensions of the struts *e b, f b*, fig. 632, of which the left hand of fig. 633

is a section : Width of table $g h$, $1\frac{1}{2}$ inch ; thickness of do., $\frac{1}{4}$ inch ; depth from j to i , $1\frac{1}{2}$ inch ; thickness of rib k , $\frac{1}{4}$ inch.

1418. *Details of Roof in fig. 632.*—In fig. 634 we give detail drawings of rafter-box or shoe, in which the lower terminations of the rafters e or g are fixed ; $a a$ is the wall-plate, to which the shoe $b b$ is bolted by bolts c , or, in place of being secured to a wall-plate, the shoe may be at once built into the wall ; d the recess in which the end of the rafter e is placed. To the front of the shoe a snag f is cast, which is embraced by the jointed end of the tie-bolt ($d b$, or $g b$, fig. 632), and secured thereto by bolt and nut.

1419. Fig. 635 is the plan of shoe ; a the recess for rafter, b the snag for tie-bolt.

Fig. 634.

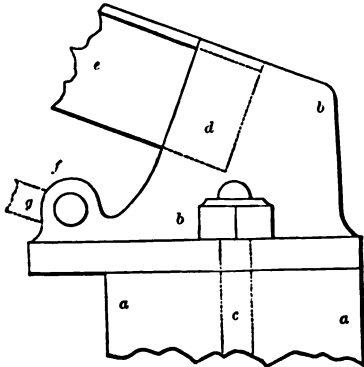

RAFTER-SHOE FOR ROOF IN FIG. 632.—SCALE IN FIG. 637.

Fig. 635.

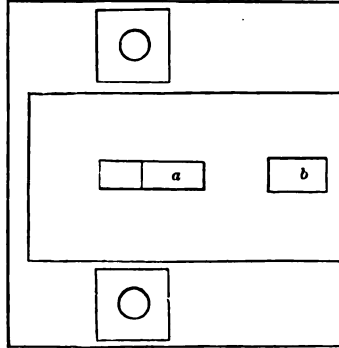

PLAN OF RAFTER-SHOE—SCALE IN FIG. 637.

1420. In fig. 636 we give a sketch of another form of shoe, in which the tie-bolt a is inserted in an aperture and secured by a key b ; c the end of the rafter. In the end view d is the recess for the rafter, e the aperture for the tie-bolt.

Fig. 636.

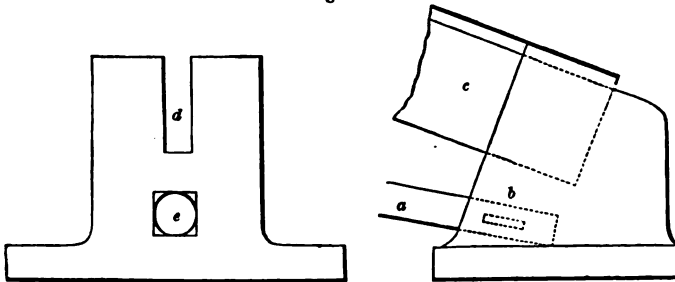

SIDE AND END ELEVATION OF RAFTER-SHOE—SCALE IN FIG. 637.

1421. In fig. 637 we give plan and elevation of the shoe, in which the upper ends of the rafters $d c$, $g c$, fig. 632, are secured. The ends of the rafters $a a$ are cut off at right angles, as at b and c , and are passed into slots made in the thickness of the shoe. The king-bolt d is passed into a circular aperture in the under side of shoe, and secured by a cotter key e ; f is the recess for ridge-pole. In the plan of lower side, $g g$ are the slots, in which the rafters $a a$ are inserted, being secured therein by rivets or bolts ; h the central aperture, in which

the king-bolt *d* is inserted. In plan of upper side, *k k* slots for rafters, *i i* recess for ridge-pole.

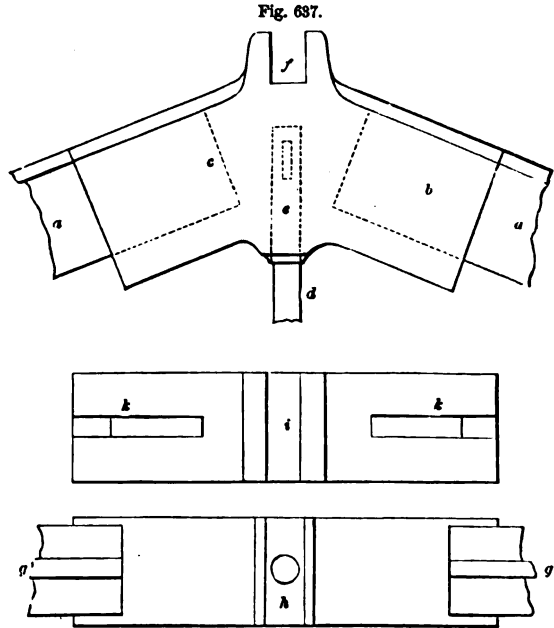

ELEVATION AND PLANS OF SHOE FOR UPPER END OF RAFTER—SCALE IN FIG. 637.

1422. In fig. 638 we give side-elevation, and elevation and plan, showing method of connecting foot of king-bolt *c b*, fig. 632, feet of struts *e b*, *f b*, and inner ends of tie-rods *a d*, *a g*.

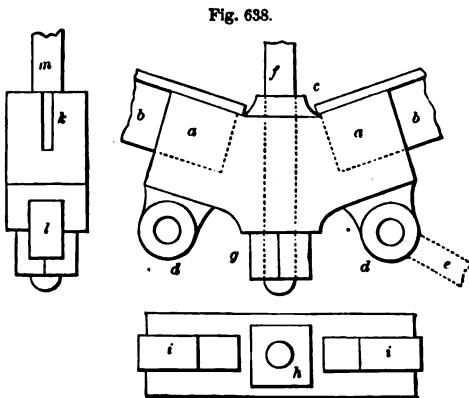

JUNCTION OF KING-BOLT, STRUTS, RAFTERS, AND TIE-RODS—SCALE IN FIG. 637.

In fig. 638 the ends *a a* of the struts *b b* are inserted in recesses made in the cast-iron shoe *c*; to the under side of the shoe two snags *d d* are provided, to which the ends of the tie-rods *e* are jointed. The king-bolt *f* passes through an aperture in the centre of the shoe, and is tightened up by a nut *g*, fitted on the screwed lower end of king-bolt *f*. In the plan of under side of shoe, *h* is the nut of king-bolt, *i i* snags to which the tie-rods are jointed. In the side elevation *k* is the recess in which the end of strut is

inserted, *l* the snag to which the end of tie-rod is jointed, *m* the king-bolt.

1423. In fig. 639 we give another method of joining the feet of struts *e* and *f*, and the ends of the tie-rods *a d*, *a g*, fig. 632. In fig. 639 the ends of the tie-rods *a* and *b* are finished with circular eyes, and plates *c c*, *d d* are secured to them by bolts *e e*, *e e* passing through circular holes and secured by nuts. The ends of the rafters *f f* are bent so as to lie flat on the upper plate *c c*, and are secured

to the plate *c c* and eyes of tie-rods *a b* by the bolts *e e, e e*. The king-bolt *g* passes through the central aperture in the plates *c c, d d*, and is screwed up by nuts. In the plan, *h h* are the upper sides of rafters, *i i* the sides of upper plates corresponding to *c c*, *k* the nut of king-bolt, *l m* the nuts corresponding to *e e*.

Fig. 639.

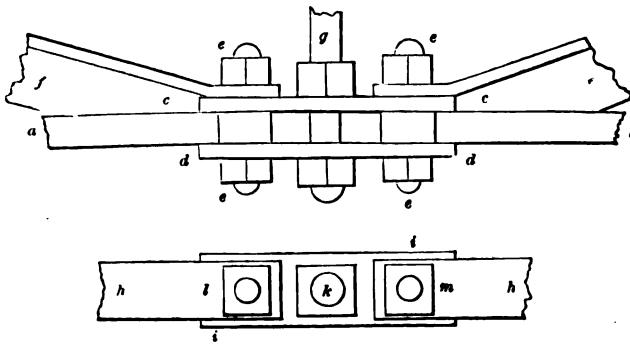

JUNCTION OF KING-BOLT, RAFTERS, AND TIE-RODS—SCALE IN FIG. 637.

1424. A third method of effecting the junction of the struts and tie-rods is shown in fig. 640, in which the tie-rods *a* and *b* pass into holes in the shoe, and are secured by keys or cotters *c c*. The king-bolt *d* passes through a central aperture, and is secured by the nuts *e e*. In the end view, *f* is the king-bolt, *g* the recess in which the ends of the struts are placed, *h* the aperture into which the end of the tie-rod *b* passes.

Fig. 640.

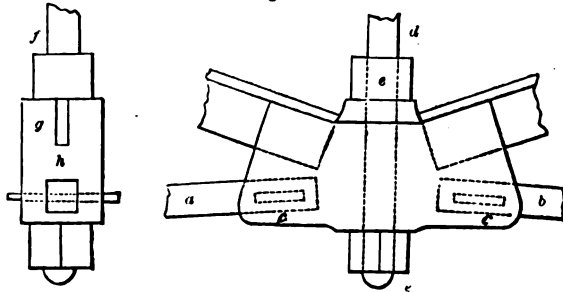

JUNCTION OF KING-BOLT, RAFTERS, AND TIE-RODS—SCALE IN FIG. 637

1425. In fig. 641 we give view of end of tie-rods *a d, a g* in fig. 632, of which *a a*, fig. 641, is the side, *b c* the plan of jointed end; the snag *d*, fig. 638, passing into the part *b*, and the whole being secured by the bolt *d* passing through the holes and tightened up by the nut *e*. The outer termination of the tie-rods, where they are secured to the snag of the rafter-shoe in fig. 634, at *g*, are precisely the same as here shown.

Fig. 641.

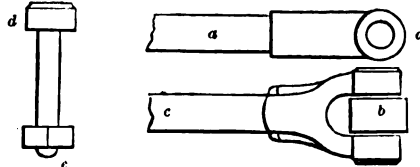

DETAILS OF TIE-RODS—SCALE IN FIG. 637.

1426. Fig. 642 shows the method of connecting the upper end of strut *b e*, fig. 632, with the rafter *c g*. The rafter is shown at *a a*, fig. 642. Two wrought-iron plates *b b*—one on each side of the web of the rafter—are secured by rivets *c c*. Into the space between these two plates the end of the strut *d* is inserted, this being terminated by a line *e* parallel to face of rafter *a a*. The plates *b b* are secured to the end of the strut *d* by rivets *f*, as shown. We

give also in fig. 642 a plan in which the plates *g* are shown secured to the strut *h h*; *i i* being the bolts and nuts by which the plates are secured to the rafter *a a*.

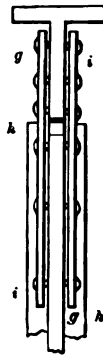
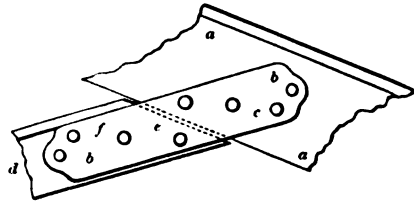

Fig. 642.



JUNCTION OF STRUTS WITH RAFTERS—SCALE IN FIG. 637.

1427. *Double Roof for Wide Spans.*—The same form of truss now illustrated may be used in forming the roof of a wide building, as the cow-byre *s s* of the Suburbial Farm-Steading for Dairy, in Plate VI., the plan of roof of which is shown in fig. 10, Plate X., and the span of which is 58 feet.

1428. Fig. 643 shows the arrangement of roof trusses. A row of pillars or cast-iron columns *a* being placed down the centre of building at distances of 6 feet apart, the inner ends of the trusses *b* rest on shoes secured to the caps of the columns, the outer ends *c c* to shoes on the walls *d d*. For a span of 29 feet the following will be the dimensions of the parts of the truss, the letters of reference being those in fig. 632: Camber of tie-rods from *a* to *b*, $8\frac{1}{2}$ inches; height from *b* to *c*, 5 feet 8 inches; diameter of king-bolt *b c*, 1 inch; diameter of tie-rod *a d*, $1\frac{1}{4}$ inch. The dimensions of rafters and struts are as follows, the letters of reference being those in fig. 633: rafters, width of table *a b*, $2\frac{1}{4}$ inches; thickness of table, $\frac{1}{8}$ inch; depth from *c* to *d*, 3 inches; thickness of rib *e f*, $\frac{3}{8}$ inch; struts, width of table *g h*, 2 inches; thickness of table $\frac{1}{4}$ inch; depth from *j* to *i*, 2 inches; thickness of rib *k*, $\frac{1}{8}$ inch.

Fig. 643.

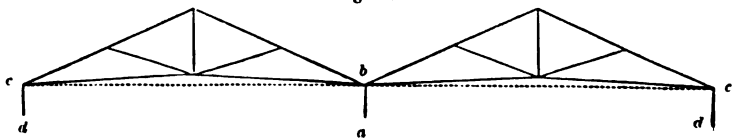

SKELETON TRUSS OF DOUBLE-SPAN ROOF—SCALE IN FIG. 637.

1429. *Details of Roof in fig. 643.*—All the details are of the same construction as those for truss in fig. 632, with the exception of the shoe for the feet of rafter at the junction of trusses at the point *b*, fig. 643. In fig. 644 we give a side elevation of the shoe for this part: *a a* the upper part of column; *b b* cap of same, to which the shoe is bolted; the ends of the rafters *c c* are passed into recesses formed in the shoe; *d d* are snags to which the ends of the tie-rods *e e* are jointed; *f* a slot, through which the truss-rods connecting the rows of pillars or columns together are passed, and which are secured as shown in fig. 626.

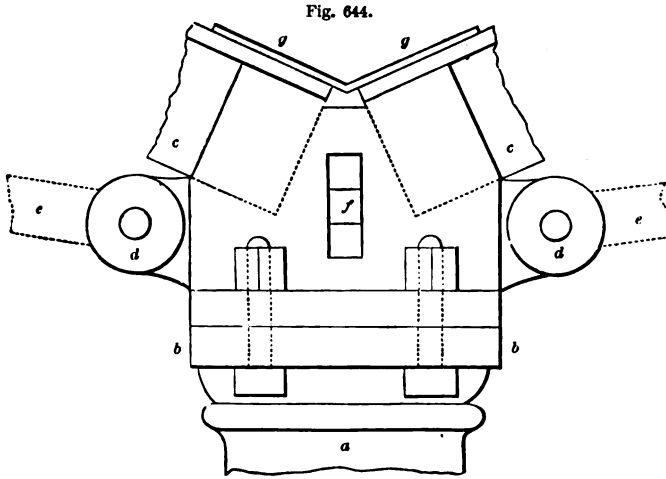

RAFTER-SHOES FOR ROOF IN FIG. 613—SCALE IN FIG. 637.

1430. *Iron Truss without King-Bolt.*—In fig. 645 we give the drawing of a truss of this kind adapted for spans from 18 to 30 feet. The span $f g$, in fig. 645, is 25 feet.

The king-bolt $c b$ is dispensed with, and two struts $d e$, $d e$ are used, with tie-bolts $c e$, $c e$. The dotted lines $g i a h f$, and $d i$, $d h$, show the position of the struts and tie-bolts before being braced up into the positions shown by the black lines.

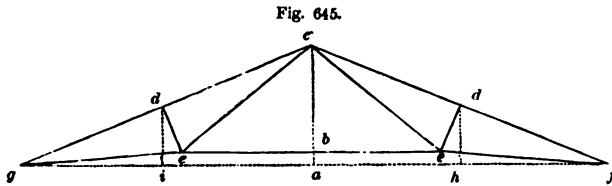

SKELETON OF IRON TRUSS FOR SPAN OF 25 FEET—SCALE IN FIG. 637.

1431. *Details.*—In fig. 646 we give a side and end elevation of a form of truss: $a a$ part of the rafter, $b b$ the strut, secured by the bolt c . In the side elevation d is the lower part of the strut, $e e$ the sides of the upper part, f the place in which the rafter $a a$ is put, $g h$ the bolt. In fig. 647 we give side, and in fig. 648 edge, elevations of the lower

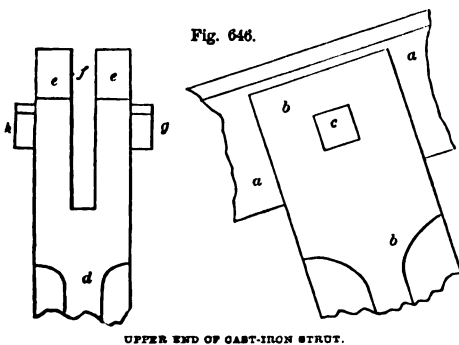

UPPER END OF CAST-IRON STRUT.

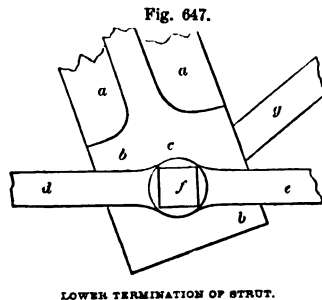

LOWER TERMINATION OF STRUT.

part of the strut $a a$, $b b$, fig. 646, provided with a bolt-hole at c . The part of the

tie shown at *e*, fig. 647, corresponds to the tie *e f* in fig. 645; the tie at *d*, fig. 647, to the tie *e b e* in fig. 645; the part of the tie at *g*, fig. 647, to the ties *e c*, fig. 645. The whole of these ties, as *d*, *e*, *g*, fig. 647, are secured to the strut *a a*, *b b* by the bolt *f*. In 648, *a b* the strut, *d g* the ties, and *f* the bolt.

1432. In fig. 649 we give a front, and in fig. 650 a side elevation of the assemblage of rafters, ridge-pole, bracket, and ties for a roof, as of fig. 645; the same letters referring to both figures: *a a* the rafter-head, or box, formed of two cast-iron plates, which embrace the ends *e* of the rafters, and are secured by bolts *f f*. They are provided with two snags *b b*, to which the ties *k k* are bolted by the bolts *d d*; the brackets *g g*, cast to the sides of *a a*, support the ridge-pole box or shoe *h h* in the cavity *i* of which the ridge-pole rests.

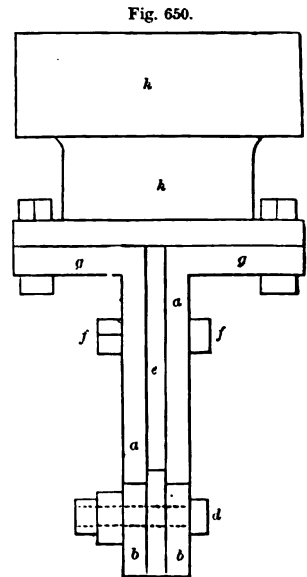
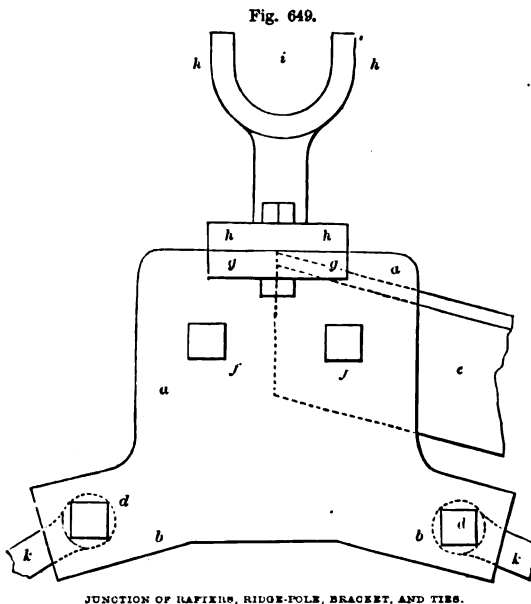
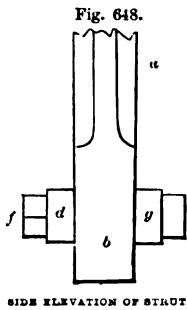

1433. We give in fig. 651 the elevation of another method of joining the assemblage of parts shown in figs. 649, 650, where *a a* is the cast-iron shoe, *b* the recess for ridge-pole, *c* the rafter, *d e* the line of tie-rods *e c*, fig. 645, of which *f f*, fig. 651, is a side elevation, and *g g* edge, showing part which embraces the shoe *a a*.

1434. *Shoe for Feet of Rafters.*—We give, in fig. 652, an elevation of shoe for the feet of the rafters *c g*, *c f* in fig. 645: *a* the rafters, *b* the bolt which secures the shoe to the wall-plate, *c* that which secures the gutter, *d* the bolt-hole for securing the end of tie-rod. In the plan below, *e* is the end of the tie-rod, with circular eye *f*, *h* the bolt, secured by the nut *i*, *k* the recess into which the end of rafter passes.

1435. In fig. 653, in the upper part, end view of shoe is given: *a* the end of tie-rod, *b* the circular eye of the same, *c* the bolt securing it to the snags *d d*, *e* the nut, *f* the recess for end of rafter. In section below, *g* is a front, and *h a* a side view of the eye of tie-rod *a*.

Fig. 651.

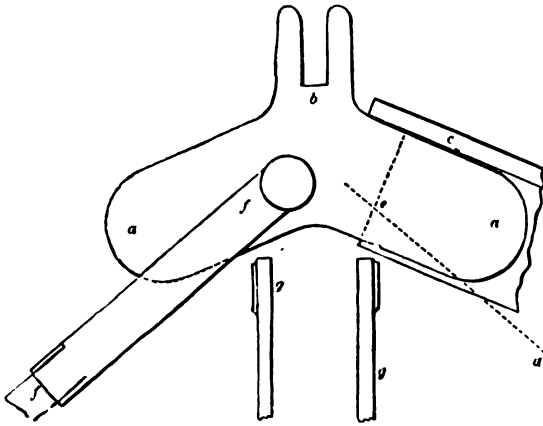

SHOE FOR RAFTERS—SCALE IN FIG. 657.

Fig. 652.

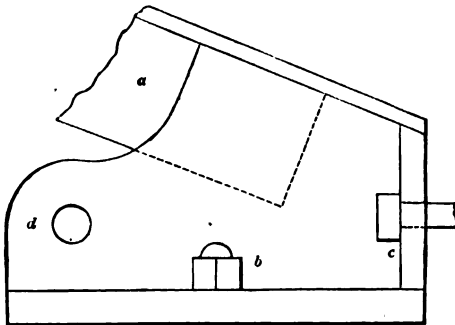
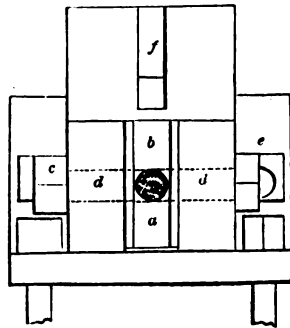
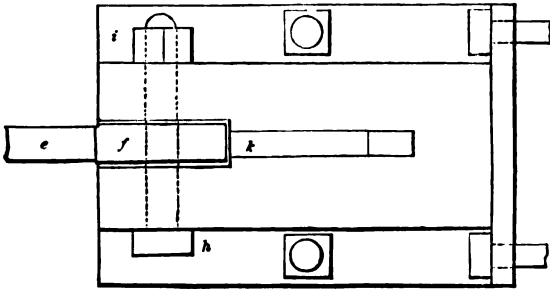

Fig. 653.



END VIEW OF RAFTER-SHOE AND DETAILS OF TIE-RODS—SCALE IN FIG. 657.



SHOE IN PLAN AND ELEVATION FOR SECURING FEET OF RAFTERS—SCALE IN FIG. 657.

1436. In fig. 654 we give side elevation of upper part of another form of strut adapted for the truss in fig. 645, in which *a a* is the rafter at part *d*, fig. 645, the bolts *b b* securing the strut *c* to the same.

1437. In fig. 655 we give side elevation of the lower part of strut *a a*, terminated with a circular plate *b b*, in the periphery of which apertures are made, in which the ends of the tie-rods *c d e* are inserted, these being secured by keys shown by the dotted lines.

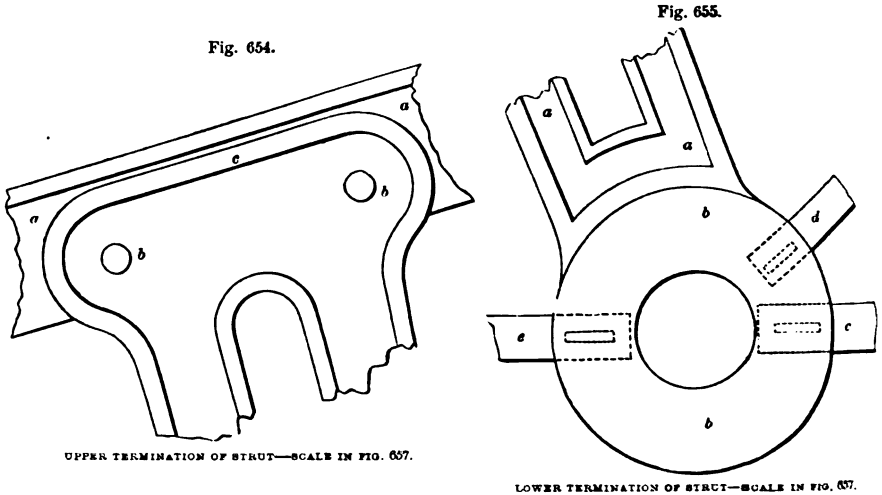

1438. *Iron Trusses with Queen-Bolts.*—Of this class of roof for spans from 28 to 40 feet, we give a skeleton diagram in fig. 656 for a span of 30 feet, and of which the following are the dimensions: camber of roof from *e* to *d*, 9 inches; rise of roof from *d* to *a*, 6 feet; distance apart of king-bolt *d* and queen-bolts *f* and *g*, 5 feet; diameter of king-bolt *d a*, $1\frac{1}{8}$ inch; diameter of queen-bolts *f f*, $\frac{5}{8}$ of an inch; of queen-bolts *g g*, $\frac{1}{2}$ inch. Dimensions of rafters and struts, the letters of reference being the same as in fig. 633:—Rafters, width of table *a b*, $2\frac{1}{2}$ inches; thickness of table, $\frac{3}{8}$ of an inch; depth from *c* to *d*, 3 inches; thickness of rib *e f*, $\frac{3}{8}$ inch. Struts, width of table *g h*, $1\frac{1}{2}$ inch; thickness of table, $\frac{1}{4}$ inch; depth from *j* to *i*, 2 inches; thickness of rib *k*, $\frac{1}{8}$ inch.

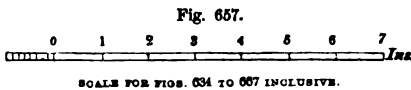
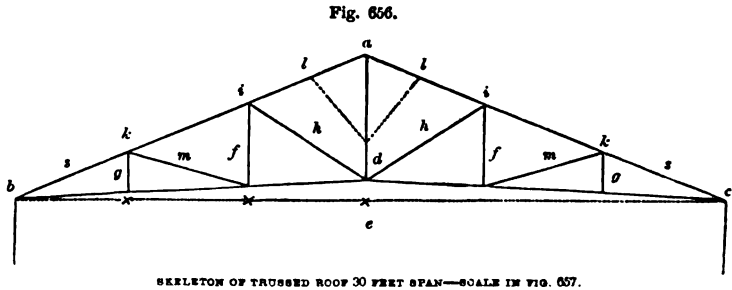

1439. *Details of Truss in fig. 656,* the scale for all of which is given in fig. 657.

1443. Fig. 662 illustrates the method of forming the connection between the upper end of the queen-bolt *c*, fig. 660, with the rafter *a a*, fig. 659. In fig. 662, the upper part of the queen-bolt is jointed as at *d*, and provided with two eye-holes at *a a*. The plates *b b*, fig. 659, pass between the forks *a a* of the end of the queen-bolt in fig. 662; and a bolt is passed through the bolt-holes in *a a*, and the bolt-hole *d* in *b b*, fig. 659, and is secured by a nut. In fig. 662, *b* shows in side view the bolt-holes at *a a*, *c* the section of the queen-bolt *f*, fig. 656 ($\frac{5}{8}$ inch), and *e* the section of queen-bolt *g* ($\frac{1}{2}$ inch), also in fig. 656.

1444. Fig. 663 illustrates the method of joining the upper extremities of the two rafters in *a b, a c*, fig. 656, the ends of which are cut off at right angles to the direction of their length, as shown by the dotted lines of *d* and *d*, fig. 663. The king-bolt-head *a a* is made of cast-iron; and space is provided between its two projecting ends, as shown at *a a*, fig. 664, into which the ends of the rafters are inserted, and secured by bolts and nuts or rivets passing through the "head" *a a*, fig. 663, and the rafters. The upper part of the head is terminated by a recess *f*, formed between two plates *e e*, fig. 663, into which the ridge-pole is placed. In the solid part of the head a core-hole is cast, into which is passed the upper end of the king-bolt *b c*; this is fixed by a key driven through slots made in the head, and the key-seat in the bolt.

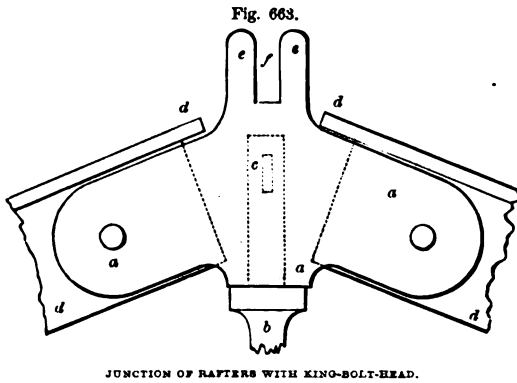

JUNCTION OF RAFTERS WITH KING-BOLT-HEAD.

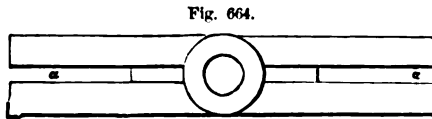

PLAN OF KING-BOLT-HEAD.

1445. Fig. 665 is an end view of king-bolt-head; *a a* the slot into which the rafter is passed, *b b* the part sustaining the ridge-pole, *c* the king-bolt. Fig. 664 is the plan of the king-bolt-head.

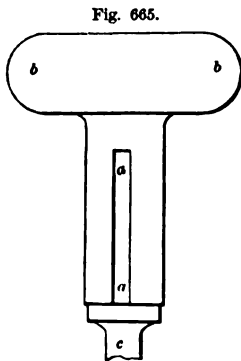

END ELEVATION OF KING-BOLT-HEAD.

1446. In fig. 666 we give side elevation of shoe, in which the lower ends of rafters *a b, a c*, fig. 656, are secured; *a a*, fig. 666, the end of the tie-rod *b c*, fig. 656, which passes into an aperture cast in the shoe, and secured by a cotter and gib *b*; *d* end of rafter, secured by the bolts *e e*.

1447. Fig. 667 is a front view of the shoe, which is built into the wall. A form of shoe, as in fig. 634, may be adopted.

1448. The following are the dimensions of the parts of wrought-iron roofs of various spans; for these we

Fig. 666.

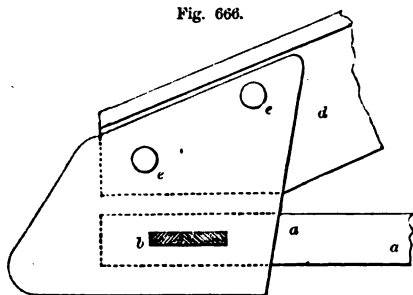

SIDE ELEVATION OF RAFTER-SHOE—SCALE IN FIG. 657.

Fig. 667.

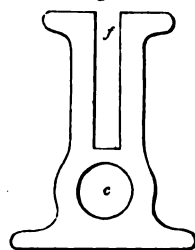

END ELEVATION OF SHOE—SCALE IN FIG. 657.

are indebted to a valuable table in Weale's *Engineer's Pocket-Book for 1855-56*; for other sizes we refer to the book itself.

1449. For a 20-foot span, as in fig. 632, the rise in the centre from *a* to *b* is 6 inches; from *b* to *c*, 4 feet; diameter of the tie-rod *d b*, *g b*, $\frac{3}{4}$ inch; of the king-bolt *b c*, $\frac{5}{8}$ inch.

1450. For a 25-foot span, as in fig. 645, the rise from *a* to *b*, $7\frac{1}{2}$ inches; from *b* to *c*, 5 feet; diameter of the tie-rod *e b*, *b e*, 1 inch; of king-bolt *b c*, $\frac{7}{8}$ inch.

1451. For a 30-foot span, as in fig. 656, the rise from *e* to *d*, 9 inches; from *d* to *a*, 5 feet. The distance from king-bolt *a d* to the queen-bolts *f f*, *g g*, 5 feet respectively. The diameter of tie-rod *b d*, *d c*, $1\frac{1}{2}$ inch; the diameter of king-bolt *a d*, $\frac{7}{8}$ inch; of queen-bolts *f f*, $\frac{5}{8}$ inch; of queen-bolts *g g*, $\frac{1}{2}$ inch.

1452. For a span of 35 feet, the truss as in fig. 656, the rise from *e* to *d*, $10\frac{1}{2}$ inches; from *d* to *a*, 7 feet. The distance from king-bolt *a d*, and queen-posts *f f*, and from queen-posts *f f* to those *g g*, 5 feet 10 inches. The diameter of tie-rod *b d*, *d c*, king-bolt *a d*, queen-bolts *f f* and *g g*, the same as for span of 30 feet, as in paragraph 1451.

1453. For a span of 40 feet, truss same as in fig. 656; rise from *e* to *d*, 12 inches; from *d* to *a*, 8 feet; distance between king-bolt *d a* to queen-bolts *f f*, *g g*, each 6 feet 8 inches; diameter of tie-rod *b d*, *d c*, $1\frac{1}{2}$ inch; of king-bolt, 1 inch; of queen-bolts *f f*, $\frac{3}{4}$ inch; and of queen-bolts *g g*, $\frac{5}{8}$.

1454. For a span of 45 feet, same truss as in fig. 656, but with a third pair of queen-posts, rise from *e* to *d*, $13\frac{1}{2}$ inches; from *d* to *a*, 9 feet; distance between king-bolts and queen-posts, and between queen-posts, each 5 feet $7\frac{1}{2}$ inches; diameter of tie-rod *b c*, $1\frac{3}{8}$ inch; of king-bolt, $1\frac{1}{8}$ inch; first pair of queen-bolts, $\frac{7}{8}$ inch; second pair, $\frac{3}{4}$; and third pair, $\frac{5}{8}$.

1455. For a span of 50 feet, the truss same as in span of 45 feet, the rise from *c* to *d*, fig. 656, $15\frac{1}{2}$ inches; from *d* to *a*, 10 feet; distance between king and queen bolts each 6 feet 3 inches; diameter of tie-rod *b c*, $1\frac{1}{2}$ inch; of king-bolt, $1\frac{1}{4}$ inch; of first pair of queen-bolts, 1 inch; of second pair, $\frac{7}{8}$; and of third pair, $\frac{3}{4}$.

1456. In fig. 633 we give section of the rafter *a b*, *a c*, and strut *m m*, *h h*, in fig. 656. The following are the dimensions of rafters for the various spans now described:—20-foot span, total depth from *c* to *d*, fig. 633, $5\frac{1}{2}$ inches, width of top table *a b* 2, thickness of top table $\frac{1}{4}$, thickness of the rib *e f* $\frac{3}{8}$; 25-foot span, *c d* 3 inches, *a b* $2\frac{1}{2}$, thickness of *a b* $\frac{1}{2}$, thickness of rib *e f* $\frac{3}{8}$; 30-foot span, *c d* 3 inches, *a b* $2\frac{1}{2}$, thickness of *a b* $\frac{3}{8}$, *e f* $\frac{3}{8}$; 35-foot span, *c d* $3\frac{1}{4}$ inches, *a b* $2\frac{3}{4}$, thickness of *a b* $\frac{3}{8}$, *e f* $\frac{1}{8}$; 40-foot span, *c d* 4 inches, *a b* $3\frac{1}{4}$, thickness of *a b* $\frac{1}{8}$, *e f* $\frac{1}{2}$; 45-foot span, *e d* $4\frac{1}{2}$ inches, *a b* $3\frac{1}{2}$, thickness of *a b* $\frac{1}{8}$, *e f* $\frac{1}{8}$; 50-foot span, *c d* $4\frac{3}{4}$ inches, *a b* $3\frac{3}{4}$, thickness of *a b* $\frac{1}{8}$, of *e f* $\frac{5}{8}$.

1457. The following are the dimensions of the struts or braces of the above

spans :—Let $j i$, fig. 633, be the depth of the strut, $g h$ width of table, k the thickness of rib, and let m represent the thickness of table. Then, for a span of 20 feet : $j i$ 2½ inches, $g h$ 2, k ⅜, and m ¼. For a span of 25 feet : $j i$ 3 inches, $g h$ 2½, k ⅜, m ¼. For a span of 30 feet : $j i$ 3 inches, $g h$ 2½, k ⅜, m ⅜. For a span of 35 feet : $j i$ 3½ inches, $g h$ 2½, k ⅞, m ⅜. For a span of 40 feet : $j i$ 4 inches, $g h$ 3½, k ½, m ⅞. For a span of 45 feet : $j i$ 4½ inches, $g h$ 3½, k ⅞, m ⅞. For a span of 50 feet : $j i$ 4½ inches, $g h$ 3½, k ⅞, m ⅞.

1458. *Iron Roof for Horse-Walk of Thrashing-Mill.*—In fig. 668 we give the plan of horse-walk ; $a a$ barn wall, $b b$ collar beam, 8 inches by 6, to support hanger for vertical shaft of mill ; $c c$, $c c$, shears, 8 inches by 4, framed into collar $b b$, and stayed by the braces $d d$; $e e$ the columns supporting the rafters and collar-beam $b b$.

1459. In fig. 669 we give a skeleton roof, showing disposition of the rafters, &c. : $a a$ the cast-iron columns, $b b$ the rafters, $c c$ the tie-bolts, $d d$ struts or braces, e king-bolt.

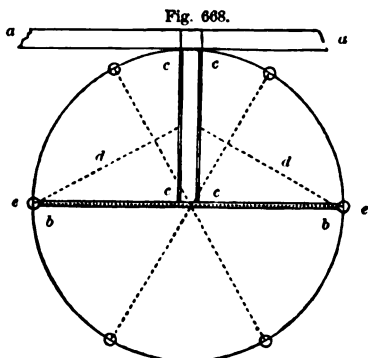

Fig. 668.
PLAN OF HORSE-WALK FOR THRASHING-MILL—SCALE,
1/8 INCH TO THE FOOT.

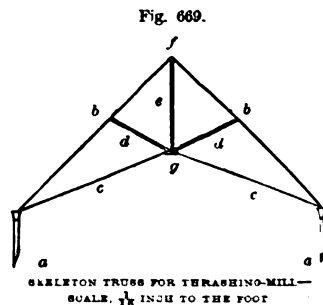
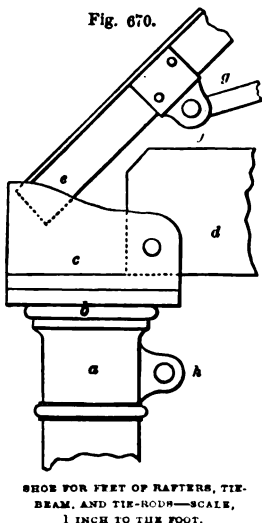

Fig. 669.
SKELETON TRUSS FOR THRASHING-MILL—
SCALE, 1/8 INCH TO THE FOOT.

1460. *Details of the Roof.*—In fig. 670 we give elevation of the shoe which supports the ends of the collar-beam $b b$, fig. 668, and the ends of two of the rafters ; a the column to the cap b , of which the shoe c is secured by bolts and nuts ; d the end of collar-beam, which is received into a recess made in the shoe, and kept in its place by a bolt ; e the end of the rafter. A stud f is riveted to the rafter, and provided with an eye, to which the tie-bolt g is jointed. To steady the two columns supporting the collar-beam d , a tie-bolt may be used, stretching from one column to the other, secured at the ends to the eyes of snags h , cast in the caps of the columns. As two columns—out of the assemblage employed to support the roof—only are required to support the collar-beam, the shoes for receiving the feet of the other rafters do not require to have recesses for receiving the ends of collar-beams, as in fig. 670 ; the shoe required, however, will be the same as in fig. 670, with the exception of the part to receive end of collar-beam.



1461. In fig. 671 we give a drawing of the king-bolt-head which receives the upper end of the king-bolt e , fig. 669, and the

upper termination of the rafters at the point *f*. In fig. 671 *a a* is an elevation of the head, *b* the king-bolt, passing through an aperture in the centre of head, and secured by a nut *c*. In the plan, *d d d* are the recesses which receive the ends of the rafters; *e* the nut of the king-bolt.

1462. In fig. 672 we give the cast-iron box or shoe for receiving the ends

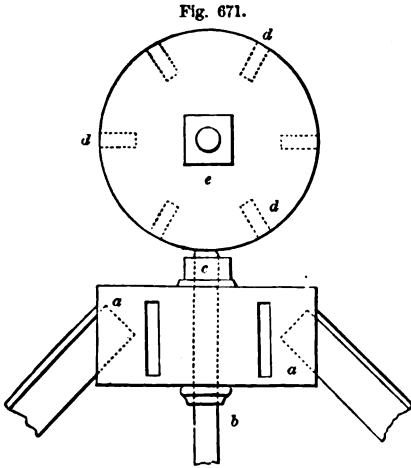

KING-BOLT AND RAFTER-SHOE IN ELEVATION AND PLAN—SCALE, 1 INCH TO THE FOOT.

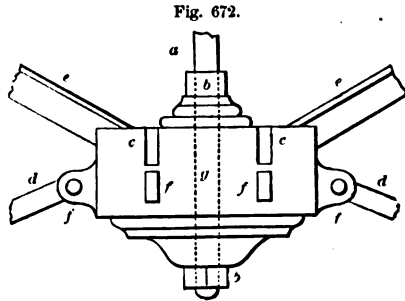

SHOE FOR RECEIVING LOWER ENDS OF STRUTS AND UPPER ENDS OF TIE-RODS—SCALE, 1 INCH TO THE FOOT.

of the struts *d d*, fig. 669, which meet at the point *g*, and to which also the ends of the tie-bolts *c c* are jointed. In fig. 672 we give the shoe, in which *a* is king-bolt, secured by the nuts *b b*; *c c* the recesses which receive the ends of the struts *d d*, fig. 669; and *d d* the tie-bolts *c c*, fig. 669; *e e* struts, corresponding to *d d*, fig. 669. The tie-bolts *d d* are jointed to the snags *f f f f* by means of eyes, through which and the tie-bolts bolts are passed; *g* the aperture through which the king-bolt *a* is passed.

1463. In fig. 673 we illustrate another method of joining the assemblage of struts *d d*, and tie-bolts *c c*, fig. 669, to the shoe. In fig. 673, *a* the king-bolt, passing through the shoe *b*; *c c* the struts, secured to the shoe by the bolts *d d* and nuts *e e*; *f f* the snags to which the tie-bolts *g g* are jointed. The lower figure is a plan of the shoe, with the ends of the struts inserted.

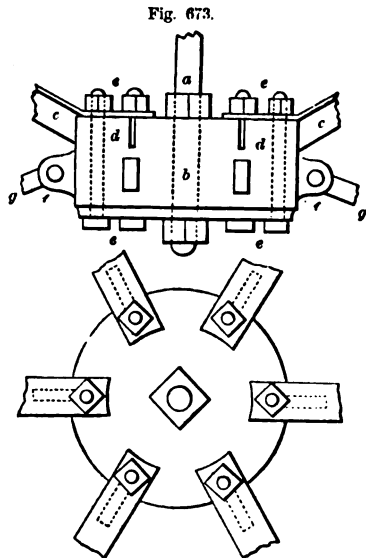

JUNCTION OF KING-BOLT, STRUTS, AND TIE-RODS—SCALE, 1 INCH TO THE FOOT.

1464. *Gutters for Iron Roofs—Gutter for Single Roof.*—In fig. 674 we illustrate a method of forming the gutter of an iron roof, in which *a* is the wall on which rests the shoe for rafter *b*. The flange *c* of the rafter *b* is continued past the butting end *c*, and carried outward beyond the wall *a*. The zinc or

iron roan or gutter *d* is riveted to the end of the flange *c*, as shown in the plan of under side of flange in the left-hand figure, where *e* is part of the flange,

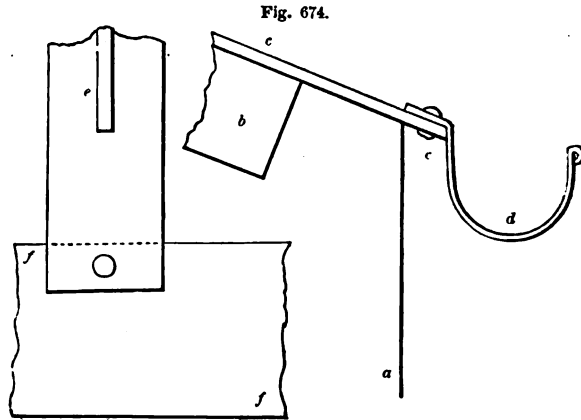

GUTTER OF IRON ROOF—SCALE IN FIG. 657.

ff body of roan or gutter *d*, which is continued along the line of wall from end to end, being riveted to the end of the flange of each principal.

1465. In fig. 675 we give another form of gutter: *aa* is the gutter-

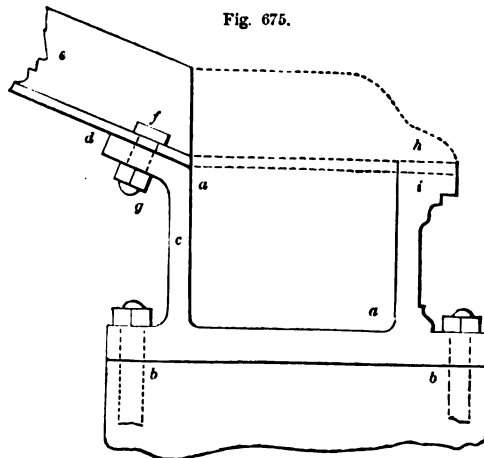

CAST-IRON GUTTER—SCALE IN FIG. 657.

box, secured to the wall by bolts and nuts *bb*, as shown. The back of the gutter-box *c* is extended upwards, and forms a part *d* at the same angle as the angle of line of rafters *e*, the lower flange of which is bolted to the gutter-box by the bolt *f* and nut *g*. The rafter, instead of breaking off flush with the inside of gutter-box, may be extended across, as shown by the dotted lines *h*, and rest on the cornice *i* of the box.

1466. In fig. 676 we give a drawing of another method of forming a gutter, in which the rafters are secured to shoes *aa*, resting on columns *b*, which are made hollow, and conduct the water from the roofs to the drains. At the back of the shoe a flange *c* is cast, to which is secured the wrought-iron gutter *d*, by the bolt and nut *ee*. A down pipe (placed at intervals in the length

of gutter *d d*, corresponding to the distance between the columns *b*) *f* is connected by a flange *g* of the elbow *h*, which conducts the water to the interior of the column *b*.

Fig. 676.

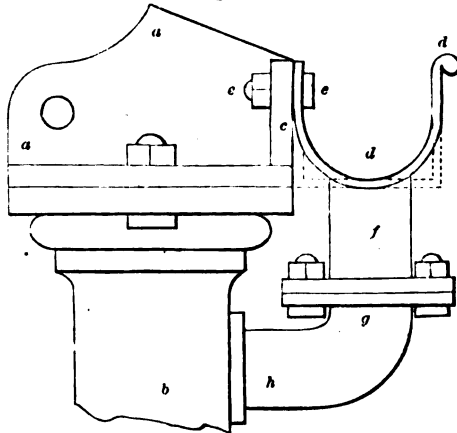

CAST-IRON GUTTER, LEADING WATER TO HOLLOW OF COLUMN—
SCALE IN FIG. 657.

1467. *Gutters for Double Roofs.*—In the double roof, of which we gave the junction of rafters at *b*, in the central column, in fig. 643, we now show a method of forming the gutter by bending galvanised iron to the form as shown at *b*, and riveting it to the flanges of the rafters.

1468. In fig. 677 we give another method of forming this central or valley gutter, in which a hollow part, *a a*, is cast in the centre of the shoe *b b*, *c* the rafter, *d* the tie-bolt, *e* the down pipe, leading the water to the centre of column, to which the shoe *b b* is bolted.

1469. In fig. 678 we give another form of gutter for a double roof: *a a* the

Fig. 677.

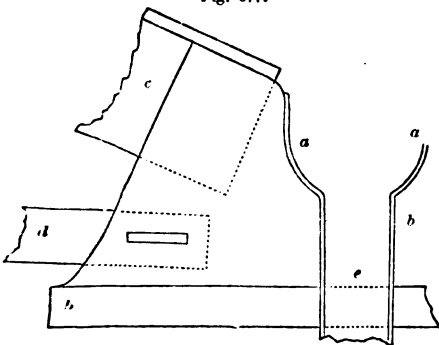

GUTTER FOR DOUBLE-SPAN ROOF—SCALE IN FIG. 657.

Fig. 678.

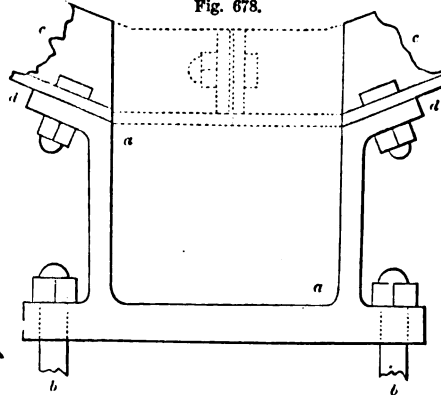

CAST-IRON GUTTER FOR DOUBLE-SPAN ROOF—SCALE IN FIG. 657

gutter-box, of cast-iron, secured to the wall-plate or column by bolts and nuts *b b*; *c c* the rafters, secured to the angular pieces *d d* by bolts and nuts as shown. The rafters may be continued, as shown by the dotted lines, and secured by bolt and nut.

1470. *Corrugated Iron Roofs.*—When the surface of a plate of iron is formed

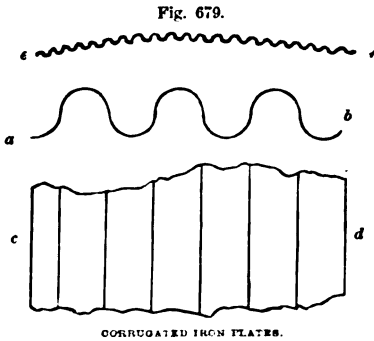

into a series of ridges and furrows, as *a b*, fig. 679, a series of arches is arranged, which, abutting against each other, enable weights laid, or a pressure made, upon the upper surface to be resisted, under circumstances in which the same piece of iron, if flat, would be bent and doubled up. In fig. 679 *c d* is the elevation of plate *a b*; and *e f* shows how, by giving a curve to the plate *a b*, so as to form it into an arch, still greater strength may be given to the plate—so much so, that it may be used as the covering

of a roof of moderate span without the use of rafters—the only point of support being at the abutments *e* and *f* of the walls.

1471. In fig. 680 we give elevation for a truss—span 18 feet—adapted for galvanised iron covering: *a a* the covered rib or rafter, resting on the shoes *b b*,

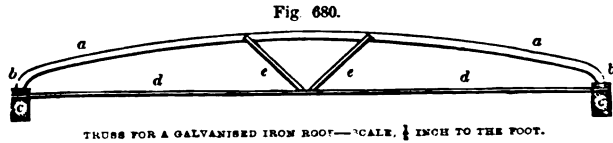

bolted to the beams *c c* which run along each side of building, and which rest on the caps of pillars placed at intervals; *d d* tie-rods, *e e* struts of wrought-iron. In fig. 681 *a* is a section, and *b* side elevation of the rafter or rib *a a* in fig. 680. In fig. 682 we give upper part of column *a*, which supports the beam

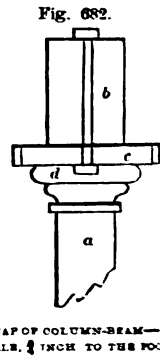
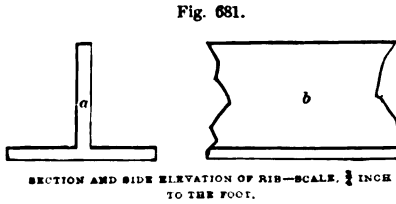

b, this carrying the series of rafter-shoes, which is bolted to the cap *c* by the bolt *d*. In fig. 683 we give plan of upper end of column *a*: *b b* cap, *c c* the beam, *d d* the nuts of the bolts securing it to *c c*.

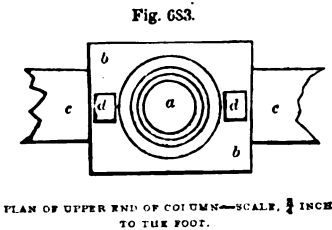

In fig. 684 we give side elevation and plan, showing the junction of feet of struts *e e*, fig. 680, with the tie-rod *d d*. In fig. 684 *a a* is tie-rod, *b b* the struts riveted to the tie-rod *a a*; one of the struts *c* is placed on one side, the other, *d*, on the opposite side of the tie-rod *e e*.

1472. In fig. 685 we show a mode of connecting corrugated arched iron plates *e* and *c* with the gutters *a*, which are either bolted to the cap of column *b*

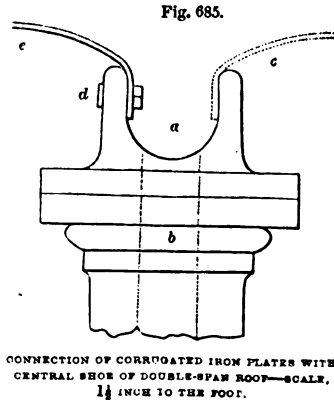
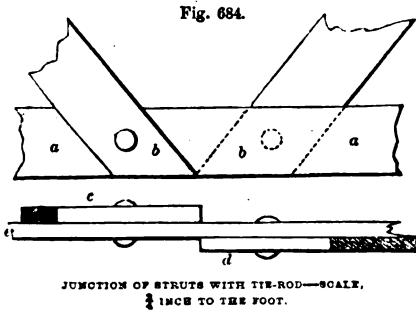

or built into a wall. The plate *e* is secured to the side of gutter with bolts and nuts *d*. This figure also shows a mode of connecting the plates of a double roof, as in fig. 643: *a* the iron gutter, stretching from column to column, or laid continuously in a central wall; *e* and *c* the plates, secured to gutter with bolts and nuts *d*. The connection of outer sides of plates is the same as at *d*. For roofs of large span, principals or iron trusses should be used—the principals being placed at distances varying from 10 to 15 feet, and the plates of corrugated iron slightly arched, so that, when secured to the trusses, the roof will be in longitudinal section, as *a b c d*, fig. 686. The upper part of same figure is a design by Messrs Dray & Co., London, for a wrought-iron truss for a span of 52 to 54 feet, adapted for corrugated iron. This roof seems well adapted for covering a stackyard.

Fig. 686.

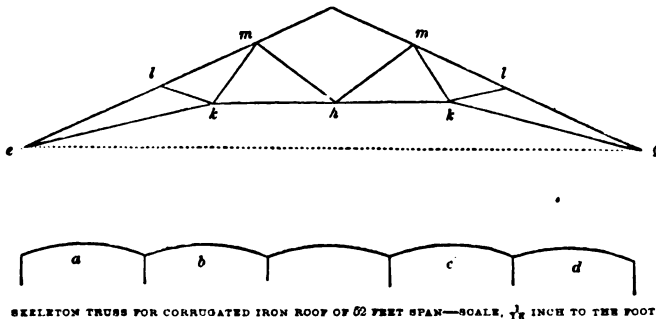

1473. *Details of Truss in fig. 686.*—In fig. 687 we give the shoe *b* for head of rafters at the point *f* in fig. 686. The rafters *a* are riveted to the shoe *b*; *c* the snag to which the tie-rod *f h* is jointed; *d* the plan, and *e* the end elevation of shoe. In fig. 688 we give the shoe *a*, to which the ends of the tie-rods *k l*, fig. 686, are jointed; *b* the snag, *c c* the rafter. In fig. 689 we give the shoe *e* for receiving ends of tie-rods *h m*, fig. 686; *d d* the rafter, *f* the snag to which the tie-rods *h m* are jointed; *h g* is end view of shoe *e*. In fig. 690 *a* is the shoe to which the lower end of the rod from *f* to *h*, fig. 686, is jointed—it

is bolted to the tie *b b*; *c* is the snag to which the lower termination of the rod *f h* is jointed; in the end elevation, in the left figure, the rod *f h*, fig. 686, passes into the space *d* of the snag *e*; *f* is section of tie *b b*. In fig. 690, right hand figure, *h i* shows the shoe to which the lower terminations of the rods *k l*, fig. 686, are jointed; *g g* the tie, corresponding to the tie *h k g* and *h l e* in fig. 686.

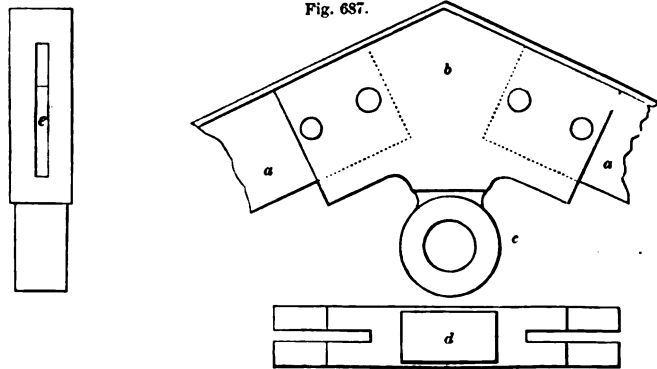

ELEVATIONS AND PLAN OF SHOE FOR UPPER TERMINATION OF RAFTERS—SCALE, 1½ INCH TO THE FOOT.

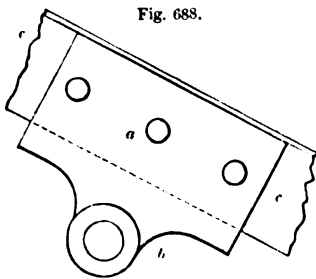

JUNCTION OF BENTS WITH RAFTERS—SCALE, 1½ INCH TO THE FOOT.



JUNCTION OF TIE-RODS WITH RAFTERS—SCALE, 1½ INCH TO THE FOOT.

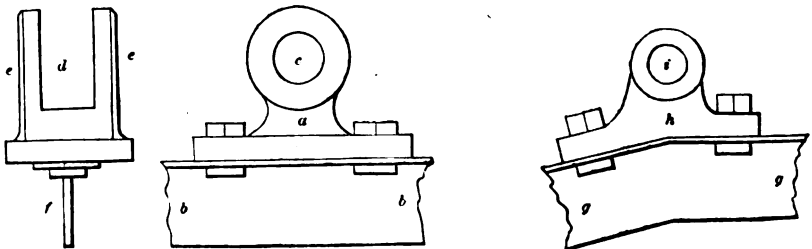

SHOES FOR TIE-RODS—SCALE, 1½ INCH TO THE FOOT.

1474. SECTION FOURTH—*Iron Fittings of the Farmhouse and Cottage—Locks.* In connection with the fittings of the farmhouse is the subject of *locks*. It is very poor economy to use ill-made locks in any apartment of a farmhouse, and especially in those which contain articles which are usually locked up. In all those places—as the store-room, linen-presses, and all wall-presses—the best species of lock should be used, as such locks are not only pleasant to use, but

cannot go wrong, and are impossible to be opened but with the proper key. The outside door of a farmhouse is commonly provided with a very common spring-lock, which is always ready to be opened but when the key is turned in it, leaving the house in that quarter constantly accessible during the day, and part of the evening. Now, such a door should be provided with one of Chubb's patent locks, which has not only a small key, but is easily opened as a check-lock; is beyond the power of any one to pick; when attempted to be picked, tells it has been so; cannot go wrong; lasts a lifetime without repairs, and affords unspeakable security. One peculiarity of this lock is, that it has a number of bolts, every one of which must be lifted before the door will open—each bolt being a security equal to any common lock. Another peculiarity is its detector, by which any attempt to pick or open the lock by a false key is immediately notified on the next application of the proper key, which will not open the lock. It, however, makes the lock again serviceable by being turned the wrong way, which no false key is capable of doing. The lock has commonly six bolts, or tumblers, and a detector; and the ordinary chances against any key but its own opening it is 720. But the height of the shortest step in the key is capable of being altered twenty times, so that the chances against opening the lock may be increased to 14,400: each of the six steps can be as many times altered, so that the chances may be increased to 86,400. The detector can be altered ten times, so the chances are increased to 864,000. Further still, the drill-pins of the locks, and the pipes of the keys, may be easily made of three different sizes, so that the number of chances may be increased to 2,592,000. In still larger locks, the chances may be increased to 7,776,000. The corn-barn, granaries, meal-chest, hen-house, and implement-house, ought all to be protected with such locks. We are far from supposing that farm-servants are more dishonest than other persons of their class; but we all know that to put temptation in the way of servants who have hitherto borne a good character may be the means of corrupting their honesty; and besides, when people are made aware that the more precious things are really secured with superior locks, the desire to attempt to obtain them, through the locks, will soon subside.

1475. The properties of a good lock are, strength of materials, simplicity of construction, durability of action, good workmanship, and perfect security. Without one and all of these properties, a lock is worthless; and Chubb's locks possess them all in an eminent degree. With such qualifications, the price cannot be low, but it is cheap in the long-run.* We have used one with six tumblers for several years in the outer door as a check-lock, which cost 15s. with two keys, and of course those with fewer tumblers will cost less.

1476. But notwithstanding that we recommend the Chubb lock to all outer doors of farmhouses as a safe and convenient check-lock, we do not say that such doors should not be provided with a strong rim-lock to be used at night, in addition to the Chubb, not only to inspire undisturbed security in a lonely part of the country, but to lock up the house when the family may have occasion to go from home for a few days. Such a rim-lock may also be used on the back-door of the farmhouse for the same purpose.

1477. *Various Forms of Locks.*—In figs. 691 to 695 we illustrate the forms of locks used. Fig. 691 is a 6-inch *Kitchen Latch*; the *Thumb Latch* is not figured. Fig. 692 a 7-inch *Rim Lock*. Fig. 693 a 5-inch *Press Lock*. Fig. 694 a 6 $\frac{1}{2}$ -inch *Mortise Lock*, of which fig. 695 is the escutcheon for the key-hole.

* CHUBB *On the Construction of Locks*, p. 15.

Fig. 691.

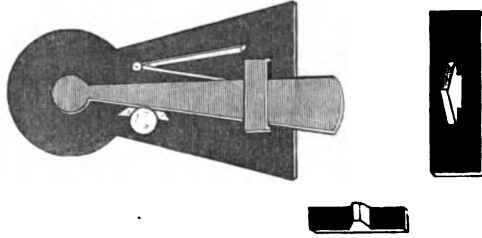

6-INCH KITCHEN LATCH.

Fig. 692.

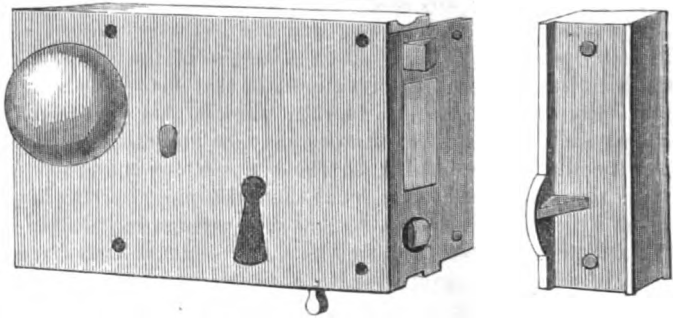

7-INCH RIM LOCK.

Fig. 693.

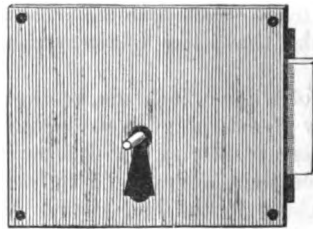

5-INCH PRESS LOCK.

Fig. 694.

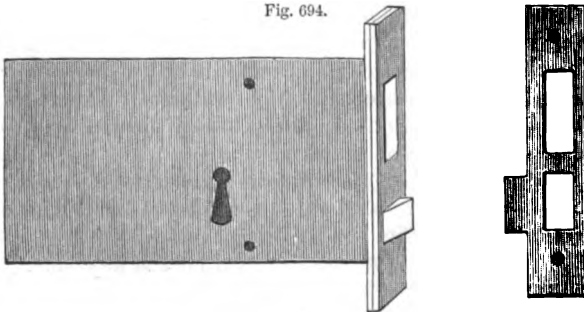

6 1/2-INCH MORTISE LOCK.

Fig. 695.



ESCUTCHEON FOR LEFT-HOLE

1478. *Hinges*.—In fig. 696 we illustrate a hinge $12\frac{3}{4}$ inches long; the part *a* $1\frac{3}{4}$ inch broad, *b* $1\frac{3}{8}$ inch broad and $5\frac{1}{4}$ long; the pin *c* $\frac{7}{8}$ inch in

Fig. 696.



12 $\frac{3}{4}$ -INCH HINGE.

Fig. 697.

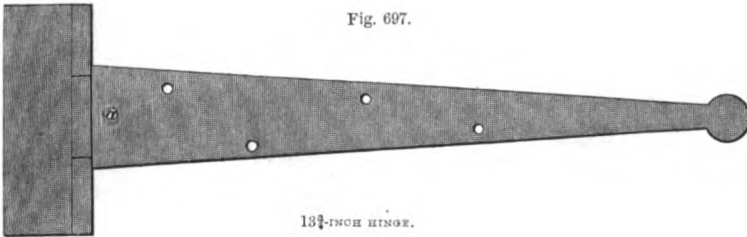

13 $\frac{3}{4}$ -INCH HINGE.

diameter. In fig. 697 the length of hinge is $13\frac{3}{4}$ inches, the breadth at part *a* $2\frac{1}{4}$ inches; the length of cross $4\frac{3}{4}$ inches, and breadth $1\frac{3}{8}$ inch. Fig. 698,

Fig. 698.

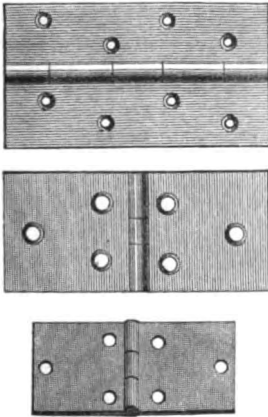

BUTT HINGES.

Fig. 699.

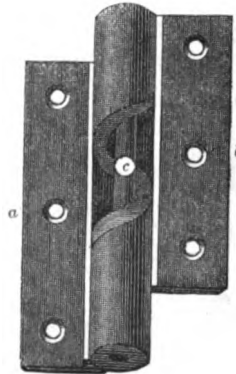

PATENT HINGES FOR SELF-SHUTTING DOORS.

Butt Hinges, 5 inches long by $2\frac{1}{2}$ broad. In fig. 699 we illustrate the *Patent Hinge*, by the use of which the door is made self-shutting; the side *a* is fixed to the door-frame, *b* to the door stile; the door rises as it is opened, and on being left free the part *b* runs down the pin *c*. In fig. 700 we illustrate *Spherical Hinge* (Collinge's patent), in which the cylindrical pin which is used in ordinary hinges is dispensed with, and a ball-ended pin substituted; this plays in a spherical cup made in the step or hook for its reception. This arrangement admits of considerable obliquity in the action of the hinges, allowing for all ordinary variation from the shrink-

Fig. 700.

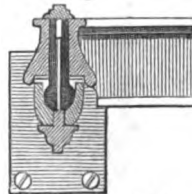

COLLINGS' PATENT SPHERICAL HINGE.

ing of the door. The cup, serving as an oil receptacle, keeps the parts thoroughly lubricated, while, by the use of a leather washer, which covers the edge of the cup, all dirt is prevented from entering it. The manufacturer's address is, John Imray, 65 Westminster Bridge Road, Lambeth, London.

1479. *Window Pulley-Stile*.—In fig. 701 we give a pulley-stile, $4\frac{3}{4}$ inches long by $1\frac{1}{4}$ broad.

1480. *Window-Latch*.—In fig. 702 we illustrate a form of latch used for fastening the lower sash, and preventing it from being lifted up.

Fig. 701.

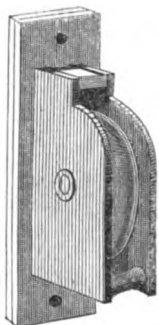

PULLEY-STILE.

Fig. 702.

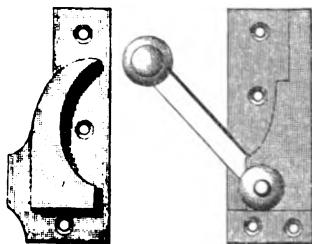

WINDOW-LATCH.

1481. *Spring Pulley for Window-Blinds*.—In fig. 703 we illustrate the patent spring-pulley, which requires one screw only for fixing it. The cord can be put on or taken off without unscrewing it. The manufacturer's address is, B. Sigrist, 47 Monkwell Street, London. In figs. 704 to 707 we give various views of the fastening for French or "caseant" windows, as adopted on the

Fig. 703.



SPRING PULLEY FOR WINDOW-BLIND CORD.

Fig. 704.

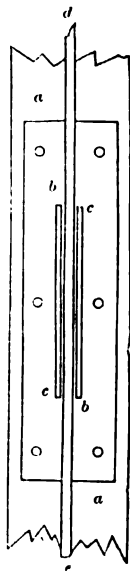

FASTENING OF FRENCH WINDOW—FRONT VIEW.

Fig. 705.

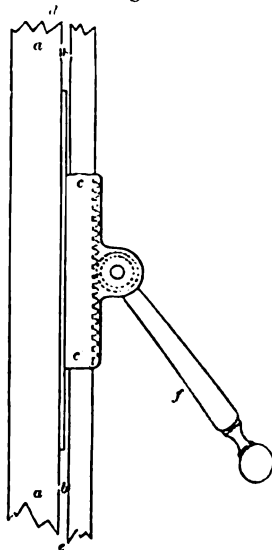

FASTENING FOR FRENCH OR CASEANT WINDOWS—SIDE VIEW.

Continent. In fig. 704 *a a* represents part of the centre stile of one-half of the window—this being grooved on the inner edge; a corresponding tongue or tenon made on the outer edge of the stile of other half of window fitting into it, and forming, when the two halves of the casement are closed, a weather-tight joint. To the stile *a a*, fig. 704, a plate of brass or iron *b b* is screwed; this carries a slotted stud *c c*, between which a bar *d e* slides. The central part of this bar is provided with a rack as shown in side view in fig. 705, into which a small pinion gears, actuated by the handle *f*. The letters in fig. 705 correspond with those in fig. 704. By moving the handle *f* upwards, the bar *d e* moves so that the bolts at its upper and lower ends pass into catches secured to top and bottom rails of window-frame—thus securing the window. In fig. 706 the bolt at lower end of bar *d e*, fig. 704, is shown; *a a* window-stile, *b* part of bar corresponding to *d e*, fig. 704; this is provided with a handle *c*, and the bar slides in a stud *d*; *e* shows the lower part of bolt or bar; this passing into a catch made in lower sill of window. In fig. 707 we show the upper bolt and catch; to the upper frame *a a* of window two pieces of iron *b b* are secured; the upper part of bar *c*, corresponding to *d e*, fig. 704, is made with a cross *d e*, which passes between the irons *b b*. When the bar *c* is moved upwards, the cross slips out from between the irons *b b*, and the window can be opened. When the bar *c* is moved

Fig. 706.

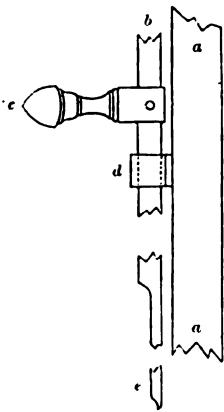

LOWER BOLT OF WINDOW-FASTENING.

Fig. 707.

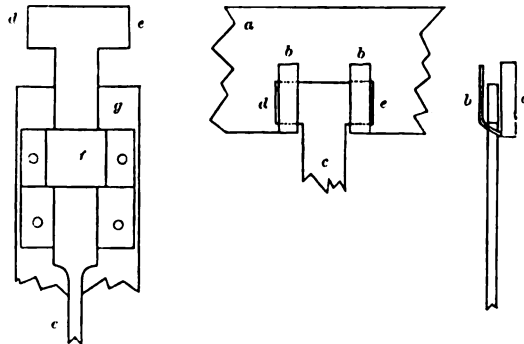

UPPER BOLT AND CATCH OF WINDOW-FASTENING.

downwards by the rack, see fig. 705, the cross passes into the space, and the window is secured: simultaneously, the bolt *e* of the lower part of bar *b*, fig. 706, is passed into its catch. In fig. 707 the bar *c* slides in a brass stud *f*, secured to the window-stile *g*, corresponding to *a a*, fig. 704, *d e* being the cross.

1482. *Fastening for Stair Rods.*—In fig. 708 we give a view of Edward's patent socket, which is to be secured to the staircase in the angle formed by the tread and the riser. The rods are triangular, and the ends being placed in the socket, a cap, fig. 709, secures them to the sockets. The objection to the common mode of fixing a stair carpet is, that the eyes of the staples are fastened so near the inner angle of the steps, that a stout rod has not room to pass through them over a thick carpet, especially in a turn of the stair, where one side of the carpet has to be doubled. The eyes should be fixed at half an inch from the inner angle of the steps.

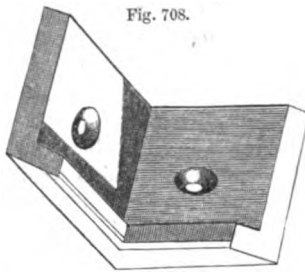

FASTENING FOR STAIR-CARPET ROD.

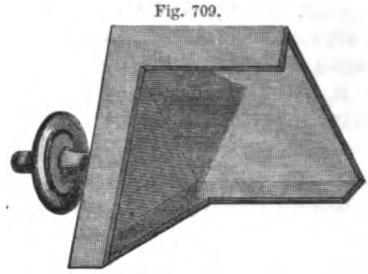

FASTENING FOR STAIR-CARPET ROD.

1483. *Ventilators*.—In fig. 710 we illustrate Arnott's chimney ventilator. The valve *a* is so nicely balanced that the upward draught of the chimney—which causes a current through the opening leading into the room (at the orifice of which the valve is fixed)—keeps the valve open, allowing of the egress of the foul air of the room; but, should the smoke be sent down the chimney,

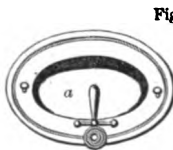

ARNOTT'S VENTILATOR.

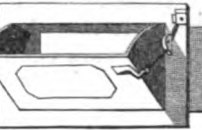
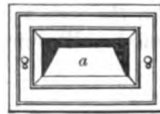

SHERINGHAM'S FRESH-AIR VENTILATOR.

and along towards the opening, the valve is instantly closed, preventing the access of all smoke to the room.

1484. In fig. 711 we illustrate Sheringham's ventilator for

admitting the external atmosphere to the interior of a room through an aperture made in the outside wall. The ventilators in figs. 528 and 529 are also Sheringham's.

1485. *Chimney-Guards*.—In certain situations, and in certain quarters of the wind, a down-draught of smoke is created in the chimney. Those situations may be in the neighbourhood of tall trees, at the base of a hill, or in the lee of a large building, against which, if from one direction, and over which, if from another, the wind may be reflected against or bend in a downward direction upon the top of the chimney. The only safeguard against such a contingency is the placing a top upon the chimney-head, or upon the can represented in section in fig. 715, where the iron cone *b b* should not be angled upwards as at *c c*, but made level, and it should be placed as much lower down the can below *d d* as to allow it to take in the top. Fig. 712 represents such a top recommended by Tredgold, where *a* is the part for fixing it to the can or chimney-head, *d* the cover, made circular or conical, for preventing the down-draught of the air from above; and *c c* are the angular edges for directing the wind upwards according to their angle. The top may be made of thin metal of any kind, and painted black. Kites' (of London) diamond deflecting chimney-top we have found very efficient as a preventor of down-draughts. A rather ingenious, and, we believe, efficient, chimney-guard is that of Mr Chadwick of Bury, Lancashire, illustrated in fig. 713. The principle of this is the employment of

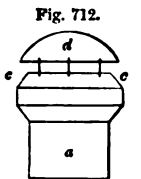

TOP OF A CHIMNEY FOR PREVENTING THE DOWN-DRAUGHT OF SMOKE.

an external vane, which, giving motion from the action of the wind, works an Archimedean screw ventilator in the interior of the guard. This acting, after the manner of a pump, creates an upward current in the chimney. With this apparatus it is almost an impossibility to have a down-draught in a chimney; and it certainly possesses this advantage—of being the most efficient in its

action when most required, as the higher and more sudden the gusts of wind, the quicker is the velocity of the vane, and of the consequent action of the "screw-pump," as it may be termed. Another form of wind-guard is shown in fig. 714, in which a sphere *a*, lightly seated, is employed. The arrows on the left show how the current of the down-draught is deflected out of its normal path, and made to pass outwards from the guard, while the ascending smoke has free egress. Where the draught in a chimney is defective, Tredgold recommends the aperture at the top outlet to be contracted; holding that, to contract it near the bottom, "it is like contracting the aperture of a pipe which supplies a jet." The contraction depends on the size of the grate for the fire; and this being kept in view, Tredgold's rule for the contraction at the top is the following: Let 17 times the length of the grate in inches be divided by the square root of the height of the chimney in feet, and the quotient is the area for the aperture at the top of the chimney in inches. For example, suppose that a grate is 15 inches wide, and the chimney 36 feet high— $17 \times 15 = 255$; and the square root of 36 is 6; therefore 255 divided by $6 = 42\frac{1}{2}$ inches is the area of the top, and the diameter of a circle of $42\frac{1}{2}$ inches in area is rather more than $7\frac{3}{4}$ inches for the contraction.

Fig. 713.

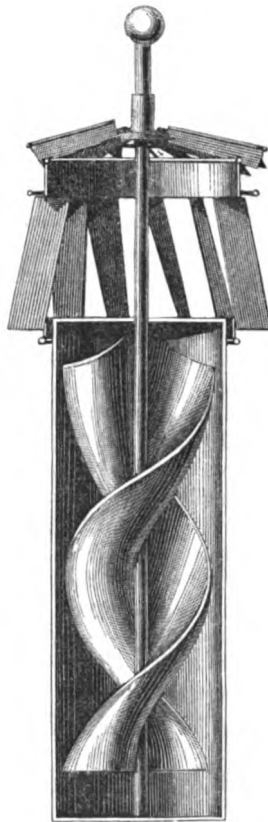

CHADWICK'S ARCHIMEDIAN SCREW CHIMNEY-GUARD WITH VENTILATOR.

Fig. 714.

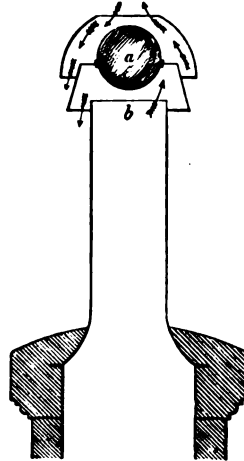

BALL CHIMNEY-GUARD.

Fig. 715.

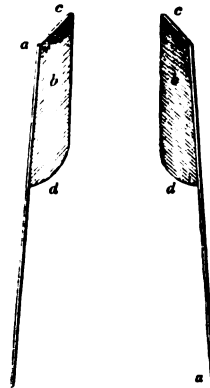

METHOD OF CONTRACTING THE TOP OF A CHIMNEY.

1486. The contraction at the top may be made in this manner: Let fig. 715 represent the section of a chimney-can, the height of which above the stalk is from *a* to *a*; *b b* is the contracting cone within it made of iron, the lower part of which is rounded off, as at *d d*; the upper part at *c c* being made angular upwards, with the view of facilitating the passing of the wind over it in an upward direction. The chimney-top, if constructed of this form at first, might answer as well as any can put up afterwards.

1487. *Chimney-Valves and Chimney Breast-Bearers.*—At the foot of every chimney, in every apartment, a valve should be placed above the throat or

opening of the flue : this is exceedingly useful in regulating the draught and the consequent rate of combustion of the fuel in the grate ; but when the fire is not in use, by shutting it close down, all " back smoke "—that is, smoke from other chimneys brought down by adverse currents—will be prevented from entering the apartment. These valves may be made in a variety of ways : the common flap of the register grate will do well, if carefully made and adjusted ; or the damper-valve, which slides in a frame, may be used. The form shown in fig. 716 may be easily constructed.

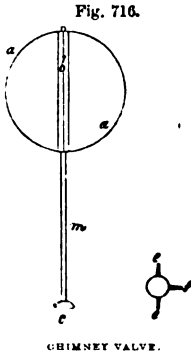

Let *a a* be the circular aperture of the chimney-flue ; a projecting ledge goes round this on the upper side ; at the two ends of its diameter, coinciding with a line drawn at right angles to the line of the chimney bar, or breast, two small apertures are made ; the spindle of the valve *b* works in these ; the spindle *m* is continued outwards, and passed through an aperture in the mantelpiece, and provided with a small button *c*, by which the valve is turned ; a half turn of this will open the valve fully. In order to

know the amount of opening, the button should have two projecting studs, as at *e e* : when these are vertical, or at right angles with the floor, the valve is shut ; when horizontal, as at *f*, it is open. The valve is thus easily adjusted to any degree of opening. The chimney bar and valve opening may be advantageously made in one of cast-iron, as in figs. 717 and 718, where fig. 717 is an elevation, and fig. 718 a

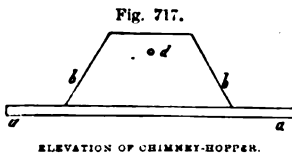

plan. The brickwork of the flue rests on *a a*, which serves as a chimney-bearer, thus obviating all necessity for using the dangerous material wood for this purpose. The hood or hopper *b b* tapers gradually upwards to the size designed for that of the flue. The upper part of *b* forms the throat of the chimney ; if the flue is made of circular

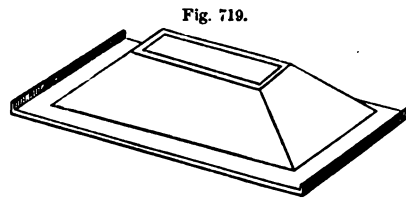
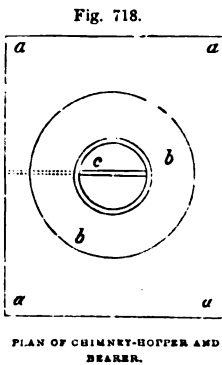

tubes, they rest on the upper edge of *b*. The valve is shown at *d*, and in fig. 718 it is shown open at *c*. A modification of this plan,

making the chimney-hopper and bar in one, of cast-iron, has been recently registered, as illustrated in fig. 719. In this, however, the opening forming the throat of the flue is left square, and of the usual orthodox size of 14 inches by 9—a size of flue which, from its almost universal adoption by builders, seems to be held of vital importance to their efficient working. Manufactured by Lynch White, Iron Wharf, Upper Ground Street, London.

1488. *Gas Regulators*.—Where the pressure from the gasometer is uniform, and the consumption of gas in the house unequal, some burners, being suddenly shut off, while others are left burning, a usual result is, that the gas is blown rapidly through the burners which are left in use—a flickering or unsteady light is thus induced, along with considerable waste. To keep the

pressure at the burner as uniform as possible is therefore of importance. A method of reducing the pressure from the gasometer, sometimes adopted, is to turn the stopcock at the meter only half or partially open. As this adjustment is troublesome, and apt to be neglected, contrivances, known as "gas regulators," or "economisers," are coming into use. A very simple form is illustrated in fig. 720: *a* being the external view, the part *b* being that which is inserted into the aperture of the gas lustre or chandelier, *c* the part from which the gas to be lighted issues. In the centre of the enlarged part *d d*, a flat disc of metal *e* is placed, having apertures at the opposite diameter, as shown by the dark parts in the plan at *f*. The gas, striking at a high or variable pressure against the lower side of the disc *e*, is reduced in velocity, passes through the apertures, and issues from the jet at a uniform pressure.

Fig. 720.

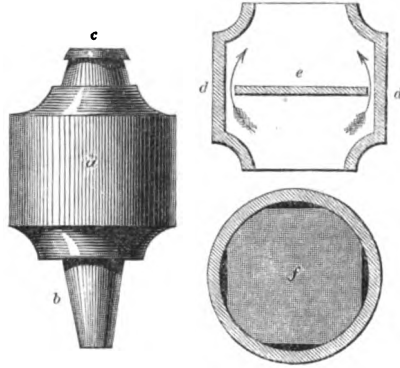

GAS REGULATOR.

1489. Another form of gas economiser is illustrated in section in fig. 721; it is known as "Hart's." In this the gas passes through a disc of felt *c*. We have seen both of these apparatus in use under varying circumstances of action, and have found the combustion uniform, where that from ordinary burners was unsteady—the flame in these reaching a great height at one time, descending to a low point at another, according as the pressure of gas from the main increased or decreased. Uniform velocity of the issuing gas must promote economical combustion; hence the saving effected by the use of such contrivances as we have just noted is stated to be very considerable—from 5 to 30 per cent, according to the variation in the pressure of the gas supplied to the gas lustres or chandeliers.

Fig. 721.

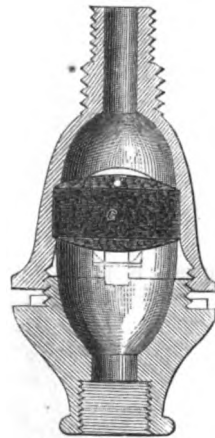

HART'S GAS REGULATOR.

1490. *Bells*.—Every farmhouse should be provided with bells. Their forms, and the mode of hanging them, are so well known that we do not illustrate them. The tubes for the wires should be placed before the finishing of the plaster.

1491. *Water Taps and Cocks*—*Chrimes's Tap*.—This form of tap, illustrated in figs. 722 and 723, is much patronised by architects in England. The valve portions consist of a brass disc covered with leather, and pressed on to the seat by a screwed spindle, working through a stuffing-box. For high pressure they are more particularly made with the valve loose from the spindle, the valve being lifted by the pressure only. The advantages claimed for this form of tap are, perfect security from leakage, facility of repair, by putting on a new leather without disconnecting the cock, the prevention of concussion, and the form of the water-way, which gives a larger area than the ordinary plug-cock. Messrs Guest & Chrimes, of Rotherham, are the patentees.

1492. *Jenning's India-rubber Tube Tap*.—This very efficient form of tap is illustrated in fig. 724, which represents the cock open. When the handle is

Fig. 722.

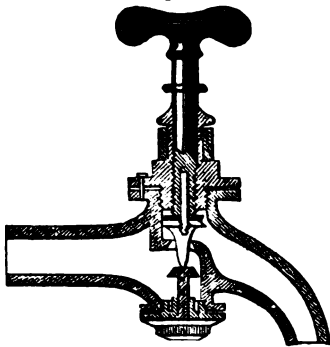

CHRIMES'S WATER-TAP.

Fig. 723.

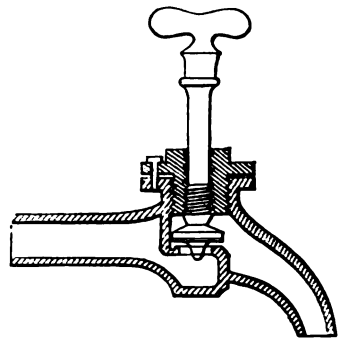

CHRIMES'S WATER-TAP.

Fig. 724.

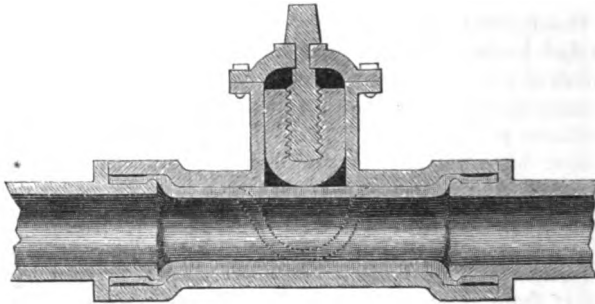

JENNING'S INDIA-RUBBER TUBE-COCK.

turned it presses upon the vulcanised india-rubber tube and collapses it, as shown by the dotted lines. One great advantage possessed by this cock is, that it gives the water-way the full size of the pipe. It is little liable to get out of order. The patentee is C. Jennings, Great Charlotte Street, Blackfriars Road, London.

Fig. 725.

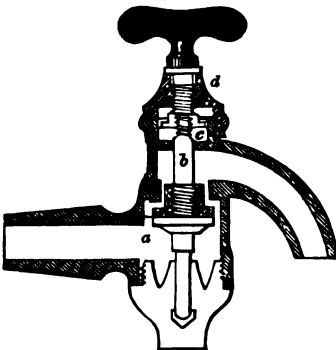

WHEATCROFT AND SMITH'S WATER-TAP.

1493. *Wheatcroft and Smith's Water-Cock.*—In fig. 725 we give a section of this form of tap, of which the principle of arrangement is the same as that adopted in the "hydrant:" *a* is the valve open for the escape of the water, *b* the spindle, *c* the vulcanised spring, *d* the screw.

1494. In cases where the water supply is on the "constant" system, as well as in those where the ordinary cistern is in use, much waste of water is occasioned by the "tap" being left open; a means of putting this waste out of the reach of a careless attendant is offered by an ingenious and philosophical invention of Mr Pilbrow, known as the "Water Waste Preventer," an elevation and section of which we give in figs. 726, 727. It may be described as a small cistern, which, when once emptied, cannot be again refilled without shutting off the delivery. The lower fig., 727, is a side elevation of this apparatus, in which *a* is the suction, and *b* the delivery pipe. The upper fig., 726, is a section showing

the method of action. The cylinder contains a ball-valve, which, when the water is at rest, remains at the suction end as at *c*. When the delivery-cock

Figs. 726, 727.

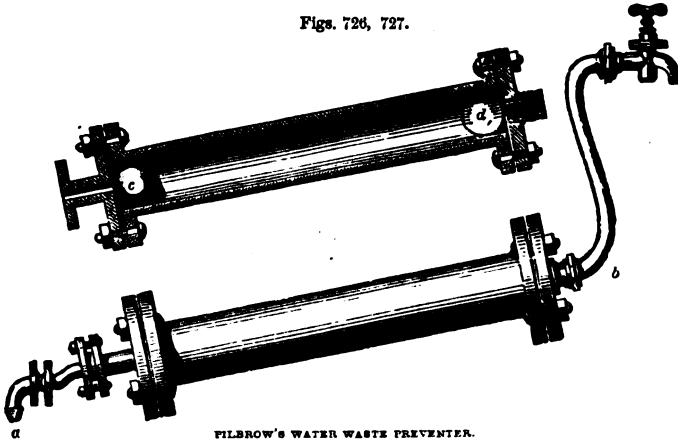

FILBROW'S WATER WASTE PREVENTER.

is opened to draw water the ball slowly rises, following the current of the water, until it arrives at the top, as at *d*, where it stops the flow of water by covering the aperture of the pipe. To obtain a fresh supply of water, therefore, the cock must be closed, when the ball, from its specific gravity, will descend in a few moments, and admit of an additional quantity of water being drawn off.

1495. *Traps for Sinks, Cesspools.*—Lowe's cast-iron trap, illustrated in fig. 728, is a very efficient form: *a a a* is the external covering, generally made of cast-iron, and fitted into the branch leading to the drain; *b* the line of grating through which the drainage fluid falls into the interior, *e e*. A partition *c* prevents the foul air from the drain, which has a tendency to pass up *d d*, as shown by the arrows, from passing through *e e*, and out by *b*, the only inlet to the drain. The prices of this form of trap, made in cast-iron, are as follows: No. 1 size, 30 inches by 18, and 16 deep, weighing about 5 cwt., is £2, 5s.; 20 inches by 12, and 13 deep, 2 cwt., 17s. 6d.; 14 inches by 9, and 9 deep, about 1 cwt., 10s.; 11 inches by 7, and 7 deep, 56 lb., 7s. 6d.; 9 inches by 5½, and 5½ deep, 25 lb., 4s. 9d. Another form of trap used for house gratings is shown in fig. 729; it is known as the "bell trap:" *a* is the entrance to the drain, the water passing through the grating at *h h*,

Fig. 728.

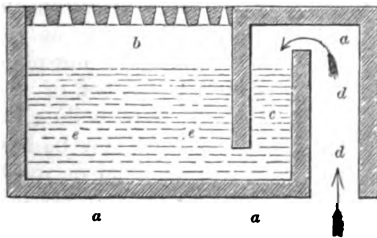

LOWE'S CAST-IRON TRAP.

Fig. 729.

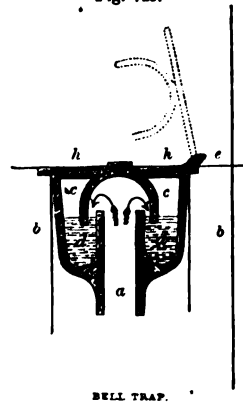

BELL TRAP.

passes into the receptacle *d d*; the bell or cup *c c* prevents the foul gases from *a* passing out by *h h*, while the water has free liberty to pass to the drain by *a*. The dotted lines at *e* show how the bell is jointed and may be raised.

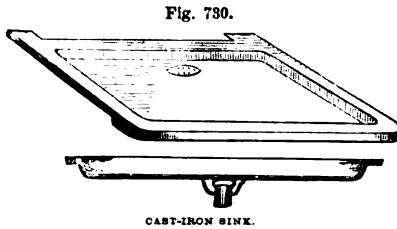

1496. *Cast-iron Sink*.—In fig. 730 we give an illustration of the cast-iron sink, with trap complete, manufactured by J. Jones, 6 Bankside, Southwark, London;

the price varying from 6s. to 12s. each, according to size.

1497. *Kitchen Grates, Ranges, and Stoves*—*The Lancashire Kitchen Grate*.—The great advantage possessed by this grate is, that no independent fire is required to heat the oven. By merely withdrawing a damper, the heated air and flame from the fuel in the body of the grate are drawn underneath the saddle on which the oven rests, passing along the bottom plate, and up and over the back and end plate, and the top of the oven, to a small or subsidiary chimney or flue, which connects itself with the main chimney a little above the breast. By this arrangement, any degree of heat required can be maintained in the oven with very little trouble and expense. It is vastly superior to the ordinary kitchen range used nearly throughout Scotland, and in which the oven is heated by a fire or furnace specially connected with it. Not only is this latter plan wasteful of fuel, but it is not capable of that nice degree of regulation necessitated by careful and economical cooking. The fire is either too brisk or too dull, and the oven is consequently over or under heated. Now, in the Lancashire grate—used by thousands in that county—the oven is not only quickly heated (for no independent fire has to be specially kindled), but it is easily kept at a uniform temperature. The price, moreover, is moderate—much, indeed, below that of the ordinary Scotch kitchen grate, and affords accommodation for a larger amount of cooking than may appear at first examination.

1498. *Goddard's Economical Cooking-Apparatus*.—Of a more pretentious

Fig. 731.

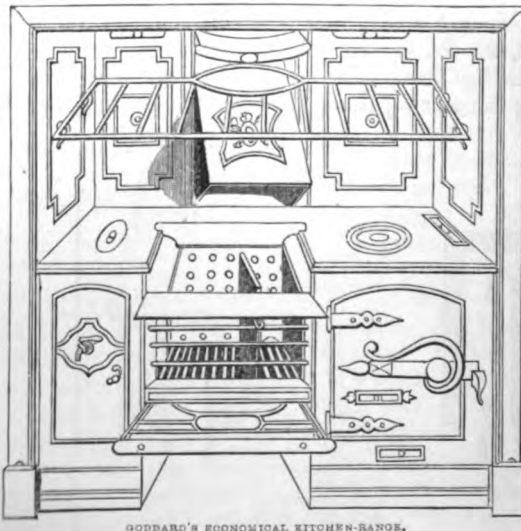

character, but on the same principle of heating the oven and boiler, &c., from a central fire, as that adopted in the Lancashire grate above described, is the "Nottingham" apparatus, manufactured by Henry Goddard of that town, and of which we give an illustration in fig. 731. These ranges consist of a surface or hot-plate, on which a number of vessels may be kept boiling, or on which irons may be heated; it has an oven or roaster, a boiler, and a plate-warmer. This range can be used either as an open fireplace or a closed stove.

1499. *American Cooking-Stove*.—Having been witness, while in the United States, to the efficiency, economy, and quickness of operation of the cooking-stoves in that country; and as, moreover, they are now being rapidly introduced into Great Britain, we have deemed it right to illustrate one of the numerous forms which this apparatus assumes; believing that for cottages they will be found useful and economical adjuncts to a poor man's house-appliances—as enabling warm and comfortable dishes to be *quickly* prepared—a matter of no small moment to a man who comes home tired and wet from his day's work on the road or in the field.

1500. Fig. 732 illustrates the stove known as the "Magnolia," for small families, adapted for heating two kettles or pans at top. The manufacturers are Messrs Smith and Wellstood, 33 Union Street, Glasgow.

1501. *Gas-Stove*.—Where gas is made at the steading, a simple form of stove may be used to heat the lobby of the farmhouse, or the wool-room, or other apartment in the steading.

1502. Fig. 733 illustrates Rickett's (5 Agar Street, Strand, London) Calorific Gas-stove, in which, by a simple provision, the products of combustion are led off to the external atmosphere—thus getting rid of the annoying smells which are produced by the ordinary form of gas-stove, in which the products of combustion are allowed to pass into the room; "a a gas-burners, b b gas-cocks to regulate the same, c c inner cylinder to direct the burnt air to top of stove before passing out at nozzle e, d door for lighting burner, f f tube to conduct the air of room through body of stove. The arrows show the passage of the burnt air, after supporting the gas flame of burner, and its exit from the stoves by the aperture e at the back. The arrow-points show the passage of the air of the room, through the body of the stove, without its coming in contact with the gas-burner. By the above it will be seen that, supposing the stove to be fixed in a bedroom, conservatory, or other close apartment, and a pipe be attached to the nozzle e, every portion of the burnt air must go up the pipe and be conveyed away."

Fig. 732.

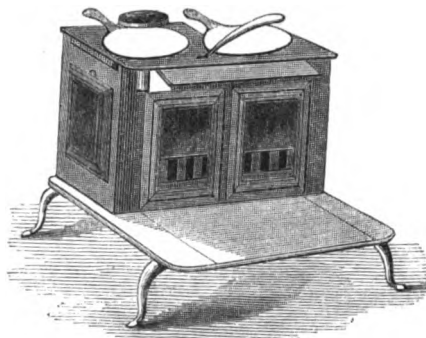

AMERICAN COTTAGE COOKING-STOVE.

Fig. 733.

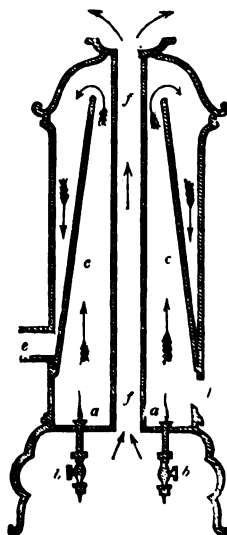

RICKETT'S GAS-STOVE.

1503. SECTION FIFTH—*Iron Fittings of the Steading—Gutters, Gratings, and Traps.*

1504. *Iron Gutters for Closed Surface Drains for Stables, &c.*—In fig. 734 we give Cottam & Co.'s (Winsley Street, Oxford Street, London) improved surface drains, and in fig. 735 the form introduced by Mr James Barton, 370 Oxford Street, London. Figs. 736 and 737 show methods of forming junctions at right angles.

Fig. 734.

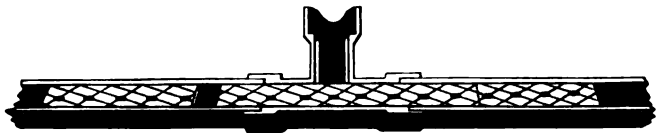

COTTAM'S IRON GUTTERING FOR CLOSED SURFACE STABLE-DRAINS.

Fig. 735.



BARION'S STABLE-DRAINS.

Fig. 736.

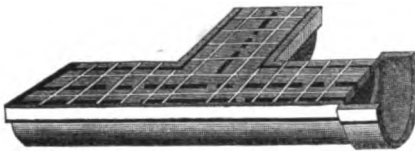

JUNCTION AT RIGHT ANGLES OF BARION'S DRAINS.

Fig. 737.

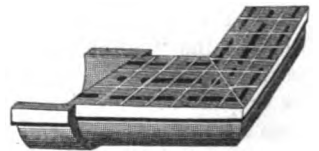

CORNER JUNCTION OF BARION'S STABLE-DRAINS

1505. *Gratings*.—Neither courts nor hammels are completely furnished for the comfort of their tenants unless provided with well-built drains to convey away the surplus liquid manure, when there happens to be any excess of it. For this purpose a drain should enter into each of the large courts, and one across the middle of each set of hammels. The ground of every court should be so laid off as to make the lowest part of the court at the place where the drain commences or passes; and such lowest point should be furnished with a strong block of hewn freestone, into which is sunk flush an iron grating, having the bars only an inch asunder, to prevent the passage of straws into the drain. Fig. 738 gives an idea of such a grating, made of malleable iron, to bear rough

Fig. 738.

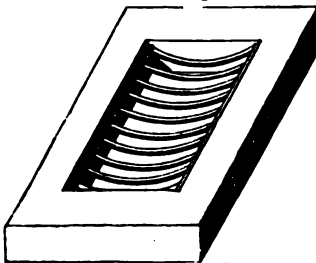

DRAIN GRATING FOR COURTS.

usage, such as the wheel of a cart passing over it; the bars being placed across with a curve downwards, to keep them clear of obstructions for the water to pass through. A writer, in speaking of such gratings, recommends "they should be strong, and have the ribs well bent upwards, as in that form they are not so liable to be choked up"—a remark quite correct in regard to the form of gratings for the sewers of towns, as with the ribs bent downwards in such a place, the accumulated stuff brought upon them by the gutter would soon prevent the water getting down into the drains; but the case is quite different in courts where the straw, covering the gratings, lies loosely over the ribs bent downwards, and acts as a drainer; but were it to be pressed against the ribs bent upwards, the water could not percolate through it. Any one who has seen the straw of dunghills pressed hard against a raised stone in the ground below it, will easily understand the effect.

1506. *Traps*.—In fig. 739 we give a view and section of Bell's patent trap for stables (manufactured by Glover Brothers, founders, 188 Drury Lane, Lon-

don), and in fig. 740 a view and section of the form introduced by Cottam & Co. In fig. 741 we give a cast-iron cesspool for stables and byres—the grating *a* of which is somewhat below the level of the pavement of stall, or the bottom of the gruiip; *b* is the entrance to the drain.

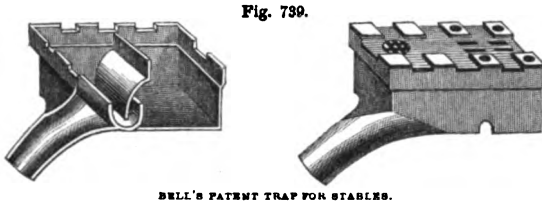

BELL'S PATENT TRAP FOR STABLES.

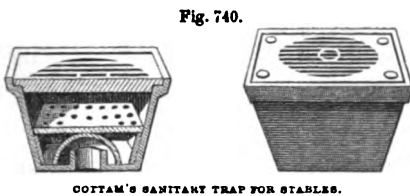

COTTAM'S SANITARY TRAP FOR STABLES.

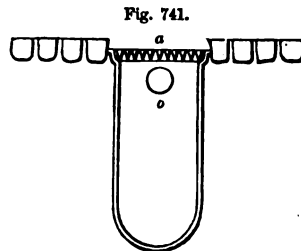

CAST-IRON CESSPOOL FOR STABLES AND BYRES.

1507. Ventilators.—In fig. 742 we give a section of a ventilator for admitting fresh air to the interior of an apartment. The aperture is made in the outer wall, near the ground, as at *a*; a door or plate *b* is hinged at the upper edge, and its lower edge is provided with a stud which works in the slot of a quadrant *d d*; a pinching or thumb screw is provided to the stud by which the valve *b* can be maintained in any position desirable. Fig. 743 is a front view, showing how the

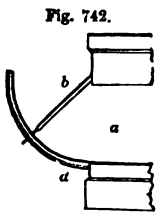

SECTION OF VALVE FOR ADMITTING FRESH AIR TO STABLES.

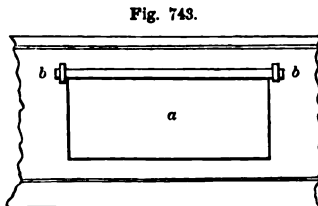

FRONT VIEW OF VENTILATOR.

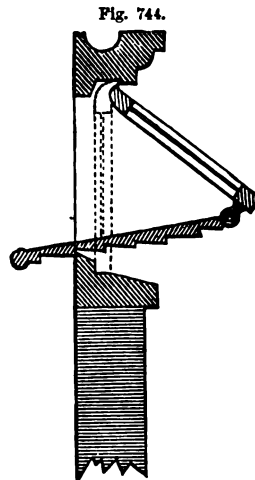

RATCHET-VALVE FOR ADMITTING AIR.

valve *a* is hinged at *b b*, the staple or bar passing through the eyes of two studs leaded into the wall. The form of ventilator, fig. 292, as Looker's ventilator, is also made in cast-iron, and is well adapted for stables. The forms illustrated in figs. 528 and 529, may also be used for admitting and regulating the supply of fresh air. In fig. 744 we give a section of a ratchet valve, for admitting fresh air, or permitting the egress of foul air.

1508. Ventilators for the egress of the foul air of apartments may be made of the form shown in fig. 742, or as in fig. 745, or fig. 746. A form of ventilator, or modification of the well-known "Watson's System," highly spoken of, is the

Fig. 745.

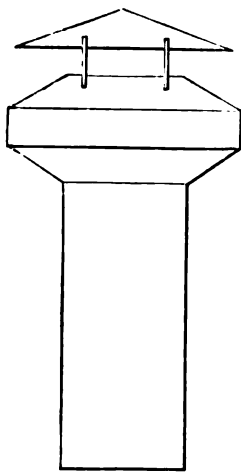

VENTILATOR FOR ROOF.

Fig. 746.

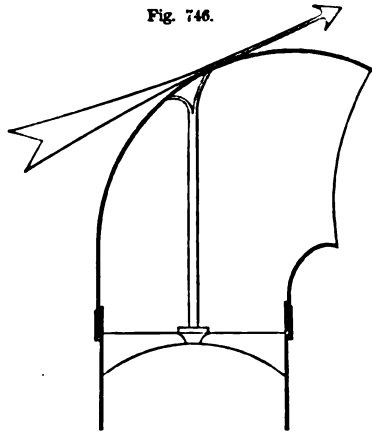

SWIVEL OR BOWL VENTILATOR.

“Four Points Ventilator,” invented by G. W. Muir, 11 Ducie Street, Exchange, Manchester. It consists of a square shaft, fig. 747, open on all sides, divided vertically into four equal compartments. While the current of external air is

Fig. 747.

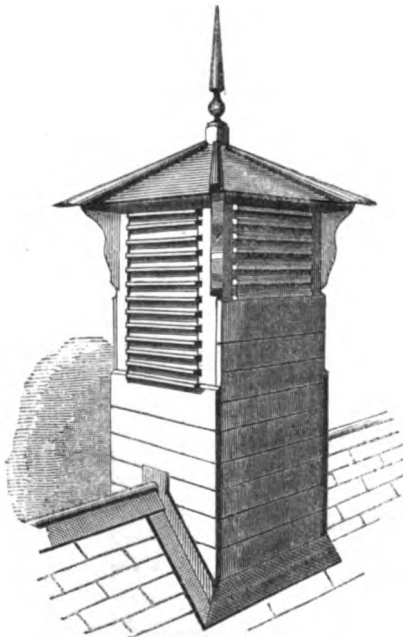

MUIR'S FOUR-POINTS VENTILATOR.

Fig. 748.

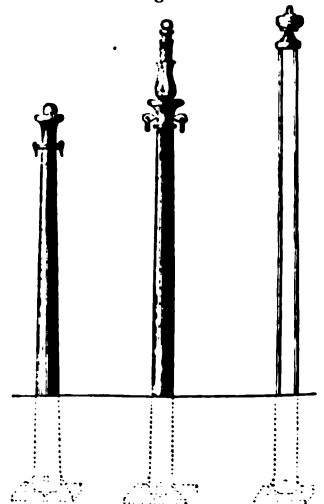

COIFAM'S HIND-POSTS FOR STALLS.

forced down one compartment, the internal or impure air passes up the opposite

compartment, and is led to the external atmosphere. By the ventilator being divided into four compartments, no matter in what direction the wind blows, the ventilator is always kept in action. It will be seen that the apparatus is designed to serve the double purpose of admitting fresh air to the interior of a room, and withdrawing from it, at the same time, the foul air.

1509. *Hind-Posts — Traverses — Stable-Fittings.*—Fig. 748 illustrates various forms of hind-posts; and in fig. 749 of traverses or divisions, as manufactured by Cottam & Co.

Fig. 749.

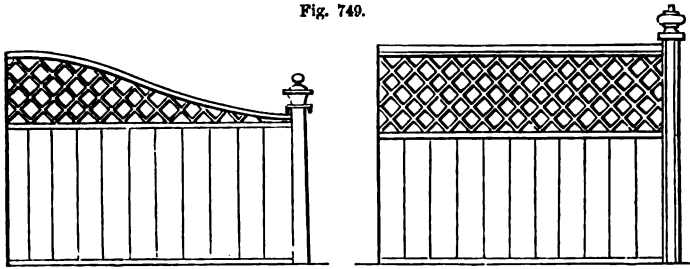

COTTAM'S TRAVERSES OR STALL DIVISIONS.

1510. *Manger, Water-Trough, &c.*—In fig. 750 we illustrate Cottam & Co.'s patent enamelled manger, water-trough, and wrought-iron hay-rack. These are made for stalls 6 feet in width. They require no front-bearer, and can be readily attached to the sides of the stall: *a* is a separate view of the seed-box attached to the bottom of the hay-rack, and is easily removable when required. The mode of fastening the horse in his stall is shown at *b c*; the collar shank is attached to the part *b*, which slides in rings, and is provided with a weight *c*.

Fig. 750.

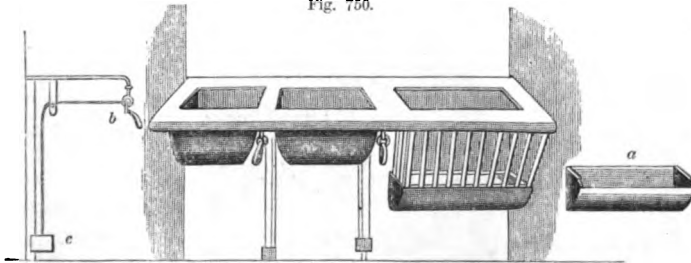

PATENT MANGER, WATER-TROUGH, AND WROUGHT-IRON RACK.

1511. *Bruce's Improved Stable Fittings.* — In fig. 751 is an illustration of these ingenious fittings (manufactured by Ransome & Sims, Ipswich), in which the peculiar feature is the employment of an adjustable hay-rack. In this the hay is placed in a movable cage, hung by chains provided with a weight which always keeps the cage with its contained hay close up to the top flat bars of the rack. By this arrangement all waste is avoided. An ingenious form of fastening is also introduced. The end of the collar shank passes down the vertical tube in the centre of the stall, and is terminated with a weight. This always keeps the collar shank out of the way, so as to prevent the horse getting his foot over it:

1512. *Garood's Adjustable Hay-Rack.*—In Bruce's stable-fittings, illustrated

Fig. 751.

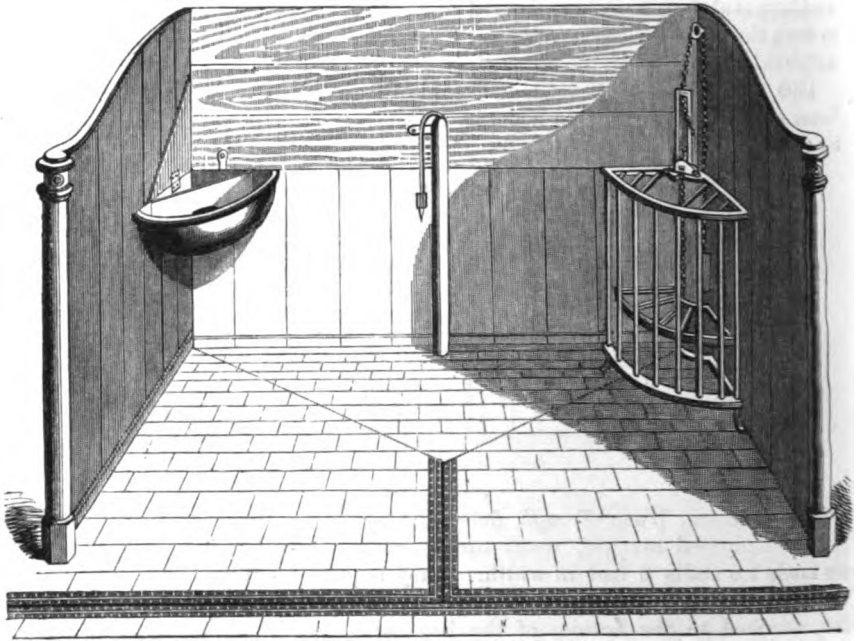

BROOK'S IMPROVED STABLE-FITTINGS.

Fig. 752.



GARROD'S ADJUSTABLE HAY-RACK.

in fig. 751, the hay-cage being suspended on one pulley, it is apt to get jammed against the side of the rack, and to remain immovable. A more perfect adjustment is obtained by using two pulleys, as illustrated in fig. 752, and designed by Mr C. Garood, late superintendent of the Agricultural Department of the Crystal Palace, Sydenham.

1513. It is obvious that these spring hay-racks are quite unsuited to a work-horse stable, but they may be, and with advantage, used in the riding-horse stable. In a work-horse stable, the simpler the fittings of the stall the better; the rounder their finishing, the safer for the horse; and the more easily cleaned, the more securely will the health of the horse be insured. The adoption in the work-horse stable of the method by which the collar-shank operates, as in fig. 751, would be a great improvement.

1514. *Cottam's Improved Stable-Fittings.*—The object of this invention is to enable the rack, manger, and water-trough to be removed when not required, so as to admit of the interior of the stall presenting a flush surface. The plan is more particularly useful where a feeding passage is made at the head of the stalls, inasmuch as the racks, &c., can be brought at once into the passage, filled and returned to the stall with very little delay. The hay-rack, fig. 753,

Fig. 753.

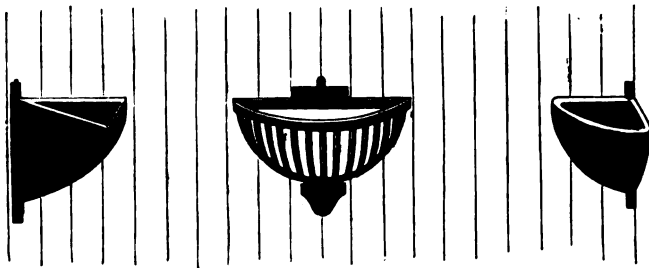

COTTAM'S STABLE-FITTINGS.

in the centre swings on a central pivot, and is provided with a flat back, so that, when turned half round, the rack is passed behind the head of the stall, while the back presents a surface flush with the stall. The manger and water-trough are quadrantal, and swing on central pivots, so that, when turned one quarter round, the flat sides are presented to the stall, while the other parts containing the corn or water are presented to the back or to the feeding passage. In fig. 754 another arrangement is shown, in which the manger is capable of being pushed out and in; it is well adapted for loose-boxes. The manger slides in and out on small pulleys on the bar *a a*; the projecting part *b* prevents it being pulled out too far.

Fig. 754.

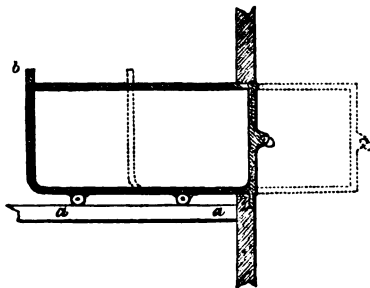

COTTAM'S SECTION OF SLIDING MANGER.

1515. *Fittings for Loose-Boxes.*—In fig. 755 we illustrate the form of manger and rack without water-trough, and in fig. 756 patent manger and water-trough, fitted to a cast-iron plate. These are manufactured by Cottam & Co.

Fig. 755.

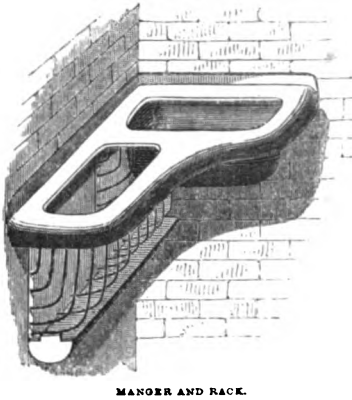

MANGER AND RACK.

Fig. 756.

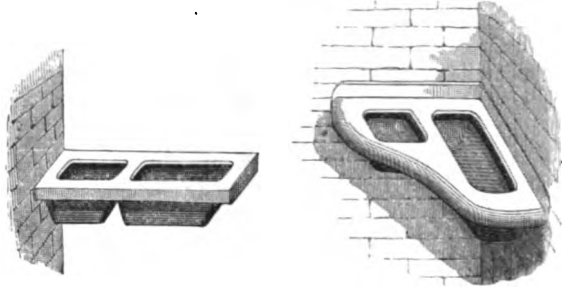

MANGER AND WATER TROUGH.

1516. *Harness Appliances.*—Fig. 757 illustrates cast-iron saddle and harness bracket, and fig. 758 cast-iron collar-holder. These articles are as well suited to a work-horse as to a riding-horse stable.

Fig. 757.

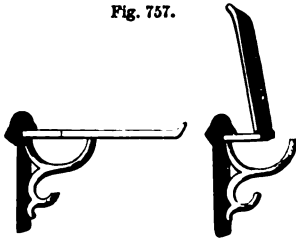

SADDLE AND HARNESS BRACKET.

Fig. 758.

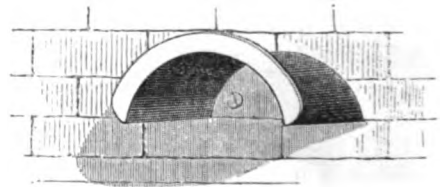

COLLAR HOLDER.

1517. *Fittings for Piggies.*—A very convenient trough for a piggery containing a number of pigs—such as young ones, or others confined in summer from roaming about—has been long manufactured by the Shotts Iron Company, of which fig. 759 is a view in perspective from the interior of the court. It is nearly all made of cast-iron, and possesses the great convenience of allowing the troughs to be filled with food from the outside of the building, the person who feeds being at the same time free of any annoyance from the pigs. Troughs of this kind are placed in proper sized openings in the external wall of the piggery court, in the manner shown in the figure, where *a* marks the wall on one side of the opening—that on the hither side being left out of the figure, in order to exhibit the form of the trough. The trough, part of which is seen at *b*, is 4 feet in length, 16 inches wide at top, 8 inches at bottom, and 9 inches deep. The two ends *c* and *d* rise in a triangular form to the height of $3\frac{1}{2}$ feet, and are connected at the top by the stretcher-bolt *e*. The lower part of each end extends inward to *f*, *g*, making a breadth of 3 feet 4 inches when complete; but this part of the end *g* in the figure is broken off, to show part of the trough *b*. Two intermediate divisions *h h* divide the trough into 3 compartments—these divisions extend to the same length as the ends *f* and *g*, and are all 21 inches in height. By means of these divisions, each animal, when there are more than one together, has its own stall, and can take its food undisturbed.

Fig. 759.

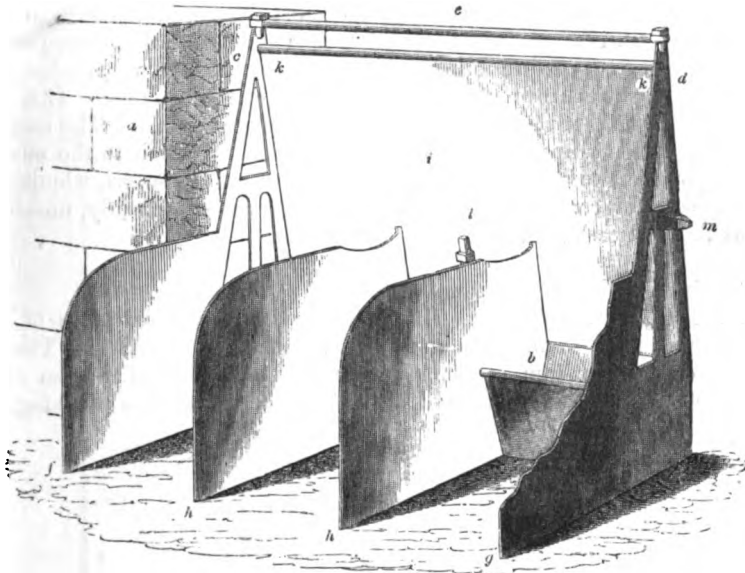

FIGS'-TROUGHS, WITH SUBDIVISIONS, TO STAND IN AN OPENING OF THE OUTER WALL OF THE STY.

1518. In fig. 760 we illustrate a circular-bottomed pig-trough, and in fig. 761 a similar bottomed hog-trough, to stand in a court.

Fig. 760.

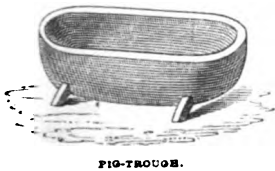
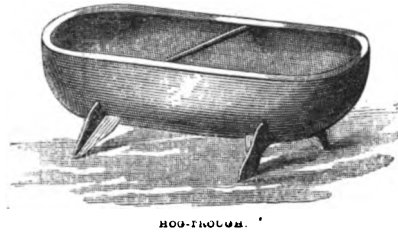
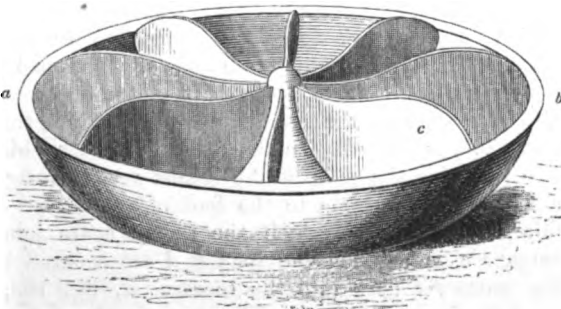

Fig. 761.



we illustrate a handsome pigs'-trough adapted for standing in the middle of a court. It consists of cast-iron in one entire piece. Its external appearance, when viewed as it stands on the ground, approaches to that of a hollow hemisphere, with the apex flattened; and interiorly the flattened part rises up in the centre in the form of a central pillar—thus converting the hemisphere into an annular trough, whose transverse section presents two troughs in the form of two semicircles con-

Fig. 762.



ROUND FIGS'-TROUGH, TO STAND IN A COURT.

joined. The diameter $a b$ of this trough is 30 inches, the rim is finished with a round edge, serving both for strength and comfort to the animals who eat out of it. The depth is about 9 inches, and it is divided into eight compartments by the division c , which are formed with a convexity in the upper edge, to prevent the food being thrown from one compartment to the other. This trough stands upon the top of the litter, and is not easily overturned. The cattle cannot hurt themselves upon it, while it is easily pushed about to the most convenient spot for it to stand. Of all the classes of pigs'-troughs, whether made of stone, wood, or cast-iron, there are none so convenient, cleanly, durable, and neat, as those of cast-iron.

1519. SECTION SIXTH—*Bridges—Sluice Valves—Hydrants.*

1520. *Cast-iron Foot-Bridge.*—In fig. 763 we give the elevation of a foot-bridge, in which the beam $a a$ is of cast-iron, and curved in outline. The standards $b b$, of wrought-iron, are braced by the tie-rods $c c$. The plan of roadway is given in fig. 764, where $a a$ are the beams, $b b$ the planking.

Fig. 763.

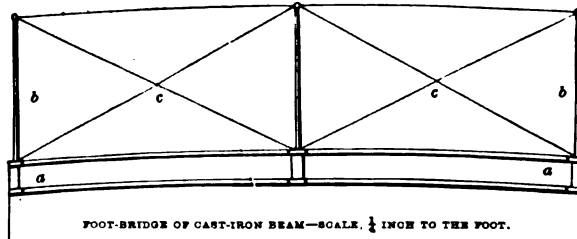
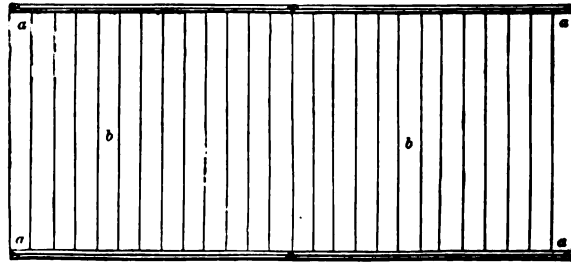
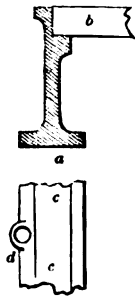

Fig. 764.



1521. *Details of Foot-Bridge.*—In fig. 765 we give at a a section of the beam—the total depth of which is 9 inches. The road planking b rests at the ends in a recess made in the upper part of the beam. At $c c$ we give part plan of the beam, showing the slot or recess d , in which the lower part of the standard b , fig. 763, is placed. In fig. 766 we give a side and end elevation of the shoe in which the ends of the beams rest. In fig. 767 we illustrate methods of joining the tie-rods to the foot of standards—either by eyes cast on the pillar, as at $a a$, to which the rods $b b$ are jointed, or by recesses in the snugs $c c$, into which the rods $d d$ are secured by the keys or cotters $e e$. The parts $f f$ pass into the recesses d , fig. 765, of the beam, and are secured by keys or bolts. The upper ends of the tie-rods are joined to the caps of the standards $b b$, fig. 763, in the same manner as now illustrated in fig. 767.

Fig. 765.



SECTION AND PLAN OF BEAM—SCALE, 1 INCH TO THE FOOT.

Fig. 766.

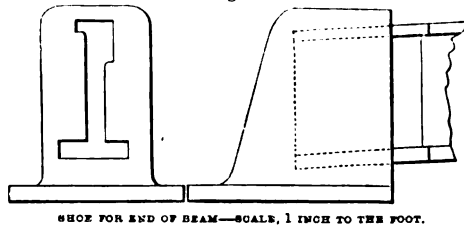

SHOE FOR END OF BEAM—SCALE, 1 INCH TO THE FOOT.

Fig. 767.

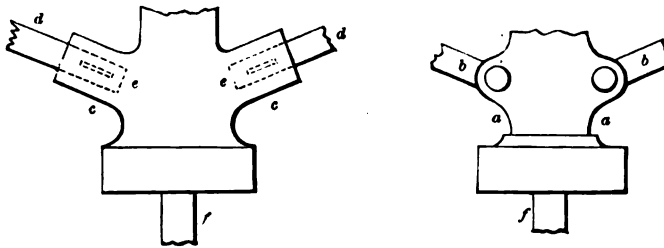

FEET OF UPRIGHTS FOR RAILS—SCALE, 2 INCHES TO THE FOOT.

1522. Simpler modes of erecting the rails of this foot-bridge are illustrated in fig. 768, where *a a* shows one of the upright standards—of which as many are placed in line as are required—which are fastened to the beam by the stud *b* passing into the slotted parts cast on the beam, as at *d* in fig. 765. The standards are kept together by chains *c* and *e*, which are connected to eyes of the piece *d* which slip over the standard. In the same figure another method is illustrated, where *f* is the standard, provided with a rectangular top *g*; this is made with a slot to permit of the top rail of wood *h h* being passed through. In fig. 769 we give at *a* and *b* an elevation and a plan of the piece *d*, in fig. 768; and in fig. 770 at *a* an elevation, and *b* an end view of the rectangular head *g* of the standard *f* in fig. 768.

Fig. 768.

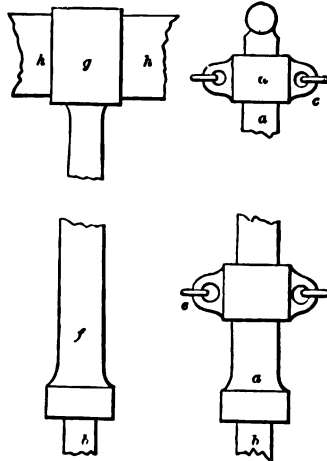

UPRIGHTS FOR SUPPORTING CHAINS AND RAILS.

1523. *Cast-iron Bridges.*—Where rectangular beams of cast-iron are used to support the roadway of a bridge, the depth should be at least six times the thickness. For a span of 20 feet, the depth of beam *a b*, fig. 771, may be $15\frac{1}{2}$ inches; the thickness *c* $2\frac{1}{2}$ inches. Where the distance between the beams—or breadth of roadway—is 6 feet, two beams, as *d e*, fig. 771, may be used; if the distance is from 10 to 14 feet, a third, as *f*, may be placed at a point equidistant between the other two. In fig. 772 we give the section of a beam of improved

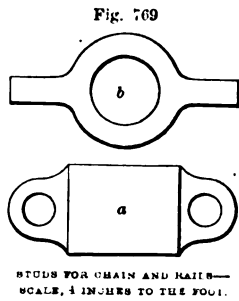

STUDS FOR CHAIN AND NAILS—
SCALE, 1/4 INCHES TO THE FOOT.

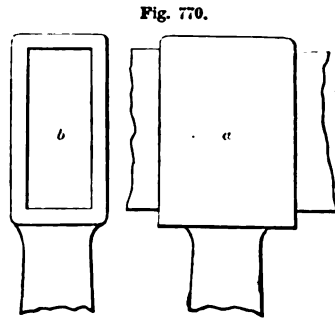

CAP FOR RECEIVING RAIL—SCALE, 1/4 INCHES TO THE FOOT.

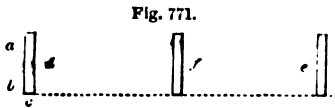

SECTION OF BEAMS FOR BRIDGE—SCALE, 1/4 INCH TO THE FOOT.

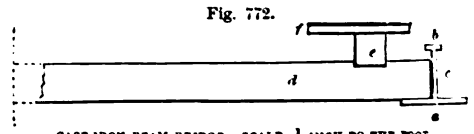

CAST-IRON BEAM BRIDGE—SCALE, 1/4 INCH TO THE FOOT.

form, two of which, placed 9 feet apart, will be adapted for a bridge of from 18 to 20 feet span. The width of lower flange *a* is 10 inches, and its thickness $\frac{3}{4}$ inch; width of upper flange *b* $2\frac{1}{2}$ inches, and thickness $\frac{3}{8}$ inch; total depth of beam, 8 inches; thickness of rib *c*, 1 inch. Oak sleepers *d*, 9 inches broad by 5 thick, are placed upon the lower flanges of the beam, the distance between oak sleepers from centre to centre being 3 feet. These sleepers again support cross-beams *e*, 4 by 4, on which the flooring planks *f* rest. The section of a beam for a span of 12 feet 6 inches—these beams being placed at a distance of 7 feet 4 inches apart from centre to centre, as shown in fig. 773—the width of lower flange is $3\frac{3}{4}$ inches; thickness $1\frac{1}{2}$ inch; breadth



SECTION OF ROADWAY WITH THREE BEAMS—SCALE, 1/4 INCH TO THE FOOT.

of upper flange $2\frac{1}{2}$ inches; thickness $1\frac{1}{2}$ inch—total depth of beam, 8 inches. In fig. 773 *a a* are the three beams bolted to the wall-plate *b b*, 6 inches by 4. Oak planks *c c*, 7 inches by 4, rest on the lower flanges of the beams; the distance between planks from centre to centre being 3 feet. On these planks the flooring *d d* is laid.

1524. Mr P. W. Barlow, civil engineer, has introduced for road-bridges over railways the use of corrugated iron plates, bolted together, to act as one plate. The practical advantages, as stated by Mr Barlow, are—“ 1st, That there is less depth required between the surface of road and the soffit of girder; 2d, that one plate assists another, and the weight of a passing load is distributed over the whole bridge, or nearly so; 3d, that all lateral vibration is avoided; 4th, that greater safety is obtained by the plates of the bridge being bolted together, as the fracture of any of them would not be attended by the fall of a load passing over the bridge. The following experiments were made: 1st, with a plate 3 feet 1 inch wide; 31 feet 6 inches between bearings—total length, 33 feet 6 inches; depth of corrugation, 8 inches; thickness of metal, 1 inch—

With 4 tons, equally distributed, deflection	1/4 inch.
9	1 1/4
13	2 1/4
18	3 1/4
19	4
19 1/2	broke.

2d, with one of the plates of the Tunbridge Wells bridge, bearing 28 feet—

With 3 tons in the centre, deflection	$\frac{1}{2}$ inch.
6 "	1 "
9 "	1 $\frac{1}{2}$ "
11 "	2 $\frac{1}{4}$ "

The bridge, being composed of 12 plates in width, would bear 132 tons in the centre; and as at least half comes into operation by a load passing over, 66 tons in the middle, or 132 tons all over, may be considered the resisting strength, which is six times what is required."

1525. *Corrugated Iron-Plate Bridge.*—In fig. 774 we give a bridge of this description, the distance to be traversed—20 feet—being divided into two spans of 10 feet each; the centre being supported on the column *a*; *b b* side columns; *d d* cast-iron beams, supporting the corrugated plate; *c c* the road-way. In fig. 775 we give a section of the corrugated plate, the diameter of the curves from *a* to *b* being 8 inches, the thickness of metal 1 inch, and the width of plates 2 feet 8 inches, or four corrugations in each width.

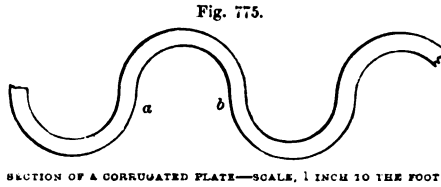
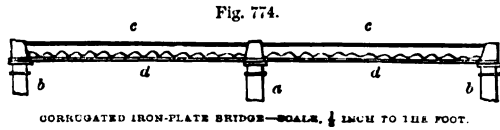

1526. *Sluice-Valves.*—In fig. 776 we give a front elevation, and in fig. 777 a side elevation, of a "self-acting valve" for a tidal sluice in sea-embank-

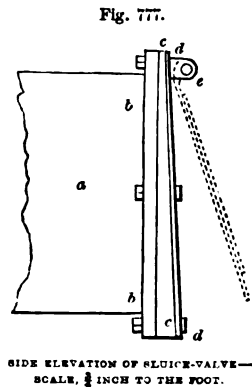
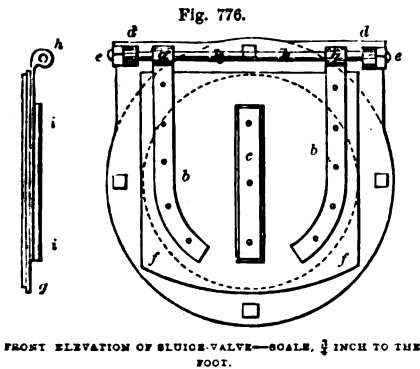

ments, &c. The water in this case is supposed to be passed through the embankment by means of a cast-iron pipe—the valve being fitted to the outer or seaward extremity. In fig. 777 *a* is the extremity of pipe; *b b* the ordinary flange; a flat disc of wood *c c*, thicker at the under than the upper side, is bolted to the flange *b b*. This disc is cut on the lower side to the form of the flange, and at the upper to the outline, as shown at *e e* in fig. 776. A circular aperture is cut out of the centre of the disc, of diameter equal to the internal diameter of the cast-iron pipe *a*, fig. 777. A thin iron plate *d d*, is cut out to the same shape as the wooden disc *c*, and is also similarly provided with an aperture in the centre. The wooden disc and iron plate are secured to the

flange of the pipe by the same bolts and nuts. To the upper part of the plate *d d* snugs with circular bolt-holes are cast, as *e*, and at *d d*, fig. 776. The valve is constructed of a thin wrought-iron plate *f f*, shown in side elevation at *g* in fig. 776. Iron straps *b b* are riveted to this, and terminated with eyes shown in side elevation at *h*. A bolt *k k* is passed through the snugs *d d*, and the eyes *a a* of the straps *b b*, and secured by bolt and nut *e e*. The inclination of the disc *c c*, fig. 777, tends to keep the valve closed; but to aid this, a piece of iron *c*, fig. 776, is riveted on to the outer side. An internal circular plate *i i* may be riveted to the interior side of the valve—the diameter of this plate being equal to the internal diameter of the pipe *a*, fig. 777.

1527. *Jenning's Sluice-Cock*.—For irrigation pipes, where the water is forced through at high pressure, sluice valves are used with advantage. In fig. 778 we give a section of a sluice valve, manufactured by G. Jennings, 29 Great Charlotte Street, Blackfriars Road, London. These have been worked for years under vertical pressures varying from 1 to 300 feet.

1528. *Brown and May's Sluice-Cock*.—In fig. 779 we give an ingenious form of sluice-cock, manufactured by Messrs Brown and May, North Wilts Foundry, Devizes. In the figure a section and elevation are given. In the section *a* is the outlet pipe; *b* the valve face which covers it, and which is provided with a rack *c c*, into which a pinion gears, worked by the handle *d*.

Fig. 778.

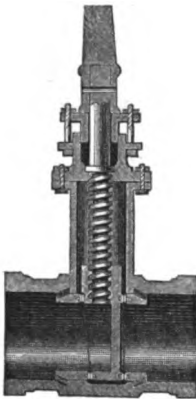

JENNING'S SLUICE-VALVE.

Fig. 779.

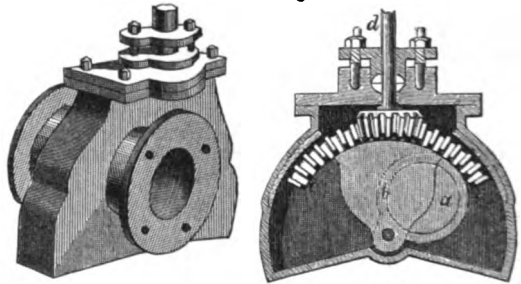

BROWN AND MAY'S SLUICE-COCK.

1529. *Wheatcroft and Smith's Hydrant*.—In fig. 780 we give a section of this hydrant. The valve-chamber *a* communicates with the supply pipe *b*, *c* being the pipe leading off the water; *d d* is the projecting valve seating, which, having a less area than the part *b*, allows sufficient space for the escape of the water required. Upon the valve *d d* rests the valve or disc *e e*, attached to the spindle *f*, which passes through the top plate, and through the vulcanised india-rubber packing *g*. This is protected by the metal cap *h*. The spindle *f* is secured by the nut *i*, which is screwed down sufficiently to give compression to the valve in its seat—forming also a tight packing round the spindle, and having the effect of keeping the valve closed, independent of the pressure of the water. To open the valve, the screw *k* is acted upon by the nut *l*.

1530. *Iron Sluice Valve and Rack*.—In fig. 781 we give an elevation of an iron sluice-valve, as used in the Campine district in Belgium: *a a* the sides of watercourse; *b* watercourse; *c* the valve; *d d* the cast-iron or stone plate, to

which is secured the standard *e e*; this carries a box *f*, in which a small pinion *g* revolves this gearing with the teeth of the rack formed on the upper part of stem *h h* of valve *c*. In fig. 782 we give plan: *a a* watercourse, *b b* stone or iron plate, *c c c c* standard, *d* box containing pinion.

Fig. 780.

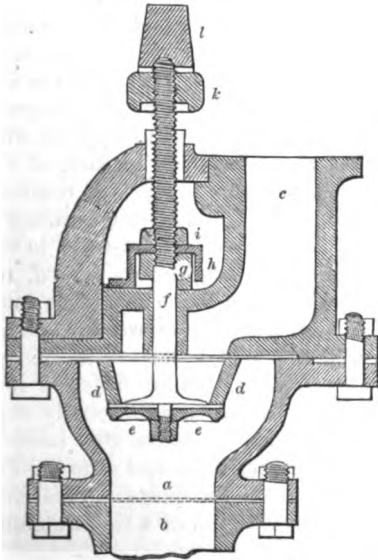

WHEATON AND SMITH'S HYDRANT

Fig. 781.

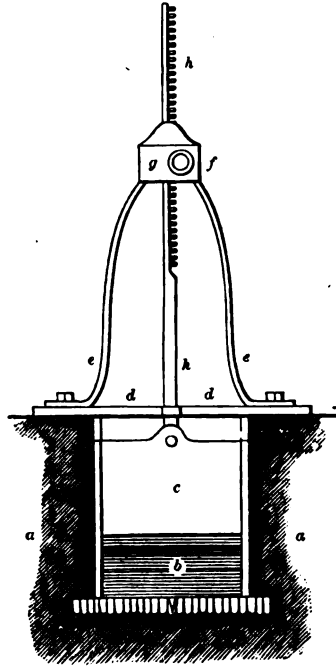

ELEVATION OF IRON SLUICE VALVE AND RACK—SCALE. $\frac{1}{2}$ INCH TO THE FOOT.

Fig. 782.

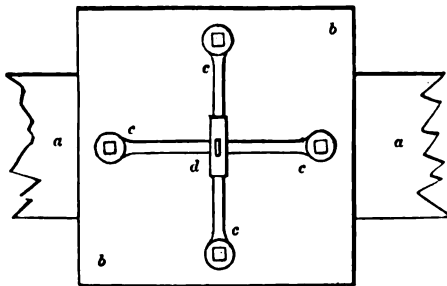

PLAN OF IRON SLUICE

1531. SECTION SEVENTH.—Iron Gates.

1532. *Malleable-Iron Gate.*—In the construction of malleable-iron gates we as frequently find malformations as in those of wood, such as placing all the bars on edge except the heel and head post, misplacing the diagonal, if single, and not unfrequently applying bars variously formed in curves and fanciful figures, to serve the purpose of the diagonals. The field-gate maker should be

instructed to hold steadily in view, that there is but *one position* and form for that member of the structure that can be fully efficient, and this is, the straight bar extending from the upper angle at the heel to its opposite angle at the head post; and, if the materials of the gate are light, to apply an antagonist diagonal crossing the first. In framing the gate, also, the top and bottom bars should be set flat-ways, to enable the structure to resist lateral strain from animals rubbing or pushing against it.

1533. Fig. 783 gives a simple form of an iron field-gate; it consists of six

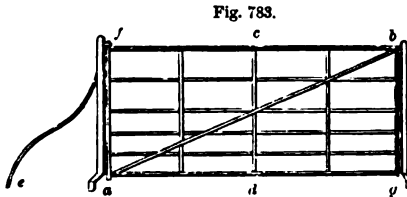

IRON FIELD-GATE WITH IRON POSTS AND STAY.

fore and hind stiles with strong solid knees. The upright bars, as *c d*, retain each of the rails in its proper place. The gate-frame is 9 feet long and 3 feet 9 inches in height. The gate can be hung upon wooden posts; but the iron posts, as shown in the figure, correspond better with the appearance of the gate. They are made of malleable-iron, and are fastened into large stones with double bats; and the hanging-post *f a* is additionally supported by a stay *e*. The cost of this gate is 30s., and the posts 20s. more—together, 50s.—which price completes all the necessary bolts and nuts for fixing them to the stone blocks, and hanging the gate on the posts. This form of gate would probably be strengthened by the introduction of a tie stretching from *f* to *g* across the centre of the diagonal *a b*.

1534. *Iron Tension Gate*.—The same species of iron gate is made on the tension principle, as seen in fig. 784, where

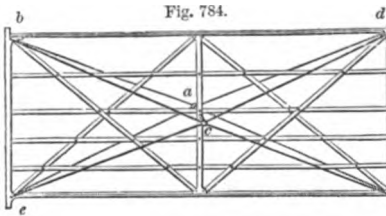

IRON FIELD-GATE ON THE TENSION PRINCIPLE.

the other parts than the tension are different from those in fig. 783, in not having diagonals, as *a b*. In fig. 784 strong iron tension-wires pass through the cast-iron blocks *a* and *c*, connected together with an iron collar, in the centre of the frame. These wires are fastened by heads to the upper bar and stiles at *b* and *d*, and drawn as tight as

required at the lower bar and stiles at *e* and *f*, by means of nut and screw. The cost of this gate, without the posts, is 25s.

1535. It will be observed that the central apparatus of this gate is similar in appearance to that of the Kilmory wooden gate in fig. 574; but their mode of action is the opposite, though the effects produced are similar. In fig. 784 the wires from *a* and *c* act as ties, drawing the posts and rails towards them from the angles, and thereby giving to the entire framing a rigid structure. In fig. 574 the wooden struts from *e* and *f*, as centres, push the posts and rails outwards at the angles against the clamps, thereby also giving the framing a rigid structure.

1536. *Angle-Iron Gate*.—One of the latest improvements in iron field-gates is the introduction of *angle-iron*, now so extensively used in boiler-making, ship-building, and other purposes. In the application of the angle-iron to the

construction of gates, the fabric acquires the rigidity of a massive wooden gate, with all the tenacity and strength of the iron, while its weight is little more than that of wood. Fig. 785 is a form of gate of this construction, from a design, slightly altered, of Mr William Dunlop, Edinburgh, and is manufactured by A. & G. H. Slight, Edinburgh. The external form is composed of four bars of angle-iron, measuring $1\frac{1}{2}$ inch on each side; and to give security to the joinings at the four angles of the truss, the ends of the bars are riveted upon cast-iron corner-plates, those of the heel-post $a b$ being formed with strong projecting pivots, by which the gate is hinged.

Fig. 785.

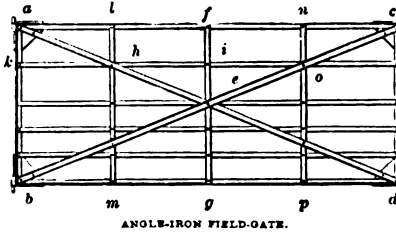

Any number of interior bars may be applied to suit the objects of the gate. The figure exhibits the arrangement adapted to retain sheep and lambs. The diagonal $b c$ is contrary to the general rule, for it is apparently a strut, but being a bar of angle-iron, of the same breadth as before, it possesses the stiffness of wood to resist lateral strains—and is hence properly adapted for a strut; to render the bracing complete, the antagonist diagonal $a d$ is applied, and this, acting as a tie, is only a flat bar 1 inch by $\frac{1}{2}$. The external frame is thus rendered unchangeable in figure by any force that may be applied to the head-post in a vertical direction, either upward or downward, short of what will fracture the gate; and the point e , where the diagonals cross each other at the centre of the gate, becomes also immovable in the plane of the truss; hence the perpendicular bar $f e g$, being riveted to the diagonal at e , acquires the same property, and by attaching all the horizontal bars to $f e g$ at their several crossings, each of them is rendered permanent in its position at that point, and no force short of breaking down the gate can bend any of the parts upward or downward in the direction of the bar $f e g$, so long as this last remains attached to the crossing of the diagonals at e . In order to give farther support to the horizontal bars by the principle of construction, we have only to take a point where a diagonal crosses a bar, as at h , forming the opposite triangles $e h i$ and $a h k$, which, when the bar and diagonal have been connected, become also immutable, and the perpendicular bar $l h m$ being secured to the point h , and again to the different bars at their intersection with $l h m$, the whole are again rendered immovable as in the middle. The support given to the horizontal bars in the line $l h m$ would have been still more complete if there had been only one intermediate bar below the middle one of e , as the three parts would then have met in one point, as they do at h , but two bars are introduced to render the gate fencible for sheep of all ages. The perpendicular bar $n o p$ is applied on the same principle as seen in $l h m$, the point of support in this case being o . This gate would perhaps become more rigid still if the upper and lower rails $a c$ and $b d$ were double flanged.

1537. In this construction of gates, the greatest possible amount of mutual support among the parts is obtained with a given quantity of materials; hence gates of this construction may be made lighter than any other form, where iron is the material employed, and yet have a greater amount of strength. In this example, the dimensions of the angle-iron are $1\frac{1}{2}$ inch each way, and about $\frac{1}{4}$ inch thick; all the other parts are $1\frac{1}{4}$ inch broad by $\frac{1}{8}$ thick, the cast-iron corner-plates at $a b c$ and d being of course stronger, and the entire weight of the gate is 112 lb. It may be of use to those who make iron gates, but who have not taken time to study the first principles of their construction, to notice this further re-

mark. Any number whatever of additional upright bars to those shown in fig. 785 would add strength or support to the horizontal bars only on the principle of superposition, or adding bar to bar, without the advantages which arise from the principle of unchangeableness to the triangle when applied in the construction of framework, whether in a simple field-gate, or in the highest branches of constructive carpentry in wood or in iron. In the one case, the stress on the parts continues to act at right angles to the bars, the direction in which they are weakest, while in the other—the principle of throwing the frame into triangles—the whole stress is thrown upon one or more parts in the direction of their length, in which position all bars and beams are strongest.

1538. *Braced Iron Gate*.—An example of an ingenious construction of iron gate is given in Parnell's work on road-making, which was improved on by the late Dr Buist of Allahabad, in Bengal, and described in the *Transactions of the Highland and Agricultural Society*. These gates consist of a wrought-iron external frame, which is supported by a very perfect system of bracing, with diagonal ties of iron wire, and filled up in a variety of forms with the same material. Fig. 786

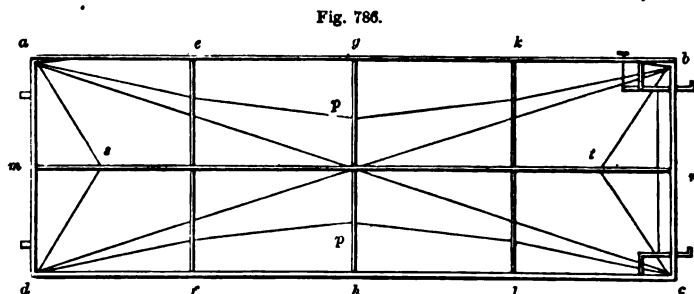

ELEMENTS OF THE BRACING OF A WIRE FIELD-GATE.

represents Dr Buist's gate with the fundamental braces and ties, which he thus describes: "The framing $a b c d$ is fashioned like that of an ordinary gate; $e f, g h$, and $k l$ are three light slips of iron parallel to the ends of the gate, and riveted to the upper and lower rails; $a p b$ is a wire about the thickness of a goose-quill, fastened by a rivet at one end, and a screw and nut at the other; it passes through holes in the slips $e f, g h$, and $k l$, and serves as a brace to support the bar $a b$. In the same manner $d p c$ serves as a brace to $d c$, while the two sides of the gate being coupled together by the slips $e f, g h$, and $k l$, the lower and upper rails have severally the benefit of both braces. The diagonals $a c$ and $d b$ keep the frame in shape, while $a s d$ and $b t c$ are braces to $a d$ and $b c$ by means of the light bar $m n$. It will be seen that all the wires and straps which act as fills-up, are either braces or supports, so that nothing can be more stiff than the gate thus completed. It weighs about 80lb. Its dimensions are 9 feet by $3\frac{1}{2}$, but may be made of any size, the price varying in proportion. It may be observed, that a gate with one bolt, when shut suddenly, vibrates for some time at the fore-foot; this is obviated by two bolts coupled together near b and c , and acting simultaneously. It is also convenient for gates opening into policy-grounds, getting bolted when thrown back by means of a short stump driven into the ground, with a catch at the height of the lower bolt c ."

1539. The wire-gates above described are admirable examples of the principles of trussed frames, and for gates. So far as that principle gives them firmness and support, they can hardly be excelled; but there is one defect attendant

upon the wire upfilling, its too great tenacity, which renders the wires liable to derangement on being loaded with any cross strain, such as a person attempting to climb over the gate, and setting foot on the wires. A diagonal wire undergoing such treatment will be liable to stretch, and thereby lose its effects. Could such accidents be effectually guarded against, these gates might be regarded as almost perfect.

1540. *Iron Side-Gate.*—In fig. 787 we give a form of wicket or side-gate to a farmhouse, constructed of malleable-iron; the pillars are of cast-iron, supported upon stone standards. The price is from 25s. to 30s., and the posts 26s. the pair.

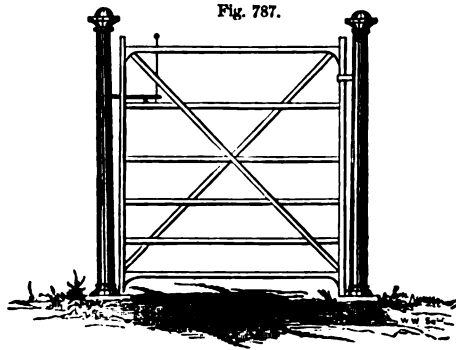

WROUGHT-IRON SIDE-GATE—SCALE, $\frac{1}{2}$ INCH TO THE FOOT.

1541. In fig. 788 we give a form of "foot-gate" for a footpath, manufactured by the St Pancras Iron Company, London.

1542. *Corrugated Iron Sliding-Gate.*—In fig. 789 we give a part front elevation of a sliding-gate, in which the framing *a a*, *a* is of angle iron; the upfilling *b b*, of corrugated iron. The wheels *c c* are supported by brackets *d d* riveted to the upper angle-iron. The rim in a notch made in the under side of the wooden beam *e e*; *f* is the side-post, against which the door or gate *b b* stops when pulled out to its greatest traverse.

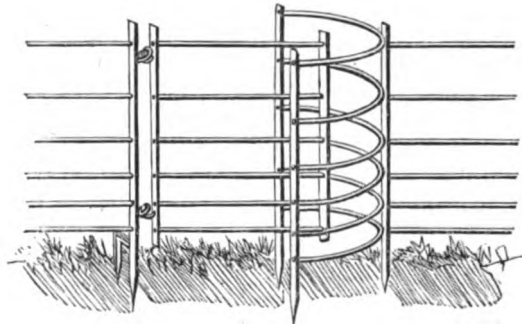

FOOT-GATE FOR FENCE.

In fig. 790 we give a section of top and bottom rail of gate, in which *a* is the upper beam, in the slot on the under side of which the wheel *b* moves; *c* is the standard carrying the wheel riveted to the upper angle-iron *d*; *e* the corrugated plate of the gate; *f* the lower angle-iron. Instead of a beam *a*, on which the wheel *b* moves, a plate of iron may be bolted to the wall at its extreme ends by bolts and nuts—the wheel running on its lower edge. Fig. 791 shows a section and elevation of the mode of hanging a sliding-gate: *a a* part of the gate, *b b* the side stop, *c c* the bar on which the pulleys slide. In the section, *d d* is part of the wall, *e* the bar corresponding to *c c*, secured to the wall by the stud *f* and bolt and nut *g*; *h* the pulley, with the strap *i* riveted to the gate *k*, which is a section of *a a*.

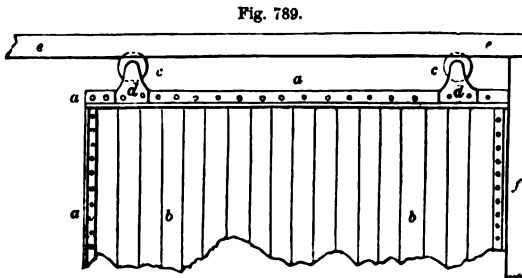

TOP OF SLIDING-GATE OF CORRUGATED IRON—SCALE, $\frac{1}{2}$ INCH TO THE FOOT.

Fig. 790 we give a section of top and bottom rail of gate, in which *a* is the upper beam, in the slot on the under side of which the wheel *b* moves; *c* is the standard carrying the wheel riveted to the upper angle-iron *d*; *e* the corrugated plate of the gate; *f* the lower angle-iron. Instead of a beam *a*, on which the wheel *b* moves, a plate of iron may be bolted to the wall at its extreme ends by bolts and nuts—the wheel running on its lower edge. Fig. 791 shows a section and elevation of the mode of hanging a sliding-gate: *a a* part of the gate, *b b* the side stop, *c c* the bar on which the pulleys slide. In the section, *d d* is part of the wall, *e* the bar corresponding to *c c*, secured to the wall by the stud *f* and bolt and nut *g*; *h* the pulley, with the strap *i* riveted to the gate *k*, which is a section of *a a*.

1543. In fig. 792 we illustrate another method of hanging the gate. A double strap *a a* passes over the T rim *b*, and is riveted thereto. The upper ends of the strap carries the wheel *c*, which runs on the beam *d*. In fig. 793 *a* is the upper part of the framing, *b* the strap, *c* the wheel, *d* the beam, *e* the side frame or beam which limits the traverse of the gate, and against which it abuts when fully open.

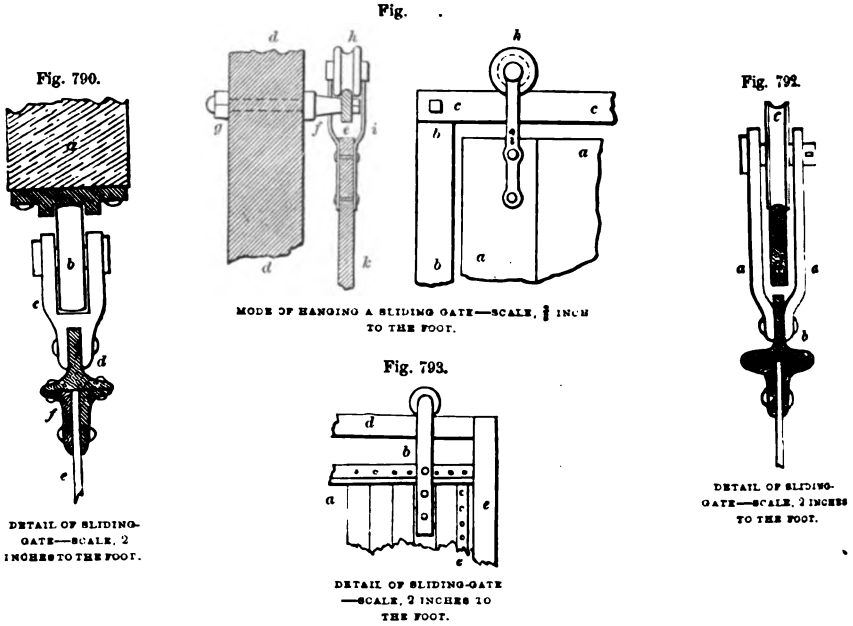

1544. *Wire-Fences.*—Wire-fences consist of three parts—the straining-posts, the standards or intermediate posts, and the wires. The *straining-posts* are made of wood or of iron; and in the country, where wood is cheaper than iron, the former will in most cases be chosen, although it can bear no comparison with iron in durability. A simple form of wooden straining-post is shown in fig. 794, where *a* is the post, 7 feet long, and 6 or 7 inches in diameter at the smallest end, is put into a pit 3 feet deep; *b* is the sole, 6 feet long, 3 or 4 inches thick, and 6 inches broad, which takes in the post *a* at 6 inches from the end *c*, and has a notch cut into its upper surface near the other end to admit the strut *d*, which is also notched and nailed into the post about 4 inches below the surface of the ground. In setting the post into the ground, the earth is firmly rammed in upon the sole, and about the strut.

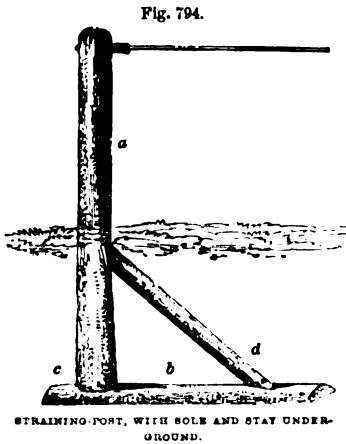

1545. Another method of securing a straining-post underground is shown by fig. 795, where *a* is the post of the same size as the preceding, at the back of

which at the bottom, is fastened a plank *b*, 2 feet long, 10 inches broad, and 2 inches thick, at 3 feet depth in the ground; and another plank *c*, of the same dimensions, is fastened in front of the post about 6 inches below the surface of the ground. The earth is then firmly rammed in until it comes to 12 inches of the surface, when another plank *d* of similar dimensions is placed opposite to the plank *c*, firmly into the ground, and then the three pieces of wood *e* are tightly driven in between the planks. This is considered a very secure mode of fixing a straining-post against the wooden tension of the wires.

Fig. 795.

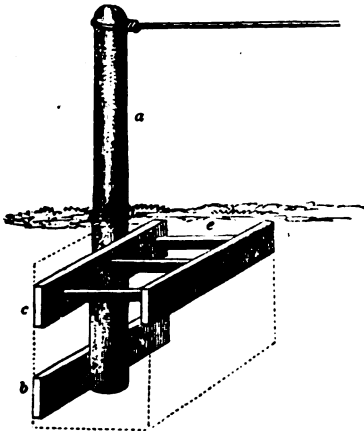

STRAINING-POST, WITH PLANKS UNDERGROUND.

Fig. 796.

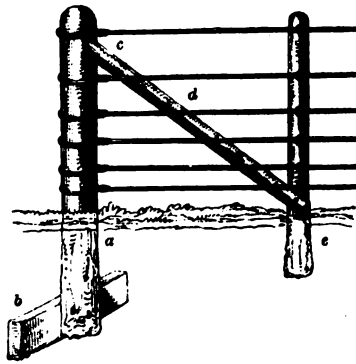

STRAINING-POST, WITH STANDARD AND STAY ABOVE GROUND.

1546. A third method still is given in fig. 796, where a similar size of post *a*, to the others, is placed in the pit, 3 feet deep, having a piece of wood *b*, 2 feet long, 6 inches broad, and 2 inches thick, nailed to the back part of the bottom; *e* is a standard driven into the ground, at 4 feet distance, in a line with the post, and the strut *d* is nailed at one end into a notch near the top of the post at *c*, and at the other end to the standard *e*, near the ground. Both the posts are fixed in the ground before the strut is nailed to them.

1547. Another sort of straining-post is made of wrought-iron, fig. 797. When wooden straining-posts decay they must be removed, and in doing which the whole fence must be taken down. Iron posts, such as *a*, obviate this inconvenience by being permanent. They are $1\frac{1}{4}$ to $1\frac{1}{2}$ inch square, and cost from 2d. to $2\frac{1}{2}$ d. per lb. Each weighs from 32 lb. to 40 lb., according to the height required. The extreme posts require a stay *b* in addition, which costs according to its weight. The cost of such a straining-post is this:—

Fig. 797.

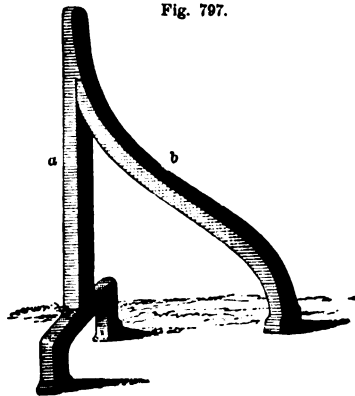

A WROUGHT-IRON STRAINING-POST.

34 lb. at 2d. per lb.,	£0	5	8
Boring in a stone 2 holes, $3\frac{1}{4}$ inches deep, and 2 inches diameter, a whinstone,	0	0	9
5 lb. lead for batting, at 2d.,	0	0	10
	<hr/>		
	£0	7	3

Boulders answer for blocks, if not under 10 or 12 cwt.; and those which have rounded tops are best, inasmuch as a greater depth of earth covers them, to the benefit of the grass growing over them.

1548. Mr Binning Munro of Auchinbowie, Stirlingshire, uses only iron straining-posts and iron standards, and considers them as cheap as wooden ones, even at first. His straining-posts are round, $2\frac{1}{2}$ inches diameter, with stays, and weigh 68 lb. The standards are made of $1\frac{1}{2}$ -inch by $\frac{1}{2}$ -inch bar iron, with 6 holes for the wires, and weigh 10 lb. each, and they are not squared at the ends, to admit them being put into a small hole, as is commonly done, and which weakens the iron where it should be the strongest, but are kept broad and flat; and the hole is made for them, and not they for the holes. The straining-posts have a hold in the stem of 6 inches, the standards 4 inches. After the posts are put into the holes, these are filled with round gravel, and melted sulphur run amongst them, at 2d. per lb., which is better than lead, because it does not shrink as lead does, and become loose.

1549. The intermediate posts should be made of larch, and the thinnings of plantations are suitable for them. If of larch weedings, the posts should be placed in the same posture as they grew, and not inverted; they will then last much longer. For a fence of $3\frac{1}{2}$ feet in height, the posts should be $5\frac{1}{2}$ feet long, with a diameter of $3\frac{1}{2}$ inches at the smallest end. In ordinary fencing, they may be used with the bark on. They should all be charred, which is done in this manner: Lay two trees of little value parallel, about a foot or fourteen inches apart, upon the ground. Between them collect chips and brushwood, and set fire to them. Lay the posts directly across the flame, at the part where the surface of the ground will touch, and turn them from side to side until they are ready. They are then smeared with coal-tar as long as they are warm, and as long as the tar may be absorbed.

1550. Intermediate posts have a sufficient hold of the ground at 21 inches deep, and will support the wire sufficiently when set 7 or 8 feet apart, in a straight line; but in curves they should be set closer, and always within the radius of the curve, and with their heads inclining outside of the curve, to meet the strain upon the wires.

1551. *Wires.*—The wires used in wire-fencing are of different kinds, and bear different names. They are named common, prepared, charcoal, and annealed wire. The common is the ordinary wire of commerce, and is the kind which has hitherto been mostly employed in wire-fences. It is made from the coarser sorts of iron, and, as its name indicates, bears a corresponding relation, both as regards quality and price.

1552. Prepared wire is made from a finer description of iron, is more carefully manufactured, comes out in longer lengths, is consequently superior in quality, and bears a higher price in the market.

1553. Charcoal wire is the best and strongest of any of the qualities made. It is drawn from charcoal iron, prepared chiefly by wood-charcoal, which is freer from the impurities known to deteriorate the quality of iron, that exist in a greater or less degree in all the fuels used in the manufacture of the other descriptions of that material.

1554. Annealed wire is the common wire softened in the furnace, and sent out in that state. It is purchased at the same price as the common, and is in some districts used in preference, from its being softer and more easily handled than the other. It is, however, the very worst that can be put into a fence, and ought always to be rejected. It easily bends, and remains so from want of elasticity; and it soon oxidises, even when painted.

1555. The following table exhibits the comparative qualities of these wires, as tested by the number of pounds each kind sustains before breaking—the the length being 10 feet:—

<i>Common Wire.</i>		
No. 8 broke with	590 lb.	} without perceptibly stretching.
No. 6 " "	844 "	
No. 4 " "	1269 "	
<i>Annealed Wire.</i>		
No. 8 broke with	605 lb., stretched $4\frac{1}{2}$ inches.	
No. 6 " "	832 " " 3 "	
No. 4 " "	1282 " " 2 "	
<i>Prepared Wire.</i>		
No. 8 broke with	955 lb., stretched 1 inch.	
No. 6 " "	1380 " " $\frac{3}{4}$ "	
No. 4 " "	2163 " " $\frac{1}{4}$ "	
<i>Charcoal Wire.</i>		
No. 8 broke with	1274 lb.	} stretched the same as the prepared wire.
No. 6 " "	1762 "	
No. 4 " "	2656 "	

These are the numbers used in wire-fences. Each bundle of wire is made up of 63 lb., and each bundle runs thus:—

No. 4 extends from	140 to 150 yards.
No. 6 " "	180 " 200 "
No. 8 " "	280 " 300 "

1556. The cost of the different kinds of wire of the same size, from Nos. 1 to 6, is the same. No. 1 to No. 6 of common wire costs from 8s. 6d. to 10s. 6d. per bundle; the prepared is 2s. more; and the charcoal 2s. more than the prepared.

1557. The number of wires employed in a fence depends on its height, but the ordinary height of $3\frac{1}{2}$ feet requires 6 wires to make the fence confine sheep and lambs. Fig. 796 shows a portion of a fence having 6 wires, the two upper ones above *d* being of No. 4, and the four below it, No. 6 wires. A not uncommon arrangement of the wires is to make the two uppermost No. 4, the two undermost No. 6, and the two intermediate, No. 8. The upper wire is first strained, and then the lowest one, and the intermediate ones are taken in succession, the tension of the upper one being the gauge to the others.

1558. As to the cost of wire-fencing, an instance may be given of a fence constructed in front of a plantation, of curved and irregular form, of wooden posts and standards, $3\frac{1}{2}$ feet high, having 6 wires, and extending to 665 yards. The two upper wires were of No. 4, and the four lower of No. 6. The undermost one was 6 inches from the ground; the second, 11; the third, $16\frac{1}{2}$; the fourth, 23; the fifth, $31\frac{1}{2}$; and the uppermost, 42 inches. The cost may be stated thus:—

35 straining-posts and angle-posts, at 1s. 9d.,	£3 1 3
17 stays for ditto, at 4½d.,	0 6 0½
230 small posts, at 4½d.,	4 1 5¼
1400 staples, at 1s. per 100,	0 14 0
10 bundles No. 4, prepared wire, and 15 bundles No. 6, at 10s. 6d. per bundle,	13 2 6
Wages for fitting up,	8 16 3
Equal to 665 yards at 10½d. per yard,	£30 1 5¼

1559. Three wires above the height of a turf or stone dyke cost about 7½d. per lineal yard.*

1560. Mr Binning Munro's account of the cost of erecting a wire-fence with iron posts, per 100 yards, is this :—

3 bundles of wire, at 8s. 6d.,	£1 5 6
Iron for posts,	1 2 6
Boring and fitting posts,	0 10 0
Straining-posts bored and fitted,	0 6 6
Making holes in stones,	0 6 2
Other expenses,	1 0 0
Equal to 11d. per yard,	£4 10 8

The stones being heavy, and the posts strong, no stays are required, and the iron work is put down at cost price and labour, the entire work having been done by country smiths.†

1561. The durability of wire-fences is greater than might be expected. They stood upon the estate of Torrance, in Strathearn, for twelve years before requiring repairs, and then some of the standards were renewed, while the wire would stand for six years to come. On other estates they have stood nearly ten years without repair. Were the posts made of iron, they might stand a lease without repairs.

1562. It is not at all probable, that however durably wire-fences may be erected, they will ever supersede thorn hedges or stone dykes on farms. They afford no shelter to stock, and, appearing insignificant to restless cattle in the fields, have been attempted to be leapt over, and the cattle, not marking the height well, have been caught by the upper wire in the groins, to their serious injury. They are well adapted to the fencing of plantations until the trees grow sufficiently high for pasturage under them. The grazings of pastoral farms might be subdivided by them, much to the advantage of both the stock and pasture. They would form a cheap mutual march-fence, even with iron posts, on large hill properties. They might be used instead of paling for protecting young thorn hedges, until these grew up to a fence.

1563. Wire would make a neat fence between the plat and a small grass field in front of a farmhouse.

1564. *Fitting-up of Wire-Fences.*—A few notes on this subject, from the pen of Mr Young, may be of service to the reader.

1565. "The wire, as it is supplied by the makers, is in coils, the length of these varying according to the size or number of the wire.

1566. "The first part of the operation in putting up wire-fences, as we have practised it, is to take the wire out of the coil—or, in other words, to straighten it. This is performed by drawing it through several iron pegs, driven into a stout board *a*, fig. 798, each peg or pin being 2 or 3 inches from each other.

* *Transactions of the Highland and Agricultural Society*, March 1850, p. 244-62.

† *Journal of Agriculture*, July 1850, p. 428.

1567. "About 2 or 3 feet of one end of the wire is now taken through the staple *b*, at the back end of the board, and placed inside of every alternate peg. This end of the wire is then turned round the handle of a hammer, or some other similar piece of wood *c*, and drawn through the pegs by one or two of the workmen, the block *a* being supported by a tressle, and kept in its position by a loop of wire passed round the post *d*; it being particularly noticed that the man who has the charge of the coil, 'gives it off,' or uncoils it, 'hand over hand,' as fast as it is drawn through the pegs; and to enable him to do this perfectly, especially at first, the wire should not be very rapidly drawn away.

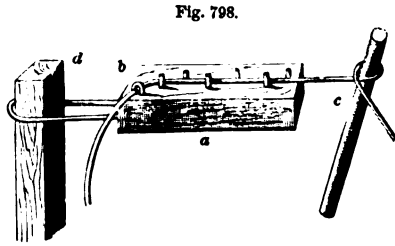

BLOCK FOR STRAIGHTENING WIRES.

1568. "We are aware that many who put up wire-fences do not straighten the wire at all, but run it at once off the coil into the fence. This is a practice, however, we have never adopted, and do not recommend. We find that, by straightening the wires first, we can not only do the work far more expeditiously, but infinitely better, as there are neither crooks nor puckers in the wire, which, when they exist, it is not possible for any strain the wire will bear, completely to obliterate.

1569. "We shall therefore suppose that the wires have all been straightened. The staples are then driven slightly into the posts at the heights on the posts at which it is desired to place the wires. The wires are now led or drawn into the staples in the posts. Having completed this, about 18 inches of each of the wires are passed through the holes in the extreme straining-post, and brought half round and twisted upon the wire inside of the post, which completes this part of the fastening.

1570. "It is very possible that the length of wire in any of the coils will not reach the whole distance between the straining-posts. When this is the case, they must be joined together, as represented in fig. 799.



1571. "With the smaller sizes of wire, no one will experience much difficulty in making such a joint; but when the wires are of the stronger kinds, we are obliged to have recourse to implements to assist us, other than the hand pliers used for the weaker wires; the most simple of which is a small block of wood *a*, fig. 800, about 12 inches long and 3 square, into one end of which *b* is driven a piece of round $\frac{3}{8}$ rod, leaving it about $\frac{1}{2}$ an inch high. Beyond this pin there are other three pegs driven, to keep the wire in the centre of the block, while its end *c* is being turned round the pin to form the eye, and which, when made, as shown in the figure at *b*, is entered into the eye of the other wire, and then taken hold of by a pair of clamps, fig. 801, by which the loose end of the wire is turned round at the neck of the eye, as shown in fig. 799. Any remaining

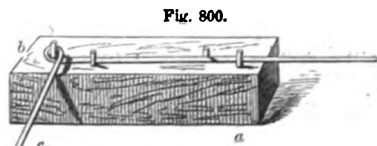

BLOCK FOR MAKING EYES IN WIRES.

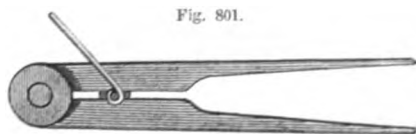

CLAMPS FOR TWISTING THE WIRE AT THE EYE.

portion of the wire is afterwards cut off by a file, which finishes the joint, and makes it ready for straining.

1572. "There is another tool very necessary to enable us, easily and neatly, to turn the thicker wires when forming the eye, or to twist the ends round the wires at the straining-posts. It is termed a "turn-key," and is represented by fig. 802.

1573. "Having now all the wires fastened to the extreme straining-post, and joined where necessary, they are cut at the next straining-post, leaving about 15 or 18 inches beyond it. To the end of the upper wire is attached the straining-screw, fig. 803, observing to place between its end *a*, and the post *b*,

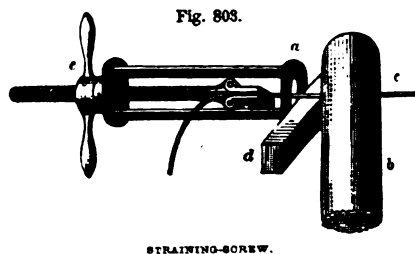
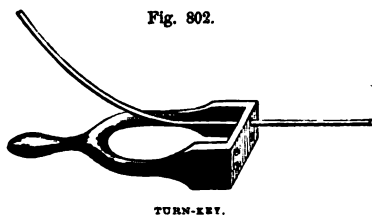

and under the wire *c*, a piece of wood *d*, about 2 inches square. It is necessary, before beginning to work the screw *e*, to place a temporary spur of wood to the inside of the post about *b*, which is removed when the next space is strained up, and so on, until the next extreme post is strained from.

1574. "The upper wire is the first that is tightened, and this is done slowly until a sufficient tension is procured. There can be no rule stated to instruct when the strain is enough, but with a little experience, and applying the hand

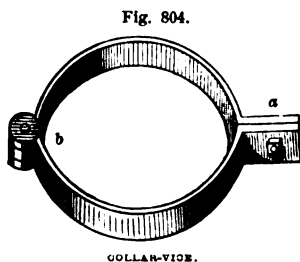

occasionally to the wire as it is being strained, a knowledge of the degree of tension will soon be acquired. The wire being sufficiently tight, we apply what is termed a "collar-vice," fig. 804, which is put round the post on the upper side of the wire, and the jaws of the vice *a*, firmly screwed on the wire inside of the post. The straining screw *e*, fig. 803, is then unfastened, and the loose end of the wire brought closely round, and a staple driven over it into the side of the post. After this is done, the collar-vice

can likewise be taken away, and the wire fixed as at the other post, either by the hand or by the turn-key, fig. 802.

1575. "The upper wire having been strained and fastened, the lowest is next

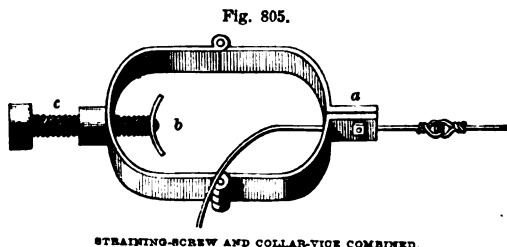

tightened, and so on, until the last unstrained upper wire is so done. The object in straining the upper wire first, is to make it a guide for the tension of the others below it, as the strain upon any of these must increase the instant the upper wire appears in any degree slacker than it was at

first. When all the wires are strained, the staples in the small posts are driven home, but not too firmly—and, when this is done, the fence is completed.

1576. "The straining-screw and collar-vice have hitherto been the ordinary implements used for the erection of wire-fences, but we have sometimes employed a collar-vice, in which is also combined a straining-screw, as in fig. 805, where *a* is the jaws of the vice, and *b* the rest against which the straining-screw *c* acts. We have found it an exceedingly useful instrument, and peculiarly adapted for short lines, as, by using two or more of them at the same time, we can procure a very equal degree of tension on all the wires."

1577. *Wrought-iron Hurdles*.—Fig. 806 represents wrought-iron hurdles of five round bars, as manufactured by Messrs Thomson and Co. of Edinburgh. Each hurdle consists of three strong uprights, one at each end, and one intermediate between them. The lower extremities of the end supports are made with a strong double knee, terminating in a prong—this varying in length from a foot upward. The middle-upright is simply continued to a point, and twisted so as to present its flat side to the pressure. The horizontal bars—in the majority of instances round, but in some cases square, set diagonally—are "tannered" at the ends by machinery, which takes off the least possible proportion to form a shoulder for riveting them to the uprights.

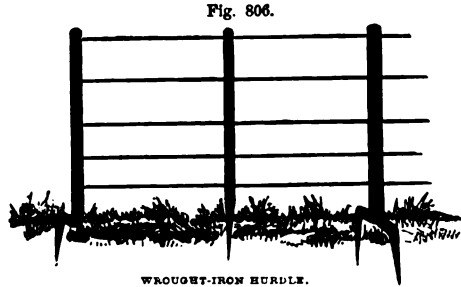

1578. In erecting the hurdles, the two end uprights are placed against each other—the knees being in opposite directions. A series of double prongs is thus formed, which, being fixed in the ground, renders the hurdles self-supporting, and obviates the necessity of using stays. In course of erection, the hurdles are fastened together by means of bolts and nuts, the bolts passing through bolt-holes made in the end uprights.

1579. For horses, cattle, sheep, and lambs, the price of this form of hurdle is from 2s. to 4s. per lineal yard; for sheep and lambs only, 2s. 6d. to 3s.

1580. Movable hurdles of iron might be conveniently used to confine a sheep or two to eat the grass of a small plat and save the trouble of cutting it. Top-dressing the grass in this manner is preferable treatment to cutting it with the scythe and carrying it away, to the impoverishment of the soil. Such hurdles make neat fences near farmhouses as a protection from the larger class of stock of cattle and horses.

1581. *Barnard and Bishop's Sheepfold Hurdles*.—Messrs Barnard and Bishop manufacture a sheepfold iron hurdle invented by Henry Gilbert of Kensington, Middlesex. They are 12 feet long, are perfectly flat, and are easily removed from place to place of a plat by means of a light iron wheel, which is readily attached to each hurdle. Price, 16s.; the cost of a wheel, 10s.

1582. *Wire-Netting*.—In fig. 807 we give strong wire-netting for sheep; its height is 3 feet, and the price per lineal yard is 1s. 3d. It is quite effectual for fencing off sheep near the farmhouse.

1583. Fig. 808 is the "mixed mesh-wire game-netting," manufactured by Messrs Barnard and

Fig. 807.

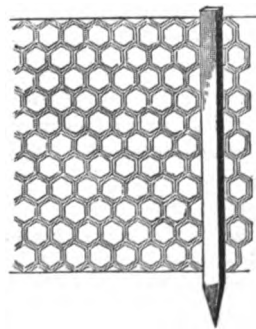

WIRE-NETTING AND STAKE.

Bishop, Norfolk Wireworks, Norwich. By making the upper part of the netting of a larger-sized mesh than the lower, the price is proportionably reduced; to work together, the upper mesh must be twice the size of the lower. This can be made to any height under 8 feet. With meshes 1 and 2 inches, wire No. 19, the price per lineal yard, 2 feet wide or high, is 9d.; when japanned, 10½d.; when galvanised, with meshes 1½ inch and 3 inches, No. 19 gauge, 5d. and 6d.; with meshes 2 inches and 4 inches, No. 19, 4¼d. and 5¼d. This is an effectual fence against rabbits and hares into gardens and shrubberies.

1584. In fig. 809 is given the ⅝-inch mesh wire-netting, manufactured also by Messrs Barnard and Bishop, suitable for various purposes; the price per square foot, wire No. 20, being 5½d., japanned, and 6d. galvanised.

1585. In fig. 810 is illustrated a recently-introduced form of spiral wirework,

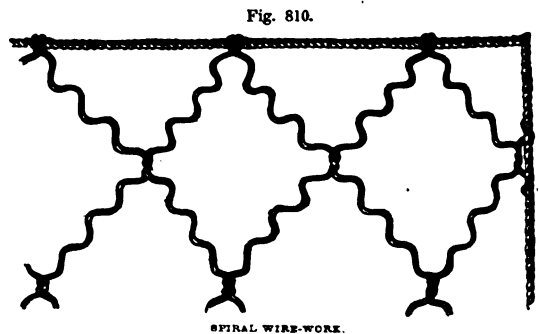
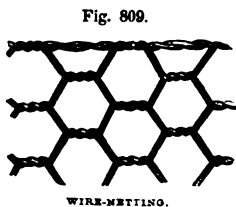
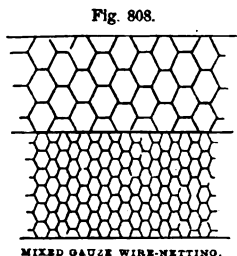

invented by Mr J. Reynolds, of 27 New Compton Street, Soho, London. It is made of hard twisted wire, galvanised after being manufactured. From the way in which the twisted wires are interlaced, no other fixing is required. This would make an ornamental fence against cattle and sheep at a farmhouse.

1586. SECTION EIGHTH—*Iron Sheds*.—These structures will generally be required of a very simple and unambitious character. In the majority of cases, simple girders or bearers of cast-iron, or of wrought-iron, will suffice. In connection with these parts of iron structures, we have given ample instructions and illustrations in Subdivision Third, p. 375, under Iron Construction, to which we here refer the reader. We, however, deem it right to supplement these by giving a few illustrations of parts not there illustrated.

1587. In fig. 811 we give a half elevation of a cast-iron girder, which stretches from column to column; shoes, as at *a b*, are cast in the girder, to support the ends of the rafters; a corresponding shoe being cast at *c* on the top of the column.

1588. In fig. 812 we give the upper part of the column; the ends of the girders are inserted in the recesses *a a*; *b* the plan of shoe.

1589. In fig. 813 we give the elevation of an open girder for supporting the roof of a large shed: *a a* the upright cast-iron columns, *b b b* the shoes for receiving the wood-beam *c c* and the ends *a*, fig. 814, of the iron rafters; *d, c e*,

and *f f* are uprights and braces. In fig. 814 we give a front elevation and section of the shoe *b*, fig. 813, in which *a* is the termination of rafter of roof *b*, the shoe bolted by the bolts *c c* to the cap of columns *a*, fig. 813; *d* the wood beam (*c c*, fig. 813); *e*, in the front elevation, is the slot receiving end of

Fig. 812.

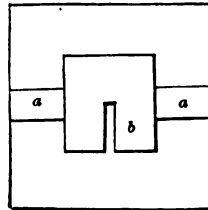

PLAN OF SHOE FOR RECEIVING ENDS OF GIRDER—SCALE, 1 INCH TO THE FOOT.

Fig. 811.

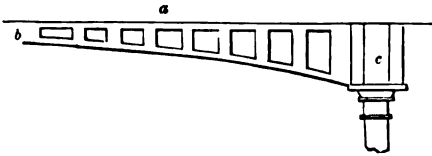

ELEVATION OF CAST-IRON GIRDER FOR SHEDS—SCALE, 1/4 INCH TO THE FOOT.

Fig. 813.

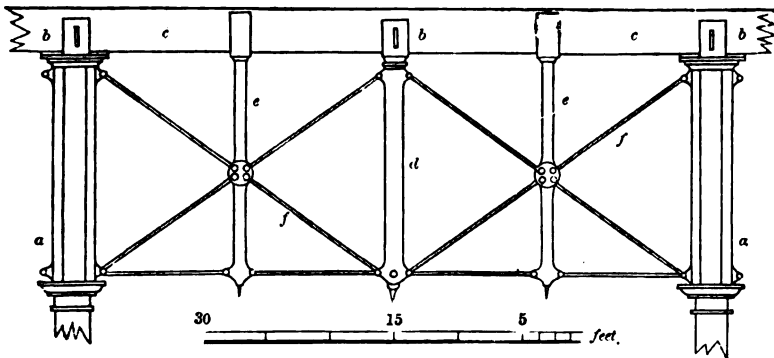

TRUSSED BEAM, OR OPEN GIRDER.

Fig. 814.

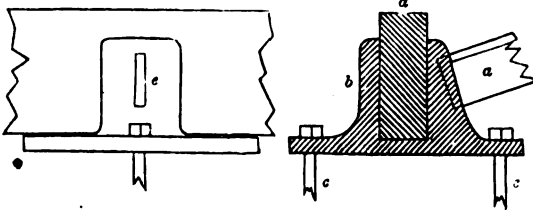

ELEVATION AND SECTION OF SHOE—SCALE, 1 INCH TO THE FOOT.

rafter *a*. Fig. 815 shows upper termination *b* of upright *d*, fig. 813; *a* the shoe receiving the end of rafter *b* and beam *c*, *d* the snug to which the diagonal ties *f*, fig. 813, are bolted. Fig. 816 shows upper termination of uprights *e e*, fig. 813: *a* is the wood beam corresponding to *c c*, fig. 813.

1590. In fig. 817 we give plan of an octagonal shed: *a b* the doors, *c d* the windows. In place of having brick or stone walls, as in the figure, cast-iron pillars are proposed to be placed at the corners of the octagon, the spaces between being filled up with corrugated iron plates, or wood planking. The double lines converging to the centre *e* show the assemblage of rafters *e f*, *e f*, fig. 818. In fig. 819 we give the plan of central ring *d*, fig. 818, to which the ends of

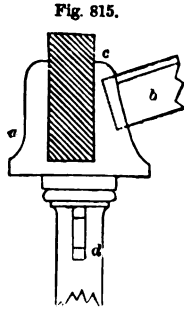

Fig. 815.
TERMINATION OF CENTRAL UPRIGHT—SCALE, 1 INCH TO THE FOOT.

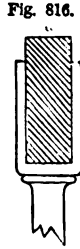

Fig. 816.
TERMINATION OF SIDE UPRIGHT—SCALE, 1 INCH TO THE FOOT.

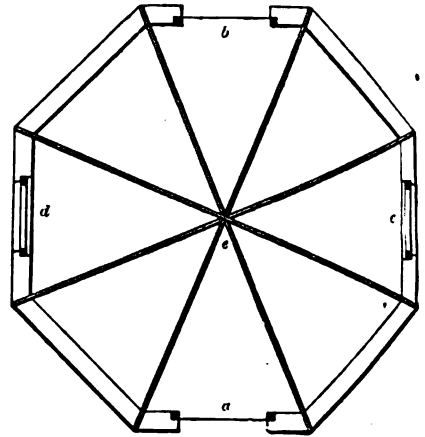

Fig. 817.
PLAN OF OCTAGONAL SHED—SCALE, 1/4 INCH TO THE FOOT.

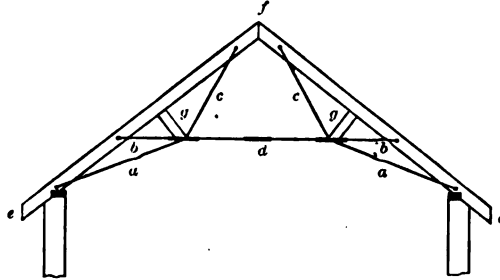

Fig. 818.
ROOF TRUSS OF OCTAGONAL SHED—SCALE, 1/4 INCH TO THE FOOT.

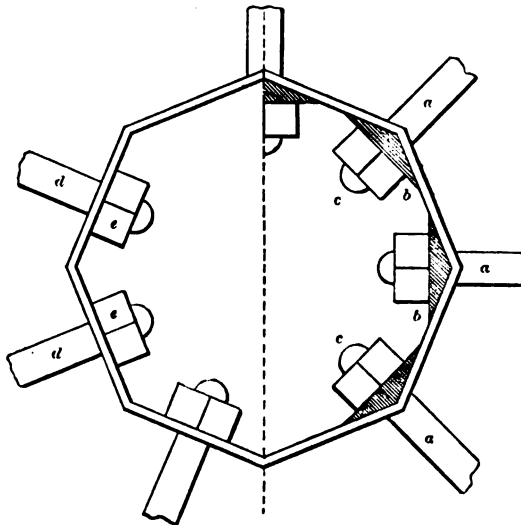
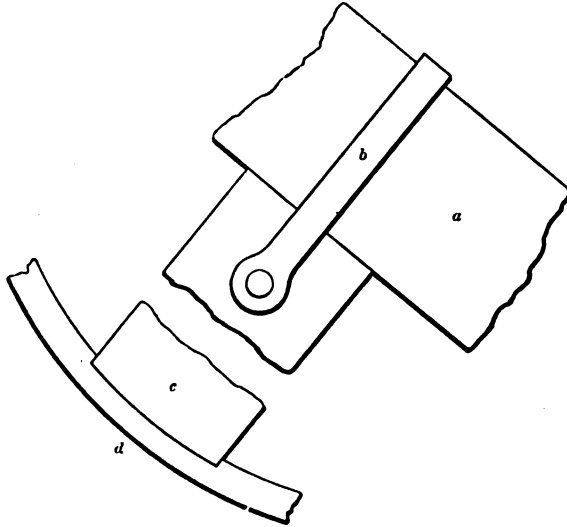

Fig. 819.
PLAN OF CENTRAL RING *d*, FIG. 818—SCALE, 1/4 INCH TO THE FOOT.

the tie-rods *b* and *d* are bolted. Where the tie-rods, as *a a*, fig. 819, join the ring at the angles, triangular bolster-pieces *b b* are inserted, against which the nuts *c c* are screwed hard up. Where the tie-rods, as *d d*, join the ring in the centre of its sides,

the nuts *e e* butt immediately against these. In fig. 820 we give end of struts *g g*, fig. 818, showing its juncture with rafter *a* fig. 820, by the strap *b*. The end *c* is rounded, and the tie-rod *d*, corresponding to *a c*, *a c*, fig. 818, passes round it. The tie-rods *b b*, fig. 818, widen out so as to embrace the ends of the struts *g g*. Fig. 821 shows the widened-out part *a a*, where the end of the strut *g*, fig. 818, passes through, as also the tie-rod *a c*; *b b* is a side view of *a a*.

Fig. 820.



END OF STRUT *g*, FIG. 818—SCALE, 1 INCH TO THE FOOT

Fig. 821.

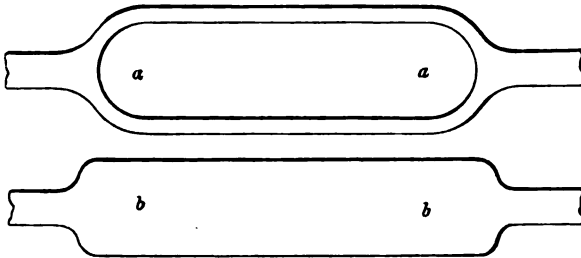

WIDENED PART OF TIE-ROD—SCALE, 1 INCH TO THE FOOT.

1591. In fig. 822—in elevation and section—is a method of forming sheds with wrought-iron columns *a a*, these being provided with caps *b b*, the upper parts of which are formed into shoes for supporting the wrought-iron beam *c*. The wrought-iron column *a* and cap *b* are secured together by the key *d*. Wrought-iron tension bars *f f* stretch from column to column, the ends being jointed to snugs *e e*, cast on the cap *b*. In place of a wrought-iron beam as *c*, a wooden beam may be used to support the rafter-shoes of the roof, as shown by the dotted outline *g*. Where the iron beam *c* is of the dimensions shown in the figure—namely, the depth 12 inches, the length from centre to centre of pillar 19 feet, the breadth of flanges at top and bottom $4\frac{1}{2}$ inches, and thickness of central rib $\frac{3}{8}$ inch—the weight it is calculated to support at its centre is 19,000 lb., or double that spread over its whole length. The distance between the pillars *a* being 19 feet, a rafter-shoe will be required at three points—above the pillars, and between the two. The rafter-shoes should be made to

clip the upper flange of beam. Or the upper flange of rafter may be extended and flattened out, so as to be riveted to the upper flange of the wrought-iron

Fig. 822.

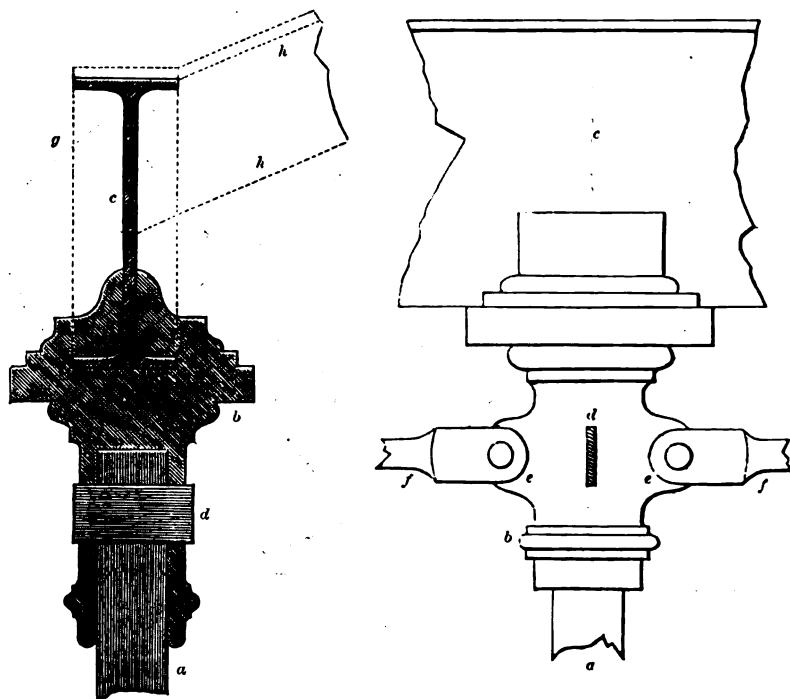

SECTION AND ELEVATION OF WROUGHT-IRON COLUMNS FOR SHEDS.

beam *c*, the rib of the rafter butting at its end on the side of the beam, as shown by the dotted lines *h h*. The dotted lines show also the mode of fastening the rafters *h h* to the wooden beam *g*—if that is used in preference to a wrought-iron one—the upper flange of the rafter being spiked down to the beam.

Fig. 823.

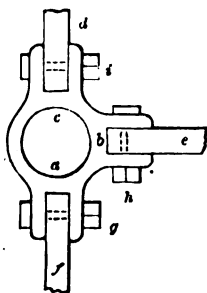

SECTION OF CAST-IRON PILLARS FOR CATTLE-BOXES IN SHEDS.

1592. *Cast-iron Pillars for Cattle-Boxes in Iron Sheds.*—Where cattle-boxes are fitted up in the interior of sheds, pillars, as in fig. 823, may be used. On three sides of these, as at *a b c*, snugs are cast, into which the wooden battens *d e f*, forming the divisions between the stalls, are passed. Thus, in *b* the transverse, and in *d c* and *a f* the longitudinal, divisions are placed. The battens may be secured in their places by bolts and nuts *g h i*; for this purpose holes—at distances corresponding to the centre of the battens—may be bored in the snugs *a b c*.

SUBDIVISION FOURTH—*Combined Work.*

1593. SECTION FIRST—*Wood combined with Iron Straps, Shoes, Trussed Beams.*—Iron straps are frequently used to connect joints; as the strap *a* to connect the tie-beam *b b* with the king-post *c* and struts *d d'*, fig. 824; or

the foot of the rafter *c* with the tie-beam *b b*, fig. 825—*a* being the strap, and *e* the eye-bolt.

1594. The following remarks from the article "Carpentry," *Encyclopædia Britannica*, on the use of iron straps, may be useful. "When it is necessary to employ iron straps for strengthening a joint, considerable attention is necessary that we may place them properly. The first thing to be determined is the direction of the strain.

We must then resolve this strain into a strain parallel to each piece, and another perpendicular to it. Then the strap which is to be made fast to any of the pieces must be so fixed that it shall resist in the direction parallel to the piece. Frequently this cannot be done, but we must come as near to it as we can. In such cases we must suppose that the assemblage yields a little to the pressures which act on it. We must examine what change of shape a small yielding will produce. The strap that we observe most generally ill-placed is that which connects the foot of the rafter with the beam. It only binds down the rafter, but does not act against its horizontal thrust. It should be placed farther back on the beam, with a bolt through it, which will allow it to turn round. It should embrace the rafter almost horizontally, near the foot, and should be notched square with the back of the rafter. We are of opinion that straps with eye-bolts in the very angles, and allow free motion round them, are of all the most perfect. A branched strap, such as may at once bind the king-post and the two braces which abut on its foot, will be more serviceable if it have a joint. When a roof warps, these braced straps frequently break the tenons, by affording a fulcrum in one of their bolts. An attentive and judicious artist will consider how the beams will act upon such occasions, and will avoid giving rise to these strains by levers. A skilful carpenter never employs many straps, considering them as auxiliaries foreign to his art, and subject to imperfections in workmanship which he cannot discern or amend."

1595. In fig. 824 we show a branched strap *a* joining the king-post *c* and the struts *d d*. The strap may be fixed by keys driven through at the upper part, or an eye may be given to the strap, and a bolt passed through it.

1596. In fig. 826 we give a form of strap for head of king-post *a*, and struts *b c*; fig. 827 shows a strap for joining collar beam *a*, and principal *b c*.

1597. Fig. 828

gives a form of strap for straining-beam *a*, queen-post *b*, and strut *c*.

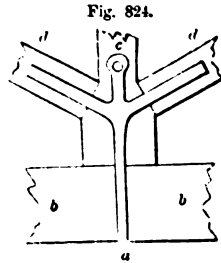

IRON STRAP FOR FOOT OF KING-POST, STRUTS, AND TIE-BEAM—SCALE, $\frac{1}{2}$ INCH TO THE FOOT.

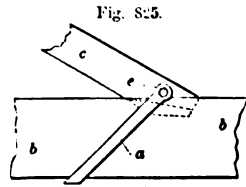

IRON STRAP FOR FOOT OF RAFTER AND TIE-BEAM—SCALE, $\frac{1}{2}$ INCH TO THE FOOT.

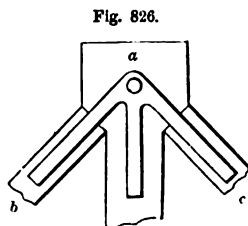

IRON STRAP FOR HEAD OF KING-POST AND BRACES—SCALE, $\frac{1}{2}$ INCH TO THE FOOT.

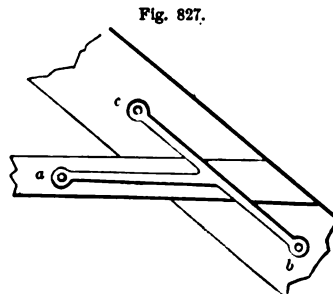

IRON STRAP FOR COLLAR AND RAFTER—SCALE, $\frac{1}{2}$ INCH TO THE FOOT.

1598. Fig. 829 shows a form of saddle for joining a beam *a*, which crosses another beam *b b*. The strap *c c* is bolted to the beam *b b* by the bolts *d* and *e*; *f f* is a plan.

Fig. 828.

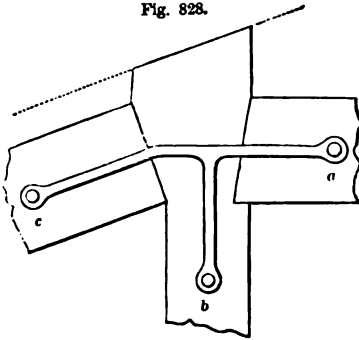

IRON STRAP FOR STRAINING-BEAM, QUEEN-POST, AND STRUT—SCALE, $\frac{1}{2}$ INCH TO THE FOOT.

Fig. 829.

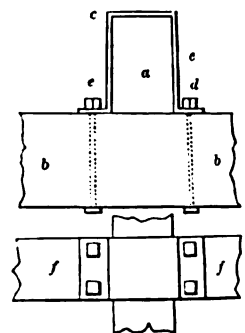

IRON SADDLE FOR JOINING BEAMS CROSSING AT RIGHT ANGLES—SCALE, $\frac{1}{2}$ INCH TO THE FOOT.

1599. *Iron Shoes for Wooden Framing.*—In fig. 830 we give a drawing of a cast-iron shoe, for the reception of the end of tie-beams or girders, as *a*. The shoe is provided with snugs *c e, f d*, which act as keys, and give a secure hold in the wall *b*.

Fig. 830.

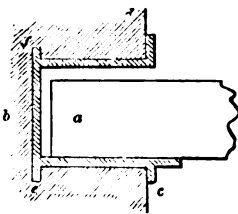

CAST-IRON SHOE FOR RECEIVING END OF GIRDER—SCALE, $\frac{1}{2}$ INCH TO THE FOOT.

A shoe for the reception of joists which require to be bolted to wooden columns, &c., is given at *e d f* in fig. 831: this is secured by bolts and nuts as shown at *f*. In the same figure a shoe for the reception of "wall-plates," running along the wall, is shown. The wall-plate rests in the recess *a*; *c* and *a* are projections. This may be adapted to secure to a post, &c., as the shoe *e d f*, by extending the projection *c*, as shown in form towards *b*, and passing bolts through apertures made in it; the upper bolt-hole at *a* will require to be counter-sunk, or have a recess in which the head of the bolt can go. This will allow it to lie flush with the inside of the recess, and the wall-plate to pass easily into the recess *a*. A front view is shown at *g*.

Fig. 831.

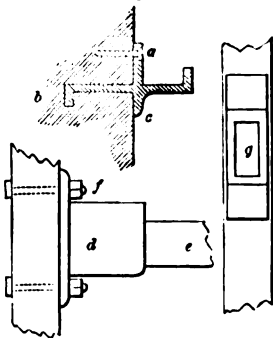

CAST-IRON SHOES FOR "JOISTS," "WALL-PLATES"—SCALE, $\frac{1}{2}$ INCH TO THE FOOT.

1600. In composite roofs—that is, roofs composed partly of iron and partly of timber—certain parts are composed of cast-iron, as queen-bolt-heads, shoes for braces, struts, or tie-beams, and purlin-boxes, &c. These we now propose to illustrate.

1601. Fig. 832 illustrates a "shoe" for the reception of the foot of struts: *a a* is the wooden tie-beam, *b b* the wrought-iron king-bolt, secured by nut and washer *c*; *d* the extremity of strut or brace, butting in the shoe, the section of which is formed of the proper shape; *f* shows the elevation of the shoe: an aperture is cast in the solid part of the shoe, through which the king-bolt is passed; *e e* are bolts fastening the shoe *f* to the tie-beam *a a*.

At *g h i* a front view of the shoe is shown: *g* is the part where the brace or strut enters, *h* the king-bolt, *i* part of the tie-beam.

1602. Fig. 833 illustrates a form of rafter-box or shoe, for the reception and

Fig. 832.

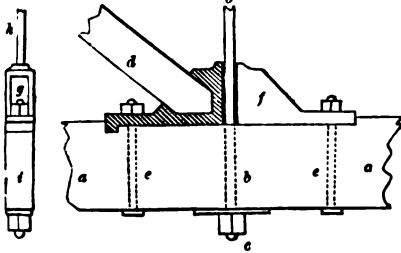

CAST-IRON SHOE FOR THE RECEPTION OF WOODEN STRUTS—SCALE, $\frac{1}{2}$ INCH TO THE FOOT.

Fig. 833.

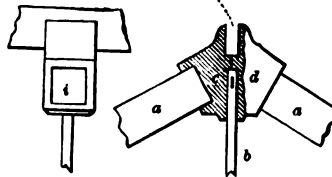

SHOES FOR KING-BOLT HEADS—SCALE, $\frac{1}{2}$ INCH TO THE FOOT.

support of the principal rafters: *a a* are the upper ends of the rafters, *b* the king-bolt, *c d* the box, the side *c* of which is in section, the side *d* in elevation. An aperture is cast through the solid part to admit of the king-bolt *b* being passed through; the ridge-pole passes into the recess *e*; *i* shows a front view of the rafter-box.

1603. In fig. 834 we give a drawing of a shoe for the reception of the foot of the strut and of the queen-bolt: *a a* is the tie-beam, *b b* the queen-bolt, *c* the brace or strut, *d* the shoe, secured by the bolts *e e*.

1604. Fig. 835 illustrates a queen-bolt-head "box" for the reception of

Fig. 834.

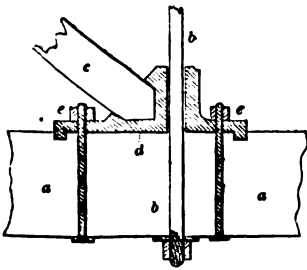

SHOE FOR QUEEN-BOLT AND STRUT—SCALE, $\frac{1}{2}$ INCH TO THE FOOT.

Fig. 835.

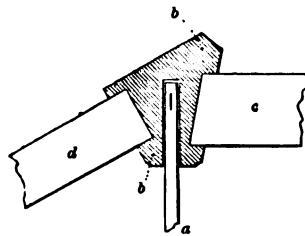

SHOE FOR QUEEN-BOLT AND STRUT—SCALE, $\frac{1}{2}$ INCH TO THE FOOT.

straining-beam and principal rafter: *a* is the queen-bolt, the head of which is sunk into a recess in the box or shoe *b b*, *c* the straining-beam, *d* the principal rafter.

1605. In fig. 836 we give a cast-iron shoe for the reception of the end of the principal rafter and the pole-plate: *a* the rafter, *b* the recess into which the pole-plate is placed. The whole is secured to the tie-beam by the bolts *c* and *d*.

Fig. 836.

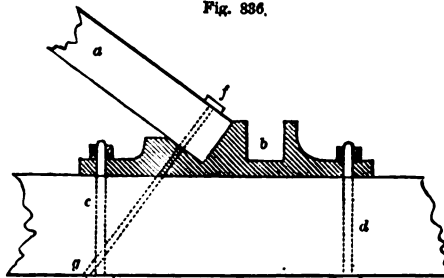

SHOE FOR FOOT OF RAFTER AND POLE-PLATE—SCALE, $\frac{1}{2}$ INCH TO THE FOOT.

Another bolt may be made to unite the
2 F

foot of the principal rafter and the tie-beam, passing through in the direction of *f g*.

1606. In fig. 837 is given a "shoe" or box for purlins, an end view of which is given at *b b*, and a side view at *g*. The shoe *g* is passed over the upper edge of the rafter *f f* which goes into the recess *a*, and is secured by bolts and nuts at *d d*; *b b*, *h* is the part receiving the purlin *c c*.

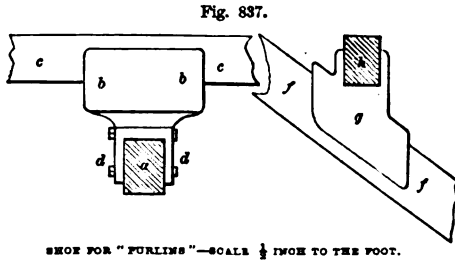

SHOE FOR "PURLINS"—SCALE $\frac{1}{2}$ INCH TO THE FOOT.

the walls in which it rests. The usual method of preventing this is to "truss" the girder. This is performed by cutting the girder in two through the centre

in the direction of its length, and inserting two pieces of timber—oak is the best—inclining towards each other as in the principal rafters of a roof. The rise of these pieces is very trifling, projecting or rising very little above the beam. Fig. 838 illustrates a method of trussing a beam with wrought-iron and wood; *a a* the beam, *b b* struts or braces abutting on the wrought-iron bolts and seats *c c c*. In fig. 839 we give another method of trussing a beam after the queen-post principle, fig. 838 being on the king-post. The abutting

Fig. 838.

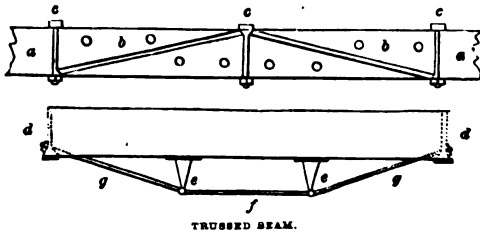

TRUSSED BEAM.

Fig. 839.

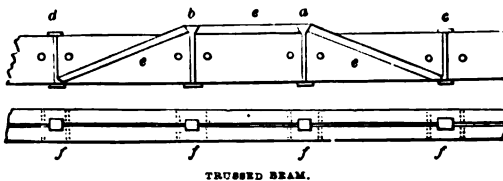

TRUSSED BEAM.

pieces *d b a c* are of wrought-iron; the struts or braces *e e e* of wood. The two halves are bolted together by bolts and nuts, as at *f*, which is a plan showing the position of these. In fig. 838 we have another method of trussing a beam: *d d* the beam: *e e* suspension-pieces fixed to the under-side of the beam

by bolts, or otherwise; *f g g* are tie-rods of wrought-iron. In fig. 840 the girder is shown trussed, with an arched piece of wrought-iron *a b c* between the two halves, the whole *d* being secured by bolts.

Fig. 840.

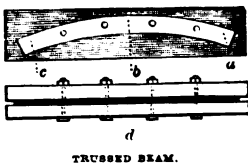

TRUSSED BEAM.

1608. In heavy girders of more than a foot in thickness, it is a good practice to saw them down the centre, turning the inside surfaces outward, bolting them together with pieces of thin wood between them; this enables the air to circulate freely, in addition to affording an opportunity to examine the quality and condition of the timber.

1609. In fig. 841 we give a trussed beam, on the principle invented by Mr Ainger—a full description of which will be found in vol. 48 of the *Transactions of the Society of Arts*, to which body the inventor communicated his

paper. The beam we have given is adapted for a span of 12 feet, and, according to Mr Ainger—the suspension rods being 1 inch square—capable of supporting easily between 4000 and 5000 pounds—more than double the weight which the beam would support if not trussed.

Fig. 841.

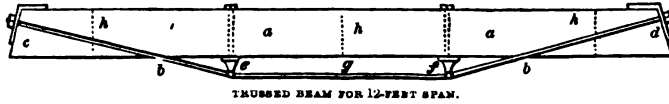

TRUSSED BEAM FOR 12-FOOT SPAN.

1610. The beam *a a*, fig. 841, to be trussed, is divided into two flitches in the direction of its length;—the sawn sides should be turned outwards. The ends are bevelled off, so that the faces thus cut shall be at right angles to the line of the inclined truss rods *b b*, the ends of which pass through iron plates *c* and *d*, and are secured by nuts. The lower ends of the truss rods *b b* are jointed to the struts or saddle-pieces *e* and *f*. A horizontal truss rod *g* is also jointed at its ends to the struts *e* and *f*. The beam may be cambered or lifted up in the centre at *h*, by tightening the nuts at *c* and *d*. The arrangement is in fact a small "suspension bridge," in which the beam *a a* is supported by the struts *e* and *f*; the upper part of the beam being in a state of compression.

1611. In the following figures—842 to 844 inclusive—we give details of the parts of this truss. These are somewhat different from those given by Mr Ainger.

1612. In fig. 842 *a a*, *b b* are cross sections of the two flitches; *c c* one of the struts, the bolts of which are passed between the flitches; the strut is made with two snags, or projecting parts, *d d*, provided with bolt-holes. These are embraced by the ends *e* and *f* of the fork of the angular truss rods *b b* in fig. 841. The end of the truss rod *g*, in fig. 841, is placed between the snags *d d*, as shown at *i*, fig. 842. A bolt *g* is passed through the bolt-holes in the snags *d d*, the ends *e f* and *i* of the truss rods, and secured by a nut *h*. In the left figure *k k* is a side view of part of one flitch, *l* the central bolt of the strut *m m*, with its snag and bolt-hole *n*.

1613. In fig. 843 we give detailed ends of the truss rods, drawn to a scale

Fig. 842.

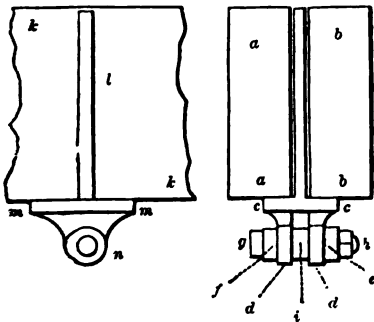

CROSS SECTION AND PART ELEVATION OF FLITCHES OF TRUSSED BEAM IN FIG. 841—SCALE, 1 INCH TO THE FOOT.

Fig. 843.

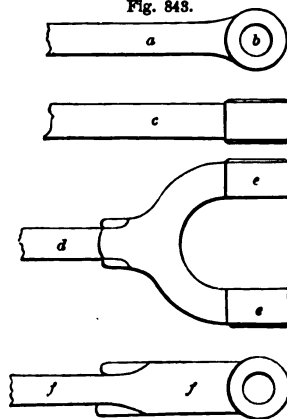

DETAILS OF TRUSS RODS—SCALE, 2 INCHES TO THE FOOT.

twice the size of the detail in fig. 842: *a* is the end of the horizontal truss rod *g* in fig. 841, with its circular head and bolt hole *b*; *c* is an edge view

of the same; *d* is the end of the truss rod *b*, fig. 841, which is expanded so as to form a fork with circular ends *e e*, provided with bolt-holes, as shown in the side or edge view at *f f*.

1614. In fig. 844 we illustrate another plan of forming the connection between

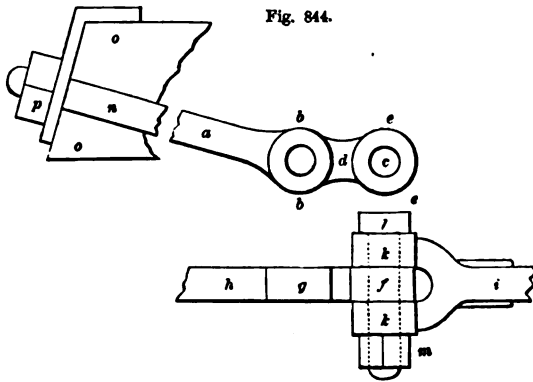

DETAILS OF TRUSS RODS—SCALE, 2 INCHES TO THE FOOT

the ends of the truss rods *b b* and *g*, and the eyes of the struts *e* and *f*, fig. 841. In this case, the end, as of the truss *b*, fig. 841, is provided with an eye *b b*, fig. 844, with bolt-hole—this being passed between the snags *dd* of the strut *c c* in fig. 842. The back of this is lengthened out at *d*, fig. 844, and terminated with a second eye *e e*, with its bolt-hole *c*. The edge view of this part is shown at *f g h*. The end *i* of the horizontal truss *g*,

fig. 841, is expanded so as to form a fork, with circular eyes *k k*, fig. 844. These embrace the eye *f* of the truss rod *g*, fig. 841; a bolt *l*, fig. 844, is then passed through, and secures them all together. The upper end of the truss rod *b*, fig. 841, is shown at *n* in fig. 844. It passes through a hole in the plate *o o*, which is placed at the bevelled end of the beam, and is tightened up by the nut *p*. The distance between the two flitches of the beam is maintained by blocking pieces, shown by the dotted lines *h h h* in fig. 841, of wood placed between them, and kept in place by iron straps. The thickness of these blocks should be a little more than the thickness of the truss rod *b b*, fig. 841.

1615. In figs. 845 and 846 we give details of a method of trussing *solid* beams,

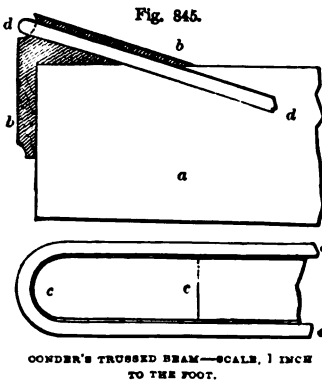

CONDER'S TRUSSED BEAM—SCALE, 1 INCH TO THE FOOT.

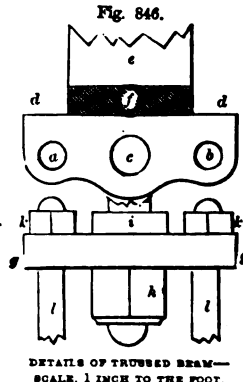

DETAILS OF TRUSSED BEAM—SCALE, 1 INCH TO THE FOOT.

invented by Mr J. Conder, and described at p. 158, vol. i. of the *Engineers' and Mechanics' Encyclopædia*. The plan is applicable to the trussing of solid beams, that is, those which are not cut down the middle into two flitches. The general appearance of the trussed beam is that of fig. 841, the truss rods being on the outside of the beam, in

place of being partially between them, as in fig. 841. In fig. 845 *a* represents the end of the beam to be trussed; a cast-iron saddle *b b* is fitted on this; an angular groove is provided in this saddle, the end being circular, as shown in the plan of the saddle at *c c*. The angle of the groove is the same as that which the truss rods make with the beam—15° in the present example. The truss rod, corresponding to *b b*, fig. 841, is bent in the middle to a circular form, so as to embrace and catch on the circular end of the grooved

saddle, fig. 845. The ends are then passed down on each side of the beam, to points placed at one-third of the length of the beam from its ends, and the ends passed through the eyes of a strut. The horizontal truss rod, corresponding to *g*, fig. 841, is passed through an eye in the centre of the strut. The strength of the horizontal truss rod being equal to that of the two side trusses combined. In fig. 845 *d d*, *e e* is the side truss rod. Fig. 846 shows the strut corresponding to *e* or *f* in fig. 841. The ends of the side trusses are passed through the holes *a b*, fig. 846, of the strut—the end of the horizontal rod being passed through *c*. The upper edge *d d* of the strut is made flat, but does not press immediately upon the under side of the beam *e*, but a blocking piece *f* is inserted. The plan of the strut is shown at *g g—h* being the nut for tightening up the horizontal rod *i*, and giving any desired degree of camber to the beam; *k k* the nuts for tightening the ends *l l* of the side truss rods.

1616. Fig. 847 shows another form of trussing a beam: *a a* one of the

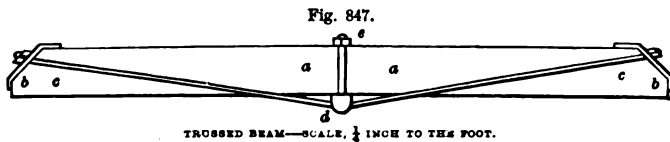

fitches; *b b* iron caps or boxes; *c c* the truss rod, the two ends of which pass through the caps *b b*, and are secured by nuts. The centre part of the truss rod *c c* passes over a curved hollow saddle *d*, secured by the bolt and nut *e*.

1617. In fig. 848 we give at *a* a side view of the saddle, and at *b* an end view of plate or cap *b b*, fig. 847.

1618. Fig. 849 shows another method of securing the ends of the truss rod, the arrangement of which is similar to that in fig. 847—the centre of the truss rod *a*, fig. 849, passing over a curved saddle, as *d* in fig. 847. In fig. 849 the end of the truss rod *a* is jointed to the stud at *b b*. The part *c* of the stud is bolted to the wall-plate *e e*; the beam *f* to be trussed to the part *d*. In the plan *g* is the truss rod, *h h i* the stud.

1619. In fig. 850 we give details of the king-post trussed beam in fig. 838: *a a* a part of the beam; *b* the central abutting piece, with two inclined faces *c c*; *d* the bolt at under side of beam; *e e* the two inclined pieces corresponding to *b b* in fig. 838. In fig. 850 the outer end of the beam *f f* is shown in the left-hand figure; *g* the end abutting piece of iron, with bolt hole *h*, or bolt *l*, with inclined face *k* for the piece *i* to abut against.

1620. In fig. 851 we give details of the queen-post truss in fig. 839: *a a*, *a a* the beam; *b b* the central abutting pieces, secured by the nuts *c c*. Two inclined faces *d e*, *d e* are the abutting pieces of *b b*, *e e* the straining piece, *d d* the struts. The abutting pieces at the end of the beam, against which the feet of the struts *d d* rest, are similar to the piece *g* in fig. 850.

Fig. 848.

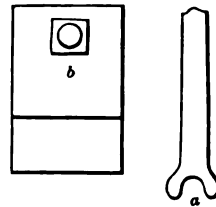

Fig. 849.

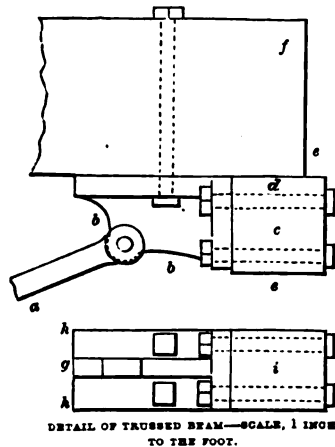
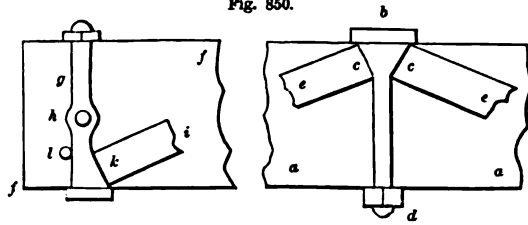
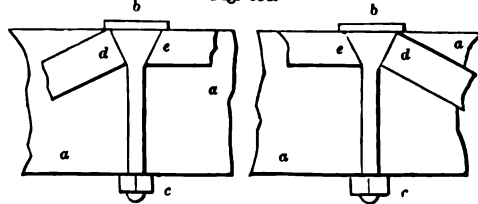

Fig. 850.



DETAILS OF KING-POST TRUSSED BEAM—SCALE, $\frac{3}{4}$ INCH TO THE FOOT.

Fig. 851.



DETAILS OF QUEEN-POST TRUSSED BEAM—SCALE, $\frac{3}{4}$ INCH TO THE FOOT.

1621. SECTION SECOND.—*Wood combined with Stone and Brick.*—In fig. 852 we give section of cornice of house, of which we give the elevation in fig. 56; *a a* a hollow brick wall, *b* brick nog, *c* wall-plate, *d d* bearer, *e* gutter, *f g* pendant of bracket, *h* lintel.

Fig. 852.

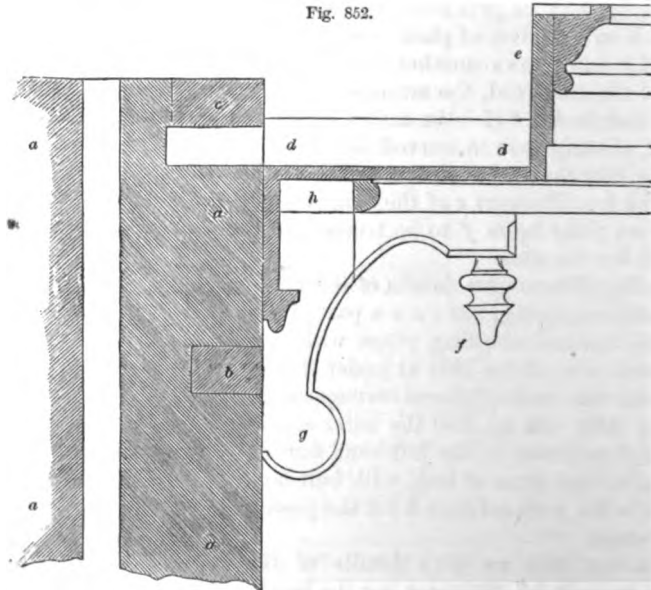

DETAILS OF CORNICE OF FARMHOUSE IN FIG. 56—SCALE, 1 INCH TO THE FOOT.

1622. In fig. 853 we give the front elevation of the cornice, showing brackets *a* and pendants *b*.

1623. In fig. 854 we give section of base of principal window to living-room *c c*, fig. 65. In fig. 854 *a a* is of stone, *b* oak sill, *c* part of sash-frame.

Fig. 853.

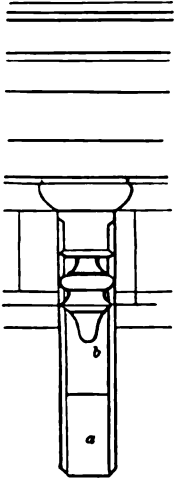

FRONT ELEVATION OF BRACKET OF CORNICE IN FIG. 56—SCALE, 1 INCH TO THE FOOT.

Fig. 854.

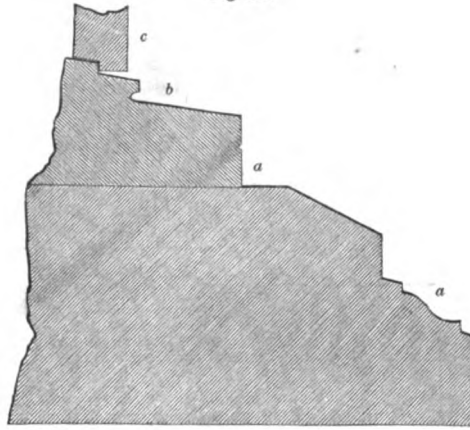

SECTION OF BASE OF PRINCIPAL WINDOW OF HOUSE IN FIG. 65—SCALE, $\frac{1}{2}$ INCH TO THE FOOT.

1624. In fig. 855 we give a section of high cornice of principal window of the house whose elevation is in fig. 67: *a* architrave, *b* *b* cradling, *c* *c* joist, *d* plaster cornice, *e* shutter, *f* sash.

Fig. 855.

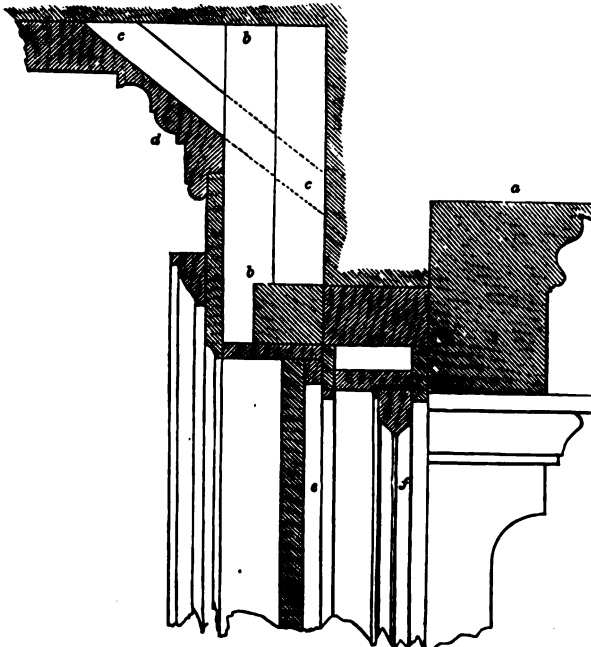

SECTION THROUGH WINDOW-HEAD OF FARMHOUSE IN FIG. 67—SCALE, 1 INCH TO THE FOOT.

1625. In fig. 856 we give plan of mullion of principal window : *a a* stone mullion, *b b* pilaster, *c c* window-bottom, *d d* sashes and frame.

1626. In fig. 857 we give section of *base of bay window* of the house of which in fig. 71 we give an elevation : *a a* stone, *b b* brick, *c c* batton, *d d* skirting, *e* sill, *f* the sash.

1627. In fig. 858 we give section of part of lower and part of upper bay window of the elevation in fig. 71 : *a* sash, *b* oak sill of upper or bedroom window, *c* stone mouldings, *d* brickwork, *e* brackets $1\frac{1}{2}$ inch thick, *f* joists, *g* pitch pine boarding, *h* sash of lower window.

Fig. 856.

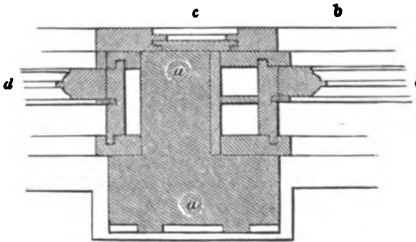

PLAN OF MULLION OF WINDOW OF FARMHOUSE IN FIG. 67—
SCALE, 1 INCH TO THE FOOT.

Fig. 857.

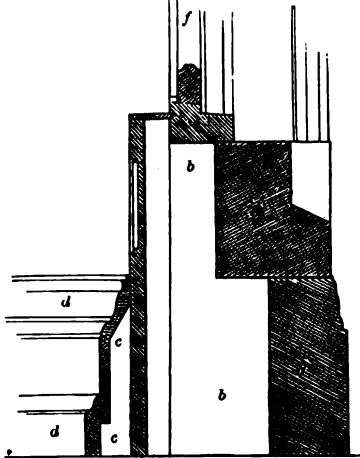

SECTION OF BASE OF BAY WINDOW OF HOUSE IN FIG. 71—
SCALE, 1 INCH TO THE FOOT.

Fig. 858.

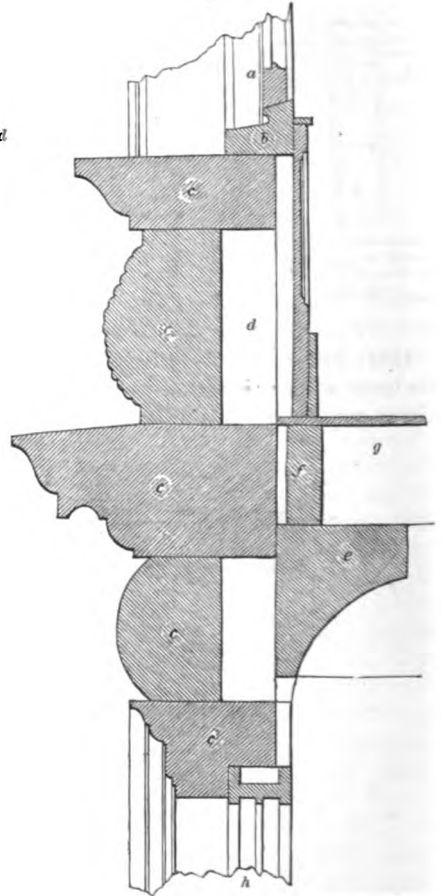

SECTION OF WINDOW-HEAD OF BAY WINDOW OF HOUSE IN FIG. 71—
SCALE, 1 INCH TO THE FOOT.

1628. SECTION THIRD—*Iron combined with Brick or Concrete—Fireproof Construction.*—We shall now describe the methods of making flooring fireproof by the use of cast-iron girders and brick arches. This is illustrated in fig. 859, representing the method adopted by Mr Fairbairn during his long practice as an engineer. The cast-iron pillars *k l*, on which the girders *c d* rest, are placed at a distance of 9 feet 6 inches apart from centre to centre—the distance covered by the arch being called a “bay.” A convenient length for the girders is 20 feet, as illustrated in fig. 611. In fig. 859 the arches are composed of a brick

in length from *a* to *e*, or from *b* to *i*, three-quarters of a brick from *e* to *f*, or *i* to *h*, and half a brick from *f* to *g*, or *h* to *g*; the position of the tie-rod is shown at the line *a b*. "When the arches are finished, and before the centres are struck, the key-bricks, from *f* to *h*, and also all the others, are wedged between the joints with thin pieces of slate, for the purpose of equalising the bearings, to prevent settling after the centres are withdrawn. The arches being thus secured, are afterwards levelled and filled up with a concrete of lime and ashes, on which is laid the flooring of tiles or stone flagging, as the case may be." The best and safest rise for arches such as now described is $1\frac{1}{2}$ inch for every foot of span.

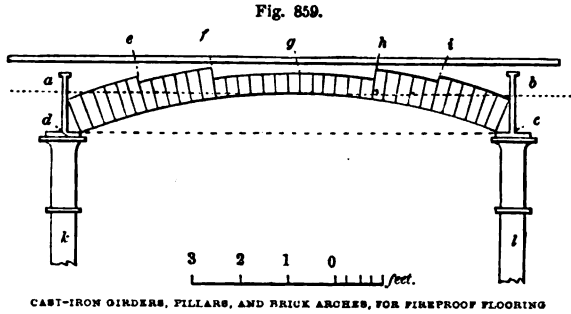

1629. *Wrought-iron Beams and Concrete*.—Wrought-iron beams or joists are rolled solid after the manner of railway bars; a usual form is the I-shaped joist, as in fig. 860 at *c c*. The same figure illustrates Fox's patented method of constructing fireproof flooring, in which the iron joists *c c* stretch across the room; *b b b* are rough strips of wood bearing on the bottom flanges; these support a layer of rough mortar, indicated by the dotted lines above *b*. The mortar is pressed down tightly so as to exude from between the joints of the strips of wood. A key or surface is thus formed, to which the ceiling-plaster, &c., *a a*, adheres. Above the layer of rough mortar a bed of concrete *d d* is placed, on which is placed the flooring-tiles or cement. If boards are used for the floor, narrow strips or battens of wood *e e* are imbedded in the concrete; on these strips the boards are nailed. The iron joists *c c*, and strips of wood *b*, are thus completely imbedded in mortar, concrete, and plaster. This system is very widely used, and forms an exceedingly strong and fireproof floor. Where the span does not exceed 20 feet, iron joists in the length may be used; for spans exceeding this, cast or wrought iron girders will require to be used; and for spans exceeding 60 feet, columns will be required.

1630. In fig. 618 we have given a section of a wrought-iron beam recommended by Mr Fairhair. In fig. 861 we give a section showing the method of carrying out fireproof floors with this form of beam, 9 feet 6 inches apart from centre to centre: *a a* the columns, *b b* the beams resting on these: wrought-iron plates *c c* are riveted to these beams, and stretch in a curve, as shown in the figure. The haunches *d d* are filled up with concrete, on which the flooring material *e e* is placed. The iron plates *c c* are strengthened by angle irons *a a*, riveted as shown in the lower figure of fig. 862. A section of the

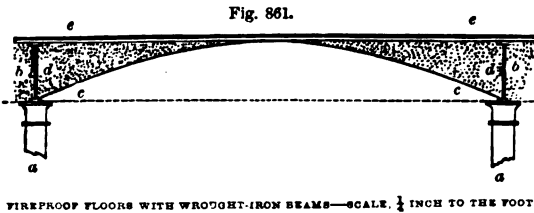

angle iron is given in the upper figure; the lower flange *a* is 4 inches wide, the thickness $\frac{1}{8}$ inch; the depth of central rib *b* 2 inches, and thickness $\frac{1}{8}$ inch; the reader desirous of obtaining full information on the subject of wrought-iron beams, &c., should consult Mr Fairbairn's work, *On Iron Applied to Construction*.

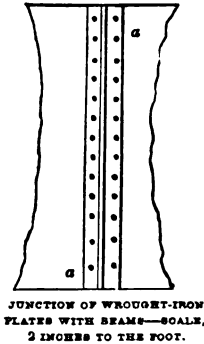
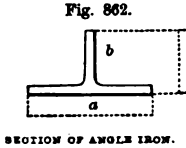

1631. Wrought-iron fireproof flooring has long been carried out with success in Paris, and various plans for it are now attracting considerable attention in this country. Of these we now propose to notice the most important.

1632. The girder or joist employed is I-shaped, as at *a*, fig. 863. These are slightly arched or cambered up, with a rise of $\frac{1}{10}$ inch in the centre. They are placed at a distance of 3 feet 3 inches from each other—a distance of 2 feet, however, gives greater rigidity. In the method of construction which has had the preference amongst the principal Parisian builders, the girders or joists are tied together in pairs, as *b c* placed parallel to each other, and at the distance above mentioned from centre to centre.

The horizontal tie-rod *d d*, $\frac{1}{2}$ inch diameter, which connects the joists, passes through holes made in the neutral axis of the joists,

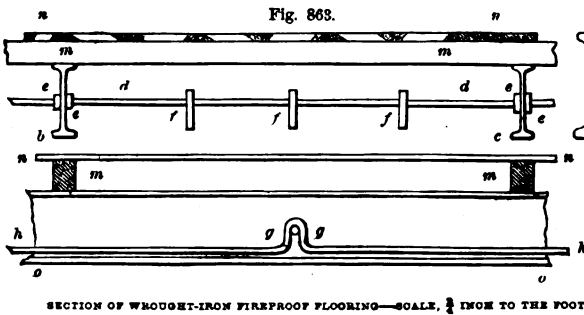

and is tightened up by nuts *e e*. On these tie-bars, cross-square wrought-iron bars *fff* are hung by hooks at their extremities—these hooks being deep enough to admit of the bars hanging nearly on a level with the bottom of girders, as at *g g*; *h h* being

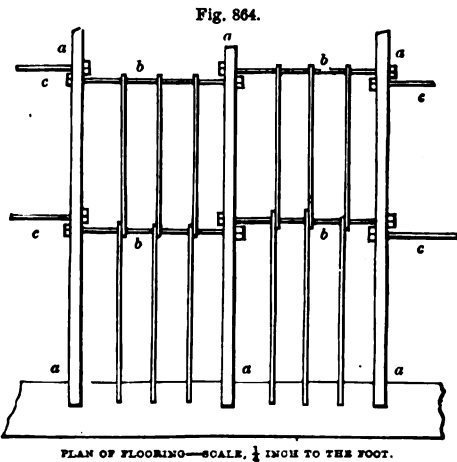

the horizontal parts of the rods. There are three of these cross-rods between each pair of girders, as shown at *b b*, *b b* in plan, fig. 864. In the plan *a a* are the joists, *c c*, *c c* the tie-rods, corresponding to *d d* in elevation. In fig. 863, *m m* the wooden joists, *n n* the flooring. The outer extremities of the cross-bars are bent downwards, and built into the walls. The plaster ceiling, extending below the joists as shown by the line *o o*, is formed as follows: A wooden platform is supported from below, its upper surface being some 2 or 2½

inches below the bottom of joists; a coarse grout of plaster of Paris is then

forced up between the joists and the tie-rods. This hardens almost immediately, and upon the removal of the platform the ceiling may be finished with the usual coat of fine plaster. Wooden joists *m m*, *m m*, fig. 863, are laid over the girders, and above these the flooring is laid in the usual way.

1633. Another method is shown in fig. 865, where *a a* are the iron joists as before; between these, square bars *b, d d, e e e* are placed, the ends of which are turned up and rest on the lower flange, as at *c c*. The length of the elbow or bend of the bars, as *d d*, is such as to bring its termination immediately beneath the upper web of the joist. Three cross-bars *b* placed at intervals of 1 foot each, as shown at *e e e* in the plan, and are held upright by the plaster which forms the ceiling.

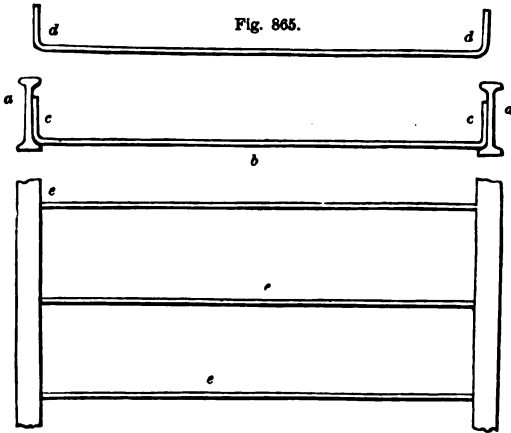

PLAN AND ELEVATION OF FIREPROOF FLOORING—SCALE, $\frac{1}{2}$ INCH TO THE FOOT.

1634. *Système de Mausné*.—In this system the iron joists are employed as before—the distance between them being 2 feet from centre to centre, but the tie-rods *a a*, fig. 866, are carried by wrought-iron clips *b b* passed over the iron joists *c c*. In the left figure a side elevation is given: *d* the clip, *e* the tie-rod, *f f* the joists.

The inventor of this system published some time ago a list of dimensions and prices, of which the following is a translation, given in a paper read before the Royal Institute of British Architects:—

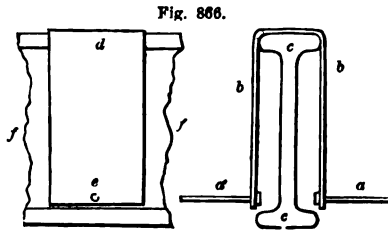

DETAILS OF BEAM—SCALE, 2 INCHES TO THE FOOT.

BEARINGS.		Depth of Joist in inches.	Depth of Floor in complete inches.	Weight per square in pounds.	Iron-work per square.	Including Grouting (12a.) per square.	
Ft.	In.					Ft.	In.
10	0 to 11	4	7½	370	2 19 5	3 11 5	
11	6 " 13	4¾	7½	420	3 6 5	3 18 5	
13	0 " 13	5½	8½	465	3 14 4	4 6 4	
16	6 " 20	6½	9½	510	4 1 9	4 13 9	
20	0 " 23	7½	10½	605	4 17 6	5 9 6	
23	0 " 26	8½	11½	700	5 12 4	6 4 4	

1635. *Loré's System of Fer Tubulaire*.—This system is described in Captain Fowler's *Report on Civil Construction* (Paris Exhibition), to which we are indebted for the following materials.—The *fer tubulaire*, or hollow girder, is of the form shown at *a a*, fig. 867—the top *b* being flat, and having flanges *c c*. The girders are placed at a distance of 2 feet 8 inches from centre to centre, and are tied together at intervals of 3 feet by flat iron bars *d*, riveted to the flanges *c c*.

The floor is formed of flat arches of hollow bricks *e e*, springing from the sides of the girders. The joists *f f* are notched into the upper part of the girders *b b*, while the flooring-boards *g g* are laid in the ordinary method.

1636. For a bearing of 20 feet the dimensions are as follows: The height of girder from *i* to *h*, fig. 867, is $4\frac{3}{4}$ inches, width at top *k* $2\frac{3}{4}$ inches, at bottom

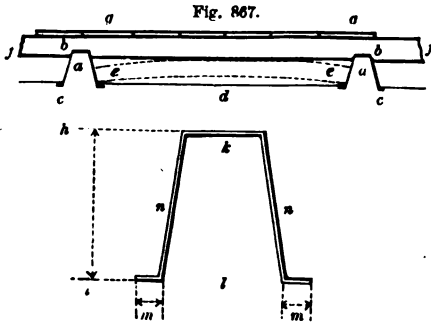

LORE'S SYSTEM OF FIRE-PROOF FLOORING—SCALE, $\frac{1}{2}$ INCH TO THE FOOT.

l 4 inches; breadth of flange *m* $\frac{3}{4}$ inch. The thickness of the sides *n n* $\frac{3}{16}$ inch, of top *k* and flanges *m m* $\frac{7}{16}$ inch. The width of the flat tie-bars *d* is $\frac{3}{4}$ inch, their thickness $\frac{1}{16}$ inch.

1637. Girders of this section are said to possess the following advantages over those used in figs. 863, 865, and 866—"first, with equal weights they give a strength or resistance nearly double, as ascertained by the following experiment: A girder of this form,

20 feet in length, $4\frac{3}{4}$ inches in depth, and weighing 9.5 lb. to the foot, deflected 2.34 inches with a load on its centre of 3 tons. A girder of the I form, 20 feet long, $8\frac{1}{2}$ inches in depth, and weighing 16.9 lb. to the foot, deflected 2.49 inches with the same weight. Again, on the score of economy, a floor of 20 feet square, calculated to bear a weight of 200 lb. on the square foot, exclusive of the cost of flooring, costs in Paris £9, 6s. 10d. per square, including everything, when executed with the I rolled iron girder; and a floor similar in all respects, but having the girder *fer tubulaire* substituted for the I, costs but £7, 9s. 5d. per square. Another great advantage that this form of joist over that in ordinary use in Paris has, is that it does not require any strutting; while the I girder requires lateral pressure to such an extent that it is said not to be employed to the best advantage unless absolutely filled in either with hollow brick arches or plaster, more than one-half of its strength being dependent on its lateral rigidity."

1638. With reference to the utility of the Parisian methods of constructing fireproof flooring, Mr Fairbairn—no better authority—in describing a method in which the I girders are used, as in fig. 866, with the hollow brick arches, as in fig. 867, says, "This description of building is in general use in Paris and other towns of France, and viewing it as a permanent fireproof structure, I should earnestly recommend its adoption in this country."

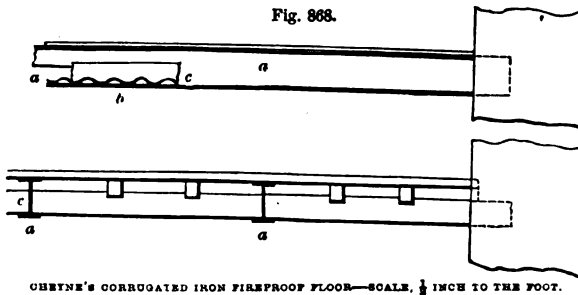

CHEYNE'S CORRUGATED IRON FIRE-PROOF FLOOR—SCALE, $\frac{1}{2}$ INCH TO THE FOOT.

1639. In fig. 868 we give a system of fireproof flooring patented by Mr C. Cheyne, C. E., of 34 Great George Street, Westminster, London, in which malleable iron corrugated plates are used in conjunction with iron beams and concrete filling in.

"Fig. 868 is a section of a floor parallel with the joists, and transverse section of same. The

joists *a a*, *a a* are of rolled iron, the proportions of which are calculated, and depend upon the strength and area of floor to be supported. In this figure they are represented $4\frac{1}{2}$ inches deep and spaced 2 feet 6 inches apart, and are calculated for a floor with 15 feet bearing, and having a load of 50 lb. per foot superficial. Plates of corrugated iron *b* rest on the bottom flange of girders, to which they are riveted; these sheets may be either flat when the floor is light, or cambered if additional stiffness is required in either case. The sheet-iron would cover the entire ceiling, through which it would be impossible for flames to pass. Concrete *c c* would be filled in above the sheets, and the floor would be either boarded or laid with cement according to the purpose for which it was intended. If the under side is to be ceiled, the inventor uses a wirecloth stretched from joist to joist, and plaster is laid on that in the ordinary way."

1640. *Bunnell's Fireproof System of Floors and Roofs*.—In this system hollow or cellular bricks are employed in conjunction with iron tie-rods. The bricks lock into each other on all sides, and are laid to break joint. Each brick receives the support of six adjoining ones. A cross section of a brick is shown in fig. 869, and in fig. 870 a longitudinal section. The ends of the arch

Fig. 869.

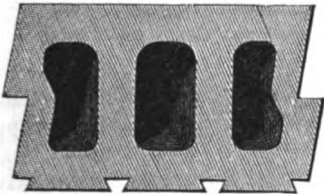

CROSS SECTION OF CELLULAR BRICK ARCH—
 $\frac{1}{2}$ FULL SIZE.

Fig. 870.

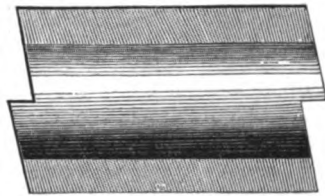

LONGITUDINAL SECTION OF CELLULAR BRICK ARCH—
 $\frac{1}{2}$ FULL SIZE

formed of the bricks are bedded, in the direction of the thrust, in strong angle-irons, as seen in fig. 871. These angle-irons are kept in their places by tension-rods passing through the bricks, as in fig. 871, or under them, as in fig. 872. Floors of wood, cement, or tiles may be laid on the arches.

Fig. 871.

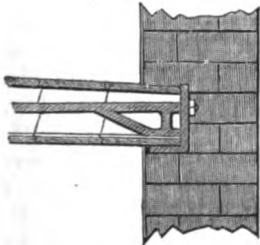

PART SECTION OF FIREPROOF FLOOR,
SHOWING TIE-RODS PASSING THROUGH
CELLULAR BRICKS—SCALE, $\frac{1}{4}$ INCH
TO THE FOOT.

Fig. 872.

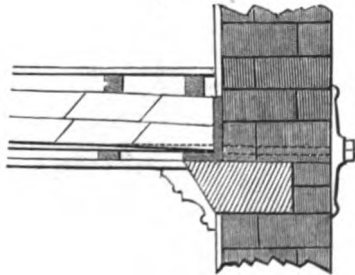

SECTION SHOWING TIE-ROD PASSING UNDER CELLULAR
BRICKS—SCALE, $\frac{1}{4}$ INCH TO THE FOOT.

1641. SECTION FOURTH—*Iron combined with Wood, Slate, or Zinc.*

1642. *Roof Covering of Wood*.—In fig. 873 we illustrate the method of fixing the wood purlin *a* to the rafter *b b*—angle-irons *c c* being riveted to the upper flange of rafter, and spiked to the purlins; *d d* the wood planking.

1643. A satisfactory mode of covering an iron roof is to place wooden boarding on the flanges of the rafters, and on these boards laying sheets of galvanised iron. This affords a roof which maintains a uniform temperature in the building.

1644. *Roofs with Slate Covering.*—Where slates are used as the roof covering, they are placed in wrought-iron angle-laths, as *a b*, fig. 874, these being riveted

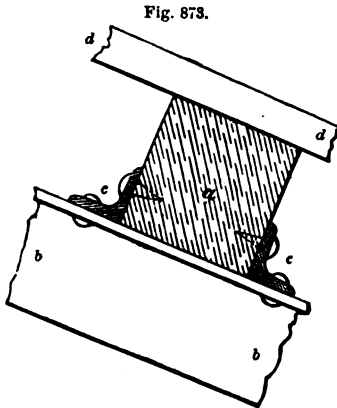

FIG. 873.
JUNCTION OF WOODEN PURLINS WITH IRON
RAFTERS—SCALE IN FIG. 857.

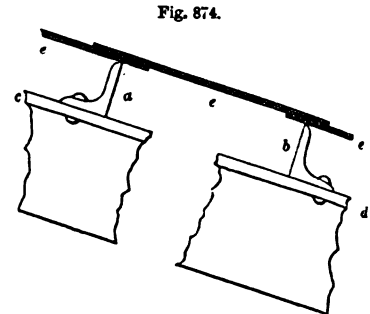

FIG. 874.
FIXING OF SLATES WITH IRON ROOF—SCALE IN FIG. 857.

to the upper flanges *c d* of the rafters. These laths are placed at such distances as to give two to the width of each slate. The slates *e e e* are secured by copper nails, these being clipped over the laths and laid on their lower flanges.

1645. When queen's slate, 27 inches wide, is used in conjunction with iron laths, the size of the laths, when the rafters are placed 5 feet apart, and the laths 12 inches distant from each other, is as follows:—Length of each side of the angle-iron $1\frac{1}{2}$ inch; thickness, "number eight" wire gauge. For princesses and duchess slate, 24 inches wide, the length will be $1\frac{1}{8}$ inch, and thickness, "number nine" wire gauge—the distance between each lath being $10\frac{1}{2}$ inches. Where countess slate is used, 20 inches wide, the size of each side of the lath—the distance between each being $8\frac{1}{2}$ inches—is the same as the last case.

The weight per square of 100 feet superficial of laths, 1 cwt. 2 qrs. 25 lb.; of corrugated iron, 3 cwt.; of queen's slates, 7 cwt. 2 qrs.; of zinc, 22 ounces to the square foot, 147 lb. Plain sheet-iron, number twenty gauge, 1 cwt. 1 qr. 18 lb.; $1\frac{1}{2}$ -inch boarding, 4 cwt. 1 qr. 24 lb.

1646. *Roofs with Zinc Covering.*—In figs. 875 to 885 we illustrate the methods of fitting up zinc-covered roofs, a species of covering well adapted to sheds and other agricultural buildings. The system we have illustrated is that recommended by the "Veille Montagne Company" (12 Manchester Buildings, Westminster Bridge, London), so well

known for the improvements they have introduced in the manufacture and uses of zinc for constructive and decorative purposes.

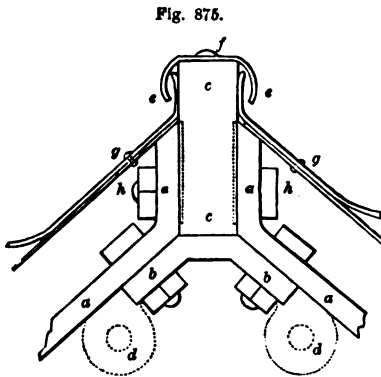
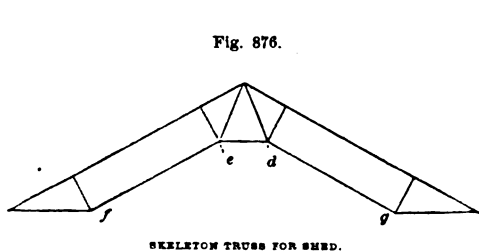

FIG. 875.
JOINING RAFTERS OF TRUSS FOR ZINC COVERING.

1647. In fig. 875 we illustrate the method of joining the rafters of the truss in fig. 876, adapted for sheds, &c.: *a a*, *a a*, fig. 875, are the rafters, butting against and bolted by *h h* to the ridge-pole *c c* of wood or iron; *b b* a binding piece, the same breadth as the rafters, bolted to them by the bolts and nuts as shown at *b b*; *d d* shows the position of the eyes to which the upper ends of the bolts *d e*, fig. 876, are connected.

1648. In fig. 877 we give the plate used for connecting the ends of the two tie-bolts and the strut which meet at points, as *f* and *g*, fig. 876: *a b*, fig. 877, is the plate; *c e* the bolt-holes for the tie-bolts; *d* the bolt-hole for the strut. A section is at *f g*, the bolt-holes at *h i j*.



SKELETON TRUSS FOR SHED.

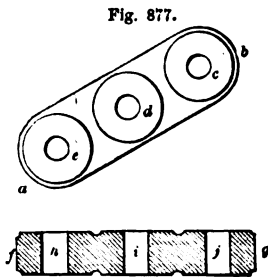
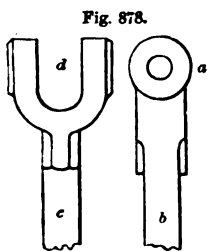

PLATE CONNECTING THE ENDS OF TIE-BOLTS AND STRUTS.

1649. In fig. 878 we give views of the termination of the struts and tie-bolts, where they are jointed to the plate *a b* in fig. 877: *a b*, fig. 878, is a side view, *d c* a front. The plate *a b*, fig. 877, is inserted in the part *d*, fig. 878, and secured by bolts and nuts. The upper termination of the bolts *d* and *e*, fig. 876, are jointed in the same manner to the eyes *d d* shown by the dotted lines in fig. 875.

1650. Fig. 879 illustrates the method of riveting the struts to the rafters: *a* the section of the rafter, *b d c* the projecting snag, riveted by the rivets *e e* at right angles to the line of rafters; *g g* is a side view of the rafter, *h h* rivets, of the snag *f*, with bolt-hole *i*; a plan is shown at *k k*, the under side of rafter; *l* the snag, *m n* the rivet-holes. The ends of the struts, of same diameter as the tie-bolts, are jointed in the manner illustrated in fig. 878.



TERMINATION OF STRUTS AND TIE-BOLTS.

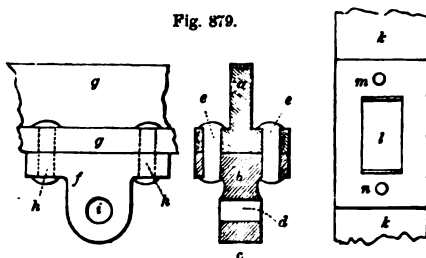

RIVETING STRUTS TO RAFTERS.

1651. In fig. 880, at *a a* we give a section of the wrought-iron rafter used, with a method of attaching the sheets of zinc which forms the roof covering. The ends of the sheets *b b* are turned up at right angles, and laid against the sides of the rafter; a "cap" *c c*, goes over these, and is secured by the pin *d*. It will be observed that the joining of the sheets of zinc will be waterproof, as well as admitting of "free expansion." This system of "free expansion" is

illustrated in fig. 875, where *g g* are the sheets of zinc covering the roof, *e e* the cap, secured by the pin *f*.

1652. The system is also illustrated in fig. 881, showing the method of making the termination of the sheets along the length of the roof. The following

Fig. 880.

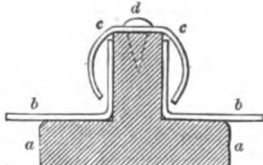

ATTACHING SHEETS OF ZINC TO WROUGHT-IRON RAFTERS.

Fig. 881.

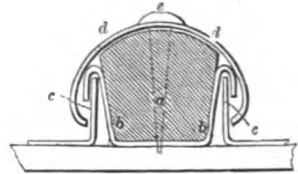

FIXING SHEETS OF ZINC TO WOODROLLS

are the directions for fixing the sheets with wood rolls, as *a*, fig. 881: If there is a gutter provided, it should be fixed first, made of the full length of the sheets—the ends to be well soldered together; one side of the gutter to cover about 3 inches of the slope of the roof, the other side to be brought down against the wall-plate, and bent up to any desired size and shape, as at *c c*. On roofs where there is no gutter, the workman begins by nailing on the lower edge of the roof a stout band of zinc, called a “welt,” projecting about 1 inch. The gutter in the one case being fixed as before described, and the welt in the other where there is no gutter, the work proceeds as follows:—The wooden “rolls” *a*, fig. 881, are nailed to the wooden boards of the roof, at equal distances from each other. When 32-inch sheets of zinc are used, the distance between the “rolls” should be 29 inches, and so on; “double clasps” *b b*, are fixed beneath the “rolls.” The sides of the sheets of zinc covering the slope of the roof are bent upwards at *c c*, and rest against the side of the “double clasps” *b b*. The lower end of each sheet is carried down into the gutter, or passed under the welt, thus preventing the rain from passing between the sheets of zinc and the boarding. After the sheets are thus fixed, the upper end of the double clasps *b b* are bent over the ends of the sheets *c c*, thus making a water-tight and expansive joint. The method of joining the sheets in the direction of the breadth of the roof—that is, from the wall-plate to the ridge—is illustrated in figs. 882, 883. Let *a a*, fig. 882, represent the boarding, *d d* the first sheet laid down as above described—the upper edge of this is bent as shown—the lower edge of the next succeeding sheet *c* being similarly bent—the two embracing each other freely, as shown between *d* and *c*. To fix each sheet to the roof independently of the others, and to allow of free expansion and contraction, the doubled-up end of each sheet is kept by two clasps nailed to the boarding, as *b*, fig. 883. The spike *d*,

Fig. 882.



JOINING SHEETS OF ZINC FROM WALL-PLATE TO RIDGE.

Fig. 883.

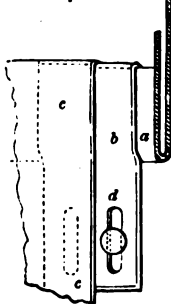

or spike *e*, fig. 882, passes through a slot made in the clasp, which allows of free expansion. The fixing of the “cap” *d d*, fig. 881, with the pin *e*, finishes the operations. The caps should weigh 2½ ounces to the square foot; they

should be laid loosely on the roll, and cover the sides of the sheets at least 1 inch. The caps are fixed by galvanised screws, and finally soldered over to prevent the admission of water. Where the fall or slope of the roof is less than 20 degrees, the ends of the sheets should be soldered together, instead of being folded as described. The method illustrated is intended for wooden roofs, where the zinc is laid on boarding in flat sheets. Where iron rafters are used, corrugated zinc is adopted—no boarding being required; or flattened sheets may be used, each sheet having a slight convexity or curve given to it, which gives them sufficient strength to allow of walking over them. The foot of each rafter *a b*, fig. 884, is expanded, and bolt or spike holes made in the expanded parts *c c*, by which the rafter is nailed to the wall-plate.

1653. In fig. 885 we show the method of joining plates of corrugated zinc together. A roof formed of this material is at once very strong and very light.

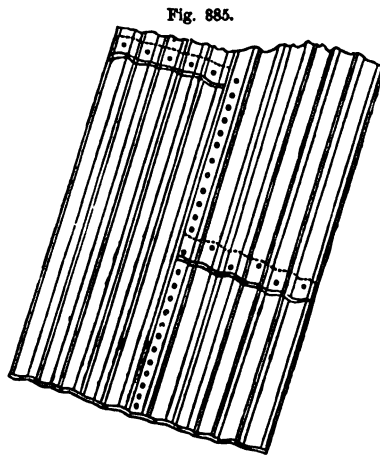
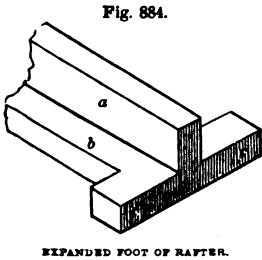

1654. We here give the relative costs of roofs of same size, covered with slates and with zinc—the trusses being composed in both cases of timber, the zinc fixed on the system illustrated in figs. 881, 882, and 883 :—

SLATE ROOF.

44 cubic feet of timber, at 3s.,	£6 12 0
589 square feet of rough boarding, at 3d.,	7 7 8
550 " " slating, countess, at 3d.,	6 17 6
284 " " 7-lb. lead for gutters, at 1s. 10d.,	26 0 8
91 " " 4-lb. lead for the ridges, at 1s.,	4 11 0
	<hr/>
	£51 8 5

ZINC ROOF.

30 cubic feet of timber, at 3s.,	£4 10 0
507 square feet of rough boarding, at 3d.,	6 6 9
456 " " 22-ounce zinc for the covering, at 6d.,	11 8 0
220 " " 24-ounce for the gutters, at 6½d,	5 19 2
	<hr/>
	£28 3 11

These estimates do not include the cost of repairs. In this respect the zinc roof has great advantages over the timber and slate roof.

1655. Putting the cost of a zinc roof with iron rafters and curved flattened sheet-zinc at £25, 7s., the cost of a timber and slate roof would be £58, 17s. 11d. Stating the cost of a zinc roof with iron rafters and corrugated zinc as in fig. 885 at £4, 3s. 6d., the cost of the same extent of slate and timber would be £10.

DIVISION FOURTH—MISCELLANEOUS APPLIANCES.

SUBDIVISION FIRST—*Fittings of the Workshop.*

1656. SECTION FIRST—*Tools of the Joiner.*—The distinction between the two operations of Carpentry and Joinery may be simply stated. In carpentry, the framing and erecting of heavy timbers for the purposes of floors, roofs, partitions, &c., is the principal business; in joinery, the making and fitting up of external and internal furnishings—as door-cases, doors, windows, window-frames, &c.—are the operations to be performed. In both, however, there are many common operations, which differ only in the fact that, for the purposes of joinery, they may be on a smaller scale than when required for those of carpentry. In general, all timbers used for carpentry are left rough as they come from the operation of the saw or the axe; while in joinery, all exterior surfaces are made smooth and uniform by appropriate instruments. The tools required for the simple operations of joinery to be carried out on a farm-steading, may be enumerated as follows: the “ripping-saw,” for cutting up heavy planks—the teeth in this are 96 to the foot, or 16 to the two inches; the “hand-saw,” for ordinary work, 45 teeth to the foot; the “sash-saw,” for cutting fine work, with a brass back—it has 156 teeth to the foot. For cutting dovetails, a small saw, having 180 teeth to the foot, is used. Tenons may be cut out by means of the “sash-saw.” A long, thin, and narrow saw, termed a “key-hole saw,” having no back, and useful for cutting out holes in wood: a size as follows will be useful—length 12 inches, breadth at point $\frac{1}{4}$ inch or $\frac{3}{8}$ ths, breadth at handle $\frac{3}{4}$ inch. The planes used in joinery are very numerous. The “jack-plane” is used for taking the rough surface off the timber to be smoothed in surface. It is used by taking off as much as can be taken in by one arm-stretch—the workman beginning at the near side of the plank, and gradually taking off the rough across the breadth of the plank. On a part of the plank within arm-reach being done, the workman moves farther along, until the whole surface is acted upon. To bring this surface properly smooth and to a level, a larger and heavier plane is used, termed the “trying-plane.” Shavings are taken off with this the whole length of the plank. To test the level of the surface, a straight-edge (that is, a piece of wood about 18 inches long, $\frac{1}{2}$ inch thick, and 2 inches broad, having one edge perfectly true and square) is laid across the face, and the workman looks along the plank, where the straight-edge is lying on it: all inequalities are then easily observed, and are to be reduced by the plane. As the edges of the plane are generally accurately cut, the workman sometimes tests the “truth” of the surface of the work by laying the edge of the under side of the plane across the face of the plank. The “hand or smoothing plane” is used for giving a final truth and smoothness to the work, and for finishing up small work. It is used with both hands in some operations—with only one in others. It is much shorter than the two others, being about 7 inches—the length of jack-plane being 18, and that of the trying-plane 22 inches. For

making varieties of mouldings, "moulding-planes" are used; but as the operations are rather difficult, and not much required for ordinary work, we do not here describe them. The farm workman should, however, provide himself with a "rebate-plane" for forming rebates on the edges of planks, framing, &c. The nature of a rebate we have already described. The "plough" for sinking a "groove," and the plane for making the "tongue," are also required. Chisels are numerous; but the "paring-chisel," of various sizes, from $\frac{1}{4}$ inch in breadth to 1 inch, will be all that is necessary. The "mortise-chisel" will also be necessary. "Gouges" are circular chisels, and are used for making hollows: they are of various sizes. Small holes are made by "brad-awls" and "gimlets;" they are of various sizes. Circular holes, of larger diameter, are made by means of a "brace" and "bit;" the bits are of various sizes. Screwdrivers of various sizes will be required; as also "hammer," "pincers," or "pliers." To assist the workman in marking off a line on a plank, parallel to the edge, and at any distance required, an instrument termed the "gauge" is required. This may be made by the workman, according to fig. 886. A piece of hard wood *d d*,

some 6 or 9 inches long, is provided, and properly squared up; at one end, within $\frac{1}{4}$ inch or so, a nail is driven so as to project about $\frac{1}{8}$ inch. This is sharpened to a point. A piece of wood, *a a*, $1\frac{1}{4}$ inch square, and 1 inch thick, is provided with an aperture *b*, $\frac{3}{4}$ square, having on one side a small mortised hole *c* cut in it, about $\frac{1}{4}$ or $\frac{3}{8}$ broad and deep. This piece *a a* is passed

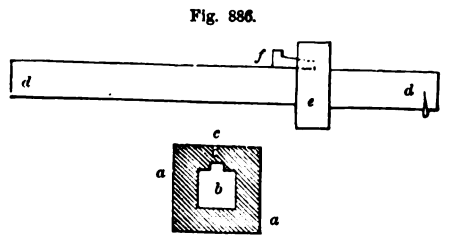

ELEVATION AND SECTION OF GAUGE—SCALE, $\frac{1}{2}$ INCH TO THE INCH

over *d d*, as *e*, and can be secured at any part by means of a small wedge *f*, passed into and driven up the mortised hole *c*. By means of a rule, the distance between the point of the nail and face of *e* may be arranged as required; and by putting the face of *e* to the edge of plank, and drawing it along, the point of the nail will draw a line on the face of the plank, at a distance from its edge, corresponding to the distance of the nail from face of *e*. A "mortise-gauge" will also be useful. This gauge has two "marking points," which can be set at any distance apart, and used to give two parallel markings in the centre of the edge of a board. When the rebate is made on each side of this central place, the tenon will be formed.

1657. For the purpose of assisting the joiner in his various operations, the "bench" is an indispensable requisite. This may be described as a species of framed table, having a level top, and a side-board perforated with holes, about 1 inch diameter, as in fig. 887. It is provided with a wooden closing-jaw and screw at one end, by which the plank to be operated upon is firmly fastened. Instead of a screw a wedge may be used, as in fig. 888: *a a* is the top of the table or bench; *b c* the part in which the wedge is placed; *d* the wedge; the board *e* (of which the upper edge is to be planed) is placed close to the side of the bench, one end being secured by driving in the wedge *d*, the other end rest-

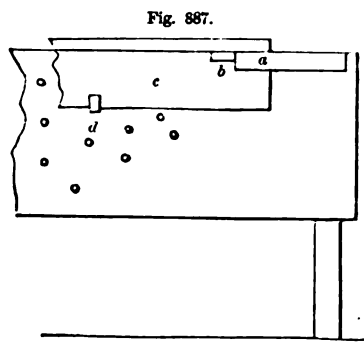

ELEVATION OF PART OF JOINER'S BENCH.

ing upon a pier *f*—shown separately at *g*—which is passed into one of the holes made in the side of the bench. In fig. 887, which shows part of the side, *a* is the part into which the wedge *b* is driven, tightening up the board *c*, and which is further supported by the pin *d*.

1658. *Tressels or Horses*, for supporting planks while being sawn asunder, are useful. In fig. 889 the board *a a* rests upon the two tressels *b b*, a side view of which is shown at *c*.

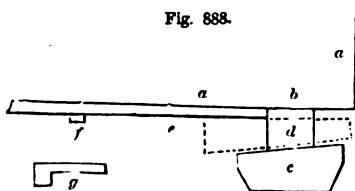

PLAN OF PART OF JOINER'S BENCH.

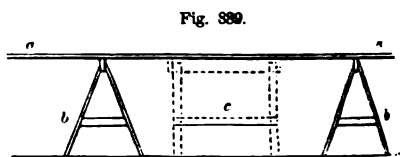

JOINER'S TRESSELS OR HORSES.

1659. *Claw-Hammer*.—The hammer used for driving and extracting nails is illustrated in fig. 890.

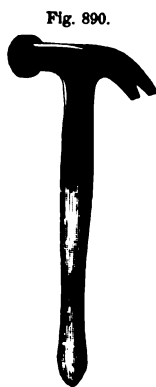

CLAW-HAMMER.

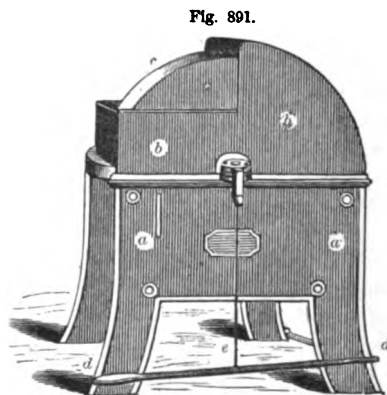

GRINDSTONE.

1660. *Grindstone*.—In fig. 891 we illustrate a convenient and cleanly form of grindstone, the framing *a a* of which is of cast-iron. The stone is covered with a casing *b b*, leaving part only of the stone exposed, as at *c*. This arrangement prevents the water from being scattered about. The revolution of the stone is caused by the action of the foot of the operator on the pedal

dd, through the medium of the connecting-rod *e* acting on a crank. The form, as here illustrated, is manufactured by Messrs Ibbotson Brothers & Company, of Sheffield, tool-makers.

1661. SECTION SECOND—*Tools of the Mason*.—The tools of the mason may be described as the mallet, the chisel, the trowel, the plumb-rule, and the square. A few notes as to the more simple operations of the mason in which these tools are used, may be found useful. The tools used are chisels, with the cutting edges of various sizes, from about $\frac{1}{4}$ inch broad up to 2 inches. A "mallet" is used for striking the chisels, of the form of a parallel section of the lowest portion of a cone, with a short handle. Short, flat-faced, heavy hammers, with short handles, are now much used by hewers, especially for hard stones. In bringing a stone, say for a fire hearthstone, or the tread of a step, to a flat surface, two chisel-draughts are made at one side and the end of the stone, somewhat like what is termed in joinery a rebate. These rebates are made perfectly flat, which is tested by placing a straight edge. Every part of the stone should coincide with the under side of straight edge. A diagonal chisel-draught is then made, connecting the ends of the side and end draughts previously made; another diagonal draught is made, crossing the first diagonal,

and meeting the angle of the end and side draughts. All these being made as near as possible of the same depth, on the spaces between the draughts being blocked out, a comparatively flat surface is obtained. This is brought as flat as required by the use of the square; or the level of the surface may be tested by using two straight edges of equal depth, thus: place one along an edge or aris of the stone, and on the opposite one the other straight edge; by looking over the upper edge of the one straight edge, if the upper edge of the other coincides, the surface is level.

1662. Masonry is built with the aid of scaffolding, supported by two sets of standards, the system of putlogs not being admissible as in brickwork. In fig. 892 the mason and bricklayer's trowel is shown, 7 inches long in the blade *a*; 5 in the handle *c*; and $1\frac{1}{2}$ inch return at *b*. In fig. 893 the plumb-level is shown. This is used to ascertain whether any surface, as a course of brickwork or masonry, is level. It is laid on the surface, as *a b*: if it is not level, the plummet *f* will not hang vertically down in the opening *e*, the cord by which it is suspended from *d* not coinciding with the line drawn on the board from the point of suspension *d* at right angles to the line of base *a b*. The plummet *f* will coincide with the line *d e* on the board, when the level rests on the dotted base line *a c*.

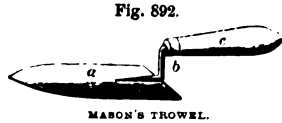

Fig. 892.

The spirit-level is used for the same purpose as this instrument; it need not be here described: suffice it to say, that when laid on the wall, if level, the "air-bubble" will be exactly in the centre. The plumb-line for adjusting vertical heights, as posts, &c., is shown in fig. 894. It consists of a flat board *a b*, down the centre of which a plummet *d* hangs; the line drawn from *c* to *d* is at right angles to the end *b*, the sides being parallel to this line. Suppose it is required to test whether an upright post *e e* of a "frame-house" is vertical, the side of the plumb-line *b* is applied to the side of *e e*; if it is vertical, the cord by which the plummet *d* is suspended will coincide with the line marked from *c*. An aperture should be made in the face of the board where the plummet *d* hangs, the centre of which should be at the end of the line from *c*.

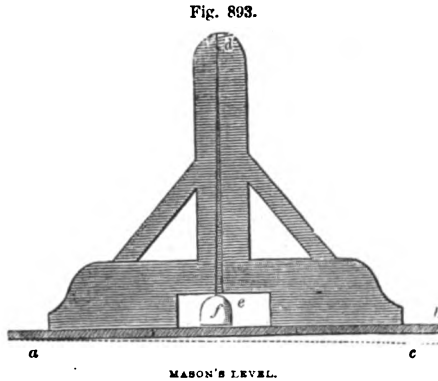
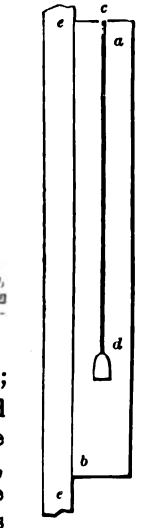

Fig. 893.

Fig. 894.



MASON'S PLUMB LINE

1663. SECTION THIRD—*Tools of the Smith.*—The appliances to aid the workman in this department of the mechanical arts with which it will be necessary to be provided, are the anvil, tilt or sledge hammer, hand hammer, a variety of swages, &c., for making round bolts, and bellows or fanners. The construction and arrangement of the forge is so well known that illustration of it is unnecessary. It closely resembles the forge in fig. 898; with this difference, that a pair of bellows are substituted for the fanner there shown. Portable forges in frames, with wheels, are now much used, and can be had at a moderate price. Forges with fanners in place of bellows will be found so efficient, that we here illustrate that mode

1663. SECTION THIRD—*Tools of the Smith.*—The appliances to aid the workman in this department of the mechanical arts with which it will be necessary to be provided, are the anvil, tilt or sledge hammer, hand hammer, a variety of swages, &c., for making round bolts, and bellows or fanners. The construction and arrangement of the forge is so well known that illustration of it is unnecessary. It closely resembles the forge in fig. 898; with this difference, that a pair of bellows are substituted for the fanner there shown. Portable forges in frames, with wheels, are now much used, and can be had at a moderate price. Forges with fanners in place of bellows will be found so efficient, that we here illustrate that mode

of construction. In fig. 895 we give a side view of "concentric fan," drawn to a scale of 2 inches to the foot. Two sides *a a*, *e e* are constructed of $\frac{1}{2}$ -inch wood, or of sheet-iron, with holes *d*, 2 or 3 inches diameter, to admit air to the interior; the extreme length of the sides is 18 inches, tapering to inch deep

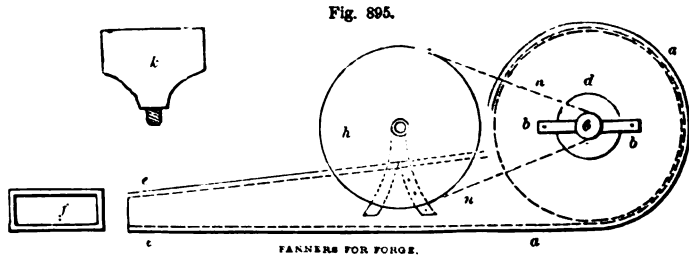

at *e e*; *f* shows the front of blowing aperture, the sides of which are kept apart a distance of $2\frac{1}{2}$ inches, throughout their whole length. Across each opening a piece of brass *b b*, $\frac{3}{4}$ inch wide and $\frac{1}{4}$ thick, is fixed. In the centre of this, corresponding with centre of circle *d*, a hole is bored to admit the spindle on which the arms of revolving fan are fixed. On one end of the spindle a small pulley, $1\frac{1}{2}$ inch diameter, is fixed; this is turned by means of a band *n n* passing round the large pulley *h*. Fig. 896 is a view of the central spindle *a*: a boss, or part longer in diameter, as *b*, is forged upon the spindle; into this holes are bored, as *c c c c*, which are screwed with a small "tap" (a set of which should be procured); into these holes the arms or blades of the fan *k*, fig. 895, are screwed, the end of blades being made circular, and screwed with a "die" corresponding to the "tap," which is used for the holes *c*, in fig. 896. In place of having the fans revolving concentric to the case, as in fig. 895, the fanners will be more efficient, and a steadier blast kept up, if the blades revolve

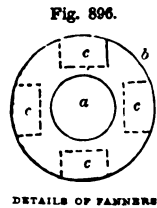

eccentric to the case, as by *a b c* in fig. 897. In fig. 898 an arrangement of a forge

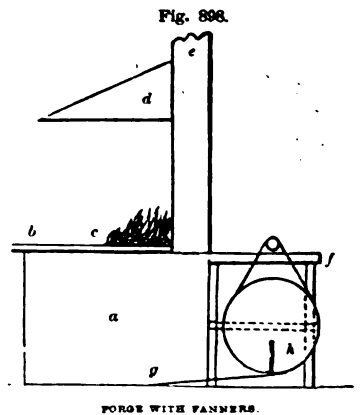
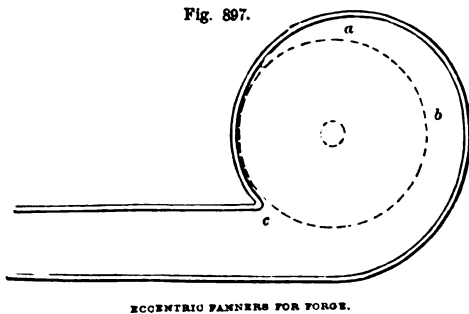

adapted for the use of the fanners is shown: the wheel for giving motion to the fan is fixed on a frame *f*, at the back of the forge, on the top of which the fan is placed. The large wheel is put in motion by a treddle *g* and connecting-rod *h*,

as in the knife-grinder's wheel, the upper end of the connecting-rod being connected with a pin inserted into the face of the wheel, at some distance from the centre of its revolution: *a* is the body of the forge, of brickwork; *b* the flat flagstone in which the fire *c* is made; *d* the iron hood placed over the fire, conducting the smoke to the chimney *e*.

1664. *Apparatus for Boring Holes in Metal.*—Holes are bored in metal by a simple contrivance known as the "brace," delineated in fig. 899. It is formed of iron, about 1 inch in diameter—the upper part *a* being brought to a point, which revolves in a small hole punched in the under side of a bar of iron *b* of considerable length, one end of which is inserted in a hole in the wall above the bench in which the operation is conducted, an assistant pressing on the other end *c*. The drill *d* is

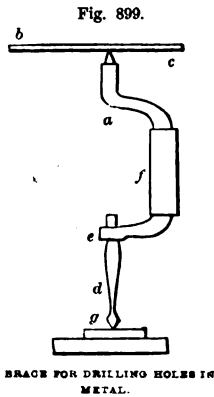

inserted in the square hole made in the lower part of the drill at *e*; a piece of thin sheet-iron *f* is passed round the brace at the bend—this, being loose, allows the brace to revolve within it, thus saving the hand of the operator, and making the turning easier. A small indentation is made in the piece of metal *g* in which the hole is to be bored. Instead of using the lever *c*, to give the pressure on the brace and boring bit, the screw apparatus illustrated in fig. 900 may be adopted with benefit. In this *a* is the frame, provided with a series of apertures in the upper part. The part *b*—on which the piece of iron *c*, to be operated upon, rests—is made hollow, as shown in plan at *d*. The screw *e*, which gives the pressure on the brace *f*, passes through the eye *g* of the arm *h*, the end *i* of which is provided with a slotted head, which passes over the upper arm of frame *a*, and is maintained at any desired height by a pin passing through the apertures in the head *i* and arm *a*. A plan of the arm *h* is shown at *k*.

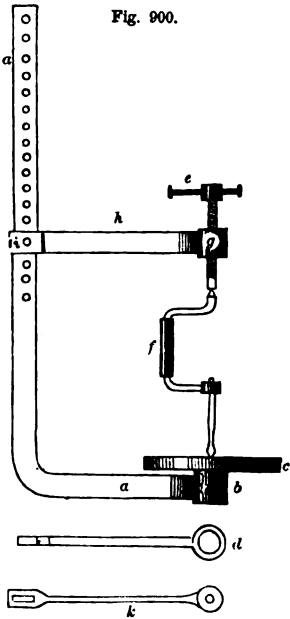

ELEVATION OF SCREW-FRAME FOR BORING BRACE—SCALE, 1 INCH TO THE FOOT.

1665. *Ratchet Braces.*—In places where the brace, as in the last illustration, cannot be used, owing to the confined space in which it may be desired to operate, and in which the brace has only space enough to give a part revolution, the ratchet brace, fig. 901, is used. The pressure is put on at the point *a* by a shifting screw, as *e* in fig. 900, or a lever, as *c* in fig. 899; the boring tool is inserted in the part *b*. The handle *c* is moved through a part only of its revolution; the click *d*, engaging with the ratchet *e*, keeps turning the boring bit always in one direction. This is manufactured by Ibbotson & Co., Birmingham.

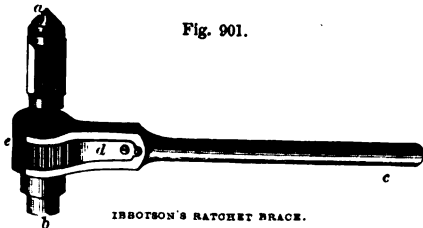

IBBOTSON'S RATCHET BRACE.

1666. *Fenn's Ratchet Drilling Brace*.—In fig. 902 we give a plan *a b* and section *c d* of the ratchet brace invented and manufactured by Joseph Fenn, of Newgate Street, the well-known tool-maker. In this the catch-wheel *e* is

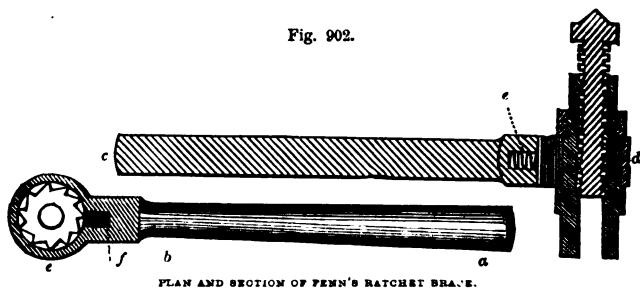

PLAN AND SECTION OF FENN'S RATCHET BRACE.

placed within the bar of iron *a b*; a slot is cut in the lever to admit of the sliding catch *f*. The greater the strain on the lever the more closely does the catch engage with the catch-wheel *e*, and which is driven up by a

spring at the back. In this brace the catch-wheel *e* is the entire width of the lever—thus rendering it fitter for heavy work.



BORING DRILLS—HALF SIZE.

1667. *Boring Drills*.—In fig. 903 we give forms of bits *a b c*. If the cutting edges, as at *b*, are made too acute, they are apt to break off; if made obtuse, as at *c*, they will be stronger, although they will not cut so quickly as in the more acute form at *b*.

1668. *Screw-Stocks*.—Screw-bolts are made by screw-stocks. Stocks for small screws are shown in fig. 904; a shifting stock in fig. 905. Taps for making screw-nuts are of various sizes.

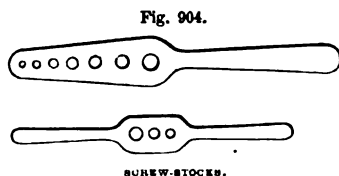

SREW-STOCKS.



IBBOTSON'S SCREW-STOCK

1669. *Keys or Spanners*.—In fig. 906 we illustrate various forms of keys manufactured by Ibbotson & Co., Birmingham: *a b* are keys to embrace nuts of determinate sizes. Keys, or shifting spanners, are shown at *c d*; by turning the handle *e a* screw is operated upon, by which the jaws *f* are made to recede from, or approach to, each other, as desired.

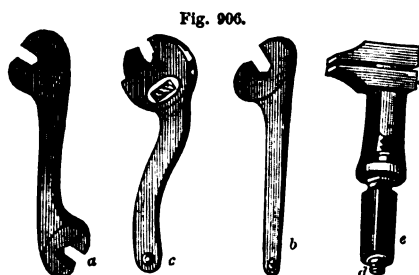

VARIOUS FORMS OF SPANNERS OF SCREW-KEYS.



RIVETING HAMMER.

1670. *Riveting Hammer*.—A small riveting hammer is illustrated in fig. 907.

1671. *Portable Vice*.—In fig. 908 we illustrate White's portable vice, manufactured by Ibbotson & Co. In this the faces of the jaws *a*, however far apart,

are always parallel to each other; thus at all points insuring a secure hold of the article operated upon.

1672. *Lifting Screw-Jack*.—In fig. 909 we illustrate a lifting-jack manufactured by Dunn of Manchester. By turning the handle *a b* the mitre or bevel wheels *c d* act upon the vertical screw *e*, on the cap of which the article to be raised rests. In fig. 910 we illustrate Halley's patent lifting-jack, manufactured by Ibbotson & Co.

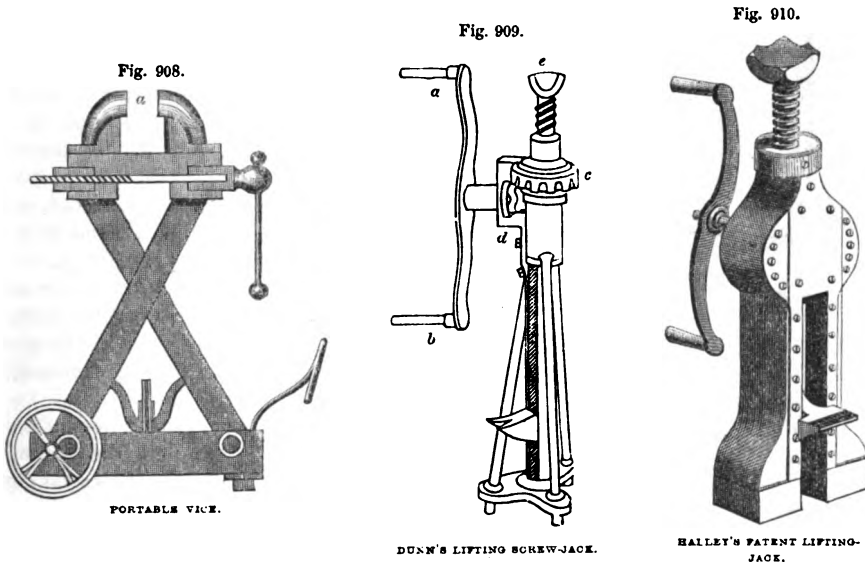

1673. SECTION FOURTH—*Machines for the Workshop—Vertical Saw Frame for Cutting Balks or Trees into Planks*.—As an apparatus of this kind may be economically used on a large estate, where home timber is extensively obtained, we deem it right to give an illustration of it. We are indebted for this to the manufacturers, Messrs Wm. Dray & Co., of London Bridge, London. In Plate XIX. we give, in fig. 1 an end, and in fig. 2 a side, elevation of the machine. In fig. 1 the vertical saws *a a*, which operate upon the balk or tree *b*, are fixed in the upper and lower frames *c c*, which have a vertical up-and-down motion given to them by the connecting-rod *d*, to which motion is imparted by the crank *e*, fitted to the horizontal shaft *f*, receiving motion from the steam-engine, or other prime mover, through the medium of the fast and loose pulleys *g*. The fly-wheel *h* is fixed on the shaft to equalise the motion. The shaft revolves in the pedestal *i i*, fixed to the brick foundation *k k*; *l l* the uprights or standards, in which the frames *c c*, supporting the saws *a a*, slide up and down. Motion is given to the tree *m m*, fig. 2, so as to keep it up to the action of the saws in manner following: The tree *m m* is secured to the travelling frame *n n* by the set screws *o o*. To the under side of the frame *n n* a rack *p p* is fixed; with this engages a small pinion, receiving motion through the medium of the ratchet wheel *r*, fig. 1. This receives a rotatory motion in alternate or intermediate movements by means of a click or pawl taking into the teeth of the ratchet wheel, and which pawl receives an up-and-down motion through the lever *s* and eccentric *t*.

1674. *Iron Bench Circular Saw*.—In Plate XX. we give various views of a circular saw frame, to scale, as manufactured by Messrs E. R. & F. Turner of

Ipswich. In fig. 1 is an elevation; fig. 2 a plan; fig. 3 part section, through line 1, 2, fig. 2; and fig. 4 section, through line 3, 4 in fig. 2. The circular saw *a*, figs. 1 and 2, is 27 inches diameter, and is calculated to cut up timber into planks 10 inches in depth. The spindle *b*, fig. 2, is fitted with

Fig. 911.

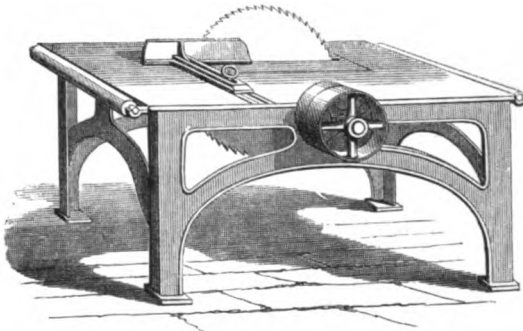

PERSPECTIVE VIEW OF TURNER'S IRON BENCH FOR CIRCULAR SAW.

fast and loose pulleys *cd*; and the termination *e* is fitted to receive a boring bit *f*, fig. 3, which may be used for boring holes in timber. The timber to be cut is placed upon the table *g*, figs. 1, 2, 3, and 4, which can, by means of a screw *h*, fig. 4, be moved laterally parallel to the saw, so the thickness of cut can be easily adjusted, and to the greatest nicety. The timber to be cut is kept up to the action of the saw by the atten-

dant; its motion lengthways on the table being facilitated by the friction rollers *i*, figs. 1 and 2. Fig. 911 gives a perspective view of this saw mounted on its iron bench.

1675. *Endless Band Saw.*—In fig. 912 we give a perspective view of the

Fig. 912.

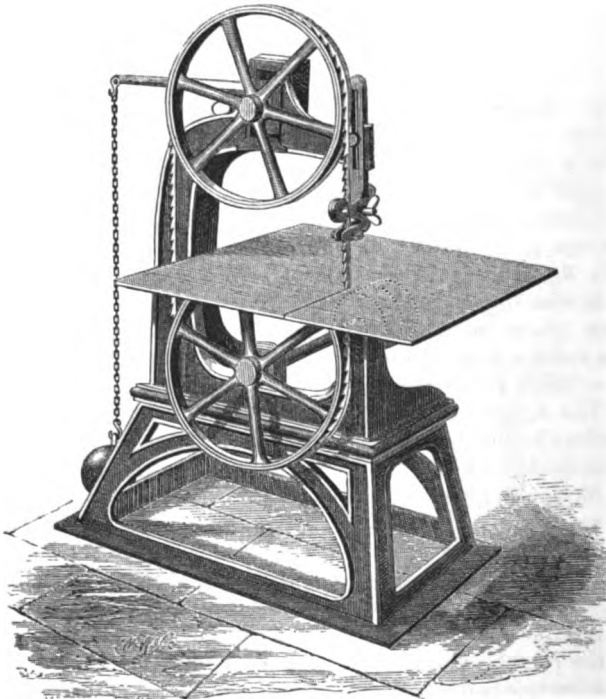

ENDLESS BAND SAW FRAME IN PERSPECTIVE.

“Endless Band Saw,” as manufactured by Messrs Barrett, Exall, & Andrews, of Reading, and in Plate XXI. figures to scale of the same, of which fig. 1 is side, and fig. 2 end, elevation—of which the upper part is in section, as shown by the cross lines. The saw consists of an endless band of thin flexible steel *a a, a a*, on one side of which a continuous row of teeth is cut. This is stretched over two pulleys *b b, b b*, of equal diameter, and placed in the same line with each other. The lower pulley is keyed on to the shaft *c*, fig. 2, and which is put in motion by the prime mover through

the medium of the fast and loose pulleys *d* and *e*. The band saw is kept in a state of uniform tension and in the same right line through the medium of the

clip *f*, lever *g*, and weight *h*, fig. 1. The saw passes up a slit made in the table *i i*, *i i*, on which the wood to be cut is placed. Such is the accuracy and precision of operation of this apparatus that timber can be cut into any form or curved outline. For small work it is invaluable.

1676. *Mortising, Tenoning, and Boring Machine*.—In fig. 913 we give an illustration of this machine, manufactured by Messrs Powis, James, & Co., of 26 Watling Street, London. When used for mortising, the handle *a*, with

FIG. 913.

balance weight *b*, is worked up and down; this gives a vertical motion to the spindle *c*, on the lower part of which the cutting tool *d* is fixed. The timber in which the mortise is to be cut is placed on the table *e*, which receives the requisite lateral motion to keep it up to the tool through the medium of the ratchet wheel and pawl *f*, receiving motion from the alternate movement of the lever *a b*, through the rod *g*. When used for boring, the handle *h* is used to give motion to the bevel gearing *i i*. The boring bit is kept to its work by the pressure of the lever *a b*. The table *e* is adjusted, when the machine is used for tenoning, by the screws having lever wheels *k* in front of the machine.

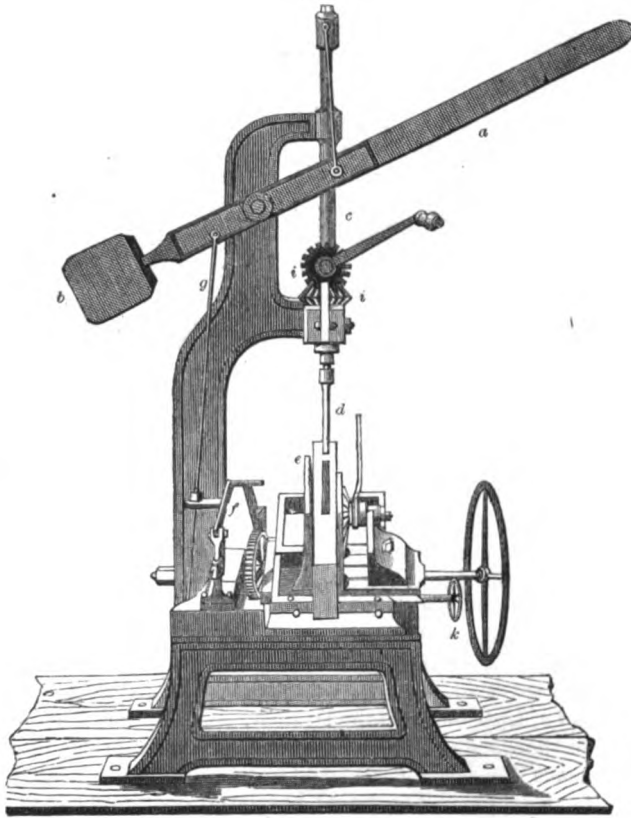

POWIS' MORTISING, TENONING, AND BORING MACHINE IN PERSPECTIVE.

1677. *Machine for making Macpherson's Portable Sheep-Fence*.—The machine, fig. 914, consists of a wooden frame 2 feet 11 inches high, and 3 feet 8 inches wide, standing on the ground, with a driving spindle *a* supported on the top near the back, carrying four bevel wheels 6 inches diameter, which give motion to four pinions of 3 inches diameter, mounted on four spindles lying longitudinally above the frame, 11 inches apart, and supported in plummer-blocks fixed to cross-rails *b* and *c*. On the overhanging end of each of these spindles, towards the front of the machine, are placed four bobbins *d d*, formed of wood with sheet-iron ends, with a light frame of wood and iron embracing both, slipped on the spindle in front of the bobbins, and secured by nuts to a spring behind them, by which they may be tightened to any extent, and made to turn on the spindle with more or less freedom. The bobbins are sufficiently large to contain each about 120 yards of small tarred rope, the end of which is led over

Fig. 914.

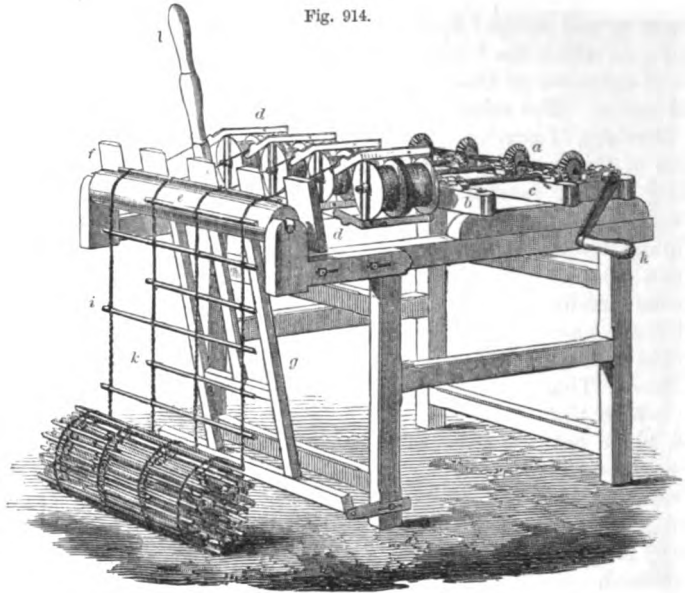

PERSPECTIVE VIEW OF MACPHERSON'S SHEEP-FENCE-MAKING MACHINE.

a small pulley in the bobbin frame, and forward through its projecting arms, which serve to twist the two strands together and form a rope. In front of the bobbins is a wooden roller *e* extending the whole width of the machine, supported in sliding brackets attached to the upper rails of the frame, so as to be set nearer to or farther from the bobbins as may be required; the several ropes as they are formed pass over this roller, and are strained by a weight or otherwise to keep them at a regular degree of tension.

1678. In making the sheep-fence, bars of wood about 3 feet 6 inches long by $\frac{5}{8}$ inch square, are worked into the ropes as they are made, at distances of 4 to 5 inches, in the following manner: The two strands from each pair of bobbins are tied together, forming, when drawn forward to the roller, an angular opening or kind of *bight* between the strands; and through the four openings thus formed, one of the wooden bars is inserted, and driven tightly into the angle of the cords by means of a board *f*, attached to a light frame *g*, jointed at bottom to the frame of the machine. The board has large openings cut in it opposite each set of bobbins, to give room for each pair of cords to revolve. In action, this board is similar to the reed of a weaver's loom, driving home the bar by means of the lever *l*, in the same way as the reed forces the warp into its place, and keeps the bars always in their proper position, square with the lines of rope. When a bar is thus inserted and held fast, the handle *h* of the driving spindle is turned three or four times, causing the bobbins to revolve simultaneously six or eight times, as may be required; this fixes the bar in its place, and twists up 4 or 5 inches of each of the four lines of rope, the bobbins being always stopped when the angle of the cords is in a vertical position, to admit the next bar. To keep the wood in its place, notches are cut in two opposite angles at the proper distances.

1679. The fence is made either entirely with long bars *i*, or with long and short ones *k* alternately; the short being 2 feet 7 inches long, and worked into only three of the ropes. The kind of rope used is tarred hemp, and weighs, when four ropes are used, 40 to 50 lb. per 100 yards of fence.

1680. Galvanised iron wire has been tried instead of rope, and found to answer

well, as it is not affected by changes in the atmosphere, like the rope. The price of the fence is the same for both; being, according to the kind of wood employed, from $5\frac{1}{2}$ d. to $7\frac{1}{2}$ d. per lineal yard, inclusive of stakes and staples, ready for putting up. The weight of 100 yards complete is about 5 cwt.

1681. *Lathe.*—A turning-lathe will be found of great service in the farm workshop. For the ordinary work of the farm, a lathe of the usual simple construction will be all that is required—that is, with the single motion head-stock, with no back motion, and the rest adjusted by the screw. Some of our readers may, however, desire a more complicated apparatus, fitted to do ornamental as well as simple work. A lathe of this kind, manufactured by Joseph Fenn (tool manufactory, 105, 106 Newgate Street, London), is illustrated in fig. 915; it is a complete apparatus, with universal chuck and screw slide-rest.

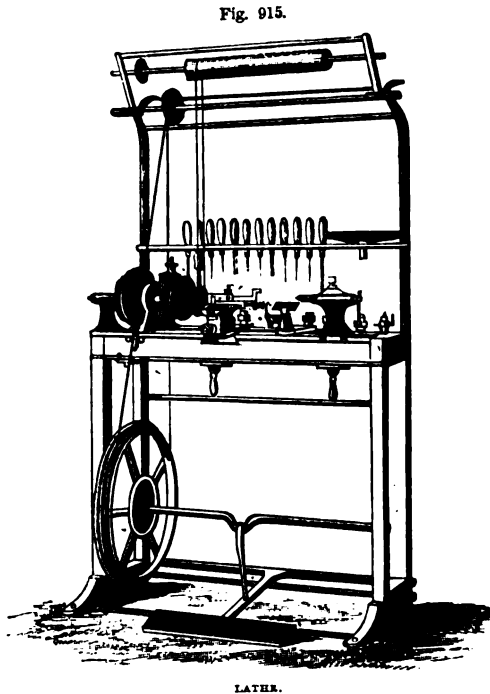

1682. *Drilling or Boring Machine.*—In fig. 916 we illustrate a portable boring machine for metal-work, which will be found of great utility, in construction as well as in repairs. A breast boring apparatus or drill-stock is illustrated in fig. 917. These are also manufactured by Mr Fenn.

Fig. 916.

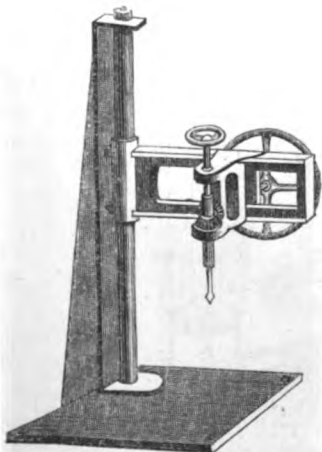

BORING MACHINE

Fig. 917.



BREAST BORING APPARATUS

SUBDIVISION SECOND—*Useful Apparatus and Erections.*

1683. SECTION FIRST—*Portable Caldron and Furnace.*—In fig. 918 we give elevation, and in fig. 919 section, of the American caldron and furnace, as manufactured by Messrs T. & C. Clark & Co., Shakespeare Foundry, Wolverhampton. By the use of an arched bottom *b*, as shown in section *a a*, fig. 919, the fuel is enabled to be raised above the lower portion of the water in the caldron; *c* the ash-pit, *d* cock. The inside of the caldron being lined with porcelain, all liability to rust is prevented.

Fig. 918.

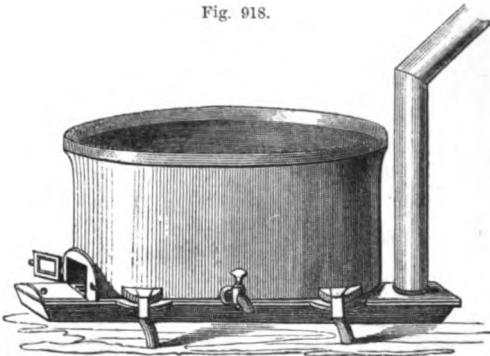

PERSPECTIVE VIEW OF COMBINED CALDRON AND FURNACE.

Fig. 919.

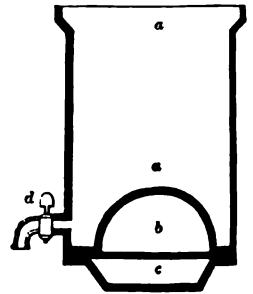

SECTION OF COMBINED CALDRON AND FURNACE.

1684. *Asphalt Caldron.*—In fig. 920 we illustrate this apparatus as manufactured by Woods, Suffolk Iron Works, Stowmarket. It will be found very

Fig. 920.

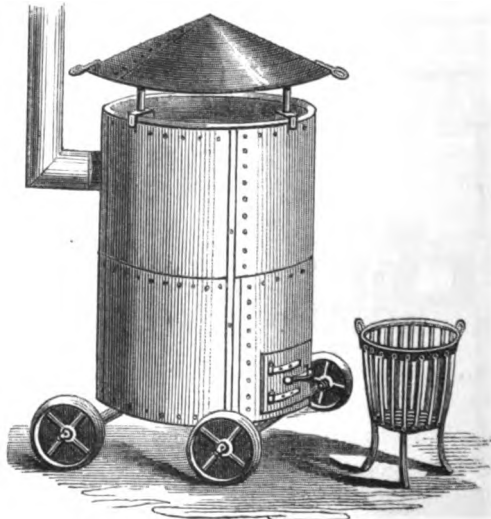

PERSPECTIVE VIEW OF ASPHALT CALDRON AND GRATE.

useful where an extensive surface of flooring in asphalt is to be carried out.

1685. SECTION SECOND—*Fire-Engine, or Liquid-Manure Pump.*—In fig. 921 we illustrate the form of double-barrel pump, as manufactured by Messrs Gynne & Co., engineers, of Essex Wharf, Strand, London. The valves are easily got at. It may be used conveniently as a fire-engine, or a liquid-manure pump for distributing liquid manure.

Fig. 921.

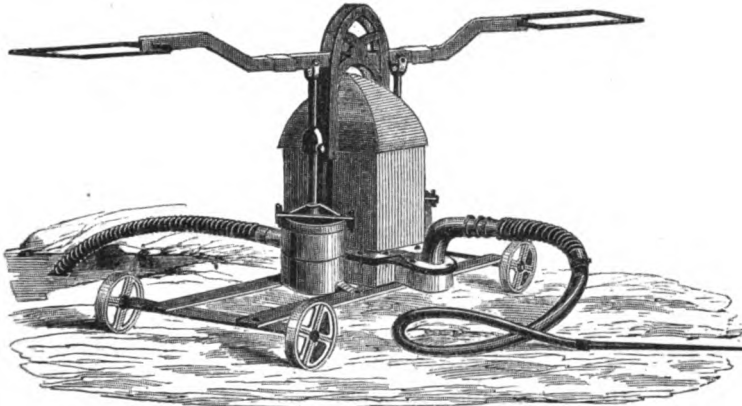

PERSPECTIVE VIEW OF FIRE-ENGINE, OR LIQUID-MANURE PUMP.

1686. *Double-Action Pumps.*—In fig. 922 we illustrate the arrangement for working, by a fixed steam-engine, the double-action pumps, patented by Mr Holman, and manufactured by Messrs Fowler & Co., Whitefriars Street, Fleet Street, London. These pumps supply a continuous stream, delivering both at the up and the down stroke. "Mounted on stout cast-iron baseplate and column, with spur-wheel and pinion, intermediate shaft, plummer-blocks, crank-pin, strap-head, slings, guide, and driving-drum complete, ready at once to connect strap from the fly-wheel shaft of either a fixed or portable engine, or from any convenient point of the main shaft. These pumps, thus arranged, are adapted for irrigation, fire-engine purposes, or for pumping liquid manure. The advantages of this arrangement consist in the facility with which the pump can be fixed, merely requiring to be securely bolted down, thus saving much expense and annoyance, besides loss of time in cutting a way for supports. It occupies very little space, the supply is continuous, the whole is extremely simple, and the working parts are readily accessible. Where the speed of engine or

Fig. 922.

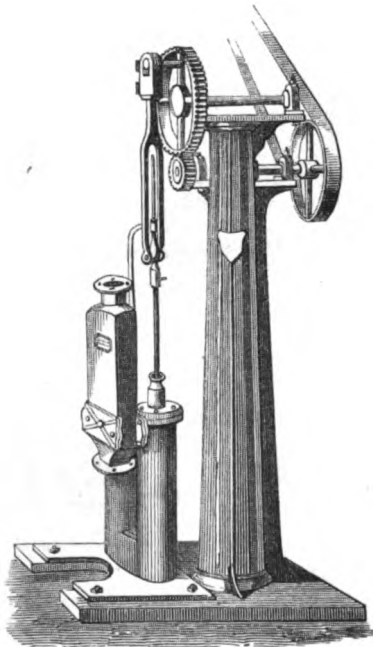

PERSPECTIVE VIEW OF HOLMAN'S DOUBLE-ACTION PUMP

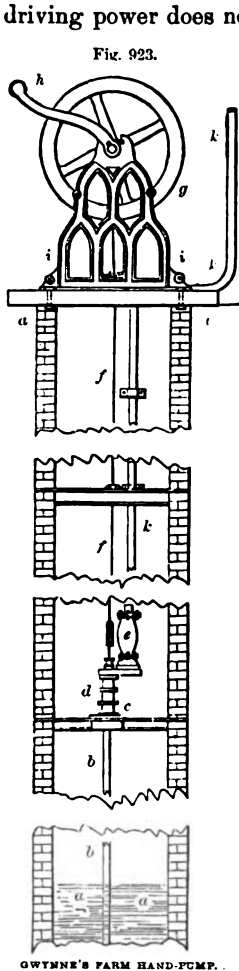

OWTNNE'S FARM HAND-PUMP.

driving power does not exceed fifty revolutions per minute, the spur-gear may be dispensed with, and the pump driven direct from a drum. Speedy access is permitted to all the valves simultaneously, by the removal of a single plate, which can be detached with perfect facility. This simple arrangement renders it unnecessary to disconnect any other portion of the pipes or gear—the inconvenience, expense, and loss of time arising from which, most persons in the habit of using pump work are well acquainted with. All the valves are out of the barrel, which permits their areas to equal that of the piston, and the water passages to be proportionately large.”

1687. The arrangement here illustrated is obviously applicable to the working of any ordinary force-pump.

1688. *Farm Hand-Pump.*—For the extinguishing of fires, a supply of water may be kept in a cistern placed at an elevated part of the steading, or it may be raised on pillars of considerable altitude, placed near the centre of the buildings. From this a supply of water may be taken to any part of the building by means of hose. The water may be supplied to the elevated cistern by means of the steam-pump, as illustrated in fig. 922; or the “farm hand-pump,” illustrated in fig. 923, may be used for this purpose. As a force-pump is, however, attached to this arrangement, it is obviously capable of being used as a means of forcing a supply of water to a distance through flexible hose. In fig. 923 *a a* is the pump-well, *b b* the suction-pipe leading to the platform *c*, to which is secured the force-pump *d*; *e* the air vessels; *f f* the pump-rod, worked by a crank in the axle or shaft of the fly-wheel *g*, turned by the handle *h*. The frame *i i* for supporting the fly-wheel shaft is bolted to the bed-plate covering the mouth of the well. The water is forced up the pipe *k, k k* from the air-vessel *e* to the elevated cistern, or the end of the flexible hose may be attached to *k*.

1689. *Hydraulic Ram.*—The ingenious contrivance known as the “hydraulic ram,” may also be used to force a supply of water to the elevated cistern. It is simple in original construction, has no parts liable to get out of order, and will work continuously for years without repairs after once being put in operation, all that is required being a small stream with a few feet of fall. The machine depends for its operation on the momentum of the falling stream, which, confined in a pipe, is led to a

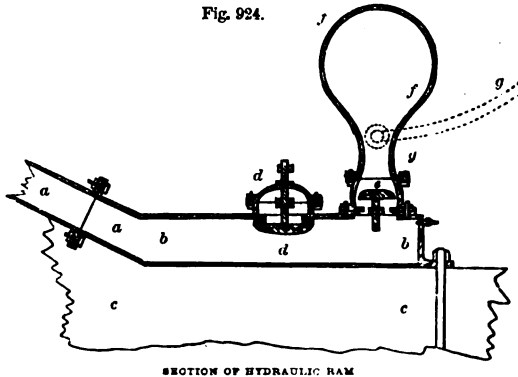

SECTION OF HYDRAULIC RAM

force a supply of water to the elevated cistern. It is simple in original construction, has no parts liable to get out of order, and will work continuously for years without repairs after once being put in operation, all that is required being a small stream with a few feet of fall. The machine depends for its operation on the momentum of the falling stream, which, confined in a pipe, is led to a

chamber in which valves are placed, and which act as follows: In fig. 924, which is a longitudinal section of a form manufactured by Messrs Gwynne, of Essex Wharf, Strand, London, *a a* is the supply-pipe, which leads the running stream down to the chamber *b b*, bolted to the bed-plate *c c*. A valve *d d* is provided to the chamber *b b*, and which has a tendency to fall from its seat so as to keep the water-way open, till the stream, flowing through the pipe *a a*, acquires sufficient momentum to close it. The velocity of the stream being thus checked, the water raises the valve *e*, which moves the reverse way of the valve *d d*, and enters the air-vessel *f f*, from which it is finally passed by the pipe *g g*, which can be led to any desired elevation above the level of the ram. On the water passing into the air-chamber *f f*, it is pressed upon by the air in the upper part of the vessel, which closes the valve *e*. The momentum of the flowing stream in the pipe *a a* and vessel *b b* being thus exhausted, the valve *d d* falls, and allows the water to escape from the vessel *b b*, through the valve opening, till the flowing stream again acquires such momentum as to close the valve *d d*. When this happens, the valve *e* is again opened, and a second quantity of water discharged into the air-vessel *f f*. The action thus described goes on continually, resulting in a regular beating or pulsation of the valves *e* and *d d*, each rising and falling alternately.

1690. A small portable fire-engine may be kept in the workshop, which will be useful in cases of fire, and at other times may be made available in cleaning out the byres, &c. The form of this is so well known that it is needless here to illustrate it.

1691. *Carrett's Steam-Pump*.—In fig. 925 we give the side elevation of steam-pump manufactured by Messrs Carrett & Co., of Leeds: The cylinder *a*, supported on two elegant side-frames *b c*, is of the inverted kind, and is provided with stuffing-boxes at the upper and lower covers; the piston-rod is passed through both ends, one of which is connected with a cross-head working in the slotted up-rights *d*, attached to the upper end of the cylinder; to the ends of the cross-heads the side-levers *e* are connected, the lower ends of

Fig. 925.

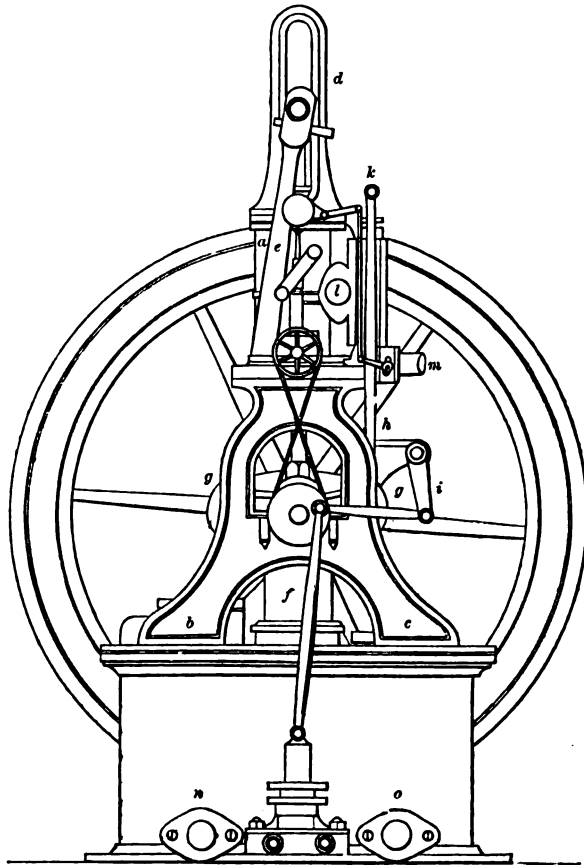

SIDE ELEVATION OF CARRETT'S STEAM-PUMP AND PORTABLE STEAM-ENGINE.

these embracing the fly-wheel crank-shaft; the other end of the piston-rod, passing through the lower cover of the cylinder, is connected with the pump-rod; the pump-rod and plunger *f* are connected together by two set-screws. These set-screws have only to withstand the strain on the up stroke, the termination of the pump-rod bearing on the bottom of the plunger, which is hollow, and down the centre of which the pump-rod is passed. The reciprocatory motion of the piston-rod produces the rotatory motion of the crank-shaft and fly-wheel by a horizontal slotted slide *g g*, in the slot of which a brass block, containing the crank-pin, slides backward and forward. The slide-valve of the cylinder is worked by the side-rods *h*, fastened at one end to the cross-head of the slide-valve rod, and at the other to the bell-crank lever *i*. This lever receives its motion from another lever connected to a pin placed eccentrically in the face of the revolving disc or plate *k*, fixed in the crank-shaft outside the framing. This also gives motion to the connecting-rod and pump-plunger of the force-pump to supply the boiler with. The steam delivery-pipe is at *l*, the exhaust at *m*. The supply of steam is regulated by a governor of peculiar construction, which consists of a ring of metal, which, as it rapidly revolves, actuates a series of levers, and through them the throttle-valve. The inlet-pipe to the pump is at *n*, the outlet is at *o*. By simply disconnecting the pump, the engine can be used for any purpose required. From the whole machinery being self-contained, it is easily moved from place to place, requiring no foundation to be prepared for it; the only labour requisite to put it in working condition being the connection of the steam and pump pipes.

1692. An important feature of improvement in this pump consists in the introduction of two accumulating reservoirs in connection with the influx and efflux water-passages, and a peculiar modification in the construction of the pump, these by their action producing a *continuous stream* of water throughout the whole length of the suctional and delivery pipes. It is capable of fetching or forcing water to any required distance and height, or depth not exceeding 25 or 30 feet, and at a considerable velocity. In this department of engineering the great object has been to work a small pump at a great velocity, and with effect. The water is not able to start and stop instantly in the suction and outlet pipes; the consequence is, that the ram is not followed by the water, and a vacuum is formed beneath it; on the ram coming down, it receives an accelerated motion from the want of resistance—coming down into the vacuum—and it strikes the water with considerable force. This rapidly wears out the clacks, and in some instances the pump-bottom has been known to give way; the delivery of water, moreover, is very irregular, and the pump is generally incapable of drawing the water more than a few feet—far under the natural limit of 30 feet. All these disadvantages are apparently obviated by the form of steam-pump now under consideration.

1693. SECTION THIRD—*Cranes*.—A crane of simple construction, adapted for quarries, &c., is shown in fig. 926. It consists of a stem of wood *a*, 14 feet long, 12 inches square; a jib or projecting arm *b b*, formed of two pieces of wood, 15 feet long, 10 inches deep, and 4 inches thick; and a wooden strut *c*, 14 feet long, 10 inches square. The sides of the jib *b b* embrace both the stem *a* and the strut *c*, and are securely bolted to them, and the bottom of the strut is notched into and bolted to the stem. The crane is supported by, and allowed to revolve on, an iron gudgeon *d*, fixed into the bottom of the stem, and resting in a hole in the rock, and by another at top *e* working in iron straps bolted to wooden stays—part of one of which is shown at *f*—which reach to the floor of the quarry at an angle of 30° to 45°, and either fixed by strong bat bolts to the rock, or loaded by a pile of stones. There are generally two straps, which ought to be placed at right

angles to each other on plan. The crab, or that portion through which the lifting power is applied, consists of two cast-iron cheeks *g*, one on each side of the stem, a blocking of wood about 6 inches thick being interposed on each side to make the width between the cheeks about 2 feet, and allow sufficient length of barrel to hold the chain. At the back of the stem *a* a spindle is supported by the cheeks, carrying at each end a winch handle *h*, and outside one of the cheeks a pinion 5 or 6 inches in diameter, gearing into a wheel about 3 feet in diameter on another spindle in front of the stem, which also carries the chain-barrel, 6 or 7 inches in diameter, with a flange 3 inches deep at each end. The chain *i i* may be $\frac{1}{2}$ inch diameter, which is sufficient, if of proper quality, to bear a load of 2 tons; it passes from the barrel upwards, and over a pulley *k*, supported on brackets at the point of the jib, and is provided with a strong hook *l* at the end, for attaching the load.

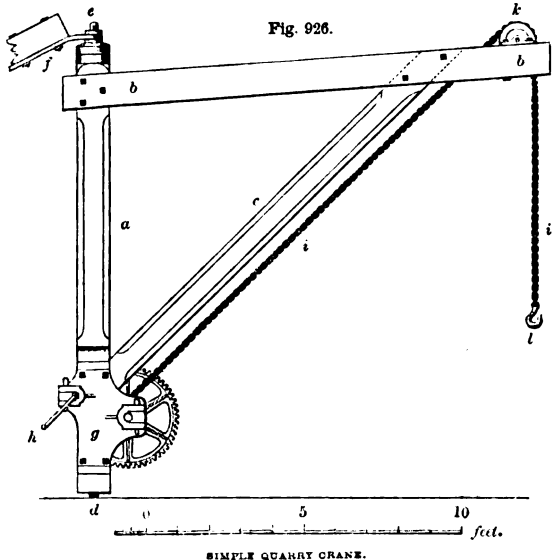

SIMPLE QUARRY CRANE.

1694. *Derrick Crane*.—A better form of crane is shown in fig. 927. The

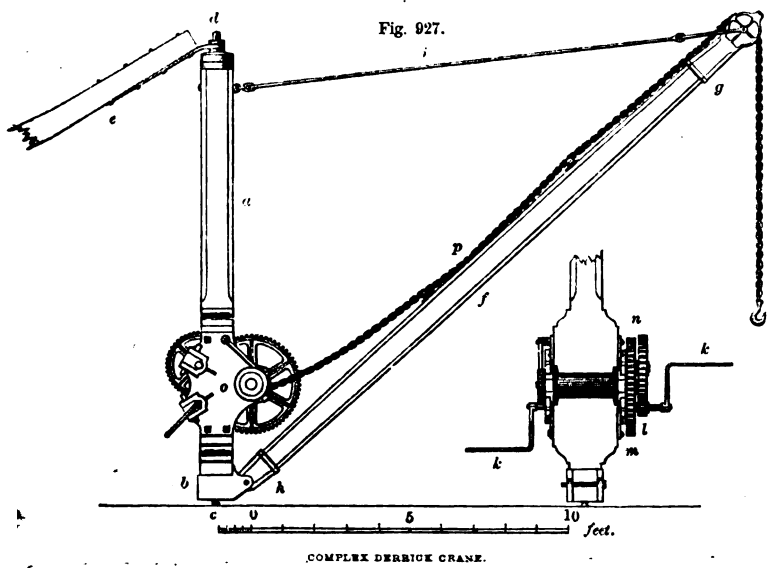

COMPLEX DERRICK CRANE.

stem *a* is of wood, 14 feet long, 12 inches square, mounted at bottom with a cast-iron box *b*, having two jaws in front, and a gudgeon *c* in the centre underneath,

and at top with a gudgeon *d*, supported by straps, part of one of which is shown at *e*, like *f* in fig. 926. A derrick *f* of wood, 22 feet long, 10 inches square, is mounted with an iron shoe or socket at top *g*, and another at *h* at bottom; the shoe at *g* carries a pulley, and the shoe at *h* is made to fit between the jaws of the bottom box *b* of the stem *a*, and fastened thereto by a round bolt, forming a joint. To support the derrick *f*, an iron rod *i* extends from the shackle, at its upper extremity, to the top of the stem, where it is secured by a link and eyebolt passing through the stem. If it be wanted to use the derrick at different elevations, to lift at different distances from the centre of the crane, a few large links of chain are formed at the end of the stay-rod next the stem, to admit of its being lengthened or shortened as may be required; but as the alteration involves some little trouble, this form of crane cannot be recommended where frequent change of radius is necessary. The crab is somewhat similar to that of the crane in fig. 926, but as it is calculated to lift a load of 4 tons, it requires a more complex arrangement, and the introduction of what is called a double purchase. The driving spindle carries two handles *k k* and one pinion *l*, and is made to slide endways when required, so that the pinion can work either into the large wheel *m* of 36 inches diameter on the barrel spindle, or into a 24-inch wheel *n* on the intermediate or second purchase spindle; this last carries also a pinion constantly in gear with the large wheel. When the pinion on the driving-spindle acts directly on the large wheel, the crane is said to be worked with a

Fig. 928.

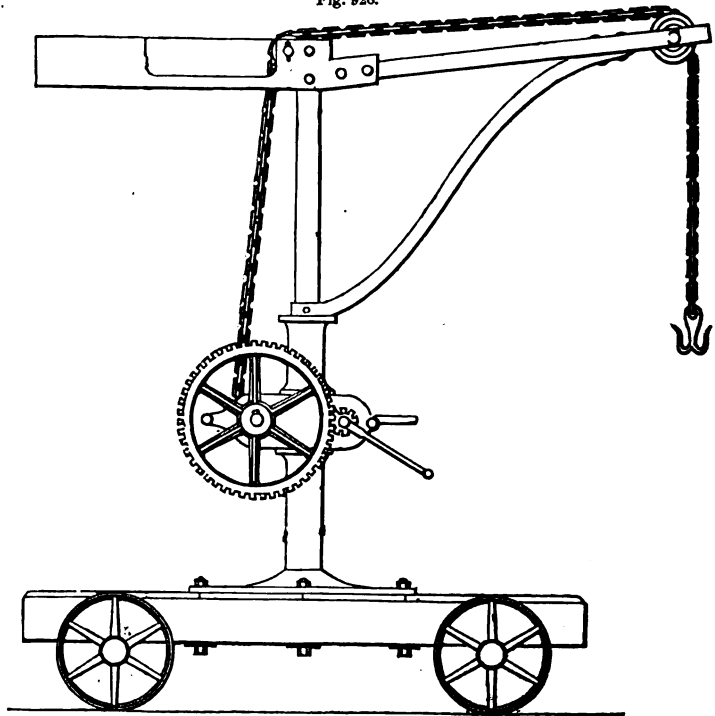

DRAY'S PORTABLE CRANE.

single purchase, and when through the intervention of the 24-inch wheel and its pinion it has a *double purchase*, acting then with greatly increased power. A

ratchet-wheel *o* is fixed on the barrel spindle outside the bearing, with its pall attached to the check for supporting the load when required to be suspended for a time. The chain *p*, sufficient to lift 4 tons, is $\frac{3}{4}$ inch diameter; it passes from the barrel along the upper side of the derrick and over the pulley at top; it is supported, when slack, by two saddles or cross bars of wood fixed on the derrick.

1695. *Portable Crane*.—In fig. 928 we give a sketch of a portable crane as manufactured by Messrs Dray & Co. of London, which requires no description.

1696. SECTION FOURTH—*Gas Apparatus—Porter's Gas Apparatus for Farm Use*.—A cheap, easily-managed, and economically-worked gas-making apparatus for farms and rural localities has long been a desideratum. A form of apparatus, manufactured by Mr T. B. Porter of Lincoln, which we have lately inspected, and of which report speaks very favourably, is, we think, likely in many respects to meet this. We give in fig. 929 this compact apparatus, the principal feature of which is the ease and economy with which the retorts are worked—that process which, in other arrangements, constitutes the most disagreeable part of gas-making, but which, in the apparatus now under notice, is effected with amazingly little trouble and inconvenience.

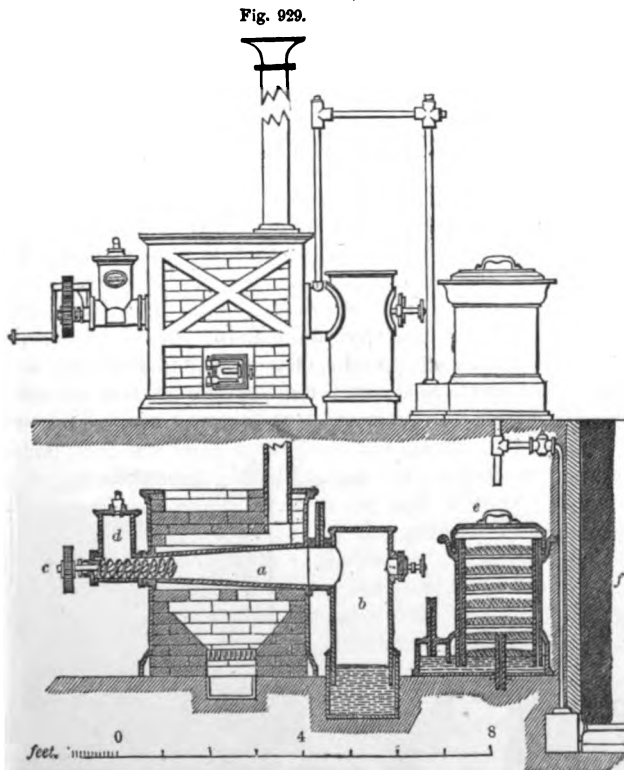

PORTER'S GAS APPARATUS FOR FARM USE.

1697. The retort used, as seen in section at *a*, is not of uniform diameter throughout its length, like the retorts usually employed, but gradually widens

from the front to the back. The back terminates at the top of a cylindrical vessel *b*, at the foot of which a tank of water is provided; into this the coke is pushed, in the manner hereafter to be described, where, by coming in contact with the cold water, it is instantly cooled, and from which it can be removed at pleasure. The front part of the retort is of uniform diameter for some distance, and contains an Archimedean screw, which is turned by a handle *c*, placed on the end of the shaft, continued through the cover of the retort. Connected with the upper part of this end of the retort is a vertical chamber *d*, the aperture of which is closed by a tightly-fitting stopper, which can be removed at pleasure. This chamber or hopper contains the charge of coal from which the gas is to be produced. On the hopper being filled with coal, the stopper is put tightly in; and on turning the handle or wheel of the Archimedean screw, the charge is gradually transferred from the hopper to the interior of the retort. The charge thus delivered to the retort is allowed to remain exposed to the action of the fire for about one hour. The hopper is then filled a second time, and by means of the Archimedean screw the charge is transferred from it to the retort—the second charge pushing the first charge forward into the gradually widening space of the retort. Another hour is suffered to expire, when a third charge is supplied to the hopper, and transferred to the retort, pushing before it the two former charges. The fourth charge, which is in like manner made, pushes the first charge out of the wide end of the retort into the vertical chamber *b*, and its water-tank. The coke thus formed is found to be a harder, denser, and consequently more valuable kind than that resulting from the ordinary system—this arising, doubtless, from the compression to which it is subjected in being forced into the retort by the screw. In consequence of there being no escape of gas during the process of charging the retort—a loss inevitable in the old system—the quantity of gas obtained by this apparatus is greater than that produced by the usual arrangements; whilst another source of increased “make” arises from the circumstance that the vapours evolved from the last charge introduced must all pass along the highly-heated charge or charges which precede it, and along three-fourths of the heated retort. Much of the tar produced in the old system is by this apparatus converted into gas. The purifying apparatus is of extreme simplicity, the “hydraulic main,” the “condenser,” and “purifier,” all being contained in one vessel *e*, of very limited dimensions. The upper part of the figure in elevation, shows the connection of the various parts—part only of the retaining wall *f* of the gasometer being shown. The cost of the gas

Fig. 930.

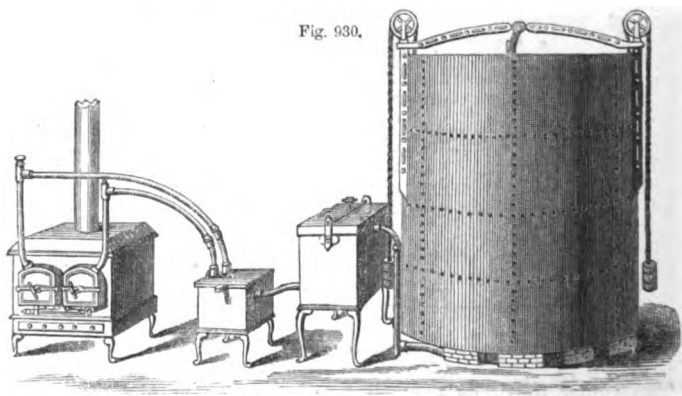

PERSPECTIVE VIEW OF MESSRS BRIDGES AND ADCHRY'S GAS-MAKING APPARATUS.

produced by this apparatus is stated to be 4s. 6d. per 1000 cubic feet, where a thirty-light apparatus is used; where a sixty-light apparatus is employed, the cost will be reduced to 3s. per 1000 cubic feet, and as much coke will be produced as will keep the fire of the retort-furnace going.

1698. In fig. 930 we illustrate a form of compact "gas-making apparatus," manufactured by Messrs Bridges, Aubury, & Co., 84 Webber Row, Westminster Road, London.

1699. SECTION FIFTH—*Detached Erections.*

1700. *Isolated Cow-Byre.*—In fig. 931 we give the plan of a detached byre

Fig. 931.

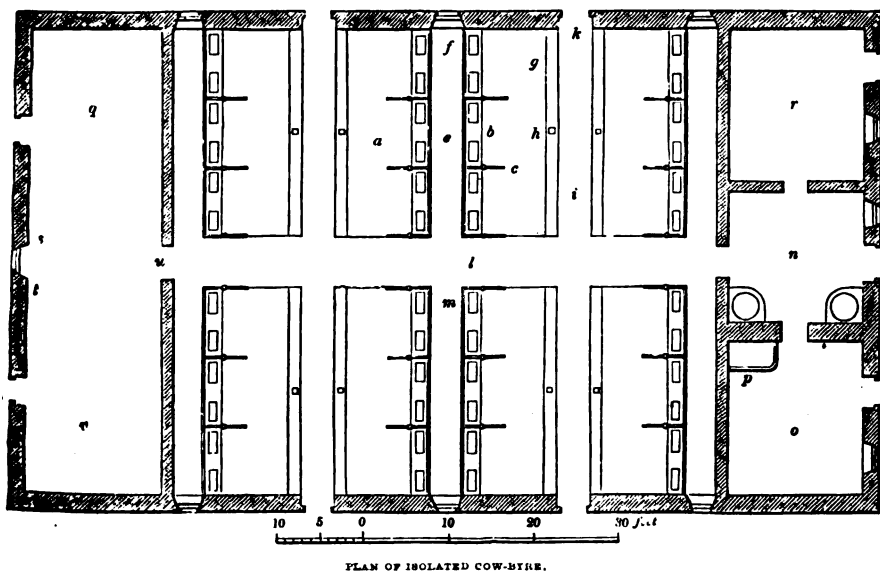

PLAN OF ISOLATED COW-BYRE.

or cow-house, showing the arrangements capable of accommodating forty-eight cows in double stalls. By this arrangement the stalls of twenty-four cows may be cleaned at one time, and the mangers of from twelve to twenty-four replenished from the same passage: *a* the double stalls, *b* the stone troughs or mangers, two of which are placed in each stall, 6 inches from the side, their dimensions being 27 inches long, 16 wide, and 8 deep; the upper edge of the trough 18 inches above the floor; *g* the gutters for receiving dung and urine, 15 inches wide, in which is a grating *h*, communicating with a drain leading to the liquid-manure tank; *i* the footpaths, 4 feet wide, from the outer door *k* to the stalls: by these paths the cows enter and leave the stalls, and the dung and litter are removed from them. The cooler, containing the food from the boil-house *n*, is drawn along the passage *l*; *k* the outer doors at the end of each path *i* by which the cows of each division enter without disturbing those of the others; *f* the windows; *m* the position of water-cock, from which to obtain a supply of water for cleansing the mangers, paths, and gutters; *c* the travis-boards, 2 feet across the mangers, and 3 feet in front of the travis-posts, from which they slope in a triangular form to the floor; *e* is the boarding, 2½ feet high, along the heads of the stalls, over which the food is handed to the manger; the boil-house *n* contains two boilers, heated alternately; *o* the store for topped and

tailed turnips : to keep the boil-house free from dust, the coals are kept in *o*, at the space *p* ; *r* the hay-house, in which is also placed the hay-cutter. At the other end of the byre is a large apartment, at one end of which *q* is used for storing turnips, to be given raw to such of the cows as have not calved, and are not in milk. At the other end of this apartment is the hay-house *v*, for the hay given as ordinary fodder. At each side of the window *s t* may be placed the linseed-crusher and oilcake-bruiser : an inside door *u* allows the turnips and hay to be taken along the passage *l*. The stone troughs should be made deeper at one end than the other, and a pipe inserted at the deepest end, by which to withdraw the water—this being stopped up with a plug or valve when required.

1701. *Isolated Dairy*.—In fig. 932 we give plan of an isolated or detached dairy, in which

Fig. 932.

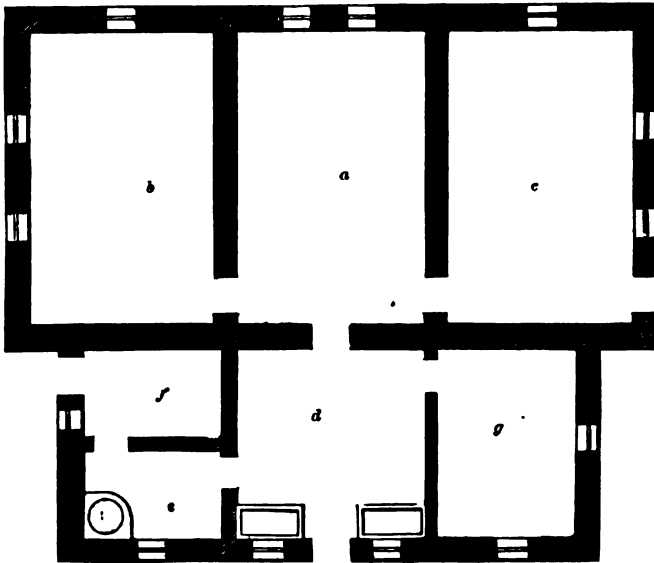

PLAN OF ISOLATED DAIRY—SCALE, $\frac{1}{16}$ INCH TO THE FOOT.

the accommodation is all on the ground - floor — the floor being a height equal to four steps above level of ground: *a* the milk-house, *b* the churn-room, *c* the cheese-store, *d* the scullery, *e* the boiler-room, *f* the fuel-store, *g* store - room for utensils, &c.

1702. In fig. 933 we give the ground-plan of a detached dairy, with second storey: *a* the milk-room, lighted to

the north by the "three-light" window *b*, *c* false or dead window, *d* churn-room, *e* scullery, *f* stairs to cheese-room *g*, fig. 934.

Fig. 933.

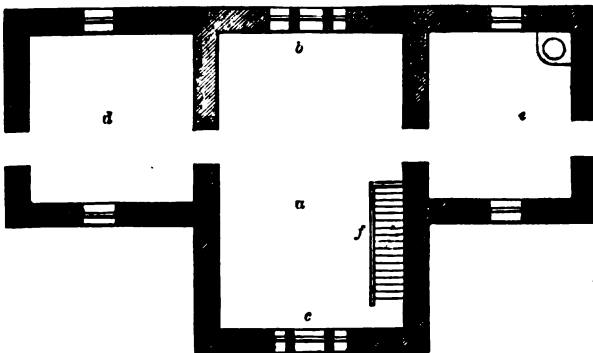

PLAN OF ISOLATED DAIRY—SCALE, $\frac{1}{16}$ INCH TO THE FOOT.

Fig. 934.

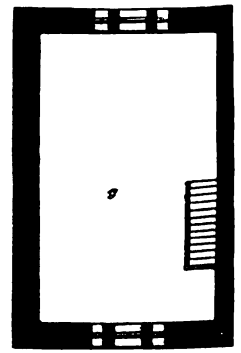

PLAN OF UPPER STOREY IN ISOLATED DAIRY—SCALE IN FIG. 933.

1703. *Sheep Feeding-Sheds.*—Of late years an opinion has prevailed among some farmers, that sheep would feed faster and better in winter in sheds than in the open fields. The opinion originated, no doubt, from the dictum of Liebig, that the more the animal heat is preserved the more rapidly and better will the animals themselves fatten. Accordingly, sheds of various degrees of cost have been erected near the steading for the accommodation of sheep, and all the upfitting they received was generally a few turnip-troughs within, and a fenced courtyard on the outside for the sheep to breathe the air. If there is any truth in Liebig's opinion, it was worth putting to the test of experiment; but a few years' trial has sufficed to determine many farmers not to pursue the experiment farther. His opinion is that animal heat is produced and maintained by the carbon of the food undergoing combustion, by means of the oxygen inhaled. This opinion is combated by some physiologists, and by none more strongly than Mr Lewes in his very interesting work, the *Physiology of Common Life*, wherein he affirms and proves, by reference to facts and experiments, that animal heat arises from the action of oxygen on the living tissues. "Food is warmth," he says, "because food furnishes the pabulum of the tissues, and warmth is evolved in the chemical changes which go forward in the formation and destruction of the tissues. If anything is burnt, it is the tissues, not the food; our warmth comes from the organic processes which make and unmake the tissues." It is therefore questionable practice to confine within doors so warm-blooded and warmly-clothed animals as sheep. In either view of the origin of animal heat, the more freely fresh air is admitted to them, the more certainly should they preserve it.

1704. Any of the wooden and iron sheds we have described will answer the purpose. If the sheep have liberty to go into a court, no subdivisions are required within the shed, but if they are desired to be confined within the shed all winter, pens are required for confining them in. Suppose the shed is 18 feet in width, a row of pens of 7 feet in depth, on each side of a passage of 4 feet in width, will be a convenient arrangement. Wooden or iron hurdles of 7 feet will divide the pens, and ordinary wooden hurdles of 9 feet will form a handy fence along their face, making each pen 7 feet by 9, which will contain four or five sheep, according to their size. Each pen will require a trough for cut turnips, and another for oilcake or corn, in front, and a rack for hay or straw at the back. While thus confined, the earthen floor of the pens will become wet and disagreeable, even with straw for litter, so that a sparred floor of wood seems necessary when sheep are so confined, that their dung and urine may pass from under them, and in such circumstances it is perhaps better they should have no litter at all. Sheep being quick-breathing animals, they require a large supply of air, so that their feeding-shed should be provided with many windows, and if these are kept shut at night, ventilators will have to be placed on the roof. We have seen sheds for sheep fitted with pens of cleaned spars of wood, nicely painted, sparred bottoms, elegant troughs, and a wooden-floored passage between. Such erections, though neat, are costly.

1705. *Turnip-Washing.*—A very convenient and ingenious mode of washing turnips is adopted on the farm of St Colme, near Dunkeld, belonging to her Grace the Duchess of Atholl. It consists of a dam of water, the issue of the water from which is regulated by a set of sluices. A dam may be made on purpose, or the water may be obtained from the thrashing-mill dam. Parallel rows of built drains are made from the dam down an inclined plane towards the steading—the drains may be built of stone-and-lime, or of brick, or, better still, of glazed pipes. The lower ends of all the drains converge towards an iron grating of sufficient width to admit water through, but not a turnip, how-

ever small. The iron grating is connected with a wooden trough, the lower end of which is narrowed so as to allow one or two turnips to pass along at a time, into the hopper of the turnip-slicing machine, which is driven by power. The turnips, as topped and tailed from the field, are stored between the rows of drains. These appliances are used in this way: The water is let on along the drain nearest the store of turnips desired to be used. The turnips are supplied by women from the store into the drain one by one, through openings in it, which are protected by hatches when not used. The turnips running down the inclined drain among the water, become thoroughly cleansed before they reach the iron grating, over which they roll into the trough, and lastly into the hopper of the slicer, while the water on leaving them falls through the grating and is conveyed away by means of a drain. A more simple and perfect arrangement for the purpose cannot be conceived, and deserves to be imitated.

1706. *Turnip-Truck*.—In modern steadings railways are becoming common for conveying the prepared food to the live stock in their respective apartments. At her Grace the Duchess of Atholl's farm of St Colme is a simple contrivance for making a truck on four wheels turn the corner of a railway without the intervention of a turn-table. It consists of making the axle of the fore-wheels of the truck turn on a pivot at its centre below the body of the truck. On coming to the end of a line of rails, where their angles are rounded off, the pivoted axle of the truck accommodates itself to the round, and guides the truck quickly and easily into the adjoining line of rails. The truck returns back in the same manner for a new load.

1707. *Poultry-Houses*.—In fig. 935 we give the plan of a detached poultry-house, of timber with brick basement, which may be made of any desired length, and divided into departments for varieties of birds: *a* steps up to floor, *b* space occupied by nests, *d* roosting-place, *c* floor. In fig. 936 is the front elevation, and in fig. 937 section; in this, *a* the nests, *b* the roosting-place.

Fig. 935.

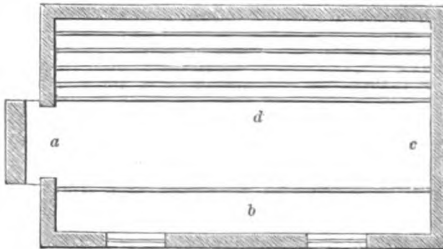

PLAN OF POULTRY-HOUSE—SCALE, 1/4 INCH TO THE FOOT.

Fig. 936.

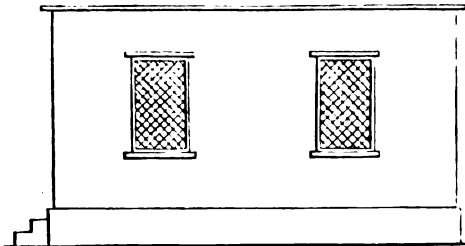

ELEVATION OF POULTRY-HOUSE—SCALE IN FIG. 935.

Fig. 937.

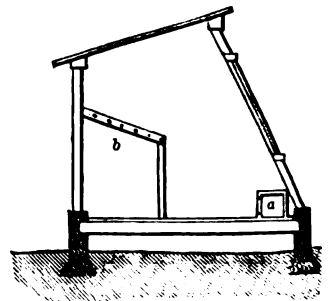

SECTION OF POULTRY-HOUSE—SCALE IN FIG. 935.

1708. In fig. 938 we give a plan of an octagonal poultry-house, in which the nests *a a* are placed one above another, while the central space within these is covered by inclined roosting-poles *b b*; a walk *c* goes entirely round the building, *d* is the door, *e e* windows.

1709. In fig. 939 we give plan of poultry-house : *a* the feeding-place, *b* *b* the nests, *c* *c* roosting-poles, *d* middle door, *e* back, and *f* front door.

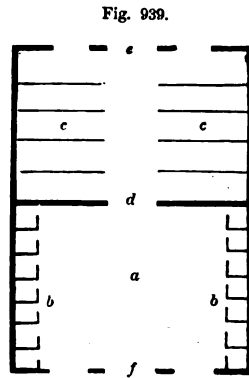
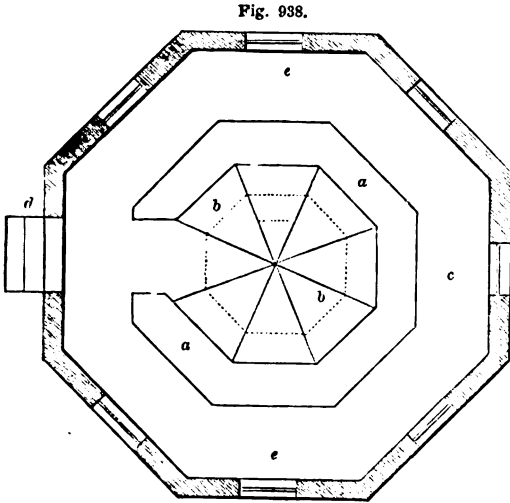

PLAN OF POULTRY-HOUSE.

PLAN OF POULTRY-HOUSE—SCALE. $\frac{1}{4}$ INCH TO THE FOOT.

1710. *Pigeon-Houses.*—In fig. 940 we give plan of detached pigeon-house, the basement of which, up to level of floor, is built of brick, the upper part being of timber : *a* *a* brick walls, *b* stair, *c* floor, *d* *d* line of nests. In fig. 941 we give part section of the house, in which the brick walls *a* *a* are shown continued ; *b* the flooring joist, *c* *c* *d* the nests. In fig. 942 we give an elevation of a detached pigeon-house constructed of timber, the base *a* *a* being supported by the central pillar *b* and struts *c* *c* ; *d* stair up to door *e*, *f* *f* ventilating openings : the birds gain access to the interior either by the holes in the cupola *g*, or at *h*.

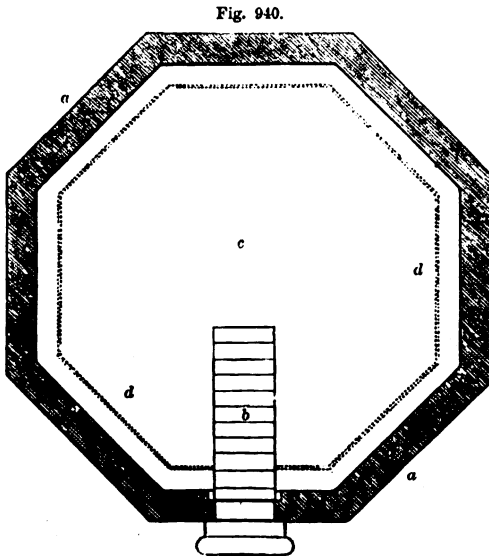

PLAN OF PIGEON HOUSE—SCALE. $\frac{1}{4}$ INCH TO THE FOOT.

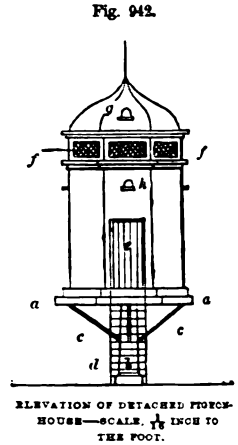
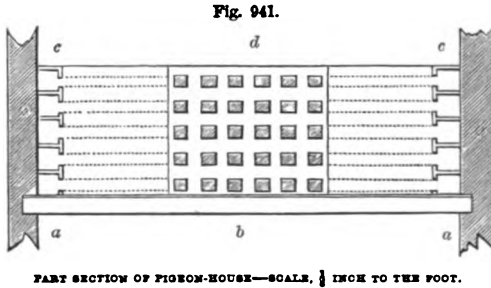

1711. *Rabbitry*.—In fig. 943 we give plan of a rabbit-house: *a a a a* the hutches for the does, with nest-boxes attached, 3 feet long, 2 deep, and 14 inches high. The breeding-place should be about 1 foot wide. Each hutch should have a wire door to the front, and an opening provided with a cover, secured by a small catch at the back, from which the manure is taken and the hutch cleaned out. The floor of the hutch should have a fall of 2 inches from front to back, and formed of zinc; this leads off the liquid manure to the drain situated in the passage between the rows of hutches. *b b* are the hutches (having the partitions between them and those of the does movable) for the young rabbits; *c c c c* are the hutches for the stock bucks; *e* the entrance to the rabbitry (another entrance is made at the end of the passage); *n n n n* are boxes made at each side of the large windows, for holding roots, hay, &c.

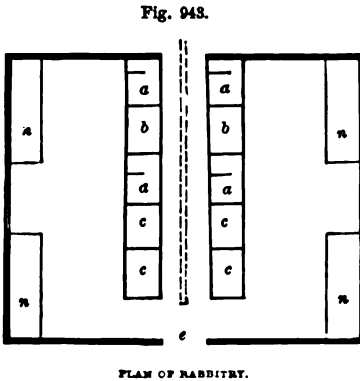
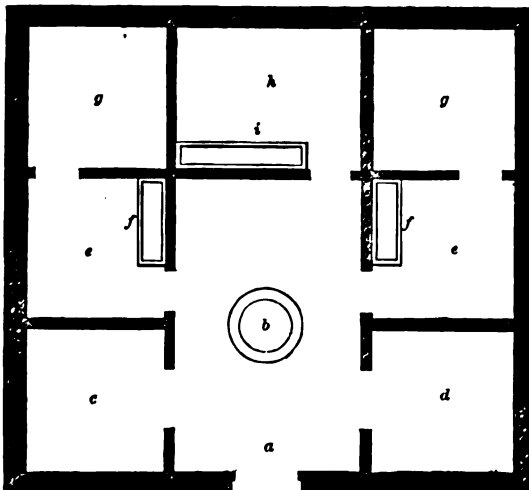

Fig. 944.



PLAN OF DETACHED PIGGERY—SCALE, 1/2 INCH TO THE FOOT.

1712. *Detached Piggeries*.—In fig. 944 we give plan of a detached piggery: *a* the central apartment, in which the food is prepared, with cooking-boiler *b*; *c* food-store, *d* fuel-store, *e e* feeding-pens, with troughs *f f*; *g g* bedding-pens, *h* young pigs'-pen, *i* trough.

The whole is lighted from the roof. In fig. 945 we give the plan of another arrangement which can be extended to any desired length; the light in this is also obtained from the roof: *a* the central dunging and feeding passage, *b* the pig-pens, with troughs *c* and doors *d*.

1713. When brood-sows are confined with their litters in their sties, they sometimes smother their young by lying down upon them, whatever degree of care they may bestow. A simple contrivance prevents such inadvertent losses, and it merely consists in fixing a spar of wood at a distance of 6 inches or more from each of the three walls of the sty, the fourth being occupied by the door, at a height of 9 inches from the ground. The spars prevent the sow lying down closer to the walls than they are, and at the same time give the young pigs a protection by escape between them and the wall.

1714. *Detached Slaughter-House.*—In fig. 946 we give ground-plan of a detached slaughter-house: *a* lower floor of pavement, *b* stairs to upper floor, *c* door, *d d* windows.

In fig. 947 we give plan of upper floor: *a* trap-door in wooden floor through which the carcasses are raised, by rope-and-tackle, from the ground-floor. In fig. 948 is vertical section of the house: *a* is the lower room, *b* the stairs, *c* the trap-door in floor, *d* block-and-tackle, *e e* hooks for suspending the carcasses of oxen from, *f f* ventilating windows. Carcasses of mutton and pork are suspended upon hooks fastened in the walls of the upper storey. Water is an essential necessary near a slaughter-house.

Fig. 945.

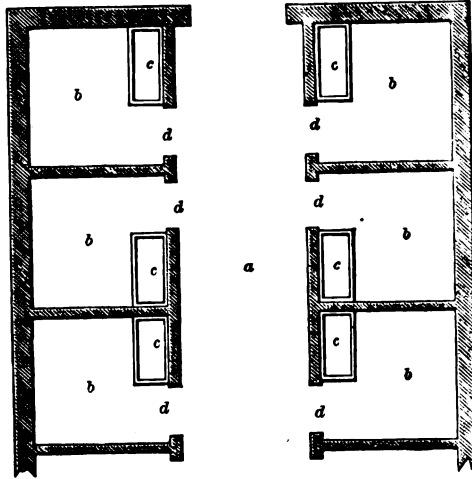

PLAN OF DETACHED PIGSTY—SCALE IN FIG. 944.

Fig. 946.

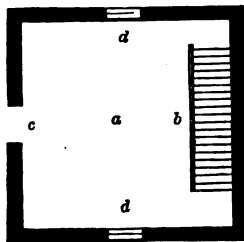

GROUND-PLAN OF DETACHED SLAUGHTER-HOUSE—SCALE, 1/4 INCH TO THE FOOT.

Fig. 947.

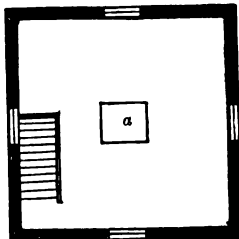

UPPER STOREY OF DETACHED SLAUGHTER-HOUSE—SCALE IN FIG. 946.

Fig. 948.

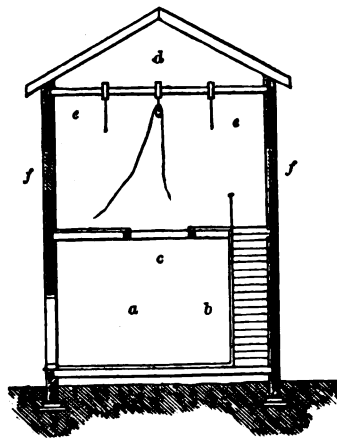

SECTION OF DETACHED SLAUGHTER-HOUSE—SCALE IN FIG. 946.

1715. SECTION SIXTH—*Drying Machines—Kilns.*

1716. *Grain-Drying Rooms and Machines.*—It is difficult to over-estimate the importance of a method or methods by which the farmer can be enabled to send his grain to market in good condition. Numerous calculations have been made, more or less accurate in detail, yet all clearly showing the existence of a loss to the farming community of serious importance—as well as from the habit of storing up grain in sheaves in a damp condition. It is quite obvious that a method or methods of increasing the bread-producing powers or qualities of a wheat, as well as of its keeping qualities (so that it may be easily stored without loss), must be of immense advantage to the farmer. These desiderata are obtainable at a small outlay of time or money by artificial drying. The advantages to be obtained from drying grain before being ground are thus summed up by a practical miller: “It will yield much more flour per bushel, and require about half the machinery to manufacture it, that it otherwise does if not dried. The quality of the flour is improved at least 10 per cent, as by drying the wheat all impurities of a vegetable nature are entirely consumed; and by extracting its natural moisture the flour will consume, when baked, more water than it would before the grain was dried, which makes the bread much more palatable, it being more spongy.” Any process, therefore, which enables the farmer to get the highest value for his crop, by preparing it ready in the highest condition for the merchant or miller, must be advantageous in a pecuniary point of view. Corn-drying, then, takes a wider range, and is valuable to a more widely-extended class, than is generally supposed. A few notes on some of the methods employed will therefore be of some utility.

1717. Corn-drying, as forming one of the many operations of agriculture, may be divided into two branches—*drying in the sheaf*, and *drying in the grain*.

1718. *Heat for the Warming of Buildings.*—But before giving our plans for the construction of drying-houses for drying produce in the bulk, it will be necessary to make a few remarks on the application of heat to the warming of buildings; or rather upon the method of supplying currents of hot air to the interior of apartments in which produce is placed to dry.

1719. Plans for the *heating* of buildings have often assumed a degree of complexity and difficulty when applied alone, but become simple and easy when attempted in connection with ventilation. Indeed, a writer on the subject remarks, and with truth, that unless a building is well ventilated, no plan of heating can be adopted with success. This is evident when we consider that such plans depend for their efficiency upon the establishment of movements and currents of air in the interior of the buildings in which they are placed. While recommending the reader, unacquainted with the nature and phenomena of heat, to study its interesting peculiarities, we will at once proceed to the more immediate consideration of our subject.

1720. The plans hitherto in use for heating large spaces are as follows: Hot furnaces, steam, and hot water. In the first, plates of metal, or masses of brick and stone, or flues, are heated in and by a furnace, and the air to be supplied to the interior is caused to impinge upon or pass through these, thus imparting a degree of heat, which it is evident cannot be controlled or regulated as required. Moreover, from the fact of the surfaces over which it is made to pass being often overheated, the air is burnt or desiccated; that is, deprived of its inherent moisture, consequently causing it to have an unhealthy action on the bodies of those subjected to its influence. Steam and hot water, as used for the purpose of heating, are caused to pass through a congeries of pipes, which heat the air surrounding them by a combination of the two modes by

which heat is derived from heated bodies—namely, radiation and contact. Passing over the first mode mentioned, as not only being expensive in its construction and *operation*, but from its incapability of being controlled so as to produce the degree of heat required, we will notice the peculiarities of these two, steam and hot water, which, in the generality of cases, are now adopted.

1721. Steam is generated in a boiler, and sent through the range of pipes arranged in number and situation as required, the water of condensation either returning to the boiler, or led to a convenient place. The hot-water system is divided into two classes, "low" and "high" temperature. The former consists of a congeries of pipes communicating with a boiler or receptacle placed at a lower level, to which the fire is applied: a receptacle is placed at the highest part or extremity of the pipes, into which the waste water caused by the expansion runs; this is open, and consequently being exposed to the atmospheric pressure, the water cannot attain to a higher temperature than that of boiling water, 212°. In the "high" temperature, the pipes are *hermetically* sealed after the water is put in, space being allowed for the expansion; and by continuing the heat of the fire, a high degree of heat, far above 212°, is attainable. The heat from steam or hot-water pipes may be applied in two ways: either by placing a congeries of pipes in an apartment distinct from the building to be heated, and causing the air to pass between these, and thereafter, in a heated state, into the interior, through apertures in such cases provided; or by placing the pipes in the interior of the building, and connecting these with a boiler situated in a distinct apartment, at or below the building to be heated. Of the two methods we decidedly recommend the former. As to the comparative methods of the two systems, we cannot find space to enter into a long discussion; but as the result of some experience, we would decidedly recommend farmers to adopt the low temperature of hot water system. Steam undoubtedly possesses the advantage of a ready means of preparing mashes and boiling water in a very short time; but to set against this, the steam often not being readily raised when required, and from the time taken up in doing so, to keep steam apparatus in continual action involves a very considerable degree of attention and outlay of fuel, while in that of the hot water a very small fire will maintain a considerable degree of heat for any length of time. "As contrasted with steam heat," says a writer on the subject, "it may be remarked, that the extreme simplicity of the hot-water apparatus, and its freedom from those casualties which are incident to an accumulated temperature in steam, renders it a desirable means for adoption in domestic economy; for while, on the one hand, heating by steam necessarily involves liability to accident from the increased ratio of the force of vapour as compared with that of its sensible heat, and which is frequently occasioned by the derangement either of the feeding or the safety apparatus; on the other hand, by the substitution of hot water, this serious inconvenience is avoided, while the expenditure of the water is in this latter mode no greater than the quantity lost from leakage; or the slight evaporation which can occur, is limited to the effect of overfiring, by which water may be driven out of the upper part of the pipes, or from the feed cistern of the apparatus, into the channel provided for its escape, so as to produce for a short interval a reduction in the temperature of the remaining quantity, by the immediate influx of cold water from the source to supply the deficiency thus occasioned." Fig. 949 illustrates the rationale of this process, where *a* represents the boiler, *b* the feed cistern, *c* the ascending or hot pipe, *d* the descending or supply pipe. The water from the feed cistern descends the pipe *d*, and fills the interior of the boiler *a*; by the action of the fire, the

temperature of the water is raised, and, according to the laws which regulate the motion of hot fluids, it flows up the pipe *c c* to the cistern *b*. A regular and unintermitting descent of cold water down the pipe *d*, and hot water up the pipe *c c*, as indicated by the arrows, goes on until the temperature of the whole body of water is the same. Properly speaking, this scarcely ever happens, as a portion of the heat is abstracted from the pipe *c c* by radiation and contact: the motion may be said to be continual so long as the fire is maintained. The feed cistern *b* is supplied with cold water by the pipe *e*, and a waste pipe *f* is provided to allow any water of expansion to escape. As the pipes in this apparatus are always open to the atmosphere, any steam or vapour generated can easily escape. It will be evident that in this apparatus the heat can never exceed that of boiling water, 212°. If the feed cistern is at a considerable elevation above the boiler, as the pressure in the water therein is greater than ordinary, the boiling will vary in proportion to the height. Thus, in an apparatus in which the boiler is 60 feet below the cistern or highest part of the pipes, the boiling point is 270° instead of 212°, and the mean temperature of the circulating pipes will in such a case be 185°. To obtain a supply of hot water for the preparation of mashes, &c., a stop-crane may be attached to the ascending pipe *c* at or near to the boiler; and by shutting this, all circulation through the pipe *c* will be stopped, consequently confining it to the pipe *d* between the cistern and the boiler. To prevent loss of heat by abstraction from the pipes, boiler, and cistern, all the parts of the pipes from which heat for useful purposes is not to be taken, should be covered with a non-conducting material: a covering of felt, well wrapped round with cord, will answer well. The boiler should have an iron case fitted to the part exposed to the open air; and between the spaces charcoal or other non-conducting substance should be placed. The cistern should be provided in the same manner with a case. We have dwelt for some length in the description of this apparatus, as, by a correct apprehension of it, the reader will have no difficulty in understanding the rationale of any low-temperature heating apparatus, however apparently complicated in its arrangements; nay, more, will be enabled to superintend the construction of one, should he be required to do so; and however apparatus may vary in their arrangements, the principle which regulates the action, in all cases, is the same. The cause of the circulation of the hot water in pipes is produced by the "unequal density of the fluid, arising from the difference of temperature in the ascending and descending columns of water connected with the heating reservoir; and its velocity is governed by the height of the columns."

Fig. 949.

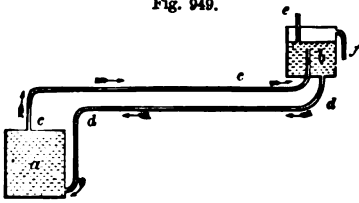

PRINCIPLE OF HOT-WATER SUPPLY.

1722. *Drying in the Sheaf or Bulk.*—In the construction of drying-houses for grain in the sheaf, attention should be paid to two things: first, the nature of the principles which regulate the drying process; and, secondly, the mode of arranging the substances to be acted upon, so as to present them in the most favourable position to the action of the drying agent.

1723. All drying consists in applying such a degree of heat as will convert the moisture contained in the substances to be operated upon into vapour, and in taking advantage of the affinity that air has for moisture. This affinity is increased by raising the temperature of the air, thereby producing an effect equivalent to a diminution of atmospheric pressure, which very much facilitates

the removal of the inherent moisture. It should be remembered, however, that "though air has affinity for moisture, it can absorb it only in the state of vapour; and, therefore, as much heat as will convert all the water in the goods into vapour will still be required besides that necessary to heat the air—the action of the air's affinity being chiefly effectual in accelerating the process of drying." Houses for drying grain may be constructed, and in some small measure made effectual, without adopting a heating apparatus; but the agriculturist may rest assured that it will be most conducive to his interests, in constructing a drying-house, to adopt thereto a proper and well-arranged heating apparatus. With it, he will find that in course of time the extra outlay will be amply repaid, and his additional trouble fully compensated, by his independence of external circumstances, such as dampness, calmness, &c., of the atmosphere.

1724. We conceive that the best mode of making the reader acquainted with the construction of drying-houses, in a simple yet efficient manner, will be to explain figs. 950 and 951, which contain a section and plan, with heating apparatus,

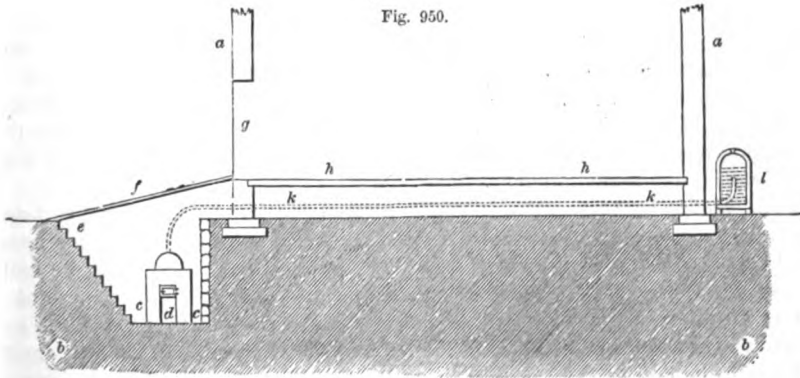

SECTION OF A HEATING APPARATUS FOR A DRYING-HOUSE.

the arrangements of which will of course differ in different localities. Fig. 950 is a longitudinal vertical section of a drying-house: *a a* the walls; *b b* the ground in which the house is built; *c c* is a place excavated in the ground in front of the house; *e* the steps by which access is gained to the floor of *c c*; *d* the furnace and boiler of the heating apparatus; *f* the gangway up to the door *g*, stretching across the excavation; *h h* a false flooring, composed of small beams, having between each an interval or space of some 2 or 2½ inches, through which the heat ascends from the pipes *k k*, traversing the space between the floor of the building and the beams constituting the false floor; *l* the feed cistern, as in fig. 949. Fig. 951 is a plan of the house, the same letters referring to it: *k* is the ascending pipe, curved as seen, and should be supported and kept clear of the ground by non-conducting supports—say bricks; the curves should not be larger than 2 inch radius, if many pipes are required; the size of the curve will of course vary according

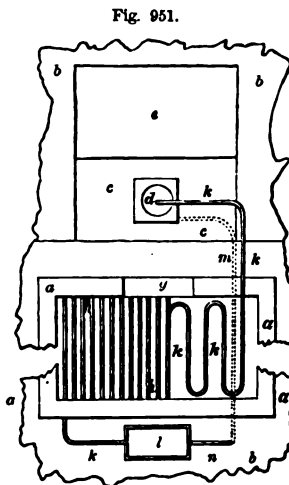

PLAN OF A HEATING APPARATUS FOR A DRYING-HOUSE.

to the size and convolutions of pipes ; this ascending pipe should be continued to within 16 or 18 inches of the surface of the water in the cistern ; m the return pipe, which should be covered over with the non-conducting wrapper previously mentioned. The supply of air to the interior, without which no dependence can be placed on the operation of the drying-house, should be ample and easily under control. And particular attention should be paid to the due adjustment of the valves in the egress ventiducts placed at the top of the house. As a corresponding quantity of fresh air should be admitted, the valves at the fresh-air ventiducts should be opened the same degree with those of the exit ventiducts ; that is, when the exit ventiducts are opened one-half, the fresh-air ventiduct valves should also be opened one-half. The fresh-air ventiducts, in a case such as is represented in the figures, would be made at the bottom of the wall near the ground, and of that construction known as the "damper valve;" the wire or rope of the exit ventiduct valve should be attached to that of the fresh, and so adjusted that when the fresh is opened one-half the exit may be the same, and so on in the same proportion. The fresh air should be so admitted as to pass below the hot-water pipes ; as a great velocity of air, through the materials to be dried, will only have the effect of drying the exterior, while the dampness will still remain in the interior. A slow rate of current, then, will be best ; say that the whole body of the air in the room were removed twice in a minute, we think this rate of speed would answer. Should this velocity be too great, by shutting the valves it may be lessened ; and *vice versa*.

1725. The calculation for ascertaining the area or surface of the hot-water pipe for any size of house is very simple, and of importance in heating houses. The temperature at which it is proposed to maintain the house must be settled on—we should say 100° would be high enough ; and, as we mentioned, at the rate of current which would be beneficial, the quantity to be heated every minute will be twice the cubical contents of the house. Suppose the cubical contents to be 800 feet, according to our data 1600 cubic feet will be required to be heated per minute. To this is to be added the loss of heat from ventilation, which will make the number of cubic feet to be heated per minute, in the above-mentioned case, 3200, or four times the quantity contained in the room. The mean temperature of the pipes, when the altitude of the feed cistern is 60 feet above the boiler, is 185° . In the generality of cases, the boiling point will rise one degree for every foot of difference between the cistern and boiler. Suppose the mean temperature to be 140° , the rule for ascertaining the quantity of surface of pipe will be as follows : "Multiply the cubic feet per minute of air to be heated to supply the ventilation and loss of heat, by the difference between the temperature the house is to be kept at, and that of the external air, in degrees of Fahrenheit ; and divide the product by 2.1 times the difference between 140° (the mean temperature of the pipes), and the temperature of the house (supposed, in our case, to be 90°), this quotient will give the quantity of surface of cast-iron pipe that will be sufficient to maintain the required temperature." The above is deduced from Tredgold's rule. What is meant by the "difference between the temperature the room is to be kept at, and that of the external air," will be seen by the following recommendation : In calculating the sizes of pipes, the temperature of the external air that supplies the ventilation, differs of course from that of the heated air supplied to the interior. This forms an important feature in the calculation. The difference, then, between the two must be ascertained. The extreme case of cold experienced during the day is 30° , and at night at zero. Tredgold is of opinion

that the difference of the air in a stove or forcing-house will never be more than 50°, and upon this founds the following rule: "To the length of the stove in feet, multiplied by half the greatest vertical height in length, add one and a half times the whole area of *glass*, and also eleven times the number of *doors*; the sum will be the number of cubic feet of air to be heated in a minute, from the temperature of the external air to that of the stove; which, being used as directed in our first rule, will give the quantity of surface of steam-pipe required." This rule will be found useful when windows are thought necessary in a drying-house, as through these a vast deal of heat is lost. Windows should generally be made double in such houses. Whenever a door is opened, a great quantity of heat escapes. But we would recommend every door of a drying-house to be made double; this, if expensive, will ultimately be found to be the most economical. In all the provisions for heating, as in ventilation, it is better to err in excess than deficit. It will save in many instances time and expense.

1726. The disposition of the matter to be dried is of some importance; this, of course, will be best arranged according to the locality or arrangements of the house. Sections of wooden beams stretched across the breadth of the house, should rest their ends on projecting brackets. If these are placed 24 inches or so apart, room sufficient will be given for the placing of the sheaves of grain, putting up a few beams, and placing on them the sheaves to be dried. The attendant will proceed till he gets to the last near the door. To insure a current of air through every part of the house, the area of tubes required for ventilation should be distributed pretty equally over the roof; thus, if the roof is twenty feet long, no less than three ventilators should be put up. To ascertain the area of tube or tubes for carrying off the vapour raised by the drying and the air through the ventilators, $1\frac{1}{2}$ square feet of aperture must be allowed for every 270 feet of surface of steam-pipe. Thus, if there are 810 feet of pipe-surface, the area of the ventilator tube will be $4\frac{1}{2}$ square feet. The area for the admission of fresh air may be the same, if admitted by pipes; but to prevent a sudden influx of air, the area should be made nearly double that of the exit ventiducts.

1727. In cases where there is a steam-engine erected in the steading, it may be advisable to make arrangements by which the steam from the boiler might be made available in supplying currents of heated air to the drying-room. In this case the arrangements of the drying-room would be precisely as figured in the illustrations just given, the pipes of course communicating directly with the engine-boiler, and so set that a fall throughout their whole length shall be given to them to enable the water of condensation to return easily to the cistern, from which the steam-engine pumps the supply of the boiler. Where ranges of pipes are carried along horizontally for some distance, its great length induces such an amount of expansion that the joints are rapidly loosened. This is to a certain extent prevented, and the range allowed free motion during expansion, by being placed on rollers, as in fig. 952, where *a* is the standard for supporting the roller *b*, *c* the steam-pipe. When ranges of pipes are laid down for "steaming purposes," the expansion drum-joint may be used with advantage. This is shown in fig. 953: the pipes *a b* are supplied with flanges *c c*, these being attached to the sides of the copper drum *d*; this, being of thin metal, ad-

Fig. 952.

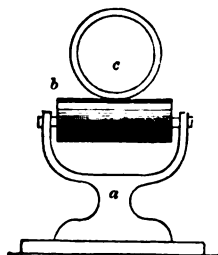

ROLLER FOR STEAM-PIPE.

mits of a considerable degree of extension and contraction, in a line coincident with its breadth.

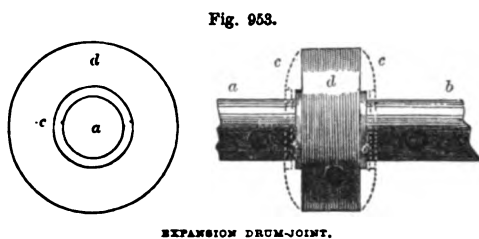

EXPANSION DRUM-JOINT.

Thus, on the pipes expanding, the sides of the drum are separated, as shown by the exaggerated dotted lines. A small aperture, fitted with a screw-plug, should be made at the lowest part of the drum, to admit of the condensed water being withdrawn. Where pipes are laid horizontally, a

considerable degree of inclination should be given to them towards the boiler throughout their length, so as to return the water of condensation to the boiler. Where they are placed at a lower level, as on the floor of a granary (for drying purposes), the pipes may incline towards a small cistern placed at a lower level, or towards a curved pipe, as fig. 954, the steam pressure forcing the water up the pipe *a b* into the cistern *c*. A small valve is placed at *a*, opening upwards to prevent the return of the water in pipe *b*.

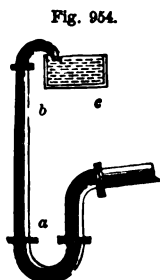

VALVED CURVED PIPE.

1728. In carrying steam-pipes underground from one apartment to another, across a yard, &c., great care should be taken to prevent the condensation of the steam in the range of pipes. These, throughout their whole length, should be carefully covered over with prepared felt, and placed in a

box, which should be well rammed up with non-conducting materials, as sawdust, ashes, &c., the box being laid in a trench lined with brick, and cemented. All steam-pipes and boiler-surface exposed to the atmosphere should be also carefully covered with the prepared felt; a great saving of fuel is invariably effected by adopting this plan.

1729. *Drying of Sheaves in the Boiler-House.*—Where a steam-engine is erected at the steading, this method of drying produce should not be neglected. The most obvious way to take advantage of the heat arising from the surface of the boiler, is to have the boiler-house carefully shut in by a door, and the roof made somewhat higher than in ordinary circumstances, to admit of a series of poles being stretched across, one above the other, on which the corn to be dried is placed. Ventilators should be fixed in the roof to carry off the vapour, and to facilitate the drying process. The heating surface may be increased at will by erecting over the boiler a congeries of pipes, into which the steam is allowed to pass, the condensed water returning to the boiler.

1730. *Hands' Patent Drying-Sheds.*—The great feature in Mr Hands' system is the economisation of the heated air which passes—and, in ordinary circumstances, wastefully—away from brick-kilns, steam-engine furnaces, and the like. The system was originally applied to brick-making, but it is applicable with equal results to all drying processes. For instance, it has been carried out with very striking success, in the drying of wood on the "Fibrous Slab Company's" premises. A principal feature in the drying-sheds is the *above-ground* flues, as shown in the section of the drying-shed, as erected at the Fibrous Slab Company's works at Staines, in fig. 955, another arrangement being shown in fig. 956. The kilns which bake the bricks or plastic ware have no chimney; a horizontal conduit, which is bent down to pass through the drying-rooms, takes the smoke and gas, still at a very high temperature, and carries it

through the series of flues so as to maintain the temperature at a high point— 120° to 130° . The vapour arising from the articles in the drying-

Fig. 955.

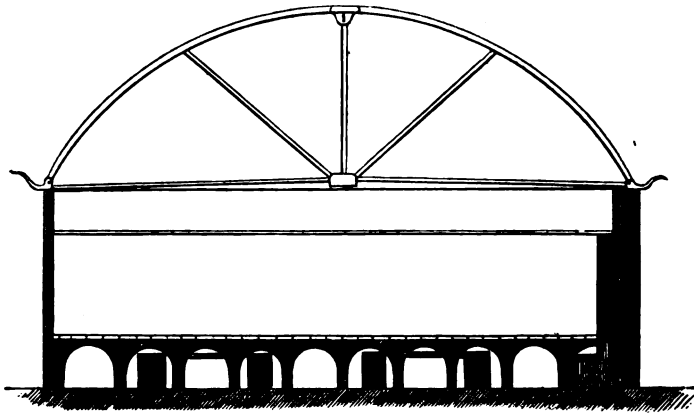

VERTICAL SECTION OF HANDS' DRYING SHEDS.

room is led off, not through ventilators placed in the roof, as usually is the case, but through the flues themselves. To enable this to be done, each flue is provided with apertures in the upper side, and these apertures furnished with valves. The current through the pipes draws in, as it were, the vapour which arises from the material to be dried; the rate or velocity of the ventilating current being regulated by the degree to which the valves in the apertures in the flues are opened. The fresh air admitted to the interior of the drying-shed takes the place of the moist air withdrawn from it; and this, to maintain the ventilating current, is not supplied in a cold state, but it first passes through pipes placed in the upper part of the kiln, the drying-shed in this way obtaining supplies of heated air only. The heated air from the kiln, after passing through the flue *a*, fig. 956, in one direction of the shed, returns by

Fig. 956.

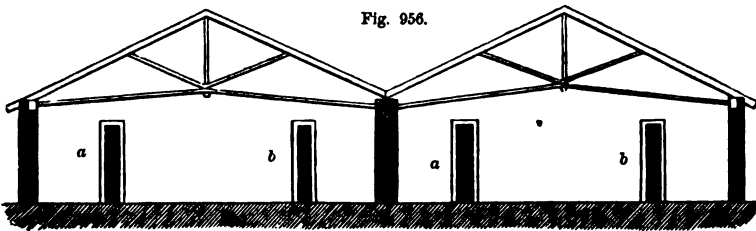

ANOTHER FORM OR SECTION OF HANDS' DRYING-SHEDS.

the other *b*, to the kiln; so that, in point of fact, but one flue heats the shed. On returning to the kiln, the current of heated air divides itself into two separate currents; and these, coming in contact with red-hot plates of iron, ignite, giving out a great heat, and which, passing up the chimney, keeps up a strong draught, the regulation of which divides the rate of passing current in the flues in the drying-shed. The system, as before stated, is applicable to the economisation of the waste heat of a steam-engine furnace. Indeed, the patentee has carried it out in airing the waste heat of the steam-engine—at Mr Payne's brick-works, at Dippen Hall, near Farnham, Surrey—to heat a shed 120 feet

long and 30 wide; the flues being 6 feet high, and about 12 inches wide. The address of the patentee, Mr Johnson Hands, is 5 Holland Street, Blackfriars, London.

1731. *Drying of Grain*.—We now come to the drying of corn after it has been thrashed.

1732. *Tile-Kiln Drying*.—The plan of drying most generally adopted is that known as the "tile-kiln;" in this the grain is placed upon tiles or iron plates perforated with holes, a fire being maintained beneath at a distance below the plates, varying from 8 to 10 or 12 feet. All the air passing through the chamber in which the grain is placed, is forced to pass through the chamber below, in which is situated the fire. This method is exceedingly defective, and admits of no regulation, either of the rate of speed at which the drying progresses, or of the amount of drying to which the grain should be subjected. It is altogether a haphazard process, which should be discarded, as highly wasteful in its operation. To obviate the defects of this system, and to introduce a process more in keeping with the regularity and precision of other operations, many inventors have devoted their attention.

1733. Taking as the standard of perfection of corn-drying, "that every individual grain should have each portion of its surface subjected to the drying influence, and the process so under control that it can be regulated to give the merest shade of surface-drying up to, and through all, the gradations of scorching or burning," the difficulty of the problem to be solved may be at once seen. A very cursory examination of the process involved in the old plan of tile-kiln drying, as already described, will suffice to show how far from the standard of perfection that plan is. The grain placed in a layer of considerable thickness on the perforated tiles or iron plates, the steam evolved from the lower grain rises upwards, and is partially condensed by the cooler layers above; a degree of moisture is imparted to them, thus bringing out, in the case of a large percentage of the grain, the very condition to do away with which is the work which the process has to perform. Here we have a series of layers in all varieties of condition—from overheating up to various degrees of moisture. The amendment here required is some means of changing the relative condition of the layers, so as to bring each under the direct influence of the heated plates; hence arises the plan of shovelling and turning the grain over. Apart from the loss occasioned by this clumsy process, it is inconvenient to be performed, and very inefficient, so far as the attainment of the desired end is concerned. The chances are all against the subjecting of each grain to the drying process. Again, the apertures in the plates are apt to be filled up with the particles of grain; this is a fruitful source of inefficiency: even on the supposition that the grain could be stirred up so as to present each portion to the plates, the stoppage of the apertures prevents that current upwards of the vapour evolved, without which all drying is inefficient. Again, from the general want of ventilation of the chamber in which the grain is being dried, the moisture from the mass is condensed on the walls or roof, and, trickling down, accumulates on particular portions of the grain, thus again inducing the very disease which the process is meant to cure. Still further, the amount of drying cannot be regulated in this process with sufficient precision, inasmuch as, from the method of firing usually adopted, the degree of heat cannot be controlled; hence the scorching of the lower layer of grain is frequently the result. Overburning impairs the quality of the grain materially, the gluten, the most nutritious portion, being made less tough and elastic; it being probable also, as Mr Beck supposes, that the proportion of dextrine and glucose is increased at the

expense of the starch : under these circumstances, a subsequent exposure to moisture, and a slight elevation of temperature, establishes the lactic acid fermentation, which, Mr Beck thinks, is the chief cause of the souring of the flour.

1734. To attain to the standard of perfection already pointed out, two things are to be considered ; one of these is the regulation of the amount of heat or drying. In some instances, placing the grain on surfaces heated by steam is adopted : this, doubtless, prevents an overheating, as the steam, under ordinary atmospheric pressure, cannot get to a higher heat than 212° , or that of boiling water. But although placing the limit in one way so as to prevent the passing over of a certain point, it does not enable the limit of drying, on the other side, to be capable of adjustment ; that is, a less degree in the amount of drying cannot be given. Possibly it may be found that steam heat is the best to be used under all circumstances ; experience certainly points that way. But the substitution of steam heat merely, for that of a fire, the grain being still allowed to lie in layers one above another, does not yet bring the process up to our standard—the means of placing the surface of each individual grain in contact with the heating surface not being attainable, any more than in the old tile-kiln. Hence, at this stage of progression in the improvement of corn-drying, the question arises, Cannot some mechanical means be adopted of moving the grain over the surface ?

1735. Numerous were the methods proposed to effect this desideratum, but all were more or less unsuccessful, until the idea of adopting the " Archimedean screw " struck some one, and evidently brought the process under control. Doubtless many of our readers have witnessed the Archimedean screw in operation in open channels, conveying flour or meal from one place to another in a mill. This screw, placed in a pipe or tube, the tube enclosed throughout its length so as to receive furnace heat on its outer surface, was the plan adopted ; the grain was put in at one end, and conveyed along it to the other by the revolution of the screw, which was effected by obvious mechanical means. In this process the grain was not allowed to remain in any one portion of the interior heated periphery of the tube or pipe, but passed unceasingly along until delivered to the other end. Here the amount of heat imparted to it could obviously be regulated, by driving the screw quicker or slower, according as required, thus allowing the grain to remain longer or shorter in the tube, and consequently exposed to the heating surface in proportion to the velocity of revolution of the screw. Or, in place of modifying the speed of one screw, a number of screws could be adopted, all revolving at a rate of speed determined on according to the heat of the furnace, or other causes—the grain on passing from one tube going into another, and so on. Practical experience, however, of this apparently efficient plan showed, what would have been obvious from a consideration of the operation of the screw, that the grain was found to pass through the tube in one mass ; that is, the portion which formed the layer next the tube on entering was found to be in the same position on passing from the tube. Such was the experience, we believe, of a machine fitted up by a Lancashire engineer at one of our government depots. A glance at the flour-carrier in a mill will show that no change takes place in the position of the layer. Here, then, was an unceasing movement of the grain obtained, without involving the required desideratum of subjecting each grain to the heating surface. The only method available was to pass through each tube a very small quantity of grain, so as to form a mere line, as it were, in the lowest portion of the tube. This involved one of two things not attainable in practice—a large number of tubes, or a large amount of time to do the work in. " The standard," with this

plan, could only have been approached by passing one grain after the other in procession; even then, however, the upper portion of each grain would be untouched. This plan, therefore, did not obtain a large adoption.

1736. The next plan we have to notice was one which was original in its conception, and comparatively perfect in working. This was the passing of a strong artificial current of air, heated to a high temperature, through the mass of grain. From the close-lying nature of the grain, small masses could only be operated upon. The process, therefore, in respect of this and other particulars, was a costly one.

1737. To subject large quantities of grain to the influence of artificial currents of heated air, so as to allow each grain, as it were, to be acted on, another inventor adopted the method of allowing the grain to fall from one floor to another, the strong current being passed at the same time through the chamber. This was bringing the process very near to the standard of perfection, and in practice it was most efficient. However, from the nature of the arrangements, it is necessarily an expensive one, as the process of falling must be gone through repeatedly, in many instances, before the requisite amount of heating could be given.

1738. There can be no doubt, we think, that the simplest method to dry grain, is by giving the heat out from heated metallic surfaces: doubtless it is the cheapest. A method, therefore, which retains this part of the old process, yet puts every portion of the grain in contact with it, will be of great advantage. This is effected, we think, very simply, and, judging from the operation as witnessed in a working model, very efficiently, by the plan which we now propose describing. The best way of witnessing the complete manner in which the grain is turned over and over again, so as to put every portion of its surface not once, but repeatedly, in contact with the metal, is by seeing the screw working in a glass tube. In this machine there are the means of regulating the degree of drying to any nicety required, by the rate of revolution of the screws and their number; and the degree of turning over, or change of contact, by the number of the rakes or mixers.

1739. In the words of the patentees, the invention consists of "certain improvements in the means of conveying, distributing, or separating granular and other substances," and is applicable to the various processes of drying and roasting, and other processes in which it is essential that the berries, grains, or particles of the substances should be regularly and frequently turned over and separated during the process. It is applicable in simple drying, and also in cases of drying in which an equal and uniform turning over is needed, for the purpose of mixing one ingredient with another; also in cases of roasting, wherein the same turning over and separating is requisite, in order to prevent scorching on the one hand, and to insure equal and uniform roasting on the other; also in other processes wherein the same equal and uniform turning over, mixing, or separating, may be required.

1740. The precise nature of the invention may be understood by considering it as a means of rendering the ordinary Archimedean conveyor, by a simple addition thereto, hereinafter described, capable of not only conveying or propelling substances as heretofore, but also, at the same time, of distributing, separating, turning over, and mixing such substances as required. And this effect is produced by adapting and applying to the "screw conveyor," plates, ribs, or blades, so disposed or arranged as to cause, by the revolution of the screw, the turning over and distribution or separation, as well as, when required, the admixture of the several grains or particles of substances or ingredients, as

they are carried along by the conveyor. The plates, ribs, or blades should be placed between the threads of the screw, but they may be varied in size and form, and mode of application to it. In order, however, that the invention may be fully understood, we will proceed to describe, by the aid of the accompanying figures, a mode by which it may be readily carried into effect.

1741. Fig. 957 is a part section of an oblong vessel or case, containing a number of tubes (two only are shown) with screw conveyors, fitted up with the plates, ribs, or blades inside them. Fig. 958 is a transverse section of the

Fig. 957.

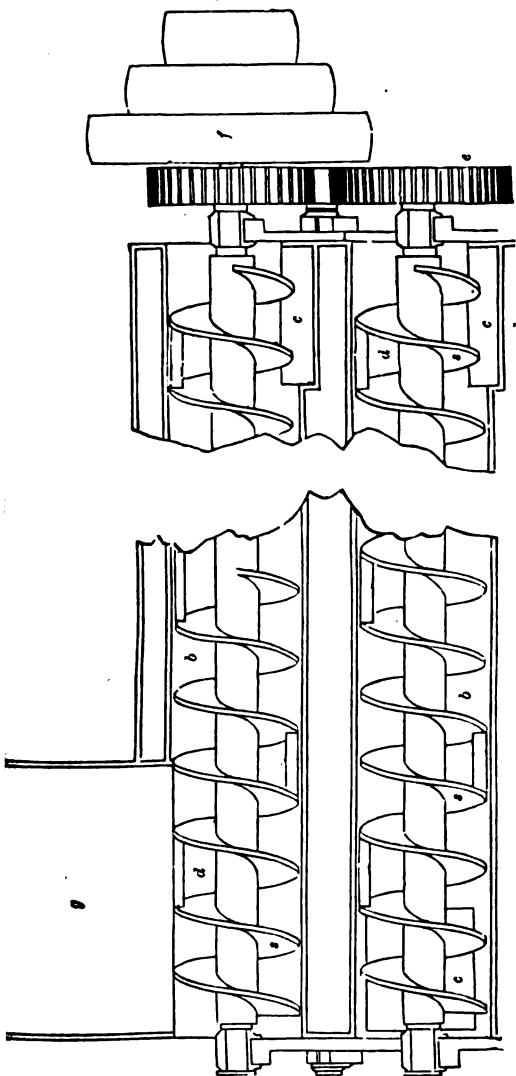

PLAN OF ARCHIMEDEAN SCREW CONVEYOR.

Fig. 958.

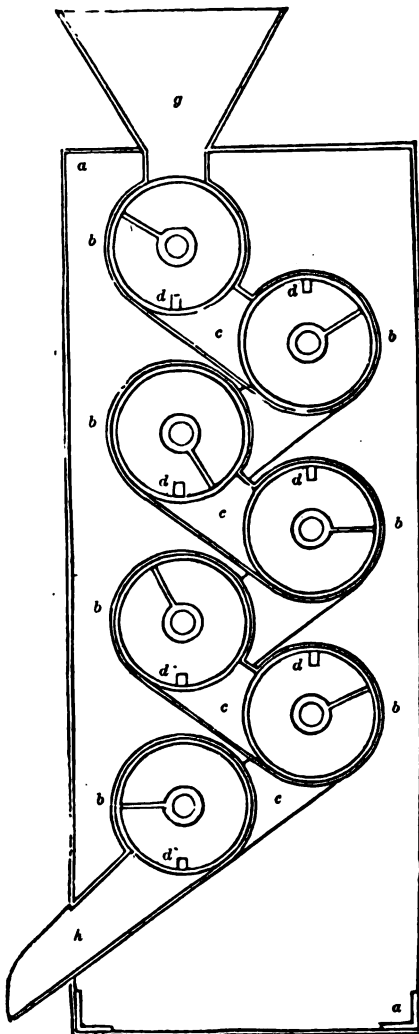

VERTICAL SECTION OF ARCHIMEDEAN SCREW CONVEYOR.

same, showing the communication of the tubes from one to another throughout the series. Fig. 959 is a detail representation, on a larger scale, of a portion

of the screw, with the additions under the invention applied thereto. The letters apply to all three figures. In fig. 958, *a a* is the case, containing a number of tubes *b*, secured and made tight at each end of the case. These tubes have pipes of communication from one to the other at their ends, as shown at *c*, by means of which the material may be passed throughout the series of tubes *b*. The screws *s*, fig. 957, within the tubes *b*, are made to revolve by

Fig. 959.

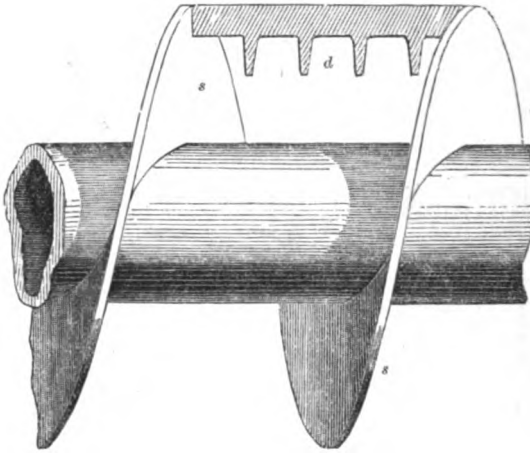

RAKE BETWEEN THE THREADS OF ARCHIMELEAN SCREW CONVEYOR.

means of the wheels *e* gearing into one another, and driven by the pulleys *f* from any prime mover; *d*, figs. 957, 958, and 959, are the plates, ribs, or rakes applied between the threads of the screw *s*, by which the grain is turned over, during the conveyance, by the screws; *g*, figs. 957 and 958, is the hopper, by which the grain is introduced into the apparatus; and *h*, fig. 958, is the shoot by which the grain is discharged after having passed through the same.

1742. The apparatus thus referred to, when employed

in the processes of drying and roasting, is combined with any suitable mode of heating; but it is to be observed, that if the tubes *b*, figs. 957, 958, are to be heated by being surrounded with steam or hot water, they must be tight, and made capable of sustaining the pressure applied to them. If, however, dry heat from a naked fire or heated air alone be applied to them, tightness is unnecessary, and the tubes may be perforated, or made of woven wire, if preferred.

1743. The operation of the apparatus is as follows: The grain to be operated upon is introduced into the hopper *g*, and thence into the upper tube *b*, at the left-hand end in fig. 957, whence it is conveyed along the tube, by the revolution of the screw *s*, to the other end, being constantly, during its course, turned over by the several plates, ribs, or rakes, as at *d*, in regular succession, until it passes down the first connecting-pipe *c* into the next tube *b*. Having fallen into this tube at the right-hand end, it is conveyed by its screw *s* to the left-hand end of the same, being constantly turned over by the plates, ribs, or rakes *d* on this screw successively, as in the former instance, until it passes down the second connecting-pipe *c* into the third tube *b*. The same operation is carried on in this tube, and so on throughout the whole series of tubes. The grain, thus continually turned over as it is conveyed along the tubes, and in the process of drying acted upon by the heat applied to the same, is eventually delivered from the apparatus at the shoot *h*. Should it be thought desirable, the grain may be carried up by an elevator to the hopper *g*, and be submitted to the same operations of turning and heating, or turning only, in the tubes *b*, two or three times. We would here remark, that the apparatus above described may be varied in the combination of its parts, and that it may be combined with other mechanism not described.

We have merely described the above as a sample form in which the apparatus may be arranged, so as to produce the desired effect.

1744. *Tanks for the Preservation of Grain.*—Corn once dried, it is desirable to keep it so. This, however, is not so easily done, especially in our humid climate, where mists and rains abound, and where “grauaries” are not constructed in accordance with what true science dictates. In connection with the subject of preserving grain, Mr Bridges Adams, a well-known and suggestive writer on scientific topics, has thrown out, in an article in the *Journal of the Society of Arts*, some hints which may by some be considered as rather speculative, but which we conceive to contain the germ of a plan or system which, if well carried out, will meet a want long desiderated in agricultural structures. Grain can be stored up so—and that, moreover, in such a good condition—that it may be preserved for years. Indeed, we see no limit to the time for which it may be kept. We have seen that on the Continent grain is kept in good condition for seven and ten years, and that in situations which may be looked upon as unpromising; and perhaps there is no more suggestive conjecture than that thrown out by Mr Adams, that the “mummy wheat” of our own time may be portions of the stores laid up by Joseph to meet the evils of the famine time of Egypt. It certainly would be a libel on the mechanical genius of the present time, every day of which brings out new wonders, to say that means could not be adopted to preserve grain in all the efficiency with which we store up other perishable articles. With all the improvements recently introduced in farm appliances, this important department—the preservation of grain—has been nearly lost sight of. Some minor improvements have doubtless been introduced; but these are rather palliatives of a disease than the introduction of methods by which the disease can be prevented. Prejudice is a mighty power by which most useful suggestions are rendered null; and we fear that, in the minds of many, the somewhat bold and original project contained in the letter of Mr Adams, will be considered as more characteristic of a day-dreamer than one likely to be carried out into the everyday usefulness of practical life. Yet we do venture to affirm that, if properly carried out, possibly with some modifications, in the manner the writer proposes, the end so much to be desired will be most efficiently attained. The project will best be explained to our readers in Mr Adams’s own words:—

1745. “There does not seem to be any difficulty in the matter, if we can divest ourselves of preconceived ideas of the notion that a granary or grain receptacle must necessarily be a building with a floor or windows more or less multiplied in altitude. We may reason by analogy as to what is the cheapest and most effective means of securing perishable commodities from the action of the atmosphere and vermin. In England we put our flour in sacks. Brother Jonathan puts his in barrels, which does not thoroughly answer. . . . If Brother Jonathan wishes really to preserve his flour or his ‘crackers’ undamaged, he makes them thoroughly dry and cool, and hermetically seals them in tin cans. This also is a common process to prevent goods being damaged at sea. The Chinese, not having much facility for metal manufacture, line wooden chests with thin sheet-lead or tin, and pack their teas in them. In England we keep our tea and sugar in cases of tinned sheet-iron. We preserve meat in tinned cases, hermetically sealed. We put fruit into sealed bottles. In all these cases the object is to exclude the air as well as vermin. . . . There can be no doubt that if we were to put dry wheat in a hermetically sealed tinned case, it might be kept as long as the famed ‘mummy wheat’ of Egypt. This will readily be admitted, but the expense would be queried. Let us examine into

this. A canister is a metallic reservoir ; so is a gasometer ; so is an iron water-tank in a ship, at a railway station, or elsewhere ; and a cubic foot of water-tank on a large scale will be found to cost very much less than a cubic foot of canister on a small scale. And if a bushel of wheat be more valuable than a bushel of water, it will clearly pay to put wheat into huge canisters of iron. The wheat-canister, in short, should be a wrought or cast iron tank of greater or less size, according to the wants of the owner, whether for the farmer's crop or the grain-merchant's stock. This tank should be constructed of small parts, connected together by screw-bolts, and consequently easily transported from place to place. The internal parts should be galvanised, to prevent rust, and the external part also, if desired. It should be hermetically tight at all the joints, and the only opening should be what is called a man-hole—that is to say, a canister-top where the lid goes on, large enough to admit a man. When filled with grain, the top should be put on, the fitting of the edge forming an air-tight joint. Wheat put dry into such a vessel, and without any vermin, would remain wheat any number of years. But an additional advantage to such a reservoir would be an air-pump, by the application of which, for the purpose of exhaustion, any casual vermin would be killed. If the grain were moist, the same air-pump might be used to draw or force a current of warm air through it, to carry off the moisture. By this process, and subsequently keeping out the air, the grain might be preserved for any length of time. As the reservoir would be perfectly air-tight and water-tight, it might be buried in the ground with perfect safety ; and thus cellars might be rendered available for granaries, economising space of comparatively little value. The grain would be easily poured in from the surface, and to discharge it an Archimedean screw should be used. The size of the reservoir should be proportioned to the locality, and it should hold a specified number of quarters, so as to serve as a measure of quantity, and prevent the expense of meterage. . . . If constructed above the ground, a stair or ladder must communicate with the upper part, and the lower part must be formed like a hopper for the purpose of discharge. For many farm localities this arrangement might be best, and wheat might be thrashed into grain direct from the field, and stored. . . . Granaries of this description would occupy less than one-third the cubic space of those of the ordinary description, and their cost would be less than one-fifth. . . . With this security for storing safely, a farmer would have less hesitation in sowing great breadths of land. He would not be driven to market under an average value, and might choose his own time for selling. The fear of loss being dispelled, people would buy with less hesitation, and the great food-stores of the community would, by wholesome competition, insure the great mass of the community against a short supply. But as long as uncertainty shall prevail in the storage of grain, so long will it be a perilous trade to those engaged in it, and so long will the food of the community be subject to a very irregular fluctuation of prices. There is nothing difficult in this proposition. It is merely applying existing arrangements to unusual cases. There needs but the practical example to be set by influential people, and the great mass will travel in the same track. To the wealthy agriculturist it will be but the amplification of the principle of the tin-lined corn-bin, that keeps out the rats from the oats of the stable. . . . Were this mode of preserving grain to become general, the facility of ascertaining stocks and crops after reaping would be very great. The granaries being measures of quantity, no hand-measuring would be needed, and the effects of wet harvest weather might be obviated."

1746. In conjunction with methods for putting the grain into proper condition

when it happened to be deteriorated by circumstances, as a wet harvest, &c., this plan of preserving grain would be highly beneficial to the farmer, at least in a pecuniary sense.

1747. *Hands' Patent Brick-Kilns and Drying-Sheds.*—We have now to show the connection of the drying-sheds with the kilns of Mr Hands. This is illustrated in fig. 960, being part of the section of kiln and drying-shed, erected

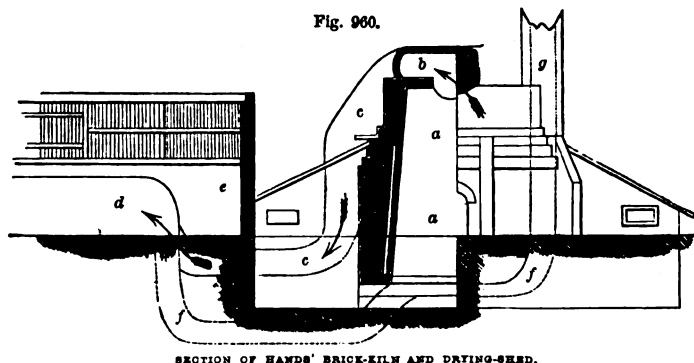

at the works of Mr Payne, alluded to at p. 501. In fig. 960, *a a* is the kiln; the heated air and gases, after passing in contact with the bricks, are led off by the flue or funnel *b*, down *c c* to the interior of the "above-ground flue" *d*, which traverses one side of the drying-shed *e*; passing through the flue on the other side of shed, the heated air is led off at the end of the building by the flue *f f*, to the chimney *g*, from which it finally escapes. The drawings of this and the other figures have been furnished us by the patentee, whose address we have given at top of p. 502.

1748. The system has been carried out in several large brick-works and potteries, and in all cases is very favourably reported of. "The general object proposed by Mr Hands," says an authority well calculated to give an opinion on the matter, "is of simple and natural means, and without extravagant outlay, to utilise the heat generated in kilns or furnaces during the burning of the wares. By this means he proposes to effect the perfect combustion of the fuel, and prevent the formation of smoke, or we should perhaps say the issue of smoke from the chimney. His plan also accomplishes a uniform and rapid drying and burning of the wares, by the same fuel used for burning, thus effecting the twofold object at the cost of burning only. Two most important features of his invention, and which deserve special notice here, as they entirely refute the statements of the old brickmaking hands, are, first, that by drying the bricks in a moist atmosphere, the inside of the brick is made to dry before the outside—in other words, the moisture of the air keeps the brick from incrusting, and thus allows the moisture from the interior to pass off. This it is which prevents the bricks from breaking, as in ordinary drying. The second point is, that bricks dried on this system dry better the hotter the temperature of the air in which they are placed, bearing 150° of temperature. This results from there being in this case more moisture in the air, which, consequently, keeps the outside of the brick more moist, and thus allows of a more rapid drying of the interior of the brick, and that without the slightest fear of breakage. These features of Mr Hands' invention are well worthy of note, and are of the greatest importance. In addition to all, it must be remembered that the

whole operations may be carried on at all times, no out-door drying being necessary—the brickfield being, as we have said, turned into a brick-factory.”

1749. *Drain-Tile Kiln*.—A general plan of a drain-tile work, in which the work is as much as possible done by machinery, is shown in fig. 961, as taken from the tile-work at Corehouse, Lanarkshire, belonging to Miss Edmonstoun Cranstoun, where *a* is the engine-room, *b* the boiler, *c* a pug-mill, driven by a shaft overhead in connection with the steam-engine, and *d* an Ainslie tile-machine, driven by a belt from the main shaft. These machines stand in a large shed, adjoining which is a range of drying-sheds *e e*, in which the tiles are placed after being taken from the machine, and where they stand until sufficiently hard to bear handling and building in the kiln. The drying-sheds may be constructed either in single lines, with a row of shelves on each side, or as represented in the plan, where two sheds, 24 yards long and 20 feet wide each, are made side by side, each with three passages, having shelves on each side; the width of the passages is 4 feet, the outer shelves 1 foot 4 inches broad, and the inner or double shelves 2 feet 7 inches broad, formed of 1-inch deals, supported in convenient lengths by standards 6 inches square, and 7 feet 3 inches high, with cross bearers for each shelf. For the smaller sizes of tiles, fourteen shelves in height are employed, but for large tiles the height and number must be made to suit the tiles. The extent of shelving necessary is that which will hold tiles sufficient to fill the kiln twice.

1750. At the end of the drying-sheds, farthest from the machine-shed, is placed the kiln *f*, represented on a larger scale, in plan by fig. 962, and in cross section by fig. 963. This kiln is of that kind known as *riddle-bottomed*, which is now considered the most suitable arrangement for equalising the heat from the furnaces; and the dimensions here given are of one which has been proved to be very efficient in working. It consists of a chamber 21 feet in length and 10 feet in width, formed by walls $3\frac{1}{2}$ feet thick. In each side wall are formed seven furnaces *a a*, fig. 962, each 14 inches wide, with doors and furnace bars, which is considered preferable to burning the fire on a simple hearth. The furnace bars are 2 feet 2 inches in length, with a dumb-plate in front $6\frac{1}{2}$ inches broad, inclusive of the thickness of the door-frame; the furnace door is sunk 9 inches within the face of the wall, and the height of the ashpit, to the furnace bars, is 1 foot 10 inches. The floor of the kiln is formed by first being made solid to the level of the furnace bars, then a division wall *b*, 9 inches thick, is made along the centre of the kiln, dividing the two sets of furnaces; from this wall to the main side walls are built dwarf walls *c* to *c*, *c* to *c*, 9 inches thick, dividing the single furnaces from each other, and on these are built arches 9 inches thick and $4\frac{1}{2}$ inches apart, on which the kiln floor is made by filling up solid above the arches to a uniform level, and connecting these spandril walls at top by bricks set on edge, with $2\frac{1}{2}$ -inch spaces between them, so that the whole floor is formed into a regular series of openings $4\frac{1}{2}$ inches by $2\frac{1}{2}$, separated *along* the kiln by divisions $2\frac{1}{2}$ inches thick, and *across* the kiln by the spandril walls 9 inches thick, as seen to the right of *c c*. The height from the level of the furnace bars to the kiln floor is 2 feet 6 inches. The inside is finished by a 9-inch semicircular arch, 10 feet high from the floor in the centre, and the roof formed by filling in above the arch with brickwork, about a foot above the arch in the centre, and sloping to the top of the side walls, which are 12 feet 6 inches high. In this roof, and through the arch, five lines of chimneys, each 6 inches square, are formed; the outer and the centre lines *d d d*, fig. 963, each consist of eight chimneys, and the intermediate ones *e e e* of nine each, making, forty-two chimneys in all. The end chimneys in each line are made straight

Fig. 961.

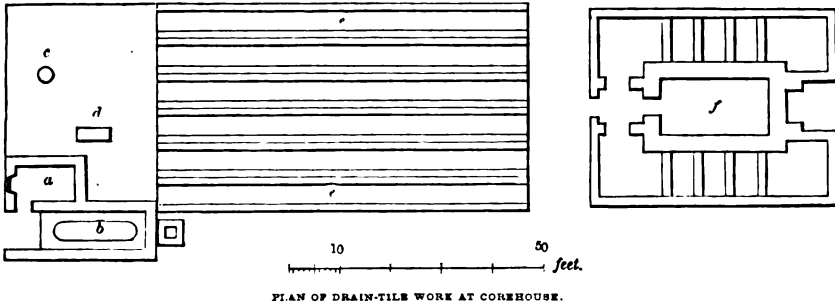

PLAN OF DRAIN-TILE WORK AT COREHOUSE.

Fig. 962.

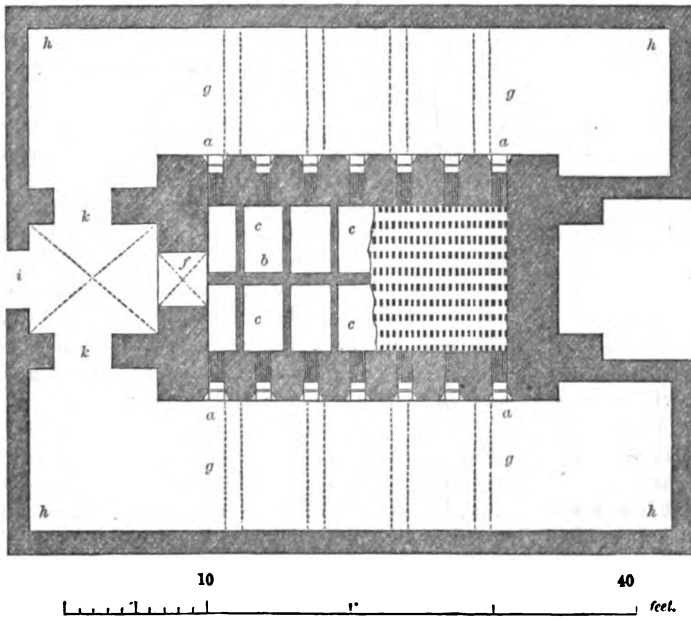

PLAN OF DRAIN-TILE KILN.

Fig. 963.

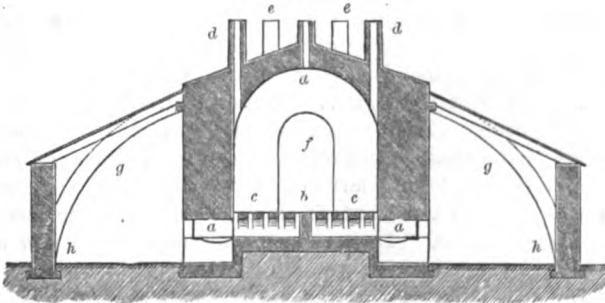

TRANSVERSE VERTICAL SECTION OF DRAIN-TILE KILN.

up from the end walls, an arrangement which is found of great benefit, by causing a regular diffusion of the heat. All the chimneys are finished to a level about 16 inches above the apex of the roof. The entrance to the kiln is at one end, by an arched doorway *f*, 3 feet 8 inches wide, and 6 feet 9 inches high. On each side of the kiln four flying buttresses, *g* to *g*, *g* to *g*, are made, springing from the ground at a distance of 9 feet from the walls, and resting on them at a height of 10 feet 6 inches; each of these buttresses is 14 inches square in section, and the whole support the walls against the lateral thrust of the arched roof. A space outside the furnaces, on each side, is enclosed by a wall *h h* and light wooden roof, the side walls being 9 feet from the kiln and 7 feet high. The gables are carried up to the pitch of the roof, entirely closed at the one end, and having a door *i*, 4 feet wide and 8 feet high, opposite the door of the kiln. The kiln and this enclosing wall are connected at each end by two walls, which form buttresses for supporting the end walls of the kiln, and are carried up to the roof, openings *k k* being left at the entrance end for communication with the furnaces; the space *i* between the doors is arched over with brick. The length over all of the enclosing wall is 48 feet, and breadth 38 feet.

1751. There is employed to drive the pug-mill and tile-machine a steam-engine of four-horse power, which seems amply sufficient. The tile-machine makes, of $1\frac{1}{2}$ -inch pipe-tiles, 12,000 per day, of $2\frac{1}{2}$ -inch pipes 8000, or of hollow bricks of the common size 6000 per day. The time required in the sheds for drying varies from forty-eight hours to four days under ordinary circumstances, but in bad weather it may be eight or even ten days. In filling the kiln, three men are required for wheeling in the tiles, and one man for building; the time required, one day four hours, and the quantity of tiles put in, 32,000 of the $2\frac{1}{2}$ -inch pipes; these are built to within 4 inches of the top of the kiln. When the kiln is filled, the door is built up by a 9-inch wall, plastered outside with wet clay; another wall is built 6 inches clear of the first, and the space between filled up with wet sand, a sight hole being left at the top, 6 inches square outside, and 18 inches wide inside. Regular firing of the kiln is a work of the greatest nicety, in order that the whole of the tiles may be properly burned; twenty-four hours are allowed for heating, forty-eight hours for burning, and forty-eight hours for cooling, before the kiln can be opened. The quantity of common coal required for each burning is $8\frac{1}{2}$ tons.

1752. SECTION SEVENTH—*Plans of Carpenter's Shop and Smithy.*—It is not absolutely necessary that a carpenter's shop or smithy should be erected at a steading, as the work of either tradesman for a farm is not of the extent to occupy his whole time. A village affords a very common site for both, and generally it is at no great distance from a number of farms. Farms employing about 30 pair of horses would give sufficient work to both; and were the village a large one, the work for the villagers would considerably curtail the number of farms for which they could work. It is not unusual in large farms to have a carpenter's shop and smithy erected near the steading, that the tradesmen may come at stated times to do the work required. Repairs only are there executed, the more important work being done at the tradesman's own premises. This is not so convenient an arrangement, however, for the farmer, as when the shops are near at hand.

1753. We give plans of a carpenter's shop and smithy which we have found convenient and commodious. They were erected at a distance of about half a mile, on a piece of ground which was conveniently situate near a public road and as many farms as afforded the tradesmen constant employment. As both shops are subject to fire, it is incumbent that they be constructed with the most

durable materials ; and perhaps no buildings admit of the application of iron for their roof so appropriately as the carpenter's shop and smithy.

1754. *Plan of a Carpenter's Shop for Farm Work.*—Fig. 964 is a plan for a carpenter's shop suited for farm work:

a is the entire shop, *b* the fireplace, situate at one of the gables, *c* a broad bench for all the purposes of carpentry and joinery, *d* a narrow bench, *e* the lathe, *f* the wheel-pit. Coupling-beams should be placed at intervals across the shop on the wall-heads, for containing articles which should always be ready when required, such as fork and rake shafts, handles of hoes, picks, spades, and shovels, wheel-naves, felloes, and spokes, and suchlike. Room should be provided outside the shop for saw-pit and timber-yard.

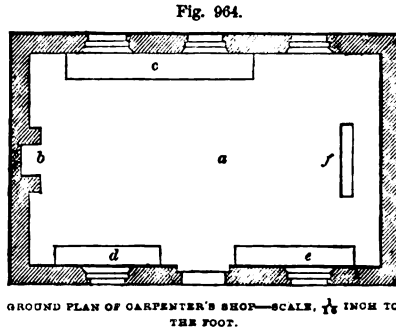

1755. *Plan of a Smithy for Farm Work.*—Fig. 965 is the plan of a farm smithy, where *a* is the smithy, *b* the forge, *c* the coal-bunker, *d* the iron store, locked up, *e* the anvil, *f* the vice-bench, *g* the lathe, and *h* the shoeing-shed, to accommodate at least two horses at a time. This should be separated from the smithy by a wall, with an internal door. The horses enter the shoeing shed by a separate outside door, and it is provided with a window.

1755. *Plan of a Smithy for Farm Work.*—Fig. 965 is the plan of a farm smithy, where *a* is the smithy, *b* the forge, *c* the coal-bunker, *d* the iron store, locked up, *e* the anvil, *f* the vice-bench, *g* the lathe, and *h* the shoeing-shed, to accommodate at least two horses at a time. This should be separated from the smithy by a wall, with an internal door. The horses enter the shoeing shed by a separate outside door, and it is provided with a window.

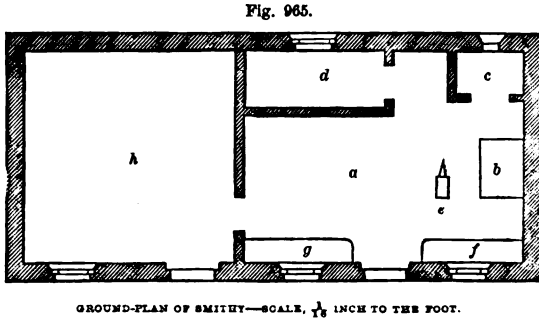

SUBDIVISION THIRD—*Foreign Farm-Buildings.*

1756. SECTION FIRST — *Belgian and Dutch Steadings.* — Excellent arrangements of barns, in which the whole of the apartments are under one roof, are met with in Belgium (Flanders) and Holland. In fig. 966 we give a plan of a Flemish barn, in which *a a* are the cow-stalls, with dunging-passage *b*, and feeding-passages *c c*; *d* hay or implement house, *e* stable, *f* piggery, *g* barn,

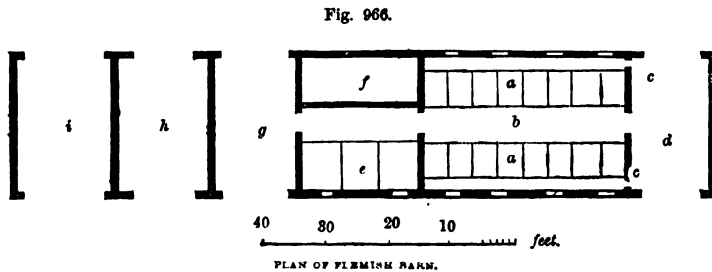

h bay for sheaf corn, *i* cart-shed. In fig. 967 we give plan showing arrangements of a Dutch barn, in which *a b* is the cow-house, *c* the barn or thrashing-floor, *d* bay for sheaf corn, *e* stable, *f* second barn-floor, *g* second bay for sheaf corn.

Fig. 967.

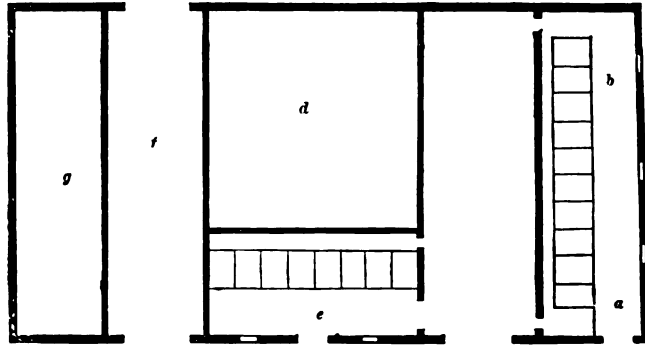

PLAN OF DUTCH BARN—SCALE AS IN FIG. 965.

1757. Although the cultivation of the soil in the provinces of East and West Flanders stands deservedly high, yet, as a general rule, little attention seems to be paid to the arrangement of the various buildings and apartments, so as to economise the working of the farm. Straggling here and there, anywhere where fancy dictates, they look picturesque and pleasing as objects in the landscape, but they by no means satisfy the mind alive to the advantages of economic working. The courtyards—if the term may be applied to a place in few cases, so far as our observation went, surrounded, like our courtyards, by buildings and sheds—are by no means in keeping with the neat and orderly condition

of the fields. The manure seems to lie about as if quite uncared for; and a general disorder, far from pleasing, seems to prevail. This is, however, more apparent than real, so far as the buildings are concerned, for considerable care is taken to have them well cleaned in the interior.

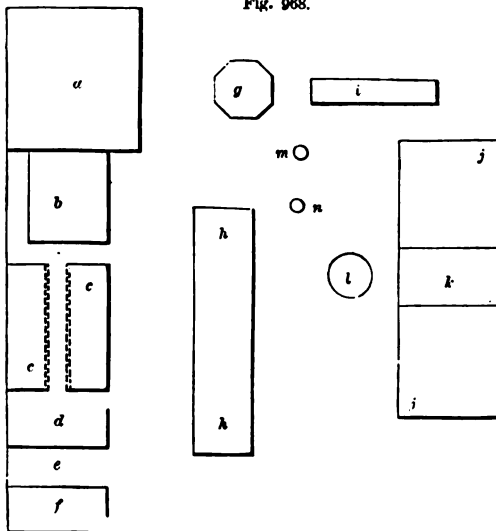

Fig. 968.

SECTION-PLAN OF FLEMISH FARM-BUILDINGS.

1758. In fig. 968 we give a sketch-plan of a Flemish farm-steading: *a* the position occupied by the farmhouse, *b* the stable, through which one entrance can be obtained to the kitchen, *c c* cattle-house, *d* calf-house, *e* cart-shed, *f* store-house, *g* machine-house, *h h* solid manure-pit or heap, *i* potato-pits, *j j* the barn, *k* space for thrashing-machine, *l* horse-

walk for thrashing-machine, *m n* pigeon-houses.

1759. In fig. 969 we give sketch-plan of farm-buildings at Courtrai, the celebrated flax-growing district of Belgium: *a* denotes the space occupied by the house of the farmer, *b* the cow-house, *c* a sheep-shed, *d* the root-cutting house, *e f* barns, *g* the bull-house, *h* baking-house, *i* lumber, wood, and implement store, *k* the cart-shed, *m* hay-shed, *l* the store-house for roots.

Fig. 969.

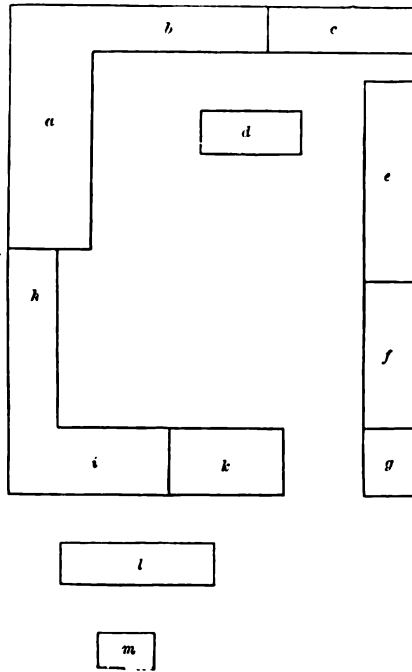

SKETCH-PLAN OF FLEMISH FARM-BUILDINGS.

1760. On many Belgian farms the machines of the steading are placed in a separate building, horse-power being used. In fig. 970 we give plan of such a machine-room *a a*. It is octagonal in outline, and is lighted by a window and door. The main driving-wheel, which is a large spur-wheel *b b* put together in segments, is connected with the central shaft *c*, formed of wood. This shaft is continued upwards through the roof of the building, the lower end being provided with an iron stud working in a step bolted to the floor, and finished with a turn-cap. To this cap a long piece of timber is connected, and continued on the outside downwards, as shown in fig. 971, to within a short distance of the horse-walk, which completely encircles

Fig. 970.

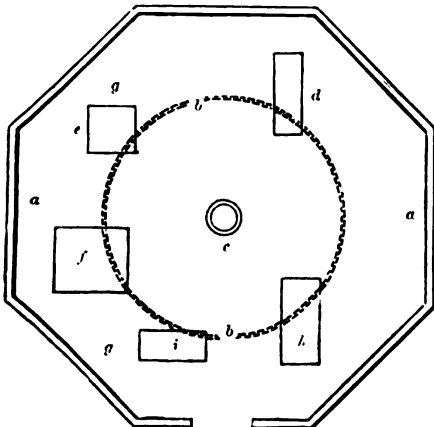

PLAN OF MACHINE-HOUSE IN FLEMISH FARM.

Fig. 971.

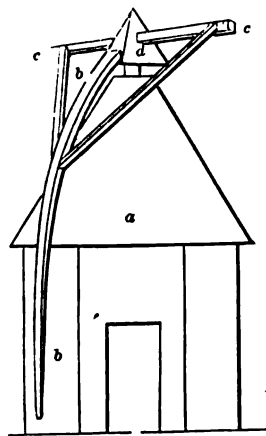

ELEVATION OF MACHINE-HOUSE.

the building *a*. Hooks are provided, to which the draught-chains are attached. The timber *b b* is curved in order to clear the building, and it is strengthened

by the diagonal stays attached to the cross-bar *c c*; and connected with the central shaft is the cap *d*. In fig. 970, *d* shows the position of the straw-cutter; the bean-mill *e*, and the corn-mill *f*, are fixed on a raised platform *g g*; *h* indicates the position of the barrel-churn, which is worked by a pulley deriving motion from the main driving-wheel *b b*; *i* shows the position of the turnip-cutter.

1761. In fig. 972 we give the plan of a large farm-steading at the Brit-

Fig. 972.

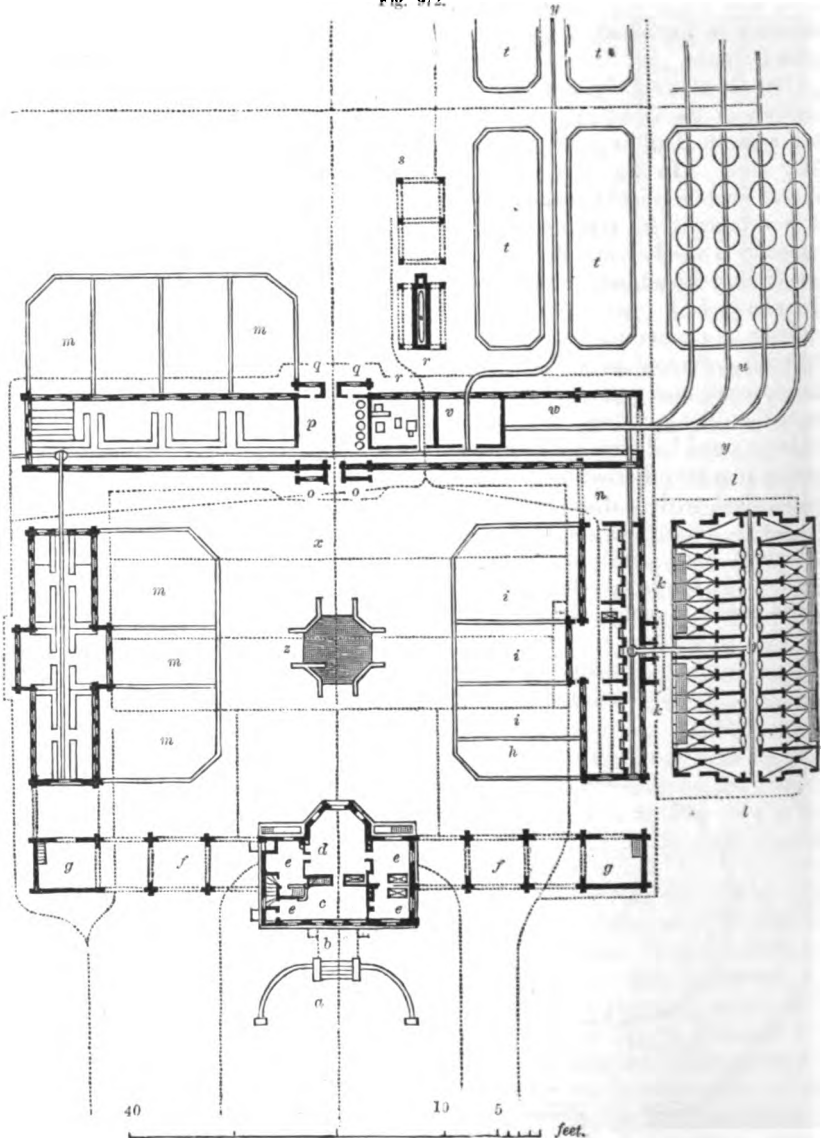

PLAN OF STEADING OF BRITANNIA FARM, BELGIUM.

annia farm, Ghistelles, near Ostend, in Belgium, belonging to M. Bortier, and for which we are indebted to the *Manual des Constructions Rurales*, pub-

lished at Brussels. The terrace of the lawn is at *a*, the carriage-drive to door *b*, *c* hall of the farmhouse, *d* kitchen, *e e e* bedrooms, *f f* coach-houses, *g g* infirmary for horses and for sheep, *h* poultry-house and yard, *i i i* boxes and yards for horses and cows, *k k* oat and bean stores, *l l* piggeries, *m m m*, *m m* sheep-sheds and yards, *n n* covered passage, *o o* salt and oilcake stores, *p* boiling-house, *q q* oat and bean stores, *r r* steam-engine and boiler-house, *s* liquid-manure tanks, *t t*, *t t* beetroot pits, *u* stackyard, *v* beetroot distillery, *w* machine-room, *x* the dotted lines show the drainage pipes, and *y y* the railways leading from the stackyard *u* and beetroot pits *t*, to the machine-room *w* and the beetroot distillery *v*; *z* the water-tank. Fig 973, *a a* covered dung-pits and cisterns for "purin," *b b* cellars for cinders.

Fig. 973.

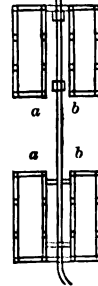

1 DUNG-PIT AND CINDER-CELLARS.

1762. SECTION SECOND—*American Barns*.—In addition to the plans of farm-buildings suited to the agricultural practice of Great Britain, we deem it likely to add to the utility of our work, by giving a few plans illustrative of farm-buildings suited to the practice of the United States and our North American colonies. The term *barn* is there equivalent to our term "farm-steading," "homestead," or "farmery;" it is not confined to signify as with us the *one* apartment of a farmery in which the corn is thrashed and prepared for market, but it comprehends *all* the apartments usually required in farm practice. Hence the term "barn" in North America is equivalent to our "covered farm-steading," a form of arrangement now by some much esteemed here, in which all the apartments required are placed under one roof. In the American "barn," however, there is one feature which is absent in all improved structures in this country — namely, very large storage-room for corn, roots, and fodder. This is necessitated by the exigencies of the climate, which prevents our system of out-of-door storage being adopted. In place of drawing upon our own notes taken during a visit paid to the United States some time ago, we prefer to present the reader with plans of acknowledged merit which have been published under the sanction, and received the good opinion of American agriculturists. The following, taken from the *American Cultivator*, will convey some idea of the nature of the arrangement of what is called a "side-hill barn:" In fig. 974 we give the plan of basement, in which *a* is the manure-pit, *b* the cattle-

Fig. 974.

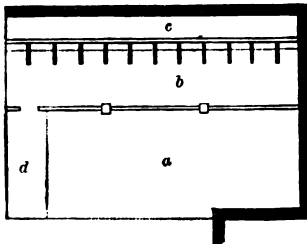

BASEMENT OF AMERICAN "SIDE-HILL BARN."

Fig. 975.

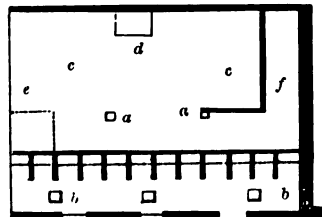

PLAN OF SECOND STOREY OF AMERICAN "SIDE-HILL BARN."

stalls, 3 feet 3 inches by 8 feet; *c* the feeding-passage, 4 feet 6 inches wide; the part *d* is paved. In fig. 975 we give the plan of second storey, in which *a a* are the posts supporting hay-floor over stable-passage, *b b* cattle-stalls, *c c* hay-mow or balk, *d* the hay-shoot or funnel, *e* another funnel, *f* passage. In fig. 976 we give a perspective elevation of the barn.

1763. "The barn is 40 feet long by 26 wide, with a basement 8 feet high; posts 20 feet above the basement;

Fig. 976.

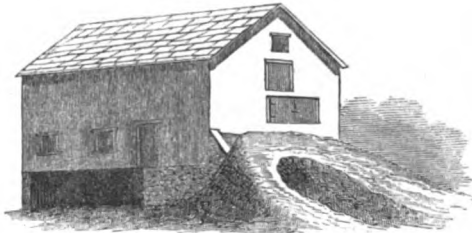

PERSPECTIVE VIEW OF AMERICAN "SIDE-HILL" BARN.

the roof steep, which gives more room for hay, is more durable and stronger if left without purlin support; two middle cross works, which make the girts 13 feet. It is situated on a somewhat steep side-hill, facing the south-east; the basement wall on the north side, and the west part of the south side to the west middle cross work, 8 feet high. The

wall at the west end is 15 feet high, the basement part of which is built very strong of heavy stone, so that the upper part of it (7 feet high), which is faced one foot back or west of the basement wall (for a cross sill to rest upon), may rest firm, and never be moved.

1764. "The post which is in the east middle cross work, south side, is supported by bridge braces, with bolt at bottom to hold up the sill, which gives free access to the manure which is kept in the south part of the basement; in the north half is a row of stanchion stables for 12 cattle, facing the north, towards a foddering-pass wide enough to fodder the cattle when in the stable. One row of cattle are kept over the manure basement facing the north, which, with a foddering-passage, occupies 13 feet, or half the width.

1765. "The earth is filled in and thoroughly packed up to the wall at the west end, and graded or inclined to drive the loaded teams with the hay, to be pitched into the barn through ample sized doors of different height; much of the hay is thus pitched down into the barn, and it is certainly 'put into place' with comparatively little labour. The barn is filled with hay, excepting two funnels through which to pitch the hay down to the two foddering-passes; and by allowing a reasonable time to settle, will hold 35 tons of hay. Our cattle are three-year-old steers, for fattening the following season when four years old. I think there are very few barns which contain so much practically valuable room under the same proportion of roof, or expense of building, and repairs for the next hundred years." The barn is built thoroughly but plainly, and we think at a cost of 400 dollars (£80).

1766. The same Journal shows the plan of a barn, which we give in

Fig. 977.

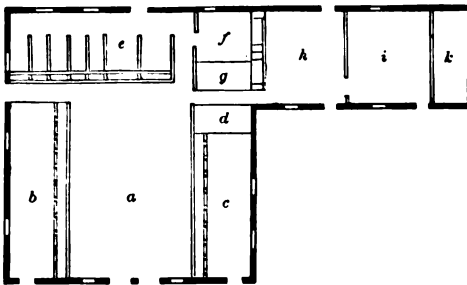

PLAN OF AMERICAN BARN.

fig. 977, in which *a* is the barn floor, 24 feet by 42; *b* cow-stable, 12 feet by 38, *c* 12 feet by 31; *d* oat-bin, 5 feet by 12; *e* work-horse stable, 14 feet by 32; *f* tool-room, 14 feet by 12; *g* wheat-bin, 5 feet by 12; *h* colt-stable, 16 feet by 20; *i* calf-stable, 16 feet by 20; *k* corn-crib, 8 feet by 20. The height over the cow-stables is 7 feet, over the main floor and horse-stable 9 feet. Fig. 603, p. 373, in the section

treating of wooden sheds, is a sectional elevation of frame of this barn.

1767. The most complete form, perhaps, of American barn is to be met with

in the state of Pennsylvania. A very distinguished agriculturist of that state, Mr Lewis F. Allen, has in his work, *Rural Architecture*, illustrated and described a barn which he built for his own use, "and which has proved so satisfactory in its use that, save in one or two small particulars, which are here amended, we would not," says Mr Allen, "for a stock-barn, alter it in any degree, nor exchange it for one of any description whatever." "For the farmer who needs one of but half the size, or greater, or less, it may be remarked that the extent of this need be no hindrance to the building of one of any size, as the general design may be adopted and carried out, in whole or in part, according to his wants, and the economy of its accommodation preserved throughout. The principle of the structure is what is intended to be shown."

1768. Fig. 978 is the principal or ground-plan; fig. 979 is an isometrical elevation. The following is Mr Allen's description of its interior arrangement: "Entering the large door *a*, fig. 978, at the front end, 14 feet wide and 14 feet high, the main floor *g* passes through the entire length of the barn and rear lean-to, 116 feet; the last 16

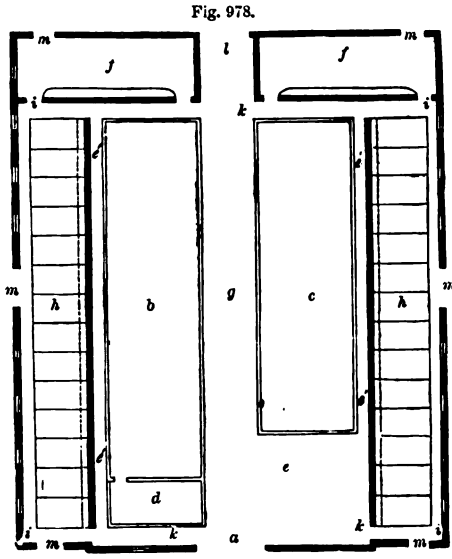

PLAN OF ALLEN'S AMERICAN BARN.

Fig. 979.

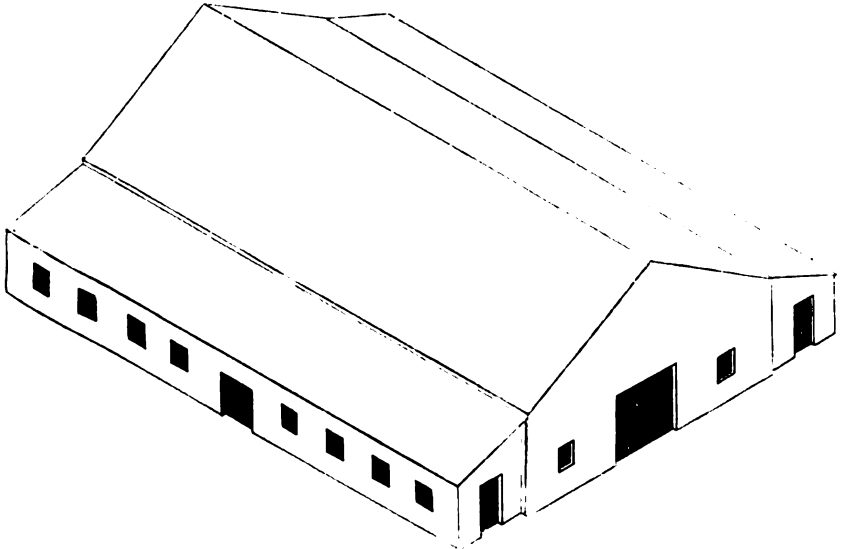

ISOMETRICAL ELEVATION OF ALLEN'S AMERICAN BARN.

feet through the lean-to, and sloping 3 feet to the outer sill and door *l*, of that appendage. On the right of the entrance is a recess *e*, 20 feet by 18, to be used as a thrashing floor, and for machinery cutting food, &c.—5 feet next the end at *k* being cut off for a passage to the stable. Beyond this is a bay *c*, 18 feet by 70, for the storage of hay or grain, having a passage *k* at the further end of 5 feet wide, to go into the further stables. This bay is bounded on the extreme left by the line of outside posts of the barn. On the left of the main door is a granary *d*, 10 feet by 18, two storeys high, and a flight of steps leading from the lower into the upper room. Beyond this is another bay *b*, corresponding with *c* on the opposite side. The passages *k k*, at the end of the bays *b* and *c*, have steps of 3 feet descent to bring them down on a level with the stable floors of the lean-tos. A passage in each of the two long side lean-tos *e' e'*, 3 feet wide, receives the hay-forage for cattle, or other stock, thrown into them from the bays and the lofts over the stables, and from them is thrown into the mangers *h h*. The two apartments *f f*, in the extreme lean-to, 34 feet by 16 each, may be occupied as an hospital for invalid cattle, or partitioned off for calves, or any other purpose. A calving-house for the cows which come in during the winter is always convenient, and one of those may be used for such a purpose.”

At the front of the stalls is the passage *i i*, for the cattle as they pass in and out of their stalls. The stable doors *m*, are six in number. In this barn, accommodation is given for fifty-six grown cattle in twenty-eight double stalls, with room for twenty to thirty calves in the end stables. Storage for 150 tons of hay is also provided.

1769. In fig. 980 we give plan of basement of another arrangement of barn designed by Mr Allen. A line of posts stands at *x*, and a wall *e e* placed backwards from these affords space for cattle-sheds. Two sheds *o o* for cattle-shelter can be run out to any desired length, at right angles to *e e*. The barn is built on sloping ground, so as to admit of the under portion being made without much excavation. Fig. 981 is the main floor

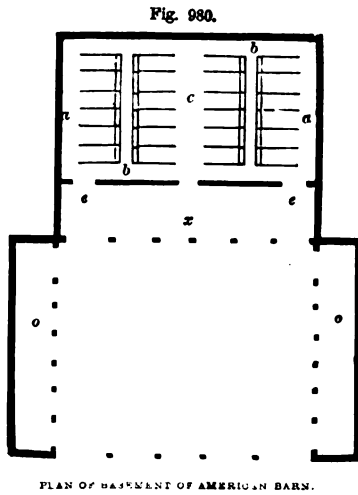

PLAN OF BASEMENT OF AMERICAN BARN.

of the barn; its dimensions are 60 feet by 46; two large doors are at the end, 14 feet square—a louvre-boarded window being above these. A door, 9 feet by 6, opens towards the yard from the apartment *f*. The main floor *a*, 12 feet wide, runs along the whole length of the barn; *h h* are trap-doors to let forage down to the stables beneath; *b* is the principal bay for hay, 16 feet wide, running up to the roof; *g* is the bay, 26 feet by 16, for the grain—more if required for that purpose; *d* the granary, 13 feet by 16 feet; *e* a storage-room for machinery, &c.; grain in the sheaf, or hay, may be stored in the space

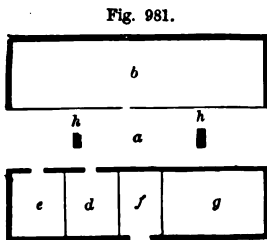

PLAN OF UPPER STOREY OF AMERICAN BARN.

above *f d* and *e*. The main floor will accommodate the thrashing-machine, &c., when at work. “A line of movable sleepers or poles may be laid across

the floor, 10 feet above it, on a line of girts framed into the main posts for that purpose, over which, when the sides of the barn are full, either hay or grain may be deposited up to the ridge of the roof, and thus afford large storage; and if the demands of the crop require it, after the sides and over the floor are thus filled, the floor itself may, or part of it, be used for packing away either hay or grain." The stables, &c., are placed beneath the body of the barn, as seen in fig. 980; it is here cut up into stables. Passages *a a* are made for the stock to go into the stalls; *c* is the centre passage, 8 feet wide; *b b* the passages, 3 feet wide, between the mangers, placed under the traps *h h*, fig. 981, in the main floor. The mangers are 2 feet wide; the stalls are $6\frac{1}{2}$ feet wide; at the end walls the cattle-passages are 5 feet wide, the partition between the stalls being sloped from 5 feet high at the upper end down to the floor. The main floor is provided with inclined planes leading from the surrounding level to the main doors: this will be found a great convenience in housing hay, &c. The sheds *o o* may be used for carts, &c., or shelter sheds: there may be storage-room for hay, &c., made over them.

1770. In fig. 982 we give plan of American farm-buildings designed by Mr Marshall, and adapted for the northern states: *a* space for roots; *b* machine-room for cutting straw, roots, &c.;

c straw-bay, *d d* feeding-passages for cow-byres *e* and *f*, sheep-shed *g*, with yard *h*; *i* piggery, with yard *k*; *l* poultry-house, *m* boil-house, *n* store for firewood, &c., *o* calf-house, *p* carpenter's shop, *r* implement-house, *s* waggon-shed, *t* yard.

1771. In the southern and western states of America the peculiarities of farming, as there practised, require several modifications of arrangement, &c., in the farm-buildings, differing from those carried out in the northern or middle states.

Professor Turner of Illinois has made public a variety of useful hints on stables and farm-buildings for the West, a portion of which will, we think, be highly useful to our readers. His remarks are given *in extenso* in Mr Downing's *American Country Architecture*. "Throughout the vast regions devoted to stock, especially in Illinois and Missouri, and all the states south of these, stables are used not for sheltering common stock or fodder, but merely for the few horses and milch-cows which are kept for family use. Many farmers in these states annually fatten some one or two hundred head of oxen, and some few even a thousand or more, for the market, and still a very moderate-sized stable, or rather no stable at all, answers their purpose." Mr Turner then gives a statement of what "ends the great majority of those who are intending to build in those regions wish to reach," the purport of which we give as follows: Wood (or *lumber*, as it is called) being very dear in the West, as also labour, economy in these is the first consideration. This is best effected by throwing all the buildings under "one roof, and in a square form, or one as nearly square as possible; the foundations, made of brick or stone—and which

Fig. 982.

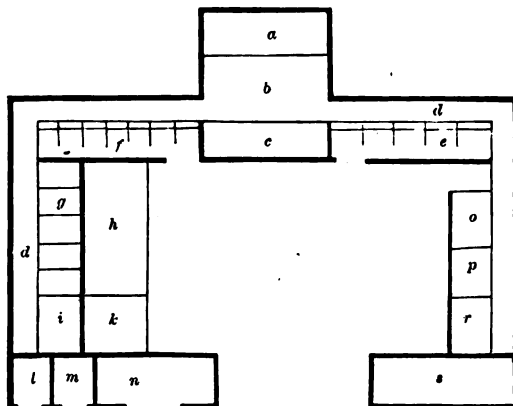

PLAN OF AMERICAN STEADING

may have to be transported from a distance at great cost—will, by the same plan, be also economised." Another desideratum, and one peculiar to these states, is to have "free access to and from their out-buildings, without passing through the terrible mud and water which, in prairie countries, always exists on all flat lands where cattle or swine are yarded, or allowed to run in small lots. Those who are accustomed only to a rocky or gravelly soil, can form no adequate conception of the inconvenience of the prairie mud throughout all the rainy seasons of the year." The location of a well is a point of great importance, as water is not found in springs or brooks, but from wells. The conveniences in the stable are, stalls for from one to four horses, stalls for cows (though sheds are generally used for them), pig and fowl house, carriage and tool house. Room for storing hay is also useful, though this crop is chiefly stacked, and the corn "cribbed" in the fields. Room will, however, be required for storing as much of these crops as will suffice for the provender of the stock. Professor Turner gives a plan illustrative of the arrangements proposed: this we now append. "At *a*, fig. 983, a door is made in the rear of the cattle-stalls *b*,

Fig. 983.

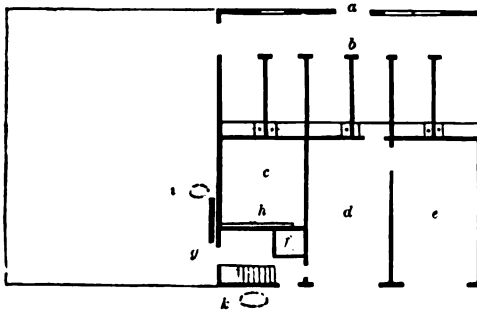

PLAN OF WESTERN STATES AMERICAN FARM-BUILDINGS.

through which to pass the manure from time to time; *c* is the corn-crib. The floor of this, as well as the corn-cribs in the stalls, indicated by the small black circles, should be from 2½ to 3 feet above the level of the ground, so as to admit of the pigs getting beneath them. By this arrangement, not only will shelter be provided for them, but they will be enabled to pick up all scattered corn, and also prevent rats from accumulating, as they will be prevented from depredating by the continual intrusion of the pigs. The front of one stall should be open, to admit of a door being made, so as to give access to the stalls from the carriage and waggon houses *d e*. As the weather in the West is at times very cold, the well should be located in a convenient recess, as at *f*; the water should be supplied to the trough *g*, in the yard, through a spout *h*. Two troughs should be made here, one higher than the other, the lower one being for the use of the pigs—these animals being, in Western farming, allowed to follow the larger stock in the yard. A small pond *i* receives the water from the troughs, and is used for ducks, &c.; another pond *k*, outside the yard, is used for goslings and ducklings. In selecting a place for the building, the yard should be on the east side, and a green grass surface on the south side of both stable and stock yard *l*, no cattle or hogs being allowed to pass in to the grass; so that the farmer may have a mudless access at all times to the farm-buildings. The ground should, if possible, be selected sloping, the stable at the highest part, so as to allow the wet to go towards the lower end of the yard. If sloping ground cannot be obtained, an artificial slope should be made. The position of the well *f* will, of course, dictate the other arrangements, the well being first dug."

1772. *American Cheese-Dairy Buildings*.—As an example of "cheese-dairy" buildings adapted for American agriculture, we here append the plan and buildings, by Mr Paris Barber of Homer, New York, given in the

American Artisan. Fig. 984 is the general plan: *a a* the byre or milking-shed, 25 feet by 75; *b b* the store-room, 22 feet by 36, with counters and shelves *c c*; *d* the work-room, 16 feet by 20, connected with the store-room by a car-way *e*. "In submitting my plan," says Mr Barber, "I will simply say that, in getting up my cheese-dairy buildings and fixtures, the first point arrived at

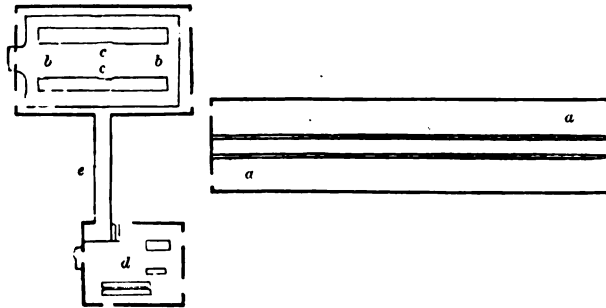

PLAN OF AMERICAN CHEESE-DAIRY BUILDINGS

was economy in construction, with the greatest convenience in all its parts for labour saving, which I consider the all-important point in dairying. The cheese-room *b b* stands 1 foot from the ground, and is thoroughly banked upon the outside of wall, to prevent frost. It is planked, and then boarded up and down, and battened. Inside it is finished by a narrow lath over each crack, lathed and plastered in the usual way. The floor is lined to make it tight, planed and jointed. The counters or shelves are around the outside, and two in the middle of the room two tier deep. The lower one is 6 inches from the floor; the space between is 2 feet 3 inches. The posts or legs are turned, to prevent the cheeses being bruised in turning. The room will hold, with the present shelves, two hundred and fifty cheeses, pressed in an 18-inch hoop; and by the addition of another tier of shelves, the number will be greatly increased. The windows have sliding shutters on the inside, by which I can make it dark, and wire gauze on the outside, to prevent flies, both of which are of importance. There is a large store-room above, with a swing stairway to rise and fall as required. The room is so tight and well-built that I have not had any trouble in keeping the cheese from freezing, during the coldest weather, with an ordinary stove. My work-room *d* is 16 feet by 20; it is 18 feet from the store-room, and is connected with it by a covered car-way *e*, which saves the trouble of carrying the cheeses by hand. I have a constant supply of soft spring-water, running from a spring on the farm. The apparatus for the manufacture of cheese consists of a furnace or steamer, for heating water and scalding whey; two cisterns, a wooden one and a tin one, suitable for the manufacture of cheese; presses; tub for hot water; and conductor for carrying the whey to the reservoir. My milking-barn or shed *a a* is 25 feet by 75. It has swing-gates on the sides, and is 6 feet in the rear of the two buildings referred to, which makes it very easy of access for the milkers. It also makes a division in my cattle-yard, and affords a fine large loft for storing hay or corn fodder." Where possible, the cheese-dairy should be placed on a higher level than that of the piggery or cow-house, so that the whey may be carried easily down by conductors to reservoirs placed in these houses, from which it may be taken as required.

1773. *American Piggery.*—In the western states of America, where hundreds of pigs are kept, the plan of sty-feeding and rearing is not adopted, as not being at all remunerative. They are allowed, therefore, to roam about. In the cold nights of winter, while endeavouring to have as much heat as possible,

they crowd much together in what are called their nests, and numbers of the weaker ones are smothered by the strong. In Mr Downing's work, a plan of what is there termed a "sifting-shed" is given, which is likely to prevent much of the loss incurred through this. We here append it in fig. 985.

Fig. 985.

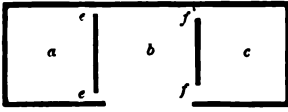

PLAN OF "SIFTING" FIGGERY.

Let *a* be the lightest and warmest place, having entrances *e e* only large enough to admit the smallest hogs. Let *c* be another shed, having doors *f f* through which the middle-sized hogs can pass. The largest ones will take up their abode in *b*. This should face to the south. The sifting of the hogs into their respective sties is done in this way: shut the doors *f f*, and the smallest will go into *a*; then shut the doors *e e*, and the middle-sized will go into *c* when the doors *f f* are opened.

Fig. 986.

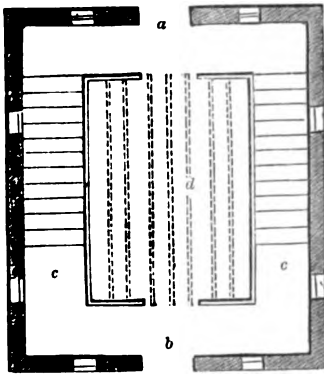

GROUND-PLAN OF AMERICAN POULTRY-HOUSE—SCALE, 1/2 INCH TO THE FOOT.

1774. *American Poultry-houses.*—In fig. 986 we give ground-plan of an American poultry-house: *a b* doors, *c c* stairs to upper floor, *d* enclosed space covered in at top with roosting-bars fixed on the inclined pieces *c c*, shown in section, fig. 987. In fig. 987 *a* is the door corresponding to *a* in fig. 986; *b b* stairs, at the back of which a series of boxes or nests are placed, into which the birds pass through circular doors made in the "riser" of each step, two nests being made to each riser; *d d* a series of nests rising one above another, with resting platforms in front of each; *e e e* ventilating windows. In fig. 988 we give section of the nests behind the stairs: *a a a* the treads, *b b b* the risers in which the entrance holes are made, *c c c* the bodies of the nests, *d d d* back doors to them.

Fig. 987.

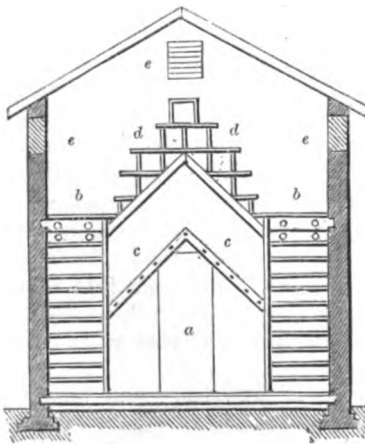

SECTION OF AMERICAN POULTRY-HOUSE—SCALE IN FIG. 986.

Fig. 988.

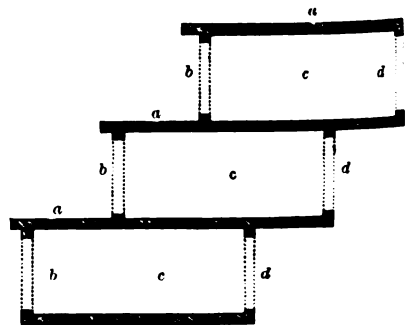

SECTION OF NESTS BEHIND STAIRS—SCALE, 1/2 INCH TO THE FOOT.

1775. SECTION THIRD—*French Steading*.—In fig. 989 we give the plan of the imperial farm-steading at Vincennes, near Paris: *a* the house of the

Fig. 989.

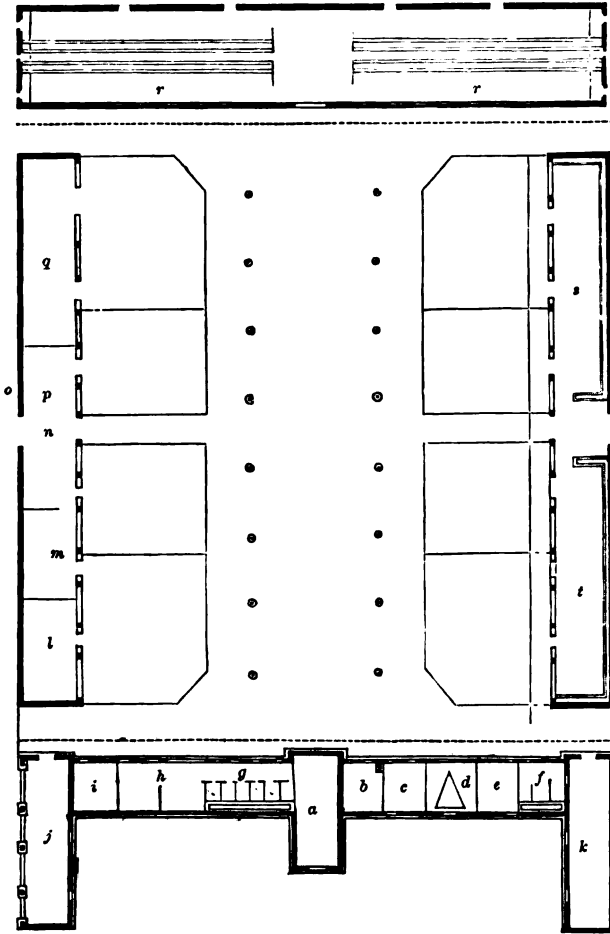

PLAN OF THE IMPERIAL FARM-STEADING AT VINCENNES.

farm-bailiff, *b* the dairy, *c* the dairy wash-house, *d* the coach-house, *e* wood-house, *f* infirmary, *g* stable, *h* harness-room, *i* implements, *j* machine-house, *k* living-room for farm-labourers, *l* piggeries, with yard; *m* box for lambs, with yard; *n* straw-cutting room, *o* place for horse-gear, outside building, for working the straw-cutter placed at *p*; *q* the shed for calves, with yard; *r r* cow-house for 50 cows; *s* sheep-shed, with yard; *t* lamb and ewe shed, with yards. The scale of this drawing is 0^m. 0012 to the metre. The French metre is 39.371 inches, or rather over 3 feet 3 inches. For the above drawing we are indebted to the *Journal d'Agriculture Pratique* (Paris), for May 5, 1860—a valuable work, and very ably conducted by M. Barral.

SUBDIVISION FOURTH—*Estimates and Calculations of Artificers' Work of various kinds*

1776. The limits of the work prevent us from giving full descriptions of the methods adopted in practice for estimating the quantities of materials used in building. The subject is too elaborate to admit of this being done; it will be sufficient for our purposes if we give in brief abstract form a selection of calculations and statements, which will enable our readers to form a rough estimate, sufficiently accurate for ordinary purposes, of the quantities of materials required for any structure or part of a structure. The quantities being known, it will be an easy matter to ascertain from a tradesman the cost of supplying them, charged in the usual way.

1777. SECTION FIRST—*Diggers' and Excavators' work* is estimated by the cubic yard of 27 feet, or a "single load." Taking the cost of digging and throwing out *common soil* to a depth not exceeding 6 feet at 5d. per yard cube, the cost of digging in gravel or clay will be 7d. A ton of excavated matter is equal to 24 cubic feet of sand, 17 cubic feet of clay, 18 cubic feet of ordinary earth or soil, 13 cubic feet of chalk.

1778. *Well-Digging and Well-Steining* with bricks is estimated by the foot in depth, the price varying according to the diameter. Thus, where the diameter is 3 feet, in clear of brickwork, and the price per foot in depth 13s., the price for a diameter of 6 feet will be 23s. 6d., or thereabouts. By multiplying the square of diameter of well, including brickwork, by .7854, the number of cubic feet of earth obtained in digging each foot of depth will be ascertained. By multiplying the square of the diameter of well by .7854, and dividing the quotient by 6, the number of *gallons of water* contained in each foot of depth will be ascertained.

1779. *In Digging a Well* 3 feet diameter in the clear, the quantity of earth removed for every foot of depth is 11 cubic feet; of 4 feet diameter, 17 cubic feet 17 in.; of 5 feet, 20 cubic feet; of 6 feet, 33 cubic feet 8 in.

1780. *In Lining a Well with Brickwork* (or steining it, as it is technically termed) of 3 feet diameter $\frac{1}{2}$ brick thick, the number of bricks required for every foot in depth is 57 laid in mortar, 68 laid dry; where the lining is 1 brick in thickness the number required is 126 in mortar, 154 dry. For a well 4 feet diameter, the lining $\frac{1}{2}$ brick in thickness, the number of bricks for every foot will be 73 in mortar, 89 dry; 1 brick thick, 159 in mortar, 194 dry. For 5 feet diameter, $\frac{1}{2}$ brick lining, 90 in mortar, 110 dry; 1 brick lining, 192 in mortar, 234 dry. For 6 feet diameter, $\frac{1}{2}$ brick lining, 107 in mortar, 130 dry; 1 brick lining, 226 in mortar, 276 dry.

1781. *The number of Imperial Gallons contained in Wells of the following Diameter for each Foot of Depth*—3 feet diameter, 44 gallons; 4 feet, 78; 5 feet, 122; 6 feet, 176.

1782. SECTION SECOND.—In estimating the quantity of brickwork, ascertain by calculation the number of cubic feet in the wall; Reduce the number of these cubic feet so ascertained to the standard of brick and half, by multiplying them by 8 and dividing by 9; or find the area of the face of wall in feet, multiply the number of feet thus found by the number of half-bricks in the thickness of the wall; divide the result by 3, which will give the superficial feet; divide the amount by 272, and the result is the number of "rods" of the standard thickness.

1783. In *one foot* superficial of wall, $\frac{1}{2}$ brick in thickness, there will be five bricks; 1 brick in thickness, 11 bricks; $1\frac{1}{2}$ brick thick, 16 bricks; 2 bricks thick, 23 bricks. In *three feet* superficial, $\frac{1}{2}$ brick thick, there will be 16 bricks; 1 brick thick, 33; $1\frac{1}{2}$ thick, 49; 2 bricks, 66. In *five feet* superficial, $\frac{1}{2}$ brick thick, 27 bricks; 1 thick, 55; $1\frac{1}{2}$ thick, 82; 2 thick, 110. In *ten feet* superficial, $\frac{1}{2}$ thick, 55; 1, 110; $1\frac{1}{2}$, 165; 2, 220 bricks. In *twenty feet* superficial, $\frac{1}{2}$ brick thick, 110; 1, 22; $1\frac{1}{2}$, 330; 2, 441. In *thirty feet* superficial, $\frac{1}{2}$, 165; 1, 330; $1\frac{1}{2}$, 496; 2, 661. In *fifty feet* superficial, $\frac{1}{2}$ brick thick, 275 bricks; 1, 551; $1\frac{1}{2}$, 827; 2, 1102. In *seventy feet* superficial, $\frac{1}{2}$, 386; 1, 772; $1\frac{1}{2}$, 1158; 2, 1544. In *ninety feet* superficial, $\frac{1}{2}$, 496; 1, 992; $1\frac{1}{2}$, 4488; 2, 1985. In *one hundred feet* superficial, $\frac{1}{2}$, 551; 1, 1102; $1\frac{1}{2}$, 1654; 2, 2205.

1784. One rod of brickwork—brick and half standard—will take, allowing for waste, 4500 bricks of the usual dimensions, $8\frac{3}{4}$ inches long, $4\frac{1}{2}$ broad, and $2\frac{1}{2}$ thick.

1785. The weight of 1000 bricks of above dimensions may be taken at $2\frac{1}{2}$ tons.

1786. The weight of 1 rod of reduced brickwork, 272 feet superficial, standard thickness of brick and half, will be about 13 tons; this includes mortar and cement.

1787. *Facings* in brickwork estimated by the "foot superficial."

1788. *Rubbed and Gauged Work in Mortar* (brickwork) estimated by the "foot run;" do. in *putty*, by the "foot superficial."

1789. *Brick Drains* estimated by the "foot run."

1790. *Brick-Nogging* by the "yard superficial." To make 1 yard of brick-nogging it will take 30 bricks on edge, and 45 on the flat.

1791. *Brick-Paving* by the square yard. 36 paving-bricks laid flat will be required to pave 1 yard surface; 82 on the edge. The size of a paving-tile is 9 inches long, $4\frac{1}{2}$ broad, $1\frac{3}{4}$ thick; the weight of each about 3 lb. 13 ounces. It will take 36 stock-bricks laid flat, and 52 on edge, to pave a yard. 9 tiles 1 foot square, and 13 10-inch tiles go to the yard. Of Dutch clinkers laid on edge 140 will be required to pave a yard, 125 laid flat, 136 laid herring-bone fashion. The size of a Dutch clinker is $6\frac{1}{2}$ inches long, 3 inches wide, and $1\frac{1}{2}$ inch thick, its weight about $1\frac{1}{2}$ lb. The size of a "foot paving-tile" is $11\frac{1}{2}$ inches square, its thickness $1\frac{1}{2}$ inches, and weight $12\frac{1}{2}$ lb. The size of a "ten-inch paving-tile" is $9\frac{1}{2}$ inches square, its thickness 1 inch, and its weight $8\frac{1}{2}$ lb.

1792. SECTION THIRD—*Stone-Paving*.—1 ton of 6-inch granite-paving will cover 4 yards superficial; a ton of 9-inch granite, $2\frac{1}{2}$ yards; a ton of pebble-paving, 4 to $4\frac{1}{2}$ yards; of ray stone, 5 to $5\frac{1}{2}$ yards.

1793. *Tiling* is estimated by the "square" of 100 superficial feet. Laid to a 6-inch gauge, it will take 768 plain-tiles to "one square" of 100 feet; to a 7-inch gauge, 655; to an 8-inch, 576. A "pan-tile" is $10\frac{1}{2}$ inches long, $6\frac{1}{2}$ wide, $\frac{3}{8}$ of an inch in thickness, and weighs 37 ounces. Laid to a gauge of 10 inches, it will take 180 pan-tiles to make a "square;" to a gauge of 11 inches, 160; and to a gauge of 12 inches, 150 to the square. The length of a "pan-tile" is $13\frac{1}{2}$ inches, its breadth $9\frac{1}{2}$, and thickness $\frac{1}{2}$ inch, its weight 75 ounces.

1794. *Mortar*.—A "2 load" is 7 cubic feet, or 21 striked bushels. To make it, there are required 9 bushels of lime, and 1 cubic yard of sand. A "hod" of mortar is equal to 1134 cubic inches, and will lay or set 100 bricks of the ordinary dimensions. The size of a hod is 9 inches by 9, and 14 inches long; it will carry 20 bricks of the ordinary dimensions. One "rod" will take 184

hods of mortar. A "rod" of brickwork will take of mortar to set them, $1\frac{1}{2}$ cubic yards of chalk-lime and 3 "loads" of drift, or 1 cubic yard of stone-lime and $3\frac{1}{2}$ loads of sand.

1795. *Cement*.—A barrel contains 5 bushels, and weighs 3 cwt. To cement a "rod" of brickwork 36 bushels are required. A yard square of 14-inch wall takes $1\frac{3}{4}$ bushels; of 9-inch, 1 bushel; of 4-inch wall, $\frac{1}{2}$ bushel. To "point" joints of a yard square, one-eighth of a bushel will be required. To plaster a yard square of plain surface in cement, about one-third of a bushel will be required.

1796. *Laths*.—Laths are of two kinds, "plain-tile" and "pan-tile." The "plain-tile" laths are $1\frac{1}{4}$ inch wide and $\frac{1}{4}$ inch thick. When 5 feet long, 100 laths make one "bundle;" when 4 feet long, 125; and when 3 feet long, 167 go to the "bundle;" 500 feet run of laths, of any length, also constitute a "bundle;" 30 bundles make 1 "load." One square of plain-tiling takes 1 bundle of laths, or 500 feet run; or it will cover $4\frac{1}{2}$ yards superficial, 500 nails being required. "Pan-tile" laths are $1\frac{1}{2}$ inch wide, 1 inch thick; 12, 10 feet long each, make 1 "bundle."

1797. *Plastering* is estimated by the square foot or yard; mouldings by the lineal foot. To cover 75 yards of "render and set" in brickwork, 1 cubic yard of chalk-lime, 2 cubic yards of sand, and 3 bushels of hair, will be required. The same quantity will cover 70 yards on lath, or 65 yards of "plaster," or "render two coats and set" on brickwork, or 60 yards of the same on lath.

1798. *Slating* is estimated by the "square" of 100 superficial feet. The "duchess" slate measures 24 inches by 12; 1000 will cover 10 squares. The "countess" measures 20 inches by 10, and 1000 will cover 7 squares. The "ladies" slate measures 15 inches by 8, and 1000 will cover $4\frac{1}{2}$ squares. The "doubles" measure 13 inches by 6, and 1000 will cover $2\frac{1}{2}$ squares. A square of "duchess," "countess," or "ladies," will weigh about 6 cwt. "Westmoreland" slate varies in size, as also do "rags" and "queens." A superficial foot of slate-slab, 1 inch in thickness, will weigh about 14 lb. Scotch blue slate is thicker, smaller, and stronger than the Welsh or English: the Scotch grey slate is thicker than either, and not so strong as the Scotch blue.

1799. A square of "pan-tiling" will weigh about $7\frac{1}{2}$ cwt.; of "plain-tiling," double. A square of lead covering, weighing 7 lb. to the superficial foot, will weigh $6\frac{1}{2}$ cwt.; of "copper," 1 lb. to the foot, 1 cwt.

1800. SECTION FOURTH.—*Carpentry and Joinery Work* are estimated by the square foot or yard; mouldings and fancywork, by the lineal or foot run. Large work, as flooring, boarding, &c., is estimated by the square of one hundred feet superficial. A "load" of timber is made up of 600 feet superficial of plank or deal 1 inch thick; or 400 feet superficial, $1\frac{1}{2}$ inch in thickness; 300 feet superficial of 2 inch thickness; 240 feet superficial of $2\frac{1}{2}$ inch thickness; 200 feet of 3 inch thick stuff; 170 feet of $3\frac{1}{2}$ inch thickness; 150 feet superficial of 4 inches in thickness. 40 cubic feet of "rough" and 50 of "square" timber make 1 load.

1801. Deals 12 feet long, 9 inches wide, and $2\frac{1}{2}$ inches thick, contain each 1 foot 10 inches cube; 120 of them make $4\frac{1}{2}$ loads of timber. Deals 12 inches long, 9 inches wide, and 3 inches thick, measure each 2 feet 3 inches cube; and 120 make $5\frac{3}{4}$ loads of timber. 120 deals make what is termed "one hundred."

1802. *Weight of Timber*.—Of fir 64 cube feet make 1 ton; of ash, 45; of beech, 51; of elm, 60; of oak, 39.

1803. The following Tables will be found useful in calculating the quantity of timber in joists of floors, rafters in roofs, partitions, and roof trusses, &c., according to given scantling and space apart:—

<p>12 INCHES APART OR 13 INCHES FROM CENTRE TO CENTRE.</p> <table border="1"> <thead> <tr> <th>In.</th> <th>In.</th> <th>Cube.</th> <th>In.</th> </tr> </thead> <tbody> <tr> <td>1</td> <td>by 3</td> <td>2</td> <td>0</td> </tr> <tr> <td>1</td> <td>... 4</td> <td>2</td> <td>8</td> </tr> <tr> <td>1</td> <td>... 5</td> <td>3</td> <td>4</td> </tr> <tr> <td>1</td> <td>... 6</td> <td>4</td> <td>0</td> </tr> <tr> <td>1</td> <td>... 7</td> <td>4</td> <td>8</td> </tr> <tr> <td>1</td> <td>... 8</td> <td>5</td> <td>4</td> </tr> <tr> <td>1</td> <td>... 9</td> <td>6</td> <td>0</td> </tr> </tbody> </table>	In.	In.	Cube.	In.	1	by 3	2	0	1	... 4	2	8	1	... 5	3	4	1	... 6	4	0	1	... 7	4	8	1	... 8	5	4	1	... 9	6	0	<p>11½ INCHES APART.</p> <table border="1"> <thead> <tr> <th>In.</th> <th>In.</th> <th>Ft.</th> <th>In.</th> </tr> </thead> <tbody> <tr> <td>2</td> <td>by 3</td> <td>4</td> <td>3</td> </tr> <tr> <td>2</td> <td>... 4</td> <td>5</td> <td>8</td> </tr> <tr> <td>2</td> <td>... 5</td> <td>7</td> <td>1</td> </tr> <tr> <td>2</td> <td>... 6</td> <td>8</td> <td>6</td> </tr> <tr> <td>2</td> <td>... 7</td> <td>9</td> <td>11</td> </tr> <tr> <td>2</td> <td>... 8</td> <td>11</td> <td>4</td> </tr> <tr> <td>2</td> <td>... 9</td> <td>12</td> <td>9</td> </tr> <tr> <td>2</td> <td>... 10</td> <td>14</td> <td>2</td> </tr> </tbody> </table>	In.	In.	Ft.	In.	2	by 3	4	3	2	... 4	5	8	2	... 5	7	1	2	... 6	8	6	2	... 7	9	11	2	... 8	11	4	2	... 9	12	9	2	... 10	14	2	<p>11½ INCHES APART.</p> <table border="1"> <thead> <tr> <th>In.</th> <th>In.</th> <th>Ft.</th> <th>In.</th> </tr> </thead> <tbody> <tr> <td>3</td> <td>by 3</td> <td>6</td> <td>4</td> </tr> <tr> <td>3</td> <td>... 4</td> <td>8</td> <td>6</td> </tr> <tr> <td>3</td> <td>... 5</td> <td>10</td> <td>8</td> </tr> <tr> <td>3</td> <td>... 6</td> <td>12</td> <td>10</td> </tr> <tr> <td>3</td> <td>... 7</td> <td>15</td> <td>0</td> </tr> <tr> <td>3</td> <td>... 8</td> <td>17</td> <td>2</td> </tr> <tr> <td>3</td> <td>... 9</td> <td>19</td> <td>4</td> </tr> <tr> <td>3</td> <td>... 10</td> <td>21</td> <td>6</td> </tr> <tr> <td>3</td> <td>... 11</td> <td>23</td> <td>8</td> </tr> <tr> <td>3</td> <td>... 12</td> <td>25</td> <td>10</td> </tr> </tbody> </table>	In.	In.	Ft.	In.	3	by 3	6	4	3	... 4	8	6	3	... 5	10	8	3	... 6	12	10	3	... 7	15	0	3	... 8	17	2	3	... 9	19	4	3	... 10	21	6	3	... 11	23	8	3	... 12	25	10
In.	In.	Cube.	In.																																																																																																															
1	by 3	2	0																																																																																																															
1	... 4	2	8																																																																																																															
1	... 5	3	4																																																																																																															
1	... 6	4	0																																																																																																															
1	... 7	4	8																																																																																																															
1	... 8	5	4																																																																																																															
1	... 9	6	0																																																																																																															
In.	In.	Ft.	In.																																																																																																															
2	by 3	4	3																																																																																																															
2	... 4	5	8																																																																																																															
2	... 5	7	1																																																																																																															
2	... 6	8	6																																																																																																															
2	... 7	9	11																																																																																																															
2	... 8	11	4																																																																																																															
2	... 9	12	9																																																																																																															
2	... 10	14	2																																																																																																															
In.	In.	Ft.	In.																																																																																																															
3	by 3	6	4																																																																																																															
3	... 4	8	6																																																																																																															
3	... 5	10	8																																																																																																															
3	... 6	12	10																																																																																																															
3	... 7	15	0																																																																																																															
3	... 8	17	2																																																																																																															
3	... 9	19	4																																																																																																															
3	... 10	21	6																																																																																																															
3	... 11	23	8																																																																																																															
3	... 12	25	10																																																																																																															
<p>11¼ INCHES APART.</p> <table border="1"> <tbody> <tr> <td>1</td> <td>by 3</td> <td>2</td> <td>6</td> </tr> <tr> <td>1</td> <td>... 4</td> <td>3</td> <td>4</td> </tr> <tr> <td>1</td> <td>... 5</td> <td>4</td> <td>2</td> </tr> <tr> <td>1</td> <td>... 6</td> <td>5</td> <td>0</td> </tr> <tr> <td>1</td> <td>... 7</td> <td>5</td> <td>10</td> </tr> <tr> <td>1</td> <td>... 8</td> <td>6</td> <td>8</td> </tr> <tr> <td>1</td> <td>... 9</td> <td>7</td> <td>6</td> </tr> </tbody> </table>	1	by 3	2	6	1	... 4	3	4	1	... 5	4	2	1	... 6	5	0	1	... 7	5	10	1	... 8	6	8	1	... 9	7	6	<p>11¼ INCHES APART.</p> <table border="1"> <tbody> <tr> <td>2</td> <td>by 3</td> <td>4</td> <td>9</td> </tr> <tr> <td>2</td> <td>... 4</td> <td>6</td> <td>4</td> </tr> <tr> <td>2</td> <td>... 5</td> <td>7</td> <td>11</td> </tr> <tr> <td>2</td> <td>... 6</td> <td>9</td> <td>6</td> </tr> <tr> <td>2</td> <td>... 7</td> <td>11</td> <td>1</td> </tr> <tr> <td>2</td> <td>... 8</td> <td>12</td> <td>8</td> </tr> <tr> <td>2</td> <td>... 9</td> <td>14</td> <td>3</td> </tr> <tr> <td>2</td> <td>... 10</td> <td>15</td> <td>10</td> </tr> </tbody> </table>	2	by 3	4	9	2	... 4	6	4	2	... 5	7	11	2	... 6	9	6	2	... 7	11	1	2	... 8	12	8	2	... 9	14	3	2	... 10	15	10	<p>11¼ INCHES APART.</p> <table border="1"> <tbody> <tr> <td>3</td> <td>by 3</td> <td>6</td> <td>8</td> </tr> <tr> <td>3</td> <td>... 4</td> <td>9</td> <td>0</td> </tr> <tr> <td>3</td> <td>... 5</td> <td>11</td> <td>4</td> </tr> <tr> <td>3</td> <td>... 6</td> <td>12</td> <td>6</td> </tr> <tr> <td>3</td> <td>... 7</td> <td>14</td> <td>8</td> </tr> <tr> <td>3</td> <td>... 8</td> <td>16</td> <td>10</td> </tr> <tr> <td>3</td> <td>... 9</td> <td>19</td> <td>0</td> </tr> <tr> <td>3</td> <td>... 10</td> <td>21</td> <td>2</td> </tr> <tr> <td>3</td> <td>... 11</td> <td>23</td> <td>4</td> </tr> <tr> <td>3</td> <td>... 12</td> <td>25</td> <td>6</td> </tr> </tbody> </table>	3	by 3	6	8	3	... 4	9	0	3	... 5	11	4	3	... 6	12	6	3	... 7	14	8	3	... 8	16	10	3	... 9	19	0	3	... 10	21	2	3	... 11	23	4	3	... 12	25	6												
1	by 3	2	6																																																																																																															
1	... 4	3	4																																																																																																															
1	... 5	4	2																																																																																																															
1	... 6	5	0																																																																																																															
1	... 7	5	10																																																																																																															
1	... 8	6	8																																																																																																															
1	... 9	7	6																																																																																																															
2	by 3	4	9																																																																																																															
2	... 4	6	4																																																																																																															
2	... 5	7	11																																																																																																															
2	... 6	9	6																																																																																																															
2	... 7	11	1																																																																																																															
2	... 8	12	8																																																																																																															
2	... 9	14	3																																																																																																															
2	... 10	15	10																																																																																																															
3	by 3	6	8																																																																																																															
3	... 4	9	0																																																																																																															
3	... 5	11	4																																																																																																															
3	... 6	12	6																																																																																																															
3	... 7	14	8																																																																																																															
3	... 8	16	10																																																																																																															
3	... 9	19	0																																																																																																															
3	... 10	21	2																																																																																																															
3	... 11	23	4																																																																																																															
3	... 12	25	6																																																																																																															
<p>11¼ INCHES APART.</p> <table border="1"> <tbody> <tr> <td>1</td> <td>by 3</td> <td>3</td> <td>0</td> </tr> <tr> <td>1</td> <td>... 4</td> <td>4</td> <td>0</td> </tr> <tr> <td>1</td> <td>... 5</td> <td>5</td> <td>0</td> </tr> <tr> <td>1</td> <td>... 6</td> <td>6</td> <td>0</td> </tr> <tr> <td>1</td> <td>... 7</td> <td>7</td> <td>0</td> </tr> <tr> <td>1</td> <td>... 8</td> <td>8</td> <td>0</td> </tr> <tr> <td>1</td> <td>... 9</td> <td>9</td> <td>0</td> </tr> </tbody> </table>	1	by 3	3	0	1	... 4	4	0	1	... 5	5	0	1	... 6	6	0	1	... 7	7	0	1	... 8	8	0	1	... 9	9	0	<p>11¼ INCHES APART.</p> <table border="1"> <tbody> <tr> <td>2</td> <td>by 3</td> <td>5</td> <td>3</td> </tr> <tr> <td>2</td> <td>... 4</td> <td>7</td> <td>0</td> </tr> <tr> <td>2</td> <td>... 5</td> <td>8</td> <td>9</td> </tr> <tr> <td>2</td> <td>... 6</td> <td>10</td> <td>6</td> </tr> <tr> <td>2</td> <td>... 7</td> <td>12</td> <td>3</td> </tr> <tr> <td>2</td> <td>... 8</td> <td>14</td> <td>0</td> </tr> <tr> <td>2</td> <td>... 9</td> <td>15</td> <td>9</td> </tr> <tr> <td>2</td> <td>... 10</td> <td>17</td> <td>6</td> </tr> </tbody> </table>	2	by 3	5	3	2	... 4	7	0	2	... 5	8	9	2	... 6	10	6	2	... 7	12	3	2	... 8	14	0	2	... 9	15	9	2	... 10	17	6	<p>12 INCHES APART OR 16 INCHES FROM CENTRE TO CENTRE.</p> <table border="1"> <tbody> <tr> <td>4</td> <td>by 4</td> <td>8</td> <td>11</td> </tr> <tr> <td>4</td> <td>... 5</td> <td>11</td> <td>2</td> </tr> <tr> <td>4</td> <td>... 6</td> <td>13</td> <td>5</td> </tr> <tr> <td>4</td> <td>... 7</td> <td>15</td> <td>8</td> </tr> <tr> <td>4</td> <td>... 8</td> <td>17</td> <td>11</td> </tr> <tr> <td>4</td> <td>... 9</td> <td>20</td> <td>2</td> </tr> <tr> <td>4</td> <td>... 10</td> <td>22</td> <td>5</td> </tr> <tr> <td>4</td> <td>... 11</td> <td>24</td> <td>8</td> </tr> <tr> <td>4</td> <td>... 12</td> <td>26</td> <td>11</td> </tr> </tbody> </table>	4	by 4	8	11	4	... 5	11	2	4	... 6	13	5	4	... 7	15	8	4	... 8	17	11	4	... 9	20	2	4	... 10	22	5	4	... 11	24	8	4	... 12	26	11																
1	by 3	3	0																																																																																																															
1	... 4	4	0																																																																																																															
1	... 5	5	0																																																																																																															
1	... 6	6	0																																																																																																															
1	... 7	7	0																																																																																																															
1	... 8	8	0																																																																																																															
1	... 9	9	0																																																																																																															
2	by 3	5	3																																																																																																															
2	... 4	7	0																																																																																																															
2	... 5	8	9																																																																																																															
2	... 6	10	6																																																																																																															
2	... 7	12	3																																																																																																															
2	... 8	14	0																																																																																																															
2	... 9	15	9																																																																																																															
2	... 10	17	6																																																																																																															
4	by 4	8	11																																																																																																															
4	... 5	11	2																																																																																																															
4	... 6	13	5																																																																																																															
4	... 7	15	8																																																																																																															
4	... 8	17	11																																																																																																															
4	... 9	20	2																																																																																																															
4	... 10	22	5																																																																																																															
4	... 11	24	8																																																																																																															
4	... 12	26	11																																																																																																															
<p>11¼ INCHES APART.</p> <table border="1"> <tbody> <tr> <td>1</td> <td>by 3</td> <td>3</td> <td>6</td> </tr> <tr> <td>1</td> <td>... 4</td> <td>4</td> <td>8</td> </tr> <tr> <td>1</td> <td>... 5</td> <td>5</td> <td>10</td> </tr> <tr> <td>1</td> <td>... 6</td> <td>7</td> <td>0</td> </tr> <tr> <td>1</td> <td>... 7</td> <td>8</td> <td>2</td> </tr> <tr> <td>1</td> <td>... 8</td> <td>9</td> <td>4</td> </tr> <tr> <td>1</td> <td>... 9</td> <td>10</td> <td>6</td> </tr> <tr> <td>1</td> <td>... 10</td> <td>11</td> <td>8</td> </tr> </tbody> </table>	1	by 3	3	6	1	... 4	4	8	1	... 5	5	10	1	... 6	7	0	1	... 7	8	2	1	... 8	9	4	1	... 9	10	6	1	... 10	11	8	<p>12 INCHES APART OR 15 INCHES FROM CENTRE TO CENTRE.</p> <table border="1"> <tbody> <tr> <td>3</td> <td>by 3</td> <td>5</td> <td>4</td> </tr> <tr> <td>3</td> <td>... 4</td> <td>7</td> <td>2</td> </tr> <tr> <td>3</td> <td>... 5</td> <td>9</td> <td>0</td> </tr> <tr> <td>3</td> <td>... 6</td> <td>10</td> <td>10</td> </tr> <tr> <td>3</td> <td>... 7</td> <td>12</td> <td>8</td> </tr> <tr> <td>3</td> <td>... 8</td> <td>14</td> <td>6</td> </tr> <tr> <td>3</td> <td>... 9</td> <td>16</td> <td>4</td> </tr> <tr> <td>3</td> <td>... 10</td> <td>18</td> <td>2</td> </tr> <tr> <td>3</td> <td>... 11</td> <td>20</td> <td>0</td> </tr> <tr> <td>3</td> <td>... 12</td> <td>21</td> <td>10</td> </tr> </tbody> </table>	3	by 3	5	4	3	... 4	7	2	3	... 5	9	0	3	... 6	10	10	3	... 7	12	8	3	... 8	14	6	3	... 9	16	4	3	... 10	18	2	3	... 11	20	0	3	... 12	21	10	<p>12 INCHES APART OR 14 INCHES FROM CENTRE TO CENTRE.</p> <table border="1"> <tbody> <tr> <td>2</td> <td>by 3</td> <td>3</td> <td>9</td> </tr> <tr> <td>2</td> <td>... 4</td> <td>5</td> <td>0</td> </tr> <tr> <td>2</td> <td>... 5</td> <td>6</td> <td>3</td> </tr> <tr> <td>2</td> <td>... 6</td> <td>7</td> <td>6</td> </tr> <tr> <td>2</td> <td>... 7</td> <td>8</td> <td>9</td> </tr> <tr> <td>2</td> <td>... 8</td> <td>10</td> <td>0</td> </tr> <tr> <td>2</td> <td>... 9</td> <td>11</td> <td>3</td> </tr> <tr> <td>2</td> <td>... 10</td> <td>12</td> <td>6</td> </tr> </tbody> </table>	2	by 3	3	9	2	... 4	5	0	2	... 5	6	3	2	... 6	7	6	2	... 7	8	9	2	... 8	10	0	2	... 9	11	3	2	... 10	12	6								
1	by 3	3	6																																																																																																															
1	... 4	4	8																																																																																																															
1	... 5	5	10																																																																																																															
1	... 6	7	0																																																																																																															
1	... 7	8	2																																																																																																															
1	... 8	9	4																																																																																																															
1	... 9	10	6																																																																																																															
1	... 10	11	8																																																																																																															
3	by 3	5	4																																																																																																															
3	... 4	7	2																																																																																																															
3	... 5	9	0																																																																																																															
3	... 6	10	10																																																																																																															
3	... 7	12	8																																																																																																															
3	... 8	14	6																																																																																																															
3	... 9	16	4																																																																																																															
3	... 10	18	2																																																																																																															
3	... 11	20	0																																																																																																															
3	... 12	21	10																																																																																																															
2	by 3	3	9																																																																																																															
2	... 4	5	0																																																																																																															
2	... 5	6	3																																																																																																															
2	... 6	7	6																																																																																																															
2	... 7	8	9																																																																																																															
2	... 8	10	0																																																																																																															
2	... 9	11	3																																																																																																															
2	... 10	12	6																																																																																																															
<p>12 INCHES APART OR 14 INCHES FROM CENTRE TO CENTRE.</p> <table border="1"> <tbody> <tr> <td>2</td> <td>by 3</td> <td>3</td> <td>9</td> </tr> <tr> <td>2</td> <td>... 4</td> <td>5</td> <td>0</td> </tr> <tr> <td>2</td> <td>... 5</td> <td>6</td> <td>3</td> </tr> <tr> <td>2</td> <td>... 6</td> <td>7</td> <td>6</td> </tr> <tr> <td>2</td> <td>... 7</td> <td>8</td> <td>9</td> </tr> <tr> <td>2</td> <td>... 8</td> <td>10</td> <td>0</td> </tr> <tr> <td>2</td> <td>... 9</td> <td>11</td> <td>3</td> </tr> <tr> <td>2</td> <td>... 10</td> <td>12</td> <td>6</td> </tr> </tbody> </table>	2	by 3	3	9	2	... 4	5	0	2	... 5	6	3	2	... 6	7	6	2	... 7	8	9	2	... 8	10	0	2	... 9	11	3	2	... 10	12	6	<p>11¼ INCHES APART.</p> <table border="1"> <tbody> <tr> <td>3</td> <td>by 3</td> <td>5</td> <td>10</td> </tr> <tr> <td>3</td> <td>... 4</td> <td>7</td> <td>10</td> </tr> <tr> <td>3</td> <td>... 5</td> <td>9</td> <td>10</td> </tr> <tr> <td>3</td> <td>... 6</td> <td>11</td> <td>10</td> </tr> <tr> <td>3</td> <td>... 7</td> <td>13</td> <td>10</td> </tr> <tr> <td>3</td> <td>... 8</td> <td>15</td> <td>10</td> </tr> <tr> <td>3</td> <td>... 9</td> <td>17</td> <td>10</td> </tr> <tr> <td>3</td> <td>... 10</td> <td>19</td> <td>10</td> </tr> <tr> <td>3</td> <td>... 11</td> <td>21</td> <td>10</td> </tr> <tr> <td>3</td> <td>... 12</td> <td>23</td> <td>10</td> </tr> </tbody> </table>	3	by 3	5	10	3	... 4	7	10	3	... 5	9	10	3	... 6	11	10	3	... 7	13	10	3	... 8	15	10	3	... 9	17	10	3	... 10	19	10	3	... 11	21	10	3	... 12	23	10																																									
2	by 3	3	9																																																																																																															
2	... 4	5	0																																																																																																															
2	... 5	6	3																																																																																																															
2	... 6	7	6																																																																																																															
2	... 7	8	9																																																																																																															
2	... 8	10	0																																																																																																															
2	... 9	11	3																																																																																																															
2	... 10	12	6																																																																																																															
3	by 3	5	10																																																																																																															
3	... 4	7	10																																																																																																															
3	... 5	9	10																																																																																																															
3	... 6	11	10																																																																																																															
3	... 7	13	10																																																																																																															
3	... 8	15	10																																																																																																															
3	... 9	17	10																																																																																																															
3	... 10	19	10																																																																																																															
3	... 11	21	10																																																																																																															
3	... 12	23	10																																																																																																															

Table of Calculations—continued.

12 INCHES APART.				12 INCHES APART.				12 INCHES APART.			
In.	In.	Cube.		In.	In.	Cube.		In.	In.	Cube.	
1½	by 3	2	5½	2½	by 3	4	2½	3½	by 3	5	9
1½	... 4	3	3½	2½	... 4	5	7½	3½	... 4	7	9
1½	... 5	4	1½	2½	... 5	7	0	3½	... 5	9	9
1½	... 6	4	11½	2½	... 6	8	5½	3½	... 6	11	9
1½	... 7	5	9½	2½	... 7	9	10½	3½	... 7	13	9
1½	... 8	6	7½	2½	... 8	11	3½	3½	... 8	15	6
1½	... 9	7	5½	2½	... 9	12	8½	3½	... 9	17	9
				2½	... 10	14	1½	3½	... 10	19	9
								3½	... 11	21	9
								3½	... 12	23	9

12 INCHES APART.				12 INCHES APART.				12 INCHES APART.			
1½	by 3	2	11	2½	by 3	4	7½	3½	by 3	6	2
1½	... 4	3	11	2½	... 4	6	2½	3½	... 4	8	4
1½	... 5	4	11	2½	... 5	7	9½	3½	... 5	10	6
1½	... 6	5	11	2½	... 6	9	4½	3½	... 6	12	8
1½	... 7	6	11	2½	... 7	10	11½	3½	... 7	14	10
1½	... 8	7	11	2½	... 8	12	6½	3½	... 8	17	0
1½	... 9	8	11	2½	... 9	14	1½	3½	... 9	19	2
				2½	... 10	15	8½	3½	... 10	21	4
								3½	... 11	23	6
								3½	... 12	25	8

12 INCHES APART.				12 INCHES APART.				12 INCHES APART.			
1½	by 3	3	4½	2½	by 3	5	0½	3½	by 3	6	4
1½	... 4	4	6½	2½	... 4	6	9½	3½	... 4	8	8
1½	... 5	5	8½	2½	... 5	8	6½	3½	... 5	11	0½
1½	... 6	6	10½	2½	... 6	10	3½	3½	... 6	12	2½
1½	... 7	8	0½	2½	... 7	12	0½	3½	... 7	14	4½
1½	... 8	9	2½	2½	... 8	13	9½	3½	... 8	16	6½
1½	... 9	10	4½	2½	... 9	15	6½	3½	... 9	18	8½
1½	... 10	11	6½	2½	... 10	17	3½	3½	... 10	20	10½
								3½	... 11	23	0½
								3½	... 12	25	2½

1804. The following are calculations of the cubical contents of timber in various roofs in a square of 100 feet:—

Ft. In.	Cube. Ft. In.	QUEEN-POST ROOF, Fig. 990.	Area. Ft. In.
32 0	11 1	Tie-beam <i>a</i> , 10 in. by 5.	
10			
5			
30 0	9 4	Principals <i>f f</i> and Straining-beam <i>g</i> , 9 in. by 5.	
9			
5			
12 6	3 0	Queen-posts <i>h h</i> , 7 in. by 5.	
7			
5			
8 0	1 4	Struts <i>i i</i> , 5 in. by 5.	
5			
5			
	24 9	Cubic feet in all.	144 0 Feet superficial

15 feet 10 inches cube in 1 square.

Fig. 990.

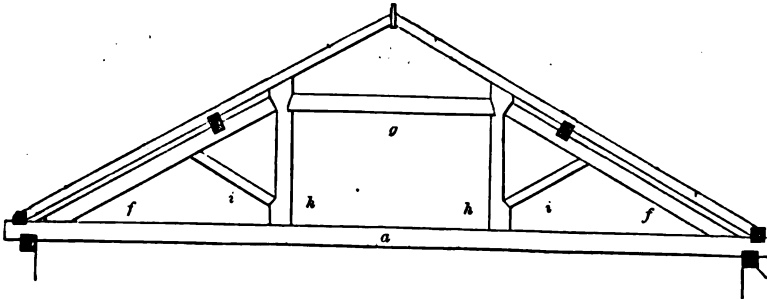

QUEEN-POST ROOF—SCALE, $\frac{1}{2}$ INCH TO THE FOOT.

Ft. In.		Cube.		King-Post Roof, Fig. 991.		Area.	
Ft.	In.	Ft.	In.			Ft.	In.
27	0	7	6	Tie-beam <i>c c</i> , 10 in. by 4.	}	13	6
10	4	7	0	Principals <i>f f, f f</i> , 9 in. by 4.		8	0
28	0	1	2	King-post <i>e e</i> , 6 in. by 4.		<hr/>	
9	4	1	4	Struts <i>g g</i> , 4 in. by 4.		108 0 Feet superficial.	
7	0	17	0	Cubic feet in all.			
12	0			16 feet cube in 1 square.			
4	4						

Fig. 991.

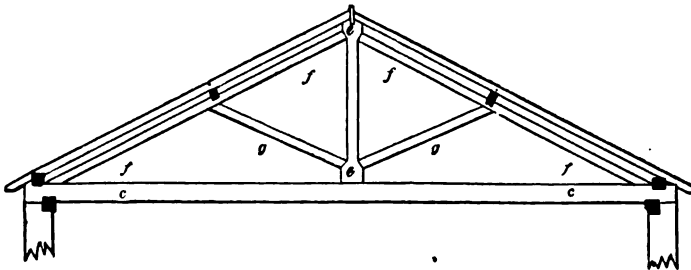

KING-POST ROOF—SCALE IN FIG. 990.

Ft.	In.	Cube.
21	0	Ft. In.
	8	3 6
	3	
<hr/>		
24	0	3 0
	6	
	3	
<hr/>		
12	0	9
	3	
	3	
<hr/>		
		7 3

TIE-BEAM ROOF, Fig. 992.

Tie-beam *bb*, 8 in. by 3.

Principals *dd*, 6 in. by 3.

Struts *ee* and Foot-piece *f*, 3 in. by 3.

Cubic feet in all.

9 feet 1 inch cube to 1 square.

Area.
Ft. In.
10 6
7 6

78 9 Feet superficial.

Fig. 992.

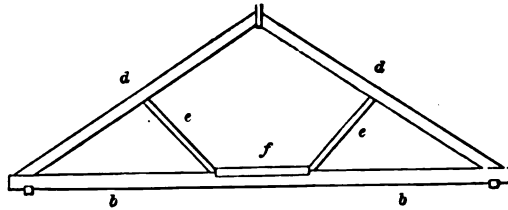

TIE-BEAM ROOF.

Ft.	In.	Cube.
27	0	Ft. In.
	5	1 10
	2	
<hr/>		
13	0	10
	5	
	2	
<hr/>		
		2 8

COLLAR-ROOF, Fig. 993.

Rafters *aa*, *dd*, 5 in. by 2.

Collar *e*, 5 in. by 2.

Cubic feet in all.

3 feet 9½ inches cube to 1 square.

Area.
Ft. In.
10 0
7 0

70 0 Feet superficial.

Fig. 993.

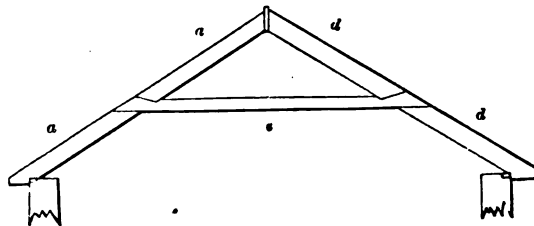

COLLAR-ROOF.

1805. These are the calculations of the cubical contents of timber in partitions in a square of 100 feet.

Ft. In.		Cube.	PARTITION, Fig. 994.	
Ft.	In.	Ft. In.		
2.28	0	11	8	Head <i>b a</i> , Sill <i>d c</i> , 6 in. by 5.
	6			
	5			
7	0	1	2	Door Heads <i>g g</i> , 5 in. by 5.
	5			
	5			
4.9	0	7	6	Posts <i>e f</i> , 6 in. by 5.
	6			
	5			
8	0	1	11	King-post <i>k</i> , 7 in. by 5.
	7			
	5			
2.12	0	4	2	Struts <i>h h</i> , 5 in. by 5.
	5			
	5			
10	0	1	0	Puncheons <i>i i</i> , 5 in. by 3.
	5			
	3			
18.9	0	16	0	Quarters <i>l l</i> , 5 in. by 3.
	5			
	3			
		43	5	Cubic feet in all.

15½ cube feet to 1 square.

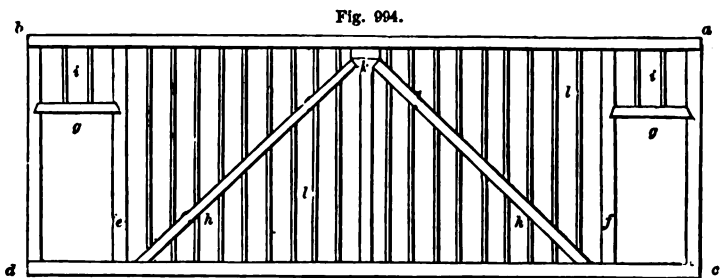

PARTITION.

1806. Purlins, ridges, to be measured separately, not being included as parts of the "Truss."

1807. SECTION FIFTH—*Wrought-Iron Girders and Beams*.—The following, on the sizes, weight per foot run, and breaking-weight of wrought-iron beams, of which the section is in fig. 619, p. 380, will be useful. The beams are manufactured by Messrs Matthew, Ledward, & Co. of Liverpool; and the results named have all been confirmed by experience. We are indebted to the above firm for the data given below. They are given only for distances of 17 feet 9 inches between the supports; the beam being laid in the wall 7½ inches on each side. The weight on the fifth column is that which the beam will bear

when suspended from a pressing upon its centre; the last column shows the weight which the same will bear when it is distributed over its surface:—

Weight in lb. per lineal foot.	Depth of Beam.	Width of Upper Flange and Lower Flange.	Thickness of Central Rib.	Breaking Weight in lb. at centre.	Breaking Weight uniformly distributed.
	Inches.	Inches.	Inches.		
44	11 $\frac{3}{4}$	4 $\frac{1}{2}$	$\frac{1}{2}$	16,082	26,840
57	11 $\frac{3}{4}$	5	$\frac{3}{4}$	21,120	35,200
42	9 $\frac{3}{4}$	4 $\frac{3}{4}$	$\frac{3}{4}$	12,760	21,340
27	9 $\frac{3}{4}$	4 $\frac{1}{2}$	$\frac{3}{4}$	8,270	13,730
26	7 $\frac{3}{4}$	4 $\frac{3}{4}$	$\frac{3}{4}$	6,290	10,450
34	7 $\frac{3}{4}$	2 $\frac{1}{2}$	$\frac{3}{4}$	8,270	13,790
13	4 $\frac{1}{2}$	3 $\frac{1}{2}$	$\frac{1}{2}$	1,980	3,300
18	4 $\frac{1}{2}$	3 $\frac{1}{2}$	$\frac{3}{4}$	2,880	4,450

1808. Beams subjected to the extreme strain indicated in the above, will retain their elasticity, but may become deflected to a greater extent than may be desirable. To avoid all risk, it will be better to reduce the loads to one-half the above. By increasing the thickness of the beams, they will be able to resist greater weights. As, in some instances, it may be necessary to retain the depth of any given beam, and yet to enable it to resist greater pressure than given in the table, the following rule will give the increased weight to be given to the beam per foot: To enable, for instance, the beam, 11 $\frac{3}{4}$ inches deep, to bear 50,000 lb. in place of 26,840 lb., as above given, what addition must be made to the weight of 44 lb. to the lineal foot? The following proportion will give it:—26,840 : 44 :: 50,000 : is to the weight required. Again, supposing it is desired to know what weight a beam will support, 9 $\frac{3}{4}$ inches deep, but weighing 60 lb. to the lineal foot, in place of 42, as above given, the following proportion will give the result required:—42 lb. : 21,340 :: 60 : is to the number of pounds the beam will bear.

1809. *Weight of Round Iron Bars used as Tension-Rods for Roof-Trusses, in 1 Foot Lengths.*—Diameter $\frac{1}{2}$ inch, weight 10 $\frac{1}{2}$ oz.; diameter $\frac{3}{8}$ inch, weight 16 oz.; diameter $\frac{1}{2}$ inch, weight 23 $\frac{1}{2}$ oz.; diameter $\frac{7}{8}$ inch, weight 32 oz.; diameter 1 inch, weight 41 $\frac{1}{2}$ oz.; diameter 1 $\frac{1}{8}$ inch, weight 53 oz.—3 lb. 5 oz.; diameter 1 $\frac{1}{4}$ inch, weight 65 $\frac{1}{2}$ oz.—4 lb. 1 $\frac{1}{2}$ oz.; diameter 1 $\frac{3}{8}$ inch, weight 79 oz.—4 lb. 15 oz.; diameter 1 $\frac{1}{2}$ inch, weight 95 oz.—5 lb. 15 oz.

1810. *Weight of Lead per Foot Superficial.*—Where the thickness is $\frac{1}{8}$ inch, the weight is 3 lb. 12 oz. to the foot; where $\frac{1}{4}$ inch thick, the weight is 7 lb. 8 oz.; where $\frac{3}{8}$ inch thick, the weight is 14 lb. 12 oz.; where $\frac{1}{2}$ inch thick, the weight is 19 lb. 12 oz.

1811. *Surface covered by 1 cwt. of Lead of a given Weight to the Foot.*—Where the weight of the lead is 4 lb. to the foot superficial, 112 lb. will cover 28 feet superficial; where 6 lb. to the foot, 112 lb. will cover 22 feet 5 inches superficial; where 6 lb. to the foot, 112 lb. will cover 18 feet 8 inches. The above are for "milled lead." Where "cast lead" is used at 7 lb. to the foot superficial, 112 lb. will cover 16 feet superficial; where the weight is 8 lb. to the foot, 112 lb. will cover 14 feet; 9 lb. to the foot, 112 lb. will cover 12 feet 5 $\frac{1}{2}$ inches; 10 lb. to the foot, 112 lb. will cover 11 feet 3 inches; 11 lb. to the foot, 10 feet 2 inches will be covered; 12 lb. to the foot, 9 feet 4 inches will be covered by the 112 lb. The reader desirous to know the price of "building materials," should consult Taylor's or Laxton's *Builders' Price-Book*, published annually.

SUBDIVISION FIFTH. — *Glossary or Explanation of some of the Terms used in Artificers' Work, as Bricklaying, Masonry, Carpentry, Joinery, Slating, Plastering, and Plumbing.*

1812. SECTION FIRST—*Glossary.*—The following must only be taken as a contribution—and a slight one—to a department of constructive literature which is singularly deficient in complete works. Many causes, however, exist to render the task of compiling a full “dictionary of terms” a peculiarly difficult one; the most important of which is, that not only in each of the three countries, as England, Scotland, and Ireland, but in many of their separate counties or districts, a set of nearly totally different terms are used. Indeed, so marked is the discrepancy between the technicalities of one district and those of another, even in the same country, that many of the terms inserted in a specification fitted for the practice of the one would be quite unknown in the other. A writer in the *Building News* puts the matter so pointedly and so well, that we cannot do better than avail ourselves of his remarks:—

“These are days of railway locomotion and telegraphic converse, which in a few generations *may* have the salutary effect of reducing to one uniform standard the phraseology of both London and provincial builders—nay, it may even destroy eventually those troublesome discrepancies that exist between town and country weights and measures. Much might be written on these discrepancies: they are well known to all town architects of extensive practice, as discrepancies that often produce great confusion and misunderstanding. Thus, while a London builder values his walls by the superficial ‘reduced rod,’ and assumes them to be $1\frac{1}{2}$ brick in thickness, in the south-west counties we find the walls valued by the *lineal* ‘rope;’ and in the northern they are again estimated by *superficial* measurement, but instead of the *rod* of $1\frac{1}{2}$ brick thick, by the square yard of 1 brick in thickness. In short, a literary comparison of the different modes of measuring a wall that prevail in the several counties of England, would create no small amazement in the minds of those town architects who have never thought much on the subject. It is in its entirety a vast question and a curious, which at present we will not further enter upon.

“Our remarks mainly apply to the mere local phraseology or trade dialect of the provincial builders, of which, as we have just said, a glossary is needed—that is to say, of the *patois* which affects *only* the nouns representing the several artificers’ works connected with building operations. A glossary of every dialectal *expression* is not our aim, since *that* would be altogether too formidable an affair. Whole sentences of *patois* must be left to time, the tram, and the telegraph to deal with; and London architects travelling into the north to look after their works must take their chance; and when they hear their contractor ordering his men to ‘*get a gate and fettle t’midden,*’ must construe the mysterious order into ‘set to work and repair the cesspool’ as they best may, with the aid of some local interpreter; but actual nouns referring to building, and which are to appear in his specifications and letters of instruction during progress of work, are matters of serious consequence, deserving of a glossary or short dictionary, such as should, as the book-reviewers say, ‘form a portion of every architect’s library.’”

1813. We have in the title to this Subdivision used the expression, “of some of the terms.” This has been done advisedly, and for the reason so well stated in the above extract. The majority, however, of “metropolitan” building phrases will be met with in our list, and also of those which are generally used by writers on the constructive arts. In this way, and so far as they go, our list of “explanations” will, we trust, be in some degree useful. We have inserted a few of the Scottish terms, and also of those used in the important dis-

tricts of Lancashire. For these last we are mainly indebted to an article in the *Building News* for July 20, 1860; from which we have made the above extract. The glossary is as follows:—

A

ABBEVOIR (used in masonry).—The space between two adjoining stones, to be filled with mortar.

ABUTMENTS (masonry).—The supporting or side walls of an arch are so termed.

ABUTTING JOINT (in carpentry).—The junction of two pieces of timber, of which the fibres of one are at right angles, or an obtuse angle to those of another. See par. 1163, p. 289.

ANGLE FLOAT (in plastering).—The part made at the internal angle formed by the junction of two sides of the room.

ANGLE OF EQUILIBRIUM IN REPOSE, in materials.—That angle at which the materials will stand without slipping down or falling. The angles for different materials are assumed to be as follows:—

Fine dry sand.....	35°
Gravel.....	37°
Dry loose shingle.....	39°
Dry common earth.....	47°
Earth slightly damp.....	54°
Earth of the strongest and most compact nature.....	55°

The term, when used in construction, has reference to that point to which an arch can sustain itself without centring.

ANGLE OF HIP RAFTER (in carpentry).—The short rafters used at the angles of a hip-roof. See figs. 417, 418, p. 305.

ANGLE-RAFTER (in carpentry).—A term equivalent to "hip-rafter," *Scottish* "piend-rafter."

APOPHYGE.—See **MOULDINGS**.

APRON (in plumbing).—A term used in Scotland equivalent to **FLUSHING**, which see.

ARCH (in masonry and bricklaying).—The curved part of a building placed over an opening. Arches used in buildings are of various kinds—as semicircular and elliptic. A "scheme-arch" is that in which the soffit or under side is less than a semicircle. An "invert" or "inverted arch" has the arch described from a centre or centres above the arch; it is usually adopted in basements where the foundation is not deemed very secure. A "relieving arch" is placed over the lintel of an opening to ease it of the pressure. For a description of the various parts of an arch, see par. 964, p. 219.

ARCHITRAVE (in joinery).—The moulded part fixed round a window or door opening, as in fig. 519, p. 332.

ARK (in masonry).—The pit in which is placed the water-wheel of a mill.

ARRIS (in joinery).—The corner formed by the meeting of two surfaces, placed at an angle to each other.

ARRIS-FILLET (in slating).—See **TILTING-FILLET**.

ASHLAR (in masonry).—The hewn stone used in fronting buildings of a superior kind.

ASPLETS (in carpentry).—The vertical strips of wood or studs placed at the sides of an attic room, dividing the angular parts formed by the slope of the roof, and forming straight or vertical sides to the apartment.

ASTRAGALA.—Sash-bars which support the frames of glass. See fig. 492, p. 322.

ATTIC.—See **GARRET**.

B

BACK-FILLET (in masonry).—The projecting margin of a door-jamb.

BACK FLAPS (in joinery).—The additional pieces *a a*, fig. 995, attached to the front shutter when that is not broad enough to cover the window.

Fig. 995.

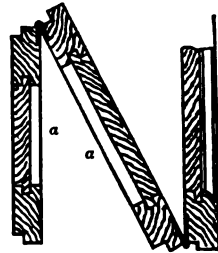

BACK FLAPS.

BACK OF A SLATE.—Its upper side.

BACKER.—Where the slates begin to narrow, the narrow slate placed on the upper side of a broad slate is termed the backer.

BACKS (in carpentry).—Lancashire name for the "principal" rafters of a roof.

BALUSTERS (in joinery).—Vertical bars placed in the treads of a stair to support the handrail above. See figs. 461-3, p. 316.

BANDS (in ironmongery).—A north of England term used to designate "strap-hinges."

BARGE BOARDS (in joinery).—The ornamented raking or inclined boards at the gable of a building.

BARRED DOOR (in joinery).—Scotch term for "ledged door."

BASTARD STUCCO (in plastering).—Three-coat plaster.

BATTEN (in carpentry).—Pieces of wood are so called which measure from 1 to 7 inches in breadth, and $\frac{1}{2}$ to $1\frac{1}{2}$ inch in thickness.

BAULK (in carpentry).—A Scotch term equivalent to "tie-beam" or collar.

BAY.—A plaster rib made to regulate the floating rule; it is formed between the screens.

BEAD.—See **MOULDINGS**.

BEAD-BUTT (in joinery).—Where the bead is worked all round on the edge of the panel.

BEAD-FLUSH.—In this case the bead is worked all round the edge of the frame in which the panel is inserted.

BEAM (in carpentry and iron-framing).—The timber or beams placed horizontally, to sustain weights or resist pressure. See fig. 323, p. 281, for timber, and figs. 607-10, p. 375, for iron beams.

BEAM-FILLING (in masonry or brickwork).—The operation of filling in the spaces between timbers with bricks or stones, is so called.

BEAM-FILLED (in bricklaying).—Where the interstices between beams, rafters, &c., are filled in with bricks and mortar, they are said to be "beam-filled."

BEARING.—The span or space in the clear between the supports of a beam. The term is also used to designate the hold which a beam has of the wall on which it rests.

BEARING WALL (in bricklaying or masonry).—The wall which supports a superincumbent part, and having a solid foundation. *See* fig. 192, p. 218.

BED OF A SLATE.—Its lower side.

BEDDING BRICKS.—Disposing them horizontally in a wall.

BEDDING TIMBERS.—Fixing various timbers, as the linings of doors and windows, in lime-and-hair mortar.

BRIDGING-JOISTS (in carpentry).—The transverse beams of a floor, carrying the bridging-joists placed above at right angles. *See* fig. 381, p. 293.

BINDING-RAFTERS.—*See* PURLINS; *see* fig. 370, p. 290.

BIRD'S MOUTH.—The joint formed by cutting an angular piece out of the foot of a rafter, so that it will rest or abut upon the wall or pole plate.

BLOCKINGS.—The solid parts placed behind, to strengthen the angles formed by the junction of two pieces of timber, *a b* or *b c*, fig. 996.

Fig. 996.

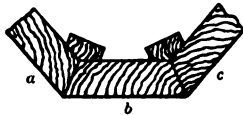

BLOCKINGS.

BOLECTION MOULDING (in joinery).—Mouldings which project above the surface of the framing.

BOND.—The manner of disposing bricks in different courses. "Flemish Bond" consists in forming every course with headers and stretchers alternately; "English Bond," in forming each course alternately of headers and stretchers throughout. *See* par. 953, p. 215.

BOND (in masonry).—Is placing the stones so that they lap one upon another, the joints of two below being covered with the solid part of the one above, the whole forming a compact mass.

BOND or LAP OF A SLATE.—The distance between the nail of the under and the lower edge of the upper slate.

BOND TIMBERS.—Pieces of timber placed horizontally between the courses of brick or stone, to unite together.

BOSGIN.—The Lancashire name for stall space in a cow-byre or stable.

BOXINGS.—The cases or recesses at the sides of a window, into which the shutters fold back. *See* fig. 514, p. 331.

BRACE (in carpentry).—A strut placed at an angle to support another and inclined piece, as a rafter, or placed between the uprights of a partition or framing to strengthen it. *See* fig. 405, p. 301.

BRACKET.—A small support against a wall, usually ornamented.

BREAKING JOINT.—Placing stones or bricks so that the solid parts of one course shall fall upon the joints of the course below.

BREASTS OF A CHIMNEY.—The solid parts of the wall between the room and the chimney-flue.

BREASTS OF THE RYBETS or REBATES (in masonry).—A Scotch term equivalent to REVEALS, which *see*.

BRESTSUMMER.—A beam placed over a void or opening, and which supports the wall over.

BRICKNOGGING.—Filling in the spaces between the quarters of a wooden partition with bricks set in mortar.

BRIDGED GUTTER.—Gutters in which the boards are supported by bearers. *See* fig. 443, p. 312.

BRIDGING (in carpentry).—The Lancashire term for strutting a floor. *See* DWANGS.

BRIDGING-JOISTS.—The beams in a floor supporting the flooring-boards. *See* fig. 381, p. 293.

BRIDLE-JOIST.—*See* TRIMMING-JOISTS.

BRINGING FORWARD (in painting) means the priming and painting of new or old work, so that all the surface shall have a uniform appearance on being finished.

BROACHED.—A Scotch term in masonry, in which the face of ashlar is worked in narrow parallel horizontal stripes with a pointed chisel.

BUILDING BEAMS.—Securing two or more beams together, in order to increase the depth, forming a deep beam out of two or more shallow ones. *See* figs. 376, 377, p. 292.

BULL-NOSED BRICKS (in brickwork).—Bricks having one angle rounded.

BURRS.—Clinker-bricks.

BUTMENT-CHEEKS.—The solid parts on each side of a mortise-hole. *See* fig. 340, p. 284.

BUTT AND BEN.—A term used in Scotland to designate a cottage or house with two rooms, as kitchen and bedroom; the bedroom end of the house is called the "ben," the kitchen the "butt."

BYRE.—Cow-house. *See* also SHIPPEN.

C

CAMBER (in carpentry).—When a beam is raised in the centre, making the upper side convex and lower concave, it is said to be cambered. Cambering is done to strengthen the beam and to prevent it becoming straight under the pressure which it has to sustain.

CANT-MOULDING (in joinery).—A moulding with a bevelled face is so called.

CANTALIVERS (in carpentry).—The pieces of timber which project at right angles to the walls and at the upper parts, to support the eaves or gutter-boarding, are so called. *See* fig. 441, p. 311.

CARRIAGE OF A STAIR (in carpentry).—The beams at the side which carry the steps. *See* fig. 456, p. 315.

CASEMENT-MOULDING (in joinery).—A "hollow" or concave moulding.

CAVETTO (in joinery).—*See* MOULDINGS.

CEILING-JOISTS.—Small beams to which the ceiling of a room is attached.

CHAMFERED (in joinery or masonry).—The edge or corner of a piece of wood or stone cut in a sloping or angular direction, is said to be chamfered. *See* SPLAYED BRICK.

CHAMFERING (in joinery).—Cutting off the corner formed by the junction of pieces of timber at right angles, so that the edge should be sloping or bevelled.

CHECKED (in joinery and masonry).—A term used in Northumberland and Scotland, equivalent to "rebated."

CHEEKS (in masonry).—A north of England term, equivalent to "jambes."

CHIMNEY.—*See* FLUES. Where there is only one it is named a chimney "shaft;" where more than one, a "stack" of chimneys.

CLAMP (in joinery).—The cross-piece uniting a

number of pieces of wood placed side by side, as is *a* to *b*, fig. 997, and which are at right angles to the cross-piece. The ends of the pieces of wood have tongues *c*, which pass into the groove made in the edge of the cross-piece *d*.

Fig. 997.

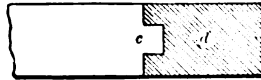
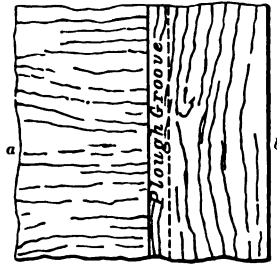

CLAMP.

CLEARCOLE (in painting).—The cheapest kind of painting is so called; the holes are first filled up with putty, then a coat of whiting and size is given, the whole finished with a coat of lead oil-colour.

CLENCHING NAILS.—Bending back the ends which pass through to the reverse side of the timber.

COARSE STUFF (in plastering).—A mixture of lime and hair used in floating, and also in the first course of plastering.

COAT (in plastering and painting).—Being one layer of plaster or paint.

COCK-BEAD.—See **MOULDINGS**.

CODDINGS (in masonry).—A Scotch term, designating the footings of the jambs of ground-floor chimney-pieces.

COLLAR.—The horizontal piece which connects rafters at any place above their ends.—See **BAULK**.

COLLAR-BEAMS (in carpentry).—The horizontal pieces framed into and between the heads of queen-posts and rafters. See fig. 400, p. 299, and fig. 407, p. 301.

CONGEE.—See **MOULDINGS**.

CONTRACT.—The agreement upon which the buildings are constructed.

CORBELS (in masonry).—Stones projecting from a wall, on which to support beams. The last stones in the coping of a gable end, and the eaves are also so called, and which serve as the abutment for the skew or gable coping.

CORNERS.—The square ashlar stones which lie at the corner of two walls and unite them.

CORNICE.—Congeries of mouldings which crown or finish any composition externally or internally.

COUNTER LATH.—The third lath placed between two gauged ones is so called.

COUPLES (in carpentry).—The principal rafters of a roof. The term is Scottish.

COUPLES (in carpentry).—Rafters framed together in pairs; a tie is usually provided, uniting their feet, the whole forming one of the simplest forms of truss. See fig. 403, p. 300.

COURSING.—A Scotch term in masonry, in which all the stones of a course are of one thickness.

CRESTING (in slatery).—Ornamental ridge-tiles well finished.

CROSS-TAILED HINGES (in ironmongery).—Hinges provided with a long piece fixed to the door, and a shorter cross-piece fixed to the frame. See figs. 696, 697, p. 405.

CROW-STEPS (in masonry).—The coping of a gable in the form of steps.

CROWN-POST (in carpentry).—A term equivalent to king-post.

CURB-ROOF (in carpentry).—A mansard-roof. See fig. 421, p. 306.

CURTAIL STEP (in joinery).—The lowest step of a staircase, the outer end of which is usually formed spirally.

CYMA-RECTA.—See **MOULDINGS**.

CYMA-REVERSA.—See **MOULDINGS**.

D

DEAFENING.—A Scotch term equivalent to **PUGGING**, which see.

DEAL (in joinery).—The standard thickness of deals is $1\frac{1}{2}$ inch, standard length 12 feet, usual breadth 9 inches.

DOG-LEGGED STAIRS (in carpentry).—Stairs in which there is no well-hole.

DOOKS (in carpentry).—A Scotch term for wood bricks built into the wall at intervals to receive nails for standards. See **NOGS**.

DOOR-FRAME (in joinery).—The casing of a door into which it shuts. See fig. 473, p. 318.

DOORS.—See figs. 464-85, p. 317.

DORMER WINDOW.—Used in a roof to light an attic; the frame is set vertically. See fig. 436, p. 310.

DOTS (in plastering).—Patches of plaster placed in the line of screed and bags to regulate the floating rule.

DOUBLE-HUNG SASHES (in joinery).—Windows in which the upper and lower sashes are alike suspended by lines and weights.

DRAG.—A tool used in masonry to work the surface of freestone, consisting of a thin steel blade, with fine teeth on one of its edges.

DRAGON TIE OR PIECE (in carpentry).—The angular piece placed near the junction of two wall-plates, to support the end of the hip-rafter in a hipped roof. See fig. 411, p. 302.

DRIFT (in masonry).—The horizontal thrust of an arch upon the buttment walls.

DRIPS (in plumbing).—Making gutters or flats; the drips are formed at the joints of the end, by turning up the edge of one piece and putting the other over it.

DROP-SPOUT.—Lancashire term for the "down spout" or "rain-water trunk," leading off rain-water from gutters to drains.

DROVED (in masonry).—A term used in Scotland to designate tooled flat work.

DUBBING OUT (in bricklaying).—Where the surface is uneven, it is levelled for plastering by using tiles.

DWANGS (in carpentry).—The Scotch name for the struts of a floor. See **STRUTS**.

E

EASING.—The Scotch term for eave.

EAVE (in slating).—The lower edge of the slates which project over the wall.

ELBOWS OF A WINDOW (in joinery).—The two side panels under the front shutter.

EXTERNAL CORNERS (in masonry).—The Scotch term equivalent to **QUOINS**, which see.

EXTRADOS.—The upper or convex part of an arch. See fig. 195, p. 219.

F

FACINGS (in joinery).—The linings of woodwork which cover the rough surfaces of interior walls.

FANG.—The narrow part of any tool which is inserted into the handle.

FEATHER-EDGED BOARDS.—Boards, one edge of which is thicker than another. They are used for covering the sides of sheds or of wooden roofs. See fig. 589, p. 370.

FILLET.—See **MOULDINGS**.

FILLING-IN PIECES (in carpentry).—The short timbers of a roof, or the studs over the door-head of partitions. See *e e*, fig. 386, or *i i*, fig. 384, p. 295.

FINE STUFF (in plastering).—Is composed of slaked lime, sifted and mixed with hair, and sometimes fine sand.

FIRST COAT (in plastering).—This is known by various terms; where in two-coat work the first coat is laid upon laths, it is termed "laying," if on brick, "rendering;" if three-coat work, it is called, if laid on lath, "pricking up;" and "roughing in," if laid on brick.

FIRST-PIECE (in carpentry).—Lancashire name for the ridge-piece, as *j*, fig. 406, p. 301.

FLOAT.—A tool used in plastering to bring the second coat of three-coat work to a fair surface.

FLOATED LATH AND PLASTER.—Three-coat work for papering. The first coat is termed "pricking up," the second, "floating," the third coat is pricked up.

FLOATED WORK (in plastering).—Work "roughed in" or "pricked off" floated and set.

FLOORS.—See figs. 380-82, pp. 292, 293.

FLOOR OF A HOUSE (in plans).—In Scotland the "first floor" is the ground-floor; in England the term is used to designate the "bedroom" or "second floor" plan. In England, in a house of three storeys, the first bedroom floor is sometimes called "one pair plan;" the second, the "two pair plan." In all plans, the ground-floor is termed the "ground-plan." The "cellar-plan" shows the accommodation below the ground-floor. Cellars are rarely used in Scotland, except in towns.

FLUES OR FUNNELS (Vents, *Scotticè*).—The tubes or channels formed vertically in walls to carry off the smoke from fireplaces.

FLUSHINGS (in plumbing).—Pieces of milled lead. They are fixed round the edge of lead gutters or flats—one edge being fixed into the brickwork, the other edge being dressed over the lead. Flushings are also used round chimney-stalks, hips, ridges, &c.

FOOTINGS (in bricklaying or masonry).—The lowest courses in a wall; they project out beyond thickness of the same, so as to give ample bearing surface. See fig. 150, p. 208, and fig. 177, p. 215.

FOOT-PACE (in joinery).—The landing-place at the end of a flight of steps in a stair.

FOUNDATION.—See figs. 147, 148, p. 207.

FRAMED AND BRACED DOOR (in joinery).—See fig. 466, p. 317.

FRAMED DOOR (in joinery).—See fig. 469, p. 317.

FRAMES (in joinery).—The wood casings or linings round door and window openings.

G

GABLE.—The triangular finish to the end wall of a house.

GABLE COPING (in masonry).—The stone coping of the gable of a building terminating the slate-work. See **SKEW**.

GAGE (in plastering).—A mixture used for forming mouldings, and for the last coat of ceilings; it is made either of plaster and course, or plaster and fine, stuff.

GARRET.—An apartment next the roof of a house, in which the ceiling is *inclined* to the sides. It is sometimes used as synonymous with "attic," which designates, however, or should designate, an apartment next the roof, in which the ceiling is *square* to the sides of the room.

GATHERING (in bricklaying).—The narrowing of the flue above the fireplace opening, bringing it into the proper dimensions of the flue.

GAUGE (in tiling).—The distance between the first and the third laths—the second lath is placed between.

GAUGED ARCH (in bricklaying).—Has the bricks of which it is composed radiating from the centre.

GIBLET-CHECK (in masonry).—A term used in Scotland to designate the "rebate" or "check" cut in the jamb and lintel of the door, to admit of the door-frame falling into. See *d e*, fig. 545, p. 353.

GIRDER.—In a framed flooring the beam of largest dimensions supporting the binding-joists. See *a*, fig. 382, p. 293.

GRAINING (in painting).—Imitating the surface of expensive woods in paint is so called.

GRUIP.—The Scotch term for the gutter running along the floor in front of cattle or horse stalls.

GROOVING (in joinery).—The cutting out in the edge of a piece of timber, of a part rectangular in section.

GROUND-PLATE (in carpentry).—The lowest beam in which the mortise-holes are cut to receive and support the upper timbers.

GROUNDS (in carpentry).—Pieces of wood built into the wall, which receive the nails used for fixing the linings. To give a hold to the plaster, they should be grooved on their outer edges.

H

HACKING (in masonry).—Where the stones in a wall are not of uniform size, and the beds thus on different levels, the irregularity in the courses thus formed is named hacking.

HALF-SPACE.—See **FOOT-PACE**.

HAMMELS.—The term used in Scotland to designate the arrangement for sheltering store cattle, consisting of a small shed with a small court attached.

HAMMER-DRESSED.—Stones are so when trimmed with the hammer.

HANDRAIL (in joinery).—The rail at the side of a staircase, placed next the well-hole, *b c*, fig. 998; *a* is section of a handrail.

Fig. 998.

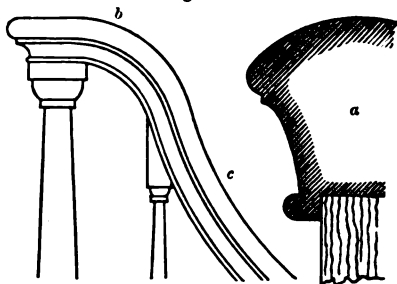

ELEVATION AND SECTION OF HANDRAIL.

HANGING-STYLE (in joinery).—That side of the frame of a door to which the door is hinged.

HARLING.—The Scotch term for rough-cast. *See* **ROUGH-CAST**.

HAWKE (in plastering).—An implement for holding the plaster; it consists of a square board, with a handle placed at its lower side.

HAWKE.—The Scotch term for the pronged implement for mixing hair in plaster-lime.

HEADERS (in bricklaying).—The bricks in a wall placed at right angles to the face or length of the wall. In masonry, it denotes the stones which are placed with their greatest length transversely to the wall. *See* *a*, fig. 176, p. 214.

HEART-BOND (in masonry).—The lapping of one stone above two others, forming together the thickness of the wall.

HIP-ROOF (in carpentry).—In this form of roof the ends are inclined at the same angles as the sides. *See* fig. 392, p. 297.

HOD.—A short angled trough with a handle, for carrying mortar upon the shoulder.

HOLING (in slating).—Making the holes in slates for the insertion of nails.

HOLLOW WALL.—Walls either of brick or of stone, having a central cavity. *See* fig. 197, p. 220. In some cases they are formed of hollow bricks. *See* fig. 201, p. 221.

HOUSINGS (in carpentry).—The spaces made in the timber, into which other pieces are inserted.

I

IMPOST (in masonry).—The upper part of a pier, from which the arch springs.

IN-BAND (in masonry).—A term used in Northumberland and Scotland to designate a "header."

INTER-JOIST (in carpentry).—The space between two contiguous joists.

INTERTIE (in carpentry).—The horizontal timber, as *e e*, fig. 385, p. 295, placed between the sill *d c* and the head *a b*.

INTRADOS (in masonry).—The under side or concave portion of the arch. *See* fig. 195, p. 219.

J

JACK-RAFTERS (in carpentry).—The short rafters which are used in filling in the spaces at the hip of a roof. *See* fig. 418, p. 305.

JAMB-LINING (in joinery).—The lining to jambs, or sides of window or door openings.

JAMES (in bricklaying and masonry).—The vertical sides of any aperture, as door or window.

JOGGLED JOINTS (in masonry).—Joints are said to be joggled when they are interlined or jointed

together, that one cannot be forced from the other by lateral pressure. *See* fig. 159, p. 211.

JOGGLE-PIECE (in carpentry).—The foot of a rafter or vertical timber which is bevelled to receive the feet of the inclined struts. *See* *e*, fig. 406, p. 301.

JOINTS.—For a description of the various joints used in framing timbers together, see paragraphs 1133 to 1168, pp. 281-90.

JOISTS (in carpentry).—Horizontal beams to support the flooring boards placed parallel to and at a certain distance from each other, their outer extremities resting upon the walls.

K

KEYS (in joinery).—Pieces of wood let into the back of a number of pieces to prevent them from warping or twisting.

KEY-STONE (in masonry).—The centre stone of an arch.

KING-POST (in carpentry).—The central timber in a roof-truss, against the foot of which the struts or braces abut. *See* *e e*, fig. 406, p. 301.

L

LANDING (in carpentry).—The part of a staircase level with the floor of the room.

LATH-BRICKS.—Bricks of dimensions larger—22 inches by 6—than the ordinary size.

LATH-LAYED AND SET (in plastering).—This term is used to designate two-coat work, in which the last is roughened or scored.

LATHS (in plastering).—Strips of wood nailed to the ceiling-joists of floors and the vertical timbers of partitions. The laths are not placed close up edge to edge, but have spaces left between; into these spaces the mortar is pressed, and forms a key by which it is retained to the face of the lathwork. Laths have different designations, as "single lath," "lath and half," and "double lath." They are also of different lengths, as "three" and "four feet."

LAYING (in plastering).—The placing in of the first coat, the surface of which is roughened with a broom, not scored.

LEAN-TO ROOF.—*See* **PENT-ROOF**.

LEDGED AND BRACED DOOR (in joinery).—*See* fig. 465, p. 317.

LEDGED DOOR (in joinery).—*See* fig. 464, p. 317.

LEDGERS (in bricklaying).—The horizontal poles or beams lashed to the upright standards to support the putlogs. *See* **PUTLOG**.

LENGTHENING TIMBERS.—For illustrations of methods of lengthening timbers, otherwise known as "scarfing," see figs. 323-39, pp. 281-4.

LEWIS (in masonry).—An iron key fitted into a wedge-shaped hole made in the upper surface of a large stone, by which the same can be lifted. *See* fig. 157, p. 211.

LIME AND HAIR (in plastering).—A compound of lime and hair used for the first coat.

LINTELS (in carpentry).—Short pieces of timber placed horizontally over an opening in a wall, the ends having bearings in the wall.

LOUVRE OR LUFFER BOARDS (in joinery).—A number of boards placed in a ventilator, parallel to one another, but inclined to the horizon at a certain angle. This angle in some instances is changeable at pleasure, the boards being fitted into movable side-pieces.

LOWER RAIL (in joinery).—The bottom rail of a door.
LYING PANEL (in joinery).—The panel of a door in which the grain of the wood is placed horizontally.

M

MANSARD-ROOF (in carpentry).—Also termed a **CURB-ROOF**, which see, fig. 421, p. 306.
MARGENTS (in joinery).—The flat parts of the styles or rails of doors.
MARGIN (in joinery).—See **MARGENTS**.
MARGIN OF A COURSE (in slating).—Those parts of the slates which are exposed to the weather.
MIDDLE AND MIDDLE (in carpentry).—A Northumberland term, equivalent to “from centre to centre.”
MIDFEATHER (in brickwork).—The *withe* of a chimney, in Lancashire so called.
MITRE.—Two pieces of wood having equal angles, or the sides forming equal inclinations, and the two sides so joined together as to make an angle double of that of either piece. See fig. 999.

Fig. 999.

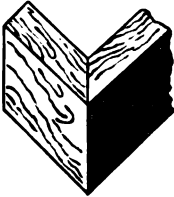

MITRE-JOINT IN WOOD.

MITRED BORDERS (in carpentry).—Narrow boards placed round, and forming a border to, hearth-stones.
MORTAR.—A mixture of lime, sand, and water; for proportions see par. 532-3, p. 141.
MORTISE (in carpentry).—An aperture made in a timber to receive another piece, which is termed the tenon. See fig. 340, p. 284.
MOULDINGS.—Profiles of various curves; they are named as follows: fig. 1000, the “fillet;” fig. 1001, the “bead” or astragal; fig. 1002, the Roman, and fig. 1003, the Grecian “Scotia;” fig. 1004, the Roman, fig. 1005, the Grecian “ovolo;” fig. 1006, the Roman, and fig. 1007, the Grecian “cavetto” or “hollow;” fig. 1008, the Roman, and fig. 1009, the Grecian “cyma-

Fig. 1000.

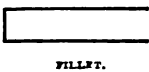

FILLET.

Fig. 1001.

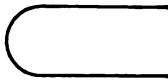

BEAD OR ASTRAGAL.

Fig. 1002.

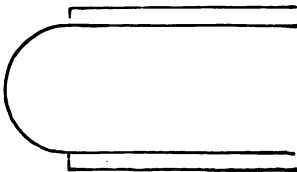

ROMAN SCOTIA.

recta;” fig. 1010, the Roman, and fig. 1011, the Grecian “cyma-reversa;” fig. 1012, the “ogee;” fig. 1013, the “congee,” or “apophygee.” Where a bead projects from the surface, as in fig. 1002, it is called a “cock-bead.”

Fig. 1003.

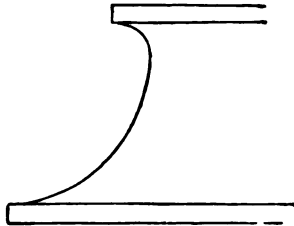

GRECIAN SCOTIA.

Fig. 1004.

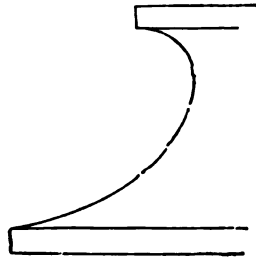

ROMAN OVULO.

Fig. 1005.

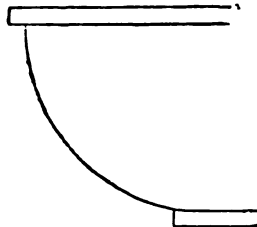

GRECIAN OVULO.

Fig. 1006.

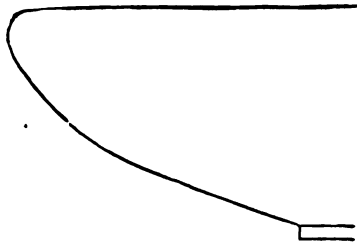

ROMAN CAVETTO OR HOLLOW.

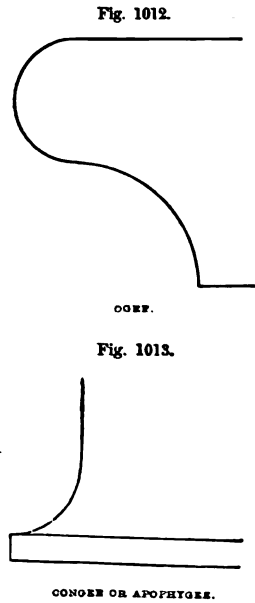
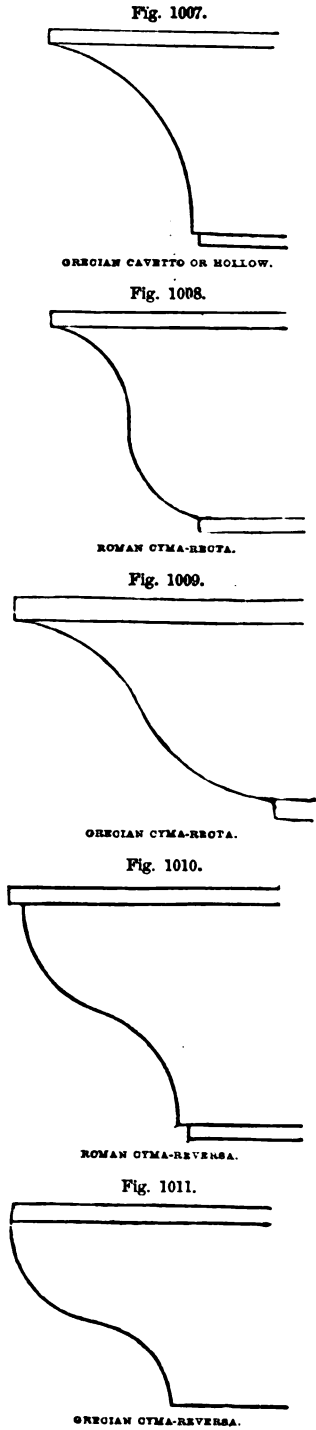

MULLION (in masonry and joinery).—The vertical bar of stone or wood dividing two casements from each other. See fig. 498, p. 326.
MUNTINS (in joinery).—The vertical pieces in the centre of a door between the styles. See fig. 474, p. 318.

N

NAKED FLOORING (in carpentry).—The rough exposed timber-work of a floor, before the boarding and ceiling-joists are placed down.
NATURAL or **QUARRY BED**.—The position in which stones lay originally; the laminae being either vertical or horizontal.
NEWEL (in joinery).—In dog-legged stairs, the post where the winders terminate, and into which the adjoining string-boards are framed. It also signifies the turned post *a a*, fig. 1014, placed at the bottom of a flight.

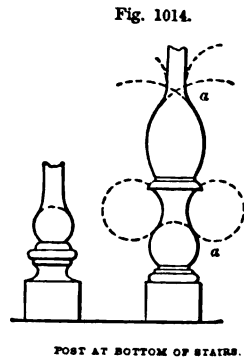

NOGS.—Wood-bricks built into the wall at intervals to receive nails, &c., for linings.

NOGS (in carpentry).—Lancashire name for wood-bricks.

NOTCH-BOARD.—The board fixed to the side of a wall, in which notches are placed to receive the ends of the treads and risers of a staircase. See fig. 457, p. 315.

NIDGED.—The Scotch term in masonry, in which the face of ashlar is gently grooved vertically with the sharp end of the hammer.

O

OFFSET (in bricklaying).—The part of a wall which is set back from the general line or face of wall below it, the thickness of the wall being reduced above it, either on one or both sides.

OGEE (in joinery).—A moulding, the outline of which is formed of two curves in contrary directions. See **MOULDINGS**, fig. 1012, p. 542.

OPEN NEWELLED STAIRS (in joinery).—Those having a rectangular well-hole, and which are divided into several flights.

OUT-BAND (in masonry).—A term used in Northumberland and Scotland, equivalent to "stretcher," in the building of a wall.

OVOLO (in joinery).—A moulding described by a quarter of a circle. See **MOULDINGS**, figs. 1004, 1005, p. 541.

P

PAN (in carpentry).—Lancashire name for **PURLIN**, which see.

PARAPET.—Breast-wall at the sides of bridges, or placed at the top of wall to hide roof.

PARGETTING (in brickwork).—Lining the inside of chimney-flues with a mixture of cow-dung and lime.

PARTITION (in carpentry).—See paragraphs 1133-91, pp. 294-96, for various illustrations of these.

PARTY-WALL (in bricklaying).—The wall which divides two adjoining buildings.

PAVILION-ROOF.—See fig. 393, p. 297. The term is used in the text, p. 32, paragraph 185, as synonymous with "hip-roof," corresponding to the part *b c d*, fig. 392, p. 297.

PENT-ROOF (in carpentry).—A lean-to roof. See fig. 391, p. 297, also fig. 397, p. 298.

PERPEND-STONE (in masonry).—A stone of sufficient length to stretch across the entire thickness of a wall.

PIEND-ROOF.—A Scotch term for **PAVILION-ROOF**, for illustration of which see fig. 393, p. 297.

PIENDS (in carpentry).—A Scotch term, equivalent to the "hip-rafters" of a roof.

PIERS (in masonry).—The walls between apertures or voids.

PITCH OF AN ARCH (in brickwork or masonry).—The vertical height from the line of springing, as *f*, to the under side of arch, at *b*, fig. 195, p. 219.

PITCH OF A ROOF (in carpentry).—The angle formed by the rafters. When the length of the rafters is equal to three-fourths of the distance between inside of walls, the pitch is said to be "common pitch."

PITCH OF A ROOF (in carpentry).—The angle or inclination of its sides.

PLASTER (in plastering).—A material used for making the mouldings and attached ornaments of ceiling, &c.

PLATBAND (in masonry).—A square moulding, the projection of which is considerably less than its height.

PLATE (in carpentry).—As a wall-plate, a horizontal piece of timber laid on the wall, on which to join a tie-beam, a joist, &c. See par. 1150, p. 286.

PLINTH (in brickwork or masonry).—The part at the base of a building which projects beyond the line of wall above.

PLOUGH-GROOVE (in joinery).—See **TONGUE**, as also fig. 997, p. 538.

PLUGS (in carpentry).—Pieces of timber inserted in a wall, to which the joinerwork is attached. They are sometimes called wood-bricks; also dooks, in Scotch terms.

POINTING (in bricklaying).—Filling up the spaces between the joints of external brickwork with putty, cement, or plaster.

POLE-PLATE (in carpentry).—The horizontal piece of timber in a roof-truss, against which the feet of the common rafters abut. See par. 1207, p. 300.

PRICKING-UP (in plastering) is a term used to describe the first coat of "three-coat" work.

PRINCIPALS, or **PRINCIPAL RAFTERS** (in carpentry).—The inclined pieces of timber in a roof-truss which support the purlins. See para. 1207, 1208, pp. 300, 301.

PUGGING (in carpentry).—An operation which has for aim the deadening of the sound passing from one apartment to another through the flooring. To the sides of the joists, near the bottom, narrow fillets of wood are nailed; these are made to support cross pieces of split wood, forming a species of floor, on which is laid a mass of mortar mixed with the cinders of a smith's fire. Same as the Scotch term **DRAFFENING**, which see.

PUNCEONS (in carpentry).—The short timbers placed above a void in a partition; as *t i* in fig. 384, p. 295. They are sometimes called "filling-in pieces."

PURLINS (in carpentry).—The horizontal timbers in a roof-truss, which rest on the principals, and support the common rafters. See para. 1207, 1208, pp. 300, 301.

PUTLOGS (in bricklaying).—The timbers which are used to support the scaffolding employed in raising brick walls. One end of the putlog is inserted in the wall, and the other lashed with a rope to the vertical poles placed at the required distance from the wall. When the building is finished, and the scaffolding taken down, the holes left in the walls when the putlogs are taken out are filled up.

Q

QUARTERING (in carpentry).—The stud-work of a partition is so called.

QUARTER-PACE (in joinery).—The landing-place at the end of a flight of steps, at the angle, or where the direction of the two flights turns.

QUARTERS (in carpentry).—The Lancashire name for **STUDS** or **STANDARDS**, which see.

QUARTERS (in carpentry).—The vertical posts bounding the framework of a partition, as those between the "sill" *c d*, and "head" *a b*, fig. 384, p. 295.

QUEEN-POST (in carpentry).—The vertical timbers in a roof-truss, in which the king-post is dispensed with in order to give a central space, as the timbers *A A*, fig. 407, p. 301.

QUIRK (in joinery).—The groove *c* between a head *a* and the solid wood *b*, fig. 1015; in fig. 1016 is a "double quirk," round the head *a*.

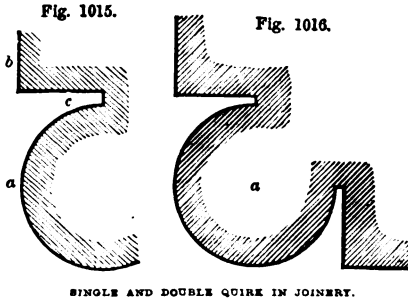

QUOIN-STONES (in masonry).—The stones placed at the corners of a wall to give an external finish; they are usually of unequal lengths, but of equal height. See fig. 80, p. 98, and **CORNERS**.

R

RAFTERS (in carpentry).—The inclined timbers of a roof: they are of three kinds, "principal rafters," as *f f*, fig. 405, p. 301; "common rafters," as *g g*, fig. 405; and "hip-rafters," as *a a*, fig. 417, p. 305.

RAGGLINGS (in carpentry).—A term used in Northumberland to designate **CEILING-JOISTS**, which see.

RAGGLINGS.—A Scotch term for the groove made in the face of a wall to admit the side or top slates of a lean-to roof, for the sake of being water-tight.

RAILS OF A DOOR (in joinery).—See fig. 471, p. 318.

REBATE (in joinery).—The rectangular piece cut away from the edge of board, as *e e*, fig. 494, p. 323.

REBATES OR RYBETS (in masonry).—A Scotch term equivalent to **JAMBS**, which see.

RENDERED AND FLOATED (in plastering).—This term is used to denote "three-coat work."

REVEALS (in brickwork or masonry).—The space in the sides of a door or window opening, which is comprised between the outside line of the wall and the outside face of window or door frame.

RIB OF A ROOF (in carpentry).—A provincial term for **PURLIN**, which see.

RIDGE-POLE OR PIECE (in carpentry).—The piece of timber which is placed at the apex of, and supported by, the king-post; the office of which is to support the upper ends of the common rafters. In fig. 405, p. 301, *m* is the ridge-pole, against which the common rafters *g g* abut.

RIGGIN.—The Scotch term for the ridge-pole of a house.

RISERS (in joinery).—The vertical parts, as *g h*, *f e*, fig. 457, p. 315, of stairs, the horizontal parts being termed "treads."

ROAN (*Scottish*).—The gutter of wood, zinc, lead, or iron, placed beneath the eaves of a roof to catch the rain-water.

ROOFS (in carpentry).—For varieties of roofs, see pars. 1193-9, pp. 297, 298, and Plate X.

ROUGH-CAST (in plastering).—A material used for finishing the outside of walls. The first coat is of lime-and-hair mortar, worked rough, with sometimes a second coat, worked smooth. On the surface of the first or second coat the "rough-cast" is put, this being composed of fine gravel mixed with lime and water.

ROUGH-RENDERING.—An operation in plastering where the rough coat only is given.

ROUGHING-IN.—A term used in plastering to designate the first coat of "three-coat work."

RUBBLE-WORK (in masonry).—A walling built of rough stones not dressed, and laid with mortar, or built dry, as in "dry-stone dykes."

RUNNERS (in carpentry).—Lancashire name for single joists.

S

SAG (in carpentry).—When a piece of timber, stretched from wall to wall, bends in the middle, it is said to "sag."

SARKING (in joinery).—A north of England term, equivalent to "boarding."

SARKING.—A Scotch term for boarding on a roof upon which to place blue slates, lead, or zinc.

SASH-BARS (in joinery).—The vertical and horizontal pieces in a window, as *a*, fig. 494, p. 323, which support the sheets of glass. They are sometimes termed astragals. See fig. 492, p. 322.

SASH-DOOR (in joinery).—See fig. 468, p. 317.

SASH-WINDOW (in joinery).—*a a c e*, fig. 1017, is termed the "casing" of the sash-frame; *e e* the pulley-piece, sustaining the pulleys over which the cords are strained which support the sash-weights *b b*; the inside lining and bead are at *c*; outside lining, *d*; back lining, *e*; *f* architrave of shutter-box; *g g*, *g g* folding shutters.

Fig. 1017.

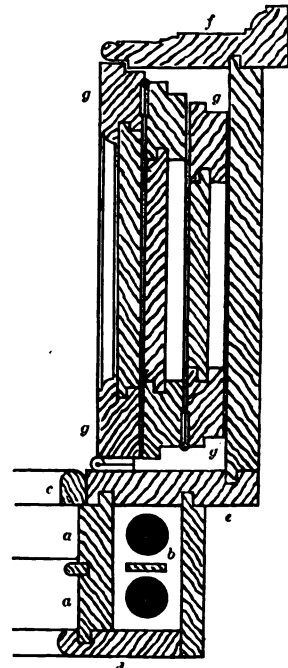

SASH-WINDOW.

SCARCEMENTS (in masonry or brickwork).—A Scotch term, equivalent to **FOOTINGS**, which see.

SCARF JOINT (in carpentry).—See par. 1135, p. 281.

SCOTIA.—See **MOULDINGS**.

SCROLL (in joinery).—The curved or spiral termination to the handrail of a stair. See **CURTAIL STEP**.

SCUNCHEON (in masonry).—A Scotch term for the inside jamb of a door or window, or the vertical end of a wall.

SHED-ROOF.—See **PENT-ROOF**.

SHIPPEN.—A Lancashire term signifying the cow-house. See **BYRE**.

SHUTTER-BOXING (in joinery).—The boxing for enclosing the shutters of a sash-window. See **SASH-WINDOW**.

SKEW (in masonry).—The term used in Scotland to designate the gable-coping of a roof. See **GABLE-COPING**.

SKIRTINGS (in joinery).—The boards surrounding the room at the floor level. See fig. 521, p. 333.

SNECK (in ironmongery).—A Scotch term equivalent to "latch."

SKY-LIGHT.—A window flush with the roof.

SOFFET.—A Scotch term for the inside upper panelling of a window.

SOFFIT (in masonry).—The under side of an arch, as *d d*, fig. 195, p. 219.

SOLPIE-ROOF (in carpentry).—Lancashire name for **SHED**, **LEAN-TO**, or **PENT-ROOF**, which see.

SOUGH.—Lancashire name for drain.

SPAN OF AN ARCH (in masonry).—Its greatest width, as *d d*, fig. 195, p. 219.

SPAN-ROOF (in carpentry).—The simplest form of inclined roof of two rafters, as *a a, d d*, fig. 399, p. 299, without the "collar" *e*.

SPAR (in carpentry).—Lancashire name for "rafter."

SPECIFICATIONS.—The particular terms upon which a contract is agreed on. See **CONTRACT**.

SPLAYED-BRICK (in brickwork).—A brick with a corner or corners bevelled off.

SPRINGING-COURSES (in masonry).—The stones, as *d d*, fig. 195, p. 219, from which the arch-stones *c c* spring.

SPUR.—See **STRUTS**.

STAIRCASE, BRACKETED.—Stairs provided with an open well-hole. The steps are housed into notches made in the string-boards, beyond which project the ends of the treads and risers; the ends of these being concealed with brackets, or ornamental pieces.

STAIRCASE, DOG-LEGGED (in carpentry).—In this the steps are supported at one end only by the wall, the other being carried by a piece of timber called the string-board. A dog-legged staircase has no well-hole.

STAIRCASE, GEOMETRICAL.—The well-hole is in the centre; the steps are supported at one end by the wall, into which they are inserted, and at the other they are mutually supported by resting one upon another.

STANDARDS (in carpentry).—Scotch term used to designate the "studs," or upright timbers, as *i i*, fig. 383, p. 294.

STINK-TRAP.—See **TRAPS**.

STOOTHINGS (in carpentry).—A term used in Northumberland to designate the quartering of a wooden partition.

STORM-WINDOWS.—The Scotch term for a dormer window.

STRAINING-SILL (in carpentry).—A piece of timber *f*, placed upon the upper side of the tie-beam *b b*, fig. 403, p. 300, abutting against the struts *e e*.

STRETCHERS (in masonry and brickwork).—The stones, as *o o*, fig. 151, p. 209, or the bricks, as *a a*, fig. 185, p. 217, which extend longitudinally along the wall.

STRUTS (in carpentry).—The inclined pieces of timber *g g*, fig. 406, p. 301, in a roof-truss which support the principal rafters *f f*, the lower ends abutting against the foot of king-post *e e*.

STRUTS (in carpentry).—Pieces of timber placed between the joists of a floor to strengthen it. See par. 1177, p. 292.

STUDS (in carpentry).—See **STANDARDS**.

STUDWORK (in carpentry).—Framework, as the quartering of a partition.

STYLES OF A DOOR (in joinery).—See *a a*, fig. 470, p. 318.

SUMMER-STONES (in masonry).—See **CORBELS**.

SURBASE (in joinery).—See **SKIRTING**.

SWORDED (in joinery).—Lancashire name for "ledged."

T

TAIL OF A SLATE.—Its lower end.

TENON (in joinery and carpentry).—See *d*, fig. 340, p. 284.

THREE-COAT WORK (in plastering).—First, "roughing in;" second, "floating;" third, "finishing."

THROUGH-BAND STONE.—Covers the breadth of the wall in the middle of a "dry-stone dyke."

THROUGH (in masonry).—A bond stone.

TIE-BEAM (in carpentry).—The lowest beam in the assemblage of beams forming a roof-truss, as *h h*, fig. 405, p. 301.

TILTING FILLET (in slating).—A piece of wood triangular in section, used to raise the slates where they join a chimney-shaft or wall; its purpose being to throw off the rain more effectually.

TONGUE (in joinery).—A projecting part on a piece of timber, as *a*, fig. 352, p. 287, to be inserted in the groove, named a "plough groove," made in another piece, as *b*.

TRANSOM (in masonry or joinery).—The cross-beam or bar across a two-light window.

TRAPS (in drain-work).—Appliances to prevent the stench from drains ascending. See figs. 293-6, p. 269.

TRAVISES.—The divisions or partitions between the stalls of a byre or stable.

TREAD OF A STEP (in joinery).—The part, as *e g*, fig. 457, p. 315, on which the feet rest in ascending and descending a stair.

TRIMMER ARCHES (in bricklaying).—Flat arches built under the hearthstone, to support the same.

TRIMMING-JOISTS (in carpentry).—See *c c, d d*, fig. 380, p. 292. See also **BRIDLE-JOISTS**.

TROUGH-SPOUT.—Lancashire term for eaves-gutter.

TRUNCATED ROOF.—See par. 1195, p. 297.

TRUSS OF A ROOF (in carpentry).—A frame triangular in form, for supporting the timbers and covering. For several forms, see figs. 403-9, pp. 300-302, and figs. 420-35, pp. 305-10.

TUSK (in joinery and carpentry).—A form of tenon with an upper shoulder. For various forms of, see fig. 348, p. 286.

V

VALLEY-GUTTER (in carpentry).—*See* figs. 444, 445, p. 312.

VALLEY RAFTER (in carpentry).—*See* *b b*, fig. 445, p. 312.

VENT.—A term used in Scotland to designate the chimney-flue.

VENTILATOR (in joinery).—An erection of luff-boards on the ridge of a house for the egress of foul air. *See* figs. 526 and 530, pp. 339, 340.

VERGE BOARDS (in joinery).—*See* **BARGE BOARDS**.

VOUSSOIRS (in masonry).—The wedge-shaped stones in an arch, as *a a*, fig. 196, p. 219.

W

WALL-PLATE (in carpentry).—*See* *d d*, fig. 406, p. 301.

WEATHER BOARDING (in joinery).—The feather-edged boards which overlap each other in covering the sides of a wooden erection. *See* fig. 588, p. 370.

WITHES or WITHS (in brickwork or masonry).—The divisions between the flues in a stack of chimneys.

WOOD-BRICKS (in carpentry).—The pieces of wood, same size as bricks, inserted and built into the walls, to which the joinerwork is nailed.

I N D E X.

The Subjects arranged Alphabetically in the Glossary (which See) are not repeated in the Index.

The Figures in the Index refer to the Paragraphs.

- Accommodation and power to the size of farm, 470-473
Adam's tanks for the preservation of grain, 1744
Ainger's trussed beam, 1609
Air required in stables, byres, &c., 1292
Allen's American barn, 1767
..... remarks on the site of farmhouse, 283
Allotments, 465-469
American barn, 1762-1766
..... cheese-dairy buildings, 1772
..... cottage cooking-stove, 1499
..... farm-steading, 1770
..... poultry-houses, 1774
..... red pine timber, 593, 600
..... sifting pigery, 1773
..... yellow pine timber, 594, 601
..... Western States of America, farm-buildings for, 1771
Angle-iron field-gate, 1536
Apartments, heating of, 1099-1102
Apparatus, and erections useful, 1683
..... gas, Bridges, Aubury, & Co.'s, 1698
..... Goddard's cooking, 1498
..... heating, for drying-house, 1724
Aqueduct, wooden, for irrigation, 1348
Arches, centres for, 1337
..... in brick walls, 962-966
..... inverted, for foundations, 939
Archimedean screw, grain drying-machine, 1735-1743
..... ventilator, Chadwick's, 1485
Architrave, 874, 1278
Arnott's ventilator, 1483
Arrangement, principles of, 1
Artificers' work, estimates and calculations of, 1776
..... glossary of technical terms used in, 1812
Artificial stones, 515
..... Ransome's, 516
..... Kuhlmann's, 517
Ash timber, 607
Ashlar work in masonry, 940, 941
Asphalted felt for roof covering, 1092
Asphalt caldron, 1684
..... flooring, 1088
Atkinson's cement, 540
Baikie for cattle, 1310
Balloon framing for timber houses, 1379
Balusters for stairs, 1246
Band saw, endless, 1675
Barlow's experiments with corrugated iron, 1524
Barn, Allan's American, 1767
..... corn, arrangement and construction of, 1327-1332
..... Dutch, 1756
..... Flemish, 1756
..... side-hill, American, 1763
..... straw, arrangement and construction of, 1326
..... American, 1762
Barnard and Bishop's sheep-hurdles, 1581
Barrett, Exall, and Andrews' endless band saw, 1675
Barton's cast-iron stable drains, 1504
Basalt, 492
Bay-window, 1266-1271
..... section of window-head, 1627
Beadon's gutter-tile, 1091
Beam, Ainger's trussed, 1609
..... cast-iron, foot-bridge, 1520
..... iron, best section of, 1386
..... iron, for span of 19 to 20 feet, 1387
..... iron, filling in space between, 1388
..... rolled iron, 1399
..... solid, Conder's, mode of trussing, 1615
..... trussed, king-post, 1607
..... trussed, queen-post, 1607
..... wrought-iron plate, 1398
Beams, increasing depth of, 1174
..... iron, 1386-1403
..... iron, best position of, tie-rods in, 1393-1395
..... iron, calculations connected with, 1807
..... iron, cast and wrought, comparative advantages of, 1396, 1397
..... iron, fixing of cross girders to, 1390-1392
..... iron, placing of binding-joists upon, 1389
..... or girders, iron, dimensions of, for various spans, 1401, 1402
..... trussed timber, 1169-1173
..... upper floors, fixing of in walls, 961
..... wooden, iron straps for, 1594-1598
Bearer, chimney, 1487
Belgian covered dung-shed, 1377
..... steadings, 1757-1761
Bellhanger, specifications of duties to be performed by the, 822
Bells, 1490
Bell's trap for stables, 1506
Bell-trap for sinks, 1495
Belvidere, wooden, for farmhouse, 1238
Bench, joiner's, 1657
Bethell's process of preserving timber, 623

- Beton, 536
 Bills of quantities for a farmhouse of stone, 848
 Bindings, cattle, 1310
 Bits, boring for iron, 1667
 Blinds, window, spring pulley for, 1481
 Boarding, weather, for timber sheds, 1374
 Boiler-house, drying of sheaves in, 1729
 Boilers, iron, cement for cracks in, 558
 Bond in brick walls, 953, 954
 Flemish, and old English in brick walls, 953
 hoop-iron for brick walls, 956, 957
 timber for brick walls, 859, 956
 Boring bits for iron, 1667
 brace, screw-frame for, 1664
 mortising, and tenoning machine, 1676
 or drilling machine, 1682
 Bothies, plans of, 446-458
 Boucherie's process of preserving timber, 626-629
 Box, loose, in stable, 1301
 Boxes, cattle, construction of, 1314
 Brace, boring, smith's, 1664
 Braced iron gate, 1538
 Bracket, wooden, for farmhouse, 1238
 Breakwater for protecting river-banks, 989-991
 Bremner's remarks on the position of stones in sea-walls, 1008
 Brick, 520
 advantages of, 522
 and concrete, combined with iron, 1623-1640
 construction, 951
 footings or foundations, 951, 952
 kilns, Hands' patent, 1747
 paving, estimates and calculations connected with, 1791
 walls, 953-961
 walls, facing of, 959
 walls, hollow, 967-974
 work, estimates and calculations connected with, 1782-1791
 Bricklayer, specifications of duties to be performed by, in the erection of farm-buildings, 658, 662, 737, 760, 881, 889, 894
 Bricks, grooved, 971
 large sized, 972
 for paving, 1086
 segmental, for drains, 1015
 walls of unburnt, 1132
 Bridge of corrugated iron plates, 1524
 foot, with cast-iron beam, 1520
 gate for centre of, 1372
 king-post truss for, 1343
 queen-post truss for, 1344
 trussed beam, 1342
 trussed girder bridge, 1342
 Bridges, Aubury, & Co.'s gas apparatus, 1698
 sluice-valves, hydrants, 1519-1530
 wooden, 1340-1347
 Bridle-joists, 1178
 Britannia farm-buildings, Belgium, 1761
 Brown and May's sluice-cock, 1528
 Bruce's improved stable-fittings, 1511
 Buildings, American cheese-dairy, 1772
 foreign farm, 1756
 heating of, 1719
 heating of, by furnaces, 1720
 heating of, by hot water, 1721
 heating of, by steam, 1721
 specifications of, 656-909
 Bunnett's system of fireproof construction, 1640
 Burnett's process of preserving timber, 622
 Butt hinges, 1478
 Byre or cow-house, 1304
 cow, isolated, 1700
 stone trough for, 1127
 width of stall in, 1304
 window, 1312
 Byres, 1304
 for fattening oxen, 1313
 manger of, 1306
 Calculations and estimates of artificers' work, 1776
 and estimates connected with brick-work, 1782-1791
 and estimates connected with diggers' and excavators' work, 1777-1781
 for carpentry and joinery work, 1800
 connected with iron beams, 1807
 of the cubical contents of timber in various roofs, 1804
 of the cubical contents of timber in partitions, 1805
 for stone paving, 1792
 Caldron and furnace, combined and portable, 1683
 asphalt, 1684
 Californian pine timber, 603
 Calves' crib door, 1319
 houses, 1317-1320
 Caps of columns, 1408-1415
 Carpenter, joiner, specification of duties to be performed by the, in the erection of farm-buildings, 665-669, 696, 741, 768, 858, 863, 890, 896, 906
 Carpenter's shop, plan of, 1754
 Carpentry work, estimates connected with, 1800
 Carrett's steam-pump, 1691
 Carse-farming, description of, plan of steading for, 82-94
 land, farming of, 4
 Carton pierre, for architectural decoration, 519
 Casement, or French window, 1263.
 Cast and wrought-iron beams, comparative advantages of, 1396, 1397
 Cast-iron bridges, 1523
 heel-posts for work-horse stable stalls, 1288
 sink, 1496
 varieties and peculiarities of, 632-645
 Cattle-binding, 1310
 boxes, construction of, 1314
 boxes, fittings for, 1315
 boxes in iron sheds, cast-iron pillars for, 1592
 courts, water-troughs for, 1119-1126
 pastoral farming, description of plan of steading for, 38-52
 pastoral farming with arable culture, description of plan of steading for, 62-71
 racks, 701
 Ceilings, fireproof, in hollow bricks, 970
 Cement, Atkinson's, 540
 clays for, 539
 experiments on, 542-547
 estimates connected with, 1795
 for covering exterior work, 562
 for cracks in iron boilers, 558
 for filling up holes in walls, 561
 for joining glass, 560
 for lining water-cisterns, tanks, &c., 556, 562
 for pottery, and drain-tubes, 559
 for stone cisterns, 557
 hydraulic, 537
 Keene's, 548
 marine, 552
 Martin's, 548
 Medina, 540
 Medina, for farm structure, 554
 Parian, 548

- Cement, Parker's, 540
 Portland, 541
 puzzolano, 538
 Roman, 540
 vermin proof, 549
 Centres for arches, 1337
 Chadwick's Archimedean screw ventilator, 1485
 Cheese-dairy buildings, American, 1772
 room of farmhouse, 296
 Chest, corn, for work-horse stable, 1303
 Cheyne's system of fireproof construction, 1639
 Chimney-cap, mouldings of, 947
 bearer, 1487
 guards, 1485
 pieces, 823
 tubes, ventilating, 1105
 valves, 1487
 Chrime's water-tap, 1491
 Circular saw, iron bench, 1674
 Cistern, rain-water, 1110
 Cisterns, 692
 stone, cement for, 557
 water, cement for lining, 556, 562
 Clamps for twisting the wire at the eye for
 fences, 1571
 Clark and Co.'s clays for cements, 539
 Claw-hammer, 1659
 Clayton's drain-tubes, 1019
 Closets, water, 872, 1115, 1116
 Closure, or closer, in brickwork, 958
 Clothing of steam-pipes, 1728
 Clump of trees within the meeting of dykes, 1049
 Cooks and taps, water, 1491
 Coffe-dam for foundation in water, 930
 Colehill steading, Berkshire, description of plan
 of, 243-256
 Collar-beam, roof-truss for, 1201
 holder, 1516
 vice for wire fencing, 1574
 Collinge's patent spherical hinge, 1478
 Colour, fawn, for walls, 570
 Columns, caps for, 1408-1415
 iron, 1404-1416
 foundation for cast-iron, 1405-1407
 junction of iron girders with, 1408-1415
 junction of, with wrought-iron beams,
 1416
 wrought-iron, for sheds, 1591
 Combined furnace and caldron, 1683
 work, iron with brick or concrete, 1628-
 1640
 iron with wood, slate, or zinc,
 1641-1655
 wood with stone and brick, 1621-
 1627
 Common farming, 6
 description of plan of steading
 for, 145-164
 Concrete, 534
 and brick combined with iron, 1628-
 1640
 and wrought-iron beams, fireproof
 floors, 1629
 Conder's mode of trussing solid beams, 1615
 Conduits or culverts, form of, 1012
 Conical roof, 1196
 truss for, 1229
 Construction, combined, 1628
 in brick, 951
 of dry-stone dykes, 1023-1049
 fireproof, 1628-1640
 iron, 1386-1592
 materials employed in, 489
 practical, 922
 practice in, 489
 stone, 940
 Construction, timber, 1133
 Contracts, 910-921
 Cooking-apparatus, Goddard's, 1498
 stove, American cottage, 1499
 Cooler for milk, 1117
 Copper, peculiarities of, 652
 Corbel, moulding of, 947
 Corshouse detached byre, 1700
 drain-tile work, plan of, 1749
 Corn-barn, arrangement and construction of, 1327-
 1332
 door, 1330
 floor, 1329, 1332
 roof of, 1327
 windows of, 1327
 Corn-chest for work-house stable, 1303
 Corn drying, advantages of, 1716
 Cornice, 1279
 details of, for farmhouse, 1622
 Corrugated iron-plate bridges, 1525
 iron roofs, 1470
 iron roof for 18-foot span, 1417
 iron roof for span of 52 feet, 1472
 iron sliding-gate, 1542
 roof-tile, 1090
 zinc joining, plates of, 1653
 Cost of first-class farmhouses, 321-325
 Cost, relative, of slate and zinc covered roofs,
 1654
 Cottage, American, cooking-stove, 1499
 door, 463
 out-houses, plans of, 459
 windows, 464, 1261
 Cottager's grate, Pierce's fire-lump, 1102
 Cottages, double detached single-storeyed, of brick,
 specification adapted for, 888-891
 single-storeyed detached, of brick, speci-
 fication adapted for, 878-887
 two-storeyed detached, in brick, speci-
 fication adapted for, 892-903
 of brick, specification adapted for, 879-
 903
 of stone, specifications adapted for, 904-
 921
 foundations for, 932
 various plans of, 350-445
 Cottam and Co.'s improved stable-fittings, 1514
 Cottam's enamelled manger for stables, 1510
 fittings for loose-boxes, 1515
 hind-posts for stalls, 1509
 iron drains for stables, 1504
 iron traps for stables, 1506
 travises for stables, 1509
 Courses of brick walls, carrying up of, 960, 961.
 Courts, fittings for, 1321
 Covered dung-shed, 1377
 stackyard, description of, 204, 205
 steadings, plans of, in Plates XIII.
 and XIV.
 Cow-byre, isolated, 1700
 Cow house or byre, 1304
 "Cramps" for joining blocks of stone, 946
 Crane, Dray's portable, 1695
 derrick, 1694
 quarry, 1693
 Cranes, 1693-1695
 Culverts, 1009
 or conduits, form of, 1012
 egg-shaped, 1013
 Curb-roof, or mansard, 1221
 Curved rib-roof, truss for, 1225
 Daines' method of preserving stones, 508
 Dairy, cheese, buildings, American, 1772
 isolated, 1701
 farming, 7

- Dairy-farming, large, description of plan of stead-
ing for, 96-107
..... small, description of plan of stead-
ing for, 108-120
- Dam or weir, construction of, 1003
..... used in Italian irrigation, 1007
- Dams, 1002, 1003
- Deafening, 861
- Dean's hollow bricks, 974
- Dearn's hollow brick wall, 968
- Decoration, architectural, materials for, 519
- Derrick crane, 1694
- Detached erections, 1699-1714
..... byre at Corehouse, 1700
..... dairy, 1701
..... poultry-houses, 1707
..... pigeon-houses, 1710
..... rabbitry, 1711
..... piggery, 1712
..... slaughter-house, 1714
- Details for iron foot-bridge, 1521, 1522
..... of Ainger's trussed beam, 1611
..... of cornice for farmhouse, 1622
..... of corrugated iron-roof for span of 52
feet, 1472
..... of double iron-roof for wide spans, 1429
..... of iron-roof for 18-feet span, 1417
..... of iron-roof for 25-feet span, 1431-1437
..... of iron-roof for 30-feet span, 1439-1447
..... of iron-roof for horse-walk of threshing-
mill, 1460-1463
..... of iron-roof, with zinc covering, 1647-1652
..... of king-post trussed beam, 1607
..... of queen-post trussed beam, 1607
..... of roof, for octagonal shed, 1590
..... of sliding-gate, 1543
..... of stonework of farmhouse, 947-950
..... of trussed beam, 1619
..... of trussed beam for sheds, 1589
..... of windows of farmhouses, 1266-1277
- Diggers' and excavators' work, estimating, 1777-
1781
- Dimensions of iron beams or girders, for various
spans, 1401, 1402
..... of iron laths for roofs, 1645
..... of liquid-manure tank, 1068
..... of parts of iron-roofs of various spans,
1448-1457
- Distemper, painting in, 577
- Door of corn-barn, 1330
..... bead butt and flush panel, 1253
..... bottom rail of, 1252
..... cottage, 463
..... circular headed, 1250
..... folding, 1257
..... for calf's crib, 1319
..... for pigsty, 1324
..... four and six panel, 1252
..... framed, and braced, 1250
..... Gothic, 1255
..... ledged, 1248
..... middle rail of a, 1252
..... muntins of a, 1252
..... panels of a, 1253
..... panels of, for a farmhouse, 1254
..... rails of a, 1252
..... raised eight-panel, 1256.
..... raised panel, 1256
..... sash, 1251
..... sliding, 1258
..... stiles of, 1252
..... stops for the prevention of draughts, 1259
..... sunk panel, 1253
- Doors, 704, 869
..... for farm-cottages, 463, 464
..... framed, 1252
- Doors, ledged and braced, 1249
- Dormer window, elevation of, 1231
..... windows, truss for, 1231
- Double-action pump, 1686
- Double and single stalls in byres, comparative
advantages of, 1308
- Doulton's patent junction and invert block for
drains, 1015
..... ventilating chimney-tube, 1105
- Dowels for joining blocks of stone, 945
- Downing's durable paint, 584
- Drainage pavement-bricks, 1118
- Drain-tile kiln, 1749
..... tubes, cement for, 559
..... tubes, lidded, 1020-1022
- Drains, 1009
..... bedding of the tubes of, 1016
..... fall of, 1017
..... house, various forms of, 1019
..... liquid-manure, 1018
..... invert block and junction blocks for, 1015
..... for roads, 1052
..... segmental bricks for, 1015
- Dray's portable crane, 1695
..... vertical saw frame, 1673
- Drilling or boring machine, 1682
..... braces, 1664-1666
- Drip-stone, mouldings of, 948
- Drumkilbo steading, Forfarshire, description of
plan of, 217-233
- Drying, principles of, 1723
- Drying of grain, 1731-1743
..... by Archimedeon screw, 1736
..... rooms and machines for, 1716
..... in the sheaf or bulk, 1723
..... by tile-kiln, 1732
..... house, heating apparatus for, 1724
..... houses, description of substances to be
dried in, 1727
..... scale for calculating the surface
of hot-water pipes for, 1725
..... steam-pipes for, 1727
..... ventilation of, 1724
..... machines and kilns, 1715-1751
..... of sheaves in the boiler-house, 1729
..... sheds, Hand's patent, 1730
- Dry-stone dyke, expedients to increase height of,
1043
..... dykes, construction of, 1023-1049
- Dunghill, tank for the waste urine from a, 1000
- Dung-shed, covered, 1377
- Dunn's lifting screw-jack, 1672
- Dutch barn, 1756
- Dykes, clump of trees formed in the meeting of
four, 1049
..... dry-stone, construction of, 1023-1049
- Earthenware staircase, 1098
- Elevation of belvidere of farmhouse, 1238
..... of wooden bracket, 1238
..... of Carrett's steam-pump and portable
steam-engine, 1691
..... of cottages, 334, 386, 388, 390, 391, 399,
403, 404, 410, 414, 417, 421, 427, 439
..... of dormer window, 1231
..... of farmhouses, 305, 310, 316, 330, 334,
338, 342, 347
..... front of farmhouses in Plate XVIII.
..... of gables of steadings, 276-280
..... of stone finials, 947
..... of detached pigeon-house, 1710
..... of machine-house in Flemish farm, 1760
..... of poultry-house, 1707
- Embankment for a small rivulet, 977-980
..... for low grounds on river-sides,
981-985

- Embankments, 975**
 principles of construction of, 976
 river, Sutter's method of forming,
 986, 987
 sea, 993-1001
- Enamelled manger for stables, 1510**
 slate, 518.
- Enlarged view of part of back elevation of farm-
 house, 319**
 of windows in part of end eleva-
 tion of farmhouse, 319
 of door and windows of part of
 front elevation of farmhouse, 318
 of bay window of farmhouse, 1268
- Endless band saw, 1675**
- Engine, fire, portable, 1685**
- English bond for brick walls, 953**
- Erections and apparatus, useful, 1683**
 detached, 1699-1714
- Errors prevalent in designing farm-buildings, 16**
 connected with brick-paving, 1791
- Estimates and calculations of artificers' work, 1776**
 connected with brick-
 work, 1782-1791
 connected with carpentry-work, 1800
 cement, 1795
 laths, 1796
 mortar, 1794
 plastering, 1797
 slating, 1798
 stone-paving, 1792
 tiling, 1793
 with well-digging and
 steining, 1778
 of diggers' and excavators' work, 1777-
 1781
- Ewart's fittings for cattle-boxes, 1314**
- Excavators' and diggers' work, 1777-1781**
- Excavations for roads, 1053**
- Excavator, specification of duties to be performed
 by, in building farm structures, 657, 684, 736,
 757, 826, 850, 880, 893, 905**
- Facing of brick walls, 959**
- Fairbairn's fireproof flooring, with wrought-iron
 beams, 1630**
 method of constructing fireproof
 flooring, 1628
 mixture of cast-iron, 640
 remarks on Parisian modes of fire-
 proof construction, 1638
- Fanners for smith's forge, 1663**
- Farm-buildings, errors prevalent in the design-
 ing of, 16**
 foreign, 1756
 for Western States of America,
 1771
 Marshall's American, 1770
- Farm-cottage, double, detached, 400**
 double, single-storeyed, plans of,
 401-410
 five-roomed and two-storeyed,
 plans of, 396-399
 five-roomed, single-storeyed, plan
 of, 387-389
 four-roomed and single-storeyed,
 plan of, 383
 remarks on arranging accommo-
 dation of, to the size of family,
 393-395
 three-roomed and single-storeyed,
 plan of, 385
- Farm-cottages, plans of, 350**
 composite, plans of, 437-445
 defective, plans suggesting im-
 provements in, 431-436
- Farm-cottages, doors and windows of, 463, 464**
 double single-storeyed, of two
 different sizes, plans of, 423, 424
 double two-storeyed, of two dif-
 ferent sizes, plans of, 425-430
 double two-storeyed, plans of,
 411-422
 for large and small families, 376,
 377
 importance of providing good ac-
 commodation in, 350-372
 out-houses of, 459-462
 single-roomed and single-storey-
 ed, plan of, 378, 379
 two-roomed and single-storeyed,
 plan of, 381, 382
- Farm, gas apparatus for, Porter's, 1696**
 hand-pump, 1687
- Farmhouse of brick, specification adapted for,
 756-824**
 detail of cornice of, 1622
 cheese-room, 296
 first-class, cost of, 321-325
 enlarged (details of, 317-319
 plans of, 301-316
 kitchen, 287
 position of, in relation to the stead-
 ing, 282
 remarks on accommodation of, 348
 remarks on the accommodation of,
 in relation to the size of the farm,
 349
 second-class, plans of, 326-330
 site of, 283-285
 of stone, specification adapted for,
 825-847
 of stone, specification for, 849-877
 third-class, plans of, 331-347
 working part of, 286-300
- Farmhouses, details of stonework of, 947-950**
 windows for, 1266-1277
 plans of, 281
 principles of arrangement of, 286
- Farm-labourers, classes of, 373-375**
- Farm, proportion of power and accommodation for
 size of, 470-473**
 roads, 1050-1059
- Farm-steading, American, 1770**
 Belgian, 1756-1761
 imperial, at Vincennes, France,
 1775
- Farming of carse-land, 4**
 causes of diversities of, 9
 common, 6
 dairy, 7
 different kinds of, 2
 incidents which modify, 15
 mixed, 8
 modifications of the different kinds of, 14
 pastoral, 3
 cattle, description of plan of
 steading for, 38-52
 sheep, 53
 state of, in middle ages in Scotland, 474-
 488
 suburbial, 5
- Fastening for stair-rods, 1482**
- Fawn-colour for walls, 670**
- Feeding-passages at heads of stable stalls, 1286,
 1287**
 troughs benches, 688, 702
- Felt, asphalted, for roof covering, 1092**
- Fence foot-gate, 1541**
 sheep, machine for making, 1677
 wires, 1551-1563
- Fences, wire, 1544-1576**

- Fences, wire, fitting up of, 1574-1576
 Fenn's boring or drilling machines, 1682
 lathe, 1681
 ratchet brace, 1666
 Ferguson's improved ventilator for stables, &c.,
 1295
 Field, common, gate, 1358
 gate, hanging-post for, 1365
 of iron, 1533
 of iron tension, 1534
 of angle-iron, 1536
 Filter, carbon, 1112
 Finial, stone, mouldings of, 947
 Fireclay hearth, 1103
 Fire-engine, portable, 1685
 lump, cottager's, grate, 1102
 proof construction, 1628-1641
 Fox's method, 1629
 Bunnett's system of,
 1640
 Cheyne's system of, 1639
 proof flooring, Fairbairn's method, 1628
 with wrought-iron beams,
 1630
 proof floors and ceilings on Roberts' hollow
 bricks, 970
 Loré's system of making, 1635
 Mausn's system of making, 1634
 Parisian methods of making,
 1631-1638
 walls of frame-houses, 1375
 Firing of drain-tile kilns, 1732
 Fitting up of wire-fences, 1564-1576
 Fittings, Bruce's improved stable, 1511
 for cattle-boxes, 1315
 Cottam's improved stable, 1514
 for courts, 1321
 iron, of the farmhouse and cottages,
 1474-1502
 iron, of the steading, 1503-1518
 for loose-boxes, 1515
 for pigsty, 1517
 of the workshop, 1656-1682
 Fixed window, 1260
 Flat arch and lintel in brick walls, 962
 roof, truss for, 1219, 1220
 Flemish barn, 1756
 Flemish bond in brickwork, 953
 farm-steading, 1757-1761
 liquid-manure tanks, 1081
 Floor of asphalt, 1088
 double, 1176
 double-framed, 1176
 of corn-barn, 1329-1332
 single, 1176
 Flooring, fireproof, Fairbairn's method, 1628
 joists, good and bad method of setting
 of, in brick walls, 961
 joists, trimming, 1178
 Mr Gwilt's remarks on, 1182
 Floors, fireproof, in hollow bricks, 970
 Loré's system of making fireproof, 1635
 Mausn's system of making fireproof,
 1634
 Parisian methods of making fireproof,
 1631-1638
 timber, 1176-1182
 Flue, ventilating and smoke, 1101-1105
 Foot-base, 873
 bridge, with cast-iron beam, 1520
 gate for fence, 1541
 Footings or foundations in brick, 951, 952
 stone, 935, 936
 Forbes's pavement-bricks, 1118
 Foreign farm-buildings, 1756
 Forge, fanners for smith's, 1663
 Forge, with fanners, 1663
 Foundation, coffer-dam for, in water, 930
 for cottages, 932
 of dry-stone dykes, 1029
 Foundations, 922
 for cast-iron columns, 1405-1407
 in compact clayey soils, 924
 in sand, 925, 926
 in soils of a yielding character, 927
 inverted arches for, 939
 points to be attended to in making,
 922-939
 on rock, 931
 in water, 928-930
 Fox's method of fireproof construction, 1629
 Frame-house, construction of, 1374
 houses, fireproof walls of, 1375
 walls of, Swedish mode of form-
 ing, 1374
 saw, vertical, 1673
 Framed doors, 1252
 and braced door, 1250
 Framing, "balloon," for timber houses, 1373
 wooden, iron shoes for, 1599-1606
 French casement window, 1263
 steading at Vincennes, France, 1775
 windows, fastening for, 1481
 Fresh air, iron valves for admitting to stables,
 1507
 Furnace and caldron, combined portable, 1683
 Furnaces, heating of buildings by, 1720

 Gables suggested for steadings, 276-280
 Gangway from stackyard to upper barn, 1332
 Garrood's adjustable hay-rack, 1512
 Gas apparatus, 1696-1698
 Bridges, Aubury, & Co.'s 1698
 for farm use, Porter's, 1696
 Gas regulator, Hart's, 1489
 regulators, 1488
 stove, Rickett's, 1501
 Gate, braced iron, 1538
 common field, 1358
 field, of angle-iron, 1536
 foot, for fence, 1541
 for centre of bridge, 1372
 iron field, 1533
 rectangular, with diagonal strut, 1355
 sliding, of corrugated iron, 1542
 suspended or hanging, 1371
 tension iron, 1534
 trussed, Kilmorey, 1359
 wooden, for the approach of a farmhouse,
 1362
 wrought-iron side, 1540
 Gates, 706, 1354-1372
 iron, 1531-1543
 General conditions of a specification adapted for
 a steading of brick, 718-736—of stone, 710-716
 Girder, cast-iron, for sheds, 1589
 cast-iron shoe for receiving end of, 1589
 open or trussed beam, for sheds, 1589
 Girders, calculations connected with iron, 1807
 iron, junction of, with columns, 1408-1415
 wood, iron trussing for, 1607-1620
 Glass cement for joining, 560
 Glazier, specification of duties to be performed
 by the, in the erection of farm-buildings, 679,
 682, 755, 820, 876, 901
 Glossary of technical terms used in artificers'
 work, 1312
 Glover Brothers' iron traps for stables, 1506
 Goddard's cooking-apparatus, 1493
 Gothic door, 1255
 or high-pitched roof, trusses for, 1222-
 1224

- Grain crops in the steading, accommodation for, 1325
 drying of, 1731-1743
 drying by Archimedean screw, 1735
 drying rooms and machines, 1716
 drying in the sheaf or bulk, 1722
 drying tile-kiln, 1732
 tanks for the preservation of, 1744
- Granary windows, 1333
- Granite, 490
- Grate, cottager's fire-lump, 1102
 stove, fire-lump, 1103
- Grates, 824, 1099
 kitchen, ranges, and stoves, 1497-1502
- Grating, ornamental, for ventilator, 1105
- Gratings for court drains, 1505
- Greenstone, 492
- Greenwood's door-stops for the prevention of draughts, 1259
- Grindstone, 1660
- Groin and dam for protecting a river side, 1008
- Grooved bricks, 971
- Ground, choice and preparation of, for foundations, 923-933
- Grout, 946
- Guards, chimney, 1485
- Gutta-percha for architectural decoration, 519
- Gutters cut out of solid wood, 1237
 for iron roofs, 1464-1469
 iron, for closed surface-drains in stables, 1504
 wooden, 1232-1237
- Gutter-tile, Beadon's, 1091
- Gwynne's portable fire-engine, 1685
- Guilt's remarks on flooring, 1182
- Halley's lifting-jack, 1672
- Hammer, claw, 1659
 riveting, 1669
- Hand-pump, 1688
- Hands' patent brick-kilns, 1747
 drying-sheds, 1730
- Hanging-post of a field-gate, 1365
 posts, fixing of, 1366-1369
- Harness and saddle bracket, 1516
 pins, 1299
- Hart's gas regulator, 1489
- Hay-house, 1302
- Hay-rack, Garrood's adjustable, 1512
 position of, in stalls, 1282
- Hearth, fireclay, 1103
- Heating apparatus for drying-house, 1724
 of apartments, 1099-1104
 of buildings, 1719
 by furnaces, 1720
 by hot water, 1721
 by steam, 1721
- Hexagonal paving-tiles, 1087
 roof for thrashing-mill, 1229
- High-pitched roofs, trusses for, 1222-1224
- Hind-posts, iron, for stalls in stables, 1509
- Hinge for self-shutting door, 1478
 spherical, Collinge's patent, 1478
- Hinges, 1478
 butt, 1478
- Hip-rafter for roof, 1211
- Hipped-roof, 1194
 plan of, 1213
- Hollow-brick, 11-inch wall, 968
 14-inch wall, 968
 Norton & Borrie's, 973
 wall, Dearn's, 968
 bricks, Dean's, 974
 fireproof floors and ceilings in, 970
- Holman's double-action pump, 1686
- Hoop-iron bond for brick walls, 956, 957
- Horse-pond, making of a, 1083
- Horses or tressels for the joiner's shop, 1658
- Hot-air seasoning of timber, 613
- Hot water, heating of buildings by, 1721
 pipes for drying-houses, rule for calculating surface of, 1725
 supply, principles of, 1721
- House drains, various forms of, 1019
 drying heating apparatus, 1724
 frame, construction of, 1374
- Houses for calves, 1317-1319
 drying, ventilation of, 1724
 pigeon, 1710
 poultry, 1707-1709
 American, 1774
 timber, and sheds, 1373-1385
- Hurdles, wrought-iron, 1577, 1581
- Hydrant, Wheatcroft and Smith's, 1529
- Hydrants, bridges, sluice-valves, 1519-1530
- Hydraulic cement, 537
 ram, 1689
- Ibbotson & Co.'s grindstone, 1660
 ratchet brace, 1665
 lifting screw-jack, 1672
 screw stock, 1668
- India-rubber, vulcanised, for architectural decoration, 519
- Inverquharary steading, Forfarshire, description of plan of, 264-274
- Inverted arches for foundations, 939
- Iron bars, used as tension-rods for roof-trusses, weight of 1 foot lengths, 1809
 beam, best section of, 1386
 beams, 1386-1403
 filling in spaces between, 1388
 fixing of cross girders to, 1390-1392
 or girders, dimensions of, for various sizes, 1401, 1402
 placing of binding-joists upon, 1389
 for span of 18 to 20 feet, 1387
 wrought, to prevent deflection of, 1808
 boring-bits, 1667
 cast, classes of, 632-639
 Fairbairn's mixture of, 640
 hot and cold blast, 642
 malleable, 645
 relative values of Scotch and English, 644
 castings, precautions to be adopted in making, 643
 columns, 1404-1416
 combined with brick or concrete, 1628-1640
 wood, 1593-1620
 wood, slate, or zinc, 1641-1655
 construction, 1386-1592
 corrugated, roofs, 1470
 drilling braces, 1664-1666
 fittings of the farmhouse and cottage, 1474-1502
 of the steading, 1503-1518
 foot-bridge, details of, 1521, 1522
 gates, 1531-1543
 gutters for closed surface drains in stables, 1504
 laths for roofs, dimensions of, 1645
 preservation of, 649-651
 rolled beam, 1399
 roof, double, for wide spans, 1427
 for 18-foot span, 1417
 for 25-foot span, 1430
 for 30-foot span, 1438
 for horse-walk of thrashing-mill, 1458
 slate-covering for, 1643
 with zinc covering, 1646

- Iron roof, wood covering for, 1642**
 roofs, 1417-1473
 dimensions of parts of, for various spans, 1448-1457
 gutters for, 1464-1469
 sheds, 1586-1591
 shoes for wooden framing, 1599-1606
 sluice-valve and rack, 1530
 Stirling's mixture of wrought and cast, 641
 straps for wooden beams, 1593-1598
 traps for stable, 1506
 travises for stable stalls, 1509
 trussing for wood girders, 1607-1620
 varieties of, 631
 ventilators, 1507
 weight of bars, round and square, 1809
 wrought, change of structure of, by vibration, 648
 varieties and peculiarities of, 646-651
Ironmonger, specification of duties to be performed by, in the erection of farm-buildings, 672, 705, 714, 823, 824, 877
Isolated cow-byre, 1700
 dairy, 1701
Isometrical elevation of Allen's American barn, 1768
 of a covered stackyard, 205
 perspective of a steading for mixed husbandry, in Plate IX.
 of steading at Coleshill, Berkshire, in Plate XV.
 of a carse farm-steading, Plate XXII.
 of a large dairy-farm, Plate XXIII.
 of a common farm-steading, Plate XXIV.
- Jacks, lifting screw, 1672**
Jamb, mouldings of, 947
Jenning's india-rubber tube water-tap, 1492
 lavatory, 1114
 sluice-cock, 1527
 water-closet, 1116
Jobbing, 693, 708
Joggles for joining blocks of stone, 945
Johnstone's method of forming embankments in low grounds on river-sides, 981-985
Joiner, tools of the, 1656-1668
Joiner's bench, 1657
Joining of plates of corrugated zinc, 1653
 of sheets of zinc, 1652
 of wires for fences, 1570
Joints, fished, for timber, 1134-1136
 for perpendicular timbers, 1137-1141
 for timber at right angles, 1142-1149
 for timbers at angles other than a right angle, 1154-1156
 of timber, 1133-1168
 of timber placed at angles to horizontal timbers, 1157-1168
 scarf, for timber, 1134-1136
 cast-iron shoe for receiving ends of, 1599
 setting of flooring, on brick walls, 961
Joists, binding, 1180
 bridging, 1180
 bridle, 1178
 calculations of quantity of timber in, 1803
 ceiling, 1179
 good and bad method of setting, in brick walls, 961
 and sleepers, 697, 860
 trimming, 1178
 trussing of flooring, 1178
- Keene's cement, 548**
Keys or spanners of various forms, 1669
Kiln for drain-tiles, 1749
 tile, for drying, 1732
Kilns, Hands' patent brick, 1747
 drying machines and, 1715-1751
 firing of, for drain-tiles, 1750
King-bolt, cast-iron shoe for receiving, 1602
King-post truss for bridge, 1343
 roof, 1207
 trussed beam, 1607
Kitchen of farmhouse, 287
 grates, ranges, and stoves, 1497-1502
 lock, 1477
Kyan's process for preserving timber, 618
Kuhlmann's artificial stone, 517
 method of preserving stone, 506
- Labourers, farm, classes of, 373-375**
Laminated rib-roof, 1227
Lancashire kitchen grate, 1497
Larch timber, 596-602
Latch, window, 1480
Latches, 705
Lathe, 1681
Lathing, 700, 866
Laths, estimates connected with, 1796
 iron, for iron roofs, dimensions of, 1645
Lavatories and wash-basins, 1113, 1114
Laycock's fittings for cattle-boxes, 1315
Lead, peculiarities of, 653
 surface covered by, at a given weight per foot, 1811
 weight of, 1810
Lean-to roof, 1193-1199
 truss for, 1199, 1200
Leather for architectural decoration, 519
Ledged door, 1248
 and braced doors, 1249
Level, mason's, 1662
Lewis for raising blocks of stone, 944
Lidded drain tubes, 1020-1022
Lifting screw jacks, 1672
Limestones, 496, 539
Lintel and flat arch in brick walls, 962
Lintels for steadings, 696
Liquid-manure drains, 1018
 pump, 1685
 pumps for lifting, from tanks, 1077
 tanks, 1065
 Flemish, 1081
 rationale of construction of, 1074
Lock, kitchen, 1477
 mortise, 1477
 press, 1477
 rim, 1477
Locks, 1474-1478
 and latches, 705
Looker's tubular ventilator, 1106
Loose-box in stable, 1301
Loose-boxes, fittings for, 1515
Loré's system of fireproof floors, 1635
Lowe's patent iron trap for sinks, 1495
- M'Culloch and Co.'s cottage window, 1261**
Machine, boring or drilling, 1682
 mortising, tenoning, and boring, 1676
Machines, drying, and kilns, 1715-1751
 of the workshop, 1673-1682
Macpherson's portable machine for making sheep-fences, 1677
Magnus's enamelled slate, 518
Manger, enamelled, for stables, 1510
 in byre or cow-house, 1306
 in stalls, 1282

- Mansard or curb roof**, 1221
Mantelpieces, 875
Manure, liquid, pump for, 1685
 tanks for, 1065-1081
Marine cement, 552
Marshall's American farm-buildings, 1770
Martin's cement, 548
Mason, specification of duties to be performed by, in the building of farm structures, 664, 684, 827, 850, 905
 tools of the, 1661, 1662
 work, 684
Masonry, stone, classes of, 940-943
Mason's level, 1662
 plumb-line, 1662
 trowel, 1662
Materials, 709
 employed in construction, 489
 for architectural decoration, 519
 for road surface, 1051
Mausné's system of making fireproof floors, 1634
Measurements, schedule of, for a farmhouse of stone, 848
Medina cement, 540
 for farm structure, 554
Memel timber, 592
Metals, 630
Miles' wooden field-gate, with cast-iron heel-post, 1360
Milk cooler, 1117
Mixed farming, 8
 description of plan of steading for, 165-183
 gauze wire-netting, 1583
Morphie steading, Kincardineshire, description of plan of, 235-241
Mortar, 532, 852
 estimates connected with, 1794
 Smeaton's, 538
Mortise lock, 1477
Mortising, tenoning, and boring machine, 1676
Mouldings of corbel, chimney-cap, string-course, summer-stone, jamb, and finial, 947
 of capping, stone-balcony front, stone finial, window cornice, drip-stone, string-course, 948
 of stone window cornice, chimney-cap, 950
 varieties of. *See* Glossary
Mullion of window, 1625
Muntins of a door, 1262

Natural seasoning of timber, 611
Netting, wire, for sheep, 1582
Norton and Borrie's earthenware staircase, 1098
 hollow bricks, 973
Norway and Petersburg timber, 591, 599
Notch-board of a stair, 1244

Oak timber, 605
Octagonal shed, 1590
Oil painting, 579-584
Old English bond in brickwork, 953
Onstead, or steading, or farmery, 37
Out-houses, cottage, plans of, 459-462
 plans of, for composite cottages, 462
 for double cottages, 461
 for single cottage, 460

Paint, durable, for outdoor work, 584, 589
Painter, specification of duties to be performed by, in the erection of farm-buildings, 679, 754, 813, 887, 891, 900
Painting in distemper, 577
 in oil, 579-584
Panels of doors, 1253

Paperhanger, specification of duties to be performed by the, 809, 821
Papier maché for architectural decoration, 519
Parian cement, 548
Parisian methods of making fireproof floors, 1631-1638
 modes of fireproof construction, Mr Fairbairn's remarks on, 1638
Parker's cement, 540
Pastoral farming, 3
 farming for cattle, description of plan of steading for, 38-52
 farming for cattle, with arable culture, 62
 farming for sheep, 53
 farming for sheep, with arable culture, 72
Partitions, 863, 1183-1191
 calculations of quantity of timber in, 1803
 trussed, 1191
Partition-tile, hollow, Stewart's, 974
Paul's method of preserving stone, 512
Pavement-bricks, drainage, 1118
Pavilion-roof, 1195
Paving, 699
 brick, estimates and calculations connected with, 1791
 bricks, 1086
 stone, estimates connected with, 1792
Paving tiles, 1087
Payne's process of preserving timber, 625
Peake's ferro-metallic paving-bricks, 1086
Perspective view of American cooking-stove, 1499
 of American side-hill barn, 1763
 of asphalt caldron and grate, 1684
 of carbon filter, 1112
 of a first-class farmhouse, Plate XXV.
 of boring machine, 1682
 of Bridges and Aubury's gas apparatus, 1698
 of Bruce's stable stall, 1511
 of Clayton's cored joint for drain-tubes, 1019
 of collar holder, 1516
 of combined caldron and furnace, 1683
 of Cooper's lidded drain-tubes and saddles, 1022
 of corn-chest, 1303
 of Doulton's lidded drain-tubes, 1020
 of Doulton's ventilating chimney-tube, 1105
 of drainage pavement-bricks, 1118
 of endless band saw frame, 1675
 of feeding-trough for cattle, 1321
 of fire-engine, 1685
 of Forbes's drainage pavement-bricks, 1118
 of Garrod's stable rack, 1512
 of hinges, 1478
 of Holman's double-action pump, 1636
 of Ibbotson's grindstone, 1660
 of Jenning's lavatory, 1114
 of a lathe, 1681
 of locks, 1477
 of manger and rack, 1515
 of a mansion-house and offices, Plate XXX.
 of marble milk-cooler, 1117
 of Miles' wooden field-gate, 1360

- Perspective view of M'Pherson's sheep-fence-making machine, 1677
 of Muir's four points ventilator, 1508
 of Pierce's cottage fire-lump grate, 1104
 of a pigsty door, 1324
 of pigs' troughs, 1518
 of Powis's mortising, tenoning, and boring machine, 1676
 of a pulley-stile, 1480
 of Ridgway's water-closet, 1115
 of a second class farmhouse, Plate XXVI.
 of spring pulley for window-blind, 1481
 of stall with cast-iron heel-posts, 1288
 of stone-dyke building, 1032
 of straw-racks for cattle, 1322
 of a third-class farmhouse, Plate XXVII.
 of Turner's iron bench for circular saw, 1674
 of a two-storeyed double cottage, Plate XXVIII.
 of a two-storeyed single cottage, Plate XXIX.
 of wash-hand basins and pedestals, 1113
 of a wooden ventilator, 1297
 of a wooden stathel, 1335
 Pierce's fire-lump stove-grate, 1102
 Pigeon-house, detached, 1710
 Piggery, American sifting, 1773
 detached, 1712
 Pigsty door, 1324
 fittings, 1517
 Pig-troughs, 1518
 Pilbrow's water waste preventer, 1494
 Piling for protecting river-banks, 992
 Pillars, cast-iron, for cattle-boxes in iron sheds, 1592
 Pins, harness, 1299
 Pipe, steam, curved valve, 1727
 roller for steam, 1727
 steam, expansion joint for, 1727
 valves for sluices, 1353
 Pipes, steam, clothing of, 1728
 steam, for drying-houses, 1727
 Pisé walls, 1130, 1131
 Plan of Allen's American Barn, 1768
 of American barn, 1766
 of American cheese-dairy buildings, 1772
 of American poultry-house, 1774
 of American side-hill barn, 1762
 of American sifting piggery, 1773
 of Archimedean screw grain conveyer, 1741
 of bay windows, 1269, 1727
 of carpenter's shop, 1754
 of carse farm-steading, description of, 82-94
 of Colehill steading, Berkshire, description of, 243-256
 of cheese-room of a farmhouse, 296
 of dam, 1004
 of detached piggery, 1712
 of detached slaughter-house, 1714
 of double detached farm-cottage, 400
 of drain-tile kiln at Corehouse, 1750
 of drain-tile work at Corehouse, 1750
 of Drumkilbo steading, Forfarshire, description of, 217-233
 of Dutch barn, 1756
 of five-roomed and single-storeyed farm-cottage, 387-389
 of five-roomed and two-storeyed farm-cottage, 396
 Plan of Flemish barn, 1756
 of Flemish farm-buildings, 1758, 1759
 of four-roomed and single-storeyed farm-cottage, 385
 of heating apparatus for drying-house, 1724
 of hipped-roof, 1213
 of Inverquharly steading, Forfarshire, description of, 284-274
 of isolated cow-byre, 1700
 of isolated dairies, 1701-1702
 of kitchen, &c., of a farmhouse, 287
 of large dairy farm-steading, description of, 96-107
 of machine-house in Flemish farm, 1760
 of Morphee steading, Kincardineshire, description of, 235-241
 of mullion of window of farmhouse in &c. 67, 1625
 of pigeon-house, 1710
 of poultry-house, 1707
 of rabbitry, 1711
 of river-bank requiring protection, 990
 of single-roomed and single-storeyed farm-cottage, 378
 of small dairy farm-steading, description of, 108-120
 of smithy, 1755
 of stackyard, 206-210
 of steading at Britannia Farm, Belgium, 1761
 of steading at Southhill Park, Surrey, description of, 213-216
 of steading for cattle pastoral farming, description of, 38-52
 of steading for cattle pastoral farming with arable culture, description of, 62-71
 of steading for common farming, description of, 145-164
 of steading for mixed husbandry, description of, 165-183
 of steading for sheep pastoral farming, with arable culture, description of, 72-81
 of steading for suburban dairy farming, description of, 131-144
 of steading for suburban farming with arable culture, description of, 122-130
 of two-roomed and single-storeyed farm-cottage, 381
 of Wark steading, Northumberland, description of, 257-262
 of Western States, American, farm-buildings, 1771
 Plans of bothies, 446-458
 of composite farm-cottages, 437-445
 of double single-storeyed farm-cottages, 401-410
 of double two-storeyed farm-cottages, 411-422
 of double two-storeyed farm-cottages of two different sizes, 425-430
 of existing steadings, 212
 of farm-cottages, 350
 of farmhouses, 281
 of first-class farmhouses, 301-325
 of out-houses for composite farm-cottages, 462
 of out-houses for double-cottages, 461
 of out-houses for farm-cottages, 459
 of out-houses for single-cottages, 460
 of roofs of steadings, description of, 184-203
 of second-class farmhouses, 326-330
 of steadings based upon fixed principles, 1
 of third-class farmhouses, 331-347
 suggesting improved arrangements in defective farm-cottages, 431-436
 Plaster-work, 715

- Plasterer, specification of duties to be performed by, in the erection of farm-buildings, 675, 715, 752, 804, 884, 891, 898, 907
- Plastering, 571-576
 estimates connected with, 1796
- Platform stairs, 1241
- Plumber, specification of duties to be performed by, in the erection of farm-buildings, 674, 711, 712, 815, 886, 891, 902, 907
- Plumb-line, mason's, 1662
- Pools, watering, in fields, formed by dykes crossing in meeting, 1045-1048
- Pole-plate, cast-iron shoe for receiving, 1605
- Pond, making of, for horses, 1083
- Porch, truss for, 1204
- Portable combined furnace and caldron, 1683
 crane, Dray's, 1695
 vice, 1671
- Porter's gas apparatus for farm use, 1696
- Portland cement, 541
 experiments on, 542, 544, 547
- Portable fire-engine, 1685
- Posts, intermediate, for wire-fences, 1549
- Poultry-houses, 1707-1709
 American, 1774
- Powis, James, and Co.'s mortising, tenoning, and boring machine, 1676
- Practical construction, 922
- Practice in construction, 489
- Preservation of grain, tanks for, 1744
 of iron, 649-651
 of wood, 614
- Press lock, 1477
- Presses, 870
- Principles of arrangement of steadings, 1
 of arrangement of farmhouses, 286
 of drying, 1723
 of grain drying, 1733
 of hot-water supply, 1721
- Pulley, spring, for window-blinds, 1481
 stile, window, 1479
- Pump, double-action, 1686
 hand, 1688
 liquid-manure, 1685
 steam, Carrett's, 1691
- Pumps for lifting liquid manure from tanks, 1077
- Purlin, cast-iron shoe for receiving, 1606
- Puzolano cement, 538
- Quantities, bills of, for a farmhouse of stone, 848
- Quarry crane, 1693
- Queen-bolt, cast-iron shoe for receiving, 1604
- Queen-post truss for bridge, 1343
 roof, 1208-1210
 trussed beam, 1607
- Rabbitry, 1711
- Rack, straw, for sheds, 1323
- Racks, straw, for courts, 1322
- Rafter, cast-iron shoe for receiving, 1605
- Rails of a door, 1252
- Rain-water cistern, 1110
- Raised panel door, 1256
- Ram, hydraulic, 1689
- Ranges, grates, and stoves, 1497-1502
- Ransome's artificial stone, 516
 method of preserving stone, 510
- Ratchet brace, Fenn's, 1666
 Ibbotson and Co.'s, 1665
 valve for admitting air, 1507
- Rawlinson's hollow brick, 1087
- Regulators, gas, 1488
- Remarks on the accommodation of farmhouses in relation to the size of the farm, 349
 on the advantages of double cottages over rows, 400
- Remarks on the arrangement of Drumkilbo steading, 234
 on the arrangement of Morphie steading, 239-240
 on arranging the accommodation of farm-cottage to size of family, 393-395
 on the Coleshill steading, 256
 on farmhouse accommodation, 348
 on furniture for small cottages, 380
 on Inverquharly steading, 275
 on the importance of providing good accommodation in farm-cottages, 350-372
 on the policy of adopting a covered steading, 242
 on Wark steading, 262
- Reservoir, water, embankment for, 1002
- Rickett's gas-stove, 1501
- Ridge and valley roof, 1198
 tiles, 1089
- Ridgway's water-closet, 1115
- Rim lock, 1477
- Risers of a stair, 1239
- River-banks, protection of, by breakwaters, 989-991
 tree, 990
 piling, 992
- Road surface, material for, 1051
- Roads, construction of, on strong soils, 1054
 convex, 1051
 drains for, 1052
 excavations for, 1053
 farm, 1050-1059
- Roberts' system of hollow brick walls, 969-971, 1087
- Rolled iron beam, 1399
- Roman cement, 540
- Roman cement, experiments on, 545, 546
- Roof, conical, 1196
 conical truss for, 1229
 corrugated iron, for span of 18 feet, 1417
 52 feet, 1472
 covering, asphalted felt for, 1092
 curb or mansard, 1221
 curved rib-truss for, 1225
 for octagonal shed, 1590
 hexagonal, 1230
 for thrashing-mill, 1229
 hipped, 1194
 plan of, 1213
 iron, covering of wood for, 1642
 double, for wide spans, 1427
 for horse-walk of thrashing-mill, 1459
 for 25-feet span, 1430
 for 18-feet span, 1417
 for 30-feet span, 1438
 slate covering for, 1644
 king-post truss for, 1207
 laminated rib, 1227
 of corn-barn, 1327
 of stable for work-horse, 1289
 pavilion, 1195
 queen-post truss for, 1208-1210
 ridge and lean-to, 1193
 ridged, meeting at right angles, 1197
 tiles, 1089
 truss for flat, 1219, 1220
 for, with king-bolt, 1207
 trusses, 1199-1230
 with queen bolts, 1438
 with hip-rafter, 1211
- Roofing, 698, 862
 tiles, 530
- Roofs, 1192-1198
 blue and grey slates for, 1093
 calculations of quantity of timber in, 1803

- Roofs, corrugated iron, 1470-1473**
 Gothic, 1222
 for thrashing-mills, 1229
 iron, 1417-1473
 iron, dimensions of parts of, for various spans, 1448-1458
 iron, gutters for, 1464-1469
 iron, with zinc, 1646
 of steadings, description of plans of, 184-203, 251
 relative cost of slate and zinc covered, 1654
 ridge and valley, 1198
 tables of scantlings of timber for various spans of, 1214
Rough-casting, 563-565
Rubber, india, tap, 1492
Rubblework in masonry, 942, 943, 946
Rule, general, applicable to all designs of farmsteadings, 17
 for calculating surface of hot-water pipes for drying-houses, 1725
Saddle and harness-bracket, 1516
Sandstones, 493-495
Sands for building purposes, 533
Sash door, 1251
 frame, Shaw's patent, 1265
Saw, circular, iron bench, 1674
 endless band, 1675
 frame, vertical, 1673
Scagliola, 551
Scantlings of timbers for floors of various spans, 1181
 of timbers for various spans of roofs, 1214
Schedule of measurements for a farmhouse of stone, 848
Scotch fir timber, 597-599
Scotland, state of farming in the Middle Ages, 474-488
Screw, Archimedean, grain drying machine, 1735
 frame for boring brace, 1664
 keys or spanners, 1669
 lifting-jack, 1672
 stocks, 1668
 ventilator, Chadwick's, 1485
Sea-embankments, 993-1001
Seal or binder for cattle, 1311
Seasoning of timber, 610
 natural, 611
 water, 612
 hot-air, 613
Section of American poultry-house, 1774
 of Archimedean screw grain-conveyer, 1741
 of base of principal window of farmhouse, 1623
 of base of bay window of farmhouse, 1626
 of a self-acting sluice, 1351
 of an improved cottage-window, 1261
 of byre travis, manger, and stake, 1309
 of cornice, base, of farmhouse, 1621
 of dam, 1004
 of detached slaughter-house, 1714
 of drain-tile kiln at Corehouse, 1750
 of first-class farmhouses, 310, 316
 of groin and dam for protecting a river-side, 1008
 of Hands' drying-sheds, 1730
 of heating apparatus for a drying-house, 1724
 of Jennings's water-closet, 1116
 of milk-house and cheese-room of a farmhouse, 305
 of moulds for pisé walls, 1131
Section of manger, and rack for cattle-boxes, 1315
 of nests behind stairs in poultry-house, 1774
 of pigeon-house, 1710
 of platform and return stairs, 1242-1243
 of portable combined furnace and caldron, 1683
 of poultry-house, 1707
 of river embankment, 981
 of road in strong clay land, 1055
 of stone trough for a byre, 1127
 of through window-head of farmhouse, 1624
 transverse, of Tudor farmhouse, 316
 of wall, showing gutter with cantaliver, 1233
 of window-head of bay window of farmhouse, 1627
 of wrought-iron columns for sheds, 1591
 fire-proof flooring, 1632
 vertical, of corn-barn, 1331
 vertical of single-storeyed detached cottage, 392
 vertical of slaughter-house, 1714
Segmental arch in brick wall, 966
Self-acting sluice, 1351
Semi-circular arch in brick wall, 966
Shaw's patent sash-frame, 1265
Sheaf, drying of grain in the, 1722
Sheaves, drying of, in the boiler-house, 1729
Shed, covered dung, 1377
 octagonal, 1590
 truss for roof of, 1647
Sheds and timber houses, 1373-1385
 cast-iron girder for, 1589
 drying, Hands' patent, 1730
 iron, 1586-1591
 sheep feeding, 1703
 shelter, at the corner of four fields, 1376
 trussed beam for, 1589
 wrought-iron columns for, 1591
Sheep feeding-sheds, 1703
 fence-making machine, 1677
 pastoral farming, 63
 with arable culture, &c.
 scription of plan of steading for, 72-81
Sheep, wire-netting for, 1582
Shelter-sheds, 1376
Shelving, 871
Sheringham's ventilator, 1296, 1484
Shoe, cast-iron, for ends of struts, 1601
 for king-bolt, 1602
 for purlins, 1606
 for rafter and pole-plate, 1605
 for struts and queen-bolt, 1604
 iron, for receiving end of girder, 1599
 iron, for joists, wall-plates, 1599
Shoes, iron, for wooden framing, 1599-1606
Shop, carpenter's, plan of, 1754
Side-gate of wrought-iron, 1540
 hill barn, American, 1762
Sienite, 491
Sifting piggery, American, 1773
Single and double stalls in byres, comparative advantages of, 1308
 storeyed detached cottages of brick, specification adapted for, 878-887
Sink, cast-iron, 1496
Sinking of wells, 1060
 in loose sand, 1061
Site of farmhouse, 285-286
Site of steading, 19, 28, 29
 particulars to be avoided in the choosing of, 26
Skirting, 707, 1279
Skylights, 713
Slate, blue, best for buildings, 529

- Slate, blue, quarries of, 524
 for shed covering, 1092
 covering for iron roof, 1643
 enamelled, 518
 roof, cost of, 1654
- Slates, blue and grey, for roofs, 1094
 grey, 526
 quarries of, 528
 sizes of, 525
- Slater, specification of duties to be performed by, in the erection of farm-buildings, 663, 711, 885, 891, 908
 and plumber work, 711
- Slating, estimates connected with, 1798
 grey, cost of, 527
- Slaughter-house, detached, 1714
- Sleepers and joists, 697
- Sliding door, 1258
 door for stables, 1370
 gate of corrugated iron, 1542
 window, 1260
- Sluice-cock, Brown and May's, 1528
 cock, Jenning's, 1527
 pipe valves, 1353
 self-acting, 1351
 valve and rack, iron, 1530
 valves, 1526
 valves, hydrants, bridges, 1519-1530
- Sluices, wooden, 1349-1352
- Smeaton's mortar, 538
- Smith, specification of duties to be performed by, in the erection of farm-buildings, 673, 753, 903
 tools of the, 1663-1673
 boring brace, 1664
 forge, 1663
- Smithy, plan of farm, 1755
- Smoke and ventilating flue, 1101-1105
- Soils, foundations in various classes of, 924-927
- Sutter's method of forming river-embankments, 986, 987
- Southhill Park, Surrey, steading, description of plan of, 213, 216
- Spanners or screw-keys, 1669
- Specification adapted for a steading of brick, general conditions of, 718-736
 adapted for a steading of brick, 717-755
 adapted for a steading of stone, 683-716
 of a steading of stone, general conditions of masonry, 694—general conditions of carpentry, 710
 of farm-house adapted for brick, 756-824
 of farmhouse, adapted for stone, 825-847, 849-877
- Specifications for cottages of brick, 879-903
 for cottages of stone, 904-909
 items to be considered in the drawing up of, 657-682
 of buildings, 656-909
 of duties to be performed by various tradesmen in the erection of farm-buildings, as follows:—*Excavator*, 657, 684, 736, 757, 826, 850, 880, 893, 905. *Mason*, 664, 684, 827, 850, 905. *Bricklayer*, 658, 662, 737, 760, 881, 889, 894. *Carpenter and Joiner*, 665, 669, 696, 741, 763, 858, 883, 890, 896, 906. *Slater*, 663, 711, 885, 891, 908. *Smith*, 673, 753, 903. *Ironmonger*, 672, 705, 714, 823, 824, 877. *Plumber*, 674, 711, 712, 815, 886, 891, 902, 907. *Plasterer*, 676, 716, 752, 804, 884, 891, 898, 909. *Painter*, 679, 754, 813, 887, 891, 900. *Glazier*, 679, 682, 755, 820, 876, 901. *Paperhanger*, 821, 899. *Bellhanger*, 822.
- Spelter. *See* Zinc
- Spiral wire-work, 1585
- Stable fittings, Bruce's improved, 1511
 Cottam's improved, 1514
 roof of work-horse, 1239
 stalls, with feeding-passages at the heads of, 1236, 1287
 windows, 1298
 work-horse, proper width of, 1230
- Stables, &c., ventilation of, 1290-1297
 sliding door for, 1370
 work-horse, proper width of stalls in, 1281
- Stackyard, 1334
 covered, description of, 204, 205
 plan of, 206-210
- Staining of wood, 585
- Stair, mode of laying out the steps in the notch-board of, 1245
 rods, fastening for, 1482
 treads and rises of, 1239
- Staircase, earthenware, 1098
- Stairs, 865, 1239-1246
 balusters for, 1246
 notch-board and string-board of, 1244
 platform, 1241
 template, for setting out steps of, 1245
- Stall-collar, 1300
 fittings for work-horse stables, 1235
 in byres, width of, 1304
- Stalls, double and single, in byres, comparative advantages of, 1308
 for work-horse stable, with cast-iron heel-posts, 1238
 iron hind-posts for stable, 1509
 mode of supplying food to, in byre, 1307
 of work-horse stables, proper width of, 1281
- Stathels, 1335
- Steading, Coleshill, Berkshire, description of plan of, 243-256
 covered, remarks on the policy of adopting, 242
 description of plan of, for carse farming, 82-94
 description of plan of, for cattle pastoral farming, 38-52
 description of plan of, for cattle pastoral farming with arable culture, 62-71
 description of plan of, for common farming, 145-164
 description of plan of, for large dairy farming, 96-107
 description of plan of, for mixed farming, 165-183
 description of plan of, for sheep pastoral farming with arable culture, 72-81
 description of plan of, for small dairy farming, 108-120
 description of plan of, for suburban dairy farming, 131-144
 description of plan of, for suburban farming with arable culture, 122-130
 Drumkilbo, Forfarshire, description of plan of, 217-233
 fittings of, 1220
 Inverquharly, Forfarshire, description of plan of, 264-274
 iron fittings of, 1503-1518
 lintels for, 696
 Morphis, Kincardineshire, description of plan of, 235-241
 of brick, specification adapted for, 717-755
 site of, 19, 23, 29
 site of, particulars to be avoided in the choosing of, 26

- Steading, Southhill Park, Surrey, description of plan of, 213-216
 Wark, Northumberland, description of plan of, 257-262
- Steadings, arrangement of, determined by the position of straw, 31, 32
 bad arrangement of, loss sustained by, 35
 Belgian, 1756-1761
 existing, plans of, 212
 gables suggested for, 276-280
 general rule applicable to the designing of, 17
 kind of building-stones to be employed in constructing, 503-505
 plans of, based upon fixed principles, 1
 principles of arrangement of, 1
 roofs of, description of plans for, 184-203
- Steam, heating of buildings by, 1721
 pipes, clothing of, 1728
 for drying-houses, 1727
 pump, Carrett's, 1691
- Stells for pastoral sheep farming, 54-61
 inside circular, with plantation, 59
 with hay-stack and racks, 60
 outside, affording shelter in all direction, 57
 sheltered by plantation on every side, 61
 simple forms, 56
- Stench-traps, 1107-1109
- Stephens' method of staining wood, 588
- Stewart's hollow partition-tile, 974
- Stile, window-pulley, 1479
- Stiles of a door, 1252
- Stirling's mixture of wrought and cast iron, 641
- Stock, position of, with reference to the straw, 33
- Stone and brick, wood combined with, 1621-1627
 blocks of, "Lewis" for raising, 944
 construction, 940
 footings, 934-936
 masonry, classes of, 940-943
 paving, estimates connected with, 1792
 trough for byre, 1127
 work of farmhouses, details of, 947-950
- Stones, absorbent power and cohesiveness, 497
 artificial, 515
 classification of, 489
 "dowels," "joggles," and "cramps," for joining blocks of, 945
 kind of, to be used in constructing steadings, 503-505
 position of, in sea-walls, 1008
 preservation of, 506
 preservation of, Kuhlmann's method, 506
 Daines' method, 508
 Paul's method, 512
 principles of, 514
 Ransome's method, 510
 Szerelmey's method, 513
 table of qualities of, 497
 their constructive qualities, 498-505
- Stops, door, for the prevention of draughts, 1259
- Storey, upper, of steadings, 67, 77, 89, 103, 116, 126, 137, 160, 177, 251. *See* Upper Storey
- Stove, gas, 1501
 grate, fire-lump, 1103
- Stoves, kitchen-ranges and grates, 1497-1502
- Straining-post for wire-fence, 1544-1548
 screw and collar-vice combined, for wire-fences, 1575
 screw for wire-fences, 1573
- Strapping, 864
- Straps, iron, for wooden beams, 1594-1598
- Straw-barn, arrangement and construction of, 1326
 position of, determines the arrangement of steadings, 31, 32
 rack for sheds, 1323
 racks for courts, 1322
 reference of, to the position of stock, 33
- String-board of a stair, 1244
 course, mouldings of, 947, 948
- Struts, 868
 cast-iron shoe for receiving ends of, 1601-1604
- Stucco, 550, 566
 Stuccoing, 564, 566, 569
- Suburbial dairy farming, description of plan of, 131-144
 farming, 5
 farming with arable culture, description of plan of standing for, 122-130
- Summer-stone, moulding of, 947
- Surface covered by a given weight of lead per foot, 1811
- Suspended or hanging gate, 1371
- Swedish mode of forming walls of frame-houses, 1374
 timber, 595-598
- Szerelmey's method of preserving stone, 513
- Table of qualities of stones, 497
 of scantlings for floors of various spans, 1151
 of bearing of floors in *Système de Masure*, 1634
 of bearing or span of joists, headers, and girders, 1180
 of the breaking weight of wrought-iron beams, 1807
- Tables for calculating quantity of timber in roofs, joists, partitions, 1803
 for calculating the cubical contents of timber in roofs and partitions in a square of 100 feet, 1804, 1805
 of scantlings of timbers for roofs of various spans, 1214
- Tank, dimensions of, for liquid manure, 1068
 for the waste urine of a dunghill, 1080
 liquid-manure, apparatus to lift manure from, 1077
- Tanks, cement for lining, 556-562
 for liquid manure, rationale of construction of, 1074
 liquid-manure, 1066-1081
 for the preservation of grain, 1744
- Technical terms, glossary of, used in artificers' work, 1812
- Tension gate of iron, 1534
- Tenoning, mortising, and boring machine, 1676
- Terms, technical, glossary of, used in artificers' work, 1812
- Thrashing-mill, iron roof for horse-walk of, 1458
 roofs for, 1229
- Thumb-latch, 1477
- Tie-beams, 1151
- Tie-rods, best position of, in iron beams, 1333-1395
- Tile, corrugated roof, 1090
 grooved ridge, 1089
 gutter, 1091
 hollow roof, 1090
 hip, 1089
 kiln, drying of grain, 1732
 ornamental ridge, 1089
 quoined valley, 1089
 ridge, 1089
- Tiles for roofing, 530
 flat, 1097

- Tiles, paving, 1087
 ridge, 1089
 roof, 1089
 valley, 1089
 Tiling, estimates connected with, 1793
 Timber, 590
 American red pine, 593, 600
 yellow pine, 594, 601
 ash, 607
 Bethel's process of preserving, 623
 bond, for brick walls, 956
 Boucherie's process of preserving, 628-629
 Burnett's process of preserving, 622
 California pine, 603
 construction, 1133
 for agricultural implements, 604
 floors, 1176-1182
 houses and sheds, 1373-1385
 joists of, 1133-1163
 Kyan's process for preserving, 618
 larch, 596-602
 Memel, 592
 Norway and Petersburg, 591, 599
 oak, 605
 Payne's process of preserving, 625
 Scotch fir, 597-599
 seasoning of, 610
 Swedish, 595-598
 ventilation of, in dwellings, 620
 Tools of the dry-stone dyker, 1026
 of the joiner, 1658-1658
 of the mason, 1661, 1662
 of the smith, 1663-1673
 Trap rock, 492
 Traps, iron, for sinks, 1495
 iron, for stable, 1506
 stench, 1107-1109
 Travis and manger of stall in byre, 1309
 stones, 689
 Travises, 703
 of stalls in stables, 1284
 iron, for stable stalls, 1509
 Treads of a stair, 1239
 Tree, structure of, 608
 Tressels or horses for the joiner's shop, 1658
 Trimming-joists, 1178
 Trough, stone, for byre, 1127
 Troughs, pig, 1618
 turnip, for courts, 1821
 water, for cattle-courts, 1119-1127
 Trowel, mason's, 1662
 Truck, turnip, 1706
 Truss, for bridge, 1343
 for collar-beam roof, 1208
 for curb or mansard roof, 1221
 for curved rib-roof, 1225
 for dormer windows, 1231
 for flat roof, 1219
 for a lean-to roof, 1199, 1200
 for a porch, 1204
 for roof of shed, 1647
 king-post, for roof, 1207
 queen-post, for roof, 1208-1210
 with king-bolt, 1207
 Trussed beam, Ainger's, 1609
 bridge, 1342
 for sheds, 1589
 king-post, 1607
 queen-post, 1607
 gate, 1359
 girder bridge, 1342
 partition, 1189
 timber beams, 1169-1173
 Trusses for Gothic or high-pitched roof, 1222-1224
 roof, 1199-1230
 Trussing of flooring-joists, 1178
 of solid beams, Conder's, 1615
 iron, of wood girders, 1607-1620
 Tubes, drain, lidded, 1020-1022
 Tubular ventilator, 1106
 Turner's iron bench circular saw, 1674
 Turnip-troughs for courts, 1821
 truck, 1706
 washing, method of, 1705
 Turn-key for wire-fences, 1572
 Tyermann's hoop-iron bond for brick walls, 957
 Unburnt bricks, walls of, 1132
 Upper storey of steading for cattle pastoral farming with arable culture, 67
 of steading for sheep pastoral farming with arable culture, 77
 of steading for carse farming, 89
 of steading for large dairy farming, 103
 of steading for small dairy farming, 116
 of steading for suburban farming with arable culture, 126
 of steading for suburban farming with dairy, 137
 of steading for common farming, 160
 of steading for mixed husbandry, 177
 of steading at Colehill, Berkshire, 251
 Useful apparatus and erections, 1683-1698
 Valley-tiles, 1089
 Valves, chimney, 1487
 Valves for sluices, 1526
 iron, for admitting fresh air to stables, &c., 1507
 Varnish for stained wood, 586
 Venetian ventilator, 1296
 Ventilating and smoke flue, 1101-1105
 Ventilation of drying-houses, 1724
 importance of, 1290, 1291
 of stables, &c., 1290-1297
 Ventilator, Arnott's, 1483
 for stables, Ferguson's, 1295
 for withdrawing foul air from dwellings, 1608
 Looker's tubular, 1106
 ornamental grating for, 1105
 Sheringham's, 1296, 1434
 Watson's, 1508
 with hinged valve, 1296
 with suspended valve, 1296
 wooden, 1295, 1297
 Ventilators, 714
 iron, 1507
 Vermin-proof cement, 549
 Vertical saw frame, 1673
 Vice, portable, 1671
 Vincennes farm-buildings, 1775
 Voids in brick walls, 962
 V-window, 1272
 Wall-plates, 1150
 cast-iron shoe for receiving, 1599
 brick openings or voids in, 962
 carrying up of courses of, in brick, 960, 961
 fireproof, of frame-houses, 1375
 hollow, of brick, 967-974
 of brick, 953-961
 bond in, 953, 954
 of unburnt bricks, 1132
 pisé, 1130, 1131

- Wall, sea, position of stones in, 1008
 whitewashing of, 567, 568
 Wark Steading, Northumberland, description of
 plan of, 257-262
 Wash-basins and lavatories, 1113, 1114
 Washing, turnip, method of, 1705
 Water-closets, 872, 1115, 1116
 cock, Wheatecroft and Smith's, 1493
 foundations in, 928-930
 rain, cistern, 1110
 raising from wells, 1064
 seasoning of timber, 610
 tap, Jenning's india tube, 1492
 taps and cock, 1491
 troughs for cattle-courts, 1119-1127
 waste preventer, Pilbrow's, 1494
 Watering-pools, formed by crossing of dykes,
 1045-1048
 Watson's ventilator, 1508
 Weather-boarding for timber sheds, 1374
 Weight of round iron bars, used as tension-rods
 for roof-trusses, in foot lengths, 1809
 of lead per foot superficial, 1810
 Weirs, 990, 1002, 1003
 Weir for a water reservoir, 1002
 Wells, raising water from, 1064
 Well digging and steining, estimates connected
 with, 1778
 sinking, 1060
 in loose sand, 1061
 West and Hubbell's "oak-hall" window, 1264
 Western States of America, farm-buildings for,
 1771
 Wheatecroft and Smith's hydrant, 1529
 water-cock, 1493
 Wheeler's mode of staining wood, 587
 White's portable vice, 1671
 Whitewashing of walls, 567
 Width, proper, for stalls in work-horse stables,
 1281
 for work-horse stables, 1280
 Window-blinds, spring pulley for, 1481
 cornice, mouldings of, 948
 stone mouldings of, 950
 dormer, elevation of, 1231
 fixed, 1260
 for cottages, 1261
 French casement, 1263
 fastenings for, 1481
 head of farmhouse, 1624
 latch, 1480
 mullion of, 1625
 oak-hall, 1264
 of byre, 1312
 pulley-stile, 1479
 sliding, 1260
 V, 1272
 Windows, 699, 867
 for farm-cottages, 463, 464
 of corn-barn, 1327
 of farmhouses, details of, 1266-1277
 of granary, 1333
 stable, 1298
 various forms of, 1260-1277
 Wire, block for straightening, 1567
 clamps for twisting the eye of, for fences,
 1571
 fence, straining-post for, 1544-1548
 Wire fence, straining-screw, 1573
 turn-key, 1573
 fences, 1544-1576
 fitting up of, 1564-1576
 intermediate posts for, 1549
 fencing, collar-vice for, 1574
 straining-screw and collar-vice for,
 combined, 1575
 joining, for fences, 1570
 netting for sheep, 1582, 1583
 work, spiral, 1585
 for fences, 1551-1563
 block for making eyes in,
 1571
 Wood combined with iron-work, 1593-1620
 with stone and brick, 1621-1627
 covering for iron roof, 1642
 its chemical properties and composition,
 614-618
 preservation of, 614
 staining, 585
 Stephens' method of, 588
 Wheeler's method of, 587
 Wooden aqueduct for irrigation, 1348
 beams, iron straps for, 1594-1598
 bridges, 1340-1347
 fittings of the farmhouse and cottage,
 1247-1279
 fittings of the steading, stable, byre,
 barn, courtyard, &c., 1280-1335
 framing, iron shoes for, 1599-1606
 gutters, 1232-1237
 sluices, 1349-1352
 ventilators, 1295, 1297
 Wood's asphalt caldron, 1684
 Workshop, fittings of the, 1656-1682
 machines of the, 1673-1682
 Work, brick, estimates and calculations con-
 nected with, 1782-1791
 estimates of diggers' and excavators',
 1777-1781
 artificers' glossary of technical terms used
 in, 1812
 Wrought-iron and cast-iron beams, comparative
 advantages of, 1396, 1397
 beams, Fairbairn's fireproof floor-
 ing with, 1630
 beams, junction with cast-iron
 columns, 1416
 beams, with concrete for fireproof
 construction, 1629
 girders and beams, 1607
 plate beam, 1398
 columns for sheds, 1591
 hurdles, 1577
 side-gate, 1540
 varieties and peculiarities of, 646-
 651
 girders and beams, 1807
 Young's instructions for fitting up wire fences,
 1565-1576
 Zinc-covered iron roof, 1646
 fixing of sheeting as roof covering, 1652
 joining plates of corrugated zinc, 1653
 peculiarities of, 654
 roof, cost of, 1654

THE END.



DETACHED PASTORAL FARM STEADING
FOR REARING CATTLE

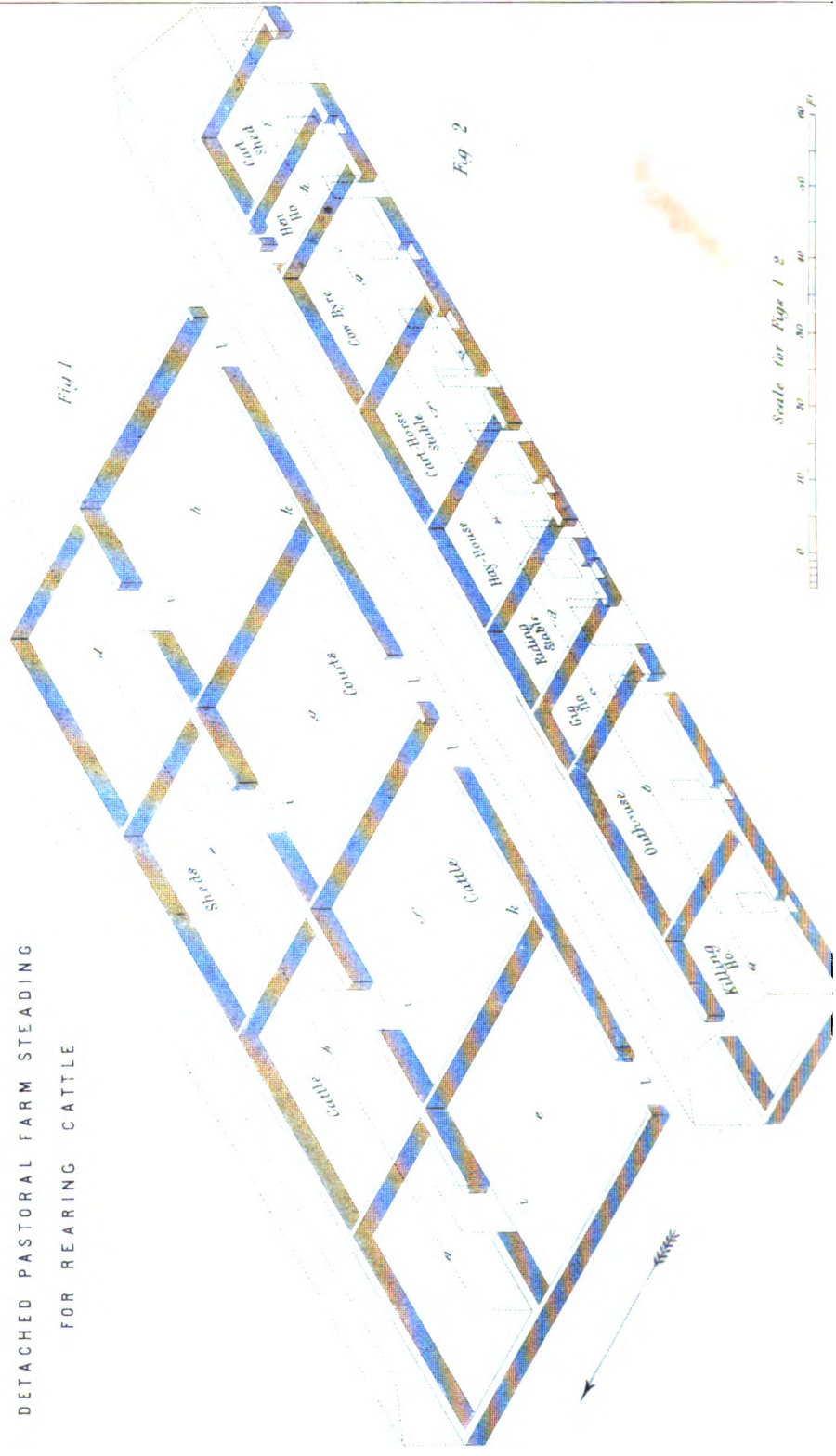

Scale for *Figure 1 & 2*

COMPACT PASTORAL FARM STEADING
FOR REARING CATTLE

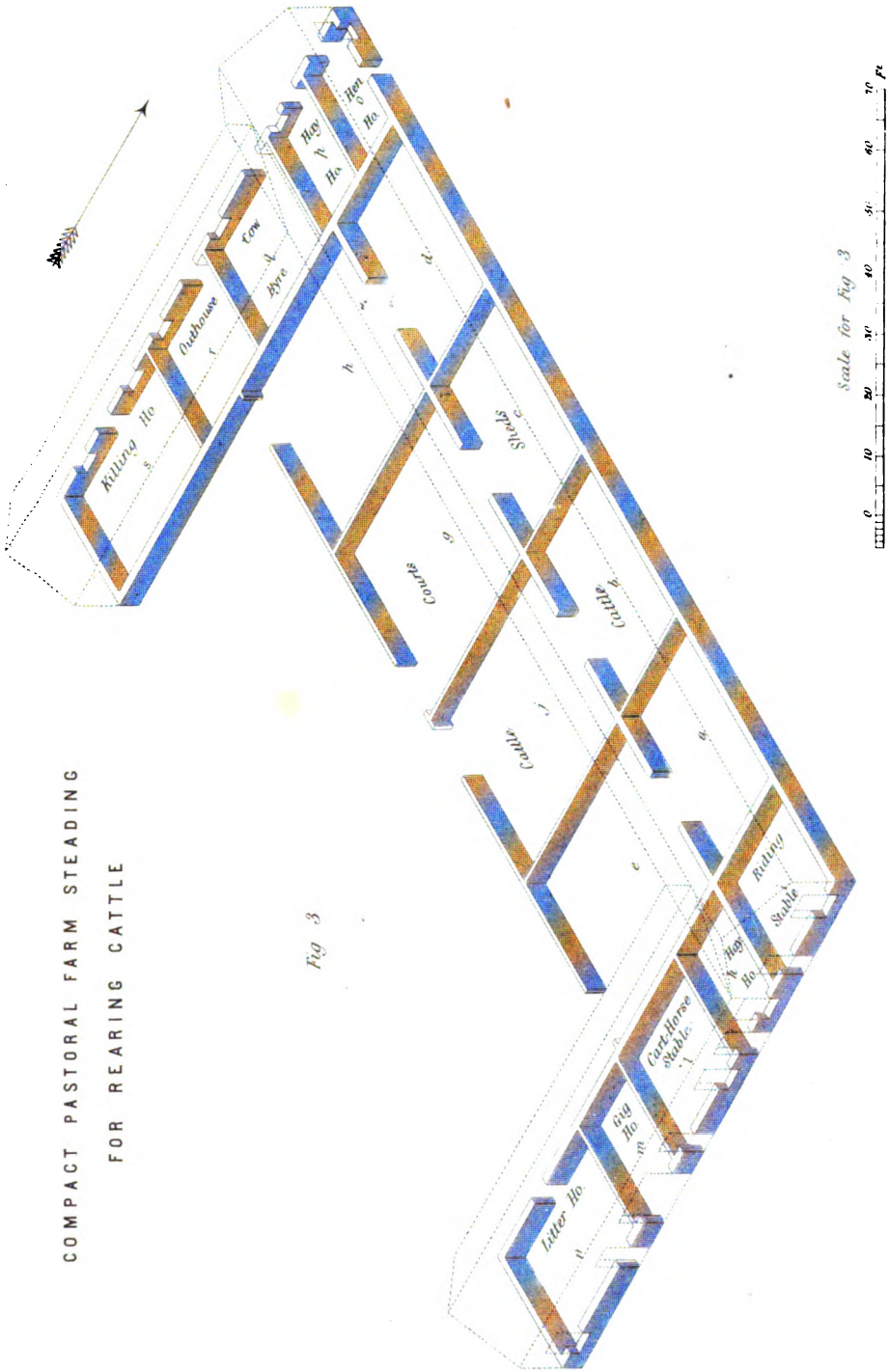
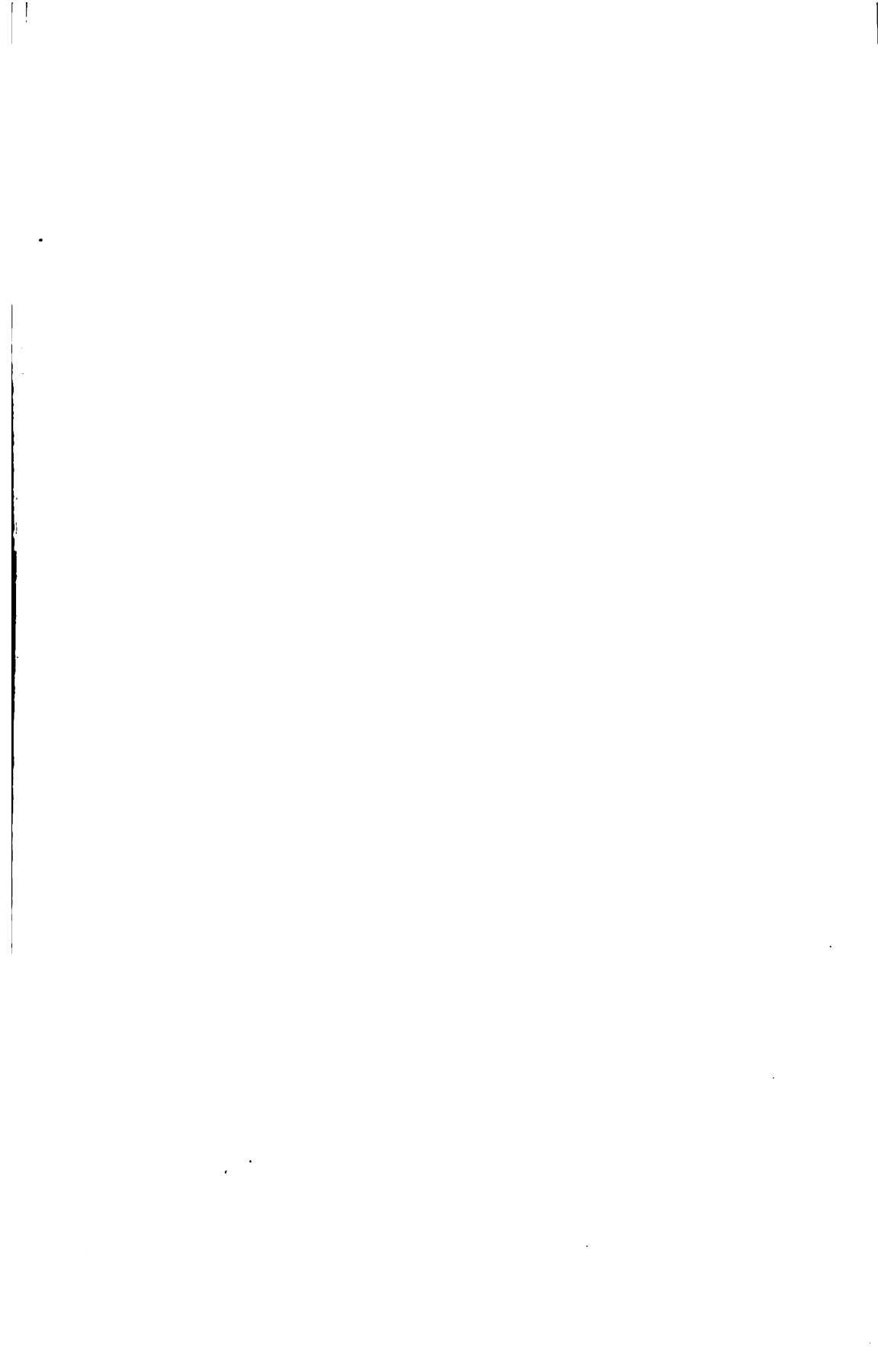

Fig. 3

Scale for Fig. 3





FARM STEADING FOR REARING CATTLE
WITH ARABLE CULTURE

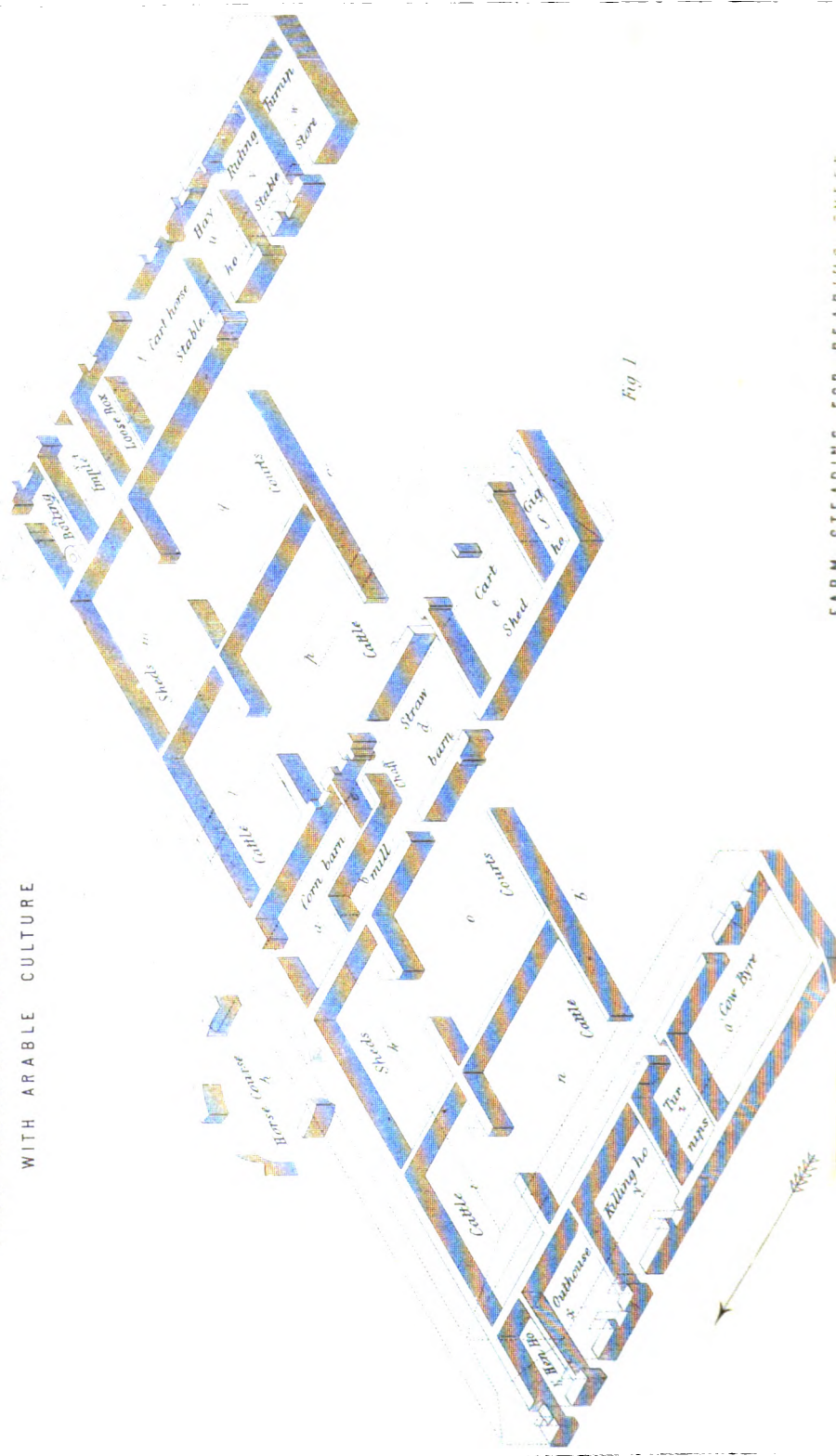
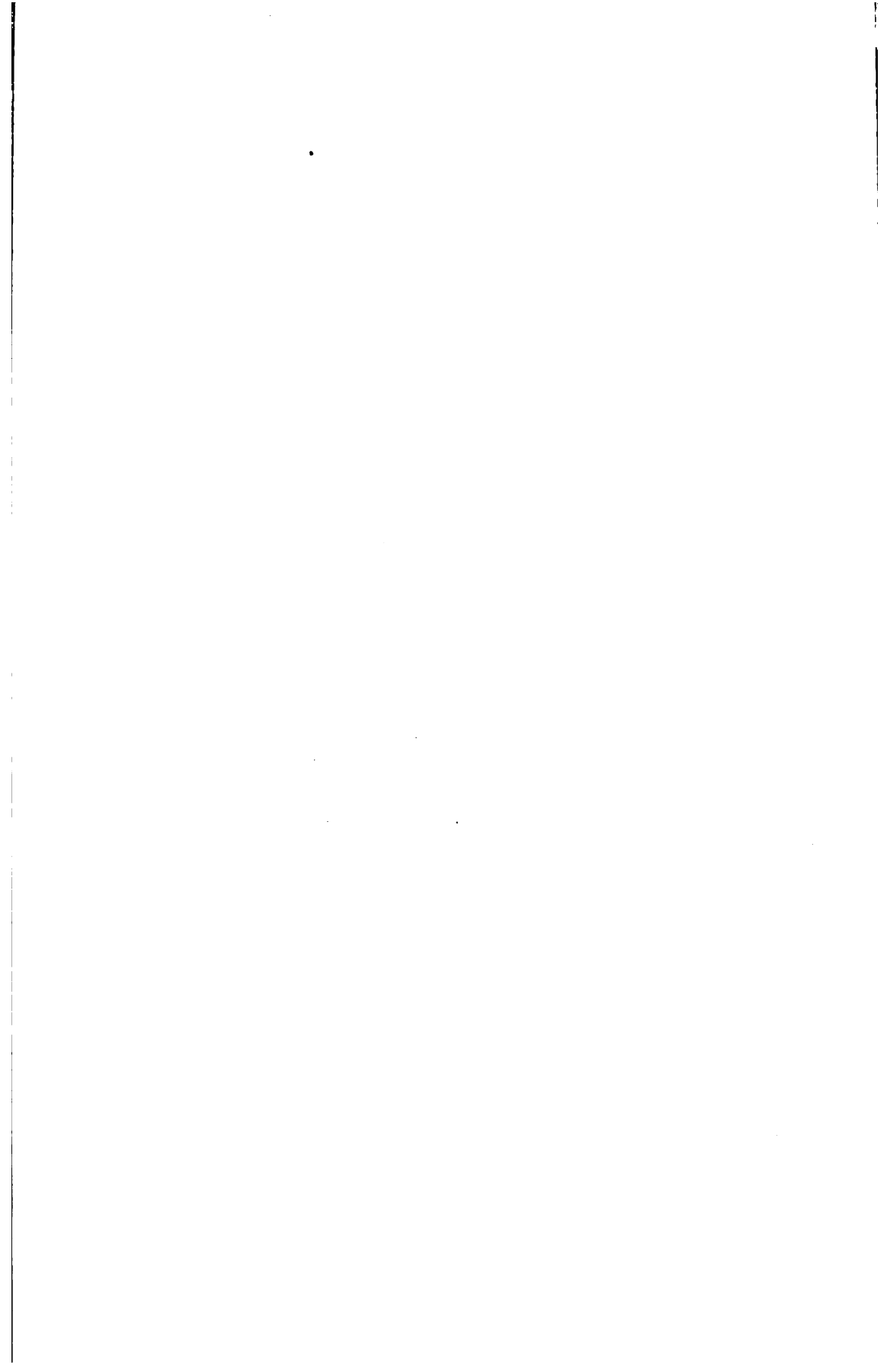
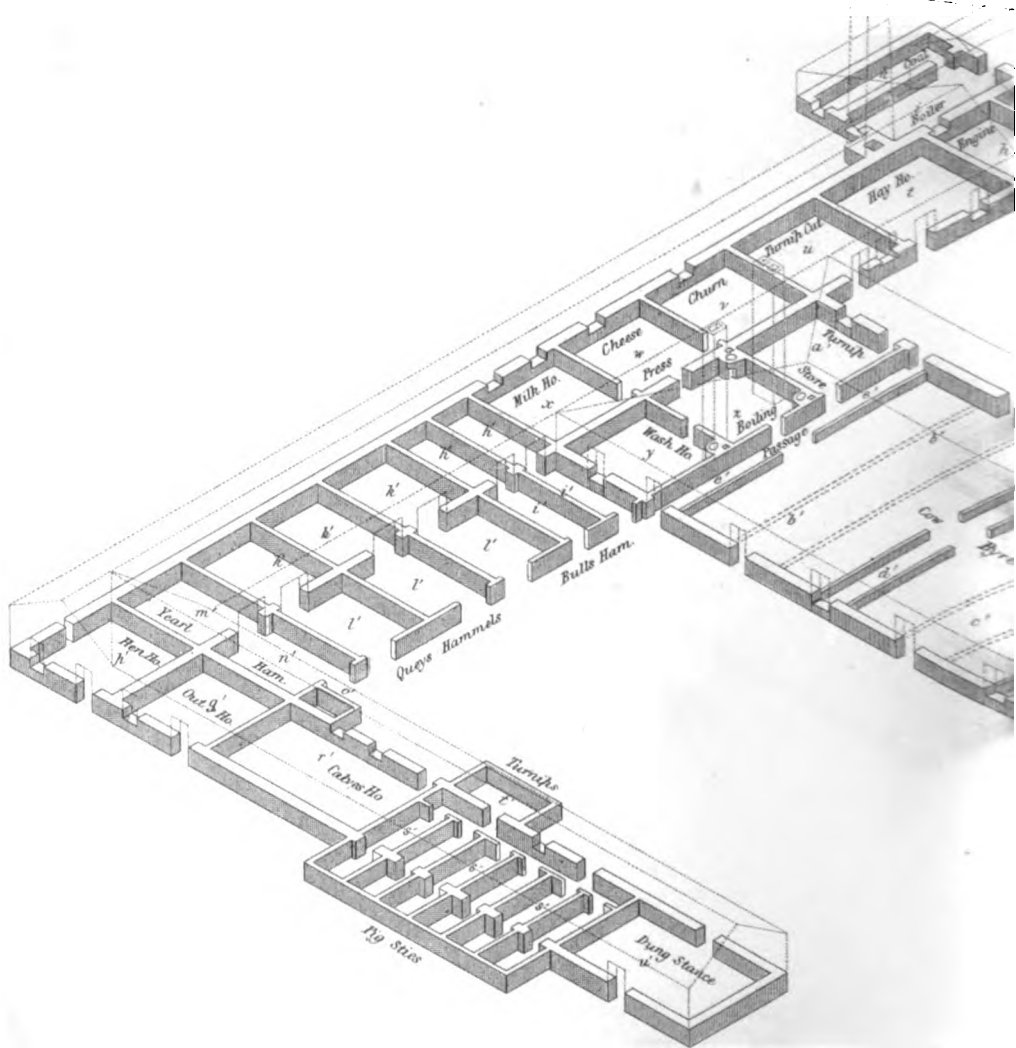

Fig 1



LARGE DAIRY F



ARM STEADING

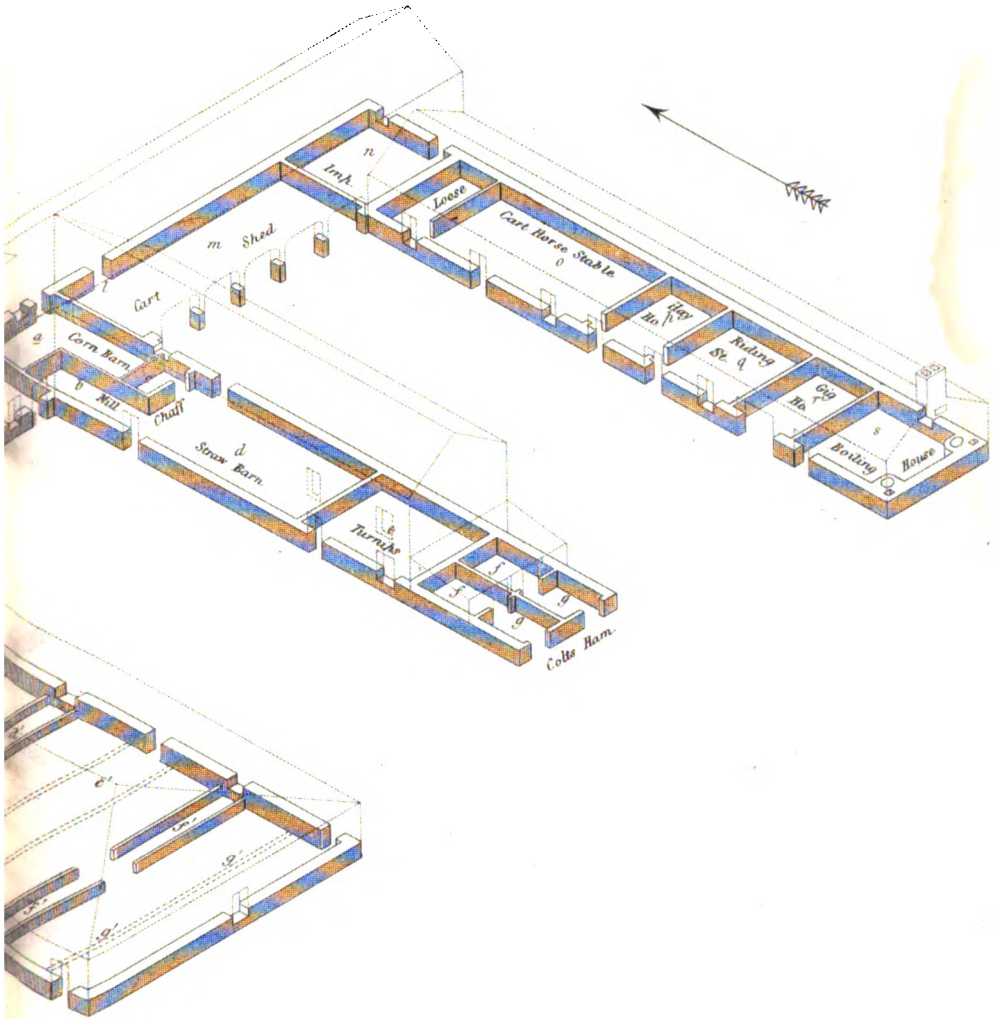

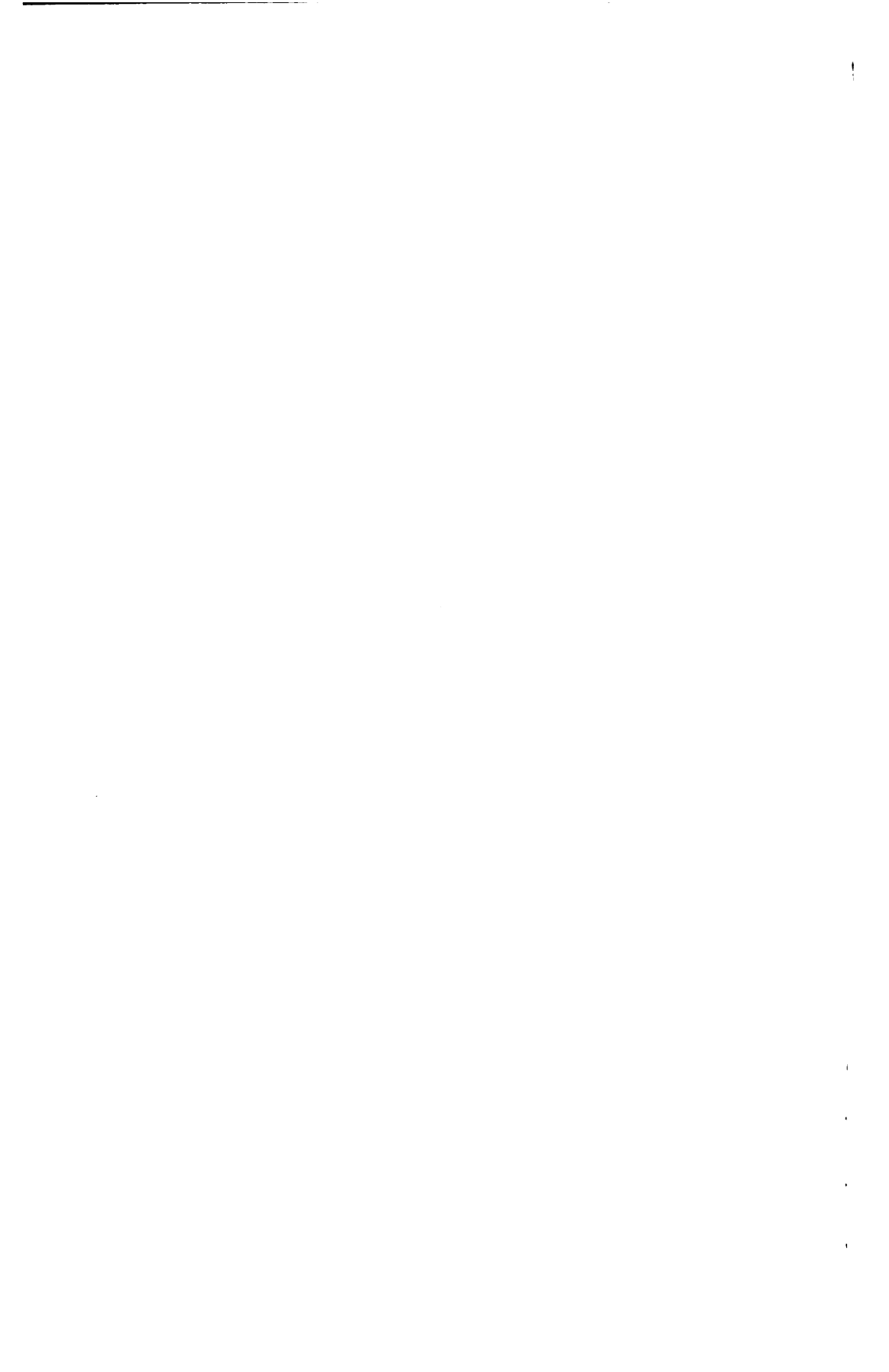



FARM STEADING

SMALL DAIRY

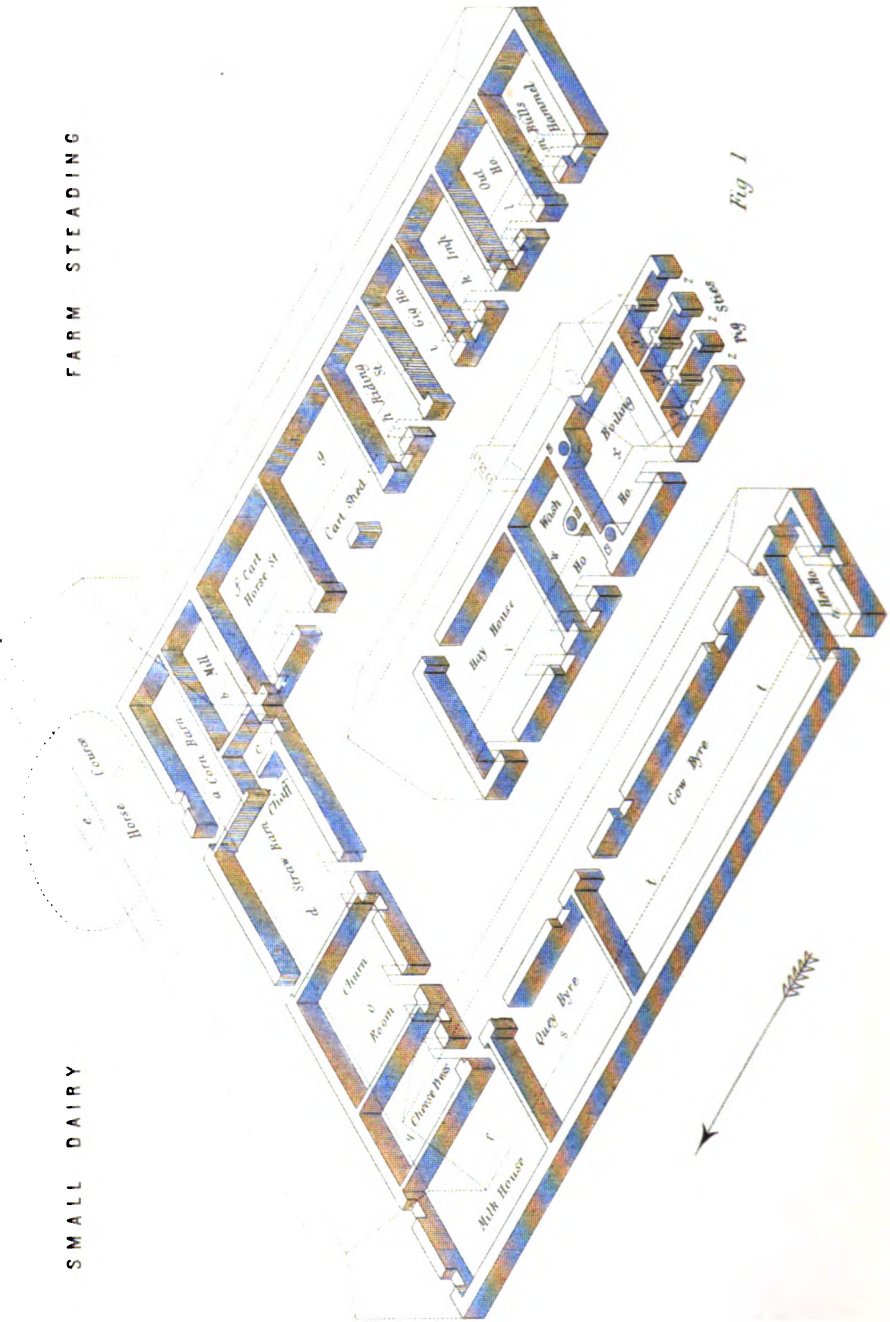

Scale
 0 10 20 30 40 50 60 70 80 90 100 110 120 130 140 150 160 170 180 190 200

FARM STEADING
ARABLE CULTURE

SUBURBIAL
FOR

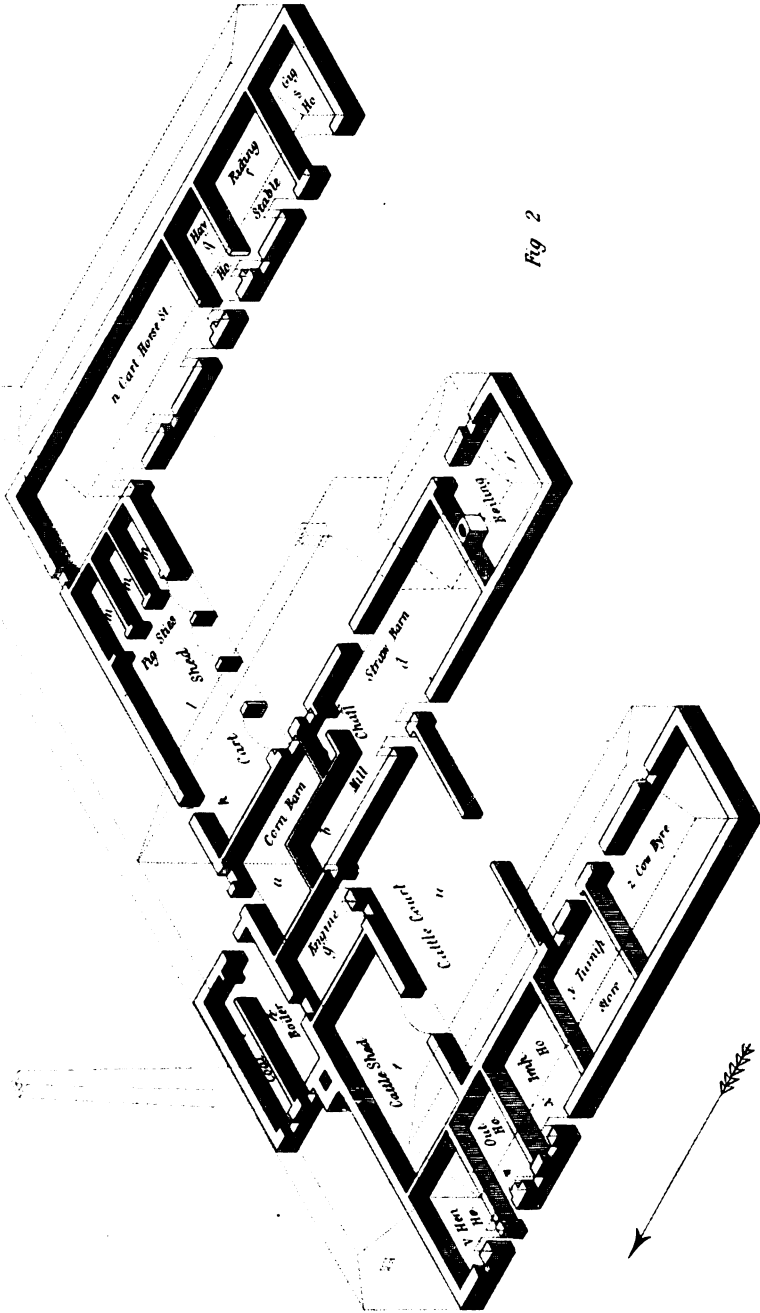
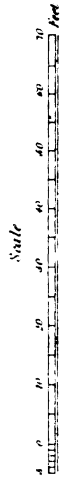

Fig 2



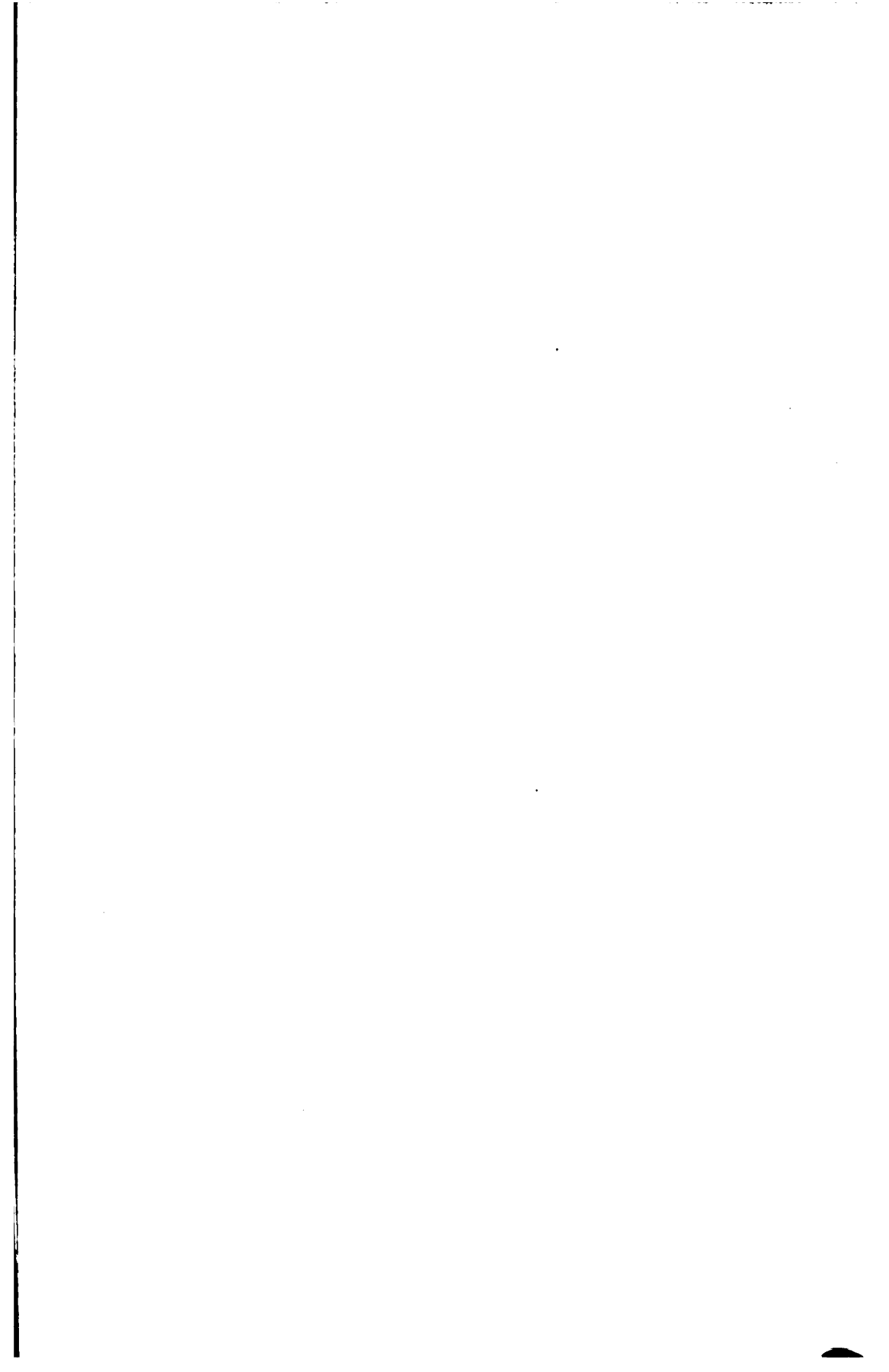
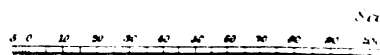
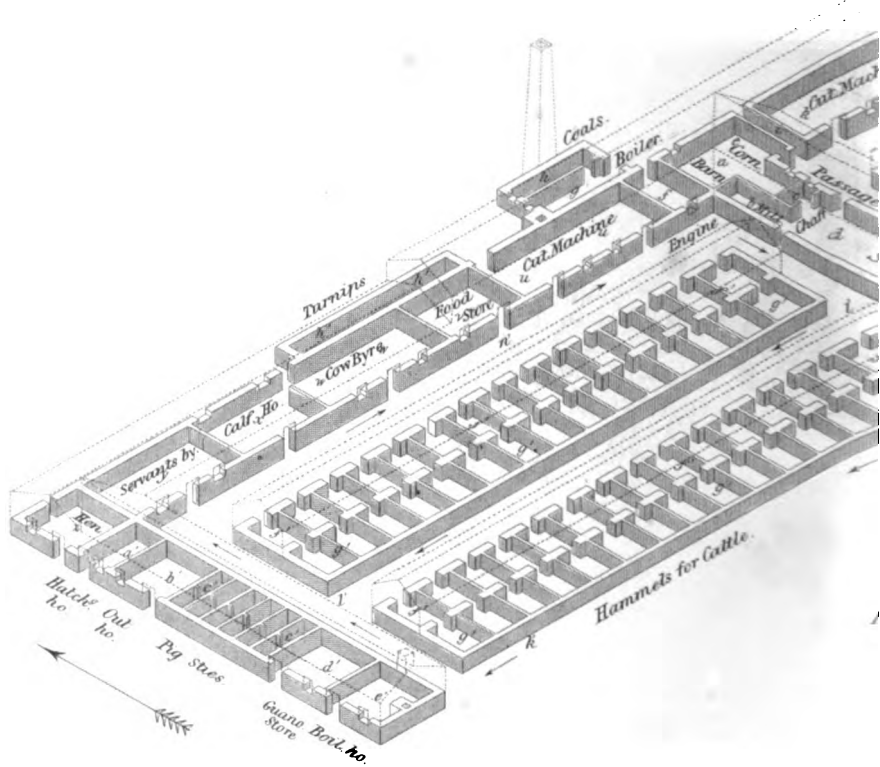

Fig 1



STEADING

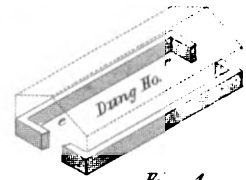
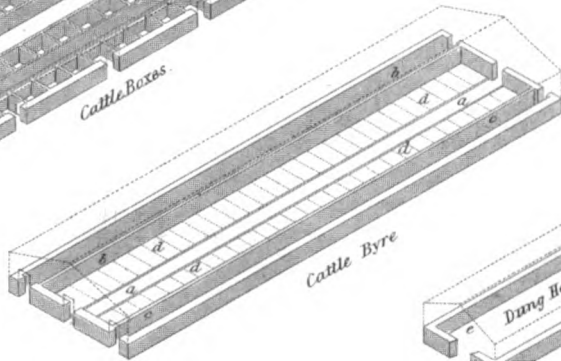
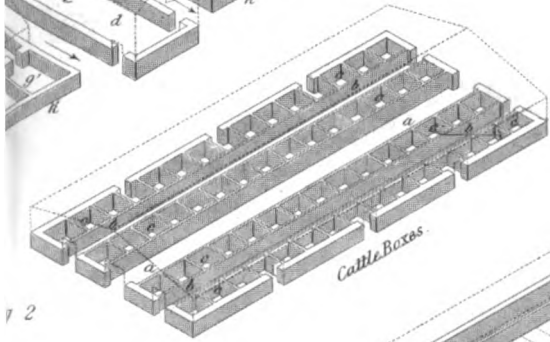
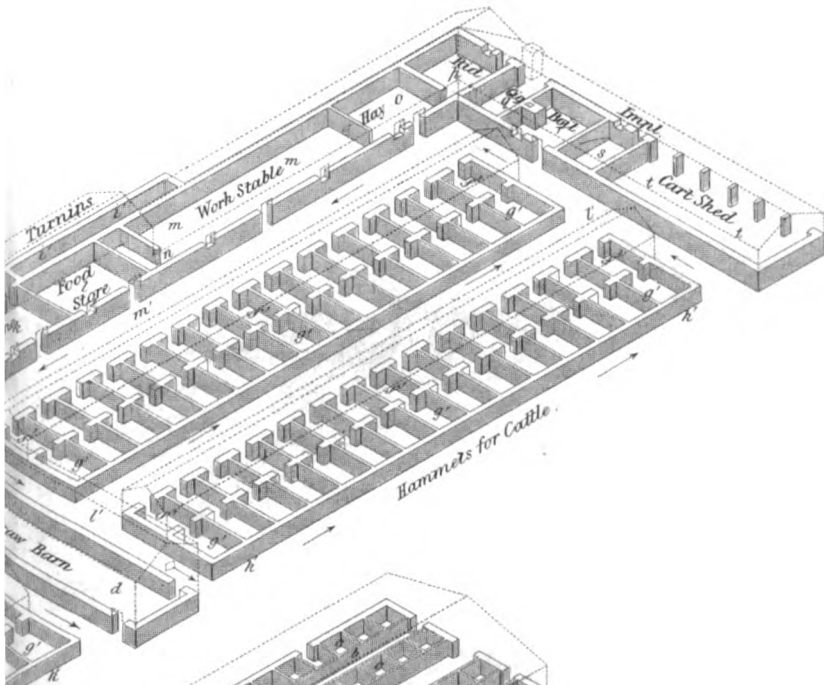

Fig 3

Fig 4



FARM STEADING FOR MIXED HUSB

Fig 1

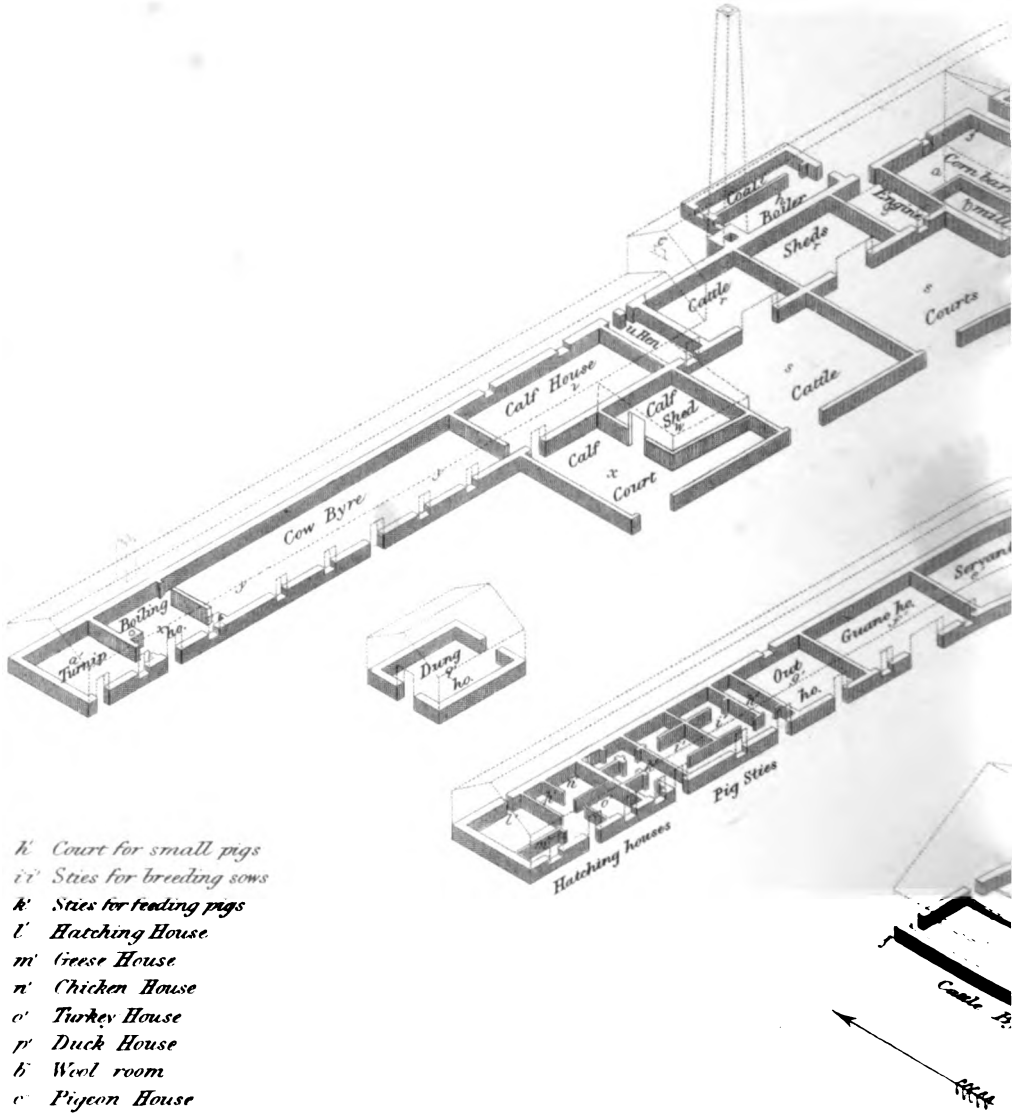

- k* Court for small pigs
- i* Sties for breeding sows
- k* Sties for feeding pigs
- l* Hatching House
- m* Geese House
- n* Chicken House
- o* Turkey House
- p* Duck House
- h* Wool room
- e* Pigeon House



NDRY

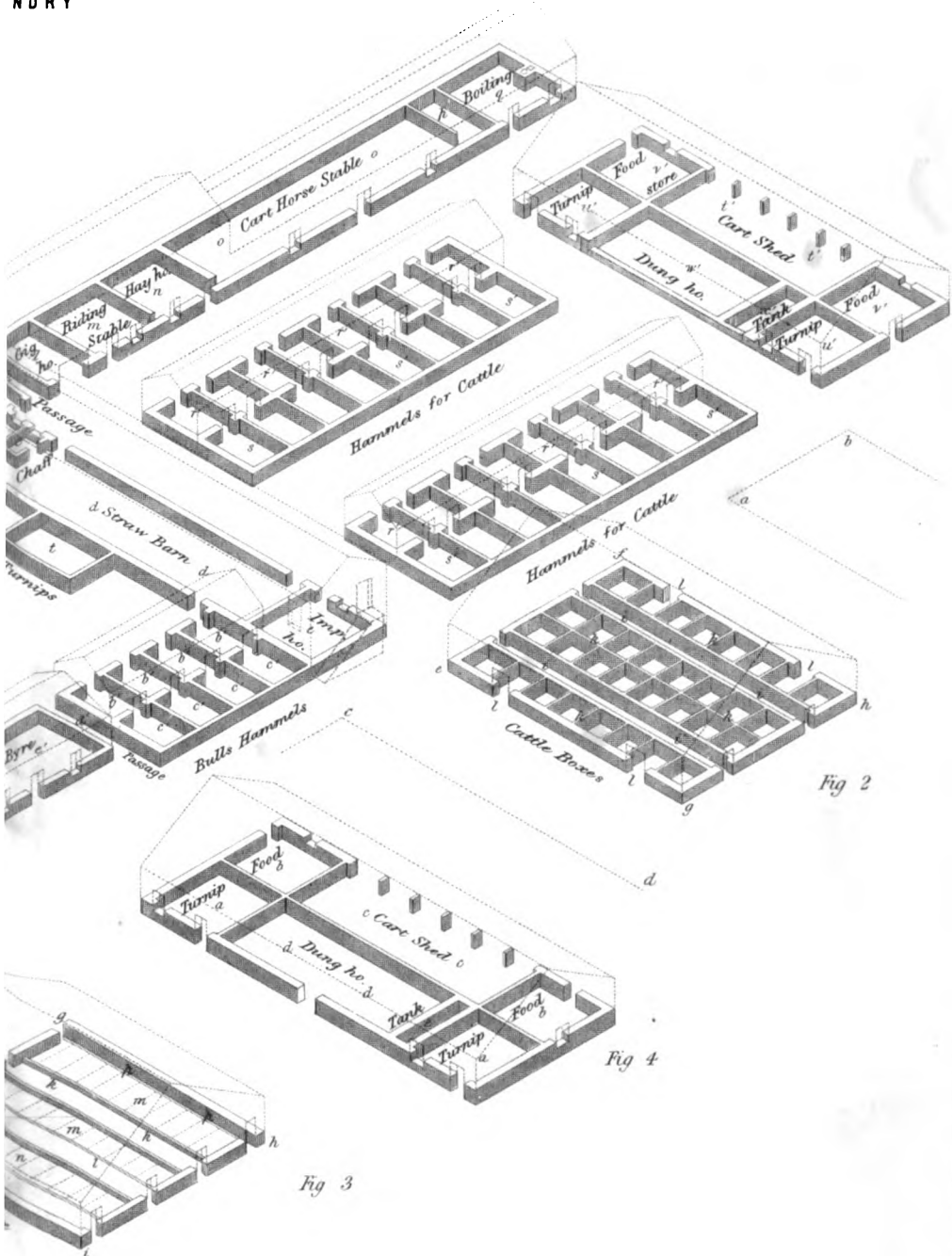
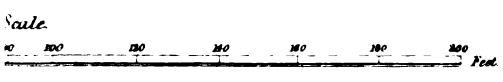
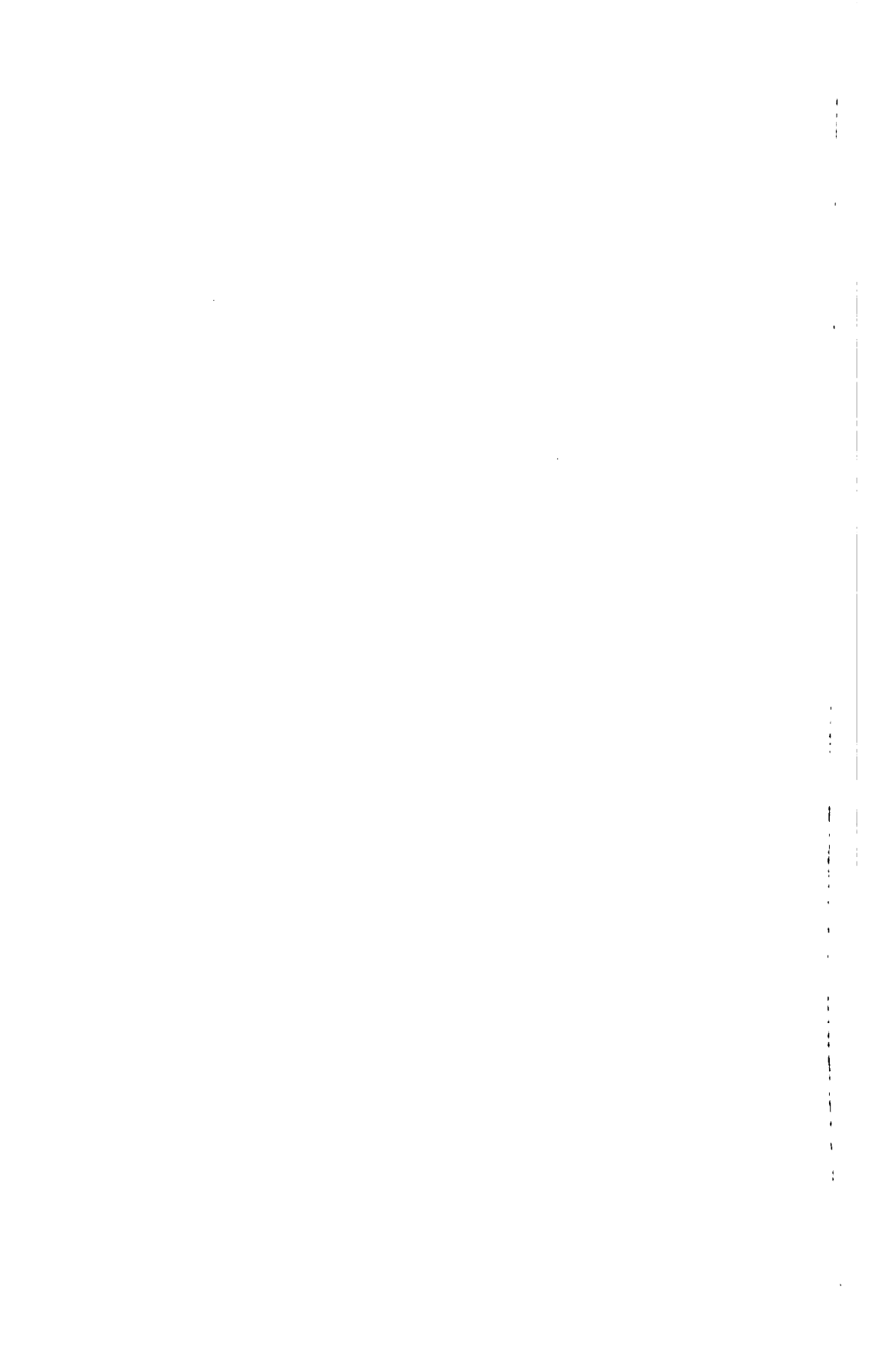

Fig 2

Fig 3

Fig 4





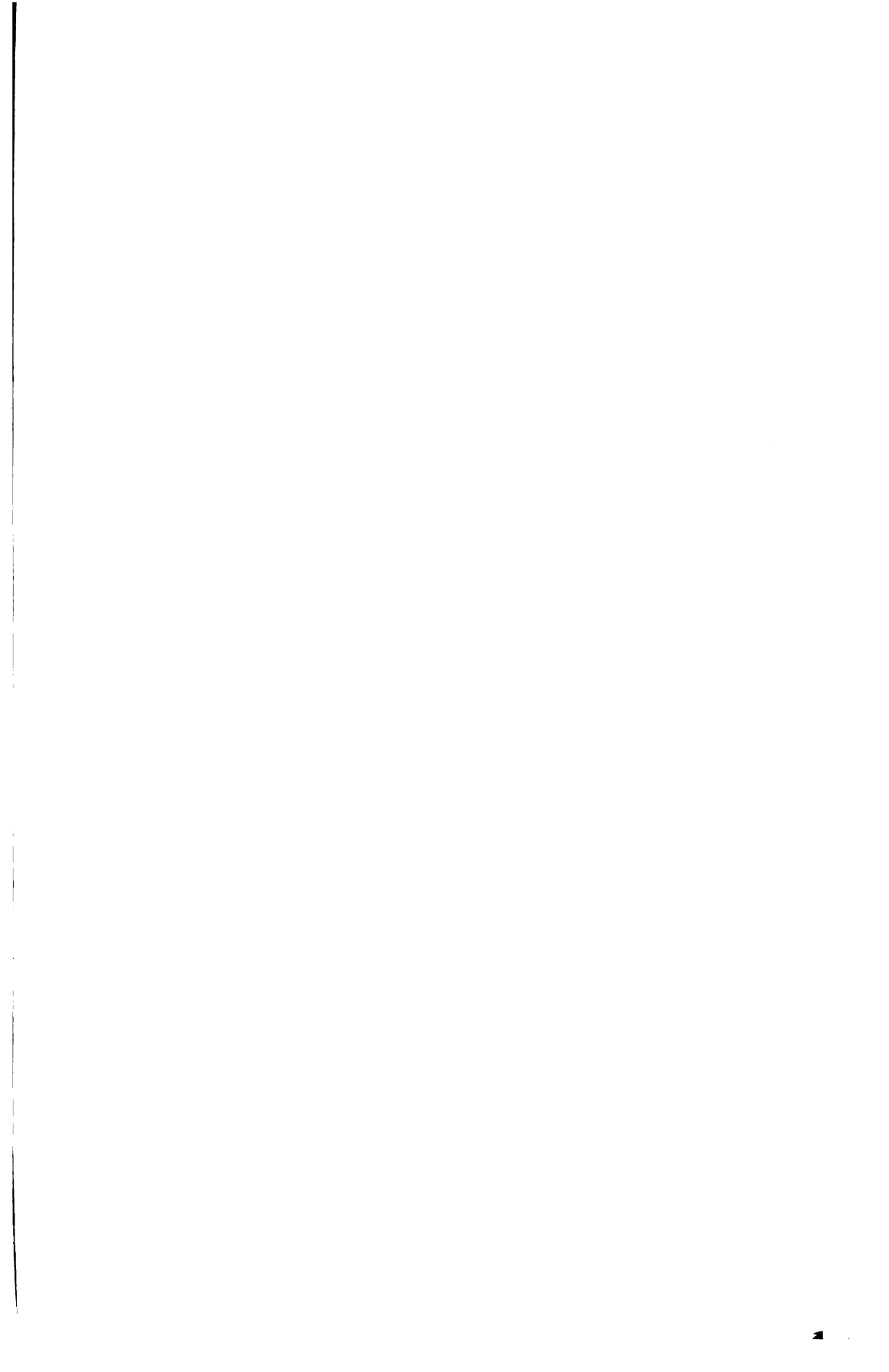
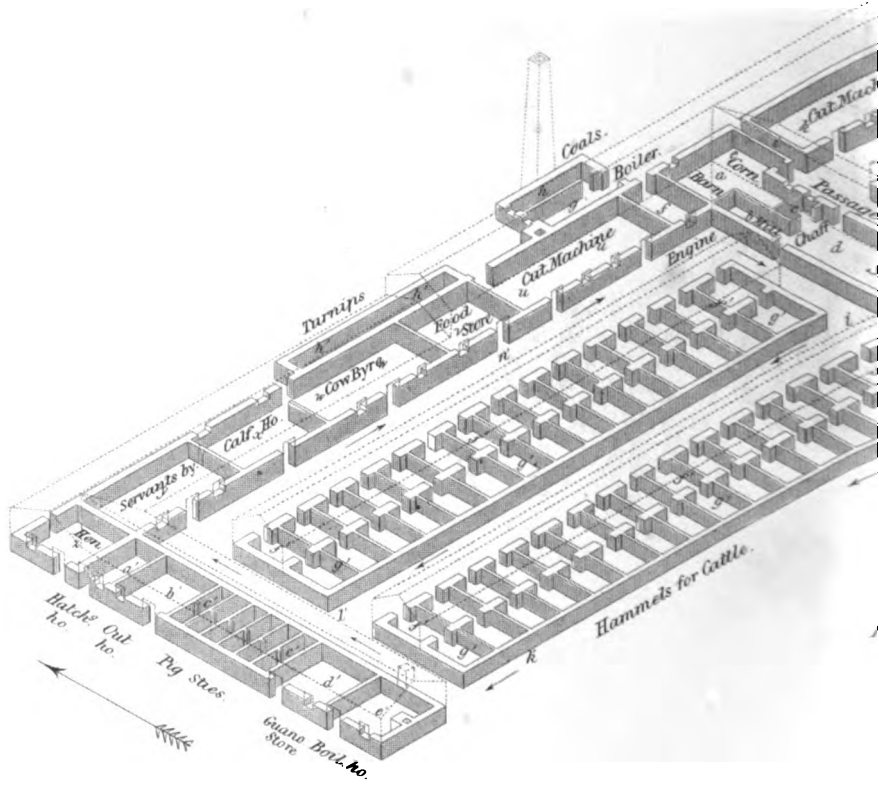

Fig 1



STEADING

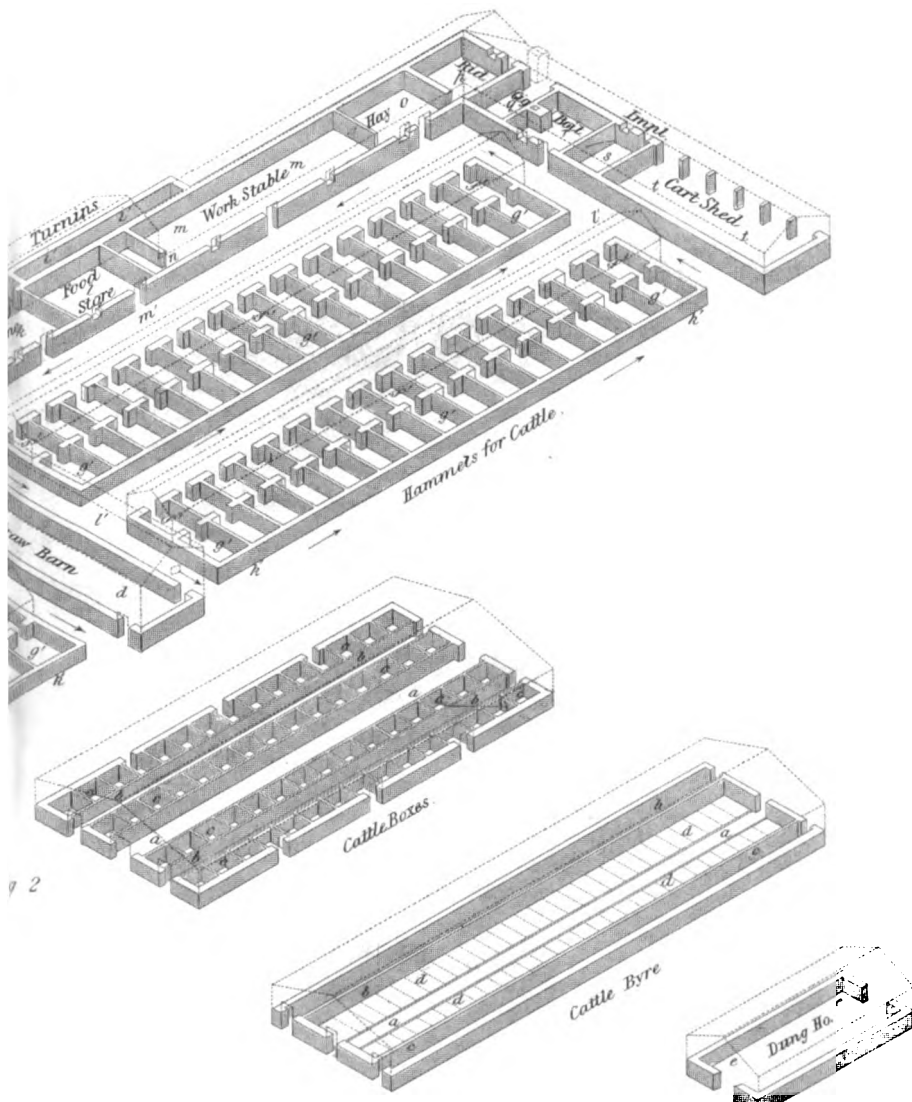

Fig 3

Fig 4



FARM STEADING FOR MIXED HUSBANDRY

Fig 1

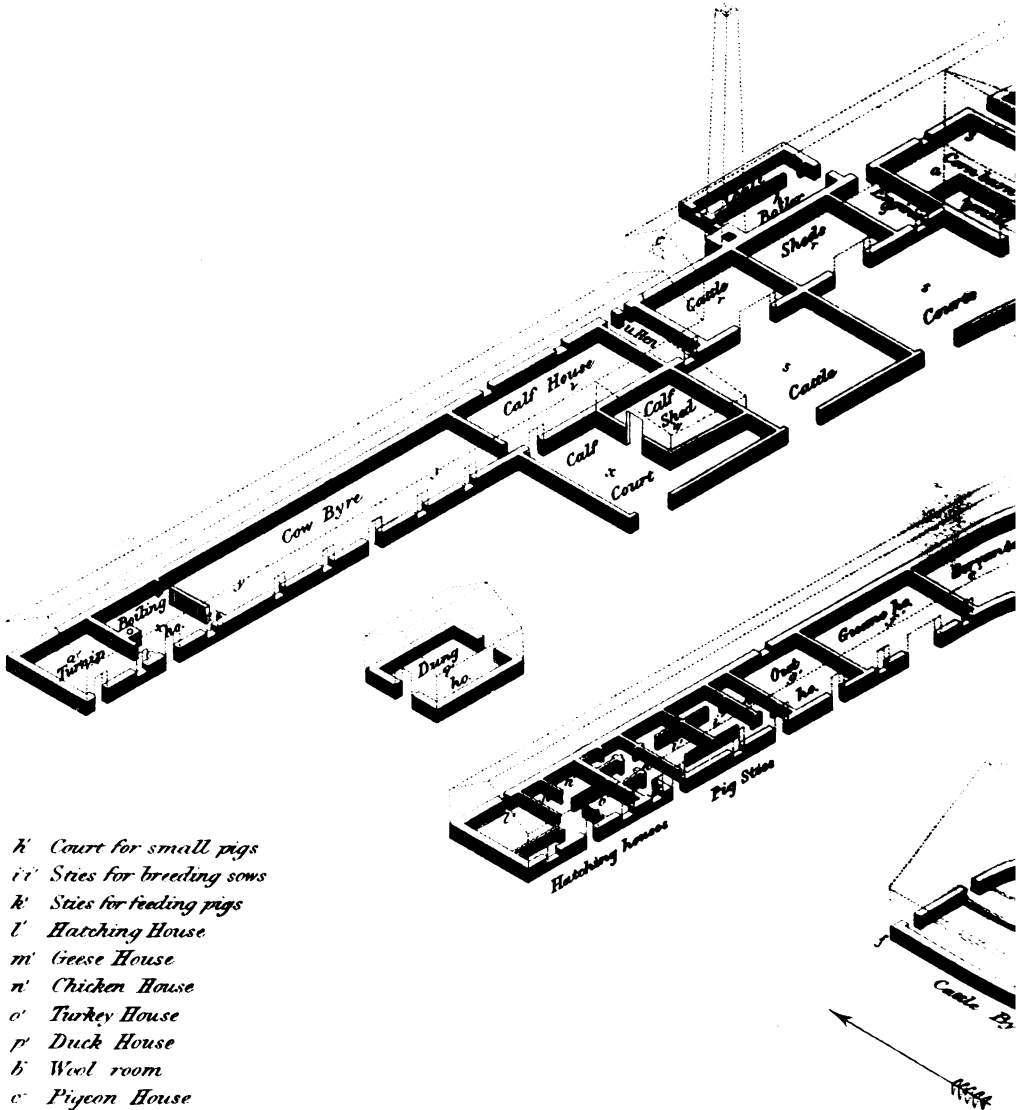

- k* Court for small pigs
- i* Sties for breeding sows
- k* Sties for feeding pigs
- v* Hatching House
- m* Grease House
- n* Chicken House
- o* Turkey House
- p* Duck House
- b* Wool room
- c* Pigeon House



NDRY

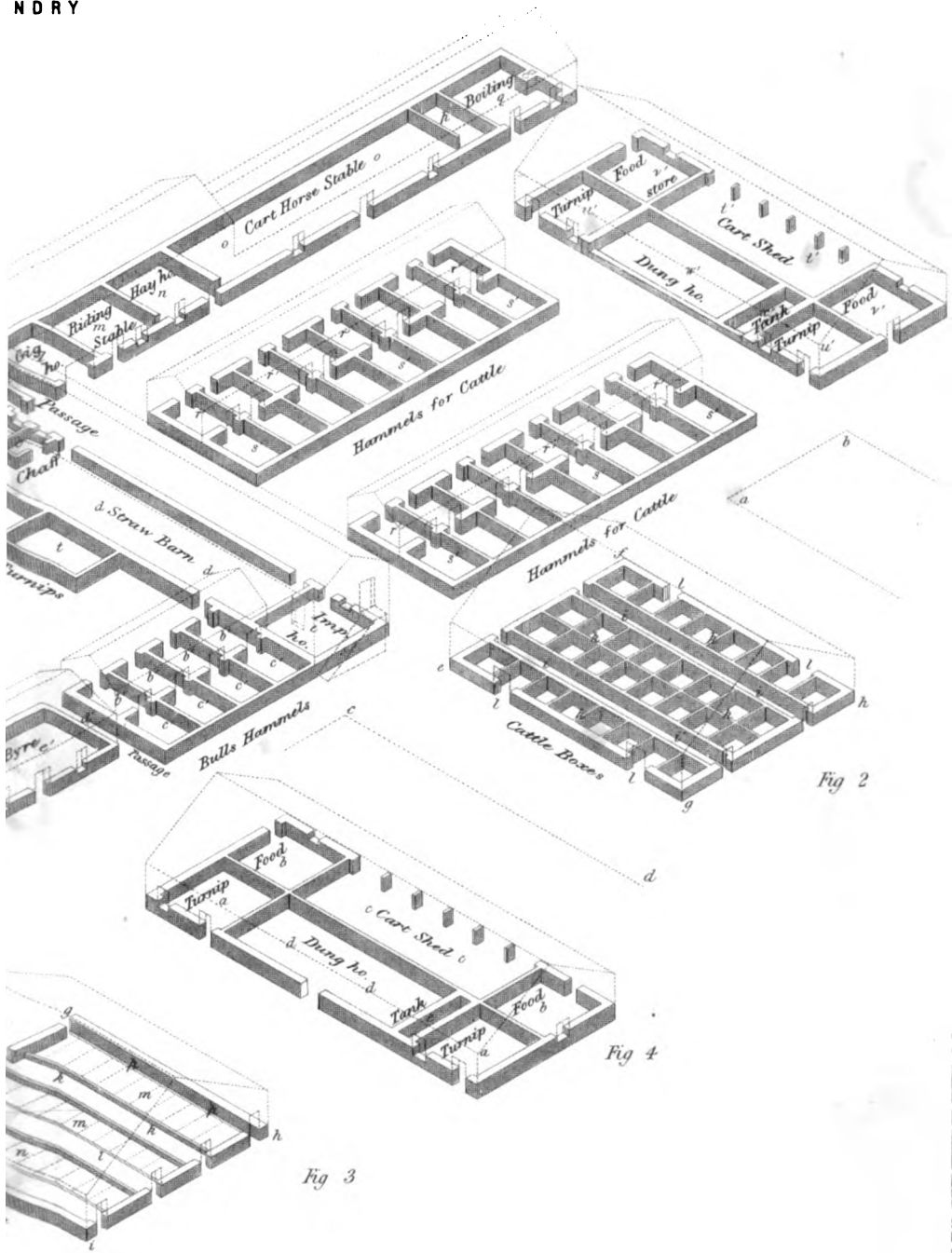
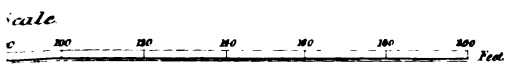
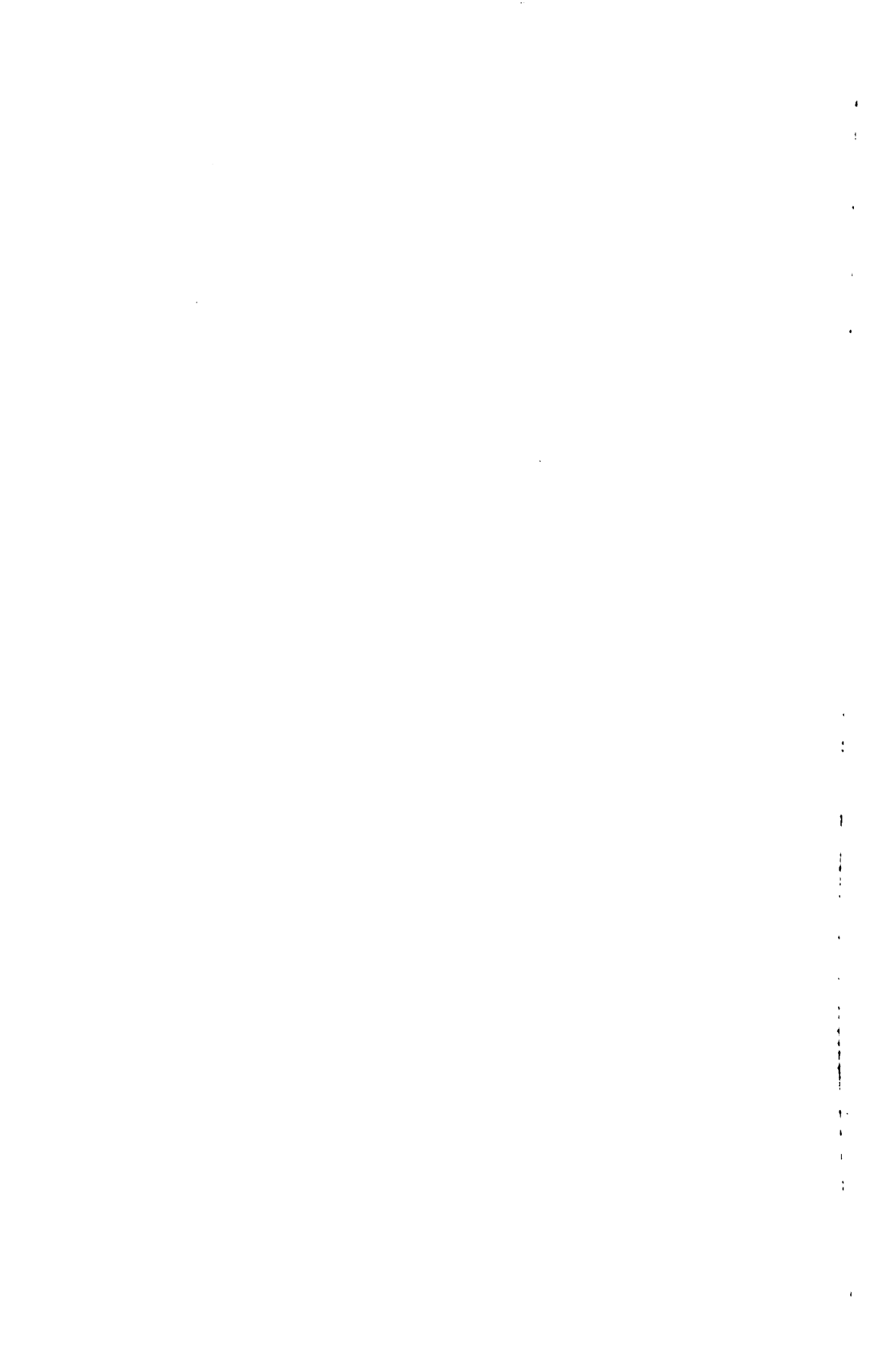

Fig 2

Fig 4

Fig 3







ISOMETRICAL ELEVATION IN OUTLINE OF FARM STEADING
FOR MIXED HUSBANDRY

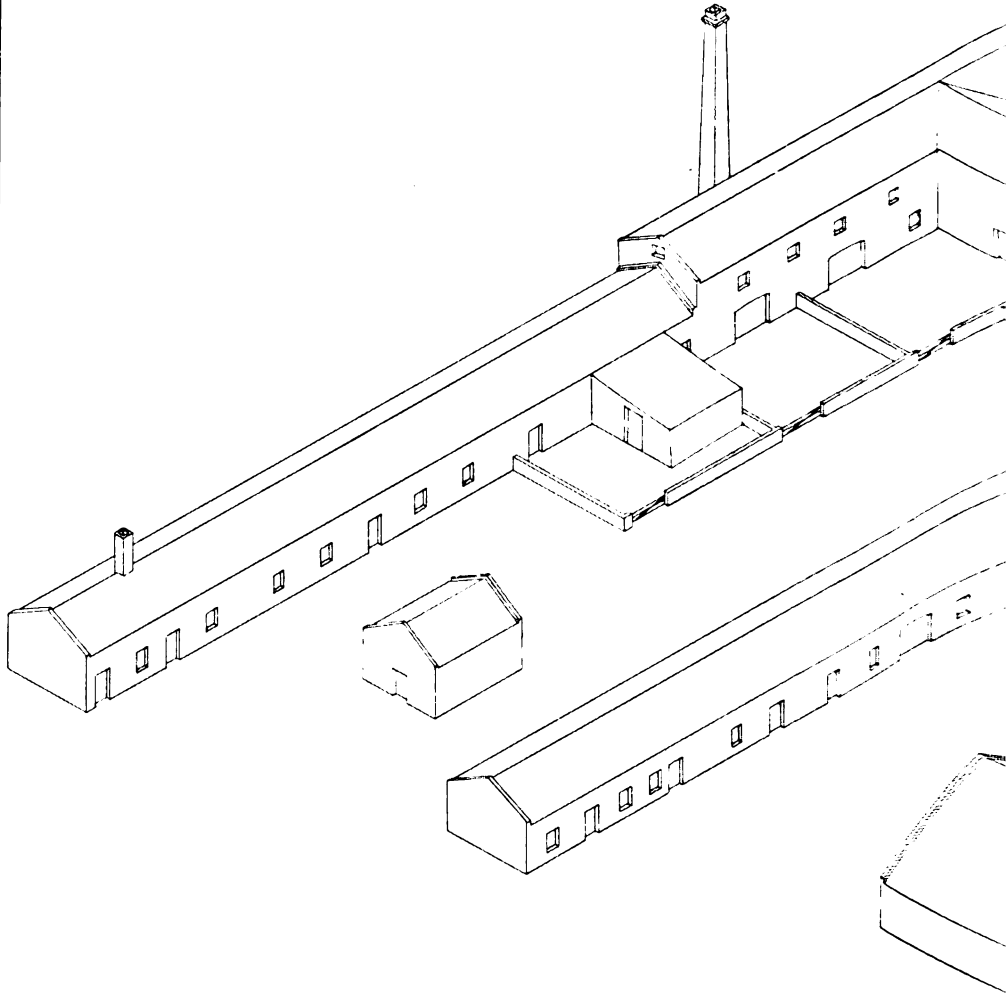

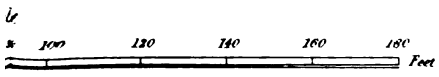
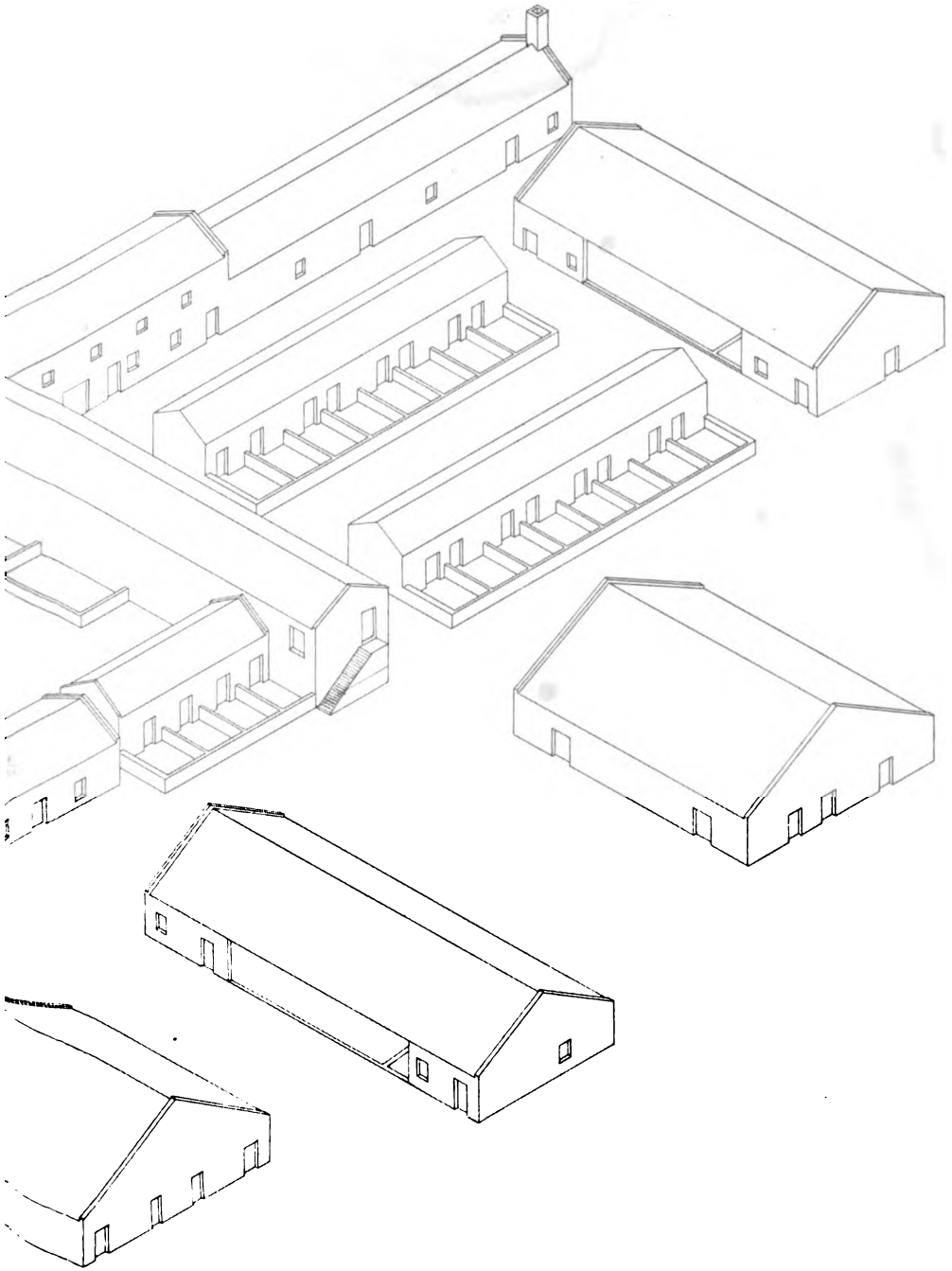





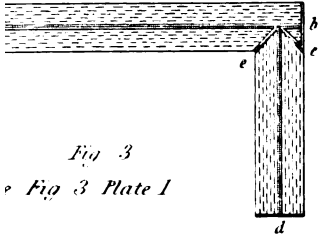

Fig 3
See Fig 3 Plate I

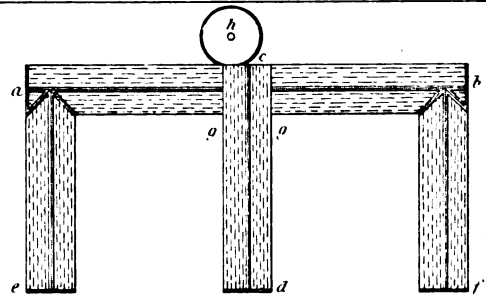

Fig 4. See
Fig 1 Plate II

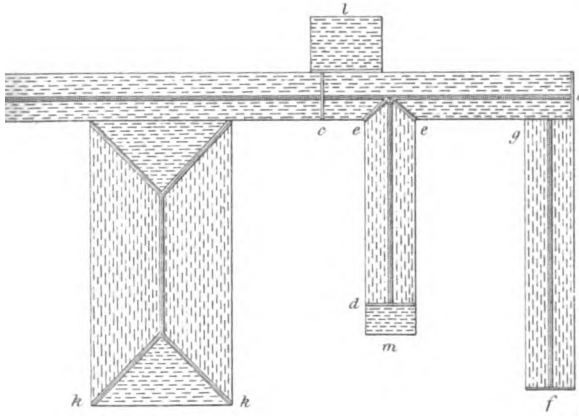

Fig 7
See Plate IV

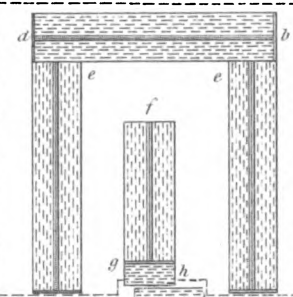

Fig 8. See
Fig 1 Plate V

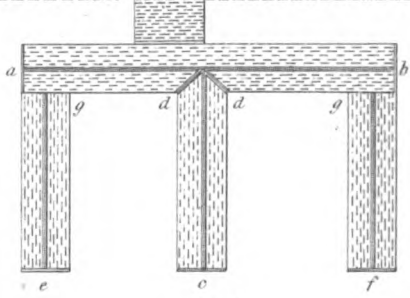

Fig 9
See Fig 2 Plate V

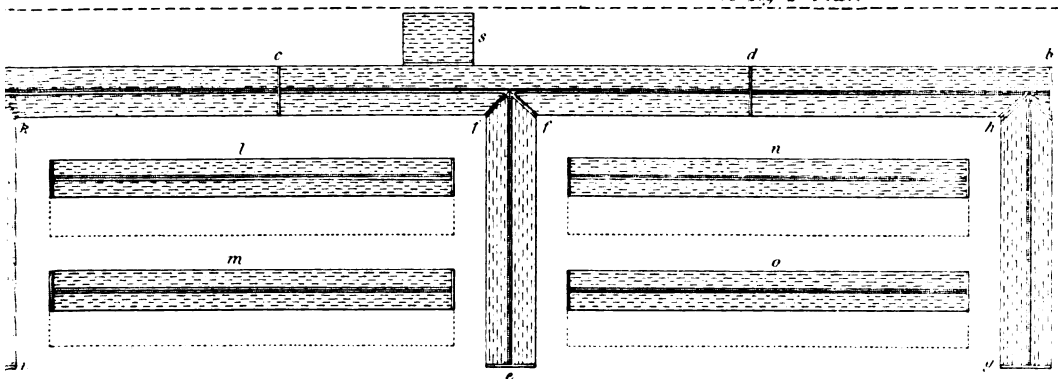
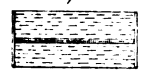
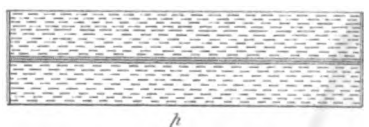
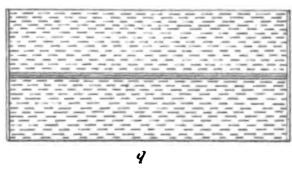
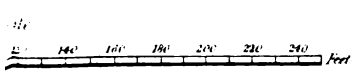
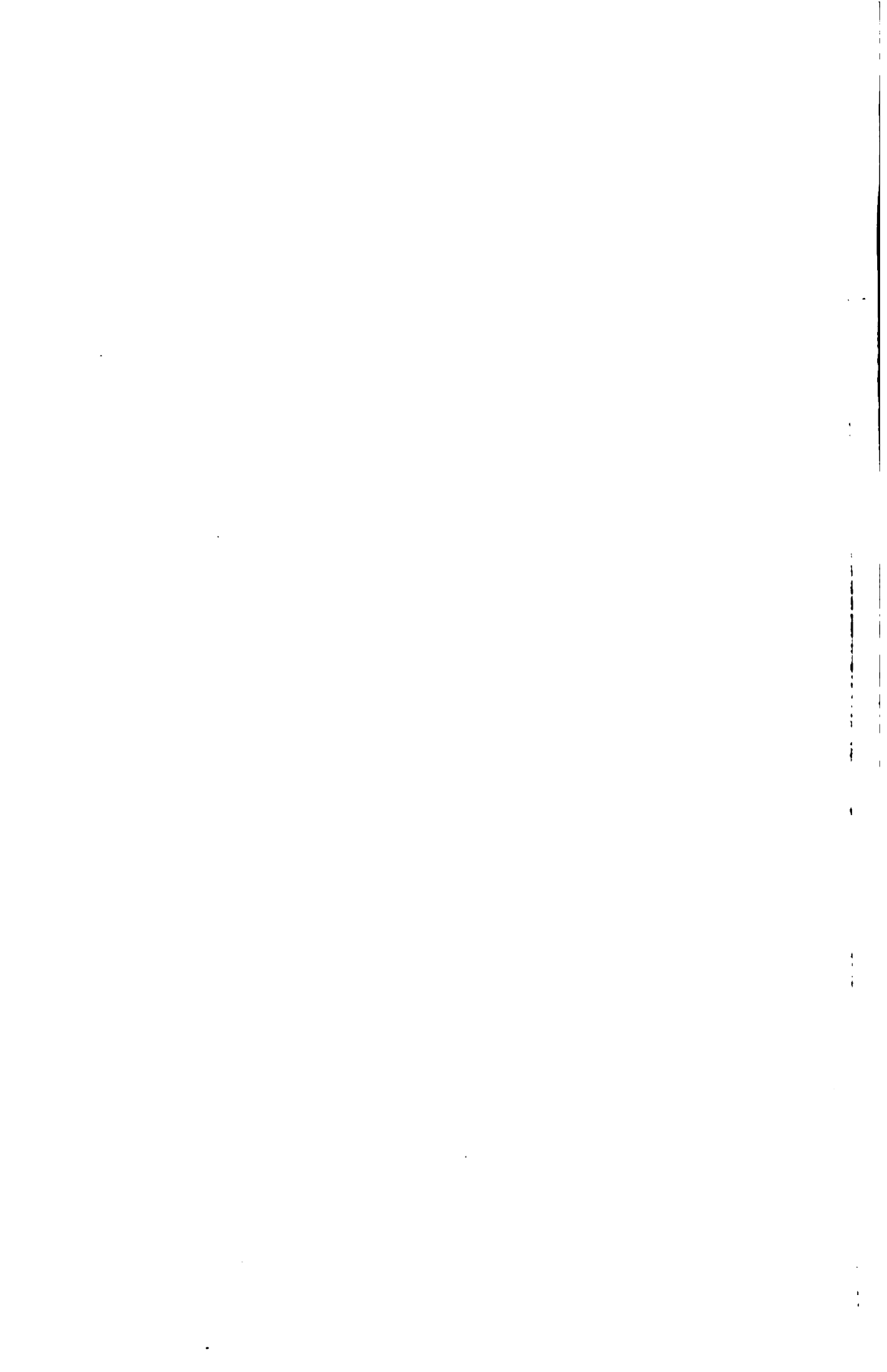

Fig 11 Plate VII

ROOFS OF
BUILDINGS
Inclusive





PLAN OF FARM BUILDINGS
 On the Property of
 SIR W. G. HAYTER, BART M.P.
 Southill Park Bracknell.
 SURREY.

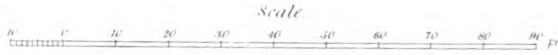
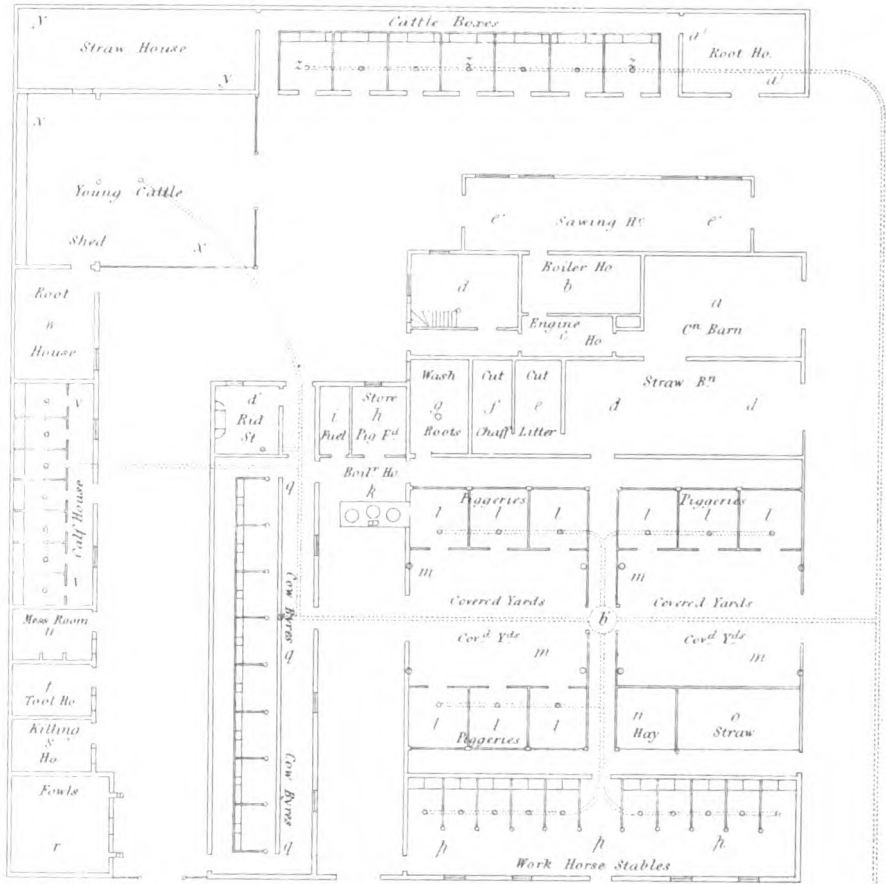

Liquid Manure



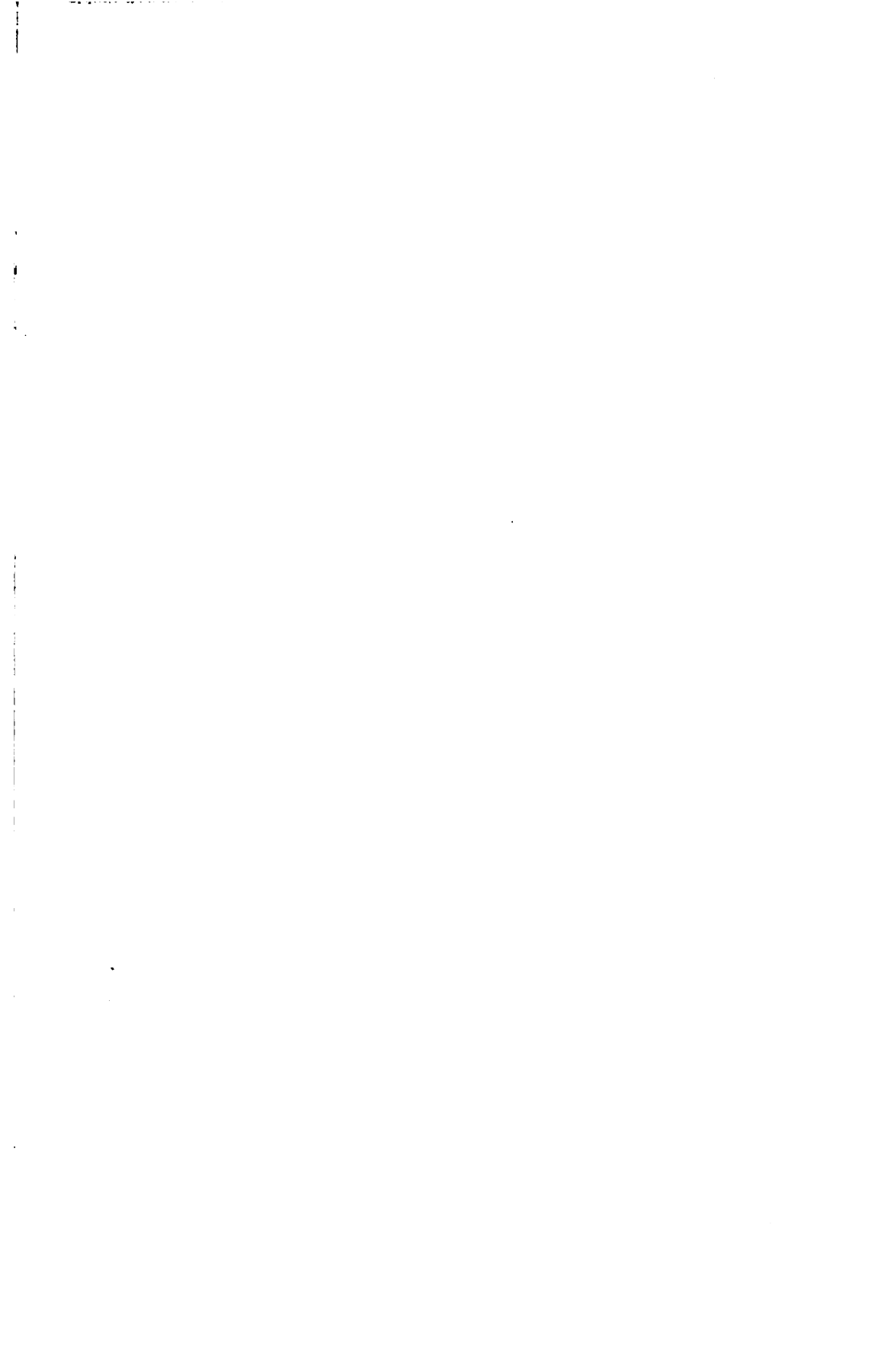

PLAN
FARM STEADING

SOUTH ELEVATION

Fig 2

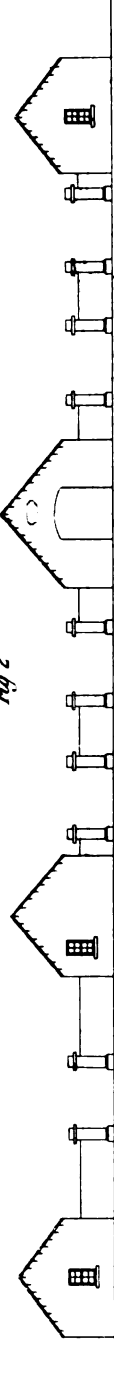

Section on the line a b Fig 1

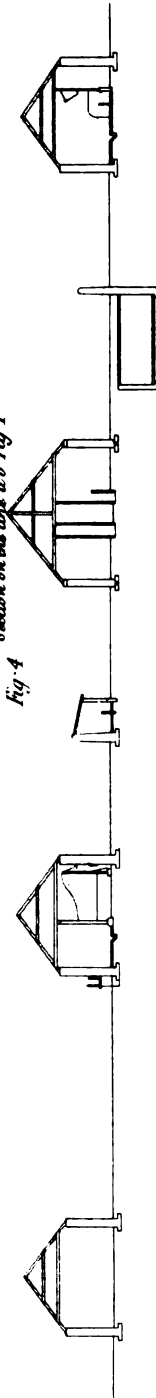

Fig 3

NORTH ELEVATION

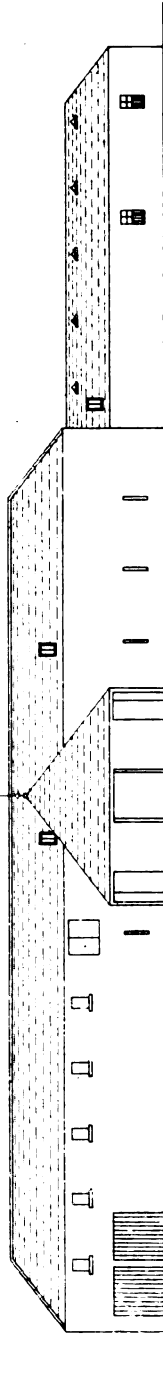

Fig 5 Section on the line
c d Fig 1

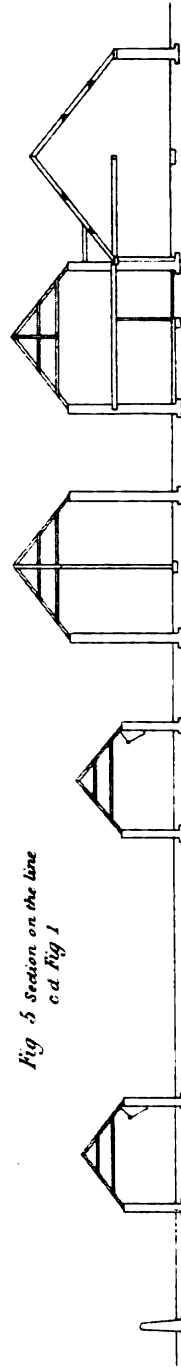

Fig 6 Section on the line
e f Fig 1

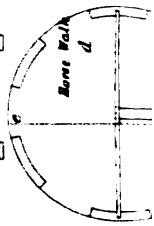
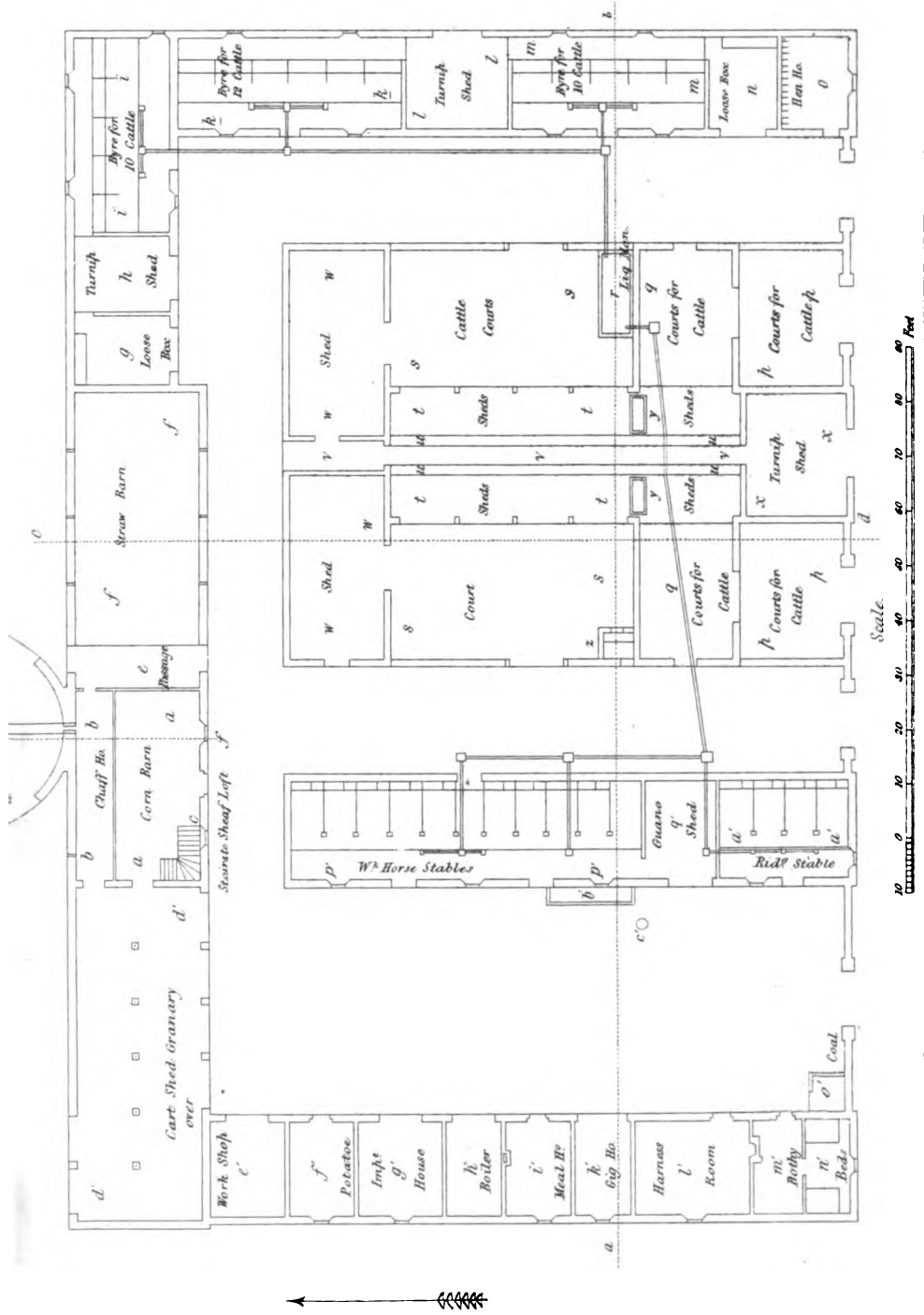
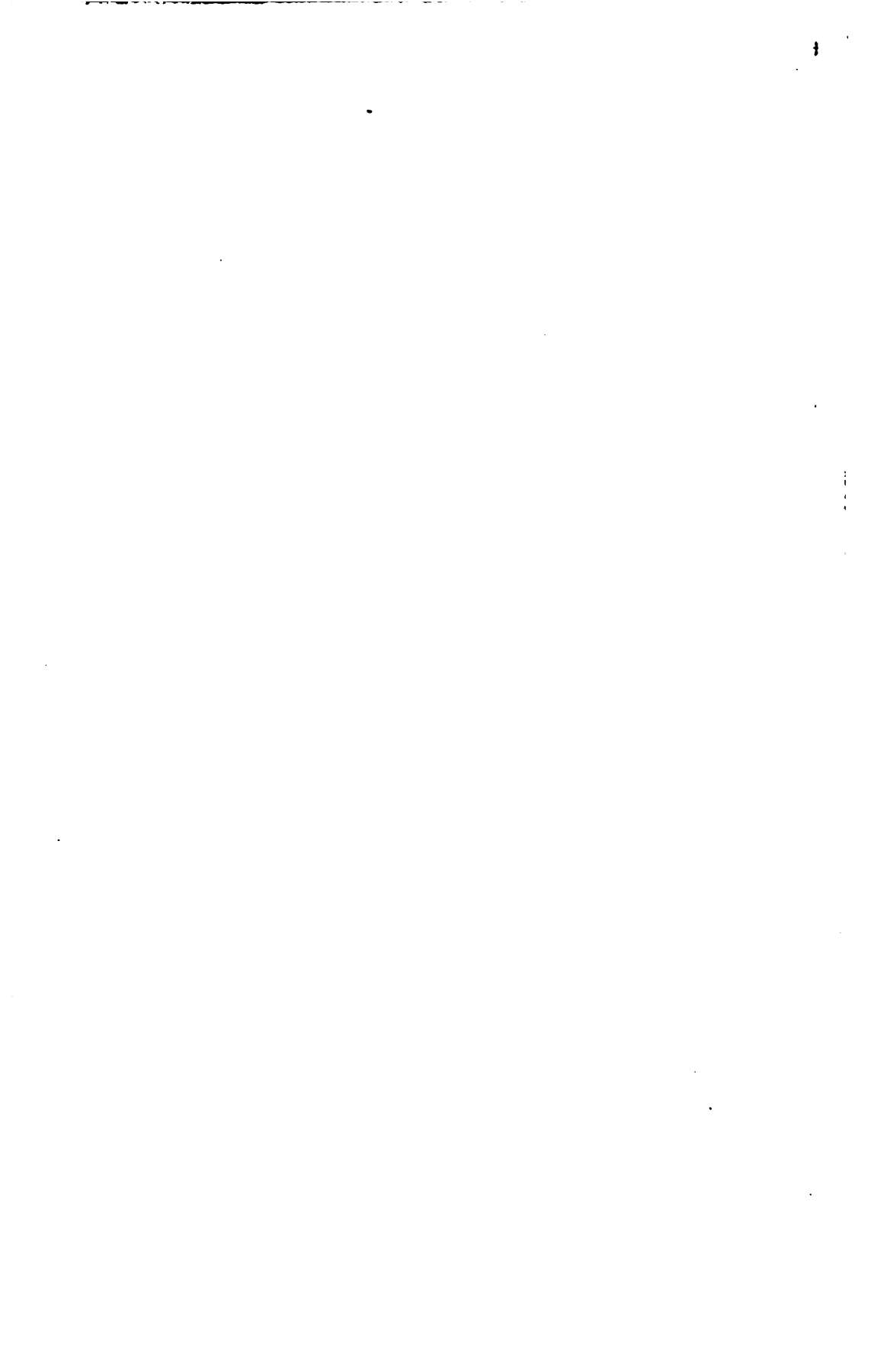
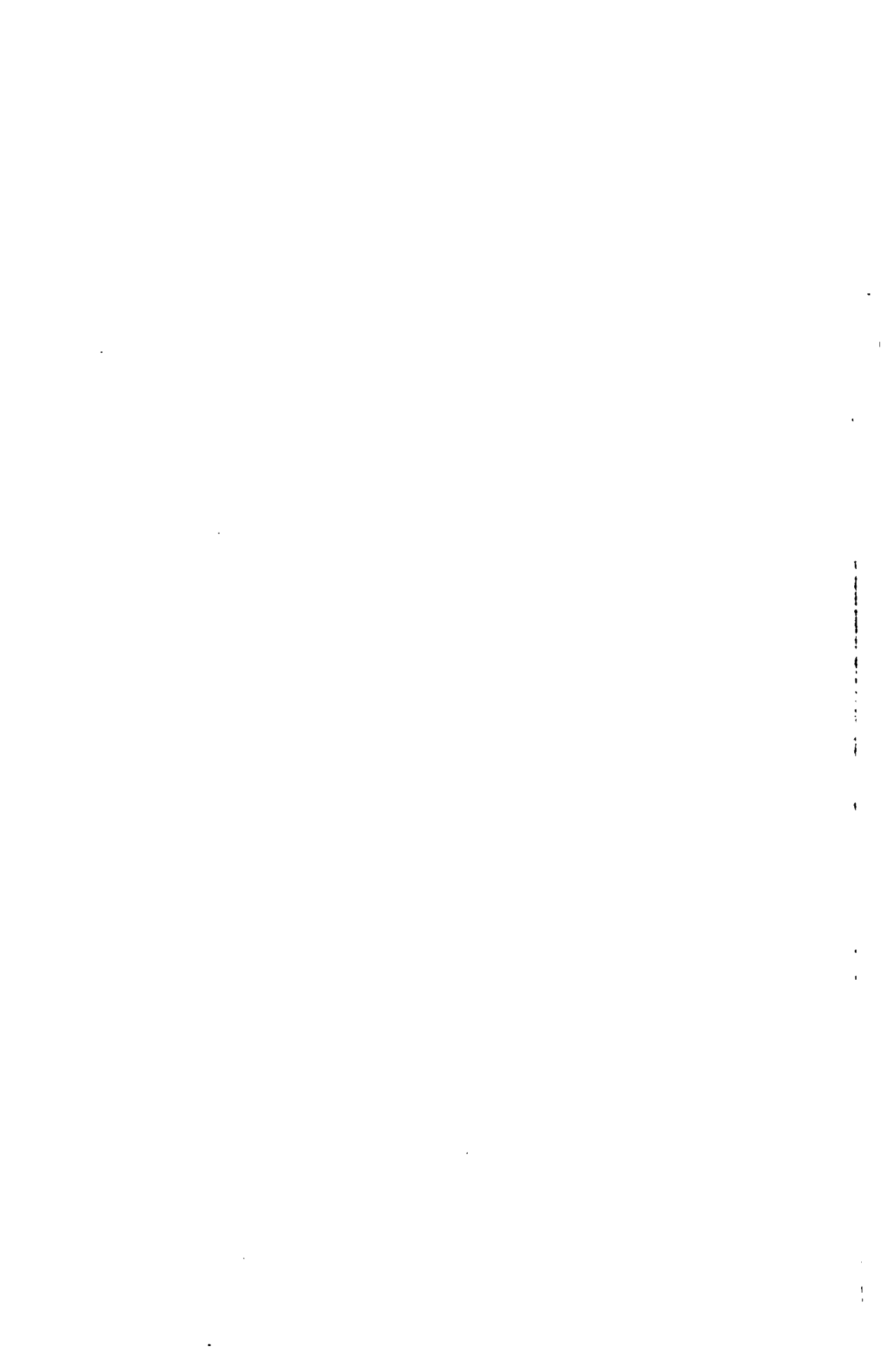

Fig 1









PLAN OF FARM BUILDINGS
On the Property of
SIR W. G. HAYTER, BART. M.P.
 Southill Park Bracknell.
SURREY.

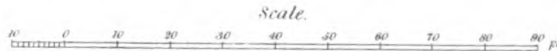
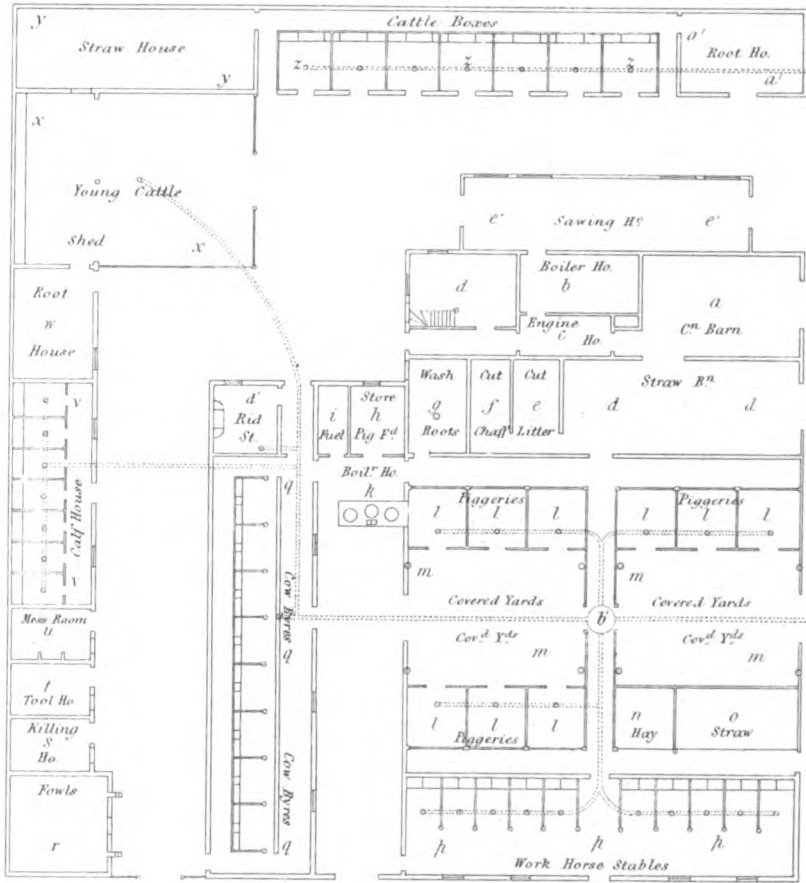

Liquid Manure



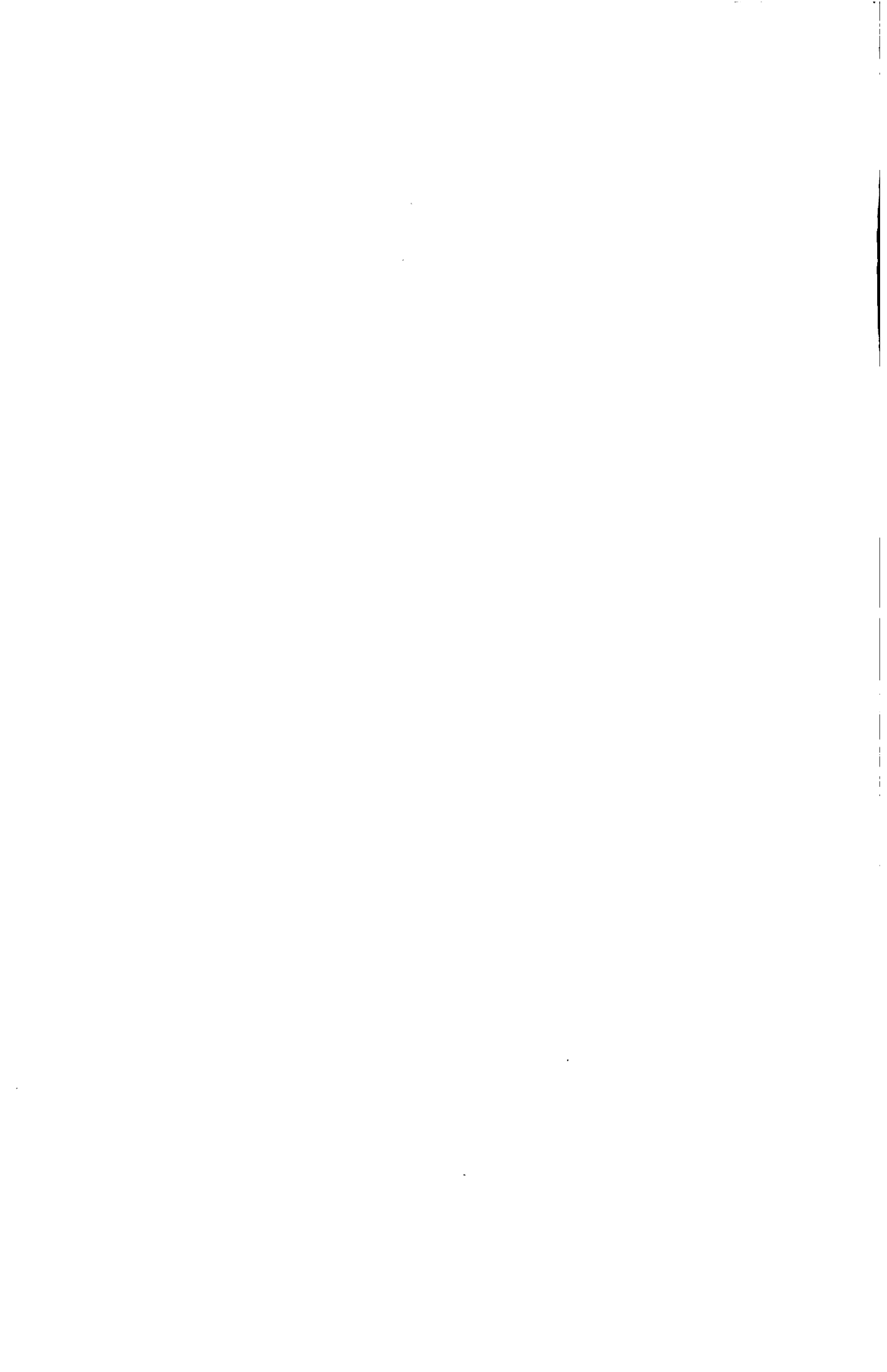



PLAN
FARM STEADING

SOUTH ELEVATION

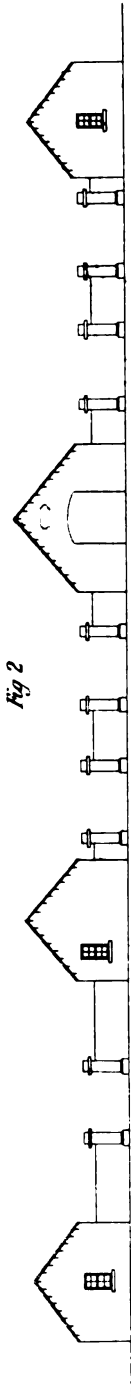

Fig 2

Sections on the line a b Fig 1

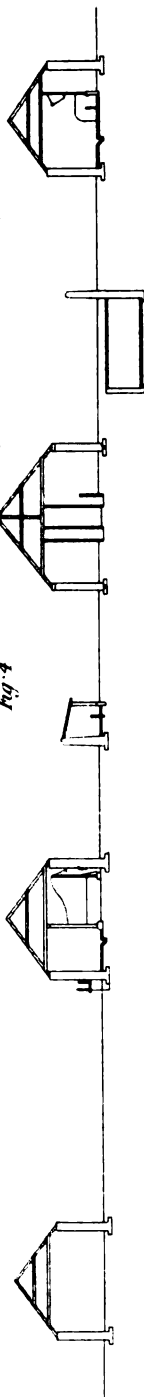

Fig 4

NORTH ELEVATION

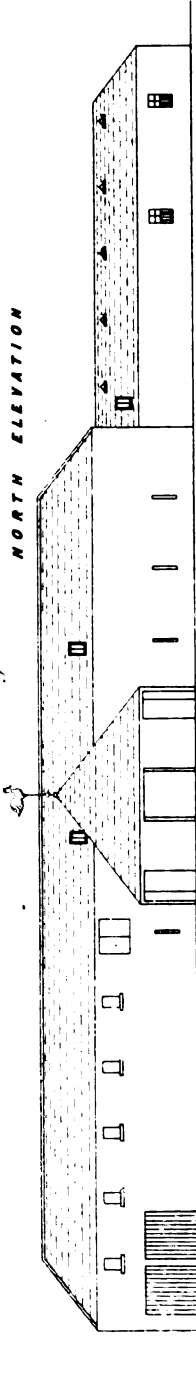

Fig 3

Fig 5 Section on the line
c d Fig 1

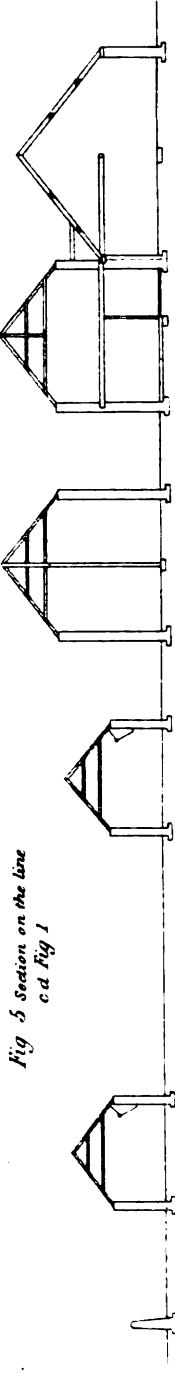

Fig 6 Section on the line
e f Fig 1

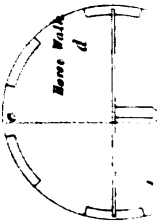
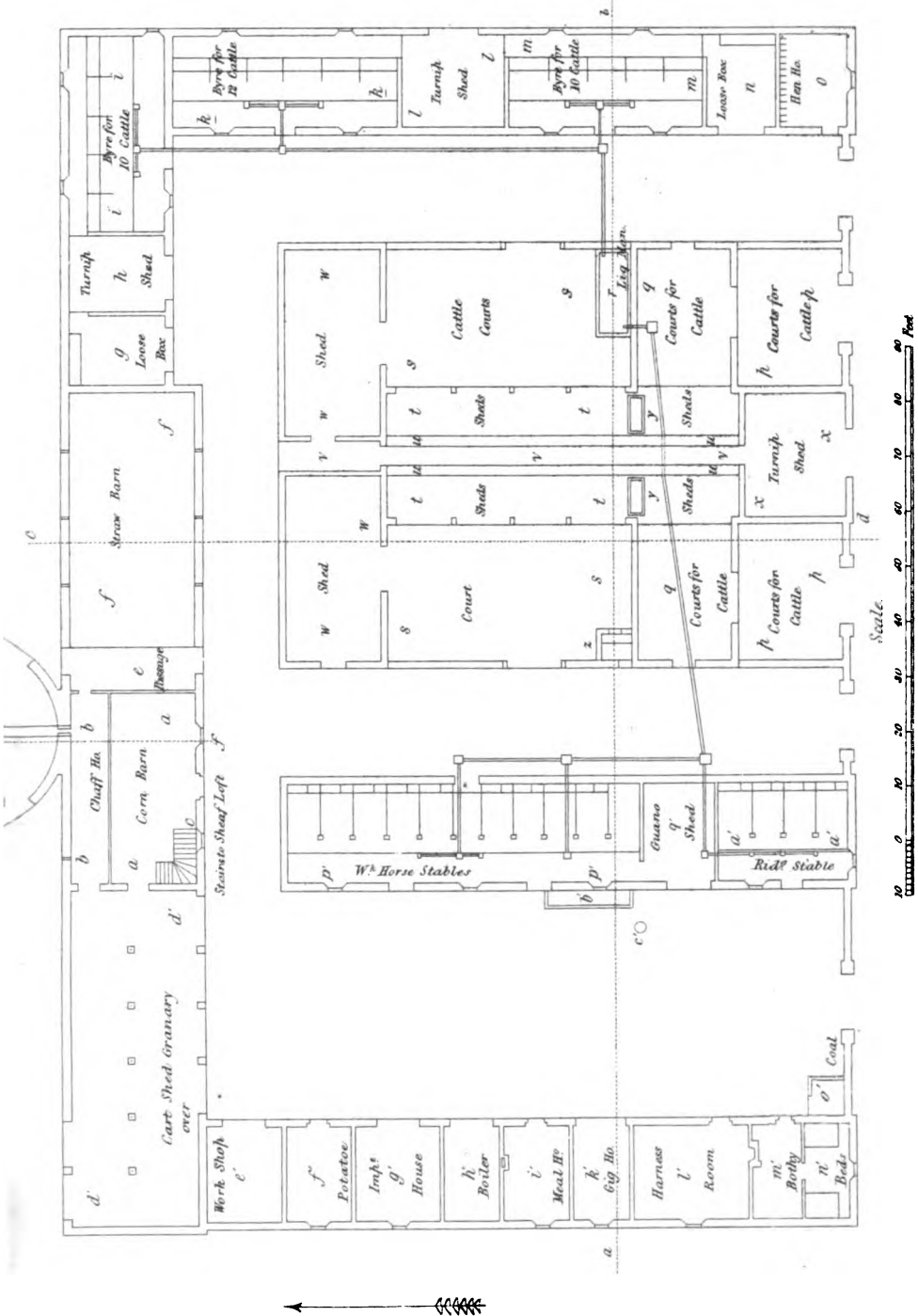
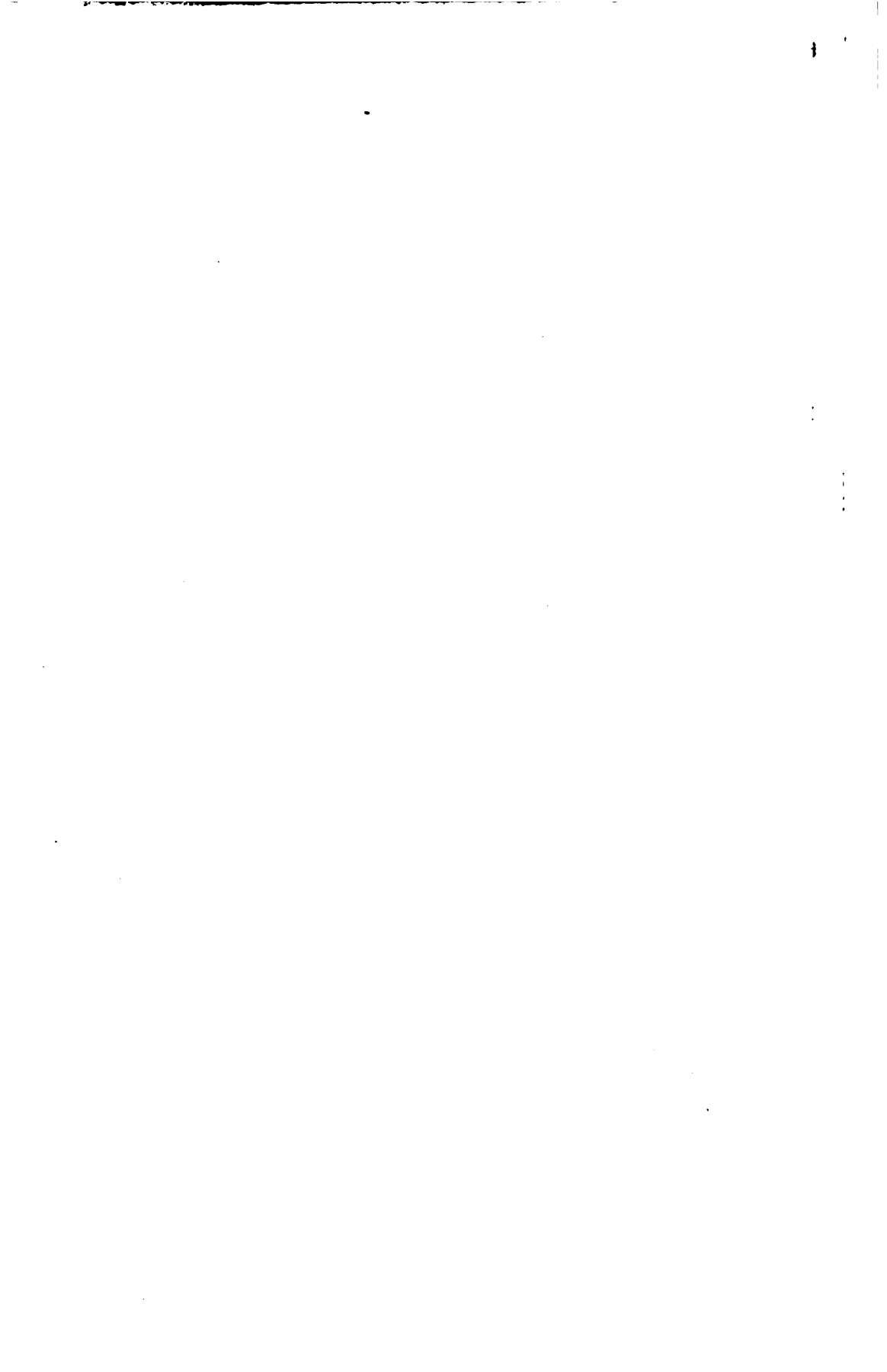

Fig 1







PLAN OF FARM ST

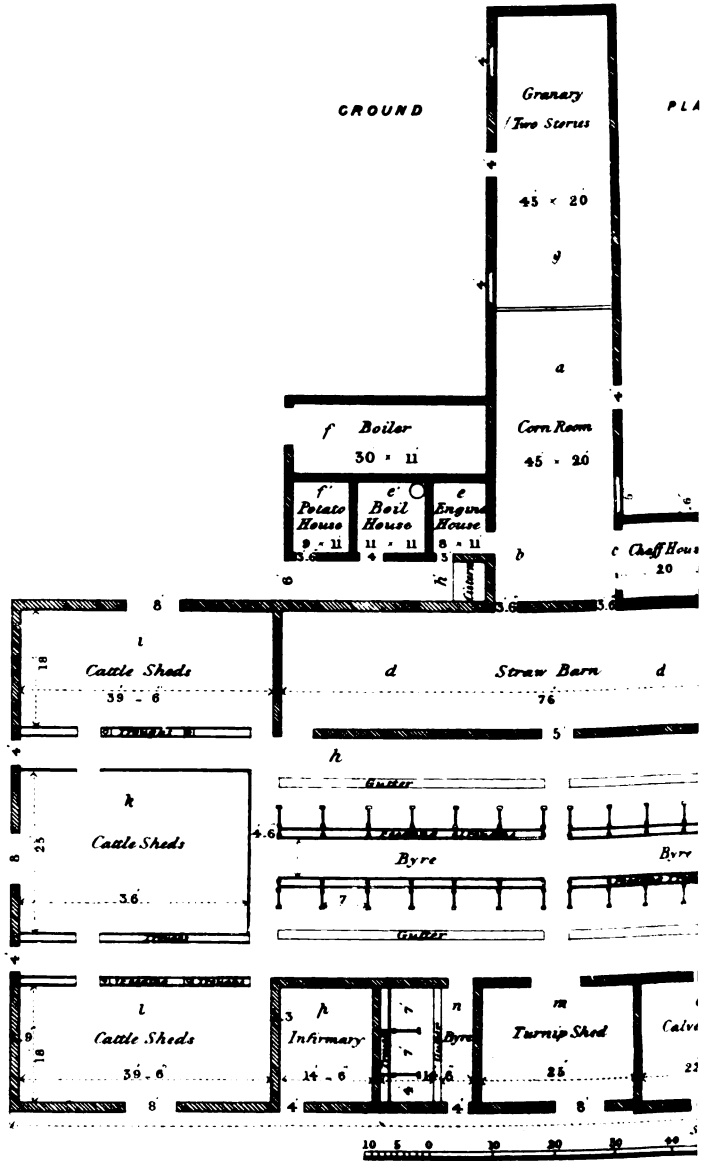
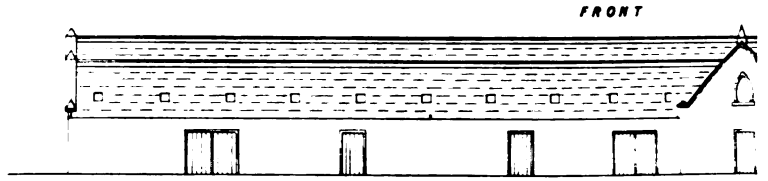

LOADING AT MORPHIE

ELEVATION.

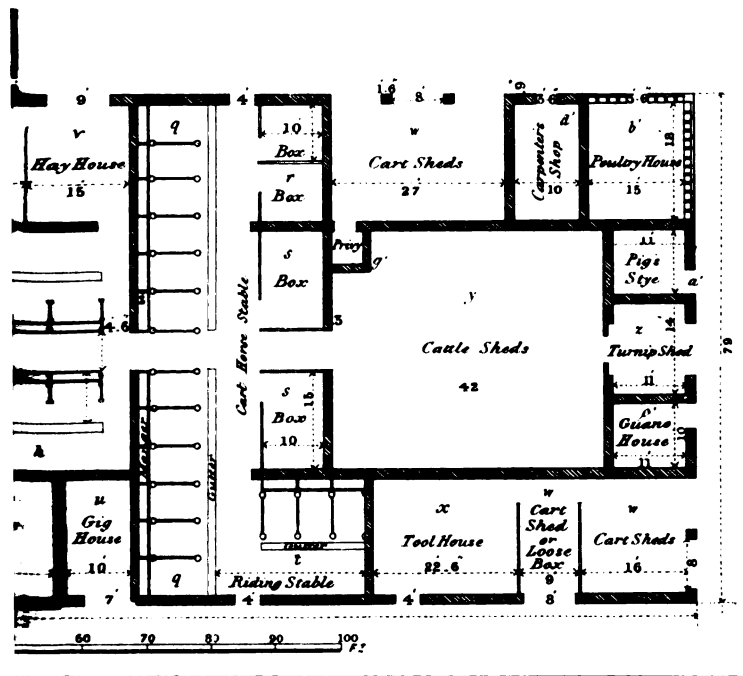
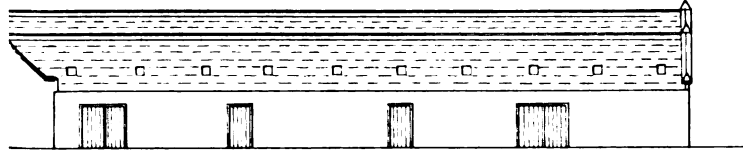

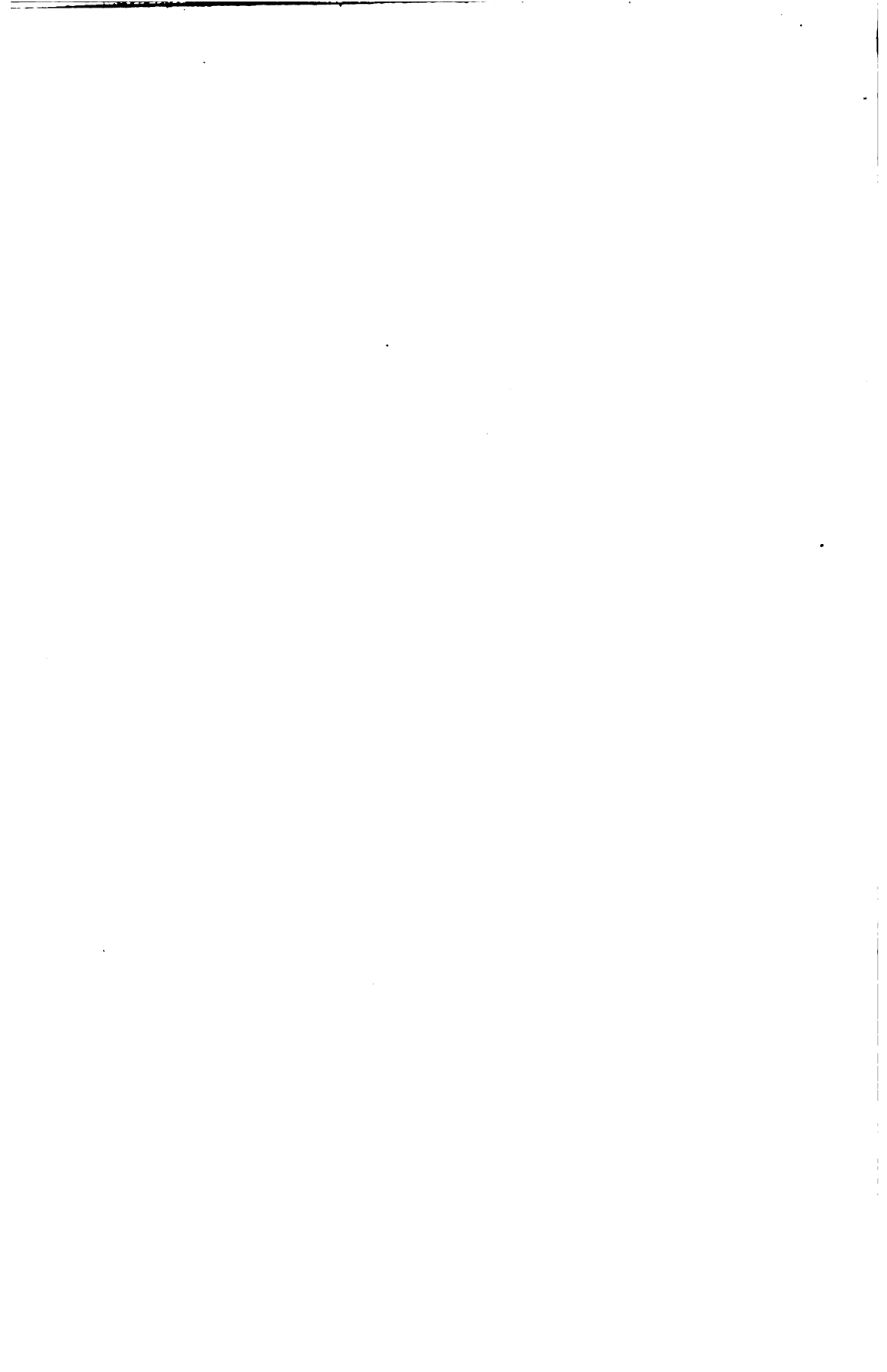

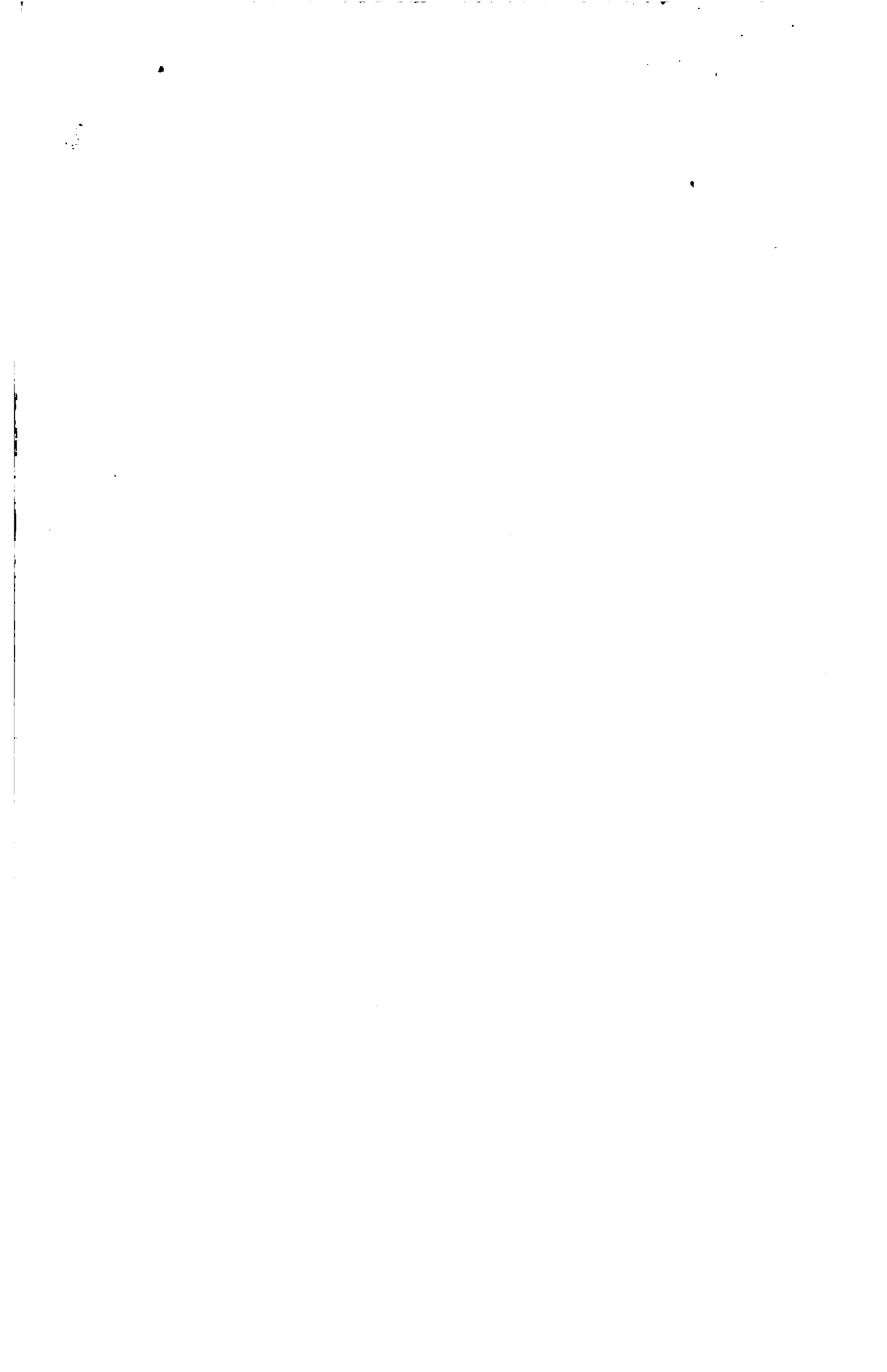

PLAN OF FARM BUILDINGS

Arranged by
E. W. MOORE ESQR
 At Coleshill Highworth,
 BERKSHIRE.

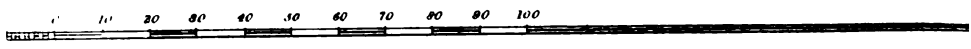
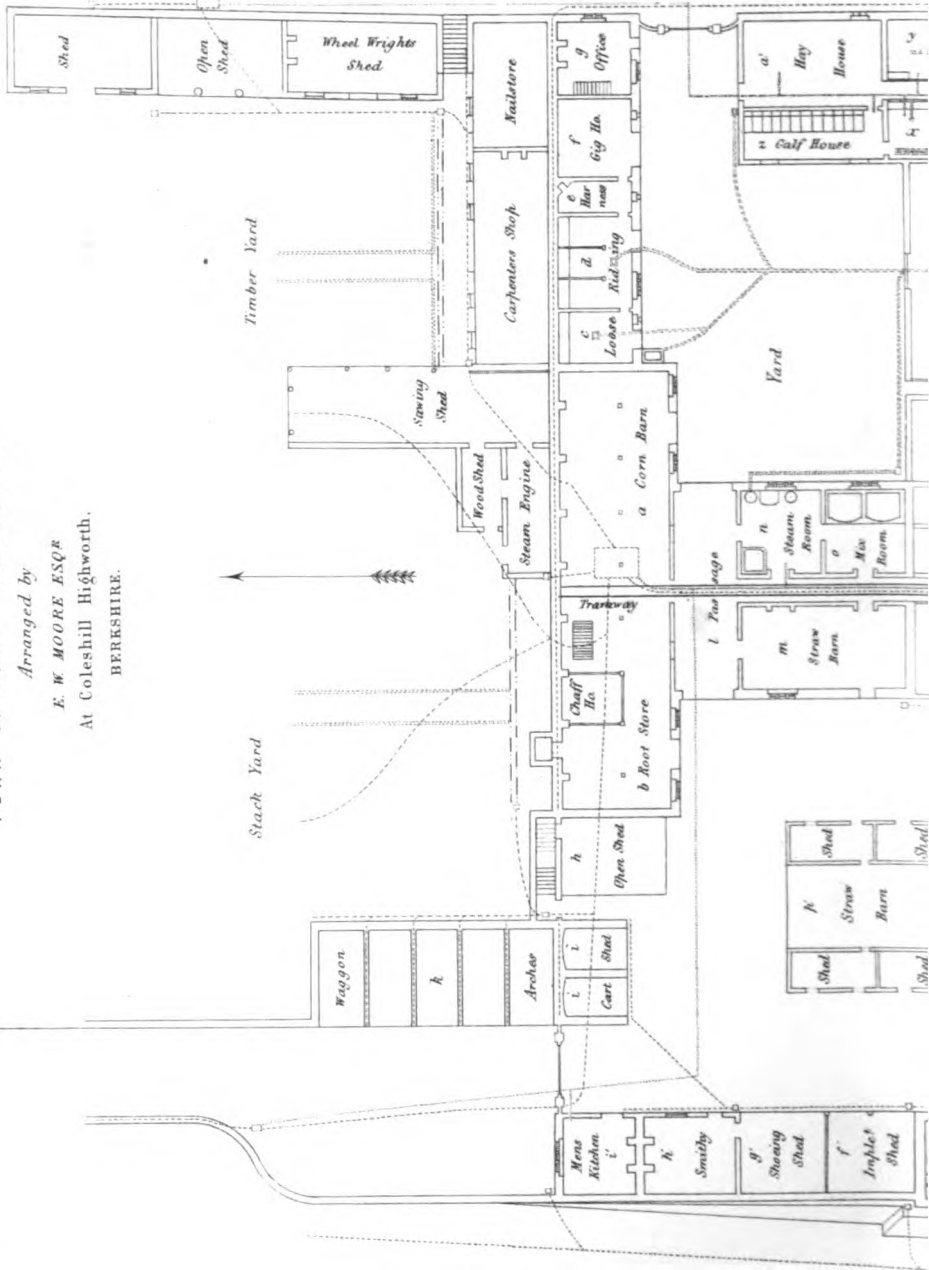

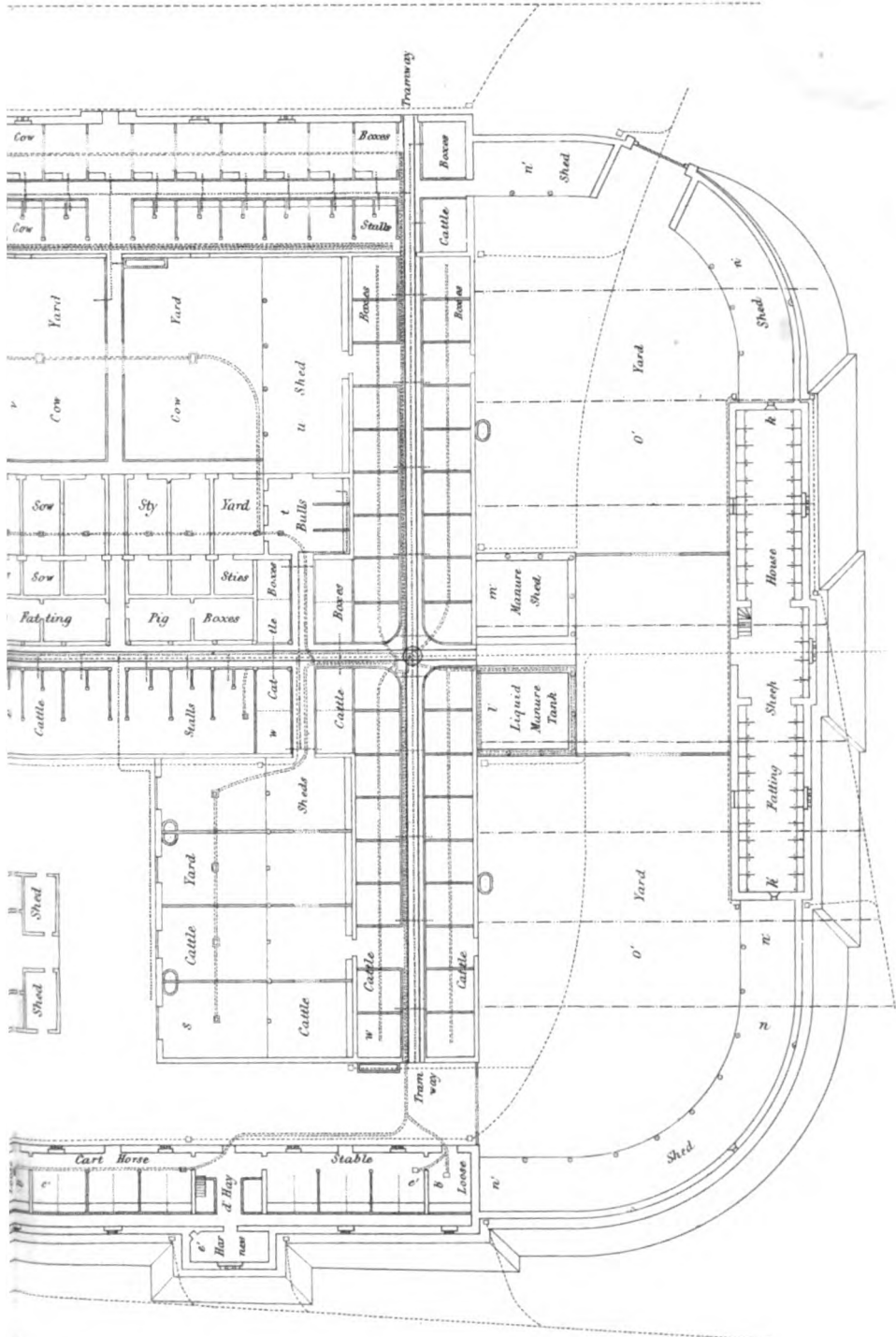

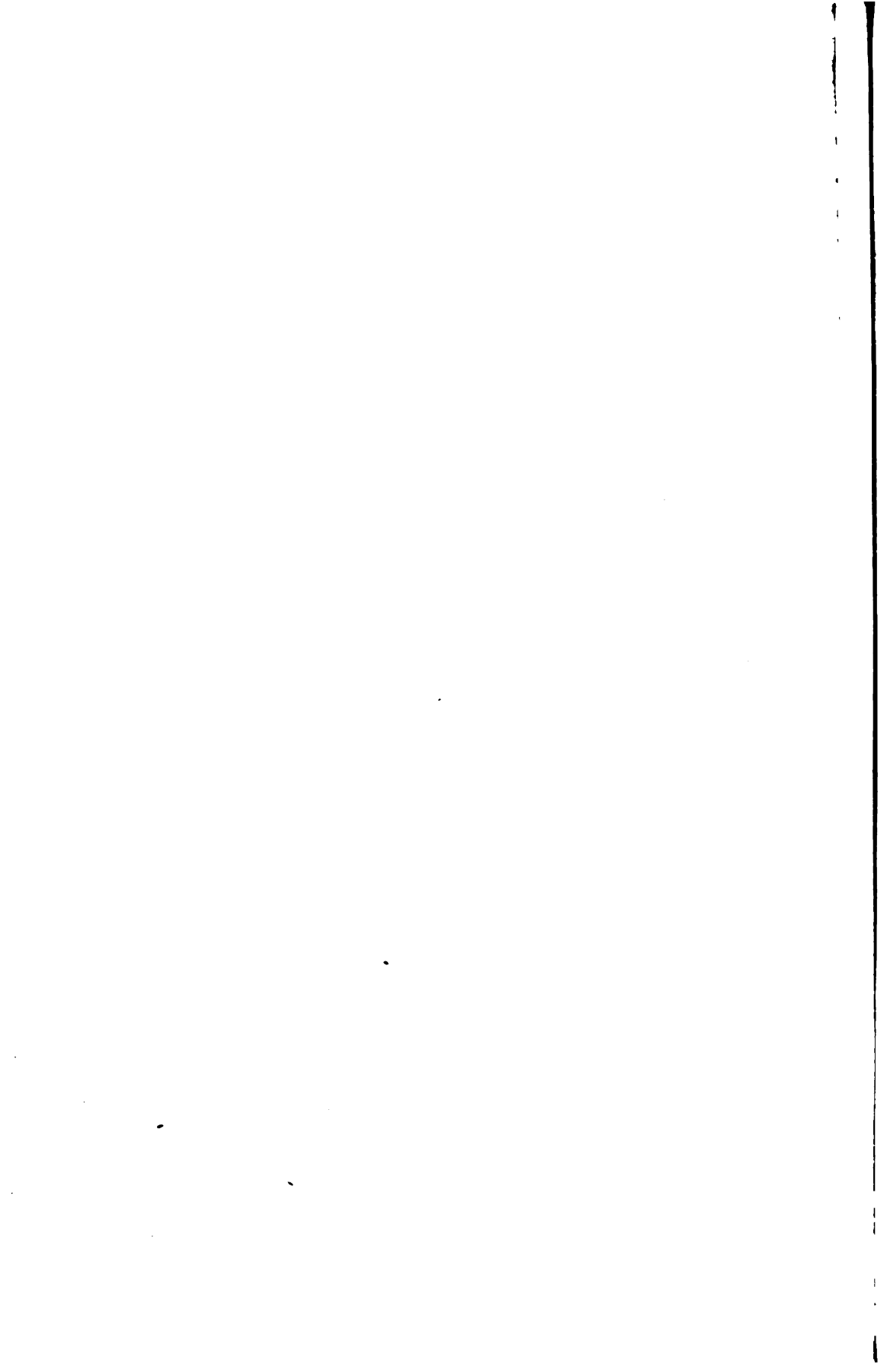

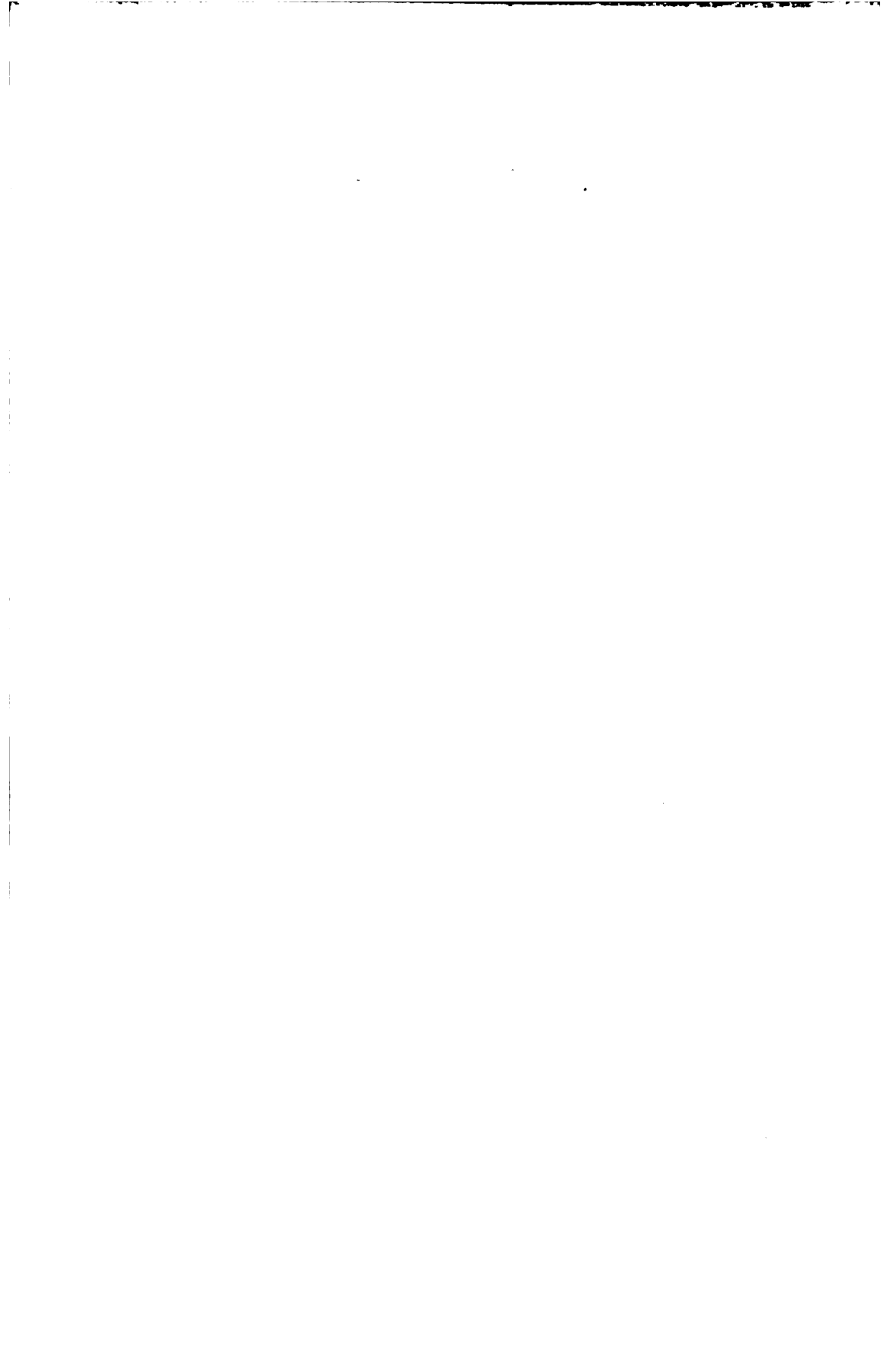

PERSPECTIVE VII
COLESHILL FAR

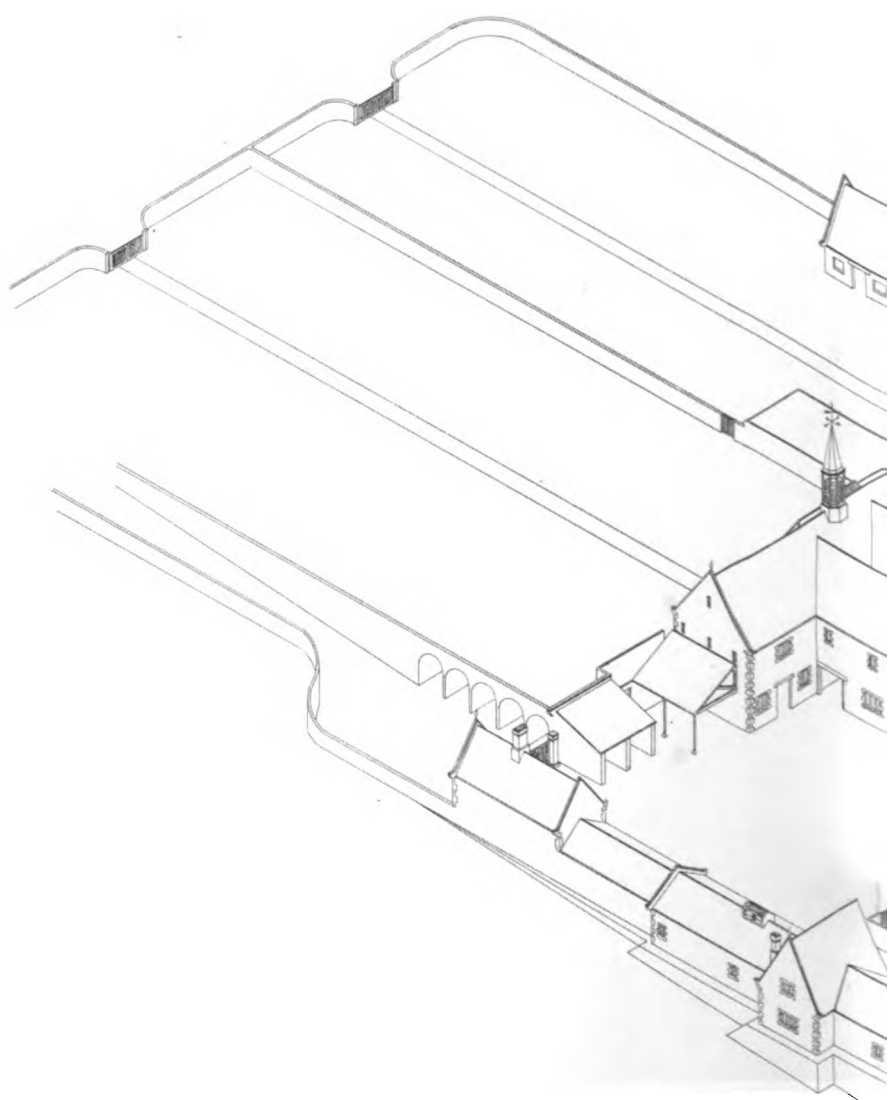

W IN OUTLINE OF
M BUILDINGS

PLATE XV

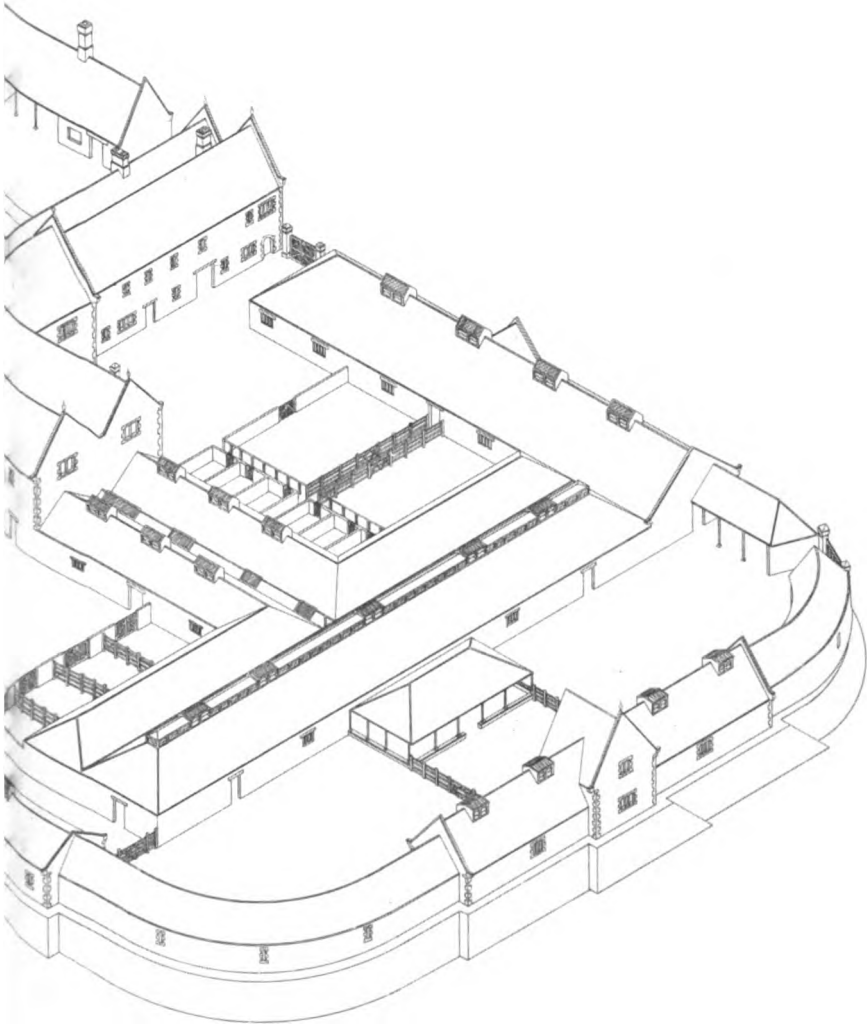



PLAN OF FARM STEADING

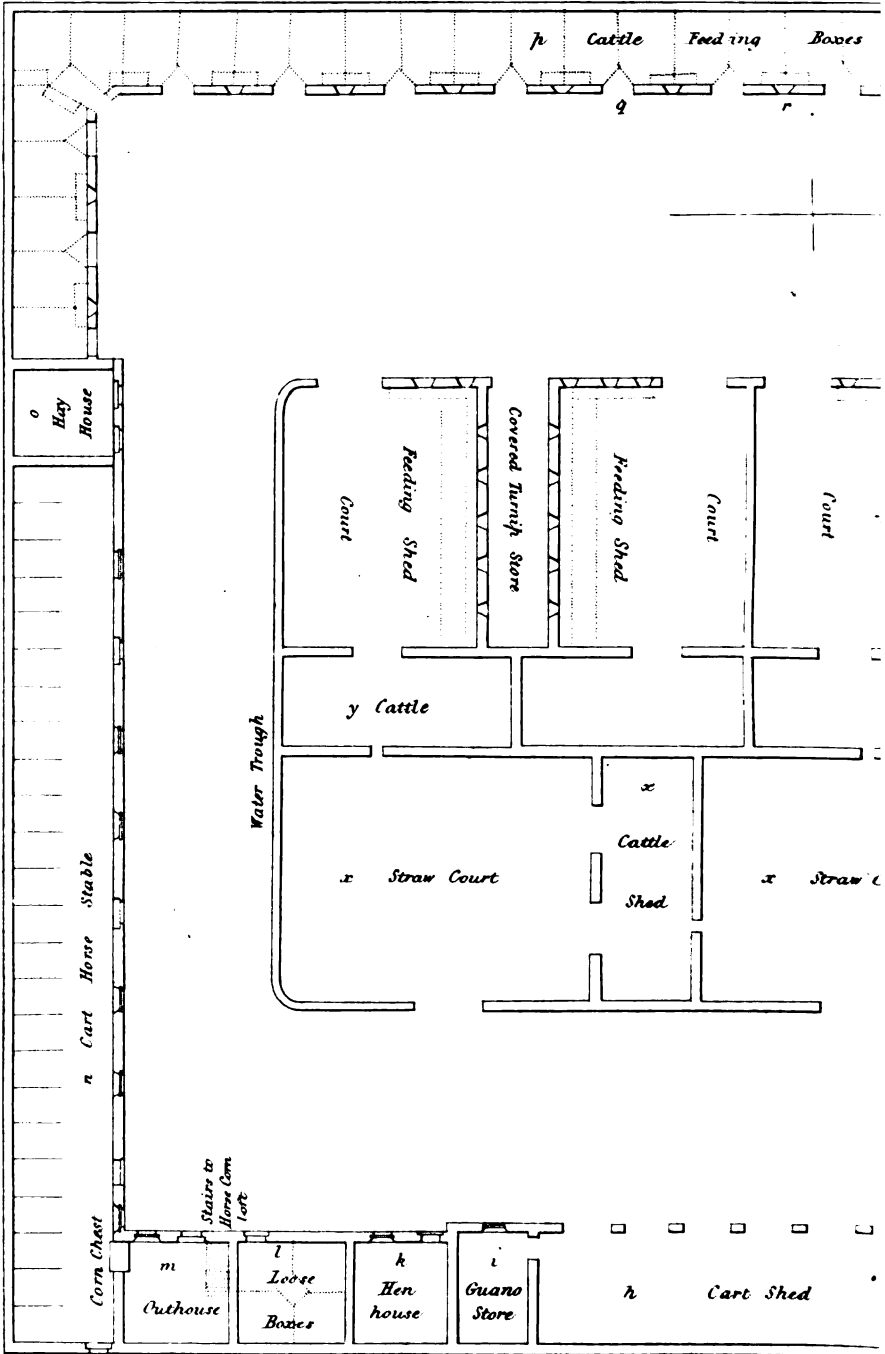

Scale

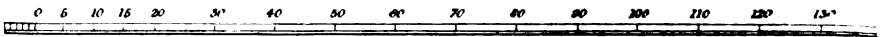

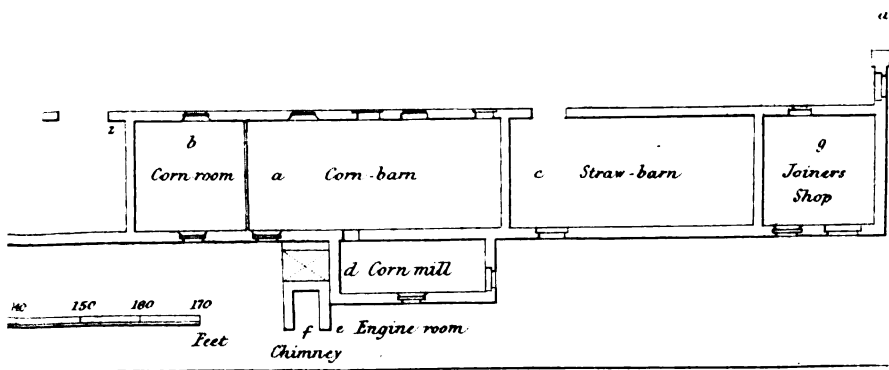
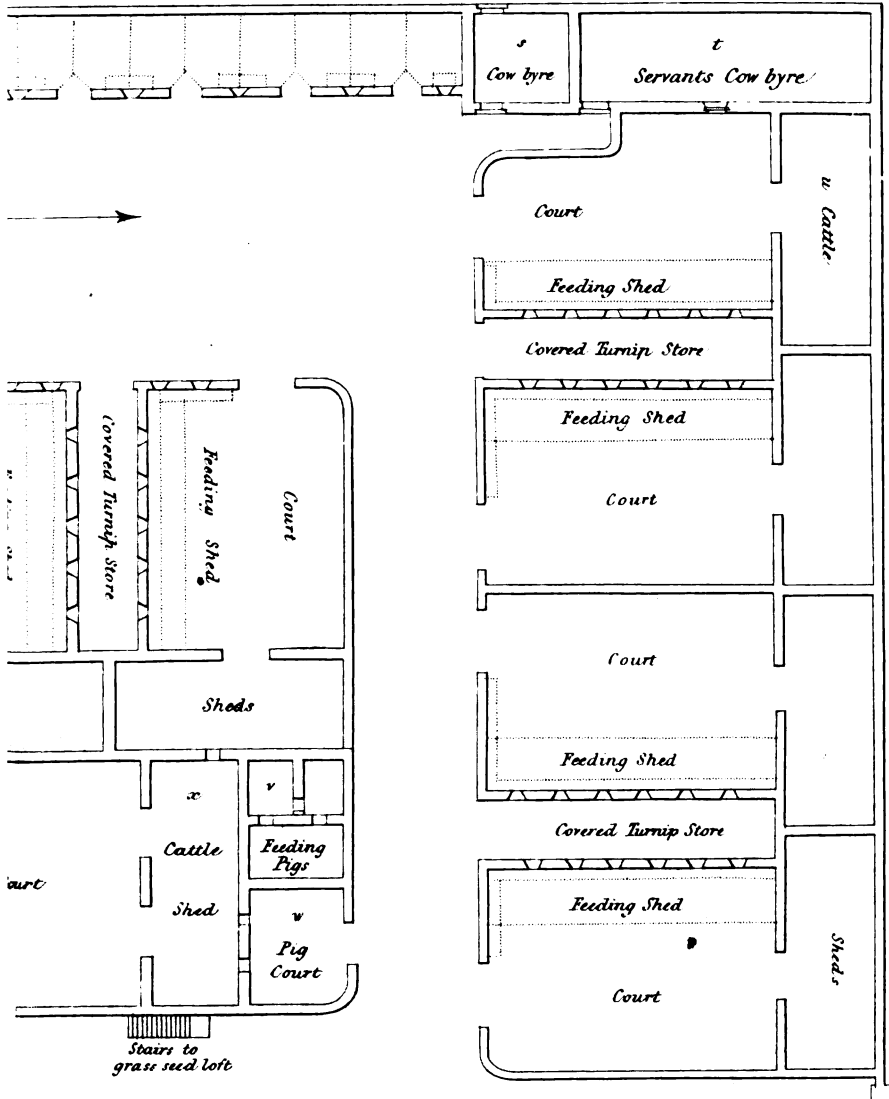

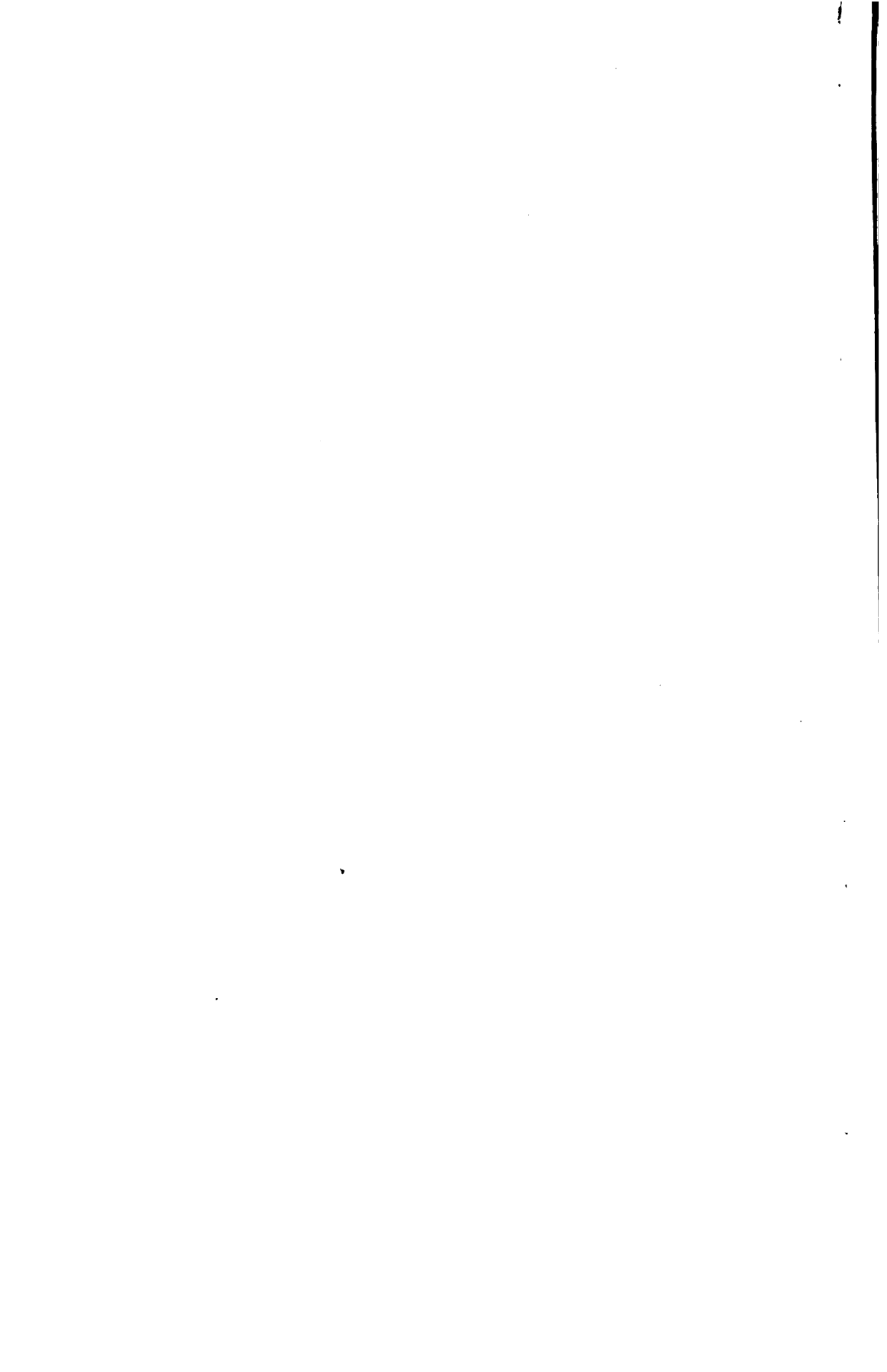



FARM STEADING AT INVERQUHARITY
With Alterations and Additions.

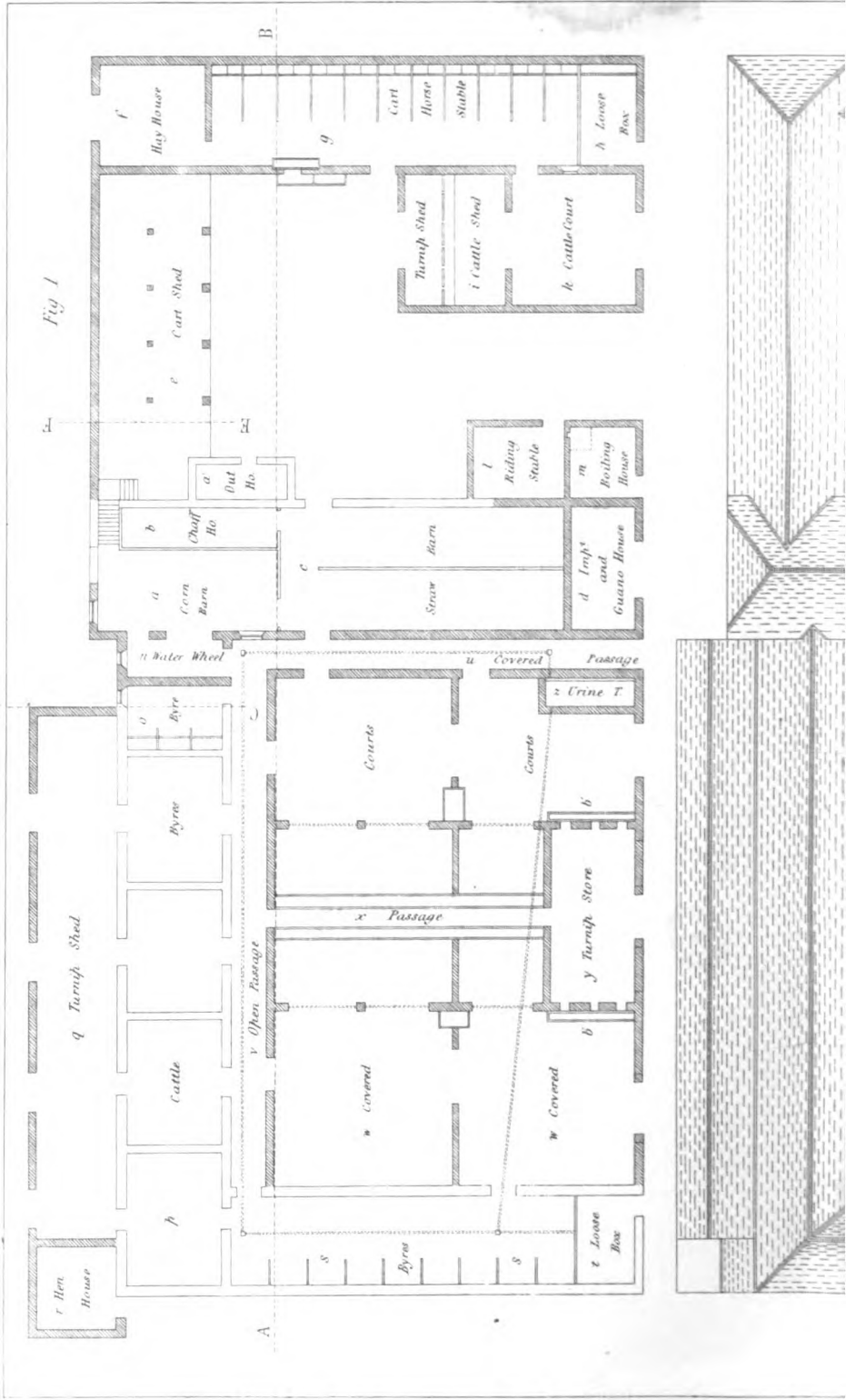

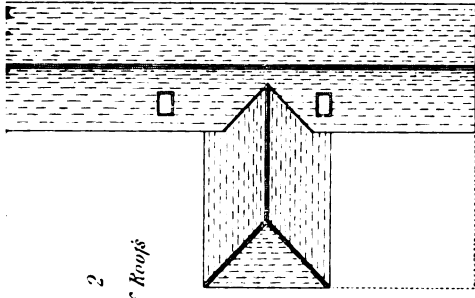
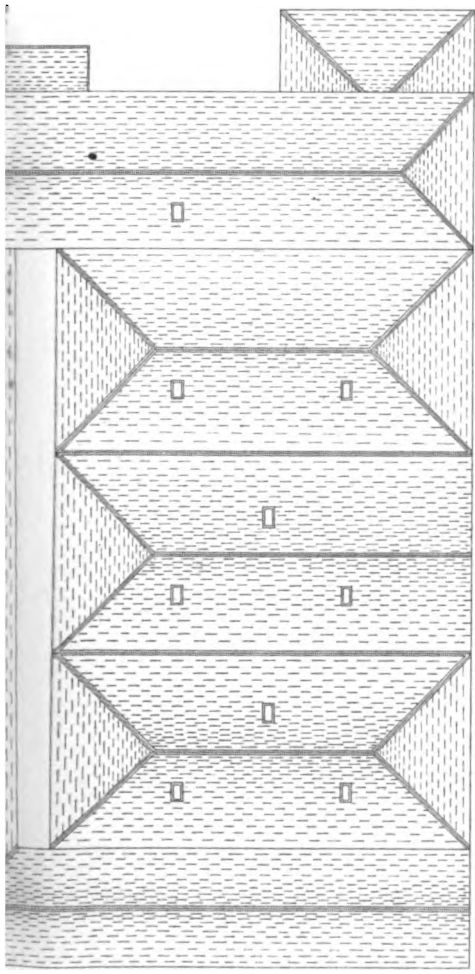

Fig 2
Plan of Roofs



SOUTH ELEVATION

Fig 3

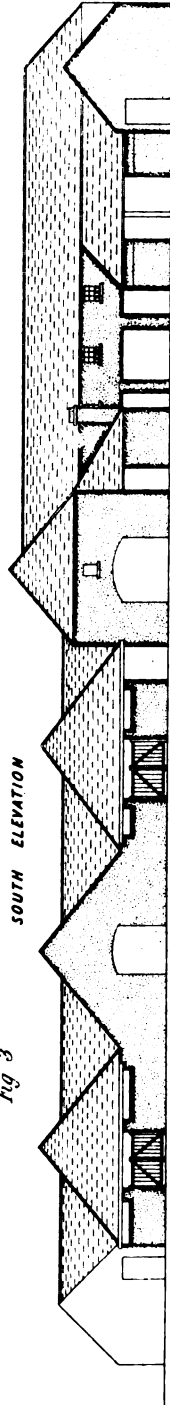

Fig 4. Section on the Line A B.

Fig 5 Section on the Line CD

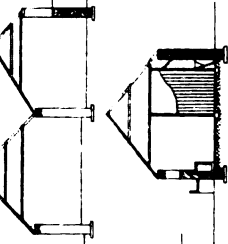
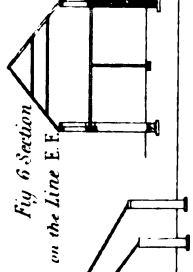
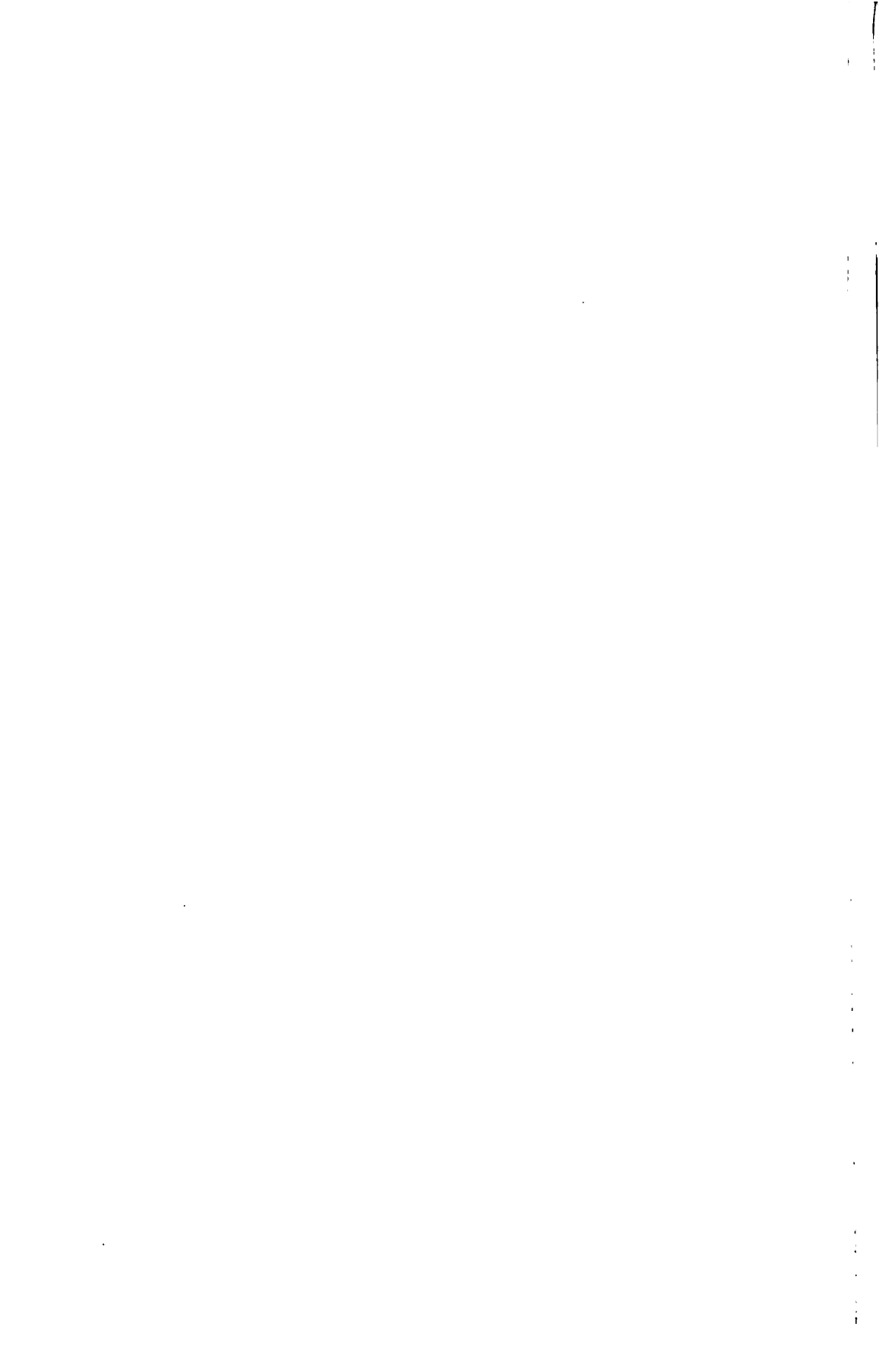
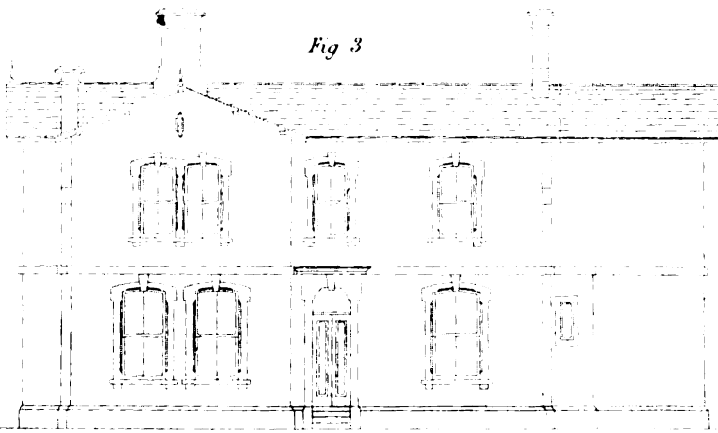
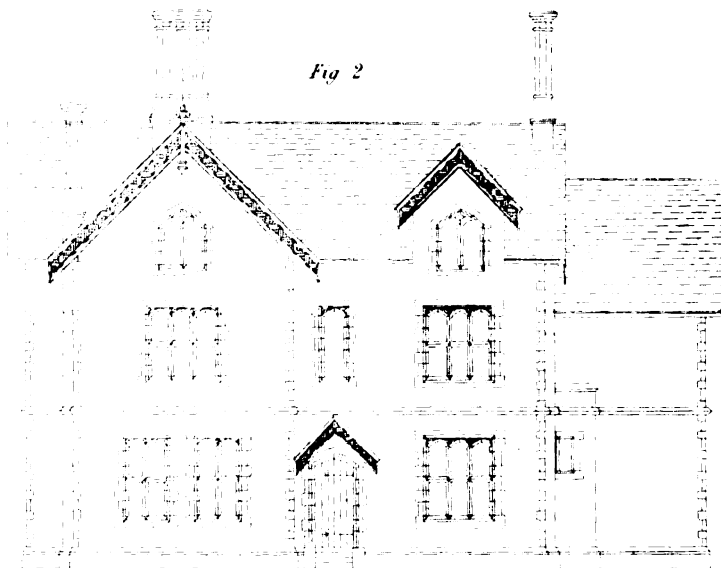
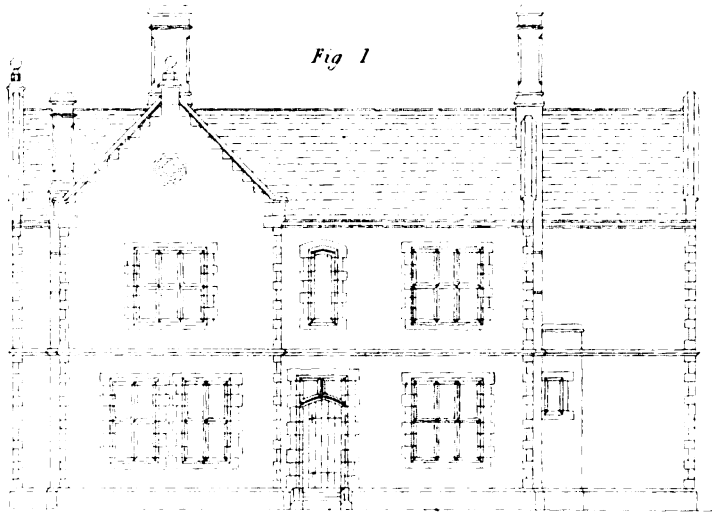

Fig 6 Section on the Line E F







Scale 0 4 10 16 20 26 30 36 40 ft

VERTICAL SAW FRAME FOR CUTTING TREES

Fig 2

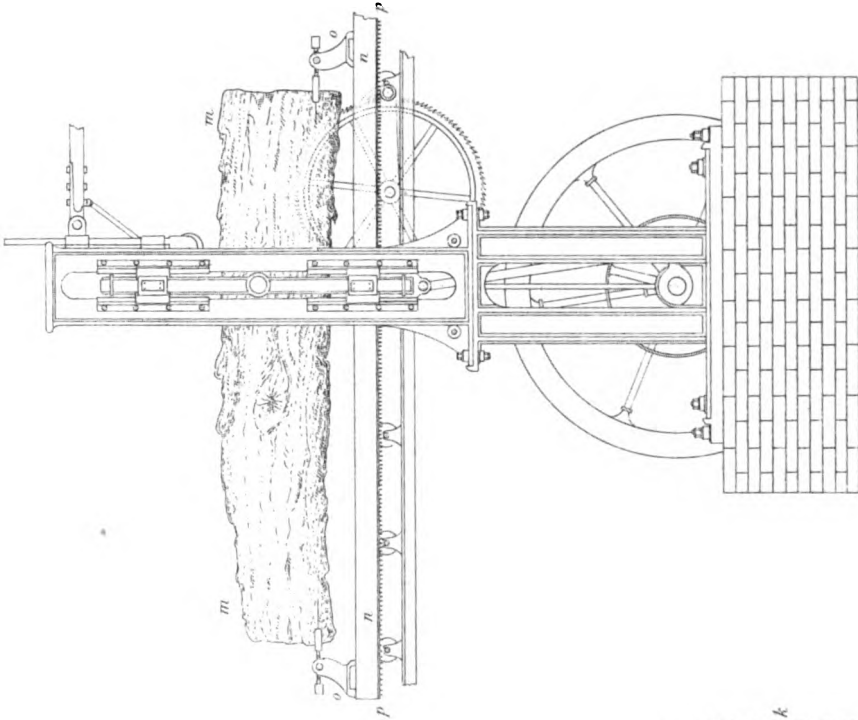
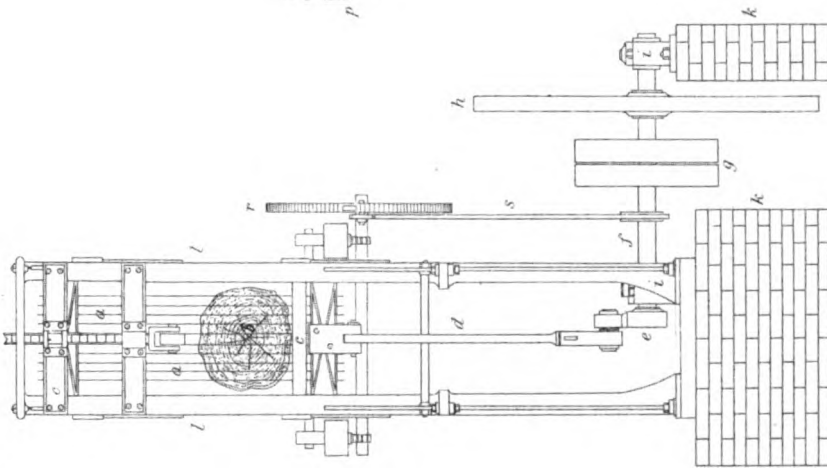

Fig 1



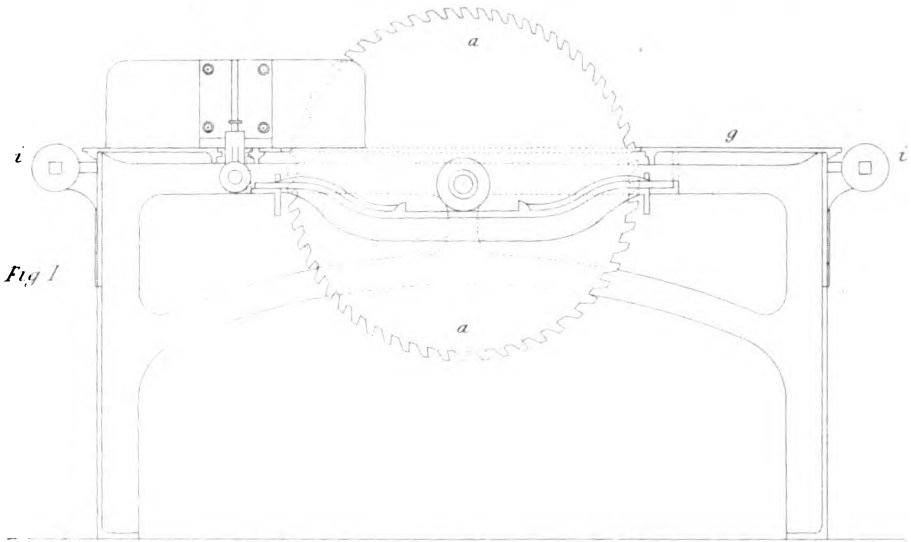

Fig 1

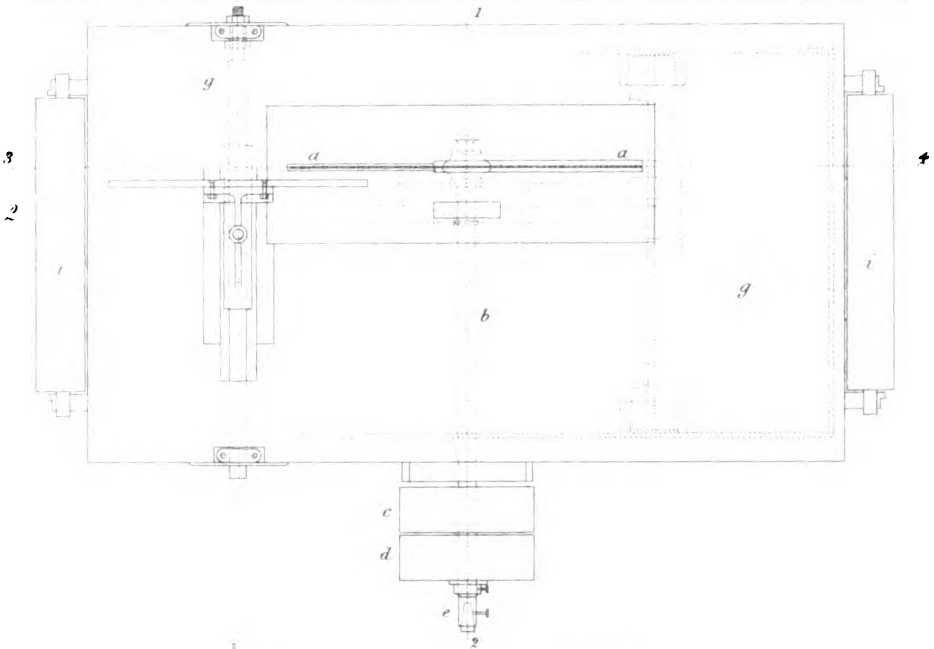

Fig 2

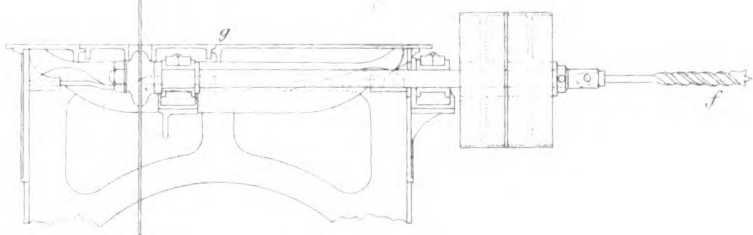

Fig 3

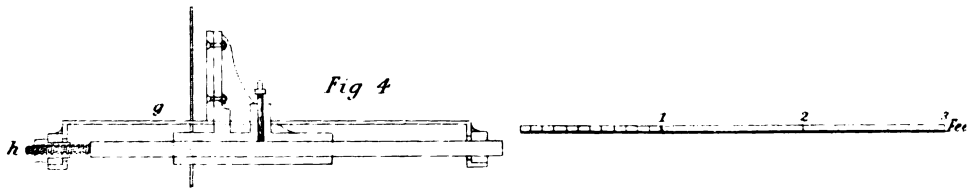
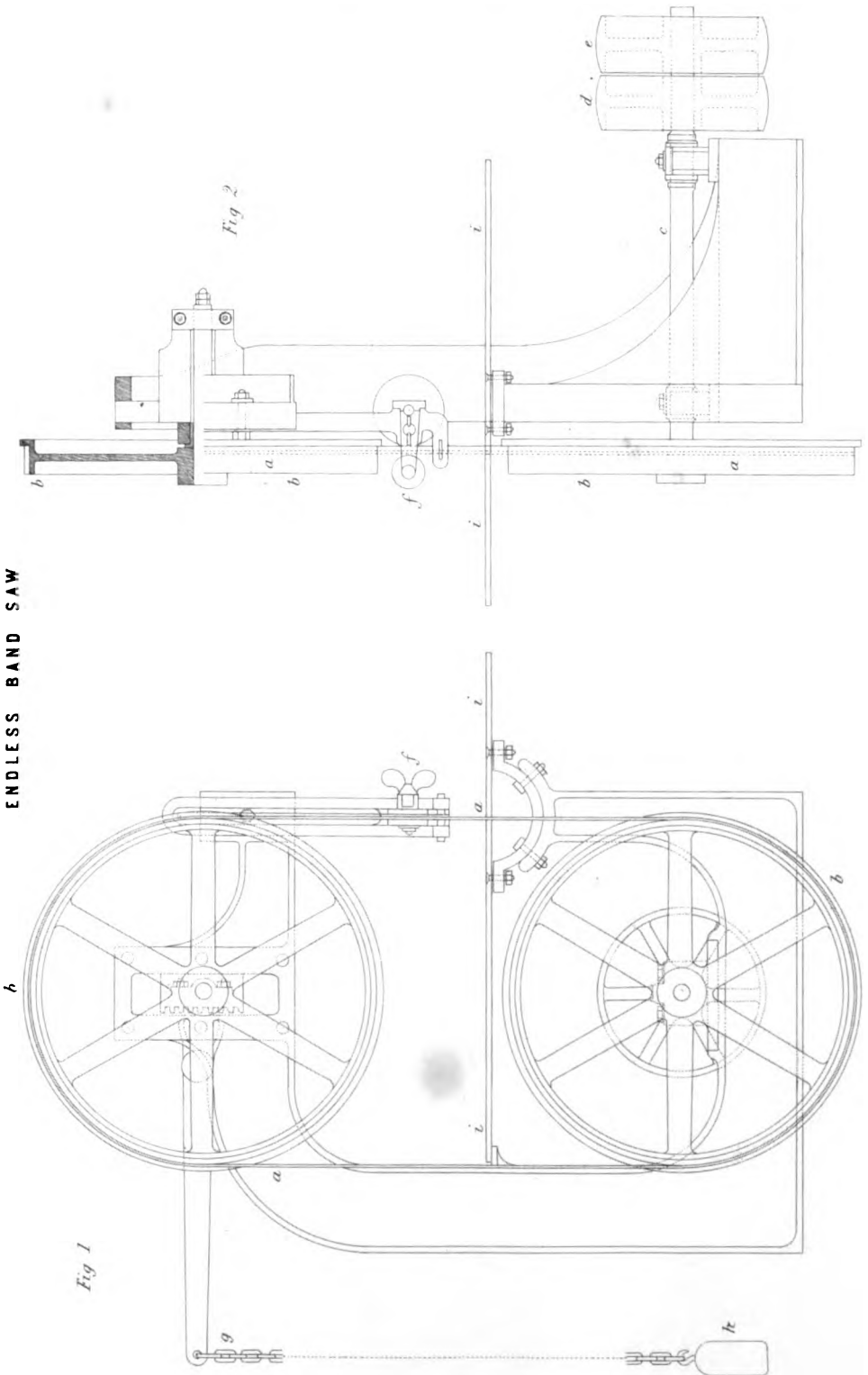
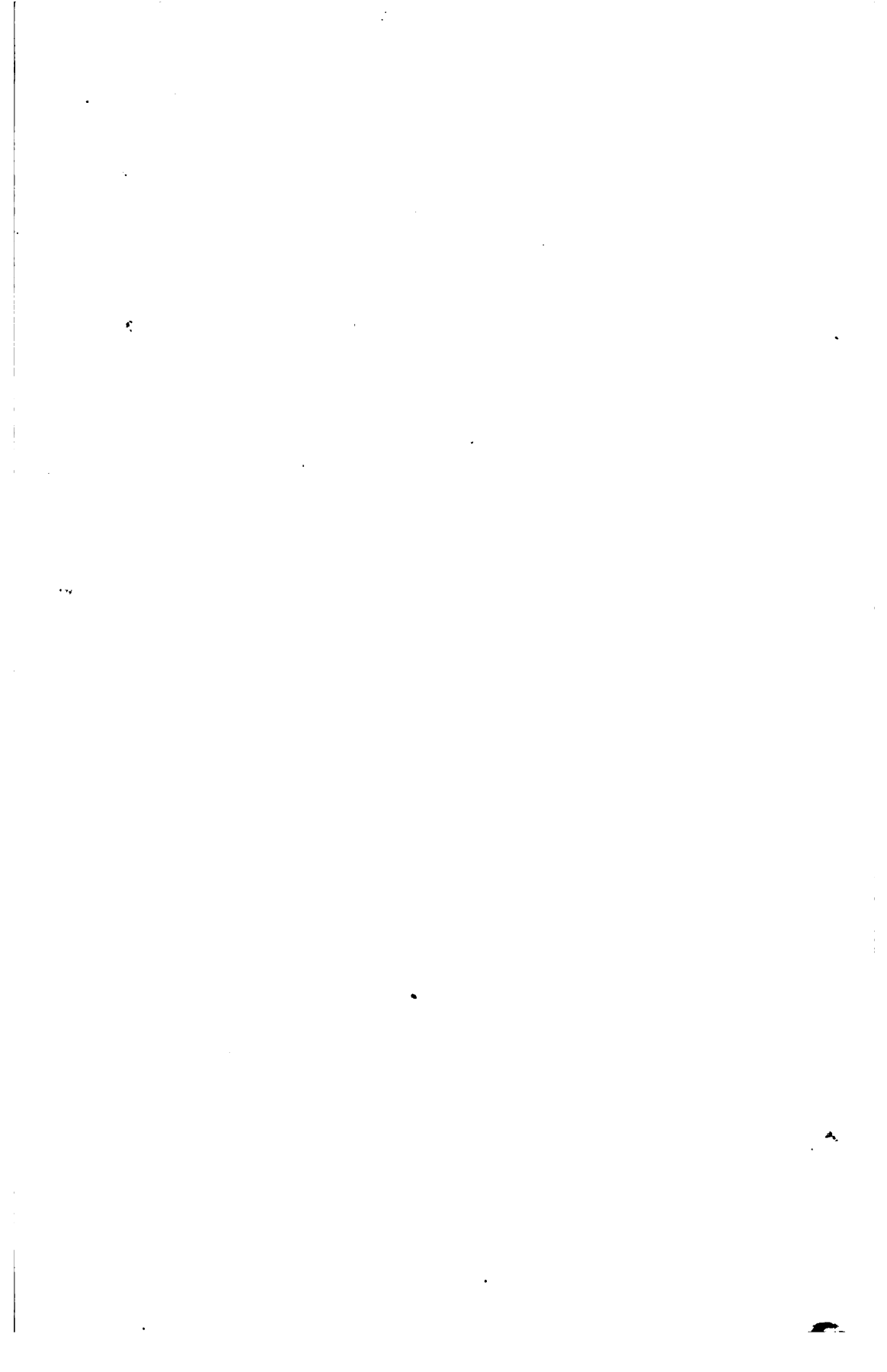

Fig 4

ENDLESS BAND SAW







ISOMETRICAL ELEVATION (

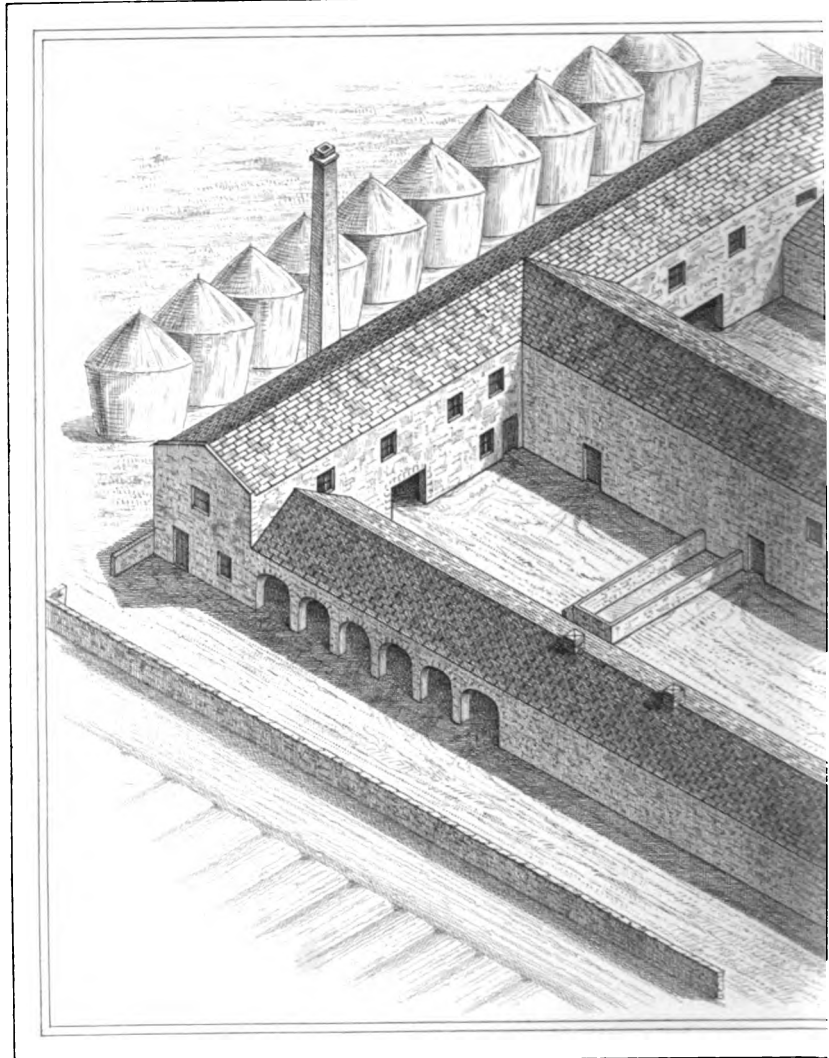
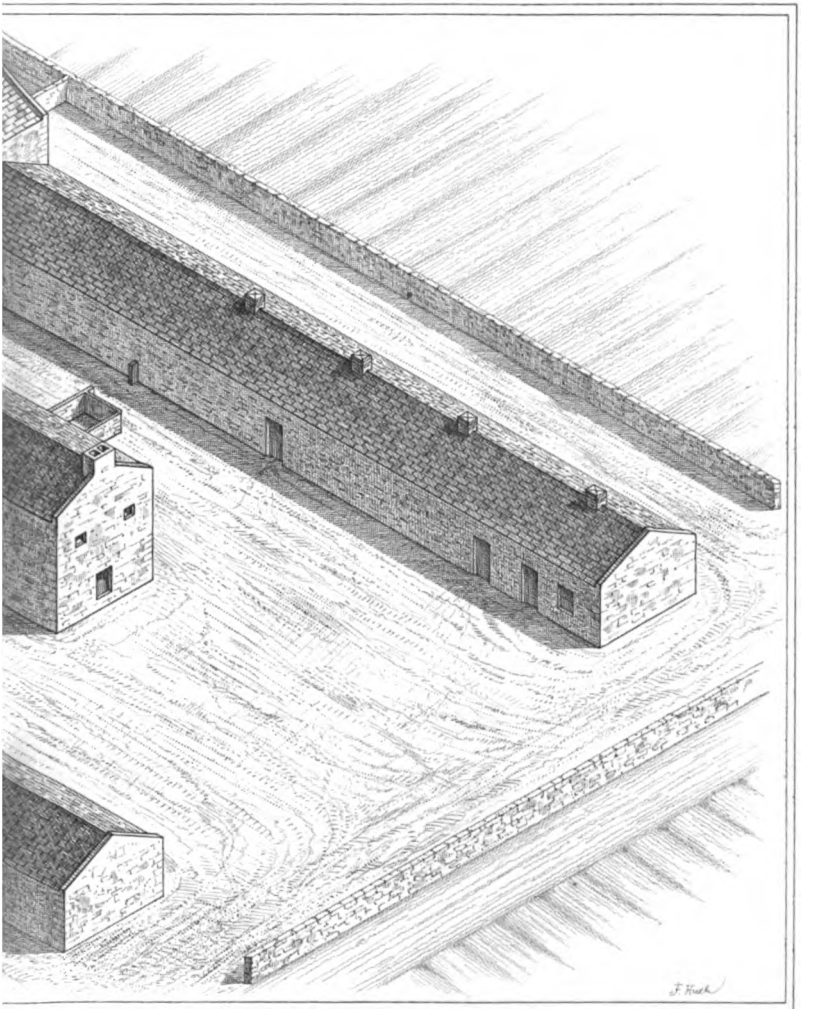
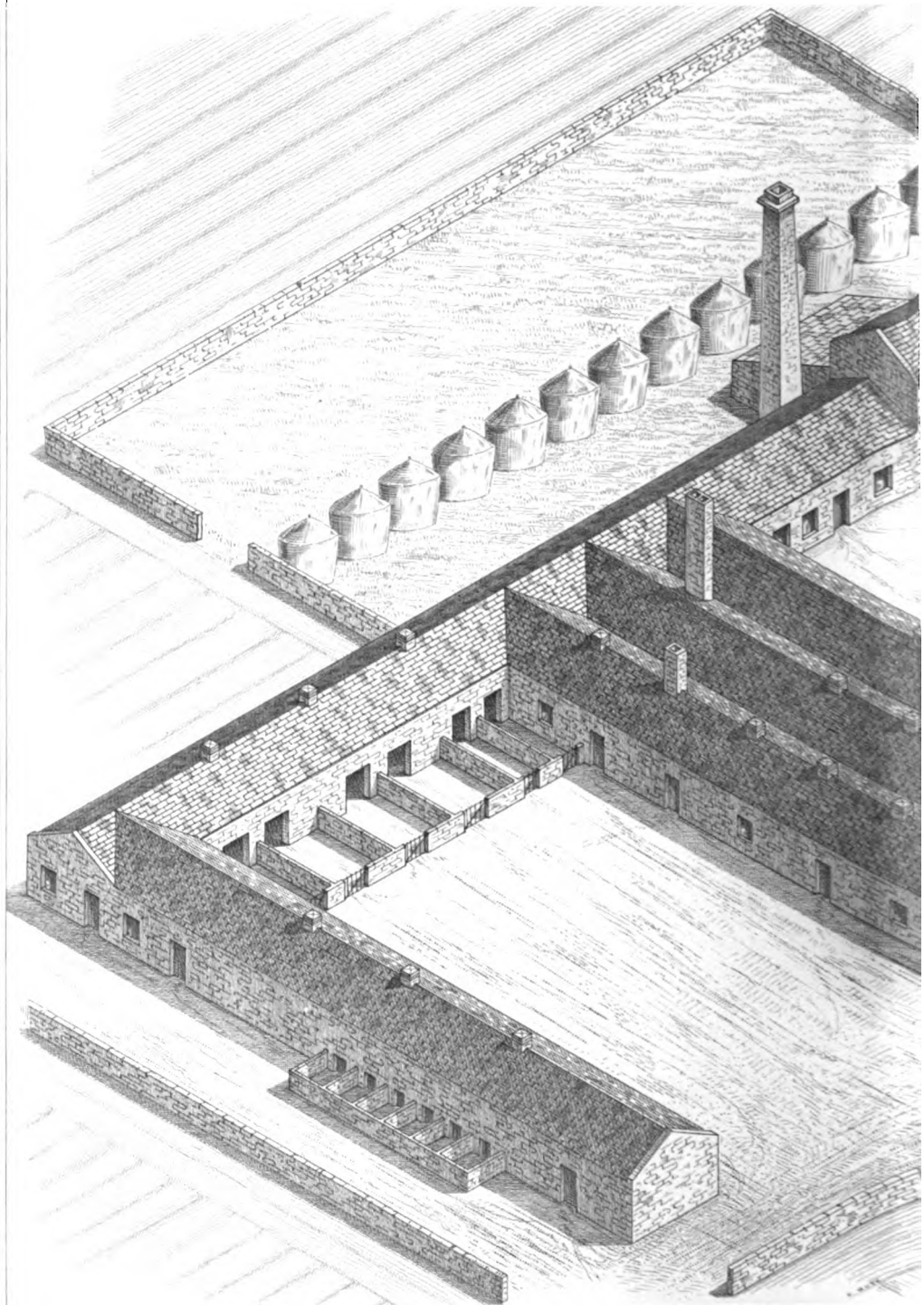

FIG. 10. (Continued)



Engraved on Stone by W. H. M. Estlin Lith. Edin'





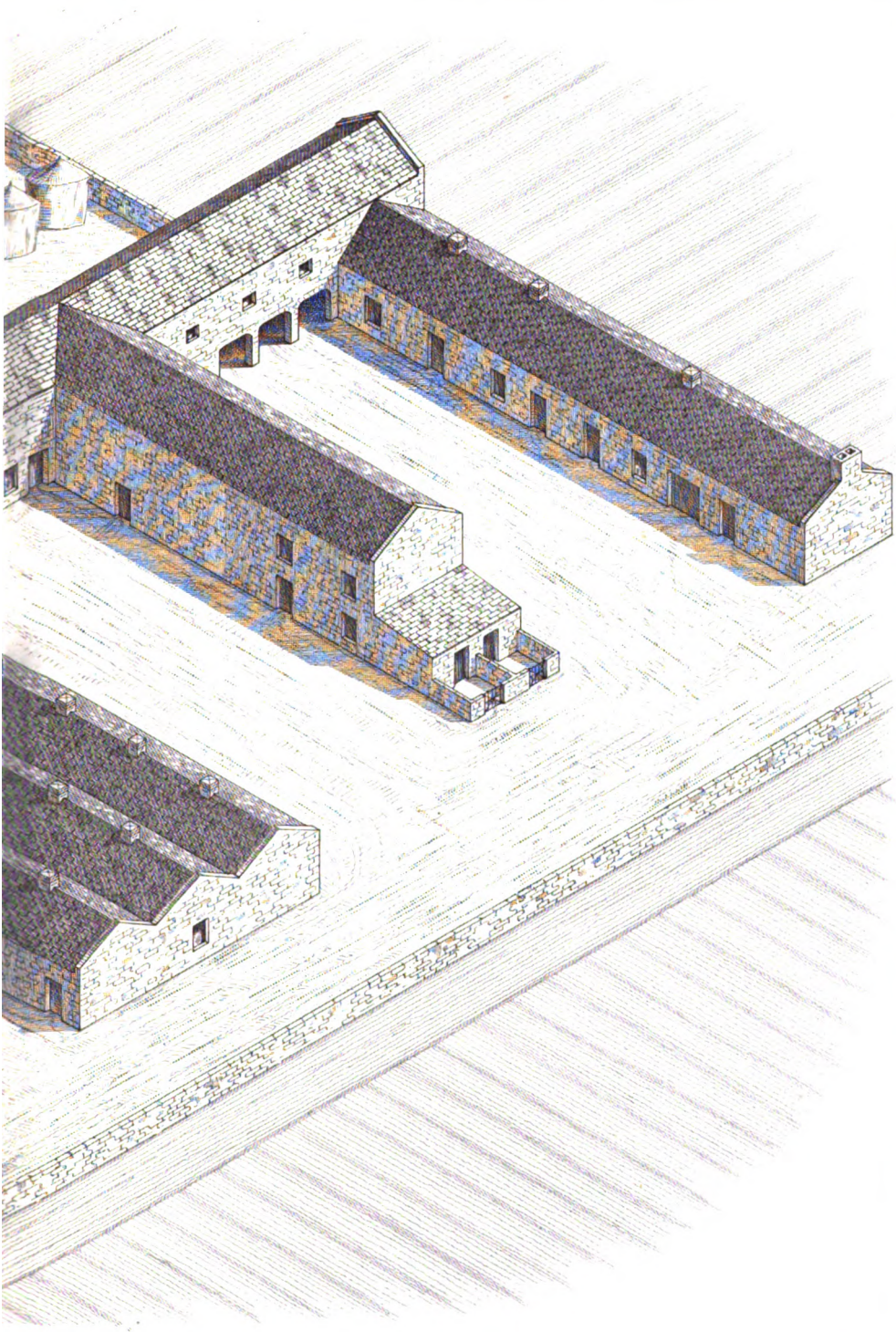

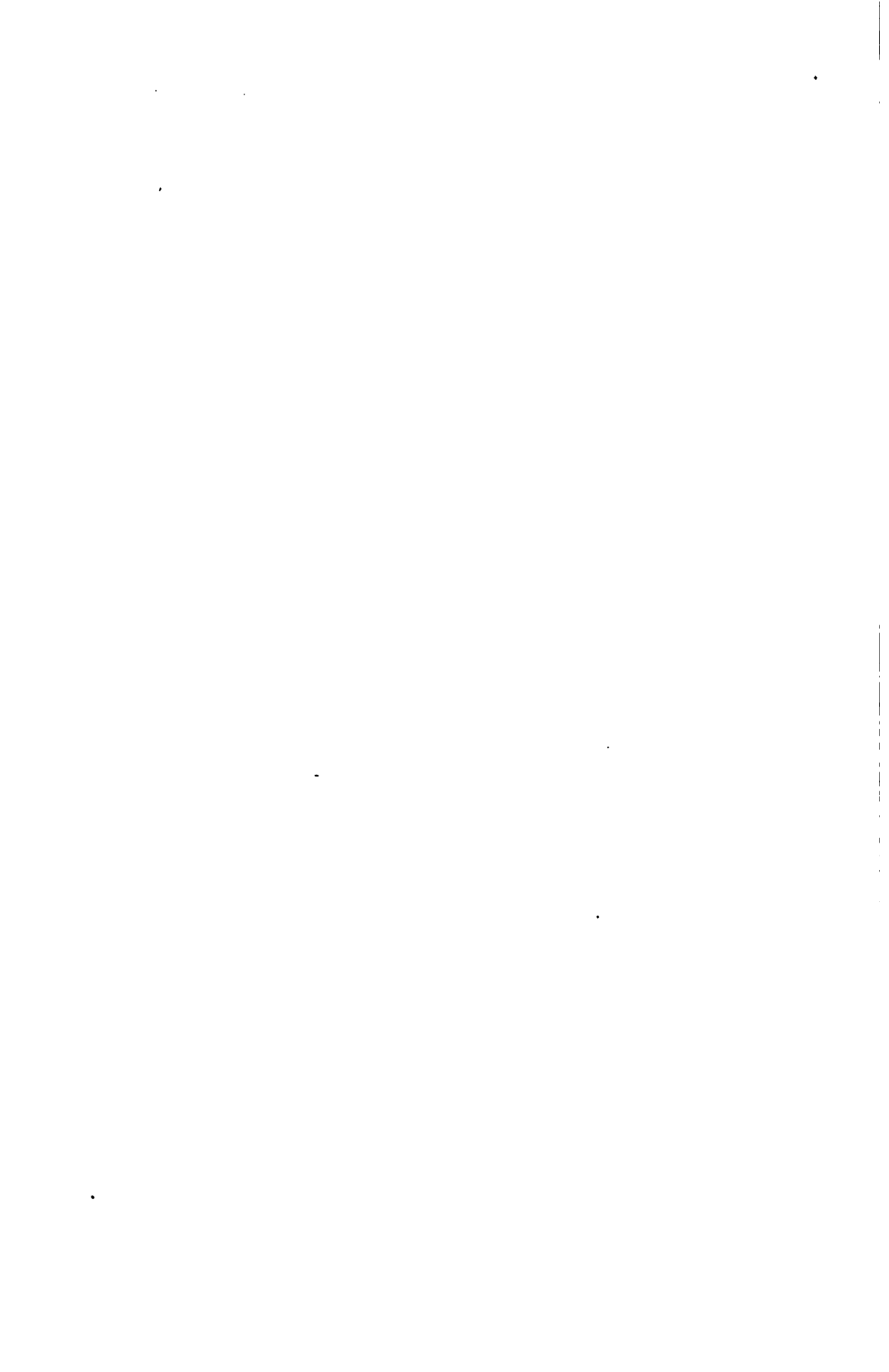



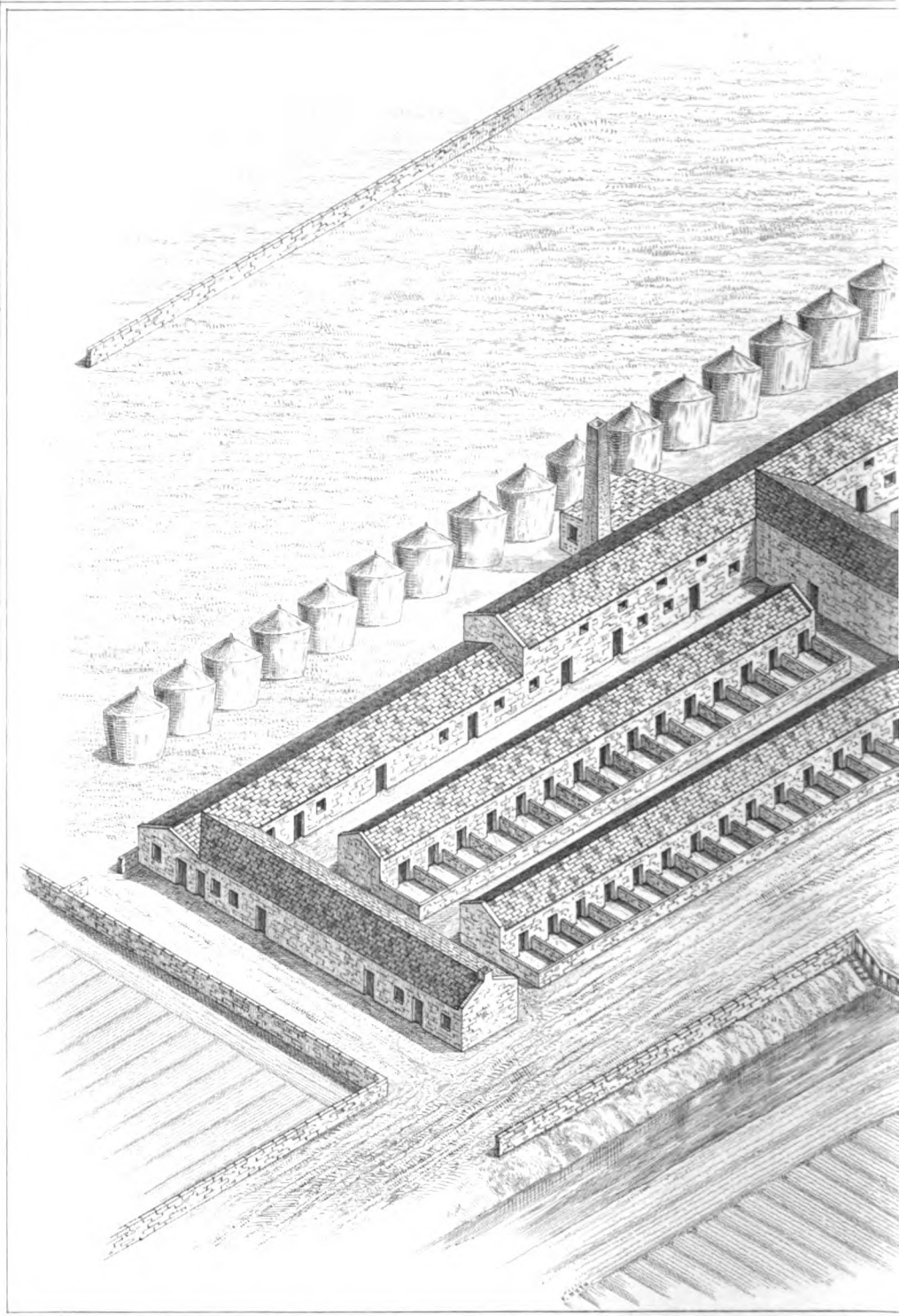

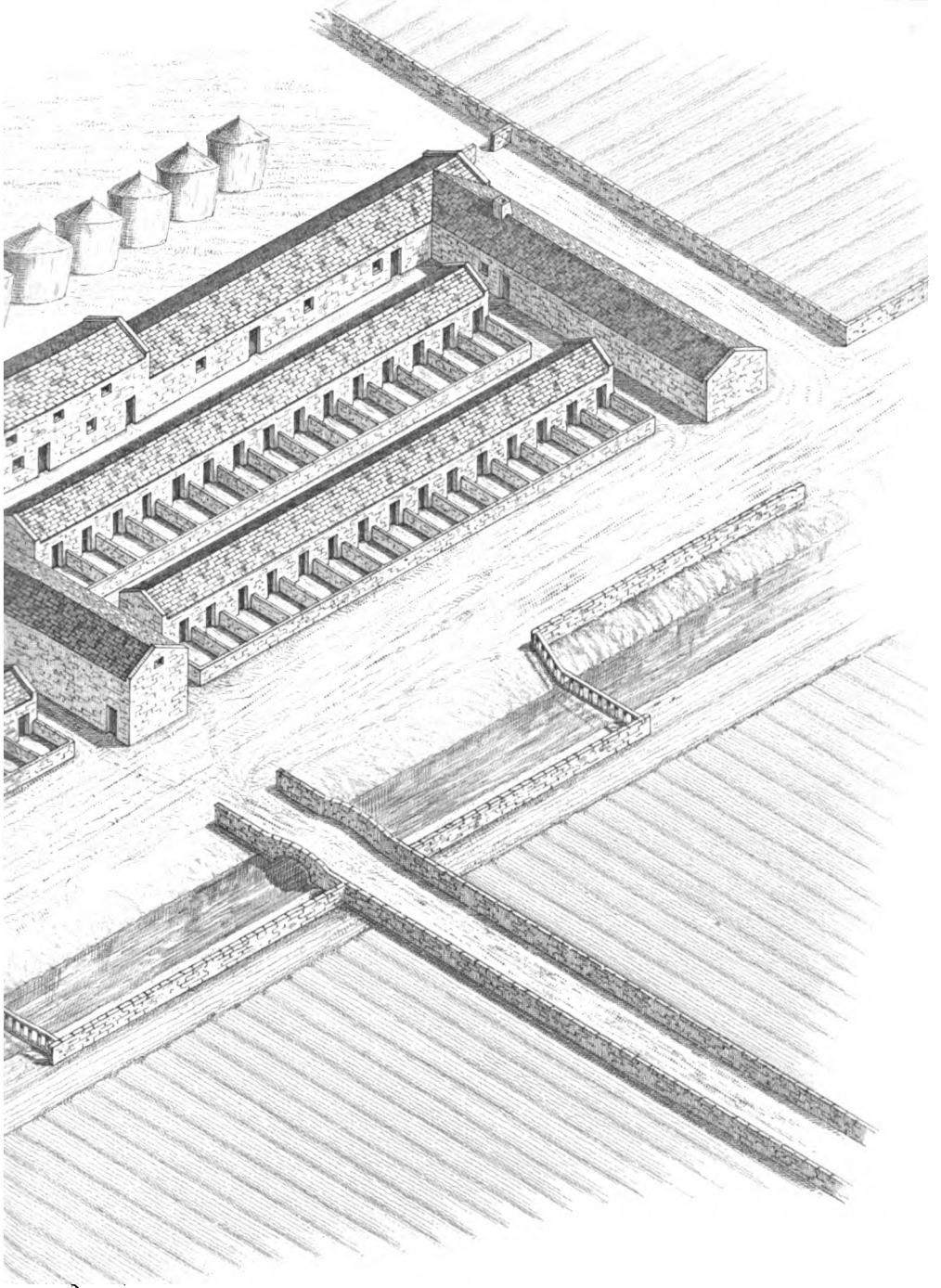

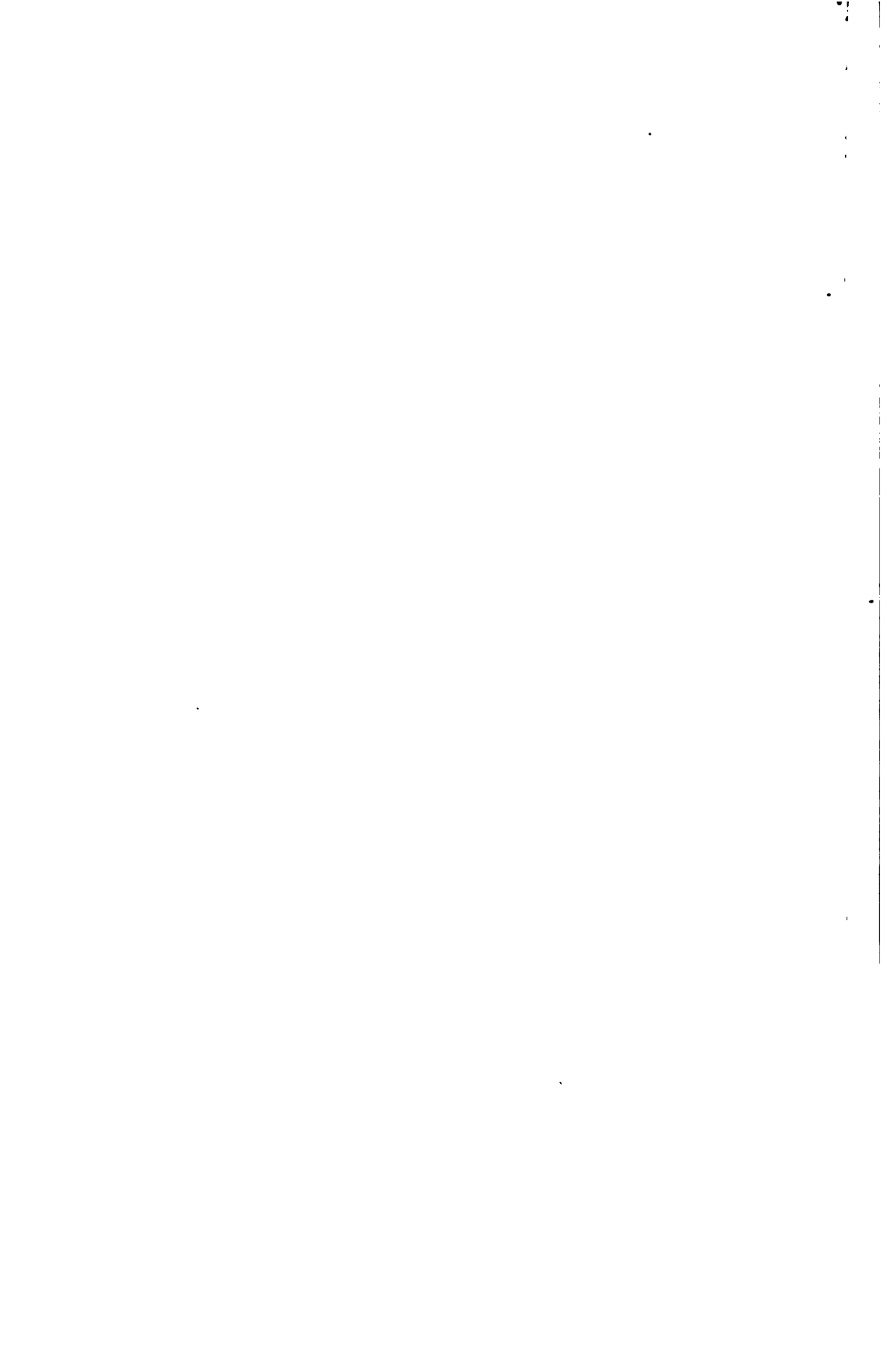

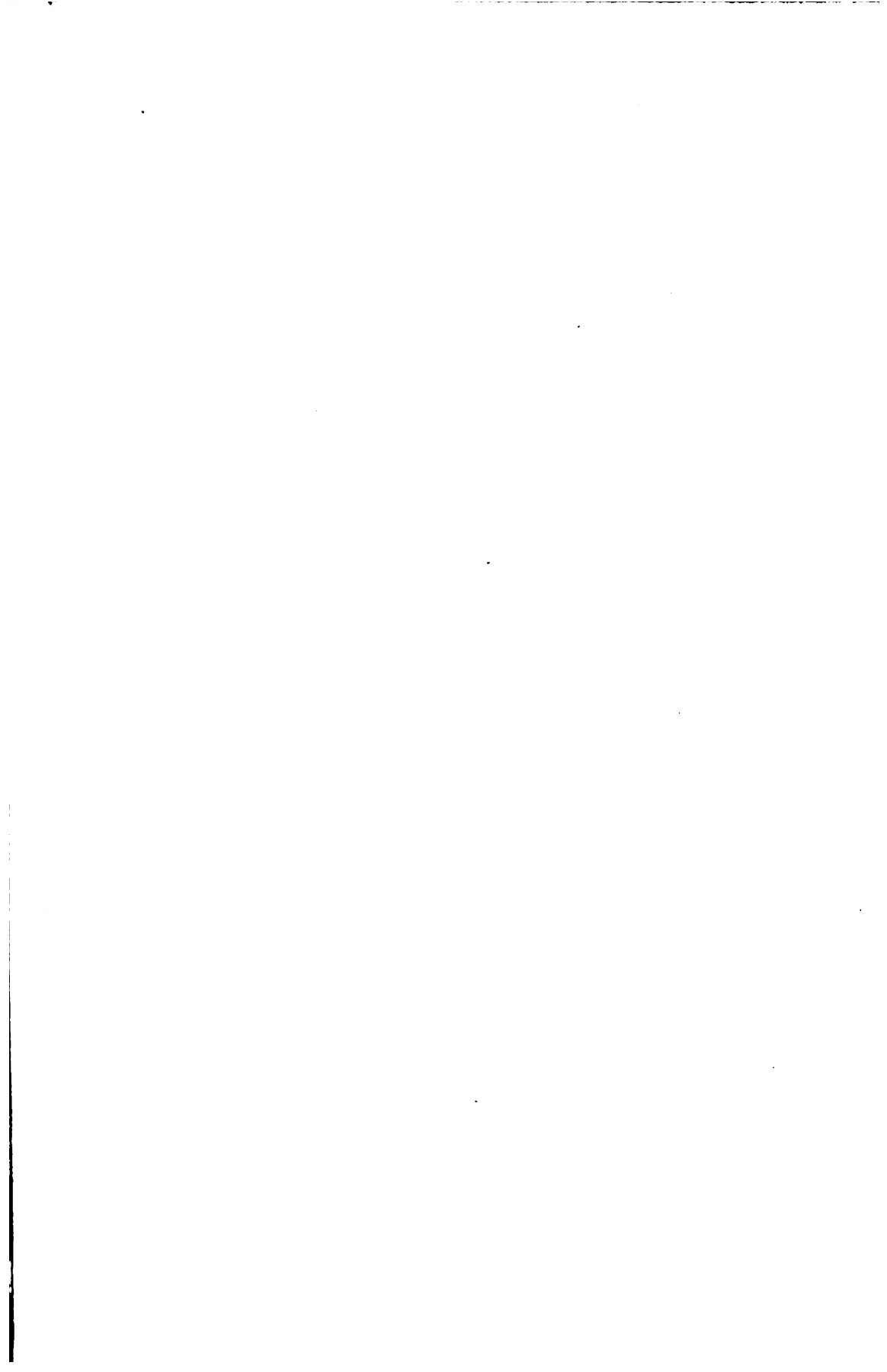

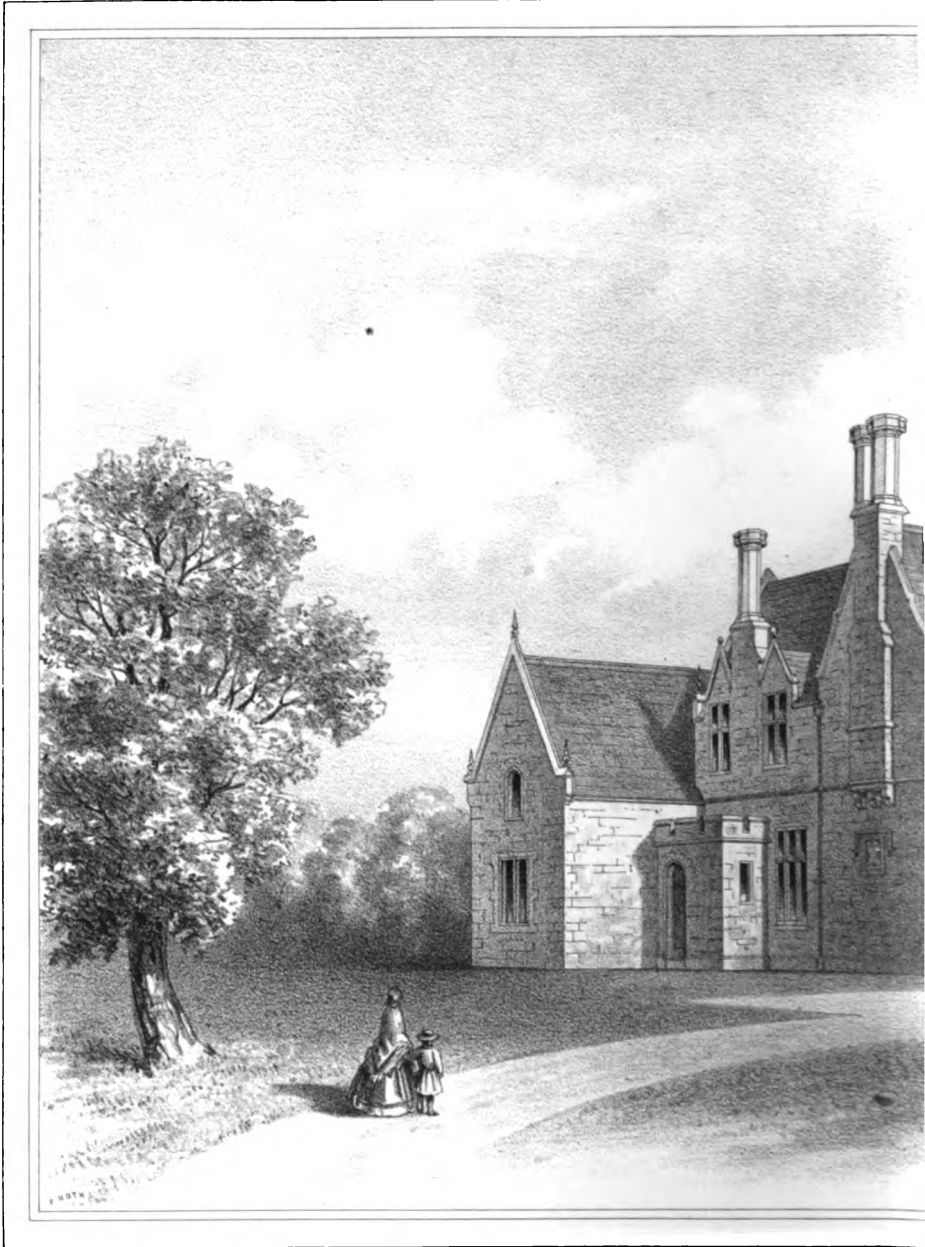



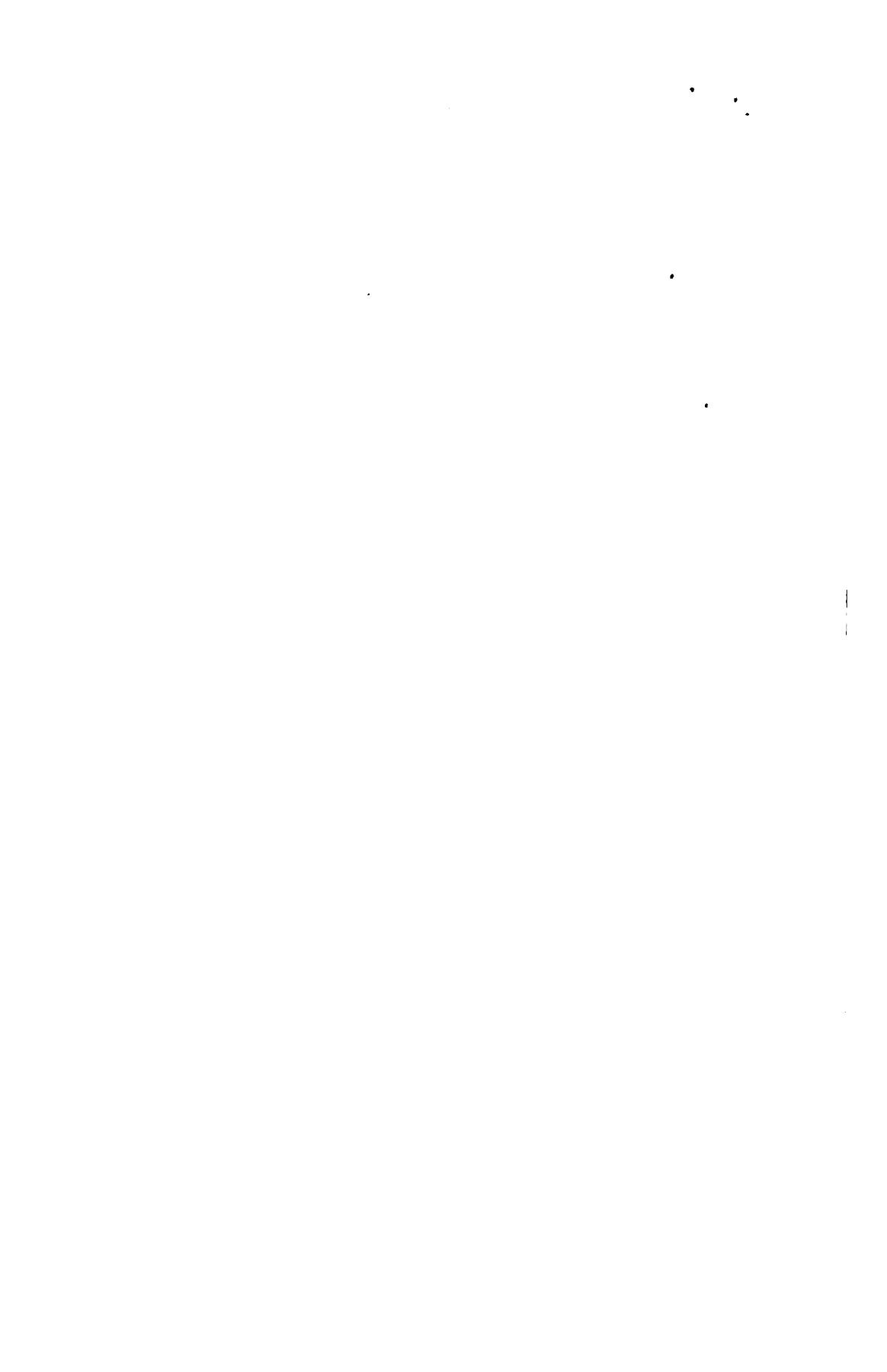

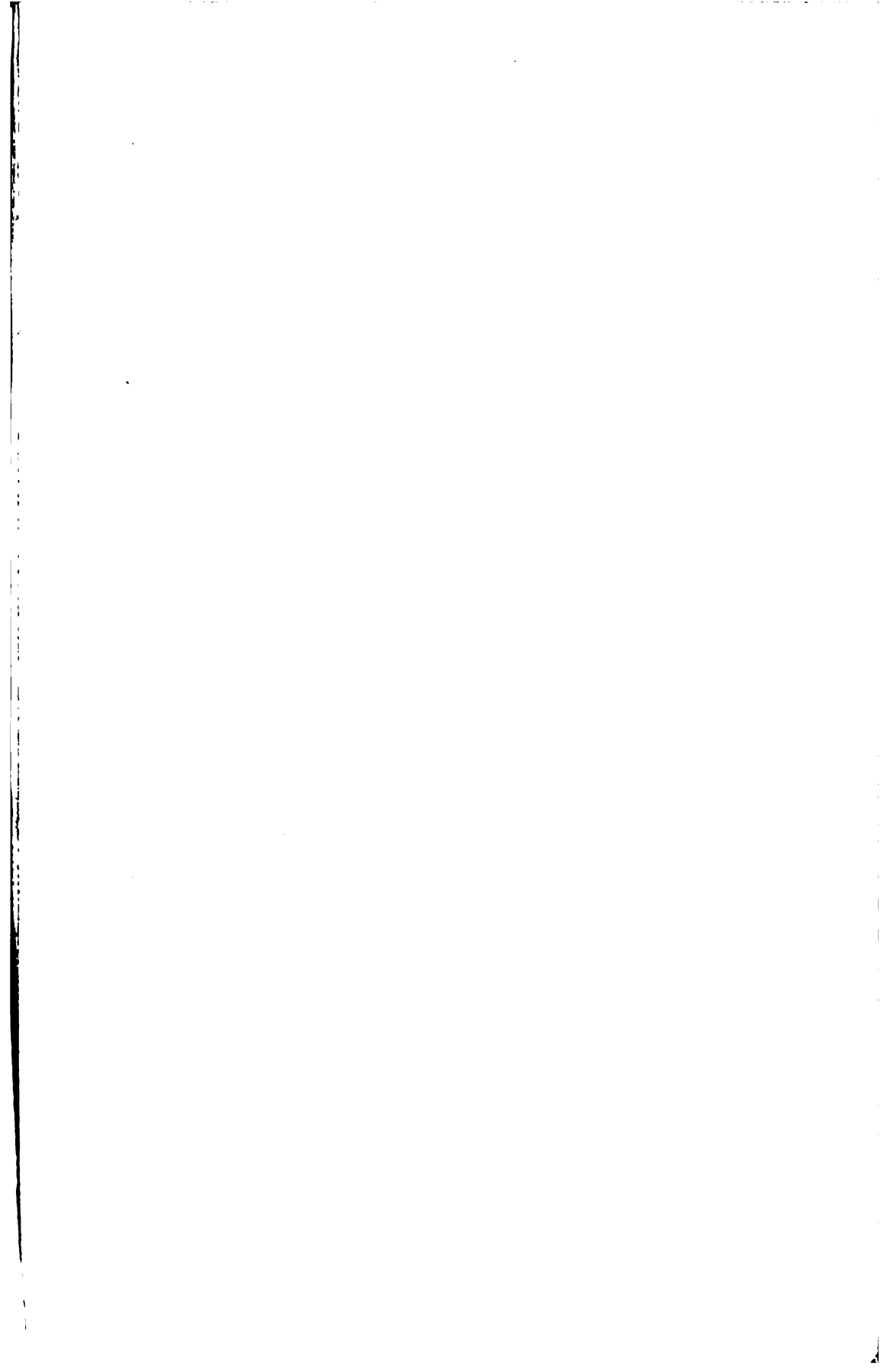

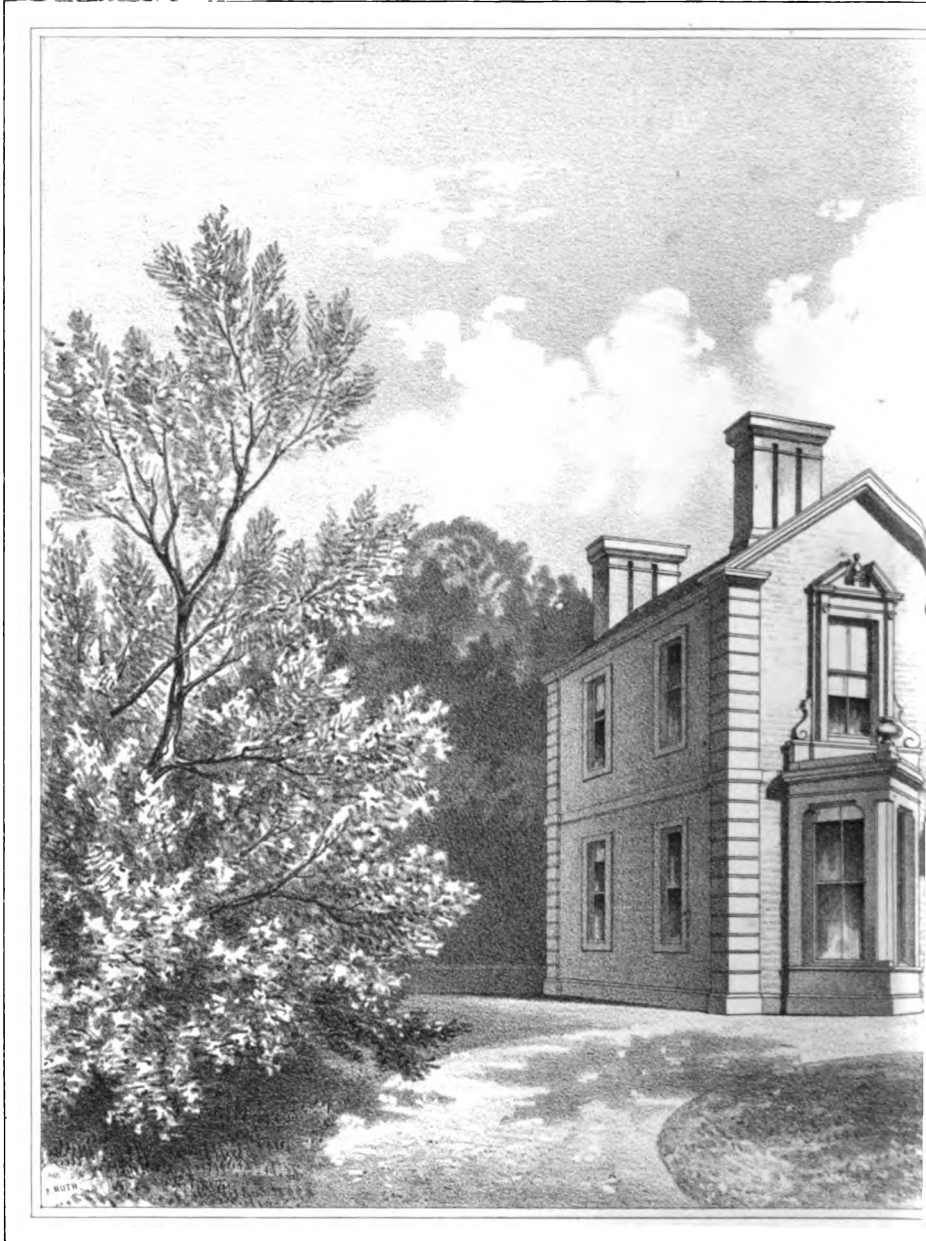

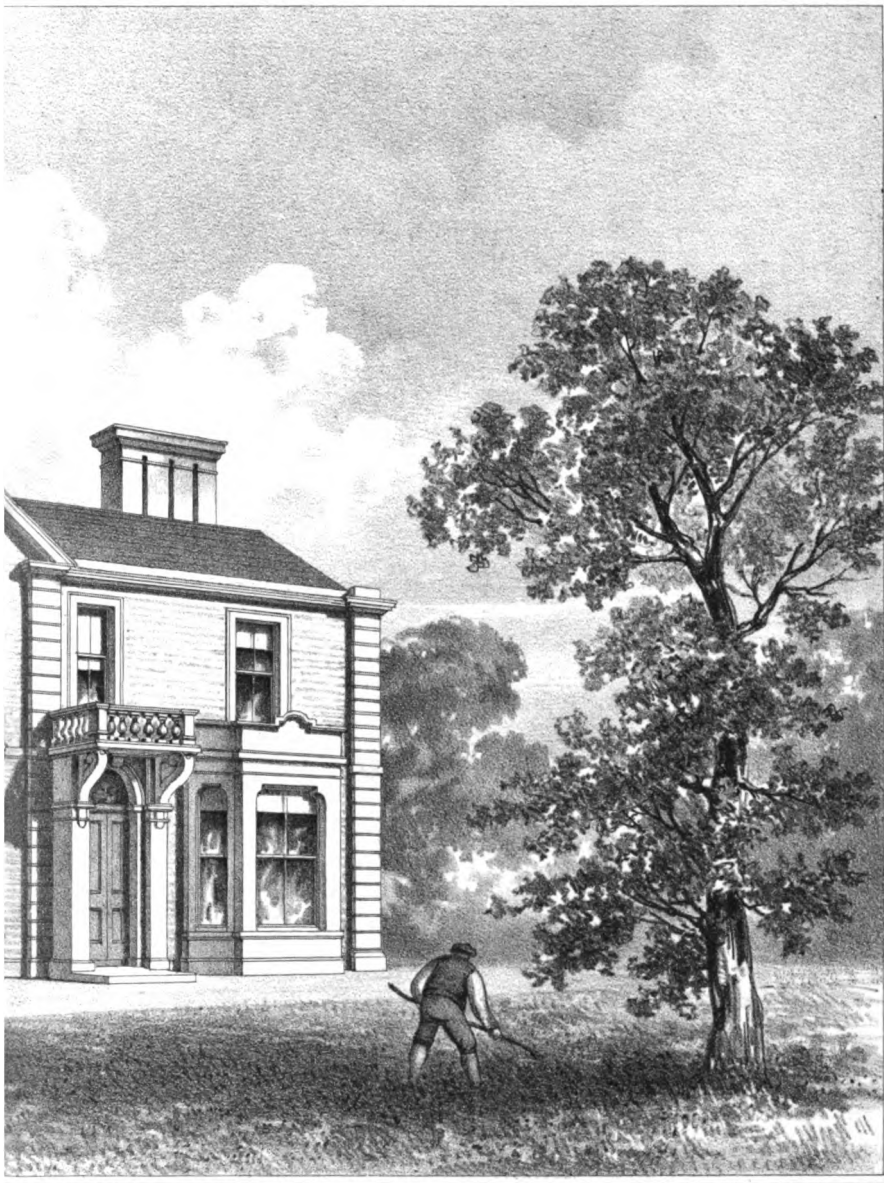

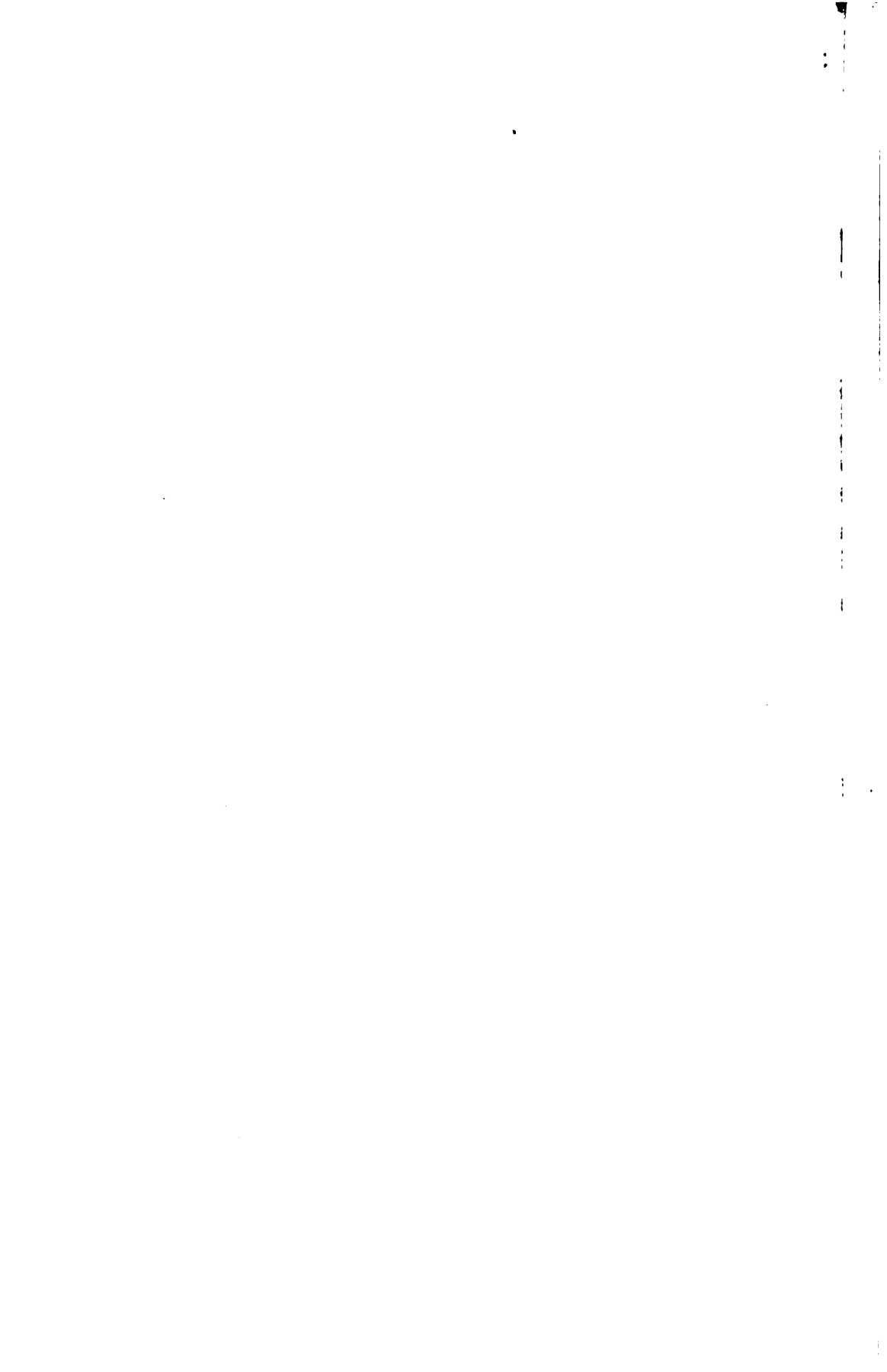

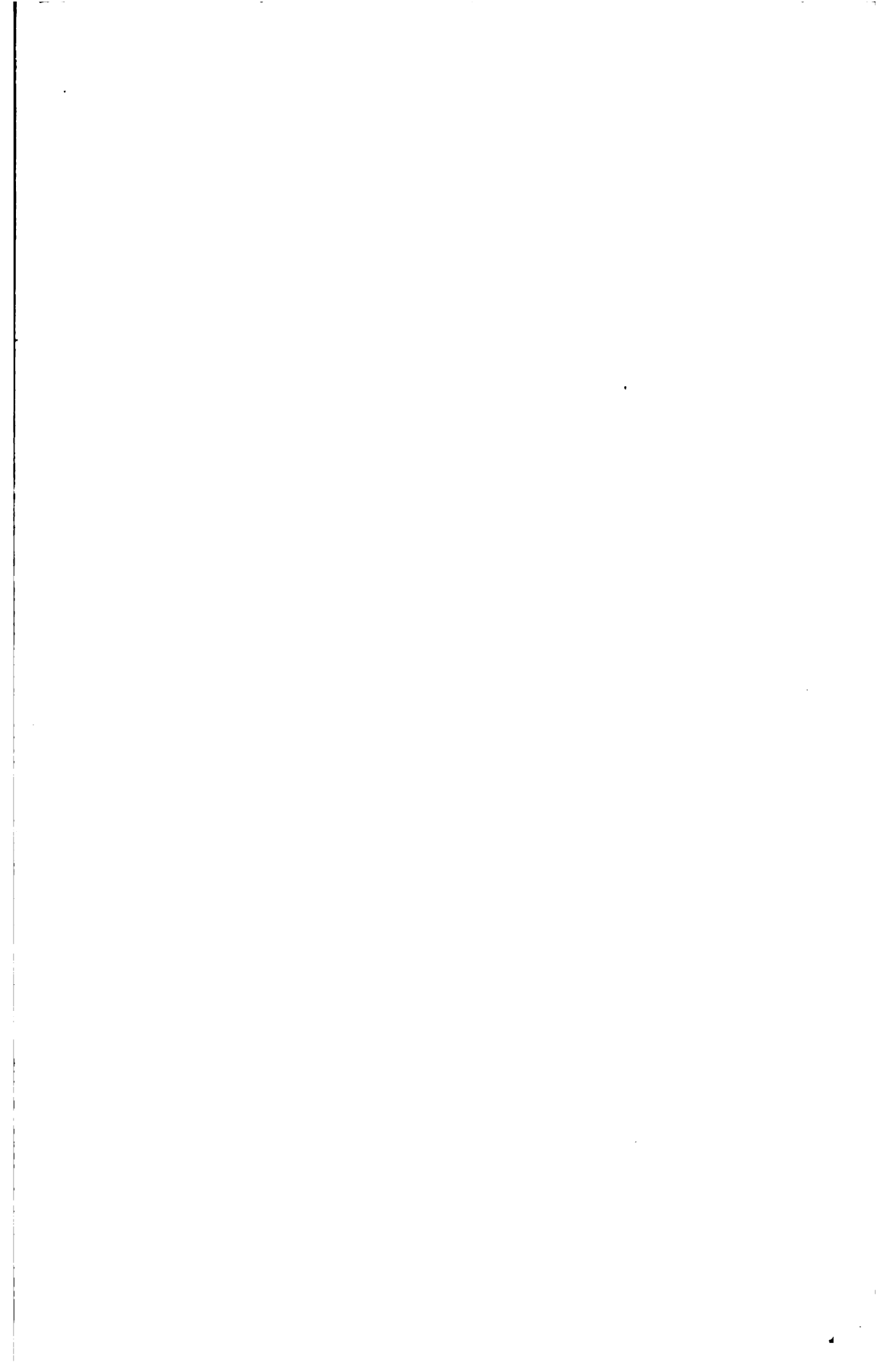

ALTERNATIVE DESIGN IN PERSPECTIVE





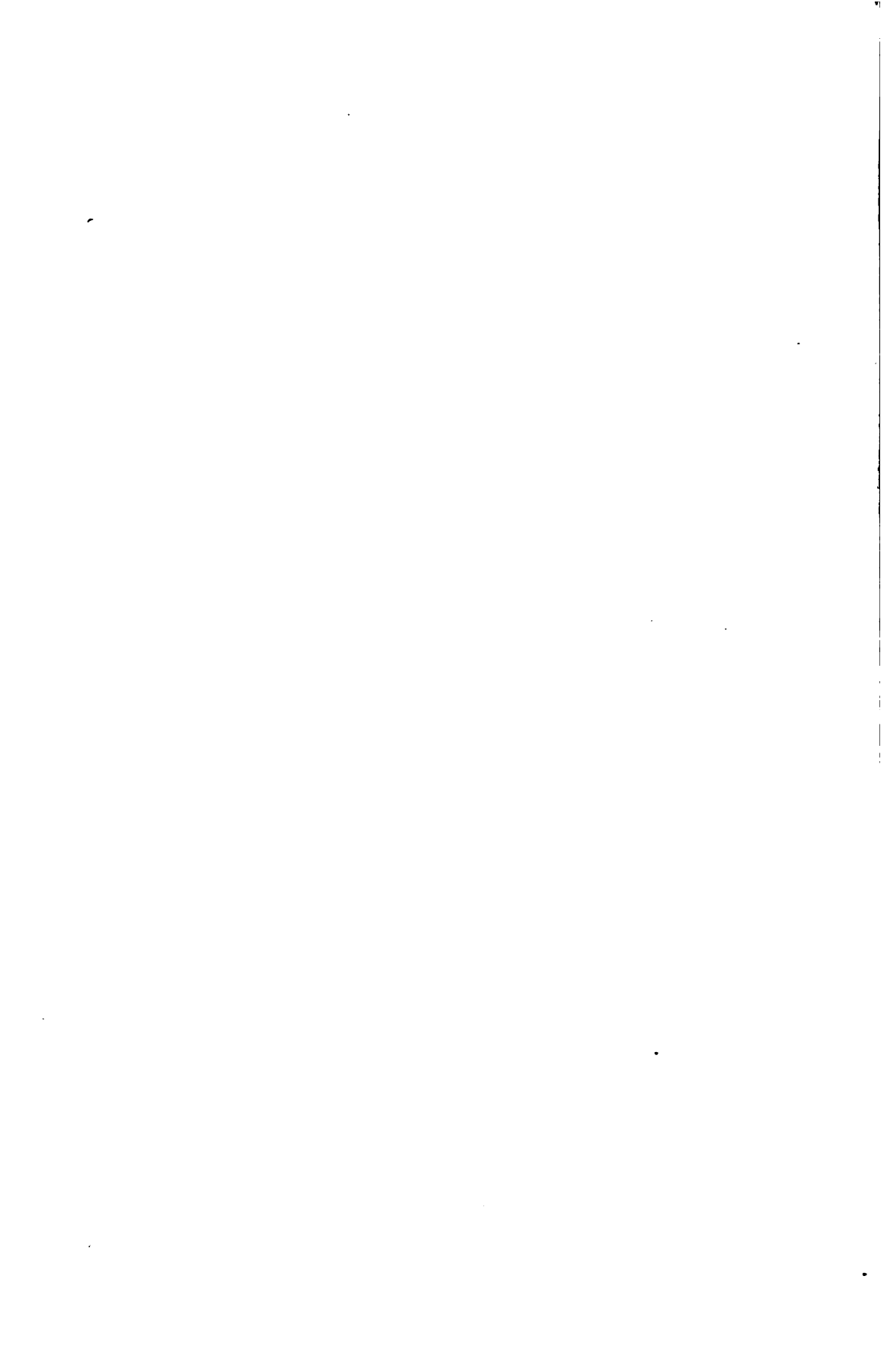

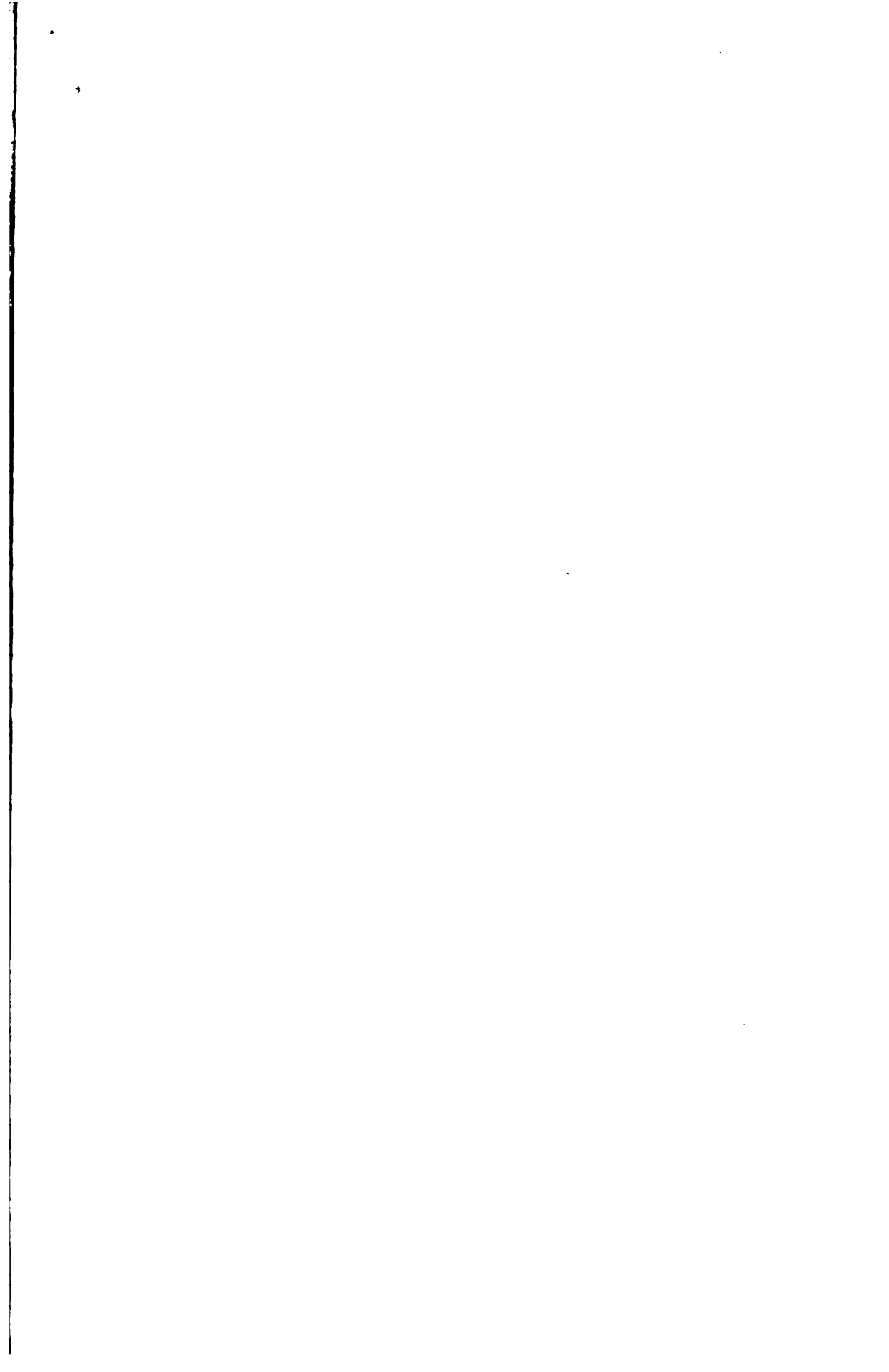

DESIGN IN PERSPECTIVE OF TWO-STORYED DOUBLE-D

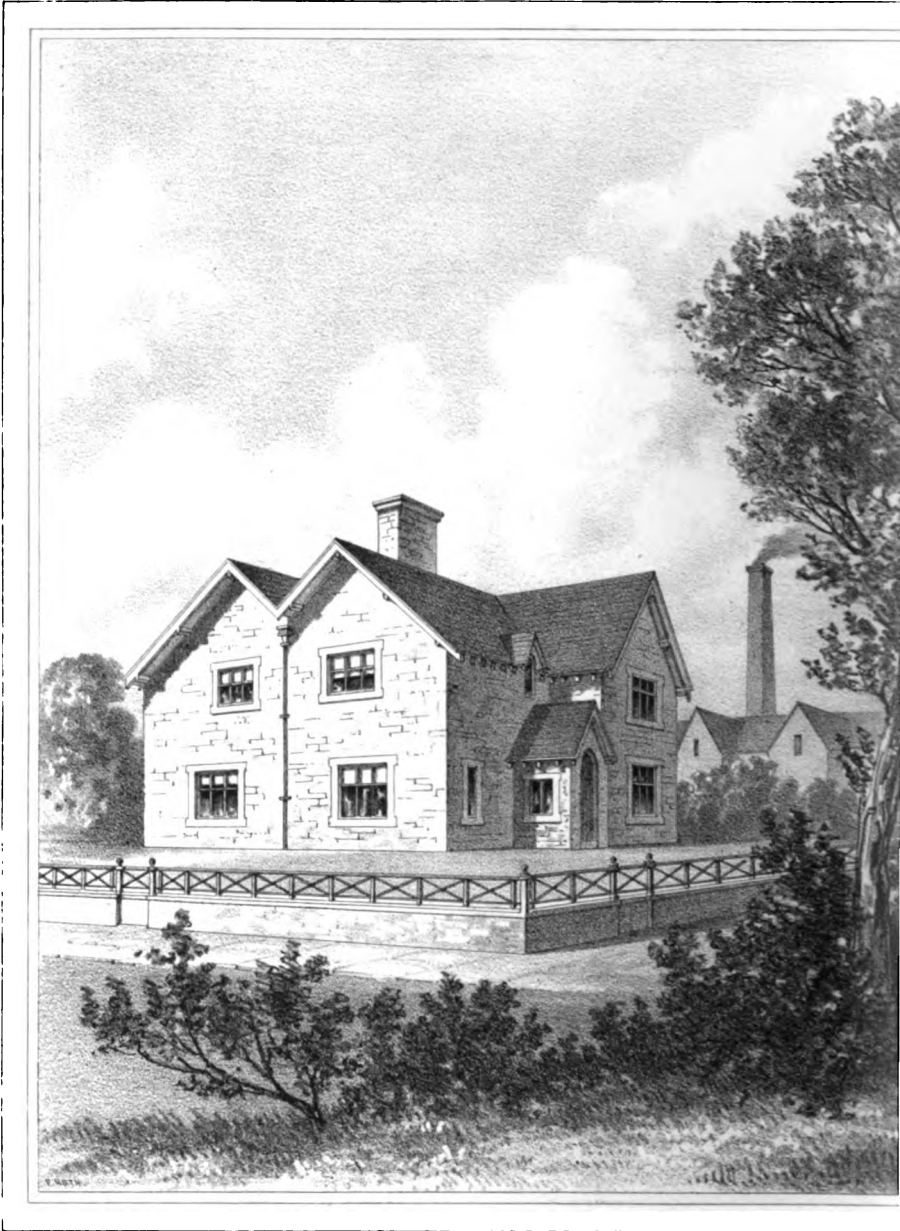

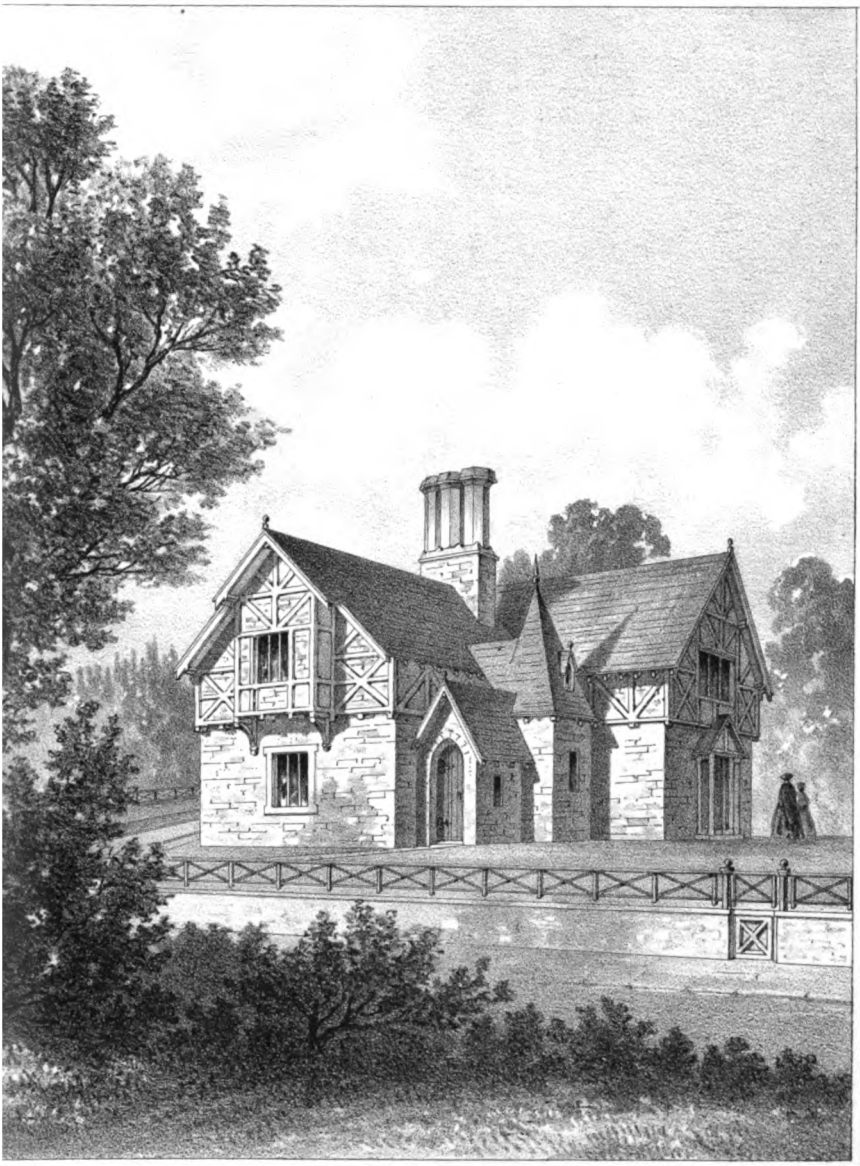

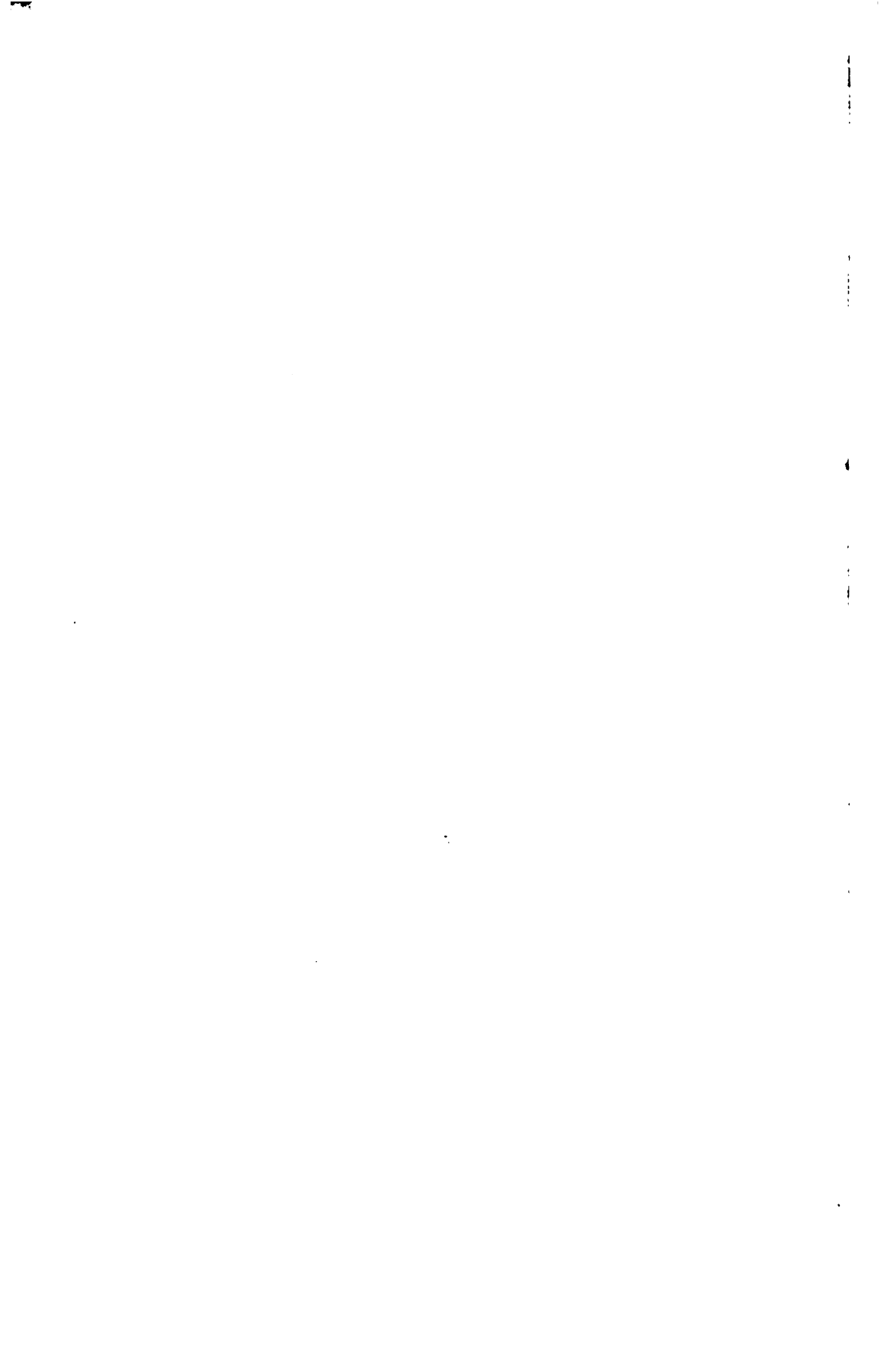



ALTERNATIVE DESIGN IN PERSPECTIVE FOR A
TWO STOREYED DETACHED COTTAGE. FIG. 87.



ALTERNATIVE DESIGN FOR A DETACHED COTTAGE. FIG. 82.

W. K. M. Yerkes Litho. Edin.

COMPANION VOLUME TO THE BOOK OF THE FARM.

THE BOOK
OF
FARM IMPLEMENTS AND MACHINES.

BY
JAMES SLIGHT AND ROBERT SCOTT BURN,
ENGINEERS.

Edited by
HENRY STEPHENS, F.R.S.E.

Author of the "Book of the Farm," &c.

In One Volume, large octavo.

ILLUSTRATED WITH 836 ENGRAVINGS ON WOOD AND 39 ENGRAVINGS ON COPPER.

Prospectus.

THOSE who recollect the appearance of our Agricultural Implements and Machines at the commencement of this century, will have no hesitation in acknowledging the superiority they now present. Being made chiefly of wood, and without regard to its intrinsic strength and comparative bulk, the implements of that period seem clumsy and ill constructed. Now that iron is employed to a large extent, and in many cases entirely, in their construction, they are not only lighter in appearance, but more elegant in form and more efficient in use. Still, a close inspection, with a critical eye, will detect, in many of them, a larger quantity of material than is necessary for strength, and a greater violation of mechanical principles, in the construction of their component parts, than their general elegance of form would indicate. It cannot be doubted that a perfect knowledge of the strength of materials and of the principles of mechanics on the part of our agricultural machinists, would produce all the existing implements and machines, and invent others much lighter in weight and simpler in construction, and therefore better adapted for the particular purposes for which they are designed. If the same degree of mechanical skill that is employed in the construction of manufacturing machinery were transferred to that appertaining to Agriculture, implements would soon become more perfect in every respect than they are. It is not, however, intended to be asserted that machines for the purposes of agriculture can be as easily perfected by any amount of mechanical skill as those used in manufactures may be; because the soil and its crops, being much more crude, unsteady, and unequal, are worse to deal with than the materials prepared for manufactures. The very distinction, indeed, which is generally made while treating of agricultural mechanism—namely, "implements and machines"—conveys in some measure this important truth. A *machine* operating upon a substance which varies little from its normal condition, may be constructed so as to be nearly in all things self-acting, requiring

from man little more attention than is necessary to supply it with the material which it is designed to operate upon. An *implement*, on the contrary, required in an agricultural operation, may, and often does, demand the exercise of mind and skill on the part of its worker, to enable it to meet the peculiarities of a soil or a crop constantly varying in character. Still it seems beyond all doubt that if the scientific truth in designing, and the workmanlike skill in executing and fitting together of manufacturing, could be transferred, as far as actually available, to agricultural mechanism, of whatever kind or class, a higher state of efficiency, both in construction and operation, would be soon attained. At the same time, it may be safely admitted that this transference has to a great extent been carried out. To ignore the improvements both in design and construction which have been effected during the last ten or fifteen years in many of our machines and implements, would be injustice to those eminent agricultural-implement makers throughout the kingdom by whose skill these improvements have been brought about; and would also convey an entirely erroneous notion of the high state of excellence to which agricultural machinery has now attained.

A superior mode of culture, in deep pulverisation of the soil, in finer treatment of its surface, in more certain and convenient modes of depositing manures and seeds, and in improved methods of securing crops, has led to a large increase of suitable machines being contrived for those purposes; and the rivalry created by the establishment of large manufactories of implements in England, giving a stimulus to their manufacture which did not exist before, has no doubt greatly tended to increase their number beyond the mere demand occasioned by superior culture, as well as to improve their construction and workmanship.

Agricultural implements and machines having thus increased in number and risen in importance from the causes which have just been indicated, the time seems to have arrived when a consideration, commensurate with their importance and utility, should be bestowed upon the principles of their construction; and such a consideration, it is conceived, can only be given in a work specially devoted to the elucidation of those principles. Descriptions of implements have at all times formed part of works on general agriculture; but hitherto no work in the English language has been entirely assigned to their discussion. It is the object of the "BOOK OF FARM IMPLEMENTS AND MACHINES" to supply that desideratum in the agricultural literature of Great Britain.

It is not, however, intended that all the existing implements and machines should be passed in review before the reader, as if under a critical examination of their mechanical construction; for, setting aside the arrogance of such a proceeding, it would be unfair to implement-makers to institute what could not but be deemed an invidious comparison betwixt their respective manufactures. The true objects of the Work will, the authors conceive, be better accomplished through its enunciating the rules by which the strength of materials employed in the making of implements may be rightly estimated, and the principles upon which they ought to be constructed, in order to their executing the largest expected amount of good work with the least expenditure of power.

Such a Work, it is believed, can only be produced by a combination of mind. A knowledge of general mechanical principles, a facility of mechanical representation, an aptitude for mechanical description, and a practical experience of the use of the implements at work, are all requisite in order to bring even the simplest implement vividly before the reader.

With what success this combination has been attained, the work itself must show. The statement, however, may be permitted, that in the selection of subjects for illustration and description, in the preparation of the drawings and the execution of the engravings, every care has been bestowed to render it a trustworthy and practically useful authority on agricultural mechanism.

LIST OF WORKS
ON
AGRICULTURE AND RURAL AFFAIRS

PUBLISHED BY

William Blackwood & Sons,

EDINBURGH & LONDON.

In Two Volumes Royal 8vo, price £3 half-bound,

THE BOOK OF THE FARM.

DETAILING THE LABOURS OF THE FARMER, FARM-STEWARD, PLOUGHMAN, SHEPHERD,
HEDGER, CATTLE-MAN, FIELD-WORKER, AND DAIRY-MAID; AND FORMING A
SAFE MONITOR FOR STUDENTS IN PRACTICAL AGRICULTURE.

By **HENRY STEPHENS, F.R.S.E.**

Corresponding Member of the Société Royale et Centrale d'Agriculture of France,
and of the Royal Agricultural Society of Galicia.

A NEW EDITION.

Illustrated with **PORTRAITS OF ANIMALS** painted from the life, engraved on Steel by **THOMAS LANDSEER** and others; and with **600 ENGRAVINGS ON WOOD** by **BRANSTON**, representing the principal Field Operations, Implements, and Animals treated of in the Work.

SUBJECTS TREATED OF IN THE BOOK OF THE FARM.

INITIATION.

On the best of the existing methods for acquiring a thorough knowledge of Practical Husbandry. Difficulties the Pupil has to encounter in Learning Practical Husbandry, and on the means of overcoming them. The different kinds of Farming, and on selecting the best. On the Branches of Science most applicable to Agriculture. Persons required to conduct and execute the labour of the Farm. On the Institutions of Education best suited to Agricultural Students. On the evils attending the neglect of Landowners and others to learn Practical Agriculture. On observing the Details and recording the Facts of Farming by the Agricultural Student.

PRACTICE.

WINTER.

Summary of the Field-Operations and of the Weather in Winter. Plough, Swing-Trees, and Plough-Harness. Ploughing and Ploughing-Matches. Ploughing different forms of Ridges. Ploughing Stubble and Lee Ground. Occupation of the Steading in Winter. Pulling and Storing Turnips, Mangold-Wurzel, Carrots, Parsnips, and Cabbage, for Consumption in Winter. Feeding of Sheep on Turnips in Winter. Accommodation afforded to Cattle in Winter by the Steading. Rearing and Fattening of Cattle on Turnips in Winter. Varieties of Turnips cultivated. Construction of Stables for Farm-Horses. Treatment of Farm-Horses in Winter. Treatment of the Farmer's Saddle and Harness Horse in Winter. Fattening of Swine in Winter. Treatment of Fowls in Winter. Rationale of the Feeding of Animals. Accommodation of the Grain Crops in the Steading. Threshing and Winnowing of Grain. Forming of Dung-hills and Composts in Winter. Liquid-Manure, and the Construction of Liquid-Manure Tanks and Carts. Sea-Weed as Manure. Gaulting or Claying the Soil.

[Continued.]

THE BOOK OF THE FARM—Continued.

SPRING.

Summary of the Field-Operations and of the Weather in Spring. Advantages of having Field-work always in a state of Forwardness. Calving of Cows. Milking of Cows. Rearing of Calves. Sowing of Spring Wheat. Drilling up of Land. Sowing of Oats, Beans, Peas, Tares. Rolling of Land. Lucerne. Transplanting of Turnip-bulbs for producing Seed. Sainfoin. Lambing of Ewes. Cross-Ploughing Land. Ribbing Land for the Seed-Furrow. Sowing of Grass-Seed. Sowing of Barley. Turning of Dunghills. Planting of Potatoes. Paring and burning the Surface. Farrowing of Sows. Hatching of Fowls.

SUMMER.

Summary of the Field-Operations and of the Weather in Summer. On the Hay given to Farm-horses. Sowing and Summer Treatment of Flax—Hemp—Hops—Turnips—Kohl-rabi—the Cabbage—Mangold-Wurzel—the Carrot—Parsnips—Rape—Buck-wheat—Sunflower—Madia—and Maize. The Rationale of the Germination of Seeds. On Sowing Broadcast, Drilled and Dibbled—Thick and Thin—and at Different Depths. Repairing the Fences of Pasture-fields. Disposal of the Fat Sheep—and Fat Cattle. Mares Foaling—Treatment of Bulls in Summer. Pasturing of Sheep and Cattle in Summer. Weaning of Calves. Pasturing of Farm-horses in Summer. Soiling of Stock on Forage Plants. Washing and Shearing of Sheep. Rolling of Fleeces, and on the Quality of Wool. Summer Culture of Beans and Pease. Weaning of Lambs. Drafting of Ewes and Gimmers. Making of Sheep—Hay-making. Summer Culture of Wheat—Barley—Oats—Rye—and Potatoes. Summer Fallow. Reaping of Turnip-seed. Making Butter and Cheese.

AUTUMN.

Summary of the Field-Operations and of the Weather in Autumn. Sowing of the Stone-Turnip, and on the Sowing of Turnip for Seed. Sowing of Winter Tares—Rape—Crimson Clover—Bokhara Clover—Red Clover for Seed—and Italian Rye-grass. Picking and Drying of Hops. Sowing of Winter Beans. Pulling, Steeping, and Drying of Flax and Hemp. Reaping Wheat, Barley, Oats, Rye, Beans, Pease, and Tares, when grown for Seed. Carrying and Stacking of Wheat, Barley, Oats, Beans, and Pease. The Common Jerusalem Artichoke. Reaping Buck-wheat, Sunflower, and Maize. Birds destructive to the Grain Crops. Putting the Tups to the Ewes. Bathing and Smearing of Sheep. Lifting Potatoes. Storing Potatoes. Sowing Wheat, Barley, and Pease in Autumn. Sowing several varieties of Grain together. Planting Potatoes in Autumn. The effects of Special Manures. Rotation of Crops. Fertility of Soils. Disposal of the Fat Pigs. Management of Fowls. Animals destructive to Poultry.

REALISATION.

Differences in the Physical Geography of Farms. Climate and its Effects. The Judging of Land. Estimating the Rent of a Farm. The Mode of Offering for a Farm. Negotiating the Covenants of the Lease. Entering to a Farm. The Stocking of a Farm. Choosing the Site, on Building, and on the Expenses of Erecting the Steading. The Farm-house. Cottages for Farm-servants. Insurance against Fire and Disease. The Principles of Enclosure, and on Shelter. The Planting and Rearing of Thorn Hedges. The Building of Stone Fences. Wire Fences. Embanking against Rivulets. Construction of Field Gates. Draining of Land. Improving Waste Land. Trench and Subsoil Ploughing. Liming of Land. Forming Water-meadows. Irrigation. Treatment of Draught-stallions. Breaking-in of young Draught-horses. Breaking-in young Saddle-horses. Training and working the Shepherd's Dog. Slaughtering Oxen, Sheep, and Pigs. The points to be aimed at in Breeding the most perfect forms in Live Stock. Description of the Animals whose Portraits are given in the Plates. Account of some other Breeds of Cattle and Sheep. The Principles of Breeding. Selection of Parents in Breeding. Breeding in-and-in. Crossing. Hiring of Farm-servants. Wages of Farm-servants. The Farm Smith, Joiner, and Saddler. The care due to the Implements. Making Experiments on the Farm. Corn-markets. Farm Book-keeping. Concluding exhortations to the young Farmer. Index.

"The best practical book I have ever met with."—*Professor Johnston*.

"We assure agricultural students that they will derive both pleasure and profit from a diligent perusal of this clear directory to rural labour. . . . We have thoroughly examined these volumes; but to give a full notice of their varied and valuable contents would occupy a larger space than we can conveniently devote to their discussion; we therefore, in general terms, commend them to the careful study of every young man who wishes to become a good practical farmer."—*Times*.

"A work, the excellence of which is too well known to need any remarks of ours."—*Farmers' Magazine*.

"Exhibiting in every page the combination of large experience, extensive observation, and a cultivated mind. . . . One of the most unique and valuable works to be found within the range of agricultural literature."—*Bell's Messenger*.

"We know of no single agricultural work to be compared with this. . . . Nothing can be more disinterestedly earnest than our recommendation of the 'Book of the Farm.'"—*Bell's Life*.

"One of the completest works on agriculture of which our literature can boast."—*Agricultural Gazette*.

A new Edition, enlarged, with Index. Crown Octavo, price 3s. 6d.

A HANDY BOOK ON PROPERTY LAW.

By **LORD ST LEONARDS.**

"Less than 200 pages serve to arm us with the ordinary precautions to which we should attend in selling, buying, mortgaging, leasing, settling, and devising estates. We are informed of our relations to our property, to our wives and children, and of our liabilities as trustees or executors, in a little book for the million, a book which the author tenders to the *profanum vulgus* as even capable of 'beguiling a few hours in a railway carriage.'"—*Times*.

In One Volume, large Octavo, uniform with the "Book of the Farm," price £2, 2s.

THE BOOK

OF

FARM IMPLEMENTS AND MACHINES.

By **J. SLIGHT** and **R. SCOTT BURN**, Engineers.

Edited by **HENRY STEPHENS**, F.R.S.E., Author of the "Book of the Farm," &c.

CONTENTS.

Book First.—Dissertations elucidating the scientific principles which regulate the choice of materials and construction of the Machines and Implements, and the structures connected with them, on the Farm—Materials employed in Construction—Principles of Construction—Practice of Construction—Friction and Force.

Book Second.—On the practical construction, properties, and uses of Farm Implements and Machines.

IMPLEMENTS AND MACHINES CONNECTED WITH THE CULTIVATION OF THE SOIL.

Ploughs, including Steam-Ploughs, Trench and Subsoil Ploughs. Grubbers, Scarifiers, Cultivators. Harrows, Land-rollers, Clod-crushers, Press-wheels. Horse-hoes. Sowing Machines and Manure-distributors. Manual Implements connected with the Cultivation of the Soil.

IMPLEMENTS AND MACHINES CONNECTED WITH THE PRODUCTS OF THE SOIL.

Hay-making Machines. Corn-reaping Machines. Barn Machines, including Threshing-Machines, Fixed and Portable; Winnowing-Machines, Hummellers, Corn-cleaning Machines, and Weighing-Machines. Carts—Waggons—Cart Steelyards. Straw-Cutters. Turnip-Slicers, Root-Graters, and Root-Washers. Corn-Bruisers—Bean-Mills—Oil-Cake Breaker. Boiling and Steaming Apparatus. Dairy Apparatus. Manual Implements connected with the Products of the Soil, as Scythes, Forks, Barn Implements, and Dairy Utensils. Machines not directly connected with any of the above Ten Sections, but useful on the Farm.

MOVING POWERS OF THE FARM.

Horse-Power. Water-Power. Steam-Power. Wind-Power.

ARRANGEMENTS OF MACHINES IN THE STEADING.

Arrangement of Machines in the Ground-Floor of the Steading. Arrangement of Machines in the Upper Floor of the Steading. Arrangement of Small Machines with the Moving Power in the Steading. The Preservation of Implements and Machines in the Steading.

40 Engravings on Steel—836 Engravings on Wood.

"This magnificent work must excite the admiration of every practical agriculturist. It forms at once a complete history of the progress made up to this day in the adaptation of mechanism to farming operations, and a brilliant analysis of the value of each additional step on the road of improvement to the farmer. . . . It is a work which, like its great predecessor, the *Book of the Farm*, supplies an obvious want, and does so to such perfection as to render any other work on the subject, for some time to come, a superfluity."—*Sussex Agricultural Express*.

Subscription, Twelve Shillings per Annum.—Published Quarterly.

JOURNAL OF AGRICULTURE,

AND THE

TRANSACTIONS OF THE HIGHLAND AND AGRICULTURAL SOCIETY OF SCOTLAND.

A few Complete Sets from the commencement of the Series are for sale—viz.,

OLD SERIES, 1828 to 1843, 21 vols., cloth, £3, 3s.

NEW SERIES, 1843 to 1855, 10 vols., cloth, £2, 12s. 6d.

Preparing for Publication,

THE BOOK OF FARM-BUILDINGS:

THEIR ARRANGEMENT AND CONSTRUCTION.

By **HENRY STEPHENS, F.R.S.E.**

Author of the "Book of the Farm,"

AND

ROBERT SCOTT BURN, Engineer.

In One Volume, Royal Octavo, uniform with the "Book of the Farm," and the "Book of Farm Implements and Machines." Illustrated with numerous Plates and Engravings.

THE object of this Work is to indicate, in the most distinct manner, that arrangement of the Apartments in Farm-Steadings best adapted for each of the methods of Farming practised in the kingdom. It may surprise those unacquainted with Agriculture to learn that there are various modes of Farming. There are not fewer than Five distinct systems of Farming pursued in this country. In view, then, of this variety in modes of practice, it will be obvious that no single arrangement, however apparently complete and well conceived, can meet the requirements of all circumstances of practice, or be calculated to secure the strictest economy of labour. As the manufactures of wool, cotton, silk, or flax, require arrangements of premises suited to the peculiarities of the material to be operated upon, so, in like manner, do the peculiarities of "dairy," "pastoral," or of "mixed" husbandry, demand arrangements calculated to aid their practice. A very slight consideration indeed of this subject will suffice to show that the accommodation required on a farm solely devoted to the rearing of live-stock, should not be the same as that required for one which is cultivated entirely for the raising of corn.

But although the arrangement of the Apartments of Steadings should vary in accordance with the kind of Farming, yet every arrangement suited to the various modes of Farming may be founded upon such a general principle as shall insure the greatest convenience and economy in the use of each arrangement.

The Authors are quite aware of the difficult task they have undertaken in order to attain the important object they have thus enunciated; but, nevertheless, they flatter themselves that the object has been attained in this Work, and that for the first time by any writer who has hitherto attempted to illustrate Farm-Buildings.

Without pledging themselves to any specific amount of matter, the Authors may be permitted the statement that, in addition to Plans expressly prepared to working scale, to elucidate the "Principle" of arrangement of Steadings suited to all varieties of Farming, and to ample working details of construction and fittings of apartments, it is proposed to give such Plans of Farm-Houses, and of Bailiff's and Labourers' Cottages, as shall exhibit details of convenient arrangements and fittings. The construction of Bridges, Embankments, Culverts, Dams, &c.—those "outlying buildings" of the Farm—will also receive due attention. It is thus the aim of the Authors to make the Work a trustworthy and practically useful authority in all matters connected with the Buildings of the Farm.

In Small Octavo, price 5s.

**THE LARCH DISEASE, AND THE PRESENT
CONDITION OF THE LARCH PLANTATIONS IN GREAT BRITAIN.** By
CHARLES M'INTOSH, Author of the "Book of the Garden," &c.

FARM ACCOUNTS.

In royal 8vo, bound in cloth, price 2s. 6d.,

A PRACTICAL SYSTEM OF FARM BOOK-KEEPING;

BEING THAT RECOMMENDED IN "THE BOOK OF THE FARM,"

BY HENRY STEPHENS, F.R.S.E. :

ALSO,

SEVEN FOLIO ACCOUNT-BOOKS, constructed in accordance with the system, Printed and Ruled throughout, and bound in separate Volumes; the whole being specially adapted for keeping, by an easy and accurate method, an account of all the Transactions of the Farm.

THE ACCOUNT-BOOKS CONSIST OF—

I. CASH-BOOK—Ruled with double money-columns for *Dr.* and *Cr.*, showing the Cash received for produce sold off the Farm, the money paid on account of the Farm; and all general Cash and Banking transactions. Price 2s. 6d.

II. LEDGER—Ruled with single money-columns, *Dr.* and *Cr.* on separate pages, containing Accounts with every Person or Company having transactions with the Farm. Price 6s.

III. FARM ACCOUNT—Contains the Cash received for all the Produce sold off the Farm, and the Cash paid for all the commodities required for the Farm, and these alone. Thus the Balance between the *Dr.* and *Cr.* sides of the Farm Account, at the end of the Agricultural Year, shows whether the farm has returned or consumed the largest amount of Cash. Price 2s. 6d.

IV. CORN ACCOUNT—Comprises all accounts and statements connected with—1. Wheat; 2. Barley; 3. Oats; 4. Straw; 5. Potatoes; 6. Turnips, Mangold-Wurzel, Carrots and Parsnips. These accounts show all the particulars connected with the different species of produce—the time when grain is thrashed—the parties to whom it has been sold—the uses which have been made of it on the Farm—the

Balance of Grain on hand at any time in the Corn-barn and Granary—the weight of the Grain, and the prices obtained for it. Price 3s. 6d.

V. LIVE-STOCK ACCOUNT—Consists of Accounts relating to—1. Cattle; 2. Sheep; 3. Pigs; 4. Horses; showing the particulars of every species of Live-Stock, the disposal of them, the cash paid and the prices obtained for them, and the numbers on hand at different periods. Price 3s.

VI. LABOUR ACCOUNT-BOOK—Contains, 1. Labour Journal; 2. Labour Account,—the former for showing the Labourers' names, the days of the week on which they have been employed, and a register of the number of work-days in each week; the latter forming a summary of the amount of all the manual labour executed on the Farm in the course of a-year, including the Harvest Expenses. Price 3s.

VII. FIELD-WORKERS' ACCOUNT—This is a simple form of keeping the Labour-Account, enabling the total number of Days in which work has been done for half a year to be summed up and calculated at the rate of wages per day, when the gross amount of the half-year's earnings is brought out distinctly. Price 2s. 6d.

The Account-Books are sold separately, the complete Set, in Eight Volumes, sells at 24s. 6d.

LABOUR ACCOUNT OF THE ESTATE.

This form of Labour Account is specially constructed for the use of Country Gentlemen, whether residing at home or abroad, who require returns to be made to them of the species of work which daily engages the time of their labourers in whatever capacity, and whether male or female; that is, besides Labourers and Field-Workers, the form is as well adapted to Gardeners, Foresters, Hedgers, Road-makers, Quarriers, Miners, Game-keepers, and Dairymaids. Price 2s. 6d.

"We have no hesitation in saying, that of the many systems of keeping farm-accounts which are in vogue, there is not one which will bear comparison with that just issued by Messrs Blackwood, according to the recommendations of Mr Stephens, in his invaluable 'Book of the Farm.' The great characteristic of this system is its simplicity. When once the details are mastered, which it will take very little trouble to accomplish, it will be prized as the clearest method to show the profit and loss of business, and to prove how the soundest and surest calculations can be arrived at. We earnestly recommend a trial of the entire series of Books—they must be used as a whole to be thoroughly profitable; for we are convinced the verdict of our agricultural friends who make such a trial will speedily accord with our own—that they owe a deep debt of gratitude both to Mr Stephens and Messrs Blackwood for providing a method so complete and satisfactory to their hands."—*Bell's Messenger.*

ANNUAL PUBLICATION.

Foolscap Octavo, price 5s.

THE YEAR-BOOK OF AGRICULTURAL FACTS FOR 1860.

Edited by ROBERT SCOTT BURN.

"Next to keeping full and complete accounts, nothing is more useful to the farmer than to have an accurate record of facts and dates."—*Economist.*

THE object of the present work is to secure for the most useful of the "FACTS" scattered through the pages of the numerous Magazines and Journals—Home and Foreign—which are devoted exclusively or partially to the dissemination of information connected with the various branches of agriculture, a permanent and easily accessible record. It embraces, moreover, the most striking of the "FACTS" promulgated at the meetings of Farmers' Clubs, Agricultural Societies, &c. &c.; and which, even when made public through the Agricultural Journals, are apt to be lost sight of, or cannot be conveniently and readily referred to, among the mass of other matter which these journals comprise.

Copies of the Volume for 1859 may still be had, price 5s.

Dedicated by permission to Her Majesty.

In Two large Volumes Royal Octavo, embellished with 1350 Engravings,

THE BOOK OF THE GARDEN.

By CHARLES M'INTOSH,

Formerly Curator of the Royal Gardens of his Majesty the King of the Belgians, and lately of those of his Grace the Duke of Buccleuch, at Dalkeith Palace.

The volumes are sold separately—viz.

VOL. I.—ON THE FORMATION OF GARDENS AND CONSTRUCTION OF GARDEN EDIFICES.
776 pages, and 1073 Engravings. £2, 10s.

VOL. II.—PRACTICAL GARDENING. 868 pages, and 279 Engravings. £1, 17s. 6d.

WORKS on Gardening have long been abundant, and the popularity of many of them has attested the general interest taken in this art, and the value of books as guides and instructors in it. None, perhaps, has enjoyed a wider or firmer reputation than the *Practical Gardening* of Mr M'Intosh, which was for many years recognised as the completest, most systematic, and most *practical* extant treatise on the art. A quarter of a century, however, has now elapsed since that work last received the revisions of the author; and in that time gardening, as a practical art, has undergone such advances and improvements, that a treatise, which might be most valuable in 1830, has ceased to be so in 1855. The *Book of the Garden* was accordingly resolved on, not merely to supersede the author's former, and now comparatively obsolete work, but designed to form for its art a text-book as full and complete as the *Book of the Farm* was for agriculture. The reception which the work has experienced from the press and the public has been more than sufficient to attest both the need of such a complete and systematic treatise on gardening in all its departments, and the degree to which Mr M'Intosh has filled up an existing blank.

The work is divided into two great sections, each occupying a volume—the first comprising the formation, arrangement, and laying out of gardens, and the construction of garden buildings; the second treating of the theory and practice of horticulture.

CONTENTS OF THE FIRST VOLUME.

INTRODUCTION.—GARDENING AS AN ART OF DESIGN AND TASTE, CONSIDERED AS REGARDS ITS ORIGIN, PROGRESS, AND PRESENT STATE.

CHAPTER I.—THE FORMATION AND ARRANGEMENT OF CULINARY AND FRUIT GARDENS IN GENERAL.—Section 1. Plan; 2. Extent; 3. Form; 4. Supply of Water; 5. Situation; 6. Soil; 7. Fruit-Tree Borders; 8. Principal Entrance; 9. Shelter; 10. Style.

CHAPTER II.—GARDEN WALLS.—Section 1. Aspect of Walls; 2. Foundations of Walls; 3. Materials for Garden Walls; 4. Copings for Garden Walls; 5. Trellised Garden Walls; 6. Height of Garden Walls; 7. Arranging Walls to suit various situations; 8. Colour of Garden Walls; 9. Construction of Garden Walls.

CHAPTER III.—HOTHOUSE BUILDING.—Section 1. General Principles; 2. Angle of Elevation.

CHAPTER IV.—HEATING AS APPLIED TO HORTICULTURAL ERECTIONS.—Section 1. Preliminary Remarks; 2. Heating by Flues; 3. Heating by Hot-Water Pipes; 4. The Tank Mode of Heating; 5. Heating by Hot-Air Stoves; 6. Heating by Steam; 7. Boilers and Pipes; 8. Hothouse Furnaces; 9. Cause of Circulation of Hot Water.

CHAPTER V.—VENTILATION.

CHAPTER VI.—FRUIT-HOUSES.—Section 1. Vineries; 2. Pineries; 3. Peach-Houses; 4. Cherry, Fig, Plum, and Apricot Houses; 5. Tropical Fruit-House.

CHAPTER VII.—PLANT-HOUSES.—Section 1. Conservatories; 2. Greenhouses; 3. Orangeries; 4. Heath-Houses; 5. Orchid-Houses; 6. Aquarium; 7. Window Gardening.

CHAPTER VIII.—PITS AND FRAMES.—Section 1. Pits and Frames Heated by Fermentation; 2. Pits Heated by Smoke-Flues, Tanks, Hot-Water Pipes, and Steam; 3. Cucumber and Melon Houses; 4. Mushroom-Houses; 5. Conservative Pits.

CHAPTER IX.—MISCELLANEOUS GARDEN STRUCTURES.—Section 1. Gardeners' Houses; 2. The Fruit-Room; 3. Ice-Houses; 5. Tanks and Cisterns; 5. Apiaries.

CHAPTER X.—DETAILS OF CONSTRUCTION.—Section 1. Glass and Glazing; 2. Lights or Sashes; 3. Rafters and Astragals; 4. Wall-Plates; 5. Covering the Roofs of Glass Houses and Pits, for the exclusion of cold or the retention of heat; 6. Espalier Railings; 7. Footpaths; 8. Painting; 9. Cements; 10. On the Preservation of Timber used in Hothouse-Building; 11. On the Durability of Materials.

[Continued.]

THE BOOK OF THE GARDEN—Continued.

CHAPTER XI.—LAYING OUT FLOWER-GARDENS.—*Section 1.* Preliminary Remarks on the Classification of Styles; 2. Situation of the Flower-Garden; 3. Flower-Garden Fences; 4. Planting with a view to produce Effect; 5. The Arboretum; 6. The Pinetum; 7. Edgings; 8. The Reserve Flower-Garden; 9. Disposal of the Ground; 10. Harmony of Colours.

CHAPTER XII.—GEOMETRICAL FLOWER-GARDEN.—*Section 1.* Their General Arrangement, &c.; 2. Fountains; 2. Vases and Urns, Dials and Mural Decorations; 4. Statues; 5. Seats; 6. Temples and Arbours; 7. Mausoleums, Cenotaphs, or Sepulchral Structures.

CHAPTER XIII.—GARDENESQUE STYLE OF FLOWER-GARDEN.—*Section 1.* Their General Arrangement; 2. Fountains and Vases; 3. Basketwork; 4. Bridges; 5. Trelliswork, Gates, Fences, and Tree-Guards; 6. Moss-Houses, Seats, and Resting-places.

CHAPTER XIV.—PICTURESQUE STYLE OF FLOWER-GARDENS.—*Section 1.* Their General Arrangement; 2. Rockwork; 3. Hermitages, Arbours, Moss-Houses, and Seats; 4. Ridges; 5. Rills, Rivulets, and Cascades; 6. Rustic Fences.

CHAPTER XV.—PRACTICAL DIAGRAMS EXPLANATORY OF THE RULES FOR LAYING OUT GARDENS, MORE PARTICULARLY FOR FORMING CURVED LINES.

CHAPTER XVI.—TOWN AND SMALL SUBURBAN GARDENS.

APPENDIX.

INDEX.

ILLUSTRATIONS.

33 COPPER-PLATE ENGRAVINGS BY W. AND A. K. JOHNSTON.
1040 ENGRAVINGS ON WOOD BY BRANSTON.

This Volume may be had separately, hf. bd., price £2, 10s.

CONTENTS OF THE SECOND VOLUME.

THE CULINARY OR KITCHEN GARDEN.

THE HARDY FRUIT-GARDEN.

THE FLOWER-GARDEN: — CHAPTER I. PLANT-HOUSES, PITS, AND WALLS;

CHAPTER II. OPEN FLOWER-GARDEN.

SELECT LIST OF VEGETABLES AND FRUITS.

SELECT LIST OF PLANTS.

GLOSSARY OF TERMS.

280 ENGRAVINGS ON WOOD.

This Volume may be had separately, hf. bd., price £1, 17s. 6d.

“ We must congratulate both editor and publishers on the completion of this work, which, whether considered in reference to the information it conveys on the theory and practice of horticulture, its numerous illustrations in the first style of art, and beautiful type, is every way worthy of the character of all concerned in its publication. The scientific knowledge and great experience of the editor in all that pertains to horticulture, not only as regards cultivation, but as a landscape-gardener and garden architect, has enabled him to produce a work which brings all that is known of the various subjects treated of down to the present time; while the manner in which the work is illustrated merits our highest approval, as most successful specimens of engraving On the practical details of culture, the editor gives, in addition to his own opinion, the pith of what others have written on the subject. . . . We hope to notice this book again. In the mean time, we strongly recommend the ‘Book of the Garden.’ To gardeners, in every way it will be indispensable, and not less so to country gentlemen, architects, and surveyors, who will find it the best authority on the subject they can refer to.”—*The Florist.*

TEXT-BOOKS on GEOLOGY, by DAVID PAGE, F.G.S.

I.

Fourth Edition, price 1s. 6d.,

INTRODUCTORY TEXT-BOOK OF GEOLOGY.

With Engravings on Wood, and Glossarial Index.

II.

Second Edition, revised and enlarged, price 6s.,

**ADVANCED TEXT-BOOK OF GEOLOGY,
DESCRIPTIVE AND INDUSTRIAL.**

With Engravings on Wood, and Glossary of Scientific Terms.

III.

In Crown Octavo, price 6s.,

HANDBOOK OF GEOLOGICAL TERMS AND GEOLOGY.

In foolscap 8vo, price 4s. 6d.,

YESTER DEEP LAND-CULTURE;

BEING A DETAILED ACCOUNT OF THE METHOD OF CULTIVATION WHICH HAS BEEN SUCCESSFULLY PRACTISED FOR SEVERAL YEARS BY THE MARQUESS OF TWEEDEDALE AT YESTER.

By **HENRY STEPHENS, F.R.S.E.,**

Author of the "Book of the Farm."

THE characteristic of the new system—for it may be well so named, different as it is from any now in use—is the complete pulverisation of the subsoil, and its mixture with the upper soil, the treatment being of a very substantial and permanent nature. The work is divided into the following sections:—

(1.) The physical geography and climate of the Yester Farms. From the details here given on these points, it will be seen that the great results obtained were not those induced by the propitious nature of the soils treated, but, from the fact that the fields operated upon were, on the contrary, by no means promising subjects for the expenditure of capital, the best evidence is obtained of the excellence of the principle upon which the improvements were founded. (2.) Thorough-draining the soils and subsoils. (3.) Deep-ploughing the soils and subsoils. (4.) Subsoil trench-ploughing. (5.) The Yester Plough. (6.) Swing-trees for three and four horses. The last four sections comprise descriptions of the peculiarities of construction of the ploughs used, and the method of working them. (7.) The physical benefits derived from the thorough-draining and subsoil trench-ploughing. (8.) The economical benefits. (9.) The system of farming now adopted at Yester Farm. (10.) Results of the system. (11.) The working strength of Yester Farm. (12.) The concluding chapter gives a detail of the advantages derivable from the thorough pulverisation of the subsoil, the whole of which abounds in suggestions of great value to the practical man.

In 2 vols. 8vo, with ATLAS in folio, price 30s. Second Edition,

ITALIAN IRRIGATION:

A REPORT ON THE AGRICULTURAL CANALS OF PIEDMONT AND LOMBARDY,

ADDRESSED TO THE HON. THE DIRECTORS OF THE EAST INDIA COMPANY;

WITH AN APPENDIX,

CONTAINING A SKETCH OF THE IRRIGATION SYSTEM OF NORTHERN AND CENTRAL INDIA.

By **Lieut.-Col. R. BAIRD SMITH, F.G.S.**

Captain, Bengal Engineers.

WHILE "Irrigation works," varying widely in character and importance, have been carried out in this country, and attention directed to their details, through the medium either of special works or periodical publications, information has been scarcely obtainable, except in small measure, and through the medium of isolated and rarely met with reports, of the nature, extent, and details of the system adopted in Italy, "the classic land of irrigation," where its influence has tended, even from the earliest period of history, to make her plains the richest on the face of the earth. And yet when we consider that the machinery of this grand system for the distribution of water, in order to the cultivation of the land, over which it is made to spread in fertilising streams, is "considered by most observers to come nearest to the type of theoretical perfection," some idea of the value of a work may be obtained which would show, in a clear, explicit, and practical manner, the various relations of the system, the details of its works, and the practical operation of its mechanism. These and many other details, interesting in a historical and social point of view, it is the object of the present work to lay before the reader. In addition to the letterpress, which fully exhausts the theory and the practice on which this the most extensive as well as the most efficient system in the world is founded and carried out, the work is enriched by a large folio Atlas of Plates, abounding in hints and suggestions on various points of constructive detail.

A New Edition, Illustrated with numerous Engravings, 1s.,

A CATECHISM OF PRACTICAL AGRICULTURE.

By **HENRY STEPHENS, F.R.S.E.**

Author of the "Book of the Farm."

For those destined to act as principals on the farm, instruction is provided by the profusion of Treatises on the various branches of the subject, by Agricultural Colleges and Lectureships, and pre-eminently by their entering as practical pupils with men of mature experience and skill; but for the far larger numbers destined to subordinate employments, no such means, and, indeed, no means of any kind, have been available. They entered on their occupation entirely unprepared for it, and were destined to acquire the knowledge and skill requisite wholly empirically, behind the plough or in the field. That through such a training multitudes have come thoroughly to understand and ably to fulfil their duties, admits of no dispute; had it been otherwise, our agriculture could never have been what it is. But still it is hardly questionable but that this knowledge and ability might have been earlier, more easily, and more generally attained, had these workers in our fields entered on their task in some degree informed, by preliminary elementary instruction, as to what was expected of them.

The favourable reception given to Professor Johnston's "Catechism of Agricultural Chemistry and Geology," suggested to the Publishers the propriety of a similar work on Practical Agriculture. In intrusting the carrying out this idea to the Author of the "Book of the Farm," they knew they were securing for the Work devised the fullest possible knowledge of the subject, sound judgment as to the wants of the class for whom he was specially writing, and orderly and methodical arrangement, and the utmost clearness and simplicity of style, in filling up the details. The method he has adopted is the same as that on which public approval has been so decisively stamped as followed in the "Book of the Farm"—the describing the various operations of the Farm in the order in which they are in the successive seasons actually performed upon it. And in following out the details, he has proceeded on the principle which all teachers of mixed classes know to be the only safe one—the assuming nothing whatever to be known beforehand of the processes described. The utmost simplicity and clearness have thus, it is hoped, been secured; and as a still further aid to full comprehension of every operation, woodcuts and diagrams have been profusely employed wherever they could be of any possible service.

Third Edition, 8vo, price 5s.,

A MANUAL OF PRACTICAL DRAINING.

By **HENRY STEPHENS, F.R.S.E.**

Author of "The Book of the Farm."

THE subject is divided into the following sections:—

(1.) The symptoms exhibited by land requiring drainage. (2.) The different methods of draining—shallow draining, with its varieties—deep draining—thorough draining. (3.) Draining by open ditches. (4.) Sheep drains in hill pastures. (5.) Drains for ground for forest trees. (6.) Ancient shallow covered drains. (7.) Isolated hollows and running sands. (8.) Bog drains. (9.) Elkington's method. (10.) Determination of the minimum depth of drains. (11.) Open ducts for drains—stone—tile ducts—necessity for soles for ducts. (12.) Estimate of the quantity of water to be conveyed by ducts. (13.) Draining of fields in succession. (14.) Period of the rotation at which drains should be executed. (15.) Position of main drains. (16.) Ditto in reference to surface. (17.) Ditto of small drains in reference to inclination of surface. (18.) Particulars determining depth. (19.) Ditto distances between drains. (20.) Contracts for cutting. (22.) Rules for filling drains with stones. (23.) Drains with soles and tiles. (24.) Laying of ditto. (25.) Pipe-drains. (26.) Laying of ditto. (27.) Tile and stone drains. (28.) Outlets and levels. (29.) Returning the soil into the drains. (30.) Conducting draining operations. (31.) Ground plan of a thorough-dried field. (32.) Physical benefits derivable from draining. (33.) Pecuniary profits. (34.) Cost of draining by different methods. (35.) Draining railway cuttings. (36.) Flat stone drains. (37.) Peat tile ditto. (38.) Plug ditto. (39.) Sod. (40.) Mole. (41.) Larch tube. (42.) Brush-wood. (43.) Brick drain. (44.) Drain ploughs. (45.) Drain-tile machines. (46.) Machines for preparing clay. (47.) Inquiry as to whether landlords ought to undertake any or what part of the expense of draining. (48.) Theory of draining. (49.) Durability of drains. (50.) Trenching rough ground preparatory to, and consequent upon, drainage.

In Demy Quarto, with Engravings, 10s. 6d.,

ELKINGTON'S SYSTEM OF DRAINING.

Edited by **J. JOHNSTONE.**

A new Edition, with the Author's last Additions and Corrections, 8vo, price 21s.,

THE PLANTER'S GUIDE.

By **SIR HENRY STEUART, Bart. of Allanton.**

TO WHICH IS PREFIXED A BIOGRAPHICAL SKETCH OF THE AUTHOR, AND AN ENGRAVING FROM A PORTRAIT BY RAEBURN.

No point in arboriculture has been more keenly contested than the possibility of transplanting trees of considerable size. There can be no doubt that this, if practicable, would be of great advantage, as respects both shelter and ornament, around newly-erected country or suburban residences; and accordingly every possible means have been tried to secure such removals with safety and economy. What was in this way accomplished by Sir H. Steuart, at his residence at Allanton, excited so much interest and admiration, that an account of the methods employed seemed imperatively called for; and with this the author combined a statement of his views as to the beneficial and ornamental disposal of wood, and the general management of forest trees. Though many years have since elapsed, and many improvements on mere machinery of removal have been made, it is still admitted by practical men that the principles of Sir H. Steuart's method are the only ones on which such transplantations can be safely effected, and that on the full carrying out of these rests our only hope of accomplishing an object of great interest to landed proprietors in particular.

In addition to a large variety of interesting and valuable notes and illustrations on various points of interest, the following are the principal sections of this work:—The art of giving immediate effect to wood—history of the art of arboriculture; new theory—its development—preparation of the soil for open and close plantation—preparation of the trees for removal—taking up and transportation of trees—with description of the machines useful in this department—planting of the trees in the new situations—treatment of trees subsequent to removal—expense of the operations—of the principal forest trees, oak, ash, &c. &c. The work is illustrated by six engravings and a portrait of the author.

In 8vo, price 12s.,

THE RURAL ECONOMY OF ENGLAND, SCOTLAND, AND IRELAND.

By **LEONCE DE LAVERGNE.**

TRANSLATED FROM THE FRENCH. WITH NOTES BY A SCOTTISH FARMER.

To those who are desirous of gaining a knowledge of the rural economy of Great Britain, no better guide could be presented than the present work. It is not only political, but it is interesting; it deals in a manner as singularly concise as it is fascinating and effective in style, with subjects valuable alike to the practical economist, the agriculturist, and the general reader.

The following is a brief outline of the points taken up and illustrated. These, however, afford but little evidence of the philosophical as well as interesting and practical style of the work:—

(1.) Soil and climate. (2.) Sheep. (3.) Cattle. (4.) The crops. (5.) The gross produce. (6.) Rents, profits, and wages. (7.) Constitution of property. (8.) Constitution of farming. (9.) Country life. (10.) Political institutions. (11.) Markets. (12.) The customs' reform. (13.) High farming. (14.) The Southern—(15.) The Eastern—(16.) Western—(17.) Midland, and—(18.) The Northern Counties. (19.) Wales and the Islands. (20.) Scotland. (21.) The Lowlands. (22.) The Highlands. (23.) Ireland. (24.) State of Wexford. (25.) The Famine and Exodus.

Third Edition, much enlarged, in Royal Octavo, with Engravings, price 30s.,

THE FORESTER:

A PRACTICAL TREATISE ON THE PLANTING, BEARING, AND GENERAL
MANAGEMENT OF FOREST TREES.

By **JAMES BROWN,**

Wood-Manager to the Earl of Seafield, and Surveyor of Woods.

WITH a view to render the book still more worthy of continuance in public favour, this edition has been carefully rewritten, and many new sections upon important subjects added, for the purpose of making it still better adapted as a complete guide in all forest operations; in short, it has been so much enlarged and improved, that it may be considered in every respect a new book.

Since the appearance of the Second Edition in 1851, the Author has been very extensively employed by landed proprietors in all parts of the country, in surveying and reporting on the present state and future management of plantations, and of grounds adapted for planting. His observations and experience have thereby been very much extended, inasmuch as each district usually presents some distinctive and peculiar features, arising from the nature of the soil, aspect, and elevation above the sea: and the whole practical results from this extended and varied field of operations have been embodied in the present edition of "The Forester." In it, as in the former editions, the Author has confined himself entirely to his own experience in forest operations; and his aim has been that of making his work plainly and practically useful as a forester's guide.

The subject of keeping the Forest accounts has also been for the first time taken up in the present edition; and a section has been added containing a complete system of Forest Book-keeping, with examples of all the various Books, and full explanations regarding them.

SYNOPSIS OF CONTENTS.

Importance of Woodlands in Great Britain.—The object of planting.—The value of wood as a crop upon land.—Forestry as at present understood and practised in Great Britain.—Education necessary for foresters.—What portions of the country should be put under trees, and what portions should not.—Laying out of land for forests and plantations.—Stones and lime walls.—Dry stone-dykes with lime on cope only.—Turf dykes.—Wooden palings.—Wire fences.—The purpose and situation for which each sort of fence is most properly adapted.—Gates.—Preparing ground for the growing of young trees.—Drainage.—Laying off and making of roads in new plantations.—Trees considered as a profitable crop, and as ornamental objects on landed property.—Descriptive character, habit, and peculiarities of the various forest trees.—Season of the year best adapted for planting operations.—How to choose young forest trees when buying them from public nurseries.—Utility of proprietors having their own home nurseries.—Management of the nursery.—Kinds of forest trees which may be most profitably planted in any given district of the country.—Expenses of laying down land under plantations.—Game injurious to young trees.—Pruning.—Thinning plantations.—Management of hardwooded plantations of considerable age, reared chiefly with a view to ornamental effect.—Management of plantations of considerable age, reared with a view to a crop of timber only.—Rules and regulations necessary to be observed in the cutting down and selling of trees, whether as thinnings or clearings of old timber.—Rearing and management of plantations for a supply of hop-poles.—Management of general coppice plantations.—The stripping and drying of bark used for tanning.—Cause of disease among larch plantations.—External symptoms of disease in trees, and general causes of the same.—The periodical increase of timber in the different species of forest trees.—How to find the value of growing plantations, and of full-grown timber trees.—Method of transplanting large trees, and description of machines for performing that operation.—Method of renewing the health of old or decayed trees.—Kinds of plants best fitted for under-wood, and how they may be planted in a wood so as to produce useful and ornamental effect.—Hints in reference to the felling of timber.—The application of water and steam powers to the manufacture of timber.—The preparing of timber for better preservation.—Reporting on woodlands.—System of book-keeping adapted to forest operations.

In Octavo, price 5s.,

VIEW OF THE SALMON-FISHERY OF SCOTLAND.

WITH OBSERVATIONS ON THE NATURE, HABITS, AND INSTINCTS OF THE SALMON, AND ON THE
LAW AS AFFECTING THE RIGHTS OF PARTIES, &c. &c.

By the Late **MURDO MACKENZIE, Esq. of Cardross and Dundonald.**

Sixty two highly-finished Engravings, medium 4to, with Descriptions, 42s.

THE ARCHITECTURE OF THE FARM :

A SERIES OF DESIGNS FOR FARM-HOUSES, FARM-STEADINGS, FACTORS' HOUSES,
AND LABOURERS' COTTAGES.

By **JOHN STARFORTH, Architect.**

THE work comprises a series of sixty-two plates, finished in the highest style of art, all the drawings and designs being carefully prepared by the Author. Eight designs for labourers' cottages, of different styles and accommodation, with two plates of working details, are given, taking up 17 plates. The next two are occupied by a design for a farm bailiff's house ; these being followed by a series of four designs for different classes of farm-houses in plates 18 to 35 inclusive. Plates 36 to 38 take up a design for a factor's house, while 39 to 44 illustrate the arrangements and decorations of a house adapted for a proprietor farming his own estate. These comprise the first division of the work ; the second being occupied with plates 45 to 62 inclusive, illustrative of designs for farm-steadings, for water, horse, and steam-power, adapted for farms of various sizes, including the design for which the Author obtained the Highland and Agricultural Society's Gold Medal.

General details of construction and descriptions of each plate are added ; and in the preparation of the work every pains has been taken to produce a practical and useful volume, calculated to meet the wants of the present time.

In Crown 8vo, with upwards of 500 Engravings on Wood. Second Edition, price 6s. 6d.,

THE HANDBOOK OF THE MECHANICAL ARTS :

CONCERNED IN THE CONSTRUCTION AND ARRANGEMENT OF DWELLINGS AND OTHER BUILDINGS,
WITH PRACTICAL HINTS ON ROAD-MAKING AND THE ENCLOSING OF LAND.

By **R. SCOTT BURN, Engineer.**

ALTHOUGH the agriculturist is not generally conversant with the operations and processes connected with the mechanical arts, still numerous instances are sure to arise in every-day practice, in which even a slight knowledge of them would be of great pecuniary value. The various operations demanded by the exigencies of farm life, and the numerous claims made on the mechanical ingenuity and abilities of the farmer, tend to render a work peculiarly valuable to him which bears on those branches of the mechanical arts which are in the most frequent requisition. This desideratum the present work is designed to supply. Every care has been taken in the preparation of the working drawings with which the work is profusely illustrated, and by judicious compression of materials to present a mass of practical information which will enable the reader to carry on many operations without involving the expense of hired labour. The following are the divisions of the work :—

(1.) House arrangement and conveniences. (2.) Building specifications—bills of quantities and estimates. (3.) Fireplaces, stoves, and cooking-ovens. (4.) Chimneys. (5.) Ventilation. (6.) Water-closets. (7.) Water—its qualities and filtration. (8.) Cisterns. (9.) Foundations and drains. (10.) Solid ground-floors. (11.) Log cabin or shanty. (12.) Frame-houses. (13.) Pisé, or hard-raumbed earth. (14.) Unburnt bricks. (15.) Brick-setting. (16.) Stone walls—construction. (17.) Fire-proof construction. (18.) Theory of carpentry. (19.) Practice of carpentry.—Joints—floors—roofs—partitions—gates and bridges. (20.) Iron-framing—roofs and columns. (21.) Joinery tools—mouldings—doors—windows—staircasing. (22.) Smith-work. (23.) Practical mechanism, and the fitting and construction of machines. (24.) Brickmaking. (25.) Roof-covering.—Exterior and interior finishings.—Plastering.—Painting. (26.) Mortars.—Concrete.—Cements. (27.) Enclosing of land.—Fences. (28.) Road-making. (29.) Well-sinking. (30.) Farm and agricultural buildings. Index.

Fifty-second Edition, price 1s.,

A C A T E C H I S M

OF

AGRICULTURAL CHEMISTRY AND GEOLOGY.

By **JAMES F. W. JOHNSTON, F.R.S.E., &c.**

THE object held in view in compiling the present little work was the preparation of a manual sufficiently elementary to be used even in our humblest schools, yet so precise and complete as to constitute in itself a complete course of instruction in the applied science of which it treats. The reception it has experienced, as exemplified in the issue of a Fifty-second Edition, may be held as proof that in general estimation it has achieved its aim.

The Work is arranged under the following sections, in the form of question and answer, and is amply illustrated by diagrams :—

(1.) General relations of the plant, the soil, and the animal (2.) Compound substances of which the organic part of plants and animals consists. (3.) Elementary bodies of which the compound substances contained in the organic part of plants, animals, and soils consist. (4.) Of the organic food of plants. (5.) Composition and properties of water, ammonia, and nitric acid. (6.) Composition of woody fibre, starch, sugar, gum, and humic acid, and how they are formed in the plant or the soil. (7.) Composition of fat, gluten, and fibrin, and how they are formed in the plant and the animal. (8.) Substances of which the inorganic, mineral, or incombustible part of soils, plants, and animals consists. (9.) Origin and general characters of soils. (10.) Improvement of the soil by deep-ploughing, subsoiling, and draining. (11.) Composition and material relations of the inorganic part of the soil and the plant. (12.) Effect of cropping upon the soil. (13.) Vegetable manures. (14.) Of the parts of animals used as manures. (15.) Of the droppings or dung of animals. (16.) Of saline and mineral manures. (17.) Of limestone, and of the burning and use of lime. (18.) Of the proportions of starch, gluten, and fat contained in the crops which the farmer usually reaps. (19.) Uses of the starch of our crops in the feeding of animals. (20.) Uses of the gluten, fat, and mineral matter of plants in the feeding of animals. (21.) Of milk and dairy produce, and the feeding of milk cows.

Seventh Edition, greatly enlarged, price 6s. 6d.,

E L E M E N T S

OF

AGRICULTURAL CHEMISTRY AND GEOLOGY.

By **JAMES F. W. JOHNSTON, F.R.S.E., F.G.S., &c.**

MANY, it was apprehended, might be deterred by the voluminous appearance of the Author's larger work ("Lectures on Agricultural Chemistry and Geology,") from giving due attention to the subject; and partly for the sake of these, partly to provide a cheap and accessible hand-book of the subject, the present work was designed and executed by the Author. Though styled "Elements," however, the book is not in the strict sense of the word an elementary one, otherwise, at least, than as the student may proceed at once to it without the slightest previous knowledge of the subject. It might safely have been called Handbook of Agricultural Chemistry and Geology, inasmuch as it presents, in a condensed rather than an abridged form, the entire subject it professes to take up.

The work is divided into sections, of which the following is a brief outline :—

(1.) Object of the farmer—what the sciences can do for him—organic and inorganic substances—relative proportions of elementary bodies contained in plants. (2.) Forms in which the organic elements enter into plants. (3.) Structure of plants. (4.) Inorganic substances of plants. (5.) Of soils. (6.) (7.) (8.) Direct relation of geology to agriculture. (9.) Of the physical, chemical, and botanical relations of soils. (10.) Of the general improvement of the soil, and how the practical man will commence such improvement. (11.) Mechanical methods continued. (12.) Improvement of the soil by planting, and by the growth of wood. (13.) Chemical methods of improving the soil—Manures—vegetable manures. (14.) (15.) Animal manures. (16.) Relative theoretical values of different animal manures. (17.) Saline and mineral manures. (18.) Why these are required by the soil. (19.) Use of lime in agriculture. (20.) Improvement of the soil by paring and burning—do. by irrigation. (21.) The products of vegetation. (22.) Average composition of root and green crops. (23.) Of milk and its products. (24.) (25.) Of the fattening of animals.

In Octavo, price 8s.,

EXPERIMENTAL AGRICULTURE;

BEING THE RESULTS OF PAST, AND SUGGESTIONS FOR FUTURE EXPERIMENTS
IN SCIENTIFIC AND PRACTICAL AGRICULTURE.

By **JAMES F. W. JOHNSTON, F.R.S.E., &c.**

IN the other works by the same Author there has been embodied all that is known with any degree of certainty in regard to the application of chemistry to agriculture. There are, however, a variety of important points about which there is as yet much obscurity, and a vast deal altogether unknown. To explain these in as far as they are capable of being immediately elucidated by experiment, is the scope of the present work. From the considerations dwelt upon, a variety of suggestions as to experimenting in the field and the feeding-house are evolved: these are presented in such a way as to point out to practical men what they may do for the advancement of the art of agriculture. The following are the leading points elucidated:—

(1, 2) The knowledge necessary in a suggestor and maker of experiments. (3) How experiments are to be made and judged of. (4) Influence of circumstances on the result of experiments. (5) Preliminary consideration connected with the making of experiments. (6) Experiments with sulphuric acid, and with the sulphates of potash, soda, lime, magnesia, and iron. (7) Experiments with gypsum, and the sulphates of magnesia and iron. (8) Do., with chloride of potassium, and with common salt. (9) With the chlorides of magnesium and calcium, muriatic acid, and the fluoride of calcium. (10) With the carbonates, phosphates, silicates of potash and soda. (11) With the nitrates of potash, soda, lime, and magnesia. (12) With the salts of ammonia.

Fourth Edition, 2s.,

INSTRUCTIONS FOR THE ANALYSIS

OF

SOILS, LIMESTONES, AND MANURES.

By **JAMES F. W. JOHNSTON, F.R.S.E., &c.**

THIS work is intended as a first help to practical and economical chemical analysis—and its value in this and other obvious ways to the farmer, the pharmaceutical chemist, the youthful student, and to rural training-schools and agricultural laboratories, will be seen by a perusal of the following brief notice of its contents:—

(1.) The work opens with a chapter showing how the physical properties of the soil are determined. (2.) How its organic matter is estimated, (3.) and its saline matter examined. These are followed by (4.) a chapter on the estimation of the saline matters, and an examination of natural water; (5.) and its earthy matters; with notes on tile and fire clay. (6.) The analysis of ores by measure is then discussed. (7.) General remarks on the analysis of soils, with practical suggestions thereon, follow. (8.) The analysis of limestones and marls, and (9.) of saline manures, next succeed; and the work closes with (10.) an examination of bone manures, guano, and oil-cakes.

In small Octavo, price 6s.,

ON

THE USE OF LIME IN AGRICULTURE.

By **JAMES F. W. JOHNSTON, F.R.S.E., &c.**

THIS work is designed to throw together, in a convenient form, the results of practice, and the suggestions of theory, in the use of a substance which has been called the basis of all good husbandry, so important a part does it perform in its practice. The points discussed are—the use of lime in its application to the soil; the artificial states in which these are made; an investigation into the points as to whether it is indispensable to the fertility of the land; and when it should be applied. Its effects on the soil and the crops are then stated, followed by a notice of the theory of its action; its exhausting influence on the soil; the length of time which it acts; and its effects on animal and vegetable life; the work concluding with two elaborate chapters on the use of lime as a sulphate and a phosphate.

In Two vols. crown 8vo, price 11s. 6d.,

WITH ILLUSTRATIONS ENGRAVED ON WOOD,

THE CHEMISTRY OF COMMON LIFE.

By **JAMES F. W. JOHNSTON, M.A., F.R.S.E., &c.**

A NEW EDITION, edited by G. H. LEWES, Author of the "Physiology of Common Life."

THE common life of man is full of wonders, Chemical and Physiological. Most of us pass through this life without seeing or being sensible of them, though every day our existence and our comforts ought to recall them to our minds. One main cause of this is, that our schools tell us nothing about them—do not teach those parts of modern learning which would fit us for seeing them. What most concerns the things that daily occupy our attention and cares, are in early life almost sedulously kept from our knowledge. Those who would learn anything regarding them, must subsequently teach themselves through the help of the press: hence the necessity for a Popular Chemical Literature.

It is with a view to meet this want of the Public, and at the same time to supply a Manual for the Schools, that the present work has been projected. It treats, in what appears to be their natural order, of **THE AIR WE BREATHE AND THE WATER WE DRINK**, in their relations to human life and health—**THE SOIL WE CULTIVATE AND THE PLANT WE REAR**, as the sources from which the chief sustenance of all life is obtained—**THE BREAD WE EAT AND THE BEEF WE COOK**, as the representatives of the two grand divisions of human food—**THE BEVERAGES WE INFUSE**, from which so much of the comfort of modern life, both savage and civilised, is derived—**THE SWEETS WE EXTRACT**, the history of which presents so striking an illustration of the economical value of chemical science—**THE LIQUORS WE FERMENT**, so different from the Sweets in their action on the system, and yet so closely connected with them in chemical history—**THE NARCOTICS WE INDULGE IN**, as presenting us with an aspect of the human constitution which, both chemically and physiologically, is more mysterious and wonderful than any other we are yet acquainted with—**THE ODOURS WE ENJOY, AND THE SMELLS WE DISLIKE**; the former because of the beautiful illustration it presents of the recent progress of organic chemistry in its relations to the comforts of common life, and the latter because of its intimate connection with our most important sanitary arrangements—**WHAT WE BREATHE FOR AND WHY WE DIGEST**, as functions of the body at once the most important to life, and the most purely chemical in their nature—**THE BODY WE CHERISH**, as presenting many striking phenomena, and performing many interesting chemical functions not touched upon in the discussion of the preceding topics—and lastly, the **CIRCULATION OF MATTER**, as exhibiting in one view the end, purpose, and method of all the changes in the natural body, in organic nature, and in the mineral kingdom, which are connected with and determine the existence of life.

"All will concur in admiring the profound thought which has ennobled so many familiar things, and has even tinged the commonest process of household life with the hues of novelty and surprise. The work deserves to be universally read."—*British Quarterly Review*.

In Octavo, with 22 Engravings, price 30s.,

THE CHEMISTRY OF VEGETABLE AND ANIMAL PHYSIOLOGY.

By **Dr J. G. MULDER,**

Professor of Chemistry in the University of Utrecht.

Translated by **Dr P. F. H. FROMBERG**; with an Introduction and Notes by
PROFESSOR JOHNSTON.

STABLE ECONOMY. A Treatise on the Management of Horses in relation to Stabling, Grooming, Feeding, Watering, and Working. By JOHN STEWART, V.S. Seventh Edition, foolscap 8vo, price 6s. 6d.

ADVICE TO PURCHASERS OF HORSES. By JOHN STEWART, V.S., Author of "Stable Economy." In foolscap 8vo, price 2s. 6d.

INTRODUCTION TO METEOROLOGY. By D. P. THOMSON, M.D. 8vo, with Engravings, 12s. 6d.

AINSLIE'S TREATISE ON LAND-SURVEYING.

A new and enlarged Edition, edited by WILLIAM GALBRAITH, M.A., F.R.A.S. One Volume 8vo, with a Volume of Plates in 4to, price 21s.

"The best book on surveying with which I am acquainted."—W. RUTHERFORD, LL.D., F.R.A.S., *Royal Military Academy, Woolwich.*

THE PREPARATION OF COOKED FOOD FOR THE FATTENING OF CATTLE; and the Advantage of Using it along with Cut Straw, Hay, Turnips, or other Vegetables. By T. HARKNESS. Price 6d.

DWELLINGS FOR THE WORKING CLASSES :

Their Construction and Arrangement, with Plans, Elevations, and Specifications, suggestive of Structures adapted to the Agricultural and Manufacturing Districts. By R. SCOTT BURN, Engineer. In Quarto, with numerous Diagrams, 3s.

AGRICULTURAL LABOURERS AS THEY WERE, ARE, AND SHOULD BE, IN THEIR SOCIAL CONDITION. By the Rev. HARRY STUART, A.M., Minister of Oathlaw. 8vo. Second Edition, 1s.

SIX LARGE SHEETS and SIX ANNUAL REPORTS, CONTAINING WORKING DRAWINGS OF AGRICULTURAL LABOURERS' DWELLINGS, with detailed Schedules of Measurement and Specifications. Published by the Association for Improvement of Agricultural Labourers' Dwellings.

SHEET 1st.—TWO DESIGNS FOR A SINGLE COTTAGE, with Schedules of Measurements.

" 3d.—A DESIGN FOR A PAIR OF COTTAGES, with Schedules of Measurements.

" 6th.—DESIGN FOR A PAIR OF TWO-STORY COTTAGES, with Schedules of Measurements.

" 7th.—TWO DESIGNS FOR PAIRS OF COTTAGES.

" 9th.—CONTAINS FIGURES OF DETAILS FOR COTTAGES.

" 10th.—DESIGNS FOR SINGLE AND TWO-STORY COTTAGES, AND AN OLD COTTAGE CONVERTED INTO A PORTER'S LODGE.

These Sheets contain the most approved Designs for Labourers' Dwellings, and furnish facilities for obtaining accurate estimates of the cost of erection. Price 1s. each Sheet; or Six Annual Reports, 1s. each.

IN THE PRESS.

I.

A MANUAL OF VILLA GARDENING. By CHAS. M'INTOSH, Author of the "Book of the Garden." In One Vol. Crown 8vo.

II.

ON THE MANAGEMENT OF BEES. By DR MACKENZIE, Eileanach.

III.

DAIRY MANAGEMENT, AND FEEDING OF MILCH COWS.

