



# IRRIGATION AND DRAINAGE

## *PRINCIPLES AND PRACTICE OF THEIR CULTURAL PHASES*

BY

F. H. KING

Professor of Agricultural Physics in the University of Wisconsin;  
Author of "The Soil"

*EIGHTH EDITION*

*New York*

THE MACMILLAN COMPANY

LONDON: MACMILLAN & CO., LTD.

1918

*All rights reserved*

COPYRIGHT 1898  
By F. H. KING

---

Set up and electrotyped October, 1899  
Reprinted with corrections January, 1902  
July, 1903, January, 1906, October, 1907  
July, 1909, January, 1911, January, 1913

Mount Pleasant Press  
J. HORACE MCFARLAND COMPANY  
HARRISBURG · PENNSYLVANIA

## PREFACE

MOST works on irrigation have been written from the legal or sociological standpoint, or from that of the engineer, rather than from the cultural phases of the subject. The effort is made here to present in a broad yet specific way the fundamental principles which underlie the methods of culture by irrigation and drainage. Distinctively engineering principles and problems, as such, have been avoided, and so have those of plant husbandry. The aim has been to deal with those relations of water to soils and to plants which must be grasped in order to permit a rational practice of applying, removing or conserving soil moisture in crop production. The immediately practical problems, from the farmer's, fruit-grower's and gardener's standpoints, with the principles which underlie them, are presented in as concrete and concise a manner as appears needful to build up a rational practice of irrigation culture and farm drainage; and the effort has been to broaden the conceptions of general soil

(v)

357438



management, even when neither irrigation nor drainage is practiced.

Great pains has been taken to personally inspect the irrigation practices of both humid and arid climates in this country and in Europe, to gain a broader view of essential details, and to secure suitable illustrations, which are presented largely as photo-engravings, in the hope of getting closer to the spirit of the subject.

Free use has been made of all available literature on the subject, and credit is given throughout the body of the text to various writers and works.

F H. KING.

UNIVERSITY OF WISCONSIN,  
March, 1899.

# CONTENTS

## INTRODUCTION (pages 1-65)

### GENERAL REMARKS ON THE IMPORTANCE OF WATER

	PAGES
Definition of irrigation and drainage—Importance of water in crop production—Plants adapted to intermittent watering—Variation in the capacity of soils for water—Adaptation of plants to soils of different water capacity—Variations in soils and in rainfall may make irrigation or drainage needful—Better aeration and deeper root feeding in arid soils—Explanations not entirely satisfactory .....	1-9
<i>The Advantages of Abundant Supply of Soil Moisture.</i> —Large volumes of water generally needed—Part played by water in crop production—Relation to plant life—Relation to soil microbes—Rains and irrigation may start formation of nitrates by diluting soil moisture—Relation of drainage to development of nitrates and soil fertility—Soil water dissolves ash ingredients of plant-food—Water causes oxygen, carbon dioxide and nitrogen to enter the soil .....	9-15
<i>Water only One of the Necessary Plant-foods.</i> —Difference in value of water for plant-food—More water used than any other substance .....	15, 16
<i>Amount of Water Used by Plants.</i> —Relation of climate to water used—Treatment of soil affects amount of water used—Irrigation and drainage modify amount of soil moisture—Apparatus used in measuring water used by plants—Aims of the experiments—First trials with oats, barley and maize—Field results with maize—Changes of soil moisture in field—Experiments with oats and barley—Experiments of 1893 to 1896.....	16-38

	PAGES
<i>Variations in the Amount of Water Used by Plants.</i> —Two years compared—Field and plant-house yields compared—Loss of water in a saturated air—Amount of water required to produce one ton of dry matter.....	39-46
<i>The Mechanism and Method of Transpiration in Plants.</i> —Transpiration and breathing—Structure of barley leaf—Inevitable loss of water by evaporation makes demands large—Amount of air breathed by clover to secure the needed carbon—Changes in humidity of air over a clover field—Assimilation of carbon takes place only in sunshine—Breathing pores in leaves—How stomata permit and prevent loss of water—Structure of breathing pores.....	46-54
<i>Mechanism by which Land Plants Supply Themselves with Water.</i> —Part played by roots—Essential features of roots—Only the newer portions active in absorbing moisture—How water is taken up—Rate of feeding slows down as thickness of film becomes less—Root hairs acid and may hasten solution of plant-food—Need of great extent of root surface—Distribution of roots in soil—How roots advance through soil—The root-cap....	54-65

## PART I

## IRRIGATION CULTURE

## CHAPTER I

THE EXTENT AND GEOGRAPHIC RANGE OF IRRIGATION  
(pages 66-90)

<i>The Antiquity of Irrigation.</i> —In Egypt—In Assyria—By the Phœnicians—Early Grecian and Roman—In China—In Mexico and Peru.....	66-72
<i>Extent of Irrigation.</i> —In the Po valley—In Sicily—In Spain—In France—In Switzerland—In Belgium—In Denmark—In Austria-Hungaria—In Bavaria—In England—In India—In Ceylon—In Australia—In other	

# Contents *or*

ix

PAGES

parts of Asia—In Algeria—In Egypt—In Cape Colony  
—In Madagascar—In the Hawaiian Islands—In Java—  
In South America—In the Argentine Republic—In  
Western United States—Amount of land irrigated..... 72-89

*The Climatic Conditions Under which Irrigation Has Been  
Practiced.*—Amount of rainfall where irrigation has been  
practiced—Distribution of rain with reference to the  
growing season ..... 89, 90

## CHAPTER II

### THE CONDITIONS WHICH MAKE IRRIGATION IMPERATIVE, DESIRABLE, OR UNNECESSARY (pages 91-116)

*Objects of Irrigation.*—To establish right moisture relations  
—To increase fertility—To change texture of soil—To  
build up low areas—For sewage disposal..... 91-94

*The Least Amount of Water which Can Produce a Paying  
Crop.*—Importance of the subject—Amount of water  
needed for wheat—Slow rate of evaporation from dry  
soil—Average yield of wheat as related to rainfall—  
Dry farming ..... 95-101

*Like Amounts of Rainfall not Equally Productive.*—Differ-  
ences in yield and in rainfall—Causes of differences .. 101-106

*Frequency and Length of Periods of Drought.*—Abundant  
watering at short intervals needful—Type of rain dis-  
tribution—Ineffective rains—Length of rainfall periods  
in Wisconsin—Yield of crops compared with rainfall—  
Length of too long periods of no rain—Yields due to  
rainfall and to irrigation compared..... 106-110

*Conditions which Modify the Effectiveness of Rainfall.*—In-  
fluence of soil texture—Amount of moisture in soil  
when growth is checked—Loss of water by percolation  
—Rapid percolation chief cause of poor yields—Supple-  
mentary irrigation helpful on light lands—Topographic  
conditions influencing effectiveness—Sub-irrigation may  
supplement rainfall... .. 110 116

## Contents

xi

	PAGES
<i>Fall Plowing to Conserve Moisture.</i> —How most effective— Amount of moisture saved—Most important in sub- humid climates—Applicable to orchards and small fruits.....	131-133
<i>Subsoiling to Conserve Moisture.</i> —Magnitude of the effects —Duration of the effects .....	133-138
<i>Explanation of Effects of Subsoiling.</i> —Increases water ca- pacity of soil stirred—Decreases the capillary conduct- ing power—Allows the water to enter soil more deeply —Larger per cent of water available to crops .....	139-142
<i>Earth Mulches.</i> —Conditions modifying effectiveness—Loses in effectiveness with age—Other mulches—Too close pasturing wasteful—Value of surface dressings of ma- nure—Harrowing and rolling small grains after they are up.....	142-147
<i>Early Tillage to Save Moisture.</i> —Amount saved—Most effective tools—Early stirring rather than early planting.....	147-151
<i>Danger of Plowing Under Green Manures.</i> —Catch crops in humid and sub-humid climates .....	151-153
<i>Summer Fallowing in Relation to Soil Moisture.</i> .....	153,154
<i>Influence of Summer Fallowing on Soil Moisture and on Plant-food</i> .....	154-157
<i>Old Systems of Intertillage.</i> —Jethro Tull's method— Hunter's modification—The Lois-Weedon system— Planting and tillage to utilize the whole rainfall— Distance roots of corn and potatoes spread laterally— Distribution of moisture in potato field—Lateral feed- ing of oats—Horse-hoeing grain a form of summer fallowing....	157-163
<i>Frequency of Tillage to Conserve Soil Moisture.</i> —Should often take place at the earliest possible moment—Dan- ger from late tillage.....	164,165

## Contents

xiii

PAGES

<i>Closer Planting Made Possible by Irrigation.</i> —Breathing room in the soil limited—Soil temperature lowered by close planting—Amount of sunshine limited—Tendency to lodge when planted too close—Possible insufficiency of carbon dioxide—Amount of carbon used by maize .....	181-187
<i>The Maximum Limit of Productiveness for Maize.</i> —Mean weight of plants—Maximum yields computed—Observed yields .....	187-190
<i>Observed Yields of Maize per acre, Planted in Different Degrees of Thickness and with Different Amounts of Water.</i> —Yields of dry matter—Yields of shelled corn..	190-193
<i>Influence of Thick Seeding and Irrigation on the Development of the Plant.</i> —Lengthening of the nodes .....	193-195

## CHAPTER V

### AMOUNT AND MEASUREMENT OF WATER FOR IRRIGATION (pages 196-221)

<i>The Maximum Duty of Water in Crop Production</i> .....	196-199
<i>Conditions which Modify the Amount of Water Required for Irrigation.</i> —Peculiarities of crop—Character of soil—Character of subsoil—Character of rainfall—Frequency and thoroughness of cultivation—Closeness of planting—Fertility of land—Frequency of applying water.....	199-208
<i>Amount of Water Used in Irrigation.</i> —In Italy—In Spain and France—In Egypt—General tables—Mean amount—For sugar cane—Highest probable duty, table—Bushels of grain per cubic foot of water, table.....	208-217
<i>Duty of Water in Rice Culture.</i> .....	217,218
<i>Duty of Water on Water-meadows</i> .....	219,220
<i>Duty of Water in Cranberry Culture</i> .....	220,221

## CHAPTER VI

## FREQUENCY, AMOUNT AND MEASUREMENT OF WATER FOR SINGLE IRRIGATIONS (page 222-247)

	PAGES
<i>Amount of Water for Single Irrigations.</i> —Soil leaching in humid climates—Conditions which determine the amount of water used—Conditions which determine the frequency of irrigation . . . . .	222-224
<i>Capacity of Soils to Store Water under Field Conditions.</i> —Amount of soil moisture when growth was checked—Upper and lower limits of best amount—Amount needed for one irrigation . . . . .	224-227
<i>Depth of Root Penetration.</i> —Prune on Peach—Apple—Grape—Raspberry—Strawberry—Alfalfa . . . . .	227-234
<i>Frequency of Irrigation.</i> —Theoretical—For wheat—For maize—For clover, alfalfa and meadows—For potatoes—For rice . . . . .	234-239
<i>Measurement of Water.</i> —Necessity—Advantages . . . . .	239
<i>Units of Measurement.</i> —Acre-inch—Acre-foot—Second-foot—Miner's inch . . . . .	239 241
<i>Methods of Measurement.</i> —Time division—Subdivision of laterals—Use of divisors—Use of modules . . . . .	241-247

## CHAPTER VII

## CHARACTER OF WATER FOR IRRIGATION (pages 248-268)

<i>Temperature of Water for Irrigation.</i> —Best temperature—Danger from cold water—Amount soil temperature may be lowered . . . . .	248-251
<i>Fertilizing Value of Irrigation Water.</i> —Amount in two acre-feet . . . . .	251-253
<i>Sewage Water for Irrigation.</i> —On Craigentenny meadows—Healthfulness of milk from sewage grass . . . . .	253-258

Contents

xv

	PAGES
<i>The Value of Turbid Water in Irrigation.—Rio Grande—Po—Nile—Durance.</i> .....	259, 260
<i>Improvement of Land by Silting.—Warping or colmatage—Silting of gravelly soils.</i> .....	261-264
<i>Opportunities for Silting in Eastern United States.—In Wisconsin and Michigan—In New York and New Jersey—In the South.</i> .....	264-266
<i>Alkali Waters not Suitable for Irrigation.—Safe and unsafe alkali waters.</i> .....	266-268

CHAPTER VIII

ALKALI LANDS (pages 269-289)

<i>Characteristics of Alkali Lands.</i> .....	269, 270
<i>Causes of Injuries by Alkalies.—Plasmolytic effects—Toxic effects</i> .....	270, 271
<i>How Alkalies Accumulate in the Soil.—By capillarity—In marsh soils by underflow.</i> .....	272-274
<i>Intensive Farming may Tend to the Accumulation of Alkalies.</i> 274, 275	
<i>Amount of Soluble Salts which are Injurious in Soils.—Conclusions of Plagniol—Of Dehérain—Of Gasparin—Of Hilgard—Plasmolytic action.</i> .....	275-278
<i>Composition of Alkali Salts.—In California—In Washington.</i> 278-280	
<i>Appearance of Vegetation on Alkali Lands.—In arid regions—In humid regions.</i> .....	281-283
<i>Conditions which Modify the Distribution of Alkalies in Soil.—Tillage—Shading—Action of roots.</i> .....	283, 284
<i>Use of Land Plaster to Destroy Black Alkali.—Hilgard's conclusions</i> .....	284, 285
<i>Kinds of Soil which Soonest Develop Alkali.</i> .....	286
<i>Correction of Alkali Water before Use in Irrigation.</i> .....	287
<i>Drainage Must be Ultimate Remedy for Alkali Lands.</i> .....	287-289



*Principles Governing the Puddling of Soils.*—Character of puddling—Bad effects—Precautions to prevent. . . . . 334-336

*Principles Governing the Washing of Soils.*—The common mistake—What constitutes good irrigation—Methods which prevent washing. . . . . 337, 338

*Field Irrigation by Flooding.*—Two different types—Used most where intertillage cannot be practiced—Flooding by running water—As practiced in Colorado—Where slopes are steep—Where fields are short—Flooding by checks—Size of checks—Forming checks—On irregular slopes—Handling the water—Large systems—Forming check ridges . . . . . 338-350

*Fitting the Surface for Irrigation.*—Leveling devices—Shuart land grader—French land grader. . . . . 351, 352

*Field Irrigation by Furrows.*—Adapted to intertillage crops—Watering before planting—Irrigation of potatoes—Watering alternate rows—Lateral spreading of water—Effect on yield—Watering sugar beets and maize. . . . . 352-359

*Water-meadows.*—Laid out for continuous flow—System at Salisbury, England—In Italy—In Belgium—Mountain meadows. . . . . 359-365

*Irrigation of Cranberries.*—Laying out the marshes—Rapid flooding and draining—Irrigation of small fields by pumping. . . . . 365-368

*Irrigation of Rice Fields.*—South Carolina system—Trunks—Germinating the rice—Dry hoeing—Irrigation after dry growth stage—Prevention of red rice—Upland irrigation . . . . . 368-373

*Orchard Irrigation.*—Furrow method best—Capillary spreading of water—Distributing flumes—Foot ditch—Watering by ring furrows. . . . . 373-381

*Cultivation after Irrigation.*—The cardinal principle—Forms of orchard cultivators—Importance of cultivation in humid climates. . . . . 381-383

## PART II

## FARM DRAINAGE

## CHAPTER XII

## PRINCIPLES OF DRAINAGE (pages 415-466)

	PAGES
<i>The Necessity for Drainage.</i> —Removal of injurious salts— Better soil ventilation—Makes the soil more firm.....	416, 417
<i>The Demands for Air in the Soil.</i> —Supply of free oxygen— To lessen denitrification—Facilitates chemical changes..	418, 419
<i>How Drainage Ventilates the Soil.</i> —Permits roots and bur- rowing animals to go deeper—Develops shrinkage checks—Favors granulation of soil—Barometric and temperature changes—Suctional effect of rains.....	419-421
<i>Too Thorough Aëration of the Soil.</i> —Leads to destruction of humus—Care of open soils.....	421, 422
<i>Drainage Increases the Supply of Available Moisture for Crops.</i> —Deeper root penetration—Stronger capillarity —Stronger nitrification—Deeper ground water more available.....	422, 423
<i>Soil Made Warmer by Drainage.</i> —By lessening surface evaporation—By lowering specific heat—Observed differences of temperature.....	423-425
<i>Importance of Soil Warmth.</i> —Relation to germination— Hastens development of plant-food.....	425-428
<i>Conditions under which Land Drainage Becomes Desirable.</i> — Lands subject to frequent overflow—Lands with strong underflow near surface—Tidal plains—Flat lands with heavy subsoils.....	428
<i>Origin of Ground Water and its Relation to the Surface.</i> — Vertical movement of rains—Surface of ground water Lines of flow—Growth of rivers.....	429-435

	PAGES
<i>Rate at which Ground Water Surface Rises away from the Drainage Outlet.</i> —In tile-drained field—Where not tile-drained .....	435, 436
<i>Depth at which Drains should be Placed.</i> —Kind of crop—Seasonal changes of ground water—Character of soil—Distance between drains .....	436, 437
<i>Distance Between Drains.</i> —Texture of subsoil—Depth of drain—Interval of time between rains or irrigations—Climatic conditions .....	437, 442
<i>Kinds of Drains.</i> —Closed—Open—Stone—Wood—Brick—Peat—Tile—Cement .....	443-445
<i>How Water Enters Drains.</i> —Rate through the walls—Through the joints—Care in making close joints—Use of collars .....	445, 446
<i>Fall or Gradient of Drains.</i> —Highest practicable—Selecting course for the main—Care in laying to grade—Change of grade—Use of silt well .....	447-449
<i>Size of Tile.</i> —No specific statement possible except where all details are known—Size increases with length—Seldom smaller than three inches in diameter—Example of sizes and lengths .....	449-452
<i>Outlet of Drains.</i> —Should have a clear fall—Precautions against injury from frost—Connecting laterals with mains .....	453, 454
<i>Obstructions to Drains.</i> —From roots—Kinds of trees most troublesome .....	455, 456
<i>Laying Out Systems of Tile</i> .....	456-459
<i>Intercepting the Underflow from Hillsides</i> .....	459, 460
<i>Draining Sinks and Ponds.</i> —By intercepting surface drainage—By subdrainage .....	460-462
<i>The Use of Trees in Drainage</i> .....	462, 463

*The Use of the Windmill in Drainage.*—Arrangement for winter pumping—Subirrigation as an adjunct . . . . . 463, 464

*Lands which must be Surface Drained.*—Ancient lake bottoms underlaid with clay—Sections where there are no natural surface outlets . . . . . 464-466

CHAPTER XIII

PRACTICAL DETAILS OF UNDERDRAINING (pages 467-492)

*Methods of Determining Levels.*—Kinds of levels . . . . . 469-471

*Leveling a Field.*—Making contour map—Using the level . . 471-473

*Location of Mains and Laterals.*—Securing the greatest fall . . . . . 474-476

*Staking Out Drains.*—Grade pegs . . . . . 476, 477

*Determining the Grade and Depth of Ditches.*—Method of marking stakes for use of ditchers . . . . . 477-481

*More than One Grade on the Same Drain.* . . . . . 481

*Digging the Ditch.*—Tools used—Method of procedure—Methods of filling . . . . . 481-488

*Cost of Underdraining.*—For mains—For laterals . . . . . 489-491

*Peat Marshes* . . . . . 491, 492

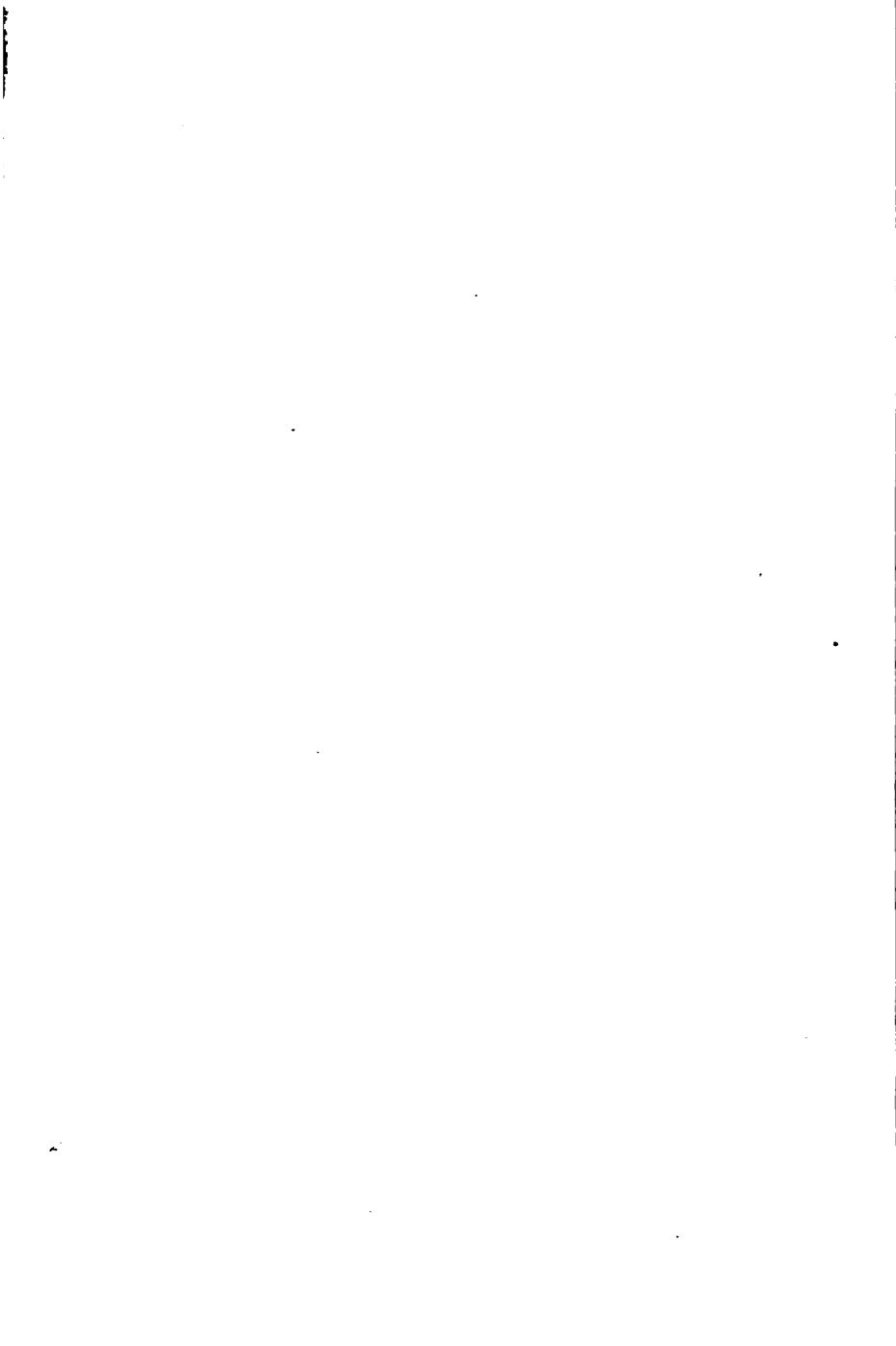

growing parts of plant life, than because it is the medium in which the transformation of the crude materials into assimilable food-products takes place, and through and by means of which these products are transported to their destinations at the various points of growth. It is only when we fully appreciate the important role played by water in crop production, that we are in position to see how necessary to large yields is the right amount of water at the right time, and thus be led to insure to our crops a sufficient irrigation and an adequate drainage.

Since the falling of rain upon soils has always been intermittent in its character, and during the intervals of fair weather a part of the water so given to the soil has been lost by drainage, land vegetation, during its evolutionary stages, has become fitted to do its best work when the soil is watered once in about so often, and when that soil retains a certain amount of the rain which falls. But the intervals between rains in almost all countries are irregular in length, and the amount of rain which falls at one time also varies between very wide limits, so that in many if not in the majority of climates, those seasons are rare indeed when a crop can be carried to maturity with the soil containing at all times the best amount of moisture. This being true, there will occur times with almost all soils when they would give larger yields if they could be artificially irrigated or artificially drained, according as the period is one of deficient or of excessive rain.

But not all soils are alike in their capacity for re-

taining moisture and of permitting it to drain away, and this being true, under one and the same conditions of rainfall one field might be benefited by irrigation while another one would profit by better drainage.

It is this fact of varying capacity of soils to store water for given periods of time that, in the long struggle for existence and of fitting and refitting among plants, has led to the evolution of certain species which can thrive best in a soil of coarse texture, retaining but small amounts of water for any length of time, while other species have become adapted to the soils of finer texture and higher water capacity. This is a fact of fundamental importance, not only in deciding what crops may be grown in a given soil, but whether or not it will be desirable to irrigate such lands beyond the natural rainfall.

A soil of fine texture is spoken of as the best grass land, for example; but this has reference, in a very large degree, to a certain amount and frequency of rainfall, which chances to be such as to maintain for the grasses the amount of water in the soil under which they have become accustomed to grow best. If there were another soil in the same locality, of similar composition but of coarser texture, and so of smaller water capacity, it is most probable that this soil would be converted into equally good grass land, giving just as large or even larger yields per acre, if only the natural rainfall were supplemented by artificial irrigation, so as to hold the water of the soil up to that quantity which the grass has become accustomed, by long breeding, to use.

Then, again, on the other hand, the soil which for a given climate is so close-grained that it does not drain sufficiently between rains to leave it dry enough for those crops which have become accustomed to the smaller water capacity of the coarser soils, may be all right for the dry-soil crop, provided it occurs in a locality of smaller or less frequent rainfall. Or, again, in the region of heavier rainfall, this soil may be fitted for the dry-soil crop by thorough under-draining, when the lines of tile are placed close enough to draw down the water to a sufficiently low point to leave the soil with the amount of moisture which is suited to the crop in question.

Another soil may be very deep and exceptionally well aërated, on account of its peculiar texture, so that the roots of cultivated crops easily penetrate it to much greater depths than is possible in the closer, more compact, non-aërated subsoils of other localities. When this is the case, as appears often to be true in arid and semi-arid climates, notably in parts of the San Joaquin Valley, in California, the smaller rainfall of the winter season penetrates the soil so deeply, and returns to the surface by capillarity so slowly, that fair and even large crops are often raised on these soils without artificial irrigation, yet not a drop of rain may fall upon the land from May first to September. So different are the conditions in humid soils, like those of the eastern United States, that even a period of ten days without rain, especially if it occurs in the height of the growing season, is sure to bring marked distress even to field crops like maize.



One of the most striking features of the arid sections of the United States, which attracted the writer's attention during his travels through the West, was this apparently greater service of water in crop production than is realized in the more humid climate of the eastern section of this country. Reasoning from general principles, one is naturally led to anticipate that in an exceptionally dry atmosphere and under a clear sky, such as we have in the western United States, the rate of evaporation, both from soil and vegetation, would be exceptionally rapid, and hence that enormous quantities of water would be required in crop production, when compared with the demands of crops under more humid conditions.

Such, however, does not appear to be the case, and it is this fortunate relation which makes it possible for larger areas to be placed under irrigation with the limited amounts of water than would be possible were the conditions of the soil more like those of humid climates.

It is not easy to assign a thoroughly satisfactory set of reasons for this marked difference without a more detailed study of the field conditions than has yet been made. It seems quite probable, however, that prominent among the reasons to be assigned for these differences is the one to which reference has already been made: namely, the texture of the soil, which allows the water to distribute itself evenly and relatively deep in the soil, and it does not return readily and rapidly by capillarity to the surface to be lost.

In passing south from San Francisco, through Lathrop, Merced and Fresno, to Bakersfield, in California, we pass across a long stretch of country where there is at present relatively very little irrigation, and yet through all of the country north of Merced wheat has been extensively grown, and during the early years, when the soil was new, large yields per acre have been realized without irrigation, the crop depending upon the rain which falls during the rainy season of winter and sinks into the soil, to be later used by the deeper feeding roots. In discussing the matter with Professor Hilgard, he informed me that the roots of crops penetrate these soils much more deeply than is normal to them under other conditions, and that some plants, when brought here, really change their habits of root growth through a dying off of the normal surface feeders on account of an insufficiency of moisture in the upper layers.

Professor Hilgard further informed me that over much of the state of California the rains only wet down a relatively short distance, and that beneath this zone of moistened soil the balance is often almost air-dry, extending, in certain cases which have come under his observation, to depths as great as forty feet. Where such conditions as these exist there is, of course, no possibility of crops deriving a supply of moisture through natural sub-irrigation from waters from the foothills or higher mountain masses which rise above the plains.

My own observations on the soils of humid climates convince me that the zone of dry soil to which

reference has been made must act as a powerful adjunct in the retardation of both capillary and gravitational movements of water below the reach of deep root feeding; and if this is true, practically all loss of water by downward percolation is prevented, and the whole rainfall not lost by surface evaporation becomes available for crop production.

There is another condition, brought about by the presence of the layer of air-dry soil beneath the moisture-bearing zone, which in humid regions only exists in exceptional localities, and which may have an important influence in making a larger part of each year's rainfall available for crop production. I refer to the possibility of the large amount of air stored in the air-dry soil beneath the moist layer contributing to deep soil breathing. By slow diffusion upward, and by movements induced by changes in atmospheric pressure, the roots may be supplied with oxygen from below as well as from above, and thus have their feeding depth lowered on this account beyond what is usual in humid soils. So, too, it appears to be quite possible that nitrification and other biologic processes may be permitted to go forward under these conditions, when in humid soils they are largely prohibited for lack of sufficient aëration.

These suggestions, however, do not appear to offer an adequate explanation of the ability of crops to reach maturity in the arid soils of the West without irrigation, when there is no rain for such long intervals; for, as we approached Merced from the north, a very sandy belt of land was passed which was white

is a matter of universal experience in humid climates that on clayey soils heavy protracted spring rains contribute more to the production of large crops of grass than all the manure which farmers can put upon their lands, and that with dry springs fertilizers, of whatever sort and however applied, are of but little avail. So, too, four weeks of copious, timely, warm rains falling upon fields of potatoes after the tubers begin to set, and of corn after the tassels and silk begin to form, are certain to be followed by enormous yields, even when the soil is not rich, unless frost or disease intervenes. On the other hand, let the tuber and grain-forming period of these crops be one of drought, and it is only those soils which are most retentive of moisture, and which have been most skillfully handled, that are able to mature even moderate yields, though the land be very rich.

What, then, do warm spring and summer rains and warm, sweet irrigation waters do in the soil which contributes so much to plant growth? In the first place, it is only through the soil, where very extensive absorbing surfaces of root hairs are developed, that plants are able to obtain the very large amounts of water they need for food and for the maintenance and carrying forward of the physiological processes which are associated with plant growth.

But it is not alone for the crop which is being grown upon the ground that water is needed in the soil; for it must never be forgotten that there are living within the dark recesses of the soil organisms of various kinds upon whose normal and vigorous activity depends, in

a high degree, the magnitude of the specific crop which is to be harvested. The germs which react upon the dead organic matter in the soil, converting it into ammonia, the germs which change the ammonia into nitrous acid, and the germs which transform the nitrous acid into nitric acid,—which is the real nitrogen supply of most of the higher plants,—each and all are dependent for their proper activity upon the right amount of moisture in the soil. Then, there are those symbiotic forms of lowly organisms whose great mission it is to take the free nitrogen from the air and compound it into such forms as shall leave it available for the higher plants, and which, like all other forms of life, must have water and to spare if they are to perform their work. Let the water content of any soil be reduced below a certain amount, and all of these vital processes are inevitably slowed down; let it be reduced to a still lower degree, and the whole line is at a complete standstill.

Now, in humid regions, where the subsoils are much of the time water-logged, and where, as a consequence of this, there is but little soil ventilation, the plant-food builders to which reference has just been made are all of them forced into a thin zone close to the surface of the ground, where their work must all be done; but if this surface zone is allowed to become dry, then the nitrogen-supplying processes must come to a standstill, and the crop which is growing above the ground must have its growth checked, even though it has put its roots down into the subsoil where moisture for its own purposes may be had. Indeed, we may

well believe that one of the chief causes which has led the higher plants to send their roots foraging so deeply into the ground is this great need of water in the surface layer, where the nitrogen suppliers dwell, and for the express purpose of not drawing upon this supply too extensively, and thus leaving the surface soil to become too dry. It is true that when heavy rains come, or when irrigation waters are applied which lead to the percolation of water downward, the nitrates which have been formed at and near the surface are dissolved and more or less completely washed more deeply into the ground, where the deep-running roots are in position to take advantage of them and prevent their being lost; and thus a double gain is secured.

Let us call attention to another important principle. In the soils which have been highly manured, or which are naturally well supplied with organic matter ready for decay, large amounts of nitrates are rapidly formed. Under such conditions the moisture which invests the soil grains rapidly approaches saturation, and finally reaches a point when it is carrying so many salts in solution that the water is no longer suitable for the use of the germs which have given rise to the salts, and their activities are on this account brought to a standstill. But let a rain come which produces percolation, or let the field be irrigated sufficiently to produce the same effect, and at once the salts which have been inhibiting the nitrate-forming process are washed out and a fresh supply of water is left, which at once becomes a stimulus for increased activity, while the ready-formed salts containing nitric acid are carried

to a lower level, where they may be taken up by the deeper-feeding roots. Here, then, we are led to see one of the ways in which water, applied at the surface at opportune times, acts as a wonderful stimulus to plant growth.

If, now, we turn from the irrigation to the drainage side of the same problem, we shall see in another way how fundamentally important this principle is. Let a soil be inadequately drained, and the roots of the plants will be forced to occupy the surface soil, for they cannot abide in the water-logged region. Then, if heavy rains come and percolation results, all of the unused nitrates which may have been in the soil at the time are at once washed below the roots, and perhaps entirely lost to the crop. But, on the other hand, if the soil had been properly drained, so that the roots of the crop could have been two, three or four feet below the surface, then, as has been pointed out, the nitrates would have been washed to the roots, where they would have become at once available. Then, too, when a dry period comes, with all the life processes going on in the soil confined close to the surface, the great demand for water from the roots forces them at once to so completely dry out the section they occupy that a violent check is at once put both upon the plant itself and upon all the food-forming processes in the soil; for, under these conditions, it is usually impossible for capillarity to keep pace with the loss of water from above, and the soil quickly becomes too dry.

So far we have been speaking of the importance of

water in the soil to the direct vital processes which are going on there whenever steady growth is taking place. But there are other processes which are purely physical, to which attention needs to be called before we have brought into view the full line of operations to which this great agent, water, leads.

Other plant-foods,—those which contain the phosphoric acid, potash, lime, magnesia, iron and sulfur,—must be taken from the inert solid form in the soil into solution in water before they can be of any service in plant growth, and this is another of the important roles which water has to play in the life processes of the soil. Then, too, all water used in irrigation, and even rain water, contains larger or smaller quantities of plant-food, either directly in solution or borne in suspension, which adds so much to the fertility of the soil itself.

So, too, all waters which have been exposed to the atmosphere have become charged with oxygen, carbonic acid and nitrogen, which they carry with them into the soil, and these always aid, in one way or another, both the physical and the life processes which make for fertility of the land. And, again, when a large volume of warm water falls upon or is applied to the soil, and it sinks deeply into it, it carries with it not only its own warmth, but also the heat which it may have absorbed from the surface of the ground; and this warmth, carried deeply into the ground, makes the root action stronger and at the same time increases the rate of solution of plant-food from the soil grains. When we have made this brief survey of what warm



much larger returns in grass than do river, lake or well waters. The writer learned, while visiting the celebrated Craigentenny meadows near Edinburgh, that the purchasers of the grass from those lands are very particular to specify, as a condition of their purchase, that their grass shall be watered with the day sewage, which contains a higher per cent of soluble and suspended organic matter than that of the night; and they are also particular to stipulate that they shall have the first rather than the second or third use of the water, knowing that water which has passed over a cultivated field or meadow has lost something of its fertilizing value.

It is asserted, also, by the owners and renters of water meadows in the south of England, where the irrigation is directly from the streams, that that land which receives the water first is most benefited by it. It is true that there are those who contend that on their lands the second and third waters are as good as the first, but this is quite likely to be due to the presence in those particular soils of an abundance of the substances carried by the waters.

It is, however, impossible to overestimate the importance of water as a plant-food. It is indispensable and is used more than any other substance. It must be borne in mind, however, that irrigation waters are seldom, if ever, a complete plant-food.

#### THE AMOUNT OF WATER USED BY PLANTS

The amount of water which is required to mature crops of various kinds under field conditions varies between wide limits ;

but just what are the precise factors, and what their quantitative relations, is not yet so definitely known as it needs to be. The problem is manifestly a complex one, and many of the factors are obscure, and will only be made known in their quantitative relations after much patient critical work has been done having for its prime object the solution of this problem.

It has already been pointed out that there appears to be relatively less water consumed in the production of a pound of dry matter under some of the conditions which exist in arid America than is required in the more humid sections of this country, and that it appears probable that a part of this difference is to be sought, possibly, in adaptive functions in the plant itself and a part in the differences of soil conditions.

Under the natural conditions of the field, it would be expected that very much will depend upon the character of the season; that is, whether the season is humid or dry, whether the temperatures are high or low, whether the wind velocities are strong or light, and whether the amount of sunshine is more or less. Very much, too, will depend upon the soil and the character of the rainfall, whether the soil is open and the rains are frequent and heavy, so that considerable amounts of water are lost to the crop by percolation and under-drainage, or whether the soil has a retentive texture, and the rainfall is so proportioned that relatively small amounts are lost, nearly all being used in the production of the crop. Then, too, the manner in which the crop is disposed on the field, whether it covers the surface closely, as do the grasses and small grains, or whether considerable areas of the field are exposed to the direct action of wind and sun, as in many of the hoed crops and in orchards, must have a marked influence in determining the actual amount of water which will disappear or will need to be applied during a season, in order to maintain the best moisture conditions for the particular crop.

Then, again, the treatment of the soil itself will have much to do with the quantity of water which disappears at once from the surface without in any way benefiting the crop, and also the quantity which drops at once entirely through the root zone, con-

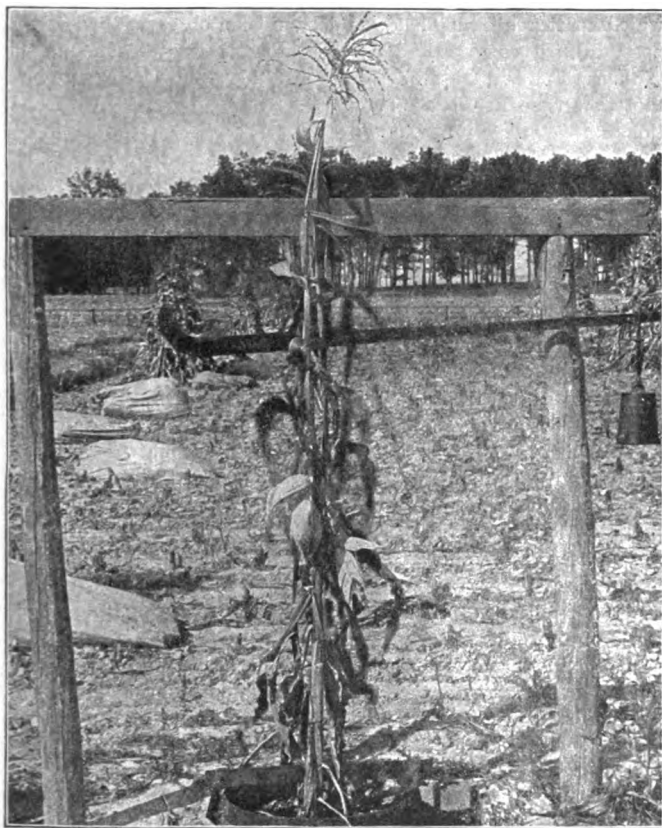

**Fig. 1.** Method used to measure the amount of water required to produce a pound of dry matter.

tions of the cylinders than could have occurred in the corresponding depths in the field soil. Just how these differences of temperature conditions have modified the results we are not yet in a position to say, but it is not likely that they have caused very

From these figures it appears that while more water was lost in the field, for each pound of dry matter produced, than in the pot experiments, the amount of water used per square foot in the pots was in every case much greater than it was in the field. So, too, were the yields of dry matter, when expressed in units of equal areas, much greater in the pots than they were in the field. These relations are very suggestive, though, of course, not at all demonstrative, that the larger amount of water used per unit area in the pot experiments is to be credited with the larger amount of dry matter produced per unit area. The differences are certainly in the direction we should expect if water plays the important part we have attributed to it, and if in the field experiments the several crops did not have all of the water they might have used to advantage.

In 1892 pot experiments similar to those described were conducted with barley, oats, corn, clover, and field peas, using galvanized iron cylinders 18 inches in diameter and 42 inches deep, placed in the field, surrounded by the field crop, and each experiment being in duplicate. The results of these trials are given in the table below:

*Table showing the amount of water used in producing a pound of dry matter in Wisconsin in 1892*

	Water used	Dry matter produced	Water per lb. of dry matter	Computed yield per acre	Water used
	LBS.	LBS.	LBS.	LBS.	INCHES
Barley 1.....	216.12	.576	375.21	14,196	23.52
Barley 2.....	206.12				
Oats 1.....	174.6	.3322	525.50	8,180	19
Oats 2.....	167.58				
Corn 1.....	235.96	.9905	238.22	10,184	25
Corn 2.....	225.24	.5657	398.15		
Clover 1.....	337.36	.5077	564.43	12,486	29.73
Clover 2.....	348.66				
Peas 1.....	155.24	.3252	477.37	8,017	16.80
Peas 2.....	139.17				

If, now, we express the relation between the amount of dry matter produced and the number of inches of water used in these trials and in those of 1891, it will be seen that the yields of dry

than 2.2 times the amount of water which was available for the field crop.

In 1893, oats used water at the rate of 595 pounds per pound of dry matter on a sandy soil where the yield was 1.196 pounds on 7.069 sq. ft., making a yield of 7,370 pounds of dry matter per acre. But in this case the pot was a galvanized iron cylinder 6 feet deep, standing above the ground, so that the evaporation would necessarily be large, as the figures show it was. Expressed in inches, the water used was equal to 19.37 inches of rain.

Clover, too, was grown in the usual form of cylinder in the ground in the field, and two crops cut from each of two cylinders, producing the yield and using the amounts of water stated below:

	—First crop—		—Second crop—	
	No. 1	No. 2	No. 1	No. 2
	LBS.	LBS.	LBS.	LBS.
Dry matter per acre.....	7,000	9,353	5,734	7,886
Water per pound of dry matter .....	423.14	370.92	983.7	730.9

It will be seen that in these cases the first crops, which were cut July 1, were much more economical of water used than were the second crops, when measured by the standard of the number of pounds of water per pound of dry matter produced. Expressing the water used in inches over the surface covered by the crop, the results stand:

	—First crop—		—Second crop—	
	No. 1	No. 2	No. 1	No. 2
	INCHES	INCHES	INCHES	INCHES
Inches of water used.....	13.06	15.28	24.80	25.44

It is thus seen that the two crops of clover, averaging for the four cases a yield of 7.493 tons of dry matter per acre, and equivalent to 8.815 tons of hay containing 15 per cent of water, used for the season a mean of 39.33 inches of water, an amount which considerably exceeds the total annual rainfall of the year for this locality.

Side by side with the clover trials of 1893, four cylinders were treated in the same manner for corn, all of them growing a flint variety. In these cases, too, one cylinder of each pair had its

soil enriched with farmyard manure, to determine if a rich soil affected in any notable way the rate at which water was used in crop production.

The results of these trials may be stated as given below:

	Flint corn		Flint corn	
	Manured 1 LBS.	Not man'd 2 LBS.	Manured 3 LBS.	Not man'd 4 LBS.
Dry matter per acre.....	34,730	33,620	22,540	9,505
Water used per lb. of dry matter	223.3	232	257.4	223
Water expressed in inches .....	34.23	34.42	25.56	13.06

The difference in yield between cylinders 3 and 4 and 1 and 2 appears to have been due to the condition of the soil at the time the cylinders were fitted, the soil being more moist in 3 and 4, which stood upon ground lower and too wet for conditions of best growth. The field yield of corn surrounding the cylinders, and with the same kind of soil, was 4.4 tons of dry matter, yielding 66.95 bushels of kiln-dried shelled corn per acre, which is large for field conditions with the normal rainfall. But the mean yield in cylinders 1 and 2 was 17.09 tons of dry matter per acre, or almost four times as much, while the average of the four cylinders was 2.85 times as large, but using 2.2 times the amount of water which fell upon the surrounding fields as rain during the growing season for this corn.

It does not, of course, follow from these experiments that well tilled field soil, if irrigated properly, will produce such yields as these which have been recorded; neither does it follow, necessarily, that these large yields owe their excess over normal crops only to the extra supply of water added at the proper times. It does, however, follow from these experiments, we think, that were our water supply under better control and larger at certain times than it is in Wisconsin, our field yields would be much increased, if not actually doubled. It does follow, also, from these experiments, that well drained lands in Wisconsin and in other countries having similar climatic conditions are not supplied naturally with as much water during the growing season as most

crops are capable of utilizing, and, hence, that all methods of tillage which are wasteful of soil moisture detract by so much from the yields per acre. Indeed, what we call good average yields per acre are determined, in a large measure, by the amount of soil moisture which the land is capable of turning over to the crops growing upon it.

In 1894, work similar to that described was done with potatoes, eight cylinders being used, two of which were placed in the

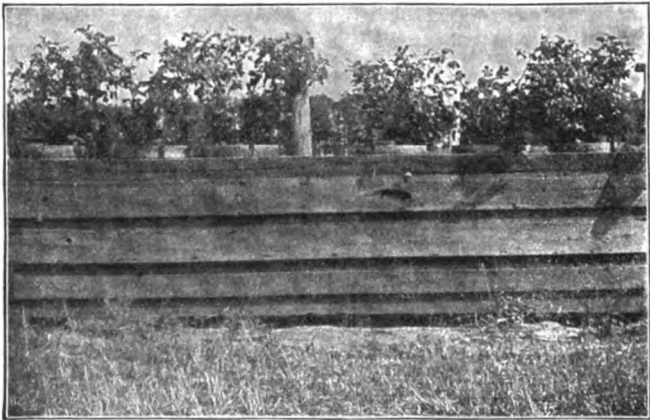

Fig. 2. Potatoes grown in cylinders to determine the amount of water used in producing a crop.

field, as already described, and six others were kept standing upon the surface of the ground, shaded on the south side from the sun in the manner represented in Fig. 2, which shows the potatoes as they appeared when growing. In the same year, oats were again grown in four other cylinders surrounded by field grain of the same kind, and in pots with their tops flush with the top of the ground. A statement of the results of these several trials is here given.

We give, in the first place, in illustration of the rate at which potato plants use water in the various stages of their growth, a

table showing the times of watering and the amounts of water given through the whole growing season for the crop:

Table showing the times of watering potatoes, and the amounts of water given

	—In field—		—Cylinders above ground—					
	No. 1	No. 2	No. 1	No. 2	No. 3	No. 4	No. 5	No. 6
	LBS.	LBS.	LBS.	LBS.	LBS.	LBS.	LBS.	LBS.
Weights at start.....	504	506.7	581	576.5	579.6	579.7	582	579.5
May 15, water added..	.....	.....	19.8	18.4	18.2	17.8	17.9	18.3
June 4, " " ..	10	10	.....	.....	.....	.....	.....	.....
June 13, " " ..	10	10	10	10	10	10	10	10
June 21, " " ..	13	13	10	10	10	10	10	10
June 25, " " ..	10	10	.....	.....	.....	.....	.....	.....
June 30, " " ..	10	10	.....	.....	.....	.....	.....	.....
July 2, " " ..	10	10	10	10	10	10	10	10
July 5, " " ..	15	15	10	10	10	10	10	10
July 9, " " ..	20	20	10	10	10	10	10	10
July 12, " " ..	20	20	12	12	12	12	12	12
July 16, " " ..	15	15	10	10	10	10	10	10
July 20, " " ..	15	15	15	15	15	15	15	15
July 24, " " ..	10	10	8.9	7.1	5.2	10.6	12	6
July 29, " " ..	15	15	15	15	15	15	15	15
Aug. 2, " " ..	10	10	10	10	10	10	10	10
Aug. 10, " " ..	15	20	9.8	22.7	18	18.3	15.1	21.7
Aug. 16, " " ..	.....	.....	10	10	10	10	10	10
Aug. 25, " " ..	.....	.....	8.1	21.4	20.9	16.9	10.3	22.1
Weights at close.....	481.7	492	554	527.8	531.6	528.8	545.5	521.4
Total water added....	198	203	168.6	191.6	184.3	185.6	177.9	190.1
Soil water used.....	22.3	14.7	27	48.7	48	50.9	36.5	58.1
Dry matter .....	.5	.5	.3	.5	.5	.5	.4	.5
Total water.....	220.8	218.2	195.9	240.8	232.8	237	214.8	248.7
Water used, in inches.	24.02	23.74	21.31	26.2	25.33	25.78	23.27	27.06

The potatoes in the two field cylinders matured first, and were dug on Aug. 25, while the others stood until Sept. 21. It should be stated in this connection that all of the potatoes, including those in the field, were affected by the hot weather blight, so that in no case were the plants in full vigor and presenting the normal amount of foliage to the atmosphere.

The yields of tubers in the several cases, and the computed yields per acre, figured as proportional to the surface and vol-



of water, although it was unquestionably less than it would have been had the plants not been affected by the blight. As it was, the plants received an average of 24.6 inches, which is three times the amount of rainfall during their season of growth.

It should be said further, in regard to the amount of water used this season, that the whole of the watering was from the bottom, so that the surface of the ground was kept dry throughout the time. In order to introduce the water at the bottom, a layer of sand was first placed in each cylinder before the soil was filled in, and then a column of 3-inch drain tile was set up against one side, reaching from the bottom to the top of the cylinders, and in adding the water it was poured into these tiles.

In the case of the cylinders of oats which were grown in 1894, they were watered in the same manner, so that in these cases nearly all of the water used did actually pass through the plants.

The results with the oats are given below:

	No. 1	No. 2	No. 3	No. 4
	LBS.	LBS.	LBS.	LBS.
Amount of water used .....	282.8	280.2	283.3	285.6
"    "    dry matter produced..	.5232	.5163	.4198	.4663
"    "    water per lb. of dry matter .....	540.6	542.7	674.0	614.7
"    "    dry matter per acre....	12,900	12,730	10,350	11,500
	IN.	IN.	IN.	IN.
Total water used, in inches.....	30.77	30.48	30.82	31.18

If reference is made to the yields of 1891 and 1892, which have been given on a preceding page, it will be seen that the yields for 1894 have been decidedly larger than they were in the former cases, but so were the amounts of water used by the plants. The mean of the three earlier trials gives a yield of 8,525 pounds of dry matter per acre, using 19.345 inches of water to produce it; but in these last cases the mean yield of dry matter was 11,870 pounds per acre, and the water used to produce it was 31.08 inches. The yields of 1894 average 1.39 times the earlier ones, and the amount of water used in producing this greater yield was 1.06 times the amount required for the smaller.

feet of soil, and all were placed in the plant-house, arranged in the manner shown in Fig. 3.

In these trials, two sizes of cylinders have been used : one 18 inches in diameter and 51 inches deep, and the other 36 inches



Fig. 3. Method of growing plants in plant-house to determine the amount of water used.

in diameter and the same depth. The large cylinders this year have been filled with a black marsh soil, and the small ones with a virgin soil of medium clay loam variety, taken from a second-growth black oak grove.

First, the results obtained from four of the large cylinders sowed to oats Dec. 12, 1896, and harvested July 1, 1897, after a period of 200 days. The oats were sown thick, and grew very rank, lodging quite badly.

The total dry matter and the total water used by the crop of the four cylinders was as given below :

No. of cylinders.....	13	14	23	24
Dry matter produced—lbs. ....	4	3.16	4.93	4.32
Total water used—lbs. ....	1,808	1,668	2,061.5	1,782.5

Dividing the amount of water used on the four cylinders by the dry matter produced, we get, as the mean of the four trials, under the conditions of the plant-house, 446.1 pounds of water for a pound of dry matter, and a yield of dry matter per acre amounting to 12.645 tons, which is very large, indeed. The water used by this crop expressed as rainfall was, as a mean of the four trials, 49.76 inches. Here is a depth of water used from this soil which is a little greater than the soil itself; but the rate at which the water was used, it will be observed, is less per pound of dry matter produced than that for the out-of-door experiments.

In the case of the clover on these black marsh soils, there were eight of the large cylinders used, in four of which medium clover grew, and on the other four alsike clover. These were sown without a nurse crop, and at the same time as the oats, but were cut July 8, so that the period of growth was 207 days. The results obtained here with medium clover were as stated below:

No. of cylinders.....	15	16	21	22
Dry matter produced—gms. ....	507	608	620	573
Water used—lbs.....	673.5	795.5	819	678

Dividing the total amount of water used on the four cylinders by the total dry matter produced, we get 582.9 pounds of water as the amount used per pound of dry matter. In this case the yield of dry matter per acre was 3.92 tons, equal to 4.61 tons of hay containing 15 per cent of water. The amount of water used, expressed in inches, was 20.16.

The alsike clover gave yields and results as follows:

No. of cylinders.....	17	18	19	20
Dry matter produced—gms. ....	628	616	576	634
Water used—lbs.....	809	758	774	804.5

In this case, the mean amount of water for a pound of dry matter was 581.5 pounds, and the yield of dry matter per acre

VARIATIONS IN THE AMOUNT OF WATER USED  
BY PLANTS

It is a matter of very fundamental importance to know what factors or conditions may cause a variation in the amount of water which is necessary to produce a ton of dry matter, because it is only by knowing these that it will be possible to lay down any general principles for determining the amount of water which will be required to produce a given yield.

If we examine the data which have been presented, it will be observed that not only is there a rather wide variation in the amount of water used by different crops, but, also, that there is, further, a wide difference recorded as occurring with the same species or variety, sometimes with the same species in the same year, and sometimes for different years, and it is important to know to what these differences are due.

In the case of corn, for example, where we have grown it under the cylinder conditions in the field, the following variations have been noted:

In 1891, *Pride of the North* dent corn used in one case 295.95 pounds of water for a pound of dry matter, and in the other 307.03 pounds. But in the first case more dry matter was produced by the individual plants, the first producing 4.369 per cent more than the other did, but in doing this only .602 per cent more water was taken; that is, the most vigorous plants have produced the most dry matter when measured by the amount of water used. Indeed, it may be laid down as a general rule, that the more favorable all conditions are for plant growth, the more effective will be the water supplied to the crop. Good management, therefore, will look closely to all details, even to the minor ones, for everything counts in plant feeding just as it does in animal feeding.

Not all varieties of the same species of plant use water in the production of dry matter with the same degree of effectiveness. In our work with dent and flint corn, for example, we have found, as a mean of four trials, that *Pride of the North* dent

corn used water at the rate of 309.84 pounds of water per pound of dry matter produced, and 25.74 inches of water when measured in depth on the area occupied. But four trials with a variety of flint corn gave a mean of 233.9 pounds of water per pound of dry matter, which is 75.94 pounds or 32.5 per cent less than in the case of the dent variety. This is not because actually less water was used per unit area, for the flint corn in these four trials did use a mean of 26.82 inches against 25.74 for the dent corn.

It seems not improbable that this more economical use of water by the flint corn may be in part due to its lower habit of growth and the greater abundance of foliage closer to the ground, for it may be expected that the lower position of the leaves, and their crowding as well, would tend to lessen the amount of evaporation in a given time. But to whatever the difference may be due, it is plain that on light soils and wherever the water supply is limited, larger returns may be secured by paying attention to the variety of plant grown.

The amount of water used by a particular crop might be expected to vary with the humidity of the season and the amount of wind movement during the period of growth of the crop; but the data obtained do not appear to show so marked a relation as would seem should exist. The mean relative humidity of the air at Madison at 2 P. M., in 1891, for June, July and August, was 63.66 per cent, while in 1892, for the same time of day and period, the mean was 68 per cent; and the total wind movement for Madison, these years, for the three months, as given by the records of the Washburn Observatory, was 20,712 miles in 1891 and 18,870 in 1892. But in 1891, 26.39 inches of water gave a yield of dry matter per acre of 19,845 pounds, and in 1892, 25.09 inches gave a yield of 19,184 pounds of dry matter per acre of corn in the plant cylinders in the field. The differences in the amounts of water used during the two years, it will be seen, is very small, especially when it is recognized that in 1892 the dry matter produced, and presumably the evaporation surface also, was less than in 1891.

So, too, in the case of oats for these two years, 19.60 inches of water gave 8,861 pounds of dry matter per acre in 1891, and in

of-doors, with the plants surrounded by the field crop and under the out-of-door meteorological conditions, than they did in the house.

This difference, however, shows larger than it really is, for it has been shown that the use of water is usually more economical in those cases in which the yields are largest, and in these cases there has been a larger yield of dry matter per unit area in the plant-house cylinders than were secured from the cylinders in the field. The total mean yield per acre for the oats, maize and clover in the field cylinders was 6.312 tons and in the plant-house 7.397 tons of dry matter per acre, making the latter yields on the average 17.19 per cent larger; and to this difference in yield must certainly be ascribed a part of the difference in the amount of water given off from the plants and from the soil during the periods of growth. It is quite plain, for example, that the loss of water from the soil surface would tend to be relatively larger, and probably, also, absolutely larger from the cylinders bearing the smallest crop of a given kind. The absolute loss would certainly be largest from the cylinders where the crop had the thinnest stand on the ground, and some of the cases of larger yield per unit area in the plant-house are due to the fact that more plants occupied the same area.

While, therefore, from the general principles governing the rate of evaporation, we are led to expect that more moisture must be lost from vegetation growing in a dry atmosphere than under more humid conditions, we are not able to point to our data as bearing out such a view in any emphatic manner. The rate of air movement in the plant-house has certainly been less than it was in the field, but the higher temperature in the plant-house has probably left the air relatively dryer during both day and night than in the field.

The conditions which did exist, both in the plant-house and in a field of maize, were noted on July 27, 28 and 29. The relative humidity of the air was measured with a wet-and-dry bulb thermometer, and the rate of evaporation was also measured under the two conditions with a form of Piche evaporimeter. Two of these instruments were hung among the corn plants in the plant-

ally controlled by changes in the transpiring surfaces of plants, and if this control is sensitive, then there would also be a tendency to cause the amount of water necessary to produce a pound of dry matter in a given species of plant to remain nearly constant under wide ranges of climatic conditions. That most land plants are provided with organs which modify the rate of transpiration has been long established; but how narrow the limits of control are remains to be demonstrated. It is fundamentally very important that such facts as these should be established, for they are needed in order that we may know how much land under a given crop a given quantity of water will irrigate.

We have, at this writing, just completed a set of observations bearing upon this fundamental problem, and although they are not sufficiently extended to be demonstrative, they are yet very suggestive, and will be of interest here.

If it is true that plants lose little moisture except through their breathing pores, and if these are closed during those times when there is not sufficient light to allow carbonic acid gas to be decomposed by the plant, then during the night, and perhaps, also, during cloudy weather, plants should lose but little moisture through their surfaces. To test this question, one of the small cylinders in the plant-house, containing four fully grown stalks of maize, was hung upon the scales, to be weighed hourly during the day; and by the side of it was set a Piche evaporimeter having an evaporation surface of 27 square inches, also to be read hourly. Below are given the results of these observations:

During the day, from 8:15 A. M. until 6:15 P. M., it was somewhat cloudy most of the time, but the clouds were not heavy, and there was a little sunshine through a haze from 11:15 A. M. until 2:15 P. M. From 8:15 A. M. until 6:15 P. M. the corn and soil lost 3 pounds of water, and there was evaporated from the evaporimeter 31.5 c. c. or 1.2 cu. in. From 6:15 P. M. until 6:45 A. M. the next morning, the corn had not lost enough to show on the scales, which are sensitive to one-half pound; and the evaporimeter showed a loss of 2.3 c. c., equal to .14 cu. in. The next day was bright and sunny the whole time, and from 6:45 A. M.

*Table showing the mean amount of water used by various plants in Wisconsin in producing a ton of dry matter*

	No. of trials	Water required to produce 1 lb. of dry matter LBS.	Water used INCHES	Dry matter produced TONS	Acre-inches of water per ton of dry matter
Barley....	5	464.1	20.69	5.05	4.096
Oats.....	20	503.9	39.53	8.89	4.447
Maize.....	52	270.9	15.76	6.50	2.391
Clover....	46	576.6	22.34	4.39	5.089
Peas.....	1	477.2	16.89	4.009	4.212
Potatoes..	14	385.1	23.78	6.995	3.399
<b>Total</b>	<b>138</b>	<b>Average 446.3</b>	<b>23.165</b>	<b>5.987</b>	<b>3.939</b>

In computing the results in this table, the combined area of all cylinders, the combined weights of dry matter produced, and the combined amounts of water used, have been divided by the number of trials with each kind of crop and the average results used in making the calculations.

In considering these results, it should be kept in mind that the water used by the several crops is made to include that which was lost through the soil by surface evaporation, because it was not easy to measure this separately or to prevent it without introducing abnormal conditions. It is quite certain, however, that during all of these trials the rate of loss from the soil has been somewhat less than would have occurred under the best possible management with field conditions.

Attention should be called to the fact, also, that the large amount of water used, averaging for the 138 trials 23.165 inches, is greater than field conditions would demand, if nothing were lost by percolation, for the reason that we have planted so as to utilize less surface area than is the practice in the field; and it is to this fact, also, that the very large average yields, when computed per acre, are due, rather than to the growth of plants of abnormal size.

#### THE MECHANISM AND METHOD OF TRANSPIRATION IN PLANTS

Since water plays so large a part in the life and development of land plants, and since such large quantities of it are



In the upper part of the figure, the under surface of the leaf is shown covered by its skin or epidermis, through which there can but little evaporation take place except through the opening which is shown at *sp* and the seven others like it; and even

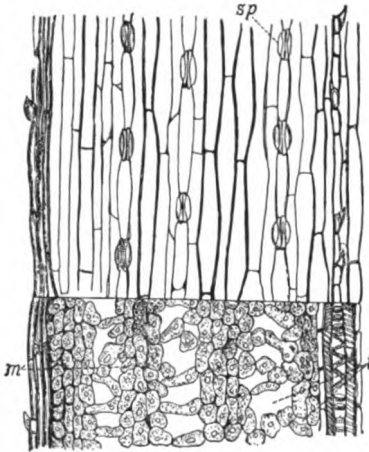

Fig. 5. Structure of barley leaf. (After Sorauer.) *sp* is a breathing-pore; *m*, chlorophyll cells; *i*, respiratory chambers.

these openings or breathing pores are so made that they may be automatically opened wide or almost completely closed when the needs of the plant call for much or little air.

In the lower part of the figure, the skin has been removed from the leaf, so as to show the actual breathing surface of the barley plant, consisting of the cells marked *m*, and which are filled with the green coloring matter of the leaf, or chlorophyll. The open spaces, marked *i*, between the breathing cells, are the breathing or respiratory chambers, which communicate with one another all through the leaf, but under the cover of its

skin or epidermis, which in various ways, by a varnish, a wax or a close mat of hairs, is rendered less pervious to water and to air. In the case of tall plants, like shrubs and forest trees, rising a hundred and more feet into the air, nature has made still greater efforts to avert the danger of plants being destroyed by the action of drying winds. Here we find the trunks and all the larger limbs thoroughly protected by a thick bark, through which there can but little water escape as it slowly ascends from the roots to the leaves; indeed, the more detailed we make the study of the structure and the function of parts in the plant, the more plain it becomes that in most land plants the

volumes of air than have been stated must be brought into close contact with the growing clover in order to meet its needs. This air, however, cannot come into intimate relations with the green chlorophyll-bearing cells of the clover in the field without of necessity permitting the evaporation of large quantities of water from the plants; and this brings us to realize how imperative is the demand for water by rapidly growing crops.

The writer has found, for example, by direct measurement, that the air passing three feet above a clover field, and at a moderate rate, even as early as May 30 in Wisconsin, when the air temperature is only 52.48° F., may have its relative humidity increased from 44 to 48 per cent by the moisture taken from the field; and this means that 3,510 pounds of water are required to make even the observed change of humidity in a volume of 152,600,000 cu. ft. of air, which is the amount required to carry to the clover crop its carbon, supposing all the carbon which the air contained to be utilized. It is quite likely, however, that the volume of air which did contribute its carbon to Boussingault's crop of clover not only exceeded fourfold the amount stated above, but that it also had its relative humidity raised at least to 94 per cent. If these suppositions are true, then the amount of water borne away from the plants in question must have exceeded 176,100 pounds, or at the rate of about 40 pounds of water for a pound of dry matter; but it has been shown on a preceding page that, as a mean of 46 trials, the clover crop did lose from its tissues and from the soil in which it grew 576.6 pounds of water per pound of dry matter produced, so that, large as are the figures stated above, they fall far below the actual ones.

With these estimates and considerations before us, we can readily understand that one of the chief functions of water in plant life is to keep the tissues moist and in a suitable condition to carry on the process of breathing, whose primary object is to get the plant its carbon from the air.

In order that the plant may utilize the carbon of the carbonic acid in the air, it is necessary that this should come to the chlorophyll-bearing cells when there is sunshine enough to decompose it; and since the carbonic acid would be useless at

other times, and since the continual ingress and egress of the air which brings it would entail a steady drain of moisture from the plant by evaporation, the breathing pores in the leaves are usually provided with a pair of guard cells, which are so constituted that they may be opened and closed, and thus exclude nearly all the air from the interior of the plant; or, by partly closing them, to vary the amount of air which may be admitted in a given time.

In order that the escape of moisture from the plant may be as little as possible when the breathing pores must be open to admit air, the great majority of them are placed on the under or shaded side of the leaf. Thus Goodale, quoting from Weiss, gives in a table the number of breathing pores observed per square millimeter of surface on both the under and the upper surfaces of the leaves of forty species of plants, from which it is computed that, on the average in these cases, there are 209 breathing pores on the lower side of the leaf for every 51 on the upper side. How numerous and how minute these openings are may be appreciated when it is said that in the forty cases cited there are, on the average, 209,000 stomata on each area the size of the square in Fig. 6, on the under sides of the leaves of these species. Taking a specific case, that of corn, *Zea Mays*, it is stated that the breathing pores number, on the under side of the leaf, 158, and on the upper side 94, or in all 252 for each square millimeter of leaf, and that the combined area of these openings is .2124 of a square millimeter, so that 21 per cent of the leaf surface of corn is made up of doorways through which air may reach the interior of the plant, and out of which moisture must escape whenever they are open.

It is not strange, therefore, that large amounts of moisture do escape from plants while they are growing, nor that there has been provided a means of checking this loss as far as possible.

The opening and closing of the guard cells is brought about by changes in the quantity of material which they contain, causing them to open when the cells become distended and to close when they again become limp. Unlike the other cells in the

and water and coal, stations itself in any fertile soil, and does its work with the warmth of a summer day.

In all our problems of land drainage and irrigation, we are searching to better understand, and through this better understanding to better meet, the conditions under which a system of roots can best do its work. But the foundation of such an understanding should be a knowledge of the root itself, and how it places itself in the soil in order that it may do its work. Let us attempt, then, to present in a brief form what has been learned regarding the essential features of root structure and root action.

Roots have three distinct functions to perform in land plants having green leaves: first, to absorb moisture and the salts held in solution; second, to convey and deliver into the stem of the plant the water which has been absorbed; and third, to act as a support to the plant and hold it upright in the air and sunshine, whenever it is not trailing or climbing in habit, or is without stems.

It appears to be the general conviction among plant physiologists that only the very tip ends of the roots are particularly serviceable as absorbing agents, and that even these are serviceable for a short time only. Farther than this, it is the root-hairs which branch out in great numbers from them, rather than the fine roots, which are the real absorbing surfaces. These root-hairs are extremely delicate, thin-walled tubes, usually not more than one-eighth of an inch long and a hundredth of an inch or less in diameter, which stand out on the root surfaces like the pile on velvet. These absorbing root-hairs never form at the very tip end of a

new advancing root, and as, according to Sachs, they die off after a few days, they form a brush-like covering on the root for a distance of half an inch to two or three inches, dying off behind and forming anew as the advance is made into new soil. In Fig. 7 are shown the roots of two seedling white mustard plants, A with the particles of soil still adhering to the



Fig. 7. Root-hairs of mustard plants.—A with soil adhering. B with soil removed. (After Sachs.)

root-hairs and held in a body about the young root, while B is intended to show the appearance of the plant with the soil grains washed away. So, too, in Fig. 8 is shown the root of wheat soon after germination, and again four weeks later, after the root has advanced into new soil, and the root-hairs have died away behind and new ones formed.



Fig. 8. Root-hairs of wheat.—A when very young, B four weeks later. (After Sachs.)

The soil grains of a good soil are very small, the majority of them even much less than  $\frac{1}{100}$  of an inch in diameter. Indeed, in a heavy clay soil one-half of the dry weight may be made up of soil grains as small as  $\frac{1}{250000}$  of an inch in diameter. Now, the fine root-hairs make their way in between these minute soil grains, and even change their shape to fit themselves closely upon their surfaces in many cases.

The soil particles are themselves invested with a thin layer of water, even in the condition which we know as air-dry, and as these minute root-hairs apply themselves closely to the surfaces of the soil grains, they are brought into immediate contact with the soil moisture. Indeed, capillarity has the same tendency to invest the root-hairs with a film of moisture that it has the soil grains, and we may suppose, in the absence of direct observation, that the root-hairs all the time carry a film of moisture equal in thickness to that which invests the soil grains of like diameters, except in so far as the film of water is thinned out by the flow through the walls of the root-hairs and away through the root to meet the demands in the green parts of the plants. Such a thinning out of the film of water on the root-hairs does take place

Just as soon as this happens, however, the balance between the motion inside of the root-hairs and that outside of them will be destroyed, and then more water will enter the root-hair from the soil than has been escaping from it into the soil in a unit of time. This will thin out the film of water which surrounds the root-hairs, and then water which has been surrounding the soil grains, impelled by surface tension, must advance upon the root-hairs to make good that which has been lost; and just so long as the water continues to enter the roots from the root-hairs faster than osmotic pressure can restore it, just so long will surface tension force the water from the soil grains upon the walls of the root-hairs.

Not only will the water which surrounds the soil grains move toward and upon the root-hairs so long as evaporation is going on from the plant and assimilation is taking place in its cells, but with it will go the salts containing potash, nitrogen, phosphorus, and other ash ingredients of plants, which have been dissolved by the moisture surrounding the grains.

In the figure the root-hair, *h, h*, leading out from the main root, *e*, is represented, for the sake of clearness, nearly full width throughout its course, and, as if it had either found or had made for itself, by setting the soil grains aside, an unobstructed path in which to develop. As a matter of fact, these root-hairs are obliged to work their way as best they can between the angles formed by the meeting of the soil grains, changing both their direction and their form in order to do so, and sometimes the spaces are so narrow or the turns so abrupt that the root-hair seems to have applied itself to the soil, and to have adapted its shape so as to more completely come in contact with the surface of the grain itself.

As the water surrounding the soil grains, and which is also drawn out upon the root-hairs, becomes more and more exhausted, the film finally becomes so thin that the rate at which the water can be moved out upon the root-hairs is so slow that it is no longer able to meet the needs of the plant, and it wilts, and finally ceases to grow altogether.

Attention should be called to the fact that fresh growing

occupied with corn roots that not a cube of earth one inch on a side existed in the three feet of depth which was not penetrated by more than one fiber of threadlike size. In many parts of the soil the roots were much closer together than this.

At the distance apart of planting in the field from which these roots were taken, there were, in the surface three feet,  $40\frac{1}{3}$  cubic feet of soil available for each four stalks, so that by multiplying the 1,729 cubic inches in one cubic foot by  $40\frac{1}{3}$ , the number of cubic feet of soil occupied, we get a total of 69,696 cubic inches. If, then, each cubic inch of this soil contained not less than one linear inch of thread-like root, their aggregate length could not be less than one-twelfth of 69,696, or 5,808 feet, which is 1.1 miles. But this extent of root-surface does not even express the amount of that to which the root-hairs, which are the real absorbing surfaces, are attached; and hence we must understand that the actual area of surface of root-hairs for a full-grown hill of corn is very much greater than would be indicated by the figures given above.

Let the reader bear in mind that the corn roots here under consideration grew in the field under perfectly natural conditions, and that the cage of wire shown in the engraving was simply slipped over the block of soil which contained the roots there shown, after the corn had reached that stage of maturity. It should also be understood that the four stalks of corn which absorbed from the soil the 150.6 pounds of water in 13 days did it at the stage of growth represented by the oldest plants in Fig. 11; and further, that these were only good average plants, such as would make a yield of 4.5 tons of dry matter per acre.

It may be difficult for some persons to realize how it is possible for the delicate roots of plants to force their way through the soil to depths such as are indicated by the engravings above, especially when the subsoil is a stiff, heavy clay, as it was in this case. Nature's method of overcoming the difficulty, however, is simple enough when we come to understand it, and it is as effective as it is simple.

The first fact which we need to understand when we wish to learn how a root advances through the soil, is that the soil grains

root in the soil. It has been found that a short way back from the tip end of a growing root, there is at 1 a center of growth, where new cells are developed by repeated enlargements and divisions. On the forward or advancing side of this center the new cells form the root-cap, which in the figure is represented by the cells

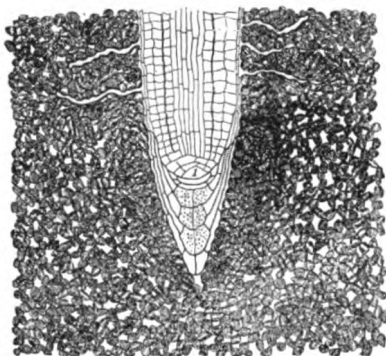

Fig. 12. Method by which root-hairs advance through the soil. (Adapted from Sachs.)

with heavier lines; while those forming on the rear side of the center are finally transformed into the various structures which constitute the body of the root proper.

The root-cap is a sort of shield or thimble, under the protection of which the root advances to set aside the soil grains, and the method of advance is this:

At the center of growth, new cells are forming and enlarging out of the assimilated products which are being brought down

from the green parts of the plants by osmotic pressure. But when this strong pressure drives the sap into the forming cells, they must enlarge just as the dry wood swells, and in doing so something must give way. As the body of the root is larger than the tip, and as it is already anchored to the soil by the root-hairs and any branches which may have formed, the direction of least resistance is forward, and the cells which are in the interior of the base of the root-cap are crowded forward and the walls of the cap are wedged outward so that the soil grains on all sides are displaced, making room for the end of the root proper to be built into it. The root-cap does not slide forward through the soil, shoving past the soil grains, but its outer and rear cells hold firmly against the earth as the root builds past them, and as fast as they have performed their function they die and new ones are



formed in advance. The root-cap, then, is a sort of point through which the root advances, and which is being continually replaced by a new growth.

The increase of the root in diameter throughout its length is produced by the addition of new cells wholly within those which lie in contact with the soil, and the same osmotic pressure is the power which is exerted outward on all sides to move the earth away and give room for the increase in size.

Since this osmotic pressure in the roots of plants may be very great, certainly more than 100 pounds to the square inch, and presumably several times this amount, and since during the growth of the root the pressure is increased slowly, and acts gradually to set the soil aside, it is not difficult to see that the plant has chosen a method of making its way through the soil which is not only effective, but one which utilizes the energy and the materials present in a soil during the growing season with which to accomplish its purpose. The molecules of soil moisture are at once the hammer and the wedge, which are driven by soil temperature into the growing cells to expand them and set the soil aside.

minions, their historian, Polybius, drew a similar picture of the high state of cultivation of this country.

In the early days of both Grecian and Roman history, great progress had already been made by these peoples in handling and conveying water by gravity over long distances for domestic purposes. At Patara the Greeks, according to Herodotus, carried an aqueduct across a ravine 200 feet wide and 250 feet deep, constructing a pipe line by drilling 13-inch holes through cubic blocks 3 feet in diameter, fitting these blocks together with curved necks and recesses, whose joints were laid in cement and held secure by means of iron bands run with lead. This was an inverted syphon, now so often used to cross a ravine or cañon in the west, but made from stone instead of steel or redwood hooped with steel, so commonly used to-day.

Rome was supplied with water in Nero's time by nine separate aqueducts aggregating a length of 255 miles, and which delivered daily 173,000,000 gallons of water, which was later increased to 312,500,000 gallons. The Aqua Martia conduit, which brought the drinking water for the city, had a diameter of 16 feet, and was 40 miles long.

When the Romans invaded France, they constructed great systems of water works for cities in various places—at Lyons, Souy, Nismes, Frejus, and Metz. The Nismes conduit was constructed at the time of Augustus, 19 B.C., and delivered 14,000,000 gallons per day. It is noted for the great Pont du Gard, which carried it across a ravine, and which is spoken

farm laterals. The water is served once each week, on the same day and hour, the amount received being regulated by the amount purchased. The delivery commences on land farthest from the main canal, and each proprietor turns off the water from his lateral when he has received the amount paid for, and the next in order is then served. The assessment is made out by November 1, and each irrigator is notified of the days and hours when water will be applied to his land. This irrigation is used almost wholly on meadows, and it is stated that the value of land has increased

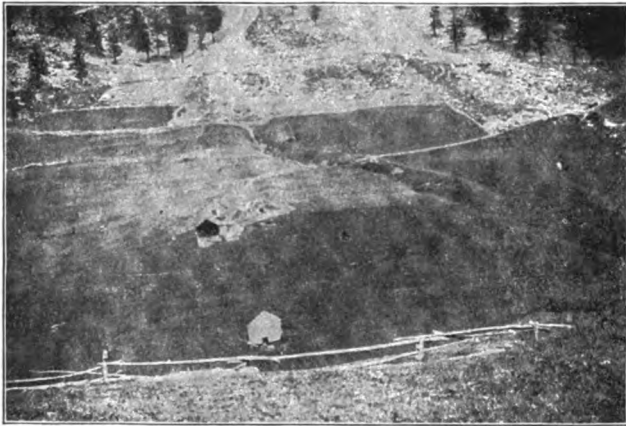

Fig. 14. Alpine water-meadows on the south side of the Simplon Pass, Switzerland.

from \$44 to \$300 per acre since the development of the irrigation facilities.

In Switzerland, the mountain streams and rills are used in very many places on meadows, and this has been done so long and continuously on some meadows that very decided ridges have been formed from the sediment moved by the water: and we were surprised to find that, even so high up as the south side of the Simplon Pass, meadows are regularly irrigated, even by the waters

posed that they were introduced from the Netherlands; but the fact that the character of the works bears a much closer resemblance to the Italian construction, and that extensive tracts of irrigated land are found in the vicinity of ancient Roman stations, as at Cirencester, lends support to the former view.

This water-meadow irrigation of England is largely confined to the southern parts of the island, as in Berkshire, along the Kennet; in Derbyshire, in the valley of the Dove; in Dorset; in Gloucestershire, along the Churn, Severn, Avon, Lidden, and other streams; on the Avon, Itchen, and Test, in Hampshire; in Wiltshire; in Worcestershire and in Devonshire, where catch meadows



Fig. 16. River and canal for water-meadow irrigation, at Salisbury, England.

are laid out in the valleys of many rivers and brooks. In Figs. 16 and 17 are shown two views of water-meadow construction at Salisbury, in England.

If we pass to the continent of Asia, we shall find irrigation practiced over a wide extent of territory in many countries, but nowhere on so large a scale as in the ancient and modern developments in India. How wide the extent of irrigation is in India may be most easily comprehended from the map, Fig. 18, where, from Lahore, in the northwest, to Calcutta, in the southeast, a distance of nearly 1,400 miles, and covering a mean width not less than 100 miles, a large share of the land is under irrigation. Other modern irrigation works are to be found at Cuttack, on the

Mahanadi River, and farther south, at various points in the Madras Presidency. On the western side of the peninsula, too, back from Bombay, both at Poona, in the valley of the Mutha River, and at



Fig. 17. Ridged surface of a water-meadow, Salisbury, England.

Bhutan, where there is a great dam 4,067 feet long and 130 feet high, which forms a reservoir for the supply of the Nira canals, are other extensive modern irrigation systems. The Vir weir, at the head of the Nira canal, is 2,340 feet long, with a maximum height above the river bed of 40 feet, and over this weir, at maximum flood, there pours 160,000 cubic feet of water per second, in a sheet 8 feet deep over the crest.

The number of wells used for irrigation in the Madras Presidency has been estimated at not less than 400,000, while the area they serve is placed at 2,000,000 acres. It is further estimated for the whole Indian peninsula, British and native, that not less than 300,000 shallow wells are in use, while they serve certainly more than 6,000,000 acres of land.

Referring, now, more particularly to the extent of irrigation enterprises in India, we learn from Richard J. Hinton's report to the Senate that in the Madras Presidency, with a population of



Fig. 18. Canal systems in India. (T. S. Geol. Survey.)

ber of wells, which supply from 4,000 to 6,000 gallons each 24 hours.

In the Indus valley, there are many small canals, ranging from 8 to 16 miles in length, having a sum total of 709 miles, which supply water to 214,000 acres. Three other important systems supply 411,000 acres, with a total length of channel amounting to 1,479 miles. The Lahore branch of the Bari-Doab canal irrigates 523,000 acres, besides supplying the water needed by 1,352 villages. The cost of these works in 1889-90 had reached \$7,872,000, while the year's net proceeds of the water supply was \$873,000, with an associated expenditure of \$288,000.

In the province of Orissa, with an area of 24,000 square miles and a population of 4,250,000, there were, in 1889-90, 511,000 acres of land under the canal systems, ready for irrigation.

Aside from these Anglo-Indian enterprises to which reference has been made, Hinton states that the native or independent states of India comprise two-thirds of the peninsula, and that their peoples are extensive irrigators. The most advanced of these states, viewed from the standpoint of agriculture and irrigation, is Jaipur, with an area of 14,463 square miles and a population of 2,500,000. It has 108 separate systems of irrigation works, with 364 miles of main canals and 422 miles of distributaries. In the native state of Mysore, there are 1,000 miles of irrigation canals and 20,000 village tanks.

In the island of Ceylon, a decided effort has been and is being made to restore and to extend the ancient irrigation systems, which have been allowed to fall into ruin. The British authorities in 1891 had already restored 2,250 of the small and 59 of the large tanks or reservoirs; they have constructed 245 wiers and 700 miles of canals. There are now over 5,000 ancient reservoirs in the island, and one king, in the twelfth century, is credited with having had constructed 4,770 tanks and 543 great canals.

In Australia, work seems to be largely prospective as yet, with but few results actually attained. But there are some 500,000 acres in Victoria to be served by irrigation works which are in progress. In New South Wales, the amount of land in 1891

against the watered area, which begins at Assuan, some 500 miles from the sea, not following the windings of the Nile. The population of this country is now given as 5,000,000, but it has been estimated that Egypt once supported 20,000,000 inhabitants; and a practice of today, which will seem strange to the reader, is that of digging up the rubbish piles on the sites of ancient villages, towns and cities, which represent the waste of the millions who have passed away, and using this as manure to fertilize the fields now under irrigation. The dry climate of this country has preserved these materials from complete decay, and the site of old Cairo is now being dug over to enrich the fields for miles around.

The mean daily discharge of water which passes from Upper Egypt, at Cairo, into Lower Egypt is estimated at 8,830,000,000 cubic feet, but as large as this amount is, it would require 20 days to place Wisconsin under an inch of water.

In the Algerian Sahara, since the sinking of the first artesian well, in 1848, at Biskra, by M. Henri Fournel, the work went forward, until in 1875 there had been 615 wells put down, having an average depth of 145 feet, 404 of which are in the province of Constantine, 194 in the province of Algiers, and 15 in that of Oran. A strange thing about these artesian waters is the presence in them of nitrates, and irrigation with them has brought upon the desert sands wonderful oases, 43 in number in the Oued Rir, supporting, in 1885, 520,000 date palms of bearing age, 140,000 palms from one to seven years old, and about 100,000 other fruit trees.

On the south side of the equator, in Africa, there has as yet but little been done in the way of irrigation, although in Cape Colony efforts are being made. In 1889 the U. S. Consul at Cape Town, Geo. F. Hollis, states that the most complete storage work now constructed in the colony, and the most important, is that at Van Wyck's Vley. The rainfall in this section is very irregular, the average for 11 years being 10 inches. The reservoir has depended upon a catchment area of, say, 240 square miles, but this has been found inadequate, and a furrow is now nearly completed to bring over water from a neighboring river, by which it



is estimated that the water-covered area will be increased to 19 square miles, with a depth of 27 feet. The land under irrigation is owned by the government, and is leased at a minimum rate of 10 shillings per acre.

In the island of Madagascar, on the east, and that of Madeira, on the west of Africa, irrigation is also practiced; in the former for rice culture only, and by the system of flooding; but in Madeira the system is both elaborate and extensive, covering over one-half of the whole island, or 120 square miles. There are no catchment basins or reservoirs other than those which nature has provided, and the water used is that which the soil collects during the rainy season and gives up in the form of springs. The water carriers have been constructed with care and skill, and some of them have a length of 60 or 70 miles. The thrifty farmers have on their lands reservoirs into which they collect their share of water when it is delivered to them, and from this distribute it to their several crops as they desire; but the poorer class, who cannot afford the reservoir, are obliged to use the water directly as it comes to them, and as the intervals are long between the delivery of water they are not able to make the best use of that which they get, and their crops suffer in consequence.

In the Pacific Ocean, too, there are islands in which irrigation is practiced with great skill outside of those of Japan, to which reference has already been made. Among these may be mentioned those of Hawaii, and the development of the sugar industry there has in recent years led to a corresponding development of the facilities for irrigation, as would be expected when it is stated that adequate irrigation there has increased the yield of sugar from 2 tons to 4 tons per acre. It is stated that there are about 90,000 acres under cane, one-half of which is irrigated; some 7,000 acres of rice, and 5,000 acres of bananas, the rice being all under water. The water supply comes from mountain streams, with their reservoirs, and from springs and artesian wells.

The artesian wells about Pearl Harbor are among the largest, yielding an enormous quantity of water, sufficient to irrigate 20,000 acres of rice and a large area of bananas and other products besides. There have been 100 of these wells sunk about the mar-

gin of this island, 21 to 42 feet above ocean level, in the last 12 years, and four of them are said to yield water enough for a city of 165,000 inhabitants.

In the island of Java, too, irrigation is extensively practiced, and regarding the island of Lomboek, still to the east of Java, Mr. Arthur R. Wallace writes: "It was here that I first obtained an adequate idea of one of the most wonderful systems of cultivation in the world, equaling all that is related of Chinese industry, and, as far as I know, surpassing, in the labor bestowed on it, any tract of equal extent in the most civilized countries of Europe. I rode through this strange garden utterly amazed, and hardly able to realize the fact that in this remote and little known island, Lomboek, from which all Europeans (except a few traders at the port) are jealously excluded, many hundreds of square miles of irregularly undulating country have been so skillfully terraced and leveled and permeated by artificial channels that every portion of it can be irrigated and dried at pleasure."

Passing, now, to the American continent, we have already referred to its prehistoric irrigation works, and to the extensive and complete systems of irrigation found in South America before the occupancy of that continent by the Spanish and Portuguese, for irrigation was practiced there on both slopes of the great Andean ranges. It must be said, however, to the shame of our boasted civilization, that a very large share of those extensive and valuable improvements have been allowed to pass into ruin, and now must be restored at great cost.

In the Argentine Republic, lying between 20° and 56° south latitude, irrigation is being practiced in the provinces of Cordoba, San Luis, Mendoza, San Juan, Catamarca, Rioja, Santiago del Estero, Tucuman; Salta and Jujuy; and it is stated that the total area under cultivation by irrigation will exceed 1,759,600 acres. According to Consul Baker's report, works were begun about 1882-83 on a number of large dams and canals, using the water of four important rivers, at an estimated cost of \$15,280,000, which were expected to have an aggregate capacity equal to about 3,020,000 acres.

While there are large areas in the aggregate irrigated in

other parts of South America, Central America and Mexico, no very definite idea of its magnitude or distribution can be given as yet.

Newell says, in the report of the Eleventh Census, that in the western part of the United States the area irrigated within the arid and sub-humid regions aggregated at the end of May, 1890, 3,631,381 acres, or 5,674.03 square miles, while the total number of farms or holdings upon which crops were raised by irrigation was 54,136. In this irrigation, water was supplied by 3,930 wells to 51,896 acres, at an average cost of \$245.58 per well, the wells yielding an average of 54.43 gallons per minute. The average value of products from this irrigated land per acre he found to be \$14.89, the farms having an estimated mean value per acre of \$83.28, while the average size of each farm or holding was 67 acres. The average value of the product of the average farm was thus \$897.63.

To bring together in close review the extent of irrigation as it is today practiced in the various parts of the world, we may quote the statements of Wilson: "The total area irrigated in India is about 25,000,000 acres, in Egypt about 6,000,000 acres, and in Italy about 3,700,000 acres. In Spain there are 500,000 acres, in France 400,000 acres, and in the United States 4,000,000 acres of irrigated land. This means that crops are grown on 40,000,000 acres which, but for irrigation, would be relatively barren or not profitably productive. In addition to these, there are some millions more of acres cultivated by aid of irrigation in China, Japan, Australia, Algeria, South America, and elsewhere."

These figures seem enormous as we read them, and so they are, but they leave an exaggerated impression on the mind which needs to be corrected, for very few realize the magnitude of the volume of water which must be handled in raising a crop by irrigation. In order that we may not mislead in this direction, we wish to make the correction. Let us suppose that the amount of land which is actually under irrigation at the present time is four times the 40,000,000 of acres which have been enumerated above. Now, were this supposition true, and all of these acres were brought together in one solid square, it would have but 500 miles

on a side. But to cover such an area as this with 2 inches of water once in 10 days would require more than three Nile rivers flowing at maximum flood—a river 50 feet deep, 1.156 miles wide, running three miles an hour.

THE CLIMATIC CONDITIONS UNDER WHICH IRRIGATION  
IS PRACTICED

If we study the conditions of rainfall under which irrigation has been practiced, we shall find rather wide variations in the mean amounts which fall upon the different countries, especially when the mean annual rainfalls are compared. In all of India except the extreme northwest part; throughout China, Japan and Siam, in Italy, and France, and Mexico, as much rain falls during the year as falls in the United States east of the 97th meridian, if we except Louisiana, Mississippi, Georgia and Florida,—an amount ranging from 23.6 inches to 51.2 inches, or between 60 and 130 centimeters. But in Asiatic Turkey, Persia, Afghanistan and the extreme northwest of India; in the irrigated parts of Queensland, Victoria and South Australia; in Cape Colony, Algiers and Spain; and in Argentina and the western United States, south of Washington state, the rainfall for the year drops from 23 inches to less than 8 inches. On the lower Ganges, from the Soane region to Calcutta, and south along the east coast as far as the Orissa canals, the yearly rainfall is equal to that of the southern states, or from 51 inches to 78 inches (130 to 200 centimeters). It is not, therefore, in regions of small rainfall alone that irrigation systems have been developed. Indeed, there must always be contiguous

## CHAPTER II

### *THE CONDITIONS WHICH MAKE IRRIGATION IMPERATIVE, DESIRABLE OR UNNECESSARY*

To understand the conditions which make it imperative, desirable or unnecessary to irrigate land, it is important to have clearly in mind the various objects which may be attained by the application of water to cultivated fields.

#### THE OBJECTS OF IRRIGATION

The first and primary object to be attained in irrigating the soils of arid climates is to establish those moisture relations which are essential to plant growth, and the same fundamental object will usually stand first in sub-humid climates, as it may even in those which are distinctly humid; for in the sub-humid climates it very often happens that the intervals between rains of sufficient quantity are so long that almost any crop may suffer; and in humid climates there are certain crops, like the cranberry and rice, which profit by more or less protracted inundations; or, again, like the pineapple, growing upon extremely leachy sands, which can retain but a small quantity of water even for a single day, and where it is neces-

passes over and leaches through, enough of potash, phosphoric acid, and other ingredients of plant-food, to hold the strength of the soil up to a uniformly high standard, even when constant cropping is practiced.

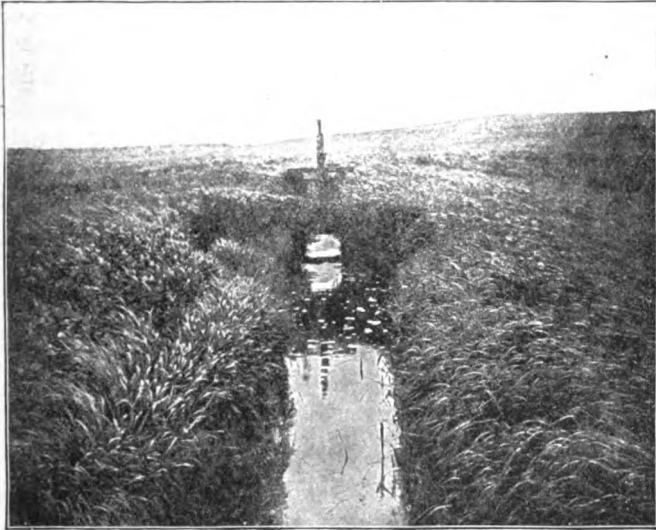

**Fig. 19.** Heavy growth of grass on the Craigentenny meadows,  
Edinburgh, Scotland.

A third object in irrigation, in certain classes of cases, is primarily to change the texture of the soil. When soils are very sandy and open, having so small a water capacity that not enough is retained for the growth of most crops, then the leading of the water of a turbid stream over such lands results in the deposition of silt to such an extent as, in the course of time, to

very materially improve their physical condition; but at the same time giving to these soils a large amount of plant-food, for the material borne along in suspension in the water of rivers is usually very valuable, derived, as it is, from the finest and best parts of fertile soils. These ingredients of the flood waters of the river Nile are extremely valuable to those desert sands which, under the long action of strong winds, have lost the major part of those fine and extremely important grains which the sand storms of the deserts have picked up and swept away.

In the fourth type of irrigation, which is an extreme case of the last, the aim is to flood low tracts of land with silt-bearing water in large volume, and to hold it there until the suspended matters have been deposited, so as ultimately to build up the whole tract, raising it to a level at which it may be naturally drained, or at which a depth of fertile soil sufficient to meet the needs of agriculture may be laid down over one which had been undesirable. Low-lying lands have been built up by this method until in the course of ten or a dozen years the whole surface has been raised as much as 5 to 7 feet.

A fifth type of irrigation, which has received a notable expansion in recent years, has for its primary object the rapid destruction of the organic matters held in solution and in suspension in the sewage waters of cities, in order that they shall reach river channels and the ground-water of the surrounding country sufficiently purified not to endanger the public health by a pollution of drinking waters, or by developing unhealthful atmospheric conditions.

THE LEAST AMOUNT OF WATER WHICH CAN PRODUCE  
A PAYING CROP

In the manufacture of butter from milk, it is a matter of prime commercial importance to know just how much butter-fat that milk contains, and what is the maximum amount of butter that fat is capable of producing; for only this knowledge can show how closely the manufacturer is working to his possible limit of profit, and how great his losses may be. For a like reason, it is very important to know what is the minimum amount of water which, under stated climatic conditions, can meet the needs of a given crop, producing a paying yield. It is important, because only such knowledge as this can show how economical or how wasteful our methods of tillage may be, and how nearly we are realizing the largest profits which are possible to the business.

In the Introduction, much pains has been taken to give in detail the evidence, and the methods of procuring it, which shows how much water must be used by a given crop in coming to maturity when placed under the best of conditions. This has been done, because it is a part of the knowledge which is needed to show under what climatic conditions irrigation may, and under what it may not, be practiced; because it is needed to show how far into the sub-humid districts agricultural operations may be pushed without the aid of irrigation; because it will help to teach how far we may hope, by the practice of the best methods of tillage, to dispense with irrigation, and avert disastrous results during seasons of drought.



We have already referred at some length to the seemingly small amounts of water used by the wheat crop in coming to maturity in the San Joaquin valley, in California, and to the long period of some 60 days at the close of its growing season during which it receives no water, either as rain or by irrigation. What is the minimum amount of water which is capable of producing a yield of 15, 20, 30 or 40 bushels of wheat per acre, and how does this compare with the actual rainfall of the San Joaquin valley?

We have made no observations with wheat, like those which have been recorded for oats, barley, maize, clover and potatoes, but from similar observations made by Hellriegel, in Germany, it is probable that the amount of water necessary to produce a ton of dry matter with wheat is not very far from 906,000 pounds or 453 tons, equal to 3.998 acre-inches. How many bushels of wheat should this give?

The ratio of the dry weight of the kernels to that of the straw and chaff in a crop of wheat has been found to be as 1 to 1.1 in a dry season, but to be as high as 1 to 1.5 when there has not been an undesirable stimulation to the growth of straw. But where wheat is irrigated in the southeast of France, Gasparin states that a ratio of 1 of grain to 2 of straw is usual.

If we take the ratio of 1 to 1.5, and allow 60 pounds to the bushel of wheat, we may compute the least amount of water which is likely to enable a crop of varying yields per acre to be produced, and the results of such a computation are given in the following table:

*Table showing the least amount of water required to produce different yields of wheat per acre when the ratio of grain to straw is 1-1.5*

No. bushels	Yield per acre			Water used ACRE-IN.
	Wgt. of grain TONS	Wgt. of straw TONS	Total wgt. TONS	
15	.45	.675	1.125	4.498
20	.6	.9	1.5	5.998
25	.75	1.125	1.875	7.497
30	.9	1.35	2.25	8.997
35	1.05	1.575	2.625	10.495
40	1.2	1.8	3	12

These amounts of water, given in the last column of the table, are so small that they appear false, for the quantity given for 15 bushels to the acre is almost covered by the rainfall of the most arid parts of the world. Several statements need to be made in order to put them in their true light.

In the first place, the figures could only be true when the amount and kind of plant-food in the soil is all that the crop can use to advantage, for no amount of pure water can make up for such deficiencies except in so far as it makes more rapid the solution of otherwise unavailable plant-food in the soil. Then, again, the data for the table were procured under conditions which permitted no loss of moisture from the soil, either by surface drainage or by downward movements beyond the depth of root action. Further than this, no account is taken of the water which may have been given to the soil in bringing it to the proper moisture conditions previous to planting the crop in it. Water enough was given to the soil to put it in the right condition to start with, and the amounts in the table

it would be 1.54 inches. It is certain that there is a further loss from these soils which is likely to be nearly if not quite as large as that computed, and that is the evaporation which takes place through the grain after coming to maturity, while it is standing upon the ground before being cut; for it is known that the movement of water through the plant does not stop at once when the kernels have fully matured. Further than this, if a considerable time intervenes between the time of the first rains and the germination of the seed, and especially if, after the grain comes up, it for any reason makes an abnormally slow growth, there will then be considerable additional losses which are not included in the figures given in the table; and it would seem that the average necessary loss of soil moisture from these lands which in no way contributes to the growth of the crop of wheat may easily be as high as 3 inches. If this be true, the figures in the last column of the table would be nearer 7.5, 9, 10.5, 12, 13.5 and 15 inches, respectively, for the different yields, than those stated. It is further probable that for the lighter yields, where the grain would have to stand thinner on the ground or else the plants be smaller, there would be absolutely more loss of water from the surface of the soil itself, and, hence, that the lower figures just given are likely to be found larger than they are there stated.

The mean annual rainfall of the San Joaquin-Sacramento valley, as given by Harrington in his rainfall map, ranges from 5 inches in the far south to 12 inches in the north, this amount all falling between

compare the yields of barley, oats, rye and wheat in the three districts, taking the Tenth Census figures for California, Washington and Kansas for comparison, the yields are largest in Washington and smallest in Kansas, as shown below:

	Mean yield per acre of			
	Barley	Oats	Rye	Wheat
Washington . . . .	38	41	14	23
California . . . . .	21	26.8	9	16.1
Kansas . . . . .	12.5	19	12	9.3

Expressing these differences in percentages, we get:

Washington . . . . .	100	100	100	100
California . . . . .	55.2	65.3	64.3	70
Kansas . . . . .	32.9	46.3	85.7	40.4

As the soils in the three regions are notably fertile, and were in 1879 very close, on the average, to virgin conditions, the differences in yield can hardly be attributed to differences in plant-food other than as influenced by soil moisture; and as the quantity of rain which falls in Kansas during the growing season, April to September, inclusive, is 11.5 to 16.8 inches, while that in Washington is only 8.4 to 13.5 inches, it appears plain that in some way the available moisture is more effective on the Pacific border than it is in the 97th meridian region.

It would be of very great practical importance to understand fully the causes which permit so small an amount of rain as that of eastern Washington, falling, so much of it, before the growing season, to ensure the

maturity of such large crops under so clear a sky and in spite of so long and continuous a period of drought, while in western Kansas 25 to 38 per cent more rainfall, well distributed through the growing season, produces less than one-half the yield per acre. The yield is certainly less than one-half, because the averages used for Kansas are too large for the western section of the state, whose rainfall has been brought into comparison.

While we are a long way from possessing the needed data for the solution of this problem, some of the factors are evident enough, and may be stated here. In the first place, the rains of the sections of California and of Washington under consideration fall in the cooler portion of the year, when the air is more nearly saturated and when the wind velocities are small, while the sun is much of the time obscured by clouds. All these conditions conspire to permit a large per cent of the water which falls upon the ground to enter it deeply, without being lost by evaporation, while a deep, retentive soil serves to prevent loss by drainage.

In western Kansas, on the other hand, where the rain falls largely in the form of showers in the heated, sunny season of the year, and where the wind velocities are high and the air extremely dry, it is plain that a much larger per cent of water falling as rain must be at once lost by evaporation from the surface of the soil, before it has had an opportunity to enter it deeply enough to be retained by soil mulches.

In the second place, a frequent surface wetting of

the soil, such as takes place in Kansas, tends strongly to hold the roots near to the surface, where with scanty mulches they are certain to suffer severely whenever a period of ten days without rain occurs; and if, under these conditions, the plant is able to send new roots more deeply into the soil, they can find there but a scanty supply of moisture, because there have been no winter rains sufficient to produce percolation. Then, again, after such a ten-day drought, with the surface roots now become inactive through a dying off of the absorbing root-hairs, when the next rain does fall, unless it is a very heavy one, the major part of it will be lost by evaporation from the soil, in the case of crops like wheat, oats, rye and barley, long before the plants are able to put themselves in position to take full advantage of it.

In California and eastern Washington, the case is radically different. There the water gets well into the soil before the crop is put upon the ground. Moisture enough is present to produce germination, and the roots develop at first near the surface, when there is ample moisture present; but later, under the rainless conditions, it is quite likely that they advance more and more deeply into the ground as the moisture in the upper layers of the soil becomes too scanty, and thus day by day the effectiveness of the soil-mulch is increased, while the roots have only to advance so far as is needful to allow capillarity to bring them the water they need from the store which the soil has retained. With these physical principles and conditions set down as foot-lights to illuminate our problem, and

with the other fact for a side-light turned upon it, that 6 inches of water, when the crop can have it to use to the best advantage, is enough to produce 20 bushels of wheat to the acre, we can see its outlines with sufficient clearness to feel sure that more study in the field would give us its full solution. As the matter now stands, the case is sufficiently clear that we may not conclude, because 9 to 12 inches of rain in California has produced abundant crops of wheat, that a similar rainfall in the sub-humid belt ought to produce like results. It should be sufficiently evident, also, that even with the best modes of tillage we can hope to adopt, there will still be much more water required per pound of dry matter produced all through the sub-humid region, than is demanded under the conditions of the lower San Joaquin valley.

The same principles make it very clear, also, that a judicious application of water by the methods of irrigation, in many humid climates, is certain to be attended by marked increase in the yield.

#### FREQUENCY AND LENGTH OF PERIODS OF DROUGHT

In humid and sub-humid regions, it is the frequent recurrence of periods of small or no rainfall, especially if they occur at the time when the crop is approaching or has reached the fruiting stage, that, more than anything else, makes extremely careful and thorough tillage, or else supplementary irrigation, indispensable, if large yields are to be realized.

In our repeated trials in the field cylinders here in Wiscon-

to permit the largest crops the soil is capable of carrying. This statement is founded upon the fact that with plenty of water the same soils did produce much larger crops, the differences being such as are given in the table below:

*Table showing differences in yield when the natural rainfall in Wisconsin is supplemented by irrigation*

Year	Yields per acre											
	Corn		Potatoes		Strawberries		Cabbage		Barley		Clover	
	Irrigated	Not irrigated	Irrigated	Not irrigated	Irrigated	Not irrigated	Irrigated	Not irrigated	Irrigated	Not irrigated	Irrigated	Not irrigated
	TONS	TONS	BU.	BU.	BOXES	BOXES	TONS	TONS	BU.	BU.	TONS	TONS
1894	5.176	3.835	....	....	6,867	3,496	....	....	....	....	....	....
1895	5.293	1.384	....	....	8,732	1,030	....	....	51	25	4.01	1.45
1896	5.15	4.145	394.2	290.5	....	....	22.79	20.04	....	....	3.632	2.254
1897	4.252	3.405	333.9	212.3	....	....	....	....	45.67	44.25	4.434	2.482

These figures show very clearly the insufficiency of rain in these four years to produce the largest possible yields, and they show to what extent irrigation in a climate such as that which has occurred during the years 1894 to 1897 in Wisconsin is likely to increase the average yields.

#### CONDITIONS WHICH MODIFY THE EFFECTIVENESS OF RAINFALL

The rains which fall upon a given area are not equally effective under all conditions of soil and topography, and hence it happens that irrigation may be desirable in localities where the amount of rain which falls may be both large and uniformly distributed throughout the growing season. It has been pointed out, in the study aiming to measure the amount of water required to produce a pound of dry matter, that it was necessary to water the sandy soils of coarse texture once in three to four days in order



## *Conditions Modifying Effectiveness of Rainfall* 111

to prevent the crops from suffering for lack of moisture, while once in seven days met the needs of plants growing upon soils of the finer texture used in the experiments.

The difficulty in the case of soils of coarse texture is, not that the water evaporates more rapidly from the surface of them, nor is it because more water must be present in them in order that plants may utilize it, for it is true that the surface evaporation from them is slower than with most other soils, and that plants may use the water more closely from them than is possible when the grains are smaller. The real trouble is found in the fact that when they are underlaid by a coarse subsoil, and when standing water in the ground is more than 5 feet below the surface, the water drains out so completely in a short time that not enough remains to keep the crop from wilting.

We do not yet know how closely the water may be used up in field soils of different textures before crops of different kinds will begin to suffer, or will have their rate of growth checked; but the writer has found that clover, timothy, blue-grass and maize have their growth brought nearly to a standstill in a clay loam soil underlaid with sand at 3 to 4 feet, when the amount of water left in it was that stated in the table below:

*Table showing the amount of water in a clay loam in the field when crops wilted and growth was brought nearly to a standstill*

Depth of sample	Clover PER CENT	Timothy and Blue-grass PER CENT	Maize PER CENT
0-6 inches loam	8.39	6.55	6.97
6-12 " clay loam	8.48	7.62	7.8
12-18 " clay	12.42	11.49	11.6
18-24 " clay	13.27	13.58	11.98
24-30 " clay	13.52	13.26	10.84
40-43 " sand	9.53	18.37	4.17

Nothing more definite can be said regarding the data of this table, than that under the moisture relations there shown, growth was practically at a standstill, and that when very considerably larger percentages of water were present in the soil the normal rate of growth was checked.

water in the ground is found at greater distances below the surface:

Table showing the per cent of water in 8-foot columns of sand after percolation periods of different lengths

Effective diameter of sand grains..... .474 mm. .185 mm. .155 mm. .1143 mm. .0826 mm.

Height of sec'n above ground water		Water retained after percolating over 2 years				
INCHES	FEET	PER CENT	PER CENT	PER CENT	PER CENT	PER CENT
96 .... 93		.27	.17	.22	1.26	3.44
93 .... 90	8	.22	.17	.23	1.16	3.44
90 .... 87		.23	.16	.29	1.34	3.82
87 .... 84		.22	.15	.32	1.61	3.83
84 .... 81		.23	.18	.61	1.98	3.93
81 .... 78	7	.29	.19	1.07	2.32	4.19
78 .... 75		.44	.26	1.33	2.61	4.38
75 .... 72		.80	.58	1.57	2.90	4.92
72 .... 69	6	1.18	1.16	1.80	3.12	4.94
69 .... 66		1.48	1.45	1.85	3.36	5.70
66 .... 63		1.71	1.67	2.03	3.56	5.91
63 .... 60		1.80	1.80	2.18	3.92	6.43
60 .... 57	5	1.83	1.86	2.26	4.22	6.77
57 .... 54		1.93	1.87	2.27	4.53	7.72
54 .... 51		1.98	1.98	2.30	4.88	8.59
51 .... 48		2.02	1.92	2.38	5.42	9.42
48 .... 45	4	2.03	2.12	2.46	6.03	10.50
45 .... 42		2.02	2.07	2.71	6.99	11.34
42 .... 39		2.06	2.18	3.08	7.47	12.58
39 .... 36		2.17	2.29	3.46	8.71	13
36 .... 33	3	2.31	2.48	4.10	10.54	14.95
33 .... 30		2.36	2.65	5.09	11.77	15.90
30 .... 27		2.63	3.14	6.36	12.95	17.20
27 .... 24		2.86	3.63	8.74	15.05	17.96
24 .... 21	2	3.42	4.71	13.52	17.24	18.92
21 .... 18		4.26	6.76	23.57	19.08	20.49
18 .... 15		6.41	9.38	27.93	19.37	21.34
15 .... 12		9.77	14.66	23.61	21.44	21.63
12 .... 9	1	16.08	21.31	22.46	22.69	22.68
9 .... 6		19.33	22.39	22.76	23.20	23.39
6 .... 3		20.96	23.52	22.88	24.22	30.28
3 .... 0		21.58	24.61	23.54	25.07	24.06

Total water retained ....	{	gms.	2,121.4	2,474.9	3,515.	4,576.2	5,831.5
		per cent	4.24	5.05	7.25	9.41	11.82
Water retained after 4 days .....	{	gms.	3,128.	3,551.1	4,259.9	5,672.	6,659.7
		per cent	6.25	7.238	8.785	11.66	13.5
Water retained after 9 days .....	{	gms.	2,926.	3,213.5	4,004.7	5,416.2	6,452.8
		per cent	5.846	6.753	8.445	11.13	13.08
Total water recovered...	{	gms.	10,425.2	10,356.2	10,329.1	10,289.7	10,606.8
		per cent	20.84	21.12	21.3	21.15	21.5
Total weight of dry sand...		gms.	50,050.	49,060.	48,490.	48,650.	49,340.

A glance at this table shows how completely and how rapidly water will drain away by downward percolation from the coarse and fine sands when there is nothing within 8 feet of the surface to prevent it. It will be seen that in four days the coarsest sand had lost nearly three-quarters of all the water it could contain under flooded conditions, while the finest had lost nearly one-half; and this has occurred, too, under such conditions that standing water is maintained within 8 feet of the surface. Had standing water been 16 feet from the surface, it is quite likely that the surface 8 feet of these sands would not have retained 3 per cent in the coarsest sample nor 5 per cent in the finest.

With such a rate of loss of water from sands as this, it must be plain that the coarser soils, when they are long distances from standing water in the ground, or are not underlaid with a more impervious stratum near the surface, must lose the water which falls upon them as rain so rapidly that even in very humid regions they cannot maintain profitable crops without irrigation.

It is this fact of coarse texture, coupled with the long intervals of deficient rain, more than a lack of plant-food, which has maintained in an unproductive state the extensive areas of sandy lands found in Minnesota, Wisconsin, Michigan, New York, New Jersey, and further south, in the United States, and throughout Belgium, Holland, and the plains of northern Germany, in Europe. Had the soils of these areas identically the same chemical composition, but a texture as fine as that of our best soils, so that water would drain from them no more rapidly, profitable agriculture could be practiced upon them under the rainfall conditions which exist. And it is possible to so supple-



very much increase the moisture in the soil above that which falls as rain or snow.

Further than this, we have no reason to believe that mere tillage, as such, can in any way diminish the rate of transpiration from the crop which is growing upon the soil being tilled, unless, indeed, it should be done by root-pruning, a method decidedly injurious in most cases. It follows, therefore, that in no way can we hope, by methods of tillage, to diminish the loss of water by transpiration through the crop itself. We may, indeed, make the conditions for growth so favorable that the maximum amount of dry matter is developed during the time a given amount of water is being evaporated from the surface of the crop; but so far as the direct influence of tillage is concerned, it can only lessen the evaporation from the soil surface, and reduce the losses by percolation and by surface drainage. No amount or kind of tillage can dispense with water; that must be had, either from rain or snow, or be supplied by irrigation. With water enough in the soil to make a crop, good tillage will bring the most out of it; but when the rainfall has really been deficient, nothing short of irrigation can make the crop.

AMOUNT OF RAIN NEEDED TO PRODUCE CROPS  
IN HUMID AND SUB-HUMID REGIONS

Having pointed out in a general way the limitations of tillage in conserving soil moisture for crop production, it is important to show how great its possibilities may be when unaided by irrigation; for if in humid and sub-humid climates tillage may enable



the growing season of the specific crop in question, in order to know whether tillage alone will answer for that crop, unaided by irrigation. The first crop of clover, for example, must be largely made by the rains of May and June in the states which have been named, while the crop of potatoes will be determined more largely by that which falls between June and October. The period of barley would extend from May 1 nearly through July; oats, from May to the middle of August; and maize, from the middle of May to the middle of September.

In the table which follows, the amount of rain which falls during the growing season of barley, oats and maize has been given, and from the averages have been deducted the amounts which it is quite certain do not become available for crop production, on account of loss by drainage and by the light rains not penetrating deeply enough to be of service agriculturally:

*Table showing the mean rainfall for the growing season for barley, oats and maize*

	Rainfall in inches for		
	Barley	Oats	Maize
Illinois .....	13	15	15.25
Indiana .....	13.5	15.25	16.25
Iowa.....	12.5	14.25	15.375
Eastern Kansas .....	12	13.625	14.5
Southern Maine.....	10.5	12.25	14
Southern Michigan.....	9.5	11	12.625
Missouri .....	13.25	15	16.375
Minnesota .....	10.75	12.25	13.75
New York .....	10.25	12	13.5
Ohio.....	11.75	13.5	15
Pennsylvania.....	12	14	15.75
Vermont.....	10.5	12.5	14.75
Wisconsin .....	11.5	13.25	15
Mean.....	11.616	13.375	14.779
Estimated loss by percolation and from light showers.	2.964	3.185	2.765
Mean effective rain .....	8.652	10.19	12.014

In estimating the loss from percolation and small showers, 2 inches has been assumed as the amount of percolation in the case of barley and oats, and 1.5 inches for maize. The amount deducted for small, ineffective showers has been gotten by taking the total

and maize for 1879 are given as reported for the 10th Census for the thirteen states:

	Bu. barley per acre	Bu. oats per acre	Bu. maize per acre
Illinois .....	22.25	32.24	36.12
Indiana .....	23.25	25.02	31.39
Iowa .....	20.23	33.57	41.57
Kansas .....	12.52	18.77	30.93
Maine .....	21.81	28.76	30.90
Michigan .....	22.1	33.03	35.3
Missouri .....	19.01	21.34	36.22
Minnesota .....	25.62	37.97	33.81
New York .....	21.85	29.70	32.97
Ohio .....	29.7	31.49	34.09
Pennsylvania .....	18.57	27.34	33.37
Vermont .....	25.36	37.57	36.46
Wisconsin .....	24.68	34.43	33.71
Mean .....	22.08	30.17	34.38

If a comparison is made between these reported yields and those which are given above as possible with the recorded rain-falls, when a favorable distribution in time occurs, it will be seen that the mean reported yields are only about half as large as the computed ones, and as observed ones are in localities where the distribution of rain in time and in quantity has been favorable.

These small average yields, reported from so many states, and agreeing so closely one with another, must be looked upon as expressing conditions unfavorable to large yields, and conditions which the best of management cannot hope wholly to counteract.

The facts are that we are here confronted with results which are due, in a very large measure, to the long intervals between effective rains, to which reference has already been made. This uneven distribution is so general in its character that when the yields over wide areas are brought together for comparison, the small yields due to faulty distribution of rain so far outweigh the large yields, where the amount of moisture has been just right, that small averages are inevitable. Nor is this condition of things strange; for, since the rainfall is in no way controlled by any factor operating to cause precipitation, either when it is



wanted or in the amount which the particular crop on the particular soil may at that time need, it cannot be expected that such a regime of chance would on the average develop the conditions most favorable to large crops.

#### THE METHODS OF TILLAGE TO CONSERVE MOISTURE ARE OFTEN INAPPLICABLE

If it is urged that better tillage and more systematic rotations of crops, coupled with a more rational practice of fertilization of the soil, would go a long way toward making larger average yields, every one must admit the truth of the assertion. But, while this is true, it must still be recognized that there are some cases in which the methods of tillage to conserve soil moisture are either wholly inapplicable or they may be applied only with so great difficulty or with so small an effect, that they have never come into general use for the specific purpose of saving soil moisture.

The most important illustration in point is that of the hay crop, with which should also be associated that of pasture as well, when these are made from the grasses and from clover. With these two crops, hay and pasture, which together cover a wider acreage than any other single crop grown, there has not been and cannot well be any method of tillage aiming specifically to conserve soil moisture for the use of the crop.

In the thirteen states referred to when discussing the yields of barley, oats and maize, there were cut 24,439,485 acres of grass, making 28,314,650 tons of hay, or at the mean rate of 1.158 tons per acre, in 1879. Nearly all of this hay is made during the months of May and June, when there is a mean rainfall for the thirteen states amounting to 7.83 inches, of which not less than 2 inches is lost by percolation, and nearly .69 of an inch is ineffective on account of showers giving less than .2 of an inch, thus leaving an effective rain of 5.14 inches

It has been shown that clover uses 5.089 acre-inches of water in producing one ton of dry matter, and at this rate 5.14 inches

of effective rain ought to give a yield of 1.01 tons of dry matter, equal to 1.188 tons of hay containing 15 per cent of water, while the observed mean yield is 1.158 tons. Now, this yield of 1.1 tons per acre is not what a farmer calls a good yield, for 1.5 tons to 2 tons per acre of hay are often cut; but these larger yields are invariably associated with seasons of early heavy rainfall. It must be evident, then, that in the thirteen states from Maine to eastern Kansas there are large areas where, if water could be applied to the first crop of hay, the yield might easily be increased 40 to 90 per cent, and there can be no question that the aggregate extent of such areas exceeds what could be supplied by all the water of all the rivers and all the ground water of those states.

Then, again, in the case of such crops as wheat, oats, barley, rye, buckwheat, and the millets, which are sown broadcast or in close drills, it has not been usual to practice methods of tillage aiming specifically to save moisture; but when the acreage of these crops in the United States, together with that of hay and pasture, is set aside, there remains relatively but a small part of the cultivated lands upon which intertillage is or can well be practiced.

These statements are made neither to depreciate the importance of conserving soil moisture by tillage nor to emphasize the importance of irrigation, but rather that each may be seen in its true perspective; for the fact is, neither method is universally adapted to meet the needs of insufficient rain at all times and in all places. But there are conditions for which each is better suited than the other, and for a man to know these is to make him a better farmer.

**TILLAGE TO CONSERVE SOIL MOISTURE IS CHIEFLY  
EFFECTIVE IN SAVING THE WINTER AND  
EARLY SPRING RAINS**

It is not sufficiently appreciated that early and frequent tillage where irrigation is not practiced is far more important and effective in conserving soil moisture than later tillage can be after the ground once becomes dry. From this it follows that

intertillage and surface tillage generally can be counted upon as capable of saving to the crop which is to be grown upon the ground only a part of the rains which fall in winter and spring. The rains of later June and July, August and September are usually beyond the power of tillage to conserve in any marked degree, without at the same time seriously injuring the roots of vegetation growing upon the ground.

In the first place, after the last of June, in climates like that of the thirteen states selected, the water of nearly all rains is absorbed and retained in the surface 3 inches of soil or less. It is only the rains exceeding 1 inch which penetrate more deeply than this; and to stir a wet soil is to hasten the rate of evaporation of moisture from the soil stirred. If, then, the roots of a crop have dried the surface 8 inches of soil so that it contains but 20 to 30 per cent of its full amount, and a rain falls which wets in but 2 inches, stirring that soil can save but little of the moisture. Further than this, when the surface of the soil has become so dry, capillarity acts very slowly to conduct the water downward into the soil.

In the second place, most cultivated crops, in order to take advantage of the general fact that summer rains do not as a rule penetrate deeply into the soil, develop a system of roots extremely close to the surface of the ground, where momentary advantage may be taken of those rains which do not wet in deeply; and hence it is that in sub-humid climates, and after a dry time in all climates, surface cultivation right after a rain may do positive injury by cutting off roots which have been developed to take advantage of such rains, while at the same time the rate of evaporation from the stirred soil has been increased. Here, again, it is seen that rigid physical laws and conditions have set limitations to the methods of tillage as a substitute for irrigation.

#### MIDSUMMER AND EARLY FALL CROPS DIFFICULT TO GROW WITHOUT IRRIGATION

The fact that after early summer the surface of the ground usually becomes quite dry, coupled with the other fact that water

percolates and travels downward through such soil with difficulty, makes the growing of a second crop of almost any kind very difficult and uncertain by methods of tillage unaided by irrigation. Every one is familiar with the fact of short pastures in midsummer and early fall, and that second crops of hay can be raised only in exceptional seasons, and even then they are seldom heavy.

The difficulty in these cases is not that less rain falls during the summer and autumn, for the measured amount is actually greater. Neither is it true that they will not grow because it is out of season, for when plenty of water is supplied heavy crops of grass are obtained for the second cutting. As a matter of fact, the summer rains are less effective because they are retained so near to the surface as not to come within reach of the roots before they are lost by surface evaporation.

In our own experiments in irrigating clover, there has been secured for the second crop of clover hay 1.789 tons in 1895, 2.035 tons in 1896, and 1.648 tons of hay, containing 15 per cent of water, in 1897, or an average for three years of 1.824 tons per acre. When it is recalled that the average yield of hay per acre for the thirteen states cited is but little more than 1 ton per acre for the first crop, when the rains have their maximum effectiveness, it is plain that without irrigation it is not possible to grow a paying second crop of hay to any extent in either the sub-humid or humid parts of the United States. Further than this, on account of the small effectiveness of summer rains, it is often quite impossible to secure a catch of clover with any of the small grains, while with irrigation the catch would be positively assured every year. These are cases in which present methods of tillage can do nothing, but in which irrigation will give certain results.

The present season we put into the silo 6,552 pounds of clover and volunteer barley, cut from .58 acres of ground upon which had been harvested 45 bushels of barley to the acre. This was rendered possible by irrigating the land, and thus forcing the new seeding of clover after the crop was removed. In this way it was possible to get two good crops in one season from the

same piece of ground ; namely, 45 bushels of barley per acre, and the equivalent of 1.4 tons of hay containing 15 per cent of water. Only very extraordinary seasons would by any method of tillage permit this to be done.

#### MEANS OF CONSERVING MOISTURE

##### 1. *Fall Plowing to Conserve Moisture*

In those parts of the world where winter precipitation is not large, so as to over-saturate the soil, and so as to cause the running together of soils, and thus destroy their tilth, fall plowing may be found very desirable when its chief object is to diminish surface evaporation during the winter and early spring, and where it is desirable to facilitate the ready and deeper penetration of the water into the soil which, during the growing season, has become dried to considerable depths.

In order that fall plowing may be most effective in this way, it should be done as late as practicable, so that its looseness may not be destroyed by the early rains, and its usefulness as a mulch thus reduced; and also in order that it may allow the later rains and melting snows to drop easily and more completely through it, when surface drainage will be prevented, and loss by evaporation will be reduced to the minimum. In such conditions capillarity and gravity may together aid in conveying the water into the second, third and fourth feet, where it will become most effective in supplementing the spring and early summer rains.

The writer has shown, in "The Soil," p. 187, that

land in Wisconsin fall-plowed late in the season was found in the spring, even as late as May 14, to contain not less than 6 pounds of water to the square foot more than similar adjacent land not so treated. This is equivalent to 1.15 inches of rain, a very important quantity to have been stored in the soil at so late a period and in such a position that inter-tillage is certain to retain it for service when it is needed.

It will be readily appreciated that this sort of tillage to conserve moisture is most important in the sub-humid and humid climates, whenever those dry seasons occur which close the year with an under-supply of soil moisture.

It should not be inferred that this sort of tillage to save moisture must be confined to such lands as are to be sowed to small grains in the spring, or even planted to corn or potatoes. It is particularly desirable in all lines of orcharding, and where small fruits and grapes are grown. The laying down and covering of the plants need not prevent it, for the plowing may immediately precede the laying down. In the growing of small fruits without irrigation, the late fall tillage, just before the ground freezes, is a matter of considerable moment, because with strawberries, raspberries and blackberries it very often happens that a shortage of soil moisture just at the fruiting season results in a very serious loss through a reduction of the yield, and late, deep tillage will usually lessen this danger. If it should be urged by some that this practice applied to orchards would tend to stimulate a too late

ground is illustrated in Fig. 24, where all losses by surface evaporation were prevented by placing an airtight cover over the areas under experiment. In order that the extreme influence of subsoiling might be ascertained, 8 inches of the surface soil was completely removed from an area 6 x 6 feet on a side, and when the subsoil had been spaded to a depth of 13 inches more it was returned to its place without firming in any way, except to smooth the surface with a plank pressed down by the weight of a man. After samples of soil had been taken from this and the adjacent area, to give the existing water content, water was slowly sprinkled over the two surfaces until 254.41 pounds, or 1.36 inches, had been added to each, and then they were covered, as shown in the figure, and allowed to stand from June 11 until June 15, when the covers were removed and samples of soil again taken, to demonstrate what changes had occurred.

When this was done it was found that the water added had effected the changes which are recorded in the table which follows :

	Subsoiled LBS.	Not subsoiled LBS.	Difference LBS.
The first foot gained .....	124.6	102.1	+22.5
The second foot gained ....	72.57	10.34	+62.23
The third foot gained .....	38.22	12.05	+26.17
The fourth foot gained ....	33.26	3.82	+29.43
The fifth foot lost .....	2.29	19.5	-17.21
Total water gained .....	268.65	128.31	
Total water added .....	254.41	254.41	
Difference .....	+14.24	-126.1	

little tendency for the deeper soil water to pass upward by capillarity into the subsoiled earth. But quite the opposite was the case with the ground not subsoiled, for here the upper 3 feet had each gained more than 1 per cent of their dry weight of water. Expressing the movement which had taken place during the 6 days in pounds of water on the 36 square feet of surface, we find that the surface 3 feet had gained 129.69 pounds, while the lower 2 feet had lost 53.52 pounds, leaving an absolute gain of 76.17 pounds. In the case of the subsoiled ground, the surface 3 feet showed a loss of 11.14 pounds, and the lower 2 feet a gain of 39.38, making an absolute gain to the area of only 28.24 pounds.

In another field trial, when a piece of land was subsoiled on October 22, while a strip on each side of this was plowed without subsoiling, the water in the soil was found in the spring to be distributed in the manner indicated below :

	Subsoiled in the field LBS.	Not subsoiled in the field LBS.	Difference LBS.
First foot .....	15.47	17.41	-1.94
Second foot .....	17.61	16.31	+1.30
Third foot. ....	18.19	17.84	+ .35
Fourth foot .....	17.83	17.20	+ .63
	<hr/>	<hr/>	<hr/>
Total .....	69.10	68.76	+ .34

Here it will be seen that the surface foot of subsoiled ground contained nearly 2 pounds less water than that not subsoiled, but that the absolute



again May 5, in order to discover whether in that time progressive changes would take place. Between the first and last date there had been a total rainfall of 5.33 inches, making conditions very favorable indeed to obliterate the effects of the subsoiling in a short time. The changes which these rains, together with the fitting and planting of the ground, produced, are shown in the table below:

	April 8			April 16		
	Subsoiled PER CENT	Not subsoiled PER CENT	Difference PER CENT	Subsoiled PER CENT	Not subsoiled PER CENT	Difference PER CENT
First ft....	19.58	22.04	-2.46	20.80	22.88	-2.08
Second ft..	19.01	17.61	+1.40	18.62	18.97	-.35
Third ft...	17.39	17.06	+.33	16.48	16.70	-.22
Fourth ft..	16.79	16.20	+.59	16.11	16.50	-.39

	May 5		
	Subsoiled PER CENT	Not subsoiled PER CENT	Difference PER CENT
First foot .....	21.28	21.34	-.06
Second foot .....	19.02	19.11	-.09
Third foot .....	19.11	18.37	+.74
Fourth foot .....	16.67	17	-.33

It will be seen that the difference between the water in the soil under the two treatments becomes less each time the samples are taken, and that on May 5 the difference between them had nearly disappeared. But it should be observed that this close agreement at the last time may be more apparent than real, on account of the fact that a rain of 1.3 inches had fallen on May 1, and it is possible that time enough had not yet elapsed to allow an equilibrium to be established.

**EXPLANATION OF THE MOISTURE EFFECTS OF  
SUBSOILING**

The results stated show that subsoiling produces several very distinct effects, so far as soil moisture is concerned, and these may be stated as follows :

1. Subsoiling increases the percentage capacity for water of the soil stirred.
2. Subsoiling decreases the capillary conducting power of the soil stirred.
3. Subsoiling increases the rate of percolation through the soil stirred, or its gravitational conducting capacity.

In order to understand how these effects are produced by subsoiling, it is necessary to have clearly in mind the nature of the physical changes in the soil which the operation in question sets up. In the small plot experiments which have been cited, the subsoiling had the effect of increasing the pore space in the soil stirred at the rate of over 245 cubic inches per cubic foot, or 14.2 per cent. Further than this, the pore space so added consisted in a large measure of cavities which were so large that air and water would move through them in obedience to the laws which govern the flow of water through large pipes, rather than those controlling the flow through capillary tubes.

It must here be born in mind that the increase of space was made as large as it could well be, and hence that the results have a maximum value.

*How subsoiling increases the water capacity of the soil stirred.—*

When a soil is broken into lumps which lie loosely together, and these lumps are saturated with water, the many lumps behave toward that water much as if each were a short column of soil which is in contact with standing water. The surface film of water which spans the pores at the surface of the saturated lump of soil has a definite strength, and, if the lump is not too large, can hold every cavity within that lump completely full of water, just as the lump of sugar dipped into the tea and then withdrawn comes forth completely filled with the fluid. But when the soil

is compact, so that each portion is part of one long and continuous mass extending downward several feet before water is reached, the surface tension of the water is not strong enough to maintain the soil cavities full of water, and a part drains away downward.

It is easy to demonstrate the nature of this action with a bit of candle wicking 2 or 3 feet long, or with two or three folds of cotton wrapping twine loosely twisted together. Placing this in a basin of water and letting it become saturated, if it is then raised out by both ends, holding it nearly horizontal and straight, the water very soon ceases to drip from it ; but if it is allowed to sag in the middle, the water will begin to drip rapidly, and will continue to do so until a new equilibrium has been reached. The string will lose its water still more rapidly and completely if it is simply suspended from one end, when it then represents the longest column of soil.

*How subsoiling decreases the capillary conducting power of soils.*—When large open spaces have been developed in a soil by any means, then every such cavity cuts off a part of the capillary passageways through which the water might travel by capillary conduction, thus making the amount of water which may move in a given direction proportionally smaller. This being true, when rain falls upon subsoiled ground it travels downward very slowly through it until after the soil has become completely filled, and drainage or percolation takes place. If, then, the shower is not heavy enough to completely fill this subsoiled layer, it is nearly all retained within it ; whereas, when the capillary connection is good, then so soon as the surface layer becomes wetter than that below, the water begins to move under the impulse of capillarity, and will continue to do so until a balance has been reached.

On the other hand, when the surface of the subsoiled ground has become dryer through evaporation or by root action, water from below will not enter it as rapidly as it will soil not so treated. It is thus capable of acting as a deep mulch, to diminish the loss of water by capillary movement upward. But should conditions chance to be such that the whole root system of the crop has been developed within this subsoiled layer, then a rapidly-growing crop upon it might suffer for want of water when there was an abun-

the plant; and if this amount would have been lost, either by downward percolation or by evaporation from the surface, then the subsoiling has been a gain.

### 3. *Earth Mulches*

When the damp surface of a soil is covered with a dry layer of earth, the rate of evaporation from it is very much decreased. It is because of this fact that thorough surface tillage is able to so conserve the soil moisture stored in the upper four to six feet of cultivated fields that fair crops may be grown with very little rain; and it is in the effective handling of these mulches that the hope of farmers in sub-humid districts must be laid.

*Conditions modifying the effectiveness of mulches.*—The laws which govern the loss of water through mulches have not yet been sufficiently worked out to permit a full discussion of this important subject, but several important facts have been definitely settled, and may be here stated.

In the first place, when other conditions are the same, the thicker or deeper the layer of loose, dry soil is, the less rapidly can the soil moisture pass upward through it, to be lost by evaporation.

It was found, for example, that when soil covered with no mulch lost water in the still air of the laboratory at the rate of 4.375 acre-inches per 100 days, the same soil stirred to a depth of .5 inches lost but 4.017 acre-inches, and when stirred to a depth of .75 inches lost 3.169 acre-inches in the same time. In another case, when the loss of water from the unmulched surface was 6.2 acre-inches per 100 days, stirring this same soil to a depth of 1 inch reduced the loss to 4 acre-inches, while stirring it to a depth of 2 inches left the loss but 2.8 acre-inches per 100 days.

So, too, when corn was cultivated to a depth of 1 to 1.5

The character of the mulch, also, has an important influence on the amount of water which is permitted to escape through it. Thus, it was found that when the same soil was covered to a depth

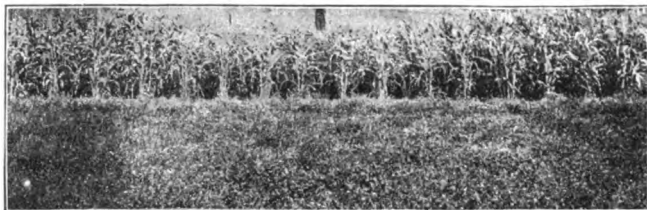

Fig. 25. Difference in growth of corn where there is a difference of 3 per cent of soil moisture in the surface foot.

of 2 inches with mulches of different kinds, the observed loss of water per 100 days was as stated below:

	INCHES
Through 2-inch mulch of coarse sand .....	1.1
" " " " black marsh soils.....	3.9
" " " " fine clay loam.....	3.9
" " " " dry peat.....	2
" " " " clay loam, crumb-form.....	2.8

From these results it is seen that a coarse-grained texture produces a better mulch than one extremely fine; that is, the loss of water by evaporation through the coarsest sand was less rapid than it was through the fine sand, and it was more rapid through the finely powdered clay loam than it was through the same soil left in the crumbled condition in which we usually find it when the soil is in good tilth. The small loss from the peat mulch, too, was due largely to the fact that it did not rub down to a fine texture.

Just why this law holds for soil mulches cannot now be stated, except that it seems evident that the water is not lost by direct evaporation at the surface of the damp soil, for in that case we should expect the largest losses to take place from the mulches having the most open structure, and the least when the diameter

from the natural rainfall on pasture land, great care should be taken to keep it in such condition that the whole surface is well and closely covered with vegetation. Of course, the same remarks apply to meadow lands.

Too close pasturing is very wasteful in every way. The animals themselves are not fed properly, the grass is not permitted to have foliage enough for the most vigorous growth, and so much of the surface of the ground is exposed to the sun that evaporation directly from the soil is rapid and a dead loss, not only doing no good in itself, but throwing out of use the upper layer of soil, in which the nitrifying processes should be permitted to go forward rapidly, because it is too dry for them.

The surface dressing of meadows with a good coating of farmyard manure, and then harrowing this thoroughly to spread it evenly over the surface, is extremely beneficial, not simply because of the plant-food which it contains, but because of the mulching effect which it furnishes to shade the naked spots of soil and those which are only thinly covered. When this dressing is applied very early, and is early spread over the surface, while the soil is yet damp, it, of course, does the most good, both as a mulch and as a plant-food; for then fermentation goes on better in the manure, and the moisture dissolves out the soluble parts and conveys it to the roots of the grass. Then, too, in the case of thin meadows, if new grass and clover seed are added at the same time, before the harrowing, much of it will be sufficiently covered by the harrowing and shaded by the manure to allow it to germinate, and thus thicken up the meadow and bring it back to its proper condition.

*Harrowing and rolling small grain after it is up.*—When the ground is closely covered with plants, as in the case of oats, wheat and barley sowed broadcast or in close drills, advantage has sometimes been found in either harrowing the ground or in rolling it for the express purpose of changing the character of the surface. The changes thus wrought have sometimes a double effectiveness, in that a thin mulch is produced which in a measure reduces the direct loss of water through the surface soil by evaporation from it; and in breaking up a crust which forms

over plowed fields when a considerable evaporation has taken place from the wet surface, and which, on account of the shrinkage and of the salts brought to the surface by the soil water, tend to close up the soil pores, and thus interfere with the proper entrance of air to it, which is essential to the best results. Rolling in such cases will seldom do much good, except where the ground was left somewhat uneven at the time of seeding, either by the drill ridges or by those left by the harrow, or unless there are many small lumps, which the rolling tends to break down, forming from them and the ridges, or both, a thin mulch. The harrowing in such cases has a wider range than rolling, and is often likely to be more effective. But neither of these treatments should be given except when the soil of the field is dry and crumbly at the surface, for otherwise no mulch will be formed, and the effect would be to increase rather than diminish the loss of water from the soil by surface evaporation from it.

#### 4. *Early Tillage to Conserve Moisture*

It has already been pointed out that tillage to conserve moisture is most useful in humid climates when it is applied as early in the season as the condition of the soil will admit. But the case is stated in the most general terms when it is said that tillage, to save moisture, should be given to the soil just as soon after the wetting of the surface as it is possible to do so without puddling or otherwise injuring its texture.

Let it be fully understood that tillage to save soil moisture is concerned almost wholly with the saving of that which has penetrated the soil to a depth exceeding that of the mulch developed by stirring, As a thoroughly effective soil mulch cannot be readily made having a depth less than 2 to 3 inches, it follows that

tillage to conserve soil moisture is chiefly concerned with saving moisture which has penetrated the ground to a depth exceeding 2.5 to 3 or more inches. The moisture which is caught and held by the soil closer to the surface than stated must usually be taken up directly by the surface feeding roots, or it must be lost by surface evaporation.

When the snows and frosts of winter have melted, and the earliest spring rains have come, the soil is usually left so moist as to be fully saturated with water to a depth exceeding 1, 2, and even 3 feet, according as the snows or rains have been copious or light. At the same time, the texture of the surface soil has been so changed as to place it in the very best possible condition for rapidly conveying the deeper soil-water to the surface, where, if the sun shines and a brisk, dry wind is blowing, it will be lost with great rapidity, sometimes in single exceptionally favorable days amounting to 2, 3, and even 4 pounds per square foot per day, equivalent to more than 40, 60 and 80 tons per acre.

But these high rates of loss are not maintained, fortunately, for long periods of time, even when there has been no effort made to prevent them. We have, however, measured losses during seven days amounting to 9.13 pounds per square foot, or at a daily rate of 1.3 pounds; and in four days a rate as high as 1.77 pounds per square foot. Under extremely favorable conditions, and where the surface of the soil was kept continuously wet, we have measured a mean daily loss by evaporation as great as 2.37 pounds for fine sand,



direct result of a thorough preparation of the seed-bed, which has always led the most successful farmers to insist upon the importance of a good seed-bed.

Let it be remembered that it is the early stirring of the soil, rather than the early planting of the seed, which is the all-important point to be insisted upon. Nothing is gained by putting seed in a soil which is too cold; but several days may often be saved in bringing the soil to the right temperature by stirring a sufficient depth of it for the seed-bed, and getting rid of the surplus water which it contains by cutting it loose from the wet soil below, and at the same time concentrating the heat from the sun in this stirred layer, because loosening it has made it a poor conductor to the unstirred cold soil below it.

Even when ground is not to be planted until quite late, as in the case of corn and potatoes, it is a far better practice to plow as early as other labor will permit, than to leave it unstirred until near the planting time, because the early fitting develops plant-food and gets it in readiness for the crop; because it saves moisture; because it prevents clods from forming, and insures a more perfect tilth, and because it allows one and sometimes two crops of weeds to be killed before the planting. This last advantage is a very important one, because weeds can be killed much more cheaply and effectively when there is nothing on the ground in the way, and because it is a very wasteful practice to permit weeds to start in a field, to use up both the moisture and the plant-food which will be needed by the crop. It is much better to plant late, and take

grow slowly, until time enough shall have elapsed for the processes of fermentation to be set up in the green crop which shall reconvert it into available plant-food. But if the spring should chance to be a dry one, so that the crop of green manure has itself left the soil deficient in moisture, or if the capacity of the soil for moisture is naturally small, then there will be present in the soil neither moisture enough to make the green crop turned under ferment rapidly, nor to enable the planted crop to make the best growth, even where there is an abundance of plant-food in the soil.

The sowing of a catch crop in the fall in humid climates is not open to the same objection, for then this crop has a tendency to gather up available nitrates which develop during the warm part of the fall, after the crop has been taken off the ground, and to carry them through the winter in an insoluble form, so that they are not lost by drainage. But to bring them into requisition, especially if the season or soil is at all dry, it is important that this should be turned under early, and a sufficient interval of time allowed to intervene for fermentation to take place before the seed of the new crop is put upon the ground.

In sub-humid climates, on soils that are not subject to washing, it is very doubtful if there is any advantage to be gained from catch crops, as such, even when sown in the fall; for in those cases there is neither winter nor spring leaching of the soil, and as there is naturally a deficiency of soil moisture, the indications are that very early fall plowing, to develop a

new mulch to lessen further evaporation during the fall and winter, and to permit nitrification in the fall to be carried forward, is likely to leave the soil in a much better condition for the next season, both as to moisture and available nitrates, than could be hoped for by the other method.

It is not only difficult to get a good catch crop in the fall on account of deficient moisture, but there is during the growing season of the sub-humid climate so little moisture that a rapid rate of nitrification in the soil is impossible, and hence all the time which can be had for this purpose is needed in order to have enough nitrates developed for the crop the next year.

#### 6. *Summer Fallowing in Relation to Soil Moisture*

The old practice of summer fallowing, which it has been the fashion for writers on agricultural chemistry to discourage of late years, has really much more of merit in it, as indeed practical experience has proved, than has been recently taught. It is not here intended to convey the idea that there are not soils and climates in which, in the majority of seasons, it would be better not to summer fallow, on account of there being danger of an excessive development of nitrates, which would be lost by drainage ; but there is much to suggest that in rich soils which are usually deficient in soil moisture, as in many sub-humid sections, there is not moisture enough in a single year to develop the requisite amount of plant-food and to mature the crop as well, and hence, that some form of summer fallowing, or

practice which is equivalent to it in effect, will be found to give better results than steady cropping, either with or without catch crops.

#### INFLUENCE OF SUMMER FALLOWING ON SOIL MOISTURE AND ON PLANT-FOOD

In a study on the influence of summer fallowing on the water content of the soil, it was found that the effect still showed, even at the end of the following season, after a crop had been matured on the ground. In order to show how great this influence may be, the results of the study are cited here, giving first the condition of the soil in the spring, when the fallowing experiment was begun. The results cited are from three adjacent plots, the middle plot being the one bearing the crop. The table which follows shows the water content of the plots as given by three determinations, on May 22, June 11, and June 17, the averages being given in every case, and the data from the two fallow plots being combined:

	Ground to be left fallow	Ground not to be left fallow
	PER CENT	PER CENT
0-12 inches.....	23.63	21.49
12-18 " .....	19.78	18.57
24-30 " .....	18.06	18.13
36-42 " .....	15.50	17.48
48-52 " .....	19.03	18.91
<b>Mean.....</b>	<b>19.20</b>	<b>18.92</b>

Here it will be seen that there is a slight tendency for the ground left fallow to be a little wetter than that which was to bear the crop, but this difference is not as large as the table shows, because the fallowing effect had begun to show its influence somewhat when the last two sets of samples were taken, corn having already begun to grow upon the intervening plot.

At the end of the growing season, August 24, the difference

water, and one which is great enough to modify the water content of the soil throughout the whole of the following season under crop. The table shows that where oats were grown, the soil, when the crop had been harvested, contained 8.21 pounds of water per square foot, or 1.57 inches more than did the ground which had not been summer fallowed the year before. The same difference also existed on the barley ground, and in both cases notwithstanding the fact that larger yields of both straw and grain had been produced on the fallow ground.

### 7. *The Old System of Intertillage*

The old system of horse-hoeing, introduced by Jethro Tull in England, and modified by Hunter, and still later by Smith, at Lois-Weedon, has much to recommend it on fertile soils, in which there is a deficiency of soil moisture, as is the case in the sub-humid regions of this country. Tull was a close observer, and early learned to appreciate the great advantage of thorough tillage, not only in conserving soil moisture, but also in developing available plant-food. He strongly advocated planting in drills, so as to admit of thorough and frequent stirring of the soil and with the aid of the horse.

Hunter modified Tull's system by laying out his fields in strips about 9 feet wide, every other one of which was sown, while the intermediate ones were left naked, and were frequently cultivated through the season, and kept free from weeds. In the fall of the year the bare strips were sown, and the others, which had borne the crop, were plowed up and tilled in a similar manner. His method amounted to a system

of summer fallowing, as that practice is now generally understood, except that it possessed one important advantage: namely, his strips being so narrow, and hence so numerous, that both the moisture saved by the tillage and the nitrates developed became available to the plants growing along the margin. Further than this, a part of the rain which fell upon the strips, both by its lateral capillary movement and by the development of roots into this unoccupied ground, contributed to the growth of the crop as though it had been partially irrigated, or its rainfall had been increased, which in fact it had.

The Rev. Mr. Smith, at Lois-Weedon, in Northamptonshire, raised wheat very successfully by still a different modification of Tull's idea. His practice was to sow about one peck of seed to the acre, by dropping the grains 3 inches apart in three rows 1 foot apart, and leaving a space 3 feet wide unplanted between each group of three rows. These strips were thoroughly tilled until the wheat was in bloom, and kept free from weeds. He even went to the extent of trenching the naked strip, bringing up some of the subsoil and putting the surface loam into the trenches. By his thorough tillage, thorough aëration and conservation of soil moisture, he was able to maintain a yield of 18 to 20 bushels per acre without manure.

These cases of old and now generally abandoned practice are called up here because they involve a principle which, when correctly applied, is of great importance in sub-humid climates, where water for irrigation is not available. The principle referred to

laterally to a distance of 3.5 to 4.5 feet; hence, if necessary, the rows of corn might be placed as far as 7 to 8 feet apart, and yet be able to take moisture from the whole field. Taking the extreme case of rows 8 feet apart and plants 2 feet apart in the row, the number of plants per acre would be 2,725. Supposing each plant to produce a large stalk and large ear, the total weight of dry matter for the acre might be 2,157.5 pounds, giving 18.32 bushels of shelled corn. This yield of dry matter per acre would call for only 2.577 acre-inches of water to produce it, at the rate of the results which have been obtained from 52 trials in Wisconsin.

Potato roots spread laterally to the distance of 2 to 2.5 feet; hence these might be planted in rows 4 to 5 feet apart without having the roots overlap in the feeding ground. The chief advantage of wider rows for potatoes in the sub-humid climate comes in its permitting intertillage after the vines have reached full size, and thus better conserving the scanty moisture, so important in the later development of the tubers, and which would travel laterally by capillarity toward the roots in case they did not reach the center. The table which follows shows the actual distribution of soil moisture in the upper 18 inches of a potato field in which the rows extended east and west, and were planted 3 feet apart, under flat cultivation:

### 8. *Frequency of Tillage to Conserve Soil Moisture*

Tillage to conserve soil moisture, like water for irrigation, cannot be applied except at an increased cost of production. Hence, to cultivate a field when there is nothing to be gained from it is to be avoided. In the early part of the growing season, when the soil is so fully charged with moisture that a small rain easily causes the soil granules to coalesce and destroy the effectiveness of mulches, it is often desirable to repeat the cultivation or harrowing as often as there has been a shower of sufficient intensity to establish good capillary connection between the stirred and unstirred soil.

It is often of the greatest importance that this reestablishment of the mulch should take place at the earliest possible moment, not only because of the rapid loss of water from wet surfaces, but because of the fact that, when the surface soil has reached a certain degree of dryness while the deeper soil is yet wet, the moisture of the surface layer so strengthens the upward movement of soil moisture into that layer that not only is all of the rain held at the surface, but a very considerable amount of the deeper soil water is brought there also. Our studies have proved, both by observation and by repeated experiment, that wetting the surface of the ground may leave the deeper soil actually dryer than it was before, and if the new mulch is not early developed the rain may leave the surface four feet dryer than it would have been had the rain not occurred.

Then, too, in the early part of the year, there are so many advantages to be gained through frequent stirring of the soil, other than the saving of moisture, that the slightest reason for going over the ground again should lead to its being done. But as the season advances, and the soil has become dryer to considerable depths, then the desirability of frequent stirrings of the surface to develop or restore the texture of the mulch, is much less. This is so, partly because when the surface of the ground is dry, it is an excellent mulch, even though it is quite firm and close in texture; but also, because the smaller showers



of the later season are largely retained very close to the surface, so that stirring the surface may hasten the evaporation of it, and at the same time prevent a part of it from being conducted downward into the soil by capillarity.

Further than this, in the latter part of the season many plants in humid climates put out new roots, which reach up extremely close to the surface, in order to take advantage of the showers whose waters are retained there; and tillage at once after a rain may do positive injury to the crop, by destroying these roots before they have conveyed the soil moisture to the plant, heavily laden with plant-food, as it is likely to be under these conditions.

### 9. *Proper Depth of Surface Tillage and Ridged or Flat Cultivation*

It will be readily inferred, from what has already been said, that the best depth of tillage will vary with the season. Early in the season it should almost invariably be deep, not less than 2 to 3 inches, but rarely should it be deeper than this. The deep stirring in the spring is to develop fertility by thoroughly aerating the soil and making it warm, so that the nitrates are rapidly formed. Later in the season the cultivation should become more and more shallow, until, as already pointed out, it should be finally abandoned altogether.

When it is stated that the early tillage should have a depth of 2 to 3 inches, this should be understood as meaning that the whole surface of ground not occupied by the plants should be stirred to this depth, and some tool which actually displaces the whole of the soil to a uniform depth does the best work. As a rule, the field should not be furrowed with deep grooves and ridges, for this method early dries out too large a volume of the soil, and thus lessens its productive power. Indeed, it should always be kept in mind that the surface soil in humid climates is the most valuable soil of the field; and for this reason, after the period of stirring for fertility is passed, as little should be moved and allowed to become dry as will answer the needs of the mulch, because in this condition the soil is valueless in plant feeding.

Throwing a field into ridges with deep furrows between, as is done with some of the wide-shovel cultivators, and as used to be done generally in laying corn by, has little to recommend it except on flat fields of stiff, heavy soil, in wet climates or seasons. The chief objection to the ridges and furrows is that they greatly increase the evaporating surface and the amount of soil which is thrown out of use. In the case of potatoes, however, especially on the heavy soils, the last cultivation should be to hill them in order to form a loose, deep, mellow soil, in which the tubers may form and expand without meeting with excessive resistance. Indeed, it is quite doubtful whether there are many soils in which potatoes will not do better if hilled to some extent the last thing before the vines spread to cover the ground. The earlier cultivation should by all means be flat.

#### 10. *Rolling in Relation to Soil Moisture*

The roller has an extensive use in many localities in fitting land for crops in the spring or fall. It should be understood, however, that when the surface of a field is finished with a heavy roller, it is left in a condition in which its moisture will be rapidly lost, and for several reasons :

1. Firming the surface reestablishes the capillary connection with the soil below, and the moisture is brought to the surface quickly from depths as great as four feet. The appearance to the eye is that the ground is made more moist, and so it is at the surface, as a matter of fact, but it must never be forgotten that this is at the expense of moisture stored deep in the ground.

2. Rolling leaves the surface smooth and even, so that it absorbs heat rapidly from the sun on a

clear day, and becomes warmer below the surface than ground not rolled. This hastens the rate of evaporation from the surface. Then, too, this smooth surface allows the wind velocity to be much greater close to the ground, and on this account the loss of water is increased.

It is often desirable to use the heavy roller in fitting ground for seed, and sometimes for the express purpose of bringing an increased amount of moisture to the seed, in order to hasten or to ensure germination when the soil has become dry. But when this has been found desirable, the roller should immediately be followed with a light harrow, in order to restore a thin mulch, which shall check the loss by evaporation from the surface without at the same time preventing the rise of water from below to moisten the soil about the seed.

The press-drill, which has been invented to assist germination, and avoid some of the bad effects of the roller, is a tool employing a sound principle. The seed is well covered to begin with, and then the soil directly above it is firmed by the press-wheel, while the intervening soil is left loose, to act as a mulch and diminish the loss of water, which would be inevitable with the roller. This tool, however, has a much safer application in the sub-humid regions than it has in the East, where the soil in the spring is naturally more moist, and where, for this reason, there is danger of the seed being so closely covered that an insufficient amount of air gets to it to enable it to germinate properly.

### 11. *Lessening Destructive Effects of Winds*

In sub-humid climates, especially like those of our western prairies, where there is a high mean wind velocity, and in the level districts of humid climates, where the soils are light and sandy, with a small water capacity, and which are lacking in adhesive quality, the fields may suffer greatly at times, not only from excessive loss of moisture, but the soil itself may be greatly damaged by drifting caused by the winds. Under such conditions, it is a matter of great importance that the wind velocities close to the surface should be reduced as much as possible.

We have, in Wisconsin, extensive areas of light lands which almost every year suffer severely from the drifting action of the winds. On these lands, wherever broad open fields lie unsheltered by any windbreak, the clearing west and northwest winds which follow storms not only rapidly dry out the soil, but often sweep entirely away crops of grain after they are 4 inches high, uncovering the roots by the removal of 1 to 3 inches of the surface soil. It has been observed, however, in these districts, that wherever there are windbreaks of any sort, even such slight barriers as fences and even fields of grass, a marked protection against drifting has been experienced for several hundred feet to the leeward of them.

In the case of groves, hedgerows, and fields of grass, the protection results partly from their tendency to render the air which passes across them more moist, and partly by lessening the surface velocity of

the wind. The writer has observed that when the rate of evaporation at 20, 40, and 60 feet to the leeward of a grove of black oak 15 to 20 feet high was 11.5 c.c., 11.6 c.c., and 11.9 c.c., respectively, from a wet surface of 27 square inches, it was 14.5, 14.2 and 14.7 c.c., at 280, 300 and 320 feet distant, or 24 per cent greater at the three outer stations than at the nearer ones. So, too, a scanty hedge-row produced observed differences in the rate of evaporation as follows, during an interval of one hour :

At 20 feet from the hedge-row	the evaporation was	10.3 c.c.
At 150 " " " " " "	" " " " " "	12.5 c.c.
At 300 " " " " " "	" " " " " "	13.4 c.c.

Here the drying effect of the wind at 300 feet was 30 per cent greater than at 20 feet, and 7 per cent greater than at 150 feet from the hedge.

Then, too, when the air came across a clover field 780 feet wide the observed rates of evaporation were :

At 20 feet from clover . . . . .	9.3 c.c.
At 150 " " " . . . . .	12.1 c.c.
At 300 " " " . . . . .	13 c.c.

Or 40 per cent greater at 300 feet away than at 20 feet, and 7.4 per cent greater than at 150 feet.

The protective influence of grass lands, and the disadvantage of very broad fields on these light lands, was further shown by the increasingly poorer stand of young clover as the eastern margin of these fields was approached, even when the drifting had been inappreciable. Below are given the number of clover plants

per equal areas on three different farms as the distance to the eastward of the grass fields increased: No. 1, at 50 feet, 574 plants; at 200 feet, 390 plants; at 400 feet, 231 plants. No. 2, at 100 feet, 249 plants; at 200 feet, 277 plants; at 400 feet, 193 plants; at 600 feet, 189 plants; at 800 feet, 138 plants; and at 1,000 feet, 48 plants. No. 3, at 50 feet, 1,130 plants; at 400 feet, 600 plants; at 700 feet, 543 plants.

In these cases the difference in stand appears to have resulted from an increasing drying action of the wind. On most of the fields, the destructive effects of the winds were very evident to the eye, and augmented as the distance from the windbreaks increased.

It appears from these observations, and from the protection against drifting which is afforded by grass fields, hedgerows, and groves, that a system of rotation should be adopted, on such lands, which avoids broad, continuous fields. The fields should be laid out in narrow lands, and alternate ones kept in clover or grass. Windbreaks of suitable trees must also have a beneficial effect upon the crops when maintained along fields, railroads, and wagon roads in such places as have been described, and especially in the prairie sections of the sub-humid regions, where irrigation cannot be practiced. It is, of course, true that trees on the margins of fields sap the soil in their immediate vicinity, and thus reduce the yield there; but it seems more than probable that in open, windy sections their protective influence, which it has been shown they exert, will much more than compensate for this where there is a general deficiency of soil moisture.

important to supplement the rainfall under wholly normal field conditions, to see if there would then be any notable increase over the yields produced under the natural field conditions. This led to a series of experiments to be conducted parallel with those on tillage, to learn how far short of possible yields our actual ones are when secured under the best moisture relations at our command; and irrigation experiments as checks on our tillage experiments were begun, the results of which it is important to state.

In conducting these control experiments on irrigation, the aim has been to treat the crop growing under the conditions of the normal rainfall and under those of the rainfall supplemented by irrigation, exactly alike in every way until it became apparent that more water might be used with advantage, when water was applied to the control plots as often as it seemed desirable. No other elements of difference have been introduced than those growing out of applying the additional water.

#### IMPORTANCE OF THE AMOUNT AND DISTRIBUTION OF WATER IN POTATO CULTURE, AND THE ADVANTAGE OF IRRIGATION IN CLIMATES LIKE WISCONSIN

There have been two seasons' work with this crop, 1896 and 1897, and both years the potatoes have been planted in rows 30 inches apart and in hills 15 inches in the row, or else twice that distance. The ground in each case was given a good dressing of farmyard manure, plowed in 6 inches deep. Large tubers were used for seed, cut two eyes to the piece, and planted with hoe about 3 inches deep, and the ground harrowed after planting.





There is thus shown a difference of 105.9 bushels of merchantable tubers per acre, as an average of two years, in favor of the larger water supply.

**EFFECT OF SUPPLEMENTING THE RAINFALL IN WISCONSIN FOR CABBAGE CULTURE**

In the work with cabbage, the rows were set 30 inches apart, and in half of the area the plants were set 15 inches apart in the row, and on the balance of the area 30 inches apart, of the variety Fottler's Drumhead. There were, in all, 22 alternating plots of 6 rows each, one half irrigated and the balance not. The soil was a rather heavy clay loam, which had been heavily manured the previous year, and had grown a crop of cabbage and cauliflower, but nothing was added this season. Flat and frequent cultivation was given until the plants were large and nearly covered the ground, July 21, when the first irrigation was made, the irrigated rows being furrowed the same as the potatoes, and not again disturbed.

The mean weight of heads produced under the two treatments was as follows :

	Thin planting		Thick planting	
	Irrigated	Not irrig.	Irrigated	Not irrig.
	LBS.	LBS.	LBS.	LBS.
Firm heads .....	7.6	6.95	5.13	4.46
Loose heads .....	4.88	4.33	3.23	2.39

The weight of the heads dressed for market, computed for one acre, was as expressed in the following table:

	Thin planting			Thick planting		
	Irrigated	Not irrig.	Diff.	Irrigated	Not irrig.	Diff.
	LBS.	LBS.	LBS.	LBS.	LBS.	LBS.
Firm heads .....	30,610	29,460	1,130	46,500	40,100	6,400
Loose heads .....	6,227	4,624	1,603	7,688	5,943	1,745
Total .....	36,837	34,104	2,733	54,278	46,043	8,235
Leaves and stumps..	42,730	39,220	3,510	64,100	57,630	6,470
Grand total....	79,567	73,324	6,243	118,378	103,673	14,705
Tons.....	29.78	26.66	3.12	50.19	41.84	7.35

The amount of water given to this crop was 8.245 inches, in four applications, July 21, Aug. 3 and 10, and Sept. 3, 2.061 inches being applied each time.

The difference between equal numbers of rows of cabbage irrigated and not irrigated is shown in Fig. 29. Were the cabbage grown for green fall and early winter feed for stock it will be seen that the close setting gives a difference in favor of irrigation



Fig. 29. Difference in yield between cabbage, irrigated and not irrigated

amounting to 7.35 tons per acre. This occurred, too, under conditions in which the plots not irrigated received considerable water from seepage from the heavy irrigation of a piece of meadow.

The same season that these experiments were made with cabbage, similar ones were conducted with mangold-wurzels and with turnips. But while a good yield of beets was secured per acre, namely, 15.7 tons, there was only 18 pounds difference, the six rows of irrigated mangolds yielding 5,100 pounds and those not irrigated 5,082 pounds. The turnips, on account of a blight, did nothing under either treatment, and the same was true for rape.

#### THE EFFECT OF SUPPLEMENTING THE RAINFALL WITH IRRIGATION ON THE YIELD OF CORN

During four consecutive years we have grown corn upon one area, irrigating a part and reserving another part not irrigated, as a check. The soil of this plot is medium clay loam.

In Fig. 30 is shown the difference between the corn on land irrigated and not irrigated in 1895, when there was the largest ob-



Fig. 30. Difference in yield between maize, thickly seeded, irrigated and not irrigated, in a dry season.

served difference in the yield. Fig. 25 shows the difference where the rows are 44 inches apart instead of 30 inches, as in the former case.

#### THE EFFECT OF SUPPLEMENTING THE RAINFALL WITH IRRIGATION ON THE YIELD OF CLOVER AND HAY

The crop of hay is, perhaps, the one above all others among the general farm crops which may be made to respond most effectively to irrigation in humid climates. Indeed, it is the chief one in Europe which has been grown by irrigation north of Italy

and southern France. Reference has already been made to water meadows.

We have shown in another place that the average yield of hay per acre in thirteen states in this country was, for 1879, only 1.1 tons. It is true, however, that good soils, well managed, may be made to yield most years an average of possibly 1.5 tons per acre. There will be seasons, however, for these soils when the yield will drop back to 1 ton per acre. Again, those seasons are rare for most soils in the United States which will permit them to produce three-fourths of a ton of hay per acre as a second crop without irrigation.

Our experiments in irrigating clover for a second crop gave 1.798 tons, 2.035 tons, and 1.773 tons of hay, containing 15 per cent of moisture, for the years 1895, 1896, and 1897 respectively. In irrigating the first crop of clover, the yields have been 4.01 tons per acre, in a case of sub-irrigation through tile drains in 1895, and 2.671 and 2.65 tons in 1897, which were surface irrigated, making an average for the two crops of 4.979 tons of hay per acre so thoroughly cured as to contain 85 per cent of dry matter. These results, it should be understood, are derived by making an actual determination of the dry matter in each crop and computing the weights of hay from the amount of dry matter.

It will be observed that these yields are more than four times the mean yield of the thirteen states cited in another place. In addition to the first and second crops, there has been each time an excellent third crop, which could be used for fall pasture, and easily double in quantity the non-irrigated fall feed of the best seasons. Fig. 31 is a view of the second crop of 1895, the third crop on the same ground, giving pasture for 58 adult sheep 31 days on 3.2 acres.

#### A CROP OF BARLEY AND A CROP OF HAY THE SAME SEASON

In the spring of 1897 we seeded a piece of ground to clover with barley, irrigating a part of the barley twice, both to see what the effect would be upon the yield of barley and upon the clover

to seed clover with either oats or barley, and by cutting the first crop early for hay and then irrigating, a second crop of hay equal at least to one ton per acre may usually be taken, besides making it certain that a good stand of clover is secured for the next year.

THE EFFECT OF SUPPLEMENTING THE RAINFALL FOR  
STRAWBERRIES

The strawberry is a crop which will respond in a marked manner to judicious applications of water in most parts of the United States suited to its growth, as the results secured at this station by Professor Goff clearly show. His yields per acre were:

	Irrigated BU.	Not irrigated BU.	Difference BU.
1894 .....	214.6	109.3	105.3
1895 .....	272.9	32.2	240.7
Mean .....	243.8	70.8	173

It is here seen that the irrigated yield was more than three times as large as that under natural rainfall conditions; and not only was the yield this much larger, but the quality of the berries was also improved by the irrigation, they being larger and more salable.

While we are able to cite no critical data regarding the advantage of irrigation in humid climates on blackberries, raspberries, currants and gooseberries, the unquestioned fact that these do very frequently suffer severely from the effects of drought leaves no room to doubt that these, like the strawberries, would be greatly benefited by irrigation in very many seasons.

CLOSER PLANTING MADE POSSIBLE BY IRRIGATION

It has been pointed out that in sub-humid climates the limiting factor which determines the number of plants which may develop to advantage in a given soil is the amount of available moisture; but that in coun-

tries where there is an abundant and timely distribution of rain, or where irrigation is practiced, the number of plants per acre may be so far increased that the limiting factors become the available plant-food stored in the soil, the amount of sunshine which falls upon the area, or the circulation of air about the assimilating foliage.

It is very evident that were the amount of available water for crop production the only factor which determines the number of plants which can be grown per unit area, the methods of irrigation would make it possible to greatly increase the yield of almost any crop in the most humid of climates. But there are many limiting factors which set rigid bounds beyond which irrigation may not pass.

*Sufficient breathing room in the soil.*—Since the roots of all cultivated plants demand free oxygen in the soil for their respiration, and since not only the possible quantity of free oxygen in the soil, but the rate at which it may be supplied, decreases as the quantity of water in the soil increases, and since the closer the plants are set upon the ground the more densely crowded must the roots be in the soil, and the more rapid must be the interchange of gases between the soil and the air above in order to meet the increased demands for growth, it is plain that the demand for free oxygen in the soil sets a rigid limit beyond which closer planting must not be pushed.

It must be kept ever in mind that the soil is like a very poorly ventilated assembly hall, which may easily be so crowded as not only to produce discomfort to

its occupants, but disaster as well. Nor do the roots of the plants which occupy the field constitute the only demand for free oxygen in the soil, for the various fermenting germs which transform humus into available nitrates must have free oxygen, or the all-important nitric acid cannot be made, and the farm-yard manures applied to the soil must lie there unaltered and of no avail.

*Soil temperature reduced by too close planting.*—Then, again, too heavy verdure above the soil so completely absorbs the heat from the surrounding air and dissipates it again into space, that the soil temperature cannot rise high enough to produce the maximum rate of solution and production of plant-food, nor the maximum root pressure so essential to sending the dissolved and prepared food into the foliage above, where assimilation takes place; while the humus and manure-fermenting germs themselves must work the slower the lower the soil temperature is after it falls below 98° F. It is true that available nitrates may be applied to the soil direct, and other of the ash ingredients in soluble form may be added, or the soil may receive thorough and repeated tillage before the crop is put upon it, and thus a supply in advance be generated, which leaves more of the oxygen and of the soil warmth for the service of the roots; but neither of these conditions can be attained except at added cost.

*The sunshine itself is limited.*—Even when we come to the item of sunshine itself, it is easy to so increase the number of plants that not enough sunshine can be absorbed to produce normal growth, and a diminished

varieties of corn, but also where the corn was irrigated and where it was not irrigated. It will be seen, further, that the smallest yield of dry matter per acre was produced where the smallest amount of seed was used, namely, where 1 stalk grew every 15 inches; but one-third the number of plants produced about three-fourths as much dry matter per acre as did the larger number of plants.

It must be understood, however, that so far as mere water is concerned, the thinnest planting had decidedly the advantage, as no effort was made, even on the ground irrigated, to make the water applied proportional to the number of plants and, therefore, to the evaporating surface. Whether making the amount of water proportional to the number of plants would have materially increased the yields of the thicker seeding, is a problem which awaits demonstration. Indeed, we do not, as yet, know that the thinnest seeding had all of the water which could be used to advantage, even where irrigation was practiced. But the fact that the smaller variety of maize, *Pride of the North*, the one which produced no suckers, and, therefore, the one which more nearly represented 1 stalk every 15 inches, only gave an increase of 408 pounds of dry matter per acre for the 7.642 inches of water added by irrigation to the rainfall of 10.66 inches, appears to show that this corn found in the 10.66 inches of rain nearly all the water it could use to advantage. This view is strengthened, also, by the fact that the theoretical yield of dry matter per acre for the maize, computed from the data in the table on page 187, is 8,848 pounds, only 312 pounds more than was observed.

Looking at the yield of kiln-dried shelled corn per acre, it will be seen that here a somewhat different relation holds, the largest crop with the white dent variety being secured from 2 stalks in a hill every 15 inches; but with the smaller variety of *Pride of the North* the largest yield of shelled corn coincided with the 3 stalks in a hill where irrigation was practiced; but where the natural rainfall alone produced the crop, the largest yield was associated with the thinnest seeding, or 1 stalk every 15 inches in the row. It is a noteworthy fact, too, that the 7.642



mally, the tassels coming into bloom before the silks were ready to receive the pollen, and it looked then as though the failure to develop the normal amount of ears might result from this abnormal development, in time, of the staminate and pistillate flowers.

The facts are that very few kernels at all formed on the non-irrigated dent variety, and only imperfect ears matured on the flint variety; while on the irrigated plots very many ears never filled at all, and with many of those which did develop ears, the kernels did not cover the entire cob, it being very often observed that no kernels at all formed at the butt of the ear, and sometimes none even half way to the tip. Whether the thick seeding and rapid growth stimulated by irrigation retards the development of the ear by shading, or overstimulates the maturing of the tassel so as to interfere with the proper fertilization, cannot be decided from data yet at hand, although the appearance of the plants looks very much as though such an abnormal development had been brought about.

The nodes of the stalks are certainly lengthened by the close planting and irrigation practiced, but not all are equally affected. If it is true that a certain intensity of sunlight is required for the proper maturing of the ear, it might be anticipated that the effect of the shading would stimulate a greater elongation of the lower than of the upper nodes of the stem, thus placing the ear in more intense light. To ascertain whether any such change as this had occurred, measurements were made of 40 stalks of irrigated thick planting, and a corresponding number of plants not so closely planted and not irrigated, of *Pride of the North* dent, with the result that in the non-irrigated corn the height of the axil bearing the ear was 46.82 per cent of the height from the ground to the base of the tassel; while that of the irrigated corn was 55.2 per cent of the height. That is to say, the ear axil in the thickly planted irrigated corn was raised 8.38 per cent nearer to the tassel.

In a second set of measurements, with the same variety of corn, the height of the axil bearing the ear was 49.44 per cent of the height of the tassel above the ground, while under the condi-

## *Influence of Thick Seeding on Development* 195

tions of irrigation the height of the axil was 56.94 per cent of the height of the tassel, making a difference in this case of 7.5 per cent in the same direction. In the case of a variety of flint corn, however, the conditions are the reverse of those just cited, the axil bearing the ear being 41.16 per cent of the height of the tassel, while on the ground irrigated this height is 39.59 per cent of the height of the tassel above the ground. The case is, therefore, not without exception as tending to show that the deficiency of light modifies the plant in the manner pointed out.

place through the foliage of the crop being fed, then a very small rainfall during the growing season, and a very small amount of water added by irrigation, would suffice for the production of large yields.

In other words, the duty of water in crop production is determined by the necessary losses: (1) by transpiration through the plant; (2) by surface evaporation from the soil; and (3) by surface and under-drainage. The more these sources of loss may be curtailed, the larger will be the duty of water in both arid and humid regions.

In countries where irrigation must be practiced in order to successfully grow crops, skillful management may almost wholly prevent loss by drainage, and loss by surface evaporation from the soil can be made relatively very small, so that the major loss may be that which is transpired through the plant itself. So, too, in humid climates, the losses during the growing season by both drainage and surface evaporation may be greatly reduced through skillful, intelligent practice.

It will, therefore, be helpful, in forming an estimate of the possible duty of water, to use the data already presented in another place to compute the minimum number of acre-inches of water which may be made to produce yields of different amounts under the conditions where no drainage takes place, and where surface evaporation is made as small as it can well be. The results of such a calculation are given in the table which follows:

as the nearest estimate now attainable of the minimum amount of water the irrigator can hope to deliver to his field where the yields there stated are expected ; and if there are necessary losses in bringing the water to the field, either by seepage or evaporation from the main or lateral ditches, or if the water is badly handled, so that there is a large amount of percolation ; or, again, if unnecessary losses occur through lack of proper tillage after irrigation, then the amounts stated in the table must be exceeded by the amount of these losses.

#### CONDITIONS WHICH MODIFY THE AMOUNT OF WATER REQUIRED IN IRRIGATION

Among the many factors and conditions which increase or diminish the duty of water may be mentioned:

1. *The peculiarities of the crop grown.*—From what has been said regarding the amount of water required for a pound of dry matter and for yields of different amounts for different crops, it will be evident that both the amount of water required by a given crop and the frequency with which it should be applied will depend much upon the crop being grown.

This variation in the amount of water required by different crops depends upon many factors, some of which are not well understood. Both the number and size of the breathing pores of the green parts of the plant, through which the air enters and from which the moisture escapes, may be expected to play an important part in determining the necessary loss of water which takes place. So, too, will the character of the foliage and the habit of the plant as influencing the amount of wind movement, and of shade over the soil of the field, effect the necessary loss of water from the soil.

In illustration of the influence of the shade offered by the crop upon the loss of water from the soil may be cited the differ-

these are much less than through the undisturbed soil, yet the relative differences are nearly as large. That is to say, the soil which, in the firm condition, has brought the largest amount of water to the surface, has also, when its surface 1, 2, 3 or 4

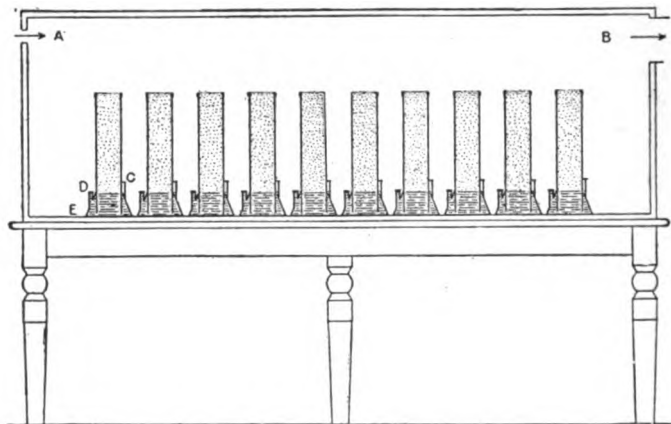

Fig. 36. Method of measuring effectiveness of mulches.

inches were converted into a mulch, permitted the largest losses to take place; while the soil having the slowest rate of loss when the surface was firm has also given the least evaporation through the several depths of mulches.

If the losses per 100 days, expressed in inches, are brought into contrast, they stand as shown below:

	No mulch INCHES	1-inch mulch INCHES	2-inch mulch INCHES	3-inch mulch INCHES	4-inch mulch INCHES
Virgin clay loam.....	21.31	11.13	8.65	7.85	7.81
Black marsh soil.....	5.19	3.12	2.38	2.27	2.23
Difference .....	16.12	8.01	6.27	5.58	5.58

It will be seen from this table that very wide differences exist between the losses of moisture through mulches of like

depth, when developed from soils of different textures, and it is plain that with equal losses by percolation from the three soils here under consideration, more water would be required to bring a crop to maturity on the virgin clay loam than on either of the other soils, and hence, that the duty of water would be less, supposing, of course, that the three soils were equally fertile.

Where water is plentiful and is being used freely, and especially where irrigation by flooding is being practiced, the soils having the coarsest, most open texture will waste the most water by percolation through the zone of root feeding. Hence on this account the duty of water would be smaller on these soils than on those having finer texture. But, on the other hand, the surface evaporation from the closer soils is so much greater than from the sandy soils that the duty of water is much more nearly equal on them than it could be were it not for these opposite characteristics.

Bearing upon this point E. Perels,\* citing Eduard Markus, gives the results of observations covering three years in northern Italy on different kinds of soils and with different crops, from which it appears that rice, meadows and field crops use water in the ratio of 7 to 3 to 1, respectively, and when field crops are grown upon very heavy soil, heavy soil, medium soil, or light soil, they take water in the ratio of—

Very heavy soil	Heavy soil	Medium soil	Light soil
100 . . to . .	115 . . to . .	168 . . to . .	230

It is quite probable, however, that these ratios represent the relations of the degree of permeability of these soils under the conditions of the district, rather than the necessary amounts of water required for irrigation on these soils, where simply the transpiration from the crops and the evaporation from the soils is considered. In the cases of the rice and meadows, it is certain that large percolation or surface drainage must have occurred.

The losses of water by seepage from canals and reservoirs

---

\*Landwirthschaftlicher Wasserbau, p. 501.

and the various distributaries will, of course, be relatively greater in regions of soils of coarse texture than where the soils are finer, so that here is a factor modifying the duty of water as considered from the standpoint of the water company and irrigation engineer especially, but also with the large irrigator, who has extensive distributaries, through which the water must be conveyed before it is finally taken out upon the land. It should be emphasized that our discussion has reference to the duty of water after it has reached the field where it is used.

If it shall be found true that the continued growth of large crops upon a piece of land, and the consequent more complete evaporation of all water brought to the soil, thus curtailing the drainage, tends to develop alkalies to an injurious extent, or other prejudicial salts, so that flooding or leaching by irrigation shall be found necessary in order to restore fertility, then here, again, the character of the soil will modify the amount of water required.

3. *The character of the rainfall* will necessarily modify in a marked manner the amount of additional water which may be used to advantage in the production of crops. It has already been pointed out on page 103 that the difference in the character of the rainfall in parts of California, Oregon and Washington, as compared with that of western Kansas and Nebraska, may explain why equivalent amounts of rain are much more effective in the former than in the latter regions, and if it is true that the frequent summer rains east of the Rocky Mountains do tend to hold the development of the roots of crops closer to the surface, and also to destroy the effectiveness of soil mulches, it is clear that the duty of water in climates where most of the growing season is an uninterrupted rainless period will be relatively higher than where frequent but inefficient showers tend to reduce the efficiency of mulches, and to hold the roots of crops closer to the surface. It is, therefore, likely to be found true that more water will be required for like results in western Texas, Oklahoma, Kansas, Nebraska, and the Dakotas, and similar climates, than will be required where the whole summer season is one continuous interval of no rain.

*Table showing the loss of water from a virgin clay loam through mulches 1, 2, and 3 inches deep, when cultivated once in two weeks, once per week, and twice per week*

	Not cultivated	Once in 2 weeks	Once per week	Twice per week
	PER ACRE	PER ACRE	PER ACRE	PER ACRE
Cultivated 1 inch deep—				
The loss in tons per 100 days was....	724.1	551.2	545	527.8
The loss in inches per 100 days was..	6.394	4.867	4.812	4.662
The percentage of water saved was..		23.88	24.73	27.1
Cultivated 2 inches deep—				
The loss in tons per 100 days was....	724.1	609.2	552.1	515.4
The loss in inches per 100 days was..	6.394	5.38	4.875	4.552
The percentage of water saved was..		15.88	23.76	28.81
Cultivated 3 inches deep—				
The loss in tons per 100 days was....	724.1	612	531.5	495
The loss in inches per 100 days was..	6.394	5.28	4.694	4.371
The percentage of water saved was..		15.49	26.6	31.64

It will be seen from this table that with each of the three depths of cultivation the loss of water decreased with the frequency, so that the per cent of moisture saved by the cultivation, when computed on that which was lost with no cultivation, was more than 31 for 3 inches deep twice per week, as against a saving of only 15 per cent where the same cultivation was made only once in two weeks. That is to say, if one is cultivating ground of this character 3 inches deep twice per week, the saving over no cultivation may be at the rate of 2.29 tons per acre per day, or 22.9 tons per each 10 days, or 2 acre-inches per 100 days.

The results presented in the table were obtained in our plant-house, with cylinders 52 inches deep and 18 inches in diameter, filled with soil under a nearly still air and a comparatively low mean temperature, not exceeding 55° F., during the short days and long nights of December and January, so that the observed losses in the several cases must be looked upon as small, and below what may obtain under field conditions. It is plain, therefore, that in orchard irrigation and in arid climates, under a clear sky, dry air and high temperature, the duty of water during the long seasons may be very materially increased by adequate cultivation, and decreased by the lack of it.

The same will also be true, but in a less marked degree,



with all cultivated crops where the soil is not completely shaded by the plants on the ground.

6. *The closeness of planting* is another factor which affects the duty of water when this is expressed in terms of land served, rather than in terms of crop produced. This is particularly true in climates where a rainy season contributes a considerable portion of the moisture needed to produce a crop ; because if one is contented with a small yield per acre, a comparatively thin stand upon the ground, with thorough tillage, may often be brought to full maturity with a relatively small amount of water applied by irrigation, thus making the duty of water to appear very high, whereas if the plants were made to stand as closely as the sunshine would permit, much more water, when expressed simply in acre-inches, would be required. The real duty, however, might be even higher in the second case, when expressed in terms of yield per acre.

7. *The fertility of the land* is still another factor which affects the duty of water, tending to make it appear less the richer and more fertile the soil is, when the standard of comparison is the unit area rather than the yield of crop. This apparent decrease in the duty results from the larger evaporation of water which takes place from the more vigorous growth of vegetation, and the closer stand which the larger amount of available plant-food renders possible. In such cases as these, however, the real duty of water is higher on the most fertile soil, when this is based upon the actual yields per acre ; not so much because the plant uses the water more economically, as that the necessary loss from the soil itself is relatively less with the large yield than it is with the small yield per acre. The loss from the soil direct may even be actually larger with the smaller crop on the ground, on account of a less complete shading and stronger air movement close to the surface.

8. *The frequency of applying water* also modifies the quantity which will be used during a season. This may be true even when the greatest skill is exercised in the application of the water. In the first place, too frequent application of water in small quantities at a time not only increases in a marked degree the

direct loss of moisture from the wet, unmulched soil ; but it may have a tendency, as has been pointed out, to induce a superficial development of roots, causing the crop to show signs of need of water sooner than would be the case if a smaller number of more thorough irrigations were resorted to. This is so, not only because the water disappears sooner from the soil, but also because of the larger amount of root-pruning which results from cultivation where the roots are developed near the surface of the ground.

It is probable that a large supply of water in the soil during the early stages of growth of many plants tends to develop in them a possibility for using more water. In some, at least, of our experiments with corn, oats, potatoes and clover, where we have started with like amounts of water in the soil, and have watered one set of plants every seven days while the others were allowed to go without water until the soil was so far exhausted that the plants were plainly suffering for want of moisture, it was found that these plants not only did not use water as rapidly after they were given it as did those which had been watered every week, but they used the water they did have with relatively greater economy. Whether this was because the plants were smaller, and thus presented a smaller surface to the air and sun, or whether the size or number of breathing pores per unit area of foliage was actually less, cannot yet be stated ; but it appeared evident that for some reason the plants which had not been watered at first were later not able to use the larger amount of water which was given to them, as they might have done had they been more freely watered at first.

#### THE AMOUNT OF WATER USED IN IRRIGATION

It is very difficult, indeed, to get data bearing upon this important subject which may be regarded as in every way satisfactory and trustworthy. Nearly all statistics are necessarily so general in their character, the exact amount of land to which the water of a

the Gattinara canal, water is provided which may be applied at the rate of 5.289 inches per 10 days. But under the Busca canal, where the utmost economy is practiced and every drop is saved, the duty of water is so much increased that one second-foot serves 106 acres, making a depth of water equal to 2.245 inches every 10 days for the irrigation season.

Bringing all cases cited by Smith into one table, and expressing the second-foot in inches of water per 10 days, the following results are found:

*Amount of water used for irrigation in Italy*

No. of acres per sec. foot	No. of inches of water per 10 days	No. of acres per sec. foot	No. of inches of water per 10 days
51.4	4.63	99.3	2.397
45	5.289	80.4	2.96
106	2.245	66.62	3.572
100.6	2.366	61.8	3.851
63	3.778	66.6	3.574
90.6	2.627	69.2	3.44
50.3	4.732	63.9	2.837
70	3.4	67.2	3.542
77	3.091	90.4	2.633
69	3.449		

This gives a general average for ordinary crops of 3.39 inches of water every 10 days and 33.9 inches per 100 days, were it used at such a rate for so long a period.

In the rice irrigation of Italy, the amount of water provided is said to be at the rate of 5.568 inches, 5.921, 3.412, 9.521, and 3.334 inches every 10 days in as many districts, or an average of 5.55 inches per 10 days.

In Spain, where the rainfall is less than in Italy, and where greater economy of water is practiced, 19 important allotments\* of water give an average of 2.353 inches every 10 days for various sections of that country.

In France, in the Department of the Upper Garonne, contracts were made calling for water at the rate of three-fourths of a liter per hectare per second, which makes a duty of about 93.25 acres per second foot, or water applied at the rate of 2.552 inches every 10 days. In the department of Vaucluse, the concession was at the rate of only 1.361 inches per 10 days.

In Egypt, Willcocks† states that in winter water is applied at an average depth of 10 c. m., equal to 3.937 inches, once in 40 days, which is a rate of .984 inches once in 10 days; but in summer the first watering is at the rate of 11.5 c. m., equal to 4.528 inches, while subsequent waterings are at the rate of 3.412 inches in depth. Cotton requires this amount once in 20 days, or at the rate of 1.706 inches per 10 days. Rice is given water at the rate of 3.412 inches once every 10 days, and maize gets the same amount every 15 days, or at the rate of 2.276 inches in depth every 10 days.

Wilson‡ gives a table of general averages of the duty of water in different parts of the world, which we put in the form stated below:

---

\*Hall, *Irrigation Development*, p. 523.

†Willcocks, *Egyptain Irrigation*, pp. 234, 235.

‡*Manual of Irrigation Engineering*, Sec. Ed., p. 49.

*Amount of water used in irrigation in different countries*

Name of country	No. of acres per sec.-ft.	No. of inches per 10 days
Northern India . . . . .	60 to 150	3.967 to 1.587
Italy . . . . .	65 to 70	3.661 to 3.4
Colorado . . . . .	80 to 120	2.975 to 1.983
Utah . . . . .	60 to 120	3.967 to 1.983
Montana . . . . .	80 to 100	2.975 to 2.38
Wyoming . . . . .	70 to 90	3.4 to 2.644
Idaho . . . . .	60 to 80	3.967 to 2.975
New Mexico . . . . .	60 to 80	3.967 to 2.975
Southern Arizona . . . . .	100 to 150	2.38 to 1.587
San Joaquin Valley . . . . .	100 to 150	2.38 to 1.587
Southern California . . . . .	150 to 300	1.587 to .793

E. Perels\* tabulates the duty of water in Algeria as follows :

*Water required for irrigation in Algeria*

Crops	No. of waterings	Water used		Length of culture period MONTHS
		Each application INCHES IN DEPTH	During the season INCHES IN DEPTH	
Alfalfa . . . . .	10	1.575	15.75	6
Vegetables . . . . .	36	1.575	56.7	6
Cotton . . . . .	10	2.52	25.2	5
Flax . . . . .				
Sesame . . . . .				
Maize . . . . .	4	1.575	6.3	2
Winter grain . . . . .	3	3.937	11.87	7
Oranges . . . . .	12	1.575	18.9	6
Tobacco . . . . .	4	1.575	6.3	3
Grapes . . . . .	4	4.725	18.9	3

From another general table giving the duty of water in different countries, by Flynn,† the results which follow are derived:

\*Landwirtschaftlicher Wasserbau, zweite Auflage, p. 502.

†Irrigation Canals and Hydraulic Engineering, p. 293.

## Amount of Water Used in Irrigation 213

### Amount of water used in irrigation in different countries

Locality	Name of country	No. of acres per sec.-foot	No. of inches per 10 days
Eastern Jumna Canal . . . . .	India	306	.778
Western Jumna Canal . . . . .	“	240	.989
Ganges Canal . . . . .	“	232	1.026
Canals of Upper India . . . . .	“	267	.891
Canals of India—average . . . . .	“	250	.952
Bari Doab Canals . . . . .	“	155	1.536
Madras Canals (rice) . . . . .	“	66	3.606
Tanjore (rice) . . . . .	“	40	5.964
Swat River Canal, 1888-89 . . . . .	“	216	1.345
Swat River Canal, 1889-90 . . . . .	“	177	1.202
Western Jumna Canal, 1888-89 . . . . .	“	143	1.664
Western Jumna Canal, 1889-90 . . . . .	“	179	1.33
Bari Doab Canal, 1888-89 . . . . .	“	201	1.184
Bari Doab Canal, 1889-90 . . . . .	“	227	1.049
Sirhind Canal, 1888-89 . . . . .	“	180	1.322
Sirhind Canal, 1889-90 . . . . .	“	180	1.322
Chenab Canal, 1888-89 . . . . .	“	154	1.545
Chenab Canal, 1889-90 . . . . .	“	154	1.545
Nira Canal . . . . .	“	186	1.28
Genil Canal . . . . .	Spain	240	.992
Jucar (rice) . . . . .	“	35	6.8
Henares Canal . . . . .	“	157	1.516
Canals of Valencia . . . . .	“	242	.984
Forez Canal . . . . .	France	140	1.7
Canals south of France . . . . .	“	70	3.4
Sefi Canals, Southern France . . . . .	“	60	3.877
Sefi, or Lower Nile Canals . . . . .	Egypt	350	.68
Sefi, or Lower Nile Canals . . . . .	“	274	.867
Canals of Northern Peru . . . . .	Peru	160	1.488
Canals of Northern Chili . . . . .	Chili	190	1.253
Canals, Lombardy . . . . .	Italy	90	2.644
Canals, Piedmont . . . . .	“	60	3.877
Marcite . . . . .	“	1 to 18	238 to 13.22
Sefi Canals, Victoria . . . . .	Australia	200	1.19

*Amount of water used in irrigation—continued*

Locality	Name of country	No. of acres per sec. foot	No. of inches per 10 days
Sweetwater, San Diego . . . .	California	500	.476
Pomona, San Bernardino . . . .	"	500	.476
Ontario . . . . .	"	500	.476
California . . . . .	"	.80 to 150	2.975 to 1.587
Canals of Utah Territory . . . .	Utah	100	2.38
Canals of Colorado . . . . .	Colorado	100	2.38
Canals of Cache la Poudre . . . .	"	193	1.233
Canals of Colorado . . . . .	"	55	4.328

It is apparent, from the data which have been presented, that the amount of water actually used in irrigation in different countries and for different crops is an extremely variable quantity; so much so, indeed, that it is hardly possible to deduce from available statistics a mean value for the duty of water. But, using the 100 cases at hand from all parts of the world, and excluding those which apply to rice culture and the irrigation of water-meadows and sugar cane, it appears that a cubic foot of water per second is made to serve on the average 117.6 acres. If this water were applied to the land once in 10 days, it would cover the surface to a depth of 2.024 inches each watering, and during a season of 100 days would be the equivalent of 20.24 inches of rain.

Sugar cane is a crop which demands large and frequent irrigations in order to secure the largest returns from the soil. In the Sandwich Islands one cubic foot of water per second is required for 41.6 acres of cane, and it is found that if the duty is made larger than 60 acres per second-foot, a falling off in yield is

In constructing this table, the season of growth has been taken at 100 days for wheat and oats, 80 days for barley, 110 days for maize, 130 days for potatoes, and 60 days for one crop of clover hay. It has further been assumed that the ground at seeding time is well supplied with moisture, while at harvest it is only so much dried out as to have just become ready for another watering.

As in the experiments which gave the fundamental data for the table above, the soil was more closely planted than is practicable under field conditions, the loss of water by evaporation from the soil of the field is likely to be greater, relatively, than was the case in the experiments; hence, the observed duty of water is likely to be lower than the table indicates. Again, in the case of the smaller yields per acre, the evaporation from the soil will necessarily be relatively larger than where the heavier crops are produced; hence, the duty expressed for water when the yields are small is likely to be farther from the possibilities than in the cases where the yields per acre are larger.

If the amount of water which the last table indicates is required to produce a crop of the various kinds is expressed in cubic feet, the figures will stand:

8,640,000 cu. ft. of water may produce	7,056 bushels of wheat
8,640,000 " " " " " "	15,030 " " oats
6,912,000 " " " " " "	7,906 " " barley
9,5040,000 " " " " " "	15,580 " " maize
11,232,0000 " " " " " "	149,620 " " potatoes
5,184,000 " " " " " "	322.7 tons of hay,



where the number of cubic feet is the product of one second-foot into the number of seconds in the season of growth, and the number of bushels is the product of the yield per acre into the number of acres irrigated.

#### THE DUTY OF WATER IN RICE CULTURE

The aquatic nature of the rice plant makes the demands for water quite different from those of ordinary agricultural crops, and so different are these needs that the quantity of water required to bring a crop to maturity is determined by quite different factors. The duty of water, therefore, in rice culture could not consistently be considered in connection with that of ordinary crops.

The normal habitat of this plant is low, swampy lands, where the surface is more or less continuously under water, and where such lands are available under suitable conditions for rice culture, they are largely brought into requisition for this purpose; but the seeding of the ground and the harvesting of the crop make it needful that the fields shall be drained at times and at others flooded. Under these conditions, there can be but little waste from seepage, and the chief demands for water are created by the loss from evaporation from the surface of the water, from the growing crop, and from the wet soil when the fields have been drained, together with the amounts which are required for reflooding the fields after they have been drained. Occasionally threatened attacks upon

the crop by insect enemies make an extra flooding or drainage necessary, and this increases the demand for water. Further than this, in order that the crop may be the best, the water must not remain long stagnant, and this requires either alternate flooding and draining, or else a considerable steady surplus flow of water over the fields.

In order to secure more economical methods of seeding and harvesting the rice fields, this crop is extensively grown on naturally dry lands, which may be readily checked off into flooding basins, to which the water may be admitted and withdrawn at pleasure. In these cases, there is added to the demands for water already mentioned the loss from seepage. This loss from seepage may be so large that rice irrigation cannot be economically practiced on uplands unless they are quite fine and close in texture, so that the rate of seepage will be small, or unless the normal level of the ground-water is within a few feet of the surface. Even here the subsoil must be pretty close, or the loss of water by under-drainage will be too large.

The various available sources of data regarding the duty of water in rice irrigation place the amounts of water used as varying all the way from one second-foot for 25, 28, 30, 35, 40, 55 and 66 acres of rice, thus making an average of 38.6 acres per cubic foot of water per second, and this is equivalent to covering the surface with water about 6.2 inches deep every 10 days.

THE DUTY OF WATER ON WATER-MEADOWS

In this form of irrigation, immense volumes of water are used on the land. In Italy, where the practice has attained the highest stage of perfection, where it may have had its origin, and from which been introduced into France, and even into England at the time of the Roman invasion, the duty of water appears to average only about 1.5 acres per cubic foot per second. On these meadows in Italy there is maintained a nearly continuous flow of water, night and day, from September 8 to March 28 of each year, this being the legal time allotted to *Marcite*, or winter-meadow irrigation.

The lands are so laid out that the roots of the grass over the whole meadow are continuously submerged beneath a thin veil of relatively warm running water, this being turned off only long enough to cut the grass, which is done two or three times during the winter season, the green grass being used for the winter feed of dairy cows, which are largely kept in the irrigated portions of Italy. So large is the quantity of water used during a single season on these meadows that did none of it drain away they would become submerged to a depth of 300 feet.

Carpenter, quoting Mangon, states that in southern France and in the Vosges, where the most careful measurements of the water applied to the meadows have been made, amounts are used in some cases sufficient to cover the surface 1,400 feet deep; and that of this great volume, as much water as 160 feet on the level sinks into and percolates through the soil of the field during a winter season. But even in the summer irrigation, as much as 374 feet of water on the level are applied between April and July, while of this amount no less than 88 feet percolates into the ground or is evaporated.

The meadows upon which these large volumes of water are applied are usually permanent ones, and have had their surfaces fitted with the greatest care, so that the relatively warm water may be kept steadily flowing over the surface about the roots of the grass in a thin veil until it is ready to cut, when it is turned off only long enough to remove the crop.

## CHAPTER VI

### *FREQUENCY, AMOUNT AND MEASUREMENT OF WATER FOR SINGLE IRRIGATIONS*

To have become able to apply water to crops at the right time, in the right amounts and in the best manner is to have attained the acme of the art of irrigation. Unfortunately, it is no more possible to bear a man to this position on the vehicle of language than it is a cook to the art of making the best bread. Both arts are founded upon the most rigid of laws, which may be readily and certainly followed when the conditions have been learned. But the minutiae of essential details are so extreme that words fail utterly to convey them to the mind, and they must be perceived through the senses, to be grasped with such clearness as to lead unerringly to the right results. There are, however, general principles underlying the art, which may be readily stated, and, when comprehended, place one in position to more quickly grasp the details essential to complete success in the application of water to crops.

#### THE AMOUNT OF WATER FOR SINGLE IRRIGATIONS

In humid climates, there is always more or less soil-leaching, resulting from super-saturation of the

of desiccation of the soil which the particular crop will tolerate before serious interference to growth results.

**THE CAPACITY OF SOILS TO STORE WATER  
UNDER FIELD CONDITIONS**

The amount of water which may be stored in soils under field conditions varies between wide limits with the character and texture of the soils, and also with the distance of standing water in the ground below the surface.

When a fine sand will hold in the first foot above the ground-water 23.86 per cent of its dry weight of water, at 4 feet above it was found to hold only 8.12 per cent, and 8 feet above only 3.14 per cent of the dry weight. When these amounts are expressed in pounds per cubic foot, they stand only a little more than 23.86 pounds, 8.12 pounds, and 3 14 pounds, a cubic foot of the dry sand weighing about 105 pounds.

In the case of a natural field soil of sandy clay loam with clay subsoil changing to a sand at 4 feet, and where the ground-water changed during the season from 7.6 feet below the surface to 8.4 feet, the water content of the soil was found to be as follows:

	1st ft. lbs. water	2d ft. lbs. water	3d ft. lbs. water	4th ft. lbs. water	5th ft. lbs. water	6th ft. lbs. water	7th ft. lbs. water
July 25	10.44	16.91	14.81	10 38	7.82	13.66	22.29
October 2	9.49	16.27	14.41	6 99	7.74	7.85	19 35
Loss	.95	.64	.4	3.39	.08	5.81	2.94

During this interval there had been a rainfall of 10.84 pounds per square foot. There is no doubt that in the upper 4 feet a considerable part of the water was lost through surface evaporation. It is quite likely, also, that a portion of the loss shown in the 5th, 6th, and 7th feet was due to an upward capillary movement. But there is little reason to doubt that the

its needs in a dryer soil, it is evident that a much higher duty of water is possible, for the simple reason that none can be lost by percolation, and much less will be lost by surface evaporation, even with deficient tillage.

We have already called attention to the probable deeper rooting of plants in soils of arid regions, where

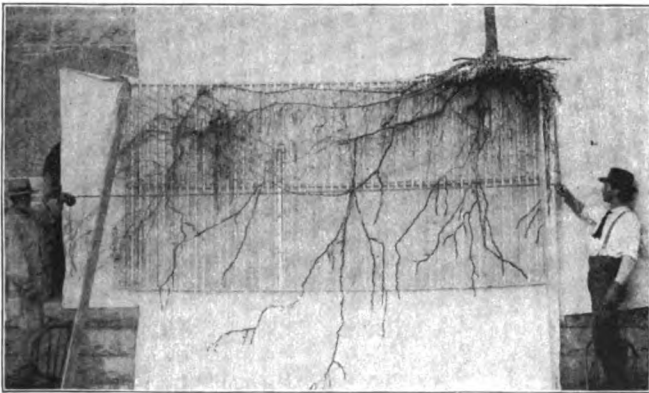

Fig. 38. Penetration of apple root in Wisconsin, 7 years planted.  
Depth 9 feet. (Goff.)

there is less distinction between the soil and subsoil, than in those of humid climates. Since writing that section, we have received Professors Hilgard and Loughridge's Bulletin 121, in which they emphasize this point by placing in evidence a photo-engraving of a prune tree on a peach root exposed in the soil to a depth of 8 feet, and represented in Fig. 37. The method they have used in exposing the root appears,

from the photograph, to have destroyed nearly all but the main trunks, unless it was true that the active

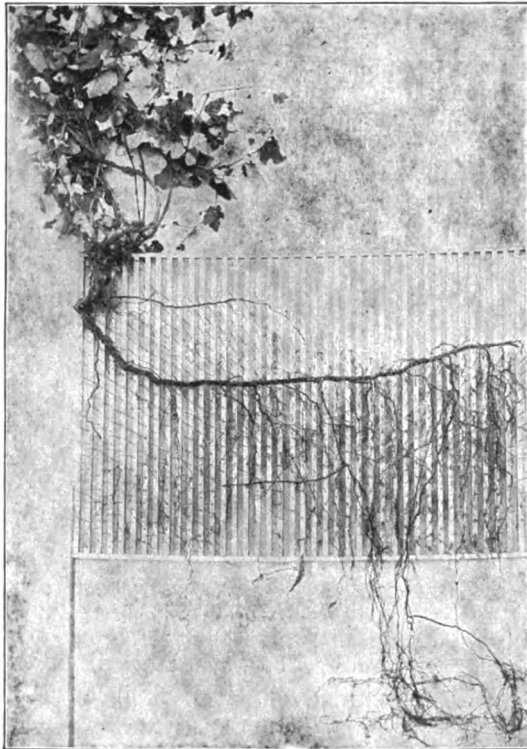

Fig. 39. Penetration of grape roots in Wisconsin soil.  
Depth 6 feet. (Goff.)

absorbing surfaces were chiefly still more deeply buried in the soil than the excavation extended. This appears quite likely to have been the case, for this penetra-

laid under tribute by them, and this makes it clear that the storage room for water in the soil for many of the fruits may be much greater than we have pointed out above.

In the case of the strawberry, however, the figure shows that it is a particularly shallow feeder, and, therefore, is certain to suffer severely in dry times if not irrigated.

In Fig. 42 are shown the roots of alfalfa only 174 days from seeding. These had forged their way through so close a clay subsoil that more than four days of continuous washing were required to dissolve away a cylinder of soil 1 foot in diameter and 4 feet long. The roots, however, had penetrated this soil to a depth exceeding four feet, and the nitrogen-fixing tubercles were already developed 22 inches below the surface.

In the rigid data here presented, combined with that shown in Figs. 10 and 11, we have a rational basis upon which to build a practice of irrigation, so far as that relates to the depth of soil

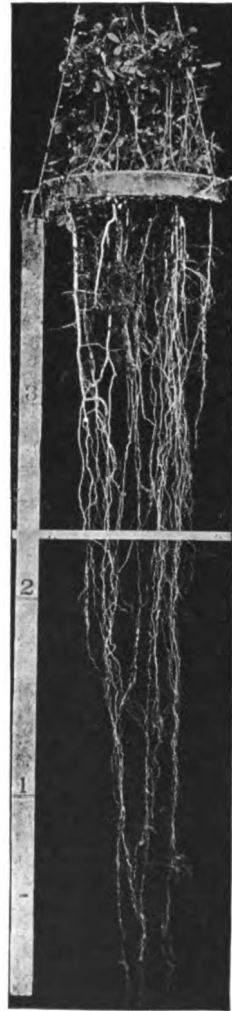

Fig. 42. Roots of alfalfa in Wisconsin 174 days from seeding.



sionally, four times, two being the usual number; in New Mexico, the ground is irrigated once before and once after seeding and five times later, making seven times in all; while in Utah the number of waterings is three to five.

The average number of irrigations appears to be from three to five for wheat in all parts of the world. But it should be understood that these irrigations are, in all cases, supplemented more or less with natural rainfall. In Colorado, for example, where the usual number of irrigations is two, the rainfall from April 1 to July 1 is often as great as 8 inches, or two-thirds the amount of water required for a yield of 40 bushels per acre, thus making the number of irrigations amount practically to six rather than two, and the mean interval  $16\frac{2}{3}$  days, instead of 33 to 20.

It must be remembered, further, that while the irrigations of wheat are in all cases supplemented with natural rainfall, the yield per acre does not average 40 bushels; hence the agreement of the theoretical frequency of irrigation, 33 to 20 days, with that actually practiced is more apparent than real.

In Egypt, maize is irrigated every 15 days, which would make seven waterings for the crop. Barker states that six irrigations are given to a crop in the Mesilla valley, New Mexico; while in Italy three is the usual number. But here, again, the spring and early summer rainfall is quite large; so large, indeed, that much maize is grown without irrigation. It appears, therefore, that where this crop must really depend upon irrigation for the water needed, it must be applied as often as

every 15 to 20 days, and our experimental studies place it at 15 to 27 days for yields of 100 bushels per acre.

The intervals between the irrigations for other cereals will be found to fall between those for wheat and maize, oats requiring the largest amount of water and barley the least, to mature a large crop.

In the irrigation of clover and alfalfa, the usual practice is to irrigate once for each crop. But there is little question that larger yields for each crop may be secured where the number of irrigations is doubled, giving six where the number of crops is three, and ten where it is five, thus making the length of the interval 10 or 20 days.

With other meadows, the general custom is to give these as much and as many waterings as the water supply will permit. In Italy, the summer meadows are watered every 14 days. In southern France they are watered every 5 to 18 days, and on the average every 10 days. Winter water meadows, as has been stated, are watered with a nearly continuous flow of water over their surfaces.

With potatoes, the custom is usually to depend upon the natural rainfall to bring the crop nearly or quite to blossoming, and then to irrigate twice on nearly level fields, and three to four times where the slopes are steep or where the soil is very porous and coarse in texture, thus making an interval for this crop of 20 to 40 days.

For this crop our experimental studies indicate that 8.24 acre-inches may produce 400 bushels per acre; hence, that two to four irrigations might be sufficient

for a full season, starting with the ground in good condition as regards moisture at time of planting, making the possible interval 33 to 65 days.

Fruit trees in Sicily and southern Italy are watered 12 to 25 times during one season or once every 7 to 14 days. The peach and apple in Mesilla, New Mexico, are watered once at the beginning of winter, once early in January, and four or five times between April 1 and September 30, thus making the interval for the growing season 30 to 40 days. In Algeria and Spain, oranges are irrigated the year round—every 15 days in spring and summer, but at longer intervals the balance of the year; and it is only on the heavy soils that irrigation is dispensed with during the rainy season. Grapes, when irrigated, are usually watered every 10 to 20 days, and young vineyards oftener than those more mature.

Rice in Italy is kept flooded from the time of seeding until the plants are coming into bloom, and then the water is drawn off, but the fields are irrigated afterwards every few days. In Egypt the water in the rice basins is changed every 15 days, and in India a crop of rice gets as many as twelve waterings.

In South Carolina, Mr. Hazzard informs me that their custom is to clay the seed to prevent it from floating, and then to flood the fields, keeping them so until the rice is well up, when the water is drawn off for 3 days to allow the plants to become rooted in the soil, when the fields are again flooded for 3 weeks, but changing the water every 7 days. The water is again drawn off for 30 days, to give the fields two

so satisfactory as one which expresses the depth of water to be applied to a unit area, and the acre-inch for English-speaking people, or the hectare-centimeter for those who use the metric system, should become universal. Rainfall is now universally measured in units of depth, and, as irrigation is intended to make good deficiencies of rainfall, it would simplify matters greatly if the irrigator could call for the depth of water he desired.

An acre-inch is enough water to cover 1 acre 1 inch deep; and 10 acre-inches of water is enough to cover 1 acre 10 inches deep, or 10 acres 1 inch deep. As an acre contains 43,560 square feet, 12 acre-inches is equal to 43,560 cubic feet of water, and 1 acre-inch equals one-twelfth of this amount, or 3,630 cubic feet. As there are 1,728 cubic inches in a cubic foot, and 231 cubic inches in a gallon, 1 cubic foot equals 7.48+ gallons, and 1 acre-inch equals 27,150 gallons.

As 1 cubic foot of water at 60° F. weighs 62.367 pounds, 1 acre-inch equals 226,392 pounds, or 113.2 tons of 2,000 pounds.

Another measure frequently used in the gauging of streams, and also used as an irrigation unit, is the second-foot, which means a discharge or flow of water equal in volume to 1 cubic foot per second of time; and a stream having the volume of 1 second-foot would supply an acre-inch in 3,630 seconds, or in 30 seconds more than one hour. In 24 hours, a stream of 1 second-foot would supply 23.8 acre-inches, and would cover 7.93 acres of land with water 3 inches deep.

Still another unit in common use in the western

be made to include a fraction of a day, say  $8\frac{1}{2}$  days instead of 8, as in the one cited; or, after a certain number of rotations, the water may be given first to a different member in the circuit, and thus change the time of day at which each gets his turn.

In those cases where the supply of water in the ditch is always the same, this is the most accurate and best method of dividing water which has been devised, and where the amount of water which the ditch carries is known, it gives every one a definite knowledge of the amount of water he is using.

It often happens, however, that the volume of water changes from time to time, and when this is true those who chance to be using water when the supply is high will receive most. But if the period of rotation is short, the injustice will seldom be very great, and where the periods of rotation are short, the service is usually more convenient and better for other reasons than that of a more equitable division of the water, because it permits a user to apply his water to certain fields one date and to another on his next turn, thus permitting him to do his fitting and cultivation between irrigations to a greater advantage.

### *The Subdivision of Laterals*

Where the lateral carries too much water to be used to advantage by single individuals, this may be subdivided readily into two exactly equal portions, and these two divisions may be again subdivided into two precisely equal streams. But in order that the division may be exact, it must be done in certain

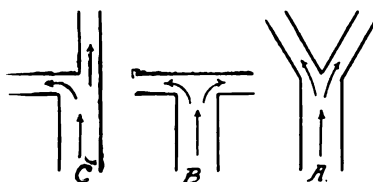

Fig. 43. Branching of canal to divide water equally (A and B) and unequally (C).

ways, as represented in Fig. 43. If the two branches of the lateral form equal angles with the main, have the same fall, and their bottoms at the same level where they start, they will carry equal

volumes of water if their dimensions are exactly the same as shown at A and B. But if the division is made as at C, or in any other manner, which makes the two arms in any way unlike, one will carry more water than the other. So, too, if care is not taken to keep the main and the two branches clean where the division is made, it will not be exact.

When an effort is made to divide the main into two unequal parts, or into an odd number of equal parts, the task becomes an extremely difficult one, and one which is not likely to be accomplished, and the attempt should be avoided.

The cause of the difficulty is found in the fact that the water travels with the greatest velocity in the center of the stream and diminishes in speed as the sides are approached, so that if the main is divided into two branches which have cross-sections in the ratio of 1 to 2, the larger arm will carry more than twice the amount of the smaller one, because it must take a larger share of the water moving in the central portion of the main. Or if the main is divided into three equal laterals, then the central branch is sure to carry more water than either of the two taking the water from nearer the sides, and it is not practicable to so adjust the dimensions of these branches that with varying volumes of water moving in the main the desired ratios shall always be secured in the divisions.

### *The Use of Divisors*

When it is desired to remove from a ditch a certain portion of the amount of water which it is carrying, this is sometimes attempted by means of an arrangement represented in Fig. 44, called a *divisor*, in which the portion A is set into the channel some fractional part of the whole width, determined by the amount which it is desired to take out. Thus, if it was desired to take out one-fifth of the stream, and the lateral had a width of 40 inches, the divisor would be set in toward the center 8 inches. But from what has already been said, it follows that less than one-fifth of the water can thus be removed, for the two reasons, that the section of the stream removed does not

## CHAPTER VII

### *THE CHARACTER OF WATER FOR IRRIGATION*

THE characteristics which determine the suitability of water for the purposes of irrigation must depend upon the chief objects for which the water is used: whether it is to control temperature, as in the case of winter-meadows and in cranberry culture; to supply plant-food, as in the case of summer water-meadows; to meet the simple need of water for the transpiration of the growing crop, or to deposit sediments for the purpose of building up the surface of low-lying areas, as in the case of warping.

### TEMPERATURE OF WATER FOR IRRIGATION

Where one of the prime objects in the use of water for irrigation is to stimulate plant-growth, the warmer the water is within the natural ranges of temperature the better are the results. According to Ebermayer, when the temperature of the soil in which a crop is growing has been lowered to from 45° to 48° F., physiological processes are brought nearly to a standstill in it, and the maximum rate of growth does not become possible until after the soil temperature has risen above 68° to 70°. It is plain, therefore, that if large volumes of cold water were applied to the soil at

one time, and especially if a flooding system were adopted by which the cold water were kept moving over the ground in the growing season during several days, the temperature of the soil might easily be brought so low as to seriously interfere with normal growth.

The dangers, however, from using cold irrigation waters are not as great as might at first be supposed; and it is seldom, where good judgment is exercised, that the low temperature of the water of wells and springs need prohibit its use for the purposes of irrigation.

In the first place, there are few cases where the temperature of well or spring water during the irrigation season will be found as cold as 45° F., the more usual temperature being nearly 50° or above. In the second place, water warms very rapidly during bright summer days, when spread over the surface of the ground, or when led along furrows, and even while flowing through ditches, for it absorbs the direct heat from the sun readily, as the rays of light penetrate it, and is further indirectly warmed by the balance of the sunshine which, passing through the water, is arrested by the dark soil beneath. While the water is flowing over the surface of the ground, if its temperature is below that of the soil, it really stores much heat which otherwise would be lost, because relatively much less will be lost by radiation from the hot surface of the soil and stored in the water, leaving less to pass away from the dry ground whose immediate surface becomes very warm, and hence fitted to lose heat rapidly.



In the third place, the temperature of the surface foot of soil in the daytime of midsummer, with its contained moisture, is usually as high as 68° to 75°, and to lower its temperature 1° F. requires the absorption by water added of from 25 to 40 heat units, according as the soil varies from a nearly pure sand, weighing 110 pounds per cubic foot, and containing 4 per cent of water, to a humus soil, containing 30 per cent of water and 50 pounds of dry matter per cubic foot.

One heat unit is taken as the amount needed to raise 1 pound of water at 32° to 33° F. With the relations stated, it appears that 4 inches of water having a temperature of 45° F. applied to a field having a soil temperature of 75° might lower the surface foot to 65° or 61.7°, according to the specific heat of the soil; and with a soil temperature of 68°, the lowest temperature the 4 inches of water could produce would range between 60° and 57.6°. But this assumes that the water is applied at once, with no opportunity for warming until it is brought into contact with the soil, which, of course, cannot be the case. If the irrigation water has a temperature of 50° F., then the lowest degree 4 inches of water could force upon the surface foot of soil would be some amount above 66.7° to 63.7° when the original soil temperature was 75°, or 62° to 59.9° if the initial soil temperature were 68° F.

The results summarized on page 214 indicate that the mean amount of water used in single irrigations is at the rate of 2.02 inches once in 10 days. Hence, were the coldest water used in this quantity, the greatest depression of the temperature of the surface foot could not exceed 6.7° F. This assumes that neither the water nor the soil receives any heat during the time the water is being applied. It is clear, therefore, that where good judgment is exercised in the application of either well or spring water, it may be used without in any serious way interfering with normal growth. The chief danger will, of course, lie in the ap-

Using the figures of T. M. Read\* regarding the amount of materials which the great rivers of the world bear in solution to the sea, it appears that the Mississippi and St. Lawrence rivers, in North America, and the Amazon and La Plata, in South America, carry an amount such that the average is 655.6 pounds per each 24 acre-inches of water.

Goss and Hare†, from analyses of the water of the Rio Grande at different periods from June 1 to October 31, compute that 24 acre-inches of the water contained in sediment and in solution 1,075 pounds of potash, 116 pounds of phosphoric acid, and 107 pounds of nitrogen. The water of this river contains a sufficient amount of sediment so that 24 acre-inches of it furnishes 81,309 pounds, or more than 4 tons per acre.

It is evident from these data that the ordinary clear waters of rivers, lakes, springs and wells cannot be expected to bear to the fields upon which they are applied a sufficient amount of plant-food to meet the needs of crops, unless the water is applied in much larger volumes than is required to meet the demands of soil moisture.

#### SEWAGE WATERS FOR PURPOSES OF IRRIGATION

It may be laid down as a general rule that the water of highest value for the purposes of irrigation is the sewage of large cities, unless it contains too

\*Am. Jour. Sci., vol. xxix., p. 290.

†New Mexico Expt. Sta., Bull. 12.

large amounts of poisonous products from factories in the form of injurious chemical compounds.

The organic matter of sewage, in both its soluble and finely divided, suspended form of solids, when sufficiently diluted with other water, is of the highest value as a fertilizer for many crops, and in all warm climates it is often practicable and very desirable to use such water for this purpose.

Reference has already been made to the use of sewage waters from the city of Milan on the water-meadows of Italy. The far-famed Craigentenny meadows, outside of Edinburgh, are another emphatic illustration of the value of sewage in the production of grass, and Storer, after visiting them in 1877, writes as follows:

"In 1877 there were 400 acres of these 'forced meadows' near Edinburgh, and they are said to increase gradually. The Craigentenny meadows, just now mentioned, were about 200 acres in extent, and they had then been irrigated 30 years and more. They were laid down at first to Italian ray grass and a mixture of other grass seed, but these artificial grasses disappeared long ago, couch-grass and various natural grasses having taken their place. The grass is sold green to cow-keepers, and yields from \$80 to \$150 per acre. One year the price reached \$220 per acre. They get five cuts between the 1st of April and the end of October. This farm of 200 acres turns in to its owner every year \$15,000 to \$20,000 at the least calculation, and his running expenses consist in the wages of two men, who keep

the ditches in order. The sewage he gets free. The yield of grass is estimated at from 50 to 70 tons per acre."

In 1895, 18 years later, the writer visited the meadows described above, and Figs. 46 and 47 were taken at the time. The first figure shows a load of grass, estimated to weigh 2,500 pounds, cut to feed 23 cows during one day, from an area of 2,734 square feet. Seven acres of this grass had been purchased to feed the herd of 23 cows from May 1 to



Fig. 46. Two thousand five hundred pounds of grass cut on 2,734 sq. ft. of Craigtinny Meadows, Edinburgh, Scotland.

October 20, during which time the grass would be cut four or five times, and the price paid for this grass, sold at auction, varied from \$77.44 to \$111.32 per acre, according to the quality of the several plots making up the seven acres purchased. The increase of these meadows about Edinburgh, it was said, was tending to lower the price which this grass could

Pollution Commissioners, the medical officer of health for Edinburgh, Dr. Littlejohn, now Sir Henry Littlejohn, said:

"The cows in Edinburgh are chiefly fed with sewage grass that is grown on Craigentenny meadows. I have thought that there might be objection to feeding cows upon grass so grown, because I was of opinion that grass so grown might be of inferior quality. But practically I have failed to detect any bad effects resulting from the use of such grass."

"Another point which these philanthropic sanitarians tried to make out against milk from sewage-grass-fed cows was that such milk 'turned putrid in a very short space of time.' The most ample evidence is forthcoming to show the absolute groundlessness of this contention also. Mr. Spier, the Scottish Dairy Commissioner, who has conducted most of the dairy experiments which have been carried on for the Highland Agricultural Society, has fully tested the matter, and he writes to us as follows on the subject:

"By way of testing this point, I set aside eighteen cows for the experiment: Of these, six were fed in the house on sewage grass, six were fed in the house on vetches, and the other six were pastured in the fields. Milk from each of these sets of cows was repeatedly set aside in separate vessels until it became decidedly tainted, and out of the numerous tests the milk from the cows fed on sewage grass never once turned sour first. In the majority of cases, the milk from the cows fed on the vetches was the first to turn sour, while the milk from the sewage grass and on the pasture was about equal in keeping properties. On several occasions the milk from the three lots of cows was kept for the same length of time and churned separately, but on no single occasion did the butter from the cows fed on sewage grass become rancid before the other lots did. Samples of the butter from the three different lots of milk were sent to the chemist of the society, and he was unable to tell which was which."

These statements will serve to call attention to the fears which have been expressed on theoretical considerations, and the nature of the evidence which appears to indicate that there is little ground for them.

influence in improving the texture of the soil is quite as great as that due to the fertilizers contained.

The sediment carried by the Po is given by Lombardini as  $\frac{1}{300}$  of the volume of the river, and on this account the waters are held in high esteem for irrigation.

The river Nile, during the time of the rainy season of mountainous Abyssinia, comes loaded with sediment constituting  $\frac{1}{14}$  of the volume of the water; and this, under the old system of the Pharoahs of basin irrigation, which permitted the rich mud to collect on the fields, kept them fertile for thousands of years, and they are so today; whereas in Lower Egypt, where the old practice has been abandoned in recent years for an "improved" system, which does not permit the utilization of the rich Nile mud, the fields are fast deteriorating in fertility, although only half a century has passed.

The Durance, in France, is famous for its fertile waters, and they carry at the ordinary maximum  $\frac{1}{3}$  of their weight of sediment, or nearly 1.9 pounds per cubic foot, equal to 82,464 pounds per each acre-foot of water. In rare cases the sediment of this stream rises to  $\frac{1}{10}$  of the water by weight, and the average proportion for nine years has been found to be  $\frac{1}{10}$ . When such waters are used year after year on poor lands, the improvement becomes very great, while on the better lands a high and permanent degree of fertility is maintained indefinitely, with heavy yields per acre as the result.

## IMPROVEMENT OF LAND BY SILTING

Nature's method of depositing the fine silt borne along by streams, whenever they overflowed their banks, early suggested the idea of directing this work so that the materials should be laid down on sandy or gravelly soils, to so improve the texture and fertility as to convert comparatively worthless areas into extremely productive lands.

In other cases, where marshy, low-lying lands, or shallow lakes and estuaries were lying adjacent to turbid streams, the waters have been so turned upon them and then led away as to lay down mantles of rich soil of sufficient thickness to raise the surface to such a height as to permit of drainage, and thus reclaim worthless swamps, converting them into rich, arable fields.

In England, where the method was introduced from Italy to reclaim waste lands near the sea, the process is called "warping," and in France "colmatage." In England, as on the Humber, where the tides rise several feet, and the waters of the river are turbid, much land has been reclaimed by warping. Centuries ago low, flat lands were dyked off from the sea to prevent inundation; but in more recent years, to this improvement was added the one under consideration. Tide sluices, provided with gates to admit the turbid water held back by the sea, were set in the dykes, and the low lands were laid out in fields surrounded by banks for retaining the water until the sediment borne in upon the area should have time

and in the district of the mouths of the Rhone, between Arles and Mirimas, for example, on broad, flat plains of extremely coarse gravel, where in earlier years the uncontrolled waters have permitted no soil to form, this system of silting, "colmatage" or

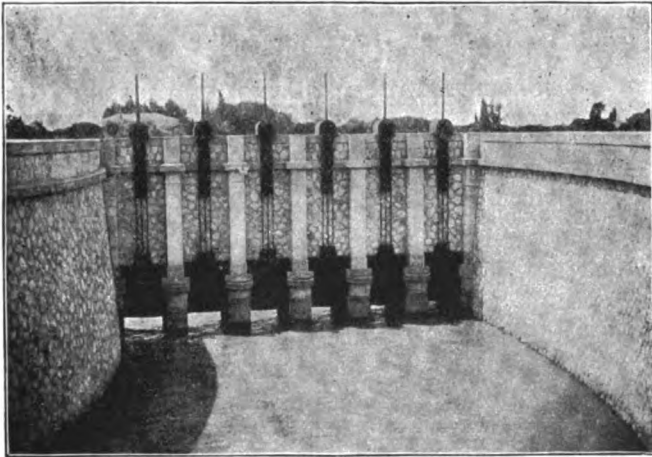

Fig. 48. Head-gate on the Durance above Avignon, France.

"warping," has been introduced, and rich deposits laid down among and above the coarse materials, until productive fields, orchards and gardens have taken the place of wide reaches of naked gravel beds.

Fig. 48 is a head-gate on the Durance, above Avignon, where a portion of the water of the district is taken out. The soil here, for depths exceeding 10 feet, as shown by cuts observed, is made up, seem-



ingly, of 70 per cent of coarse gravel from  $\frac{1}{4}$  inch up to 4 and 5 inches in diameter, and a surprisingly large per cent is composed of the larger sizes. Among this gravel the river silt has been deposited until fields of alfalfa and wheat, as well as gardens and almond orchards, are grown upon these extremely pervious beds.

OPPORTUNITIES FOR SILTING IN EASTERN  
UNITED STATES

East of the Mississippi, extending from Wisconsin through Michigan, New York, and into New Jersey, as well as in New England, there are extensive areas of very sandy lands which, if they were subjected to this process of silting, so as to render them less open in texture, and to increase the per cent of plant-food they contain, would become productive and very desirable lands. At present they are gently sloping sandy plains, bearing a scant vegetation, but presenting ideal slopes for irrigation, and very many of which are so situated that water could readily be led upon them, both for silting purposes and for permanent irrigation, at relatively small cost.

Then, again, in the southern states, notably in the Carolinas and Georgia, there are vast areas of sandy soil which stand greatly in need of such improvement as flooding with silt-laden waters could bring about. These lands possess surface features and slopes which readily permit of this being done; and, what is more to the point, the streams are abundant and heavily

laden with silt which they are carrying out to sea in great volumes, thus robbing the Piedmont country at a fearful rate, through lack of sufficient care, of its most fertile soil, and transporting it directly through the fields to which it should be applied and upon which it could readily be led to great advantage.

On the sea coasts of these three states, and particularly in South Carolina, there lie those extensive and once wonderfully productive rice fields upon which so much labor and capital have been spent, but which are now largely abandoned, since the war of the rebellion, for the lack of sufficient energy to bring the needed capital to the region.

Here are opportunities for capital to find splendid permanent investment at good rates of interest, to reclaim the vast rice fields now fast falling into ruin, and to apply the methods of warping to these and other lands until they become what they may certainly readily be made, both thoroughly healthful and the richest of fields, adapted to a wide diversity of productions. The opportunities for warping are better nowhere in the world, and there must certainly be a great future awaiting intelligence, energy and capital here to work out the needed improvements.

#### ALKALI WATERS NOT SUITABLE FOR IRRIGATION

In many portions of the world, and oftenest in arid and semi-arid regions, the waters of some streams and wells, and particularly those of lakes, are too heavily charged with the salts of sodium—

sible to state with certainty precisely how these elements were combined in the sample. It is more unfortunate that chemists are not agreed as to how results should be interpreted, and that different systems are followed by different analysts. But what is most unfortunate of all, is that many chemists have published their computed results, as though there were but one interpretation of them, and have not given the data upon which their computations were based. Hence, we have found it impossible to arrive at what may be regarded as the safe amount of black or white alkali an irrigation water may contain. The table given above represents the opinion of two chemists as shaped by their system of computing the amounts of the alkalies in the samples analyzed, but it must be understood that another chemist using the same data, with a different system of apportionment, would compute either less or more black alkali and more or less white alkali than the authors have credited the samples with as given in the table above.

We make this explanation, that the irrigator may understand that when the water from a given source is said to contain .022 parts in 1,000 of black alkali, more allowance must be made in regard to accuracy than is required for the statement that the water carries in solution 11.234 grains of solids per gallon.

It should be understood further, as will be shown in the next chapter, that a given quantity of black alkali may prohibit the use of the water for irrigation purposes on one soil, when upon another it may be used with perfect safety.

It sometimes happens that waters draining from swamp lands where there has been considerable stagnation, or where there are too strong solutions of humic acids or salts of iron, are not suitable for irrigation purposes, and must be avoided. In portions of Europe, too, there are streams used for irrigation which are known as "good" streams and "bad" streams. Crops irrigated from one produce heavier yields than when irrigated from the other, and cases are cited where the differences in yield are so large that they can hardly be assigned entirely to difference in the amount of plant-food carried by the two.

## HOW ALKALIES ACCUMULATE IN THE SOIL

Everywhere in the soil where there are sufficient changes in the air and the moisture, the soil grains are being broken down and dissolved by both physical and chemical means, and unless the rains are sufficiently heavy to carry the ever-forming dissolved salts away in the country drainage, they will be brought to the surface by capillarity and there concentrated until precipitated. The more insoluble of the plant-foods, and other salts which are not such, cannot charge the water sufficiently high to do serious harm, hence in common language and in the sense the term is here used, they do not become "alkalies."

But with the other salts the case is different. They are precipitated when the solution becomes strong enough, and form deposits on the surface or about the roots in the soil where water is being removed, but before this actually occurs one or both of the actions referred to above begins to take place.

In arid regions, where the alkalies proper are most abundant, rains enough may fall to slowly carry forward their formation, but not enough to carry them out of the land. From the higher levels and steeper slopes they are readily moved by surface drainage and wind action to the lower lands, where the amount may become so large as to form thick beds. During the wet season of such countries, these salts may sink into the soil, but to rise again when dry weather restores the action of capillarity.

In the humid regions, there is necessarily an even

more rapid formation of all the true alkalies of arid climates; for fundamentally similar rock ingredients are subjected to identical weathering processes, but of a more intense nature, because the rainfall is greater. If, therefore, there occur conditions favorable to the accumulation of the soluble salts formed at and near the surface of the soil, these should be expected to show as alkalies.

Most of the marsh lands of the world, excepting those under the influence of tide waters, owe their wet character to the underflow of ground-water which has percolated into the adjacent higher lands, and which rises to or near the surface wherever this is sufficiently low to permit of it doing so. When such lands are drained, the rate of surface evaporation and the rise of capillary water from below may exceed the annual rainfall, and thus lead to an accumulation at the surface of salts of such intensity and character as to interfere with the normal growth of plants.

It must be kept in mind that where the ground-water level is near the surface, the rate of capillary rise may many times exceed what it could be under other conditions, and since the rate of evaporation is most rapid where the surface soil is wettest, the conditions are extremely favorable for the accumulation of soluble salts at the surface of marsh lands in humid climates after they have been drained. The waters leaching through the more open, higher lands become charged with salts, and as these waters come again near the surface under the low areas they are raised by capillarity and evaporated, leaving the salts which

had been taken up along the underground path to accumulate over the low-lying lands, and since the evaporation of 12 inches of salt-laden water may produce more deposits than the same depth of rain would be sure to remove in leaching downward, the chances are favorable to accumulation.

INTENSIVE FARMING MAY TEND TO THE ACCUMULATION OF ALKALIES

It has already been pointed out that during the growing season, after vegetation has come into full action, nearly all of the rains which fall in humid climates are retained near the surface until they are evaporated, either through the growing crop or from the soil, and since these waters tend to form salts when they are in contact with the soil grains, they must tend to increase the salt content near the surface. It is plain, too, that the heavier the crops produced and the greater the number of them in the season, the less is likely to be the loss of any water from the field by under-drainage; hence the greater the tendency for soluble salts to accumulate. Then, if during the winter season of a country the rainfall is deficient, so that little leaching can take place, conditions become still more favorable for the accumulation of alkalies.

Further than this, if irrigation is practiced during the growing season only, and this water also is evaporated from the soil in addition to the natural rainfall, it is plain that the amount of soluble salts in the soil must increase, both on account of that which may have been in the water applied, and that

which this additional water may have been instrumental in producing from the soil on the spot through the processes of weathering.

Indeed, the more we study and reflect upon this problem, the more we are led to fear that in all arid climates, where irrigation is practiced, it will not be found sufficient to apply simply enough water to the soil to meet the needs of the crop growing upon the ground at the time, but, on the contrary, there must be enough more water applied to take up and carry away into drainage channels and out of the country to the sea not only the soluble salts which the irrigation waters carry, but also those which it causes to be produced from the soil and subsoil. In other words, it appears that an excess of soluble salts in a thoroughly irrigated field is not only a normal but an inevitable condition, unless sufficient leaching takes place; and if this is true, the sparing use of water can only increase the number of years required to bring the salts up to the danger point of concentration.

AMOUNT OF SOLUBLE SALTS WHICH ARE INJURIOUS  
IN SOILS

Storer states that it is a matter of record that long experience in the south of France has shown that any soil which becomes visibly covered with a slight incrustation of salt in times of drought is improper for cultivation, unless special pains are taken to prevent the surface from becoming dry.

Plagniol insisted, in his time, that soils containing more than 2 per cent of salt are unfit for the growth



of any other than samphire, saltwort, and the like, and that even these cannot thrive when the salt becomes as high as 5 per cent.

Dehérain concludes, from his studies in France, that while soils kept very moist may produce crops even when 2 per cent of salt is present, yet if the soils dry out badly they become sterile with no more than 1 per cent present. Gasparin has maintained, however, that while soils containing .02 per cent of salt may produce good crops of wheat, .2 per cent is more than this crop can bear.

Speaking, next, of the alkali salts of arid climates, we may cite some of the data procured by Hilgard in his extended and careful studies of the alkali problems of California. At their Tulare Experiment Station, he gives both the amount and the distribution of soluble salts in the surface 18 inches of soil where, in one case, barley grew to a height of 4 feet, and in another the amounts of the salt were so great that this crop would not thrive. The data which we give in tabular form have been read from his plotted curves, hence the values must be regarded as not quite exact.

*Table showing amount and composition of alkali salts in parts per 100  
Taken September, 1894, Tulare Experiment Station, California*

Depth in 3-in sections	Ground upon which barley grew 4 feet high				Ground upon which barley did not grow			
	Sodium carb'ate Na <sub>2</sub> CO <sub>3</sub>	Sodium sulphate Na <sub>2</sub> SO <sub>4</sub>	Com'n salt NaCl	Total soluble salts	Sodium carb'ate Na <sub>2</sub> CO <sub>3</sub>	Sodium sulphate Na <sub>2</sub> SO <sub>4</sub>	Com'n salt NaCl	Total soluble salts
0 to 3 in...	.008	.68	.36	1.2	.07	1.22	.68	2.44
3 to 6 in...	.009	.26	.07	.34	.1	.16	.1	.38
6 to 9 in...	.013	.1	.03	.168	.009	.11	.05	.28
9 to 12 in...	.024	.057	.02	.143	.009	.148	.06	.334
12 to 15 in...	.038	.037	.02	.119	.14	.1	.04	.29
15 to 18 in...	.04	.02	.02	.09	.18	.06	.02	.263

Sodium nitrate is also given in these cases as a constituent, but as this may be regarded as a plant-food, we have omitted it from the table. It will be observed that the total soluble salts in the surface 3 inches where the barley grew well was about half that found in the case where it would not grow, the amounts in the two cases being 1.2 and 2.44 per cent of the soil. The difference between the amounts of the black alkali in the two cases stands as 8 to 70, or much more.

Referring to the possibility of these salts interfering with plant life simply on account of their plasmolitic action, it may be said that DeVries found, as represented in Fig. 49, that when the living cells of a plant were immersed in a 4 per cent solution of potassium

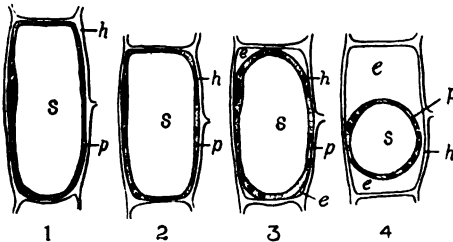

Fig. 49. Effect of too strong solution of potassium nitrate on the protoplasm of plant cells. (After De Vries.)

nitrate, there was first a shrinkage in volume through a loss of water, as shown between 1 and 2. When the solution was given a strength of 6 per cent, then, in addition to the change in volume, the protoplasmic lining P began to shrink away from the cell wall h, as shown at 3, and when the strength of the solution was made 10 per cent, the conditions shown in 4 were

produced. When such conditions as those represented in 3 and 4 are set up, marked wilting must result and growth be brought nearly or quite to a standstill.

It is not possible to state with certainty what strength of salt solution existed in the soil moisture in the cases cited above, but an approximate estimate may be made. Hilgard's analyses show, in the case of the sample from where barley would not grow, that the soluble alkalies amounted to 2.44 pounds per 100 pounds of soil. If these salts were all in solution in the soil-water, and if the soil-water amounted to 30 per cent of the dry weight of the soil, then the salts in solution would have a strength of 8.13 per cent. But if only 15 per cent of moisture existed in the soil, as might easily have been the case, and all the salts were in solution, then its strength would have been double that above, and much stronger than DeVries' most severe trial. It does not appear improbable, therefore, that even were there no poisonous effect exerted upon the barley by the salts in the soil, the plants could not have grown, on account of the wilting which would have resulted from the presence of too strong a salt solution outside the cell walls of the root-hairs in the soil.

#### COMPOSITION OF ALKALI SALTS

To show the character of the salts which accumulate in the manner under consideration, we have computed the mean composition from a number of analyses as given by Hilgard, and the results are stated in the table which follows :

It will be seen from these two tables that there may be associated with the undesirable salts quite notable quantities of others which are valuable plant-foods. This is as should be expected, for the more soluble plant-foods, as well as the salts not suitable for plant life, must be moved by the same waters, and tend to collect with them.

Hilgard points out that where the soluble phosphates and considerable quantities of humus are associated with the sodium carbonate or black alkali, it is often desirable to first transform the sodium carbonate into sodium sulphate through an application of land plaster. By so doing both the humus and phosphates are rendered insoluble, but not unavailable for plant-food, hence may be retained in the soil for future use after the alkalies, which are harmful, have been washed out or otherwise disposed of. This is an important suggestion to keep in mind.

#### THE APPEARANCE OF VEGETATION ON ALKALI LANDS

When cultivated crops are grown upon alkali lands, characteristic effects are produced which serve to point out the difficulty with the soil and the remedy which should be applied. If the salts in the soil are not too concentrated, the crop may germinate in a perfectly normal manner, but after a time begin to languish in spots, and remain dwarfed in stature or entirely die out. It is very common to see a field upon which the crops present an extremely uneven stand, some areas

being entirely destitute of plants, or bearing only those which are small, while closely adjacent spots may be covered with large, vigorous, and perfectly normal growths. Fig. 50 illustrates this feature, as it is exhibited in the San Joaquin valley of California, and Fig. 51 shows essentially similar features as they develop on black marsh soils in Wisconsin after they have been tile-drained. In this latter case, the crop on the afflicted areas comes to an early standstill, or a plant



Fig. 50. Vegetation on alkali lands in California. (Hilgard.)

may go through all the phases of growth, reaching maturity, but with a very dwarf habit, so that maize in tassel and ear may not stand higher than 6 to 10 inches, while close by may stand another hill or group of them where the growth has been unusually rank and luxuriant. On these soils the afflicted plants possess a very imperfect root system, the older roots turning brown, soft, and apparently decaying, while new ones form above.

strong, the alkalis will necessarily be brought to the surface and become concentrated there, hence in position to do the greatest harm to growing crops.

If thorough tillage is practiced early, so that but little water is evaporated except that which passes through the roots of the crop, then the salts cannot become concentrated in a narrow zone, but, on the contrary, will be left all through the soil where the roots which are taking water are distributed. In those cases, therefore, where the general soil water is not too highly concentrated to permit normal growth, crops may prosper so long as the surface is kept shaded and thoroughly tilled.

It must be observed, however, and kept in mind, that the roots of plants cannot withdraw moisture from a soil without at the same time tending to concentrate the salts in solution in the zone where the roots do their feeding; hence, that if alkali waters are being used for irrigation, and in the long run if the purest waters are being used under conditions of no drainage, sooner or later the soil of the root zone must become so highly charged with the alkali salts that reduced yields are inevitable.

#### USE OF LAND PLASTER TO DESTROY BLACK ALKALI

Hilgard long since pointed out that in regions where the water contained sulphate of lime in solution, there sodium carbonate was absent, or existed in such small quantities as not to be harmful to crops, and he early saw and recommended that where fields were

## KINDS OF SOIL WHICH SOONEST DEVELOP ALKALI

Where alkali waters are used for purposes of irrigation, and where sweet waters are being used under conditions of little or no drainage, the clayey soils are the ones which soonest begin to show the bad effects of concentrated salts. This is so for many reasons.

In the first place, the soils of clayey texture, as has been established by experiments recorded on page 201, are not as effective mulches as the sandy soils, hence, even where thorough tillage and shade are resorted to, there must necessarily be a larger rise of salt-bearing water to the surface to produce accumulation than is the case with the coarse, sandy soils.

In the second place, when water is applied to a sandy soil, not nearly as much remains adhering to the surface of the soil grains and entangled between them, so that it quickly spreads downward farther below the surface than is the case with the clay. This being true, it takes less water to produce effective drainage, and the roots of the crop spreading farther in the sands, the salts cannot become concentrated as they may in the clays.

In the third place, since more water is held in contact with the soil grains of the clays, and since the total surface for chemical action to take place upon is very much larger in the clayey soils than in the sands, it is plain that soluble salts, including alkalis, may form more rapidly in one case than in the other, and hence, that the open, sandy soils cannot become

tion of water and air, it is only too plain that where conditions are persistently maintained which allow the formation of the salts without permitting them to be removed by any cause whatsoever, there must come a time, sooner or later, when the amounts produced and accumulated in the soil shall reach the degree of concentration which is intolerable to cultivated crops. Under the natural conditions of rainy countries, there is usually a sufficient amount of leaching to permit the white and black alkalis to be borne away in the country drainage with sufficient completeness to prevent their effects attracting general attention, and if the same processes obtained in irrigated countries, it is plain that in these, too, the difficulties would not arise. The conclusion is irresistible, therefore, that some method must be devised by which, periodically at least, sufficient water is applied to irrigated fields to pick up and carry out of the country the soluble alkali salts which are fatal to cultivated crops.

In the old-time irrigation of the Nile valley, the greater part of the land was under basin irrigation, and thus thoroughly washed during some fifty days every year. Lands not so treated were the lighter sandy soils near the Nile, protected by only slight banks from inundation, and these dykes usually gave way as often as every seven or eight years, so that they, too, were occasionally thoroughly flooded. Under this system of washing and drainage, the fields of the Nile were kept free from alkalis for thousands of years. But at the present time, when what are called more rational methods are being applied, but with no



## CHAPTER IX

### *SUPPLYING WATER FOR IRRIGATION*

It is not the purpose in this chapter, nor has it been the purpose in this work, to discuss the larger questions of water supply for irrigation. These are quite purely engineering problems, involving a mass of detail and technicality which concern the agriculturist only in the final results which they bring to him; hence, he is interested in them only in a general way.

We shall aim, therefore, in dealing with the supply of water to whole communities for purposes of irrigation, to present only a general idea of the systems which have been evolved and adopted under the varying conditions of different countries and climates, reserving the main part of the chapter for the discussion in detail of the cases where water is supplied by individual effort for individual use.

#### DIVERTING RIVER WATERS

By far the most general method of supplying water for the use of large sections of country is to throw a dam across a stream, and divert from the channel a portion of the river water, leading it out into the district to be watered through canals provided for the purpose.

canals of the Durance, and given an engraving of it in Fig. 48. In further illustration of the methods used in diverting by gravity the water of a stream for purposes of irrigation, Fig. 53 shows diagrammatically how the Kern Island canal, in California, is taken from the Kern river, together with the position of the regulator, and of the waste gate by which the unused water finds

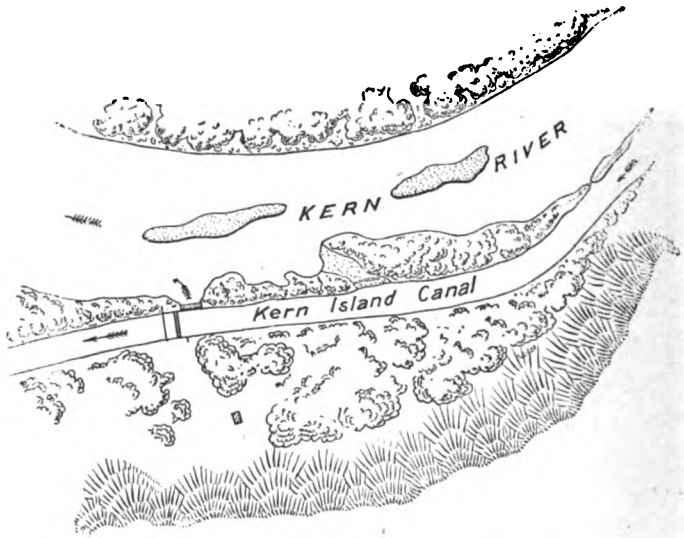

Fig. 53. Head of Kern Island canal, California.  
(Grunsky, U. S. Geol. Survey.)

its way back into the channel. Figs. 54 and 55 are bird's-eye views of the same thing, showing the regulator and the waste gate. In Fig. 56 is given a nearer view, looking across the canal over the waste gate, the regulator being at the left.

In aligning these canals, they are led back from the stream as far as the general fall of the valley will permit, and in taking out the laterals and distributaries, these are carried to the highest portions of the fields to be irrigated, and at the same time are

The dangers in this direction will be least in countries where the natural drainage facilities are best ; where the streams, draws and washes are sunk deepest below the surface of the fields ; and where the subsoil is the most open, thus providing an easy escape of the seepage waters into the natural drainage channels. Under such conditions as these, it would be only the most wasteful, extravagant and inexcusable use of water, with no attention to proper methods of tillage, which could lead to the evils pointed out.

But, on the other hand, in countries where the natural drainage lines are shallow and few, and where the soil and subsoil are close, it will require the greatest vigilance and the rarest skill and judgment to avert the evils of swamping, the development of a malarial atmosphere, and the formation of alkalies. If, in addition to the conditions last pointed out, the irrigation water is naturally heavily charged with undesirable salts, then the situation becomes as serious as possible.

When capital, therefore, is seeking permanent investment in the development of an irrigation system, the difficulties pointed out are matters for first and most serious consideration ; and when agriculturists propose to establish homes under such surroundings, the same serious attention should be given the probable permanency of the conditions of fruitfulness and healthfulness.

It sometimes happens that water for irrigation must be taken from mountain cañons and led out upon the mesas and over the valleys under great difficulties, such as tax the highest engineering skill to its utmost to accomplish. As an illustration of this type of irrigation engineering, the case of one of the canals supplying Redlands, California, may be cited. In Fig. 57 the dark line on the flank of the mountain on the right is an open canal, with cement masonry lining, which winds up the valley until it can draw its supply from the Santa Ana river. Lower down the mountain valley it becomes necessary to cross the cañon, and this is accomplished by using the large redwood siphon represented in Figs. 58 and 59. This gigantic pipe has an inside diameter of 4 feet, and in one portion of its course is obliged

ground cement pipes to the lands where it is to be used. These pipes extend beneath the surface, out of sight and out of the way, ranging from 14, 12, 10 and 8 inches in diameter for the mains, to 6 and 5 inches for the laterals; and there were in 1888 some 13 miles of these pipes in the Redlands settlement.

In the general system, the lands are plotted in square 10-acre lots, and a 5- or 6-inch lateral supplies one tier of these, delivering the water usually at the highest corner. These pipes

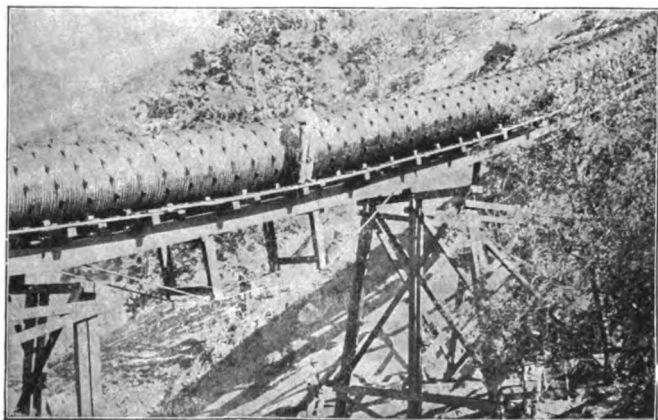

Fig. 59. Pipe line carried on trestle.

are generally laid on the slope of the country, which one way ranges from 50 to 100 feet per mile, and do not carry the water under much pressure, but rather more nearly as though it were running in open channels. The accumulation of pressure as the face of the country falls is prevented by the introduction of small concrete chambers from 5 to 6 feet square, placed at frequent intervals, and at the places of branching. As the water passes along the supply pipes it enters these chambers, rising until it falls over measuring weirs in the partition walls of the chamber, and drops into other compartments from which other pipes lead away in their respective directions.

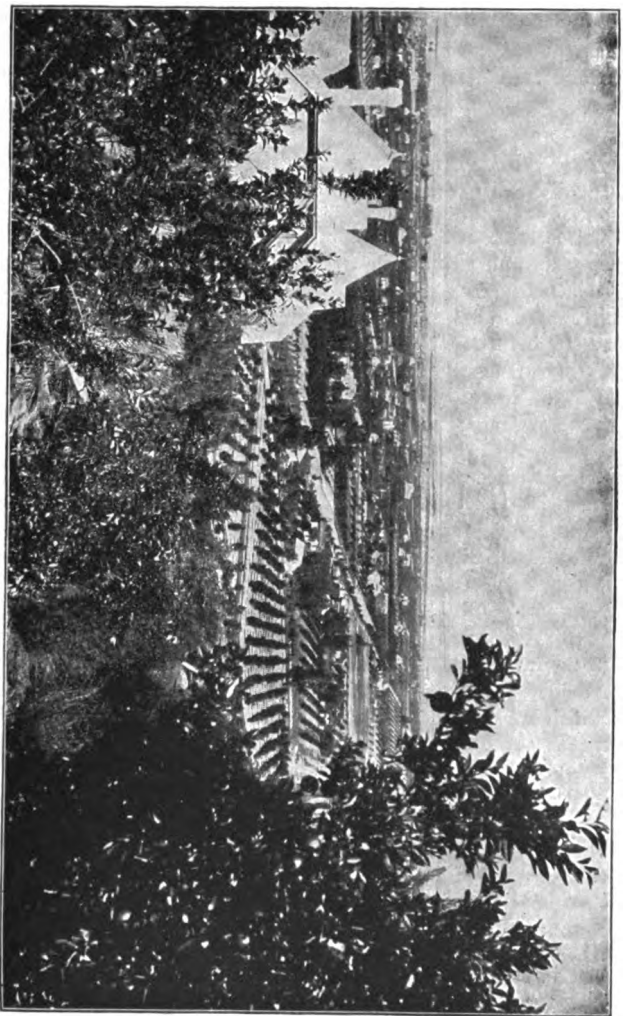

Fig. 65. Ultima Thule of rural life.

the land is next to impossible with any rational use of water. When one stands upon Smiley Heights, in Redlands, and looks out over such panoramas of luxuriant growth as the one represented in Fig. 65, the reflective mind is almost convinced that here is in reality the *ultima thule* in rural life.

The cases now cited may suffice to illustrate the manner in which water is diverted from streams for gigantic irrigation enterprises, where the government itself does the work, as in India; where state aid supplements the united efforts of a district, as in the case of the Kern river canal, and where one or more stock companies develop the system as a means of finding permanent investment for capital, as is the case with the system worked out to meet the needs of the Redlands district.

It is, of course, practicable for individuals to divert portions of the water from streams passing through their property, provided the fall is such as to permit of this being done, and where large quantities of water are to be used there is seldom a cheaper or more effective method of supplying water, if only the land and the stream are properly related for it, and the water is not already held by prior rights.

#### DIVERTING UNDERGROUND WATERS

In mountainous and hilly countries, where river valleys have become deeply filled with sands and gravels, it frequently happens that much of the water of the drainage basin flows below the surface through the valley sands and gravels, the bed of the channel becoming nearly or quite dry for long distances.

In such cases, where the slope of the valley is considerable, and where the water has not fallen too far below the surface, tunnels are occasionally driven into the sands and gravels up the valley at a small grade until the water-bearing beds have risen above the line of drift sufficiently to allow the water to percolate into the tunnel and be led out upon the surface. Sometimes it is only necessary to dig open ditches, making them deeper up stream, to develop considerable quantities of water on the same principle.

Then, again, in steep valleys, where the streams carry plenty of water, but too far below the surface to be diverted, it frequently happens that at the foot of a terrace water may be flowing very near the surface toward the river channel, and by ditching or tunneling here this may be diverted to the surface when that in the river must be pumped.

Another method of utilizing the waters which have fallen below the surface in the valley gravels is by building what is called a submerged dam across the valley, excavating to bed

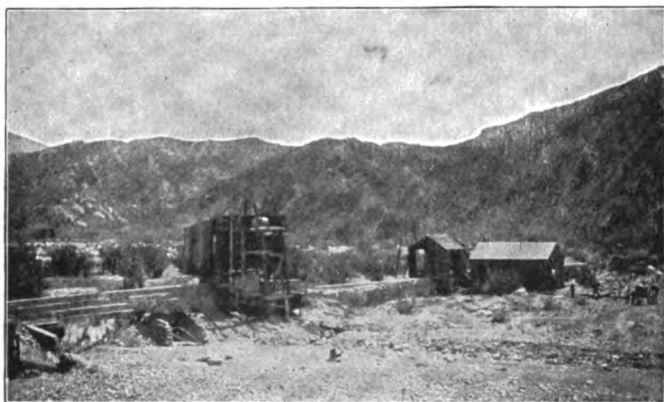

Fig. 66. Submerged dam at San Fernando, California.

rock and erecting a water-tight dam, which shall hold the underflow back until it has filled the gravels above the dam and flows over it at the surface high enough to be taken away in cement ditches, flumes or pipes to the land it is desired to irrigate. One such submerged dam is shown in Fig. 66, built near San Fernando, California. It was not, however, sufficiently well built to hold the water back until it could be made to overflow, and they were, in 1896, using two gasoline engines with pumps to lift the water held back by the dam, instead of depending upon gravity, as planned.

## DIVERTING WATER BY TIDAL DAMMING

Where lands bordering rivers leading to the sea lie high enough above low tide to admit of adequate drainage, and at the same time below high tide level, these may be dyked off from the sea, and then, by erecting sluices controlled by gates at suitable places in the dykes, connecting with canals and distributaries on the land side, water may be led at will on or off the fields as the tides come or go. One of the most notable examples of this method of procuring water for irrigation is at the mouth of the Santee river, in South Carolina, to which reference has already been made, and a portion of which is represented in Fig. 67.

It will be readily understood that as the tide rises along the coast, the discharge of the fresh water coming down the river is prevented and the channels fill with it, it being held there by the dam of salt water formed by the tidal wave. When the fresh water has accumulated to a sufficient extent, the trunks may be opened and the fields flooded, or they may be kept closed and the water held off. The diverting of water from rivers by tidal damming is only practicable where the river carries a sufficient volume of fresh water to prevent the salt water from ascending the channel, for were the volume small the sea would drive it back, and only salt or brackish water would be found against the dykes.

DIVERTING WATER BY THE POWER OF THE  
STREAM

Where rivers run too low in their channels to permit the water being led out directly, many devices have been employed by which a portion of the water is made to drive machinery which, in turn, lifts another portion out upon the land, where it may be led away. One of the oldest, commonest and simplest devices used for this purpose is the undershot water-wheel, set up in the stream and carrying buckets on its



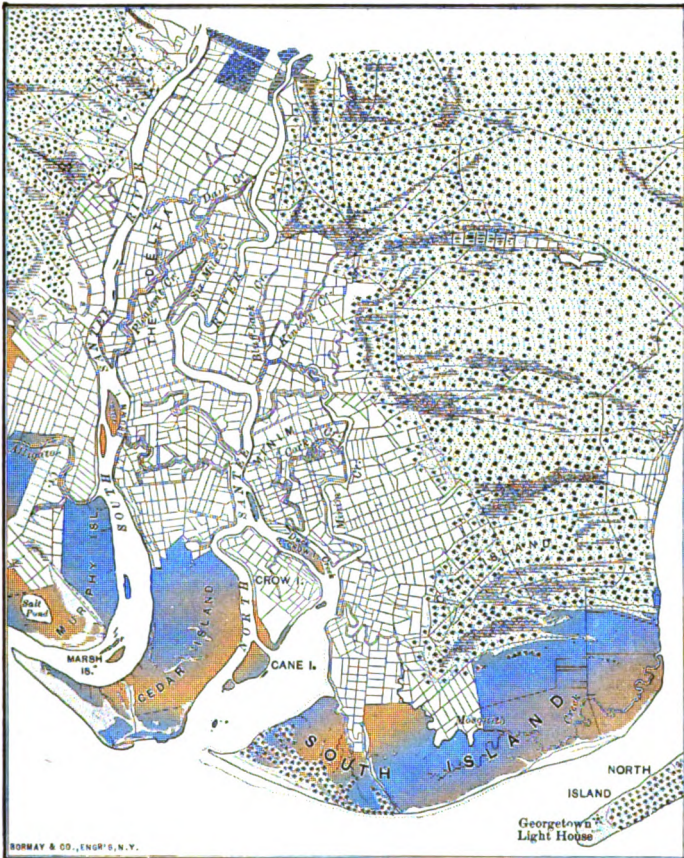

Fig. 67. Section of rice fields in South Carolina.  
(U. S. Coast and Geodetic Survey.)

circumference, which raise the water in the manner represented in Fig. 15, page 76. This view was taken on the river Regnitz, a branch of the Main, in Bavaria, where in a distance of one

and one-fourth miles the writer counted no less than twenty such wheels.

The wheels were 16 feet in diameter, provided with a row of 24 churnlike buckets on one or both sides, emptying their contents into a trough, from which the water was led away in a flume hewn from a log. At the time the view was taken, this wheel was making three revolutions per minute, and discharging 450 gallons, or enough to supply nearly 120 acres with 2 inches of water every 10 days, the water being raised 12 feet.

On the Grand river, near Grand Junction, Colorado, the Smith Brothers have placed two 36-inch turbine wheels so that they drive a battery of two centrifugal pumps, one above the other, on the same 8-inch discharge pipe, and lift water 82 feet, discharging it into a flume, as represented in Fig. 68,



Fig. 68. Mouth of 8-inch discharge pipe 82 feet above Grand river, Grand Junction, Colorado.

at the rate of 2,200 gallons per minute. The two wheels were together rated at 90 horse-power, and were developing not far from 54, as measured by the water lifted. They were supplying water for 80 acres of alfalfa and 120 acres of orchards, working only during the daytime, the water being carried a mile in flume and ditches.

Other forms of water wheels, like the overshot, undershot and breast wheels, are used for driving centrifugal and other pumps to lift water for irrigation, and in large streams, where

The total water pumped during the year by this windmill was enough to cover 79.1 acres 12 inches deep, thus showing an average daily rate of 2.6 acre-inches. The largest amount of water pumped on any single day was 39,540.2 cubic feet, or a rate for 24 hours of 27.46 cubic feet per minute. There were short times occasionally, however, when more water than this was pumped, but the capacity of the siphon was such as to cause it then to discharge continuously, and thus prevent a record being made.

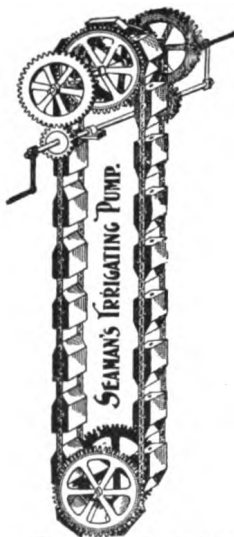

Fig. 74. Bucket irrigation pump.

Most of the water was lifted by two pumps, working singly or in combination. These were an Acromotor 14-inch reciprocating pump, worked on a 9-inch stroke, represented in Fig. 73, and a Seaman & Schuske bucket pump, with 1-gallon buckets, as represented in Fig. 74. When the wind was light the mill was given the bucket pump, when stronger the reciprocating pump, and when strongest both pumps at the same time, and more work was accomplished in this way than would have

been possible with any single pump.

#### WATER PUMPED DURING 10-DAY PERIODS

Since the availability of wind power for irrigation is limited not so much by the total work of the year as by the water which may be pumped in times of special need, a clearer idea of the possibilities of wind power for irrigation can be gained by tabulating the work done during the year by 10-day periods. This has been done in the table which follows, but first reducing the results to a lift of 10 feet instead of 12.85 feet, the height the water was actually raised :

Table showing computed amount of water lifted 10 feet high during consecutive 10-day periods for one full year, expressed in acre-inches

DATE	Water pumped	DATE	Water pumped	DATE	Water pumped
	Acre-in.		Acre-in.		Acre-in.
Feb. 28-Mch. 10....	33.540	July 8-18.....	21.53	Nov. 15-25.....	52.77
Mch. 10-20.....	36.620	July 18-28.....	29.73	Nov. 25-Dec. 5..	47.46
Mch. 20-30.....	52.77	July 28-Aug. 7..	9.87	Dec. 5-15.....	39.52
Mch. 30-Apr. 9....	47.01	Aug. 7-17.....	36.26	Dec. 15-25.....	31.18
Apr. 9-19.....	54.11	Aug. 17-27.....	20.20	Dec. 25-Jan. 4..	51.22
Apr. 19-29.....	63.05	Aug. 27-Sept. 6..	21.27	Jan. 4-14.....	33.92
Apr. 29-May 9....	59.97	Sept. 6-16.....	18.00	Jan. 14-24.....	29.16
May 9-19.....	28.69	Sept. 16-26.....	40.42	Jan. 24-Feb. 3..	59.36
May 19-29.....	51.38	Sept. 26-Oct. 6..	23.79	Feb. 3-13.....	33.45
May 29-June 8....	40.54	Oct. 6-16.....	55.07	Feb. 13-23.....	75.73
June 8-18.....	27.50	Oct. 16-26.....	18.45	Feb. 23-28.....	16.20
June 18-28.....	13.82	Oct. 26-Nov. 5..	36.71		
June 28-July 8....	26.68	Nov. 5-15.....	49.40		

Referring to the table, it will be seen that the smallest amount of water pumped in any 10 days was 9.87 acre-inches, this occurring between July 28 and August 7, at a time when most water is needed. In this period there were 7 full days when no water was pumped, all the water being raised during 3 days of the period.

The mean amount of water pumped during the 100 days from May 29 to September 6 was 24.5 acre-inches per 10 days, and as this is the season in the United States when most water is needed for irrigation, the figure may be taken as representing the capacity of such a pumping system. That is to say, such a plant is able to supply 10 inches of water to 24.5 acres during 100 days when the lift is 10 feet, and to 12.25 acres where the lift is 20 feet. If the crop irrigated demands 20 inches of water in 100 days, then the area which could be supplied under a 10-foot lift would be only 12.25 acres, and under a 20-foot lift only 6.12 acres. It must be understood, however, that these results are possible only under conditions of no loss between the pump and the land to which the water is applied.

From theoretical considerations and the above data, it appears probable that for different sizes of wheels and for different lifts, but under otherwise similar conditions, areas may be irrigated as given in the table below.

If reciprocating pumps are used, the strokes should be made as long as possible and the number not higher than 20 to 25 per minute, to avoid loss of energy in pounding. Suction and discharge pipes should, as a rule, be as large as the cylinder, and where water is to be raised above the surface, this should be done by carrying the discharge pipe up into the tower to the necessary height to avoid the use of stuffing boxes. The large wooden plunger rods, which displace one-half the volume of the water raised with each stroke, are in the direction of economy in making the pump in a measure double-acting. If a screen must be used over the end of the suction pipe, it should be given large capacity, and be carefully watched, to see that it does not become clogged. All valves should have large ports, easy action, and be tight fitting, so that every stroke, whether slow or quick, shall discharge the full capacity of the cylinder.

There should be two pumps of different capacities, so arranged that either may be used alone, or the two used at once, thus providing three loads, to be applied when the wind is light, medium or strong. This can readily be arranged by attaching the lighter pump directly to the mill and the larger one to a walking-beam; or both may be attached to a walking-beam, one end of which is carried by the driving rod of the mill.

The geared windmills may readily be made to work a pump of the bucket type, Fig. 74, and if the buckets can be provided with valves which do not leak, a pump of large size may be used, speeded back so as to be driven by the mill in the lighter winds, and with increasing speed in the higher winds, without reaching the limit at which the buckets fail to empty.

But as the power of the mill increases more rapidly than the velocity of the wind, what is needed is a device which is capable of increasing the load more rapidly also. Attaching an additional pump secures this end, but the objection to the plan is that it is not automatic, and much service must be lost by the mill being either too heavily or too lightly loaded until an attendant can make the change. Still, this plan is worth following until something better can be had.

## THE USE OF RESERVOIRS

To employ wind power for irrigation to the best advantage, a reservoir is required in most cases. There are localities on the seashore where nearly every day a sufficient breeze springs up to drive the windmill, and in such cases, if the supply of water is large, the lift small, and the demand for water moderate, the ground for many crops may be laid out in such a manner that a system of rotation may be followed, and the reservoir dispensed with; but in such cases the time and attention required for the distribution of the water will usually be greater than where a reservoir is used.

The reservoir should be placed where it is high enough to serve all the ground to which it is desired to supply water, but it is very important to keep it just as low as possible, because since the economic lift of the mill is only 10 to 25 feet, every foot saved on the height of the lift into the reservoir is a large percentage gained in efficiency. The elevated wooden tanks, placed on towers far above the ground to be irrigated, are very expensive in themselves, and greatly reduce the area which a windmill can irrigate.

In constructing a reservoir where soil and subsoil are reasonably fine and close, the first step is to remove from the area all rubbish and coarse litter that may interfere with the close packing of the soil. The land upon which the walls of the reservoir are to be built is then plowed, leaving a dead furrow in the center, which may be filled with water until the whole area is thoroughly saturated. When the water has drained away sufficiently to permit of teams driving over the ground, the soil should be thoroughly trampled and puddled, after which dirt from the bottom of the reservoir may be scraped on and trampled with the teams continuously and thoroughly. It is recommended as an excellent plan to maintain the sides of the walls higher than the center, but all portions nearly enough horizontal, so that water may be pumped into the furrow at night, to help in settling the materials more closely and render the puddling more complete.

After the walls have been raised to the proper height, the bottom of the reservoir is plowed, harrowed fine, and the whole flooded with water, if practicable, to better fit the soil for puddling. In case the soil is at first too open for flooding all at once, the water may be led in furrows close together, filling as many at a time as the capacity of the pump will permit, turning the water into others when a sufficient saturation has been reached. When the bottom of the reservoir has been thoroughly puddled over the whole area and continuous with the puddled bottom and sides of the walls, there will usually be but little loss from seepage.

The sluice for taking out water for irrigation should be laid in the wall at the level of the ditch outside which carries the water to the fields or garden, but at some distance above the bottom inside, so that the water may not be entirely withdrawn and permit the sun to dry the soil, thus destroying the effect of puddling. In cold climates, it is also important to retain enough water in the reservoir to prevent the bottom from freezing, as this may destroy the effect of puddling.

The sluice should project entirely through the walls on both sides, and be provided with a suitable gate or valve for closing and opening it, either fully or only in part, according to the amount of water needed, and the dimensions should be such as to permit more water to be taken out than is likely to be needed.

The most thoroughly satisfactory and permanent outlet for a reservoir can be provided by using wrought iron pipe of suitable size, provided with an elbow at the inside, which opens upward. This may be closed by means of a plug worked by a T lever or handle, keeping the threads well protected with cylinder or wagon grease, to prevent rusting in.

Oftener the sluice is made of 2-inch plank, tightly put together and provided with a gate, as represented in Fig. 75\*. In other cases, the mouth of the sluice is cut off obliquely, and a gate is hinged to the upper side and provided with a handle reaching above water, to which a cord is attached for opening

---

\*From Bulletin No. 55, Kansas Agr. Exp. Station.

the gate by simply pulling upon it. This is very simple and easily operated. In placing the sluice in the wall of the reservoir, great care is needed to get the dirt thoroughly tamped and puddled about it, so that water shall not follow its sides and develop a leak.

To prevent injury from waves, the walls of the reservoir should be sloping and not steeper inside than a rise of 1 in 2.

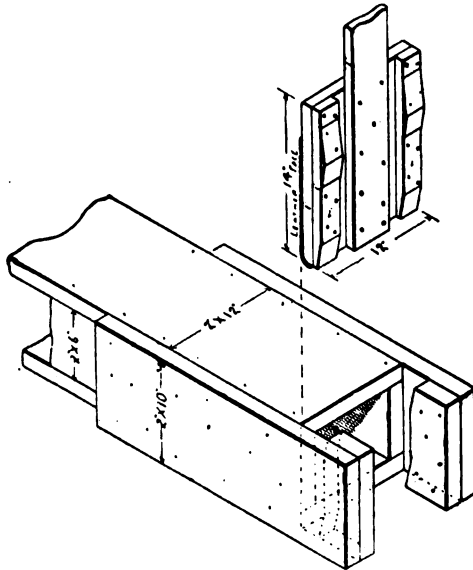

Fig. 75. Sluice and gate for reservoir. (Kansas Agr. Exp. Station.)

At the outlet ditch there should be provided an overflow weir sufficiently below the top of the wall to prevent wave action from starting a cut in the top by breaking over. A reservoir, completed and filled with water, is represented in Fig. 76, but where these are made circular in form there must be less seepage through the banks in proportion to the amount of water stored, because less wall is required to enclose a given area when this is circular.



The amount of seepage from reservoirs must vary with the character of the soil, but Carpenter cites a case where the loss from this cause did not exceed 2 feet for a whole year, and this is satisfactorily small.

Where the soil is very open and sandy, it may be necessary to haul on clay or fine soil to use in puddling, or the reservoir may require covering with coal tar, asphalt or cement. These



Fig. 76. Rectangular reservoir for windmill irrigation.

materials, however, are expensive, and usually not within the reach of small irrigators.

The loss of water from a reservoir by evaporation in dry, windy climates is much larger than the necessary seepage, and this can only be lessened by planting windbreaks about the reservoir.

A circular reservoir 4 feet deep and 40 feet in diameter will supply .35 acres with 4 inches, and .69 acres with 2 inches of water. One, 100 feet in diameter and 4 feet deep will irrigate 4.32 acres with 2 inches of water and 2.16 acres with 4 inches, while a reservoir 209 feet on a side and 4 feet deep will supply water enough to irrigate 12 acres with 4 inches of water, 16 acres with 3 inches, and 24 acres with 2 inches.

## PUMPING WATER WITH ENGINES

The amount of water which was pumped by a 16-foot geared windmill with a lift of 12.85 feet has been given as 79.1 acre-feet as the work of a year.

A  $2\frac{1}{2}$  horse-power Webster gas engine was used on the same pumps with which the windmill did most of its work, and with the same lift, to see what amount of water could be supplied by such a power. During a 6-hours' run the engine lifted 13,202.2 cubic feet 12.85 feet high, with a consumption of 458 cubic feet of gas costing \$1.25 per thousand, or at a rate of 95.4 cents per day of 10 hours.

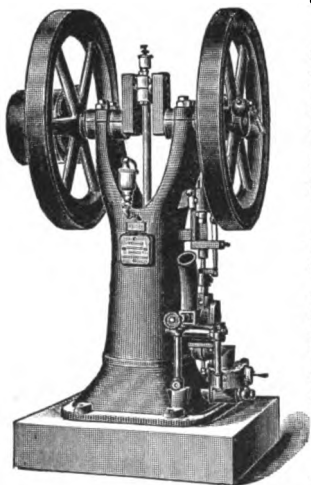

Fig. 77. Webster  $2\frac{1}{2}$  horse-power vertical gasoline engine.

At this rate of pumping and cost for fuel, the engine could supply in 100 days 50.67 acres with 12 inches of water at a cost for fuel of \$95.40 or \$1.88 per acre for the season, and \$3.76 where 24 acre-inches of water is applied.

On our own place the same make and size of engine as that used above, and represented in Fig. 77, but using gasoline at 9 cents per gallon for fuel, and lifting the water against a head of 50 feet with a double-acting pump, discharging 75 gallons per minute, the cost for a 96-hours' run was \$4.95.

The water pumped in this time was 432,000 gallons at the rate of \$1 for 3.214 acre-inches. In 100 days of 10 hours this plant would lift, under its conditions, 601,605 cubic feet of water, or 13.81 acre-feet, at a cost for fuel of \$51.56, thus making the expense \$3.73 for 12 inches in depth of water per acre, and \$7.46 for 24 inches.

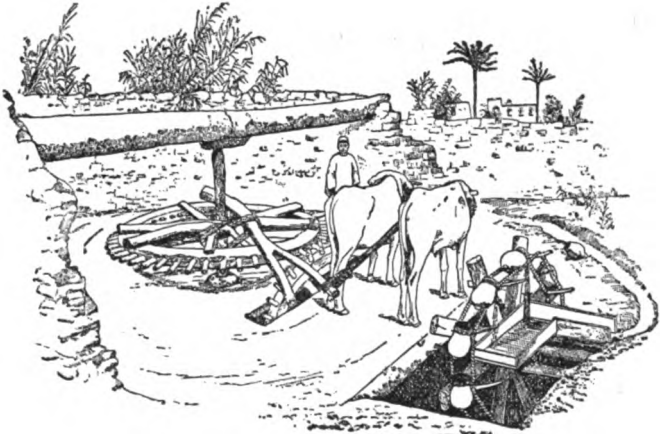

Fig. 78. Persian wheel for lifting water. (Wilson, U. S. Geol. Survey.)

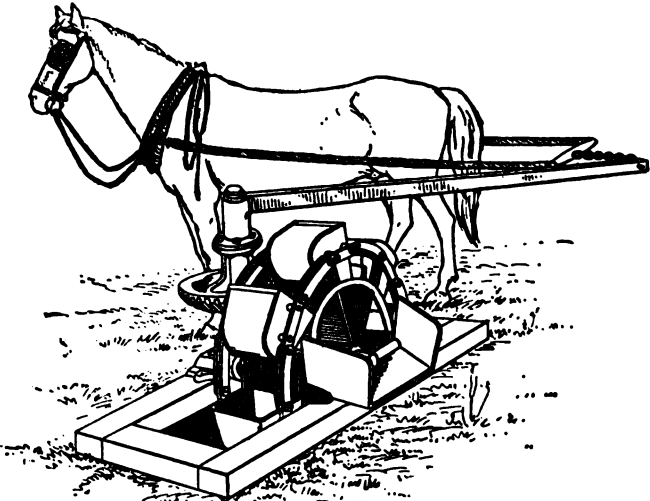

Fig. 79. Bucket pump for use with horse power. (Wilson, U. S. Geol. Survey.)

Such a pumping plant as this would easily irrigate 10 acres 12 inches deep and 5 acres 24 inches deep without the aid of a reservoir, and with the aid of a reservoir the area could be made 15 acres or 7.5 acres, according to amount of water used.

For the field irrigation on the Wisconsin Agricultural Experiment Station farm, we have used an 8-horse-power portable steam engine driving a No. 4 centrifugal pump. Soft coal at \$4 per ton has been used for fuel, and with a lift of 26 feet, drawing the water through 110 feet of 6-inch suction pipe and discharging it through varying lengths of the same pipe up to 1,200 feet, the coal consumed has been at the rate of one ton for an average of 80,210 cubic feet, or 22.1 acre-inches.

At the above rate the fuel cost of an acre-inch of water is 18.1 cents, making 12 inches of water amount to \$2.17 per acre, and 24 inches \$4.34 as the cost for fuel.

Willcocks states that taking the mean of some 60 observations carefully made in the delta and Upper Egypt, the actual discharge obtained for a 4-meter lift is 480 cubic meters per horse-power per 12 hours, taking the 8-horse-power engine as the standard, and he italicizes this statement: "*A discharge of 480 cubic meters per nominal horse-power per 12 hours is the mean in Egypt.*"

He also estimates the cost of working a 10-horse-power engine in the interior of Egypt as follows:

	£	\$
Driver and stoker, per day.....	.15	.73
Oil, etc., per day.....	.05	.24
Coal, away from canals per day.....	1.00	4.84
$\frac{1}{3}\frac{1}{2}$ of 10 per cent per annum on cost of engine, for depreciation, repairs, etc.....	.10	.48
Total.....	£1.30	\$6.29

The amount of water pumped by the 10-horse-power engine to a height of 13.12 feet is 3.891 acre-feet, which from the above table makes the cost per acre-foot \$1.62 where the ground is covered to a depth of 12 inches, and \$3.24 per acre where the depth is made 24 inches.



Fig. 80. Shadoof of Egypt, or Paecottah of India. (Wilson, U. S. Geol. Survey.)

Taking an average 8-hour day for pumping, the above pumping plant should irrigate during a 100-day season 259.4 acres to a depth of 12 inches and 129.7 acres to a depth of 24 inches, at a total cost for pumping of \$420.23.

THE USE OF ANIMAL POWER FOR LIFTING WATER  
FOR IRRIGATION

Many and very old are some of the devices invented to utilize both human strength and that of cattle and horses. Fig. 78 represents the Persian wheel, very extensively used in Asia Minor and in Egypt for lifting water, two cattle raising as much as 2,000 cubic feet per day on low lifts. A more

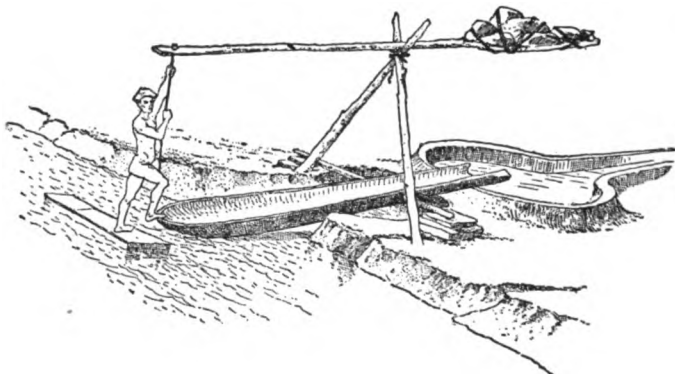

Fig. 81. Doon of India. (Wilson, U. S. Geol. Survey.)

modern device is represented in Fig. 79, where one horse may elevate through a height of 20 feet 500 cubic feet of water per hour and 5,000 per day of 10 hours, or a rate which, if followed for 100 days, would give more than 11 acres 12 inches of water in depth.

Much land is irrigated in India, Asia Minor and Egypt, where the water is lifted by man-power, and Figs. 80 and 81 show two of the forms of lifting devices upon which men are worked. Two men, working alternately, are said to irrigate an acre in 3 days with the shadoof, lifting the water about 4 to 6 feet.

## PRINCIPLES GOVERNING THE WETTING OF SOILS

When water is applied to a soil which becomes more open in texture and coarser grained as the depth below the surface increases, it will travel downward in nearly straight lines, and will spread laterally but very little except by the relatively slow process of capillarity. This fact is forcibly illustrated in Fig. 82, where the experiment consisted in maintaining the level of the water in a hole at the place designated by the arrow until 200 cubic feet had percolated into the soil. The heavily shaded area in the figure shows the mass of soil completely filled with water on the two dates, October 15 and 17, while the water was running. It will be seen that although the hole was kept full and the water-level within 8 inches of the surface, the water did not spread sideways more than 2.5 feet until below a depth of 11 feet.

If we imagine this to represent a cross-section of the soil under a water-furrow extending across a field, it will be readily seen how much water would be lost by rapid percolation directly downward, and how little, even after a long time, would have spread laterally to wet the field. To irrigate such soils satisfactorily and economically, the water must be spread over the whole surface, or be led in furrows which are near together across the field, so that the soil between the furrows may quickly become wet.

While the water is in the furrows, it will travel sideways by capillarity fastest in those soils which are coarsest, for the same reason that it flows downward

If a soil decreases in fineness of texture as the depth increases, then there may be a considerable lateral spreading of the water due to gravity, and

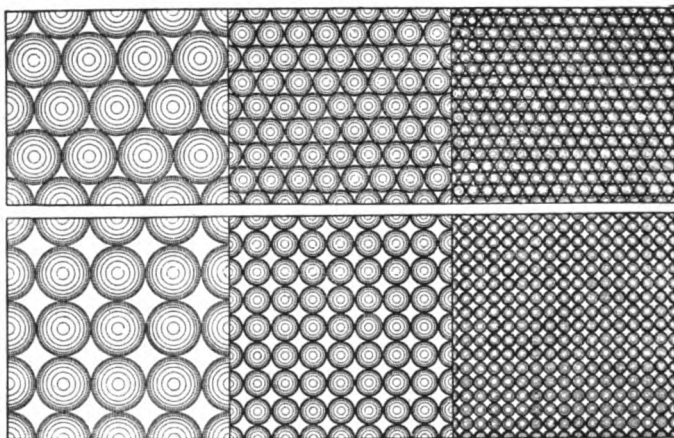

Fig. 83. Size and arrangement of soil grains as influencing pore space and capillary waterways.

this, aided by capillarity, will permit the furrows to be placed farther apart and the water to be run more slowly over the ground.

Where a fine, loamy soil is underlaid at 3 to 5 feet with a subsoil of much finer texture, through which the water percolates slowly, then water may be led quite rapidly through furrows some distance apart and considerable quantities applied at once, depending upon it to spread laterally by gravity, and to rise by capillarity under the spaces between the furrows, in this way wetting the larger part of the soil of the



field by a sort of sub-irrigation, which should be utilized to the fullest extent possible, for then the intervals between irrigations may be longest and the duty of water will be highest.

If the soil is allowed to become very dry before watering, especially if the texture is close and the grains fine, water will percolate downward less rapidly, and it will move sideways and rise under the influence of capillarity more slowly, because the air of the soil must be displaced ahead of the water.

A fine soil, flooded under these conditions, will take water very slowly, because the surface pores become filled with water, which is retained with so much force that air bubbles cannot readily rise through it, and the conditions are similar to a jug filled with air bottom upwards under water,—the one cannot escape nor the other enter. Such soils, therefore, which must be flooded should not be allowed to reach this dry condition. The case is not so bad when furrow-irrigation is practiced, because the water pressure in the furrow may displace the air laterally where it can escape upward between the furrows unhindered by the water.

On the other hand, there are conditions when it is desirable to take advantage of this hindrance of air to percolation. Where a clover, alfalfa, grass or grain field must be watered by flooding, and where the head of water is small, the fall slight, and the distances the water must be led long, the spreading will be much more rapid and better when the surface soil has become dry. Indeed we have repeatedly tried to

water a certain piece of land when the surface soil was yet quite moist, and found it impossible to do so with the available head, because the water would sink into the ground faster than it could be supplied; but by letting the soil become dryer the same head spread the water easily over the whole area, wetting it evenly, though there was greater hindrance from the clover having become thicker and larger.

In furrow irrigation, the same principle may be taken advantage of in cases where the rows are long and the head of water too small, though not to the same extent; but the difference is sufficiently pronounced to be sometimes quite helpful in open soils.

#### PRINCIPLES GOVERNING THE PUDDLING OF SOILS

A puddled soil is one in which the compound soil kernels or crumbs have been broken down more or less completely into separate grains and run together into a closely compacted mass. Such a soil may hold its pores between the grains so completely filled with water until lost by evaporation that little free air is present except that absorbed in the water itself. In such a soil roots quickly suffer for lack of air, the process of nitrification cannot go on, and, what is even worse, the nitrates already present in the soil when the puddling occurred may be rapidly lost by the process of denitrification.

The water-logging of a soil has the same disastrous effects regarding the roots of plants and on the processes of nitrification and denitrification. Both

conditions should, therefore, be studiously avoided by every irrigator.

If soils to be irrigated contain black alkali, and this has been permitted to accumulate at the surface during the interval between waterings, it is evident that the flooding of such soils will redissolve the alkali, and as this, in solution, tends of itself to produce puddling, it is evident that the irrigation of such lands should always be done with the greatest care, in order not to complicate the difficulties of the crop by adding that of a puddled soil to the deleterious action of the carbonate of soda.

It is extremely difficult to completely submerge a recently stirred soil of any kind without breaking down the crumb structure so essential to perfect tilth, and all are familiar with the fact that there is no way to so effectually compact loose soil in a trench as to completely fill it with water. It is, therefore, plain that soils should be watered before plowing and fitting, when the running together cannot take place, rather than after the ground is seeded. Indeed, water enough should always be present in a soil at seeding time, not only to germinate the crop, but to carry it well on in growth, so that if baking of the soil must take place, less harm will be done. There are few soils which it would be safe to flood just after a crop like oats, wheat or barley is up, for fear of packing the soil and seriously injuring the crop.

When the plants have attained some size, when the soil has gained in firmness by the natural processes of settling, and when the roots have spread

and occupied the soil, the shading, the firming and the root binding all conspire to prevent puddling and baking, so that flooding may then be practiced with less danger of harm; and so grass lands, alfalfa and clover may always be flooded with little danger of injuring the texture of the soil, because the extensive root systems prevent it.

When water is applied in furrows without washing, so that it rises and spreads through the soil between the furrows by capillarity, it then has the opposite effect from puddling, and tends rather to improve the texture by drawing the loosened soil grains together into clusters by an action of surface tension like that which rolls drops of water into spheres on a dusty floor. As the soil crumbs become saturated with capillary water the loose dust particles which have been formed in tilling are drawn to them and bound closely by the pull of the surface film; but so soon as the whole soil becomes immersed in water, as in the case of flooding, and as happens in the bottoms of the furrows, there is then no surface tension, and the soil grains fall apart under the water of their own weight, and compacting and puddling are the results.

It follows, therefore, that all crops where the ground is not covered by them, and where cultivation is resorted to to prevent loss of water by evaporation, should so far as practicable be irrigated by the furrow method; and since the bottoms of the furrows must be subjected to the conditions which puddle, it follows that the furrows should always be as far apart as other conditions will permit.

## PRINCIPLES GOVERNING THE WASHING OF SOILS

One of the commonest mistakes of beginners in irrigation is the use of too large volumes of water in a place and hurrying it over the ground too rapidly. It must be kept ever in mind, in all sorts of irrigation, that the eroding and transporting power of water increases with the velocity with which it moves, but in a higher ratio; to double the rate at which water moves in a furrow or over the surface, increases its power to wash and carry the soil forward nearly fourfold.

In good irrigation, the water is forced to move so gently that it runs nearly or quite clear and without washing the sides or bottom of the furrows, and if one does not succeed in securing flows without washing, the only conclusion which should be drawn is that the right way has not yet been learned, not that it cannot be done.

Naturally, the steeper the slope of the furrows the faster the water tends to run. So, too, when the slope remains the same, the larger the volume of water in the furrow the faster the water will flow, and these two principles give the irrigator nearly complete control of the situation.

If the ground is flat and the water moves too slowly, increase the amount in the furrow, and if there is not water enough to do this, decrease the number of furrows handled at one time. If the water runs too fast and washes, divide up the stream, leading it into more furrows until the movement comes

to be the rate which does not wash or erode. We have seen orchards in the foothills of California irrigated by carrying the water in furrows down the hill where the slopes were too great to readily plow with a team and yet it was done with such skill that no appreciable wash was produced, neither did any water run to waste. Everything was adjusted with such nicety that by the time the streams had reached the ends of the furrows the whole of the water had been absorbed by the soil. The 30 acres referred to were owned and managed by a Swede, and when he was asked if he did not find it difficult to handle the water so as not to wash his soil and waste the water on these steep hills, with no grading or terracing, the reply was: "Easy now; but was very hard when I didn't know."

The most essential point in the distribution of water is to have the furrows on a nearly uniform slope, so that the velocity of flow will be closely uniform through their entire length. If the same grade cannot be secured throughout, it is better to change from a steeper slope to one more flat than the reverse, because then the reduction in velocity will be partly made up by a greater depth of water in the furrow on the flatter reaches.

#### FIELD IRRIGATION BY FLOODING

When large areas of land are to be irrigated in single blocks, there is no method of applying water which is so economical of labor and of time as the

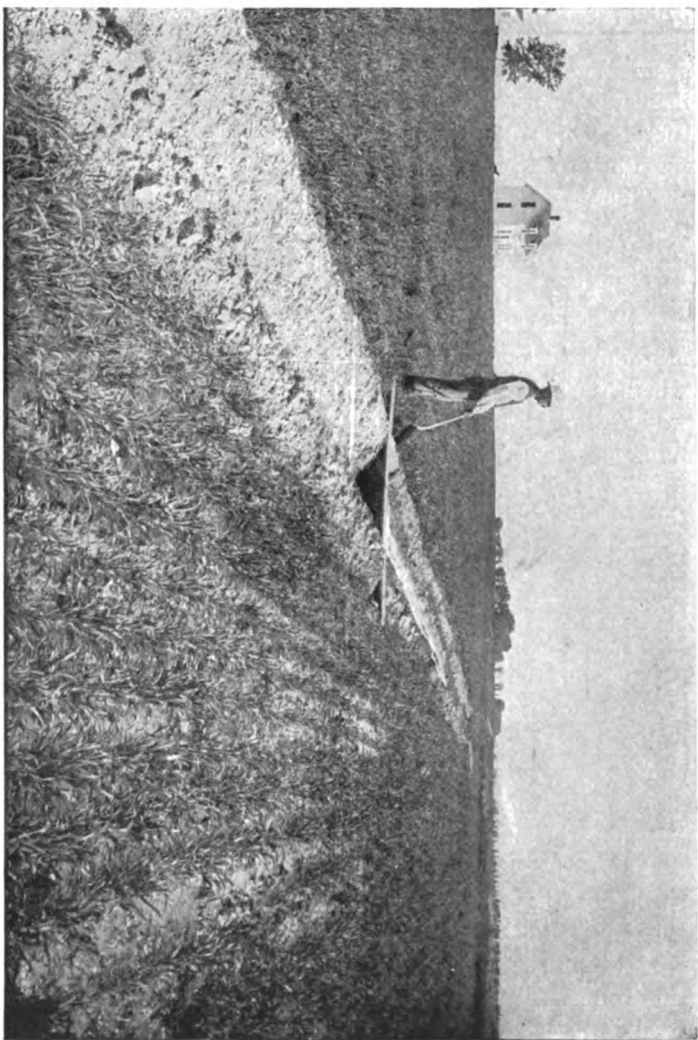

Fig. 84. Disturbing water with furrow and canvas dam. (Cowgill, U. S. Geol. Survey.)

systems of flooding, whenever it is possible to establish and maintain the best conditions for them, and there is no other system which permits of so uniform a wetting of the surface.

There are two fundamentally different systems of flooding. One covers the surface of a field with a thin sheet of running water, maintained until the desired saturation has been reached; the other covers the surface with a sheet of standing water, which is allowed to remain until the soil has absorbed enough, when the balance is drawn off; or, simply as much water as is desired is placed upon the land, and this remains on the surface until it is absorbed.

The two systems are used most for crops like the small grains, grasses and clovers, which closely cover the ground, and where intertillage is not practiced. They are also used extensively where fields for any crop must be moistened preparatory to plowing and seeding.

Flooding by running water is practiced with great nicety and thoroughness on large fields of 40, 80 and even 160 acres in the old Union Colony at Greeley, Colorado. Here, usually, the natural slope of the country is good, and a distributing ditch is carried along the highest edge of a field to be irrigated. When the time for watering has arrived, the field is divided into lands of 60 to 120 feet by parallel furrows, made by using a wide V-shaped plow, throwing the earth both ways, thus forming distributing furrows, represented in Fig. 84, about 30 inches wide at the top. These furrows are made rapidly with a 3- or 4-horse team, and when a crop of grain is ready



When in use, it is laid in the furrow with the canvas up stream and the free edge loaded with earth to hold it down, when it effectually holds back the water and throws it out upon the strip to be watered.

Water is turned into one, two, three or more of these distributing furrows from the head ditch, according to the amount available, and when the lands have become sufficiently wet as far below the canvas dams as the water will readily flow through the grain or grass, these are picked up and moved farther down and the stream again turned out. Water is thus led over successive lands until the whole field has been irrigated easily, rapidly, cheaply and, at the same time, well.

Where crops are grown in short rotation on a large scale, as they are at Greeley, wheat, alfalfa or clover and potatoes following one another in regular order, it is doubtful if a better or more satisfactory system of irrigation can be devised than the one described.

If the slopes of the field are steep, and especially if they incline in various directions, then the small grains and grasses may sometimes be irrigated better by the method represented in Fig. 86, where water-furrows are thrown across the surface of the slope nearly along contour lines, giving them only so much fall as is needed to lead the water forward.

These furrows for grain fields, where they are temporary, would be best formed with the ordinary plow, at the time of seeding, and the upturned earth smoothed down, so that it may become set before the

water must be led across it. Where help is scarce and the price of the crop small, it is often the practice to enter the field with the plow just before the water is to be applied, and form the furrows then.

In watering by this method, the aim is to throw

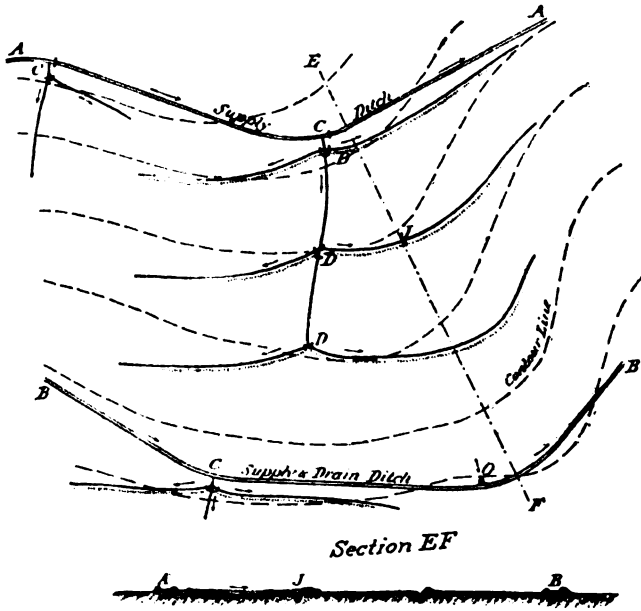

Fig. 86. Flooding field on steep slopes. (Grunsky.)

the water over the lower edge of the furrow in a continuous sheet or else at short intervals, to flow down the slope until the portion of the field within reach has received what is needed. To do this, canvas dams or temporary earth dams are used, as

described above ; then, when the water is to be carried forward, the dams are also shifted

As represented in the figure, water may be carried directly down the slope across a series of secondary furrows, as at C, D, D, D, and the main supply furrows may be set one below another at such intervals as the extent of the fields and the slope of the surface may demand. In the figure, a second water furrow is marked "supply and drain ditch," but if the best work is done in handling the water, there should be no surplus to drain away.

When slopes like those under consideration are in permanent meadows or pastures, or if they are in meadows for three or more years, it will be best usually to give more time to shaping the furrows, so that washing will not occur when less attention is given, and so that the mower and horse rake may readily work over and across them.

In European countries, where so much labor is done by hand, little attention has been paid to developing systems of applying water to fields which will readily permit of the use of machinery, as must be the case in this country, at least for a long time to come.

Where grain fields are not very long, and where the slope is gentle and uniform, the water may be distributed from a single head ditch by simply marking the field, after it has been sowed, with a tool like the corn-marker, but having runners close enough to give shallow furrows every 15 or 20 inches. These shallow furrows lead the water forward in par-

allel lines from which the lateral spread may be, to a large extent, by capillary creeping, and they guide the flow past minor inequalities, preventing the water from becoming concentrated so as to do injury through increase in volume and velocity and from running around areas, leaving them dry. This marking is so rapidly and cheaply done, and obstructs the surface so little, that it is to be highly recommended where applicable.

A corrugated roller might be used instead of the sliding marker to form the water lines, but this would have no tendency to throw the kernels of grain to one side, and the channels would be more obstructed by the plants. Neither could so great a depth be secured, especially on heavy soils not deeply and recently worked.

In the second flooding system, where the water is made to stand over the whole surface to any desired depth, the fields must be laid out in areas bounded by ridges or low levees, which check the flow of water and hold it as in a wide and extremely shallow reservoir.

The size of the checks in which a field is laid out will be determined by its general slope, by the head of water available, and by the height of the levees or check ridges. It is desirable, for meadow and grain irrigation, to make the checks as large as practicable and at the same time to keep the ridges so low as not to interfere with the movement of farm machinery over the field.

If the slope of the field is 6 inches in 200 feet,

and it is desired to place the upper edge of each check under 2 inches of water, it would be necessary to construct the levees, for checks 200 feet square, about 10 or 12 inches high, because the water would be 8 inches deep on the lower edge when the surface was covered 2 inches at the higher side, and a margin of 2 to 4 inches is needed for safety against the water breaking across over slight depressions or against wave action.

If the fields are to be used continuously for meadows, pastures, alfalfa, or either of these, in rotation with small grains or similar crops which may be best irrigated by flooding, it will usually be desirable to make the check ridges broad and flat, so that mowers and harvesters and even plows may readily move over them. They thus become permanent features of the field. If a 20-, 40- or 80-acre field is to be laid off in regular checks, this would probably be most rapidly and cheaply done by a system of plowing in repeated back-furrows until the desired height of ridges is reached. The sizes of the checks would first be determined, and then all the ridges extending in one direction formed, first at the distance apart found desirable, after which the field would be crossed in the other direction, forming in the same manner the other sides of the checks.

In cases where a single plowing does not give sufficient height to the ridges, and in countries where the rainfall is sufficient to permit moderate crops to be grown without irrigation, the labor of fitting the ground in this way may be made a part

of the regular plowing for the crops, and permitted to extend through a number of years, thus making the expense of fitting the ground for irrigation mainly that of fitting the land for crops. By this plan the field would be plowed in lands in one direction, with the back furrows always in the same place, until the desired height is attained; then these back furrows would be crossed to form the other sides of the checks, plowing in the same manner.

In case the checks are large, the land between the ridges may be subdivided and plowed in the ordinary way, letting the back furrows and dead furrows alternate in position with the seasons, in the usual manner. There will be some finishing work required, especially where the check ridges cross one another.

It is not, of course, necessary that the flooding checks shall be square. If the field has a considerable fall in one direction and little or none in the other, the checks may be made much longer in the nearly level direction, and thus reduce the labor and inequalities in the field.

In cases where the slopes are more or less undulating, the check ridges which are horizontal will necessarily follow the course of contour lines, and may neither cross the others at right angles nor be parallel with one another, but they may still be formed in the same manner.

When it comes to flooding, the water may be taken from the head distributary and sent down first one tier of checks and then another, dropping the

water from the first into the second and the second into the third, over one or more breaks or weirs in the dividing check ridges. If, however, the checks are large or very many, this plan will be unnecessarily wasteful of water, and a better plan is to take the water down the crest between two lines of checks in a secondary furrow. From this furrow the water may be turned into the check on one side and then on the other, flooding by pairs down the whole line.

In the San Joaquin valley of California, in Kern county, there is laid out one of the largest flooding systems in the world. Here are more than 30,000 acres of alfalfa in a single solid block. The slope of the country ranges from 5 feet to the mile to less than 2. Large volumes of water are at the command of the company,—30 cubic feet per second,—and so the checks, laid out with their level ridges on contour lines, have various sizes and many shapes. The largest checks contain 200 acres, while the average is about 40. The ridges are 12 to 20 inches high, with a maximum width at the base of 12 to 18 feet, broadly rounded, and all covered with the growing alfalfa.

Where the period of rotation is short, and where crops not suited to flooding are used in the rotation, then narrower and temporary check ridges would be formed for the crops to be watered in this way. The smallest ridges may be rapidly made on recently plowed fields by using a V-shaped ridging scraper drawn by horses, with the open side forward. The spreading wings throw the loose earth into the angle,

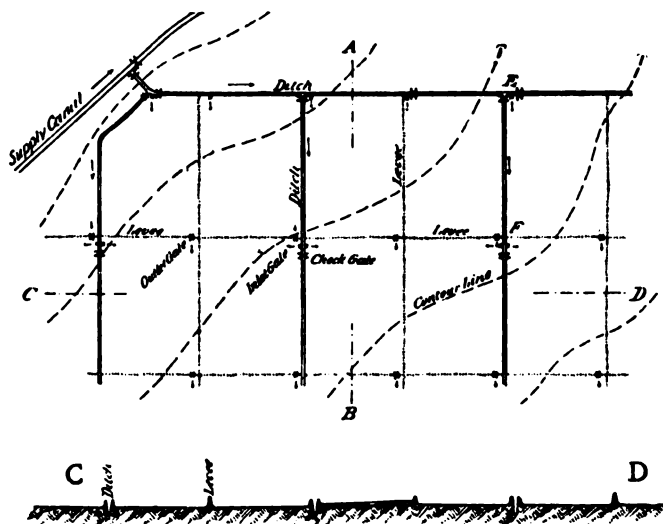

Fig. 87. Flooding field by rectangular checks. (Grunsky.)

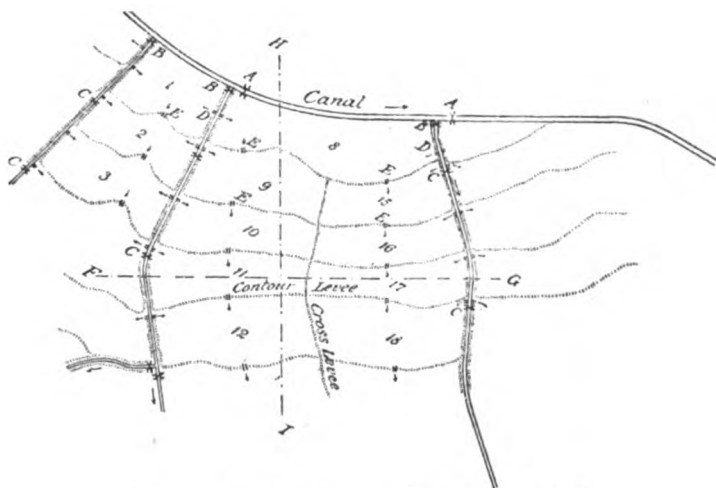

Fig. 88. Flooding field by contour checks. (Grunsky.)



where it is dropped in a continuous ridge, because a portion of each plank is cut away at the vertex, thus leaving an opening which passes over the gathered earth. If larger ridges are desired, a wider scraper, with wide opening in the rear, may be followed by one of smaller dimensions, to complete the gathering.

The mounted road grader may be used to advantage in forming such ridges, and it would be an easy matter to construct a special tool for this purpose on

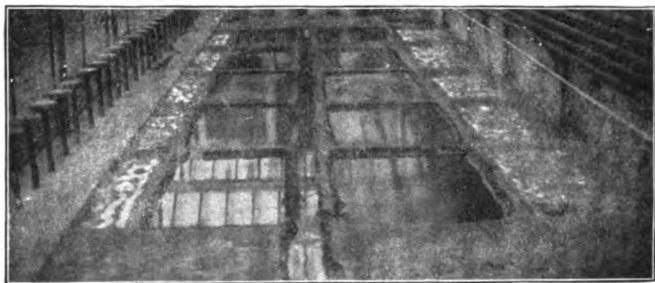

Fig. 89. Model of flooding by checks.

the principle of the road grader, but having two scrapers instead of one, mounted in such manner that they could be set closer together or farther apart, as desired.

After the earth has been gathered into ridges, this may be smoothed down and rounded with a light harrow, followed by a roller, if greater firmness is desired. In Figs. 87, 88 and 89 are different forms of flooding checks, showing how the water may be handled in them.

## FITTING THE SURFACE FOR IRRIGATION

Whichever system of flooding or other irrigation is used, it is very important that the smaller inequalities of the surface should be removed by some method of grading, in order that the water may spread uniformly, wetting the whole area. If this leveling is not done, some portions of the field will receive too much water while other areas will receive too little or none at all, and hence yields far below the maximum will be the result.

Various forms of leveling devices are in use, and Fig. 90 represents one of the best, made specially for this purpose, and an ordinary road grader would unquestionably form an excellent tool for doing this work.

There are many forms of scrapers of simple construction which are improvised on the farm to meet the needs of the moment. One of these is a letter A form, made of two 2x12-inch plank, put together so as to stand on edge and be drawn over the ground weighted with the driver riding upon it. The lower edges of the plank may be shod with strips of steel or band iron, and thus made more durable and effective.

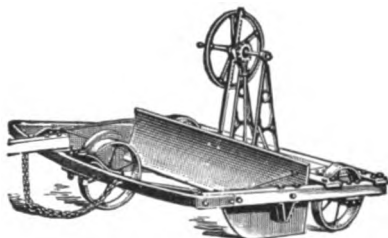

Fig. 90. Shuart land grader.

Another form is represented in Fig. 91, and consists of two side runners held together by cross-bars

where the soil must be prepared for planting by first watering, it is very important, especially with potatoes, that the soil should be thoroughly saturated to a depth of 4 feet before fitting the ground.

If these crops are to follow clover or alfalfa, as will usually be the case, the preliminary watering may be given in the late winter or early spring by one of the flooding methods, if the ground has been fitted for that; but however the saturation is accomplished, the soil should have all it will carry at the time of fitting for seed, unless natural rainfall may be depended upon.

After planting, frequent surface tillage to conserve the moisture should be practiced, and the crop carried forward as far as possible without irrigation. The harrow should follow the planter at once for both maize and potatoes, and frequently thereafter as long as the crop will bear it without injury, which will be after both are well out of the ground.

Where a vigorous growth of vines can be maintained by intertillage alone until they cover the ground and the tubers begin to set, this is by far the best practice for potatoes. So, too, is it best for nearly all crops planted in rows which permit of cultivation; and it should ever be kept in mind that 4 feet of good soil well saturated and well cared for by intertillage may easily carry 6 and even 8 inches of available water, and this, under good conditions, is far more effective than any which may be applied later.

When potatoes are ready to be laid by, the last

cultivation should be with a double-wing cultivator, which will form a furrow midway between the rows and at the same time throw the soil up under the vines, forming a high, broad ridge of mellow soil above the roots in which the tubers may set and over which the water should never rise. The furrows thus formed fit the field for irrigation.

When the time for irrigation has arrived, which should be deferred as long as the vines continue to grow vigorously, water will be taken from the head ditch and subdivided between as many rows as it will supply, as represented in Figs. 92, 93 and 94, where the first one shows the canvas dam just put in place in a head ditch in a field near Greeley, Colorado. Fig. 93 shows the irrigator, with rubber boots and spade, opening the head ditch to let the water into the furrows; while Fig. 94 shows the water 30 minutes later, as it is flowing between rows 40 rods long.

It will be noted that the water has been let into only alternate rows, and this is a common practice where water is scarce. It is also a frequent practice where water must be taken in rotation and the time is too short to go over the whole field. In such cases, when the next turn comes the water would be sent down the remaining rows.

Very great care is taken not to let in so much water as to fill the furrows and flood the hills, for it is far better to let the water rise under the hills by capillarity.

In another field near the same city, two men were irrigating 47 acres of potatoes planted in rows 120

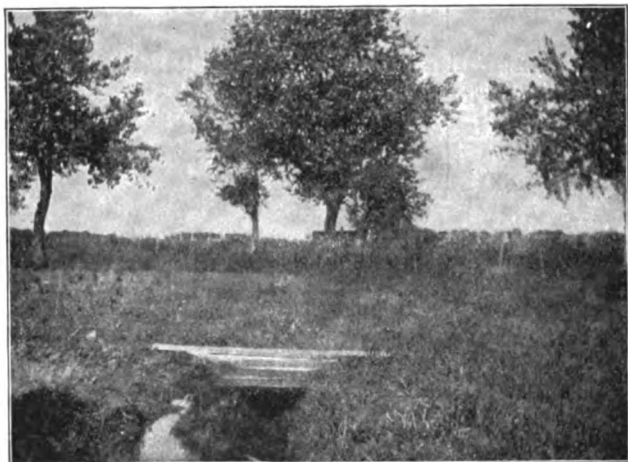

**Fig. 92.** Canvas dam in place, preparatory to turning water into potato rows of Fig. 94.



**Fig. 93.** Opening head ditch of Fig. 92, to turn water into rows of Fig. 94.

rods long and, from a single head ditch, sending the water the whole length. They were nominally using 175 Colorado inches of water, distributing it in alternate furrows.

Before going home at night they divided this head between 40 rows which had been once irrigated,



Fig. 94. Irrigating potato rows 40 rods long from head ditch of Fig. 92.

gauging the flow in each, so that, in their judgment, the lower ends of the furrows would be nearly reached on their return in the morning. After watering once begins, it is kept up until the crop is matured, going over the field every 10 to 15 days.

In the growing of potatoes by irrigation, it is a matter of the greatest importance that the ground shall be kept well moistened continuously after the tubers have begun to form, so that they shall be kept

steadily growing. If the ground is allowed to become dry enough to check their growth and another irrigation follows, the tubers will then throw out new growths and become irregular in form and unsalable.

In Colorado the potatoes are usually planted in rows 4 feet apart. This distance is much greater than is required in humid climates, and it would seem that were the same amount of seed planted upon three-fourths of the ground, or even five-eighths, making the rows 36 inches or 30 inches apart instead of 48 inches, the ground could be more thoroughly watered and larger yields per acre secured.

It is certain that the practice of only watering alternate rows, which is common where water is scarce, does not permit the largest yields to be secured. It has been shown by studies in the humid climate of Wisconsin, and with only 30 inches between the rows, as a mean of two years' trials, that watering between all rows gave a yield of 317.3 bushels per acre; watering between alternate rows gave 277.1 bushels per acre, when the natural rainfall alone gave 211.6 bushels per acre. That is to say, the irrigation between all rows increased the yield over the natural rainfall 105.7 bushels per acre, while irrigating between alternate rows only increased the yield 65.5 bushels per acre, making a difference between the two methods of irrigation of 40.2 bushels of merchantable tubers per acre.

In these experiments the field was divided into alternating groups, which were watered and not watered, so that there were two rows in each irrigated plot

watered on but one side, and it was the yield from these rows which has been used in making the comparison.

It was also found that the first row not irrigated on either side, and hence standing 45 inches from the center of the water furrow, had its yield increased by the watering only 7.9 bushels per acre. This makes it appear that were the potatoes planted in rows 90 inches apart and the water applied in a single furrow between each two rows, the benefit derived from the water would be much less.

It is very clear, therefore, that in furrow irrigation care must be taken that the water is not led along lines too distant from the plants which are to use it.

Where the water is to be allowed to run some time in individual rows, and where considerable quantities are being handled, it will often be found desirable to take it out of the head ditch into short feeders which supply a certain number of rows, as represented in Fig. 95, where the water in the foreground is in the head ditch, the feeder standing next sending water into 8 rows of rape, 28 inches apart from center to center, from which the first cutting has just been removed.

Sugar beets, maize, and all field crops upon which intertillage is practiced would be irrigated in a similar manner; but in such close planting as that above on sandy loams or lighter soils, it would probably be sufficient to lead water down every other furrow, keeping the other rows under frequent flat cultivation.



In Italy, where so much work is done by hand, it is a frequent practice to throw the field for maize into flat ridges or beds 6 feet wide with strong irrigation furrows between, planting the corn in an open broadcast manner on the beds, to be watered



Fig. 95. Dividing water between eight rows of recently cut rape.

by flooding through the heavy furrows. The same practice is followed to some extent for the small grains and clover also.

#### WATER-MEADOWS

Most water-meadows are laid out with the view of maintaining a continuous flow of water over the whole surface for considerable periods of time, with

but little personal attention. Large volumes of water are usually used, and in Europe especially this is applied more extensively out of the growing season than during it, or, more exactly stated, during times when the crop is off rather than when on the ground.

Reference has already been made to the water-meadows near Salisbury, England, where Fig. 16 shows a large part of the river Avon diverted into a canal to be led out for water-meadow irrigation. In Fig. 96 is represented a diagram of one of these water-meadows covering about 15 acres. The solid lines are permanent distributing ditches beginning in the head distributary and ending near the river at the foot of the field. They are placed about 3 rods apart, upon the crests of ridges which are quite steep, sloping from 1 in 12 to 1 in 15 feet toward the dotted lines, which are permanent drainage furrows. It is on this field that the photograph shown in Fig. 17 was taken. In talking with a "mead-man," whose business is to water one of these meadows, it appears that water has been run over them year after year for so long a period that no one knows who laid them out. The mead-man in question was past sixty years of age, and both his father and grandfather had been mead-men for the same field. It is quite probable, therefore, that the steep slopes now found have been to a considerable extent a matter of growth due to deposit of sediments in the distributaries, and to some extent to erosion along the drainage lines. The plan of this system of irri-

ing gradually narrower toward the foot, while the drainage ways increase in width toward the foot. In the meadow in question, the measured widths and depths of the distributaries at their heads were 42 inches by 24 inches respectively, in all except Nos. 10, 11, 12 and 13, 10 and 11 being 28 by 24, 12 being 48 by 24 inches, and 13 14 inches wide and 12 inches deep; but the capacity of the drainage ditches was only about one-fourth that of the distributaries.

In Italy the winter meadows, when laid out in what is regarded as the best manner, have sloping faces not wider than 25 to 30 feet, and with the crests 12 inches higher than the hollows, while the lengths are quite variable, depending upon the volume of water at command, but usually being 8 or 10 times the width. The distributaries have a width of 12 inches and a depth of 6 to 7 inches, while the drainage lines have dimensions about one-half of these.

In the summer water-meadows of Italy, the surface is much more nearly level between the distributaries, and often there is no intermediate drainage furrow, its function sometimes being fulfilled by a line of drainage tile beneath the surface.

In the Campine of Belgium, extensive sandy plains have been laid out in water-meadows, and Fig. 97 represents a small section of this system near Neerpelt, where the water is distributed through canals on the crests of ridges, as already described, and in the plan the heavy lines represent the distributaries, while the lighter lines represent the drainage

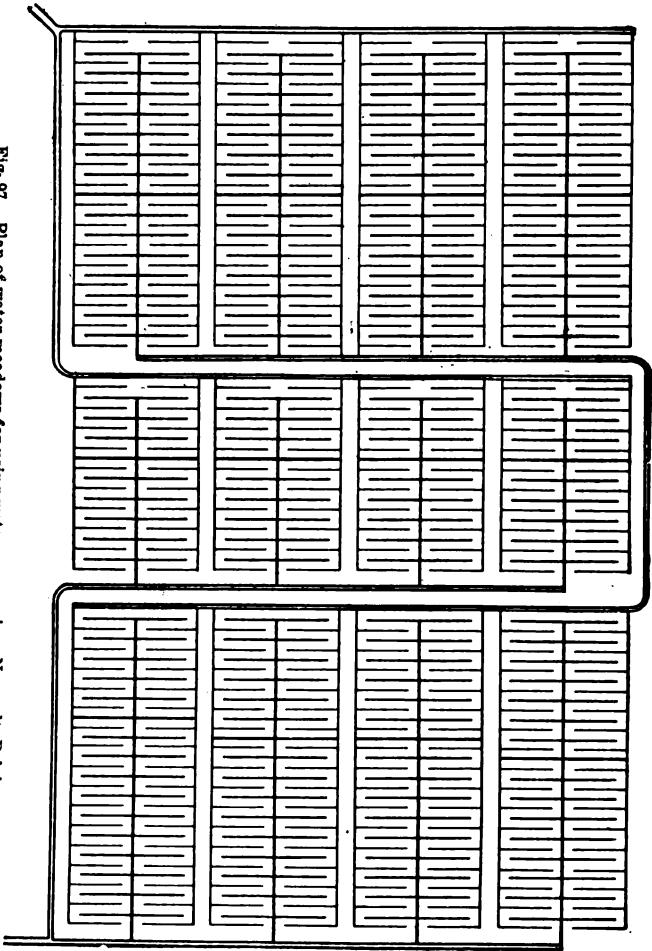

Fig. 97. Plan of water-meadows for using water over again. Neerpelt, Belgium.

system. It will be seen that the land is laid out so as to use the surplus drainage water over again, by collecting it into a foot ditch which is extended to a lower level in the field, where it becomes the head ditch, and discharges its water into another set of distributaries, as represented in the plan, the over-

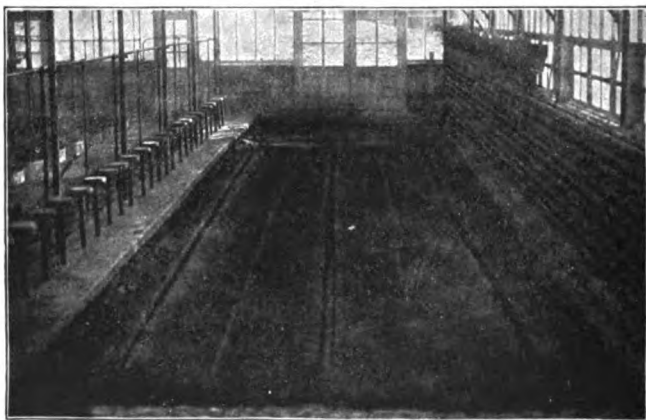

Fig. 98. Model of field laid out for water-meadows, with slopes exaggerated.

flow water from the upper section being used upon the third or lower section. The area shown in the plan is about 26 acres, the distance between the distributaries about two rods, and the crests stand nearly 10 inches above the troughs. In Fig. 98, there is represented a small piece of ground laid out upon this plan on a reduced scale.

It will be seen that this system of irrigation not only involves a large amount of labor to fit the land,

The object of placing the reservoir in the center of the area to be controlled is to utilize the seepage from the reservoir to hold up the ground water to the desired level more readily. A 12-foot steel mill should readily handle 3 to 5 acres if the water supply is abundant, the ground not too porous, and the lift not more than 20 feet. But if by such an arrangement as this a farmer could have only two acres or even one acre of cranberries under complete control as regards frost and insects, as an adjunct to his general farming, it would net him a handsome profit which would supplement in an important way his yearly income.

It would, of course, be necessary to be able to drain the area quickly after flooding, and if facilities are not the best for this, it would be possible to so arrange the pump that the water could be thrown back into the reservoir again, and this could readily be done for small areas where an engine was used instead of a windmill for power.

#### IRRIGATION OF RICE FIELDS

In the irrigation of rice fields, where this is to be done under the best conditions and where the highest quality of rice is to be produced, it is a matter of prime importance that the fields shall be properly laid out, and that an abundant supply of suitable water shall be under complete control. It has been pointed out, in discussing the duty of water in rice culture, that available statistics make the

average amount used equal to a flooding of the field 6 inches in depth once every 10 days, and since so much water must be used on this crop, the means for handling it must be constructed with ample proportions.

In South Carolina, at the mouths of the Santee river, where the natural conditions for rice culture exist in almost ideal perfection, the fields have been laid off into flooding basins, varying in size from a few acres to thirty and more. Each basin is surrounded by a dyke, at the foot of which is a main distributing ditch 4 to 6 feet wide and 30 to 36 inches deep, much as has been described for cranberry irrigation, but on a larger scale, and the resemblance is made still closer by the division of the fields into narrow lands 20 feet in width by parallel ditches 36 inches wide and 36 inches deep, which are at once the ultimate distributaries and the drainage channels. Trunks or sluices are provided controlled by semi-automatic tide gates, which may be raised at will, on the sea side, to admit the water to these ditches and flood the fields to any desired depth, and then closed and the water retained; or the gate on the field side may be raised and the water withdrawn.

After the fields have been plowed and seeded in the spring, they are flooded to a depth of 6 inches and allowed to so remain until the seed has germinated and the first three roots formed. At this stage the water is let off for three days to force rooting, when flooding again occurs to overtop the

plants and be sure to submerge the highest points in the field and start the rice there. This done, the water is drawn to a gauge and changed every seven days until the stage for dry growth has arrived, after 21 days, or the fifth irrigation.

The water is now held off during 30 days and the fields are given two dry hoeings. This stirring of the surface of the rice fields appears to have two important objects to secure: (1) to destroy weeds, and (2) to so aërate the soil as to admit air to the roots and to the niter germs for the development of nitrates. If the soil is not stirred, the plants take on a yellow color, which quickly changes to a dark green after the cultivation, proving this tillage very important. During this time the dry-growth roots are formed, which penetrate the soil sufficiently to enable the plants to stand securely, while at the same time they absorb the nitrates, potash, phosphoric acid and other ash ingredients required to mature the grain.

The cultivation is made more urgent on these fields because of the fine silt borne in the river water, which settles and overspreads the surface, forming so impervious a film that air can only pass it slowly, and if not broken would set up the processes of denitrification, which in turn must check the growth of the crop and cause it to turn yellow.

After the dry-growth stage has been passed and the head is ready to form, the 7-day irrigations are resumed and maintained until the crop has been matured. The frequent irrigations are necessitated



because of the tendency of the waters to become stagnant and poisonous to the rice. So important is the complete removal of the stagnant water, that provision is made at the farther corner of each field, by means of a trunk in the dyke, to permit the water which has been left standing in the ditches after draining to be forced out by the incoming water into another ditch leading to a canal or creek, and careful watch is kept until the yellow river water has finally reached the extreme corner and forced out all of the standing water which has been "bagged" in the ditches.

When the rice crop reaches maturity and is ready to harvest, a few of the topmost kernels are more advanced than the balance of the head and certain to shell and fall upon the field. These tip kernels, too, are liable to be red, and if allowed to germinate the next season would mature heads with kernels still more highly colored, and tend in a short time to develop the "red rice" which so seriously lowers the grade and market price.

To avoid the development of red rice on the marshes, it is the practice, after the harvest has been removed, to again flood the fields and germinate at once all of the shelled rice which has fallen upon the ground, so that the winter frosts shall kill the plants and thus remove the red rice. It is stated that if the seed is placed in the ground where it cannot germinate, it may retain its vitality for five years, and hence where the practice of fall flooding cannot be resorted to it becomes necessary to adopt some system

of rotation in rice culture which shall furnish opportunity for all of the red rice to have been germinated and killed before another crop is placed upon the ground, and it is the great ease with which the Carolina planters are able to control this difficulty, and the greater cost of rotation necessitated by other

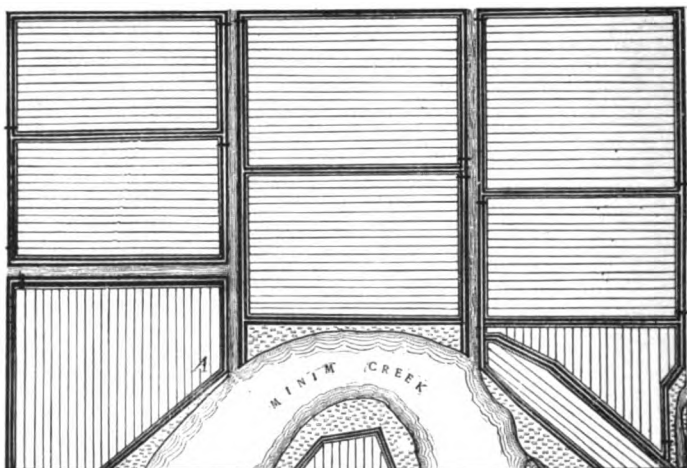

Fig. 101. Plan of rice irrigation, as practiced in South Carolina.

conditions, which gives them one of their great advantages over other rice-growers, enabling them to command the highest price in the markets of the world.

The detailed method of handling water on a Carolina rice plantation is represented in Fig. 101, where eight of the many fields shown in Fig. 67 are represented enlarged.

When the tide falls, the gates on the inner ends of the trunks automatically close and prevent the escape of the water during any desired period, while the dropping of the outer gates prevents the entrance of any more water until they are again raised. To drain the fields with an outgoing tide, it is only necessary to lift the inner gates and the work goes forward to completion without further attention, so that the handling of the water both ways is extremely simple, effective, and remarkably cheap.

The irrigation of rice on higher lands more nearly resembles the irrigation of meadows where flooding in checks is resorted to, except that here the checks are filled to a standard gauge with water, and then a slow stream is kept moving into and out of them as long as desired, the water usually entering at one corner and leaving at the diagonally opposite corner. The dividing ridges which form the checks have a height of about two feet, and the rice fields are kept under water until the heads are formed, when the water is drawn off and let on again at short intervals until the kernels are well formed, when the water is removed and the fields allowed to become dry and the grain mature, preparatory to harvesting.

#### ORCHARD IRRIGATION

In orchard irrigation, several methods of distributing water are practiced, but there is none followed so generally and with so good results as the furrow method, represented in Fig. 102, where the water is

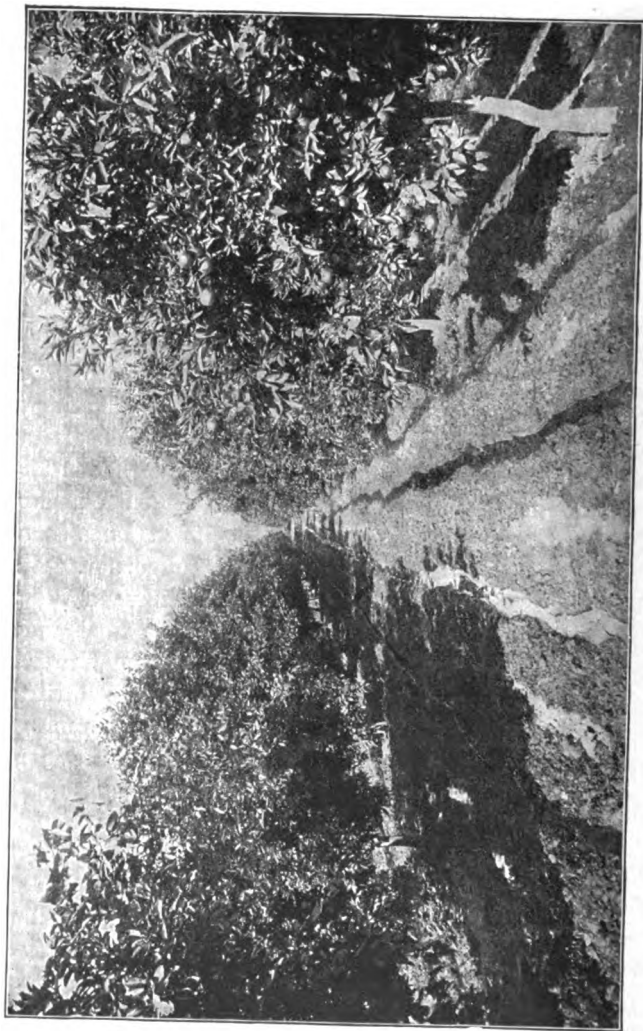

**Fig. 102. Ideal handling of water in orchard irrigation.**

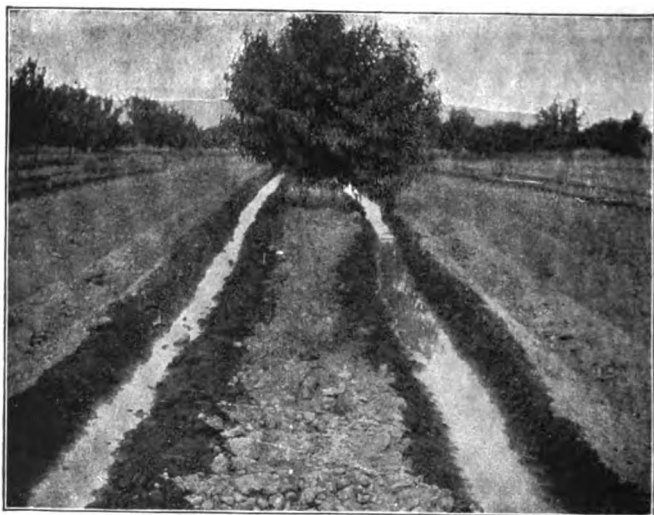

**Fig. 104.** Capillary spreading of water through soil from water furrows in peach orchard, Grand Junction, Colorado.



**Fig. 105.** Foot ditch for one orchard and head ditch for lower one.

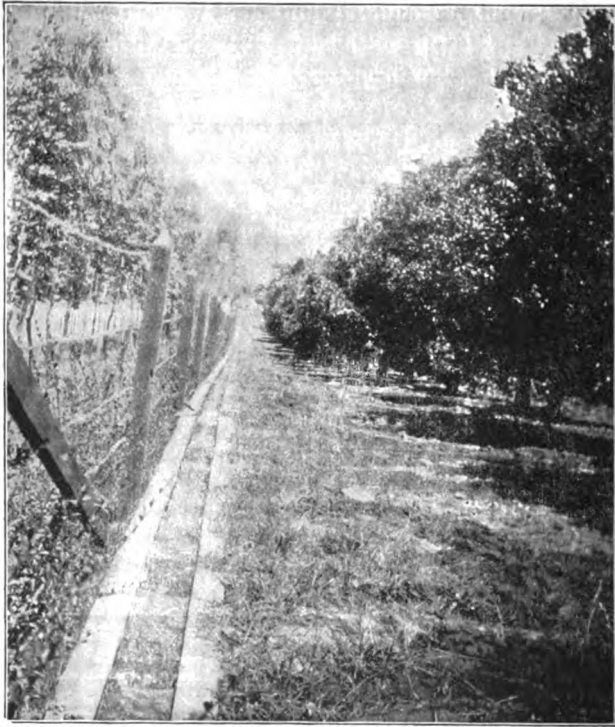

Fig. 107. Head ditch or cement flume for orange orchard,  
Redlands, California.

Figs. 105 and 106, so that the surplus water from the furrows in the upper one is collected in a foot ditch shown in the center of Fig. 105, and redistributed in a second set of furrows crossing a lower level, shown in Fig. 106. The water may be controlled by a simple gate in a sluice-box, shown at 1, 1 in Figs. 105 and

trees become older, the encircling furrows may be made larger, until finally it is better to lead the water along two single furrows on each side of the row, as shown in Figs. 104 and 106. With increasing spread of root, the number of furrows would be increased until a watering of the whole ground has become needful.

#### CULTIVATION AFTER IRRIGATION

A cardinal principle in orchard irrigation should ever be thorough, deep saturation, followed, as soon as the soil will permit, with thorough cultivation, frequently repeated. In Fig. 110 is represented an excellent mulch-producing tool for orchard work. It is drawn by three horses; can be set to run at any depth; makes a clean cut of the whole soil without bringing the moist portion to the surface, and is provided with a steering wheel, which permits the driver to easily throw one end of the long cutting blade quickly and accurately to one side and bring it close to the trunk of a tree without driving the team near enough to endanger either the trunk or limbs. As the blade of the tool is 8 feet long, the orchard may be covered quickly with it. Smaller sizes, with 5-foot blades, are also on the market in California.

Another form of orchard cultivator to which furrow plows may be attached is represented in Fig. 111. Ordinary forms of cultivators must necessarily tend more to invert the soil and bring the wet portions to the air, and thus be less economical of moisture. They

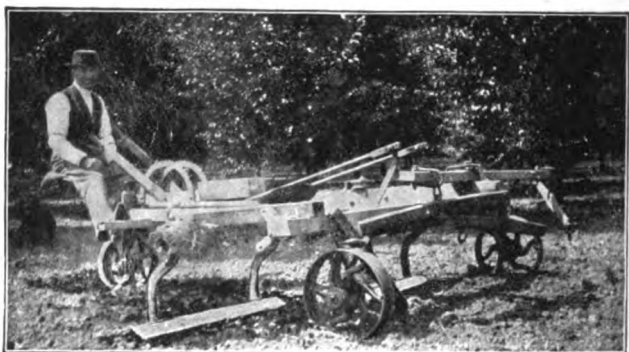

**Fig. 110.** Three-horse orchard cultivator used at San José, California.



**Fig. 111.** Combined orchard cultivator and furrowing tool.



have, however, advantages over the other form for going over the ground the first time after irrigation, when it is important to break the moist soil into a crumbled condition.

Systems of flooding are also adopted in orchard irrigation, sometimes flooding the whole ground or small checks surrounding the trees, when these are young and the water scanty, but this method is far more wasteful of water and much more injurious to the texture of the soil, unless it is sandy. When following it, care must be taken to prevent water from coming against the trunks of the trees and standing there.

In humid climates, on lands where the soil will not wash badly, the methods of orchard cultivation practiced in the west would give far better results than leaving them so persistently in grass, as is the more common practice. The moisture of the soil should be saved for the trees as a rule, rather than used for any other crop after the trees become large.

#### SMALL-FRUIT IRRIGATION

In the irrigation of strawberries, raspberries, blackberries, and similar fruits, the furrow method will almost always be practiced, leading a slender stream along each side of the row and quite close to it.

Blackberry and raspberry roots penetrate to a sufficient depth to permit a thorough saturation of the soil and good cultivation before the berries are ready to pick, so that no irrigation will be required during

the picking. Strawberries, however, are so shallow-rooted that water enough cannot be placed within reach of the plants to make irrigation during the picking season unnecessary. It is, therefore, a common practice to lay out strawberry fields in such a way that the water may be led only between alternate matted rows in deep broad furrows, holding the water well up the sides so that it may better spread laterally under the plants. This practice, although not as economical of water as irrigating between every row, has the advantage of not seriously interfering with picking, there being always sufficiently firm ground upon which to walk.

#### GARDEN IRRIGATION

Garden vegetables are oftenest raised in beds and patches of such small dimensions, and on soils so light and open, that the irrigation of them is accomplished most readily by methods closely allied to those of flooding. A relatively large volume of water is quickly brought to the point needed and applied all at once, and without waiting for either percolation or capillary spreading to take place.

A method represented in Fig. 112 consists in laying the ground off into beds, and getting the seed planted, when the surface is overspread with a thin dressing of rather coarse litter or horse manure.

Water is turned into the head ditch, which is choked with a little soil or an irrigator's broad hoe set so as to turn the stream between the

method, as practiced by the Italian gardeners, both in their native country and on the sandy lands at Ocean View, south of San Francisco.

In Fig. 116 is shown another cabbage field recently transplanted by the Chinese gardeners at San Bernardino, Cal. In this case the field is quickly and roughly-ridged and then the large plants hastily set low down in one side of the ridge. After irrigation, and when the water has settled away so as to permit working, a little soil from the ridge is pulled about the plants, as seen in the cut. In time the whole ridge has been pulled over, leaving the plants standing in the center of the crest.

The French about Paris throw their fields into broad double ridges, wide enough to carry two rows

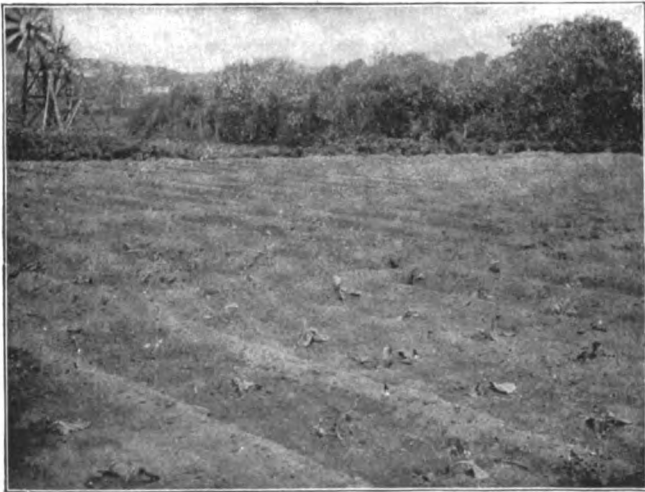

Fig. 115. Basin flooding of cabbage in garden of sandy soil.

of vegetables 24 inches apart, and these are separated by furrows a foot wide and 6 inches deep, through which water is led for irrigation, and Fig. 117 is a plan of a section of the upper end of a cabbage field as laid out on the valley sands of the river Seine, just outside the city walls.



Fig. 116. Chinese method of irrigating cabbage.  
San Bernardino, California.

Melons and cucumbers are planted upon still broader beds, 6 to 8 feet wide, separated by water furrows, as represented in Fig. 118, the hills being planted near each margin of the bed and the vines trained away from the furrows.

At Rocky Ford, Colorado, where melons are raised

on a large scale, fields are furrowed every 6 feet with a double shovel plow. The seeds are planted in the edge of the ridge away from the furrows, and the soil watered through the furrow only, by lateral capillary flow, great care being taken to avoid flooding the surface. Cultivation follows each irrigation after the plants are up until the vines become too large, but watering must be kept up about once in ten days until the crop is mature.

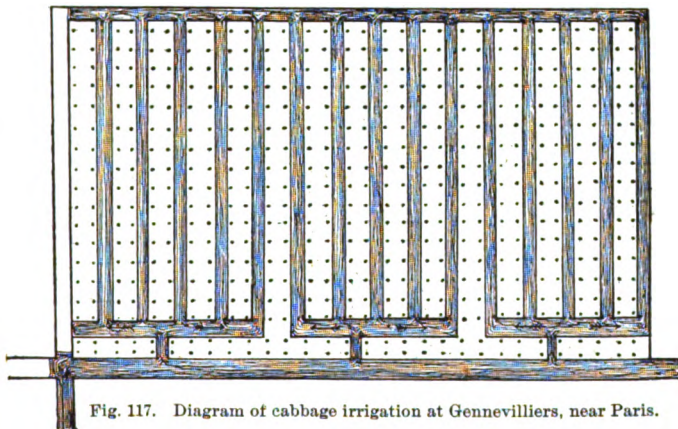
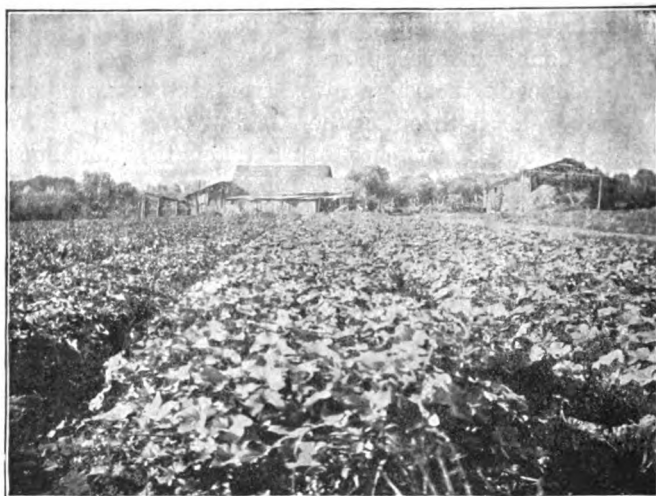

Fig. 117. Diagram of cabbage irrigation at Gennevilliers, near Paris.

Another system of irrigating gardens is represented in Fig. 119, where the rows are hilled, leaving shallow furrows between them, but arranged so that a stream of water can be led across the ends and turned into them one by one. The water is led to the lower rows down the middle furrow, and with a broad irrigating hoe, having a blade 12 inches



[Fig. 118. Irrigation of melons and cucumbers by Chinese at San Bernardino.

long and 10 inches deep, the soil at 1 is quickly turned over to 2, to form a dam in the stream, thus allowing the water to flow between the two lower rows until that furrow has been filled to a sufficient height. The soil from 3 is then turned over to 1, thus closing 1 and allowing the water to enter 3. When 3 is full the soil from 4 is brought back to 5, which turns the stream in there. When 4 has received enough, the water is turned into 6 by moving the soil from there to 4. In this manner the irrigator advances from row to row until both sides of the whole bed have been watered.

In other cases, small or large areas of garden plants are enclosed in small, shallow basins by throw-

monly the practice in humid climates, that two crops are being grown at the same time upon the land, and that under these conditions more water is demanded. The roots of shrubs and trees are more deeply placed in the subsoil than are most of those which feed the lawn grass, and hence all rains too light to oversaturate the surface 6 inches are practically secured by the grass, and since to maintain a good lawn

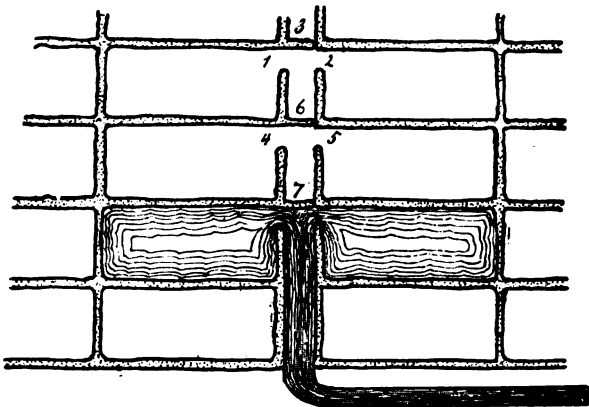

Fig. 120. Plan of basin flooding in garden irrigation.

requires more water than ordinarily falls as rain, even in quite humid climates, it follows that in all public parks, cemeteries and ornamental grounds about homes, there should be provided an abundant supply of water for thorough irrigation.

In watering lawns and parks, so much water is demanded that it ought usually to be applied by some flooding system rather than by spraying, as

and would answer admirably for a small market-garden, where vegetables and fruits are raised.

#### SUB-IRRIGATION

This method of applying water consists in placing lines of tile or perforated pipe varying distances below the surface of the soil, and distributing water through these instead of in furrows or by methods of flooding. This system of irrigation quickly suggests itself to most thoughtful men when they first begin to handle water for irrigation, on account of the many difficulties and inconveniences which are associated with surface watering; but there are several very fundamental objections to it which have usually led to its abandonment sooner or later in nearly every place where tried.

Were it not for the objections just referred to, sub-irrigation would constitute an ideal method of applying water, and would be universally practiced. Could it be used, much of the expense of fitting the surface would be avoided; the fields would be almost wholly unobstructed; all of the ultimate distributaries would become permanent improvements; the surface of the soil could not become puddled; mulches developed would not be periodically destroyed, and the duty of water would be vastly increased. Indeed, so many things appear to be in favor of the method that it is only with great reluctance that it is abandoned.

The most insuperable difficulty with sub-irrigation



unless the tile are as close as 4 feet apart and very near the surface.

The second great obstacle in applying sub-irrigation is the expense required to purchase and place the necessary lines of tile. In watering strawberries,

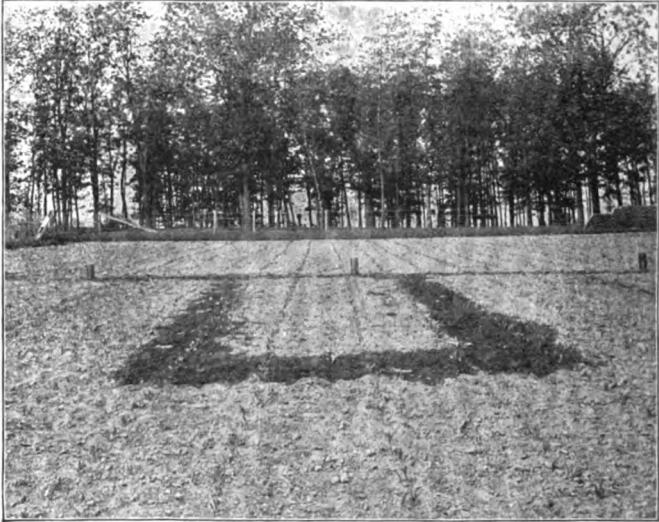

Fig. 123. Difficulty of wetting surface soil by sub-irrigation.

blackberries, raspberries, and other small fruits, one line of tile would be required under each row. For orchard irrigation, two lines of tile would be needed, one on each side of the row when the trees are small, and the number would have to be increased as the trees reached maturity, until there was at least one every 5 feet. For general field crops, the number of

ditch, and maintenance, which, in the aggregate, could not be less than \$12.88 per acre when done on a large scale and under the most favorable conditions. or a total cost of \$100 per acre, at the very best figure which could be hoped for.

Only in those cases where tile could be placed barely below the surface could there be as high a duty of water as with furrow irrigation, and hence, where water is high and labor cheap, the cost of water would decide against sub-irrigation.

Where a field has been underdrained, as represented in Fig. 124, in the lower lefthand corner, it is easy to introduce the irrigation water at the upper end of the main, as shown at F, and allow it to set back through the laterals. By forcing the water in the main to rise to the surface of the ground at G, H and A before passing on to lower levels, the water in all the tile would be placed under pressure which would force it to the top of the ground without waiting for capillarity to bring it there. In this manner if the field were underlaid by sand at the level of the tile, the whole area may be quickly watered, provided the main has capacity sufficient to deliver the water to all the laterals as rapidly as percolation can take place from them. With the outlet of the tile at E closed and water admitted to the main at both F and A, the 7,022 feet of tile took water at the rate of 48 cubic feet per minute under the 5 acres, or at the rate of 5 gallons per 100 running feet of tile where these were placed in sand 33 feet apart. During the irrigation, water was brought

## CHAPTER XI

### *SEWAGE IRRIGATION*

THE methods of distributing water in sewage irrigation are essentially the same as those already described. The topography of the field to be watered and the character of the soil or of the crop, will determine which method shall be employed. It remains here to state, from the agricultural side of the subject, under what conditions sewage irrigation may be practiced to advantage and what crops are best suited to utilize the water.

#### OBJECTS SOUGHT IN SEWAGE IRRIGATION

There are two main objects sought in the use of sewage in irrigation. The first and primary one is to oxidize and render innocuous the organic matter which it contains. The secondary object is to utilize this organic matter, together with the water and other fertilizers which it may contain, in the production of crops. Reference has already been made to this point in connection with the Craigentenny Meadows, where a poor soil has been made to yield a gross income of \$75 to more than \$100 per acre per annum for nearly a century.

The oxidation and denitrification of the organic matter borne in the sewage water must be accomplished largely, if not wholly, through the agency of fermenting germs, and this being true, it is imperative that the methods of treatment shall be favorable to the activity of these forms of life.

CLIMATIC CONDITIONS FAVORABLE TO SEWAGE  
IRRIGATION

Since the fermentive processes which convert organic matter either into nitric acid, which is the nitrogen supply for most cultivated crops, or into free nitrogen gas can take place rapidly only under temperatures above 50° F., it follows that sewage irrigation is best suited to warm climates, where crops may be grown the year round, and where the fermentive processes will be least checked by frosts. In tropical and semi-tropical climates, therefore, sewage disposal by surface irrigation may best be practiced when other needful conditions are also favorable.

In cold climates, like those of the northern United States and Canada, where the ground is frozen during five months or more of each year, it is plain that only about one-half of the sewage water can be used in crop production, and that during only about one-half of the year can there be much oxidation and denitrification of organic matter. Under these conditions, therefore, if water is applied to land one-half of it must be filtered by the soil without the concurrent purification which results from fermentation, and this being true, there can be only so much of purification as naturally results from the physical filtration and such chemical fixation as the soil may be capable of accomplishing.

It is true that the purification of sewage resulting from filtration through soil is very considerable, so that if isolated lands of sufficient area are selected for this purpose, the organic impurities reaching the ground water will be greatly reduced. It is also true that in cold climates fields to which no sewage has been applied during the warm season may be reserved specially for the reception of it during the winter. These soils would, therefore, be comparatively dry and capable of receiving 6 to 12 inches of water and of retaining it by capillarity until warm weather could subject it to organic purification, and when crops could also be made to utilize the nitrates developed and other fertilizers brought by the water.

have completely used up the organic nitrogen, then it will be only partly purified; or if the flow over the field is made continuous, then the supply of oxygen in the soil becomes so small that the germs are unable to carry forward the work, and organic nitrogen passes through largely unchanged and liable to become the food in drinking water of other but dangerous forms.

#### SOILS BEST SUITED TO SEWAGE IRRIGATION

In humid climates, where the rainfall is both frequent and abundant, the lighter loams and sandy soils are best suited to this type of irrigation, because upon them there is less danger of water-logging. It should be understood, however, that from the agricultural standpoint sewage may be applied to any soil, provided it is not used in too large quantities or too continuously; but as the sandy soils are usually more in need of artificial fertilization, and at the same time likely to be deficient in water, they are preëminently suited to this use, and will usually be chosen by city authorities when they are available, but simply because a smaller number of acres will answer the purpose and the cost of the plant be less.

The agricultural value of sewage when properly applied to land has been so thoroughly demonstrated under so many conditions of soil and climate that there can no longer be any doubt as to the desirability of its use if the expense of getting it to the land were eliminated, and it would appear that lands enough in the vicinity of most cities could profitably receive and use the sewage if only it were led to them.

#### DESIRABILITY OF WIDER AGRICULTURAL USE OF SEWAGE IN IRRIGATION

In countries like Italy, where there are extensive canal systems largely used for irrigation, it would appear that sewage disposal by irrigation should become the general practice, pro-

vided the canals are carrying constantly a sufficient volume of water to make the needful dilution. The disposal of the sewage of the city of Milan in this manner has already been referred to as extremely satisfactory from the agricultural point of view.

In speaking of the opportunities for and the desirability of improving sandy lands in various parts of the eastern United States and in the South by silting, it was pointed out that many



Fig. 125. Instruction of practical gardeners in garden irrigation.

hundreds of square miles of now nearly worthless lands could be reclaimed by methods of irrigation, and wherever this shall be undertaken the disposal of the sewage of the same sections through the canal waters could not fail to be of great advantage to the lands when applied either in winter or in summer.

Outside the walls of the city of Paris, on the once nearly worthless gravelly sands of the Seine, is located a garden whose sign is represented in Fig. 125, where, in the midst of a district

devoted to sewage irrigation, an effort is being made to teach in a concrete way how thoroughly purified sewage water may be made by irrigation, and what luxuriant growths may spring from nearly sterile sands. Fig. 126 is a view within the garden, where grapes are growing on the left, with dwarf pears and apples on the right, while in the center is a trench of water cress grown for market in filtered sewage, the trench being at the foot of one of the drainage lines leading the filtered water

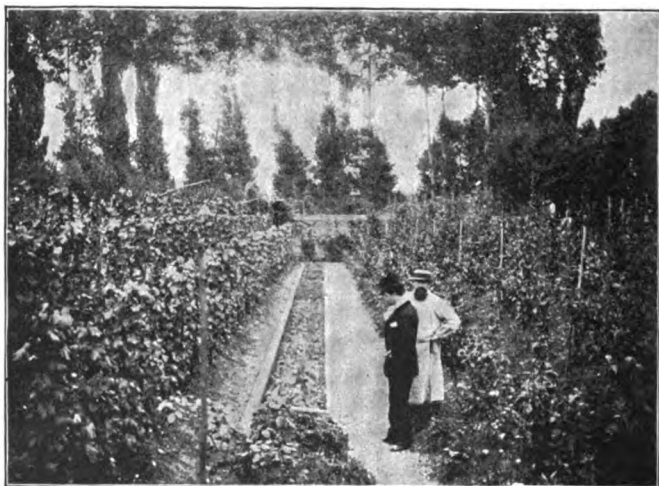
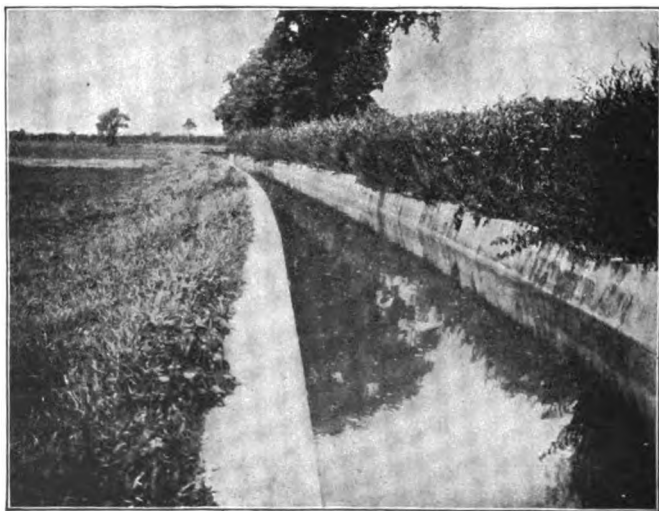

Fig. 126. Sewage irrigation, model garden, Paris.

to the Seine. So clear was this water that it had the sparkling brilliancy of that from the purest springs, and outside the garden women and children came with their buckets and filled them for use at home. Inside, the superintendent keeps a glass, and insists that every visitor shall taste and convince himself how sweet and pure the water is. Here and further out, at Gennevilliers, the lands are laid out and divided much like village lots, where homes, with their vegetable, fruit and flower



**Fig. 129.** Harvesting early potatoes on Croyden sewage farm, England.



**Fig. 130.** Cement canal at sewage farm, Croyden, England.



main object, together with the disposal of the sewage, lands may be irrigated at once after the removal of a crop, such as wheat or any of the small grains, so that there may be ample latitude for distributing the water at almost any season of the year.

In climates where the winters are severe, it is necessary to apply the sewage to land not in grass or other perennial crop, as the freezing of thick coats of ice over the meadows is quite certain to greatly injure if not kill the grass. Another point which the agriculturist should keep in mind and guard against, is the application of sewage to crops in too concentrated a form, and especially should it be so much diluted or strained that the sludge will not collect upon the surface in sufficient quantity to close up the pores of the soil and interfere with proper aëration.

#### INFLUENCE OF SEWAGE IRRIGATION UPON THE HEALTH

Reference has been made to experiments and observations which show that the feeding of grass from sewage farms to milch cows produces no injurious effects upon the milk itself. The late Colonel Waring states that the health of the people living upon the sewage lands at Gennevilliers is generally excellent, and that "even in 1882, when there was a cruel epidemic of typhoid fever in Paris, there was none here." He further says: "If there is still room for doubt on any point, it is as to the character of the few bacteria which escape the action of the process employed, and are found in the effluent. It is not known that disease germs exist among these, and it is altogether probable that they do not. So far as these organisms are understood, it is thought that they cannot withstand the destructive activity of the oxidizing and nitrifying organisms which are always present, and it is believed that only these hardier organisms exist in the effluent of land-purification works. Certain it is that no instance has been reported where contagion was carried by such effluents, and experience at Genne-

villiers has shown that typhoid fever and cholera, when rife in Paris, were completely arrested at the irrigation fields."

"In the Massachusetts table of comparison of the purified effluent of seven sewage filters and the waters of seven wells used for drinking by many persons, it is shown that there were three and one-half times as many bacteria in the well waters as in the effluents "

PART II  
FARM DRAINAGE

---

CHAPTER XII

*PRINCIPLES OF DRAINAGE*

It has been pointed out that if all of the irrigated lands of the world were brought together in a solid body, they would scarcely aggregate more than an area 500 miles on a side, or 250,000 square miles. But Professor Shaler estimates that in the United States alone, east of the 100th meridian, there are more than 100,000 square miles of swamp lands. Some of these have been reclaimed by drainage, and the great majority of them could be, if the expense of the reclamation would be warranted by the returns which would follow. In the Canadas, in Europe, and in other portions of the world, also, there are vast areas of land, when measured in the aggregate, which must be drained before they can become agriculturally productive. Hence the principles of land drainage, like those of irrigation, must be clearly understood by those who are concerning themselves with

the great world problems of better homes and all which these mean.

Further than this, on account of the fact that a large majority of swamp lands and lands which may be improved by drainage are not massed together, but are scattered broadly in small tracts, so related to the higher and better-drained lands that these must often be improved in order to work the others to the best advantage, the principles of farm drainage become a matter of great importance to a large proportion of the rural population, and through good roads to the people of cities as well.

#### THE NECESSITY FOR DRAINAGE

The first and most fundamental necessity for land drainage, as has been pointed out in discussing alkali soils, is the removal of the more soluble salts formed by the decay of rock and organic matter, because too strong a solution of salts in the soil water is fatal to the growth of vegetation, and gives rise to the alkali lands. So long as there is sufficient leaching to hold the soluble salts down to small percentages, so that neither plasmolytic nor toxic effects result, then the first imperative demand for thorough drainage in all soils is met.

The second imperative demand for drainage is to prevent a stagnation of the soil water, which means, to avoid the exhaustion of oxygen from the air in the soil water and in the spaces not occupied by water, because an abundance of free oxygen in the

soil is a fundamental necessity to plant life, and thorough drainage secures this.

The third demand for drainage is to render the soil sufficiently firm and solid to permit the field or road to be moved over without difficulty or inconvenience. If the spaces between the soil grains are completely filled with water, then there is no surface tension, and so only a slight friction to bind the grains together, and hence they move so easily upon one another as to be unable to sustain much weight, and the horse or wagon mires.

Everyone is familiar with the hard surface possessed by wet beach sand, from which the water has just withdrawn, and how yielding it is when under water and also when it becomes dry. In the first case, the sand grains are bound together by the thin films of water which surround them; in the second case, there is no free water surface between the grains, and the sand tends simply to float and so moves easily; while in the third case, when the sand is dry, the binding water films have either drained away or have been lost by evaporation, hence there is nothing to hold the grains together.

The hard, firm character of a clay soil when it loses its moisture is due to the fact that the grains are so small and so close together that the little material which is held in solution in the soil water cements them together when dry. Were the grains large like those of the sands, with few of the fine particles between them, the contact areas would be so few and so small that little binding could result.

## THE DEMANDS FOR AIR IN THE SOIL

It must ever be kept in mind that an abundance of free oxygen in the soil is as indispensable to the life of the plant as it is to that of an animal. The germinating seeds must have it, or they rot in the soil; the roots of plants must have it to enable them to do their work; and the vast army of soil bacteria, which change the nitrogen of decaying organic matter into nitric acid, which is the chief nitrogen supply for most higher plants, must have it or they cannot thrive. Again, those very important germs which live on the roots of clover and other allied plants, and which are the chief source of the organic nitrogen of the world, must have an ample supply of both free oxygen and free nitrogen in the soil, or they are unable to accomplish their task.

Again, there lives in all fertile soils a class of germs which have the power of breaking down nitrates, or even organic matter, to supply themselves with oxygen whenever the conditions are such that the soil does not contain enough to meet their needs. But when these germs are forced to do this, as happens in a water-logged or poorly drained soil, the nitrogen of the soil nitrates and of organic matter is liberated in the form of free nitrogen gas, and hence the soil may thus be depleted of this most expensive ingredient of plant-food wherever proper drainage does not exist.

Finally, many purely chemical changes taking

the lime which in its turn tends to force the fine clay particles into larger compound clusters, thus rendering the soil more open, and hence better drained, better ventilated, and at the same time better and more thoroughly occupied by the roots of plants.

But all of these changes, which result directly from lowering the ground-water surface, are only means which make underdrainage more effective in ventilating the soil. In an underdrained field, where lines of tile are laid 3 to 4 feet deep and 50 to 100 feet apart, there is provided a very effective system of soil ventilation as well as of drainage; for with every fall of the barometer and rise of soil temperature, some of the deeper soil-air expands and drains away through the lines of tile. Then, when the barometer rises again, or when the soil temperature falls, a volume of air equal to that which left the soil under the other conditions now enters it again, not only through the surface of the ground, but also through the tile drains. It is thus seen that a deep, well-laid system of tile drains permits the free oxygen of the air to reach the roots of plants both from above and below. Under these conditions, the roots of crops are better supplied with oxygen; nitrates develop faster and deeper in the soil; there is less occasion for denitrification to set in, and so larger yields result.

When deep underdrainage has permitted the roots of plants to penetrate the soil from 3 to 4 feet and there withdraw moisture, this action on their part becomes a means for drawing air into the ground,

both from the surface and through the tile drains, because the removal of the soil water by the roots leaves an open space, which must be filled with air so far as capillarity fails to do it with water, and hence deep root feeding means deep soil ventilation.

Then, again, when heavy rains fall which move downward through the soil, they displace both the air and the water previously there, crowding them forward into the drains, and then draw in after them a fresh supply from above. But only on well-drained soils is this action marked and helpful.

A word should be said here regarding the value of clover and alfalfa as soil ventilators, for by their thicker, stronger roots they set the soil aside more than most other cultivated crops do, and when these roots decay the soil is left better aërated and better drained. Further than this, the roots of these leguminous plants remove from the soil both free oxygen and free nitrogen, and in so far as they do this without returning an equal volume of another gas, their action tends to develop a vacuum which must be filled by bringing in a fresh supply from without.

#### TOO THOROUGH AÉRATION OF THE SOIL

There may be too strong and rapid changes of soil-air, just as there may be too rapid and complete drainage. If the air enters a rich, damp soil too rapidly, there is so strong a development of nitrates that the humus and other organic nitrogen are quickly changed into the soluble forms, and rapidly leach



away. It is in this manner that coarse, sandy soils are impoverished, and their lack of productiveness is often due quite as much to too thorough ventilation as to too complete drainage; and in handling these soils the utmost care should be exercised to keep the content of humus high, the moisture plenty, and the winds from drifting away the finest dust particles, because all of these tend to close up the pores, giving the soil a texture which diminishes the amount of ventilation.

DRAINAGE INCREASES THE AVAILABLE SUPPLY OF  
SOIL MOISTURE FOR CROPS

When soils are poorly drained during spring and early summer, the root system of the various crops is forced to develop near the surface, and if this is the case until the demands for moisture become large, the soil in which the roots are confined becomes very dry, because capillarity brings the water up from below too slowly to meet the demand.

It is a familiar fact that a damp cloth is much better to remove water from the floor than a dry one, and the same is true of soils; water rises by capillarity in them when quite moist much faster than when they become dry, and so it is a matter of the greatest moment to keep the surface soil, beneath the mulch, as damp as the best conditions for growth will permit. When the deeper soil in the spring and early summer is well drained, and the roots of the crop penetrate it, they not only find themselves closer

temperature. Stated in another way, the amount of sunshine which will warm a given weight of water 10° F. will raise the temperature of an equal weight of dry sand 52.38° F., clay 44.58° and humus 22.6°. It is plain, therefore, that very wet soils must warm in the sun more slowly because the water which they contain tends to hold the temperature down.

The chief cause, however, which makes a wet, undrained soil colder than the better drained one, is the cooling effect which results from the more rapid evaporation of water from the wetter soil surface. When the bulb of one of two similar thermometers is covered with a jacket of muslin moistened with pure water, and the two are swung side by side in a dry air, it will often be observed that the bulb bearing the moist cloth will have its temperature lowered as much as 20° F. by the cooling effect of evaporating water. So, too, when water evaporates from any surface, no matter what, its temperature is lowered in proportion to the rate at which evaporation is taking place. The teakettle boiling over the hot fire has its temperature constantly held down to 212° by the rapid evaporation of water, although the heat of the fire playing upon it is very many degrees hotter.

It is the same way with a wet soil through which water is continually brought to the surface as rapidly as it can be evaporated in the heat of the sunshine. The loss of the water in this way necessarily holds the temperature down, and the lower the more rapidly the evaporation takes place. The following table\*

---

\*The Soil, p 227.

similar to this are often observed early in the spring, when leaves are just unfolding. A strong drying wind on a cool day, with the soil also cold, withers the leaves much as if they had been frosted.

The germination of seed is very much influenced by the temperature of the soil, maize requiring 16 days to appear above the ground when the soil temperature is 60° F., or below, when if the warmth is 72° or above, 3 days or less will do the same work, besides giving much stronger plants. These effects

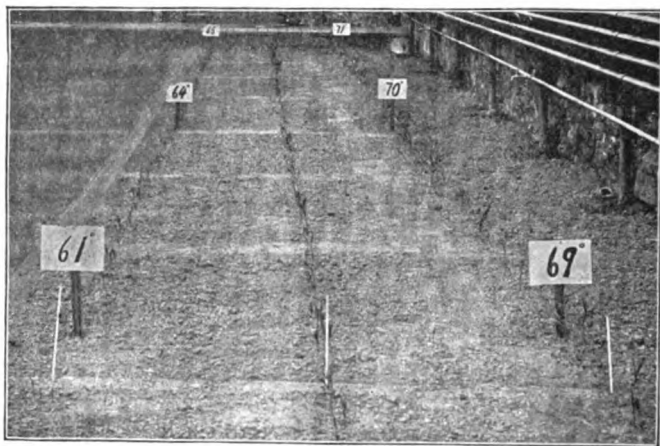

Fig. 131. Influence of soil temperature on the rate of germination of maize.

of soil temperature are clearly demonstrated in Fig. 131. Indeed, it will often happen that when seed of rather low vitality is planted in a soil a little too cold, germination will not take place at all, or if it

soils, and hence land drainage may be beneficial to crop growth in this manner.

CONDITIONS UNDER WHICH LAND DRAINAGE  
BECOMES DESIRABLE

It must be kept ever in mind that all lands, of whatever kind, require draining, but it is extremely fortunate that for most lands this is done by the natural methods of percolation and underflow of ground water.

The cases in which it becomes desirable to supplement the methods of natural drainage fall into five classes: first, those comparatively flat lands or basins upon which the surface waters from surrounding higher land frequently collect; second, areas bordering higher lands, whose structure is such as to permit the underflow of the ground water from the adjacent regions to rise from beneath, thus keeping the soil too wet; third, lands regularly inundated by the rise of the tides, or which would be if not shut off by dykes; fourth, those extremely flat lands which are underlaid by considerable thicknesses of close, heavy beds of clay, through which water does not readily percolate, and which lie very close to the surface, so that the clays become the subsoil of the fields, and fifth, lands like rice-fields, water-meadows and cranberry marshes, to which water is applied by irrigation in excessive quantities. It may also be found desirable on some irrigated lands to introduce drainage to remove injurious salts, as described under alkalis.

THE ORIGIN OF GROUND WATER AND ITS  
RELATION TO THE SURFACE

To understand the laws governing the flow of water into tile drains and ditches, it is necessary to know how the flow into streams and lakes takes place, and how the surface of the water in the ground is related to that in the streams and lakes into which it is continually draining.

The rains which fall upon the surface tend, first of all, to sink vertically downward until they reach the level at which the pores in the soil or rock are completely filled with water. There are no soils and very few rocks through which there can be absolutely no flow, but the downward percolation is very much slower in some than it is in others. This being true, everywhere beneath the land surface a place may be reached where the pores are filled with water, and the level at which this occurs is called the ground-water surface.

This ground-water surface is seldom horizontal, but usually rises and falls much as does that of the ground above it, but with gradients less steep. In Fig. 132 is represented a section of land adjoining a lake, where the differences in level of the surface are shown by means of contour lines passing through all places, having the height above the lake indicated by the number set in the line; while in Fig. 133 the surface of the ground water for the same area is also indicated in like manner. The data for the levels of the ground water were procured by sinking wells

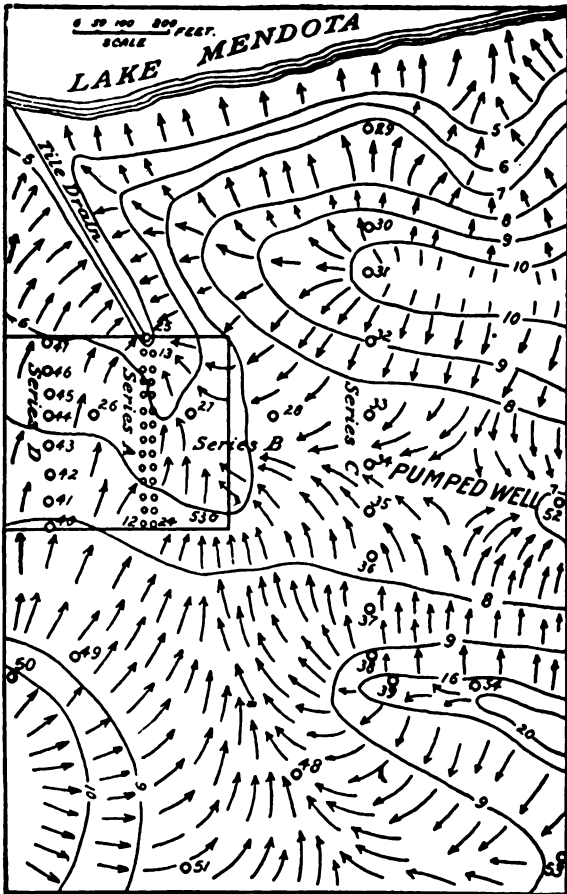

Fig. 133. Contours of the level of the ground-water surface under the locality represented in Fig. 132.

at the places designated by the small numbered circles.

Referring to the two figures, it will be observed that there is a marked tendency for the ground-water surface to stand highest where the level of the field is also highest, and that there are valleys in the ground-water surface beneath the valleys in the field. It will be seen that the water rises as the distance from the lake increases, and that in places it stands 10 and even 20 feet higher.

This distorted surface of the ground water cannot be a condition of rest, for gravity tends continually to force a flow from the higher toward the lower levels along the lines indicated by the arrows shown in Fig. 133. Since the further this water must travel through the soil to reach the lake the more resistance it must meet, it is plain that a greater pressure will be re-

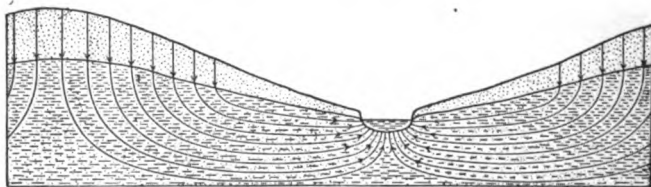

Fig. 134. Diagram of lines of flow of water in the drainage of a river valley.

quired to overcome this resistance, and hence the water must stand higher in the ground the farther the distance to the drainage outlet. The space enclosed by the rectangle in Fig. 133 is an area which required underdraining to fit it for farm crops, and the reason it did is clearly shown by the contours of the two

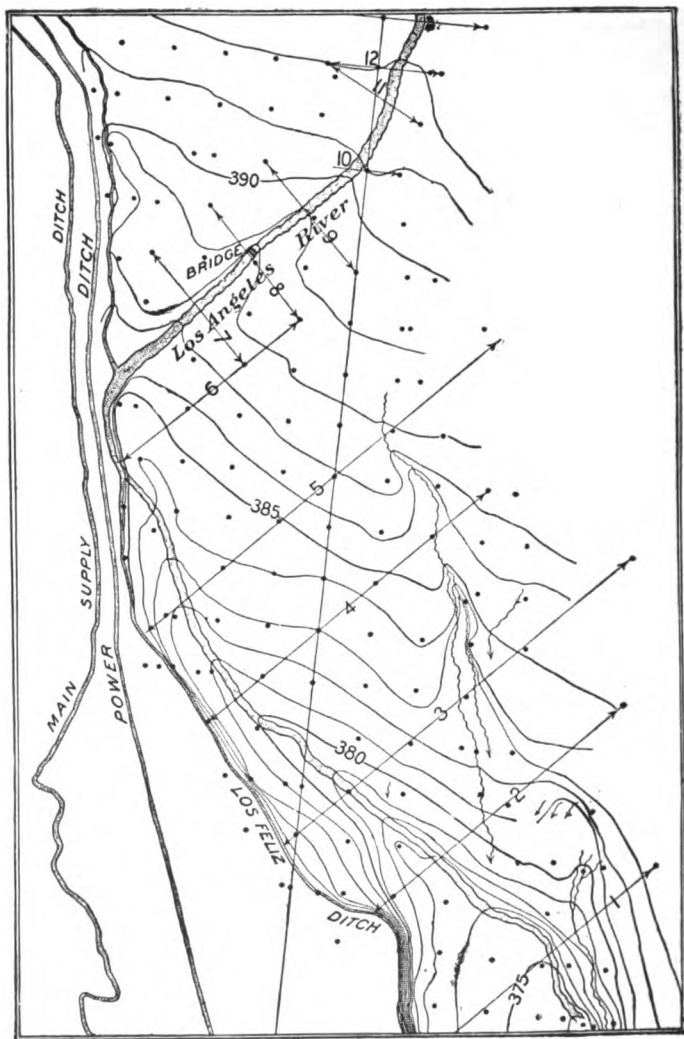

Fig. 10k. Contours of ground water in the Los Angeles river valley, California. (U. S. Geol. Survey.)



It will be clear, therefore, from the cases cited, that wherever the moving sheet of ground water approaches within capillary range of the surface of the ground, there the soil is liable to be too wet for crops unless underdrained.

RATE AT WHICH THE GROUND-WATER SURFACE  
RISES AWAY FROM THE DRAINAGE OUTLET

In well 29 of Fig. 133, situated 150 feet from the lake, the water stood 7.214 feet above the level of the lake June 27, 1892, thus showing a rise of 1 foot in every 24.4 feet. At another place in the same locality, but not shown in the map, a well 1,250 feet from the lake shows the ground-water surface to stand 52 feet above, thus giving a gradient of 1 foot in 24 feet. Later in the season, when the ground had become dryer, the gradient at well 29 became 1 foot in 35.86 feet.

Between tile drains 33 feet apart and 4 feet deep, laid within the rectangle of Fig. 133, measurement showed the surface of the water to rise at the mean rate of 1 foot in 25 feet 48 hours after a rainfall of .87 inches, and the shape of the ground-water surface at the time in question is represented in Fig. 137. Of course, after the lapse of a longer interval of time the gradient here would have become less steep, just as was the case in the other instance cited.

The subsoil in which these gradients were observed was a fine sand, in some places with grains so small as to approach the character of quicksand, and they

represent conditions which are very common in localities where underdrainage is needed, and, therefore, furnish a good basis upon which to form a judgment regarding the distance apart tile should be laid.

#### DEPTH AT WHICH DRAINS SHOULD BE LAID

The depth to which water should be lowered by drainage need seldom exceed 4 feet for ordinary farm crops, and often the lowering of the water surface may be less.

It should be kept in mind that the level of the ground water changes with the season, and that many lands benefited by underdrainage are only too wet early in the spring, and if such lands are to be used for ordinary farm crops, it may only be needful to draw the water down so far as to make the surface dry enough to give good working conditions for the soil. In such cases, tiles placed  $2\frac{1}{2}$  to 3 feet deep, rather than  $3\frac{1}{2}$  to 4 feet, will usually be found sufficient. If the tiles are placed deeper than this, not only will there be a permanent lowering of the ground water, but the low stage will be reached so much earlier in the season that a smaller amount of the water flowing under the field may be used by the crop.

Where fields are underlaid by sandy subsoils, it is quite important not to draw the water down far into the sand, because the height to which the water can be lifted rapidly in these by capillarity is quite short. To carry the ground-water surface below this

ment of the water in cases like that represented in Fig. 136 will be chiefly straight down through the soil and clay until the sand is reached, when the movement will be sideways toward the drains and finally upward, the water entering them chiefly from the under side. That is to say, the flow sideways through the clay toward the drains will be very slight indeed.

Since the resistance to flow of water increases as the soil texture becomes more close, it is clear that the more open the soil the farther apart the drains may be placed. It is common to place lines of tile in underdraining varying distances apart, from 30 feet to 100 and even 200 feet. The reasons for these wide differences will be better understood after considering the way the ground-water surface changes under a tile-drained field following a rain.

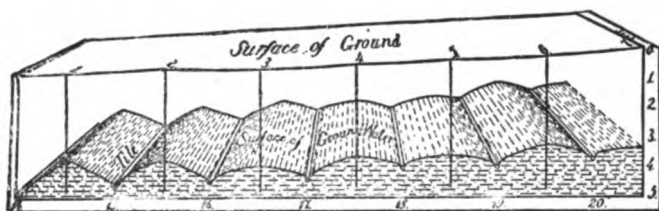

Fig. 137. The observed surface of the ground water in a tile-drained field 48 hours after a rainfall of .87 inches.

In Fig. 137 is represented the observed slope of the ground-water surface in a tile-drained field where the lines are placed 33 feet apart and between 3 and

4 feet below the surface. The conditions there shown had developed 48 hours after a rainfall of .87 inches, and the facts were obtained by sinking lines of wells at right angles to the drains, there being 3 wells between each pair. It will be seen that the height of the water on the crest between the drains varies, being much greater at 1 and 2 than elsewhere, and this is where the soil is more clayey, and so closer in texture.

In Fig. 138 is represented the heights of the ground-water surface midway between the drains as they occurred 2 days,  $2\frac{2}{3}$  days and  $5\frac{2}{3}$  days after the same rain, and the differences in the steepness of the slopes in the several cases should be understood as due chiefly to differences in the size of the soil grains. It will be seen that after a period of nearly 6 days the surface of the ground water in the upper portion of

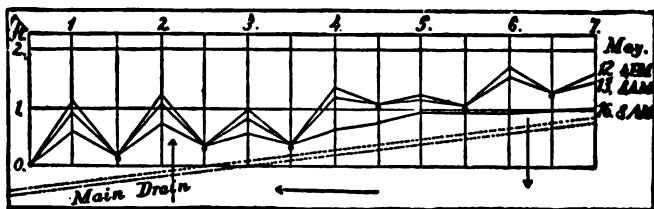

Fig. 138. Changes in the level of the ground-water surface in tile-drained field.

the field has become quite flat, having fallen below the level of the drains, and the gradient being reduced to 1 foot in 175 feet, while at the lower end, where the soil is heavier, the slope is still 1 in 27.

Taking these two cases, let it be assumed that it

is desired to place the lines of tile close enough together, so that after 6 days following an inch of rain the water shall nowhere stand within 3 feet of the surface, and that the tiles are placed 4 feet deep. Since in the sandy subsoil of the upper part of the

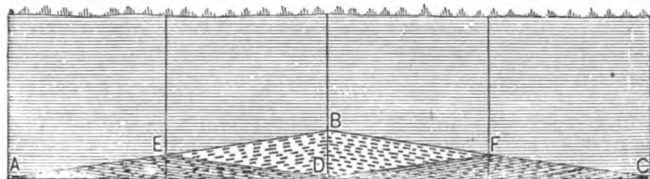

Fig. 139. Diagram of influence of distance between drains on depth of drainage.

field the mean gradient is 1 foot in 175, the lines of tile may, under such conditions, be placed twice this distance apart, or 350 feet, for then halfway between them the water would only stand 1 foot above the drains and hence 3 feet below the surface. But in the lower part of the field, where the soil is finer and where the observed mean gradient is 1 in 27, the lines of tile could only be placed 54 feet apart to ensure the same conditions.

It was pointed out, in connection with Fig. 133, that the slope of the ground water toward the lake was at the rate of 1 foot in 24.4 early in the season, and later 1 foot in 35.86 feet, which would call for placing the lines of tile 50 to 72 feet apart. Referring to the diagram, Fig. 139, it will be readily understood that when there is a drain at A and C only, the soil undrained must be highest at B, but if an

intermediate line of tiles is placed at D, then the highest levels of the ground water would be found at E and F, farther below the surface, leaving the field better drained. It is very important that this principle be thoroughly grasped, because so many local conditions affect the depth and distance apart at which drains should be placed that no specific figures can be safely followed in all cases. It is generally true that in loose, loamy soils, and especially if underlaid by sand, good drainage will be secured with drains 100 feet apart and  $3\frac{1}{2}$  feet deep. On heavier soils, they must be closer, and on more open ones they may be farther apart.

In regard to depths of drains, it should be understood that the deeper they are placed the better work they do as a rule. If one soil has had its non-capillary pores emptied to a depth of 4 feet, and another one only to a depth of 2 feet, the capacity of the former to store a heavy rain without oversaturation will evidently be greater than that of the latter, and hence the shallow drained fields will oftenest become over-wet in wet seasons. But the cost of digging 4 feet is much greater than  $2\frac{1}{2}$  feet, the expense increasing faster than in proportion to the depth.

In cold climates the tiles must be placed as deep as 2 feet, to prevent their destruction by frost. Tiles are laid at a depth of 18 inches, but the practice is not only unsafe so far as destruction of the tiles is concerned, but not half the advantage can then be secured which they are capable of giving if laid deeper.

## KINDS OF DRAINS

Drains are called closed or open, according as they are covered or not. There are conditions under which open drains or ditches should and must be used, but the closed forms are always to be preferred where thorough drainage and facility in working the land are desired. In the earlier practice of underdraining, before tiles were invented and manufactured on a large scale, various means were adopted to provide waterways through which the water could more readily drain away from the field. An early method was to place in the bottom of a ditch bundles of faggots end to end and then fill in, expecting the water to flow through the spaces between the faggots. Three slender poles were often used, one laid upon two others, thus forming a waterway; or again, a single larger pole was split in two and these laid in the ditch side by side with the flat faces up. Two boards nailed together V-shaped and laid on the bottom of the ditch formed still another method of securing underground drains with wood.

Stones were also used in various ways for the same purpose; sometimes the bottom of the ditch was filled with small stones and then covered; two rows of flat stones placed on edge to form a V opening downward, was another common plan. Two flat stones on edge, with a cover, were extensively used, and some even went to the trouble of paving the bottom of the ditch with flat stones and forming a closed stone drain by adding sides and top, which,

when well done, was permanent and effective. Square blocks of peat have been grooved on one face and two of these placed together to form a tile, thus making a drain of another kind. Each of these methods of securing underdrainage involved much labor; gave channels in which the water flowed with great resistance; clogged easily, and while beneficial results invariably followed their use, they were neither wholly satisfactory nor permanent.

When the manufacture of tiles from burned clay was begun, various shapes were adopted and abandoned for the present cylindrical type, which when well made and laid, has been found entirely satisfactory for the construction of closed drains.

In more recent years an effort has been made to build a continuous line of tiles in the bottom of the ditch after it is dug and graded, using a concrete made from the best hydraulic cement, lime and sand. The mortar, when made, is fed through a simple machine, which determines the size and shape of the tile, making it continuous, cylindrical and smooth on the inside. A trowel is used to cut the tile through to near the lower side with sufficient frequency to permit the necessary percolation from the soil, thus securing a drain with all joints perfect. The system, however, has not been sufficiently long in use to enable one to say how meritorious it is.

Open surface drains, where they are permanent improvements, should, if possible, be made wide and with sides so gently sloping as not to be washed, and, if possible, so as to be grassed over and driven through



The facts are, however, that there is so ready a movement through the walls of ordinary tiles themselves, and through the joints when they are made as perfect as possible, that every precaution should be taken in laying tiles to make perfect joints, in order that the silt and soil may be excluded, to prevent clogging the drain.

A series of observations on 2-inch Jefferson, Wis., tiles, relating to the rate of percolation through the pores in the walls, showed that under a pressure of 23.5 inches the discharge per 100 feet into the tile was at the rate of 8.1 cubic feet during 24 hours. This occurred when the walls were surrounded by water only. When the tiles were covered with a fine clay loam, so that water had to flow through 3 inches of this soil to reach the tiles, the discharge was reduced to the rate of 1.62 cubic feet per 100 feet of tile in 24 hours. It is plain, therefore, that with this porosity and with the openings at the joints, there is ample opportunity for the water to find its way into the drains after reaching them, and great pains should always be taken to make as close joints as possible.

The use of collars to keep sediment from entering the joints is not a good practice. They will not, as a rule, fit closely; they tend to encourage careless laying; they increase the first cost, and the soil, if it works under the collars so as to fill the space, will retard the entrance of water into the drain. Tile well made, with ends square and whole, if properly laid, make a sufficiently close joint.

fectly uniform fall for the whole main or the whole of any given lateral, and the greatest care should be exercised to lay the tiles perfectly true to the grade when that has been determined. When this is done, there is the least tendency for sediment to lodge and clog the drain.

It will not be possible in all cases to maintain a constant gradient, and when this is true it is best always to change from a less fall to one which is greater, because then any sediment which should be

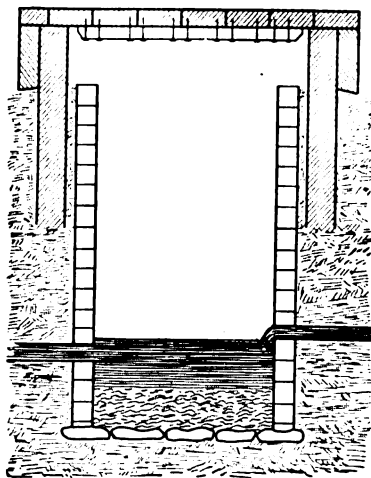

Fig. 140. Silt basin.

carried in the upper part of the drain will also be carried when the fall is increased; but with the reverse conditions the lower fall must have a tendency to cause the drain to become clogged.

Where a change from a larger fall to one less must be made, and the latter gradient is 3 inches per 100 feet or less, it will usually be prudent to place a silt basin where the change of grade occurs, as represented in

Fig. 140. The silt basin, if the line of tiles is short and small, may be made by sinking an 8-, 10- or 12-inch tile below the level of the bottom of the ditch, and then notching another section of the same size,

so that it may receive the drain from above and below. The sediment brought will then be dropped in the still water of the basin, and may be removed from time to time. To bring the silt basin to the top of the ground, it will be best to use one length of the glazed sewer tile, because this will not be injured by freezing. Where the line of tiles is large, and much sediment is likely to be moved, the silt basin should be dug larger and bricked up. Silt basins should be kept covered to avoid accidents, and especially in winter, to prevent injury to the tile by freezing.

#### SIZE OF TILE TO USE

It is not possible to give specific directions for selecting the sizes of tiles which are best, except where all the details regarding the field to be drained are known. It may be said, in general, that their capacity must be large enough to remove the excess of water of the heaviest rains which fall inside of 24 to 48 hours, but how much this excess may be will vary between wide limits.

If the tile are  $3\frac{1}{2}$  to 4 feet deep, and the soil has been depleted of its moisture by a heavy crop, the cases are very exceptional when even a rainfall of 2.5 inches in 24 hours would produce much percolation into the drains. It is the rains in the spring of the year which will most tax the drains, but it should be understood that so long as the water is moving quite rapidly through the soil it is sucking fresh air in after it, and there is little danger

to crops, and for this reason much smaller tiles are permissible than would otherwise be the case. It is when the ground water in a cultivated field becomes stagnant or stationary that poisonous principles are developed and suffocation for lack of air occurs.

The greater the gradient or fall of the line of tiles, the greater will be its capacity and the smaller it may be for a given area. The area of cross-section of tiles increases in the ratio of the squares of the diameters; thus for diameters of tiles of 2, 3, 4, 5, 6, 7, 8 and 9 inches, the areas will be 4, 9, 16, 25, 36, 49, 64, and 81 square inches, and hence, when running full with the same velocity, their capacities would be in the relations of the second series of numbers. The friction on the walls of the tiles, and the eddies which the joints and other inequalities tend to set up, reduce the velocity in the small tiles more than they do in the large ones, hence doubling the diameter of tiles considerably more than makes its capacity four times as great.

The longer the line of tiles the less it is able to discharge when running full, but just how much the capacity is decreased by the length cannot be simply or accurately stated.

In speaking of the proper size of mains, C. G. Elliott\* states: "For drains not more than 500 feet long, a 2-inch tile will drain two acres. Lines more than 500 feet long should not be laid of 2-inch tiles. A 3-inch tile will drain five acres, and should not be of greater length than 1,000 feet. A 4-inch

---

\* *Practical Farm Drainage*, p. 57.

between laterals is about 150 feet ; an effort was not made to secure perfect drainage, but rather so nearly sufficient for ordinary crops as to make the increase in yield pay a fair return for the money invested.

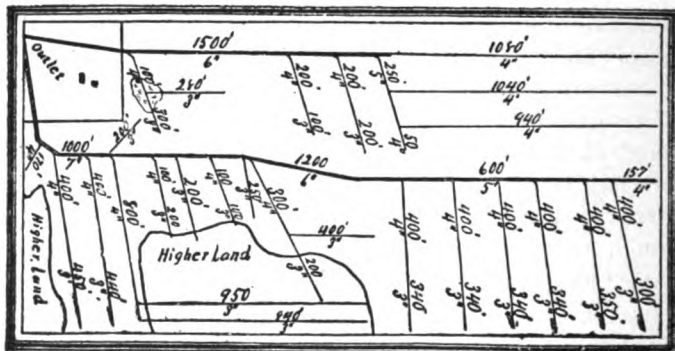

Fig. 141. Drainage system of 80 acres. Double lines represent mains ; single lines are laterals. Numbers give length of drains and diameter of tile. After C. G. Elliott.

The double lines represent the mains and sub-mains ; the single lines are laterals, and the numbers of three or more figures express the number of feet of each size used in the line against which they stand, while the single figures under these show the inside diameter of the tiles used.

It will be seen that the main begins with 1,000 feet of 7-inch tiles, carrying the water from 80 acres of flat land surrounded by comparatively level fields ; next follow 1,200 feet of 6-inch tiles, then 600 feet of 5-inch, the line closing with 157 feet of 4-inch tiles into which no laterals lead.

are also used for this purpose, but a section or two of the cast iron sewer pipe of the size of the main will be found better, because more durable.

Where the laterals are connected with the mains, an effort should be made to introduce the branch above the axis of the main, and where there is fall enough to permit of doing so the method used extensively in Europe

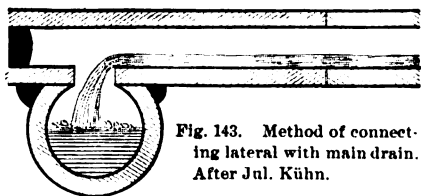

Fig. 143. Method of connecting lateral with main drain.  
After Jul. Kühn.

seems to be the best. This consists in perforating the top of the main and the bottom of the end tile of the lateral, placing the

two openings together, as represented in Fig. 143, but first closing the ends of the tile with a stone and ball of clay. This arrangement allows the lateral to empty itself completely into the main, and prevents it from becoming clogged with sediment by the setting back of water into it.

Where connection is made direct with the side of the main, it should be done by approaching at an angle down stream, as shown at C, Fig. 142, rather than as at D. This can be done, even if the lateral is at right angles to the main, by curving the ditch gently for a rod or more as the place of junction is approached. With this mode of joining, the least interference is brought about when the two currents unite and there is the least tendency to clog.

plete mat of fine fibers, which will fill the whole drain and by arresting the silt moving with the water, completely closes it. In Fig. 144 are shown two bundles of roots of the European larch which entered and completely choked a 6-inch main lying 5 feet below the surface, and where the trees were standing 15 feet away from the line. There are but few trees that will grow in such places which can be trusted near the drain, but the willow, elm, larch or tamarack, and soft maple are among the worst. It should be understood that so long as the water in the drain is flowing it is highly charged with air, and trees may even better immerse their roots in this than in the more stationary water between the soil grains, hence they do so wherever opportunity is offered, unless the water should be poisonous.

#### LAYING OUT SYSTEMS OF DRAINS

In preparing to drain a piece of ground of considerable extent, careful study should always be given to the best way of laying out the system so as to secure the greatest fall and the most complete drainage with the least digging and the smallest number of feet of tile at the lowest cost. To do this, care must be taken to avoid laying the lines so as to bring their influence within territory already sufficiently drained by another line; to make the outlets and junctions as few as possible; to avoid the necessity of the more expensive large sizes of tiles, and of digging more deeply than is required for good drainage.

In actual practice, it will usually be found that no single system, such as has been represented, can be used alone, but rather a combination of them in various ways growing out of the irregularity of slopes and surface conditions.

#### INTERCEPTING THE UNDERFLOW FROM HILLSIDES

Cases are not infrequent where seepage from the high lands surrounding a flat area approaches so close to the surface at the foot of the rising ground that a single line of underdrains placed here at a good

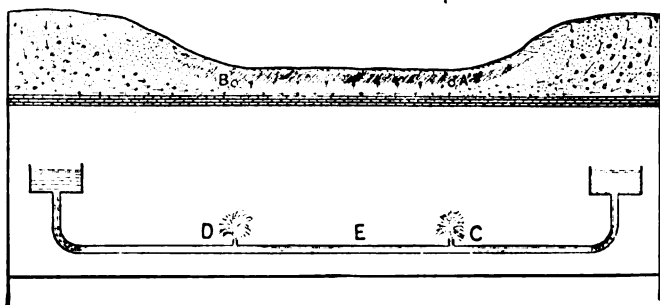

Fig. 147. Structural conditions producing swamp lands by underflow, and methods of intercepting the underflow.

depth will so completely intercept the underflow as to make little other draining needed. The structural conditions which render underdrainage in such cases needful, the method of accomplishing it, and the underlying principle, are represented in Fig. 147.

In this case the comparatively impervious rock bottom of the valley holds up the water and forces



it to spread laterally and to underflow the low ground through the sandy stratum covered by the closer textured layer above, and to rise up through that soil layer, both by hydrostatic pressure and by capillarity, and thus keep it too wet for agricultural purposes. But when tiles are placed at A and B, at the foot of the high lands on both sides, the water can more easily escape into the drain than it can flow on through the sand stratum, and the result is, the pressure which before was forcing the water beyond A to the left and beyond B to the right may now be so nearly all absorbed by the flow of water into the tile drains that no more water reaches the flat land between them than is needed to meet the demands of vegetation and surface evaporation. The case is exactly similar to what is shown in the lower portion of the diagram; here it is plain that if water is allowed to discharge at C and D nearly as fast as the pipes can bring it from the reservoir, there would be little left to pass on and escape through openings beyond, while if C and D are closed, the full pressure would operate to increase the discharge at lower openings, as at E.

#### DRAINING SINKS AND PONDS

It frequently occurs that low places are entirely surrounded by such high lands as to make it difficult to provide an outlet for the surface water which collects in them, especially during the winter and early spring, keeping them too wet for agricultural purposes.

Where the water collecting in such places is largely from surface drainage, it is frequently possible to reclaim them by intercepting the water and diverting it around the sink in the manner suggested in Fig. 148, where A B represents a surface ditch taking the water from the higher land above.

It is frequently true that such low places without natural outlets are underlaid with well drained beds of coarse sand and gravel, and in such cases, if the volume of water is not very large and if the bed of sand and gravel

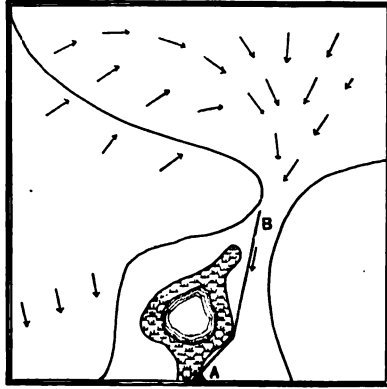

Fig. 148. Method of intercepting surface drainage. A, B, surface ditch.

beneath it is thick and only 10 to 15 feet from the surface, a well sunk into the sand and gravel and stoned or bricked up may serve as an outlet for under or surface drains.

Instead of curbing the well, it may be simply filled with loose stones to within 3 feet of the surface, covering these with smaller ones and finally with gravel and then sand, leaving the surface unobstructed.

Unless the approach to this drain is so gradual that there is no danger of fine silt being deposited over it, it would be better to have this in a shallow sink surrounded by a slightly higher border, grassed over

to hold back the water and throw down the sediment before reaching this place, as shown in Fig. 149, where a pit has been sunk into the porous gravel below and broadened at the surface to give more area for percolation through the finer material at the top. There are also represented lines of underdrains leading to the filter outlet, which might be needed in order to bring the land quickly into the best condition. If necessary, a line of such wells may be formed in a surface ditch or depression, and thus increase the capacity.

#### THE USE OF TREES IN DRAINAGE

In some instances where sinks without available outlets are to be drained, and where the method illustrated in Fig. 149 cannot be used, it is pos-

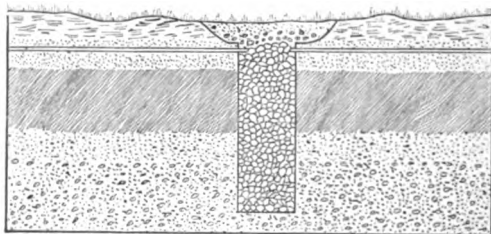

Fig. 149. Method of draining sinks.

sible to throw up lands of higher ground with deep, open ditches between them, in the lowest portion of the sink, into which the other ground may be drained, and then plant water-loving trees, like the willow or larch, on the sides of the ditches, where, by their

well, as in Fig. 150, into which the main drain, A, discharges, and from which there is an overflow, B, to the reservoir. The object of the well is to place the pump under conditions where it will not freeze in the severest weather, and thus prevent the ground from becoming over-saturated at any season. The water may be made to discharge through an under-ground drain connected directly with the pump, as at C, or a flume-box above ground may be used, as is most convenient.

It might even be practicable to have this drainage water discharged into a reservoir and used for irrigation at a lower level during the dry season of the year, or it would be practicable to discharge it into a series of tiles laid 2 feet below the surface on a section of higher ground which is naturally well drained, and thus sub-irrigate this at the same time the low place is being drained, the two systems caring for themselves continuously.

#### LANDS WHICH MUST BE SURFACE DRAINED

There are many ancient lake bottoms now constituting wide stretches of very flat country underlaid by heavy deposits of a very close lacustrian clay, through which water percolates with extreme slowness. Such lands must generally be surface drained, not only because it is difficult to find adequate fall for proper outlets for underdrains, but because the water would not reach underdrains quickly enough to meet the demands of crops unless the lines were laid closer together than could be afforded.

underdrains, and the small squares cover 40 acres each.

Another drainage system of this sort in the same state is found in Mason and Tazewell counties, where by a coöperative plan the open ditches have been dug

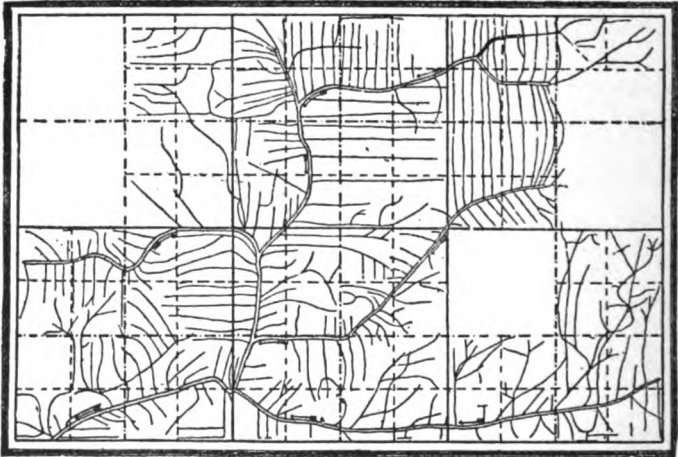

**Fig. 151.** Plan of drainage of lands of the Illinois Agricultural Company, Rantoul, Illinois. After J. O. Baker. The smallest squares are 40 acres; double lines show open ditches; single lines are tile drains.

and the expense divided among the landowners in proportion to the benefits derived. The work was begun in 1883, completed in 1886, and has 17.5 miles of main ditch 30 to 60 feet wide at the top and 8 to 11 feet deep. Leading into these mains there are five laterals 30 feet wide at the top and from 7 to 9 feet deep, the whole system embracing 70 miles of open ditch, excavated for the express purpose of providing outlets for underdrains after the manner of Fig. 151.

So true is this, that a good drainage engineer employs his men by the season or longer, if possible, and divides his work among them in such a way that each man does only one kind of digging. In this way each one becomes an expert in his place, doing more and better work with less effort than is possible in any other way. The man who finishes the bottom of the ditch and the man who lays the tiles must not only be skillful, but must be thoroughly trustworthy and patient, or faulty work will be done. The work is often so unpleasant, defects are so easily covered from inspection, and it will be so long before they could be discovered and the responsibility properly placed, that only men of peculiar fitness should ever be trusted with it. These men must be well paid, they must not be crowded, and there must be nothing else to take their attention. When the right sort of man has been secured for this work, and has been trained to it, he is far more to be trusted than almost any farmer, even for whom the work is to be done, because the farmer will have so many other things to take his attention, and he will be so anxious to have the job off his hands, that his patience will not permit him to take the necessary time to get every joint of the 100,000 *just right* before it is left. Important drainage work, then, should be left to expert men wherever practicable.

It is very important that the farmer who has land to drain should thoroughly appreciate these essential conditions for safe work, not only to prevent himself from undertaking what he cannot hope himself to do

well, but, what is more important, that he may be able to recognize the essential qualities in the man who will place the tiles, and satisfy himself that he possesses them.

It will often happen, however, that drainage experts cannot be had, and there may be small areas to drain, involving relatively but small expense, where the farmer may do his own work or supervise it.

#### METHODS OF DETERMINING LEVELS

Where the services of a man with instruments for determining levels for lines of drains cannot be had, there are various simple means for doing this work which may be employed where great accuracy is not required, and among these perhaps the safest is the water-level, represented in Fig. 152. This may be made of  $\frac{3}{4}$ -inch gas pipe, with two elbows and a T, as shown in the sketch, the standard being sharpened by a blacksmith or by inserting a wooden point. In the two elbows, which are about four feet apart, there are cemented short pieces of glass tube, or slender phials,  $\frac{1}{2}$ -inch in diameter; with the bottoms broken out, and provided with corks. To use the instrument, the tube is filled with water colored with bluing or ink, so as to show in the two tubes of glass, when the arm is horizontal. By forcing the foot

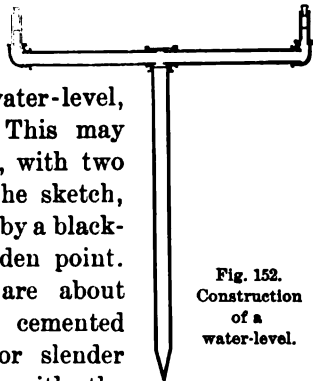

Fig. 152.  
Construction  
of a  
water-level.

and there will be errors in deciding when it is set exactly, whereas the water-level can never be in error, and automatically adjusts itself at once, the only chances for error being in taking the sights. Other forms of drainage levels are represented in Fig. 153.

#### LEVELING A FIELD

If the field has but small fall, and is quite flat and even, so that the inexperienced eye fails to detect the direction of greatest slope, it will usually be safest to check it into squares of 50 or 100 feet, driving short stakes at the several corners, whose elevations may then be determined. To do the leveling, set the instrument at *a*, Fig. 155, midway between stations I-1 and I-2, having first provided a notebook, ruled as indicated in the table below. Turning the level first upon I-1, its distance below the instrument is read on the target-rod held upon that stake, and the result, 4 feet, is recorded in the table in the column headed "back-sight." The instrument is next directed to I-2 and its distance below the level found to be 3.8 feet, which shows that its elevation must be

$$4 \text{ ft.} - 3.8 \text{ ft.} = .2 \text{ ft.}$$

above that of station I-1. This reading of the target-rod is entered in the column headed "fore-sight." In the column headed "Elevation" the first station is given arbitrarily a value of 10 feet, as is customary to avoid minus signs, and on the same plan station



I-2 will have an elevation of 10.2 feet, as stated in the table.

*Table giving data obtained in leveling field, Fig. 156*

Station	Back-sight	Fore-sight	Difference	Elevation
I-1	4			10
I-2	4.2	3.8	.2	10.2
I-3	3.8	4	.2	10.4
I-4	4	3.6	.2	10.6
I-5	3.9	3.8	.2	10.8
I-6	4	3.7	.2	11
II-6	3.8	3.98	.02	11.02
II-5	3.9	3.995	.195	10.825
II-4	4	4.095	.195	10.63
II-3	4.1	4.19	.19	10.44
II-2	3.9	4.26	.16	10.28
II-1	3.8	3.98	.08	10.2
III-1	4	3.6	.2	10.4
III-2	3.9	3.96	.04	10.44
III-3	4.2	3.775	.125	10.565
III-4	4.1	4.045	.155	10.72
III-5	3.8	3.93	.17	10.89
III-6	4.1	3.625	.185	11.075
IV-6	4	4.185	.085	11.16
IV-5		3.84	.16	11

The level is now moved to *b* and the distance of I-2 below it again measured and found to be 4.2 feet, which is entered in the notebook under "back-sight," and the instrument turned upon I-3, where the reading is found to be 4 feet, and entered in the table. The difference between the fore- and back-sights, placed in the column headed "Difference," shows how much higher one station is than another, and when the first is added to the elevation above datum, 10

## LOCATION OF MAIN DRAINS AND LATERALS

After the notes of the field leveling have been obtained, and the elevations computed from them, these may be transferred to a diagram of the field, as

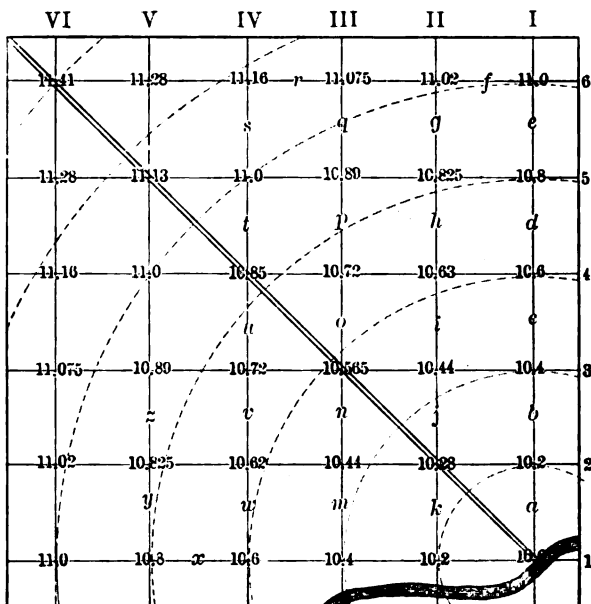

Fig. 155. Leveling for a contour map of field to be drained.

in Fig. 155, where they will show at a glance the slope of the surface, and where the mains must be placed in order to secure the greatest fall, both for them and for the laterals. It will be seen that station VI-6 is the highest point in the field, while I-1 is the

lowest, and that if a straight main were laid through these two points it would be given the course along which surface water would naturally flow, which is also the direction of steepest slope.

The dotted lines in the figure are contours, or

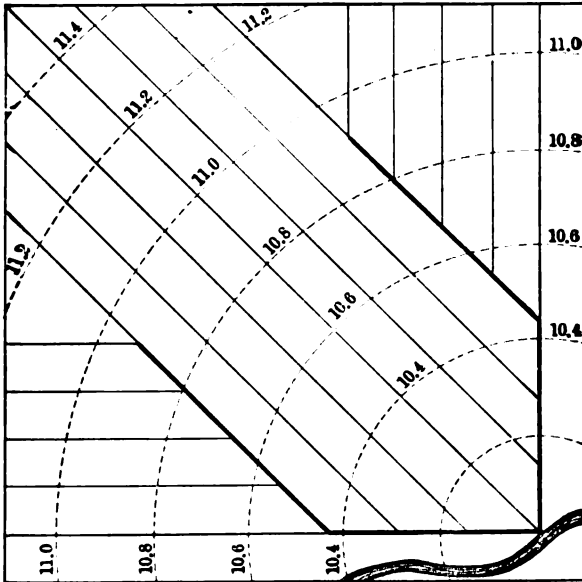

Fig. 156. Arranging drains to secure the maximum fall.

lines of equal elevation, and as in this case these are circumferences of circles with centers at station I-1, it is clear that the shortest distance between any two contours will be measured along their radii, and hence, that there also will be the greatest fall. Since the diagonal line from VI-6 and the lines I and 1

are each a radius of a circle from the same center, I-1, the fall along each will be the same, namely, 2.4 inches per 100 feet; hence, to drain this piece of land, three mains may occupy the positions of these three lines, meeting at station I-1. But if laterals are to be placed 100 feet apart, these could be given about as great a fall if they were to connect with the diagonal as a main, and take the positions indicated by the two right-angle systems of lines in Fig. 155, I, II, III, IV, V, representing laterals on the upper side of the main, and 1, 2, 3, 4, 5 on the lower. If, however, drains were to be placed 50 feet apart, then the most rapid fall could be secured and the least amount of tile would be required, by arranging the laterals as shown in Fig. 156, where the same area is represented with the contour lines drawn 100 feet apart horizontally and .2 foot vertically, as they are also in Fig. 155, and where the heavy ruling represents main drains and the light ones laterals.

#### STAKING OUT DRAINS

When the location of mains and laterals has been determined, the next step in the practical work is staking out the drains. There are various methods of doing this, but one of the best is as follows: Short stakes, about 8 to 10 inches long, called grade pegs, are provided, and another set upon which records can be made with lead pencil, longer than the others, and called finders. With a tape line or chain and hatchet, the work begins by laying off along the main, begin-

or 2.88 inches per 100 feet, it will be necessary to place the bottom of the tile, at 600 feet from the outlet,

$$6 \times .24 = 1.44 \text{ feet}$$

higher than the outlet; that is,

$$7 + 1.44 = 8.44 \text{ feet}$$

above datum plane; but as the surface of the ground at the 600-foot station is 11.36 feet above this plane, as given in the table, it is clear that the ditch must be dug at this place

$$11.36 - 8.44 = 2.92 \text{ feet}$$

deep, as written on the finder stake in Fig. 157, and as given in the table of field notes in the column headed "depth of ditch."

Since the grade line rises .24 foot per 100 feet and .12 foot per 50 feet, the data in the table under "grade line" are obtained by adding .12 foot to 7 feet, the distance of the outlet above datum, for the 50-foot station; twice .12 foot to the second or 100-foot station, etc.

The numbers in the column of differences are obtained by subtracting the front-sight from the back-sight, taken with each setting of the level, and these differences, added to the height of the lower station, give the elevation of the higher station above datum plane, thus:

$$4 - 3.87 = .13 \text{ feet};$$

and this amount, added to the height of the back-sight station, gives

$$10 + .13 = 10.13 \text{ feet}$$

as the elevation of the 50-foot station, and subtract

ing from this elevation that of the bottom of the proposed ditch at this place, there is obtained

$$10.13 - 7.12 = 3.01 \text{ feet,}$$

or the depth which the ditch must be dug at this station, and it is the custom to write these depths on the finder stakes, to serve as the guide to the ditchers in digging, as represented in Fig. 157.

These values are given in feet and hundredths rather than in feet and inches, because it is much simpler to make the calculations in this way. The target-rod should be made to read in this way rather than in feet and inches, and if the farmer makes his own this may readily be done by first dividing the rod into feet and then, taking a pair of dividers, set them so as to space off ten equal divisions within each foot. The tenths of a foot may then be subdivided in the same manner into ten equal divisions, or hundredths of a foot.

Where a level without a telescope is used, the measuring rod should be provided with a sliding target, as shown in Figs. 153 and 158, which may be moved up and down by the target man, as directed, to mark the elevation indicated by the instrument. The best target is provided with an opening in front of the rod, which permits the figures to be seen at the junction of the cross lines of the target.

In taking the elevations, the target-rod should always be set upon the grade peg, and all subsequent measurements in digging should also be made from these pegs, which are driven in flush with the surface,

greater stiffness, and to permit them to be thin and light. The solid blade gives better satisfaction generally than the other form shown in the cut.

Besides the spade, there must also be the tile hoe, or scoop, for cleaning out and grading the bottom of

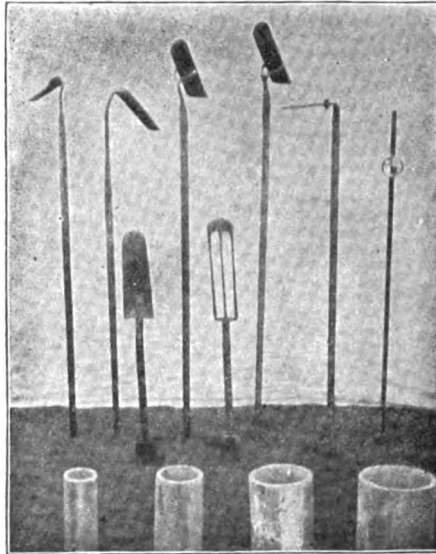

Fig. 158. Some drainage tools.

the ditch, fitting it for the tile, different widths being used for different tiles, as shown in the cut. Some of these scoops are made with adjustable handles, permitting the blade to be set at any desired angle, so as to be used from the last spading of earth in the ditch or from the top.

When digging begins, a strong line is stretched about 4 inches back from the side of the ditch and a narrow cutting made, seldom necessarily more than 12 inches wide, as shown in Fig. 159, the effort being to remove as little earth as possible. The sides are cut true to line to begin with, and maintained so to the bottom, in order that a straight bed may be finished to receive the tiles. When the ditch is deeper than 4 feet, it is necessary to make it a little wider at the top but not much, as will be seen in Figs. 160 and 161, where the first shows the men in line cutting a ditch 4.5 to 5 feet deep, while the second figure shows another man following with the tile hoe, working from the top, cleaning out the bottom and bringing it to grade line. The line which is seen in Fig. 161, stretched along the ditch, is placed parallel with the grade line some whole number of feet above it, and is used by the man to measure from when finishing the bottom. The line is a slender but strong cord, which may be stretched tightly, so as not to sag. In the case in question, the man determined his depths with the measuring rod in the foreground, his long experience enabling him to dispense with a sliding arm, which is generally used, forming a right angle with the rod and long enough to reach the grade line. In Fig. 162, the last man is using the tile hook, shown second from the right in Fig. 158, to lay the tile in place. This ditch, although for 6-inch tile, laid 4.5 to 5 feet deep, is scarcely more than 15 inches wide at the top, as the length of the tile placed across the ditch for a scale shows.



These men never get into the bottom of the ditch, and yet the tile are laid with great accuracy and turned about with the hook until close fitting joints are secured.

It is preferred by some to lay the tile by hand, the operator standing on the tile, which are covered with earth 4 to 6 inches deep as rapidly as placed, using the wet clay last thrown out, or some taken from the side of the ditch, which is thoroughly worked in about the tile, care being taken not to get them out of alignment. By whatever method the tile are laid, the greatest care must be observed in securing close joints and in covering them, to see that they do not become displaced.

The work should begin at the outlet with the laying of the main, and proceed backward to the first lateral, when this should be started and the junction made at once, laying two or three tile of the lateral before proceeding further with the main. If junction tile are not used, the opening through the walls for the connection is made with a small tile pick with a sharp point, and great care should be taken to make a close connection by shaping and fitting both pieces together and covering the joint with stiff clay, well packed about it.

If for any reason the line of tile is left, as at night or over Sunday, the open upper end should be plugged with a bunch of grass or covered with a board, to prevent dirt being washed into the line in case of rain. When the end of the line is reached, the opening of the last tile should be closed with a brick or stone.

It is very important to get the dirt well filled in about the tile and at the same time well packed, in order that large open water channels may not exist through which streams of water may flow in sufficient volume to carry silt into the tile through the joints, and also in order that open channels may not exist outside and under the tile along which streams may gather and flow. The clay soil, usually last taken out of the ditch, is the best for this purpose.

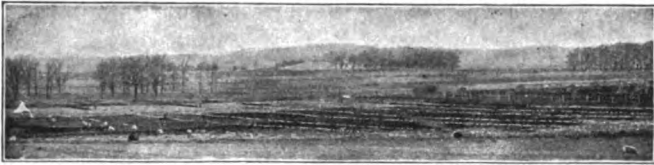

Fig. 163. The start and finish of tile draining.

Various methods of filling the ditch, after the first covering of the tile, are in use, and Fig. 163 represents one, where a plow is drawn by a team working

on a long evener. Where a road scraper is available, this makes a good tool for finishing up with after the line is filled enough to cross with the team. Another method of filling, where the work is done by hand, is to tie a rope to the handle of a broad scoop, which is worked by a man across the ditch, while another guides the shovel as though not assisted by the man with the rope. In this way the dirt is filled in rapidly.

Still another method is to use a team on a wide board scraper provided with handles, drawing it toward the ditch, the team being attached by means of a long rope and working on the opposite side of the ditch, the filling being done by driving forward and then backing, the man holding the scraper pulling the tool back.

When quicksand is encountered in laying tile, it may be necessary to brace the sides of the ditch to prevent caving, when digging. This may be done by driving sticks in between two pieces of board, thus holding them against the opposite sides of the ditch. It is occasionally true that the bottom is so soft from quicksand that the tile cannot be laid to grade, and in such cases a fence board may be placed on the bottom and the tile laid upon this. In other cases the ditch may be dug a little below grade line, and the bottom covered with clay, if that is available, so as to form a foundation upon which to place the tile. It will sometimes be true that a quicksand spot will become sufficiently firm to lay across if it is permitted to drain three or four days,

and the level of the ground water be thus lowered. The reason for this is that the quicksand character is due to the water being forced up through the fine sand, which has little adhesion between its grains, and the water tends to float the sand, thus causing it to run with unusual freedom; but when the water is given time to drain away, so that the sand is no longer full of it above the bottom of the ditch, it becomes firm, and the tile may then be laid.

#### COST OF UNDERDRAINING

It is not possible to give the cost of draining land without knowing all of the details which go to make up the total expense; but certain general statements may be made, which will enable any one to compute for himself what the cost is likely to be.

In the case represented by Figs. 159 to 163, the work was done by a professional drainage engineer at an average cost of \$3 per 100 feet for digging and laying the tile, and 30 cents per 100 feet for filling the ditches, thus making the labor after the tile had been placed upon the ground \$3.30 per 100 feet, including the board of the men. The ground drained in this case was such as to represent about average conditions, where the spade may be readily put into the soil with the pressure of the foot, where no stones or quicksands are encountered, and where the main has a depth of 3 to 5 feet, and the laterals an average depth of 3 feet. In the case represented in Fig. 141, Mr. Elliot gives the cost of the different items as expressed in the table which follows:

*Irrigation and Drainage**Cost of main drains per 1,000 feet*

No. of feet	Size	Depth	Tile	Digging, laying and filling	Total	Cost per rod
1,000	7 in.	5 ft.	\$60.00	\$37.20	\$97.20	\$1.60
2,700	6 in.	5 ft.	40.00	36.60	206.82	1.26
850	5 in.	4 ft.	30.00	24.20	46 07	.89

*Cost of lateral drains*

8,280	4 in.	3.5 ft.	\$20.00	\$20.00	\$331.20	\$0.66
7,030	3 in.	3 ft	13.20	20.00	233.40	.55

Total . . . . . \$914.69

It will be seen from this table that the cost of draining 80 acres, as represented in the figure, averaged \$11.43 per acre where everything was counted. It will be seen that the cost of mains was from two to three times as much as laterals of 3-inch tile, and hence, that the larger and longer the mains must be made the more expensive relatively the draining will be.

*Cost of mains per 100 feet*

	Depth of ditch	Cost of digging and laying	Cost of tile	Cost of filling ditch	Total cost per 100 feet
5-inch	3 feet	\$1.50	\$3.00	\$0.30	\$4.30
	4 feet	2.00	3.00	.42	5.42
	5 feet	3.00	3.00	.60	6.60
	6 feet	4.50	3.00	.75	8.25
6-inch	3 feet	1.50	4.00	.30	5.80
	4 feet	2.10	4.00	.42	6.52
	5 feet	3.00	4.00	.66	7.66
7-inch	6 feet	5.10	4.00	.78	9.88
	3 feet	1.80	6.00	.36	8.16
	4 feet	2.40	6.00	.48	8.88
8-inch	5 feet	3.00	6.00	.72	9.72
	6 feet	5.70	6.00	.90	12.60
	3 feet	1.92	8.50	.42	10.84
	4 feet	2.58	8.50	.54	11.62
8-inch	5 feet	3.90	8.50	.78	13.18
	6 feet	6.00	8.50	1.00	15.52

We quote this table regarding the cost of mains, as estimated by Mr. Elliot, where the price paid for good ditchers is \$2 per day; but in this estimate the board of the men is not included, neither is the cost of hauling the tile from the station to the field.

This same writer estimates the cost of 3-inch laterals, placed 3 to 3.5 feet deep, at \$2 per 100 feet for the digging, laying and filling, and tile at the present writing would add another dollar, making \$3 per 100 feet, not including board or hauling the tile.

The cost per acre will, of course, vary with the distance between lines of tile, and will increase very nearly in proportion to the number of feet of tile used.

#### PEAT LANDS

There are many marshes underlaid by beds of peat not yet well rotted; peat so free from silt and so fibrous in texture that when dry it could be used for fuel. Where fields are underlaid by such beds having a depth of three or more feet, they are not likely to become at once productive if well drained. On the other hand, where the peat deposit is only from 6 to 18 inches deep, there are likely to be better returns from thorough drainage.

In the first class of cases referred to, underdraining is not usually to be recommended as the first step toward improvement. The difficulty lies in the fact that when peat beds are drained they shrink greatly in volume, thus lowering the surface in a

marked degree, and if underdrains were laid at once, the lines of the tile would ultimately be found too close to the surface. It is, therefore, usually better in such cases to drain first with open ditches, placing them where ultimately they may be deepened and converted into underdrains. The surface ditching will dry out the marsh to a considerable extent, and permit the needed decay and shrinkage of the peat to take place, although several years may be required for this.

If the peat is very coarse and thick, and if little vegetation grows upon it, it may be well to burn it over several times when not too dry, in order to increase the silt and ash in the soil and to hasten the shrinkage. The ash thus formed will so much improve the texture of the surface as to very materially assist in getting a crop started upon the area.

It is very important to get a crop started upon the soil as soon as practicable, because this greatly facilitates and hastens the rate of decay. This should be done, even though it may not be remunerative in any other way than that of improving the texture of the soil.

## INDEX

- Acre-foot, 230.  
Acre-inch, 230.  
Aërmeter, windmill, 313; pump, 316.  
Air, in the soil, 7, 182; humidity, 40, 41.  
50; required by clover, 49; by corn, 185; interferes with percolation, 333; need of in soil, 182, 370, 418; lack of in puddled soil, 334; changes in temperature and pressure influence ventilation, 420.  
Alfalfa, roots, 233; irrigation, 237, 346, 348; utilizing waste water, 379.  
Algeria, irrigation, 85, 238; duty of water in, 212; artesian wells, 85.  
Alkali, composition, 278; accumulation, 223, 266, 270, 272, 274, 284; cause of injuries, 270, 416; accumulation by intensive farming, 274, 284; amounts injurious, 275, 278; develops soonest in clay soil, 286; correction by land plaster, 280, 284, 287; distribution in soil, 282; influenced by tillage, 284; influenced by roots, 284; cause of abandonment of ancient irrigation systems, 289; geographical distribution, 272; formed by canal seepage, 294; soils which soonest develop alkali, 286; cause of puddling, 335.  
Alkali lands, 269, 416; alum spots, 269; soluble salts, 260, 276; character of vegetation, 281; land plasters, 280, 284; improvement by drainage, 223, 284, 288; ultimate remedy drainage, 288.  
Alkali salts, 266; kills barley, 276; see Alkali.  
Alkali water, unsuitable for irrigation, 266, 284, 285; correction before use, 287.  
Alum spots, 269.  
Animal power for irrigation, 328.  
Ants, work in soil ventilation, 419.  
Apple, roots, 231.  
Argentina, irrigation, 87.  
Arid climate, efficiency of rainfall, 4, 104; accumulation of alkalis, 272.  
Armenia, irrigation, 84.  
Artesian wells, in Sahara, 85; in Hawaii, 86.  
Assyrian irrigation, 67.  
Australia, irrigation, 81.  
Austria-Hungary, irrigation, 75.  
Baker, J. O., 466.  
Barker, F. C., 236.  
Barley, water used, 21, 24, 34, 46, 235; available rainfall, 124; yield, 129; yield increased by irrigation, 110; second crop, 130, 179; number of irrigations, 235; on alkali lands, 276.  
Barrens, 114.  
Basin irrigation, 387, 390; Egypt, 288.  
Bavaria, irrigation, 76.  
Bear valley dam, 302.  
Belgium, water-meadows, 362.  
Blackberry irrigation, 383.  
Black marsh soil, mulches, 201; alkali, 269, 273; vegetation, 281.  
Boussingault, 49.  
Breathing of plants, 47, 182; pores, 51.  
Bucket pump, 316, 319, 325.  
Busca canal, 210.  
Cabbage, irrigation, 387; yield increased by irrigation, 110; effect of supplementing rainfall in Wisconsin, 175.



- Canal, ancient, 67; Busca, 210; Ceylon, 81; Doab, 80; Egyptian, 68; Euphrates, 68; Forez, 72; Gattinara, 210; Great Imperial, 71; Ganges system, 80; India, 79; Indus valley, 81; Ivrea, 209; West and East Jumna, 80; Kern Island, 292; Nahrawan and Dyiell, 69; Nira, 78; Santa Ana, 297; Sirhind, 291; Soane circle, 80; cement, 300, 412; dangers, 295; sewage, 410, 412; stone, 410.
- Canvas dam, 339, 341, 355.
- Cape Colony irrigation, 85.
- Capillary spread of water, 161, 330, 375.
- Capillarity, rate in sand and loam, 148.
- Carbon dioxide, consumed by clover, 49; possible insufficiency in close planting, 185; in soil ventilation, 419; consumed by maize, 185.
- Carpenter, L. G., water-meadows, 210; seepage from reservoir, 323; water divisor, 245.
- Catch crops, 152.
- Celery, irrigation, 385.
- Ceylon, irrigation, 81.
- Checks, 345, 348, 350.
- Check ridges, 346, 348.
- Child, J. T., 83.
- China, irrigation, 71, 82.
- Chinese irrigation, 387.
- Clay soil, develops alkali, 286.
- Climate, arid, 4, 104; for irrigation practice, 89; for sewage irrigation, 404; rainfall needed for humid and subhumid, 121.
- Clover, water used, 24, 34, 36, 41, 46; irrigation, 110, 130, 179; on sandy soil, 169.
- Colmatage, 94, 261.
- Corn. See Maize.
- Cotton, duty of water, 211.
- Craigentenny meadows, 16, 92, 254, 403.
- Cranberries, duty of water, 220; irrigation, 365.
- Cranefield, F., irrigation with cold water, 251.
- Crops, yields, 125, 126, 174, 175, 177, 179, 187, 190, 216; for sewage irrigation, 409, 411.
- Cucumbers, irrigation, 388.
- Cultivation. See Tillage.
- Cultivator, orchard, 381; potatoes, 354.
- Croyden, sewage irrigation, 411, 412, 413.
- Dam, submerged, 305; canvas, 339, 341, 355; Bear valley, 302; Vir weir, 78.
- Deberaln, 276.
- Delaware river water, 252.
- Denitrification, 334, 370; in sewage, 403; lessened by drainage, 420.
- Denmark, irrigation, 75.
- De Vries, 277.
- Divisors, 244.
- Ditches, depth and grade, 477; bringing to grade, 484; digging, 481; commencing and finishing, 483; filling, 487.
- Doon, for lifting water, 328.
- Drainage, principles, 415; influence on fertility, 13; remedy for alkali lands, 284, 288; made necessary by seepage from canals, 295; of water-meadows, 360, 364; of cranberry marshes, 366, 368; rice fields, 369, 371; necessity, 416; ventilates soil, 418, 419; lessens denitrification, 420; increases available moisture, 13, 422; makes soil warmer, 423; where needed, 428; sinks and ponds, 460; intercepting underflow, 459; intercepting surface water, 461; use of trees, 462; use of windmill, 463; levels, 470; tools, 482; peat lands, 491.
- Drainage levels, 470; use, 471, 473, 477.
- Drainage, surface, 464, 466.
- Drains, depth, 436, 442; distance apart, 437, 439; used in sub-irrigation, 400; entrance of water, 438, 445; kinds, 443; rate of entrance of water, 446; use of collars, 446; fall or gradient, 447; size of mains, 450, 452; size of laterals, 450, 452; outlets, 453; obstructions, 455; laying out systems,

- Gasoline engine, 305, 324, 393; cost of running, 324.
- Gasparin, ratio of grain to straw, 96; salt in soil, 276.
- Gennevilliers, sewage irrigation, 389, 411; model gardens, 408; sewage hydrant, 410; stone canal, 410; healthfulness, 413.
- Gipps, F. S., 66.
- Goff, E. S., irrigation of strawberries, 181; depth of roots, 231.
- Goodale, G. A., 51.
- Goss, Arthur, 253, 259.
- Grade pegs, 478.
- Grader, 350, 351, 352.
- Grading for irrigation, 346, 348, 351.
- Grain, irrigation, 340, 342, 344, 346; dry farming, 103; harrowing and rolling, 146; thin seeding, 163; duty of water, 198.
- Grapes, roots, 232; frequency of irrigation, 238.
- Grass, observed yields, 127; on sewage meadows, 92, 400; on water-meadows, 219; irrigation, 340, 342, 346; in lawns and parks, 392.
- Gravel, silted, 263.
- Greeley, Colorado, irrigation of grain, 340; potatoes, 354.
- Green manure, 151.
- Ground-water, origin, 429; relation to surface, 431, 435; lines of flow, 432, 438; discharge into streams, 433; gradient, 435; changes in level, 440.
- Growth of river, 433.
- Grunsky, C. E., 292, 349.
- Hall, Wm. H., 211.
- Hare, R. F., 253.
- Harrington, M. W., 99.
- Harvey, F. H., 309.
- Hawaii, irrigation, 86; duty of water for sugar cane, 214.
- Hay, yields, 127, 178; need for irrigation, 128; second crop, 130, 179; duty of water, 215.
- Hazzard, W. M., rice irrigation, 238.
- Health, influence of sewage, 256, 295.
- Hellriegel, 96. [413.]
- Hilgard, E. W., peculiarities of arid soils, 6, 229; alkali lands, 269, 276; composition of alkali salts, 278; land plaster for alkali lands, 280, 284; roots in arid soils, 6, 229.
- Hinton, R. J., 78, 81.
- Hollis, Geo. S., 85.
- Humidity of air, 40, 44, 50.
- Hunter, intertillage, 157. [410.]
- Hydrants, distributing, 301; sewage.
- Hydraulic rams, 310.
- Inch, acre, 240; miner's, 241. [291.]
- India, irrigation, 77, 328; Sirhind canal.
- Insects, destroyed by irrigation, 218, 221.
- Intertillage, 157.
- Irrigation culture, 66.
- Irrigation, antiquity, 66; extent, 72; objects, 91; climatic conditions, 89; frequency, 107, 212, 223, 234, 236; insufficiency of water, 117; amount of water, 106, 208, 212, 213, 214, 236; late crops difficult to grow without, 129; increase of yield in humid climates, 171; closer planting possible, 181; tillage as a substitute, 117; character of water, 248; temperature, 248; number of irrigations required, 235; fertilizing value, 251; supplying water, 290; methods of application, 329; sewage, 403.
- Italy, irrigation, 71, 359; duty of water, 209, 219; water-meadows, 219; marcite, 219; sewage, 220.
- Ivrea canal, 209.
- Japan, irrigation, 82.
- Java, irrigation, 86.
- Kansas, yields of grain, 103; rainfall, 103.
- Kern Island canal, 292.
- Kühn, Jul., 454.

- Land plaster, for alkalies, 280, 284, 287.
- Laterals, subdivision, 223; length and size, 452; outlet, 454; junction, 464; cost, 490.
- Lawn, irrigation, 391; cost of plant, 393; method, 395.
- Laveleye, E., 75.
- Leaching, 222; may assist nitrification, 12; prevents alkali, 223, 284, 288; necessary, 275.
- Leveling, methods, 471, 473, 477.
- Levels, methods, 469; instruments, 470.
- Lois Weedon, system of intertillage, 157.
- Lombardini, 260.
- Lombeck, irrigation, 87.
- Lettuce, irrigation, 385.
- Lew Chew, irrigation, 83.
- Loughridge, R. H., 229.
- Madagascar, irrigation, 86.
- Madeira, irrigation, 86.
- Maeris, Lake, 66.
- Mains, 451, 457; size, 451; length, 452; cost, 490.
- Maize, water used, 21, 24, 38, 39, 41, 46, 60, 177, 234; flint and dent, 40, 184; roots, 61, 160; yields and rainfall, 109; yield increased by irrigation, 110, 177; observed yields, 126, 177, 190; variation of yield with soil moisture, 144; rain of growing season, 124; maximum limit of yield, 187; need for air, 182, 185; close planting, 184, 193; yields with varying closeness of planting, 190; duty of water, 211, 215; frequency of irrigation, 235.
- Mangon, water on water-meadows, 219.
- Marcite, 219.
- Markus, E., duty of water, 203.
- Meadows, water, 16, 92, 219, 251, 359; Craigentiny, 16, 92, 254, 403; English, 76, 360; Italian, 362; Belgian, 362; mountain, 365; marcite, 219; duty of water, 219; sewage, 220, 254; mulching, 146; irrigation, frequency, 237.
- Measurement of water, 239; units, 239; methods, 241; by time, 242; subdivision of laterals, 243; with divisors, 244; modules, 245.
- Melons, irrigation, 388.
- Milan, sewage irrigation, 220.
- Milk, from sewage grass, 256.
- Miner's inch, 241.
- Mississippi, annual discharge, 117.
- Modules, 245; spill-box, 245.
- Mulches, 145; of soil, 142; effectiveness in arid climates, 104; lose effectiveness, 145, 164; for meadows, 146; influence of depth, 147, 206; vary with kinds of soil, 201; production after irrigation, 381.
- Neerpelt, water-meadows, 362.
- Newell, F. H., irrigation, 88; dry farming, 102; run-off, 119.
- New Jersey, water analyses, 252.
- New Mexico, frequency of irrigation, 238.
- Nile, irrigation, 67, 84, 262, 288; daily discharge, 85; delta, 68; sediment in water, 260.
- Nitrates, in artesian waters, 85; in river water, 252; in sewage, 404.
- Nitrification, in arid soils, 7; needs water, 11; influenced by drainage, 13, 420; effect of tillage, 149, 163, 165; needs oxygen, 183, 334, 370, 418.
- Nitrogen-fixing tubercles, 233.
- Oats, water used, 21, 24, 31, 41, 46; rain of growing season, 124; yields, 126; water needed, 215.
- Oranges, frequency of irrigation, 238; furrow irrigation, 374.
- Orchards, irrigation, 338, 373; frequency of irrigation, 238; ring furrows, 380; cultivator, 381; cultivation, 381, 383; sub-irrigation, 398.
- Osmotic pressure, 63.
- Pascottah, 327.
- Palms, irrigation, 85.

- Park irrigation, 391.  
 Peas, water used, 46.  
 Peat lands, 491; warping, 262.  
 Percolation of water, 225; through sand, 113, 205; on duty of water, 203; through shrinkage cracks, 227; into tile, 446; loss, 330; rate from tile, 400.  
 Perels, E., duty of water, 203, 212.  
 Persian wheel, 325, 328.  
 Peru, irrigation, 71.  
 Phœnician irrigation, 69. [299.  
 Pipe line; Redlands, 296; redwood, 298.  
 Pipes for lawns, 394.  
 Plagnol, salt in soils, 275.  
 Plant breathing, 47.  
 Plant feeding, 52, 57.  
 Plant-food, 14, 15, 93, 252, 259; developed by tillage, 149; effect of fallowing, 154; in alkali salts, 280, 285.  
 Plant-house experiments, 18, 35, 43; yields, 25, 41.  
 Plowing, fall, 131; plowing under green manure, 151; to form check ridges, 346.  
 Plow, for producing mulch, 149; for producing distributing furrows, 340, 342. [260.  
 Po, irrigation, 72; sediment in water.  
 Potatoes, irrigation, 28, 32, 35, 172, 353, 357, 413; water used, 30, 37, 46, 174, 237; yields, 110, 357; advantages of irrigation in humid climates, 172; watering alternate rows, 354, 357; distance between rows, 357; moisture in rows, 161, 200; duty of water, 215; number of waterings, 237, 356.  
 Press drill, 167.  
 Puddling of soils, principles governing, 334.  
 Pumping, with windmill, 313, 316; with engines, 324; cost, 324, 326; for cranberries, 368; for drainage, 463.  
 Pumps, with windmill, 316, 319; with engines, 324, 326, 393; with water wheels, 76, 306, 308, 309; with horse power, 325.  
 Quicksand, 486.  
 Rainfall, in arid and semi-arid climates, 4, 6, 99, 101; timely, 10; of irrigated countries, 89; in Kansas, 105; frequency in Wisconsin, 108; like amounts not equally effective, 101, 115, 204; relation to yield, 109, 125; conditions modifying effectiveness, 110; in United States, 123; in eastern United States, 124; amount needed in humid regions, 121; of growing season, 124; distribution in time unfavorable to maximum yields, 125; early rains saved by tillage, 128; affects duty of water, 204; in Colorado, 236; in India, 291.  
 Ramming engine, 310.  
 Rape, irrigation, 359.  
 Raspberries, roots, 231; irrigation, 363; sub-irrigation, 398.  
 Read, T. M., solids in river waters, 253.  
 Redlands, Cal., irrigation systems, 296.  
 Red rice, 371.  
 Reservoir, distributing, 297; construction, 320; sluice, 321; circular, 322; seepage and evaporation, 323; capacities, 323; for cranberries, 367; use in drainage, 464.  
 Rice, irrigation, 368; in Italy, 210; in Egypt, 211; South Carolina, 238, 296, 306, 369, 372; duty of water, 217; frequency of irrigation, 238; cultivation, 370; red rice, 371; upland, 373.  
 Ridge cultivation, 165.  
 Rio Grande, analyses of water, 253, 259.  
 Road grader, 350.  
 Rolling in relation to soil moisture, 166; cause of loss of moisture, 167.  
 Roman canals, 70.  
 Root cap, 64.  
 Root hairs, 55; relation to soil grains, 55; acid reaction, 59.  
 Roots, depth of penetration in arid soils, 6, 229; shallow in undrained soil, 13; function, 55; absorbing sur-

- 201; lose effectiveness, 145; of different soils compared, 144, 201; depth, 147, 165, 206; frequency of stirring, 164.
- Soil moisture, advantages of abundant supply, 9; mechanism of plant supply, 54; effect of subsolling, 134; effect of fallowing, 153, 155, 162, 225; in potato rows, 161; means of conserving, 131; conservation by tillage, 164; influence of rolling, 166; loss through mulches, 144, 201; best amount, 226.
- Soil ventilation, 419; need, 11; work of carbonic acid, 419; influence of drainage, 418; part played by roots, 420, 421; influence of changing air temperature and pressure, 420; may lessen denitrification, 420; may increase nitrates, 420; may be too thorough, 421.
- Soil temperature, 248, 250, 425; influenced by drainage, 423; importance, 425; influence on germination, 425; influence of cultivation, 427.
- Soil warmth, 425.
- Soil water, plant-food dissolved, 14; amount of alkalies carried, 278; stagnation prevented by drainage, 416.
- South America, irrigation, 87.
- South Carolina, rice irrigation, 238, 266, 306, 369, 372.
- Spain, irrigation, 72, 238; duty of water, 211.
- Spill-box, 245.
- Spraying lawns, 393.
- Strawberries, irrigation, 110, 181, 384; roots, 232; sub-irrigation, 398.
- Storer, F. H., 254, 275.
- Sub-irrigation, 396; of clover, 179; objections and difficulties in the way, 396, 397, 401; water-meadows, 401; orchards and small fruits, 401; danger of clogging tile by roots, 401; time required, 401; through tile drains, 400; conditions necessary, 401; an adjunct to drainage, 460.
- Subsoil, affects duty of water, 205.
- Subsolling, 133; effects, 139; sugar cane, irrigation, 214; duty of water, 215.
- Summer fallowing, 153, 154, 163.
- Sunlight, evaporation during, 44; action in plant-feeding, 49; limited in close planting, 183, 194.
- Surface drainage, 464; examples, 466; peat lands, 491.
- Surface tension, 57.
- Swamp lands, 273; area in United States, 415; improved by drainage, 416; intercepting underflow, 459; intercepting surface water, 461.
- Switzerland, irrigation, 74, 365.
- Target-rod, 470, 471.
- Temperature of soil, 248; subsoll changed by rains and irrigation, 14, 248; reduced by close planting, 183; favorable to sewage irrigation, 404.
- Temperature of water for irrigation, 250.
- Tidal irrigation, 238, 261, 306, 369, 373.
- Tigris, canals, 69.
- Tile, injury by frost, 442; for sub-irrigation, 398, 400; size, 449, 452; laying, 484; in quicksand, 488.
- Tile-hook, 482.
- Tillage, extent to which it may replace rain or irrigation, 117; most which may be hoped for tillage, 120; inapplicable in some cases, 127; chiefly saves early rains, 128; may do harm, 129; late plowing, 132; subsolling, 133; earth mulches, 142, 164, 206; mulches lose in effectiveness, 145; harrowing and rolling, 146, 166; early tillage important, 148; plow as a tillage tool, 149; intertillage, 157, 163; frequency of tillage, 164, 205; depth, 165, 206; ridged and flat cultivation, 165; in rice fields, 370; after irrigation, 381, 389; with orchard cultivator, 381.

Windmills, conditions for highest service, 318; for lifting water, 312, 316, 318, 367; capacity for irrigation, 318; use in drainage, 463.	Wind power, for irrigation, 312; work done by months, 315; work done by 10-day periods, 316. Wolff, A. R., 318.
--	--

AUG 26 1920

