





Class TJ151

Book .T8

Copyright N^o 1900

COPYRIGHT DEPOSIT.





2

68
2043
Pat 21



Henry C. Pulley

HANDBOOK ON ENGINEERING.

THE PRACTICAL CARE AND MANAGEMENT

OF

DYNAMOS, MOTORS, BOILERS, ENGINES, PUMPS, INSPIRATORS AND INJECTORS, REFRIGERATING MACHINERY, HYDRAULIC ELEVATORS, AIR COMPRESSORS, AND ALL BRANCHES OF STEAM ENGINEERING.

BY

HENRY C. TULLEY,

Engineer and Member Board of Engineers, St. Louis.

SOLD BY
HENRY C. TULLEY & CO.,
Wainwright Building, St. Louis, Mo.
PRICE, \$3.50.

95355

TJ151
-T8
1900

Library of Congress
TWO COPIES RECEIVED
DEC 28 1900
Copying entry
Oct. 15, 1900
No. <u>A 25558</u>
SECOND COPY
Delivered to
ORDER DIVISION
IAN 3 1901

Entered according to Act of Congress, in the year 1900, by
HENRY C. TULLEY,
In the Office of the Librarian of Congress, at Washington.

1-29-043

INTRODUCTION.

The object of the writer in preparing this work has been to present to the practical engineer a book to which he can, with confidence, refer to for information regarding every branch of his profession.

Up to the date of the publication of this book, it was impossible to find a plain and practical treatise on the steam boiler, steam pump, steam engine, and dynamo, and how to care for them; electric and hydraulic elevators, and how to care for them; and all other work that an engineer is apt to come in contact with in his profession.

An experience of over twenty-five years with all kinds of engines and boilers, pumps, and all other kinds of machinery, enables the writer to fully understand the kind of information most needed by men having charge of steam engines of every description, and what they should comprehend and employ.

With this object in view, the writer has carefully made note of his past experience, and has also made note of things that came to his notice while visiting different engine rooms, and accordingly, has taken up each subject singly, excluding therefrom, everything not strictly connected with steam engineering.

Particular attention has been given to the latest improvements in all classes of steam engineering and their proportioning, according to the best modern practice, which, it is hoped, will be of great value to engineers, as nothing of the kind has heretofore been published.

This book also contains ample instructions for setting up, lining, reversing and setting the valves of all classes of engines.

THE AUTHOR.

CONTENTS.

CHAPTER I.

	PAGE
The Elementary Principles of Electrical Machinery	1

CHAPTER II.

The Principles of Electromagnetic Induction	14
---	----

CHAPTER III.

Two-Pole Generators and Motors	27
--	----

CHAPTER IV.

Multipolar Machines	38
-------------------------------	----

CHAPTER V.

Switch Board, Distributing Circuits, and Switch Board Instruments	47
--	----

CHAPTER VI.

Electric Motors	64
---------------------------	----

CHAPTER VII.

Instructions for Installing and Operating Slow and Moder- ate Speed Generators and Motors	74
--	----

CHAPTER VIII.

Why Commutator Brushes Spark and Why They Do Not Spark	80
---	----

	PAGE
CHAPTER IX.	
Instructions for Installing and Operating Apparatus for Arc Lighting, Brush System	117
CHAPTER X.	
Installation of Arc Dynamos, T. H. System	168
CHAPTER XI.	
The Selection of an Engine	210
CHAPTER XII.	
The Steam Engine	237
CHAPTER XIII.	
A Successful Engineer	323
CHAPTER XIV.	
The Force of Steam and Where It Comes From	348
CHAPTER XV.	
A Few Remarks on the Indicator	407
CHAPTER XVI.	
Mechanical Refrigeration	438
CHAPTER XVII.	
Use and Abuse of the Steam Boiler	465
CHAPTER XVIII.	
Steam Pumps and How to Care for Them	598

CHAPTER XIX.

	PAGE
The Injector and Inspirator, and How to Operate Them . . .	585

CHAPTER XX.

Some Practical Questions Usually Asked of Engineers When Applying for License	608
--	-----

CHAPTER XXI.

Instructions for Lining up Extension to Line Shaft	636
--	-----

CHAPTER XXII.

Horse Power of Gears	671
--------------------------------	-----

CHAPTER XXIII.

Hydraulic Elevators	695
-------------------------------	-----

CHAPTER XXIV.

The Driving Power of Belts	717
--------------------------------------	-----

CHAPTER XXV.

Capacity of Air Compressors	729
---------------------------------------	-----

CHAPTER XXVI.

The Water Tube Sectional Boiler	738
---	-----



HANDBOOK ON ENGINEERING.

CHAPTER I.

THE ELEMENTARY PRINCIPLES OF ELECTRICAL MACHINERY.

The operation of electric generators, or dynamos, as they are ordinarily called, and also that of electric motors, depends upon a simple relation between electricity and magnetism, which will be explained in a simple manner in the following paragraphs.

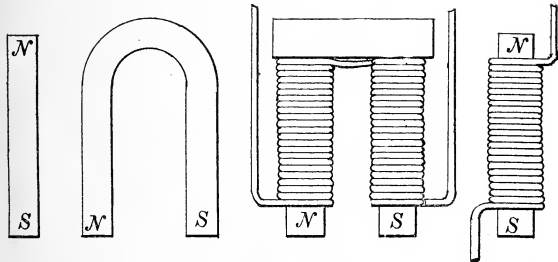


Fig. 1.

Fig. 2.

Fig. 4.

Fig. 3.

A permanent magnet, as is well known, is a bar of steel which possesses the power of attracting pieces of iron. These bars may be made straight, as in Fig. 1, or in the form of a U, as in Fig. 2, or in any other shape desired. The strength of a permanent magnet depends upon the kind of steel of which it is made, and

also upon the temper it is given. Generally speaking, the harder the steel the stronger the magnet. A bar of soft steel, or wrought iron, cannot be made into a permanent magnet of any noticeable strength, but if such a bar is covered with a coil of wire, as shown in Figs. 3 and 4, and a current of electricity is passed through the wire, the bar will be converted into a very strong magnet so long as the current flows. As soon as the electric current stops flowing through the wire, the magnetism of the bar will die out.

Magnets of the last-named type are called electro-magnets, as they do not possess magnet properties except when the electric current flows around them. Electro-magnets, when energized by sufficiently strong electric currents, can be far more powerful than the permanent magnets, and on that account they are used in electric generators and motors. In addition to being stronger magnets, the electro-magnet has the advantage that it can be magnetized and demagnetized almost instantly, by simply cutting off the exciting electric current, and on this account they can be used for parts of electrical machines and apparatus, for which the permanent magnet would be entirely unsuited.

If we test the attractive power of a magnet, we will find that it is greatest at the ends, the force at the middle point being scarcely noticeable. A bar such as Fig. 1 or Fig. 3 might hold a piece of iron weighing several pounds, if presented to either end, while at the middle point, it might not be able to sustain more than an ounce or two. Owing to this fact, the ends are called the poles of the magnet.

If any magnet is suspended from its center, like a scale beam, and allowed to swing freely, it will be found that it will come to rest in a north and south position, and no matter how violently it may be moved around, it will always come to a state of rest with the same end pointing towards the north. On this account, the ends are called north and south poles, the north pole being the end that points toward the north.

If **two-bar magnets** are suspended side by side with the north end of one at the top and the north end of the other at the bottom, as is illustrated in Fig. 5, they will attract each other; but if both magnets had the north end at the top, they will push away, as shown in Fig. 6. It is evident that there is a good reason for this difference in action, and this reason we can find out by experiment.

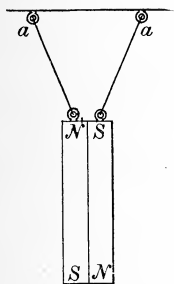


Fig. 5.

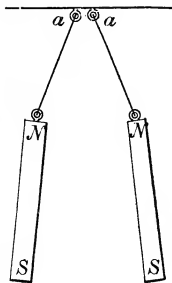


Fig. 6.

A **magnet needle**, such as is used in mariner's compasses, is simply a small magnet. If we place a magnet bar, as shown in Fig. 7, and then set near to it, in different positions, a compass containing a very small needle, we will find that in these several positions the direction of the needle will be about as is indicated by the small arrows marked *b* on the curved lines *a a*; the point of the arrow being the north end, or pole, of the needle. The reason why the needle will take up these positions is that the north end of the bar attracts the south end of the needle, and pushes away the north end, just as in Figs. 5 and 6, and the south end of the bar acts in the same way; so that there is a tug of war going on, so to speak, between the attractions and repulsions of

the two ends of the bar upon the two ends of the needle, the result being that the position assumed by the needle is the resultant of these several actions. When the needle is near the

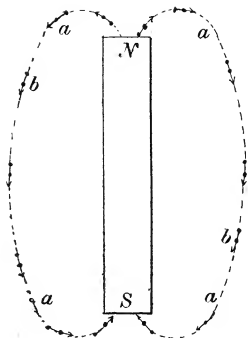


Fig. 7.

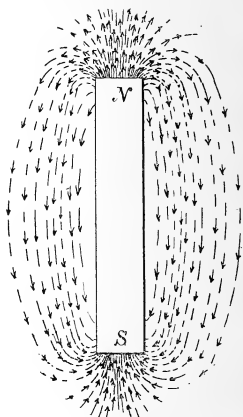


Fig. 8.

north pole of the bar, its south end is attracted with the greatest force, and when near the south end of the bar, the north end experiences the greatest attraction.

If we were to place the exploring needle in all possible positions near the magnet and trace lines parallel with it, in these positions, we would obtain a large number of curves about the shape of those shown in Fig. 8. As these curves represent the direction into which the magnet needle is turned at the various points in the vicinity of the magnet, they represent the direction in which the combined forces of the two poles act at these two points, hence, these lines are called magnetic lines of force.

When two magnets are suspended as in Fig. 5, the lines of force of both will be in the same direction as is indicated in Fig. 9 by the arrow heads on the curves *a a*. That this is true can be seen from Fig. 7, in which it will be seen that the arrow heads point toward the south pole and away from the north pole. As the north pole of a magnet has an attraction for the south pole, we can readily see that there is an endwise pull in the lines of force, which tends to make them contract, like rubber bands, hence, we can imagine the lines *a a* in Fig. 9 to contract and thus draw the two magnet bars together.

The repulsion of the two magnets, when the north poles are at the same end, is illustrated in Fig. 10. Here we see that the lines of force passing on the outside of the bars, as indicated by lines *a a*, are unobstructed, and can assume their natural posi-

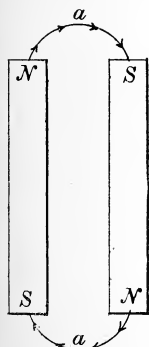


Fig. 9.

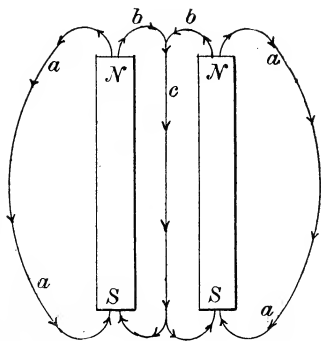


Fig. 10.

tion, but those that pass between the bars, along line *c*, are pressed out of position. If we assume that the lines of force make an effort to retain their position, like so many wire

springs, then we can see that the repulsion is due to the effort that the lines make to assume their natural form in the space between the bars.

Magnetic lines of force have no real existence, they simply indicate the direction in which the force acts, but if we keep this fact in mind, it helps us to understand magnetic actions, if we treat the lines of force as if they were something real. This fact will become more evident as we proceed.

Lines of force always pass from the north to the south pole through the space between these poles, and through the magnet itself, they are assumed to pass from the south to the north pole. The form of the lines of force depends upon the relative position of the north and south poles. In Fig. 9 they are curved, as

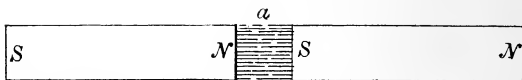


Fig. 11.

the magnets are placed side by side, but if the bars were arranged end to end, as in Fig. 11, the lines of force would be straight, as is shown at *a*. From the north end of the right side magnet, the lines of force would pass in curved line, as in Fig. 10, to the south pole of the magnet on the left side, thus completing the magnetic chain, or circuit, as it is called.

If we take the two magnet bars of Fig. 11 and stand them on end, as in Fig. 12, and suspend a bent wire *C* in the manner shown, effects can be produced that are interesting and instructive, as they illustrate the principle upon which generators and motors act. The wire *C* should be journaled at *DD*, so as to swing with as little friction as possible, and its ends are to be connected with a battery *B*, by means of fine wires *a* and *b*; a switch being provided at *c* so as to stop the flow of current when desired.

If the switch *c* is opened, so that no current flows through *C*, the latter will not be disturbed, and if we give it a swing, it will oscillate back and forth, like a clock pendulum, and in a few seconds come to rest in the position in which it is shown. If the switch is closed, *C* will at once swing out of the stream of magnetic lines of force and will remain in that position as long as the current from the battery passes through it. The direction in which *C*

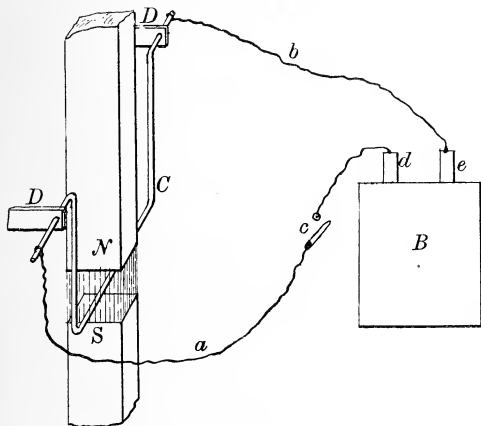


Fig. 12.

will swing will depend upon the direction of the current through it. If with the wires *a* and *b* connected with the battery, in the manner shown, the wire *C* swings to the right side, then if *a* is connected with *e*, and *b* with *d*, the direction of swing will be reversed; that is, *C* will swing toward the left.

From this experiment we see that the magnetic lines of force can develop a repulsive force against an electric current, and that the direction of the repulsion depends upon the direction of the

electric current with respect to the direction of the lines of force. We now desire to know why this repulsion is developed, and this we can ascertain by the following experiments:—

If we arrange three wires as shown in Figs. 13, 14 and 15, so as to run north and south, the upper end being north, and place over these magnet needles *D D D*, pivoted at *e e e*, we will find that if there is no current flowing through the wire, the needle will point toward the north, or be parallel with the wire, as is

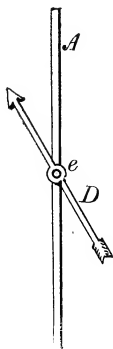


Fig. 13.



Fig. 14.

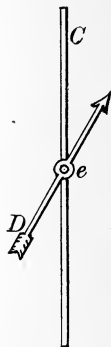


Fig. 15.

shown in Fig. 14. If the current runs through the wire from south to north, the north end of the needle will swing to the right, as in Fig. 15, and if the current runs through the wire from north to south, the north end of the needle will swing toward the left, as in Fig. 13. From this we see that an electric current can repel a magnet, and that the direction in which it repels it depends upon the direction of the current.

If we stand the three wires on end, as shown in Figs. 16, 17 and 18, in which *A B C* represent the wires as seen from above, we will find out more about the relation between electric currents

and magnets. If we place four small magnet needles around each one of the wires, as shown at *a a a a*, we will find that those around the center wire, through which no current flows, will all

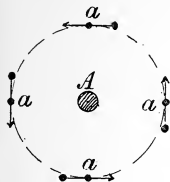


Fig. 16.

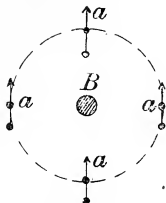


Fig. 17.

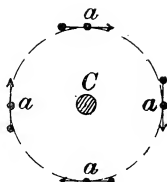


Fig. 18.

point toward the north, as shown, while those around the wire Fig. 16, through which a current flows upward, that is, away from the center of the earth, will point in a direction opposite to that in which the hands of a clock move; and in wire Fig. 18, in which the electric current flows down toward the center of the earth, the north ends of all the needles will point in the direction in which the hands of a clock move, that is, just opposite to those in Fig. 16.

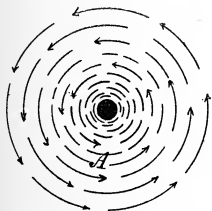


Fig. 19.

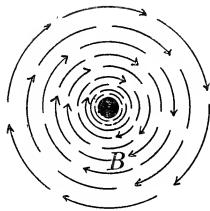


Fig. 20.

From these actions, we infer at once that when an electric current flows through a wire, the latter becomes surrounded with magnetic lines of force, as is illustrated in Figs. 19 and 20,

and that there is a fixed relation between the direction of the current and that of the lines of force. At *A*, Fig. 19, the direction of the lines of force is shown for a current moving upward, and at *B*, Fig. 20, the direction of the lines of force is that due to a current moving downward through the wire.

Inasmuch as an electric current flowing through a wire is surrounded by magnetic lines of force, we can say that a complete electric current consists of two parts, one the current proper, which traverses the wire, and the other the magnetic casing which envelops the wire. It is the action between the latter part of the current and the lines of force of magnets that develops the current in a generator, or the power in a motor.

With the aid of Figs. 21 and 22, we can now show how the force is developed that thrusts the wire to one side in Fig. 12. The lines of force of the magnet, which constitute what is called the magnetic field, will flow from the north pole at the top to the south pole at the bottom, as is shown in Figs. 21 and 22. If the electric current flows through the wire *C* from the back toward the front, the lines of force developed around it will have the direction shown in Fig. 21. As lines of force cannot flow in opposite directions in the same space, the lines of the field will swing over to the left side of the wire, but in doing so they will be stretched out of the straight form, and they will also push the lines surrounding the wire out of their central position. Under these conditions, which are illustrated in Fig. 21, the effort made by the field lines to straighten out, together with the effort made by the wire lines to return to the central position, will develop a thrust between the wire and the field, and thus force the former out toward the right side.

If the direction of the current through the wire is reversed so as to flow from front to back, the direction of the lines of force around the wire will be reversed, and will be as in Fig. 22. Under these conditions, the lines of force of the magnetic field will

swing over to the right side of the wire, and thus the thrust will be in the opposite direction.

Fig. 12 represents the principle of an electric motor in its simplest form, and from it we see that the force that causes the armature to rotate is developed by the repulsion between the magnetism of the field magnet and the magnetism that surrounds the wires wound upon the armature.

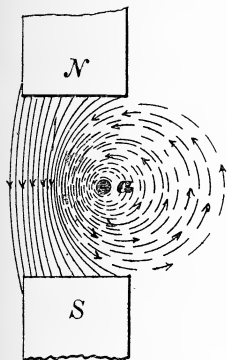


Fig. 21.

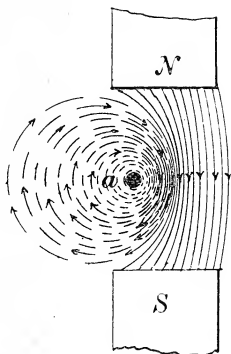


Fig. 22.

It is self-evident that if we undertake to force the wire C through the magnetic field in the opposite direction to that in which it swings, we will have to make an effort to do so; that is, if we try to move the wire from right to left in Fig. 21, or from left to right in Fig. 22, we will have to apply power. Now nature is a strict accountant and does not allow any power to be lost; therefore, all the energy we expend in moving the wire through the magnetic field must appear in some other form, and the form in which it appears is as an electric current that is generated in

the wire. If we were to remove the battery in Fig. 12 and put in its place an instrument to indicate the presence of a current in the wire, we would find that when we move the latter in the opposite direction to that in which it moves under the influence of the current, we generate a current; that is, we convert the device into a simple electric generator. If in Fig. 21, we move the wire from right to left, the direction of the current generated in the wire will be the same as that of the current which causes the wire to swing in the opposite direction, that is, from back toward the front. As it is a poor rule that does not work both ways, we would naturally infer that if moving the wire from right to left develops a current from back to front, movement in the opposite direction would develop a current from front to back; and such is actually the case. This fact can be demonstrated by Fig. 12. Suppose that in this figure we hold C stationary in the central position, and then pass a current through from back toward the front; this current would exert a force to swing C to the right side. If we release the wire, it will swing to the right and as soon as it begins to move, the current will become weaker, showing that the movement of the wire developed therein a current in the opposite direction. If we force the wire over to the left side, the current flowing through it will begin to increase as soon as the wire moves.

All the foregoing shows us that when a wire is moved through a magnetic field, a current will be generated in it if it forms part of a closed circuit, and it makes no difference whether there is a current already flowing in the wire or not. When the wire is caused to move through the magnetic field by a current flowing through it from an external source, the current developed in it will be in opposition to that which comes from the external source, and, as a consequence, the movement produces an actual reduction of the strength of current flowing through the wire. The stronger the magnetic field and the greater the velocity of the

wire, the stronger the current generated in opposition to the driving current, and, therefore, the weaker the latter. It is on this account that if a motor is allowed to run free, the faster it runs the weaker the current through it becomes, as the actual current in every case can only be the difference between the main driving current and the one developed in the wire, which latter runs in the opposite direction.

CHAPTER II.

THE PRINCIPLES OF ELECTROMAGNETIC INDUCTION.

By Electromagnetic Induction, I mean the induction of electric currents by magnetic action. In the preceding chapter it has been shown that if we move a wire through a magnetic field, an electric current will be generated in it, providing its ends are joined, so as to form a closed circuit. If the ends are not joined, then there will be no current developed, because, an electric current cannot flow except in a closed circuit. When the ends of the wire are not joined, the movement through the field develops simply an electromotive force. Electromotive force is that force which causes an electric current to flow when there is a circuit in which it can flow. Electromotive force is a long-winded name and on that account it is always abbreviated into e.m.f., so that hereafter when these letters are used, it will be understood that they stand for electromotive force.

Metals and all other substances that allow electric currents to flow through them are called conductors, while glass, mica, wood, paper and many other similar forms of matter that do not allow currents to flow through them are called insulators. The difference between conductors and insulators is only one of degree, for there is no known substance that is an absolute non-conductor of electricity; that is, a perfect insulator; and there is no substance that does not resist to some extent the passage of a current — that is, there is no such thing as a perfect conductor. Some substances, like damp paper or wood, which stand midway between good conductors and good insulators, can be regarded as either one or the other, depending upon the service for which they are used. For currents of very low e.m.f., they would be in-

sulators, but for currents of very high e.m.f., they would be conductors.

The current that will flow through any circuit when impelled by an e.m.f., will have a strength that will depend upon the amount of resistance that opposes its flow. As all conducting materials are not of the same degree of conductivity, their relative values are determined by the amount of resistance they interpose to the flow of the current. The resistance of a conductor is measured in units called ohms; the strength of current is measured in units called amperes, and the e.m.f. is measured in units called volts. The relation between these units is such that an e.m.f. of one volt will cause a current of one ampere to flow in a circuit having a resistance of one ohm.

When a wire is moved through a magnetic field, the e.m.f. induced in it will be determined by the strength of the field and the velocity with which the wire moves, and will not be affected in any way by the resistance of the circuit of which the wire forms a part. If the resistance is very great, the strength of current generated will be very low, and if the resistance is very low the current will be strong, but in either case the e.m.f. will be the same.

If movement of the wire in one direction develops an e.m.f. in a given direction through the circuit, then movement of the wire in opposite direction will reverse the direction of the e.m.f. Thus, in Fig. 23, which represents a magnetic field between the poles *N S*, if wire *a* is moved from right to left, it will have induced in it an e.m.f. that will be from back to front, and if the direction of motion of the wire is reversed, the e.m.f. will also be reversed. This will be true whether the wire is near the *N* pole or *S* pole. This being the case, it can be seen that if *a* represents the end of a wire moving in the direction of arrow *d*, and *b* the end of a wire moving in the opposite direction, the e.m.f.'s in these two wires will be in opposite directions. The

direction of the e.m.f. in a will be up from the paper toward the observer, and the direction of the e.m.f. in b will be down through the paper. If these two wires are secured to a shaft placed in the center of the field, then by the continuous rotation

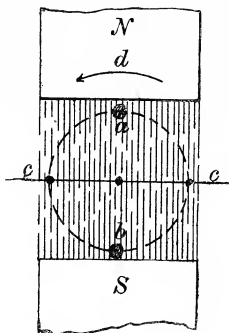


Fig. 23.

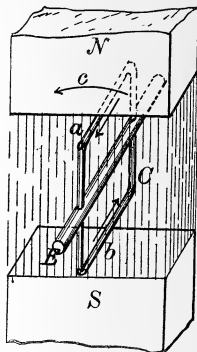


Fig. 24.

of the shaft, the two wires can be made to revolve around the circular path shown.

If these two wires are joined at the ends, as shown in Fig. 24, they will form a closed loop, and although the direction of the induced e.m.f. in the two sides will be opposite, when compared to a fixed point in space, they will be in the same direction so far as the loop is concerned; that is, both e.m.f.'s will develop currents that will flow through the wire in the same directions.

Returning to Fig. 23 it will be noticed that if the wires revolve around the circular path at a uniform velocity, their movement in the direction of line ec will not be uniform, but will be the greatest when the wires are in the position shown, and least, when they cross the line ec . In fact, when the wires cross line ec their motion in the direction of this line will be zero, for this

is the point where the direction of movement reverses. Now, the magnitude of the e.m.f. induced in the wire is proportional to the velocity in the direction of the line $c c$, hence, when the wires are crossing this line, the e.m.f. will be zero, and when they are one-quarter of a turn ahead of the line, the e.m.f. will be the highest.

In Fig. 24 we see that in side a , the direction of the current is toward the front, and in b it is the reverse; now, when a moves through half a turn, it will take the place of b , and the direction of the e.m.f. induced in it will be the same as in b in the figure: that is, it will be the reverse of what it is when passing in front of the pole N . This being the case, it is evident that each time the loop makes a half-revolution, the direction of the current generated in it reverses.

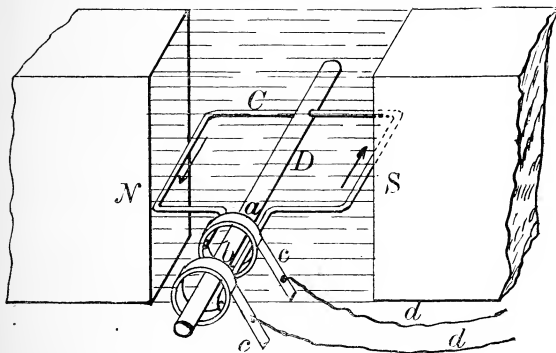


Fig. 25.

As the loop in Fig. 24 is closed, the current generated in it would be of no practical value, but if we cut the wire at one side and connects the ends with rings as shown at a and b in Fig. 25, then by means of collecting brushes $c c$ we can take the cur-

rent off through the wires *d d*. This current, however, would consist of a series of impulses that would flow in opposite directions, each one starting from nothing and increasing to its greatest

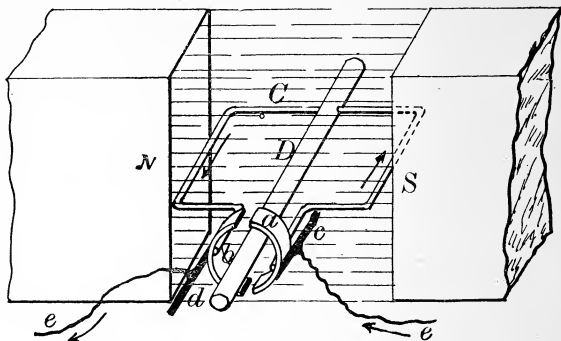


Fig. 26.

strength when the loop reaches the position shown in the figure, and then declining and reaching the zero value when the loop reaches the vertical position. Such a current is called an alternating current, because it flows first in one direction and then in the opposite direction. All forms of machines that generate currents by electromagnetic induction, develop alternating currents, but in the class of machines known as direct or continuous current, a rectifying device is used which rectifies the current before it reaches the external circuit. This rectifying device is called a commutator, and is illustrated in its simplest form in Fig 26. In this illustration it will be noticed that the ends of the wire, instead of being attached to two independent rings, placed side by side, are secured to two half-rings, placed opposite each other. The brushes *c d*, through which the current is taken off, are held stationary; therefore, as can be readily seen, *c* will make contact

with *a* during one-half of the revolution, and with *b* during the other half; and this will also be the case with brush *d*. Now, as the half-rings with which the brushes are in contact change at each half revolution, it follows that by properly setting the brushes, they can be made to pass from one-half ring to the other at the very instant when the direction of the current in the loop reverses, so that through each brush there will be a succession of current impulses, but all in the same direction.

The device shown in Fig. 25 is a perfect alternating current generator, and that shown in Fig. 26 is a perfect direct current generator. In both cases, however, the e.m.f. induced is so low as to be of no practical value. To obtain serviceable machines, capable of developing the e.m.f. and current strength required in practice, it is necessary to provide very strong magnetic fields and to rotate in these a large number of loops of wire. In order that the operation of such machines may be understood, I will first show how the powerful magnetic fields are obtained.

In Fig. 27 two wires are shown as seen from the end, these being marked *A* and *B*. The lines of force surrounding them are

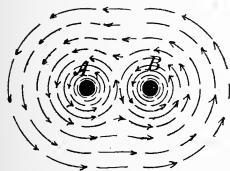


Fig. 28.

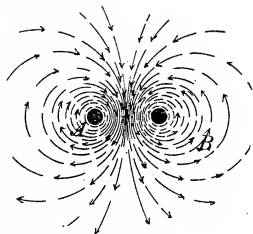


Fig. 27.

in directions that correspond to opposite directions of current in the wires. In wire *A*, the current flows away from the observer. As can be seen, the lines of force of both wires have to crowd into

the space between the wires, for on the outside of *A* the two sets of lines would meet each other head on, and this would also be the case on the right side of wire *B*. This crowding of the lines of force into the space between the wires causes them to distort from their natural position and instead of being central with the wires, are eccentric to them. If we take a long wire through which a current is flowing and bend it into a loop, we will see that if the current flows out through one side, it will return through the other side, so that in the two sides of the loop the current will flow in opposite directions. This being the case, Fig. 27 can be regarded as showing the two sides of such a loop, and from it we find that the effect of such a loop is to concentrate within its interior nearly all the lines of force that surround the wire.

In Fig. 28 the two wires *A* and *B* are surrounded with lines of force that correspond to the same direction of current. In this case it will be noticed that in the space between the wires the lines of force flow in opposite directions; hence, only a few of the lines will follow this path, simply that number surrounding each wire that can traverse the space without encroaching upon the path of the lines belonging to the other wire. If the two wires are very near to each other, practically all the lines of force of both wires will join forces, so to speak, and pass around the two wires. Now, if we wind a wire into a coil of many turns, the direction of the current in the several turns will be the same, so that the lines of force of all the turns will combine into one large stream and circulate around the entire coil side, no matter how many turns of wire it may contain. From this it can be seen that if we have a current of say ten amperes, we can make it produce just as powerful magnetic effect as a current of one thousand amperes, by simply increasing the number of turns of wire in the coil. A current of ten amperes passing through a coil of wire containing one hundred turns, will have the same magnet-

ism in effect, as a current of one hundred amperes passing through a coil of ten turns, or as a current of one thousand amperes passing through a coil of a single turn.

If we place at the side of a wire through which an electric current is flowing a piece of iron, as is shown in Fig. 29, the effect will be that the lines of force will no longer flow in circular paths, as indicated by the circle *a*, but will be deflected in the manner illustrated, by the presence of the iron. If, instead of

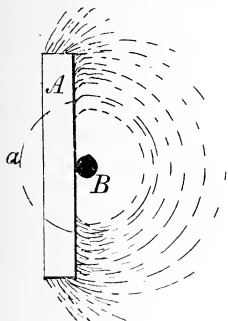


Fig. 29.

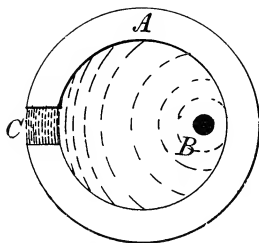


Fig. 30.

the straight iron bar, we substitute a ring of iron, as in Fig. 30, nearly all the lines of force will be concentrated in the metal, and the magnetic field in the space *C*, between the ends of the ring, will be vastly greater than at any other point. The explanation of these actions is that all forms of matter oppose the development of magnetic force, but some offer greater resistance than others. Iron, steel, nickel, and one or two other metals, offer less resistance to the magnetic lines of force than air, and are said to have a higher magnetic permeability. Nickel is only a slight improvement on air, but steel and iron are far superior, iron being of about two to three times the permeability of hard-

ened steel, and about one thousand times the permeability of air, when magnetized to the density ordinarily used in practice. The iron in Figs. 29 and 30, therefore, becomes the path of the lines of force, because it interposes a much lower resistance. Owing to this difference in the resistance of iron and air, it is possible to make an iron magnet core of any desired form, and to concentrate within it nearly all the lines of force developed by the current flowing through the wire wound upon it. The presence of the iron not only serves to concentrate the magnetism in it, but as it reduces the resistance opposing the development of the magnetism, it enables the field to be made vastly stronger than it could be with air alone, say a thousand times as great.

If we make a magnet in the form of Fig. 31, with a coil of wire around the part *B*, practically all the lines of force will flow to

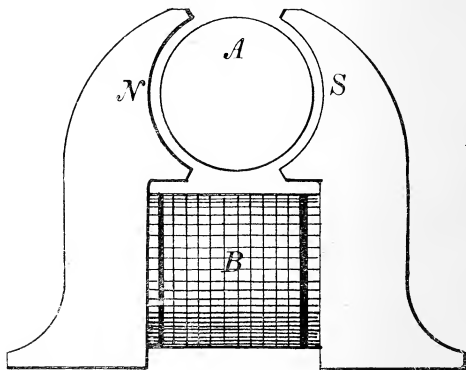


Fig. 31.

the poles *N S*, and will pass through the air space between them. If this air space is nearly filled with a cylindrical mass of iron, *A*, the strength of the magnet will be increased, for, by doing this,

we replace air which is a poor magnetic conductor, by iron which is a far superior conductor. Electric motors and generators are made with a cylindrical mass of iron at A , which is the armature

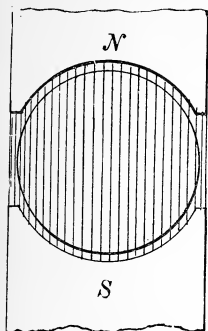


Fig. 32.

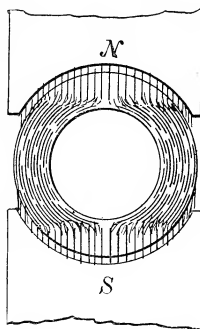


Fig. 33.

core, and the air space between it and the faces of the poles of the field magnet is made just sufficient to accommodate the wire coils, and by this means the field strength is increased as much as possible.

The armature cores are sometimes made solid, as in Fig. 32, and sometimes as a ring, as in Fig. 33. When they are solid, the lines of force cross through them in straight lines, see Fig. 32; and when they are ring form, the lines follow the ring and do not penetrate the interior space.

If the single loop of Fig. 24 is replaced by a coil containing many turns of wire, the e.m.f. induced in it will be increased in proportion with the number of turns of wire in the coil, so that by using such a coil in a field such as shown in Fig. 31, a high e.m.f. can be obtained. This e.m.f., however, would be alternating, and if the current were rectified by means of a commu-

tator, it would not be of uniform strength, but would fluctuate from a maximum value to zero. Just how the current would fluctuate and how the construction can be changed so as to get rid of the fluctuation, we can explain by presenting a diagram that illustrates the alternating current as it flows in the armature coil, and the rectified current as it leaves the commutator.

In Fig. 34, let the distance $f h$, $h i$, $i n$, along the line $f f$ represent half-revolutions of the coil, and let distances measured on the vertical line $c d$ represent the strength of current, distances above f being current flowing in one direction, and distances below f being for current flowing in the opposite direction. Let us consider the instant when the coil is passing the point where the e.m.f. induced is zero: then this instant will be represented by the point f , at the left of the diagram, and the curve a will start from this point; as at that instant, the current which it represents has no value. As the coil rotates, the current begins to grow, and this fact we indicate by causing curve a to gradually

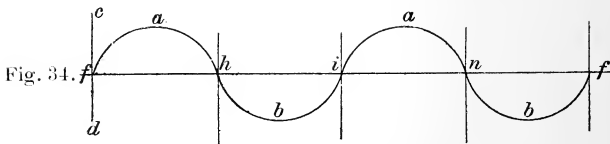


Fig. 34.

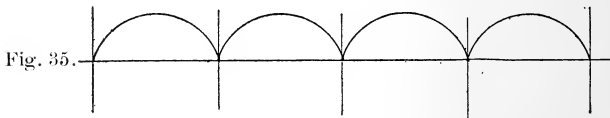


Fig. 35.

rise above the horizontal line. At the quarter turn, the current reaches its greatest strength, thus this forms the highest point of curve a , and is midway between f and h . From this point

onward, the current declines and becomes zero, when the rotation of the coil has reached one-half of a revolution, which is represented by the point *h*. In the next half-revolution, the current

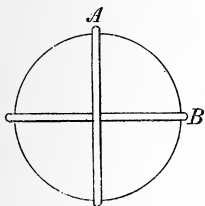


Fig. 36.

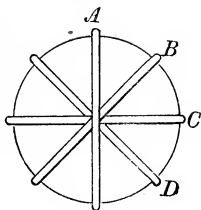


Fig. 38.

flows in the reverse direction, but has the same maximum strength and increases and decreases at the same rate; therefore, the curve *b*, drawn below the horizontal line, represents the reverse current; and point *i* corresponds to one complete revolution, so that beyond *i* the curves *a* and *b* are repeated in systematic order.

Now, if we provide a commutator to rectify this current, all we can accomplish is to turn curve *b* upside down and transfer it to the upper side of the horizontal line, as in Fig. 35; but, as will be seen, all we accomplish by this act is to obtain a current that flows always in the same direction, but at each half-revolution it drops down to a zero value.

If we wind two coils upon the armature, placing them at right angles with each other, as is indicated by *A* and *B* in Fig. 36, then if the currents of these two coils are rectified, they will bear the relation toward each other shown at the upper line in Fig. 37, the *a a* curves in solid lines representing the current from the *A* coil, and the *b b* curves in broken lines, representing the current from the *B* coil. As will be seen, when one of these currents is zero, the other is at its greatest value, so that if we run both into

the same circuit, the lowest value of the combined current would be equal to the maximum of either one of the single currents, and the maximum value would be equal to the sum of the two currents when the coils are on the eighths of the revolution.

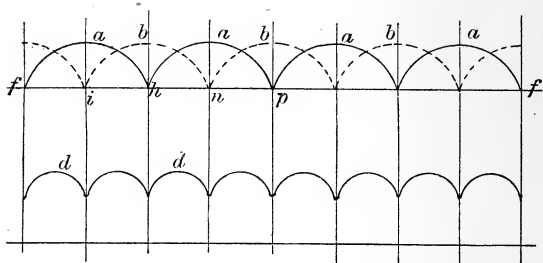


Fig. 37.

This resulting current is shown on the lower line in Fig. 37 by the curve *d d*. From this curve we see that the number of fluctuations in the current has been doubled, but the variation in the strength is greatly reduced. If we wound four coils upon the armature, as indicated by *A B C D*, in Fig. 38, the number of undulations in the combined current would be again doubled, but the fluctuation would be very much less. If the number of coils is increased to twenty-five or thirty, the fluctuations in the current become so small as to be hardly worth noticing.

With coils such as shown in Fig. 26, a separate commutator would have to be provided for each coil, and this would render the machine very complicated, if the number of coils were even six or eight; hence, in actual machines, the winding of the coils is modified so as to be able to use a single commutator for any number of coils. This construction will be explained in the next chapter.

CHAPTER III.

TWO POLE GENERATORS AND MOTORS.

The simplest type of armature winding is that used with ring cores, and is illustrated in Fig. 39. As will be seen, it is simply a continuous winding all the way around the circle, the end of the last turn of wire being connected with the beginning of the first turn, so as to form an endless coil. If wires are attached at a and b , and a current is passed through, it will divide into two halves, one part flowing through the wire above $a b$, and the other part through the wire below $a b$. In the upper half of the wire, the direction of the current in the front sides of the turns will be toward the center of the ring, as is indicated by the arrow heads, and in the lower half it will be away from the center. If, in-

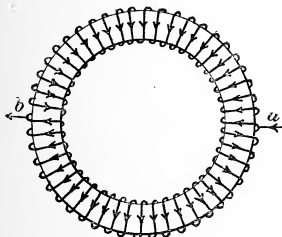


Fig. 39.

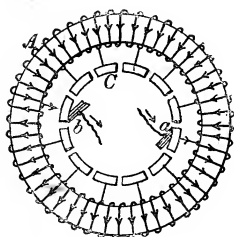


Fig. 40.

stead of attaching wires at a and b we place stationary springs, so as to press against the wire, then we could revolve the ring, and still the current would enter and leave the wire at the same points. Small armatures are often made in this way, but for regular

machines it is more desirable to provide a commutator as shown in Fig. 40 at C , and then the several segments can be connected with the wire at regular intervals. In the figure, the commutator is provided with twelve segments, and these connect with the armature wire at every fourth turn, so that the wire is divided into twelve coils of four turns each.

The only difference between this diagram and a regular generator armature of the ring type, is that it shows the wire coils spread out with a considerable space between them, and only in one layer, while in the actual machine, the wire is wound close together and generally, in several layers; but no matter how many layers there may be, or how many turns in a coil, the principle of winding is the same.

I **have** shown the ring winding first, because it is so simple that it can be understood with the most superficial explanation. The drum winding, which is used to a much greater extent, is the same in principle as the ring, but owing to the fact that the coils cross each other at the ends, it appears to be decidedly different. By the aid of Figs. 41 to 44, the drum winding can be made perfectly clear.

Fig. 41 shows a ring armature core with a single coil wound upon it; and Fig. 42 shows a drum core, with a single coil wound upon it. In the ring, only one side of the coil appears upon the outer surface of the armature, but in the drum, as there is no open space for the coil to thread through, both sides of the coil must be placed upon the outer surface. The side B of the coil may be called the live side, as it is the one from which the ends project, and the lower side c , may be called the dead side. Since only the live side of the coil has ends to be connected, it can be readily seen that if in the drum winding we leave spaces between the live sides for the dead sides, and then connect the ends of the live sides by jumping over the dead side between them, that we will have the same order of connection as in the ring winding.

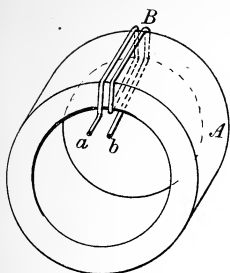


Fig. 41.

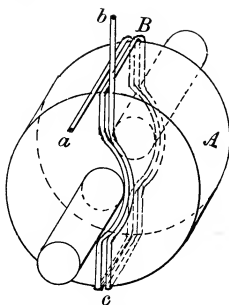


Fig. 42.

The dead side of each coil adjoins the live side of a coil that is, in reality, half a circumference away from it; thus, in Fig. 43, the live side of coil *a* is at the top and the dead side is at the bottom; while the live side of coil *n* is at the bottom and the dead side is at the top. The live sides of these two coils are on opposite sides of the armature, so that the coil side to the right of *a* is simply

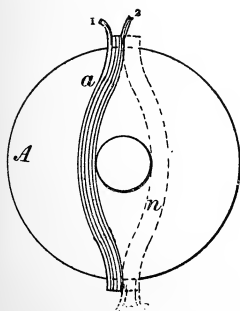


Fig. 43.

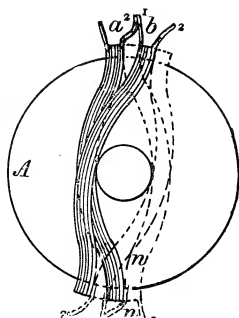


Fig. 44.

the dead side of a coil whose live side is on the other side of the diameter. In Fig. 44 the two coils *a* and *b* are adjoining coils, for the coil side between them is the dead side of coil *n*. To connect the armature, therefore, we join end 2 of coil *a* with end 1 of coil *b*, and the end 2 of coil *b* would jump over a dead side and connect with end 1 of coil *c*. Coil *c*, however, would appear to be two coils ahead of *b*, just as *b* appears to be two coils ahead of *a*.

In winding drum armatures, the coils are generally placed in pairs, as shown in Fig. 43 and also in Fig. 44. The object of this is simply to make the ends of the armature look more even. A drum armature can be wound out of a continuous wire, by simply making a loop to take the place of the ends 1 and 2, and then skipping a space, as shown by coils *a* and *b* in Fig. 44. After the armature is half covered, there will be spaces left between the coils, these spaces being of the width of a coil; we then proceed to fill up the vacant spaces, and when they are all filled, the last coil put in will be the proper position to connect with the first one wound. A little practice with a piece of twine and a wooden cylinder, will enable any one to find out in short order how to wind drum armatures.

The two types of winding I have explained, are those used with two pole machines, motors as well as generators. I may here add that there is no difference, electrically, between a motor and a generator, and any machine can be used for either service. Motors, however, are somewhat modified in design so as to make them more suited to the work they have to perform. The modification consists mainly in protecting the parts liable to be injured by objects falling upon them.

The general arrangement of the field and armature in a two pole machine is shown in Fig. 31. The design can be changed in a vast number of ways, but it will always be two-pole, or bipolar, as it is called, if only two poles are presented to the armature.

Generators and motors are arranged so that the current that magnetizes the field may be the whole current that flows in the circuit, or only a part of it. When the whole current passes through the field magnetizing coils, the machine is said to be of the series type; this name being given because the armature wire and the field coils are connected in series, so that the current first passes through one and then through the other. If the field coils are traversed by only a portion of the current, the machine

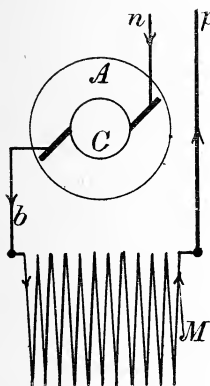


Fig. 45.

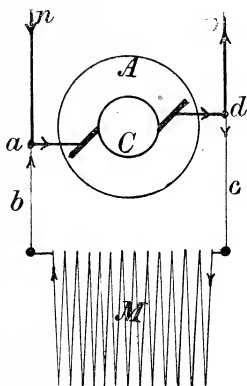


Fig. 46.

is said to be of the shunt type, owing to the fact that the field is supplied with a current that is shunted from the main circuit. Generators and motors are also arranged so that there are two sets of field coils and one is traversed by the whole current, and the other by a portion thereof. The best way to understand these different types of connection is by means of simple diagrams that show the wire coils of the field and the outline of the armature. Such diagrams are presented in Figs. 45 to 50. Fig. 45

represents the series connection, A being the armature, C the commutator, and M the field coil. The direction of the current is indicated by the arrow heads. Fig. 46 is the shunt connection, and the arrow heads show the direction of the currents in the case of a generator. As will be seen, at d the field current branches off from the main line and returns to it at a , after having passed through the field coil. Fig. 47 shows the type in which the field is magnetized by two sets of coils, one being in series with the main circuit and the other in shunt. As will be noticed, all the armature current passing out through wire d , goes through coil F , except the portion that is shunted at c , into the shunt coil M . This type of winding is called compound, being a combination of the series and shunt. When the shunt coil is connected as in

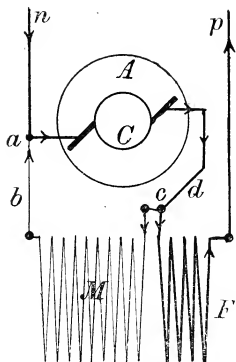


Fig. 47.

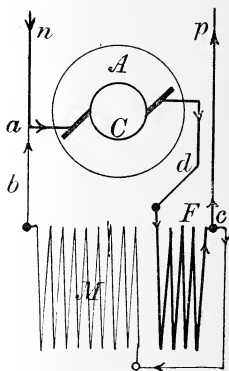


Fig. 48.

Fig. 47, it is called a short shunt, and when as in Fig. 48, it is a long shunt. In the first case, the coil M shunts the armature only, and in the second, it shunts the coil F also.

Figs. 49 and 50 show the shunt and compound types for motors, and as will be noticed, the only difference between them and the generator diagrams, is that the direction of the current

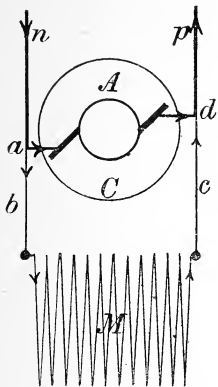


Fig. 49.

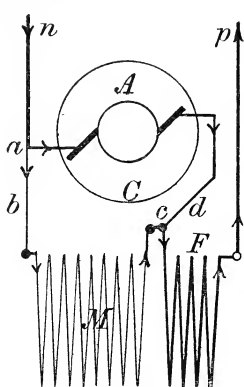


Fig. 50.

in the shunt coils is not the same. This difference in direction is due to the fact that in the generator the armature generates the current that passes through coil *M*; hence, at point *d*, the current flows up to the main line and down to the field coil. In the motor, the current comes from an external source through main *n*, and thus passes from *a* to the armature, and also to the field coil, thus traversing the latter in the opposite direction. In the series coil *F*, the direction of the current is the same in both machines.

Generators are made so as to keep the strength of the current constant, and allow the voltage to vary as the demands of the service may require; or they may be wound so as to keep the voltage constant and allow the current strength to vary. Machines

of the first class are called constant current, and are used principally for arc lighting. Machines of the second class are called constant potential and are the kind used for incandescent lighting, for electric railways and for the operation of motors of every description. For constant current generators the series winding is used in connection with some kind of regulating device that prevents the current strength from varying more than the small fraction of an ampere. The shunt and compound windings are used for constant potential generators. If the armature wire had no resistance, the shunt winding would enable a generator to maintain a constant voltage at its terminals, no matter how much the strength of the current might vary; but armature without resistance cannot be made; therefore, a shunt-wound machine will develop a slightly lower voltage with full current than with a weak one, but the difference will not be more than three to five per cent. By the aid of the compound winding, the generator can be made so as to develop the same voltage with light or full load, and if desired, the voltage can be made to increase as the current increases. If a compound generator is so proportioned that the voltage is the same for weak and strong currents, it is said to be evenly-compounded, and if the voltage increases as the current increases, it is said to be over-compounded. If the voltage is five per cent higher, with full load than with no load, the generator is said to be over-compounded five per cent, and if the increase is ten per cent, it is said to be over-compounded ten per cent.

The way in which a compound generator increases the voltage can be readily understood from an examination of Fig. 47. The current that passes through the shunt coil *M*, is practically one of the same strength at all times; therefore, the magnetizing effect of this coil does not change. Through coil *F* the whole current passes, hence, the magnetizing effect of this coil increases as the current strength increases. Now the total field

magnetism is that due to the combined action of the two coils, so that as the action of F increases, the strength of the field increases. If F has only a few turns of wire, it will only help slightly to magnetize the field; therefore, its increased effect, due to increase in current, will not be very noticeable; but if F has many turns, it will develop a large proportion of the field magnetism, and, under this condition, the change in current strength will make a decided change in the strength of the field, and thus in the voltage, for the voltage is directly proportional to the strength of the field.

In motors, the coil F can be connected so as to act with coil M , or against it. If both coils act together, the motor is compound-wound; and if F acts against M , the motor is differentially-wound. A compound-wound motor will slow down more with a heavy load than a simple shunt machine, but it will carry the load with a smaller current, and, on this account, this winding is commonly used for elevator motors. A differential motor will hold up the speed better with a heavy load than a simple shunt machine, but it will take a correspondingly larger current to do the work. The differential winding is not used to any great extent, except in cases where it is desired to obtain as uniform a velocity as possible.

In explaining the principles of armature winding, it was shown that the commutator brushes must make contact with the commutator on the sides, that is, that in Fig. 51, they would be placed on the diameter $n n$. In actual machines, they are either ahead of this line, as in Fig. 52, or back of it, as in Fig. 53. The first position is that of the generator and the second that of the motor. The reason why the brushes have to be set ahead of line $n n$ in a generator, and back of the line in a motor, is that the armature current develops a magnetization of its own, and this reacts upon the magnetism of the field so as to twist the lines of force out of their true path. If we look at Fig. 39, we can see

that the direction of the current through the wires is such that the magnetizing effect produced upon the armature core is the same as it would be if the wire were wound in the way indicated by the vertical lines in Fig. 51. Now this current will develop a magnetization in the direction of line nn ; that is, at right angles to the field magnetism. These two magnetic forces of the armature and the field, engage in a tug of war, and the result is that the actual magnetization that acts upon the armature wire is the combined effect of the two. If the strength of the field magnetism

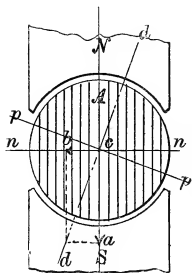


Fig. 51.

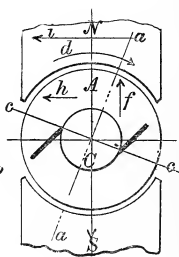


Fig. 52.

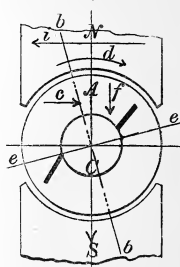
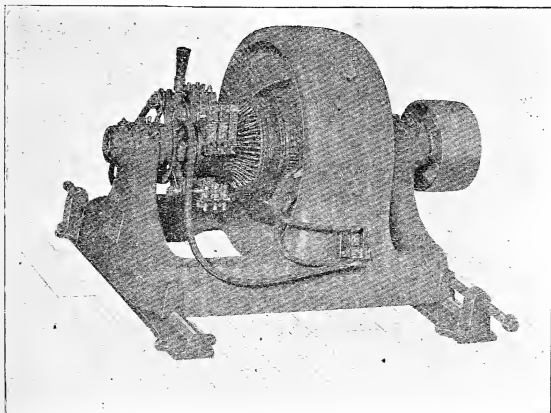


Fig. 53.

is proportional to line ca , and the strength of the armature magnetization is proportional to line cb , then the actual magnetization will be equal to line cd , and in the direction dd . In Fig. 52, which represents a generator, if the current in the field coils passes over the front side in the direction of arrow i , and the armature revolves in the direction of arrow d , then the armature current will be in the direction of arrow f and the armature magnetization will be in the direction of arrow h . The field magnetization will be from N to S , therefore, the resulting magnetization will be in the direction of line aa . Now the proper position for

the brushes is on a line at right angles to the direction of the field, hence, they must rest upon line cc . If the machine is a motor, the only change effected will be that the direction of the armature current will be reversed, so that arrow f will point downward instead of upward, and the magnetism of the armature will be directed to the right as shown by arrow e . Under these conditions, the actual direction of the field magnetism will be that of line bb , and upon line ee , at right angles to this the brushes must be set.



CHAPTER IV.

MULTIPOLAR MACHINES.

The only difference between a bipolar and multipolar machine is, that the latter has two poles, and the former has two or more pairs of poles. In consequence of this difference in the number

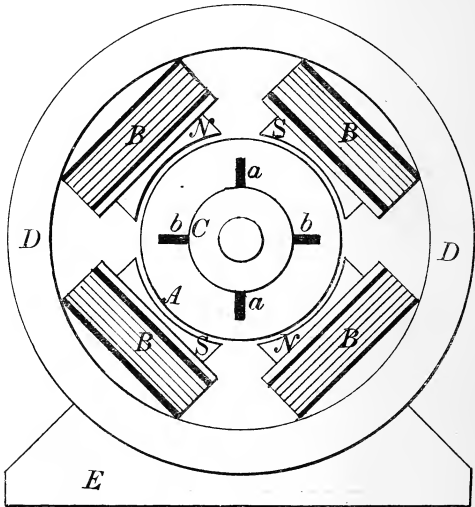


Fig. 54.

of poles, the armature winding has to be slightly modified, as will be presently explained. Fig. 54 illustrates a four-pole machine,

and, as will be noticed, the *N* and *S* poles alternate around the circle. This arrangement is followed, no matter what the number of poles may be.

The advantage of the multipolar construction is that it increases the capacity of the machine for a given size and weight. Figs. 55 to 57 illustrate the gain effected in weight. The first figure shows a two-pole machine, the second a four-pole and the third an eight-pole, the three being of the same capacity. The poles of the second machine are half as wide as those of the first, as there are twice as many. The other parts are reduced in like proportion. In Fig. 57, the poles are one-quarter as wide as in

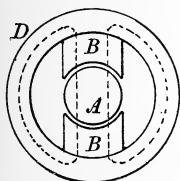


Fig. 55.

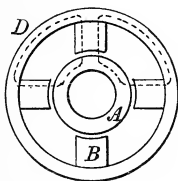


Fig. 56.

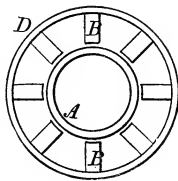


Fig. 57.

Fig. 55, as there are four times as many. On account of the reduction in the width of the poles, the armatures can be increased in diameter as the number of poles is increased, without increasing the outside dimensions of the machine, so that in reality, Fig. 56 is somewhat more powerful than Fig. 55, and Fig. 57 is still more powerful.

The fields of multipolar machines are wound the same as those of the bipolar; that is, as series, shunt or compound. Figs. 58 to 60 show the three types of winding for a four-pole machine and Fig. 61 is a diagram of compound winding for an eight-pole generator. The number of commutator brushes used is equal to the number of poles, although with one type of armature

winding, two brushes are sufficient, no matter how many poles the machines may have. In practice, however, even with this winding, the number of brushes is generally made equal to the number of poles.

With a four-pole machine the brushes can be connected in a simple manner, as shown in Figs. 58 to 60, but with a greater number of poles, two rings are generally provided, to which the brushes are connected in the manner shown in Fig. 61.

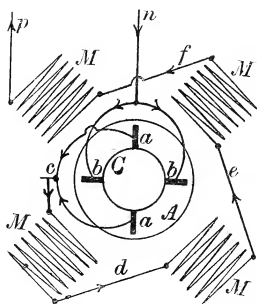


Fig. 58.

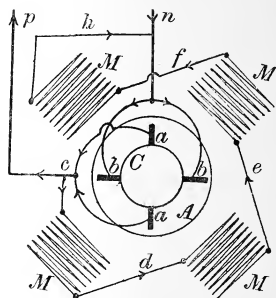


Fig. 59.

Looking at Fig. 54, it can be seen that if the current flows up from the paper, under the N poles, it will flow down through the paper, under the S poles: hence, the armature coils in a four-pole machine must span only one-quarter of the circumference, and not one-half, as in the two-pole armature. For a six-pole armature, the coils must span one-sixth of the circumference, and for an eight-pole, one-eighth, and so on, for any higher number of poles.

There are two types of winding for multipolar armatures, one being called the lap, or parallel winding, and the other the wave

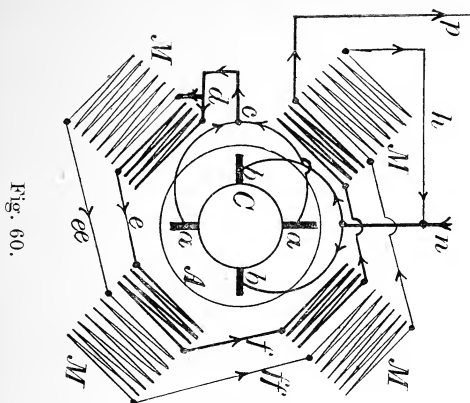


Fig. 60.

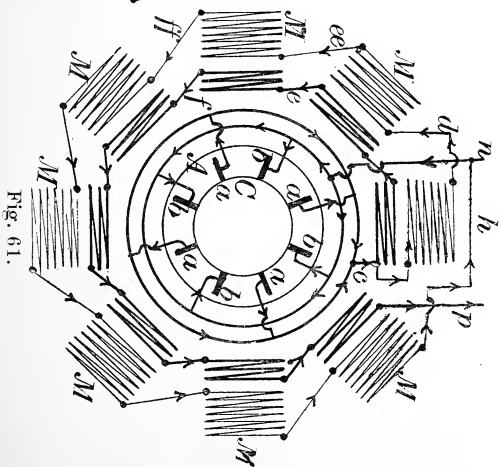


Fig. 61.

or series winding. Fig. 62 is a diagrammatic illustration of the lap winding, and Fig. 63 of the wave winding, both for four poles.

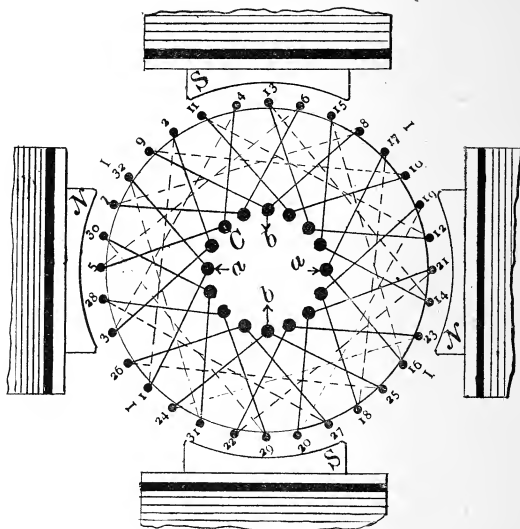


Fig. 62.

The small circles around the outside of the armature represent bars or wires, which are connected with the commutator segments by means of the solid lines, and with each other at the opposite side of the armature, by means of the broken lines.

If we start from coil side, or bar 1 on the left, and follow the connections as guided by the numbers, we will finally reach 32, and thus come back to left side brush *a*, which is the starting point. As will be seen, bar 1 connects at the back of armature,

with bar 2, and then over the front, the connection runs in the backward direction, to bar 3; thence, forward again, at the back end, to bar 4, and again backward over the front, to bar 5. The connections, therefore, lap over each other and it is on this account, that it is called a lap winding.

Fig. 63 shows the wave winding, and it will be noticed that if we start from bar 1 at the top, we advance around the right to bar 2, and then we go further ahead to bar 3, and in like manner advance to bar 4, the connections in every case advancing in the

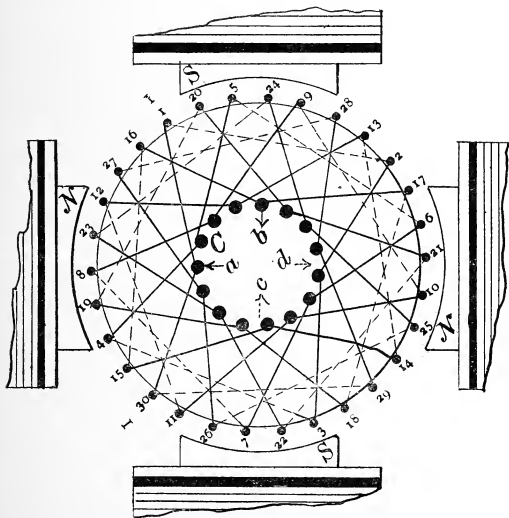


Fig. 63.

same direction around the circle. It will be further noticed that the connections run zig-zag from side to side of the armature core

as they advance, thus forming a wave-like path for the current, and it is on this account that this style of connection is called wave winding.

With the lap winding, the brushes *a a* are connected with each other, and so are the *b b* brushes. In the wave winding, two brushes set one-quarter of the circle from each other, will take the current off properly as indicated by *a* and *b* in Fig. 63, but four brushes can also be used.

In Fig. 54, the brushes are shown midway between the poles, while in Figs. 62 and 63, they are opposite the poles. This difference in position is due to the fact that in the last two named figures, the connections between the armature coils and the commutator segments do not run in radial lines from either side, but one connection bends backward and the other forward. In actual machines, the connections are run as in these diagrams, and in some cases, one of the sides runs in a radial direction; therefore, in some generators, the brushes are opposite the poles, and in others they are between them.

Diagrams 62 and 63 show coils of a single turn, but by regarding the broken lines as representing the position of the end of the coil at front as well as the back of the armature, and the solid lines as simply the ends of the wire that connect with the commutator segments, they become accurate representations of coils of any number of turns.

The coils of multipolar armatures are made on forms, and in the finished state are placed upon the armature core. Some coils are so formed as to bend down over the ends of the armature, and are then given the form at the ends, shown in Fig. 64, so they may fit into each other. In some machines, the coils do not bend down over the ends of the armature, but run out parallel with the shaft. Armatures so wound are sometimes said to have a barrel winding, and the coils, if laid out upon a flat surface, would present the appearance of Fig. 65; that is, if they con-

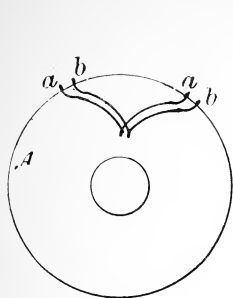


Fig. 64.

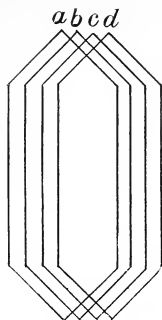


Fig. 65.

tained more than one turn. If of the single-turn type, they would look like Fig. 66, if for a lap winding; and like Fig. 67, if for a wave winding, the ends $d d$ being joined and then connected with the commutator segments.

In connecting the field coils of multipolar machines, it is necessary to be careful not to make mistakes, so that some of the

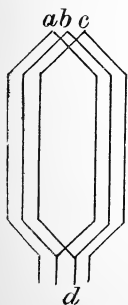


Fig. 66.

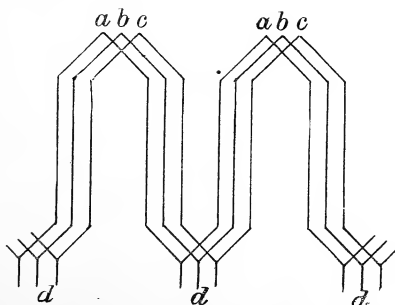


Fig. 67.

coils will act to magnetize the field in the wrong direction. By studying Fig. 27 and the explanation of it, the direction of the magnetic lines of force with respect to the direction of the current through the magnetizing coils, can be clearly understood, and then there will be no difficulty in determining the proper way in which to connect the coil ends, for all we have to do is to make the connections such that if one pole is *N* the one next to it is *S*. With two-pole machines, it is also necessary to be careful not to connect the field coils improperly; that is, if there is more than one coil, and in most machines this is the case. As a rule, two-pole machines have two field coils; many machines are made with only one coil, but as an offset to this, there are machines with four and even more coils.

CHAPTER V.

SWITCH-BOARDS, DISTRIBUTING CIRCUITS AND SWITCH-BOARD INSTRUMENTS.

Generators of the constant potential type are made so as to develop a certain voltage at a given velocity, but in some cases it is not practicable to run them at the exact speed for which they are designed; and in others, it is desired to vary the voltage slightly, hence, all machines are provided with means for changing the e.m.f. slightly. This regulating device is also necessary in cases where the load is for a time light, and for the balance of the time heavy; for, as we have shown, the voltage will vary to some extent with changes in the strength of the current. If the generator is at some distance from the points where the current is used, the drop of voltage in the lines will be greater with strong currents; hence, when the load is heavy, it is necessary to increase the voltage developed by the generator. As it is not advisable to change the speed of the engine, the variation of voltage is obtained by changing the strength of the current that flows through the shunt field coils, and this is accomplished by providing a resistance that can be cut in or out of the shunt coil circuit, as is illustrated in Fig. 68, in which R represents the resistance, or field regulator, as it is called. When the lever is moved to the extreme left position, all the regulator resistance is cut out of the circuit, and then the voltage of the generator is the highest that can be obtained with the speed at which it is running. When the lever is moved to the extreme right, all the resistance of the regulator is introduced into the shunt coil circuit, and then the voltage is the lowest. By placing the lever in

intermediate positions between the extremes right and left, different voltages may be obtained.

To be able to operate a generator furnishing current to a system of distributing wires, it is necessary to have a number of

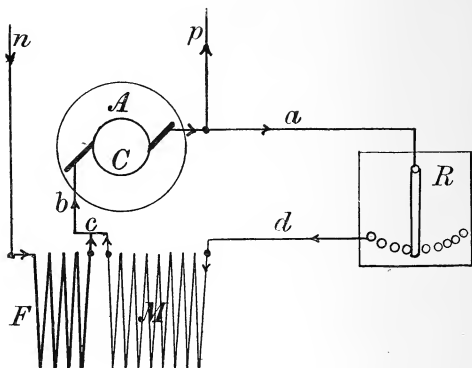


Fig. 68.

instruments and other devices, included in the circuit, some of which are absolutely indispensable, and others of which are simply conveniences, and may be looked upon as luxuries. The various devices required are shown in Fig. 69. The generator is shown at *M*, and at *e* the field regulator is placed, and it is connected with one of the generator armature terminals and with one end of the shunt coil wires by means of wires *d d*. The wires *c c* run from the generator terminals to the voltmeter *V*, and thus enable us to see what the voltage is at all times. Wires *a* and *b* convey the current to the external circuit, with which they can be connected or disconnected by means of switches *ss ss*. At *A* an ammeter is placed which indicates the strength of current in

amperes. The ammeter can be placed in either *a* or *b*, as the same strength current flows in both. At *ff* safety fuses are provided, so as to open the circuit in case the current becomes so strong as to be capable of overheating the generator wire. If one of the line wires runs out into the open air, and is carried along on poles, we will have to provide a lightning arrester, as shown at *h*, this being connected with the ground as at *g*. If both lines run into the open air, an arrester must be placed in both; and if both are confined to the interior of a building, no arresters will be required. From the points *m m* branch circuits may be run off in as many directions as necessary, and by providing switches *s s*, these can be connected or disconnected from the main line when desired.

This crude arrangement would enable us to operate the system successfully, but it would not be so convenient as a more methodi-

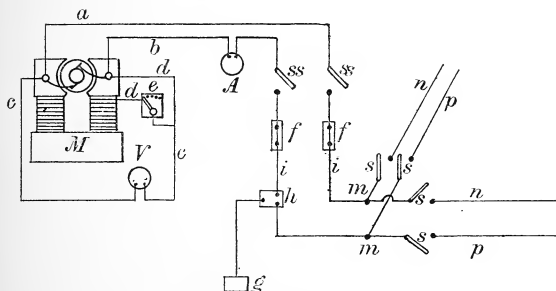


Fig. 69.

cal grouping of the several devices and instruments. It represents the way things were done in the early days of electric lighting, but at the present time, instead of having the several parts scattered about in a helter-skelter fashion, they are all assembled

upon a large panel, which is called a switch-board. Fig. 70 gives the general arrangement of wiring and location of devices for a simple board arranged for one generator feeding into five external

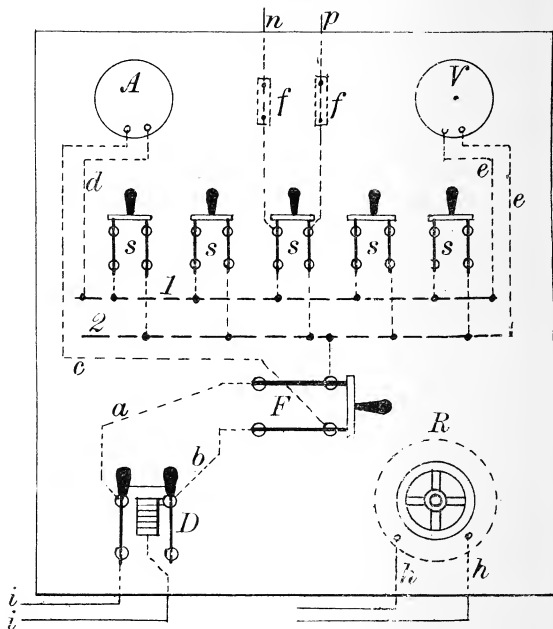


Fig. 70.

circuits. The ammeter and voltmeter are placed at the top of the board, and directly under these are arranged five switches, *s*, which control the external circuits. One of these circuits is indi-

cated by the lines $n p, f f$, being safety fuses. The wires $i i$ convey the main current from the generator to a circuit breaker D , which is simply a switch that is constructed so that it will open automatically when the current becomes too strong. From the circuit breaker, the current passes through wires a and b to the main switch F , and by wire c , it runs from here to the ammeter A and from the latter by wire d to a rod 1 which is called a bus bar. The upper side of the main switch is connected directly with bus 2. The voltmeter is connected with two busses by the wires $e e$. The field regulator is located back of the board at R , and is connected in the shunt coil circuit by means of wires $h h$. The switch of the regulator R is connected with a hand-wheel on the front of the switch-board, so that the attendant can watch the voltmeter as he turns the wheel and thus see just what effect the movement is producing on the voltage.

In addition to the devices shown in Fig. 70, we can, if desired, provide a recording ammeter, a recording voltmeter and a wattmeter; the first two would give us a record of the amperes and volts for a certain length of time, generally 24 hours, and the last one would register the amount of electrical energy. We could also provide ammeters for each one of the distributing circuits, so as to know the strength of current in each one.

If we desire to arrange the switch-board for two generators, and these are of the shunt type, we will require no changes in Fig. 70, except to provide another regulator and a main switch and circuit breaker for the additional machine. This arrangement of board is suitable for a single compound wound generator, or any number of shunt wound machines, but if we have two or more compound generators, the connections between these and the bus bars will have to be somewhat modified.

The modifications required in a switch-board for two or more compound generators can be made clear by the aid of Figs. 71 and 72. In the first figure, we can see that if the current return-

ing from the main line through n divides into wires a and b , it will remain divided until it passes through the armatures and the F coils of the two machines, and thence through wires $e e$, it will

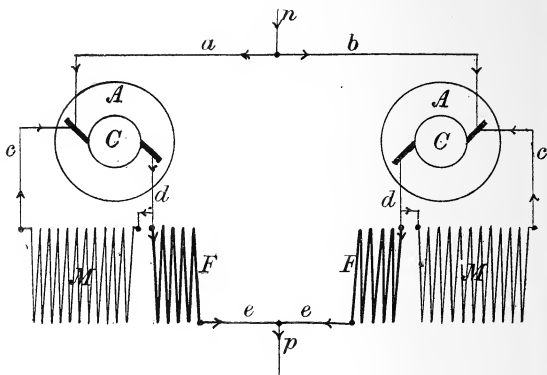


Fig. 71.

reunite again in wire p . In Fig. 72, the two parts of the current will flow through wires $d d$ to the single wire e , and then divide into wires $f f$, and thus reach the coils $F F$, and, finally, through wires $h h$, reach p . In Fig. 71, if the right side armature generates more current than the other one, the F coil of that generator will be traversed by the strongest current, for in each machine the strength of current in the armature and the F coil will be nearly the same. Now, if the right side machine generates the strongest current, it is because its voltage is the highest, but the fact that its F coil will be traversed by the strongest current will make its voltage still higher, thus increasing the difficulty. In Fig. 72, the current flowing through the two F coils will be the same, no matter how much the two armature currents may differ,

for these come together in wire e , and passing from this to the two F coils, the current will divide in equal amounts. As can be seen, the effect of adding the wires $d d$, e and $f f$ in Fig. 72 is to equalize the currents that flow through the F coils, and thus prevent, as far as possible, the unequal action of the generators.

When two or more compound generators are connected so as to feed into the same general circuit, the connections are made in accordance with Fig. 72. Fig. 73 illustrates a switch-board for two compound generators, and, as will be noticed, the most striking difference between it and Fig. 70, is that there are three bus bars instead of two. One of these busses is called the equalizer, and it takes the place of wires $d d e$ and

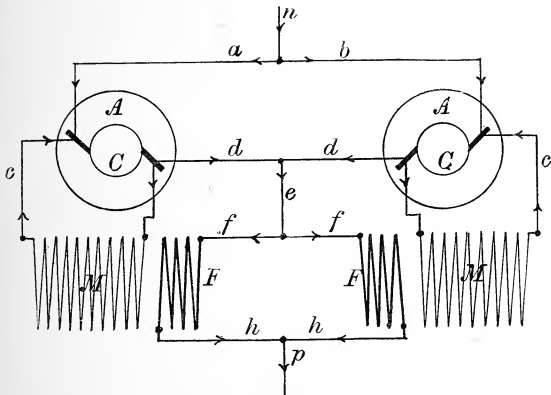


Fig. 72.

$f f$ in Fig. 72. The equalizing connections run from generator wires f to the main switches S , and thence to bus 1. The h wires of the generators run to one side of the circuit breakers $D E$,

and thence to the middle blades of the S switches, and from these to the bus 2. The generator wires run to the outside blades of of

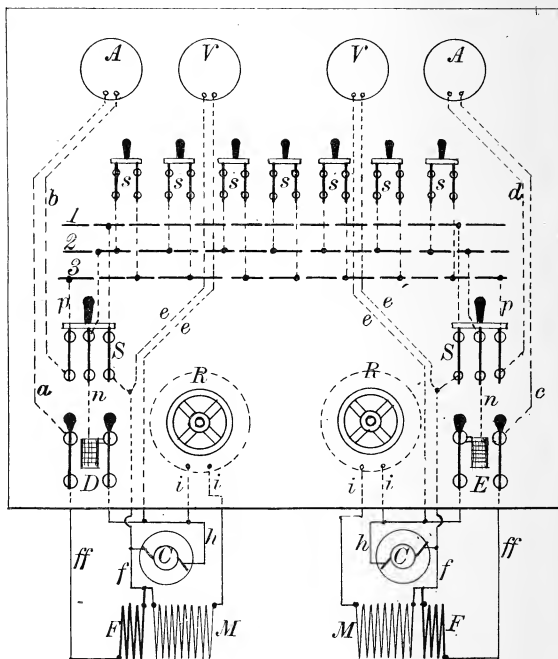


Fig. 73.

the circuit breakers, and from these to the ammeters A A , and thence to bus 3. The voltmeters are connected with wires h and f , and thus indicate the e.m.f.'s of the generators.

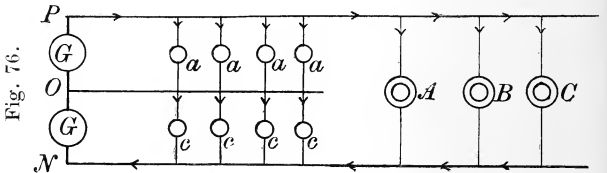
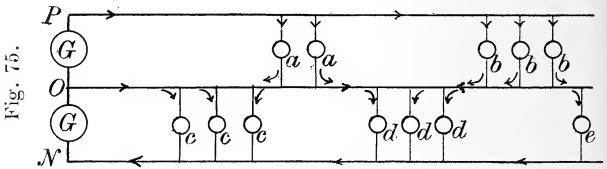
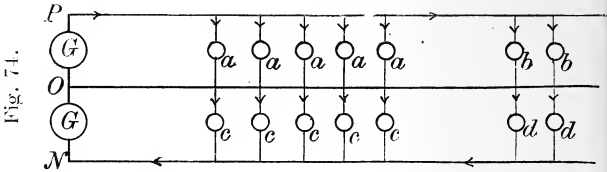
If another generator were added, it would be connected with the bus bars in the same way.

In starting two or more compound-wound generators, one machine is started first, and then the second is run up to full speed, and its voltage is adjusted by means of the regulator R , so as to be the same as that of the machine that is running. When the voltages of the two machines are equal, the main switch of the second machine is closed so as to connect it with the bus bars. This action will generally make a slight change in the voltage of the second machine, causing it to run up or down a trifle; and as a result by looking at the ammeters, we will find that it is taking more or less than its share of the load. If such is the case, we manipulate the regulator R , until the loads are properly divided. Whether the voltage of the second machine will rise or fall after it is connected with the bus bars, will depend upon the extent to which it is compounded; if slightly compounded, the voltage will drop, and if heavily compounded, it will rise.

The switch-boards illustrated are adapted to what is called the two-wire system of distribution, but in cases where it is desired to transmit the current to a considerable distance, without using extra large wire, the three-wire system of distribution is employed. This system is illustrated in Figs. 74 to 76.

Suppose we have two generators as indicated at $G G$ in these diagrams, and let the direction of the current through both be from bottom toward the top; then it is evident, that if we remove the middle wire O , the lower machine will deliver current into the upper one, and if each generator develops an e.m.f. of 115 volts, the combined e.m.f. will be 230 volts, and this will be the pressure between the bottom and top wires; but the voltage between either wire and the center one will only be 115. Suppose we have a number of lamps connected between wire P and the center wire O , and an equal number of lamps between O and N , as is shown in Fig. 74; then it is evident that the same amount

of current will flow through both sets, and as a consequence, all the current that passes from the upper generator into wire *P* will go directly through both sets of lamps to the lower wire *N*, and thus return to the lower side of the bottom generator. Under



these conditions, the lamps will be acted upon by 115 volts each, but the current will be driven through the circuit by a voltage of 230. Now, if the voltage is doubled, four times the number of lamps can be supplied with the same size wires; hence, the cost of line wire per lamp will be reduced to one-fourth. Suppose, that instead of having the lamps equally divided as in Fig. 74.

they are arranged as in Fig. 75; then since the current fed into the system from the upper wire P is only sufficient for five lamps, while there are seven lamps in the lower section, it follows that through wire O a current sufficient for two lamps must be supplied. The way in which the currents would flow in this case is clearly indicated by the arrows.

In Fig. 74, it will be seen that if we removed the middle wire, the lamps would not be affected, for none of the current comes through it; but in Fig. 75, if we cut the middle wire, two of the lower lamps would be unprovided for. From this it will be seen that the object of the middle wire is simply to provide the extra current required for the side that carries the largest number of lamps. If the lights are so arranged that on both sides of the central wire O the number is practically the same at all times, the center wire can be made very small, but such perfect balance cannot be obtained always, and on that account, the center, or neutral wire, as it is called, is made of the same size as the others, except in large systems, in which it is sometimes not more than one-third the size.

As motors require large amounts of current, they are nearly always made to operate with a voltage of 230, and are connected with the outside wires of the system, as is shown in Fig. 76, in which $a a a a$ and $c c c c$ indicate lamps connected between the sides and the neutral wire, and $A B C$ are motors connected across the outside lines.

When a switch-board is arranged for two generators connected with a three-wire system, we use three bus bars, just as in Fig. 70, but discard the equalizing connection, and connect the generators with the busses in the same way as they are connected with wires $N O$ and P in Figs. 74 to 76. If we have a number of generators feeding into the three-wire system, then we connect each set with an equalizer bus; that is, provide two sets of busses, and the P and N busses of these two sets we connect

with a third set in the proper order for the three-wire system, and from the latter busses the external circuits are fed.

If we desire to supply a larger building with a lighting and power system, we can run the wires in almost any way, providing we make connections with the lamps and motors, but if we adopt

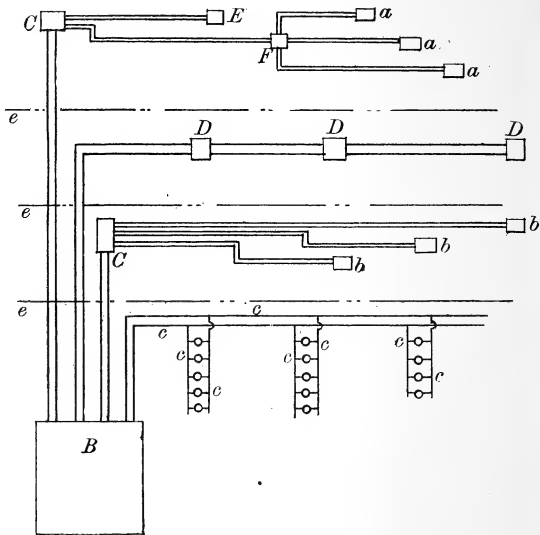


Fig. 77.

a systematic arrangement it will require less labor to operate the plant, and when anything goes wrong we will be able to locate the difficulty with much less trouble and in less time. The best way to accomplish this is by the use of small switch-boards located at different points in the building, these becoming centers

of distribution, from which all the lamps are supplied. The general arrangement of such a system can be understood from Fig. 77, in which *B* represents the main switch-board, located in the engine room, and *e e e* the several floors upon which the lights are located. From the main switch-board we run up four lines, one to each floor, and locate secondary boards at *C C* and *D D D*. We can also run out lines directly from the board to the lamp circuits as at *e e e e*. From the boards *C C*, we run circuits to smaller boards, as shown at *E, F, A, A, A*, and *b b b*. From each one of these small boards we can run out circuits to the lamps.

These small switch-boards are called panel boards or boxes, and also distribution boards. They are made of all sizes from eight or ten inches square, up to four or five feet, and are arranged to feed into one or two, or fifty or sixty circuits, supplying anywhere from five or six lights up to a thousand or more.

The construction of distribution boards can be understood from Figs. 78 and 79, the first being arranged for the three-wire system, and the second for the two-wire. Fig. 78 is arranged to feed ten circuits, and is provided with one main switch by means of which the entire box can be disconnected from the main line. The distributing circuits are provided with safety safety fuses on the outside wires, so that if anything goes wrong and the current increases to a dangerous point, the circuit will be open. No fuse is placed on the middle wire, as it is not necessary, and might result in cutting out both sides of the circuit when only one was disabled.

Fig. 79 is a more complete panel, because each one of the six distribution circuits is provided with a switch, so that it is possible to disconnect any of the circuits without interfering with the others. In some cases a distribution board of this kind is the only thing that will answer the purpose, but in others, the more

simple construction of Fig. 78 answers just as well. The fuses in Fig. 78 are shown at *E F*. These fuses are sometimes made so that they can be used as switches; that is, they can be pulled out

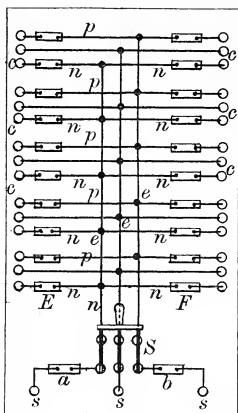


Fig. 78.

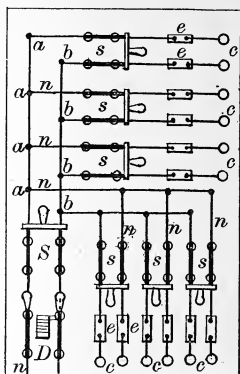


Fig. 79.

of place and thus open the circuit, and if one blows out it can be removed and a new fuse be put in, and then it can be replaced, thus placing the disabled circuit in service without interfering with the others.

The ammeters and voltmeters used on switch-boards depend for their operation upon the repulsion between magnetic lines of force. A great many different constructions are used, but most of them operate upon the principles illustrated in Fig. 80 or 81. If a small bar of iron *c* is placed between the poles of a permanent magnet, as in Fig. 80, it will be held in the horizontal position by the attraction of the magnet. If it is surrounded by a stationary coil of wire *b*, through which a current of electricity passes, then

it will be under the influence of two forces, one the attraction of the poles $N S$ of the magnet, and the other the attraction of the lines of force developed by the current flowing through coil b . The action of the latter will tend to swing the rod c into the vertical position. The force of the magnet will remain constant, but the force of the coil will vary with the strength of the current passing through it; hence, the stronger the current the more the bar c will be swung around into the vertical position. If we provide a small counter-weight, as shown in the illustration, to resist the action of the coil, we will have a means that will enable us to adjust the movement of the bar, so that it will swing around through a given angle for a given increase in current. If a pointer a is secured to c it will swing over the scale as shown, when c is rotated by the action of the coil.

If coil b is mounted so that it may swing around the center pivot, we can discard bar c , for then as soon as a current traverses b , the lines of force developed around it will be attracted by

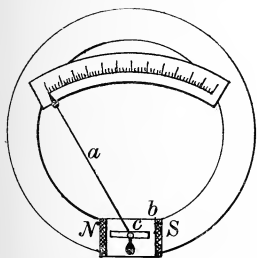


Fig. 80.

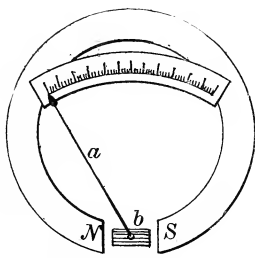


Fig. 81.

those of the permanent magnet, and will exert a twisting force so as to place the axis of the coil parallel with the lines of force passing from N to S . In this case as in the previous case, the

effort to twist b around will be proportional to the strength of the current, hence, the stronger the current the greater the swing. Ammeters and voltmeters are made on these principles, and the only difference in the two instruments is in the size of the wire used for the coils.

Figs. 82 and **83** illustrate the principle upon which circuit breakers are made. In **Fig. 82**, suppose a current flows through magnet E , then it will attract the lever A , the latter being made

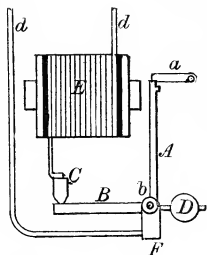


Fig. 82.

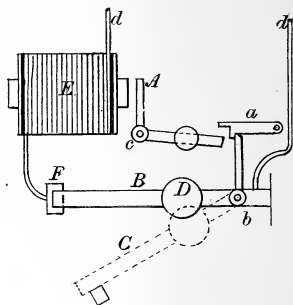


Fig. 83.

of iron. If the current is weak it may not develop a sufficient attractive force in E to lift the weight D , and in that case A will remain where it is. If, however, the current is increased until E becomes strong enough to lift D , then A will move over toward the magnet, and the catch " a " falling behind it, will not allow it to return to its former position until placed there by hand. When A swings over, it carries B , and thus breaks the connection with C and opens the circuit. Thus it will be seen that by properly adjusting the weight D and the magnet E , we can set the device so as to open the circuit whenever the current reaches a certain strength. This is the principle upon which circuit break-

ers act, but such a device as Fig. 82 would be of no service for lighting circuits, because the distance by which C and B are separated is too small to break the current. By modifying the construction as in Fig. 83, we can obtain a device that will give a wide separation at the breaking point. In this construction, the lever A when drawn towards the magnet, strikes the catch a , so as to release lever B , and then the weight D throws the latter down to the position shown in broken lines, thus giving a wide separation between F and C . By moving the weight on the lower arm of A , the device can be adjusted so as to act with different strengths of current.

Circuit breakers as actually constructed, do not have the appearance of this diagram, but they operate on the principle illustrated by it.

CHAPTER VI.

ELECTRIC MOTORS.

Motors are made so as to run at a constant velocity, or for variable speed. For the latter type of machine, the field coils are wound in series, and for constant speed the shunt winding is used. A motor of either kind cannot be started successfully without placing an external resistance in the armature circuit, because, when the armature is at a standstill, there is nothing but the resistance of the wire to hold the current back, and as a result, if no extra resistance is provided, the first rush of current would be very great. As soon as the armature begins to revolve, an e.m.f. is induced in its wires, and this acts in opposition to the e.m.f. of the line current; that is, it acts like a back pressure, and holds the current back. On this account, the e.m.f. of a motor is called a counter e.m.f., and it is abbreviated into c.e.m.f.

The way in which the external resistance is connected with a motor is illustrated in Fig. 84, in which M is the motor and R the external resistance. D is a main switch, by means of which the motor is connected with the main line. This switch is closed first, and then switch F is moved to the right until it covers the first contact of the resistance R . The current can then pass directly to the field shunt coils through wire e , and thence by wire a , return to the main line. The armature current, however, has to first pass through the resistance R , before it can reach wire i , and thus the armature. As soon as the armature begins to speed up, the switch F is advanced, step by step, and in a few seconds it is moved to the extreme right position, in which all the resistance R is cut out of the armature circuit. When F reaches this position, the motor should be running at full speed.

If the current should stop while the motor is running, the machine would stop, also, and then, if the current were turned on again, the motor would be caught with the armature connected across the line without an external resistance, and as it would be at a standstill, the current would rise to an enormous strength. To prevent this, the switch *F* is always opened whenever the motor stops. The attendant may forget to do this, however; therefore automatic switches have been devised that will open themselves whenever the current dies out.

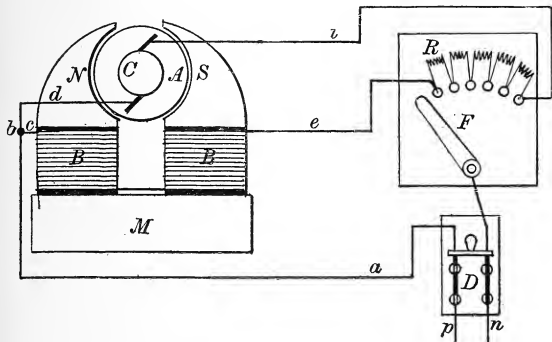


Fig. 84.

A simple switch provided with a resistance so as to be suited to start a motor, is called a motor-starter, and one that in addition is provided with means for automatically flying to the open position whenever the current fails, is called an automatic under-load starter.

If the motor is very much overloaded, its speed will slow down and the current will increase in strength. If the overload is sufficient, the current will become so strong as to be able to burn out

the armature; hence, it is desirable to provide a circuit breaker that will open the circuit when the current becomes so strong as to be liable to burn out the machine. Motor-starters are made with a circuit-breaking attachment, and are then called automatic overload motor-starters. A device that combines the under and overload starter, features is called an automatic under and overload starter, and by some people it is called a "no voltage" and "overload starter."

When motors were first introduced, a great deal of trouble was experienced with the starters, owing to the fact that they were arranged so that when the motor was stopped, the connection with the field coils was broken. Now, the current flowing through the field coils objects to stop flowing when the connection is broken, and, consequently, it continues to flow between the end of switch *F* in Fig. 84, and the last of the contacts of *R*, until the distance is more than the e.m.f. of the current can overcome.

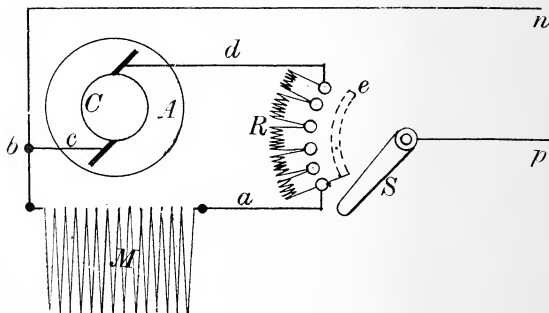


Fig. 85.

This action produces serious sparking at the last terminal, and in addition, produces a severe strain upon the insulation of the

field coils, because, as the current is headed off in one direction, it tries to find an outlet in another. This action is what is

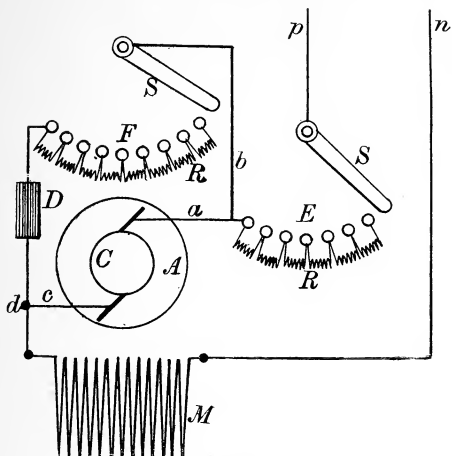


Fig. 86.

commonly called the "kick of the motor field." All this trouble can be obviated by connecting the starter with the motor in such a way that the field circuit is never opened, as is shown in Fig. 84. As this is quite an important point, I will present it in a more simple form in Fig. 85, in which it will be seen that the field coils and armature are permanently connected, so that when switch *S* opens the circuit, the field current can flow through the armature, until it dies out. All first-class concerns make motor starters with this connection, at the present time. Some of them add the curved contact *e*. Without this contact, it can be seen that when the switch *S* is moved to the top position, the

resistance R is simply transferred from the armature to the field circuit, and that the current going to the field coils has to pass through this resistance. As this resistance is insignificant in comparison with that of the shunt coils, it makes little difference whether it is left in the field circuit or not, but by the addition of e it can be cut out.

Variable speed motors are always arranged so that the speed may be changed by hand as conditions may require. Trolley-car motors are of this type, and so are the motors used for printing presses, and many other kinds of work. Figs. 86 to 88 show arrangements by means of which the speed may be varied with series wound motors. In Fig. 86, E is the starting box and F is the speed regulator. In the act of starting, the switches are in the position shown. To start, the switch S and E is turned so as to close the circuit with the resistance R all included. S is moved toward the left as the armature speeds up, and reaches the last position when full speed is attained. If the switch of F is now closed, a portion of the current will be diverted from the armature, and thus its rotating force will be reduced, and thereby its speed. This method of speed control is also arranged so that the two switches act together, so as to introduce resistance into the motor circuit, and at the same time divert more or less of the current around the armature. It is not used extensively, as all the current that passes through F is just so much thrown away.

In Fig. 87 the speed is controlled by means of the switch F , which cuts out portions of the field coils and this changes the strength of the field. With this arrangement, if a portion of the field is cut out, the motor will run faster, because the c.e.m.f will be reduced, therefore, the armature current will be increased. To obtain a wide range of regulation, it is necessary to wind a large number of turns of wire on the field, so that with all the wire in service, the speed may be the lowest required.

Fig. 88 shows another arrangement that varies the strength of the field by diverting a portion of the current through switch *F*. It gives as wide a range of regulation as Fig. 87, but is not so economical.

Figs. 86 and 88 cannot be used to regulate the speed of shunt motors, but Fig. 87 can. The first two named figures, if used

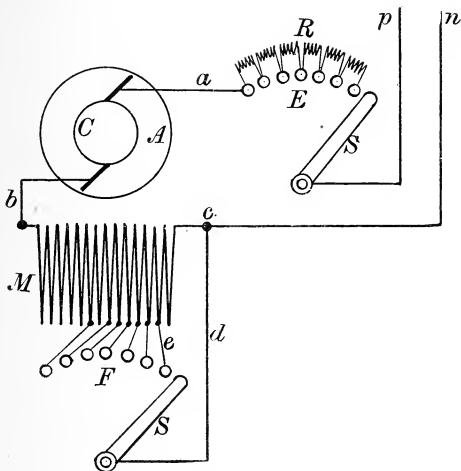


Fig. 87.

with a shunt motor, would simply afford a third path through which current could pass from one side of line to the other, that is, from the *p* to the *n* wires, but this would not materially affect the strength of current that would flow through the armature and field coils. They work with series wound motors, because the current is not shunted from wire *p* to wire *n* but simply from one side of the armature, or the field, to the other.

Fig. 89 shows an arrangement by means of which a shunt motor can be made for variable speed. In this case, the switch

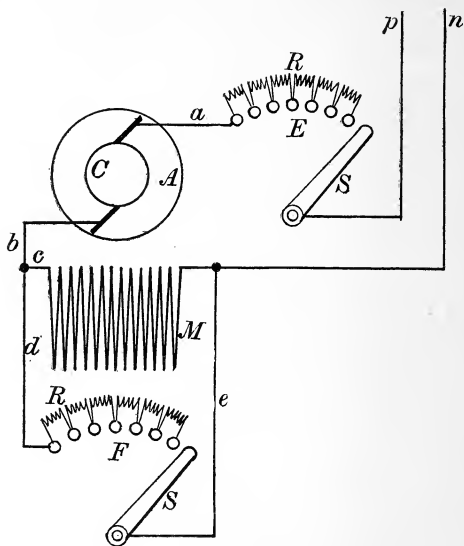


Fig. 88.

and resistance E is simply an ordinary starter, and F is a resistance that is introduced in the field circuit, so as to vary the strength of the field. With this arrangement the slowest speed is obtained when all the resistance of F is out of the circuit.

The direction in which a motor runs can be reversed by simply reversing the direction of the current through the armature. Any of the arrangements for varying the speed can be used in connection with reversible motors by arranging the switch so as

to reverse the armature connections. Fig. 90 will give a fair idea of the way in which a reversing switch is made. This represents the type of switch used most generally for this purpose, and it is known as the cylinder switch. It is the kind used on trolley-cars. The vertical row of circles numbered from one to eleven represents stationary contact pieces, to which the terminals of the motor, the line and the resistance are attached. The shaded parts *B B* are metal plates that are secured to the surface of a cylinder, that is so located that as it is turned in one direction or the other, these plates slide over the stationary contacts. If the cylinder is turned so that the plates on the right side slide over the contacts, the motor will run in one direction, and if the cylinder is turned in the other direction, the motor will be reversed. Suppose the right side plates slide over the con-

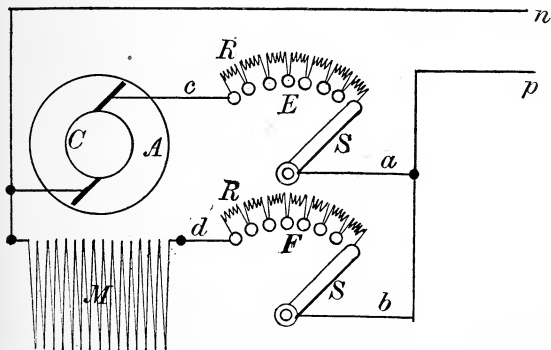


Fig. 89.

tacts, then the current from *p* will pass to contact 2, and thence to wire *a*, and to the left-side of the field. Through wire *d* it will return from the field to contact 5, and by means of

plates N and T , which are connected as shown at X^1 , it will reach contact 3 and wire b , which runs to the lower side of the armature. From the top of the armature, through wire c , the current will return to contact 4 and through plates S and M and the connection X will reach contact 6, which by one of the wires e con-

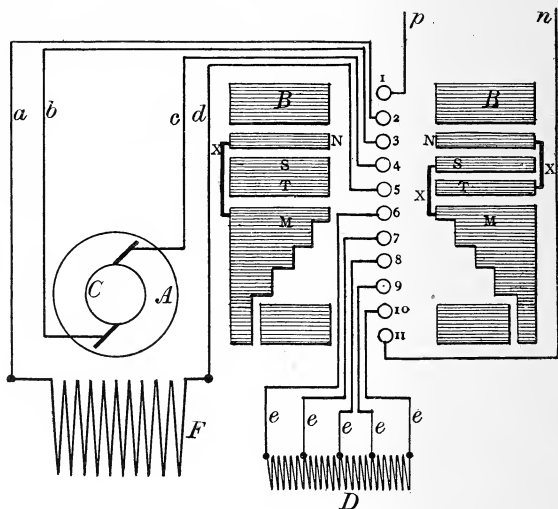


Fig. 90.

nects with the left-side of the resistance D . From the right-side of this resistance, the current will pass to contact 10, and thus to contact 11, through the cylinder plate, and in that way reach line wire n .

If the cylinder is turned further around, contact 7 will be covered by plate M , and this will cut one section of D . By a further

movement contact 8 will be covered, thus cutting out another section, and by continuing the movement, all of D can be cut out.

If the cylinder is turned so as to slide the left-side plates over the contacts, the change effected will be that contact 5 will be connected with 4 instead of with 3, and contact 6 will be connected with 3 instead of 4, thus reversing the direction of the current through the armature.

CHAPTER VII.

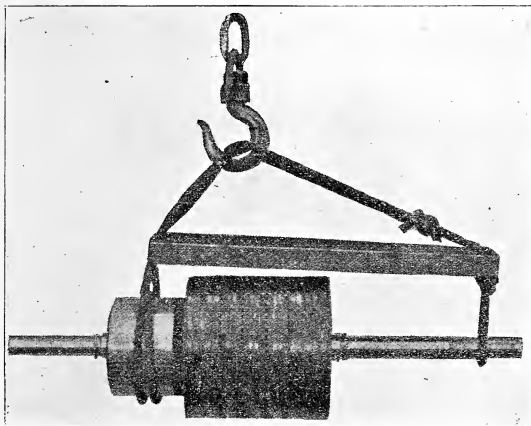
INSTRUCTIONS FOR INSTALLING AND OPERATING SLOW AND MODERATE SPEED GENERATORS AND MOTORS.

To remove the armature, take off the brush-holders, brush yoke, pulley and bearing caps and put a sling on the armature, as shown in accompanying illustration. The rope should make two or more turns about the commutator and each turn should lie straight and flat. A spreader of suitable length should be used and its location adjusted to prevent the rope from drawing against the flange or end connections, by tying a double knot in the sling, as shown. After the armature has been raised free from the bearings, the sleeves can be taken off and the armature supported in some convenient place by arranging blocks under the shaft at either end.

In assembling, marked parts of the machine should be assembled strictly according to the marking. Clean all connection joints carefully before clamping them together. Wipe the shaft-bearing sleeves and oil cellars perfectly clean and free from grit. Place the bearing sleeves and oil rings in position on the shaft and then lower the armature into place, taking care that the oil rings are not jammed or sprung. As soon as the armature is in position, pour a little oil in the bearing sleeves, put the cap on the boxes and screw them down snugly. If the caps are not put on immediately, the boxes should be covered to prevent dirt or grit falling into the bearings. The top field should next be put on and bolted firmly into position, and a level placed on the shaft to check the leveling of the foundation.

Fill the bearings with the best grade of thin lubricating oil and

do not allow it to overflow. Oil throwing is usually due to an excess of oil and can be avoided by care in filling the oil cellars.



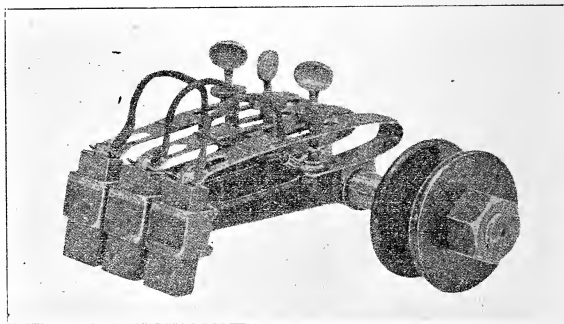
To complete the assembly, place the pulley on the shaft, draw up the set screws and put on the brush rigging and connection blocks.

BRUSH SETTING.

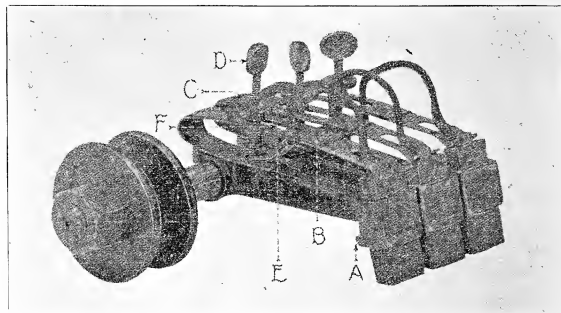
Place the brush-holders on the studs so that the boxes (A) which hold the brushes, shall be about $\frac{1}{2}$ " from the surface of the commutator, and clamp them firmly in this position. From time to time the brush-holders should be turned slightly on the studs, to compensate for the wear of the commutator.

Place the brushes in the holders, as shown in the figure and screw down the pressure spring "B" by turning the nut C, so as to give about $1\frac{1}{2}$ lbs. pressure for $1\frac{1}{4}$ " brushes and $\frac{3}{4}$ lb. for $\frac{3}{4}$ " brushes. Nothing is gained by increasing the pressure per

square inch on a carbon brush above two pounds, as the resistance per square inch beyond this point is practically not reduced,



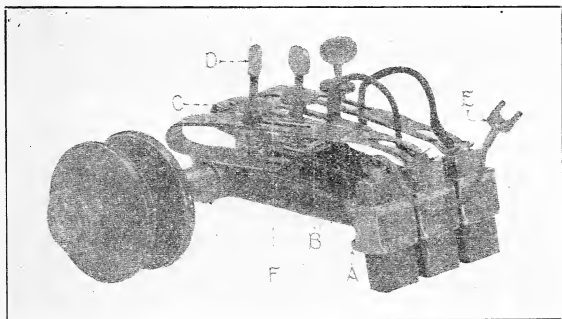
whereas, the friction is increased in direct proportion to the pressure.



Fit the carbon brushes carefully to the commutator by passing beneath them No. 0 sandpaper, the rough side against the brush

and the smooth side held down closely against the surface of the commutator. Move the sandpaper in the direction of rotation of the armature, and on drawing it back for the next cut, raise the brush so as to free it from the sandpaper, then lower the brush and repeat the operation until a perfect fit is obtained. If the brush requires considerable sandpapering, No. 2 sandpaper may be used at first, but the final fitting must be done with No. 0. If an attempt be made to fit the brushes without raising them when drawing the sandpaper back, it will in every case fail to give satisfactory results. When thick brushes are used — say $\frac{3}{4}$ " — in addition to following the above instructions, the machine should be run as long as convenient without load in order to improve their surface. As soon as the brushes of a set appear to make a good fit, one of them should be removed from the brush-holders in the following manner, to determine if they are worn to a surface.

Unscrew the stud *D*, thereby freeing the end of the pig-tail *E*, and push the spring *B* forward, so that there will be plenty



of room to draw the tip *E* on the end of the pig-tail through the slot *F*. Then draw the pig-tail through the slot *F*, bend it

forward and turn the spring *B* to one side, as shown in the last cut. The brush may then be withdrawn from the box. In replacing the brush, these directions should be followed in reverse order.

Care should be taken not to disturb the nut *C*, after it has once been set, as it is not necessary to alter the pressure of the spring *B* in removing or replacing a brush. By this means a practically constant pressure may be kept on the brush.

STARTING.

Before putting on the belt, see that all screws and nuts are tight and turn the armature by hand to see that it is free and does not rub or bind at any point. Put on the belt with the machine so placed on the rails as to have the minimum distance between pulley centers. Start the machine up slowly and see that the oil rings in bearings are in motion. As the machine comes up to speed, tighten the belt till it runs smoothly, and run the machine long enough without load to make sure that the bearings are in perfect condition. The bearings, when running, should be examined at least once a week. When it is necessary to renew the oil, draw the old oil from the reservoir through the opening in the side of the pedestal.

CARE OF COMMUTATOR.

The commutator brushes and brush-holders should at all times be kept perfectly clean and free from carbon or other dust. Wipe the commutator from time to time with a piece of canvas lightly coated with vaseline. If vaseline is not at hand, use oil, but lubricant of any kind should be applied very sparingly.

If a commutator when set up begins to give trouble by roughness, with attendant sparking and excessive heating, it is necessary to immediately take measures to smooth the surface. Any

delay will aggravate the trouble, and eventually cause high temperatures, throwing off solder, and possibly displacement of the segments. No. 0 sandpaper, fitted to a segment of wood, with a radius equal to that of the commutator, if applied in time to the surface when running at full speed (and if possible with brushes raised), and kept moving laterally back and forth on the commutator, will usually remedy the fault. If this does not suffice, it will then be necessary to tighten up the segments and turn them off true. A machine tool will not leave the surface smooth enough to give perfectly satisfactory results. It is always necessary before putting on the load, after the commutator has been turned, to carefully smooth the surface with the finest sandpaper, thus removing all traces of the tool point.

GENERATORS.

As soon as the machine is set up and in running order, see that it excites itself and comes up to full voltage. If it does not, trace out the field connections and test the polarity. The trouble will probably be found in improper field connections.

When the machine is to be run in parallel with other machines, and the direction of the current is found to be opposite to that desired, raise the brushes and excite the fields by closing the main switch from the bus-bars.

DIRECTIONS FOR STARTING DYNAMOS.

General. — Make sure that the machine is clean throughout, especially the commutator, brushes, electrical connections, etc. Remove any metal dust, as it is very likely to make a ground or short circuit.

Examine the entire machine carefully, and see that there are no screws or other parts that are loose or out of place. See that the oil-cups have a sufficient supply of oil, and that the passages

for the oil are clean and the feed is at the proper rate. In the case of self-oiling bearings, see that the rings or other means for carrying the oil work freely. See that the belt is in place and has the proper tension. If it is the first time the machine is started, it should be turned a few times by hand, or very slowly, in order to see if the shaft revolves easily and the belt runs in centers of pulleys.

The brushes should now be carefully examined and adjusted to make good contact with the commutator and at the proper point, the switches connecting the machine to the circuit being left open. The machine should then be started with care and brought up to full speed, gradually if possible; and in any case the person who starts either a dynamo or a motor should closely watch the machine and everything connected with it, and be ready to throw it out of circuit if it is connected, and shut down and stop it instantly if the least thing seems to be wrong, and should then be sure to find out and correct the trouble before starting again.

STARTING A DYNAMO.

In the case of a dynamo it is usually brought up to speed either by starting up a steam-engine or by connecting the dynamo to a source of power already in motion. The former should, of course, only be attempted by a person competent to manage steam-engines and familiar with the particular type in question. This requires special knowledge acquired by experience, as there are many points to appreciate and attend to, the neglect of any of which might cause serious trouble. For example, the presence of water in the cylinder might knock out the cylinder-head; the failure to set the feed of the oil-cups properly might cause the piston-rod, shaft, or other part, to cut. And other great or small damage might be done by ignorance or care-

lessness. The mere mechanical connecting of a dynamo to a source of power is usually not very difficult; nevertheless, it should be done carefully and intelligently, even if it only requires throwing in a friction-clutch or shifting a belt from a loose pulley. To put a belt on a pulley in motion is difficult and dangerous, particularly if the belt is large or the speed is high, and should not be tried except by a person who knows just how to do it. Even if a stick is used for this purpose, it is apt to be caught and thrown around by the machinery, unless it is used in exactly the right way.

It has been customary to bring dynamos to full speed before the brushes are lowered into contact with the commutator; but this is not necessary, provided the dynamo is not allowed to turn backwards, which sometimes occurs from carelessness in starting, and might injure copper brushes by causing them to catch in the commutator. If the brushes are put in contact before starting, they can be more easily and perfectly adjusted, and the e.m.f. will come up slowly, so that any fault or difficulty will develop gradually and can be corrected; or the machine can be stopped, before any injury is done to it or to the system. In fact, if the machine is working along on a system, and is absolutely free from any danger of short-circuiting any other machine or storage battery on the same circuit, it may be started while connected to the circuit, but not otherwise. If there are a large number of lamps connected to the circuit, the field magnetism and voltage might not be able to "build up" until the line is disconnected an instant.

If one dynamo is to be connected to another, or to a circuit having other dynamos or a storage battery working upon it, the greatest care should be taken. This coupling together of dynamos can be done perfectly, however, if the correct method is followed, but is likely to cause serious trouble if any mistake is made.

SWITCHING DYNAMOS INTO CIRCUIT.

Two or more machines are often connected to a common circuit. This is especially the case in large buildings where the number of lamps required to be fed varies so much that one dynamo may be sufficient for certain hours, but two, three or more machines may be required at other times. The various ways in which this is done depending upon the character of the machines and of the circuit and the precautions necessary in each case make this a most important and interesting subject, which requires careful consideration.

Dynamos may be connected together either in parallel (multiple arc) or in series.

DYNAMOS IN PARALLEL.

In this case the $+$ terminals are connected together or to the same line, and the $-$ terminals are connected together or to the other line. The currents (i. e. amperes) of the machines are thereby added, but the e.m.f. (volts) are not increased. The chief condition for the running of dynamos in parallel is that their voltages shall be equal, but their current capacities may be different. For example: A dynamo producing 10 amperes may be connected to another generating 100 amperes, provided the voltages agree. Parallel working is, therefore, suited to constant potential circuits. A dynamo to be connected in parallel with others or with a storage battery, must first be brought up to its proper speed, e.m.f., and other working conditions, otherwise, it will short-circuit the system, and probably burn out its armature. Its field magnetism must, therefore, be at full strength, owing to the fact that it generates no e.m.f. with no field magnetism. Hence, it is well to find whether the pole pieces are strongly magnetized by testing them with a piece of

iron, and to make sure of the proper working of the machine in all other respects before connecting the armature to the circuit. It is a common accident for the field-circuit to be open at some point, and thus cause very serious results. In fact, a dynamo should not be connected to a circuit in parallel with others until its voltage has been tested and found to be equal to, or slightly (not over 1 or 2 per cent) greater than that of the circuit. If the voltage of the dynamo is less than that of the circuit, the current will flow back into the dynamo and cause it to be run as a motor. The direction of rotation is the same, however, if it is shunt-wound, and no great harm results from a slight difference of potential. But a compound-wound machine requires more careful handling.

DIRECTIONS FOR RUNNING DYNAMOS AND MOTORS.

In the case of a machine which has not been run before, or has been changed in any way, it is of course wise to watch it closely at first. It is also well to give the bearings of a new machine plenty of oil at first, but not enough to run on the armature, commutator or any part that would be injured by it, and to run the belt rather slack until the bearings and belt have gotten into easy working condition. If possible, a new machine should be run without load or with a light one for an hour or two, or several hours in the case of a large machine; and it is always wrong to start a new machine with its full load, or even a large fraction of it.

This is true even if the machine has been fully tested by its manufacturer and is in perfect condition, because there may be some fault in setting it up, or some other circumstance which would cause trouble. All machinery requires some adjustment and care for a certain time to get it into smooth working order.

When this condition is reached, the only attention required is to supply oil when needed, keep the machine clean and see that it is not overloaded. A dynamo requires that its voltage or current should be observed and regulated if it varies. The person in charge should always be ready and sure to detect the beginning of any trouble, such as sparking, the heating of any part of the machine, noise, abnormally high or low speed, etc., before any injury is caused, and to overcome it by following directions given elsewhere. Those directions should be pretty thoroughly committed to mind, in order to facilitate the prompt detection and remedy of any trouble when it suddenly occurs, as is apt to be the case. If possible, the machine should be shut down instantly when any trouble or indication of one appears, in order to avoid injury and give time for examination.

Keep all tools or pieces of iron or steel away from the machine while running, as they might be drawn in by the magnetism, and perhaps get between the armature and pole-pieces and ruin the machine. For this reason, use a zinc, brass or copper oil-can instead of iron or "tin" (tinned iron).

Particular attention and care should be given to the commutator and brushes to see that the former keeps perfectly smooth and that the latter are in proper adjustment. (See Sparking.)

Never lift a brush while the machine is delivering current, unless there are one or more other brushes on the same side to carry the current, as the spark might make a bad burnt spot on the commutator.

Touch the bearings and field-coils occasionally to see that they are not hot. To determine whether the armature is running hot, place the hand in the current of air thrown out from it by centrifugal force.

Special care should be observed by any one who runs a dynamo or motor to avoid *overloading* it, because this is the cause of most of the troubles which occur.

PERSONAL SAFETY.

Never allow the body to form part of a circuit. While handling a conductor, a second contact may be made accidentally through the feet, hands, knees, or other part of body in some peculiar and unexpected manner. For example, men have been killed because they touched a "live" wire while standing or sitting upon a conducting body.

Rubber gloves or rubber shoes, or both, should be used in handling circuits of over 500 volts. The safest plan is not to touch any conductor while the current is on, and it should be remembered that the current may be present when not expected, due to an accidental contact with some other wire or to a change of connections. Tools, with insulated handles, or a dry stick of wood, should be used instead of the bare hand.

The rule to use only one hand when handling dangerous electrical conductors or apparatus is a very good one, because it avoids the chance, which is very great, of making contacts with both hands and getting the full current right through the body. This rule is often made still more definite by saying, "Keep one hand in your pocket," in order to make sure not to use it. The above precautions are often totally disregarded, particularly by those who have become careless by familiarity with dangerous currents. The result of this has been that almost all the persons accidentally killed by electricity have been experienced electric linemen or stationmen.

CHAPTER VIII.

WHY COMMUTATOR BRUSHES SPARK AND WHY THEY DO NOT SPARK.

I might give a long list of reasons why commutator brushes spark, and why they do not spark, but by such a procedure no light would be thrown on the subject, because the reasons would not be understood unless fully explained. I therefore propose to explain the subject and let the reader tabulate the reasons after digesting the explanation of the principles involved.

Whenever an electric current is interrupted, a spark is produced, and it makes no difference how the current is generated, or what kind of a conductor it is flowing through. To break a current without a spark is not a possibility; hence, if we desire to open a circuit without producing a spark, the only way to accomplish the result is by killing the current before the circuit is opened. The brushes resting on the commutator of a motor or a generator have to transmit to the armature and take away from it the current that is generated, in the case of a generator, or the current that drives the machine in the case of a motor. If the brushes were made so narrow that they could only make contact with one commutator segment at a time, it would be impossible to run the machine without producing very destructive sparks. To fulfill these conditions, the brushes would have to be very thin, and the insulating separation between the segments rather wide, so that the width of the latter would be more than the width of the end of the brush. With these proportions, the brush could rest entirely upon an insulating strip, and would not touch the adjoining segments. Commutators, however, are not made in this way. The insulation between the seg-

ments is narrow, and the brushes are wide enough to be always in contact with two segments, and part of the time with three, while in some machines the brushes cover three segments, and part of the time make contact with four. Now, suppose that the proportions are such that during most of the time the brush only touches two segments, as, for example, the proportions shown in Fig. 1. With these proportions, it will be seen, by reflecting upon the subject, that so long as there are two segments in contact with each brush, it is a possibility for the current to be diverted through one of them only. Now, suppose that at the instant when the forward segment is passing from under the brush, all the current flows through the rear segment; then it is quite evident that the first-named segment will break away from contact with the brush without making a spark, for there will be no current flowing from it to the brush, hence, no current to interrupt; and there can be no spark unless there is an interruption of a current.

All the foregoing is self-evident, but it will be suggested that although the brush can break away from the front segment without producing a spark, it cannot do the same thing with the rear segment, for all the current is flowing through this one. This way of looking at the matter is not correct, however, for while it is true that when the forward segment passed from under the brush all the current was flowing through the rear segment, it is not true that the current continues to follow this path. As soon as the front segment passes from under the brush, the rear one becomes the forward segment, and while it is advancing to the point where it must pass from under the brush, the current can be transferred to the next segment back of it which now plays the part of rear segment. Thus we see that to be able to run a machine without producing sparks at the commutator, all we have to do is to provide means whereby the current is transferred from one segment to the one back of it as the

commutator revolves, so that when the segments pass from under the brush there is no current flowing through them. This result is accomplished more or less perfectly in all machines, made by responsible firms. There are machines on the market that have been designed by men that are not well enough posted in the principles of electrical science to obtain proper proportions, and these are not proportioned so as to shift the current from the forward to the rear segment as fast as the machine revolves; such machines always produce more or less serious sparking.

If a machine is accurately made and the armature coils and commutator segments are properly spaced and sufficient in number, it is possible to get the brushes so there will be little or no spark at a given load; but if the current strength be increased or reduced, the sparks will appear, and the more the current is changed the larger the sparks will be, the increasing current producing the greatest sparking.

The way in which the current is shifted from the front to the rear segment I will explain in connection with Fig. 1. In this figure, *A* represents a portion of the core of a ring armature. The shaft upon which it is mounted is shown at *D*, and *P N* are the corners of the poles between which it rotates. The small blocks *C* represent a portion of the commutator segments, which we have placed outside of the armature, so as to make the diagram as simple as possible. For the same reason I have shown the armature coils as made of two turns of wire each. The line *F F* divides the space between the ends of the poles into two equal parts, and the line *E E* divides the armature into the two halves on which the direction of the induced currents is opposite. In all the coils to the right of line *E E* the currents are induced in a direction away from the shaft, and in all the coils to the left of line *E E* the currents flow toward the shaft, all of which is clearly indicated by the arrow heads placed upon the lines representing the coils. The outline *B* represents the end of one of

the brushes, and from the direction in which it is inclined it will be understood that the armature revolves in a direction counter to that of the hands of a clock.

When the armature is in the position shown, the current flowing in the coils to the right of line $E E$ passes to segment b , and

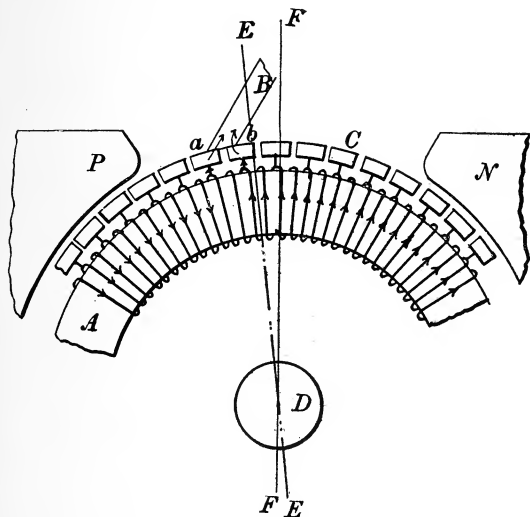


Fig. 1.

thus reaches the brush, while the current flowing in the coils to the left of line $E E$ reaches segment a , and through this passes to the brush. As the brush rests upon segments a and b , the coil with which they connect is short-circuited, and therefore a current can flow in it in any direction, or there may be no current. To be able to run without spark, or to obtain per-

fect commutation, as it is called, the current in this short-circuited coil, when in the position shown, should be zero, or nearly so. This coil, which is short-circuited by the brush, is called the commutated coil, or the coil undergoing commutation. It will be noticed that this commutated coil is in a position just forward of the line $E E$; hence, the action of pole P will be to develop a current in it that will flow in the same direction as the current in the coils ahead of it, that is, in the coils to the left. Now if this current flowed through the brush, it would be in a direction contrary to that of the arrow at a ; hence, it would act to check the current flowing from the front segment a to the brush, and would divert it through the commutated coil to the rear segment b . If the action of pole P upon the commutated coil is sufficiently vigorous, the current developed in it will be as strong as the current in the coils ahead of it, by the time the end of the segment is about to break away from the brush; and this being the case, there will be no current from segment a to the brush, and consequently, no spark. If the action of pole P is not strong enough, then there will be a small current from segment a to the brush when they separate, and as a result, a small spark. If the action of pole P on the commutated coil is too vigorous, then the current developed in it will be too great, and it will not only divert all the current coming from the forward coils, through the commutated coil to segment b , but in addition will develop a local current that will circulate through the end of the brush, and therefore, when the separation occurs, there will be a current flowing from the brush to the front segment, and consequently, a spark.

If the commutated coil were placed astride of line $E E$, the action of pole P upon it would be no greater than that of pole N , so that no current would be developed in it while undergoing commutation. The further the coil is in advance of line E , when short-circuited by the brush, the stronger the action of pole P

upon it; therefore, the strength of the current developed in the commutated coil can be increased by moving the brush further away from pole *P*. Hence, by trial, a point can be found where the current developed will be just sufficient for the purpose and no more. This is true, supposing the current developed by the armature to remain constant, but, if it varies, the current in the commutated coil will be either too great or too small. If, when the brushes are set, the armature is delivering a current of, say, twenty amperes, then the current flowing through the coils to the left of the brush will be ten amperes, and the current in the commutated coil will also be ten amperes. If the armature current increases to forty amperes, the current in the forward coils will be twenty amperes, and as that in the commutated coils will still be ten amperes, it will have only one-half the strength required for perfect commutation. In practice, however, it is found that if the commutator have a sufficient number of segments, and the proportions of the machine are such that the line *E E* remains practically in the same position for all strengths of armature current, then, if the brushes are set so as to run sparkless with an average load, they will run so nearly sparkless with a heavy or light load as to make it difficult to detect the difference.

Even when a machine is properly proportioned, the brushes may spark badly if they are not set in the proper position and with the proper tension. If the tension is not right, they will spark no matter where they are set. If the tension is too light, they will spark, because they will chatter and thus jump off the surface of the commutator. If the tension is too great, they will spark because they will cut the commutator, and then the latter will act as a file or grindstone and cut away particles from the brushes, and these will conduct the current from segment to segment, as well as from the segment to the brush. Whenever a commutator is seen to be covered with fine sparks, some of which

run all the way around the circle, it may be depended upon that the surface is rough, due in most cases to too much pressure on the brushes, and the remedy is to smooth it up and reduce the tension and set the brushes where they will run with the smallest spark. When the brushes begin to spark they rarely cure themselves and the longer they are allowed to run with a heavy spark, the worse they will get.

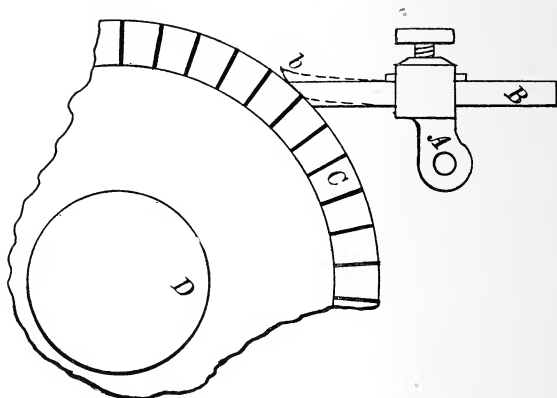


Fig. 2.

Two-pole machines in which gauze brushes are used, frequently give trouble on account of the tension being so great as to cause the brushes to cramp and be dragged along by the friction against the commutator surface. This action is illustrated in Fig. 2, in which the dotted lines show the end of the brush pulled forward by the friction against its end. Sometimes this occurs from using gauze brushes in brush-holders that were originally made to hold copper leaf brushes. As the gauze is not very elastic, if it gets a bend it does not come back to its original shape, hence in the

course of time it gets badly out of line. To remedy this difficulty, the best procedure is to place a strip of spring brass on top of the brush that will reach nearly to the end. Then unless the tension is entirely too great, it will not be pulled forward by the friction on the end.

SPARKING AT COMMUTATOR.

This is one of the most common troubles, the objection to it being that it wears, or may even destroy the commutator and brushes, and produces heat, which may injure the armature or bearings. Any machine having a commutator is liable to it, including practically all direct-current and some alternating-current machines. Alternating-current machines have continuous collecting rings which are not likely to spark, but self-exciting or compound-wound alternators require a supplementary continuous-current commutator which may spark. This trouble can be prevented in most cases, however, by proper construction and care. Of all the troubles which may occur, sparking is the only one which is very different in the different types of machines. In some its occurrence is practically impossible. In others, it may result from a number of causes. The following cases of sparking apply to nearly all machines, and they cover closed-coil dynamos and motors completely.

The very peculiar cases which may arise in particular types of open-coil armatures can only be reached by special directions for each. A certain amount of sparking occurs normally in most constant-current dynamos for arc-lighting, where it is not very objectionable, since they are designed to stand it and the current is small.

Cause.—Armature carrying too much current, due to (a) overload (for example, too many lamps fed by dynamo, or too much mechanical work done by constant potential motor): a bad short-circuit, leak or ground on the line may also have the effect

of overloading a dynamo; (b) excessive voltage on a constant-potential circuit or excessive amperes on a constant-current circuit. In the case of a motor on a constant potential circuit, any friction, such as armature striking pole-pieces, or shaft not turning freely, will of course have the same effect as overload in producing excessive current. The armature of a motor on a constant-current circuit does not tend to heat more when overloaded, because the current and the heat it produces in the armature ($C^2 R$) are constant. In fact, the armature can be stopped with full current on without injury, except loss of ventilation.

Symptom.— Whole armature becomes overheated, and belt very tight on tension side, and sometimes squeaks, due to slipping on pulley. Overload due to friction is detected by stopping machine and then turning it slowly by hand. (See "Heating of Bearings" and "Noise," Cause.)

Remedy.— (c) Reduce the load or eliminate the short-circuit, leak or ground on the line; (d) decrease the size of driving-pulley, or (e) increase the size of driven pulley; (f) decrease magnetic strength of the field in the case of a dynamo, or increase it in the case of a motor. If excess of current cannot satisfactorily be overcome in any of the above ways, it will probably be necessary to change the machine or its winding. (Overload due to friction is eliminated as described under "Heating of Bearings" and "Noise.")

If the starting or regulating box of a motor on a constant potential circuit has too little resistance, it will cause the motor to start too suddenly and spark badly at first. The only remedy is more resistance in the box.

Cause.— Brushes not set at the neutral point.

Symptom.— Sparking, varied by shifting the brushes with rocker-arm.

Remedy.— Carefully shift brushes backwards or forwards

until sparking is reduced to a minimum. This may be done by simply moving the rocker-arm. If only slightly out of position, heating alone may result, without disarrangement being bad enough to show sparking. If the brushes are not exactly opposite, or in a four-pole machine 90° apart, they should be made so, the proper points of contact being determined by counting the commutator-bars, or measuring with a string or paper. The brushes should also be carefully adjusted in line with each other. If one is ahead or behind the others, they may span too much of the commutator.

The usual position for brushes in two-pole machines is opposite the spaces between the pole-pieces. If the brushes are set very far wrong, namely, half way toward the proper position for the other brush, it will cause a dynamo to fail to generate, and a motor to fail to start. (See "Dynamo Fails to Generate.")

Cause. — Commutator rough, eccentric, or has one or more "high bars" projecting beyond the others, or one or more flat bars, commonly called "flats," or projecting mica, any one of which causes brush to vibrate, or to be actually thrown out of contact with commutator. The effect of eccentricity may be produced by the shaft being *loose* in bearings while commutator is perfectly true on shaft. This will allow whole armature to chatter when running at full speed. Hard mica between the bars which does not wear as rapidly as the copper, will throw brushes off.

Symptom. — Note whether there is a glaze or polish on the commutator, which shows smooth working: touch revolving commutator with tip of finger-nail, and the least roughness is perceptible, or feel of brushes to see if there is any jar. If the machine runs at high-voltage (over 250), the commutator or brushes should be touched with a small stick or quill to avoid danger of shock. In the case of an eccentric commutator, careful

examination shows a rise and fall of the brush when commutator turns slowly, or a chattering of brush when running fast. Sometimes, by sighting in line with brush contact one can see clear daylight between commutator and brush, owing to brush jumping up and down.

Remedy.—Smooth the commutator with a fine file or fine sand-paper, which should be applied by a block of wood which exactly fits the commutator (in latter case, be careful to remove any sand remaining afterward; and *never use emery*). If bearing is loose, put in new one. If commutator is very rough or eccentric, the armature should be taken out and put in a lathe, and the commutator turned off. Large machines sometimes have a slide-rest attachment, so that the commutator can be turned off without removing the armature. This is clamped on the pillow-block after removing the rocker-arm.

In turning a commutator in the lathe, a diamond-pointed tool should be used, this being better than either a round or square end. The tool should have a very sharp and smooth edge, and only an exceedingly fine cut should be taken off each time in order to avoid catching in or tearing the copper, which is very tough. The surface is then finished by applying a "dead smooth" file while the commutator revolves rapidly in the lathe. Any particles of copper should then be carefully removed from between the bars.

In order to have the commutator wear smooth and work well, it is desirable to have the armature shaft move freely back and forth about $\frac{1}{16}$ or $\frac{1}{8}$ of an inch in the bearings. The position of the bearings, pulleys, collars, and shoulders on the shaft and of the machine with respect to the belt should be such as to cause this to take place of itself—except in the case of types of machines in which the pole-pieces surround the ends of the armature. It is desirable for the commutator to have a dull glaze of a brown or bronze color. A very bright or scraped appearance does not

indicate the best condition. Sometimes a *very little* vaseline, or a drop of oil may be applied to a commutator which is rough. Too much oil is very bad, and causes the following trouble.

Cause. — Brushes make poor contact with commutator.

Symptom. — Close examination shows that brushes touch only at one corner, or only in front or behind, or there is dirt on surface of contact. Sometimes, owing to the presence of too much oil or from other cause, the brushes and commutator become very dirty and covered with smut. They should then be carefully cleaned by wiping with oily rag or benzine, or by other means.

Occasionally a "glass-hard" carbon brush is met with. It is incapable of wearing to a good seat or contact and will only touch in one or two points, and should be discarded.

Remedy. — File, bend, adjust or clean brushes until they rest evenly on commutator, with considerable surface of contact and with sure but light pressure. Copper brushes require a regular brush-jig. Carbon brushes may be fitted perfectly by drawing a strip of sand-paper back and forth between them and the commutator while they are pressing down, which cuts them to the shape of the commutator. A band of sand-paper may be pasted or tied around the commutator, and if the armature is then slowly revolved by hand or by power, and the brushes are pressed upon it, they will be very effectively, rapidly and perfectly shaped to the commutator.

It sometimes happens that the brushes make poor contact, because the brush-holders do not turn or work freely.

Cause. — Short-circuited coil in armature or reversed coil.

Symptom. — A motor will draw excessive current, even when running free without load. A dynamo will require considerable power even without any load. (For reversed coil, see "Heating of Armature.")

The short-circuited coil is heated much more than the others, and is very apt to be burnt out entirely; therefore, stop machine

immediately. If necessary to run machine to locate the short-circuit, one or two minutes is long enough, but it may be repeated until the short-circuited coil is found by feeling the armature all over.

An iron screw-driver or other tool held between the field-magnates near the revolving armature vibrates very perceptibly as the short-circuited coil passes. Almost any armature, particularly one with teeth, will cause a slight but rapid vibration of a piece of iron held near it, but a short-circuit produces a much stonger effect only *once* per revolution. Be very careful not to let the piece of iron be drawn in and jam the armature.

The current pulsates and torque is unequal at different parts of a revolution, these being particularly noticeable when armature turns rather slowly. If a large portion of the armature is short-circuited, the heating is distributed and harder to locate. In this case a motor runs very slowly, giving little power, but having full-field magnetism. A short-circuited coil can also be detected by the drop-of-potential method.

Remedy. — A short-circuit is often caused by a piece of solder or other metal getting between the commutator-bars or their connections with the armature, and sometimes the insulation between or at the ends of these bars is bridged over by a particle of metal. In any such case the trouble is easily found and corrected. If, however, the short-circuit is in the coil itself, the only real cure is to rewind the coil.

One or more "grounds" in the armature may produce effects similar to those arising from a short-circuit.

Cause. — Broken circuit in armature.

Symptom. — Commutator flashes violently while running, and commutator-bar nearest the break is badly cut and burnt; but in this case no particular armature coil will be heated; as in the last case and the flashing will be very much worse, even when turn-

ing slowly. This trouble, which might also be confounded with a bad case of "high-bar" or eccentricity in commutator (sparking), is distinguished from it by slowly turning the armature, when violent flashing will continue if circuit is broken, but not with eccentric commutator or even with "high bar," unless the latter is very bad, in which case it is easily felt or seen. A very bad contact would have almost the same effect as a break in the circuit.

Remedy.—The trouble is often found where the armature wires connect with the commutator and not in the coil itself, and the break may be repaired or the loose wire may be resoldered or screwed back in place. If the trouble is due to a broken commutator connection and it cannot be fixed, then connect the disconnected bar to the next by solder, or "stagger" the brushes; that is, put one a little forward and the other back so as to bridge over the break. If the break is in the coil itself, rewinding is generally the only cure. But this may be remedied temporarily by connecting together by wire or solder the two commutator-bars or coil terminals between which the break exists. It is only in an emergency that armature coils should be cut out of commutator bars connected together, or other makeshifts resorted to, but it sometimes avoids a very undesirable stoppage. A very rough but quick and simple way to connect two commutator-bars is to hammer or otherwise force the coppers together across the mica insulation at the end of the commutator. This should be avoided if possible, but if it has to be done in an emergency, it can afterwards be picked out and smoothed over. In carrying out any of these methods, care should be taken not to short-circuit any other armature coil which would cause sparking.

Cause.—Ground in Armature.

Symptom.—Two "grounds" (accidental connections between the conductors on the armature and its iron core, or the shaft or spider) would have practically the same effect as a short-circuit,

and would be treated in the same way. A single ground would have little or no effect, provided the circuit is not intentionally or accidentally grounded at some other point. On an electric railway ("trolley"), or other circuit which employs the earth as the return conductor, one or more grounds in the armature would allow the current to pass directly through them, and would cause the motor to spark and have a very variable torque at different parts of a revolution.

Remedy.— A ground is detected by testing with magneto bell. Another way to locate it is to wrap a wire around the commutator so as to make connection with all of the bars, and then connect a source of current to this wire and to the armature core (by pressing a wire upon the latter). The current will then flow from the armature conductors through the ground connection to the core, and the magnetic effect of the armature winding will be localized at the point where the ground is. This point is then found by the indications of a compass-needle when slowly moved around the surface of the armature. The current may be obtained from a storage-battery or from the circuit, but then it should be regulated by lamps or a resistance box, so as not to exceed the normal armature current. Sometimes the ground may be in a place where it can be corrected without much trouble, but usually the particular coil, and often others have to be rewound. A ground will be produced if the insulation is punctured by a spark of static electricity, which may be generated by the friction of the belt; in fact, a belt usually gives off electric sparks while running. If the frame of the machine is connected to the ground, the static charge will pass off to the ground, but this grounding is not generally considered allowable. The frame may be connected to the ground through a Geissler tube, a wet thread, a heavy pencil-mark on a piece of unglazed porcelain, or other very high resistance which will carry off a static charge that is of very high potential and almost infinitesimal quantity, but

will not permit the passage of any considerable current, which might cause trouble.

Cause. — Weak field-magnetism.

Symptom. — Any considerable vibration is almost sure to produce sparking, of which it is a common cause. This sparking may be reduced by increasing the pressure of the brushes on the commutator, but the vibration itself should be overcome by the remedies referred to above.

Cause. — Chatter of Brushes. The commutator sometimes becomes sticky when carbon brushes are used, causing friction, which throws the brushes into rapid vibration as the commutator revolves, similarly to the action of a violin-bow.

Symptom. — Slight tingling or jarring is felt in brushes.

Remedy. — Clean commutator and oil slightly. This stops it at once.

HEATING IN DYNAMO OR MOTOR.

General Instructions. — The degree of heat that is injurious or objectionable in any part of a dynamo or motor is easily determined by feeling the various parts. If the heat is bearable for a few moments, it is entirely harmless. But if the heat is unbearable for more than a few seconds, the safe limit of temperature has been passed, except in the case of commutators in which solder is not used; and it should be reduced in some of the ways that are given below. In testing with the hand, allowance should always be made for the fact that bare metal feels much hotter than cotton, etc. If the heat has become so great as to produce an odor or smoke, the safe limit has been far exceeded and the current should be shut off and the machine stopped immediately, as this indicates a serious trouble, such as a short-circuited coil or a tight bearing. The machine should not again be started until the cause of the trouble has been found and positively overcome. Of course neither water nor ice should ever be used to cool elec-

trical machinery, except possibly the bearings of large machines, where it can be applied without danger of wetting the other parts.

Feeling for heat will answer in ordinary cases, but of course, the sensitiveness of the hand differs, and it makes a very great difference whether the surface is a good or bad conductor of heat. The back of the hand is more sensitive and less variable than the palm for this test. But for accurate results, a thermometer should be applied and covered with waste or cloth to keep in the heat. In proper working, the temperature of no parts of the machine should rise more than 45° C. or 81° F *above* the temperature of the surrounding air. If the actual temperature of the machine is near the boiling point, 100° C. or 212° F., it is seriously high.

It is very important in all cases of heating to locate correctly the source of heat in the exact part in which it is produced. It is a common mistake to suppose that any part of a machine which is found to be hot is the seat of the trouble. A hot bearing may cause the armature or commutator to heat or vice versa. In every case, all parts of the machine should be felt to find which is the hottest, since heat generated in one part is rapidly diffused throughout the entire machine. It is generally much surer and easier in the end to make observations for heating by starting with the whole machine perfectly cool, which is done by letting it stand for one or more hours or over night, before making the examination. When ready to try it, run it fast for three to five minutes, with the field magnets charged; then stop, and feel all parts immediately. The heat will be found in the right place, as it will not have had time to diffuse from the heated to the cool parts of the machine. Whereas, after the machine has run some time, any heating effect will spread until all parts are equal in temperature, and it will then be almost impossible to locate the trouble.

Excessive heating of commutator, armature, field magnets, or bearings may occur in *any* type of dynamo or motor, but it can almost always be avoided by proper care and working conditions.

THE EFFECT OF THE DISPLACEMENT OF THE ARMATURE.

After an electric generator or motor has been in use for several years it is liable, like other machines, to begin to act badly. It is then examined, and if anything is noticed that is not what it should be in appearance, this particular thing is assumed to be the cause of all the trouble. Sometimes the conclusion may be correct, but very often it is not. If a machine is old, it is more than likely the shaft will be found out of center, and if this fact is discovered at a time when things are not working as they should, it is taken for granted this is the cause of the trouble. What is true of shafts out of the center is true of several other things that are liable to get out of place. For the present it will be sufficient to investigate just what effect the displacement of the shaft can have; then if the trouble with a machine so afflicted is not in the category of shaft disorders, we will know that we must seek further for the cause of the complaint.

Fig. 1 illustrates an armature of a two-pole machine which is out of center in one direction, and **Fig. 2** shows another two-pole armature out of center in a direction of right angles to that shown in the first figure. The condition shown in **Fig. 1** could be produced by a heavy armature running in rather light bearings for several years, and the side displacement of **Fig. 2** could be produced by the tension of an extra tight belt. The mechanical effect of both these conditions would be to increase the pressure on the bearings, as the part *a* of the armature would be drawn toward the poles of the field with greater force than the opposite side. The downward pull, due to the attraction of the magnetism, would be greater in **Fig. 1** than the side pull in **Fig.**

2, supposing both armatures and fields to be the same in both cases, and the displacement of the shafts equal. This difference is due to the fact that in Fig. 1 the magnetism of both poles is concentrated at the lower corners on account of the shorter air gap; hence, both sides pull much harder on the lower side. In Fig. 2, the pull of the *N* pole is greater than that of the other, simply because in the latter the magnetism is more dispersed, but the difference in the density on the two sides will not be very great. If the bearings of a machine, with the armature displaced, have shown any signs of cutting, or if they

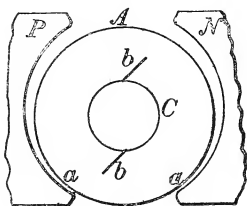


Fig. 1.

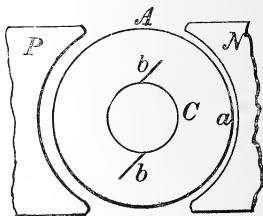


Fig. 2.

run unusually warm, their condition will be improved by putting in new bearings that will bring the shaft central.

If the armature is of the drum type, the displacement of the shaft will have no effect upon it electrically. This is owing to the fact that all the armature coils are wound from one side of the core to the other, and, therefore, at all times, every coil has one side under the influence of one pole and the other side under the influence of the opposite pole, and if one side is acted upon strongly by one pole, it will be acted upon feebly by the other. If the armature is of the ring type, then the displacement of the shaft will affect it electrically, for in a ring armature, the coils on one side are acted upon by

the pole on that side, only, and as the magnetic field from one pole will be stronger than that from the other (that is, considering the action upon equal halves of the armature), the voltage developed in the coils on one side of the armature will be greater than that developed on the other side. In Fig 1 if the brushes *b b* could be placed on the vertical diameter, as shown, the electrical action would not be interfered with, for on each side of the vertical line the magnetic action would be the same. But the reaction of the magnetism developed by the armature current twists the magnetism around, so that the brushes have to be rotated around some distance from the vertical line; therefore, even in the case of Fig. 1, the electrical balance will be disturbed if the armature is of the ring type.

The effect of the disturbance of the electrical balance will be that the brushes will spark badly, because the voltage of the current generated on one side of the armature will be greater than than that of the current on the other side. Hence, when these two currents meet at the brushes, the strong one will tend to drive the weak one backward. If, while the armature is out of center, we wish to adjust the brushes so as to get rid of the excessive sparking, all we have to do is to set them to the right of the center line, as in Fig. 2, so that the wire on the left side will cover a greater portion of the circumference than the right; or, what is the same thing, so there will be more commutator segments between the brushes on the left side than on the right. In this way the voltages of the two armature currents can be equalized and the sparking can be reduced to the normal amount, or nearly so.

In a multipolar machine, the displacement of the armature will have the same effect mechanically as in the two-pole type; that is, it will increase the pressure on the bearings and probably cause them to cut, or at least to run warmer than they should. The effect produced upon the electrical action will depend upon the way in which the armature is wound; or, more properly

speaking, upon the way in which the armature coils are connected with each other and with the commutator segments. As was explained in articles on construction of electrical machines, multipolar armatures are connected in two different ways, one of which is called the wave or series winding, and the other the lap or parallel winding. In the first named type of winding, the ends of all the coils on the armature are connected with each other and with the commutator segments in such a manner that there are only two paths through the wire for the current; therefore, these two armature currents pass under all the poles and the voltage of each current is the combined effect of all the poles. From this very fact, it can be clearly seen that it makes no difference what the distance between the several poles and armature may be, for if some are nearer than the others, the only effect will be that these poles will not develop their share of the total voltage, but whatever their action may be, it will be the same on the coils in both circuits.

When a multipolar armature is connected so as to form a parallel or lap winding, then the connections between the coil ends, and between these ends and the commutator segments, are such that as many paths are provided for the current as there are poles, and each one of these paths is located under one pole, and as a consequence, the voltage developed in it is proportional to the action of this pole. The diagram 3 illustrates a six-pole armature with the ends of the field poles, and the arrows *a a*, *b b*, *c c*, indicate the six separate divisions of the coils in which the branch currents are developed. Now, it can be clearly seen that as the armature is nearer to the lower poles than to any of the others, the action of these will be the strongest. Hence, the currents *a a* will be stronger than the others and will have a higher voltage. These two currents will be taken off the commutator by the brushes at the lower corners. These same brushes also take off the currents developed by the action of the side poles, and

which are indicated by the side arrows *b c*. These last two currents will be weaker and of lower voltage than the *a a* currents, hence, the latter will try to crowd them back, and thus sparks will be produced at these brushes.

The two upper currents are weaker than the side ones and their voltage is also lower, so that, the current returning to the

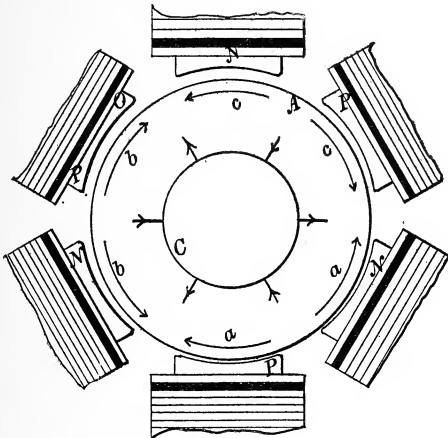


Fig. 3.

commutator through the brushes at the upper corners, will not divide equally, but the larger portion will be drawn into the coils on the side; and as the upper coils will have to fight to hold their own, so to speak, there will be a disturbance of the balance that is required for smooth running. The result will be heavy sparking at these brushes. If these four brushes were shifted downward, the lower ones being moved more than the upper ones, points could be found where the sparking would disappear. This

readjustment of the brushes would be the same thing, for a multipolar machine, as the shifting to one side, as explained in connection with the action of a two-pole ring wound armature. Multipolar machines, however, are seldom made so that the brushes can be moved individually, so we cannot count on correcting the trouble temporarily in this way. In the great majority of cases, if the brushes of a multipolar machine spark on account of the armature being out of center, the only cure is to reset the bearings, if they are adjustable, and if they are not, to put in new ones.

In the two-pole machines, we have seen that if the armature is of the drum type, the action of the brushes will not be affected by the displacement of the shaft, and this will also be the case in a multipolar machine if the armature is wave, or series wound. From this it will be inferred that there is a similarity between the two-pole drum winding and the multipolar wave winding, and such is really the case. The multipolar lap winding is the counterpart of the two-pole ring winding, and in fact, a ring wound armature will work perfectly in a machine with any number of poles, provided we place upon the commutator as many brushes as there are poles. If we made a ring armature and provided a number of different fields into which it would fit properly, one being two-pole, one four-pole, one six-pole, one eight-pole, and the others of greater number of poles; then, if each machine had as many brushes as poles, and these were set in the proper position, the armature would run as well in one as in the other, without requiring any changes in the connections between the armature coils and the commutator. In fact, all we would have to do would be to remove it from one machine and place it on the other, and it would be ready to run.

The regular ring winding is not used very often for multipolar machines, owing to the fact that the coils have to be wound in place, and on that account are not so mechanical in appearance,

and are more expensive to make. The former coils used almost universally for multipolar armatures, have both sides on the outer surface of the core, and on that account, when they are connected into a lap, or wave winding, they will not operate perfectly with a number of poles different from that for which they are connected, but they will run, although imperfectly, with any number of poles. From this it will be seen that if we have two generators of four and six poles respectively, both using armatures of the same diameter, and both lap wound, if one armature gives out we can use the armature of the other machine as a makeshift, but it will not give as good results as in its own field. An armature with a wave winding cannot be used except with a field of the number of poles for which it is wound.

As sometimes it may be advantageous to change an armature from one machine to another while repairs are being made, provided the dimensions of the machine are the same, it is desirable to know how to determine whether the winding is wave or lap connected. You cannot tell from the general appearance of the armature, because both are wound with formed coils, but if we examine the two ends of the armature, we will find that with the lap winding the coils bend toward the same side after leaving the grooves, while with the wave winding, they bend in opposite directions. To make this clearer, suppose we are standing at the side of the machine so we can see both ends of the armature; if the coils on the commutator end bend down toward the floor, the ends will bend up toward the ceiling at the pulley end, if the connection is wave, and they will bend down, the same as at the commutator end, if the connection is lap. Sometimes the ends of the coils at the pulley end of the armature cannot be seen, but in such cases we can determine the type of connection if we can find out whether the connections from the coils to the commutator run in the same direction as the coils, or opposite to it. If the connections and the coil ends run in the same direction, the con-

nection is for lap winding, and if they run in opposite directions, the connection is for wave winding. If there are only two sets of brushes on the commutator, the armature is wave wound. If the armature is wave wound and there are as many brushes as poles, we will be able to remove all but two sets without making any material difference in the running of the machine; but if the armature is lap wound, it will not run without the proper number of brushes. If a set of brushes is removed while the machine is in operation, a heavy flash will be produced with a lap winding, but with the wave winding there will be only a moderately large spark. Thus it will be seen that there are several ways in which we can determine the type of winding.

NOISE.

Cause.—Vibration due to armature or pulley being out of balance.

Symptom.—Strong vibration felt when the hand is placed upon the machine while it is running. Vibration changes greatly if speed is changed, and sometimes almost disappears at certain speeds.

Remedy.—Armature or pulley must be perfectly balanced by securely attaching lead or other weight on the light side, or by drilling or filing away some of the metal on the heavy side. The easiest method of finding in which direction the armature is out of balance is to take it out and rest the shaft on two parallel and horizontal A-shaped metallic tracks sufficiently far apart to allow the armature to go between them. If the armature is then slowly rolled back and forth, the heavy side will tend to turn downward. The armature and pulley should always be balanced separately. An excess of weight on one side of the pulley and an equal excess of weight on the opposite side of the armature will not produce a balance while running, though it does when

standing still; on the contrary, it will give the shaft a strong tendency to "wobble." A perfect balance is only obtained when the weights are directly opposite, i. e., in the same line perpendicular to the shaft.

Cause. — Armature strikes or rubs against pole pieces.

Symptom. — Easily detected by placing the ear near the pole pieces, or by examining armature to see if its surface is abraded at any point, or by examining each part of the space between armature and field, as armature is slowly revolved, to see if any portion of it touches, or is so close as to be likely to touch when the machine is running. Or turn armature by hand when no current is on, and note if it sticks at any point. It is unwise to have a clearance of less than $\frac{1}{8}$ to $\frac{1}{4}$ inch.

Remedy. — Bind down any wire, or other part of the armature that may project abnormally, or file out the pole-pieces where the armature strikes, or center the armature so that there is a uniform clearance between it and the pole-pieces at all points.

Cause. — Shaft collar or shoulder, hub or edge of pulley or belt strikes or scrapes against bearings.

Symptom. — Rattling noise, which stops when the shaft or pulley is pushed lengthwise away from one or the other of the bearings.

Remedy. — Shift the collar or pulley, turn off the shoulder on the shaft, file or turn off the bearing, move the pulley on the shaft, or straighten the belt until there is no more striking and noise ceases.

Cause. — Rattling due to looseness of screws, or other parts.

Symptom. — Close examination of the bearings, shaft, pulley, screws, nuts, binding-posts, etc., are touching the machine while running, or shaking its parts while standing still, show that some parts are loose.

Remedy. — Tighten up the loose parts and be careful to keep them all in place and properly set up. It is very easy to guard

against the occurrence of this trouble, which is very common, by simply examining the various screws and other parts each day before the machine is started. Electrical machinery being usually high-speed, the parts are particularly liable to shake loose. A worn or poorly fitted bearing might allow the shaft to rattle and make a noise, in which case the bearing should be refitted or renewed.

Cause.—Singing or hissing of brushes. This is usually occasioned by rough or sticky commutator, or by tips of brushes not being smooth, or the layers of a copper brush not being held together and in place. With carbon brushes, hissing will be caused by the use of carbon which is gritty or too hard. Vertical carbon brushes, or brushes inclined against the direction of rotation, are apt to squeak or sing. A new machine will sometimes make noise from rough commutator, no matter how carefully it is turned off, because the difference in hardness between mica and copper causes the cut of the tool to vary, thus forming inequalities which are very minute, but enough to make noise. This can best be smoothed by running.

Symptom.—Sound of high pitch, and easily located by placing the ear near the commutator while it is running, and by lifting off the brushes one at a time, provided there are two or more on each side, so that the circuit is not opened. If there is no current, there is no objection to raising the brushes.

Remedy.—Apply a *very little* oil or vaseline to the commutator with the finger or a rag. Adjust the brushes or smooth the commutator by turning, filing, or fine sand-paper, being careful to clean thoroughly afterwards. Carbon brushes are apt to squeak in starting up, or at slow speed. This decreases at full speed, and can usually be reduced by moistening the brush with oil, care being taken not to have any drops, or excess of oil. Shortening or lengthening the brushes sometimes stops the noise. Run the machine on open circuit until commutator and brushes are worn smooth.

Table of Carrying Capacity of Wires. — Below is a table which must be followed in placing interior conductors, showing the allowable carrying capacity of wires and cables of ninety-eight per cent conductivity, according to the standard adopted by the American Institute of Electrical Engineers.

B. & S. G.	TABLE A.	TABLE B.	Circular Mills.
	Rubber-Covered Wires. Amperes.	Weatherproof Wires. Amperes.	
18	3	5	1,624
16	6	8	2,583
14	12	16	4,107
12	17	23	6,530
10	24	32	10,380
8	33	46	16,510
6	46	65	26,250
5	54	77	33,100
4	65	92	41,740
3	76	110	52,630
2	90	131	66,370
1	107	156	83,690
0	127	185	105,500
00	150	220	133,100
000	177	262	167,800
0000	210	312	211,600
Circular Mills.			
200,000	200	300	
300,000	270	400	
400,000	330	500	
500,000	390	590	
600,000	450	680	
700,000	500	760	
800,000	550	840	
900,000	600	920	

Circular Mills.	TABLE A.	TABLE B.
	Rubber-Covered Wires. Amperes.	Weatherproof Wires. Amperes.
1,000,000	650	1,000
1,100,000	690	1,080
1,200,000	730	1,150
1,300,000	770	1,220
1,400,000	810	1,290
1,500,000	850	1,360
1,600,000	890	1,430
1,700,000	940	1,490
1,800,000	970	1,550
1,900,000	1,010	1,610
2,000,000	1,050	1,670

The lower limit is specified for rubber-covered wires to prevent gradual deterioration of the high insulations by the heat of the wires, but not from fear of igniting the insulation. The question of drop is not taken into consideration in the above tables.

Insulation Resistance. — The wiring in any public building must test free from grounds; i. e., the complete installation must have an insulation between conductors and between all conductors and the ground (not including attachments, sockets, receptacles, etc.) of not less than the following: —

Up to 5 amperes,	4,000,000	Up to 200 amperes,	100,000
“ 10 “	2,000,000	“ 400 “	25,000
“ 25 “	800,000	“ 800 “	25,000
“ 50 “	400,000	“ 1,600 “	12,500
“ 100 “	200,000		

All cutouts and safety devices in place in the above.

Where lamp sockets, receptacles and electroliers, etc., are connected, one-half of the above will be required.

Soldering Fluid.—*a.* The following formula for soldering fluid is suggested:—

Saturated solution of zinc chloride,	5 parts.
Alcohol,	4 parts.
Glycerine,	1 part.

Bell or Other Wires.—*a.* Shall never be run in same duct with lighting or power wires.

Table of Capacity of Wires.—

B. & S. G.	Area Actual C. M.	No. of Strands.	Size of Strands B. & S. G.	Amperes.
19	1,288
18	1,624	3
17	2,048
16	2,583	6
15	3,257
14	4,107	12
12	6,530	17
...	9,016	7	19	21
...	11,368	7	18	25
...	14,336	7	17	30
...	18,081	7	16	35
...	22,799	7	15	40
...	30,856	19	18	50
...	38,912	19	17	60
...	49,077	19	16	70
...	60,088	37	18	85
...	75,776	37	17	100
...	99,064	61	18	120
...	124,928	61	17	145
...	157,563	61	16	170

B. & S. G.	Area Actual C. M.	No. of Strands.	Size of Strands B. & S. G.	Amperes.
...	198,677	61	15	200
...	250,527	61	14	235
...	296,387	91	15	270
...	373,737	91	14	320
...	413,639	127	15	340

When greater conducting area than that of B. & S. G. is required, the conductor shall be stranded in a series of 7, 19, 37, 61, 91 or 127 wires, as may be required; the strand consisting of one central wire, the remainder laid around it concentrically, each layer to be twisted in the opposite direction from the preceding.

CHAPTER IX.

INSTRUCTIONS FOR INSTALLING AND OPERATING APPARATUS FOR ARC LIGHTING, BRUSH SYSTEM.

Theory of the brush arc generator.—The Brush Arc Generator is of the open coil type, the fundamental principle of which is illustrated in Fig. 1. Two pairs of coils, placed at right angles

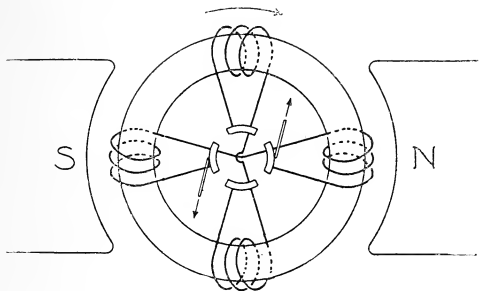


Fig. 1.

on an iron core, are rotated in a magnetic field. The horizontal coils represented in the diagram are producing their maximum electromotive force, while the pair of coils at right angles to them is generating practically no electromotive force. The brushes are placed on the segments of the four-part commutator, so as to collect only the current generated by the two horizontal coils. The other coils are open circuited, or completely cut out of the circuit.

Such a machine will generate current, continuous in direction, but fluctuating considerably in amount. These fluctuations will be diminished by the addition of more coils to the armature.

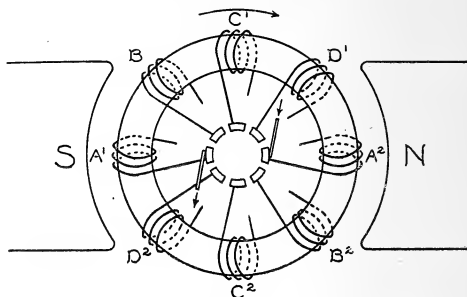


Fig. 2.

Fig. 2 is a diagrammatic representation of an eight coil machine. The ends of coils diametrically opposite are connected as in the four-pole machine, but to avoid complications, these connections have been omitted on the diagram. In the eight coil machine, one pair of coils, A^1 , A^2 , is generating maximum electromotive force. At right angles to these coils, the coils C^1 and C^2 are generating no electromotive force. In intermediate positions, the coils B^1 , B^2 , D^1 , D^2 are generating a useful electromotive force, although one which is not so high as that generated by the coils A^1 and A^2 .

In collecting the current from such an armature, the coils in the intermediate positions cannot be connected in parallel with the coils generating maximum electromotive force, because their electromotive force is lower. The pair of coils A^1 , A^2 can, however, be placed in series and connected in series with the two pairs

of coils B^1 , B^2 and D^1 , D^2 , which may be placed in parallel with each other, since they occupy similar positions in the magnetic field.

The resistance of the coils in intermediate positions is, therefore, halved, and the electromotive force is equal to the electromotive force developed by one pair of coils. In the Brush Arc Generator a double commutator is used to automatically make these connections.

In Fig. 3 this commutator is developed or spread out, and the coils are represented diagrammatically. With the brushes in the position shown, the current enters the brush P and the coil A^1 , which is placed in series with the coil A^2 in a similar part of the magnetic field. From the brush Q , the current is transferred to the second commutator, which it enters by the brush R . This brush, in the position shown, rests on two segments, thus connecting two pairs of coils in parallel. The current flowing

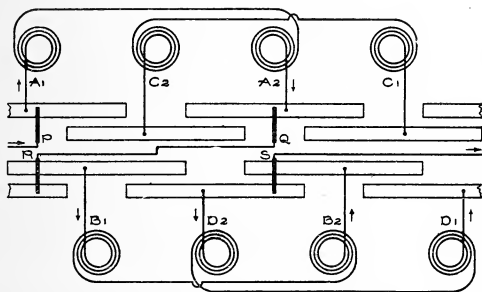


Fig. 3.

through these coils, B^1 , B^2 and D^1 , D^2 , leaves the machine by the brush S . The coils C^1 and C^2 which are generating no electromotive force, are disconnected.

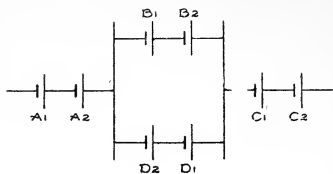


Fig. 4.

The same arrangement is shown in Fig. 4, in which the coils have been replaced by battery cells.

Although the number of coils, and, therefore, the number of commutator segments in larger Brush machines do not correspond

with these diagrams, the principle of operation of the machine is, in every case, the same, and can be readily understood by reducing it to these elementary forms.

THE BRUSH MULTI-CIRCUIT DEVICE.

The function of the Brush Multi-Circuit Device is to divide the load into several circuits, thus reducing the maximum potential required and, consequently, the strain on the insulations. The operation of the device will be understood by reference to the following diagrams and explanations:—

Figs. 1 to 4 show that the potential of an eight coil machine is made up of the potential of one pair of coils, giving maximum electromotive force, and the potential of two other pairs in parallel, giving a lesser electromotive force.

Fig. 3 is a development of the commutator of the Brush Arc Machine, showing how the potentials of the different coils are compounded. In this diagram the current takes the following path: Brush *P* to coils A^1 , A^2 , brush *Q* to brush *R* to coils B^1 , B^2 and D^1 , D^2 , in parallel, to brush *S*.

Inasmuch as one pair of coils is always in series with two other pairs in parallel, it is immaterial whether the load is all placed between the terminals of the machine or divided between the various coils; for example, instead of connecting *all* the lamps between the brushes *P* and *S*, some may be connected be-

tween brushes P and S , and the remainder between brushes R and Q .

The arrangement will be clearly understood by reference to Figs. 5 and 6, in which the coils of the machine have been replaced by battery cells. These diagrams show the arrangement of cells (coils) when the brushes occupy the position shown in Fig. 3. The potential of the machine at this time is seen to be made up of the electromotive force of the pair of coils A^1, A^2 , in

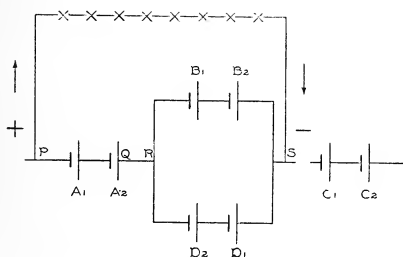


Fig. 5.

series with the two pairs of coils B^1, B^2 and D^1, D^2 , which are parallel. The pair of coils C^1, C^2 is disconnected.

With this arrangement it is evident that, having a given number of lamps to install, they may be connected between the points P and S , as in Fig. 5, or part of them may be connected between P and S and the remaining ones between R and Q , as in Fig. 6. Inasmuch as the potential between P and S (Fig. 5) is adequate to supply the total number of lamps installed in the circuit, it is immaterial as to how the lamps are divided between P and S and R and Q (Fig. 6). If more lamps are installed between P and S than are provided for by the potential generated by the cells (coils) connected between the points P and Q , the

deficit will be made up by the potential generated between R and S .

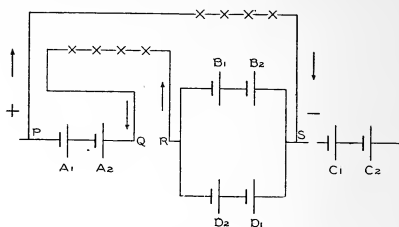
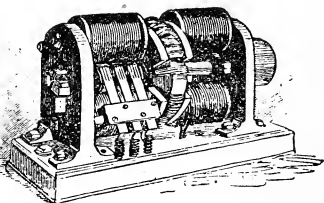


Fig. 6.

In the **Brush Multi-circuit Device**, a number of switches are so arranged that lamps may be cut in or out of a divided circuit in the manner indicated. In the larger machines, the principle of operation is the same.

BIPOLAR BRUSH ARC GENERATORS.

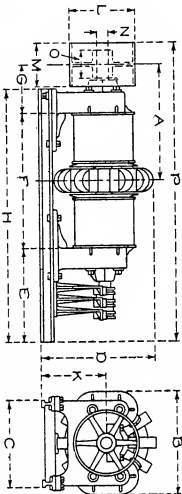
Bipolar Brush Machines were built in eight sizes, ranging in capacity from 1 to 65 lamps of 2000 candle-power, and 2 to 45 lamps of 1200 candle-power. (See table, page 123.)



Although now superseded by the larger multipolar machines, so many bipolar machines are still in use that I consider it advisable to

publish the following instructions for operating and making such repairs as become necessary after the long service which thousands of these machines have undergone.

GENERAL DATA ON BIPOLAR BRUSH ARC GENERATORS.



DIMENSIONS.

Volts.	Amperes.	Capacity in 1200 C.P. Lamps.	Capacity in 2000 C.P. Lamps.	Watts.	Class No. of Machine.	Diam. of Armature.	H.P. Required at Pulley.	Revs. per Minute.	DIMENSIONS.															
									A	B	C	D	E	F	G	H	K	L	M	N	O	P		
48	9.6	—	1	400	2	9"	1½	1000-1500 Acc'ding to Resistance of Line.	13 3/8"	11 3/8"	10 3/4"	12 7/16"	12 3/4"	15"	5 1/2"	31"	7 1/2"	8"	3 1/2"	1 1/2"	3"	36 1/4"		
96	6.6	2	2	633	3	11"	3		14 1/2"	13 1/2"	13"	15"	14 1/2"	17 3/8"	6 1/2"	35"	8 1/2"	8"	3 1/2"	1 3/8"	3"	39 5/8"		
144	6.6	3	4	950	4	12"	4		15 3/4"	15"	13 1/2"	16 3/4"	14 3/4"	18 1/2"	6 3/8"	37"	9 1/2"	8"	3 1/2"	1 1/2"	3"	41 1/8"		
192	9.6	6	10	1360	5	15"	9		19 1/2"	18 1/2"	16 3/4"	19 7/8"	17"	23 1/4"	7 7/8"	44"	10 1/2"	10"	4 3/4"	1 3/4"	4 1/2"	50 3/4"		
288	6.6	6	15	4800	6	18"	17		23 1/8"	21 1/2"	18 7/8"	25"	18 1/2"	28 5/8"	8 1/4"	51 1/2"	13 1/2"	14"	6 1/2"	2"	5 1/2"	59 3/8"		
480	9.6	15	20	4750	7	20"	25		27 1/2"	24 1/2"	22 1/2"	27 1/2"	19 3/4"	32 5/8"	11 3/8"	57 1/2"	14 3/8"	14"	9"	2 1/4"	6 1/4"	68 1/8"		
720	9.6	30	30	9220	8	24"	40		30 1/4"	28 1/2"	24 3/4"	29 3/4"	25 3/4"	37"	11 1/2"	68 1/2"	16 1/2"	18"	10 1/2"	2 1/4"	7 1/4"	79 3/4"		
960	6.6	45	65	9500	9	26"	50		34 1/4"	32 1/4"	26 1/2"	33 3/8"	26 3/8"	41 1/4"	13 1/2"	74"	17 5/8"	20"	12 1/2"	2 1/2"	8 1/2"	87 1/4"		

The general construction of the bipolar machine is shown in the diagram on page 123. Four field spools are provided, one pair to each side of the armature. The field cores are bolted to vertical yokes at each end of the machine, which also carry the bearings for the armature shaft.

The machines should be set up in the manner described under Multipolar Generators on page 131. The wood base frame is fitted with belt tighteners, and anchor bolts and plates can be provided for the larger sizes, if ordered. To operate satisfactorily, the machines must be kept perfectly clean, the oil cups well filled and the commutator surfaces smooth. (See page 140.)

The armature with its shaft may be readily removed after unscrewing the bolts and lifting the caps from the bearings at each end.

Each coil or bobbin on the armature is wound independently, and may be rewound without disturbing any other part of the armature. The inside ends of coils diametrically opposite are connected together, while their opposite ends are connected by means of wires running through the hollow shaft to opposite segments of the commutator.* Thus each pair of coils has a separate pair of segments lying in the same radial plane as the two coils.

The pairs of segments are grouped in sets of two to preserve the continuity of the current. Each ring represents two pairs of coils 90° apart.

Proper connections are made by having separate brushes for each commutator ring consisting of two pairs of segments. Thus in an eight coil machine, the lower brush on one commutator ring is connected to the upper brush on the next ring. By cutting out

* That is for 2000 and 1200 candle-power machines. On machines for 4000 candle-power, each pair of opposite coils is connected in multiple instead of as above described.

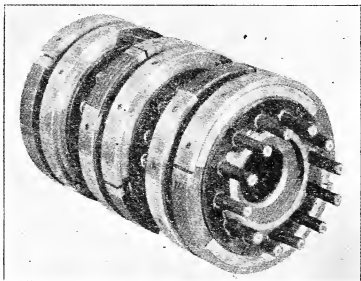
the coils when they are in action, any loss due to dead resistance is prevented.

The commutator segments are mounted on an insulated body, and when worn out may be easily replaced.

Insulating break blocks for No. 7½ and No. 8 machines are now made 2½" in length, but some old machines were provided with 2⅜" blocks. With the 2½" blocks a higher voltage is obtained at the brushes, as the series combination of coils is maintained for a longer time before the coils are connected in multiple. The 2½" blocks may be used on machines formerly using 2⅜" blocks by cutting away a portion of the commutator segments.

A new form of commutator,

shown in the accompanying illustration, has been designed for the No. 7½ and No. 8 machines and has improved segments. These segments may be turned end for end when one end becomes burned or worn, and



each segment is interchangeable with the others. New segments will not fit old commutator bodies.

CONNECTIONS OF ALL BIPOLAR GENERATORS SMALLER THAN NO. 7½.

The outside right-hand brush is connected to the large line binding post, while the inside right-hand brush is connected to the field and also to one of the small binding posts. The outside left-hand brush is connected to the other small binding post and to the other side of the field circuit, while the inside left-

hand brush is connected to the large binding post which connects to the other side of the line.

CONNECTIONS OF NO. 7½ AND NO. 8 BIPOLAR GENERATORS.

The field switch on the later No. 7½ and No. 8 machines is different from that of the smaller sizes, and there is but one small binding post for connection to the regulator. The internal connections of the regulator are also slightly different. The in-

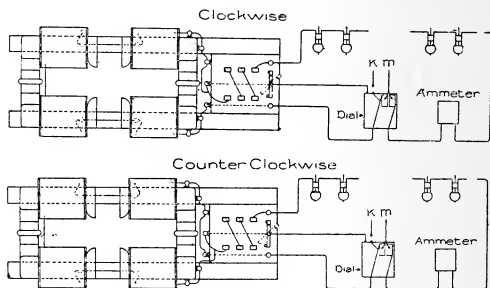


Fig. 7.

side terminal of one upper binding post K (see Fig. 7) is connected to the positive (left-hand) wire which connects the main binding post to the magnets M . The regulator connections for the earlier types of No. 7½ and No. 8 machines are the same as for smaller machines.

As the No. 7½ and No. 8 machines have three commutator rings, cross-connections between the brushes are required as shown in the diagram. The outside left-hand brush is connected across to the middle right-hand brush, and the middle left-hand brush is connected to the inside right-hand brush. The inside left-hand brush is connected to the fields, and, on a new type

machine, to the shunt leading to the regulator. On the old type machines, the inside left-hand brush is connected to the right-hand small binding post.

TO CHANGE DIRECTION OF ROTATION.

A right-hand machine is one that revolves in a counter-clockwise direction when viewed from the commutator end, and a left-hand machine is one that revolves in a clockwise direction. Thus a right-hand machine will have the upper brushes on the right-hand side, and the lower ones on the left-hand side.

To change a machine from right or counter clockwise, to left or clockwise rotation, simply reverse the connections given on pages 125 and 126 ; that is, read outside for inside and *vice versa*. The diagram should be carefully studied and rigidly followed.

In changing any of these types of machines for a different direction of rotation, the brush-holders should always be carefully readjusted.

The brush clamps must be changed to the opposite end of the rocker, and the beveled plates placed equally distant from the face of the commutator, and with their centers on an exact line across the center of the shaft.

The rockers must all line up to bring the beveled plates on a level and equally distant from the commutator face. If necessary, paper may be used to adjust the level of these beveled plates.

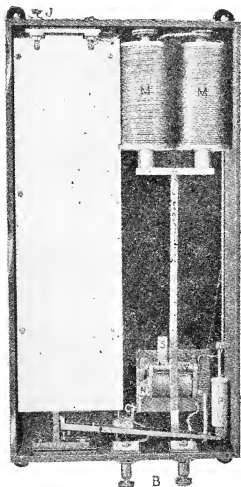
The commutator must be turned on the shaft, so that the segment for any coil (bobbin) will lead it by the width of the coil. The screw fastening the commutator in position should be screwed into a hole drilled and tapped into the shaft, and, if the commutator is fitted with wood blocks, the blocks must be changed end for end.

No. 7 $\frac{1}{2}$ and **No. 8** machines have no automatic rocking device for the brushes. The amount of current is automatically

controlled by a regulator which is attached to the wall or mounted on a suitable stand in the dynamo room.

AUTOMATIC REGULATOR FOR BIPOLAR BRUSH ARC GENERATORS.

The **Brush Automatic Regulator** or "Dial" is shown in the accompanying illustration. It contains a variable resistance which



is connected as a shunt to the fields, and automatically changed to increase or decrease the field current, and thus the voltage of the machine. The resistance is composed of columns of carbon plates which rest on the level L .

When the current rises above normal, the magnets M draw up the level L and compress the carbon columns, reducing their resistance and shunting more current from the fields. The electromotive force of the generator is thus reduced and the current maintained constant. As the resistance of the line is increased by the addition of lamps, the current in the magnets M is diminished and the lever

drops, separating the carbons and increasing the resistance of the shunt. More of the current must then pass through the generator fields and raise the electromotive force of the machine.

The dash pot P is to prevent sudden changes of resistance, and should be kept full of pure cylinder oil or glycerine. It should move easily, so that the regulator can respond quickly to changes in the current.

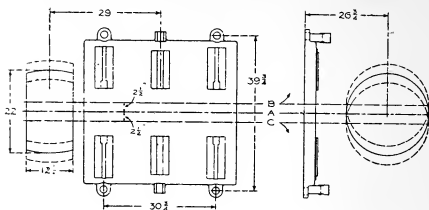
The variable resistance W , which is adjusted by the spring S , is connected as a shunt to the magnet coils M and regulates their current. The spring S should be kept as far to the left as practicable, since a low shunt resistance increases the spark at the contact C and destroys it more rapidly, besides tending to make the regulator "pump," unless the dash pot is very stiff. The opening of the contact C is adjusted by the fiber nut N . With the shunt resistance properly adjusted and the lever in a midway position, the current can be increased by tightening the nut N , and decreased by loosening it. When the shunt resistance W is once properly adjusted, it should not be changed, unless the magnets M are changed.

To connect the regulator into the circuit, the main line is brought in at the large binding posts B , the positive being connected to the left-hand binding post. The current *must enter* at the left hand.

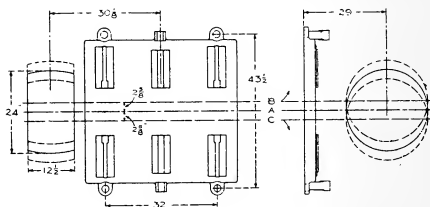
The small binding post J is connected with the small binding post on the generator, so that the carbon resistance plates are in shunt with the field of the generator.

While adjusting the regulator, the generator should run at normal speed, and the first test should be made on short circuit. If the current indicated by the ammeter is too low, the lever L should begin to drop at once and so increase the current. If this lever should stand at its lowest position and the current still remain too low at full load, the speed of the generator must be increased. If the current is too high, the lever should rise and so reduce it; but if it fails to rise, the contact C should be examined. The current at this contact should spark all the time, but the contact should not open more than $\frac{1}{16}$ ". If it is not open when the current is too high, the fiber adjusting nut N should be loosened until the contact opens, when the lever will rise. If the lever rises when the contact is below normal, the nut N should be tightened.

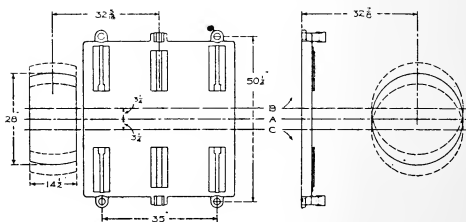
Center Lines for No. 9 and No. 9 1-2 Generators.



Center Lines for No. 10 Generator.



Center Lines for No. 11 and No. 12 Generators.



A is Center Line of Bed-plate—Always Work from this Line.
 B and C are Center Lines of Generators when Belted from Side
 Indicated by Arrow.

The resistance of the shunt W should be so adjusted by removing the spring S that the lever will rise when the contact is opened and descend when the contact is closed. If it fails to descend, the resistance of the shunt should be decreased by moving the spring S to the right, which will shunt more current from the magnets M , and thus allow the lever to drop. When the generator is running at lightest load, the armature A on the regulator should stand at its highest position — about $\frac{1}{8}$ " from the magnets M . Should it touch the magnets, the set screw I should be turned to the right to draw the lever downward.

Once in six months the carbon resistance columns should be loosened up and the dust and loose carbon particles blown out with a bellows. The regulator must then be readjusted.

MULTIPOLAR BRUSH ARC GENERATORS.

Each machine is provided with an iron bed-plate fitted with a ratchet and screw for sliding the machine to adjust the belt tension. This bed-plate should be securely fastened to a dry wood sub-base not less than 10" in thickness, except on wood floors, in which case it may be somewhat less, according to the thickness of the floor.

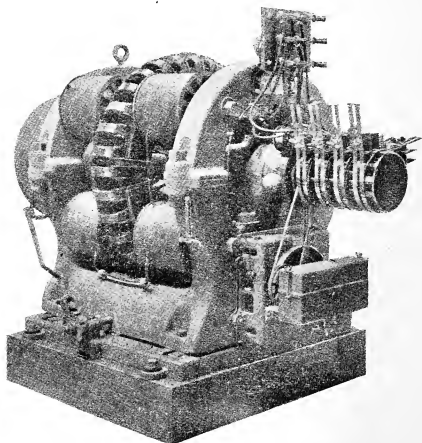
Unless the generator can be set up on a substantial floor, a foundation of masonry must be built. (See diagram No. 13396 on page 134).

The brick work is laid on a bedding of cement, and the section plates and bolts properly placed as the work progresses. The foundation bolts should be cut off at least 2" below the top of the wood sub-base and well covered with sulphur to insure complete insulation from the iron bed-plate.

In whatever manner the bed-plate is mounted, the greatest care must be taken to have a thorough and permanent insulation from earth.

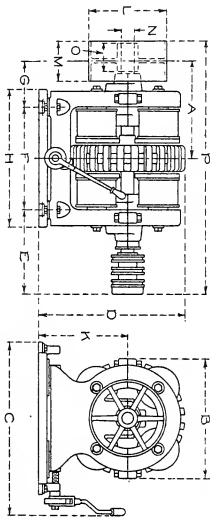
Four short bolts pass through the generator frame and are used to hold the machine in position on its bed-plate. They are inserted in the slots in the iron base-plate, and provided with square nuts at their lower ends. The nuts must be placed in position before the bolts are inserted in the holes, and as the bolts are not long enough to reach the nuts if simply placed on the base under the bed-plate, the nuts must be raised at least $\frac{1}{2}$ " by means of wood blocks. The bolts should be kept tight, except when adjusting the tension of the belt.

To allow for stretching of the belt, the bed-plate should be so placed that the center line of the generator will be nearer the engine or counter-shaft than is the center line of the bed-plate. (See diagram on page 130.) The center lines are marked on the castings.



Multipolar Brush Arc Generator.

GENERAL DATA ON MULTIPOLAR BRUSH ARC GENERATORS.



DIMENSIONS.

Volts.	Amperes.	Capacity in 1200 C.P. Lamps.	Capacity in 2000 C.P. Lamps.	Watts.	Class No. of Machine.	Diam. of Armature.	H.P. Required at Pulley.	Revs. per Minute.	A	B	C	D	E	F	G	H	K	L	M	N	O	P
3250	9.6	—	65	31200	85	26"	48	750	26 3/4"	32 1/2"	47 1/4"	41 1/2"	25 1/2"	28"	12 3/4"	38 1/2"	25 1/4"	20"	12 1/2"	3 1/2"	8"	72 1/2"
4500	6.6	90	80	29700	81	31 1/4"	60	700	29"	33 3/4"	47 1/4"	45 1/2"	25 5/8"	30 3/4"	13 5/8"	41 1/2"	26 3/4"	22"	12 1/2"	3 1/2"	8"	76 1/2"
6000	9.6	120	—	38400	9	31 1/4"	60	700	29"	33 3/4"	47 1/4"	45 1/2"	25 5/8"	30 3/4"	13 5/8"	41 1/2"	26 3/4"	22"	12 1/2"	3 1/2"	8"	76 1/2"
6000	6.6	120	—	38400	9	31 1/4"	60	700	29"	33 3/4"	47 1/4"	45 1/2"	25 5/8"	30 3/4"	13 5/8"	41 1/2"	26 3/4"	22"	12 1/2"	3 1/2"	8"	80 1/2"
8000	6.6	120	—	40000	9 1/2	31 1/4"	60	700	29"	33 3/4"	47 1/4"	45 1/2"	25 5/8"	30 3/4"	13 5/8"	41 1/2"	26 3/4"	22"	12 1/2"	3 1/2"	8"	80 1/2"
5000	5.	—	100	48000	10	33 1/4"	73	600	30 1/4"	37 1/4"	51 1/4"	48 1/2"	25 9/16"	32"	14 1/4"	42 3/4"	29"	24"	12 1/2"	4 1/2"	9"	77 1/2"
5000	9.6	—	125	48000	11	38 1/4"	90	500	32 5/8"	42 1/2"	57 1/2"	55 1/2"	26 1/8"	35"	14 1/2"	46 1/2"	32 1/2"	28"	14 1/2"	4 3/8"	9 3/4"	83 1/2"
6250	9.6	—	135	60000	11	38 1/4"	90	500	32 5/8"	42 1/2"	57 1/2"	55 1/2"	26 1/8"	35"	14 1/2"	46 1/2"	32 1/2"	28"	14 1/2"	4 3/8"	9 3/4"	87 1/2"
6250	9.6	—	150	60000	12	39 1/4"	90	500	32 5/8"	42 1/2"	57 1/2"	55 1/2"	26 1/8"	35"	14 1/2"	46 1/2"	32 1/2"	28"	14 1/2"	4 3/8"	9 3/4"	87 1/2"
8000	9.6	100	—	52800	13	42 3/4"	114	500	34 3/4"	49 3/4"	62 3/4"	61"	37 3/4"	35"	17 1/8"	48 3/4"	34 3/4"	32"	16 3/4"	5"	11 1/2"	92 3/4"
8000	9.6	—	160	76800	13	42 3/4"	114	500	34 3/4"	49 3/4"	62 3/4"	61"	37 3/4"	35"	17 1/8"	48 3/4"	34 3/4"	32"	16 3/4"	5"	11 1/2"	92 3/4"

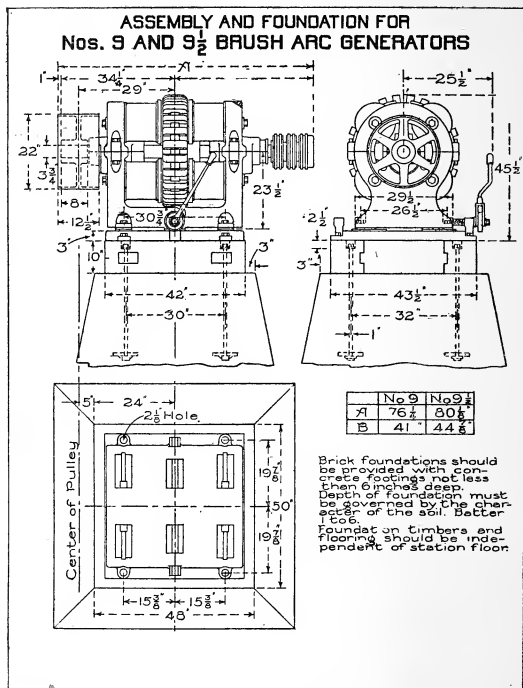


Diagram No. 13396.

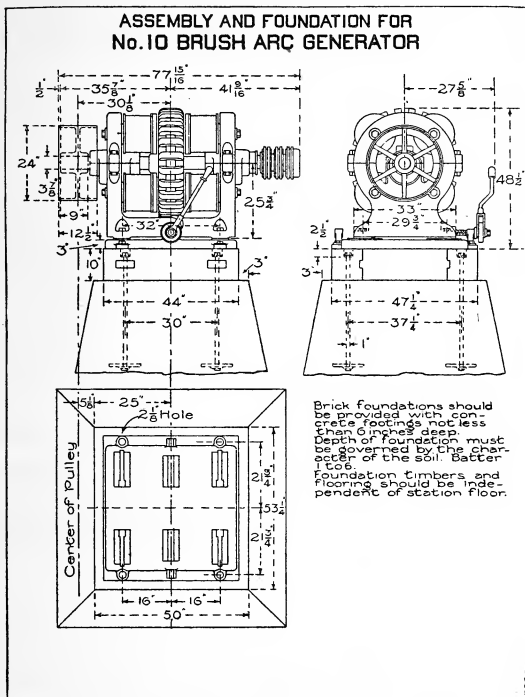


Diagram No. 13397.

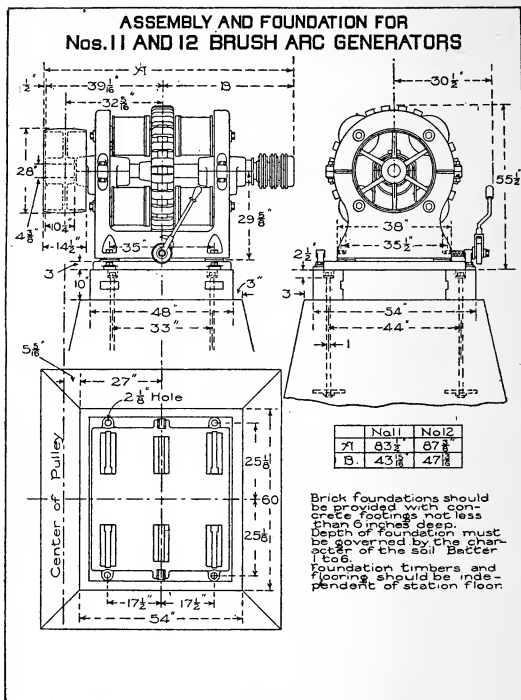
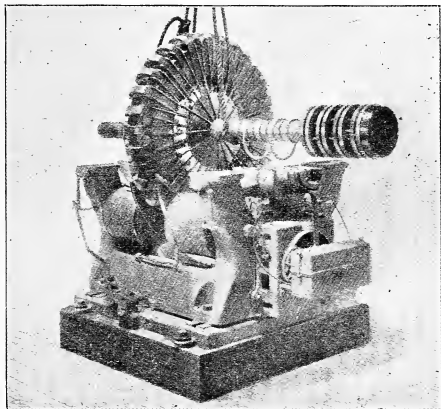


Diagram No. 13398.

The various parts of the machine should be unpacked carefully to prevent abrasion of the insulation and damage to the commutator.

The white lead should be carefully wiped off, especially from the planed surfaces of the magnet yokes and the armature shaft.

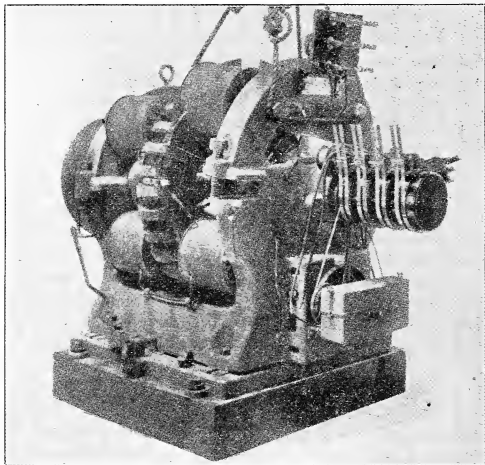


• Method of Suspending Armature.

The lower half of the frame is first placed in position on the bed-plate and bolted down. While this is being done, the ratchet screw for adjusting the belt should be screwed into the frame and slipped into place on the bed-plate as the frame is lowered.

The lower halves of the bearing boxes should be removed and the oil chambers thoroughly cleaned and filled with a good quality of stringy oil, to the height indicated by the mark on the oil gauge. The lower halves of the bearing boxes may then be replaced.

The proper method of suspending the armature is shown on page 137. Before lowering it into place, the oil rings, which are always tied to the armature hub when shipped, should be put on the shaft. When placing the armature in its bearings, it is important to prevent the armature coils (bobbins) from rubbing against the pole pieces.



Method of Handling the Magnet Yoke.

The upper halves of the bearings with their cast-iron washers may next be put on and securely bolted down with the clamping screws.

When handling the magnet yokes, a rope sling should be used, as shown in the illustration above. The yoke should hang

very nearly level with the pole shoe slightly raised, so that in lowering the piece into place there will be no danger of chafing the armature coils or insulation. The bolts should be inserted as shown, and as the yoke is lowered, these will act as a guide and drop it into its proper place. The frame bolts must be screwed up especially tight, as any movement of the yokes while the machinery is running will ruin the armature.

The **brush-holder yoke** and the regulator rocker arm should be put in place with a little oil on the bearing seats to insure freedom of movement through the entire range.

The **regulator** is ready for operation when shipped, but a little light oil should be put into the gear housing, and the various bearings oiled through the oil holes, which are plugged with screws to exclude dust. It is also well to rub a little oil on the contact buttons of the rheostat. The small belt for the regulator should run open for either clockwise or counter clockwise machines.

SETTING THE BRUSHES.

A **pressure brush** should always be used over the under brush, as it improves the running of the commutator and secures a better contact on the segment. The combination is referred to as a "brush." The brushes should be set $5\frac{1}{8}$ " from the front side of the brass brush-holder.

In **setting** the brushes, commence with the inner pair and set one brush about $5\frac{1}{8}$ " from the holder to the tip of brush, then rotate the rocker or armature until the tip of the brush is exactly in line with the end of a copper segment, as shown in Fig. 8. The other brush should be set on the corresponding segment 90° removed (the same relative position on the next forward segment) but if the length of the brush from the holder is less than $5\frac{1}{8}$ ", move both brushes forward until the length of the shorter brush from the holder is $5\frac{1}{8}$ ". Now set the two extreme outer brushes

in the same manner, clamping firmly in position, and by using a straight edge or steel rule, all the brushes can be set in exactly the same line and firmly secured. The spark on one of the six brushes may be a trifle longer than on the others. In this case, move the brush forward a

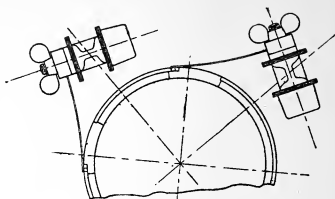


Fig. 8.

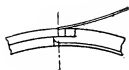


Fig. 9.

trifle so as to make the sparks on the six brushes about the same length. Equality in the spark lengths is not essential, but it gives at a glance an indication of the running condition of the machine.

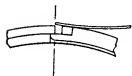


Fig. 10.

Brushes should not bear on the commutator less than $\frac{1}{8}$ " from the point of the brush, or, as illustrated in Fig. 9, they will tend to drop into the commutator slots and pound the copper tip of the wood block. If, on the other hand, the bearing is too far from the end, or the brushes are set too long, as in Fig. 10, the point of the brush is lifted from the leaving end of the segment, causing sparking.

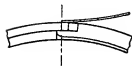


Fig. 11.

Fig. 11 shows correct setting with the tip of the brush nearly tangential and still on the segment as it leaves.

CARE OF COMMUTATOR.

If the commutator needs lubrication, oil it very sparingly. Once or twice during a run is ample. If the oil has a tendency

to blacken the commutator instead of making it bright, wipe the commutator with a dry cloth.

The machine, of course, generates high potential, and the cloth, or whatever is used to oil the commutator, should, therefore, be placed on a stick so that the hand is not placed in any way between the brushes.

A rubber mat should be provided for the attendant to stand on when working around the commutator and brushes.

To prevent any possibility of shock, all switches on the terminal board should be closed.

As soon as the current is shut off from the machine, the commutator should be cleaned. A piece of very fine sandpaper held against the commutator under a strip of wood for about a minute before the machine is stopped, will scour the commutator sufficiently. The brushes need not be removed. An effort should be made to have the machine cleaned immediately after it is shut down. Five minutes at that time will give better results than half an hour when the machine is cold. Never use a file, emery cloth, or crocus, on the commutator. New blocks will sometimes cause flashing, due to the presence of sap in the wood. The machine should be run for a few hours with a slightly longer spark, say $\frac{1}{2}$ " , and the commutator then thoroughly cleaned with fine sandpaper.

CONNECTIONS OF MULTIPOLAR BRUSH ARC GENERATORS.

Connections of Multipolar Brush Arc Generators are shown in Diagrams Nos. 13442, 13443, 13452. The current enters the field from the negative side of the circuit and takes the following course: Spool 1, to 2, to 7, to 8, to 5, to 6, to 3, to 4, to terminal board, to commutator. The field current is in the same direction for clockwise and counter clockwise machines.

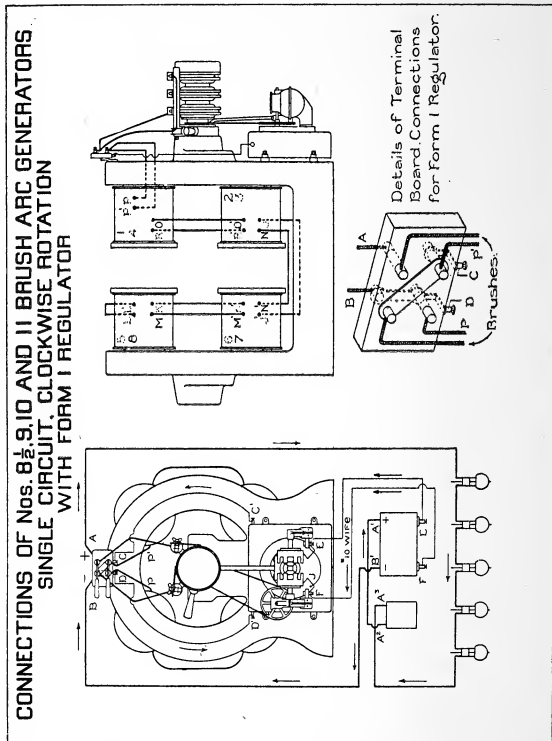
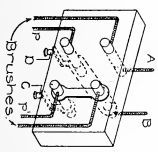
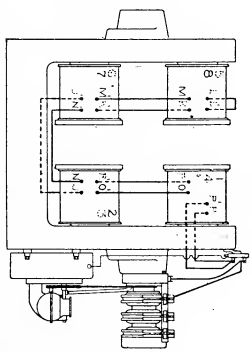
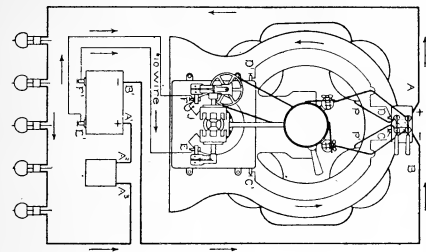


Diagram No. 13442.

CONNECTIONS OF Nos. 8½, 9, 10 AND 11 BRUSH ARC GENERATORS
SINGLE CIRCUIT, COUNTER CLOCKWISE ROTATION
WITH FORM I REGULATOR



Details of Terminal Board Connections for Form I Regulator

Diagram No. 13443.

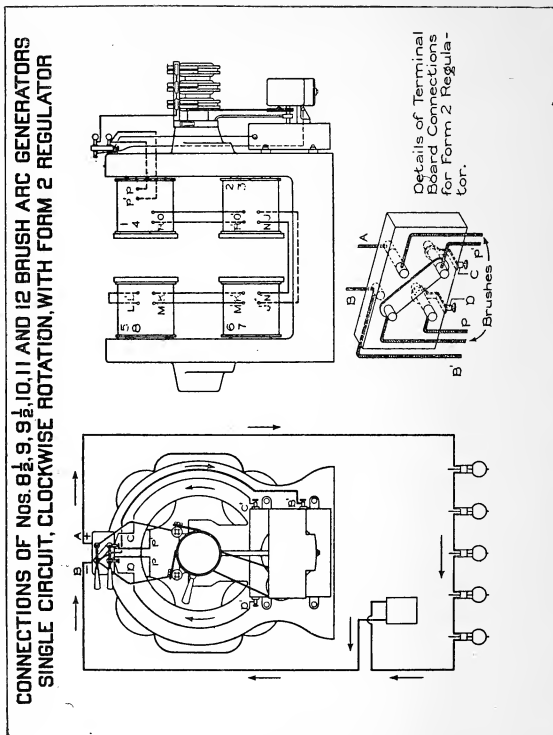
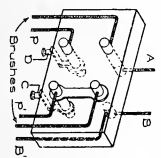
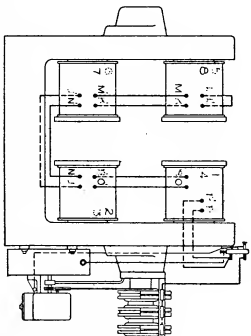
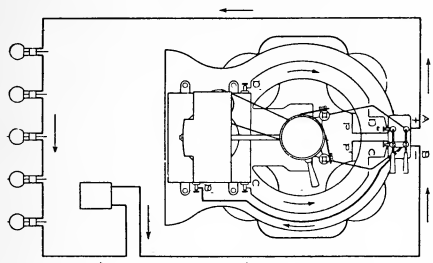


Diagram No. 13452.

CONNECTIONS OF NOS. 8 1/2, 9, 9 1/2, 10, 11 AND 12 BRUSH ARC GENERATORS SINGLE CIRCUIT, COUNTER CLOCKWISE ROTATION, WITH FORM 2 REGULATOR



Details of Terminal Board Connections for Form 2 Regulator.

Diagram No. 13453.

TO CHANGE DIRECTION OF ROTATION.

Connections. — Remove the brush-holder cables and the studs from the rocker. Take off the brush-holder rocker, and reverse it so as to bring the handle on the opposite side of the machine, changing, at the same time, the clamp stud to the same side as the handle. Replace the brush-holder studs in the rocker, but before setting, remove and reverse the brush-holders, so that the binding screws may be brought on the same side of the stud as the clips which hold the cables in position. Carefully square the brush-holders with the studs, and securely fasten, setting the studs according to instructions below.

Remove the external rack at the lower end of the rocker arm, and replace by an internal rack, using the same insulation and being careful to so align the rack that it will run freely through its entire arc.

Setting brush-holder studs. — Remove the brush-holder caps and placing angle gauge *A* on the commutator as shown in Fig.

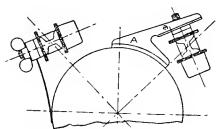


Fig. 12.

12, turn the stud until the gauge rests squarely on the face of the brush-holder. Tighten the stud moderately, and repeat the operation on the extreme outer and inner rings of the commutator, noting the positions of brush-holder faces relative to the line at *a* in gauge (see Fig. 12). If the position of the line *a* relative to the face is not the same in both instances, the stud is not parallel to the commutator face and should be packed with mica or paper between the shoulder of the stud and the brush rocker till parallelism is obtained; then tighten the studs securely in position.

Care should be exercised in setting and securely fastening the stud in position, as noted above, as otherwise, the length, position, and tension of the brush will be changed.

Commutators.— Remove the commutator segments and turn the wood blocks end for end, or in such position that the brush in leaving the copper segment will come in contact with the copper tip of the wood block. It will also be found more convenient to change the position of the switch handles on the terminal board, which can readily be done by removing the binding posts and switch posts and reversing their positions on the board.

Connect up the brush-holders to the terminal board, as shown in the diagram of connections.

Wires between controller and regulator should be reversed, and the clutch short circuiting cable (which is attached to the lower button on the left-hand side of the rheostat) should be carried to the opposite binding post with the wire from the left-hand lower binding post on the controller.

The current of the Brush Arc Machine is automatically maintained constant by a regulator of one of the forms described on the following pages.

FORM 1 REGULATOR FOR MULTIPOLAR BRUSH ARC GENERATORS.

The Form 1 Regulator is placed on the frame of the machine beneath the commutator, and a constant motion is imparted to its main shaft through a small belt running around the armature shaft. (See Fig. 13.) By means of magnetic clutches and bevel gears, a pinion shaft is rotated, which moves the rack and the rocker arm and so shifts the brushes on the commutator to maintain a spark of about $\frac{3}{8}$ " on short circuit and $\frac{1}{8}$ " at full load; at the same time the rheostat arm is moved over the contacts to cut resistances in or out of the shunt around the field circuit.

The current for the magnetic clutches is regulated by the controller.

The controller consists principally of two magnets which are

energized by the main current and act when the current is too high or too low, by sending a small current to one of the clutches.

A careful examination of the controller (see Diagram 13454, page 150) in connection with Fig. 31 will give a clear idea of its

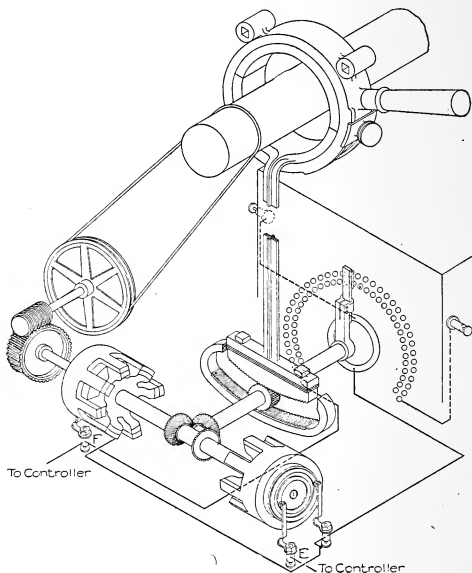


Fig. 13.

regulating action. It is generally advantageous to make the yoke which carries the brushes on the machine and the arm moving the rheostat, rather tight. As the magnetic clutches act with considerable force, it is not necessary to adjust these moving parts

so loosely that they will move without considerable pressure on the rocker handle. Less difficulty will then be experienced in adjusting the controller.

For shunt lamps the controller may be adjusted to permit a variation of .4 ampere above and below normal; for differential lamps, the variation above and below should not exceed .2 ampere. The limits given in the following instructions are for differential lamps, and may be extended .2 ampere above and below for shunt lamps.

If the controller is out of adjustment and fails to keep the current normal, do not try to adjust the tensions of both armatures at the same time. For example, suppose the current is too high, either one of the two spools may be out of adjustment. The left-hand spool *I* (see Diagram No. 13,454) may not take hold quickly enough, or the spool *F* may take hold too quickly. To make the adjustment, screw up the adjusting button *K* on the right-hand spool, increasing the tension. This will have a tendency to let the current fall much lower before the armature comes in contact with *H*, to cause the current to increase. By simply tapping the armature *G* quickly with a pencil or piece of wood, forcing it down with its contact, and at the same time watching the ammeter, the current may be brought up to 6.8 amperes if 6.6 amperes is normal, or 9.8 if 9.6 is normal. With the current at 6.8 amperes, which is .2 ampere high, the adjusting button *L* should be turned to increase the tension on this spring until the armature *M* comes in contact with contact *N*, which will force current down through *O*. The clutch which pulls the brushes forward and rocks the rheostat back for less current will thus be energized. Repeat this adjustment two or three times, but do not touch the adjusting button *K*; adjust *L* until it is just right.

At the side of the armature *M* a little wedge is screwed in by means of an adjusting button, and increases or decreases the

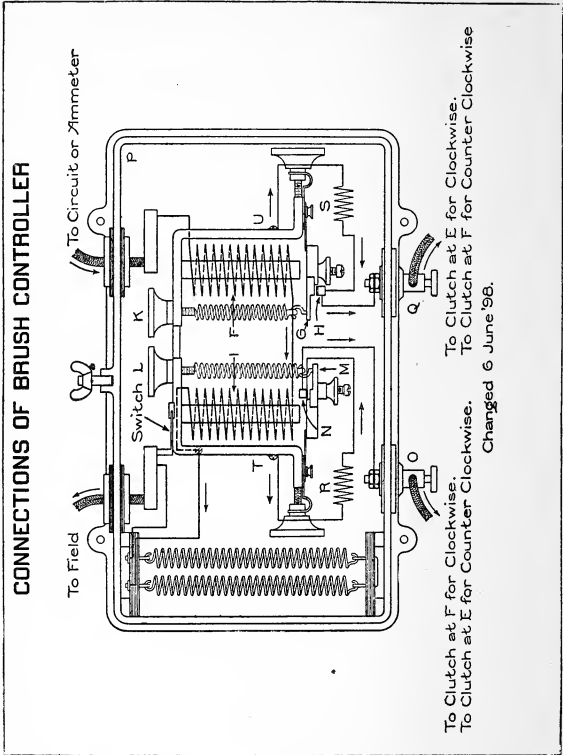


Diagram No. 13454.

leverage on this armature. See that this wedge is fairly well in between the core or frame of the spool and the spring of the armature. The armature M may have to be taken out and the spring slightly bent. It is advisable to have the screw which passes through the adjuster button L about half way in, to allow an equal distance up and down for adjusting this lighter spring after the wedge-shaped piece is in the right position to give the necessary tension on the spring which is fastened to the armature M .

In the right-hand corner P , a small bent piece of wire is placed for tightening up the screw which fastens the spring to the frame of the spool. As the contact made by the spring and the frame of the spool held together by a screw and button is a part of the magnetic circuit, it will be almost impossible to get this spring back to exactly the same tension after once moving it. Therefore, the adjusting buttons of the controller must be turned slightly in order to bring it back to its proper adjustment. This, however, is an after consideration, and care should be taken to have the screw which holds the spring and frame together always tight.

Having adjusted the spool I so that the current will not rise above 6.8 (or 9.8) amperes, move the armature M up to contact N with a pencil or piece of wood, causing the current to be reduced to about 6.2 (or 9.2). After the current settles at this point, decrease the tension on the spring which is fastened to armature G , allowing this armature to fall down to contact H . Current will then flow through Q , which will rock the brushes back and also move the rheostat arm for more current. As the spool I has been adjusted for 6.8 (or 9.8) amperes, the current cannot rise above that amount, no matter how the spool F is adjusted.

With a very little practice in moving the armature of one spool with a pencil, the other can be adjusted much more readily

than if an attempt is made to adjust the screws *K* and *L* at the same time.

The two small shunt coils, *R* and *S*, are connected around the two contacts simply to decrease the spark between the silver and platinum contacts. If they should become short circuited in any way, so that their resistance becomes diminished, sufficient current may pass through either of them to operate the regulator. If unable to locate the trouble, disconnect these coils at points *T* and *U*, when a thorough examination can be readily made. *M* and *G* need not move more than just enough to open the contact — $\frac{1}{32}$ " is ample.

STARTING THE MULTIPOLAR BRUSH ARC GENERATOR WITH FORM 1 REGULATOR.

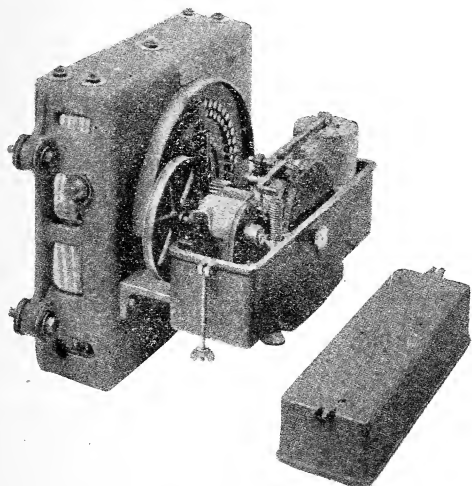
In starting, the lower switch, which short circuits the field, should be opened last.

The switch in the left-hand corner of the controller (Diagram No. 13454) cuts out the two resistance wires which are used to force the current through wires *O* and *Q* to the clutches. Open this switch which leaves the automatic device of the controller in circuit so that it will move the brush rocker. Unclasp the brush rocker from the rheostat rocker. Move the brushes by hand to give the proper spark, allowing the rheostat arm, however, to be moved by the controller. After the switches are opened, the rheostat arm will go clear around to a full load position, and then, as the current rises, the controller takes hold and brings the arm back. In the meantime, rock the brushes forward or backward and keep the spark about the proper length, say $\frac{1}{8}$ " at full load to $\frac{3}{8}$ " on short circuit. Gradually the rheostat arm will settle, the spark will become constant, and the machine will give its proper current. Then clamp the rocker and rheostat arm together and let the machine regulate itself.

This method is much better than opening the switches on the

machine and allowing the wall controller to take care of the machine from the start. By allowing the controller to start the machine, a trifle longer spark is obtained than by the other method, unless the machine is run from the beginning on a very full load.

The machine will require a trifle longer spark on light loads, or on bad circuits, than when running at full load. This fact should be borne in mind in wet weather, when trouble with grounds is experienced.



Form 2 Regulator.

FORM 2 REGULATOR FOR MULTIPOLAR BUSH ARC GENERATORS.

The connections for clockwise and counter clockwise generators of the single-circuit or multi-circuit type, are shown in Dia-

grams Nos. 13452 and 13453 on pages 144 and 145. The connections of the field magnets are the same for either clockwise or counter clockwise.

The switches on the terminal board should be arranged as shown in Diagram No. 13452 for clockwise, and No. 13453 for counter clockwise single circuit generators. The counter clockwise generator has a straight vertical strap connecting the two vertical clip posts. The clockwise generator has a diagonal strap. The terminals of the machine are on the back of the board.

A, the positive terminal, is connected through the board to the switch post; **B**, the negative terminal, is insulated from the switch clip post, and is used only as a connector for the cable running down to B^1 on the regulator. In returning to the machine, the current can go directly to B^1 instead of to **B**.

The connections of the Form 2 Regulator are shown in Fig. 14. The regulator performs two operations; sweeps a set of contacts, throwing more or less resistance in shunt with the field circuit, and at the same time, rocks the brushes so that the spark is kept at proper length, varying at from $\frac{1}{8}$ " at full load to $\frac{3}{8}$ " on short circuit.

A small belt runs over the armature shaft *M* and drives the rotary oil pump *P*. The pump draws the oil from the containing case and forces it through passages to the valve *T*, a section of which is shown in Fig. 15.

The ports overlap this valve so that the oil may flow through when the valve is in its central position. The valve is controlled by the electromagnet *F* (Fig. 14) which actuates the armature *U* and the lever *H*. The pull on armature *U* varies with the strength of the current which excites *F*. The opposite end of the lever *H* is attached to spring *G*, which is adjusted by the screw nut *R* so as to hold the valve in central position when normal current is flowing through the controlling magnet.

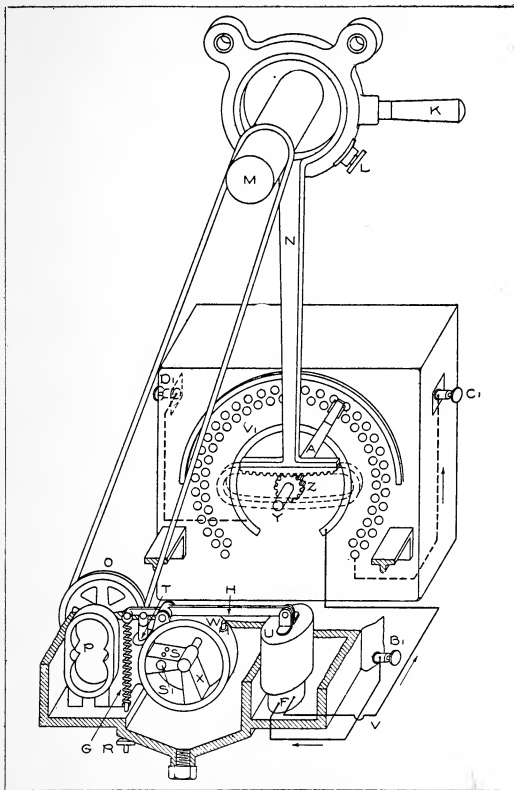


Fig. 14.

If the **current** is too strong, it pulls down the armature U , raising the valve, throwing more oil on the upper side of the circular piston head S , and allowing the oil to run out from the

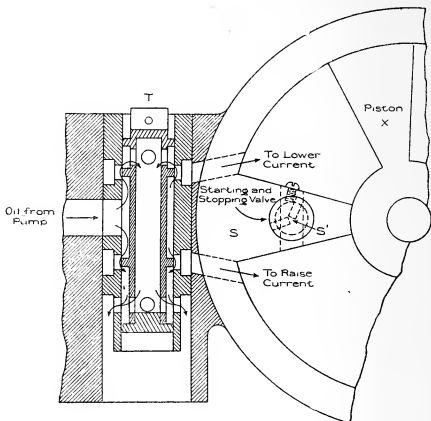


Fig. 15.

lower side, thus forcing the piston X around clockwise, lowering the current by moving the contact arm so as to shunt more current from the fields, at the same time moving the brushes forward until the current returns to its normal value.

If the current is too low the operation is reversed.

ADJUSTMENT OF FORM 2 REGULATOR.

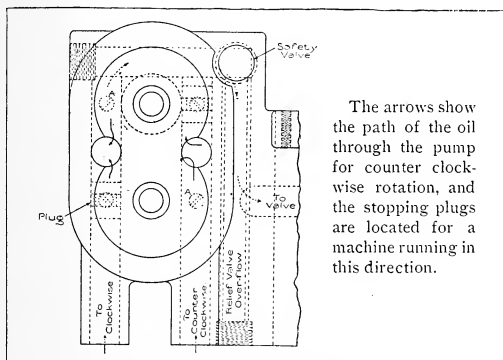
To raise the current, turn the hard rubber nut R (Fig. 14) to the right. If the current is too high, turn the nut to the left.

The limits between which the regulator operates are determined by the number of turns in the spring G . If the spring G

is stiffened by cutting off some of the turns and stretching it out, the limits of regulation will be wider. If the spring has a greater number of turns, it will regulate within narrower limits, but be more liable to "pump." The regulators are shipped with springs which have been found to give the best service for usual conditions.

The regulator may be caused to operate quickly in one direction and slowly in the reverse direction by changing the position of the stops on lever *H*. By raising the stop on the right-hand side of lever *H*, the movement on increasing the current will be retarded.

The safety of relief valve, shown in Fig. 16, is set to operate at a pressure of about fifteen pounds to the square inch, so as to



The arrows show the path of the oil through the pump for counter clockwise rotation, and the stopping plugs are located for a machine running in this direction.

Fig. 16.

relieve the pump. Fig. 16 also shows the ports and the method of changing the plugs, so as to run the pump with an open belt for either clockwise or counter clockwise machines. There is a

small wire on the back of the circular piston, which may be screwed into the plugs in these passages for the purpose of drawing them out and changing their position.

STARTING THE MULTIPOLAR BRUSH ARC GENERATOR WITH FORM 2 REGULATOR.

Before starting the machine, the oil box of the regulator should be filled with a light spindle or dynamo oil nearly up to the shaft which carries the contact arm, etc. As soon as the machine is started, the level of the oil will be somewhat lowered.

If the pump fails to start promptly, it may be started by shifting the brushes backward and forward, and moving the contact arm, to force out the air and draw in the oil.

In a newly installed machine, the oil should be changed at least once a week for the first month or six weeks, until all dirt and grit are thoroughly removed. The oil may be drawn off by unscrewing the cap bolt at the bottom of the oil box.

Special care has been taken to provide a good fitting cover for the oil box, so as to prevent sand and dirt from getting into the oil when the commutator is cleaned. The cover must always be kept on.

In general, Brush machines with Form 2 Regulators are started as described on page 152, but the following additional instructions should be noted: —

Having correctly adjusted the regulator for the desired current, as previously described, the starting valve handle S^1 (Figs. 14 and 15) should be turned counter clockwise when the machine is running without load. This handle operates a valve which connects both sides of the circular cylinder, thereby giving a free flow of oil between the two sides, and preventing the operation of the piston and relieving the pump from any undue load.

To put the machine in operation, the valve should be gradu-

ally thrown around clockwise, cutting off the flow of oil from the two sides of the cylinder after the switches have been opened. This valve may also be used to throw the regulator out of operation if desired.

FORM 3 REGULATOR FOR MULTIPOLAR BRUSH ARC GENERATORS.

In the Form 3 Regulator a belt from the armature shaft runs a small countershaft with crank attached. A rocking or reciprocating motion is thus imparted to the main lever, on which are pivoted two self-adjusting clutch jaws or grips. When the current is normal, the clutches are held stationary, but as the current varies, either above or below normal, the clutch on one side is dropped so that it will grip the clutch disk, and the mechanism revolves in the proper direction to restore the current.

With slight variations of the current, the regulator contact arm is moved forward or backward very slowly; while, with greater variations, caused by any considerable number of lamps being cut in or out, the movement is increased and the normal point or position more quickly reached.

The same form of bell magnet is used as in the Form 2 Regulator, and it is adjusted in the same manner (see pages 156 and 157).

For starting Brush Arc Generators with Form 3 Regulators, see general directions under Form 1 Regulator on page 152.

FORM 4 REGULATOR FOR MULTIPOLAR BRUSH ARC GENERATORS.

The Form 4 Regulator is similar to the Form 3; the countershaft and rocking lever are identical, but instead of using clutches, the lever operates two pawls, which engage in ratchet wheels. The pawls are not in contact when the current is normal, but are

thrown in to move the arm to either right or left as the current varies and the regulator is called upon to shunt more or less current from the field.

With this form of regulator, the motion is positive, and the ratchets are advanced by the full length of one tooth, whether the variation in current be great or small. The ratchets are so arranged that the contact arm moves across no more than one and one-half of the contact buttons for each tooth.

AMMETER.

A reliable ammeter should always be connected in the circuit of an arc generator, so that the exact current may be read at a glance. It should be connected into the negative side of the line where the circuit leaves the regulator.

INSTRUCTIONS FOR INSTALLING AND OPERATING IMPROVED BRUSH ARC LAMPS.

Unpacking.— Remove all strings and wedges from the mechanism, and carefully clean the lamp, using a small bellows to remove dust and any pieces of packing which may have lodged inside the casing.

Examine the packing carefully for small pieces of the lamp which may be wrapped up separately, or possibly have worked loose during transportation.

Suspension.— One of three methods of suspension may be used for Brush Arc Lamps. If chimney suspension, which is the most common, is adopted, the wire, cable or rope used to suspend the lamp must be carefully insulated from the chimney. For this purpose a porcelain insulator should be inserted between the support and the lamp.

Hook suspensions may be used to advantage in some places, but greater care must be taken to insulate the supporting wires

**TERMINAL BOARD CONNECTIONS FOR
Nos. 9, 10 AND 11 BRUSH ARC GENERATORS 3 CIRCUITS**

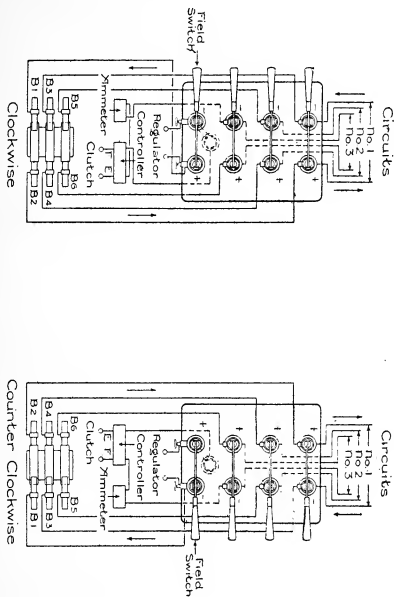


Diagram No. 13444.

TERMINAL BOARD CONNECTIONS FOR NOS. 9½ AND 12 BRUSH ARC GENERATORS 2 AND 4 CIRCUITS

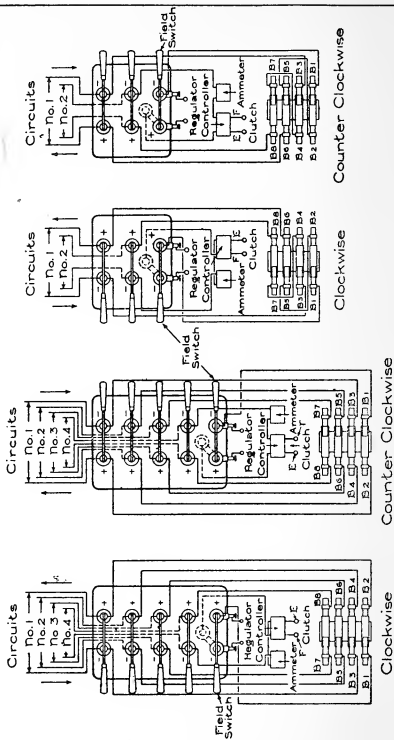


Diagram No. 13445.

from any conductors, as the hooks form the terminals of the lamp.

The most convenient arrangement for indoor use is to suspend the lamp from a hanger board. The porcelain base of the hanger board prevents short circuits or grounds.

A protecting hood is not necessary for outdoor use, as the lamp chimney and its base are one casting and effectually exclude rain or snow water.

If the magnets have become damaged, new ones should be substituted, and the lamp readjusted.

The lamps run nominally on circuits of 6.6 amperes for 1200 candle-power and 9.6 amperes for 2000 candle-power. In case it is necessary to run a lamp on a circuit differing from the standard, the lamp may be adjusted by moving the contact on the adjuster. This will compensate for about one ampere either way from normal and is set in about the middle position when the lamp is shipped.

Permanent adjustment for special circuits of variation greater than one ampere from standard is made by filing the soft iron armature. The clutch should be so adjusted that the center of the armature is $\frac{1}{8}$ " above the plate when the trip on the first rod is touching the bushing, and $\frac{1}{16}$ " when the trip on the second rod is in a similar position. A small gauge is convenient for adjusting the clutch. The position of the trip of the clutch determines the feeding point of the lamp.

After thoroughly repairing and cleaning the lamp, it should be run a short time before installing. Lamps should not be tested in an exposed place, as a strong draft of air will cause unpleasant hissing, which may be mistaken for some internal trouble.

Lamps should not hiss or flame if good carbons are used. A voltmeter should always be used when adjusting or testing.

Connecting. — The lamp terminal hooks are marked *P* (posi-

tive) and N (negative), and should be connected into circuit accordingly.

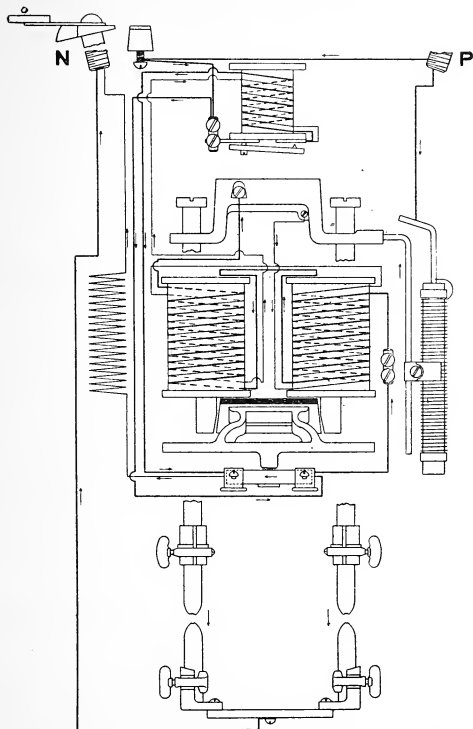
In the Form 1 lamp, both upper and lower carbon holders are adjustable for various sizes of carbons, but, when shipped, the holders are adjusted for $\frac{7}{16}$ " carbons. The upper carbon holder of the Form 2 lamp is made in two sizes, one taking $\frac{7}{16}$ " to $\frac{1}{2}$ " carbons and the other taking $\frac{9}{16}$ " to $\frac{5}{8}$ ". The lower carbon-holder is adjustable as in the Form 1 lamp. If the carbons are straight, they should line up properly. The carbons must be clamped firmly to prevent heating or possibility of arcing at the holder.

The carbons should rest in contact when the lamp is cut out. When the switch is opened, part of the current from the positive terminal hook (P) goes through the adjuster to the yoke, and thence through the carbon rod and carbons to the negative terminal hook (N). The remainder of the current goes to the cut-out block, but, as the cut-out is closed at first, the current crosses over through the cut-out bar to the starting resistance, and so to the negative side of the lamp. A part of it, however, is shunted at the cut-out block through the coarse wire of the magnets, and so to the upper carbon rod and carbons and out. This shunted current energizes the magnets and so raises the armature which opens the cut-out and at the same time establishes the arc by separating the carbons.

The fine wire winding is connected in the opposite direction from the coarse winding, and its attraction is therefore opposite. When the arc increases in length, its resistance increases, and consequently, the current in the fine wire is increased. The attraction of the coarse wire winding is, therefore, partly overcome and the armature begins to fall. As it falls, the arc is shortened and the current in the fine wire decreases. The mechanism feeds the carbons and regulates the arc so gradually that a perfectly steady arc is maintained.

The fine wire of the magnets is connected in series with the

winding of a small auxiliary cut-out magnet at the top of the mechanism.



CONNECTIONS FOR IMPROVED BRUSH ARC LAMPS.

This magnet, which also has a supplementary coarse winding, does not raise its armature unless the voltage at the arc increases

to 70 volts. The two windings connect at the inside terminal on the lower side of the auxiliary cut-out magnet, and the current from the fine wire of the main magnets passes through both windings and then to the cut-out block and so to the starting resistance and out.

If the main current through the carbon is interrupted (as by breaking of the carbons), the whole current of the lamp passes through the fine wire circuit. Before this excessive current has time to overheat the fine wire circuit, it energizes the auxiliary cut-out magnet and closes a circuit directly across the lamp through the coarse wire on the auxiliary cut-out to the main cut-out block, and thence to the negative terminal.

The auxiliary cut-out operates instantly and prevents any danger to the magnets during the short period required for the main armature to drop and throw in the main cut-out. When the main cut-out operates, the armature of the auxiliary cut-out fails, because there is not sufficient current in that circuit to energize the magnet.

The voltage at which the auxiliary cut-out magnet operates depends on the position of its armature, which is regulated by the screw securing the armature in position. It should not be adjusted to operate at less than 70 volts.

Trimming. — The globe may be lowered by releasing a thumb screw at the side of the holder. When lowered, the globe is supported by a center rod with a crown which engages the lower carbon-holder stand.

The carbons should be solid and of uniform quality. For the best results, the upper carbon should be $12'' \times \frac{7}{16}''$, and the lower $7'' \times 7 \frac{7}{16}''$. The stub of the upper carbon may then be used in the lower holder when retrimming.

At each trimming the rod should be carefully wiped with clean cotton waste. It should never be pushed up into the lamp in a dirty condition.

In order to remove the carbon rod or examine the mechanism, the jacket must be lowered by pressing a spring clip on its under side.

The carbon rod may be unscrewed and removed by a small screw-driver or small strip of metal inserted in the slot cut in the rod cap. The cap will remain in the hole through the yoke when the rod is taken out.

The lamp must never be left burning with the jacket off, nor be allowed to hang with the mechanism exposed to the weather.

Repairing, cleaning and testing. — If the lamps show a tendency to hiss or work badly after long service, they should be removed to a convenient place and carefully inspected.

All wearing parts should be examined, and, if necessary, renewed by ordering new parts.

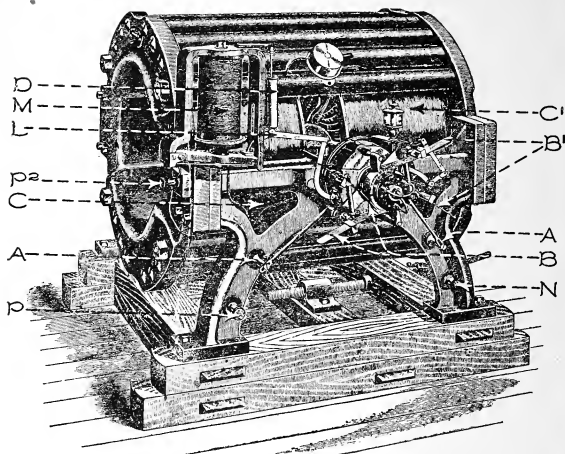


Fig. 1. The Thomson-Houston Standard Arc Dynamo Arranged for Right-hand Rotation.

CHAPTER X.

INSTALLATION OF ARC DYNAMOS.

Location and mounting.— The generator should be located in a cool, dry room, free from dust, metal chips or flying particles of any sort. Space should be allowed around the machine to give ample room for reaching all parts of it, particularly the commutator. The generator must not be placed in a room where

moisture is liable to collect upon it. Basements are often very objectionable on this account. The generator should be set upon a firm foundation of well-seasoned wood, and should be mounted upon a sliding bed-plate, so that the belt can be tightened or loosened while the generator is running. The generator should be thoroughly insulated from earth. The sliding bed-plates as now manufactured are designed to provide perfect insulation, and meet this requirement fully. The direction of rotation of the armature in the standard generator is from right to left, or counter-clockwise, as seen when facing the commutator. This is called a right-hand machine. Right-hand machines may be run left-handed by replacing certain parts of the brush-holder and regulating mechanism, per instructions on page 185.

Pulleys.—The generator is provided with a pulley of proper size to transmit the power demanded, and a smaller one should not be substituted.

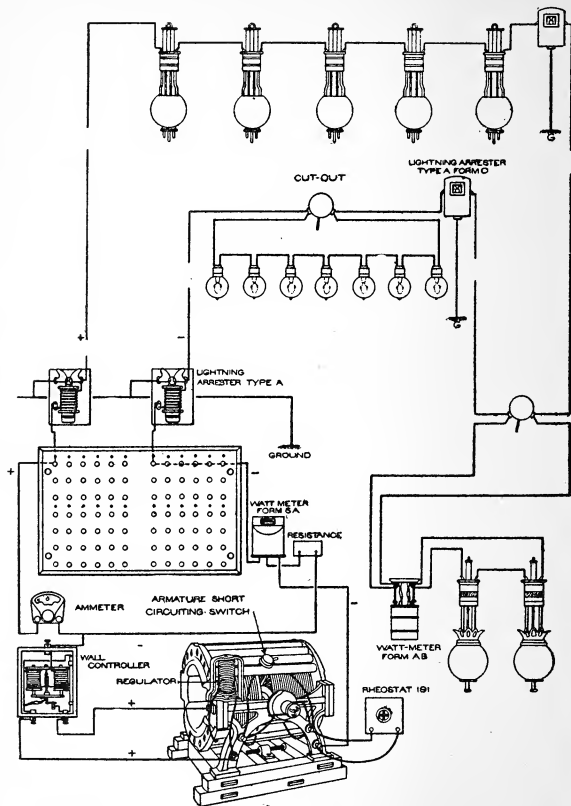
Bearings.—The oil in the reservoir should be renewed once a week for the first two or three weeks, in order to wash out any grit which might become loosened by the churning of the oil while the machine is running.

Speed.—The generator should be run as nearly as possible at the speed given by the maker. An increase of speed, if not too excessive, will do no harm, but a considerable diminution in speed below normal, when the generator is doing its maximum work, is liable to cause unsteadiness in the lights.

The automatic regulator will adjust perfectly for fluctuations in speed near or above normal, unless the fluctuations are extremely sudden, as in the case of slipping of the belt.

Belts.—The belt of the generator should be about half an inch narrower than the face of the pulley. An endless belt is desirable.

Brushes.—When the generator is in position the brushes or strips of copper $B B$, $B^1 B^1$ (see Fig. 2), are placed on the



CONNECTIONS FOR ARC LIGHTING SYSTEM.

Fig. 2.

machine in the manner shown. All four brushes should be set exactly to the gauges sent with each machine, so that they press with sufficient force on the surface of the commutator to insure good contact at all times.

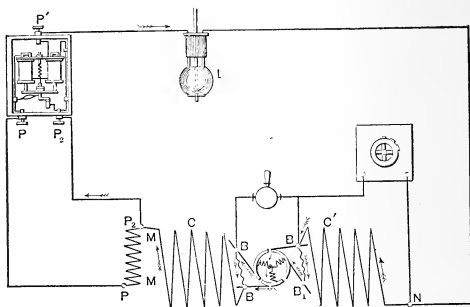
The length of the gauge is such that the brushes project a little past the center of the commutator, as shown in Fig. 5, to avoid catching in the slots should the armature be turned backward.

Air Blast. — The air blast or blower on the arc light generator plays an important part in the successful operation of the machine. Its construction is very simple; it has but few moving parts and these are made strong and durable. The air blast requires no attention, except that it should be kept scrupulously clean and well oiled. Only the best quality of mineral oil should be used. Poor oil will always cause trouble.

The screens which cover the air inlets on the air blast, should be kept clean and free from dust. They should be taken out about once a month and cleaned in kerosene oil. If it should become necessary to cut a new air blast keyway the proper place to cut it is exactly one-third of the way round from the old one.

Regulator. — The regulator is fastened to the frame of the machine by two short bolts. On the right-hand machine its position is on the left-hand side, as shown in Fig. 2. On the left-hand machine, *i. e.*, one which runs clockwise, its position is on the opposite side. Before filling the dash-pot *D* with glycerine, see that the regulator lever and its connections, brush yokes, etc., are free in every joint, and that the lever *L* can move freely up and down. Then fill the dash-pot *D* with concentrated glycerine. The long wire from the regulator magnet *M*. is connected with the left-hand binding post *P* of the machine, and the short wire with the post *P*² on the side of the machine. The inside wire of the field magnet, or that leaving the iron flange of the left-hand field should be connected into the post *P*² also, as shown in Fig.

2. The electric current (see Fig. 3), should be complete from P^1 on the controller magnet, through the lamps to post N on the machine, through the right-hand field magnet C^1 , to the brushes



CONNECTIONS FOR RHEOSTAT.

Fig. 3.

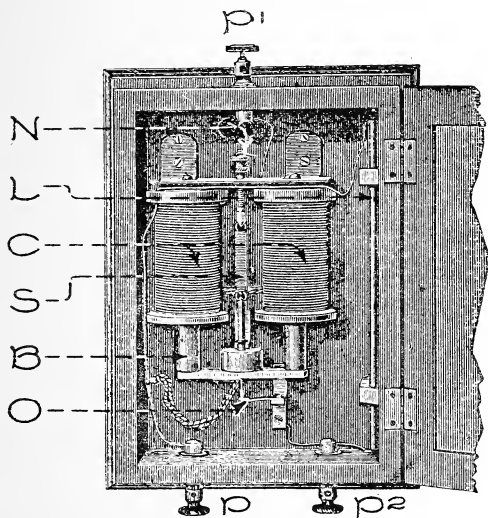
$B^1 B^1$, through the commutator and armature to the brushes $B B$, through the left-hand field C , to posts P^2 and P , thence to posts P^2 and P on the controller magnet, through the controller magnet to P^1 . The current passes in the direction indicated by the arrows.

Rheostat.— When an arc machine is to be run frequently at a small fraction of its normal capacity, the use of a light load device is advisable to secure the best results in regulation.

The rheostat (see Fig. 5) is connected in shunt with the right field of the generator. Facing the rheostat with right binding posts at the bottom, the contact on right side or No. 1 gives open circuit and throws the rheostat out of use. Point No. 2 gives a resistance of 44 to 46 ohms, and point No. 3 gives a resistance of 20 to 22 ohms.

This rheostat is regularly shipped with MD^{12} , 75 light generators and allows the following variations: Point 1, 75 to 48 lights; Point 2, 48 to 25 lights; Point 3, 25 lights or less. For use with other sizes of generators, the adjustment of the rheostat must be made to suit the conditions.

When the rheostat is in use, the sparks at the commutator will be somewhat larger than normal, but will not be detrimental.



CONTROLLER FOR ARC DYNAMO.

Fig. 4.

Controller. — The controller magnet (see Fig. 4) is to be fastened securely by screws to the wall or some rigid upright sup-

port, taking care to have it perfectly plumb. It is connected to the machine in the manner shown in Fig. 3, *i. e.*, the binding post P^2 on the controller magnet, is connected to the binding post P^2 (see Fig. 2) on the end of the machine; and likewise, the post P on the controller to the post P on the leg of the machine; the post P^1 forms the positive terminal from which the circuit is to run to the lamps and back to N .

Great care should be taken to see that wires $P P$ and $P^2 P^2$ are fastened securely in place; for if the connection between P and P should be impaired or broken, the regular magnet M would be thrown out of action, thus throwing on the full power of the machine, and if the wires $P^2 P^2$ should become loosened, the full power of the magnet M would be thrown on, and the regulator lever L , rising in consequence, would greatly weaken or put out the lights.

The wires leading from the controller magnet to the machine should have an extra heavy insulation. Care should be taken in putting up the controller magnet that the following directions are followed:—

(1) The cores B of the axial magnets $C C$ must hang exactly in the center, and be free to move up and down.

(2) The screws fastening the yoke or tie pieces to the two cores must not become loosened.

(3) The contacts O must be firmly closed when the cores are not attracted by the coils $C C$, which is the case, of course, when no current is being generated by the machine, and when the cores are lifted, the contacts must open from $\frac{1}{64}$ " to $\frac{1}{32}$ "; a greater opening than $\frac{1}{32}$ " has the effect of lengthening the time of action of the regulator magnet. This tends to render the current unsteady, and in case of a very weak dashpot or short circuit, might cause flashing. Adjustment may be made if necessary by bending the lower contact up or down, taking care that it is kept parallel with the upper contact, so that when they are closed,

contact will be made across its whole width. If this adjustment is not properly made there will be destructive sparking on a small portion of the contact surfaces.

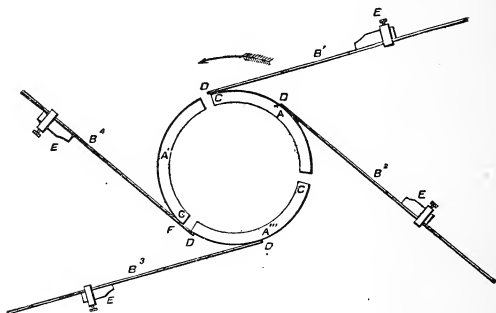
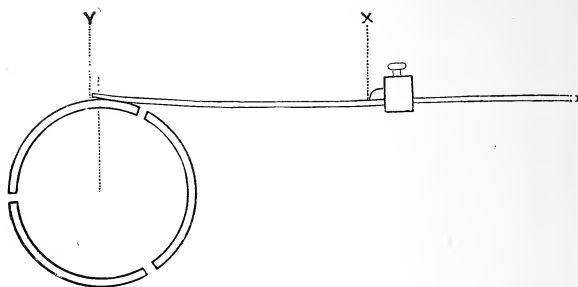
- (4) All connections must be perfectly secure.
- (5) The check-nuts N must be tight.
- (6) The carbons in the tubes L must be whole.

These carbons form a permanent shunt of high resistance around the regulator magnet M , and if broken will cause destructive sparking at contacts O , burning them and seriously interfering with close regulation of the generator. In case a carbon should become broken, temporary repairs may be made by splicing the broken piece with fine copper wire. To keep the action of the controller perfect, the contacts O should be occasionally cleaned by inserting a folded piece of fine emery cloth and drawing it back and forth.

The amount of current generated by each machine depends upon the adjustment of the spring S . If the tension of this spring is increased, the current will be diminished; if the tension is diminished, the current will be increased.

Once set up and in perfect working condition, adjusted to the proper current, the controller magnet should rarely need any adjustment.

Testing arc light dynamos. — The points here noted are very essential to the successful operation of the arc generator, and are very carefully carried out in testing arc machines at the factory. They are given for the benefit of those who have not had experience in that line. The commutator should fit the shaft snugly, but be sufficiently free to turn easily on the shaft. Be very careful to put the short brush-holders on the outer yoke, and the long brush-holders on the inner yoke. Also see that the long binding post, attached to the sliding connection, is on the lower left-hand brush-holder, and the short post on the lower right-hand brush-holder. Always set the brush-holders to the proper angle by the



A — Commutator Segments.

B² } Primary Brushes.

B⁴ }
B¹ } Secondary Brushes.

C — Forward Point of Segment.

D — Point of Brush.

E — Brush-holders.

F — Point of Contact.

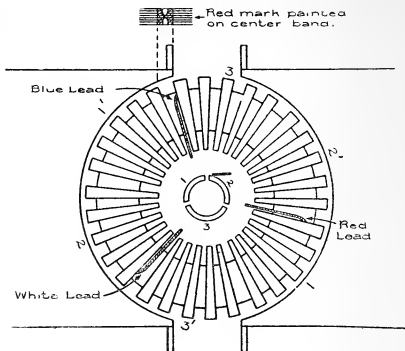
Figs. 5 and 6.

brush-holder gauge. First tighten up the brush-holders and then turn them to the correct position by means of a piece of steel wire passed through the holes. Then permanently tighten up the brush-holders very firmly, trying them with the gauge to see that they are the same distance from the commutator. Always be careful to get the brushes exactly straight and flat before clamping them to the brush-holders, and always set them to the exact length of the brush gauge.

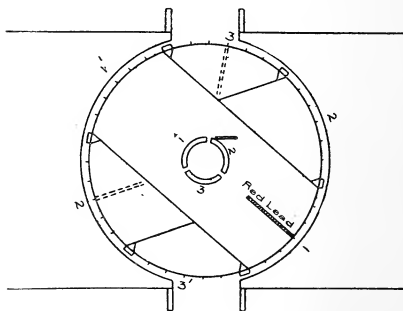
Setting the cut-out. — After the brushes are in position, the cut-out must be set. This is done by turning the commutator on the shaft in the direction of rotation (if the commutator is set in position the whole armature must be revolved), until any two segments are just touching the primary brush on that side, as segments A' and A'' touch brush B^1 in Fig. 6. Under these conditions brush B^1 should be at the left-hand edge of upper segment. Then turn commutator until the same two segments are just touching brush B^2 , when the end of brush B^3 should just come to the right-hand edge of the lower segment. If the secondary brush projects beyond the edge of the segment the regulator arm should be bent down; if it does not come to the edge of the segment the arm should be bent up.

Care must be taken that the regulator armature is down on the stop when the cut-out is being set. These adjustments by bending regulator arm are always made in the factory before testing the machine, and should never be made on machines away from the factory unless the regulator arm has been bent by accident. If it becomes necessary to make any adjustments they should be made by means of the sliding connection attached to the inner yoke.

Always try the cut-out on both primary brushes. If it does not come the same on both, turn one over. If the brush-holders are correctly set by the gauge, there should be no trouble in getting the cut-out set properly after one or two trials.



RIGHT-HAND RING ARMATURE.



RIGHT-HAND DRUM ARMATURE.

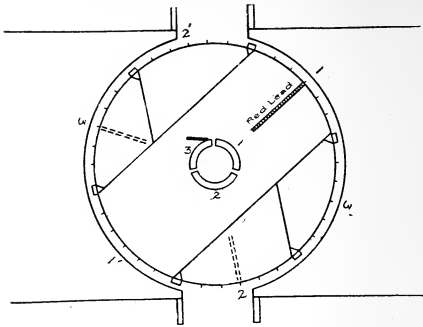
Figs. 7 and 8.

To set the commutator in the proper position on a right-hand machine, with a ring armature, find the leading wire of No. 1 coil. It is the custom in the factory to paint this lead red, also to paint a red mark on the center band between the two groups of coils, namely, the last half of No. 1 coil and the first half of No. 3 coil. The first half of a coil is that group from which the lead comes. The last half is diametrically opposite the first half, and the lead wire belonging to it is connected with the brass ring on the outside of the connection disk on the commutator end.

In Fig. 7 the first halves of the three coils are represented by 1, 2, and 3, and the last halves by 1', 2', and 3'. A narrow piece of tin with sharply pointed ends is bent up over the sides of the middle band at the center of the red mark, so that the points are opposite each other. When the red mark and red lead have been found, turn the armature until the last half of No. 1 coil has wholly disappeared under the left field, and until the left-hand edge of the first coil to the right of the red mark (No. 3 in Fig. 7) is just in line with the edge of the left field. The red lead will then be in position shown in Fig. 7, and the armature is in proper position to set the commutator. In the case of the right-hand drum armature, the leading wire of the first coil should be found. This lead may be recognized from the fact that it is more heavily insulated than the rest, and is found in the center of the outer coil, on the commutator end. With this wire turned underneath, rotate the armature forward, or counter-clockwise, until the pegs on the right-hand side of this coil just disappear under the left field (see Fig. 8).

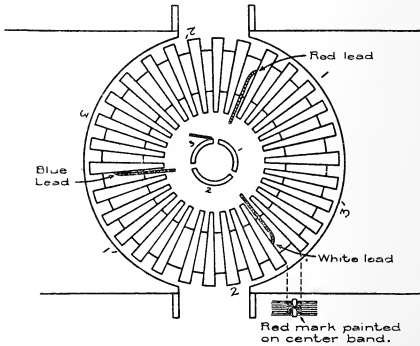
The position of the red lead and the red mark on the band are the same on all armatures, but their positions in the fields of machines called left-hand (clockwise rotation) should be as shown in Figs. 9 and 10, when setting the commutator.

When the armature of a right-hand machine is in position, the commutator is turned on the shaft until segment No. 1 is in the same relative position as the last half of No. 1 coil; segment No.



LEFT-HAND DRUM ARMATURE.

Fig. 9.



LEFT-HAND RING ARMATURE.

Fig. 10.

2 should correspond with last half of No. 2 coil, and segment No. 3 with last half of No. 3 coil, as shown on Figs. 7 and 8.

For left-hand machines, see Figs. 9 and 10.

The distance from the tip of the brush, which is on top, to the left-hand edge of No. 2 segment on a right-hand machine, or to the right-hand edge of No. 3 segment in a left-hand machine, is called the lead, and should be made to correspond to the following table: —

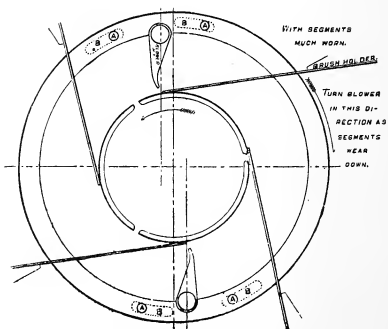
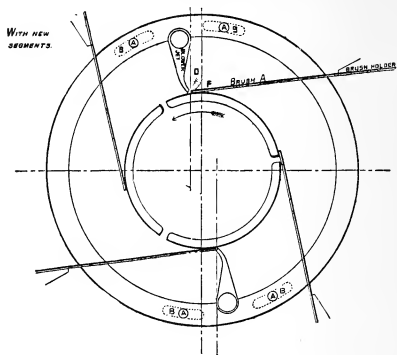
TABLE OF LEADS.

DRUM ARMATURES.	RING ARMATURES.
C ¹² $\frac{1}{4}$ " positive.	K ¹² $\frac{3}{16}$ " positive.
C ² $\frac{3}{8}$ " "	K ² $\frac{1}{8}$ " "
E ¹² $\frac{7}{16}$ " "	M ¹² $\frac{1}{4}$ " negative.
E ² $\frac{1}{4}$ " "	M ² $\frac{1}{2}$ " "
H ¹² $\frac{1}{4}$ " "	LD ¹² $\frac{1}{4}$ " positive.
H ² $\frac{1}{4}$ " "	LD ² $\frac{1}{8}$ " "
	MD ¹² $\frac{1}{3}\frac{3}{2}$ " "
	MD ² $\frac{1}{3}\frac{3}{2}$ " "

Place the screws in the binding posts at the lower ends of the sliding connections and put on the dash-pot connections between the brushes, with the heads of the connecting screws outward. In every case the barrel part of the dash-pot is connected to the top brush-holder, and plunger part to the bottom brush-holder. See that the field and regulator wires are connected and that all connections are securely made. When all connections have been made, make a careful examination of screws, joints, and all moving parts. They must be free from stickiness, and not bind in any position.

To determine when the machine is under full load, notice the position of the regular armature, which should be within $\frac{1}{8}$ " of the stop. At full load the normal length of the spark on the commutator should be about $\frac{3}{16}$ ". If it is less than this, shut down

BEST POSITION OF AIR BLASTS AND JETS ON LD AND MD DYNAMOS.



Lift Regulator as high as possible.

Figs. 11 and 12.

the machine and move the commutator forward, or in direction of rotation until the spark is of the desired length. If the spark is too long, move the commutator back the proper amount.

DIRECTIONS FOR SETTING THE AIR BLAST JETS ON LD AND MD DYNAMOS.

With new segments.— Loosen bolts *A-A-A-A* and turn the air-blast so as to bring the bolts in the centers of the slots *B-B-B-B*. Set the brushes by the gauge. Lift the regulator lever as high as possible and set the point *D* of the air blast jet $\frac{1}{32}$ " in front of the point *P* of the brush *A*. Place the lower jet in the same relative position with the lower brush.

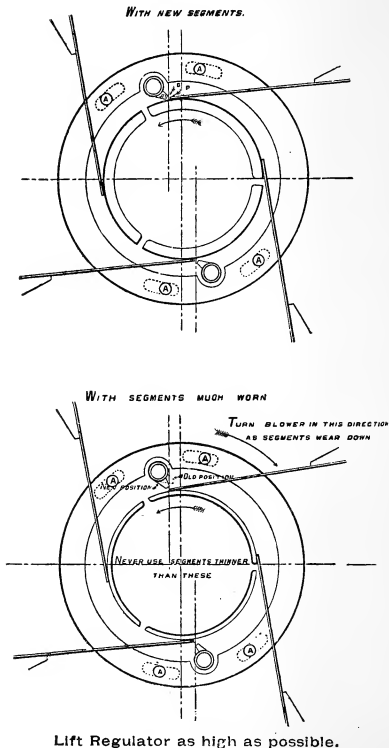
As segments wear down.— Loosen the bolts *A-A-A-A* and follow up the wear of the segments by turning the air blast against direction of rotation of armature as indicated. Turn the point of the jet downward, so as to blow more directly through the slot between the segments. Set the lower jet in the same relative position with the lower brush.

DIRECTIONS FOR SETTING THE AIR BLAST JETS ON E, H, K, L AND M DYNAMOS.

With new segments.— Set the brushes by the gauge. Lift the regulator as high as possible, and set the point *D* of the jet in line with the point *P* of the brush. Keep a space of $\frac{1}{32}$ " between the jet and the segment.

As segments wear down.— Loosen the bolts *A-A-A-A* and follow up the wear of the segments by turning the air blast against direction of rotation of armature, as indicated. Turn the point of the jet downward, so as to blow more directly through the slot between the segments. Set the lower jet in the same relative position with the lower brush.

BEST POSITION OF AIR BLASTS AND JETS ON E, H, K, L AND M DYNAMOS.



Figs. 13 and 14.

THOMSON-HOUSTON ARC DYNAMOS TO RUN LEFT-HAND OR CLOCKWISE, FACING COMMUTATOR.

In changing over a *T-H* dynamo from right-hand to left-hand, the following new parts, which are made specially for left-hand machines, must be ordered: —

MD² and LD².

Quantity.		Cat. No.
1	Air Blast with Back Plate and jets	1525
1	Yokes with equalizer bar and link	1571
2	Brush-holder Posts	1799
2	“ “	1800
1	Regulator	1733

MD¹² and LD¹².

Same as for MD² and LD² except:

1	Regulator (for MD ¹²)	2121
1	Regulator (for LD ¹²)	1813

K², L² and M².

1	Air Blast with Back Plate and Jets	1523
1	Yoke	1543
1	“	1544
1	Adjustable connection	1559
2	Brush-holder posts	1787
2	“ “	1788
1	Regulator	1729

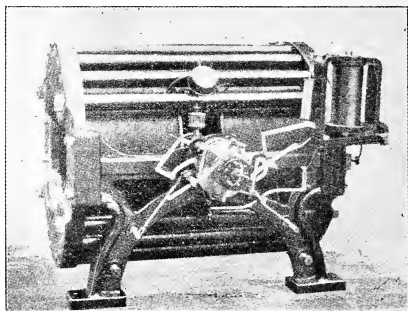
K¹² and M¹².

Same as K² and M² except:

1	Regulator	1726
---	---------------------	------

In case it should be preferred to change over the right-hand regulator so that it could be used on left-hand machine, the following instructions should be followed: —

The regulator should be taken apart and reassembled with "supporting arm" projecting from the proper side of regulator, to allow of bolting to the right-hand side of generator frame. Holes for this purpose should be laid out with a regulator in place,



Are Generator Arranged for Left-hand Rotation.

Fig. 15.

drilled in any convenient manner (usually with a ratchet) and tapped. Holes should also be drilled and tapped on right-hand side of frame for the vulcanite block which carries the binding post for the field and regulator wires.

The cut-out is set in precisely the same manner as with right-hand machines.

The commutator is set in the following manner (see Figs. 9 and 10): After setting the brushes accurately to gauge for brushes, turn the armature so that the lead wire of No. 1 coil is

on top. Then turn the armature in the direction in which it is to rotate until No. 1 coil just appears under right field. Now set the commutator with segment No. 1 corresponding in position with coil No. 1 and set the lead on segment No. 3. The commutator may then be secured in place and the machine started up in the usual manner.

The controller will now be on the negative side of the machine, whereas, before it was on the positive side. If it is desired to keep the controller side positive, it will be necessary to remagnetize the fields so that the right field will attract the north end of a compass needle.

SOME TROUBLES WHICH MAY BE MET AND THEIR CAUSES— REVERSAL OF POLARITY.

Cases are frequently reported where generators, from lightning discharges, wrong plugging on switch-board, or some other reason, suffer a reversal of polarity. The effect of reversal is that the lamps in circuit with the machine burn "upside down;" that is to say, the lower carbon becomes positive, which has the effect of throwing much of the light up instead of down, and with some carbons the arc will flame badly. This can be remedied temporarily, by changing the plugs on the switch-board, so that the current will enter the line where ordinarily it returns.

Occasion should be taken, however, the following day, or as soon thereafter as possible, to properly magnetize the fields so that they will be the right polarity. This may be done as follows:—

Close the armature short circuiting switch on the frame of the machine and run a loop from some other arc generator which happens to be in operation. Connect the positive side of this loop to the lower binding post *N* on the right leg of the machine, and the negative side of the binding post *P*² on the end of the frame

under the regulator, see Fig. 2. Then open the armature short circuiting switch on the second generator. A very few seconds will suffice to correctly polarize the first machine. Sometimes one or more layers of the field winding may become short circuited by lightning discharge or by the dropping of water or oil on them. A machine with such a field will not carry its load without flashing.

To detect a short circuit in the field, make all adjustments as if working under normal conditions, then run the machine at the proper speed on a dead short circuit. If there is no short circuit in the field, the armature of the regulator will be drawn up hard against the bottom of the magnet, but if there is a short circuit in the field the armature will drop more or less according to the amount of field wire cut out of circuit.

To find out which half of the field is affected, close the field switch and remove the regular wire from the Post P^2 , Fig. 2, then connect posts P^2 and N to some source of direct current, as a 110-volt exciter, and with a volt-meter measure the drop in voltage between posts N and A^1 and between A and P^2 . The drop should be very nearly the same in both cases if the winding is perfect, but the drop will be less across that field which is short circuited. If an ammeter is at hand, readings of the current and voltage may be taken, from which the resistances can be easily calculated.

The resistances of one single field of the various machines are given below:—

CLASS.	COLD RESISTANCE.	CLASS.	COLD RESISTANCE.
K ²	3.40	P ²	7.50
K ¹²	6.60	LD ²	7.00
L ²	5.50	LD ¹²	12.00
M ²	5.80	MD ²	5.75
M ¹²	14.00	MD ¹²	13.60

Another trouble which is liable to be met is flashing. When a generator flashes an arc is drawn around the commutator from one brush to the other, which soon short circuits the armature, putting out the lights. This arc is usually broken very quickly, but the flashing may be repeated at frequent intervals. There are several causes of flashing, such as overload, low speed, stickiness in the regulating mechanism, short circuit in the field, commutator not in proper position, or a dash-pot which is too stiff or too loose. If a machine flashes when running under proper load and at proper speed, see that there is no stiffness in the regulating mechanism, then examine the cut-out and note the length of the spark, which should be about $\frac{3}{16}$ " long at full load.

If all these adjustments are right, make the test described above for a short circuit in the fields.

RING ARMATURES.

All K, M, LD and MD machines are now made with ring armatures, which are a great improvement over the old style armature in that they have better ventilation, higher insulation, greater freedom from burning out and improved facilities for removing faulty coils and substituting new ones.

A recent improvement in the construction of these armatures consists in the removal of all insulation from the cores and the addition of more insulation to the separate coils. The cores are divided into three sections with ventilating spaces between. Armatures which are constructed according to this method run much cooler than the older forms. By removing the insulation from the cores these new coils may be applied to any of the older armatures now in use.

These armatures are interchangeable with the old style armatures, and can be used in any of the machines mentioned on page 185.

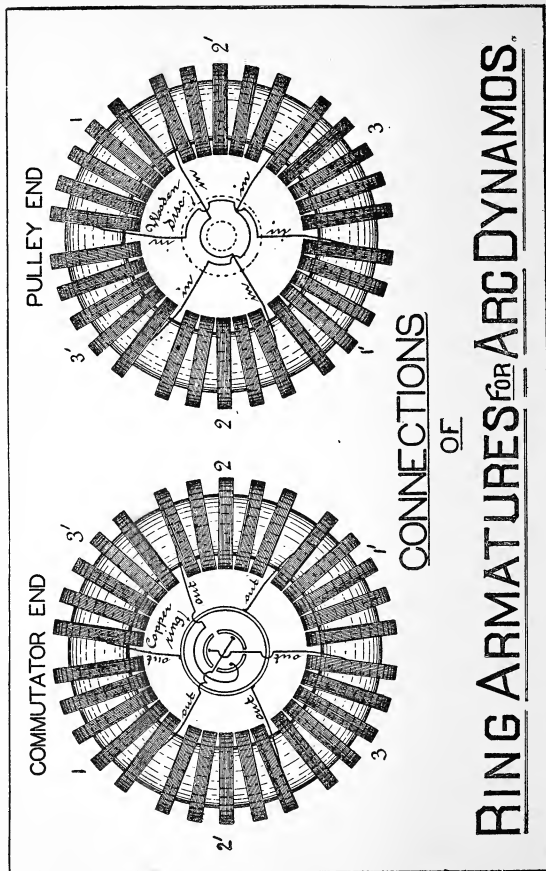
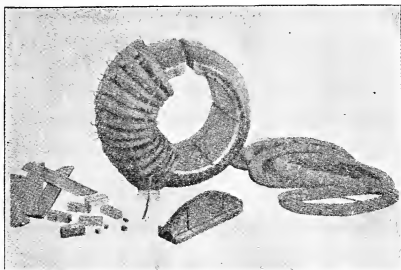


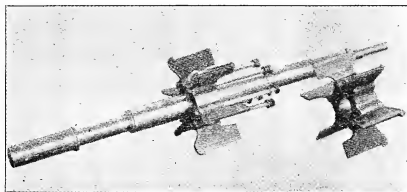
Fig. 16.

In case it becomes necessary to remove a faulty coil, the following directions should be carefully followed: —



Armature Core and Winding.

Fig. 17.



Armature Spider and Shaft.

Fig. 18.

DIRECTIONS FOR PLACING COILS IN RING ARMATURE WITH INSULATED CORE.

After the armature has been taken out of the machine, remove the brass binding wire by cutting the bands with a hack-saw or

file, carefully covering all the exposed parts of the armature with a cloth, so as to prevent filings from lodging on the winding. Carefully remove the insulating bands, as they can be used again in rebinding the armature. Remove the cord and the tape from the joints of the lead wires and cross connections, at each end of the armature. Take out the lead wires and remove the wooden disks from the shaft. These disks are held in place by a set-screw, passing through a brass piece let into the disk, and resting on the shaft. Unsolder the joints on the coils that are to be removed. Take out the bolts holding the two gun-metal spiders together, and with a long steel pin or drift, drive out the key, which fastens the loose spider to the shaft; the loose spider is on the commutator end. The spider next to the pulley is securely fastened to the shaft by a steel pin drawn tightly into a reamed hole, passing through both spider and shaft. By driving on the commutator end of the shaft with a hard-wood block and mallet, or lead hammer, the shaft with the fixed spider may be removed, and the remaining loose spider can then be driven out with the hard-wood block and mallet. Before removing the shaft and spiders, note the position of the wedge in the armature core, its position is always indicated by the letter *W*, plainly stamped on the hub of the loose spider.

Remove the wood spacing blocks, slip the coils around on the core until the imperfect coils are over the wedge, then spread these coils apart so as to expose the wedge, and cut away the insulation on the core for a space of $3\frac{1}{2}$ " on top and bottom, over the space containing the wedge; the wedge may then be driven towards the center of the core, taking care that it does not drop on the coils opposite and injure them. The faulty coils may now be removed, new ones be inserted and the wedge be replaced and very carefully reinsulated. This insulation is put on, beginning with the layer next to iron core, as follows: —

- | | |
|--------------------------|------------------------|
| (1) 1 layer of paper, | (5) 1 layer of mica, |
| (2) 1 layer of mica, | (6) 1 layer of canvas, |
| (3) 1 layer of sheeting, | (7) 1 layer of tape, |
| (4) 1 layer of tape, | (8) 1 layer of paper. |

On armatures with bare cores the insulation given above is, of course, not used.

While working on the armature it should rest upon a mattress or bag of waste on the floor, so as to avoid any injury to the coils.

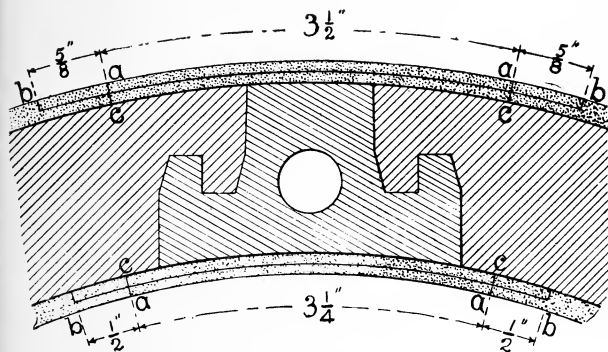


Fig. 19.

As shown in Fig. 19, the insulation of the wedge should break joints with the insulation of the body of the core; i. e., on a line $\frac{1}{2}$ " to $\frac{5}{8}$ " from *a* cut half through and remove the insulation, then insulate the space *cc* one-half the regular thickness, and the space *bb* the remaining half. This will break joints and prevent any possibility of a contact through the opening caused by cutting away the wedge insulation.

Slip the coils around to their proper places, so that they will be in correct position with regard to the arms of the spiders.

The loose spider may now be put in place and afterwards the fixed spider and shaft, the bolts being inserted and the nuts tightened up. Replace the key in the loose spider, put on the wooden disks and carefully solder and tape all the joints of lead wires and cross connections. Replace the spacing blocks in their proper positions, solder and tape the connections, and the armature is ready to be bound. This can best be done in a lathe, but the armature may be mounted in the regular dynamo legs, set out on the floor and the power applied either by hand or any other convenient method.

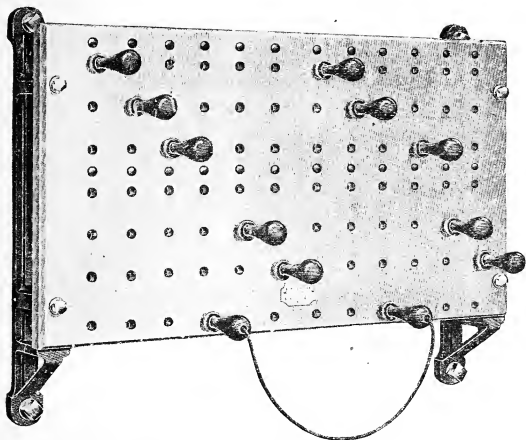
The binding wire used is No. 11, hard brass. The arrangement of the binding wire is clearly shown in the original bands of the armature and should be carefully noted before they are removed. The same brass clips may be used again, provided due care is taken in bending up the ends, when the old band is taken off.

SWITCHBOARDS.

The standard arc lighting switchboard consists of a marble panel, to the back of which the conductors are attached. When very large boards are built they are made by combining several panels. Switchboards of any capacity can be constructed without difficulty. The general arrangement of conductors is the same for all sizes.

Each panel is drilled with counter-sunk holes arranged in rows, and in each hole, a brass bushing is fitted. All the bushings of the same horizontal row on the right of the center of the panel are electrically connected, except those of the bottom row, and a similar connection is made between the bushings on the left of the center. A heavy brass strap is supported by the back of the panel behind each vertical row of holes and has bushings

in it corresponding to those in the face of the panel. These straps are placed several inches back of the marble, but any one of them can be put in electrical connection with any horizontal conductor it crosses by the use of suitable brass plugs inserted in the bushings.



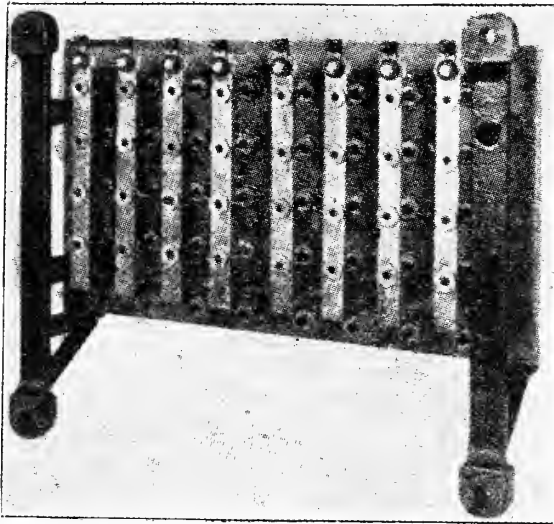
Standard Plug Switchboard for 6 Circuits.

Fig. 20.

In a standard panel the number of horizontal rows of holes equals one more than the number of generators. The vertical rows are always twice the number of generators. The positive leads of the generators are attached to binding posts on the left-hand ends of the horizontal conductors. The negative leads are connected to the corresponding binding posts at the right-hand end of the board.

The **positive** line wires are connected to the vertical straps on the left, and the negative wires to similar straps on the right of the center of the panel.

If a **switch board plug** be inserted in any of the holes of the board, it puts the corresponding generator lead and line wire in elec-



Back of Switchboard.

Fig. 21.

trical connection, but as the positive line wires are back of the positive generator leads only, it is not possible to reverse the connection of the line and generator accidentally, though any other combinations of lines and generators can be made readily and quickly.

The holes of the lower horizontal row have bushings connected with the vertical straps only. Plugs connected in pairs by flexible cable and inserted in the holes put the

corresponding vertical straps in connection as needed, and normally independent lines may be connected when one generator is required to supply several circuits.

Lines and generator leads may be transferred, while running, by the use of these cables, without shutting down machines or extinguishing lamps.

The **standard boards** are arranged for an equal number of generators and circuits, but special boards for any ratio of circuits to generators can be built. As it is sometimes convenient, even in small plants, to interchange lines and generators without shutting down machines, a special transfer cable with plugs has been devised. This serves the same purpose as the regular trans-

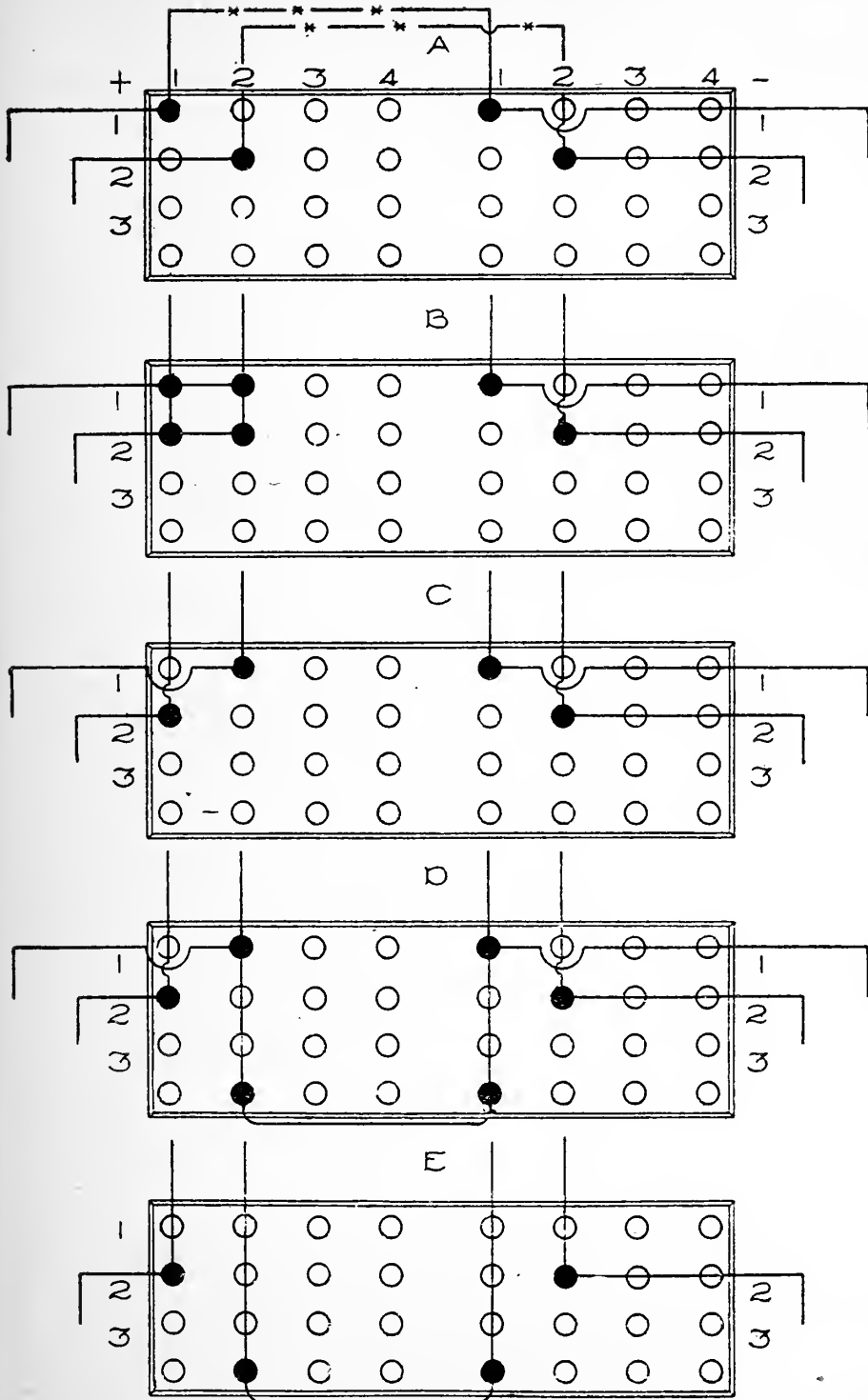


Fig. 22.

fer cable, but the plugs may be used in any of the holes of the switchboard as they are insulated, except at the tip, and when inserted connect with the line strips only.

The transfer of circuits from one generator to another gives trouble to dynamo tenders who are not familiar with the operation of plug switchboards. Fig. 22 illustrates the successive steps for transferring the lamps of two independent circuits from two generators to one without extinguishing the lamps on either circuit. This process is a very simple example of switchboard manipulation, but illustrates the method used for all combinations.

The location of plugs is shown by the black circles, which indicate that the corresponding bars of the horizontal and vertical rows are connected.

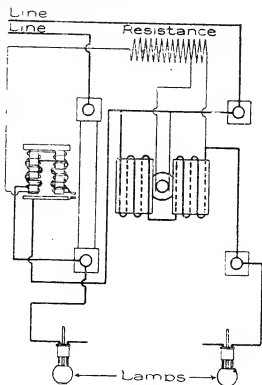
Circuits No. 1 and 2, running independently from generators No. 1 and No. 2 respectively, are to be transferred to run in series on generator No. 2.

In *A*, Fig. 22, are two circuits running independently. In *B*, the positive sides of both generators and circuits are connected by the insertion of additional plugs.

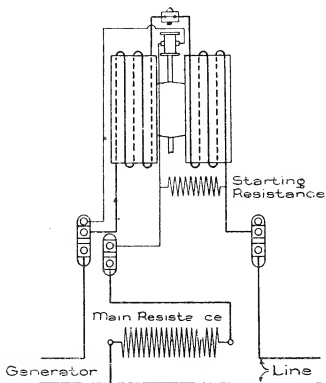
At *C* both generators and circuits are in series.

Before passing from *C* to *D*, raise the generator arm of No. 1 generator slowly until it reaches the top, and all of the load of this machine is transferred to No. 2. Close the armature short-circuiting switch No. 1, cutting the generator out of action. Next, insert plugs and cable as shown in *D*. Then withdraw plugs on row corresponding to generator No. 1 and the circuits No. 1 and No. 2 are in series in machine No. 2, and machine No. 1 is disconnected as at *E*.

Similar transfers can be made between any two circuits or machines and by a continuation of the process, additional circuits can be thrown in the same machine. The transfer of the two circuits to independent generators is accomplished by reversing the process illustrated.



METER FOR 4 to 8 LAMPS.



METER FOR STATION USE.

CONNECTIONS FOR WATT-METERS FOR SERIES ARC CIRCUITS

Fig. 23.

WATT-METERS.

Watt-meters are now built to measure the power supplied on series arc circuits. These watt-meters are similar in principle to those used on incandescent lighting systems, and, being extremely accurate, are equally effective in preventing waste of current. The watt-meters supplied to customers are made in 4 lamp or 8 lamp capacities. An excess of voltage equivalent to two lamps over the rated load causes the meter to automatically cut out, both lamps and meters being short-circuited. This prevents the interruption of the series circuit in case of any local trouble with lamps or line inside the meter circuit. Station watt-meters are arranged to measure the total output of a generator, and are made with capacities for 35, 50, 65, 80, 125 or 150 lamps.

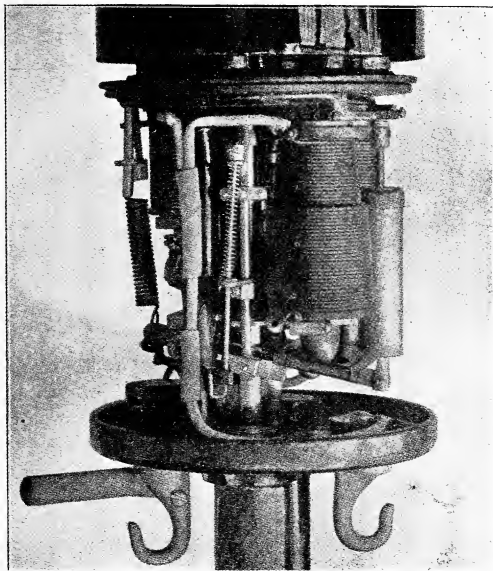
INSTRUCTIONS FOR THE INSTALLATION AND CARE OF ARC LAMPS.

The lamps should be hung from the hanger boards provided with each lamp, or from some suitable supports of wire or chain.

As the hooks on the lamp form also its terminals, they should be insulated, where a hanger board is not used, from the chains or wires used to support the lamp.

To make the upper carbon positive, the wire from the positive terminal of the machine should be fastened into the binding post hook, on the switch side of the *D* lamp, and on the opposite side in the *M* and *K* lamps. When the lamps are hung where they are exposed to the weather, they should be covered with a metal hood, to prevent injury from rain or snow. In such cases care should be taken that the circuit wires do not form a contact on the metal hood, and short-circuit the lamp. Before the lamps are hung up, they should be carefully examined to see that the joints are free to move, and that all connections are perfect.

No lamp should be allowed to remain in circuit with the covers removed and mechanism exposed. Such practice is dangerous.



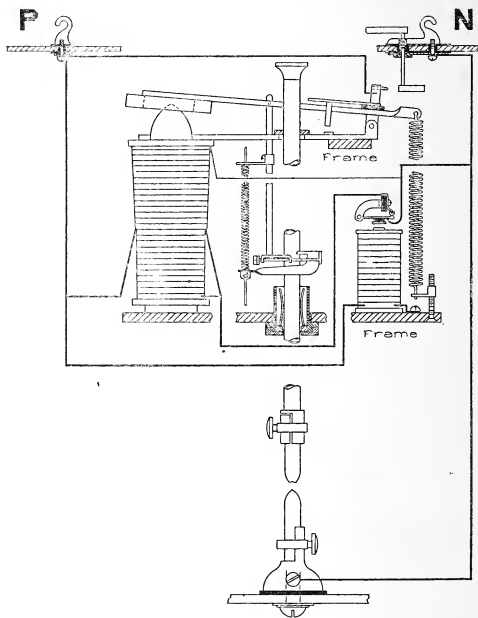
Interior of M Arc Lamp.

Fig. 24.

STARTING THE LAMPS.

When the lamps are all in position and ready for operation, the machine may be started, and when the armature has reached

its proper speed, the short-circuiting switch on the frame should be opened.



CONNECTIONS FOR M AND K ARC LAMPS.

Fig. 25.

This method allows the generator to take up its load gradually, and is a very important point in the handling of the machine, particularly when series incandescent lamps are in the circuit.

The generator should be driven at its proper speed, as designated by the maker. The regulator lever will first rise and then oscillate slowly up and down for short distances, as the regulator is cut in and out by the controller magnet. If the movements are too great, the lights will vary in intensity — first up, then down. This condition will result from a weakness of the regulator dash-pot. The regulator lever should always be a short distance away from the stop — say from $\frac{1}{8}$ " to $\frac{1}{2}$ " or more, according to conditions — and should always vibrate up and down in the manner stated. Should the lever of the regulator remain down, it shows that the speed of the machine is not sufficient to supply the circuit, or that the machine is overloaded with lights.

The controller magnet should be constantly opening and closing its contacts. This movement is very slight. The arc of the 2000 c. p. lamps should be $\frac{3}{32}$ " to $\frac{1}{8}$ " in length and the 1200 c. p. lamps should have an arc $\frac{1}{32}$ " to $\frac{1}{16}$ " in length. If the carbons are of good quality, the arc should not flame or hiss.

INSTRUCTIONS FOR REPAIRING, TESTING AND ADJUSTING ARC LIGHTS.

It frequently becomes necessary, after the lamps have been in use for a considerable length of time, especially when used for street lighting, to clean, repair and readjust them. If the parts are not complete, additional parts should be ordered by catalogue number and inserted in the lamp.

After cleaning and repairing, the lamp should be tested and readjusted. Experience shows that whenever even one new part has been put into a lamp or generator, trouble may result if tests and readjustments are not made before putting the apparatus into regular service.

In order to properly test the lamps that have been repaired, select some part of the engine room where the lamps can be hung

up and burned without being subjected to drafts of air; otherwise, they may hiss and act badly, no matter how carefully the adjustments may be made.

When the lamps have been hung up and attached to the hanger boards, or some similar arrangement for connecting to the circuit in the usual manner, the carbon rods should be cleaned thoroughly with cotton waste. If any sticky or dirty spots appear, which cannot be readily removed with waste, use a piece of well-worn crocus cloth, always being careful to use a piece of clean waste before pushing the rod up into the lamp. Under no circumstances whatever should the rods be pushed up into the lamps in a dirty condition; they should always be cleaned in the manner described.

The tension of the clamp which holds the rod is adjusted by raising or lowering the arm at the top of the guide rod. If the tension is too great, the rod and clutch will wear badly and the feeding will be uneven, causing unsteadiness in the lights. Too light tension will not allow the clutch to hold up the rod and any sudden jar to the lamp will cause the rod to fall and the light to go out.

The double carbon or *M* lamp should have the tension of the second carbon rod a trifle lighter than the first one.

When adjusting the tension, be sure to keep the guide rod perpendicular and in perfect line with the carbon rod; it should be free to move up and down without sticking.

The tension of the clutch in the *D* lamp should be the same as that of the *K* lamp. It is adjusted by tightening or loosening the small coil spring from the arm of the clutch to the bottom of the clamp stop.

To adjust the feeding point in the *K* lamp, press down the main armature as far as it will go, then push up the rod about one-half its length, let go the armature and then press it down slowly, and note the distance of the bottom side of the armature

above the base of the curved part of the pole. When the rod just feeds, this distance should be $\frac{1}{4}$ ". If it is not, raise or lower the small stop which slides on the guide rod passing through the arm of the clutch, until the carbon rod will feed when the armature is $\frac{1}{4}$ " from rocker frame at the base of the pole.

To adjust the feeding point of the *M* lamp, adjust the first rod as in the *K* lamp. Then let the first rod down till the cap at the top rests on the transfer lever. The second rod should feed with the armature at a point $\frac{1}{16}$ " higher than it was while feeding the first rod, that is, it should be $\frac{5}{16}$ " from rocker frame at base of pole.

The feeding point of the *D* lamp is adjusted by sliding the clamp stop up or down, so that the rod will feed, when the relative distances of the armature of the lifting magnet and the armature of the shunt magnet from rocker frame are in the ratio of 1 to 2. There should be a slight lateral play in the rocker, between the lugs of the rocker frame.

Make a careful examination of all joints, screws, wires and other parts of the lamps. The armatures of all the magnets should be central with cores, and come down squarely and evenly. There should be a separation of $\frac{1}{32}$ " between the silver contact points, when the armature of the starting magnet is down. This contact should be perfect when the armature is up. The arm for adjusting the tension should not touch the wire or frame of the lamp, when at the highest point. There should be a space of $\frac{3}{32}$ " or $\frac{1}{8}$ " between the body of the clutch and the arm of the clutch, to allow for wear on the bearing surfaces.

Always trim the lamps with carbons of proper length to cut out automatically, that is, have twice as much carbon projecting from the top as from the bottom holder. Always allow a space of $\frac{1}{4}$ " when the lamp is trimmed, from the round head screw in the rod, near the carbon holder, to the edge of upper bushing, so that there will be sufficient space to start the arc. Be careful to

get the carbons as accurately centered as possible. They will generally come right after one or two trials.

The arcs of the 1200 candle-power lamps should be adjusted to $\frac{3}{64}$ " , with full length of carbon. Arcs of 2000 candle-power lamps should be adjusted from $\frac{1}{16}$ " to $\frac{3}{32}$ " when good carbons are used. Lamps should always maintain a fairly even arc. The length of the arc will slightly increase as the carbons burn away, but they should not hiss, flame, or overfeed at any time. If the switch is thrown and the lamp cut off, and then turned on quickly, the upper carbon should "pick up" promptly with a normal arc, not hiss over a few seconds, and then burn as quietly as before.

When the upper carbon rod is drawn up by the hand, the lamp should cut out promptly and not "flash" the generator. In the case the arc is very long or causes flashing, look at the contacts and see that they are clean and make a good square contact. Also examine the centering of the armature. The cause of the trouble will usually be found in one of these places.

The action of a lamp that feeds badly may often be confounded with that of a badly flaming carbon. The distinction can readily be made after a short observation. The arc of a lamp that feeds badly will gradually grow long until it flames, the clutch will let go suddenly, the upper carbon will fall until it touches the lower carbon, and then pick up. A bad carbon may burn nicely and feed evenly, until a bad spot in the carbon is reached, when the arc will suddenly become long and flame and smoke, due to impurities in the carbon. Instead of dropping as in the former case, the upper carbon will feed to its correct position, without touching the lower carbon.

After the lamp has been tested and burns satisfactorily in the station, tighten up the adjusting screws, and if necessary, put a small amount of thick shellac on the bottom of the guide rod. This will prevent the stop from falling, in case the screw which holds it becomes loose or broken. The lamps are now ready to

be placed on the circuit, but if it is necessary to store them, they should be put into some part of the building or engine room where they will not become covered with dust before they are taken out. If they become dusty, use a small hand bellows to blow away the dust which may have collected on the working parts of the lamps, before placing them on the circuit.

SUMMARY.

The following summary of the foregoing instructions may be useful for the guidance of men in charge of dynamos:—

1. In operating an arc system, attend strictly to all the points herein given.
2. Be sure that the speed of the dynamo is right and that the belt has its proper tension.
3. See that the regulator always works properly, and has sufficient "surplus" or space between its armature and the stop.
4. Be careful that all connections of wires are well made.
5. Do not allow the circuit to become uninsulated at any point.
6. Keep every part of the machine and lamps scrupulously clean.
7. Keep all the insulations free from metallic dust or gritty substances, by a careful cleaning once a day.
8. Keep the bearings of the machine well supplied with the best quality of mineral oil.
9. Do not use water or ice on a bearing in case of heating, as the water is liable to get into the armature and injure the insulation.
10. Lubricate the commutator of the *C* and *E* machines by touching the surface occasionally with an oiled cloth.
11. The commutator on the machine is set carefully before leaving the factory in the best position for proper working, and its position marked by chisel marks on the commutator and shaft.

If the commutator is ever removed from the machine, it must be put back in exactly the same position on the shaft, and the red, white and blue leads must be put into the posts marked 1, 2 and 3 respectively. If wrongly placed, the machine will either not generate, or will act very badly.

12. When the commutator segments become badly worn, they may be turned down in a lathe, either by removing the commutator entirely from the shaft of the machine and putting it upon an arbor, or by removing the segments separately and screwing them to a jig, which may then be put into the lathe. The use of the jig is especially recommended for turning down the segments as the adjustment of the commutator is less liable to be changed than when the arbor is used.

13. The durability of the commutator segments will depend on the care exercised in the running of the machine.

14. The brushes must be set carefully by the "gauge for brushes," in the manner explained before.

15. The spark on the tips of the brushes will vary with the set and wear of the brushes. It should be from $\frac{1}{8}$ " to $\frac{1}{4}$ " long, and only on the forward brushes.

16. The carbon rods in every lamp should be carefully cleaned daily.

17. The carbons should be in perfect alignment and firmly clamped in the holders.

18. If a lamp burns badly and with a bluish flame, or continually hisses, it is probably due to poor carbons, which should be removed and better ones substituted.

19. The lamps rarely burn as well when first started as afterwards. This is principally due to the fact that the carbons require a little time to burn to the proper shape.

20. The automatic regulator prevents the machine from generating more than the amount of current required, so that the lamps may be thrown on or off the circuit at pleasure.

21. Do not tamper with adjustments made in the factory.

22. Do not imagine that every time a lamp hisses or flames a little it is out of adjustment. As a rule, bad working is due to stickiness of the moving parts, or to poor carbons. The lamps once properly adjusted and operated with good carbons, should not get out of adjustment, and should be let alone in that respect.

23. If the machine works badly, it should be tested with a magneto for grounds of connection between the circuit and the frame of the machine. The circuit should also be daily tested, and any faults found should be immediately remedied, as otherwise they will inevitably cause trouble.

24. All construction and repair work should be done in strict accordance with the rules herein laid down.

CHAPTER XI.

THE SELECTION OF AN ENGINE.

There are so many conflicting statements in regard to the merits and demerits of the several engines placed in the market that one is often confused in judgment, and scarcely knows how to proceed in the matter of selection,

It is easy to advise that "When you are ready to buy, select the best engine, for in the long run the best is the cheapest." No one would pretend to deny this as a general rule, yet there are circumstances which so materially modify this rule that it would seem to a casual observer to be entirely set aside. There are localities in which the price of fuel is so low that it scarcely warrants the doubling of the price on an engine to save it; and in such localities the owners usually want an engine of the very simplest construction; hence, they almost invariably select an ordinary slide valve engine with a throttling governor. This selection is made for several reasons, among which are low first cost, simple in detail, remoteness from the manufacturer or from repair shops.

For small powers in which it is desirable that the investment be as low as consistent with commercial success, the engine selected should be fitted with a common slide valve; this will in general apply to all engines having cylinders eight inches or less in diameter.

If upon a thorough canvass of the situation, it then be thought advisable to employ an automatic cut-off engine, the next question would probably be whether it shall be fitted with a positive, or some one of the various "drop" movements now in the market.

For the smaller sizes, say 8 to 24 inches diameter of cylinder, it will perhaps be found more desirable to use an automatic slide cut-off, of which there are now several varieties offered through the trade. This style of engine has the advantage of being low-priced, efficient and economical.

Small engines are usually required to run at moderately high speed; there is a very decided advantage in this on the score of economy, as a small engine running at a quick speed will be quite as efficient as a large engine running at a slow speed, with the further advantage that the former will not cost in original outlay more than about two-thirds of the latter, while the cost of operating will be no greater per indicated horse power.

The slide valve is still used to the almost total exclusion of all other kinds in locomotives. It is doubtful whether a better valve for that particular use can be devised. It is simple, efficient, and readily obeys the action of the link when controlled or adjusted by the engineer. For portable engines and the smaller stationary engines it leaves little to be desired in point of simplicity.

One objection to a slide valve is that it cannot readily be made to cut off steam at, say, half-stroke or less, without interfering with the exhaust. In ordinary practice $\frac{5}{8}$ to $\frac{2}{3}$ seems to be where most slide valves cut off as a minimum, perhaps $\frac{3}{4}$ would represent nearer the actual average conditions.

It can easily be shown that this is very wasteful of steam, and consequently not economical in fuel; but as there are cases in which the loss in fuel is fully gained by other advantages, the ordinary slide valve will, in all probability, continue to be used.

High speed engines. — The general tendency seems now to be in the direction of a horizontal engine with a stroke of medium length having a rapid piston speed and a rapid rotation of crank shaft, rather than a longer stroke with a less rate of revolution. This rapid movement of piston and crank shaft permits the use of

small fly-wheels and driving pulleys, and thus very materially reduces the cost of an engine for a given power.

To illustrate this, it may be said that a 16 x 48 inch engine using steam at 80 lbs. pressure and cutting off $\frac{1}{4}$ stroke, running at the rate of 60 revolutions per minute, may be replaced by an engine having a 13 x 24 inch cylinder, running at the rate of 200 strokes per minute, the pressure of steam and point of cutting off remaining the same, both engines being non-condensing, and representing the best examples of their kind. The difference between 60 and 200 revolutions per minute in millwright work is very great, but there is a constantly growing demand for an engine which shall meet such a requirement whenever it shall present itself; by this is not to be understood an engine which shall be used at either speed indiscriminately, but rather a type of engine which shall be economical in fuel, and shall be of a kind by which the rate of revolution may be such as to suit the millwright's work without loss of economy in working, and without excessive outlay for the engine itself in proportion to power developed.

Slow speed engines are designed and built from a standpoint entirely different from that of high speed engines; in the former case the reciprocating parts are made as light as possible, consistent with safety. The fly wheel is large in diameter and made with a very heavy rim, especially is this the case with automatic cut-off engines of long stroke and slow revolution of crank shaft.

In high speed engines the reciprocating parts are often of great weight, in order to insure the utmost smoothness of running. The piston and cross-head are made of unusual weight that at the beginning of the stroke they may require a large part of the steam pressure to set them in motion; this absorbing of power at the beginning of the stroke is for the purpose of temporarily storing it up in the reciprocating parts that it may be given off at the

later portions of the stroke, by imparting their momentum to the crank; thus at the beginning of the stroke, these reciprocating parts act as a temporary resistance, but once in motion they tend by their inertia to equalize the pressure on the crank pin, and so produce not only smooth running, but a very uniform motion.

Results to be obtained in practice. — The best automatic non-condensing engines furnish an indicated horse power for about three pounds of good coal, depending somewhat upon the fitness of the engine for the work and the quality of the coal. With a condenser attached, a consumption as low as two pounds has been reported, but this is an exceptional result; $2\frac{1}{2}$ pounds may be quoted as good practice. The larger the engine the better the showing, as compared with smaller engines.

For ordinary slide valve engines, the coal burned per indicated horse power will vary from 9 to 12 lbs., for the sake of illustration, we will say 10 lbs., and that the engine is of such size as would require for a year's run \$3,000 worth of coal; now, an ordinary adjustable cut-off engine with throttling governor, ought to save at least half that amount of coal, or say \$1,500 per year; if the best automatic engine were employed using $2\frac{1}{2}$ lbs. of coal per horse power, a further saving of \$750 per year could be effected, or between the two extremes \$2,250 per year in saving of coal, without interfering in any way with the power, with the exception, perhaps, that the automatic engine will furnish a better power than the former engine. It is easy to see that it is true economy to buy the best engine and pay the extra cost of construction, if the saving of fuel is an element entering into the question of selection.

The cost of an engine for any particular service is always to be taken into consideration, for it is possible to contract for a certain saving of coal at too high a price, not simply when paid out as the original purchase money, but with this economy of fuel, the purchaser may have many vexatious and damaging

delays caused by the breaking of the automatic mechanism of the engine. All such delays which would not have occurred to an ordinary or simpler engine, are to be charged against any saving credited to the engine which failed in producing a regular and constant power. Take a flouring mill for example, producing 400 barrels per day; it is easy to see how a single day's stoppage would interfere with the trade and shipment by the proprietors, yet it would require a very small break in an engine that would require less than a day for repairs.

This does not argue against high grade engines, but the purchaser should be certain that the engine when once on its foundations shall be as free from dangers of this kind as any other engine of similar economy.

There are engines which from their peculiar construction appear to be very complex, and this objection is often urged against them, while the fact is the complexity is apparent rather than real. Take the Corliss engine, for example; it is doubtful whether there is another automatic cut-off engine in successful use in this or any other country which has cost less for repairs during the last ten or twenty years. It is true it contains a great many separate pieces in the valve mechanism, but the pieces themselves are simple, durable, easily accessible and always in sight. These several parts are not liable to excessive wear, but such as there is can be readily adjusted.

The engines to be preferred are those in which the valve adjusting mechanism is outside of the steam chest and which is in plain sight at all times when the engine is in motion.

Location of engine.—This will depend upon circumstances, but it is far from true economy to place an engine in a dark cellar, or in some inconvenient place above ground. The engine as the prime mover, should have all the care and attention which may be needed to insure regular and efficient working.

Machinery in the dark is almost sure to be neglected. If the

design of the building, or the nature of the business, is such that the engine must be located underground, there should be some provision for letting in the daylight; the extra expense incurred will soon be saved by the order, cleanliness and fewer repairs required, following neglect.

The engine should always be close to, but not in the boiler room. Many a high-priced engine has had its days of usefulness shortened by the abrasive action of fine ashes and coal dust coming in contact with the wearing surfaces. There should always be a wall or tight partition between the engine and fire room.

The foundations for an engine should be large and deep. Too many manufacturers in marking dimensions of foundation drawings for engines, make them altogether too shallow. The stability of an engine depends more on the depth than on the breadth of the foundations. Stone should be used for foundations rather than brick, but if the latter must be used they should be hard burned and laid in a good cement rather than a lime mortar. If the bottom of the pit dug for the engine foundation be wet, or the soil uncertain in its stability, it is a good plan to make a solid concrete block about a foot and a half thick, on which the foundation may be continued to the top. If such a concrete block be made with the right kind of cement it will be almost as hard and solid as a whole stone.

The most economical engine is the one in which high pressure steam can be used during such portion of the stroke as may be necessary, then quickly cut off by a valve which shall not interfere with the exhaust at the opposite end of the cylinder, and allow the steam to expand in the cylinder to a pressure which shall not fall below that necessary to overcome the back pressure on the piston. In general, the most successful cut-off engines use the boiler pressure for a distance of one-fifth to three-eighths of the stroke from the beginning; at this point the steam is cut off and allowed to expand throughout the balance of the stroke.

The gain by expansion consists in the admission of steam at a pressure much above the average required to do the work, and allowing it to follow but a small portion of the stroke, then expanding to a lower than the average pressure at the end of the stroke. The mean effective pressure on the piston is that by which the power of the engine is measured; hence, it follows that the higher economy is to be reached, other things being equal, where the mean effective pressure on the piston is highest when compared with the terminal pressure, or the pressure at the end of the stroke. In order to get this, a high initial pressure is used; the steam follows as short a distance as possible to keep the motion regular under a load, and then expanding down to as near the atmospheric pressure as possible.

The following table exhibits at a glance the performance of a non-condensing engine cutting off at different portions of the stroke. The initial pressure of steam being in each case eighty pounds per square inch.

CUT-OFF IN PARTS OF THE STROKE.

	1 10	2 10	3 10	4 10	5 10
Mean effective pressure .	18	35	48	57	65
Terminal pressure . . .	11	20	30	39	48
Pounds water per h'r per H. P.	20	21	22	23	25

Fractions are omitted in the above table and the nearest whole number given.

Governor.— Any automatic device by which the speed of an engine is controlled may properly be called a governor. There

are now two distinct methods by which the steam supplied to an engine is thus brought under control. The first is usually applied to slide valve engines having a fixed cut-off, and consists in the adjustment of a valve by which the *pressure* of steam in the cylinder is increased or diminished in order to maintain a constant rate of revolution with a variable load. The second device consists in a mechanism by which the whole boiler pressure is admitted to the cylinder, which is allowed to follow the piston to such portion of the stroke as will maintain a regular rate of revolution; the steam is then suddenly cut off at each half revolution of the engine, thus furnishing a greater or less *volume* of steam at a constant pressure. Neither of these two varieties of governors will act until a change in the rate of revolution of the engine occurs, and this change will either admit more or less steam as it is faster or slower than that for which the governor is adjusted. The commonest form of a governor consists of a vertical shaft to which are hinged two arms containing at their lower ends a ball of cast iron; as the shaft revolves the balls are carried outward by the action of what is commonly called centrifugal force; the greater the rate of revolution the further will the balls be carried outward; advantage is taken of this property to regulate the admission of steam to the engine. The action of the balls and that of the valve include two distinct principles and should be considered separately; an excellent valve may be manipulated by an indifferent governor and so produce unsatisfactory results; on the other hand, the governor mechanism may be satisfactory in its operation, but being connected with a valve not properly balanced, is likely to cause a variable rate of revolution in the engine.

Fly-wheel. — The object in attaching a fly-wheel to an engine is to act as a moderator of speed. The action of the steam in the cylinder is variable throughout the stroke, against which the revolution of a heavy wheel acts as a constant resistance and limits the variations in speed by absorbing the surplus power of the first

portion of the stroke, and giving it out during the latter portion. The fly-wheel is simply a reservoir of power, it neither creates nor destroys it, and the only reason why it is attached to an engine is to simply regulate the speed between certain permitted variations which are necessary to cause the governor to act, and to equalize the rate of revolution for all portions of the stroke, thus converting a variable reciprocating power into a constant rotary one. It is considered good practice to make the diameter of the fly-wheel four times the length of the stroke for ordinary engines, in which the stroke is equal to twice the diameter of the cylinder. This may be taken as a fair proportion in engine building, and furnishes a wheel sufficiently large to equalize the strain and reduce any variation in speed to within very narrow limits, if the engine is supplied with a proper governor. The greater the number of revolutions at which the engine runs, the smaller in diameter may be the fly-wheel, and it may also be largely reduced in weight for engines developing the same power.

Horse-power. — By this term is meant 33,000 pounds raised one foot high in one minute. The horse-power of an engine may be found by multiplying the area of the piston in square inches by the average pressure throughout the stroke; this will give the total pressure on the piston: multiply this total pressure by the length of the stroke of the piston in feet; this will give the work done in one stroke of the piston; multiply this product by the number of strokes the piston makes per minute, which will give the total work done by the steam in one minute; to get the horse-power, divide this last product by 33,000. From this deduct, say, 20 per cent, for various losses, such as friction, condensation, leakage, etc.

CARE AND MANAGEMENT OF A STEAM ENGINE.

It is to be supposed to begin with that the engine is correctly designed and well made, and that, after a suitable selection of an

engine for the work to be done, nothing now remains except proper care and management.

Lubrication.— The first and all-important thing in regard to keeping an engine in good working order is to see that it is properly lubricated. This does not imply, neither is it intended to encourage, the use of oil to excess; all that is needed is simply a film of oil between the wearing surfaces. It is marvelous how small a quantity of oil is required when of good quality and continuously applied. There are several self-feeding lubricators in the market which have been tested for years and are a pronounced success; these include crank-pin oilers, in which the oscillatory motion of the oil makes a very efficient self-feeding device, the flow being regulated by means of an adjustable opening to the crank-pin, or in the adjustment of a valve by which its lift is regulated by each throw of the crank; and in others by a continual flow through a suitable tube containing a wick or other porous substance. For stationary engines, it is desirable that the main body of the oiler be made of glass that the flow of oil may be closely watched and adjusted accordingly. For the reciprocating and rotary parts of the engine, a modification of the above mentioned oilers may be used. They are of various patterns and devices and many of them very good. It is also a good plan to have some device by which the cross-head at each end of each stroke will take up and carry with it a certain amount of oil; for the lower half of the slide this is not difficult to arrange: for the upper side an automatic feeder placed in the middle of the slides will provide ample lubrication.

For oiling the main bearing there should be two separate devices, one an automatic glass oiler; and in addition, a large tallow cup attached to the cap of the bearing. This cup should be filled with tallow mixed with powdered plumbago; the openings from the bottom of the cup to the shaft should be not less than quarter-inch for small engines, and three-eighths to half-inch

for larger ones ; so long as the main bearing runs cool the tallow will remain in the cup unmelted ; but if heating begins, the tallow will melt and run down on the surface of the revolving shaft, and thus provide an efficient remedy when needed. For oiling the valves and piston, a self-feeding lubricator should be attached to the steam pipe ; this by a continuous flow of oil will be found not only satisfactory in its practical working, but economical in the use of oil.

In selecting an oil for an engine, it is in general better to use a mineral rather than an animal oil, especially for use in the valve chest and cylinder. The objection to an animal oil, and especially to tallow or suet, is that it decomposes by the action of heat, often coating the surface of the steam chest, the piston ends and the cylinder heads with a deposit of hard fatty matter ; or forms into small balls not unlike shoemaker's wax. There is no such decomposition and formation in connection with mineral oils, which may now be had of uniform quality and consistency, and at much lower prices than animal oils.

The slide valve should be kept properly set and should be examined occasionally to see that the face and seat are in good condition. So long as this is the case, the valve mechanism and the valve itself must be let alone and not tampered with.

The piston packing will need looking after occasionally to see that it does not gum up and stick fast, which it is very likely to do when the cylinder is lubricated with tallow or animal oil.

The rings should fit the cylinder loosely and should be under as little tension as possible and insure perfect contact. If the rings are set out too tight they are liable to scratch or cut the cylinder ; if too loose, the steam will blow through from one end of the cylinder, past the piston and into the other. In adjusting the springs in the piston, care must be exercised that the adjustments are such as will keep the piston rod exactly central, to prevent springing the rod, or causing excessive wear on the stuff-

ing box. There are several packings which do not require this adjustment, the rings being narrow, and either expanding by their own tension or by means of springs underneath. The only thing to be done with such a packing is to keep it clean, and when lubricated with a mineral oil this is not a difficult matter. If it groans, take rings out and file sharp edges off.

The stuffing boxes whether for the piston or valve-stem need to be looked after carefully, and to prevent leaking, will require tightening from time to time. There are several kinds of ready-made packings in the market, containing rubber, canvas, garlock, soapstone, asbestos and other substances which form the basis of a good durable packing. These can be had in sizes suitable for all ordinary purposes, and their use is recommended. In the absence of any of these, a packing made of clean manila or hemp fiber will serve a useful purpose. Formerly it was the only substance used, but is being gradually superseded by the other kinds mentioned above. In packing the small and delicate parts, such as a governor stem, a good packing is made by pleating together three or more strands of cotton candle-wick. This is soft, pliable, free from anything like grit, and will not get hard until soaked with grease and baked into a brittle fiberless substance not easily described.

Crank-pins. — There are few things more troublesome to an engineer than a hot crank-pin, and it is sometimes very difficult to get at the real reason why it heats. Among the principal reasons for heating are: the main shaft is not "square" with the engine, or, that the pin is not properly fitted to the crank; or, perhaps, it is too small in diameter — defects which are to be remedied as soon as practicable. Heating is often caused by the boxes being keyed too tightly, or by insufficient lubrication. There are now several good self-feeding lubricators in the market which will supply the oil to a crank-pin continuously; these are recommended rather than the old style of oil cup, which was

not only uncertain, but doubtful in its action. Many troublesome crank-pins have been cured of heating by this simple matter of constant lubrication. When the crank-pin is rather small for the engine and the load variable, there is a possibility of having a hot pin at any time; it is advisable to have ready some simple and effective expedient to be applied when it does occur; for this there is perhaps nothing better and safer than a mixture of good lard oil and sulphur.

Connecting rod brasses. — In quick running engines the brasses should be fitted metal to metal; or, if this is not desirable, several strips of tin or sheet brass should be inserted between them and keyed up tight. This gives a rigidity to a joint which is difficult to secure when the brasses have a certain amount of play in the strap. It is a common practice to bore the brasses slightly larger than the pin, so that when fitted to it the hole shall be slightly oval, and thus permit a freer lubrication than is secured by a close fit around the whole circumference.

Knocking. — There are several causes which, combined or singly, tend to produce knocking in steam engines. In most cases the difficulty will be found to be in the connecting rod brasses; but whether in the crank-pin end or at the cross-head is not easily determined in all cases. A very slight motion will often produce a very disagreeable noise; the remedy is, in most cases, very simple, and consists in simply tightening the brasses by means of the key or other device that may have been provided for their adjustment. In adjusting a key it is the common practice to drive it down as far as it will go, marking with a knife blade the upper edge of the strap, then drive the key back until it is loose; after which drive it down again, until the line scratched on the key is within $\frac{1}{4}$ or $\frac{1}{8}$ inch of the top of the strap. The size of the strap joint and the judgment of the person in charge must decide the best distance. This may be done

at both ends of the connecting rod. On starting the engine, the cross-head and crank-pins must be carefully watched, and upon the slightest indication of heating, the engine should be stopped and the key driven back a little further. A slight warmth is not particularly objectionable, and will, as a general thing, correct itself after a short run. Knocking is sometimes occasioned by a misfit, either in the piston or cross-head, and the piston rod. These connections should be carefully examined, and under no circumstances should lost motion be permitted at either end of the piston rod.

If the means of securing are such that the person in charge can properly fasten the piston to the rod, he should see that it is kept tight; if not, then it should be sent to the repair shop at once, as there is no telling when an accident is likely to overtake an engine with a loose piston.

The connection between the piston-rod and cross-head is usually fitted with a key and furnishes a ready means of tightening the joint, if proper allowance has been made for the draft of the key. In case there has not, the piston-rod and cross-head should be filed out so that the draft of the key will insure a good tight joint when driven down.

The main bearing should be examined and if there should be too much lateral movement of the shaft, the side brasses should then be adjusted until the shaft turns free, but has no motion other than a rotary one. The cap to the main bearing should also be carefully examined, as it may need screwing down and thus prevent an upward movement of the shaft at each stroke; this applies more particularly to quick running engines.

Engines which have been in use for some time are likely to have a knock caused by the piston striking the head. This is brought about by having a very small clearance in the cylinder and in not providing, by suitable liners, for the wear of the connecting rod brasses. In a case of this kind, liners should be inserted behind

the brasses in the connecting rod, or new brasses put in, which will restore the piston to its original position.

Knocking may be caused by defects in the construction of the engine; such, for example, as not being in line, the crank-pin not at right angles to the crank, the shaft may be out of line, etc.

Whenever the cause is one in which it can be shown that it is a constructive defect, there is but one remedy, and that is the replacing of that part, or the assembling of the whole until perfect truth is had in alignment of all the parts. This may or may not require the services of an experienced engineer but all improperly fitting pieces should be replaced by new ones as a safeguard against accident, which is likely sooner or later to overtake badly fitting pieces.

If the boiler is furnishing wet steam, or priming, so as to force water into the steam pipe, it will collect in the cylinder and will not only cause knocking, but on account of its being practically incompressible there is danger of knocking out a cylinder head, bending the piston-rod, or doing other damage to the engine. The cylinder cocks should be opened to drain any collected water away from the cylinder.

Repairs. — Whenever it is necessary to make repairs the work should be done at once; oftentimes a single day's delay will increase the extent and cost fourfold. If an engine is properly designed and built, the repairs required ought to be very trivial for the first few years it is run, if it has had proper care. It may be said in reply to this "true, but accidents will happen in spite of every care and precaution." That accidents do occur is true enough; that they occur in spite of every care and precaution is not true. In almost every case, accidents may be traced directly back to either a want of care, negligence, or to a mistake.

Fitting slide-valves. — The practice of fitting a slide-valve to its seat by grinding both together with oil and emery, is wrong and should never be resorted to. The proper way to fit the sur-

faces is by scraping; this insures a more accurate bearing to begin with, and will also be entirely free from the fine grains of emery which find their way and become imbedded in the pores of the casting, and are thus liable to cut the valve face and destroy its accuracy. The scraping of the valve and seat has a beneficial effect by causing the removal of the fine particles of iron, which are loosened by the action of the cutting tool in the planing machine, and which ought to be fully removed before the engine leaves the manufacturers' hands. Aside from this, it is doubtful whether the scraping amounts to anything practically, for the reason that the cylinder and valve are fitted cold, and their relative positions are distorted by the action of the heat of the steam, once the engine is in use. The scraping which simply renders the valve face and seat smooth and hard is all that is sufficient to begin with, and may be re-scraped after the valve has been in use a few days, should it be found necessary, which will not often be the case in small and ordinary sized engines.

Eccentric straps are likely to need repairs as soon as anything about an engine. They should be carefully watched at all times. If they are likely to run hot, it is also probable there is more or less abrasion or cutting going on, and if prompt measures are not taken to arrest it, they are likely to cut fast to the eccentric, and a breakage is sure to occur.

When the straps begin to heat, the bolts should be slackened a little, and at night, or perhaps at noon, the straps should be taken off and all cuttings carefully removed with a scraper (not with a file); the rough surfaces on the eccentric should be removed in the same manner.

The straps should be run loose for a few days, gradually tightening as a good wearing surface is obtained.

The main bearing, if neglected, is a very troublesome journal to keep in order. The repairs generally needed are those which

attend overheating and cutting. The shaft, whenever possible, should be lifted out of the bearing, and both the shaft, bottom of main bearing and side boxes, carefully scraped and made perfectly smooth. It sometimes occurs that small beads of metal project above the surface of the shaft which are often so hard that neither a scraper nor file will remove them; chipping is then resorted to and the fitting completed with a file and fine emery cloth.

Heating of journals. — A very common cause for the heating of journals having brasses and boxes composed of two halves, is that both halves alter their shape from causes attending their wear. Thus, most engineers will have noticed that, although there is no wear between the sides of a brass and the jaws of a box, yet in time the brass becomes a loose fit in the box. Now, since the sides of the brass have, when fitted, no movement in the box, it is evident that this cannot have proceeded from wear between those surfaces, and it remains to find what causes this looseness. Most engineers will also have observed that though the bottom or bedding surfaces of a brass and of the box may have been carefully filed to fit each other when new, yet if in the course of time the brasses be taken out and examined, and more especially the bottom brass that receives the weight, the file marks will become effaced on all parts where the surfaces have bedded together well, the surface having a dull bronze and condensed appearance. This is caused by the vibrations under pressure having condensed the metal. Now, this condensation of the metal moves or stretches it, and causes the sides of the brass to move away from the sides of the box, and, consequently, to close upon the journal, creating excessive friction that may often, and very often does, cause heating. It is for this reason that on such brasses the sides of the brass boxes are, by a majority of engineers, eased away at and near the joint, and it follows from this cause the same easing away is a remedy.

Governor. — It not infrequently occurs that after an ordinary

throttling engine has been used a few years, the speed becomes variable to such a degree that it interferes with the proper running of the machinery. This occurrence can generally be traced directly to the governor. When it does occur, the governor should be taken apart and thoroughly examined; if the needed repairs are such as can be easily made in an ordinary repair shop, they should be made at once; if not, a new governor should be purchased. The price of governors is now so low that it is better and more economical to buy a new one than lose the time and pay the bills for repairing an old one.

AUTOMATIC ENGINES.

In the care and management of this class of engines, it is difficult to say just what particular attention they need, owing to the variety of styles and the peculiarities of each. As a rule, however, they require first, to be kept well oiled; second, to be kept clean; third, to be kept well packed; and fourth, to be let alone nights and Sundays. There is little doubt that there has been more direct loss resulting from a ceaseless tinkering with an engine than results from legitimate wear and tear to which the engine is subjected. The writer does not wish to be understood as saying that builders of this class of engines are infallible; it might be difficult to prove any such assertion in case it was made; but it may be said with truth, that the engines of this class now in the market are carefully designed, well proportioned, of good materials and workmanship, and as examples of mechanism are entitled to take very high rank. The writer knows of several engines of this class which have not cost their owners for repairs so much as five dollars in five years' constant use. It is essential to the economical working of these engines that the cut-off mechanism be in good order and properly adjusted. Whenever the valves need resetting, the final adjustment should be made

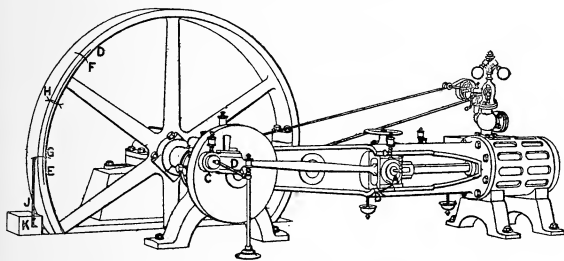
with a load on the engine and with the indicator attached to the cylinder, the valves being set by the card rather than by the eye. No general rule can be given for setting the valves, as the practice varies with the size and speed of the engine; nor is any rule needed, for the indicator will furnish all the data required. The adjustments may then be made so as to secure prompt admission, sharp cut-off, prompt release, and the proper compression.

TO FIND THE DEAD CENTERS.

When setting the valve of an engine by measuring the lead, as is the usual method, it is necessary that the crank be accurately placed on the dead centers at each end of the stroke. Sometimes an engineer, when adjusting the valves of his engine, will attempt to place the crank on the dead center by watching for the point at which the travel of the cross-head stops, or by the appearance of the connecting-rod as related to the crank. These methods are totally unreliable for obtaining accurate results, especially the first one mentioned. The travel of the cross-head and the piston near the point of reversal of motion is very slow when compared with the valve. The velocity of travel of the valve is at nearly its maximum amount when the crank is on the dead center, and a slight error in finding the dead center point makes a very appreciable error in the position of the valve, with a subsequent error in its proper setting.

There are several methods for finding the dead center. The method that can be recommended and the one that should always be used when the dead center of an engine is to be found is that familiarly known as "trammig." The dead centers when found by this method, are geometrically accurate, no matter if the engine is out of level or if the shaft is above or below the axis of the cylinder. Some simple tools are required which are generally available, with the exception of the trams, which may be readily

made for the purpose. Two trams are required, one of which should be 6" or 7" long and the other about 24" or 30", as the condition may require. The smaller tram may be made of $\frac{1}{4}$ " steel wire with the points turned over at right angles to the body, so as to project about 1". The points should be sharpened so that a hair line may be drawn by them. The larger tram should be made from rod of at least $\frac{3}{8}$ " diameter and the points made in the same way as for the smaller tram. Oftentimes, the long tram



Finding the Dead Center.

is made with one leg longer than the other, on account of being handier to reach some stationary part, but this is a minor point, which has nothing to do with the principle to be described. The other tools required are a light hammer, a prick-punch, a pair of 10" or 12" wing dividers and a hermaphrodite caliper, or a scribing block. A chunk of chalk will also be found convenient to facilitate scribing lines on the metal parts with the trams or dividers.

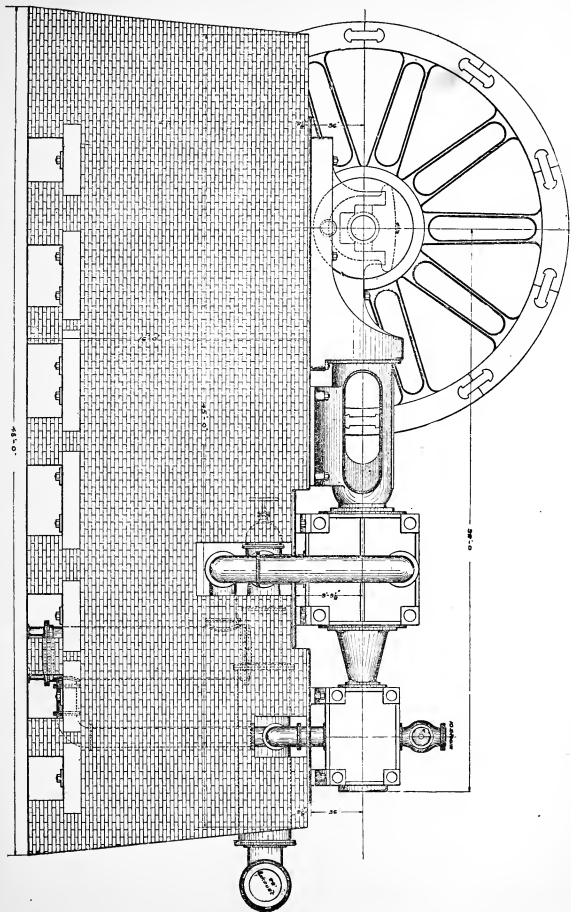
Having the necessary tools, we are ready to begin operations,—you may start at either end of the stroke, as circumstances may favor. The fly-wheel is turned so that the crank stands at about the angle shown in the accompanying illustration, which

may, however, be approximated as the operator may desire. The effort made, being to give sweep enough to the cross-head to allow accurate measurements and still not have such an excessive arc on the fly-wheel as to make its bisection difficult.

A prick mark is made on the guides, or some convenient stationary point, as at *B*, and an arc struck on the cross-head with the small tram. At the same time, an arc is scribed on the rim of the fly-wheel at *G*, using some convenient point for the lower point of the tram as at *K*. The fly-wheel is now turned until the crank passes the center and the cross-head travels back until the scribed line will coincide exactly with the point of the tram when held in the same position as in the first case. When this point has been reached, the wheel is stopped and a second arc is scribed on the fly-wheel rim at *F* with the tram *J*. The herma-phrodite caliper, or the scribing block, is now used to scribe a concentric line *D E* on the fly-wheel rim and the arc *C F* is bisected with the dividers. When the center *H* has been accurately located, it should be carefully prick-marked. The scribing of the concentric line *D E* is a refinement that is not strictly necessary if care be taken to locate the points of the dividers at the same distance from the outer periphery of the wheel in each instance when finding the center *H*. The marks left by the lathe tool will sometimes be plain enough for a guide. When the center *H* has been found, the fly-wheel is turned so that the point of the tram will fall into the prick-mark *H* when its lower end is in the stationary point *K*. When this condition is effected, the crank is exactly on the dead center and the position of the valve may be taken with confidence that its location at the dead center point is accurately found. The same procedure is followed to place the crank on the dead center at the opposite end of the stroke.

The cut on the opposite page is an elevation of Twin Tandem Compound Engine, showing engine erected on brick foundation. It also shows a line through cylinders; also a line over the shaft.

Elevation of Twin Tandem Compound Engine, Showing Engine Erected on Brick Foundation.



These lines are used in the erection of a new engine, or to line up an old one, or with an engine that is out of line. The cut also shows how the foundation is made; also how the anchor bolt is fastened.

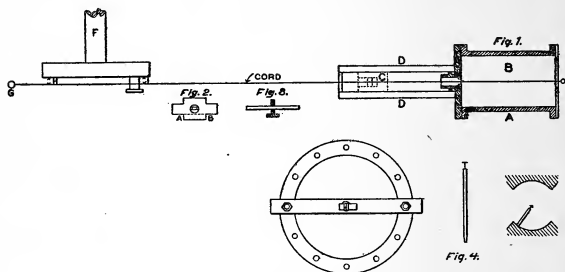
The cut on the opposite page shows how to pipe a Twin Tandem Compound Condensing Engine. The plan shows two receivers, heaters, relief valves, gate valves, etc., and is so arranged that either side can be run independently of the other. It also shows how to line a pair of these engines up by following the lines and noting the distance between each line. An engineer would have no trouble in lining up a pair of these engines.

HOW TO LINE AN ENGINE.

The method followed when lining different types of engines, such as vertical, horizontal, portable, etc.:—

The method followed in lining any piston engine is essentially the same in all cases, as far as determining when adjustments are needed. The method of making the adjustments after the character and amount of them is determined, depends entirely on the construction of the engine, and will necessarily have to be determined in each individual case. Lining an engine consists of adjusting the guides so they shall be parallel to the bore of the cylinder, and in such a position that the center of the piston socket of the cross-head shall coincide with the axis of the cylinder. Under these conditions only, can the piston and cross-head travel through the stroke freely, and without distorting any of the parts. After this adjustment has been made, the truth of the right-angle position of the shaft must be determined as being "out of square;" this will make an engine run badly, and is often the unsuspected cause of much trouble to engineers. We will assume that we have an engine with four-bar or locomotive guides, and that the connecting rod, cross-head, back cylinder

head and piston have been removed. If the engine is of the horizontal type, the first step will properly be to ascertain if the engine is level on the foundation, and if not, proceed to make it so. After having leveled the engine, stretch a smooth linen thread, as shown in Fig. 1, through the bore of the cylinder and the stuffing box, to a point beyond the shaft, where it should be attached to an iron rod driven into the floor. The other end is fastened to a cross-bar bolted across the face of the cylinder to



two of the studs, as shown in Fig. 4, or the bar may preferably be somewhat longer than one-half of the diameter of the cylinder, and with a saw cut for a short distance lengthwise at the inner end. In this case, it is held by only one of the cylinder studs and can be somewhat more easily adjusted. The line or cord is adjusted to approximately the proper position, and is drawn taut and fastened through the cross-bar by being tied to a short stick that is too long to pass through the hole. In this position it is held by the friction, and can be readily adjusted to the required position. An assistant is required to move the line in the directions indicated, as the work proceeds, and then you are ready to center it in the cylinder. The only tool required for this purpose is a light pine stick of slightly less length than the radius of the

bore, and it should have an ordinary pin pushed into the head for a "feeler." Now adjust the line in the cylinder so that the head of the pin will just tick the line from four points of the counter-bore, which is always the part of the cylinder to work from, as it is not affected by the wear. The line should then be adjusted to the center of the other end of the cylinder, but not from the stuffing box, as this is likely to be out of center somewhat. Make the adjustment at this end from the counterbore, if possible, the same as in the first instance, and then it will be necessary to try the position of the line in the back end of the cylinder, as the changes made at the other end will affect it slightly. After the line is truly centered, you are ready to adjust the guides. With some types of cross-heads, it is possible to use the cross-head for determining the proper location of the guides, but with the ordinary form, such as shown in Fig. 2, this cannot be done, but you will need a tool similar to that shown in Fig. 3, which consists simply of a piece of flat iron long enough to reach across the guides, and having a hole drilled and tapped in the center for the thumb-screw. This thumb-screw is adjusted so that its point is the same distance from the lower side of the bar, as the lower face of the wings of the cross-head are from the center of the piston socket. To find this distance, lay a straight edge across the end of the cross-head and draw the line AB , and then, having found the center of the hole, the measurement may be accurately taken. The lower guides are now adjusted by the tool, so that the point of the screw will tick the line throughout the length, and then the top guides are put in position with the cross-head in place and adjusted for a proper working fit.

Before removing the line from the cylinder, however, the shaft should be tested for the truth of its right-angle position, which may be done by calipering between the crank disc and the line at the points H and I . If the distances are equal, the shaft is square with the bore of the cylinder, providing, of course, that

the disc is faced true with the shaft. If there is any doubt as to its accuracy, turn the shaft as nearly half way around as the crank-pin will admit without disturbing the line. Then caliper the distance of a point on the disc that will not be far removed from the first position, thus reducing the chance for error. If the shaft shows "out," move the outward bearing until the measurements show equal in both positions. The horizontal truth of the shaft can be found by laying a level on it, and if "out," raise or lower the out-board bearing until the level shows fair. Work of this kind requires skill and patience and belongs properly to the sphere of the chief engineer. It requires a delicacy of touch and an appreciation of what is meant by close measurement that can come only through experience. In centering the line, one should be able to detect when it is as little as $\frac{1}{1000}$ of an inch out of center. A piece of ordinary tissue paper is about .00125 inch thick. A man should be able, therefore, to adjust a line so accurately that if the "feeler," with one or more pieces of the paper under it, just clips the line, it will miss the line when one thickness is removed. While it may not always be necessary to work as closely as this, a person cannot expect to line up engines successfully until he has a full knowledge of what this degree of accuracy means.

CHAPTER XII.

THE STEAM ENGINE.

Work consists of the sustained exertion of force through space. The unit of work, the foot-pound, is a force of one pound exerted through one foot space. The work done in lifting one pound ten feet, or ten pounds one foot, is ten-foot pounds.

Power is the rate of work, or the number of foot-pounds exerted in a unit of time. The unit of power is the horse-power, and equals 33,000 foot-pounds exerted in a minute, or 550 foot-pounds exerted in a second, or 1,980,000 foot-pounds exerted in an hour. An engine developing fifty-horse power, exerts 27,500 foot-pounds per second, 1,650,000 foot-pounds in a minute. It could raise (friction neglected) 41,250 pounds forty feet in one minute.

A **belt** running over a pulley at 4,000 feet per minute, pulling with a force of 240 pounds (fair load for a 4-inch belt) will transmit

$$\frac{240 \times 4,000}{33,000} \text{ equal thirty horse-power (nearly).}$$

If moving at 1,100 feet per minute, the result would be

$$\frac{240 \times 1,100}{33,000} \text{ equal eight horse-power.}$$

A **gear-wheel**, the cogs of which transmit a pressure of 1,800 pounds (fair load for $1\frac{1}{2}$ " pitch 6" face) to the cogs of its mate, the periphery velocity of the wheels being ten feet per second, transmits

$$\frac{1,800 \times 10}{550} \text{ equal thirty-three horse power.}$$

If speed was 360 feet per minute, it would transmit

$$\frac{1,800 \times 360}{33,000} \text{ equal twenty horse-power.}$$

The **horse-power** developed by a steam engine consists of two primary factors, *Piston Speed and Total Average Pressure* of steam upon the piston.

Piston speed depends upon the stroke of engine and the number of revolutions per minute. An engine with stroke of twelve inches, making 300 revolutions per minute, has a piston speed of

$$\frac{2 \times 12 \times 300}{12} \text{ equal 600 feet per minute.}$$

Piston speed of an engine with 24" stroke at 150 revolutions per minute:

$$\frac{2 \times 24 \times 150}{12} \text{ equal 600 feet per minute.}$$

Total average pressure depends on *area of piston and mean effective pressure* per square inch exerted on piston throughout stroke. The mean effective pressure (M. E. P.) in any case can only be accurately obtained by means of the steam engine indicator, and depends upon the load engine is carrying.

GENERAL PROPORTIONS.

Diameter of steam pipes:

Slide-valve engine, $\frac{1}{4}$ diameter of piston.

Automatic high-speed engines, $\frac{1}{3}$ diameter of piston.

Corliss engine, $\frac{3}{10}$ diameter of piston.

Diameter of exhaust pipes:

Slide-valve engine, $\frac{1}{3}$ diameter of piston.

Automatic high-speed engine, $\frac{3}{8}$ diameter of piston.

Corliss engine, $\frac{1}{3}$ to $\frac{3}{8}$ diameter of piston.

Displacement of piston

in one stroke.

Clearance spaces :

Slide-valve engine	0.06 to 0.08
Automatic high-speed engine, single valve	0.08 to 0.15
Automatic high-speed engine, double valve	0.03 to 0.05
Automatic cut-off engine, Corliss type, long stroke	0.02 to 0.04

Weights of engines per rated horse-power :

Slide-valve engine	125 to 135 lbs.
Automatic high-speed engine	90 to 120 lbs.
Corliss engine	220 to 250 lbs.

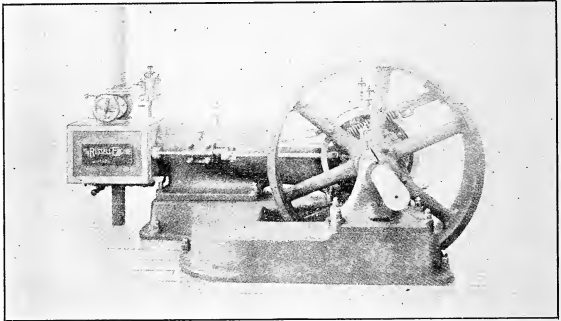
Fly-wheels, weight per rated horse-power :

Slide-valve engine	33 lbs.
Automatic high-speed engine	25 to 33 lbs.
(According to size and speed.)	
Corliss engine	80 to 120 lbs.
(According to size and speed.)	

RULES FOR FLY-WHEEL WEIGHTS, SINGLE CYLINDER ENGINES.Let d = diameter of cylinder in inches. S = stroke of cylinder in inches. D = diameter of fly-wheel in feet. R = revolutions per minute. W = weight of fly-wheel in pounds.For slide-valve engines, ordinary duty $W = 350,000 \frac{d^2 S}{D^2 R^2}$ For slide-valve engines, electric lighting. $W = 700,000 \frac{d^2 S}{D^2 R^2}$ For automatic high-speed engines $W = 1,000,000 \frac{d^2 S}{D^2 R^2}$

For Corliss engines, ordinary duty . . . $W = 700,000 \frac{d^2 S}{D^2 R^2}$

For Corliss engines, electric lighting . . . $W = 1,000,000 \frac{d^2 S}{D^2 R^2}$



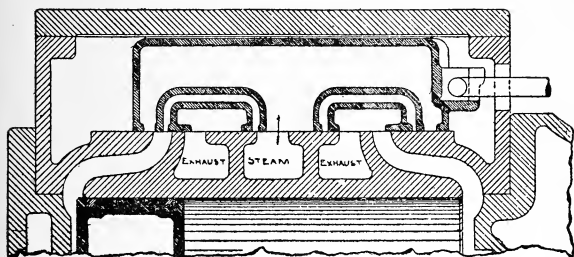
The Russell Engine.

SETTING THE VALVE ON A RUSSELL ENGINE, SINGLE VALVE TYPE. THE SAME PRINCIPLE LAID DOWN IN THE SETTING OF THE COMMON SLIDE VALVE MUST BE ADHERED TO.

The style of valve is shown in cut, Fig. 1. It is, to some extent, a moving steam chest with the steam all within itself, admitting only enough steam into the chest to keep the valve to its seat, against the maximum tendency to leave it. This pressure in the chest is found with the valve as at present proportioned, to be about 45 per cent of that contained within the valve. The cut shows the valve and section of cylinder so plainly as to render any detailed explanation of same almost unnecessary.

The *eccentric* operating the valve is under control of the governor, as shown in cut Fig. 2, which regulates the speed of the engine by sliding the eccentric across the shaft, either forward or backward, as the weights change their position, thereby cutting the steam off earlier or later in the stroke, as the governor, or more properly, the weights adjust themselves to the load.

When the *eccentric* is moved across the shaft in a direction that reduces its eccentricity, the steam is cut off earlier in the



(FIG. 1)

stroke; when the *eccentric* is moved in the opposite direction, the steam is cut off later in the stroke. The extreme range of this cut-off is from 0 to $\frac{3}{4}$ of the engine's stroke, and this whole range of adjustment is under complete control of the governor.

To preserve a certain determined speed with the smallest possible variation, as changes occur in the load or pressure, is the function of the governor. The cut-off must always be proportioned to the load. When the engine is running empty, the steam is cut off at the beginning of the stroke and the governor weights are at their extreme outer position. With a heavy load, steam follows further and the weights are nearer their inner position. Be-

tween these two limits, any number of positions of the weights, and corresponding angular positions of the eccentric, may be had ; and

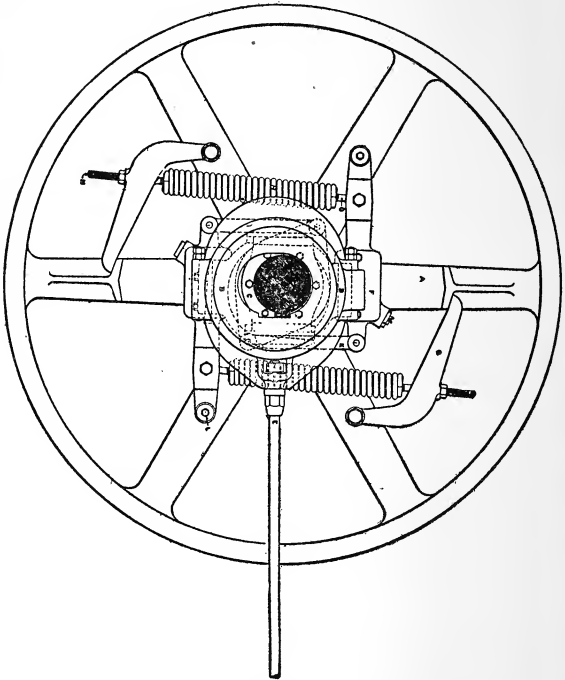


Fig. 2.

as the steam is thus adapted to the load in each position, it follows that a slight increase or decrease in speed must make a change in the cut-off and bring the engine again to standard speed.

In setting the valves it is necessary to mark the ports in the valve face at the outer edge of the steam chest, and also to mark on the back of the valve the ports in its face, so that it may be adjusted after being placed in the chest, in which position it presents a blank surface that, without these marks, would afford no means for knowing its position.

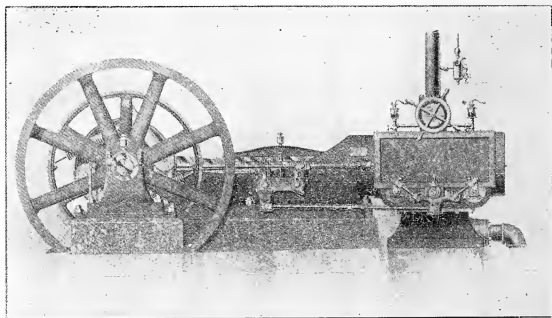
In placing the valve in the chest, see that it fits perfectly against the seat and that the bottom bearing, on which the valve rides, is at right angles to the valve seat, and in such a condition that the valve will not be tipped away from its seat, but rather against it. This latter condition will be insured by easing off the bottom strip at the inner corner, so that the valve would bear hardest at the outer edge. The hinge nut, into which the valve stem is screwed, as well as its trunnion bearings, should fit so that the valve lays closely to its seat, rather than be held away from it.

Having extended the marks of the ports as well in the valve seats as in the valve itself, to the outside, it now becomes necessary to get the center of the travel of the eccentric and connect the valve and rod, so that the valve will travel equally on either side of this center. The throw of the eccentric leads the crank in the direction the engine runs, and with the eccentric properly located, as it cannot help being, because it is attached to the governor and the governor is keyed to the shaft, the lead will remain the same with the governor weights in their outer as well as in their inner positions.

These valves are usually marked with the engine on the center at either end, marks corresponding with the admission edges of valve and seat. The hinge nut connection makes it convenient to examine these valves without disconnecting or disturbing any adjustments made. The valve rod has right and left-hand threads for adjustment, and final adjustment can be made without taking off the steam chest cover.

Of course, the proper way to make the final adjustment is by the aid of an indicator, but if the indicator is not at hand the engineer can, by the use of the right and left-hand threads, adjust the valve to a nicety.

While the engine is running slowly, leave the holes for the indicator connection open and notice the sound of the steam escaping through these openings. Then, with a wrench on the valve stem, the sound can be made even at both ends and the valve will be surprisingly close to the proper point of adjustment. In fact, a good ear can adjust in this way so closely that a subsequent indicator test will fail to find very much wrong.



Four Valve Type.

To set the valves on a four-valve Russell Automatic Engine, in which admission and cut-off is controlled by two separate valves, Fig. 3, and where, as in the four-valve Russell Automatic Engine, the exhaust is controlled by a separate arrangement of valves, Fig. 4. This arrangement has many advantages over the single-valve type, as the admission, release and compression all

remain constant for whatever cut-off; the economy of the engine is not nearly so dependent on a certain point of cut-off as is the single-valve type.

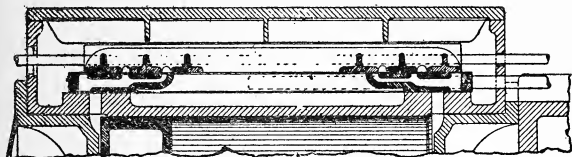


Fig. 3.

In the engine under consideration, the release and compression can be very readily and nicely adjusted by simply loosening the nut, clamping the arm, shown in cut, Fig. 5, to the valve stem; then by putting the wrench on the square end of the valve stem,

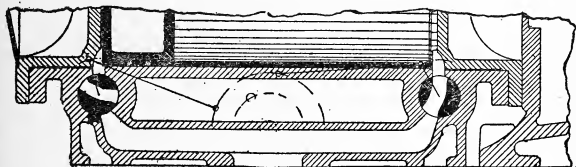
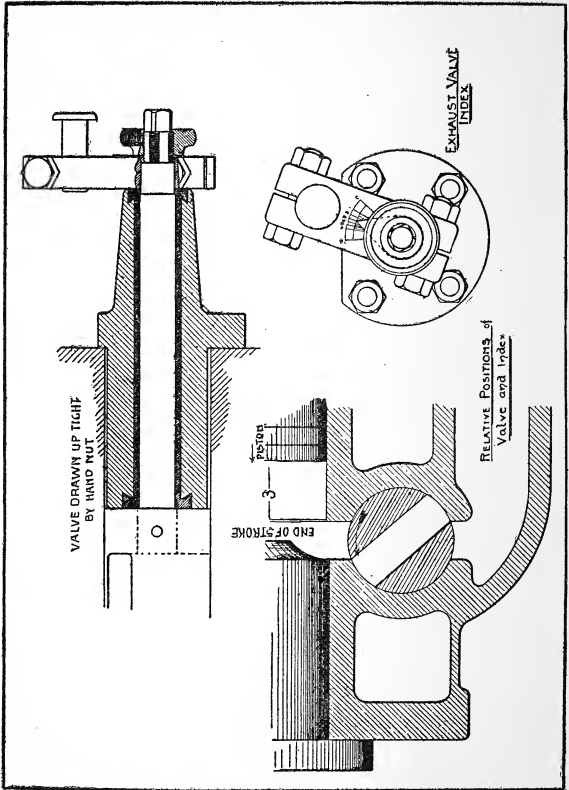


Fig. 4.

shown in Fig. 6, the valve can be turned to any amount of compression, as shown by the pointer and graduated index.

Fig. 7 shows a section through the valve and cylinder, revealing a portion of the piston and showing the point of compression at its beginning. Piston being within three inches of the end of



Figs. 5, 6 and 7.

its travel, the exhaust port has just been closed, as denoted by the direction of motion of exhaust valve, shown by arrow.

In setting the valves of this engine, put in main valve; find its point of mid-travel by placing it alternately at points of opening to cylinder, marking face of seat lightly along the admission edge of valve at the other end, and then moving valve until the distances between these marks and the admission edges of valve are equal.

Mark this position with a chisel. Leaving main valve at mid-travel, put in cut-off valve and move it along until it shows equal port openings at each end with main valve. Mark this position with a chisel. Put on main and cut-off valve stems and long and short exhaust connections, adjusting their lengths so that the rocker arms will stand plumb when main and cut-off valves are at mid-position and wrist plate is plumb.

To plumb wrist plate, mark distance between the center of the exhaust valve stems and the small pins in wrist plate, to which the exhaust valve stems are connected equally. Put on connecting rod.

Next, put on main eccentric so its throw will lead that of the crank in the direction the engine is to run. The shaft and eccentric being key-seated, the eccentric cannot be placed wrong if this point is observed; namely, that the throw, or heavy side of the eccentric, will lead that of the crank in the direction the engine is to run. The eccentric being in halves, it can be taken off and turned around so that the face that is next to the cut-off eccentric will be next to the pillow block, and this operation reverses the motion of the engine, Figs. 8 and 9.

Put on main eccentric rod, and adjust its length by nuts at straps until main valve shows equal opening at the same end at which piston or cross-head is, with engine on center. Attach cut-off eccentric and rod. Turn the eccentric by hand on shaft, and adjust length of rod as before until cut-off valve travels

equally on each side of its middle position, as found previously. Put governor together, so weights will follow or drag behind the

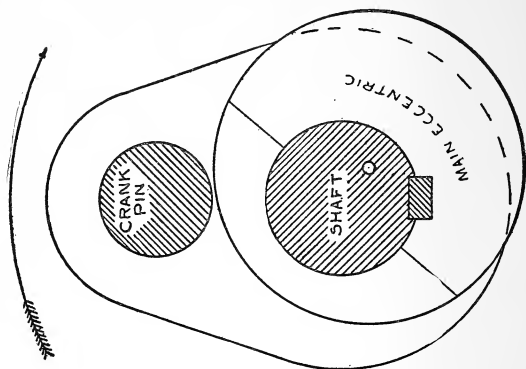


Fig. 9.

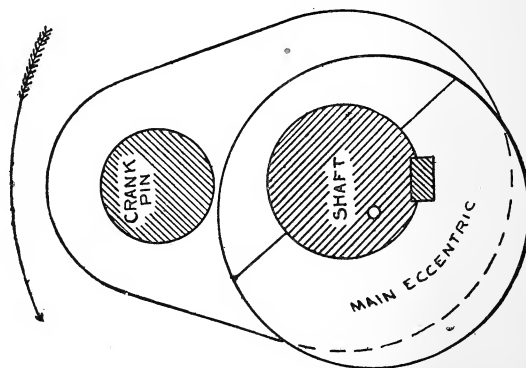


Fig. 8.

trunnions in arms of governor wheel, to which they are attached when engine is running.

Block weights one-half way out. Turn engine over in the direction it is to run until the cross-head has traveled one-eighth to one-sixth of its whole stroke. With governor wheel loose on the shaft, turn it in the direction engine is to run until cut-off valve closes ports in the main valve *from* which the cross-head is traveling. Fasten governor wheel to shaft.

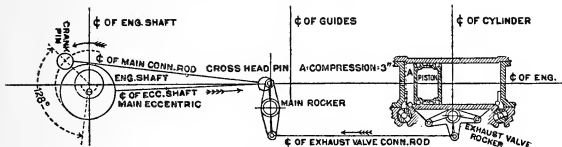


Fig. 10.

Now try the cut-off for both ends, adjusting the cut-off valve rod by the union nut or swivel, until it cuts off at equal points in the stroke.

The **compression** is shown by the index upon the exhaust valve arms, which may be verified or corrected if the index has become disarranged by markings on the back of ends of exhaust valves and chest.

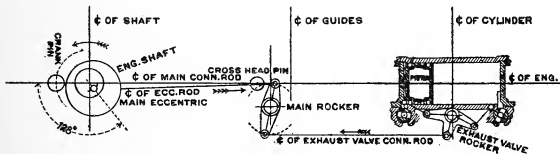
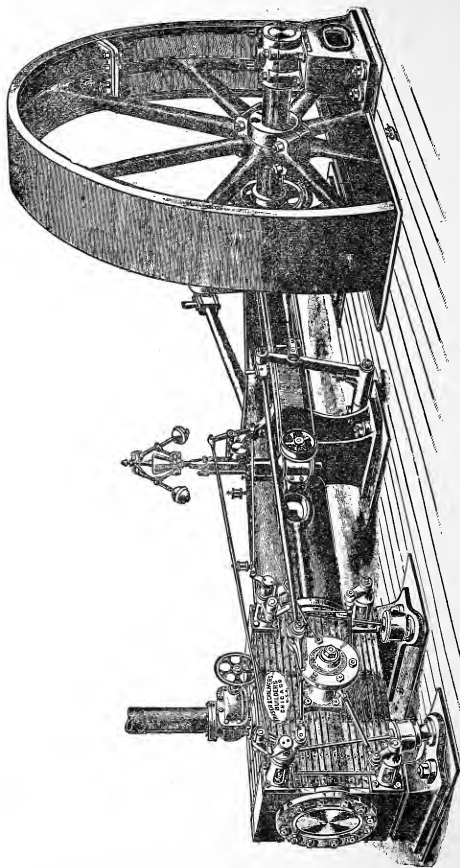


Fig. 11.

The two diagrams, cuts, Figs. 10 and 11, show the different positions of the main exhaust valves, with relation to the different positions of crank; and they also show the arrangement of motion of these exhaust valves, as transmitted through the double bell crank or exhaust valve rocker, to which they are connected.



STANDARD HORIZONTAL CORLISS ENGINE.

This motion is such that during the admission of steam when the highest pressure is on the exhaust valve, its speed is at its minimum, and at the moment of release, when the pressure is reduced to its lowest tension, its travel is at its maximum. This serves the double purpose of reducing the wear on the valves and making a comparatively sharp corner on the indicator card at the point of release.

DIRECTIONS FOR SETTING UP, ADJUSTING AND RUNNING THE IMPROVED CORLISS STEAM ENGINE.

Location of foundation.—The foundation must be at right angles with main line shaft. If main line shaft is not already in position, then foundation must be set by two points, located and connected with a line parallel with the buildings, and at right angles to an imaginary line through center of cylinder.

Foundation plans should show all center lines. If a templet is furnished to locate the foundation accurately for the mason, the center line of engine cylinder and guides and right angle for crank center are drawn thereon.

Cap stones.—Examine carefully the lap faces of cap stones and, if necessary, have them trimmed off by cutter or mason, so that each is true and level, and in exactly the plane shown in formation plan.

Cylinders and frame.—Put engine cylinder and frame in position and bolt them together.

Lining off crank shaft and out-end bearing.—Stretch a line at right angles to main center line, through main bearing to represent center line of crank shaft. See that this line is exactly in the center and level. By this line place out-end bearing square and true. Put crank shaft in its bearings after bottom box has been placed in main bearings. Insert quarter boxes and adjusting wedges into main bearing and put cap on.

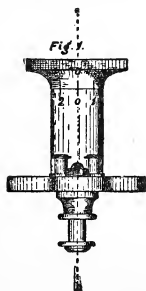
To ascertain that shaft is at exact right angles to main center

line, turn engine shaft until the crank-pin comes nearly to the main center line, then with a pair of calipers, or rule, measure from shoulder of crank-pin to line, and after noting this distance, turn the crank back towards opposite center until pin is in same relative position to line, and measure again. If both measurements do not correspond, out-end bearing must be moved either way as required, until measurements show equal. Then take up slack around shaft in main bearing, being careful not to force the adjusting wedge too tight.

Fly-wheels. — The fly-wheel is next placed on shaft and firmly keyed in position.

Placing valve gear. — Steam and exhaust valve covers or bonnets on valve gear side are next bolted to place, taking care that no dirt or foreign substance gets between the surface underneath the covers.

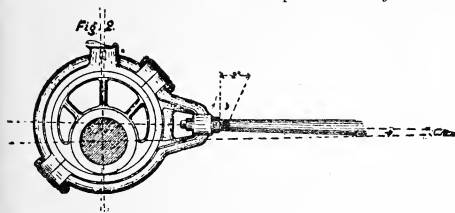
Valve stems are inserted from opposite or front of cylinder and the valves put in after them, the *F* head of valve stem entering slot in valve. Couple up all valve gear parts, i. e., disc plate, valve-stem cranks, valve-connecting rods, dash pots and dash-pot rods, valve-rod rocker, eccentric and straps on crank-shaft, first and second eccentric rods. The dash pots should be thoroughly cleaned and oiled before putting in place.



Valve gear adjustment. — The valves are well marked to their respective places in the cylinder. All the valve connections are screwed up tight to proper length (after adjustment and setting of valves in shape). The dash pot connecting rods require adjustment after dash pots are in place. (In the present style of engines the position of dash pots is unalterably fixed by a finished seat for each in the feet of cylinder.) Move disc plate (Fig. 1) until line *I* marked on same meets line *O* marked on fixed disc bracket, then adjust

the dash pot so that the hook of the lever connecting rod to steam valve stem engages the catch block free and easy; repeat this with the other steam valve connecting rod.

NOTE. — The 1 and 2 on disc plate represents travel of same. The first eccentric rod will require no adjustment if placed thus:



(see Fig. 2) it being so marked on every engine, and the measurements from nut to mark being always two inches. Secure the eccentric

to the shaft as it is marked, always ahead of the crank, whichever way the engine is required to run.

Governor. — Bolt the governor stand to its place on engine frame, first removing any grit or dirt upon surfaces which come together. Connect the cut-off rods to cut-off cams, also the governor rods and fixtures. The cut-off rods are already adjusted to proper length before shipment from the shop and screwed up tight. If loosened by accident, they should be set thus: Set the governor in the top notch of the collar (see Fig. 3); unhook second eccentric rod from disc plate, and with hand lever (which insert in disc plate for the purpose) move valve gear to one end of travel (as indicated by lines 1 and 2 on disc plate and center line *O* on fixed disc bracket (see Fig. 1) and adjust the rods so that steel trip toe on cut-off can just touch the claw without unhitching same. Reverse disc plate and repeat this on the other end.

Fig. 3.



Safety collar. — The safety collar on governor (A Fig. 3) is provided with a spring which turns said collar. This collar is properly spaced so that the deep notch takes place of shallow

one, and should governor belt break, the governor would drop so low that the adjustable toe on cut-off prevents claw from engaging catch block, thus stopping the engine, as no steam will be admitted to the cylinder.

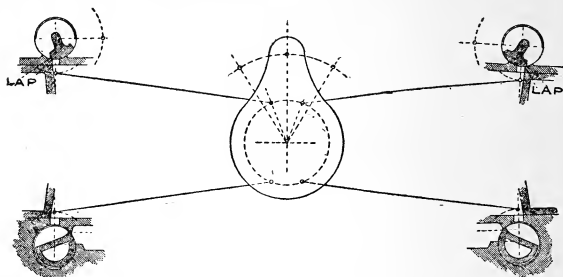


Fig. 4.

Setting valves.—If the length of valve rods should have changed by accident, place valve disc on center (O to O , Fig. 1); remove back valve chamber covers where edge of ports and valves and the parts are marked plainly by chiseled lines, and set the valves as per marks.

Adjust the length of eccentric rod so that the valve disc swings equal both ways from the center line on hub of disc (see Fig. 1). Place the valve disc in the center (lines O and O , Fig. 1) and set the valve as shown above, the admission or steam valves to have $\frac{5}{16}$ inch lap, the exhaust port valves edge to edge.

Set the crank on dead center. (To get engine on center see page 228.) Turn the eccentric ahead of the crank pin in the direction the engine is to run until the valve shows $\frac{1}{16}$ inch opening, then secure the eccentric. If any difference of opening is detected, it can be adjusted by the nuts on eccentric rod, moving the rod in or out as the case may require.

Piston.—Before placing the piston in cylinder, remove the

exhaust valves from their seats and insert starting bar in wrist plate. After lifting hook up off pins place wrist plate in central position (as shown by lines *O* and *O*, Fig. 1) and admit a small amount of steam through stop valves. Then by working the wrist plate back and forth with starting bar, the dirt and grit will be entirely removed from the internal surface of cylinder and steam passages.

CONDENSERS.

When steam expands in the cylinder of a steam engine, its pressure gradually reduces and ultimately becomes so small that it cannot profitably be used for driving the piston. At this stage, a time has arrived when the attenuated vapor should be disposed of by some method, so as not to exert any back pressure or resistance to the return of the piston. If there were no atmospheric pressure, exhausting into the open air would effect the desired object. But, as there is in reality a pressure of about 14.7 pounds per square inch, due to the weight of the superincumbent atmosphere, it follows that steam in a non-condensing engine cannot economically be expanded below this pressure, and must eventually be exhausted against the atmosphere, which exerts a back pressure to that extent.

It is evident that if this back pressure be removed, the engine will not only be aided by the exhausting side of the piston being relieved of a resistance of 14.7 pounds per square inch, but moreover, as the exhaust or release of the steam from the engine cylinder will be against no pressure, the steam can be expanded in the cylinder quite, or nearly, to absolute 0 of pressure, and thus its full expansive power can be obtained.

Contact, in a closed vessel, with a spray of cold water, or with one side of a series of tubes, on the other side of which cold water is circulating, deprives the steam of nearly all its latent heat, and condenses it. In either case the act of condensation is

almost instantaneous. A change of state occurs and the vapor steam is reduced to liquid water. As this water of condensation only occupies about one sixteen-hundredths of the space filled by the steam from which it is formed, it follows that the remainder of the space is void or vacant, and no pressure exists. Now, the expanded steam from the engine is conducted into this empty or vacuous space, and, as it meets with no resistance, the very limit of its usefulness is reached.

The vessel in which this condensation of steam takes place is the condensing chamber. The cold water that produces the condensation is the injection water; and the heated water, on leaving the condenser, is the discharge water. To make the action of the condensing apparatus continuous, the flow of the injection water and the removal of the discharge water, including the water from the liquefaction of the steam, must likewise be continuous.

The vacuum in the condenser is not quite perfect, because the cold injection water is heated by the steam and emits a vapor of a tension due to the temperature. When the temperature is 110 degrees Fahr., the tension or pressure of the vapor will be represented by about 4" of mercury; that is, when the mercury in the ordinary barometer stands at 30", a barometer with the space above the mercury communicating with the condenser, will stand at about 26". The imperfection of vacuum is not wholly traceable to the vapor in the condenser, but also to the presence of air, a small quantity of which enters with the injection water and with the steam; the larger part, however, comes through air leaks and faultly connections and badly packed stuffing boxes. The air would gradually accumulate until it destroyed the vacuum, if provision were not made to constantly withdraw it, together with the heated water by means of a pump.

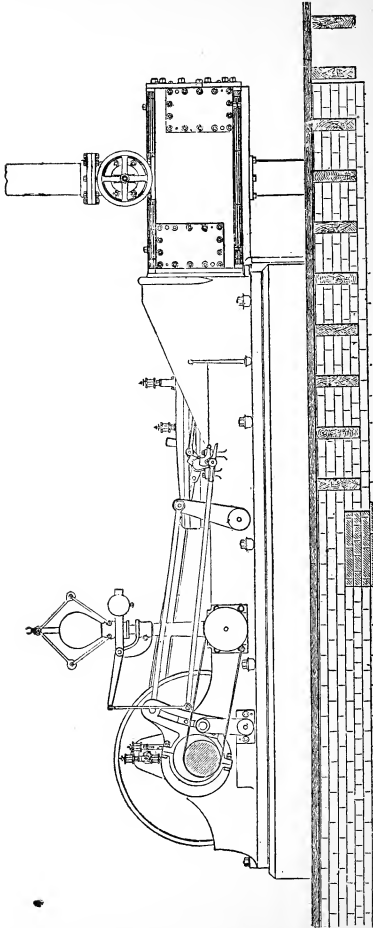
The amount of water required to thoroughly condense the steam from an engine is dependent upon two conditions: the total heat and volume of the steam, and the temperature of the injection

water. The former represents the work to be done, and the latter the value of the water by whose cooling agency the work of condensation of the steam is to be accomplished. Generally stated, with 26" vacuum, the injection water at ordinary temperature, not exceeding 70° Fahr., from 20 to 30 times the quantity of water evaporated in the boilers will be required for the complete liquefaction of the exhaust steam. The efficiency of the injection water decreases very rapidly as its temperature increases, and at 80° and 90° Fahr., very much larger quantities are to be employed. Under the conditions of common temperature of water and a vacuum of 26" of mercury, the injection water necessary per H. P. developed by the engine, will be from $1\frac{1}{4}$ gallons per minute when the steam admission is for one-fourth of the stroke, up to two gallons per minute, when the steam is carried three-fourths of the stroke of the engine.

CORLISS ENGINE REGULATION.

The question of why an ordinary Corliss Engine will not cut off later than about half stroke, is often asked by engineers, although the reason is simple.

When the engine is on a center, the eccentric must be a little ahead of the vertical position in order to give the valves an opening at the correct time. By the time the piston has reached about half stroke, therefore, the eccentric will have reached its extreme travel one way, and the valve lever will begin to move back in the opposite direction. Now the nature of the mechanism is such that the valve can be tripped only when the valve lever is moving in a direction which will bring the trip arrangement or catch, against the knock-off lever. Just as soon as it begins to move back away from the knock-off lever, which it does at about half stroke, owing to the motion of the eccentric, cut-off cannot be effected by the action of the governor.



THE PORTER-ALLEN ENGINE.

THE PORTER-ALLEN STEAM ENGINE, MADE BY THE SOUTHWARK FOUNDRY & MACHINE CO.

This engine claims the distinction of being the original and most perfect type of the high-speed steam engine. In truth, however, it should not be termed a high-speed engine. Relatively, indeed, to those speeds to which it has hitherto been found necessary to limit the motion of engines, its speed is high; but considered absolutely, and as it appears to all persons accustomed to it, this engine is ordinarily run at what is undoubtedly the natural, and on all accounts, the desirable speed at which a properly designed and constructed steam engine ought to be run, for ordinary purposes; while this is much below the speed of which it is capable, and at which it is run with entire success, in cases where such speeds are required. This engine is presented as one which, distinguished by a system of valves and valve movements perfectly adapted to improved rotative speed, has also been designed upon sound principles, and is made in the most excellent manner; so that, without the least drawback, all the advantages of this speed may be realized by the use of it. A description of this engine naturally commences with the valve gear and valves.

Its central feature is a link actuated by a single eccentric, from which separate and independent movements are given to the admission and the exhaust valves.

Attention is first invited to

The position of the eccentric.—The eccentric is placed on the shaft in the same position with the crank, and cannot be altered from this position. The lead of the valves is adjusted by other means. The first requirement of this system is, that the crank and the eccentric shall have coincident movements, and so shall arrive on their dead points, or lines of centers, simultaneously.

To insure the permanence of the eccentric in its correct position, and also for compactness, and as a superior mechanical con-

struction, it is formed in one piece with the shaft, and its low side is brought down to the surface of it, as shown in the above illustration.

The link.—The construction of the link is also shown in the above cut. It is of the form known as stationary link, and consists of a curved arm, partly slotted, formed in one piece with the eccentric strap, and pivoted at its middle point on trunnions, which

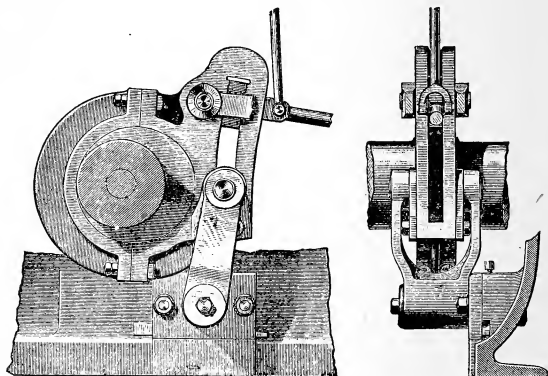


Fig. 1.

vibrate in an arc whose chord is equal to the throw of the eccentric, about a sustaining pin secured rigidly to the bed. The radius of the link is equal to the length of the first rod, by which its motion is communicated to the admission valves.

In the slot is fitted a block from which the admission valves receive their motion. This block is moved by the action of the governor, which thus varies the point of cut-off. If the center of the block is brought to the center of the trunnions, the port is not opened at all, except by the lead given to the valves, and this

opening is closed before the piston has advanced a sensible amount. If, on the other hand, the block is brought to the end of the slot, as here represented, the steam is not cut off until the piston has reached about six-tenths of the stroke, which is the limit of the admission.

The exhaust valves are driven from a fixed point on the link, and have, of course, an invariable motion. The movements of the link at this point are admirably suited to this function, causing the steam, wherever it may have been cut off by the admission valves, to be held until near the termination of the stroke, when it receives a free and ample release, and is confined again near the end of the stroke by the closing of the exhaust valves at a point which provides the compression required to arrest the motion of the reciprocating parts, and at the same time, fill the end clearance of the cylinder with the compressed steam.

The peculiar motion of the link is given to it by a combination of the horizontal and the vertical throws of the eccentric. The horizontal throw alone only moves the link from one to the other of the lead lines, which motion only draws off the lap of the valves. The opening movement is produced by the tipping of the link alternately in the opposite directions beyond the lead lines, and these tipping motions are given by the vertical throws of the eccentric. Its upward throw tips the link in the direction from the shaft and opens the port at the further end of the cylinder; and its downward throw tips the link towards the shaft, and opens the port at the crank end of the cylinder. At the same time, its horizontal throw is drawing the valve back, and when in this return movement, that point in the link at which the block stands, crosses the head-line, the steam is cut off.

This link possesses a distinguishing excellence, which will now be described.—The angular vibration of the connecting rod causes a considerable difference in the motion of the piston in the opposite ends of the cylinder, retarding it in the end

nearest to the crank, and accelerating it at the end farthest from it. When the length of the connecting rod equals six cranks, as is usually the case, this difference in velocity averages 20 per cent, and at the commencement and termination of the strokes, reaches the great amount of forty per cent.

The driven arm of the link is of such length that its angular vibration coincides in degree, as well as in time, with those of the connecting rod; and so the trunnions of the link receive a motion coincident with that of the piston, and the link gives to the valves, in opening and closing their ports, different velocities, accelerated at one end of the cylinder and retarded at the other, corresponding to the difference in the velocity of the piston.

Difference of lead.—The application of this gear to the engine under an adjustment provides for a slight difference in lead at either end of the stroke, and the amount of this dissimilarity is in the direct ratio as the variation of the piston velocities at the end of the stroke.

The manner in which the link imparts to the exhaust valves their movements.—The exhaust valves open and close their ports in such manner that the opening is made while the valve is moving swiftly, and one-half of the opening movement has been accomplished when the piston arrives at the end of its stroke. The valves are so constructed that this portion of the movement opens the whole area of the port, which does not begin to be contracted again until the center line of the link has re-crossed the lead lines on its return. The speed of the piston is then also diminishing, and the exhaust is not throttled at all until the port is just about to be closed.

The differential valve movement.—A wrist motion is introduced into the connection of the admission valves.

In this movement, an arm which is connected by a rod with the block in the link, communicates through a rock shaft, motion

to the two other arms, causing them to vibrate in the same vertical plane in which the valves move. Each of these arms alternately rises nearly to the vertical position, while the other, at the same time, descends to and beyond its dead point.

Each by a separate connection, imparts motion to one of the admission valves, and at the top of its vibration causes it to open and close its port swiftly and then, descending to its idle arc, reduces the motion of the valve to an interval practically of rest.

These movements can be followed in the cut where the upper arm is about to move in its arc to the left, and thus, through the lower connections, to open the port at the further end of the cylinder, while the lower arm will be scarcely moving in its valves at all. In this manner, the width of opening is largely increased, chiefly by a difference in the length of the levers, while, at the same time, fully one-half of the lap, or the useless motion of each valve after it has covered its port, is got rid of, so that smaller valves and narrower seats are employed, and notwithstanding the greater opening movement, the total motion of the valves is very much reduced.

THE ADJUSTABLE PRESSURE PLATES.

Description of these plates. — The construction of these pressure plates and the method of adjusting them are fully represented in the sections of the cylinder, Figs. 2 and 3.

On the lower side of the horizontal section, Fig. 2, both admission valves are shown, working between their opposite parallel seats, one of which is formed on the cylinder, and the other on the pressure plates, the latter having cavities opposite the ports.

The valve at the further end of the cylinder is at the extremity of its lap, while the one at the crank end has commenced to open the four passages for admission of the steam.

The vertical cross-section, Fig. 3, passes through the middle of one pressure plate and shows its form and the means employed for its adjustment. It is made hollow and most of

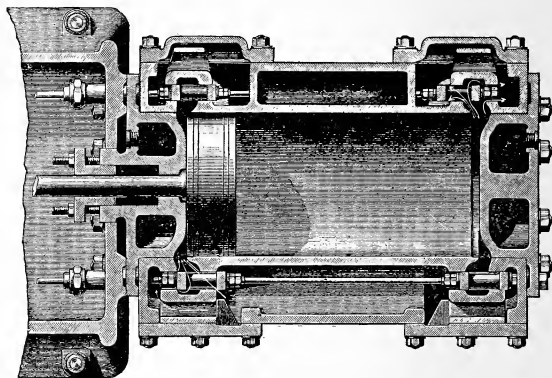


Fig. 2.

the steam supplied to two of the openings passes through it. It is arched to resist the pressure of the steam without deflection. It rests on two inclined supports, one above and the other below the valve. These inclines are steep, so that the plate will be sure to move freely down them under the steam pressure, and also that it may be closed up to the valve with only a small vertical movement. It is prevented from moving down these inclines by a screw, passing through the bottom of the chest, the point of which, as also the plug against which it bears, is of hardened steel.

The pressure plate is held in its correct position by projections in the chest, on one side, and tongues projecting from the cover on the other, which bear against it near each end, as shown.

Between these guides, it is capable of motion up and down its inclined supports, and also directly back and forth between the valve and the cover.

The pressure of steam is always on this plate, and tends to force it down the incline to rest on the valve. By means of the screw it is forced against the steam pressure, up the inclines and away from the valve. This adjustment is capable of great precision, so that the valve works with entire freedom between its opposite seats, and still is steam-tight.

How these plates act as relief valves. — Whenever the pressure in the cylinder exceeds that in the chest, the admission

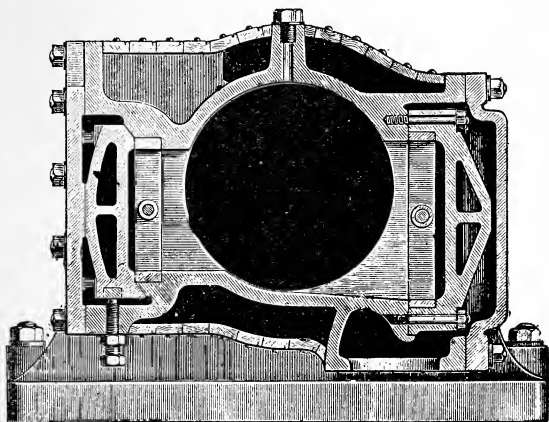
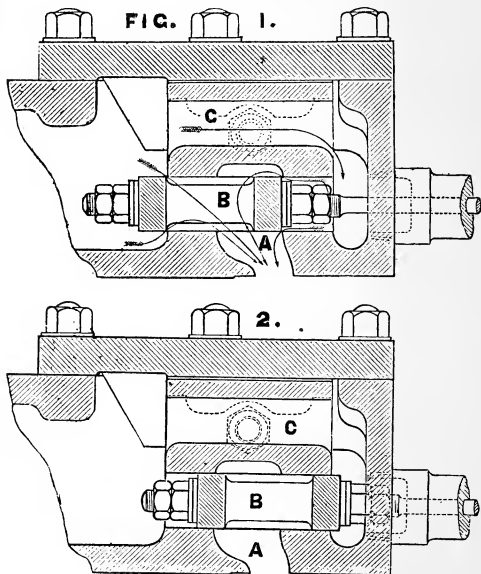


Fig. 3.

pressure plate is instantly moved back to contact with the cover, thus affording an ample passage for the discharge of water before it can exert a dangerous strain. This plate is superior

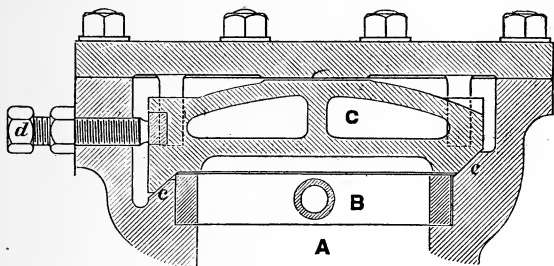
in this action to any of the ordinary forms of relief valve, both in the area opened, and also in being self-adjusted to the pressure, and opening fully the instant that is exceeded.

How to keep the admission valves tight.—These valves, though moving in complete equilibrium, are liable to slight wear.

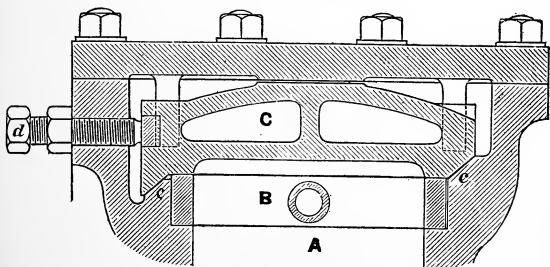


This should be taken up as it appears, by letting down the pressure plates. The construction of these plates and the method of adjusting them, are shown in the accompanying sections, made through the steam chest at one end of the cylinder. Of these, Figs. 1 and 2 are horizontal sections, showing the four-opening of

the valve — first, when commencing to open, with arrows indicating the course of the steam; and, second, at the extreme point of its lap; while Figs. 3 and 4 are vertical sections, showing the



pressure plate — first, when by turning the bolt *d* forward it is forced up the inclines and away from the valve, producing a leak; and second, when it is let down to its proper working position. *A* is the port, *B* the valve, and *C* the pressure plate. The latter



is made with a trussed-back and so cannot be deflected by the steam pressure. Through the passage thus formed, the steam reaches two of the openings.

The **pressure plate** rests on two inclined supports, *c*, *c*, and the pressure of the steam forces it down these inclines as far as the bolt *d* underneath will allow. This bolt holds the plate just off from the valve, so that the latter moves freely, and is still steam tight. Whenever leakage appears, a minute turning of this bolt backwards lets the pressure plate down and closes it.

Provision is made for readily detecting the least leakage, as follows: When the engine is warmed up in its normal working condition, open the indicator cocks, or in the absence of these, remove the plugs from the top of the cylinder, unhook the link rod, and set the valves by the starting bar so that both ports are covered, and turn on the steam. If the valve leaks at the end of the cylinder, which is not then open to the atmosphere or the condenser, the steam will blow out at the opening provided, having no other outlet. Then let down its pressure plate by backing the bolt very carefully till the leak disappears. The valve should still move freely when the leak has disappeared, and the pressure plate must not be let down any closer than is necessary for this purpose.

Leakage at the opposite end of the cylinder will not generally be seen, the steam escaping freely by the open exhaust. To test its valve in the same manner, the engine must be turned on to the opposite stroke. These examinations should be made from time to time.

In the small engines which have no starting bar, the valve rod can be disconnected and moved by hand to test this point.

An engine should never be started till it is warmed up. The valves warm quicker than the supports on which the pressure plates rest, and are tight between their seats by expansion, until the temperatures have become nearly equalized. Provision for detecting and stopping any leak of steam is the crowning excellence of this valve.

These valves are small and light; each admits and cuts off the steam simultaneously at four openings; each works in complete equilibrium; their line of draft is central, so that unequal wear is entirely avoided.

To set the admission valves.—Place the engine on one of its dead centers as explained on page 228. Then raise the governor, bringing the center of the block between the centers of the trunnions of the link.

With the governor remaining up, set the valve that is about to open, giving to it a lead of from $\frac{1}{16}$ " to $\frac{3}{16}$ ", according to the size of the engine. High speed requires considerable lead. Repeat this for the other valve on the opposite center.

On letting the governor down, the crank remaining on the dead center, it will be seen that the valve is moved a short distance. This motion of the valve, produced by moving the block from the trunnions to the extremity of the link while the crank stands on the center, is the same in amount on either center and takes place in the same direction; namely, towards the crank. Its effect is, therefore, to cover the port nearest the crank and to enlarge the opening of the port farthest from it; so that the lead, which is equal at the earliest point of cut off, is at the crank of the cylinder gradually diminished, and at the back end increased in the same degree as the steam follows further.

The effect of this is to equalize the opening and cut-off movements, so that, on setting the governor at any elevation whatever and turning the engine over, the openings made and the points of cut-off will be found to be identical on the opposite strokes, from the commencement up to the maximum admission. This difference in the lead is also singularly adapted to the difference in the piston velocity at the two ends of the cylinder.

In case the indicator shows that the lead of either admission valve requires to be changed, this is done without opening the chest, by lengthening or shortening the stem at the socket of

its guide, bearing in mind that each valve moves towards the middle of the cylinder to open its port.

To set the exhaust valves. — These have an invariable motion, and are admirably adapted to their purpose. They are set so as to open before the end of the stroke enough to give ample lead, and close again when the piston is on the return stroke, early enough to effect the required compression.

All the valves are held between pairs of brass nuts, of which the inner one is flanged. These nuts must be securely locked, and should be so set upon the valve that it is free to adjust itself between the nuts while yet sufficiently tight that no "lost motion" exists. To avoid the consequences of a mistake, care should be taken, before closing the valve chests, to turn the engine slowly through an entire revolution, while the movements of the valves are carefully watched, so as to insure that they have not been so set as to bring the valves or their nuts into contact with the ends of the chest at the extremes of their movements.

The governor. — The Porter Governor, original in its type, stands unexcelled as adapted to stationary engines, requiring close regulation. The active parts are very light, the power being derived from a high rotative speed, causing a sensitiveness in its movements that will arrest fluctuations and produce uniformity in the running of the engine. It has been so perfected that at the present day it is easily adapted to the requirements of any class of work necessitating a governor, and is especially desirable for an engine where a steady speed is necessary.

The speed of this governor being constant, makes it equally efficient upon an engine running either at a high or low number of revolutions. That is to say, the speed of engine can be altered from time to time by changing the governor pulley, the governor itself continuing to run at the same speed and under the same strains, and being stationary, it is always open to observation. Whereas, any change in speed of engine with the wheel or

shaft governor, increases or decreases the initial strains upon all the parts of the governor, and they have to be adjusted accordingly.

It is manufactured and sold separate from the Porter-Allen engines.

How to tighten the side boxes of the main bearing.— This is done by drawing up the wedge with the bolts by which it is suspended from the cap. The time to do this is when the engine is running and the freedom of the journal between its side boxes can be felt. The engineer can then draw up the wedges to take this out as much as he deems prudent.

DIRECTIONS FOR SETTING AND RUNNING THE PORTER-ALLEN STEAM ENGINE.

The foundation.— This should be made of concrete, hard bricks or stone laid in cement. Bricks are preferred on account of their rectangular form and of the more perfect bond they make with the cement. Stones of irregular form are sure to have the cement bond broken and to spread under the strain of the bolts. The bricks should be wet, and the cement washed into every course.

Time should be allowed for the cement to set before any weight is put upon it. A week, at least, is required for this purpose; a month is none too long.

Heavy cut stone is ornamental for a coping, but not essential where there is a bed-plate; the bed-plate of an engine being not a mere name, but a reality.

A foundation plan for locating the bolts should be made for each engine. The bolts should have some play in the masonry. The best way of insuring this is to inclose each bolt in a wooden box of half-inch stuff, about sixteen inches long, which is drawn up as the courses are added and removed entirely before the engine is placed on the foundation, so the bolt holes may be poured full of cement after the setting is completed.

Under ordinary circumstances, a foundation built to the plan furnished is ample to hold the engine still; but when it must be built on soft ground, or on sand or loose gravel, or must be carried up through a basement or cellar, it should be extended at the base lengthwise in each direction. Sometimes, both these obstacles to stability are met with, when the foundation should be extended as far as practicable, and at one end, at least, tied to a wall quite up to the engine-room floor. The builders of the engine should be consulted in such cases.

Setting the bed.— This setting is done in the usual manner, by a line through the cylinder, which is bolted at the end of the bed in alignment with the guides. In case the cylinder is not yet in place, it is represented by the bore in the head of the bed, and the line is to be continued midway between the side rails of the lower guide bars.

The guides lie in one plane and are to be used for leveling the bed in both directions.

The base of the bed is not brought in contact with the foundation. Thin parallel packing pieces are to be placed on each side of each bolt and under each end of the main bearing, and the bed must bear equally on all these, when the guides are level in all directions, before any strain is put on the bolts. After these have been tightened and the guides are finally found to be level, the broad flange of the bed is brought to a general bearing on the foundation, by running sulphur under it, or by caulking with iron borings wet with water made only slightly acid with sal-ammoniac.

Setting the shaft.— In placing the shaft in position, three requirements must be observed. First, to place it at a right angle with the axis of the cylinder. Second, that it shall be level. Third, that it lies fairly in its bearings. It is readily squared. The crank disc is finished on the shaft centers after the pin has been set, so that its rim is on the opposite side equally

distant from its center line, the shaft is square. It is leveled by plumbing the crank disc. When thus set it will lie fairly in the main bearing; and if the outer bearing has been correctly set, it will lie fairly in that also. This is tested by rotating the shaft entirely dry. Brightened rings will show what parts of the journals have found bearings, and on lifting the shaft, bright spots on the babbitt metal will show where these bearings were.

The boxes are slightly larger than the journals and so the latter should bear along the center of the lower box and not on the sides.

The journals of the shaft if set as here directed will, with ordinary lubrication, run cold from the start. Should the shaft ever get out of line, it may be squared by gauging between the rim of the crank disc and bosses provided on the bed.

SPECIFICATIONS FOR CENTRALLY BALANCED CENTRIFUGAL INERTIA GOVERNOR.

It is difficult to say just what is the most important part of a modern steam engine, but certainly its governor is among the very first. Here then is my idea of what they should be:—

First. The governor must so regulate the speed of the engine's revolutions that when starting or stopping it shall not "pound" or knock, which means some danger, considerable wear and much annoyance.

Second. It must so regulate the engine's speed when in service, that when 125 per cent of its rated capacity be instantly thrown upon the engine, the change in speed will not be more than $1\frac{1}{2}$ per cent greater or less than the constant speed; and that if the same load be instantly thrown off the engine, the variation shall, in that case, be no greater than one per cent.

Third. That the governor must show every evidence of stability or ability to have all descriptions of break loads thrown on or off,

or both, without "racing" or "weaving" beyond $1\frac{1}{2}$ per cent of constant speed. This is to insure against accident and expert assistance.

Fourth. Should any part of the governor or its attachments break or become disconnected, the device must not do otherwise than to bring the engine to a full stop.

Fifth. All the parts of the governor must be light, yet of finest materials, to save wasted energy and yet insure reliability.

Sixth. The construction must be such that during all ranges of cut-off, the parts shall remain at all times in perfect balance. "Out-of-balance" almost more than any other one difficulty has prevented the full success of wheel governing engines, therefore, this feature must be eliminated. No device obviously incapable of constant balance should be considered unless that long sought and potential factor of fine running is to be sacrificed with open eyes.

Seventh. All parts subjected to transmitting strains must be of steel.

Eighth. All transmitting bearings must be provided with hardened and ground to gauge steel pins, each of which must be furnished with movable phosphor bronze bushings to save wear and enable quick and interchangeable repairs.

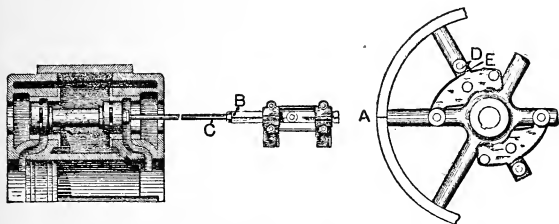
Ninth. Springs must be of best quality and made with screwed "plug" connections. The bending of the spring into hook or eye for connecting will not be permitted.

Tenth. Governor must be so designed and provided with movable weights, that the speed may be diminished or increased graduated amounts without disturbing otherwise the adjustment of the mechanism.

Eleventh. Any governor so designed as to accomplish regulation clause primarily, and at the same time fulfills all other requirements will naturally receive preference over other devices, which evidently fairly accomplish regulation but fail in other

expectations, and yet apparently have only lower first cost as a defense.

The Armington and Sims Engine, as is well known, is of the high speed type, and in its earlier form was designed with double eccentrics, one inside of the other. These eccentrics are operated by the shaft governor, and the compound motion produced by the movements of the two eccentrics is such that the valve has equal lead for all points of cut-off.



Valve Gear of the Armington & Sims Automatic Engine.

The method of setting the valve is very simple, for all engines of this make are sent out with the valve stem and slide marked at points *C* and *B* in the sketch, and these points should be set just three inches apart. The following are the directions which the builders supply: —

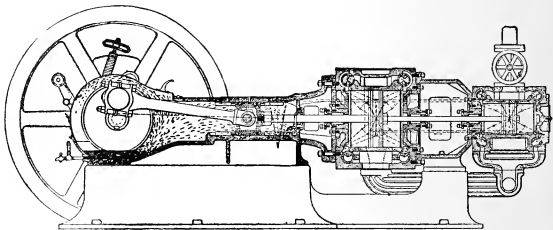
“ If the distance between *B* and *C* is just three inches you will know that the valve is all right. If, however, you wish to put in a new valve and adjust, then remove the steam-chest cover and place the engine on the center as follows: Place line marked *A*, which is on the crank pin side, with line on opposite side of rim marked *F* (not shown in drawing), level with engine; now take out, or loosen up the springs and block the weights out so that the distance between weights and pin at *D E* will be $\frac{3}{4}$ of an inch; adjust the valve-stem at the guide so that by turning the engine over

from one center to the other the lead will be the same at both ports; then make a new mark distinctly on the valve-rod, so that the distance $B C$ will be the standard three inches.

“It is not possible to reverse the direction of running without sending to the factory for new parts. The governor is not constructed so that one set of parts can be used for running both ways.”

THE CARE AND MANAGEMENT OF HARRISBURG ENGINES.

It is essential to the successful operation of any high-class and expensive machinery, that the person in charge be gifted with a fair degree of intelligence and alertness, and while I have attempted to formulate a few rules as a guide to the person in



Sectional Elevation of Harrisburg Standard Four-Valve
Tandem Compound Engine.

charge of an engine, the fact must not be overlooked that a great deal depends upon the skill and judgment of the operator himself, and that it is manifestly impossible to give rules other than of a general character and which may frequently have to be modified to suit the different conditions that may arise. However, the

following are some suggestions for the convenience of operating engineers: —

When engines of these styles have been properly erected, the steam, exhaust and drain connections completed, and the piston and valve rods packed, the operator should be careful to see that all parts are in proper position and firmly secured.

The bed should be thoroughly cleansed inside and a good quality of machine oil poured into the reservoir beneath the crank, until it is just in contact with the crank disc.

A mineral oil only should be used, and of medium viscosity. Fill the eccentric lubricating cup and flush the main bearings with the oil.

The cylinder lubricator should be filled with a first-class quality of cylinder oil, of heavy body.

The best oils obtainable are the most economical, without question.

Careful preparations before starting engine. — The cylinder and steam chest drain valve should now be opened, and the throttle valve carefully started just enough to allow a small quantity of steam to flow through the cylinder and out through the drain pipes, but not enough to actually start the engine in motion.

After the cylinder and valves have been thoroughly heated and any water standing in the steam pipes thus blown off, start the oil flowing in the cylinder lubricator cup. A general survey of the engine should now be taken and if everything is found to be in proper condition, carefully open the throttle valve and bring the engine gradually up to speed, when it should be noted that the governor is controlling the machine. Examine the bearings and eccentric to see if the oil is flowing properly, and make sure that every part is operating smoothly, after which the drain valves may be closed.

Adjustments for wear. — When the engine has been in opera-

tion long enough to necessitate the adjustment of the working parts, care should be used to avoid adjusting them so close as to cause heating, and the following general rules should be observed: —

The caps on the main bearings should always have sufficient liners underneath to enable the nuts on the bearing studs to draw the cap down solidly upon them and not pinch the shaft, which should be free to revolve in its bearings without unnecessary play.

Adjustment of crank-end connecting rod. — In adjusting the connecting-rod box at the crank pin end the same general rules should be observed regarding the liners under the cap, the large nuts drawn solidly upon it, the small nuts firmly jammed, and the cotter pins placed in position.

The adjustment of the box should then be tested with a lever about 12 inches in length, the adjustment being so made that with a lever of this length the operator can easily move the end of the connecting rod sufficiently to take up the side play between the flanges on the crank pin and the ends of the box. The adjustment should never be made so close that this side movement cannot be observed.

Adjustment of cross-head pin box. — The adjustment of the connecting-rod box at the cross-head pin end should be made by removing the name plate from the engine frame and placing the crank on the center nearest the cylinder, then with the wrench provided for that purpose, slack off both wedge screws at the upper and lower sides of the connecting rod, and draw the wedge up until it is solid against the box, then slack off that screw about a sixth of a turn and draw up the other so as to firmly lock the wedge; this method prevents the box from pinching the cross-head pin.

The "flats" on the cross-head pin should always be at the top and bottom to avoid wearing a shoulder, and the nut on the end should be drawn up firmly, but not so much as to spring the

bosses of the cross-head together, nor yet enough to make the box tight on the ends.

I prefer adjustment of the cross-head in the guides made by liners of paper or tin, placed between the bronze shoes and the body of the cross-head.

Adjustment of cross-head shoes. — In order to do this it is necessary to remove the pin and the end of the connecting rod from the cross-head, and with a wooden lever placed in the pin hole turn the cross-head until the shoes are out of the guides, then remove the shoes and place the liners beneath them. Care should be used that the cross-head does not fit the guides too closely, and that it can be moved freely with a short lever from one end of the guides to the other, while disconnected from the connecting-rod.

The cross-head should never be run very close and should always be free enough to allow long and continuous runs without causing the top of the bed over the guides to feel uncomfortably warm to the touch.

Attachment of cross-head to piston rod. — When making any adjustments of the cross-head, it is well for the operator to assure himself that the lock nut, which prevents the piston rod from turning in the boss at the end of the cross-head, is securely in place. All but the largest Harrisburg engines are tested under steam before leaving the works, and the valves set with the indicator.

The distance from the cylinder head end of the valve, when the crank is on the center nearest the cylinder, is marked on the end of the cylinder directly underneath the steam chest cover. If from any cause the valve should become deranged, place the crank on the center described and with a scale or rule, see that the valve position corresponds to the dimension marked on the end of the cylinder; and if out of position, it can easily be re-adjusted by means of the device provided for that purpose, at the outer end of the valve stem.

On the Harrisburg Ideal Engines, where the ball joint connection is used between the valve stem and the eccentric rod, the wear is followed up by filing the end of the bronze connection that the cap is screwed against, which holds the ball in place. And on the Harrisburg Standard Engines, where the ram box connection is used, the adjustment is made by filing the half of the bronze box, which is attached to the end of the eccentric rod that connects with the ram.

Adjustment of eccentric strap.—The eccentric strap adjustment is made by liners placed between the halves of the strap and double nutted bolts. When adjustment is necessary, the other end of the eccentric rod should be disconnected and after drawing up the strap bolts it should be tested by giving the strap a half revolution about the eccentric. If it is found that the friction between the strap and eccentric is sufficient to support the weight of the rod, the bolts should be loosened until the strap moves freely without lost motion. The double nuts should then be locked and the cotter-pins replaced in the ends of the bolts.

How to alter engine speed.—The governor used on all Harrisburg Engines is the Centrally Balanced Centrifugal Inertia Type. A few words of explanation may be of service to operating engineers.

The weight arms are constructed with differential weight pockets, to allow of a considerable range of speed adjustment without altering the tension of the springs. If an increase in speed is desired, remove weights of an equal thickness from the weight pockets of the levers, and add weights of an equal thickness to obtain a decrease in speed. If an increased speed causes the governor to “race” or “weave,” move the clamp in the clot, to which the outer end of the spring is attached, farther from the small end of the weight lever. If this does not entirely correct this sensitive condition, screw the plug into the spring until the racing ceases. If the decrease of speed so obtained renders the governor too sluggish in action, move the clamp in the

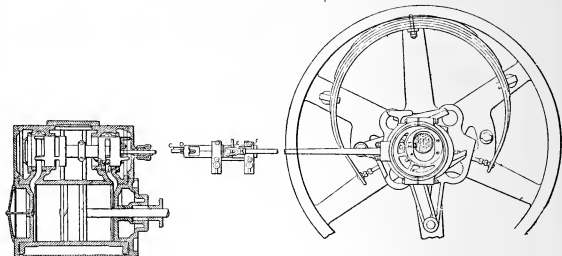
slot in the opposite direction. If this does not improve the regulation, and the speed is lower than desired, add weights of an even thickness, increasing the spring tension until the proper speed is obtained. The main lever bearings which are equipped with anti-friction steel rollers, should be oiled about once a week, and taken out and cleaned about once a month; the other joints fitted with compression grease cups, should be treated in the same manner. About once a month, also, the springs should be disconnected and the governor and valve gear tested by hand, to make sure all joints are working freely.

The foregoing will apply also to the Harrisburg Standard and Ideal Compound Engines, and, in general, to the Harrisburg Self-Oiling Four Valve Engines. Adjustment for wear in the valve gear connection of the latter type of engines is obtained by filing the halves of the bronze boxes on the ends of the rods connecting the valves with the wrist plates and rocker arms, and on the wrist plate and rocker arm pins, by means of bronze shoes let into the sides of the bearings, the wear being followed up by the screws provided with lock-nuts, and all bearings lubricated by means of compression grease cups. The Harrisburg Corliss Engines, of the larger sizes, are provided with quarter boxes in the main bearings with wedge and screw adjustment, and are built self-oiling or otherwise, according to size. The lubrication of the principal bearings is accomplished by means of oil cups, and the valve-gear connections by means of conveniently arranged grease cups.

MCINTOSH AND SEYMOUR HIGH SPEED ENGINE.

How to set the valve. — When the engine is sent out from the shop, the valves are set and trammed with three inch tram from the valve-rod to the valve-rod slide at *C D*, and from the eccentric rod to the eccentric rod head at *E F*, on the valve-slide end, and a tram is furnished with the engine, or a new tram can be made with exactly three inches distance between the points, which will suffice.

In case the tram marks become lost, or, owing to wear of the valve gear, the length of connection is altered, the proper procedure is to put the engine on one center, and then on the



A Sectional Cut of McIntosh and Seymour High-Speed Engine, Showing Valve and Governor.

other, and observe the leads which occur when the governor is in the normal position of rest, as shown. The lead on the crank end should be three times as much as the lead on the head end, if the connection between the valve and eccentric is of proper length.

When the valve is set this way, the cut-off on the two ends of the cylinder will be approximately equal at one-quarter cut-off on the smaller size engines having inside governors.

Preliminary to adjusting connections between the valve and eccentric, care should be taken that the mark on eccentric *G H*, corresponds to the mark on the pendulum.

In examining the steam leads, as described above, it should be noted that the surface *B* on the valve has nothing to do with the steam distribution, but it is merely to give ample wearing surface, and that the steam is admitted to the cylinder through the part which is between *B* and the steam edge which is at *A*, and the lead should be measured between this steam edge and the

edge of the port leading to the cylinder. On engines of larger size having outside governors, a similar method should be employed in setting the valves, except that the trams are four inches from point to point, and should be used between the valve-rod slide and valve-rod, and the eccentric rod and the eccentric rod head at governor end, instead of slide end, as above.

INSTRUCTIONS FOR STARTING AND OPERATING IDEAL ENGINES.

Before starting engine. — Open cylinder cocks and throttle valves sufficiently to warm the cylinder and valve. Place sufficient oil in the basin under the crank so it will stand one inch above the bottom of crank discs. When receiving a new engine from the shops with visible stuffing-box and water drain, before you fill the crank case with oil, previous to starting, pour water in opening

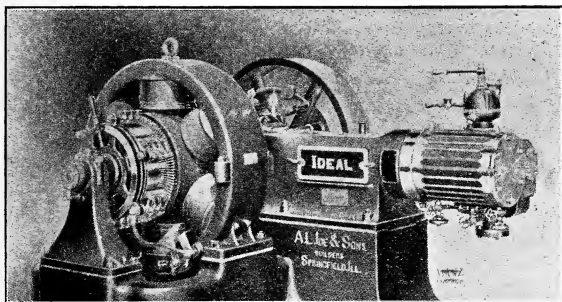


Fig. 1.

in frame into pocket under piston rod stuffing-box, until water overflows through trap connected therewith attached to outside of frame. Fill cylinder lubricator and start it to feeding. Fill oil

pump, and pour engine oil into pocket on main bearings. Fill eccentric oiler and start it feeding. After the steam chest and cylinder are warm, turn the engine over by hand to see that all is free and right to start.

Open the throttle valve gradually, *start engine slowly*. After the engine is up to speed, pump five or six strokes of oil into cylinder with oil pump. The oil should flow in streams through both pipes on the crank cover into the pockets of the main shaft bearings.

This oil passes from the main bearings through the crank pin and is distributed over cross-head pin and slides. Occasionally clean out the oil passages in crank pin.

Supply, as needed, a little fresh oil to the basin, and if the oil in the engine bed becomes thick, gritty or dirty, so as not to flow freely through oil passages, draw it off and replace with fresh oil. Filter the old oil and use it over continuously. Use a pure mineral oil that will not thicken by the churning it receives.

Serious damage and cutting of the cylinder and valve will result from allowing the lubricator to cease feeding, even for a few minutes. If your engine is a new one from the shops, feed plenty of oil through the lubricator and oil pump for the first few weeks after starting. Use one drop of oil per minute for each ten horse-power, or ten drops per minute for 100 horse-power engine, for the first thirty days; after which, one-half this amount will be sufficient, if the oil is of good quality. If your boiler is priming or foaming, use double the quantity of oil to protect the cylinder and piston from cutting. A little graphite fed into cylinder is very beneficial.

The governor. — Fill the cups on governor bearing with grease and give the cap $\frac{1}{4}$ turn every day. Screw the cap to the stuffing-box on dash pot loosely, only using your hand to turn the cap. The governor should be taken apart every two or three months and bearings cleaned with coal oil to remove gum. If governor

has a dash pot, it should be refilled with glycerine once or twice a year. Oil may be used in the dash pot in place of glycerine, unless the engine is in a cold room where the oil is liable to congeal. To refill dash pot, unscrew cover on end.

In taking the governor apart, allow the sliding block which holds the end of the governor spring to remain with its outer edge on a line with a mark across the face of the slide, and in re-adjusting the spring, place the same tension on it as before, which can be ascertained by measuring the length of the thread through the nuts before slacking up the spring. If you have trouble with springs breaking it is because you are working them under too much tension. The speed of the governor is changed by moving the weight on the lever.

To increase the speed of the engine, move the weight on the governor lever near to the fulcrum pin. To reduce the speed, move the weight out toward the end of the lever. Tightening the spring will also increase the speed, but will cause the engine to "race," unless at the same time the block which holds the end of the spring, is moved toward the center of the wheel. The proper way to change the speed is by moving the weight, allowing the spring to remain in its marked position.

Moving the block, which holds the spring, towards the rim of the wheel, will make the governor more sensitive and regulate more closely; but if moved too far, this will cause the governor to "race." Moving the block towards the hub of the wheel has a tendency to stop the "racing," but if moved too far the speed of the engine will be reduced with the increased load. If any of the bearings of the governor bind, or require oiling or cleaning, the governor will "race." These bearings should be kept clean and in good condition and the stuffing-box to the dash pot must not be screwed up tight, as that will cause the governor to "race" when set for close regulation.

The face of the slide is marked with a line where the outer

edge of block which holds the spring should be. Figures stamped on the face of the slide, give length of end of eye-bolt extending through nuts. This gives the right tension to the spring. Tightening the spring will give closer regulation, but will cause the governor to "race" if the spring is too tight. "Racing" caused by over-tension of spring, can be stopped by moving block nearer to center of wheel.

To set valve. — Should you wish to ascertain if the steam valve is properly set, proceed as follows: Take off the cover or elbow on outer end of steam chest, so you can have access to end of valve. Turn the engine over until the engine has traveled as far as it will go towards end of steam chest. Then measure from the end of steam chest to the end of the valve, and this distance should be represented by the figures in inches and fractions on end of steam chest. If measurements do not agree, set valve by screwing the valve stem at the ball joint.

Square, braided flax packing is the best kind for piston rod and valve stem. Don't screw the glands up tight; allow them to leak a little. The valve stem has only exhaust steam — don't pack it tight. Screw it up by hand only. Screwing the piston rod gland up tight may cause the piston to thump or pound the cylinder, and heat and cut the piston rod.

Safety caps. — The safety caps attached to drip valve under the cylinder are intended to break, in order to save damage to the engine if water enters cylinder. They will protect the engine from breaking if the amount of water is not too large to pass through the valves and pipes. If they break, they have accomplished their purpose and new ones should be attached.

Eccentric. — Take up lost motion by reducing the brass liners between the lugs on eccentric strap, and unscrew and disconnect the ball joint on the eccentric rod to see that the eccentric strap will turn freely on the eccentric. If a close fit it will heat, cut, seize and break the eccentric rod or valve stem. Allow

the eccentric strap to run loose; no harm if it knocks a little. It will not wear out of round on account of running loose; it is dangerous to run with the strap snug.

Ball joint.—Take up lost motion in the ball joint, on the valve stem, by unscrewing the joint at eccentric rod and turning or filing off the face of the brass part attached to the valve stem, so as to allow the male part to screw in a greater distance.

Connecting rod.—Take up the lost motion on the crank pin bearing by removing the cap and taking out two of the steel liners; take one from each side, put the cap back and set the nuts up snug. Disconnect the cross-head end of the rod by removing cross-head pin, and try lifting the rod up and down to see that it does not pinch the crank pin. If it pinches the pin when the bolts are drawn up snug, place the liners back or substitute thinner ones. Always screw the cap back solid on the liners, and keep in sufficient liners so the cap will not pinch the pin when the bolts are screwed down snug. NEVER RUN THE ENGINE WITHOUT HAVING THE CAP SCREWED UP SOLID AGAINST THE ROD, with liners between if needed, to make the proper fit. If you remove some of the liners be sure to take out an equal amount from each side, for if you take out more on one side you are liable to throw the cap at an angle in tightening up the bolts, which, in time, will cause the bolt to break and is liable to wreck the engine.

The brass in the cross-head end of the connecting rod is set up by a wedge. This wedge is drawn down by the steel bolt until the brass is forced solid against the shoulders in the end of the connecting rod, which prevents any movement of the brass. The upper bolt is used to lock the wedge in position; also in withdrawing the wedge when the brass is to be removed.

To take up lost motion in the cross-head end of the connecting rod, remove the brass and file an equal amount, even and square, from each edge of the brass, so as to allow the brass part to come up to the pin. When filing the brass, try the pin in the rod

and do not file enough to allow the brass to pinch the pin when the wedge is screwed *down solid*. If, by mistake, too much is filed off, put in a sheet of copper or sheet brass liner, so the wedge may be drawn snug without pinching the pin.

Cross-head. — For adjusting the lower cross-head slide, take out the cross-pin, turn cross-head $\frac{1}{4}$ round with the lower brass slipper opposite opening in engine frame; loosen nuts and insert paper or thin metal strips between cross-head and slipper. The top slide will never require adjustment. The lower slide should run five years before requiring lining or adjustment. Turn the cross-head pin $\frac{1}{4}$ way around every three months. This will prevent it wearing out of round.

Main bearings. — To take up lost motion in the main shaft bearings, remove the cap and file, scrape or plane an equal amount from each of the babbitt metal liners or strips which are in the main bearings under the inside edge of the cap. Remove the metal evenly, so the liners will remain of equal thickness at each end. Do not remove enough from the liners to allow the cap to pinch the shaft when the nuts are screwed down snug. If, by mistake, too much metal is removed, put in paper strips on top of the liners so the cap can be screwed down solid without pinching the shaft. You can tell when the cap pinches the shaft by turning the engine over by hand; it will not turn freely when the cap is too tight. With proper care the main bearings will run two years before requiring adjustment. NONE OF THE BEARINGS OF THE ENGINE SHOULD BE SO TIGHT AS TO PREVENT TURNING THE ENGINE FREELY OVER BY HAND. Always test the engine in this manner after adjusting bearings.

If a bearing heats, stop the engine immediately, take out shaft or box, clean out the cuttings, scrape smooth, clean out oil passages and run bearings loose.

Heating or cutting *will never* occur if liners are put in so caps cannot be set up to pinch the bearings and they receive proper

lubrication with oil free from grit or dirt. After adjusting any of the bearings, run the engine for a few minutes; then stop the engine and feel the bearings which have been adjusted to see if they are running cool. This precaution may obviate having to shut down your engine while performing regular duty.

Do not allow your engine to run with bearings so loose as to thump or pound, as this will cause the bearings to wear out of round. If the shaft or wheels run out of true or wobble, it is because the main bearings are loose and should be taken up. The engine will run smooth and noiseless if bearings are properly adjusted.

THE STEAM CHEST.

Fig. 2 shows a section through cylinder and valve. The steam chest is bored out and fitted with a pair of cylinders or bushings,

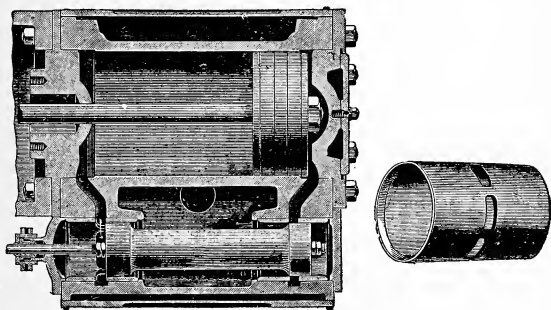


Fig. 2.

which have supporting bars across the parts, to prevent any possibility of the valve catching upon the parts.

The valve is of the hollow piston type — a hollow tube with a piston at each end. The live steam is entirely upon the outside

of this piston, pressing equally on each end ; the exhaust steam is entirely on the inside of the piston, so the valve is perfectly bal-

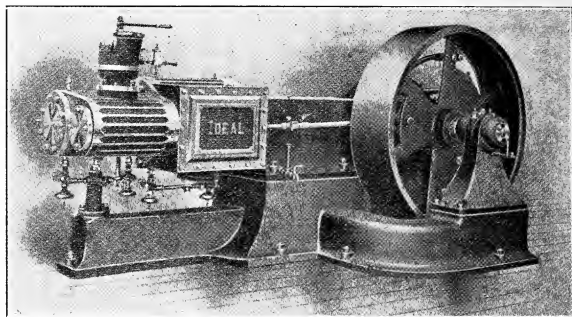


Fig. 3 is a Tandem Compound.

anced and can easily be moved by hand when under full boiler pressure.

Fig. 4 is a cross-section of cylinder and valve of the Tandem Compound engine. The cylinders of the Ideal Compound engine in Fig. 4, the stuffing-box between the two cylinders, is dispensed with entirely. It is replaced by a long sleeve of anti-friction metal. This sleeve is light and free to adjust itself central with the rod. Grooves are turned on the inner surface, so as to form a water packing.

Both valves of engine are controlled by the same governor on the same stem, moving together and varying in stroke as the load and steam pressure vary. This gives the advantage of automatic cut-off in both cylinders and dispenses with the complication of double eccentrics, rock arms, slides and stuffing-boxes.

The high-pressure cylinder has a piston valve, same as used in all ideal engines. For the low-pressure valve in order to bring it

into line with the high-pressure valve and keep clearance spaces at minimum, which thus gives a quick and wide opening at the beginning of the stroke, in order to reduce the pressure on exhaust end of high-pressure piston.

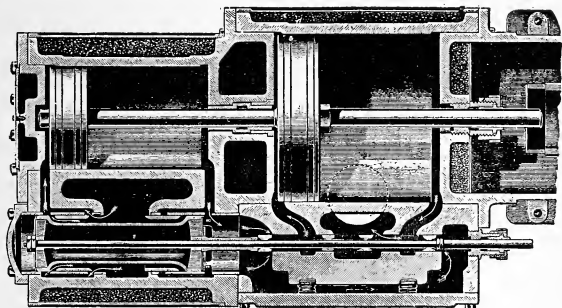


Fig. 4.

The cover of this valve is held in place by springs and will lift and prevent excessive pressure in the cylinder from water or other causes.

FOR INDICATING IDEAL ENGINES.

The illustration (page 292) shows the reducing motion attached to engine ready for taking indicator cards.

To apply the Ideal Indicator Rig: Screw slotted stud in cross-head pin, first removing the cap screw. Set the slot perpendicular to line of motion of cross-head. Set cross-head exactly in center of its travel. Fasten on top of bed where oil funnel is placed, first removing the oil funnel.

Lever should be adjusted so it will travel in slot without strik-

ing bottom, or passing out at top. Make sure that lever will travel freely in slot without binding. Select a hole on string carrier that will give the necessary motion to indicator drum.

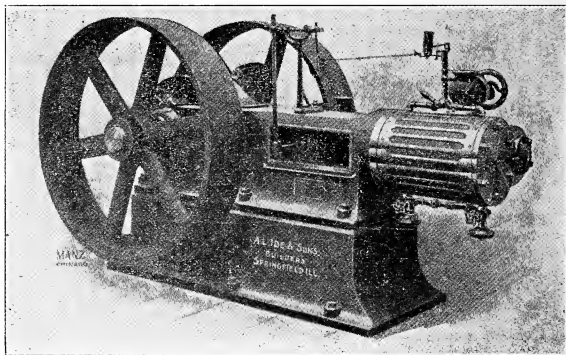


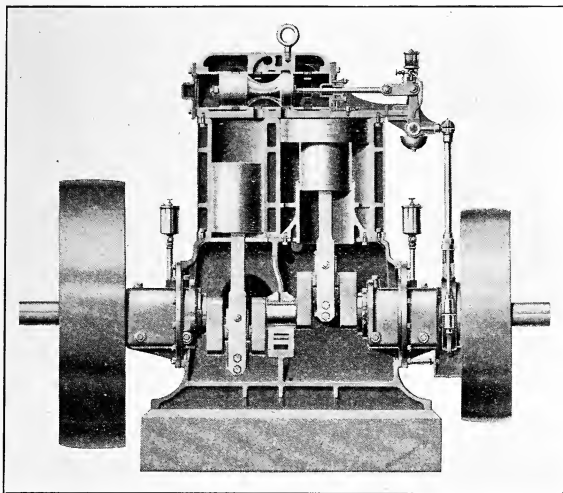
Fig. 5.

With string attached from indicator through hole, so adjust this carrier that lines drawn on polished surface shall come exactly parallel with string. Make all adjustments while cross-head is in center of its travel.

POINTS ON STARTING AND RUNNING A WESTINGHOUSE COMPOUND ENGINE.

In the compound engine, the automatic governor is located on the shaft inside an inclosed case filled with oil, which forms the center of one band wheel. Its action varies the travel of the valve in accordance with the amount of work demanded of the engine. The other end of the shaft carries an ordinary band-wheel, or combination pulley, of any required diameter and

face. Set up the engine as directed, keeping the combination pulley, or band-wheel, as close to the engine as possible. Work the wheel on by turning it around while the shaft is held stationary. Do not attempt to drive it on.



The above is a cut of the Westinghouse Compound Engine.

In order to put on the governor case with its band-wheel, it will be necessary to first remove the lid or cover of the case, so as to get at the set screws and keyway. It is to be put on carefully and should not be driven on hard enough to in any way injure the shaft. The keys are to be carefully fitted to their places, and this should be done by a competent mechanic. It is not possible, in every case, for the wheels to be put on the engine to

which they belong and keys fitted in their proper places, for various reasons; therefore, the keys are left as they come from the planer, a trifle full of the required size, so that a little filing will bring them to a good fit. If the keys are not fitted in well and carefully at the start, they may become the cause of a great deal of subsequent trouble; but if this be well done at the beginning, there will be no trouble afterwards. It is the practice of some to tie a tag to each key, designating which one is intended for the governor case wheel and for the band wheel. It is important they should not be put in the wrong places. If the band wheel key should be a trifle too long, no harm will result; but if the governor case key be too long, it will protrude through the case and bind the eccentric so that the latter will not have free movement across the shaft, and this will seriously affect the regulation of the engine. The key in the governor case should be from $\frac{1}{4}$ " to $\frac{1}{2}$ " shorter than the hub in the governor case, to prevent this possibility. When the keys are well fitted they should be driven home with a degree of tightness depending on the size of the engine, and the set screws should be pulled down hard and fast to hold them. The keys are not intended to fit top and bottom, but must fit exactly sideways.

After the governor case with its wheel is properly located on the shaft, the key fitted and set screws pulled down hard and fast, the governor case lid is to be put on, having a paper gasket, both on its outer edge and at the hub, to prevent leakage of oil past these surfaces; and it is to be bolted up tightly in its place, and the governor case completely filled with cylinder or Dalzell crank-case oil, through a connection provided for this purpose.

Turn the engine over by hand to make sure that everything is free. Before starting the engine for the first time, oil both pistons thoroughly by taking off the relief valves and pouring oil into the ports. This oil will work through the valve and oil it also. Swing aside the bonnets from the crank case, and see that the

latter is clean and free from the cinders and dust of travel, which generally find their way into the interior. When found to be perfectly clean, supply oil and water according to the following directions: Pour in water until it makes its appearance at the outlet of the overflow cup; then pour in one gallon of Westinghouse crank-case oil for every 10 H. P. of the rating of the engine for the smaller compounds, and about half this amount for the larger ones. This will raise the water and oil in the interior to such a level as to almost touch the crank-shaft, so that the connecting rods will be plunged into the liquid at every revolution. Take off the eccentric strap, clean it thoroughly, also clean the hollow eccentric rod, then oil and replace it. Be liberal in the use of oil all over the engine, at least for the first few days. Remember that there are two large cylinders and a valve to be lubricated and that the low-pressure cylinder gets its oil only through the high-pressure cylinder. The engine should now be ready to start. Fill the automatic lubricator on the steam pipe with good cylinder oil; fill the side oil cups over the main bearing with Westinghouse crank-case oil, and open the drip-cocks over each main bearing, so that the drip is continuous and regular at the rate of about 2 to 10 drops per minute from each cup, according to the size of the engine. If undue service is required of the engine, so that the main bearings show signs of heating, the amount should be increased. Start the automatic lubricator; give the eccentric strap some direct lubrication from a squirt can, and start the cup over the rocker arm to feeding from each cock.

To start the engine. — the throttle valve being closed, open the drain cocks in the throttle-valve and steam and exhaust pipes, blow them out thoroughly and then close them. Open both cylinder drain cocks; raise the check valve on the crank case by setting the handle down; open the by-pass valve. Turn the engine round until the high-pressure piston is on the upper center. Now, open the throttle-valve slightly, for the purpose of warming up the

steam-chest and valve equally, as otherwise the valve, by heating quickest, may expand and bind. The engine being on its center will not start. When sufficiently warmed up, say in three minutes by your watch, close the throttle valve for an instant and bar the engine off the center. Then open the throttle-valve quickly, but not too far, which will insure the engine passing the first center. As soon as the engine is up to speed, close the by-pass valve tight and keep it closed thereafter. When the water is thoroughly worked out of both cylinders, close the cylinder cocks and keep them closed, and at the same time, close the check valve and open main throttle-valve gradually until it is wide open. Never attempt to regulate the speed of the engine by the throttle-valve.

In stopping the engine, open the cylinder cocks, check valves and by-pass valve and close the throttle slowly, so as to allow the engine to lose speed by degrees. Do not stop suddenly, as the momentum of the pistons and fly-wheels, at standard speed, is great, and the strain thrown on the connecting rods and crank-shaft, in being suddenly stopped, is unnecessary and may, in time, become injurious.

In general, it is well to run a new engine empty (that is with no belts on) in order to be certain that everything is right; then, if the performance is all right, the belts can be thrown on.

With a compound engine properly adapted to its work, not overloaded, and running under proper conditions, the duty of the engineer may be said to be merely nominal. Nevertheless, this engine, when it requires the attention of an engineer, needs the proper kind of attention. One competent man can operate a very large number of these engines. What is meant in this connection by the terms "properly adapted" and "proper conditions," is: a load corresponding to a mean effective pressure in the high-pressure cylinder not exceeding one-half of the boiler pressure; a boiler pressure as high as possible, the engine erected

in compliance with the directions given, and the directions as to lubrication followed carefully.

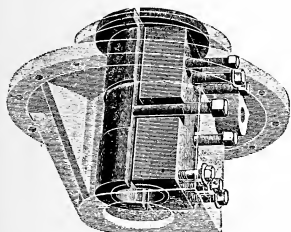
The wear is constant in one direction, namely, downward. The steam acts only on the upper side of the pistons. The two crank-pins are exactly opposite each other. Each piston in its downward stroke raises the other piston. The direction of the wear on all the bearings being downward, the lost motion may be considerable without detriment to the quiet running of the engine. In starting and stopping the engine, however, the accumulated lost motion will cause a noise, inasmuch as this motion is taken up at each revolution; the greater the amount of lost motion, the greater this noise will be in starting and stopping. The cause of this is apparent; the crank, while the engine is stopping, must pull the piston down and the effect of lost motion then becomes similar to that in a double-acting engine. The effect of this action is not conducive to good wear or long service. It allows a shock to come on the connecting rod strap with considerable force; this wear, therefore, should be taken up frequently, but it can be allowed to accumulate to a greater degree than will be possible in any double-acting engine. The wear is taken up on both ends of the connecting rod at once, by the upper bolt at the lower end. The engineer on opening the crank case will see a bolt with a squared end and a lock nut; with the large end of the socket-wrench, he will slack off the lock nut, and then with the small end of the wrench he will turn the bolt to the left until the brasses come up solid; then slack off half a turn and set up the lock nut. The construction of the rod and the way in which a single wedge is made to take up both ends of the rod at once, is evident from the cut. The piston wrist-pins, if worn or cut, should never be dressed off or turned down, as they will not fit the bushing or have a proper bearing. Order a new pair, and throw the old ones away. When the babbitt is about worn out of the main bearing shells, they can be

re-babbitted and put back again. The cylinder packing rings will, after much wear, become unfit for service, and will allow steam to blow past the pistons into the crank-chamber. There will be at all times, when the engine is running loaded, a small amount of vapor arising in the crank-case. This does not necessarily indicate that there is a leakage of steam past the pistons, as the heat generated by the splashing of the water on the hot pistons and cylinders, and by the leakage of the hot water of condensation past the pistons, will heat up the water contained in the crank-case, until it vaporizes slightly. New packing rings can be easily sprung into place by the engineer.

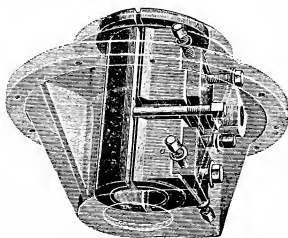
The principal duties of the engineer will be to see that the automatic lubricator, which oils the cylinders and valve and the oil cup over the rocker arm, perform their work properly and regularly. Feed slowly, drop by drop, according to the requirements of the engine. The engineer must also see that the oil tanks on the sides of the engine are supplied with oil and fed slowly, drop by drop, into each main bearing.

The inclosed construction of the engine, whereby all oil used in lubrication is completely distributed on the wearing surfaces and is prevented from wasting, renders it unnecessary for the engineer to pay as close attention to this engine as to any other, as it, in a sense, lubricates itself. The crank-case bonnets should be removed regularly, preferably every morning, as it is the work of only a few minutes. The interior of the engine should be examined to make sure that no nuts or bolts (of which there are the fewest possible number) have worked loose, bushings worn out, or lost motion become unduly great; this internal examination is absolutely imperative, at least, once a week. The proper drainage of water in the steam pipes should demand his attention, to prevent any entrainment, resulting from the foaming of the boilers or from any other cause. Entrained water is always a prolific source of trouble in steam engineering; it is particularly

troublesome in all piston valve engines, even with Westinghouse engines, which are provided with water relief valves. The engineer should become thoroughly acquainted with his engine so as to understand its operation and principle, and be at all times familiar with its precise condition. All adjustments being made in the shop before shipment, it is unnecessary for the engineer to set any valves or take any part in the adjustment of a new engine; but as wear occurs, he must be able to intelligently make the needful adjustments of wearing parts. After an engine has run a long time, the downward wearing of the reciprocating parts will have the effect of throwing the valve slightly out of adjustment. That is to say, it will draw the valve gear downward with the shaft, and favor one cylinder more than the other. The valve, therefore, will require resetting occasionally, but not at all frequently. It should be adjusted by lengthening the eccentric rod, just the amount to which the shaft is worn downwards.



MAIN BEARING.



MAIN BEARING.

The main shaft bearings are now made adjustable. There is a slight difference of construction here in the various sizes, occasioned by limited space in the castings; but they are all alike in this respect, that the bottom half of the main bearing is stationary, being turned off on its outer shell eccentric with the shaft journal and held down firmly by a long set screw on each

side, which prevents it from rotating or from rattling loose. The top half of the main bearing is adjustable downwards, so as to follow up any wear either of the babbitted bearing or of the shaft. In the 8 and 13 x 8 and 9 and 15 x 9 engines, this top half of main bearing is adjusted downwards by three set screws located at the apexes of a triangle, and the bearing is locked firmly by three tap bolts oppositely placed so as to hold it secure after adjustment. In the case of all larger sizes of compound engines, the downward adjustment is made by wedges bearing on the inclined tops of the upper half of the bearing. These wedges are moved and locked by a tap bolt in each end, which passes through and draws against the shell of the crank-case head. The top half of main bearing is drawn up and locked in position after adjustment by tap bolts which pass down through the top shell and are screwed into the bearing. Some of these bolts and wedge screws are inside of the crank-case, and adjustment must, therefore, be made while the engine is standing idle. It is customary to mark with an arrow head on the outside of the crank-case head to indicate which way the wedge will move to tighten up.

The proper condition of the compound engine, while performing its work, is one of perfect quiet, without leaks of steam past any joint and without noise. Any noise in the engine, after it has attained full speed, may be immediately accepted as an indication that something is wrong and the engineer should familiarize himself with it, so as to be able to discover the cause and the remedy. Hot bearings may be said to be unknown in this engine; occasionally, however, they have been met with but they are always traceable to the use of improper oil; dirt and grit in the oil; the filling up of oil grooves, or the wearing out of the oil grooves in the main bearing shells; or to worn out or broken packing rings in the piston. The eccentric strap is the only point liable to run dry, and the engineer should see that the oil cup feeds with certainty. All joints in the governor are bushed and

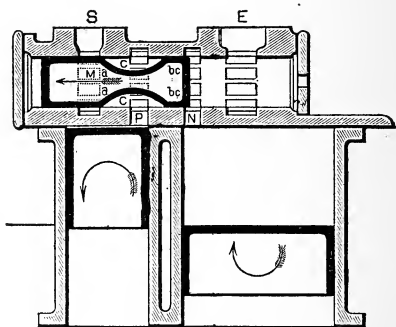
these bushings are provided with sufficient oil holes; they can readily be replaced with new ones when necessary. In replacing bushings, always be careful to provide ample oil-holes, the same as were in the old removed bushings, and observe the same precaution in the case of other repairs.

As above stated, it is the duty of an engineer to know in what condition every part of his engine is at all times. All wearing parts should be examined from time to time, so they can be replaced before they are entirely worn out and damage is done. It is too late to find out that a bushing needs replacing after it has been worn entirely through and the pin has cut into the solid metal. While the engine is built of the very best materials and with the greatest care, and while the means and the opportunity for lubrication are the best known, yet it is not claimed that it possesses any miraculous virtues by which it will run on forever without any attention and without repairs. Nowhere is the old proverb more forcibly demonstrated than in the case of machinery, that "A stitch in time saves nine." The wearing parts of the engine are few, are easily reached and placed, and the engineer who waits until some accident happens to announce that he has long neglected the proper inspection of the part which could, at the proper time, have been replaced at a trifling cost, is not worthy of being placed in charge of any machine more complicated than a wheel-barrow. The same principle will apply with equal force to machinery of every type. There is a proper time to replace worn parts and a time it is too late to replace them.

HOW TO SET THE MAIN VALVE.

The only exact and final setting of the valve is by means of the indicator. As the valves are permanently set and all adjustments made before the engine is shipped, it is not supposed that

the engineer will have occasion to reset them. Should the necessity for setting the valves arise, however, the following method will be sufficiently accurate: Break joints and take off the throttle-valve. The steam ports in the bushing will then be seen through the steam connection *S*. (This opening is on the side in fact, but is here shown on the top for convenience.) Bring the high-pressure piston exactly to the top of its stroke by turning the shaft in the direction the engine runs. This may be ascertained



by either taking off the water relief valve and measuring through its port, or more conveniently, by bringing the middle of the keyway in the shaft exactly over the center of the shaft. The keyways are planed exactly with the cranks, so that the position of the keyway is the position of the high-pressure piston. With this piston at the top of its stroke, the valve edge *a a*, should show about $\frac{1}{16}$ of an inch port or lead, and be moving towards the right as you stand behind the engine. If out, it may be brought to position by screwing the valve-stem into or out of the valve which is tapped to receive it. Be sure and set the jam nut solid when through.

After a test of a compound engine has been completed with the indicator, and the valve has in this manner been accurately adjusted, marks are scored on the end of the rocker arm, at its junction with its supporting bracket, in order to show the extreme points of oscillation of the rocker arm. If, therefore, in starting up a new compound engine, the eccentric rod is too long or too short, these marks will not coincide when the engine is turned round by hand to examine this point. The eccentric rod must then be adjusted with the nuts provided for that purpose, until the scored lines on the rocker arm will coincide exactly. When this rod has thus been proven correct, the engine should then be put by hand on the dead center, with the high-pressure piston at the top of its stroke. In order to prove this upright position of the high-pressure piston exactly, two lines are scored on the faced-off end of the crank-box head on the high-pressure side, to which marks the keyway in the main shaft must be brought exactly. Then remove the back head from the steam chest and measure the distance from the rear end of main valve to the end of the steam chest, while the engine is in this position. This distance measured will be found stamped with steel figures on the finished face of the steam chest, underneath the back head. If the valve has not been disturbed, the measurement thus taken will agree with the figures. If it has been disturbed, the valve must be adjusted to correspond with the measurement.

ADJUSTMENT OF ECCENTRIC STRAP AND CONNECTING ROD.

Before starting the engine for the first time, the eccentric strap must be taken off and both the strap and eccentric carefully cleaned and lubricated with clean oil. The eccentric rod is hollow and might contain dirt or other injurious matter, and should be examined and thoroughly cleaned before putting on the engine. There must be a sufficient number of liners between the

joints of the strap, so that when the bolt is pulled up hard and tight the eccentric strap will still be free to run without binding. After the bolt has been tightened, take hold of the strap and shake it back and forth to be sure that it is free. If it binds in the least, it is certain to heat or cut either itself or the eccentric or probably both. When the upper ball joint on eccentric rod becomes worn it should be adjusted to take up the lost motion promptly.

As to the connecting rods, the lost motion should be simply taken up without binding. No possible good, but much harm, can come from too tight an adjustment.

GENERAL INSTRUCTIONS FOR HOME REPAIRING.

How to put in new bushings and cut the oil holes and grooves.— When new bushings are shipped to fill repair orders, they are turned to gauge so as to fit tightly in their respective places. A very careful mechanic may, by the use of a wooden block and hammer, be able to drive in bushings properly. The much safer course, however, is to use a bolt which passes through the bushing, and a nut and washer; by screwing up the nut and taking reasonable care, the bushing is thus drawn surely and gradually into place. After the bushing is in place, the oil grooves must then be cut into it with a half-round chisel and hammer. The oil-holes must then be drilled; these latter should be large and free; no harm can come from having them too large, but much trouble will result if they are too small. The oil should have very free access through these holes to the grooves. We have conducted a long series of experiments to determine what form or style of oil groove would produce the best lubrication, and consequently, the most satisfactory results in each bushing, and, therefore, urge that grooves be cut in new bushings in strict accordance with the grooves and oil holes as shown in the old

bushing which has been removed. This course is safer and better than to try experiments of your own.

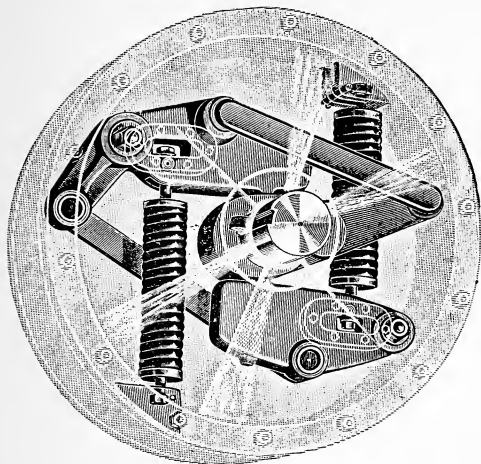
How to rebabbitt connecting rods. — Connecting rods may be re-babbitted at home, if preferred. You should provide yourself with a plug, preferably of cast-iron, turned to the exact diameter of the shaft or crank-pin and squared accurately on the end. A perfectly true surface is then required on which to lay the rod, so that the plug will stand in its proper position, exactly square with the rod. The original length of the rod must be known, and will be furnished by us on application, by stating the number of your engine. The center of the plug must then be placed at the proper distance from the center of the eye of the connecting-rod pin, and the babbitt metal poured into place. Moistened fire-clay will be found very convenient for confining the molten babbitt metal within its proper limits. After cooling, the babbitt metal should be dressed with chisel and file. Bear in mind that heavy service is required of these connecting rods, and that the engines run at higher speeds than is possible in any other type of engine, hence, nothing but first-class babbitt metal, or "genuine" babbitt metal, as it is called in the trade, will answer the purpose. I would, however, advise that the brasses be sent to the shop to be re-babbitt, and that duplicates be kept on hand, if necessary.

How to rebabbitt main bearing shells. — This is a very difficult piece of work to do at home, and it is not recommended that you attempt it; it cannot possibly be done accurately by any one without special appliances for the purpose. The lines of the babbitt, internally, when complete, must be exactly parallel with the outside lines of the shell, else the shaft cannot lie on its bearings with equal contact throughout the length of the shell. The lack of equal contact will cause the shaft to bind, and in all probability, the limited bearing surface will cause friction and heating. The only way in which main bearing shells can be properly rebabbitted at home, is to first provide yourself with what is called

a "jig," which is simply a special device that holds the main bearing shell and the central plug in their relative positions, exactly, while the babbitt metal is being poured. After cooling, the ends of the shell should be dressed and the oil-holes and grooves must be properly cut, exactly as they existed when the shell was new. A simple and more satisfactory method, would be for each owner of an engine to purchase an extra pair of main bearing shells; in this way, while one pair of shells is in use in the engine, the other pair may be sent in for rebabbiting, without the loss of time, and at trifling cost. Use nothing but first-class "genuine" babbitt metal in the main bearing shells.

How to repair worn or badly scored wrist-pins. — Instructions on this point are very simple: Don't! If, on examination, you find you have allowed the wrist-pins at the upper ends of the connecting rods to become worn, or even badly scored, it is recommended that, having bought a new pair of wrist-pins and rebabbitted the brasses, you immediately take out the old pins and throw them away. It is useless to attempt to repair worn wrist-pins. If you turn them down until they present a smooth exterior (as some have proudly announced they have done) the diameter of the pin is so reduced that it will not fit the brasses and the reduced bearing surface will soon destroy it. Or, if you attempt to use a badly scored wrist-pin in new brasses, it will cut them out so rapidly that it would be more economical in the end for you to buy new wrist-pins than to attempt to use the old ones. The service on the wrist-pin of any engine is extremely heavy. These pins are made with the best possible care, using the best selected materials, and after machining them they are ground in special machinery. The brasses are lined with the finest possible babbitt metal and should last a long time under heavy duty if properly lubricated; yet, the use of an improper oil in the crank-case — either volatile or gritty — nullifies all these precautions. Therefore, if you find on examina-

tion, that the wrist-pins in your engine have become badly worn or badly scored, I would urge you to throw them away and buy new ones.



Where the inclosed form of governor is used, the governor case is to be *filled completely full* of good cylinder oil, or with James Dalzell & Son., Ltd., Crank-case oil. Use nothing else. A nipple is screwed into the face of the inner case and extends through the first flange of the wheel in a radial direction. This nipple is closed by a cap. Turn the engine around till this nipple is on top and fill the case entirely full through the opening. The joint at the outer rim of the case, also the joint on face of hub, is made with a paper gasket. The oil is prevented from escaping along the spindle of the eccentric and out past the eccentric by a leather packing ring fitting around the spindle and between the

eccentric and the face of the case. If, after service, this should leak oil when the engine stands still, you must pack it tighter by putting in a thicker packer-ring of leather, so it shall be held tightly in its place and prevent the passage of oil. Be careful in locating the governor case on the shaft, so that the average position of the eccentric rod shall be vertical and that its extreme positions shall be alike on each side of a vertical line drawn through the center of eccentric. Be very careful as to the lubrication of the eccentric strap at the start. After it runs for a few weeks and gets a good surface, it will require little attention beyond regular oiling. When you start the engine, be sure to put plenty of oil on the eccentric direct, by hand.

The best means for lubricating the valve and pistons is an Automatic Sight Feed Lubricator, which is treated of elsewhere. It is manufactured in a variety of forms, many of which are very effective in their working. With a good cylinder oil, the number of drops per minute can be regulated so as to effect the greatest economy of oil and distribute it in such a way as to do the engine the greatest amount of good. Any other system of lubricating the cylinders is defective. It will not suffice to give the engine an hour's supply of oil at one dose and then allow it to run without any cylinder lubrication for the remainder of that hour. The construction of the Westinghouse engine is such as to be favorable to the economy of oil in this direction, because the pistons moving up and down in a vertical direction do not have the same tendency to wear as in the case of a horizontal engine, where the heavy piston-head drags back and forth. These immense bearing surfaces, moreover, reduce the amount of pressure per square inch to a minimum. The Automatic Lubricator is to be attached to the steam-pipe, within easy reach of the engineer, so that it can be refilled without loss of time. With each lubricator is packed specific directions for starting and operating it, which should be followed carefully. It may

be well to note here that, in order to get the best results and avoid trouble, no other than a first-class cylinder oil should be used in the cylinders. Approximately, one pint of cylinder oil per day for every fifty horse-power, and proportional, will be required for engines, depending on the amount of work to be done. The lubricator furnished on each engine will serve as a partial index of the quantity of oil required. These cups are not intended to hold over 8 to 10 hours' supply in any case. Feed regularly and slowly. The use of Valvoline, or 600 W. Vacuum Cylinder Oil, made by the Vacuum Oil Co., Rochester, N. Y., is recommended, although there are others who make a first-class article.

SOME POINTS ON CYLINDER LUBRICATION.

“In the first place, use the best automatic feed cup that can be secured. Don't be satisfied with the old-fashioned direct feed, or a cheap automatic. A good cup will save many a hundred per cent on its cost in a year. Don't get the kind which, on account of its peculiarity of feed, is adapted for a light oil only; you will then be shut out from using a dark oil, which may be far more serviceable and economical in every respect. Get a cup where the drop of oil cuts off square and passes either down or up through a glass tube into the steam pipe. This kind will feed oil perfectly; if yours is not this kind, it will pay you to change it.”

“Take good care of your cup. Don't let it leak around the glass tubes or other joints, for if it does the water will escape as it condenses, and the oil will clog up the escape pipe and stop feeding. Use in it only the best grades of cylinder oil, made by large manufacturers of established reputation. Don't run in your cylinders any kind of poor stuff that may be offered, because it is cheap; it is a dangerous experiment. Feed a good

oil sparingly — don't drench the cylinder. Too much oil is as bad as water in the cylinder. Engineers have been known to run a couple of quarts per day of cheap oil into an ordinary sized cylinder, and thought they were doing just right; this is positive abuse of an engine. In almost all cases where too much oil is fed,— cut it down. Two to four drops per minute on engines from 50 to 150 H. P. are all that is necessary, if the oil is good. Just enough to do the work and no more, will afford best results. As long as the valve stem does not cause trouble, you may know the valves are working smoothly and that you are giving oil enough.

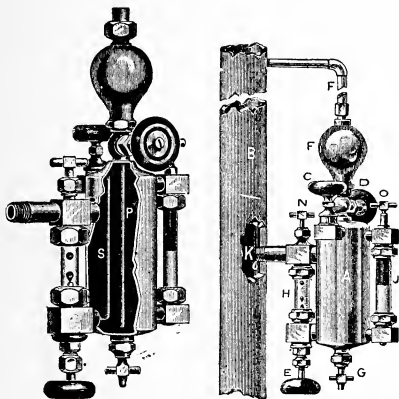
AUTOMATIC LUBRICATORS.

An Automatic Sight Feed Lubricator should be furnished with every engine, which enables the engineer to see the oil as it is fed drop by drop to the engine. The construction of these lubricators is such that the steam entering a chamber is condensed and this water of condensation finds its way into another compartment of the lubricator, wherein is contained the oil to be fed to the engine. The drop of water, by reason of its greater specific gravity, seeks the bottom of this oil compartment and forces out an equivalent bulk of oil into the steam pipe, whence it is carried by the current of steam into the cylinders and is distributed upon the wearing surfaces intended to be lubricated. This method insures regularity and economy.

There are numerous automatic lubricators made by various manufacturers throughout the country, many of which will perform their functions successfully. I have used several of the best types, and consider any of them suitable for the purpose; cut herewith is submitted, with description of the cup I have been using for some years.

This is the up-feed cup, showing an external view and sectional view of the same. Attachment is made to the steam-pipes

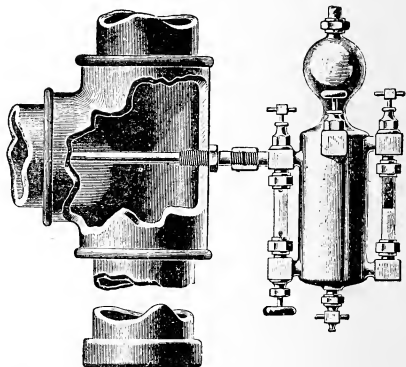
at the points *F* and *K*. In operation, the condensing chamber *F* provides for the condensation of steam which enters at the pipe *F*. This water of condensation passes down through the valve *D* and through the tube *P* shown in the section and discharges into the bottom of the oil vessel *A*. This vessel is filled with oil when the cup is started, the height of oil being shown in the index glass *J*.



THE "DETROIT" LUBRICATOR.

The operation is as follows: The valve *N* being opened, the valve *D* is opened and the drop of water is allowed to pass from the condensing chamber *F* downward through the water tube and into the bottom of the oil chamber *A*, where it displaces a drop of oil of equal bulk on account of its greater gravity, and this drop of oil is forced out past the valve *E*, making its appearance in the feed glass *H*, as it starts on its way to the steam-pipe. It is carried by the current of steam to the engine and lubricates the valve and the pistons. When the oil cup is empty, the valve *D*

is closed and the drain valve *G* is opened, which will allow the water in the oil chamber to be blown out preparatory to the re-filling at the plug *C*. By opening the valves *G* and *D*, steam will be blown through the sight glass *J*, thereby clearing the same from any clogging up of the oil, which would disfigure it. The amount of oil to be fed by the lubricator will be regulated by the valve *D*, controlling the amount of water admitted, and the valve *E* controlling the discharge of the oil into the sight glass. The valve *N* is to be left wide open in operation and its object is to provide for the accidental breaking of the glass *H*.



Sketch showing proper method of attaching cup to prevent the oil from dropping into the well, and not going into the cylinder.

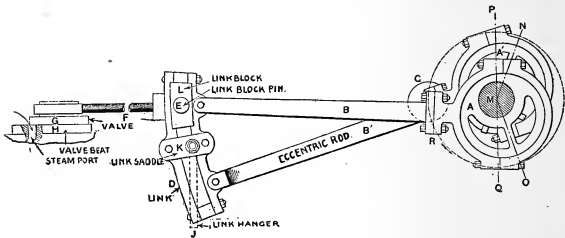
These cups should be attached to the steam pipe, in strict accordance with the instructions contained in the box in which the lubricator is packed. The greatest enemy to proper performance is leakiness; all joints must be absolutely tight, otherwise the

water of condensation, instead of performing its duty of displacing the oil, will ooze out at the leaks and the cup will refuse to work. In most cases, provision is made for a column of water which may stand 12" or more in height and enable the cup to work more positively, by giving it a greater pressure in the displacement chamber, due to the height of the column. A suitable oil is essential to the proper working of such a lubricator, as well as to the proper lubricating of a steam-engine. An improper oil will not feed through the cup as it should, on account of its disposition to disintegrate and go off in bubbles, when exposed to the heat of the steam.

SETTING A PLAIN SLIDE VALVE WITH LINK MOTION.

The **setting** of a slide valve operated by a link motion does not differ materially in principle from the method pursued when setting the ordinary slide valve driven by one eccentric. A link motion may be considered as a means of driving a valve by two independent eccentrics, either of which controls the functions of the valve wholly or in part, according to the position of the link. Thus when the link is in either extreme position, the eccentric driving that end of the link in line with the link-block pin may be considered as being entirely in control of the valve action, and, *vice versa*, when the link occupies the other extreme position of its throw, as actuated by the reverse lever, the other eccentric becomes possessed of the controlling function. Practically, however, the operation of the link motion is very complicated and the movement of one eccentric materially modifies the action of the other. Since the interfering action is least at the extreme positions of the link and greatest in mid-gear, the plan is followed of setting the valve with the link in full gear both forward and backward motion, and, as before stated, the procedure is on the theory of independent action of the eccentrics.

In the accompanying diagram, a link motion is shown driving a plain slide valve without the intervention of a rocker. Each eccentric is set with reference to the crank-pin, the same as it would be with a simple slide-valve engine. The eccentric *A* is set on the shaft with the same angular advance, *QMO*, as would be required for an ordinary engine to run in the direction indicated by the arrow. Now, since the crank pin is at *C*, if it were necessary to reverse the simple engine with one eccentric, it would be necessary to change the position of the eccentric so that instead of being ahead of the bottom quarter line *QM*, it would be ahead



of the top quarter line *PM* by an amount of angular advance made necessary by the lap and lead of the valve. Therefore, the eccentric would come in the position of the eccentric *A*¹, or with its center line coinciding with *MN*, giving it the angular advance *PMN*. Now it should be clear that if an engine is to be equipped with two eccentrics, so that it may run with equal facility in either direction, they will occupy the positions *A* and *A*¹. We will suppose that an engine having a link motion is to be overhauled and the valve motion to be properly set. This will mean that the eccentrics will be properly located for the correct angular advance, and that the eccentric rods will be adjusted to the right length. When these conditions are obtained, the valve should

perform its functions properly in both forward and backward motions, and also when the link is "hooked up."

Before starting to set the valve, it is best to take a general survey of the valve motion parts and see if the eccentrics are somewhere near the proper location on the shaft relative to the crank-pin. If they are obviously much out of position, they should be shifted and adjusted as near the correct position as possible by the eye; doing this at the beginning will often save confusion and much time. The dead centers will be found by the method given on page 228. The operation should be carefully performed, as upon it depends the success of the work. After having found the dead centers and having them marked so that no mistake will occur when "catching" them with the tram, the valve positions may be taken for the four positions; that is, front and back centers in forward motion, and the front and back centers in backward motion. Put the reverse lever in full gear in one motion or the other, whichever is most convenient, and turn the fly-wheel in the direction the engine would run for the given reverse lever position. Suppose the link stands in the position shown in the diagram, the fly-wheel should be turned in the direction indicated by the arrow until the dead center is reached, which is known when the tram drops into the prick mark. The position of the valve is then noted and a measurement taken. If the valve shows the steam port open, measure the distance with a steel scale, or it may be done by sharpening a stick wedge-shaped and shoving it into the opening. By noting the depth to which it goes at the valve face the opening can be readily measured on the removal of the wedge. We will suppose the distance is found to be $\frac{3}{8}$ ". The measurement should be set on a sheet of paper laid out as follows: —

FORWARD MOTION.

Front center,
Back center.

BACKWARD MOTION.

Front center,
Back center, $\frac{3}{8}$ " lead.

It will be seen that the valve opening is set down as being $\frac{3}{8}$ " lead, and as being on the back center in the backward motion. After having verified the measurement taken, the engine can be "turned over" in the same direction as before until the opposite dead center is caught by the tram. It may be found that the valve does not show open in this position but covers the steam port. To find the position of the valve edge relative to the steam port, scribe a line in the valve seat face along the edge of the valve and then turn the fly-wheel until the valve uncovers the steam port. The distance the valve laps over when the crank is on this dead center can then be readily measured. Suppose the distance is found to be $\frac{1}{8}$ ". It is set down on the log as follows:—

FORWARD MOTION.

Front center.

Back center.

BACKWARD MOTION.

Front center, $\frac{1}{8}$ " blind.Back center, $\frac{3}{8}$ " lead.

The valve position is put down as being $\frac{1}{8}$ " blind, which is the same as saying that it has $\frac{1}{8}$ " negative lead, and is fully as comprehensive as the latter term. The reverse lever should now be thrown into the opposite gear and the measurements taken for both front and back centers the same as has been described for the backward motion. It may now be supposed that when all the measurements have been taken the log reads as follows:—

FORWARD MOTION.

Front center, $\frac{1}{4}$ " blind.Back center, $\frac{5}{16}$ " lead.

BACKWARD MOTION.

Front center, $\frac{1}{8}$ " blind.Back center, $\frac{3}{8}$ " lead.

When in forward motion, the valve is open $\frac{5}{16}$ " on the back center and lacks $\frac{1}{4}$ " of being open when the crank is on the front center. The total lead due to the angular position of the eccentric is $\frac{5}{16}$ " minus $\frac{1}{4}$ " = $\frac{1}{16}$ ". One-half the total lead should be given to each edge of the valve so that it will be necessary to lengthen the eccentric rod B^1 , $\frac{1}{32}$ " + $\frac{1}{4}$ " = $\frac{9}{32}$ " to get the valve

into its proper position. A little reflection will show the reason for lengthening the eccentric rod B^1 . In speaking of the front and back centers, they are taken to coincide with the crank and head ends of the cylinder. When the piston is at the crank end of the cylinder, the crank is on the front center. By referring to the log it will be seen that to adjust the backward eccentric rod B , it will also be necessary to lengthen it. The valve is $\frac{1}{8}$ " blind on the front center and has $\frac{3}{16}$ " lead on the back center. The total lead is, therefore, $\frac{3}{8}$ " minus $\frac{1}{8}$ " = $\frac{1}{4}$ ". One-half $\frac{1}{4}$ " = $\frac{1}{8}$ ", which being added to the amount the valve is lapped on the front center, makes $\frac{1}{4}$ ", or the amount the eccentric rod B will have to be lengthened to make the valve open equally at each end of the piston stroke. The opening the valve has when the crank is on the centers is called the lead and in the case of the backward motion, it is found that after the eccentric rod is lengthened, the lead is $\frac{1}{8}$ ", which is too much for most cases and in this one we can assume that $\frac{1}{32}$ " would be about right.

Before explaining the adjustment of the eccentric for the correct angular advance, it will be in order to call attention to the necessity of making the adjustment for the eccentric rod lengths first. The eccentric rods are lengthened or shortened, as the case may require, by inserting or removing liners between the eccentric rods and straps at R . Other forms of construction provide different means for adjustment, but the principle is the same in each. It will be noted that the correct length for the two motions is obtained by adjusting the eccentric rod corresponding to that motion. Any attempt to correct an irregularity by changing the length of the valve rod F will result erroneously, unless both eccentric rods require the same amount of movement and in the same direction. After having adjusted the eccentric rods to the correct lengths, the angular advance of the eccentric A can be changed. Place the crank on a dead center and have the reverse lever thrown in the backward motion and then

loosen the set screws that hold the eccentric to the shaft and turn it towards the crank until the valve shows open $\frac{1}{32}$ " , and then tighten the set screws on the shaft. After all the adjustments have been effected, it is always advisable to turn the engine over again and catch all the dead centers, so that the correctness of the adjustments can be verified. After taking the new log, it will usually be found that some slight irregularities have been introduced, especially if any of the adjustments have been considerable, as the changes made for one motion will affect the other slightly.

The link motion shown in the cut is so connected that the lead increases as the link is shifted towards the center. If the eccentric rods be oppositely connected to the link, the engine will run in an opposite direction for a given reverse lever position and the lead will decrease as the lever is shifted towards the center. The link motion for hoisting engines is quite commonly connected in this manner, for the reason that the engine will stop when the lever is put on the center, which is not the case when connected as shown. Of course, in such a case, the admission and cut-off take place at the same position in the stroke and the compression is high, but with a light load the engine will run on the center, which is considered objectionable in the case of the hoisting engine.

VALVE-SETTING FOR ENGINEERS.

Plain slide-valve. — The plain slide-valve, while the simplest valve made, is perplexing to one who has not made a study of it. Unless one understands the principles of the valve and its connections, he will probably meet with trouble when he attempts to set it. We will assume that the engineer understands how to set the crank on the dead point, and will simply explain the other steps that have to be taken. In the first place, it should be understood what result is obtained by adjusting the position of the eccentric

and the length of the valve stem. The position of the eccentric, when the valve is set, depends upon which way the engine is to run and whether the valve is connected directly to the eccentric or whether it receives its motion through a rocker which reverses the motion of the eccentric. When the valve is direct connected, the eccentric will be ahead of the crank by an amount equal to 90° , plus a small angle called the angular advance. When a reversing rocker is used, the eccentric will be diametrically opposite this position, or it will have to be moved around 180° and will follow instead of lead the crank. Shifting the eccentric ahead has the effect of making all the events of the stroke come earlier, and moving it backwards has the effect of retarding all the events. Lengthening or shortening the valve stem cannot hasten or retard the action of the valve, and its only effect is to make the lead or cut-off, as the case may be, greater on one end than on the other. The general practice is to set a slide-valve so that it will have equal lead. The lead is the amount that the valve is open when the engine is on the center. To set the valve, therefore, put the engine on the center, remove the steam-chest cover so as to bring the valve into view, and adjust the eccentric to about the right position to make the engine turn in the direction desired. Now make the length of the valve-spindle such that the valve will have the requisite amount of lead, say $\frac{1}{16}$ of an inch, the amount, however, depending upon the amount and speed of the engine. Turn the engine over to the other center and measure the lead at the end. If the lead does not measure the same as before, correct half the difference by changing the length of the valve-stem, and half by shifting the eccentric. Suppose, for example, that the lead proved to be too great on the head end by half an inch. Lengthening the valve-stem by half of this, or $\frac{1}{4}$ inch, would still leave the lead $\frac{1}{4}$ inch too much on the crank end. That is to say, the valve would then open too soon at both head and crank ends, and to correct this, the eccentric would

have to be moved back far enough to take up the other quarter-inch. Sometimes it is not convenient to turn the engine over by hand, in which case the valve may be set for equal lead as follows: To obtain the correct length of the valve-stem, loosen the eccentric and turn it into each extreme position, measuring the total amount that the valve is open to the steam ports in each case. Make the port opening equal for each end by changing the strength of the valve-stem. This process will make the valve-stem length as it should be. Now put the engine on a center and move the eccentric around until the valve has the correct lead and fasten the eccentric in that position. This will determine the angular advance of the eccentric.

The plain slide valve.—The function of the slide-valve is to admit steam to the piston at such times when its force can be usefully expended in propelling it, and to release it when its pressure in the cylinder is no longer required. Notwithstanding its extreme simplicity as a piece of mechanism, no part of the engine is more puzzling to the average engineer when the problem to be solved is to determine beforehand the results which will be produced by a given construction and adjustment, or the proportions and adjustment required to produce given results. All who have had any experience in constructing and setting slide-valves are aware, in a general way, that the events of the stroke cannot be independently adjusted; for instance, a cut-off earlier than about $\frac{3}{4}$ of the stroke.

To set a slide valve.—The valve should be set in such a manner that when the engine is on the dead center, the part admitting the steam to the cylinder is open a small amount, as shown in Fig. 1, which is called lead. The object of lead is to enable the steam to act as a cushion against the piston before it arrives at the end of the stroke, to cause it to reverse its motion easily, and also to supply steam of full pressure to the piston the instant it has passed dead center. The lead required varies in different engines from

$\frac{1}{84}$ to $\frac{3}{16}$ without regard to size or kind. Fig. 1 also shows the position of eccentric, which should always be set ahead of the

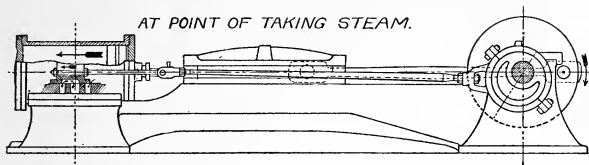


Fig. 1.

crank at an angle of 90° , plus another angle called the "angular advance." When the valve is to have lead the angular advance must be a little greater than when no lead is desired.

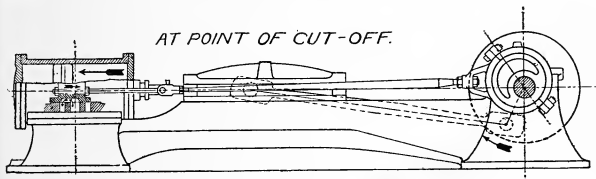


Fig. 2.

Fig. 2 shows the position of eccentric at point of cut-off; also position of Piston.

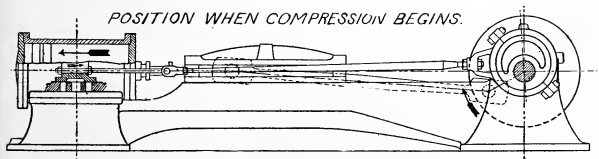


Fig. 3.

Fig. 3 shows position of valve when compression begins. It also shows position of eccentric. The compression at the left

end, towards which the piston is moving, has just commenced, and the exhaust is about to take place from the other end.

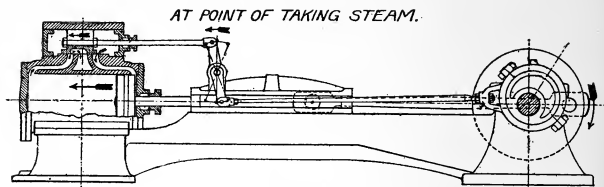


Fig. 4.

Fig. 4 shows the position of eccentric and valve in an engine with a rocker-arm.

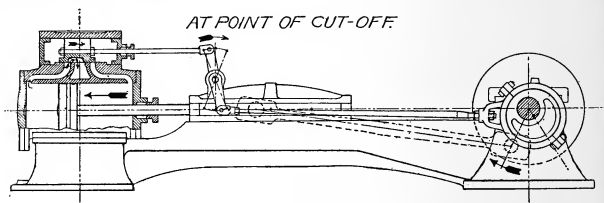


Fig. 5.

Fig. 5 shows the position of valve and eccentric at point of cut-off.

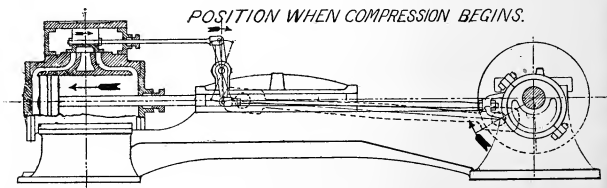


Fig. 6.

Fig. 6 shows point of compression.

CHAPTER XIII.

A SUCCESSFUL ENGINEER.

To be a successful engineer he must not only keep the machinery under his charge in proper order, but he must discipline, direct and control the human machine that operates the dynamo, the engine, and all help that may come under his charge. He should, therefore, be a good mechanic, as well as a good leader of men. He should be familiar with tools, and should understand theoretically and practically, the steam engine and boiler, as well as the laws of combustion. He cannot ignore, in fact, any branch of the profession. He should cultivate the habit of critically analyzing the operating expenses of plants similar to his own, and compare them with his own. He should cultivate a spirit of relentless self-criticism; should never be quite satisfied with what he has accomplished; he should always try to improve his plant. To be a good leader of men, he should cultivate perfect patience, forbearance and self-control, remembering that no man ever controlled others who did not start by controlling himself. He should be even-tempered; or, if not born so, should not let any one discover it. He should be strictly just, granting cheerfully everything due his employees, while jealously guarding his employer's interests, curbing his generosity in spending funds intrusted to him.

EDUCATION FOR STEAM ENGINEERS.

There is probably no class of men who, by reason of their peculiar environment, have more opportunities for reflection and study than engineers in charge of well-regulated steam-plants.

The nature of the calling, the comparative leisure and a certain degree of isolation all have a tendency to make the engineer studious and of an investigating disposition. We have abundant evidence that these influences are not without results in the many instances of stationary engineers who have refused to remain "stationary," but having improved their opportunities for study, have naturally found some opening that afforded greater play for their abilities. It is evident that if an engineer thoroughly understands the phenomena that take place in the apparatus under his charge, he is quite well versed in the elementary principles of motion and the action of fluids, and if his plant embraces a dynamo, he will require a working knowledge of the principles of electricity. Having mastered these elementary principles, the broad field of thermodynamics opens before him with its ramifications that embrace every known field of science. It is very evident that study and independent investigation along these lines will prove profitable, not only in the gain of knowledge, but in the possibilities of discoveries that may work great changes in the production of power. The stationary engineer must not consider that the engine of which he has charge is perfect, because built by some well-known maker; neither must he go to the other extreme and regard all steam engines as crude machines that at best are only makeshifts for the transformation of energy at an enormous loss. Neither of these ideas would be correct, as the machine is not built that is not susceptible of more or less improvement at the hands of the builder, or some one else who can perceive its faults. On the other hand, it is a recognized fact that the best engines are working very close to the theoretical limit of economy. While it is possible that discoveries may be made that will materially alter these views, it is fair to presume that they will be the result of intelligent investigation pursued with a definite object in view. To be able to study phenomena intelligently, it is

necessary for the observer to have a certain amount of knowledge, either proven or presumptive, that will form a basis for the discovery of new facts. For this reason, if no other, there is considerable inducement for the engineer to study for something more than a first-class license, as it will not only make him alive to the possibilities of his profession, but broad-minded and progressive. One of the most important points encountered by a steam engineer in his duties, is the faithful watching of the amount of coal required by his engine to produce a horse-power. The amount of steam required by an engine to produce a horse-power is governed by the value or values of the engine, since it is a well-known fact, that the same engine with its valve set in one way may require considerably more steam than when the valves are set in another way.

TAKING CHARGE OF A STEAM POWER PLANT.

It is frequently the case that an engineer, on assuming charge of a steam power plant, proceeds as though he were thoroughly familiar with the condition of the engine, boiler and entire surroundings. He plunges headlong into his duties, without first taking his bearings. A skillful physician on taking a case, would not proceed in this manner; neither would a lawyer. The physician would feel the patient's pulse, look at his tongue, take his temperature, observe his color and ask a number of questions, all for the purpose of enabling him to make a correct diagnosis of the patient's ailment. The first duty of an engineer, when he takes charge of a plant, is to ascertain the arrangement and condition of the plant. Since the boiler is the most important member of the plant, it should be the first to engross his attention, and it, together with its connections, should be examined as closely as time and surrounding conditions will permit. He should look the boiler all over, internally and externally, if possible, in view of

mud, scale, grooving, pitting and defective braces. The furnace should be examined next, in view of burnt-out brickwork, grate bars and door linings. It may be that the furnace has distorted or cramped proportions, or it may be too large. The bridge wall may be so constructed as to huddle the flames in one spot on the fire sheets of the boiler; or it may be of such shape and in such condition as to cause the ignited gases to become dissipated in the combustion chamber. Even the combustion chamber itself may require the service of a bricklayer. He should next examine the safety valve and see that it is of ample capacity to relieve the boiler of surplus steam, and that it is in thorough working order. The first duty of an engineer when entering his plant at any time, is to ascertain how the water in the boiler stands, or, in other words, just how much water the boiler contains. He should open the gauge cocks first and note what comes from each in turn; then open the cocks or valves connecting the glass gauge and note the water line there shown. He should also blow the water column out, in case any sediment may have choked any of the passages, which would be liable to give a false impression as to the actual quantity of water contained in the boiler. Should the water be found at the correct height, he may now proceed to get up steam; open the damper, pull down the banked fire and spread it evenly over the grate, adding a quantity of green fuel. Allow the steam to rise slowly; do not force it. This applies especially to raising steam in a boiler which has been cold, as the expansion of the parts of the boiler due to the heat should take place slowly and evenly; otherwise, the life of the boiler will be shortened. While waiting for the steam to come up to the desired point, the engineer should now get his engine ready for the day's run. Fill all the oil cups and cylinder lubricator, so as to be ready to operate as the engine starts. With a hand oil squirt can, go around all the small brasses, connections, etc., and, in a word, well lubricate all the parts where friction takes place. If

you have an oil pump for your cylinder and valves, it would be well to inject a small quantity of cylinder oil before the engine is started, while the stop-valve is open, during the time the engine is being "warmed up." After the engine cylinder is warmed through, the fire should again be looked at, and dealt with according to the indications. Of course, the water gauge glass must be looked at frequently, not only while raising steam in the morning, but at all times while the boiler is in operation.

Everything being in readiness, the engine is started slowly at first, the speed being gradually increased until the limit is reached. The day's run is now fairly commenced. A boiler should be blown down one gauge every morning before starting the day's run to get rid of the mud, scale or anything that is held in mechanical suspension in the water. Before starting in the morning and at noon is the best time to do this, as the sediment has settled to the bottom during the night, after the circulation of the water has stopped. When blowing a boiler down, always remember to open the blow-valve slowly — be careful not to blow too long, and then to close the valve slowly.

An engineer or attendant cannot be too careful in handling the many appliances with which a steam plant is equipped. The principal things to which an engineer should give his attention during the operation of his boiler day by day are, as follows: The maintenance of the water at the proper level, as near as possible, and avoiding fluctuations in the pressure of steam. See that the firing is done correctly and economically so as to obtain from every pound of coal all that is possible under the conditions existing. The raising of the safety valve from its seat, at least once daily; the blowing out of the water column twice daily, or oftener, if the water used is very dirty; the frequent opening of the water gauge cocks, or try cocks, as they are sometimes called, and not depending entirely on the gauge glass for the correct height of water; the blowing down of the boiler

one gauge every day; the keeping of all valves, cocks, fittings, steam and water-tight, clean and in good working order.

When shutting down the plant for the night, the fires should be cleaned out and the live coals shoved back on the grates and banked; that is, green coal should be thrown upon them, sufficiently thick to cover all the glowing fuel. Pump in the water until it reaches the top of the glass gauge. This should be done to insure a sufficient quantity from which to blow down in the morning, and also to allow for any small leaks. Then close the cocks or valves connecting the glass gauge. Should this glass break during the night and the valves be left open, there would not be much water to start with in the morning. Leave the damper open a little, just sufficient to allow the gases which will rise from the banked fires to escape up the chimney. Finally, make sure that all the valves about the plant which should be closed, are closed; and all those which should be left open, are open. Of course, the foregoing is applicable to a plant where there is no night engineer. But in any case, no matter how many assistants an engineer may have under his control, he should be familiar with all details of the plant under his charge.

One of the most important points in connection with the operation of a steam boiler, is the preventing of corrosion, both internally and externally. One of the best aids to secure the well working and longevity of the steam boiler, or, in fact, the whole plant, is by being regular and punctual in a certain course of treatment, which has been proven to be effectual and beneficial in its results. All conditions do not require the same methods of treatment; therefore, it is absolutely necessary that the engineer in charge familiarize himself with all the conditions under which his plant is running, for then, and then only, can he intelligently prescribe and act accordingly. Above all, let him remember the adage, "Eternal vigilance is the price of safety," especially where a steam boiler is concerned.

LET THEM ALONE.

I have recently run across some amusing experiences in which persons have been induced, either by personal favor, or in hopes of financial gain, to displace a good engineer who was doing his work so that not a particle of fault could be found with it, in favor of a friend or engineer recommended by some one whom they wish to please. In one case, the new man was not a fixture, and his successor succeeded in one week in melting the babbitt out of a crank-pin and in breaking two valve stems. In another case, a first-class man was dismissed without cause. His successor did not stay three weeks, but it took three weeks to fix the machine after he had left. Don't be too willing to keep changing your engineer. If you have a man who is devoted to your interest, who keeps your engine moving right along, is careful of your property and supplies, do not be too willing to let him go, just because some great "I am" tells you he can send you a man who is better. If you find that you are not getting as many horse-power from a like quantity of coal as some of your neighbors, do not begin to look around for a new engineer the first thing, but search out from the dim recesses of your memory some of the things which you have promised the present incumbent that you would "have attended to right away," and think if some of them were attended to, if you would not get a horse-power for less money. No engineer can make steam and use it economically with an illy-designed and proportioned, or a deficient plant, and it will be well to place the fault where it belongs before making any decided move in the matter. If you have a good engineer, let him alone until you are not only sure that you have got a better one, but are also sure that the better one will stick to you when you have made a place for him.

ECONOMY IN STEAM PLANTS.

In these days of close figuring upon expense in office buildings and manufacturing plants, what may at first appear insignificant items may actually make all the difference between a good margin of profit and an actual loss.

The fuel expense is one of the largest in the operation of the majority of plants, and any reduction which can be made in the amount of fuel used, while maintaining the same amount of power, is considered a direct gain. The evaporation of more than nine pounds of water per pound of coal, is looked upon with suspicion by many, as it is not thought possible to obtain more than this amount in even the best designed and well regulated furnaces and boilers, especially when the firing is done by hand. The actual value of the fuel depends upon the way in which it is used, fully as much as on any other factor. The heat unit in the coal should be as much as possible utilized, as in one pound of good steam coal there is about 14,000 B. T. U., and about 10,000 of this amount can be utilized, so that 4,000 heat units are lost. The mixture of gases in a furnace depends upon the amount of air used. One pound of coal requires, theoretically, about twelve pounds of air to burn completely. But, in practice, about twice this amount is required in the present boiler furnace. To have good combustion coal requires a good draft. The gases are consumed near the fire, and the waste gases carry the heat to the boiler on their way to the stack. The boiler ought to have sufficient heating surface, or the hot wasted gases ought to travel a sufficient distance to be cooled down to about 350 degrees Fahrenheit; which temperature is found high enough to produce a good draft in a stack of, at least, 100 feet high.

How a bad draft will unnecessarily increase the coal bill, is this: That of all the fuel burnt to perform certain work, ascertained proportion is consumed to keep the heat of the furnace up

to say, 212 degrees Fahr., without making any steam whatever which is available for work. This quantity varies from 20 to 30 per cent, according to conditions, which are affected by various causes, such as leakages of steam, air, or water. Now, the only available power for work which we get from our fuel is the margin between this, say thirty per cent required for the said purpose, and what we generate above that. An engineer should notice the general condition of his boiler or boilers, and the equipments of same; he should examine the boiler both inside and outside, ascertain the dimension of grates, heating surfaces, and all important parts. The area of heating surfaces is to be computed from the outside diameter of water-tubes, and the inside diameter of fire-tubes. All the surfaces below the main water level which have water on one side and products of combustion on the other, are to be considered as water-heating surfaces. If he finds that the boiler does not come up to what he thinks it should, he should put the boiler and all its appurtenances in first-class condition. Clean the heating surfaces inside and outside of boiler, remove all scale from flues and inside of boiler; remove all soot from inside of flues, all ashes from the flame-bed or combustion chamber, and all ashes from smoke connections. Close all air leaks in the masonry and poorly fitted cleaning door. See that the damper in britching or smoking-flue will open wide and close tight. Test for air leaks through the crevices, by passing the flame of a candle over cracks in the brick work. A good, attentive fireman, who understands his business and will keep his bars properly covered without chocking his fires, is really worth double the wages of an ignorant or inattentive one, as his coal bills would certainly prove. All an engineer can do is to keep the steam piston and valve or valves tight. Also the drains from his engine, and all drains on steam traps in the plant tight; also, his engine cleaned and well-oiled, and not keyed up too tight. If in a heating plant, he should see that the back pressure valve is

at all times tight, as it does not take much of a leak to show a difference in his coal bill at the end of a month. He should keep all valves in the pumps in his plant tight, and see that the pump piston is packed, but not too tight. After a pump is packed, you should be able to move it back and forth by hand; if the pump valves leak he can take them out and smooth them up with sand-paper. He should see that the feed-water to the boiler is at least 208 degrees Fahrenheit; if it is under 204 degrees, his heater is not right, as the poorest heater will heat the feed-water to 204; it would be well to overhaul the heater — it may be full of scale; or, if an open heater, the spray may be off. In most first-class plants, the feed-water is 212 Fahrenheit.

PRIMING.

The term priming is understood by engineers to mean the passage of water from the boiler to the steam cylinder, in the shape of spray, instead of vapor. It may go on unseen, but it is generally made manifest by the white appearance of the steam as it issues from the exhaust-pipe as moist steam, which has a white appearance and descends in the shape of mist, while dry steam has a bluish color and floats away in the atmosphere. Priming also makes itself known by a clicking in the cylinder, which is caused by the piston striking the water against the cylinder head at each end of the stroke. Priming is generally induced by a want of sufficient steam-room in the boiler, the water being carried too high, or the steam-pipe being too small for the cylinder, which would cause the steam in the boiler to rush out so rapidly that, every time the valve opened, it would induce a disturbance and cause the water to rush over into the cylinder with the steam.

CONDENSING ENGINES.

It has been explained that the atmosphere exerts a pressure of about 15 lbs. per square inch on all surfaces with which it

is in contact. The atmosphere is in contact with one side of an engine piston when the exhaust is open, and, consequently, the steam in pushing the piston forward, has to overcome this atmospheric pressure of 15 lbs. per square inch. The useful pressure of steam is, therefore, whatever pressure there is above the pressure of the atmosphere, and this is the pressure that the steam gauge shows. When the gauge says 60 lbs. we really have 75 lbs., but 15 lbs. of it does not count, because it is balanced by the atmospheric pressure on the other side of the piston. If we had sixty-pound steam pressing on the piston and could get rid of the atmospheric pressure on the side of the piston, the steam would exert a force of 75 lbs. per square inch, a very respectable gain, indeed. We might remove the air pressure by pumping it out, but the amount of power required in doing the pumping would be equal precisely to all gain hoped for, plus the friction of the pump; therefore, there would be an actual loss in the operation. But there is another way of removing the air pressure. It has been explained that a cubic inch of water vaporizes and expands into a cubic foot of steam at atmospheric pressure. If, after getting this cubic foot of steam, we take the heat out of it, we again turn it into the cubic inch of water. Assume the engine cylinder to hold just a cubic foot of steam, and assume that the stroke is complete and ready for the exhaust valve to open and permit this foot of steam to escape, and assume that this cubic foot of steam has expanded down to atmospheric pressure, that is, 15 lbs., absolute pressure. Now, instead of opening the cylinder to the atmosphere, we dose the cylinder with cold water. The heat leaves the steam and goes into the water and the steam turns to water, leaving in the cylinder the condensed steam in the form of a cubic inch of water. The steam formerly filled the cylinder, and now it fills but a cubic inch of it, consequently, we have produced in the cylinder a vacuum which has the effect of adding about 15 lbs.

per square inch, to the force of the steam on the other side of the piston, by virtue of removing that much resistance to its forward motion. The heat which was in the steam has gone into the condensing water, except the trifle that remains in the cubic inch of condensed water. We must get this condensed water out of the cylinder, and it will be an advantage to pump it back into the boiler, for it is pure and it is hot.

This is the general principle of the condensing engine. It gives us the grand advantage of a heavy increase in the useful pressure acting to push the piston forward; it gives us pure water for use in the boiler, and it saves in the feed-water the heat that would otherwise go out of the exhaust pipe. But it is not practicable to condense the steam in the cylinder by dosing the cylinder with cold water. In practice, the steam is allowed to go into a separate condensing vessel, called the condenser. The condenser is precisely the opposite of the boiler. The boiler is the machine for putting heat into the steam to vaporize it, and the condenser is the machine for taking heat out of the steam and turning it into water again. In the condensing engine, one of these machines is pushing on the piston and the other machine is pulling on the piston. The gain by condensing is so great that it is a profitable piece of business to apply a condenser to any large non-condensing engine. The condenser requires a pump to withdraw the water of condensation, and this pump must be in reality an air-pump. In practice, they employ an air-pump and condenser combined in one structure, separate from the engine, and driven either by rod connection from the engine, or by a belt from the engine, or by an independent steam pump. The arrangement will depend much upon the situation. The belt-driven pump permits of the condenser being set in any convenient position independent of the engine,

HIGH PRESSURE STEAM.

It is generally believed that high-pressure steam is cheaper to use and costs but little more to generate than low pressure steam. A study of a table of the properties of saturated steam, to be found on another page in this book, will show why high-pressure steam is economical to generate, and a few calculations will prove instructive by showing what may be expected from its use. To generate one pound of steam at 25 lbs. pressure, absolute, requires an expenditure of 1,155 thermal units, and to generate steam at 200 lbs. pressure, absolute, requires 1,198 thermal units, or an increase of only 43 thermal units for an increase of 175 lbs. pressure. Further investigation shows that the temperature of steam at 25 lbs. pressure is 240° and at 200 lbs. pressure, 382° , the difference, 142, being the number of degrees that the temperature of steam is raised with an expenditure of 43 thermal units. To put it in another way, the temperature of the steam has been raised nearly 60 per cent, with an increase of less than 4 per cent in the number of thermal units. It is convenient to consider that the generation of steam takes place by two different steps, one of which is raising the water from 32° to the temperature corresponding to the pressure of the steam, and the other is giving off the steam at this pressure, which process absorbs a quantity of heat that becomes latent or non-sensible. At 25 lbs. pressure, the sensible heat required to raise one lb. of water from 32° to 240° is 209 units, and to raise it from 32° to 382° degrees, the temperature of steam at 200 lbs. pressure requires 355 thermal units. The increase in the sensible heat of the water, therefore, is 355 minus $209 = 146$ units, or about the same as the temperature increase for these two pressures, which 142° . It is thus clear that the total increase in the number of heat units in steam raised from 25 lbs. to 200 lbs. pressure is small (43° as found

above) because the latent heat absorbed in the formation of the steam decreases as the pressure increases. It requires less heat to generate steam from water raised to 382° at 200 lbs. pressure, than from water previously raised to 240° at 25 lbs. pressure. To generate high pressure steam, therefore, we must first apply enough heat to bring the water to the temperature corresponding to the higher pressure. To generate higher pressure steam, therefore, we must first apply enough heat to bring the water to a temperature corresponding to the higher pressure. This heat will be nearly proportionate to the increase in temperature. Then enough heat must be applied to the water to generate the steam, the amount of heat required for this purpose decreasing as the pressure increases. The combined result of these two processes is that it takes only a very small increase in the total heat to produce the higher pressure steam. The idea may be suggested that if this higher pressure is obtained at the cost of so small an expenditure of heat, it would not be reasonable to expect a large gain in economy from it, since it is not possible for the steam to do a greater amount of work than the equivalent of the heat which it contains. This would be true were it not for the fact that the larger part of the heat in the steam is rejected during the exhaust. To illustrate, suppose an engine to exhaust at atmospheric pressure, or at about 15 lbs., absolute, and that the steam is saturated. As may be determined from the steam tables, there would be ejected 1,147 heat units per pound of steam, or 51 heat units less than were found to be in a pound of steam at 200 lbs. pressure. That is to say, under the above assumption, there are available only 51 heat units per pound of steam to do the work in the engine cylinder when the steam pressure is 200 lbs. But we also found that the increase in the heat units in raising the steam pressure from 25 to 200 lbs. was 43, and hence the increase in proportion to the number available is large, although the increase in proportion to the total number required

to generate the steam is small. This shows why high-pressure steam is economical to generate and profitable to use. It should be stated that the only way in which the full benefit can be derived from high pressure-steam is by using the steam expansively, keeping the terminal pressure at release as low as possible. I will not take the space to give the calculations to prove this, but will compare a few results of calculations. Suppose steam to be used in a theoretically perfect engine at the pressure of 25 lbs., 50 lbs., 100 lbs. and 200 lbs. We will assume that in each case the cut-off is at one-third stroke, giving three expansions and a terminal pressure of one-third the initial pressure. The steam consumptions will then be, respectively, about $16\frac{1}{2}$, 16, $15\frac{1}{2}$, and 14 lbs. per horse-power, showing that gain from the increase in pressure is very slight. On the other hand, suppose the expansions to be carried to the atmospheric pressure in each case. The consumptions will then be about 27, 15, 11 and 8 lbs. respectively, showing a marked decrease.

Still another point should be mentioned in relation to the relative gain that is to be expected with the increase in pressure. Comparing the last figure, it will be observed that the decrease in consumption when the pressure increased from 25 to 50 lbs. was $27 - 15 = 12$ lbs., or 44 per cent. Again, when the pressure doubled from 50 to 100 lbs., the consumption decreased only 4 lbs., or 27 per cent; and when the pressure was again doubled to 200 lbs., the consumption only decreased 3 lbs., or about 27 per cent. It is evident from this that the saving from an increase in steam pressure grows less as the pressure increases, and this is found to be the case in actual practice. There is another reason for this, also, coming from the losses incident to cylinder condensation and re-evaporation, which is more marked where there is a wide range in pressures than where the pressures are more uniform throughout the stroke. It is found that where the steam pressure is much above 100 lbs. gauge pres-

sure, no gain will result from a further increase in pressure without compounding, the advantage of the compound engine being that the extremes of temperature in the cylinders are not so great as with a simple engine.

USING STEAM FULL STROKE.

The steam engine is nothing in the world but an enlargement upon the end of the steam pipe, containing a piston against which the steam in the boiler may press. The piston moves a certain distance, and then the steam is allowed to press upon its other side, while the steam on the first side is allowed to flow into the atmosphere and go to waste. The slide-valve is the device ordinarily employed to admit the steam, alternately, to opposite sides of the piston, and to permit the free outflow of steam from the reverse side of the piston. As the steam presses upon the piston the piston moves forward with a force equal to the pressure of steam per square inch, multiplied by the number of square inches of piston surface. Steam occupies the entire space from the surface of the water in the boiler, to the piston of the engine. The steam space, therefore, includes the steam space of the boiler, the steam pipe, the steam chest, and the cylinder space upon one side of the piston. As the piston moves, the entire steam space becomes a little larger, by reason of the cylinder space becoming longer. Thus it will be seen that all of the steam in the boiler and pipe and engine, would expand a trifle and the pressure become somewhat reduced, were it not for the fact that new steam is made by the fire as fast as the piston moves forward. By this means the steam is maintained at about uniform pressure. It will be seen that the pressure is produced upon the piston by the generation of new steam from the water, that is, the fire causes the water to generate a quantity of steam, and this quantity of steam forces its way into the other steam, exerting a force upon the whole body of steam and pushing the piston ahead.

If an engine piston has a surface of 100 square inches and a stroke of ten inches, it follows that the piston will yield a thousand cubic inches additional steam space by its movement during one stroke, and consequently, the fire will be called upon to produce 1,000 cubic inches of new steam for each single stroke of the engine. If the pressure of the steam be eighty pounds to the square inch, the engine piston will move with the force of 8,000 pounds. When the engine has completed one stroke, we find an amount of power exerted equal to 8,000 pounds moved ten inches, and we then open the exhaust valve and empty into the atmosphere 1,000 cubic inches of eighty-pound steam. We keep on doing this for each stroke. Now your attention is particularly called to the fact that when we empty the steam out of the cylinder, it is just as good as when it went into the cylinder; that is, it was 1,000 cubic inches of steam at a pressure of eighty pounds to the square inch, and when it goes into the atmosphere it will expand into over 6,000 cubic inches, at fifteen pounds pressure to the square inch, or the same pressure as the atmosphere. This 1,000 cubic inches of steam which we dumped out of the cylinder, is precisely the same quality of steam as the steam which we have penned up in the boiler; and which we have to be making new all the time in order to keep the engine running. Such is the operation of the steam engine which receives its steam the full length of the stroke; and such an engine may be described, briefly, as a very wasteful machine which throws away steam as good as it receives it, and which requires the generation of a cylinder full of full pressure steam for each stroke. It should be readily understood that when the piston has completed its stroke, and just before the exhaust valve is opened to allow the steam to escape, the cylinder contains 1,000 cubic inches of steam at eighty pounds pressure, which it is capable of expanding into many thousand cubic inches at constantly decreasing pressure. The first step in the improvement of such an

engine would be to so arrange things as to get some benefit from this enormous power of expansion. The full stroke engine does not get one-half of the power before it throws the steam away. The engine which we would have referred to would yield a power of 8,000 pounds moved ten inches at each single stroke; 33,000 pounds moved one foot in one minute is a horse-power; 66,000 pounds moved half a foot would be the same. An engine using steam full stroke is such an extravagant contrivance that we, nowadays, seldom find them in use. There are certain classes of engines built, fitted with link motions for driving the valve, and they are arranged so as to carry their steam full stroke, but provision is also made for quickly hooking up the link and suppressing the full-stroke feature.

SLIDE VALVE ENGINES.

If we have an engine arranged to receive its steam full stroke and to dump the steam out into the air in as good condition as it was received, and we wish to get some of the benefits of the expansive power of the steam, there is a simple way of doing it and without any great change in the engine, and that is, to lengthen out the slide valve so that after the cylinder is half full of steam, the valve will shut and let no more steam enter. During the balance of the stroke, the entire power comes from the gradual expansion of the steam shut up in the cylinder, and it will be readily seen that whatever power we succeed in getting out of the expansion of the steam, is pure gain. The lower the pressure of the steam is when it is exhausted into the air, the more it has expanded, the more power we have gotten out of it, and the more we have gained. It may be said in a few words, that all slide-valve engines are now arranged to work their steam expansively. But it is, unfortunately, found that the slide-valve possesses a peculiar defect which prevents the system being carried very far. We can lengthen out a slide-valve so as to cut the

steam off at any desired point of the stroke, and we must then increase the throw of the eccentric in order to properly operate the long valve. But the minute we do this we find that we have interfered, to a certain extent, with the proper operation of the exhaust. No matter what we do about the admission of steam or about cutting off before the end of the stroke, we must arrange our exhaust to take place at a certain point at the end of the stroke. It is found in practical operations that this necessary quality of the slide-valve prevents our arranging it to cut off the steam properly at an earlier point than about five-eighths or three-quarter stroke. The consequence is, that an engine with two-feet stroke will receive steam 18 inches, then have 6 in. of expansion. It may be fairly said, in a general way, that about all the slide-valve engines now manufactured, cut off the steam at about five-eighths or three-quarters stroke; and it may be further said that this is about all we can get out of a slide-valve engine. Even the trifling expansion got from such engines as this, represents an immense amount of money in the course of a year in large establishments, but it is not good enough for anyone who seeks even a decent investment of money, in power-getting appliances.

REGULAR EXPANSION ENGINES.

A liberal expansion of steam being desirable and the slide-valve proving totally incapable of providing for such expansion, the first step in the desired direction is to totally discard the slide-valve. The Corliss valve is a cylindrical piece, oscillating in a cylindrical hole. The valve does not fill this hole, but seats against one side only. Hence, the fitting qualities are about the same as with the slide-valve and, in fact, the principle is about the same, the Corliss representing a portion of the slide-valve, rolled into the form of a cylinder and operating in a concave seat. We must not only discard the slide-valve arrangement, but in the valve arrangement which we select, we must secure an abso-

lute independence between the steam admission part of the system and the exhaust part. The slide-valve is one chunk of cast iron, letting in and cutting off steam at its outside edges, and opening and closing the exhaust by its inside edges. When one of these valve edges moves, everything else has to move. There is, consequently, no independence of action. In the Corliss engine there are parts to let steam into the cylinder and to quit letting it in at the proper time, and there are valves to let it out at the proper time, and they are perfectly independent of each other in all of their movements. The consequence of this arrangement is, that the steam valve may open, steam flow into the cylinder, the valve suddenly shut and chop the steam off short, the piston move forward in its stroke by the expansion of the confined steam, and finally, be let out by the opening of the exhaust valve, which has all the time stood ready for the discharge. Here we have a regular expansion engine. We can cut the steam off as early in the stroke as we desire, and hence, have any degree of expansion we desire. And we can do this without interfering with the exhaust valves. It is found, in practice, that an engine cutting off at about one-fifth of its stroke and expanding the other four-fifths, will yield the fairest practical economy.

AUTOMATIC ENGINES.

In order that those not posted may understand what is meant by the term "Automatic Engines," we will have to go back a step. Take, for instance, a full-stroke engine. It ought to be well understood how the ordinary governor does its work. Suppose, for instance, that there is no governor, and that we regulate the speed of the engine by having a man stand at the throttle-valve all the time. If the engine runs too fast, he shuts the throttle-valve a little. This makes the steam pipe so small that the steam cannot flow fast enough to keep the pressure up, and consequently,

the speed goes down. If the engine runs too slow, he opens the throttle-valve and lets the steam flow free, so as to maintain higher pressure. Thus it will be seen that the man at the throttle regulates the engine by altering the pressure with which the steam acts upon the engine. An ordinary engine governor is simply a man at the throttle. When the engine runs too fast the balls fly out, the governor valve shuts a little and the pressure of steam entering the engine is reduced, and so on through all the changes continually taking place. All steam engines, in which the regulation of steam is effected by means of a governor operating upon a throttle, are called throttling engines. They operate by reducing the pressure of the steam admitted to the engine, and thereby taking so much of the vitality out of the steam. It is entirely the wrong way to do it. After once spending our money to get up pressure in the boiler, we should make the greatest possible use of that pressure, so long as we are taking the steam from the boiler. It is, therefore, desirable that the full boiler pressure should be admitted to our cylinder; and the question arises as to how we shall be able to regulate the speed if we do not tinker with this pressure. The Automatic Engine regulates the speed by the simple act of altering the point of cut-off. If the engine is cutting off at one-fifth stroke, we get a power equal to the incoming force of steam for one-fifth of the stroke, and the expansion of the steam for the other four-fifths of the stroke. If the engine runs too slow we cut the steam off a little later and thereby increase the average pressure during the expansion. The Automatic Engine, then, is an engine which cuts off the steam at an earlier point in the stroke, if the engine runs too fast, and cuts it off at a later point if it runs too slow. It is the duty of the governor to say just when the steam valve should close and not let any more steam into the cylinder. In the Corliss Engine the steam valves open wide at the beginning of the stroke and let full boiler pressure smack in against the piston.

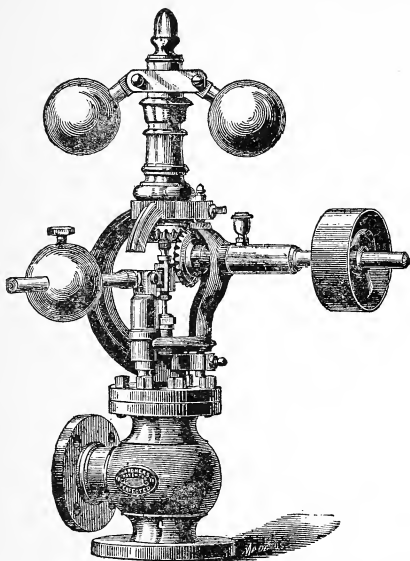
After the piston has advanced to, say one-fifth of its stroke, the valve shuts up as quick as a flash and the expansion begins. If the engine starts too slow, the governor will hold the steam valve open a trifle longer, but will not interfere with its full opening at the beginning of the stroke, or with its flash-like closing when the cut-off is to take place. During all these operations of the governor and the admission valves, the exhaust valves are left entirely alone, and they continue their work unchanged. It will thus be seen that the expansion engine makes provision for the utmost economy in the use of steam, and with the automatic feature added to it, provides that this economy shall not be sacrificed for the purpose of regulating the speed.

THE GARDNER SPRING GOVERNORS.

Construction. — Two balls are rigidly connected to the upper ends of two flat, tapering, steel springs — the lower ends of the springs being secured to a revolving sleeve which receives rotation through mitre gears; links connect the balls to an upper revolving sleeve, which is free to move perpendicularly.

The valve stem passes up through a hollow standard upon which the sleeves revolve, and is furnished with a suitable bearing in the upper sleeve; the closing movement of the valve is upward, and is obtained in the following manner: The balls at the free ends of the springs furnish the centrifugal force and the springs are the main centripetal agency (gravity is not employed). As the balls fly outward, under the centrifugal influence, they move in a curved horizontal path which may be described as an arc, modified by a radius of changing length — the radius being represented by the length and position of the springs; the links represent a radius of lesser length, while the sleeve to which the lower ends of the links are pivoted, being free to rise and fall, nullifies the effect of the links in determining the arc in which the balls travel. As the

balls move outward in their peculiar path, the sleeve is drawn upward by the links, and, as the balls move inward, the sleeve is pushed downward. The change of speed is obtained by increas-



THE GARDNER STANDARD GOVERNOR—CLASS "A"
WITH AUTOMATIC SAFETY STOP AND SPEEDER.

ing or decreasing the centripetal resistance, and accomplished by the action of a spiral spring pivoted against the lever, and by means of a shaft and arm against the valve-stem in the direction to open the valve; a thumb-screw is used to adjust the compres-

sion. A convenient Sawyer's lever is attached to the shaft, and a reliable automatic safety stop is furnished when desired.

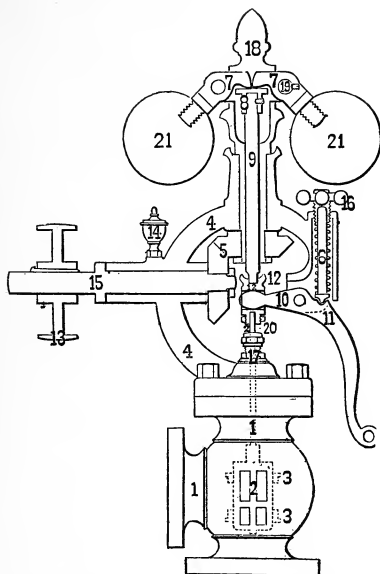
The cut on the preceding page represents the Gardner Standard Governor, Class "A."

This is a Gravity Governor, having an Automatic Safety Stop and Speeder. It is made in sizes from $1\frac{1}{2}$ inches to 16 in., and is especially adapted to the larger type of stationary engines. In action, the centrifugal force of the pendulous balls is opposed by the resistance of a weighted lever, the speed being varied by the position of the weight. The Automatic Safety Stop is very simple in construction and reliable in action. It is accomplished by allowing a slight oscillation of the shaft bearing, which is supported between centers and held in position by the *pull* of the belt; a projection at the lower part of the shaft bearing supports the fulcrum of the speed lever. If the belt breaks or slips off the pulley, the support of the fulcrum is forced back, so as to allow the fulcrum to drop and instantly close the valve. The valve is not affected by steam current and both valve and seats are made of special composition, that effectually resists wear and the cutting action of the steam. The workmanship is of the highest class, all parts being made by the duplicate system, with special machinery.

The cut on the following page represents Class "B" Governor — a combination of the gravity and spring actions.

They are made in sizes from $\frac{3}{4}$ to 10 inches inclusive, and are adapted to all styles of engines. They are provided with Speeder and Sawyer's Lever, but are not automatic. In the Class "B" Governor the centrifugal force of the pendulous balls operates against the resistance of a coiled steel spring, inclosed within a case and pivoted on the speed lever by means of a screw; the amount of compression of the spring can be changed so as to give a wide range of speed. A continuation of the Speed Lever makes a convenient Sawyer's hand lever, which controls the valve by

means of a cord. Sizes $\frac{3}{4}$ to $1\frac{1}{4}$ in., inclusive, have an adjustable frame, which can be set at any desired angle in relation to the



THE GARDNER STANDARD GOVERNOR — CLASS "B."

valve chamber. The valve and chamber are the same as used on Class "A" Governor, and they are made with the same care and style of workmanship.

CHAPTER XIV.

THE FORCE OF STEAM AND WHERE IT COMES FROM.

If water be heated it will expand somewhat, and will finally burst forth into vapor. The vapor will expand enormously, and naturally occupy more space than the water from which it is formed. A cubic inch of water will make a cubic foot of steam; that is, the water has been expanded by heat to seventeen hundred times its original bulk. The steam is very elastic; the water was not. When we say that a cubic inch of water will form a cubic foot of steam, we mean that it will do so when the steam is allowed to rise naturally from the water without any confinement. If the steam is confined, as it would be in a boiler, it could not expand, and consequently would not. If the steam is allowed to rise into the atmosphere from an open vessel, the pressure of the steam would be precisely the same as the pressure of the atmosphere, that pressure being about fifteen pounds to the square inch. An ordinary steam gauge only takes notice of the pressure above the atmospheric pressure. When the hand of the steam gauge stands at zero, it indicates that there is no pressure above the ordinary pressure of the atmosphere. An ordinary steam gauge not connected with anything has the atmosphere acting upon it in both directions, the same as the atmosphere acts upon everything when it can reach both sides. If the air be pumped out of the steam gauge, the atmosphere will then act upon one side, and the hand will move backward until it stands at fifteen points less than nothing. In this condition the steam gauge indicates the absolute zero of pressure. If now the air be allowed to re-enter where it was pumped out, it will begin to exert its pressure upon the steam

gauge, and the hand will move forward; when the full air pressure is on, the gauge hand will stand at its usual zero.

To go into this matter in order that it may be understood that the real pressure of steam is always fifteen pounds greater than ordinary steam gauges indicate. In all of the finer calculations relating to the action of steam, its total pressure must be known, and this total pressure is to be counted from the absolute zero. The real pressure of steam is always the steam gauge pressure, plus fifteen pounds. When a steam gauge shows fifty pounds, the steam really has a pressure of sixty-five pounds. The fifteen pounds of this pressure is nullified by the atmospheric pressure, and the steam gauge shows us our useful pressure. As before stated, a cubic inch of water will make a cubic foot of steam at atmospheric pressure; that is, fifteen pounds to the square inch, absolute pressure, or zero by the steam gauge. If this cubic inch of water was made into steam in a boiler holding just a cubic foot, the steam gauge would show zero. If the boiler was only large enough to hold half a cubic foot, the steam would all be in the boiler, and being confined in half its natural space, it would have double pressure. It would have an absolute pressure of thirty pounds to the square inch, and the steam gauge would indicate fifteen pounds. If this steam was then allowed to pass into a chamber holding a cubic foot, the steam would expand until it filled the chamber, and its pressure would go down again to fifteen pounds absolute. In short, the pressure is in reverse proportion to the amount of space it occupies. The pressure of steam may be doubled by compressing the steam into one-half its former volume, and so on. After water is turned into steam, the steam may be made hotter, but it is not very much expanded. The pressure of steam is increased by forcing more steam into the space occupied. If a boiler contains steam at 50 lbs. pressure, we may increase the pressure by adding more steam, and thus compressing all the

steam that the boiler contains. In the ordinary operation of a steam boiler, the fire turns the water into steam and the more steam there is made and confined, the greater the pressure will be. If the steam is constantly flowing out of the boiler into an engine, the pressure in the boiler must be kept up by continually making new steam to take the place of that drawn off. If we make steam as fast as it is drawn off, and no faster, the pressure will remain the same. If we make steam faster than the engine draws it off, the pressure will rise, and if it is drawn off faster than we make it, the pressure will go down.

The pressure of the steam is due to its desire to expand into a larger body, and it acts outwardly in every direction against everything upon which it presses. If we crowd 600 cu. ft. of steam in a boiler, which will only hold 100 cu. ft., the steam will be held compressed into one-sixth its natural bulk, and will thus have a pressure of 90 lbs., and the steam gauge will show 75 lbs. If a hole 1 in. square be cut in the boiler, and a weight of 75 lbs. be laid over the hole, the steam will just lift the weight. If the atmospheric pressure could be removed from one sq. in. of the top of the weight, the steam would then be capable of lifting a 90 lb. weight. The force which this steam will exert to lift a weight, or any similar thing against which it acts, will equal the pressure per square inch multiplied by the number of square inches which the steam acts upon. It will thus be readily understood that if we lead a pipe from the boiler and fit a piston in the pipe, the steam will tend to force this piston out of the pipe.

THE ENERGY STORED IN STEAM BOILERS.

A steam boiler is not only an apparatus by means of which the potential energy of chemical affinity is rendered actual and available, but it is also a storage reservoir, or a magazine, in which a quantity of such energy is temporarily held; and this quantity,

always enormous, is directly proportional to the weight of water and of steam which the boiler at the time contains. The energy of gunpowder is somewhat variable, but a cubic foot of heated water under a pressure of 60 or 70 lbs. per square inch, has about the same energy as one pound of gunpowder; at a low red heat, it has about forty times this amount of energy.

The letters B. T. U. are the initial letters of the words British Thermal Unit, and are used as abbreviations of those words. The British Thermal Unit is the unit of heat used in this country and England, and may be said to be the amount of heat required to raise the temperature of one pound of pure water from 60 to 61 degrees Fahr. It is often necessary to distinguish between B. T. U. used in this country and the French thermal unit used in France and most of the countries of Europe. The French terminal unit is called the calorie, and is the heat required to raise the temperature of one kilogram of water one degree centigrade.

Safety at high pressure depends entirely upon the design, material, and workmanship, and it is a question that may be regarded as settled long since, that a steam boiler properly constructed and designed for a working pressure of 150 pounds is as safe as a properly constructed boiler designed for eighty pounds, with the chances in favor of the high pressure, for the reason that less care is taken in selecting boilers for the ordinary pressure, as anything in the shape of a boiler is regarded, by careless people, as good enough for the lower pressures, with which they have become so familiar as to become almost too careless.

SPECIAL HIGH PRESSURE BOILERS.

The extending use of compound steam engines, which make necessary the employment of high steam pressures, calls for steam boilers specially designed to successfully operate under working pressures ranging from 100 to 160 pounds. These boilers must be safe and economical and of such construction as to afford

access for examination and repair, moderate in first cost and maintenance and of simplest possible form. Fortunately, the controlling conditions are not difficult to meet, and there are several well-tried and approved types of steam boilers from which to make your selection, choice being governed by the space at disposal, arrangement of plant, kind of fuel and other circumstances.

TYPES OF BOILERS.

Four types that are very successfully used, and they represent good practice for high pressure work, being respectively the Horizontal, Tubular and Vertical Fire Box Tubular Boilers. The Fire Box Locomotive Tubular Boiler may safely be added to this list and gives most excellent satisfaction.

THE WATER TUBE BOILER.

Steam boilers must be designed with reference to the pressure of steam to be carried, and when so designed and constructed are quite as safe at one pressure as another, preference being given to the type that is simplest in form and the least liable to destruction, not so much by reason of the pressure carried as by failure to provide for the strains of expansion and contraction within itself.

HORSE POWER OF BOILERS.

In determining the proper size or evaporating capacity of a boiler to supply steam for a given purpose, it is necessary to consider the number of pounds of dry steam actually required per hour at the stated pressure. The standard horse power rating for any steam boiler is 30 pounds of water evaporated (made into steam) from feed water at 212° per hour. The total pounds steam required for your purpose per hour on this basis divided by 30 will give the standard boiler horse power required. Manu-

facturers of steam boilers sometimes rate the horse power of their boilers by so many square feet of heating surface per horse power ; 8 to 15 sq. ft. of heating surface, they figure, equals one horse power. This rating does not represent the actual capacity of the steam boiler, the only safe guide being the evaporative performance in pounds of steam from water at 212° to steam at 212°. Some boilers will evaporate this with 8 sq. ft., some requiring from 15 to 18 sq. ft., hence, the absurdity of rating horse power of boilers of unlike construction by the square feet of heating surface. But as the practice is an old one in the case of the well-known tubular boiler, so deservedly popular and used more than any other kind, good practice is to allow approximately as follows : —

Allow for each Horse Power —

Steam for Heating, etc.	15 sq. ft. heating surface.
For Plain Throttle Engine,	15 “ “ “
For Simple Corliss Engine	12 “ “ “
For Compound Corliss Condensing .	10. “ “ “

Hence, a boiler for heating purposes or furnishing steam for —

Plain Slide engine with 1,500 sq. ft. surface, equals .	100 H. P.
For Simple Corliss Engine, same boiler “ .	125 H. P.
For Compound Engine “ .	150 H. P.

The best method is to compare boilers with their evaporative efficiency and not by heating surface.

The following is an approximate consumption of steam per indicated horse power per hour for engine : —

Plain Slide Engine	60 to 70 pounds.
High Speed Automatic Engine	30 to 50 “
Simple Corliss Engine	25 to 35 “
Compound Corliss Engine	15 to 20 “
Triple Expansion Engine	13 to 17 “

depending upon the horse power, steam pressure, condition of engine, load, etc.

Each pound of first-class steam coal consumed under a well-proportioned steam boiler, well managed, should evaporate 10 pounds of steam from water 212° to steam at 212° . The average boiler throughout the country, with ordinary fuel and management, ranges from 5 to 8 pounds steam per pound of coal, and it would scarcely be safe to make fuel guarantees per horse power of engine without a counter guarantee on the part of the purchaser, when his old boiler is used, that the fuel economy is based on an evaporative efficiency of a given pounds water evaporated per pound of coal per hour of his boiler. The usual practice is to ignore the boiler altogether and guarantee pounds of steam per indicated horse power per hour used by the engine. This affords an exact method and is not hampered by unknown conditions and places all tests on an equal or comparative basis.

THE RATING OF BOILERS.

It is considered usually advisable to assume a set of practically attainable conditions in average good practice, and to take the power so obtainable as the measure of the power of the boiler in commercial and engineering transactions. The unit generally assumed has been usually the weight of steam demanded per horse power per hour by a fairly good steam engine. In the time of Watt, one cubic foot of water per hour was thought fair; at the middle of the present century, ten pounds of coal was a usual figure, and five pounds, commonly equivalent to about 40 lbs. of feed water evaporated, was allowed the best engines. After the introduction of the modern forms of engine, this last figure was reduced 25 per cent, and the most recent improvements have still further lessened the consumption of fuel and of steam. By general consent the unit has now become thirty pounds of dry steam per

horse power per hour, which represents the performance of non-condensing engines. Large engines, with condensers and compound cylinders, will do still better. A committee of the American Society of Mechanical Engineers recommended thirty pounds as the unit of boiler power, and this is now generally accepted. They advised that the commercial horse power be taken as an evaporation of 30 lbs. of water per hour from a feed water temperature of 100° Fahr. into steam at 70 lbs. gauge pressure, which may be considered equal to $34\frac{1}{2}$ lbs. of water evaporation, that is, $34\frac{1}{2}$ lbs. of water evaporated from a feed water temperature of 212° Fahr. into steam at the same temperature. This standard is equal to 33,305 British thermal units per hour. A boiler rated at any stated power should be capable of developing that power with easy firing, moderate draught and ordinary fuel, while exhibiting good economy, and at least one-third more than its rated power to meet emergencies.

WORKING CAPACITY OF BOILERS.

The capacity or horse-power of a boiler, as rated for purposes of the trade, is commonly based upon the extent of heating surface which it contains. The ordinary rating was for a long time 15 sq. ft. of surface per horse-power. At the present time most of the stationary boilers are sold on the basis of from 10 to 12 sq. ft. per horse-power, the power referred to being the unit of 30 lbs. evaporation per hour. This method of rating is arbitrary, inasmuch as it is independent of any condition pertaining to the practical work of the boiler. The fact that 10 or 12 sq. ft. of surface is sold for one horse-power is no guarantee that this extent of surface will have a capacity of one horse-power when the boiler is installed and set to work. The boiler in service and the boiler in the shop are two entirely different things, and where one passes to the other, the trade rating disappears. New

conditions, such as draft, grate surface, kind of fuel and management, then take effect, and these have a controlling influence upon the working capacity. The working power may be found to be much less than the arbitrary rate, or it may be a much larger quantity; all depending upon the surrounding conditions. I call attention to this subject, because it is important in some cases to have a clearer understanding as to what is the working capacity of a boiler. Suppose a boiler manufacturer enters into an agreement to install a boiler which will have a capacity of 100 horse-power. Suppose that on account of poor draft, low grade of fuel, or unfavorable surroundings, all of which are known beforehand, the boiler develops the power named only with the most careful handling. Is the working capacity, under the circumstances, 100 horse-power? Assuredly not, for the purchaser could not depend upon it in ordinary running for that amount of power. Yet the builder may claim that he has fulfilled his contract.

The former boiler test committee of the American Society of Mechanical Engineers established a working rate for boiler capacity which meets such cases in a definite and satisfactory manner. They realized that for the purpose of good work, a boiler should be capable of developing its capacity with a moderate draft and easy firing; and that it should be capable of doing one-third more in cases of emergency. In other words, a boiler which is sold for 100 horse-power should develop $133\frac{1}{3}$ horse-power under conditions giving a maximum capacity. In the instance cited above, the boiler should have been capable of giving 100 horse-power with such ease that there would be a reserve of $33\frac{1}{3}$ horse-power available when urged to this extra power. According to this rule, the capacity of a boiler in a working plant would be found by determining how much water it can evaporate under conditions which will give its maximum capacity; that is, with wide open damper, with the maximum draft available and with the best con-

ditions as to the handling of the fire, and in this way ascertain the maximum power available under these circumstances. Having found this maximum quantity, the working capacity or the rated power would be determined by deducting from the maximum 25 per cent. This rule, it will be seen, does not take into account the extent of the heating surface or the trade rating, but it deals solely with the capabilities of the boiler under the conditions which pertain to its work.

CODE OF RULES FOR BOILER TESTS.

Starting and stopping a test.— A test should last at least ten hours of continuous running, and twenty-four hours whenever practicable. The conditions of the boiler and furnace in all respects should be, as nearly as possible, the same at the end as at the beginning of the test. The steam pressure should be the same; the water level the same; the fire upon the grates should be the same in quantity and condition; and the walls, flues, etc., should be of the same temperature. To secure as near an approximation to exact conformity as possible in conditions of the fire and in the temperature of the walls and flues, the following method of starting and stopping a test should be adopted:—

Standard method.— Steam being raised to the working pressure, remove rapidly all the fire from the grate, close the damper, clean the ash-pit, and, as quickly as possible, start a new fire with weighed wood and coal, noting the time of starting the test and the height of the water level while the water is in a quiescent state, just before lighting the fire. At the end of the test, remove the whole fire, clean the grates and ash-pit, and note the water-level when the water is in a quiescent state; record the time of hauling the fire as the end of the test. The water-level should be as nearly as possible the same as at the beginning of the test. If it is not the same, a correction should be made by computa-

tion, and not by operating pump after test is completed. It will generally be necessary to regulate the discharge of steam from the boiler tested by means of the stop-valve for a time while fires are being hauled at the beginning and at the end of the test, in order to keep the steam pressure in the boiler at those times up to the average during the test.

Alternate method. — Instead of the standard method above described, the following may be employed where local conditions render it necessary: At the regular time for slicing and cleaning fires have them burned rather low, as is usual before cleaning, and then thoroughly cleaned; note the amount of coal left on the grate as nearly as it can be estimated; note the pressure of steam and the height of the water-level — which should be at the medium height to be carried throughout the test — at the same time; and note this time as the time for starting the test. Fresh coal which has been weighed, should now be fired. The ash-pits should be thoroughly cleaned at once before starting. Before the end of the test the fires should be burned low, just as before the start, and the fires cleaned in such a manner as to leave the same amount of fire, and in the same condition, on the grates as on the start. The water-level and steam pressure should be brought to the same point as at the start, and the time of the ending of the test should be noted just before fresh coal is fired.

DURING THE TEST.

Keep the conditions uniform. — The boiler should be run continuously without stopping for meal-times, or for rise or fall of pressure of steam due to change of demand for steam. The draught being adjusted to the rate of evaporation or combustion desired before the test is begun, it should be retained constant during the test by means of the damper. If the boiler is not connected to the same steam-pipe with other boilers, an extra outlet

for steam with valve in same should be provided, so that in case the pressure should rise to that at which the safety valve is set, it may be reduced to the desired point by opening the extra outlet, without checking the fire. If the boiler is connected to a main steam-pipe with other boilers, the safety valve on the boiler being tested should be set a few pounds higher than those of the other boilers, so that in case of a rise in the pressure the other boilers may blow off, and the pressure be reduced by closing their dampers, allowing the damper of the boiler being tested to remain open, and firing as usual. All the conditions should be kept as nearly uniform as possible, such as force of draught, pressure of steam and height of water. The time of cleaning the fires will depend upon the character of the fuel, the rapidity of combustion and the kind of grates. When very good coal is used and the combustion not too rapid, a ten-hour test may be run without any cleaning of the grates, other than just before the beginning and just before the end of the test. But in case the grates have to be cleaned during the test, the intervals between one cleaning and another should be uniform.

Keeping the records.—The coal should be weighed and delivered to the firemen in equal portions, each sufficient for about one hour's run, and a fresh portion should not be delivered until the previous one has all been fired. The time required to consume each portion should be noted, the time being recorded at the instant of firing the first of each new portion. It is desirable that at the same time the amount of water fed into the boiler should be accurately noted and recorded, including the height of the water in the boiler, and the average pressure of steam and temperature of feed during the time. By thus recording the amount of water evaporated by successive portions of coal, the record of the test may be divided into several divisions, if desired at the end of the test, to discover the degree of uniformity of combustion, evaporation and economy at different stages of the test.

PRIMING TESTS.

In all tests in which accuracy of results is important, calorimeter tests should be made of the percentage of moisture in the steam, or of the degree of superheating. At least ten such tests should be made during the trial of the boiler, or so many as to reduce the probable average error to less than one per cent, and the final records of the boiler tests corrected according to the average results of the calorimeter tests. On account of the difficulty of securing accuracy in these tests, the greatest care should be taken in the measurements of weights and temperatures. The thermometers should be accurate to within a tenth of one degree, and the scales on which the water is weighed to within one-hundredth of a pound.

ANALYSES OF GASES.

Measurement of air supply, etc.—In tests for purposes of scientific research, in which the determination of all the variables entering into the test is desired, certain observations should be made which are in general not necessary in tests for commercial purposes. These are the measurements of the air supply, the determination of its contained moisture, the measurement and analysis of the flue gases, the determination of the amount of heat lost by radiation, of the amount of infiltration of air through the setting, the direct determination by calorimeter experiments of the absolute heating value of the fuel, and (by condensation of all the steam made by the boiler) of the total heat imparted to the water.

The analysis of the flue gases is an especially valuable method of determining the relative value of different methods of firing, or of different kinds of furnaces. In making these analyses, great care should be taken to procure average samples,

since the composition is apt to vary at different points of the flue, and the analyses should be intrusted only to a thoroughly competent chemist, who is provided with complete and accurate apparatus. As the determination of the other variables mentioned above are not likely to be undertaken except by engineers of high scientific attainments, and as apparatus for making them is likely to be improved in the course of scientific research, it is not deemed advisable to include in this code any specific directions for making them.

RECORD OF THE TEST.

A "log" of the test should be kept on properly prepared blanks, containing headings as follows:—

TIME.	PRESSURES.			TEMPERATURES.					FUEL		FEED WATER.	
	Barometer.	Steam gauge.	Draft gauge.	External air.	Boiler room.	Flue.	Feed water.	Steam.	Time.	Pounds.	Time.	Lbs. or cu. ft.

REPORTING THE TRIAL.

The final results should be recorded upon a properly prepared blank, and should include as many of the following items as are adapted for the specific object for which the trial is made. The items marked with a * may be omitted for ordinary trials, but are desirable for comparison with similar data from other sources.

Resources of the trials of a	
Boiler at	
To determine	
1. Date of trial	hours.
2. Duration of trial	hours.

DIMENSIONS AND PROPORTIONS.

3. Grate-surface wide long area	Sq. ft.
4. Water-heating surface	Sq. ft.
5. Superheating surface	Sq. ft.
6. Ratio of water-heating surface to grate-surface	

AVERAGE PRESSURES.

7. Steam pressure in boiler, by gauge	lbs.
*8. Absolute steam pressure	lbs.
*9. Atmospheric pressure, per barometer	in.
10. Force of draught in inches of water	in.

AVERAGE TEMPERATURES.

*11. Of external air	deg.
*15. Of fire-room	deg.
*13. Of steam	deg.
14. Of escaping gases	deg.
15. Of feed-water	deg.

FUEL.

16. Total amount of coal consumed	lbs.
17. Moisture in coal	per cent.
18. Dry coal consumed	lbs.
19. Total refuse, dry pounds equals	per cent.
20. Total combustible (dry weight of coal, item 18, less refuse, item 19)	lbs.
*21: Dry coal consumed per hour	lbs.
*22. Combustible consumed per hour	lbs.

RESULTS OF CALORIMETRIC TESTS.

- | | |
|---|-----------|
| 23. Quality of steam, dry steam being taken
as unity | |
| 24. Percentage of moisture in steam . . . | per cent. |
| 25. Number of degrees superheated . . . | deg. |

WATER.

- | | |
|---|----------|
| 26. Total weight of water pumped into boiler
and apparently evaporated | lbs. |
| 27. Water actually evaporated, corrected for
quality of steam | lbs. |
| 28. Equivalent water evaporated into dry
steam from and at 212° F. | lbs. |
| *29. Equivalent total heat derived from fuel
in B. T. U. | B. T. U. |
| *30. Equivalent water evaporated in dry
steam from 212° F. per hour | lbs. |

ECONOMIC EVAPORATION.

- | | |
|---|------|
| 31. Water actually evaporated per pound of
dry coal, from actual pressure and
temperature | lbs. |
| 32. Equivalent water evaporated per pound
of dry coal, from 212° F. | lbs. |
| 33. Equivalent water evaporated per pound
of combustible from and at 212° F. | lbs. |

COMMERCIAL EVAPORATION.

- | | |
|--|------|
| 34. Equivalent water evaporated per pound
of dry coal with one-sixth refuse, at 70
lbs. gauge pressure, from temperature of
100° F., equals item tests 33 X. 0.7249
pounds | lbs. |
|--|------|

† Corrected for inequality of water level and of steam pressure at beginning and end of test.

RATE OF COMBUSTION.

35. Dry coal actually burned per sq. foot of grate-surface per hour lbs.
- | | | | | |
|------|---|---|---|------|
| *36. | { | Consumption of dry coal per hour. Coal assumed with one-sixth refuse. | Per sq. ft. of grate surface . . . | lbs. |
| *37. | | | Per sq. ft. of water heating surface . | lbs. |
| *38. | | | Per sq. foot of least area for draught. | lbs. |

RATE OF EVAPORATION.

39. Water evaporated from and at 212° F. per square foot of heating surface per hour.
- | | | | | |
|------|---|---|--|------|
| *40. | { | Water evaporated per hour from temperature of 100° F. into steam of 70 lbs. gauge pressure. | Per sq. ft. of grate surface . . . | lbs. |
| *41. | | | Per sq. ft. of heating surface . . | lbs. |
| *42. | | | Per sq. ft. of least area for draught. | lbs. |

COMMERCIAL HORSE POWER.

43. On basis of 30 lbs. of water over hour evaporated from temperature of 100° F. into steam of 70 lbs. gauge pressure (34½ lbs. from and at 212°) H. P.
44. Horse-power, builders' rating at sq. ft. per horse-power
45. Per cent developed above or below rating per cent.

* NOTE. Items 20, 22, 33, 34, 36, 37, 38 are of little practical value. For if the result proves to be less satisfactory than expected on the actual coal, it is easy for an expert fireman to decrease No. 20 by simply taking out some partly consumed coal in cleaning fires, and thus make a fine showing on that simply ideal or theoretical unit, the "pound combustible." The question at issue is always what can be done with an actual coal, not the "assumed coal" of items 34, 36, 37 and 38.

IMPORTANCE OF THE BOILER.

Too often it is considered as of secondary importance.— It is too frequently the case that the engine is looked after sharply and trimmed and plumed as though it was the only part of the steam plant that needed attention, while the boiler plant is left to care for itself. We may derive satisfaction from an engine that works quietly, and feel we are getting the most out of it, and those in charge are generally powerless to obtain a higher standard, because mistakes in construction cannot be afterwards modified. Too often the engine may be said to have the defects of its qualities, and though we may know the faults, we are not in position to remedy them. Great fascination is experienced, however, in endeavoring to find out the errors of omission and commission, and the fewer they are the greater is the credit to the maker. As a long period is required for some of these errors to develop themselves, watchful care goes on continually. The engine favors this solicitude, as it is in the nature of an exact science in almost every part. If we are not sure of making up for deficiencies, we are able to put our finger on the weak spots, and that sufficiently or accurately enough to leave no doubt as to their locality. We can trace the steam as it leaves the boiler and account for it in its passage through the pipes, valves, cylinders, and so on, to the condenser. The effects of excessive lengths and sizes of connections from boiler to engine, undue clearance, the correct setting of valves, due proportions of cylinders and receivers, are all well known and understood. A capable engineer, therefore, finds that his interest increases with the lessons every day brings forth. The motion itself is the cause of many of the demands upon him from the wear and tear produced thereby; adjustments have continually to be made to keep even an engine that runs well up to its proper standard, and if from any ill design, attention is constantly required, then very little opportunity is left for

outside matters. These remarks generally apply where any high-class installation is fitted, whatever it be for — electric lighting, mill work, marine, pumping or similar work — if the machine is to be kept running for stretches at a time and give the best torsional effect with less expenditure of steam. Hence, it can be well understood why the boiler often suffers for want of recognition. The conditions ruling with it are quite different. It cannot be set down in place just as it leaves the factory, fully ready for work, as the engines can. There are its brickwork casings and chimney to be put up, and these very often have a great deal to do with the economical question. The engine only requires erecting just as it was in the shop, but the boiler must be complete with its settings before it can be steamed, and this is where some of the otherwise good qualities of the generating apparatus may be nullified. The course of the flues, or the distance of the chimney from them may not be correct, so that the height of the chimney does not have its full effect on the draft.

The brickwork may not be of a character to prevent leakages and keep the boiler what it should be — a good reservoir of heat, ready for all demands of the engine upon it. On the other hand, when once started there are no risks of breakdown. There are no parts, which, by reason of their motions, have a tendency to get out of order or to come to a sudden stop. Thus the steady-going servant is left pretty much to take care of itself, and mountings have to be of a kind requiring no attention of any sort, or they will certainly get into disuse. In a word, they must be automatic in their action, or duplicated. Valves are arranged so that if one should stick, there is a second one on which to rely; gauge glasses to avoid false indications; fusible plugs for emergencies in case of low water. These and other contrivances are made to meet every possible contingency from want of oversight, and that such few accidents happen proves that they come up to expectation. Taking a boiler plant as a whole, unlike the

engine as it is in every respect, details of improvement may be applied at any time. The engine is constructed and no fault in principle admits of amelioration afterwards. We can but attend to trifles, but with the boiler, though the structure itself cannot be modified much, we find there are several fittings which may be applied both to boiler and flues at any period; therefore, though an engineer must of necessity never leave his engine, it is much more likely to repay him to give what spare time he has to the source of his power. Varying according to the class of engine, there should be an efficient water heater fixed, and no impurity admitted thereto. If the form of the boiler is in any way detrimental, aids to circulation are required, so that there is no stagnant water anywhere. Dry steam is such a desideratum that any good means for its provision is always sure to be of advantage.

Prominence has been given in recent years to heating the air before it reaches the fire, and to exhausting to a minimum what remains in the gases from the flues. There is certain prejudice against mechanical firing and grate fittings, but there can be no question as to the economical results obtained from them, and that is why this class of apparatus has made its way in recent years. The same is the case as regards forced draught for getting large powers in emergency or burning inferior coal. The whole subject of economical firing and smoke consumption is but imperfectly understood, and if instead of the old standard of coal in terms of water evaporated, the cost of the steam were taken in money value, then the interest on the relative prices of the different apparatus would receive their proper measure. What may be very good when tested on coal saving alone, would not come out always so well if the amount paid for it, and any after repairs were strictly considered. Again, if great care is not taken, the adoption of an otherwise important improvement may lessen the advantage of something equally good already in use.

before. There is no settled consensus of opinion possible on this matter, because no two sets of conditions are alike. Not only do the different types of boilers require to be looked at from different standpoints, but even two exactly similar ones may be perfectly at variance in their steaming powers by reason of the surroundings with which each is erected in place.

A **boiler-maker** can well plead that his responsibility ends with test and delivery, but this can never be so with the engine maker, and it is customary to retain a portion of the purchase money for a time to insure due performance of the contract entered into. This is too much to ask, because though an engine may appear in every respect satisfactory in the shop, when it comes to steady daily running, if there are any flaws in manufacture, they are certain to be discovered. With the boiler itself, however, the double water pressure to which it is subjected represents sufficiently all the strains it will have to undergo under steam. To what extent the difference in the conditions pertaining to the two component parts of a steam plant may have had to do with the general separation of the trades from each other, it is not my present province to enter; but where an engine maker formerly produced his own boilers, he now finds it more profitable to buy from regular factories turning only the one class of work. There is no risk to run, because boilers seldom fail to come to the standard expected of them, but where the engineer can rest satisfied in purchasing a boiler, it would not be possible for a boiler maker to do the same with an engine. The latter, therefore, starts in life with an importance that is denied to its fellow, and this continues throughout its existence. I have endeavored to show, however, that the boiler should not be despised because it does not start with the lead, but rather that it admits of improvements after location that are well worthy the attention of all engineers who have economy in view.

DEFINITIONS AS APPLIED TO BOILERS AND BOILER MATERIALS.

Cohesion is that quality of the particles of a body which causes them to adhere to each other, and to resist being torn apart.

Curvilinear seams. — The curvilinear seams of a boiler are those around the circumference.

Elasticity is that quality which enables a body to return to its original form after having been distorted, or stretched by some external force.

Internal radius. — The internal radius is one-half of the diameter, less the thickness of the iron. To find the internal radius of a boiler, take one-half of the external diameter and subtract the thickness of the iron.

Limit of elasticity. — The extent to which any material may be stretched without receiving a permanent "set."

Longitudinal seams. — The seams which are parallel to the length of a boiler are called the longitudinal seams.

Strength is the resistance which a body opposes to a disintegration or separation of its parts.

Tensil strength is the absolute resistance which a body makes to being torn apart by two forces acting in opposite directions.

Crushing strength is the resistance which a body opposes to being battered or flattened down by any weight placed upon it.

Transverse strength is the resistance to bending or flexure, as it is called.

Torsional strength is the resistance which a body offers to any external force which attempts to twist it round.

Detrusive strength is the resistance which a body offers to being clipped or shorn into two parts by such instruments as shears or scissors.

Resilience or toughness is another form of the quality of

strength; it indicates that a body will manifest a certain degree of flexibility before it can be broken; hence, that body which bends or yields most at the time of fracture is the toughest.

Working strength.— The term “ working strength ” implies a certain reduction made in the estimate of the strength of materials, so that when the instrument or machine is put to use, it may be capable of resisting a greater strain than it is expected on the average to sustain.

Safe working pressure, or safe load.— The safe working pressure of steam-boilers is generally taken as $\frac{1}{3}$ of the bursting pressure, whatever that may be.

Strain in the direction of the grain, means strain in the direction in which the iron has been rolled; and in the process of manufacturing boiler-plates, the direction in which the fibres of the iron are stretched as it passes between the rolls.

Stress.— By the term “ stress ” is meant the force which acts directly upon the particles of any material to separate them.

HEAT AND STEAM.

The steam engine is a machine for the conversion of heat into power in motion. The heat is generated by the combustion of fuel; the transmission is accomplished through the agency of steam; the power is made available and brought under control by means of the engine.

The effect of heat upon water is to vaporize it, if there be intensity enough, the heat will, under proper conditions, cause water to boil; the vapor produced by boiling is called steam, and steam under pressure is a product which is the end and aim of that portion of that steam engine known as the boiler and furnace. The steam engine then is to be considered as a form of the heat engine; of which the furnace, boiler, and the engine itself are to be regarded as separate portions of the same mechanism.

The conditions demanded upon economic grounds to secure the highest efficiency in the steam engine are: —

1. A proper construction of the furnace so as to secure the perfect combustion of fuel.

2. The heat generated in the furnace must be transferred to the water in the boiler without loss.

3. The circulation in the boiler must be so complete that the heat from the furnace may be quickly and thoroughly diffused throughout the whole body of water.

4. The construction of an engine that will use the steam without loss of heat, except so much as may be necessary to perform work required of the engine.

5. The recovery of heat from exhaust steam.

6. The absence of friction and back pressure in the working of the engine.

It is superfluous to say that these conditions are not fulfilled in any engine of the present day. At best the combustion of fuel is only approximately perfect, the losses being due to several causes, among which are, — unburned fuel falling through the spaces in the grates and mingling with the ashes. This, with some kinds of coal, and improper firing, amounts to a large percentage of the furnace waste. It is not possible with any present method of setting boilers to transfer all the heat of the furnace to the water in the boiler; nor can there be, for the reason that the temperature of the escaping gases must not be lower than that of the steam in the boilers, or direct loss will result in the radiation of heat from the tubes or flues in the boiler, by thus reheating the gases to the steam temperature. If the steam pressure is 80 lbs. per square inch above the atmosphere, the corresponding temperature due to this pressure is 324° Fahr. The temperature of the escaping gases ought not, therefore, to be less than 350° Fahr., where they leave the boiler flues or tubes to pass off into the chimney. If the temperature of the furnace be taken

at 2,000° Fahr., and the escaping gases at 400° Fahr., it will be seen that one-fifth of the heat generated in the furnace is passing off without performing work. This is a very great loss, and these figures understate, rather than correctly give, the loss from this one source. Efforts have been made to utilize the temperature of these waste gases by making them heat feed water by means of coils, or by that particular disposition of pipes and connection known as an economizer. Others have turned it into account by making it heat the air supplied the fuel on the grates. Any heat so reclaimed is money saved, provided it does not cost more to get it than it is worth in coal to generate a similar quantity of heat. It is doubtful whether the loss in this particular direction can be brought below 20 per cent of the fuel burned, at least, by any method of saving now known.

The loss by bad firing and by a bad construction of furnace is often a large one. It has been demonstrated experimentally that 20 to 30 per cent of fuel can be saved by a proper construction and operation of the furnace. The direct causes of loss are, too low temperature of furnace for properly burning fuels, especially such as are rich in hydro-carbon gases; or, by the admission of too much cold air over or back of the fire; or, by the admission of too little air under the fire so that carbonic oxide gas is generated instead of carbonic acid gas, the former being a product of incomplete, the latter the product of complete combustion. The relative heating powers of fuel burned, resulting in the production of either of these two gases being as follows:—

	Heat Units.
1 pound of carbon burned to carbonic acid gas . . .	14,500
1 pound of carbon burned to carbonic oxide . . .	4,500
	<hr style="width: 20%; margin-left: auto; margin-right: 0;"/>
Units of heat lost by burning to carbonic oxide . . .	10,000

It will be seen that here is an enormous source of loss, and all that is required to prevent it is a proper construction of furnace.

Smoke is a nuisance which ought to be prohibited by stringent legislation. There is no good reason for its polluting presence in the atmosphere, defiling everything with which it comes in contact. Smoke regarded as a source of direct loss is greatly over-estimated; the fact is, the actual amount of coal lost to produce smoke is very trifling. The presence of smoke indicates a low temperature of furnace or combustion chamber; if the temperature were sufficiently high and the furnace properly constructed, smoke could not be generated. The prevention of smoke is easily accomplished, and with it a more economical combustion of hydro-carbon fuels.

Radiation.— A considerable loss of heat occurs by radiation from the furnace walls; this may be prevented in part by making the walls hollow, with an air space between. If a force blast is used the air may be admitted at the back end of the boiler-setting and by passing through between the walls will become heated, and if conveyed into the ash pit at a high temperature will greatly assist combustion and thus tend to a higher economy.

Air required.— In regard to the quantity of air required, it will vary somewhat with the fuel used, but in general, 12 pounds of air are sufficient to completely burn one pound of coal; practically, however, 15 to 25 pounds are furnished, being largely in excess of that which the fire can use, and must pass off with the gases as a waste product. This surplus air enters cold and leaves the furnace heated to the same temperature as that of the legitimate and proper products of combustion, and thus directly operates to the lowering of the furnace temperature.

Measurement of heat.— A heat unit is that quantity of heat necessary to raise the temperature of one pound of water one degree, from 39° to 40° Fahr., this being the temperature of the greatest density of water. A thermal unit, a heat unit, or unit of heat, all mean the same thing. Experiments have been made to determine the mechanical equivalent of a heat unit, and it is

found to be equal to 772 pounds raised one foot high. This is sometimes called "Joule's equivalent," after Dr. Joule, of England; it is also known as the dynamic value of a heat unit.

Knowing the number of heat units in a pound of coal enables us to calculate the amount of work it should perform. Let us suppose a pound of coal to be burned to carbonic acid gas, and to develop during its combustion 14,000 heat units, then: $14,000 \times 772$ equals 11,008,000 foot pounds.

That is to say, if one pound of coal were burned under the above conditions it would have a capacity for doing work represented by the lifting of eleven millions of pounds one foot high against the action of gravity. Suppose this to be done in one hour, then we should expect to get from one pound of coal an equivalent of 5.56 H. P. It is well known that only a very small fraction of such equivalent is secured in the very best modern practice. The question is, where does this heat go, and why is it so small a portion of it is actually utilized? The losses may be accounted for in several ways, and, perhaps, as follows: —

The heat wasted in the chimney	25 per cent.
Through bad firing	10 "
Heat accounted for by the engine (not indicated)	10 "
Heat by exhaust steam	55 "
	—————
	100 per cent.

This is about 2 pounds of coal per hour per indicated horse power, which is regarded as a very high attainment, and is seldom reached in ordinary cut-off engines. It requires good coal, good firing, and an economical engine to get an indicated horse power from two pounds of coal burned per hour. As coal varies in quality it is a better plan to deduct the ashes and other incombustible matter, and take the net combustible as a basis of comparison. The best coal when properly burned

is capable of evaporating 15 pounds of water from and at a temperature of 212° Fahr. The common evaporation is about half that amount, and with the best improved furnaces and careful management, it is seldom that 10 pounds of water is exceeded, and is to be regarded as a high rate of evaporation. In experimental tests, 12 pounds have been reported, but it is doubtful whether there is any steam boiler and furnace which is constantly yielding any such results.

Circulation of water in a boiler is a very important feature to secure the highest evaporative results. Other things being equal, the boiler which affords the best circulation of water will be found to be the most economical in service. Circulation is greatly hindered in some boilers by having too many tubes; in others, by introducing in the water space of the boiler too many stays and making the water spaces too narrow. To secure the highest economy there must be thorough circulation from below upwards, in the boiler. There is no doubt that a great deal of heat is lost because the construction is such as to hinder a free flow of water around the tubes and sides of the boiler.

The construction of an engine that will use steam without loss of heat, except so much as may be necessary to perform work required of it, is a physical impossibility. Among the sources of loss in an engine are: radiation, condensation of steam in unjacketed cylinders, and the enormous loss of heat occasioned by exhausting the steam into the atmosphere.

Radiation is usually classed among the minor losses in a steam engine. There is a considerable loss of heat caused by radiation from steam boilers and pipes exposed to the atmosphere, and not protected by a suitable covering. Much of this heat may be saved by employing a non-conducting material as a covering, which, though not preventing all radiation, will save enough heat to make its application economical. It is well known that some bodies conduct and radiate heat less rapidly than others, but it

must not be understood that the absolute value of such a covering is inversely proportioned to the conducting power of the material employed, because, in its application, the outer surface is enlarged and the radiation will be going on less actively at any given point, but the enlarged surface exposed reduces somewhat the apparent gain.

SELECTION OF A BOILER.

The selection of a boiler for a particular service will naturally suggest the following questions: —

1. What kind of a boiler shall it be?
2. Of what material shall it be made?
3. What size shall it be in order to furnish a certain power?

In reply to the first question, it is to be expected there will be wide differences of opinion, varying with the locality, usage, and service for which it is intended. One of the first things to be taken into account in the selection of a boiler is the quality of water to be used in it for generating steam. If the water is pure, then it makes little difference what kind of boiler be selected, so far as incrustation affects selection. If the water is hard and will deposit scale upon evaporation, then a boiler should be selected which will admit of thorough inspection and removal of any deposit formed within it.

For hard water, the ordinary flue boiler will be found a good one, as it is favorable to a thorough circulation of water, and permits easy access to all parts of it for examination and cleaning. It does not, however, present the extent of heating surface for a given space that tubular boilers offer; but with hard water the boiler is quite as economical if kept in good condition.

The difficulty with tubular boilers when used in connection with hard water is that the tubes will in a short time become coated with scale; this prevents the transmission of heat, not only, but impairs the circulation of the water around them.

Both of these are opposed to economy in the fact that it requires more coal to generate a given weight of steam in the first case; and second, by reason of deficient circulation the plates over the fire are likely to become overheated and burnt and so become dangerous; thus directly contributing to accident or disaster.

The matter of circulation in boilers is one which should have careful attention in making a selection. There is little trouble in this regard with any of the ordinary types of boilers so long as they are clean and new, and properly proportioned. Nor is there likely to be any difficulty thereafter if the water is soft and clean. Circulation is often seriously impaired by putting in too many tubes in a boiler, the effect of which is to so fill up the space that the heated particles of water forcing their way upwards from below meet with so much resistance that they can hardly overcome it, and the result is that a boiler does not furnish from one-fourth to one-half as much steam for a given weight of fuel as it should, from this very cause.

Boilers intended for use in distant localities where the facilities for repairs are meager or entirely wanting, and fuel low priced, should be of the simplest description. Cylinder boilers or two-flue boilers will perhaps be found most suitable. These are largely used by coal miners, blast furnaces, saw mills, and other branches of industry, which must, of necessity, be removed from the larger towns and engineering work shops.

In selecting a boiler for a mill of any kind where they burn shavings or offal, or any other place in which the fuel is of a similar description and the firing irregular, there should be large water capacity in the boiler that it may act as a reservoir of power in much the same way that a fly wheel acts as a regulator for a steam engine. It is a common notion among wood-workers that firing with shavings or light fuel is "easy on the boiler." There is abundant reason to doubt this. The suddenness and rapidity with which an intense fire is kin-

dled in the furnace, filling all the furnace space and the tubes with flame, and with an intense heat which envelops all within the limits of draft opening, continuing thus for a few minutes only, and as suddenly going out, can hardly be regarded as the ideal furnace. Yet there are thousands of just such furnaces at work, and it is altogether probable that little or no change will be made in them by this class of manufacturers, at least in the near future. In regard to the selection of a boiler for this service, we are brought back again to the question of hard or soft water. The decision should be largely influenced by this, but whatever type of a boiler is selected there should be a surplus of boiler power of at least 20 per cent, that is, if a 50 horse-power boiler is needed to do the work, put in one of 60 horse-power; this will prevent the fluctuations of speed in the engine which are sure to follow a reduction of boiler pressure.

This increase in boiler power ought not to be simply that of tube surface, but should also include extra water space. The reserve power of a boiler is in the water heated up to a temperature corresponding to the steam pressure; when this pressure is lowered, the water then gives off steam corresponding to the lower pressure; the more water the more steam; and in this way the water in the boiler stores up heat when overfired, to give it off again when the fire is low, and so acts a regulator of pressure, a thing that extra tube surface cannot do. This kind of firing is apt to induce priming, and for this reason a boiler should be selected having a large water surface. Horizontal boilers are, in general, to be preferred over vertical ones for mills, because of the larger water surface exposed in proportion to the heating surface. If a tubular boiler is selected, the water line above the tubes should be not higher than two-thirds the diameter of the boiler measured from the bottom, and the boiler should be made having the upper edge of the top row of tubes at least three inches below this; there should also be a clear space up through the center of

the boiler of sufficient width to insure a perfect circulation of water.

Horizontal tubular boilers are to be recommended when pure soft water is used. They combine at once the qualities of great strength without excessive bracing, large heating furnace, high evaporative capacity without liability to priming, and are convenient of access for external and internal examination when set in the furnace.

Fire box boilers, or locomotive boilers, as they are commonly called, are best adapted for small powers and with a fuel which deposits but little soot in the tubes. This kind of boiler is supplied with portable or agricultural engines and is very well adapted for that particular service. In canvassing the desirability of this kind of a boiler for stationary use, we must again refer to the kind of water to be used in it. If the water is soft and clean there is then no particular objection to a boiler of this construction being used for small powers; if the water is hard and will form scale, it ought not to be chosen, but a flue boiler selected instead.

Vertical boilers are used in great numbers for small engines, heating, etc. They have the merit of being compact and low priced. A common defect in the construction of this kind of boiler is that too many tubes are put in the head in the fire box, thereby preventing a proper circulation of water between them. This defect in construction induces priming, with all its attendant annoyances and dangers. This style of boiler is not suited to hard water, but pure soft water only. These boilers should be provided with hand holes above the crown sheet and around the bottom of the water legs; at least three at each place mentioned. In regard to the material of which a boiler shall be made there is but the simple choice between iron and steel.

Steel for boilers should not be of too high tensile strength; 60,000 to 65,000 pounds tensile strength per square inch makes

the best boilers. If the steel is of too high a grade it will take a temper, and, therefore, is utterly unfit for use in steam boilers; if the steel is of too low tensile strength it is apt to be loose or spongy. Among the advantages steel possesses over iron may be mentioned the circumstance that it is a practically homogeneous material when properly made and rolled, consequently, it is nearly as strong in one direction as it is in another. In this respect, steel is superior to iron plate of equal thickness, because the latter is made up of several pieces of iron welded together and in rolling into the plate it becomes fibrous, and thus of unequal strength, being greatest in the direction of the fiber, and least, when tested across it.

BOILER TRIMMINGS.

The common trimmings to a steam boiler are a safety valve, feed and blow-off pipe, steam pipe, gauge cocks, glass water gauge and steam gauge; to which may be added a steam drum or dome and a mud drum. There are numerous other devices which are attached to boilers such as safety gauges, alarms, fusible plugs, automatic dampers, etc.; many of these are very serviceable and are well liked by those using them.

Safety valves should always be large enough to permit the escape of all the steam a boiler is capable of making and each boiler should have its own safety valve rather than connecting two or more boilers together and depending on one valve for the whole. The valve and seat should be made of hard gun metal, or any other composition that will not rust and stick fast. At one time it was quite a common thing to see a brass valve fitted to a cast-iron seat; this is wrong, for the rusting of the iron would fix the valve so tightly that the boiler would be in constant danger of rupture from over pressure. For stationary boilers the common ball and lever safety valves are generally used. For stationary boilers it is immaterial whether the safety valve be fitted with a

lever and weight, or whether it be fitted with a spring. The former is the usual manner of loading a safety valve and has but few objections. For portable engines and locomotives safety valves are loaded with springs, which by suitable adjustment may be made to blow off at any desired pressure.

The following rule is that enforced by the U. S. Government in fixing the area of safety valves for ocean and river service, when the ordinary lever and weight safety valve is employed: —

Rule.— When the common safety valve is employed it shall have an area of not less than one square inch for each two feet of grate surface.

Another rule is to multiply the pounds of coal burned per hour by 4; this product is to be divided by the steam pressure, to which a constant number 10 is added.

EXAMPLE: What would be the proper area for a safety valve for a boiler having a grate surface 5 feet square and burning 12 pounds of coal per hour per square foot of grate; the steam pressure being 75 pounds per square inch?

5×5 equal 25 square feet of grate.

25×12 equal 300 lbs. of coal per hour.

300×4 equal 1200.

75 plus 10 equal 85 equal steam pressure with 10 added, then $1200 / 85$ equal 14.11 inches area, or $4\frac{1}{4}$ inches diameter.

A feed pipe should be at least twice the area over that which is regarded as simply necessary to supply the boiler with water, as sediment or scale is likely to form in it, which will materially reduce its area. In localities where the water is hard the feed pipes should be disconnected near the boiler and examined occasionally to ascertain whether or not scale is forming in them.

In general, the sizes of feed pipes leading from the pump to the boiler are fixed by the size of tap used by the maker of the pump. It is not well to reduce the diameter of the pipe and the size should be the same throughout. Care should be exer-

cised in putting pipes in place that no strain be brought upon them by imperfect fitting, as it is certain to lead to leaky joints at some time or other. It is also desirable that the pipes be as short and straight as possible. Feed pipes should never be placed under ground if it is possible to make any different disposition of them. In locating pipes it is desirable to arrange for the expansion of the boiler, as well as for that of the pipes themselves. In selecting a pump it should have a much larger capacity than that needed to supply the boiler, as there are many things which affect the working of a pump, such as defective suction pipes, leaky valves, etc. It is the practice of most manufacturers to give the capacity of their pumps in gallons of water delivered per minute, from which it is easy to select a suitable size; but the speed given in the tables at which the pump is to run is generally faster than that which it is desirable to run them. As a general thing, and without referring to any particular maker or design, it is a good plan to select a pump having four times the capacity actually needed for the boiler; then the speed may be reduced to half that given in the table, and will require less repairs, and will be a more satisfactory purchase in the long run.

In selecting an injector or inspirator, the size should not greatly exceed that actually required to supply the boiler. In making the steam connections the pipes should start from the steam space of the boiler and should not be branches merely from the other steam pipes; neither should the diameters of the pipes be less than that which the instrument calls for. The pipes should be as short and straight as practicable; abrupt bends should always be avoided in the suction pipes. If the water is taken from a place in which there are floating particles of wood, leaves, etc., a strainer should be used; a large sheet metal box with perforated sides, makes a good strainer; the openings ought not too greatly exceed an eighth of an inch in diameter, and should be several times the area of the suction pipe.

A **check valve** should be fitted with a valve between it and the boiler, so that in the event of its not working satisfactorily it may be taken apart, cleaned and replaced without stopping for examination or repairs.

The **blow-off pipe** should be so arranged that it will entirely drain the boiler of water; it is also a good plan to set a boiler with a slight inclination toward the blow-off pipe that it may be thoroughly drained; an inclination of two inches in twenty feet works well in practice. The blow-off pipe is usually fitted at the back end of the boiler.

The **steam pipe** may be connected at any convenient point on the top of the boiler. If the boiler is to furnish steam for an engine only, the common practice is to make the diameter of the pipe one-fourth that of the cylinder. The steam pipe should be as short and straight as possible. If bends are to be introduced in steam pipes it is better to have a long curved bend than the abrupt right-angle fitting usually employed for the purpose. It is also a good plan to provide a stop-valve next to the boiler to shut off the steam and prevent it condensing in the steam pipe at night, or other long stoppages.

The **gauge cocks** should not be less than three in number, and may be of any of the various kinds now in the market. For stationary boilers, the Mississippi gauge cock is, perhaps, as good as any. For portable engines a compression gauge-cock is, perhaps, the best. The lower gauge-cock should be at least 2" above the tubes or crown sheet, the middle 2" above the first ordinary water line, the upper 2" above the 2 on 2" to 3", depending on the size of the boiler.

A **glass water gauge** should be provided for each boiler and should be so located that the water level in the boiler when at the lower end of glass shall be one inch above the top of flue. When glass gauges are so fitted the fireman can always tell at a glance just how much water he has above the flues or crown sheet; it

also permits the easy test of accuracy by trying the gauge-cocks with the water at a certain known level. Too much dependence must not be placed on the glass water-gauge alone, but should be used in connection with the gauge-cocks.

A steam gauge is a very important appendage to a steam boiler, and should be chosen with special reference to accuracy and durability. The ordinary gauges now in the market are the bent tube and the diaphragm gauges. It matters little which of the two kinds is selected, provided it is a good and first-class gauge. A steam gauge should be compared with a standard test gauge at least once a year, to see that it is correct. The importance of this will be fully apparent when it is known that it furnishes the only means by which the fireman is to judge of the steam pressure in the boiler. A siphon should be attached to every gauge, and provision should also be made for draining the gauge or siphon, to prevent freezing when steam is off the boiler. Neglect of this may endanger the accurate reading of the steam gauge and render it useless.

Steam dome.—This is a reservoir for steam riveted to the upper portion of the shell and communicated by a central opening with the steam space in the boiler. When this reservoir forms a separate fixture and is attached to the boiler by cast or wrought iron nozzles, it is then called a *steam drum*. The latter answers all the purposes for stationary boilers that the former does, and is to be preferred because of the smaller openings in the shell of the boiler. A considerable number of boiler explosions have been traced directly to the weakness of the shell, caused by the large opening in and imperfect staying of the shell underneath the dome. When a dome is employed and has a large hole underneath, the strength of the shell is impaired in two ways: 1. By reducing the longitudinal sectional area of shell through the center of opening cut for it, which weakness cannot wholly be made good by a strengthening ring around the opening. 2. By causing

a tension equal to that on the crown area of steam dome, upon the annular part of the shell covered by the flange of the dome. The weakest part of the boiler shell will be where the distance from rivet hole at the base of the dome to edge of plate is least. It is difficult, owing to the complex nature of the strains, to form a rule whereby to determine how much the strength of the shell is impaired by using a dome; but it is quite apparent from general experience that they are in many cases a source of weakness, and the larger the dome connection with the shell, the greater the liability to rupture. This tendency to rupture is due to the fact that the dome, with its connecting flange, is practically inelastic; that portion of the shell of the boiler covered by the dome is, as soon as the pressure is introduced on both sides of the plate, simply a curved brace. The pressure of the steam in the boiler has a tendency to straighten the shell under the dome and thus brings about a series of complex strains which are not easily remedied by any system of bracing, so that on the whole it is preferable to use a small connecting nozzle with a drum above it, rather than to rivet a large dome directly to the shell.

Dry pipe.— This is a pipe having numerous small perforations on its upper side, and inserted in the upper part of the steam space of the boiler. This pipe does not dry the steam, but acts mechanically by separating the steam from the water when the latter is in a violent state of agitation, and is liable to be carried in bulk toward or into the steam pipe. The object of these numerous small holes in the pipe is that a small quantity of steam may be taken from a large number of openings at one time, and thus carried over a larger extent of surface than that afforded by a single opening, and by this single device checking the tendency to priming.

Steam boiler furnaces are receiving more attention now than perhaps ever before. The question of economy of fuel is being closely studied, and there is now an effort to save much of the

heat which had formerly been allowed to go to waste. The main thing in furnace construction is to get perfect combustion. Without this there must be of necessity a great loss constantly going on. There are some losses which it is difficult to prevent, for example—the loss by the admission of too much air in the ash pit; the loss by incomplete combustion; the loss occasioned by the heated gases escaping up the chimney; the loss by radiation; but, chief among these, is that of incomplete combustion. To burn a pound of coal requires about twelve pounds of air, or, say 150 cubic feet. Most boiler settings permit from 200 to 300 feet to pass through the fire. It is needless to point out the great source of loss arising from this one cause alone. This may be prevented in a measure by having a suitable damper in the chimney, and regulating the flow of escaping gases by it, instead of the ash pit doors. If the furnace is so constructed that the fuel is imperfectly burned, so that carbonic oxide instead of carbonic acid gas is formed, the loss is very great. This results often from too little air supply and too low temperature in the furnace. The furnace doors should be provided with an opening leading into the space between the door proper and the liner; this opening ought to have a sliding or revolving register by which the admission of air may be controlled. By this means, the quantity of air admitted above the fire may be adjusted to its needs by a little attention on the part of the fireman. The liner to the furnace door should have a number of small holes in it, rather than a solid plate, with a space around the edges. Great care should be exercised in the construction of furnace walls, that the materials and workmanship be good throughout. The entire structure should be brick. The outer walls may be of good hard red brick, but the interior walls, around the furnace bridge wall, and should be of fire brick. The best quality of fire brick for withstanding an intense heat are very, very strong and tenacious; the structure is open and they are free from black

spots, due to sulphuret of iron in the clay; if well burned they will not be very light colored on the outside, and will have a clear ring when struck.

Fire brick should be dipped in a thin mortar made of fire clay, rather than in a lime and sand mortar, such as is used in ordinary red brickwork. In laying up these portions of a boiler furnace requiring fire brick, provision should be made in the original wall for replacing the fire brick and without disturbing the outer brickwork.

CARE AND MANAGEMENT OF A BOILER.

It is not enough that a boiler be of approved design, made of the best materials, and put together in the best manner; that it have the best furnace and the most approved feed and safety apparatus. These are all desirable, and are to be commended; but cleanliness and careful management are quite essential to getting high results, and are also conducive to long use in service.

Pumps. — Special attention should be given at all times to the feed and safety apparatus; the pumps should be in good working order; it is preferable that they be independent steam pumps rather than pumps driven by the engine, or by a belt; they should be kept well packed and the valves in good condition.

Firing. — Kindle a fire and raise steam slowly; never force a fire so long as the water in the boiler is below the boiling point. The fire should be of an even height, and of such a thickness as will be found best for the particular fuel to be burned, but should be no thicker than actually necessary. In regard to the size of coal used, that will depend upon circumstances. If anthracite coal is used, it should not, for stationary boilers, be larger than ordinary stove coal. For bituminous coal, which is always shipped in lumps as large as can be conveniently handled, the size will vary somewhat in breaking, but it may in general be used in larger lumps than anthracite. If the coal is likely to cake in burn-

ing, the fire should be broken up quite frequently with a slice bar, or it will fuse into a large mass in the center of the furnace and lower the rate of combustion. If the coal is likely to form a considerable quantity of clinker, or enough to become troublesome, it may be advantageous to increase the grate area and thus lower the rate of combustion per square foot of grate, and have a fire of less intensity. The fire should be kept free from ashes, and the ash pit should be kept clean. Whenever the fire door of a steam boiler furnace is opened, the damper should be closed to prevent the sudden reduction of temperature underneath, which is likely to injure the boiler by contraction, and thus render it likely to spring a leak around the riveted joints. Some firemen are very careless in this respect, and there is little doubt that many a disagreeable job of repairing a leaky seam might be prevented by this simple precaution.

Gauge cocks should be used constantly to keep them free from any accumulation of sediment. It is a very common practice to rely wholly on the indications of the glass water gauge for the water level in the boiler. This is all wrong and should be discontinued, if once begun. The glass water gauge serves a very useful purpose, but it should not be wholly relied on in practice. In using the ordinary gauge cocks, the ear more than the eye, detects the water level, and thus acts as a check on the indications given by the glass gauge.

Water gauges should be tested several times during the day to see that they are clear, and to keep them free from any sediment likely to form around the lower opening to the water in the boiler. If this is not attended to, the water gauge is likely to indicate a wrong water level and a serious accident may be the result.

Steam or pressure gauges are likely to become set after long use and should be tested at least once, or better still, twice a year by a standard gauge known to be correct. They should also be

tested every few days if the boilers are constantly under steam by turning off the steam and allowing the pointer to run back to zero. If there are two or more boilers set together in one battery, and each boiler has its own steam gauge, and which will, starting from the zero point, indicate the same pressure on all the gauges, they may be assumed to be correct.

Blow-off cocks or valves should be examined frequently and should never be allowed to leak. In general a cock is to be preferred to a valve, but both is safer than one; if the latter is selected it should be some one of the various "straight-way valves," of which there are now several in the market. If the cock is a large one, and especially if it has either a cast iron shell or plug, it should be taken apart after each cleaning out of the boilers, examined, greased with tallow and returned.

Blowing out.—This should be done at least once a day, except in the very rare instances in which water is used that will not form a scale. The water should not be let out of a boiler or boilers until the furnace is quite cold, as the heat retained in the walls is likely to injure an empty boiler directly by overheating the plates, and indirectly by hardening the scale within the boiler. Bad effects are likely to follow when a boiler is emptied of its water before the side walls have become cool; but greater injury is likely to result when cold water is pumped into an empty boiler heated in this manner. The unequal contraction of the boiler is likely to produce leaky seams in the shell and to loosen the tubes and stays. It is a better plan to allow the boiler to remain empty until it is quite cold, or sufficiently reduced in temperature to permit its being filled without injury. Many boilers of good material and workmanship have been ruined by the neglect of this simple precaution.

Fusible plugs should be carefully examined every six months, as scale is likely to form over the portion projecting into the water space. It is only a question of time when this scale

would form over the end of the plug, and thick enough to withstand the pressure of steam and thus fail in the accomplishment of the very object for which it was introduced. This applies especially to the fusible plugs inserted in the crown sheets of portable engine boilers.

Cleaning tubes. — This should be done every day if bituminous coal is used. A portable steam jet will be found an extremely useful contrivance which will keep them reasonably clean by blowing out the loose soot and ashes deposited in the tubes. Every two or three days, or at least once a week, a tube scraper or stiff brush should be used to take out all the ashes or soot adhering to the tubes and which cannot be blown out with the jet. Flues may be cleaned the same way but will not require to be done so frequently.

Low water. — If from any cause the water gets low in the boiler, bank the fire with ashes or with fresh coal as quickly as possible, shut the damper and ash pit doors and leave the fire doors wide open; do not disturb the running of the engine but allow it to use all the steam the boiler is making; do not under any circumstances attempt to force water in the boiler. After the steam is all used and the boiler cooled sufficiently to be safe, then the water may be admitted and brought up to the regular working height; the damper opened and the fires allowed to burn and steam raised as usual; provided, no injury has been done the boiler by overheating.

Foaming or priming is always troublesome and often dangerous. Some boilers foam almost constantly, because of their bad proportion, and will require the constant care of the person in charge, especially at such times as the engine may be using the steam up to the full capacity of the boiler. In a case of this kind, an increase in pressure will often check, but will not entirely prevent it; nothing short of an increase of water surface, or a better circulation of water, or a larger steam room will afford a

complete remedy. If the foaming or priming is due to a sudden liberation of steam, or on account of impure feed water it may be checked by closing the throttle valve to the engine and opening the fire door for a few minutes. The surface blow may be used with advantage at this time, by blowing off the impurities collected on the surface of the water. The feed pump may be used if necessary, but care should be exercised that too much cold water be not forced into the boiler, and thus lose time by having to wait for the accumulation of the regular steam pressure required for the engine. The dangers attending foaming or priming are: the laying bare of heating surfaces in the boiler, and of breaking down the engine by working water into the cylinder. The commonest damage to the engine being either the breaking of a cylinder head, or the cross-head, or the breaking of the piston. When boilers are new and set to work for the first time priming is a very frequent occurrence; in fact, it may be said that for the first few days there is always more or less of it. All that is needed during this time is a little care on the part of the attendant to see that the water is kept up to the required level in the boiler; it is also recommended that the throttle valve to the engine be partially closed to prevent any very great variation of pressure in the boiler, and thus prevent water passing over with the steam in such quantities as to become dangerous. If a boiler continues to prime after it has had a week's work and then thoroughly cleaned, the causes are to be attributed to other than the grease and dirt in it, which are inseparable from the manufacture. As already said, priming may be caused by a sudden reduction of pressure; that is, a boiler may be working smoothly and well with say 80 pounds pressure; if an increase of load be suddenly applied to an engine so as to reduce the pressure to 70 or 60 pounds, this sudden reduction of pressure will almost always cause priming; the less the steam space in the boiler, the greater the tendency to prime, and the greater the

difficulty in checking it. The only permanent cure for this is more boiler power; as a temporary expedient, the engine should be throttled sufficiently to make the drain upon the boiler constant instead of intermittent. If the duty required of an engine is irregular, the steam pressure should be carried higher; in any case similar to the above, it is recommended that the pressure be increased to 90 or 100 pounds and the throttling to begin with the increased drain upon the boiler. But this is at best a mere makeshift, and a larger boiler power becomes imperative both on the score of economy and safety.

WATER FOR USE IN BOILERS.

Water is never pure, except when made so in a laboratory or by distillation; the impurities may be divided into four classes: 1. Mechanical impurities. 2. Gaseous impurities. 3. Dissolved mineral impurities. 4. Organic impurities.

(a) Mechanical impurities may be both mineral and organic. The commonest suspended impurity in water is mud or sand; these may be removed by filtration or by allowing the water to stand long enough to let them settle to the bottom of the tank or cistern and then carefully drawing the water from the top, and without disturbing the bottom.

(b) Gaseous impurities in water vary somewhat according to the localities from which they are obtained. The commonest gases found in the water are an excess of oxygen, nitrogen and carbonic acid. These have no effect on water intended for steam boilers.

(c) Dissolved mineral impurities in water are of the most varied description, and are almost always found in it. Among these are found salts of iron, sulphate and carbonates of lime; sulphate and carbonates of magnesia; salt and alkalies, such as soda, potash, etc.; acids, such as sulphuric, phosphoric, and others. All of these are more or less injurious to steam boilers. The most objectionable are the salts of lime and magnesia, which impart to water that property known as hardness. When such

water is used in a steam boiler a scale will gradually form, which will, in a short time, become very troublesome.

(d) Organic impurities are present, to a certain extent, in most waters. They are sometimes present in the water in sufficient quantities to give it a very decided color and taste.

The presence of organic matter in water is often dangerous to health, and may be a means of spreading contagious diseases, but has little or no bad effect in any water used for steam boilers. In general, water is regarded by engineers as being either soft, hard or salt.

Ebullition.—Is the motion produced in a liquid by its rapid conversion into vapor. When heat is applied to the bottom of a boiler, the particles of water in contact with the plates become heated and immediately expand, and becoming specifically lighter, pass upwards through the colder body of water above; the heat of the furnace is in this way diffused throughout the whole body of water in the boiler by a translation of the particles of water from below upwards, and from top to bottom in regular succession. After a time this liquid mass becomes heated to a degree in which there is a violent agitation of the whole body of water, steam is given off and it is said to boil. The temperature at the boiling point of water, at ordinary atmospheric pressure, is 212° Fahr., and increases as the pressure of steam above it increases.

Distilled water for boilers is not to be recommended without some reservation. Chemically pure water, and especially water which has been redistilled several times, has a corrosive action on iron which is often very troublesome. The effect on steel plates by the use of water several times redistilled, such, for example, as that supplied for heating buildings, is well known; information is yet wanting which shall point with certainty to the exact change which the water undergoes and explain why its action on or affinity for steel is so greatly intensified. It has been suggested as a means of neutralizing this corrosive action of the water, to

introduce with the feed other water, which shall have the property of forming a scale and continuing it long enough and at such intervals as will permit the formation of a thin scale in the interior of the boiler. However objectionable this may seem at first sight, it is at present the best practical solution of the difficulty.

Scale is a bad conductor of heat and is opposed to economical evaporation. It is estimated that a thickness of half an inch of hard scale firmly attached to a boiler plate will require a temperature of about 700° Fahr. in the boiler plate in order to raise and maintain an ordinary steam pressure of 75 pounds. The mischievous effects of accumulated scale in the boiler, especially in the plates immediately over the fire, are: (1) preventing the water from coming in contact with the plates, and thus directly contributing to the overheating of the latter; and (2) by causing a change of structure in the plates and the consequent weakening brought about by this continual overheating, which would, in a short time, render an iron or a steel plate wholly unfit for use in a steam boiler. The two principal ingredients in boiler scale are lime and magnesia. The lime, when in combination with carbonic acid, forms carbonate of lime; when in combination with sulphuric acid, it then becomes sulphate of lime. This is also true of magnesia.

Carbonate of lime will form in the boiler as a loose powder which is held mechanically in suspension; while in this stage it may be blown out of the boiler without injury to it; but it is seldom that a pure carbonate is formed in the boiler as there are other impurities in the water with which it combines to form a hard scale. This is especially true in such waters as also contain sulphate of lime in solution. This fine powder (carbonate of lime), will form a hard scale should any adhere to the sides or bottom of a boiler; in any case where the boiler is blown out dry while the furnace walls are still hot; and this, in itself, forms an excellent reason why boilers should stand until the furnace walls

are cold before blowing out. When emptied, nearly or all of this slushy deposit may be washed out of the boiler by means of a hose.

Sulphate of lime is not so easily got rid of, as it is heavier than carbonate of lime and adheres to the plates while the boiler is at work. It is the most troublesome scale steam engineers have to deal with; it is very difficult to remove and by successive layers becomes dangerous, on account of the thickness to which it eventually accumulates.

The carbonates of lime and magnesia may be largely arrested by passing the feed water through a suitable heater and lime extractor. It must be apparent to every one that any device which will accomplish this is a very desirable attachment to a steam boiler. As it is not possible to eliminate all the foreign matter in the water from it, recourse is often had to the use of solvents and chemical agencies for the prevention of scale. Some of these are very simple and within easy reach; others are surrounded by an atmosphere of uncertainty and the real nature of the compound is hidden under a meaningless trade-mark. For carbonate of lime, potatoes have been found to be very serviceable in preventing the formation of scale; its action appears to be that of surrounding the particles of lime with a coating of starch and gelatine, and thus preventing the cohesion of these particles to form a mass. Various astringents have been used for this purpose, such as extracts of oak and hemlock bark, nutgalls, catechu, etc., with varying success.

Carbonate of soda has been used and with very great success in some localities, not only in preventing, but in actually removing scale already formed. It acts on carbonate of lime not only, but on the sulphate also. It is clean, free from grit, and is quite unobjectionable in the boiler; one or more pounds per day, depending on the size of the boiler, may be admitted through the pump with the feed water; or admitted in the morning before

firing up, by simply mixing with water and pouring into the boiler through the safety valve or other opening.

Tannate of soda has been similarly employed and is an excellent scale preventive. It will also act as a solvent for scale already formed in the boiler, acting on sulphate as well as carbonate of lime.

Crude petroleum has been found very beneficial in removing the hard scale composed principally of sulphate of lime.

Zinc in steam boilers.—The employment of zinc in steam boilers, like that of soda, has been adopted for two distinct objects: (1) to prevent corrosion, and (2) to prevent and remove incrustation. To attain the first object, it has been used chiefly in marine boilers, and for the second, chiefly in boilers fed with fresh water. In order that the application of zinc in marine boilers may be effective, it is necessary that the metallic contact should be insured. If galvanic action alone is relied upon for the protection of the plates and tubes, it will doubtless be diminished materially by the coating of oxide that exists between all joints of plates, whether lapped or butted, and also between the rivets and the plates. Assuming the preservative action of zinc to be proved when properly applied, we have now two systems for preventing the internal decay of marine boilers, viz.: allowing the plates and tubes to become coated with scale, and employing zinc. It remains to decide which of these two systems is the best with respect to economy and practicability.

We come now to consider the use of zinc for preventing and removing incrustation.

At one time it was considered that the action of zinc in preventing incrustation was physical or mechanical. The particles of zinc, as it wasted away, were supposed to become mixed amongst the solid matter precipitated from the water, in such a manner as to prevent it adhering together, so as to form a hard scale; or the particles of zinc were supposed to become deposited

upon the plates, and so prevent the scale from adhering to them. Then it was suggested that the zinc acted chemically, and now, it is the generally received opinion that its action is galvanic in preventing incrustation as well as in preventing corrosion. When the water contains an excess of sulphates or chlorides over the carbonates, the acid of the former will form soluble salts with the oxide of zinc, the surface of the zinc will be kept clean, and the galvanic current, to which the efficiency of the zinc is due, will be maintained. On the other hand, should there be a preponderating amount of carbonates, the zinc will be covered first with oxide, then with carbonates and its useful action arrested and stopped. It is quite as important that the zinc should be in metallic contact with the plates when used to prevent incrustation, as when employed to prevent corrosion. The application of zinc for the former purpose should never be attempted without first having the water analyzed in order to ascertain whether it is likely to be effective. The use of zinc in externally fired boilers should be attempted with great caution, as when efficacious in preventing the formation of a hard scale, it is liable to produce a heavy sludge that may settle over the furnace plates and lead to overheating. On the whole we cannot but regard the evidence as to the effect of zinc upon incrustation as being very conflicting.

Leaks should be stopped as soon as possible after their discovery; the kind of leak will indicate the treatment necessary. If it occurs around the ends of the tubes, it may be stopped by expanding the tubes anew; if in a riveted joint, it should be carefully examined, especially along the line of the rivets and care should be exercised in determining whether there is a crack extending from rivet to rivet along the line of the holes; should this prove to be the case, the boiler is then in an extremely dangerous condition and under no circumstances should it be again fired up until suitable repairs have been made which will insure its safety.

Blisters occur in plates which are made up of several thicknesses of iron and which from some cause were not thoroughly welded before the final rolling into plates. When such a plate comes in contact with the heat of the furnace the thinnest portion of the defective plate "buckles" and forms what is called a blister. As soon as discovered, there should be thorough examination of the plate and if repairs are needed there should be as little delay as possible in making them. If the blister be very thin and altogether on the surface it may be chipped and dressed around the edges; if the thickness is equal or exceeds $\frac{1}{16}$ " the blister should be cut off and patched, or a new plate put in.

Patching boilers. — When a boiler requires patching it is better to cut out the defective sheets and rivet in a new one; or if this cannot be done, a new piece large enough to cover the defect in the old sheet may be riveted over the hole from which the defective portion has been cut. If this occurs in any portion of the boiler subject to the action of fire, the lap should be the same as the edges of the boiler seams, and should be carefully calked around the edges after the riveting. Whenever the blisters occur in a plate, patching is a comparatively simple thing as against the repairs of a plate worn by corrosion. In the latter case, the defective portions of the plate should be entirely removed and the openings should show sound metal all around and of full thickness. If this cannot be obtained within a reasonable sized opening then the whole plate should be removed.

It often occurs that a minor defect is found in a plate and at a time when it is not convenient to stop for repairs; in such an event a "soft patch" is often applied. This consists of a piece of wrought iron carefully fitted to that portion of the boiler plate needing repairs; holes are fitted in both plates and patch, and "patch bolts" provided for them. A thick putty consisting of white and red lead with iron borings or filings in them placed evenly over the inner surface of the patch, which is then tightly

bolted to the boiler plate. This is best but a temporary makeshift and ought never to be regarded as a permanent repair. A mistake is often made of making a patch of thicker metal than that of the shell of the boiler needing it. A moment's reflection ought to show the absurdity of putting on a $\frac{5}{16}$ or $\frac{3}{8}$ patch on an old $\frac{1}{4}$ inch boiler shell; yet it is not so rare as one would imagine. A piece of new iron $\frac{3}{16}$ " thick will, in most cases, be found to be stronger than that portion of a $\frac{1}{4}$ " old plate needing repairs.

Inspection. — A careful external and internal examination of a boiler is to be commended for many reasons. This should be as frequent as possible and thoroughly done; it should include the boiler not only, but all the attachments which affect its working or pressure. Particular attention should be paid to the examination of all braces and stays, safety valve, pressure gauges, water gauges, feed and blow-off apparatus, etc.; these latter refer more particularly to constructive details necessary to proper management and safety. The inspection would obviously be incomplete, did it not include an examination into the causes of "wear and tear," and determine the extent to which it had progressed. Among the several causes which directly tend to rendering a boiler unsafe, may be mentioned the dangerous results occasioned by the overheating of plates, thus changing the structure of the iron from fine granular, or fibrous, to coarse crystalline. This may easily be detected by examination, and will in general be found to occur in such cases where the boilers are too small for the work, are fired too hard, or have a considerable accumulation of scale or sediment in contact with the plates. Blistered plates are almost instantly detected at sight, so also is corrosion, from whatever cause it may have proceeded.

Corrosion of boiler plates. — Iron will corrode rapidly when subjected to the intermittent action of moisture and dryness. Land boilers are less subject to corrosion than marine boilers. The corrosion of a boiler may be either external or internal. Ex-

ternal corrosion may, in general, be easily prevented by carefully caulking all leaks in the boiler; by preventing the dropping of water on the plates, such, for example, as from a leaky joint in the steam pipe or from the safety valve. A leaky roof, by allowing a continual or occasional dropping of water on the top of a boiler, especially if the boiler is not in constant use, would promote external corrosion. Sometimes external corrosion is caused by the use of coal having sulphur in it, and acts in this way: The sulphur passes off from the fire as sulphurous oxide, which often attaches to the sides of a boiler; so long as this is dry no especial mischief is done; but if it comes in contact with a wet plate the sulphurous oxide is converted into sulphuric acid over so much of the surface as the moisture extends; this acid attacks, and will, in time, entirely destroy the boiler plate. Internal corrosion is not so easily accounted for and is very difficult to correct, especially when it occurs above the water line. It is generally believed to be due to the action of acids in the feed water. Marine boilers are especially subject to internal corrosion when used in connection with surface condensers. A few years ago it was generally supposed to be due to galvanic action but that idea is now almost entirely given up. From the fact that boilers using distilled water fed into them from surface condensers are more liable to internal corrosion than other boilers, has led to the theory that it is the *pure* water that does the mischief, and that a water containing in slight degree a scale-forming salt, is to be preferred to water which is absolutely pure. Whatever may be the truth or falsity of this theory, it is a well established fact that distilled water has a most pernicious action on various metals, especially on steel, lead and iron. This action is attributed to its peculiar property, as compared with ordinary water, of dissolving free carbonic acid. One of the worst features in connection with internal corrosion is that its progress cannot be easily traced on account of the boiler being closed while at work. As it does not

usually extend over any very great extent of surface, the ordinary hydraulic test fails to reveal the locality of corroded spots; the hammer test, on the contrary, rarely fails to locate them, if the plates are much thinned by its action.

Testing boilers.—It is the general practice to apply the hydraulic test to all new steam boilers at the place of manufacture, and before shipment. The pressure employed in the test is from one and a half to twice the intended working steam pressure. This test is only valuable in bringing to notice defects which would escape ordinary inspection. It is not to be assumed that it in any way assures good workmanship, or material, or good design, or proper proportions; it simply shows that the boiler being tested is able to withstand this pressure without leaking at the joints, or distorting the shell to an injurious degree. Bad workmanship may often be detected at a glance by an experienced person. The material must be judged by the tensile strength and ductility of the sample tested. The design and proportions are to be judged on constructive grounds, and have little or nothing in common with the hydraulic test. The great majority of buyers of steam boilers have but little knowledge on the subject of tests, and too often conclude that if they have a certified copy of a record showing that a particular boiler withstood a test of say, 150 lbs., it is a good and safe boiler at 75 to 100 lbs. steam pressure. If the boiler is a new one and by a reputable maker, that may be true; if it has been used and put upon the market as a second-hand boiler, it may be anything but safe at half the pressure named. By the hydraulic test, the braces in a boiler may be broken, joints strained so as to make them leak, bolts or pins may be sheared off, or so distorted as to be of little or no service in resisting steam when pressure is on.

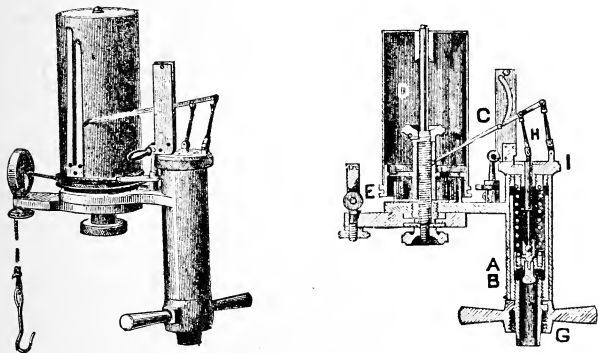
Hammer test.—The practice of inspecting boilers by sounding with a hammer is, in many respects, to be commended. It requires some practical experience in order to detect blisters and

the wasting of plates, by sound alone. The hammer tests is especially applicable to the thorough inspection of old boilers. It frequently happens in making a test that a blow of the hand hammer will either distort it, or be driven entirely through the plate; and it is just here that the superiority of this method of testing over, or in connection with the hydraulic test, becomes fully apparent. The location of stays, joints and boiler fittings all modify and are apt to mislead the inspector if he depends upon sound alone. There is a certain spring of the hammer and a clear ring indicative of sound plates, which are wanting in plates much corroded or blistered. The presence of scale on the inside of the boiler has a modifying action on the sound of the plate. When a supposed defect is discovered, a hole should be drilled through the sheet by which its thickness may be determined, as well as its condition.

CHAPTER XV.

A FEW REMARKS ON THE INDICATOR.

The *steam-engine indicator* is an instrument designed to show the steam pressure in the cylinder at all points in the stroke. It consists primarily, of a piston of known area capable of moving in a cylinder and resisted by a coil spring of known strength. To this piston is attached, by means of suitable piston rod and levers, a pencil capable of tracing a line corresponding to the motion of the indicator piston. This line is traced on a paper slip attached to the drum of the indicator, which drum is connected to some moving part of the engine in such a way as to have a back and forward movement, coincident with the steam piston of the engine.



By referring to the above selected view of an indicator, which is generally recognized as the best known, the construction will be readily understood.

THE USE OF THE STEAM ENGINE INDICATOR IN SETTING VALVES AND THE INVESTIGATION OF SOME OF THE DEFECTS BROUGHT OUT BY THE INDICATOR CARDS.

The steam-engine indicator has come into such general use that to-day there are but few men running engines who are not familiar with its construction and manner of attachment to engines, and the method of calculating horse-power from cards. The indicator is attached to pipes tapped into the cylinder heads, or into the barrel of the cylinder opposite the counterbore, beyond the travel of the piston rings. The indicator consists of a cylinder with piston and compression spring and a drum attached to a coiled spring, used for returning the same. The pressure of steam on the piston of the indicator compresses the spring above it. The motion of the piston is carried by a piston-rod to a pencil motion, which multiplies the motion of the spring some five or six times. The springs are marked 20, 40, 80, etc. This meaning that 80 lbs. pressure per square inch on the indicator piston (or whatever the spring may be marked) will cause the pencil at the end of the pencil-arm to move an inch. The pencil marks on paper, which is fastened on a drum. This drum is moved by the cross-head of the engine, through some form of reducing motion, such as pantograph, lazy-tongs, brumbo pulley, etc. To obtain the horse-power, we first need the mean pressure equivalent to the variable pressure on the card. This is most easily found by dividing the area of the card by the length, giving the height of a rectangular card of equivalent area, and then multiplying this height by the scale of the spring. The mean effective pressure per square inch on the piston, times the area of the piston in square inches, times the speed of the piston in feet per minute, divided by 33,000, gives the horse-power. If there is a loop at either end of the card, the area of this loop is to be subtracted from the larger area before finding the mean height of

the card, since such a loop represents work opposed to the working side of the piston. In getting areas by means of a planimeter, no attention need be given to the loops. By following the lines in order, as drawn by the indicator pencil, the loops will be subtracted from the main card, for if the main body of the card is traced in a right-handed rotation, the loops will be traced in a left-handed rotation.

DIAGRAM ANALYSIS.

Figs. 1 and 2 are from throttling engines; the former representing good performances for that class of engine, and the latter,

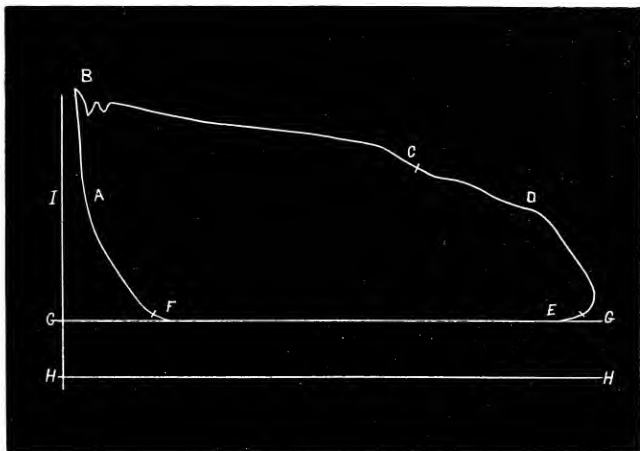


Fig. 1.

in some respects which the engineer will readily recognize, bad performances.

Figs. 3, 4, and 5, are from automatics; Fig. 3 representing what is now considered rather too light a load for best practical economy; Fig. 4 about the best load, and Fig. 5 is from a condensing engine.

Line $A B$ is the induction line, and $B C$ the steam line; both together representing the whole time of admission.

C is about the point of cut-off, as nearly as can be determined by inspection. It is mostly anticipated by a partial fall of pressure due to the progressive closure of the valve.

The usual method is, to locate it about where the line changes its direction of curvature.

$C D$ is the expansion curve. D is the point of exhaust.

$D E$ is the exhaust line, which begins near the end of the stroke and terminates at the end of the stroke, or, at latest, before the piston has moved any considerable distance on its return stroke.

The principal defect of Fig. 2 is, that this line occupies nearly all the return stroke. $E F$ is the back pressure line, which, in non-condensing engines, should be coincident with, or but little above, atmospheric pressure. In Fig. 5 it is below the atmospheric line to the extent of the vacuum obtained in the cylinder. Some authorities would call it the vacuum line in Fig. 5 but that name properly belongs to a line representing a perfect vacuum.

F is the point of exhaust closure (slightly anticipated by rise of pressure) and $F A$ the compression curve, which, joining the admission line at A , completes the diagram proper, forming a closed figure.

$G G$ is the atmospheric line traced when the piston of the indicator is subject to atmospheric pressure, above and below alike. Some pull the cord by hand when tracing it, to make it longer than the diagram. $H H$ is the vacuum line, which, when required, is located by measurement such a distance below the atmospheric line as to represent the atmospheric pressure at the time and place, as nearly as can be ascertained. The mean

atmospheric pressure at the sea level is 14.7 pounds. For higher altitudes, the corresponding mean pressure may be found by multiplying the altitude by .00053, and subtracting the product from 14.7. When a barometer can be consulted, its reading in inches multiplied by .49 will give the pressure in pounds.

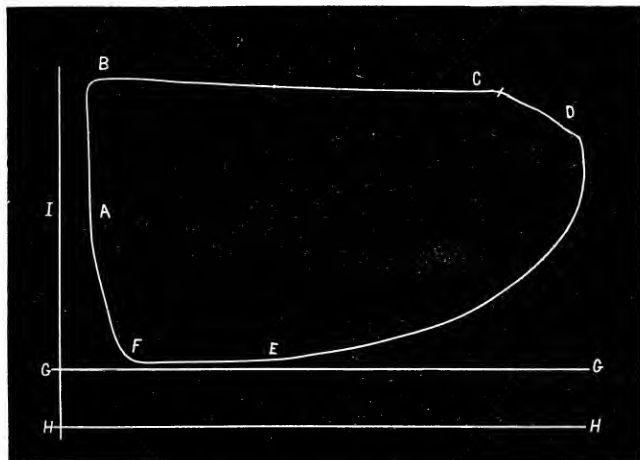


Fig. 2.

I is the clearance line, representing by its distance from the nearest point of the end of the diagram at the admission end, as compared with the whole length, the whole volume of clearance known to be present. Its use is mainly to assist in constructing a theoretical expansion curve by which to test the accuracy of the actual one.

Calculating mean effective pressure. — Since the simplification and popularization of the planimeter, no engineer who has occa-

sion to compute the "indicated horse-power" (IHP) of engines should be without one; for, if properly handled, the results

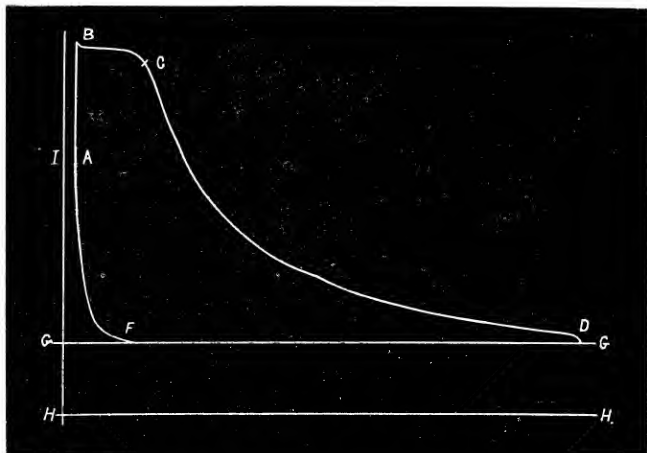


Fig. 3.

obtained by them are more accurate and more quickly obtained than by any other process. The diagram is pinned to a smooth board covered with a sheet of smooth paper, the pivot of the leg pressed into the board at a point which will allow the tracing point to be moved around the outline of the diagram without forming unnecessarily extreme angles between the two legs, and a slight indentation made in the line at some point convenient for beginning and ending; for it is vitally important that the beginning and ending shall be at exactly the same point. The reading of the wheel is taken, or it is placed at zero, and the tracing point is

passed carefully around the diagram, following the lines as closely as possible, moving right-handed, like the hands of a watch. The reading obtained (by finding the difference between the two, if the wheel has not been placed at zero) is the area of the diagram in square inches, which, multiplied by the scale of the diagram, and divided by its length in inches, gives the mean effective pressure.

The process of finding the mean effective pressure by ordinates. — Fig. 4 is too well known to require any detailed explanation; but I wish to call attention to a frequent mistake, viz.,

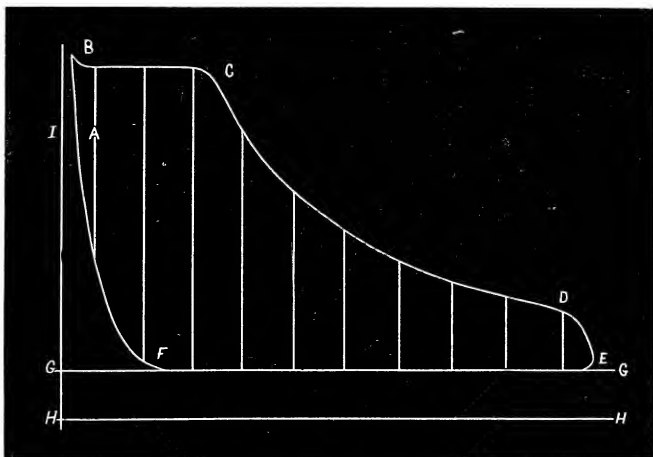


Fig. 4.

making all the spaces equal. The end ones should be half the width of the others, since the ordinates stand for the centers of

equal spaces. Ten is the most convenient and usual number of ordinates, though more would give more accurate results. The aggregate length of all the ordinates (most conveniently measured consecutively on a strip of paper) divided by their number, and multiplied by the scale of diagram, will give the mean effective

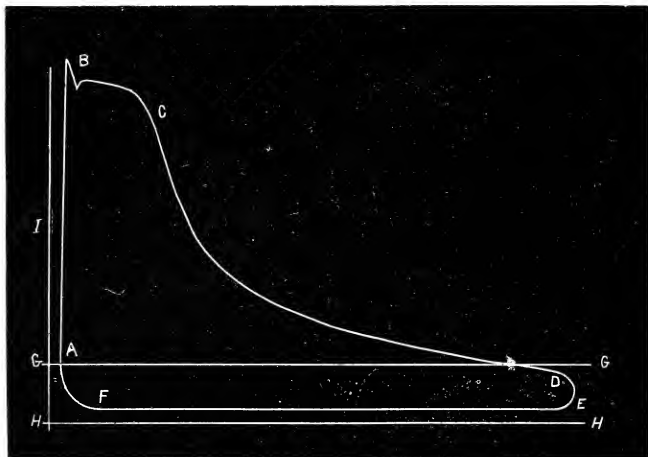


Fig. 5.

pressure. A quick way of making a close approximation to the mean effective pressure of a diagram is, to draw line ab , Fig. 6, touching at a , and so that space d will equal in area spaces c and e , taken together, as nearly as can be estimated by the eye. Then a measure, f , taken at the middle, will be the mean effective pressure. With a little practice, verifying the results with the planimeter, the ability can soon be acquired to make estimates in

this way with only a fraction of a pound of error with diagrams representing some degree of load. With very high initial pressure and early cut-off, it is not so available.

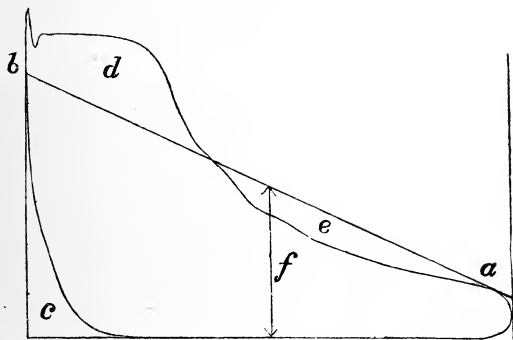


Fig. 6.

The indicated horse-power.—IHP is found by multiplying together the area of the piston (minus half the area of the piston-rod section, when great accuracy is desired), the mean effective pressure and the travel of the piston in feet per minute, and dividing the product by 33,000. It is sometimes convenient to know the HP constant of an engine, which is the HP for one revolution at one pound mean effective pressure. This multiplied by the mean effective pressure, and by its number of revolutions per minute, gives the IHP.

THEORETICAL CURVE.

Testing expansion curves.—It is customary to assume that steam, in expanding, is governed by what is known as Mariotte's law, according to which its volume and pressure are inversely pro-

portional to each other. Thus, if a cubic foot of steam at, say, 100 pounds pressure be expanded to 2 cubic feet, its pressure will fall to 50 pounds, and proportionately for all other degrees of expansion. The pressures named are "total pressures;" that is, they are reckoned from a perfect vacuum. A theoretic expansion curve which will conform to the above theory may be

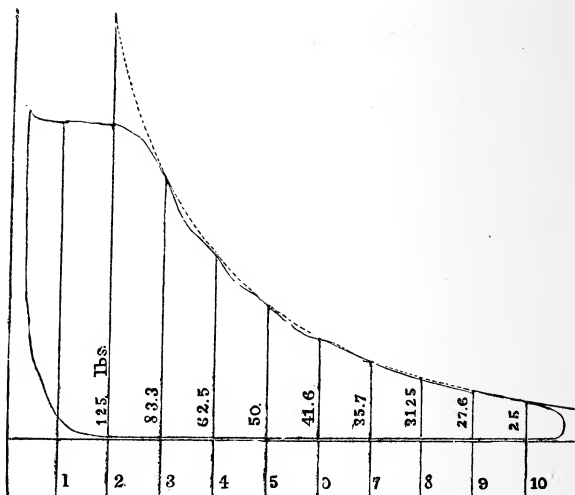


Fig. 7.

traced by the following method: Referring to Fig. 7, having drawn the clearance and vacuum lines as before explained, draw any convenient number of vertical lines, 1, 2, 3, 4, 5, etc., at equal distances apart, beginning with the clearance line and number them as shown. Decide at what point in the expansion curve

of the diagram you wish the theoretic curve to coincide with it. Suppose you choose line 10, on which you find the indicated pressure to be 25 pounds. Multiply this pressure by the number of the line (10) and divide the product (250) by the numbers of each of the other lines in succession. The quotients will be the pressures to be set off in the lines. Thus, 250 divided by 9 gives 27.7, the pressure on line 9; and so for all the others. The same curve may also be traced by several geometric methods, one of which is as follows, referring to Fig. 8:—

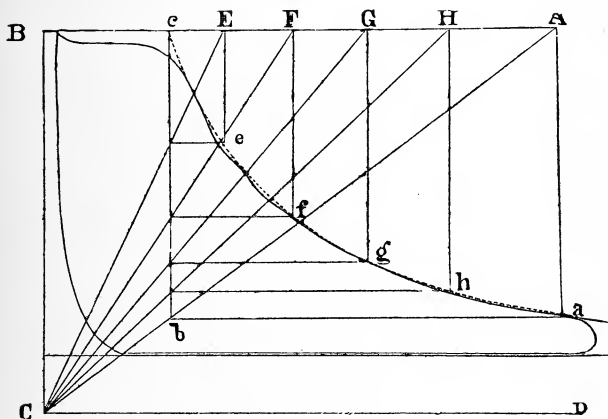


Fig. 8.

Having drawn the clearance and vacuum lines as before, select the desired point of coincidence, as *a*, from which draw the perpendicular *aA*. Draw *AB* at any convenient height above or near the top of the diagram, and parallel to the vacuum line *DC*. From *A* draw *AC* and from *a* draw *ab* parallel to *DC*, and from

its intersection with AB , erect the perpendicular bc , locating the theoretical point of cut-off on AB . From any convenient number of points in AB (which may be located without measurement) as E, F, G, H , draw lines to C , and also drop perpendiculars Ee, Ff, Gg, Hh , etc. From the intersection of EC with bc , draw a horizontal to e , and the same for each of the other lines FC, GC, HC ; establishing points e, f, g, h , in the desired curve. Any desired number of points may be found in the same way. But this curve does not correctly represent the expansion of steam. It would do so if the steam during expansion remained or was maintained at a uniform temperature; hence, it is called the isothermal curve, or curve of same temperature. But, in fact, steam and all other elastic fluids fall in temperature during expansion, and rise during compression; and this change of temperature augments the change of pressure slightly; so that if, as before assumed, a cubic foot of steam at 100 pounds total pressure be expanded to two cubic feet, the temperature will fall from nearly 328° to about 278° , and the pressure instead of falling to fifty pounds, will fall a trifle below 48 pounds. A curve in which the pressure due to the combined effects of volume and resulting temperature is represented, is called the adiabatic curve, or curve of no transmission; since, if no heat is transmitted to or from the fluid during change of volume, its sensible temperature will change according to a fixed ratio, which will be the same for the same fluid in all cases. I need not attempt to give any of the usual methods of tracing the adiabatic curve, since the isothermal curve is the one generally used for that purpose. And while it is incorrect in that it does not show enough change of pressure for a given change of volume, the great majority of actual diagrams are still more incorrect in the same direction; so that when a diagram conforms to it as closely as the one used in these illustrations, it is considered a remarkably good one. A sufficiently close approximation to the adiabatic curve to enable the non-profes-

sional engineer to form an idea of the difference between the two, may be produced by the following process: Taking a similar diagram to those used for the foregoing illustrations, we fix on a point A near the terminal, where the total pressure is 25 pounds. As before, this point is chosen in order that the two curves may coincide at that point. Any other point might have been chosen for the point of coincidence; but a point in that vicinity is generally chosen so that the result will show the amount of power that should be obtained from the existing terminal. This point is 3.3 inches from the clearance line, and the volume of 25 pounds is 996; that is, steam at that pressure has 996 times the bulk of water. Now, if we divide the distance of A from the clearance line by 996, and multiply the quotient by each of the volumes of the other pressures indicated by similar lines, the products will be the respective lengths of the lines measured from the clearance line, the desired curve passing through their other ends. Thus, the quotient of the first, or 25-pound pressure line divided by 996 is .003313; this multiplied by 726, the volume of 35-pound pressure, gives 2.4, the length of the 35-pound pressure line; and so on for all the rest.

Fig. 9 shows a card taken from a Corliss engine, running at a speed of about ninety revolutions per minute. On account of the slow speed and the quick admission obtained by this form of valve gear, but little compression is needed. For high speed engines, there is much more compression. At high speeds, the expansion line of the indicator card, instead of

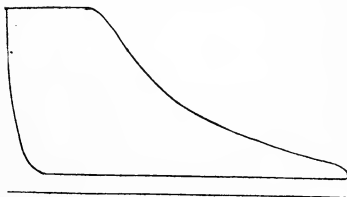


Fig. 9.

being a smooth curve like that shown in Fig. 9, is often a wavy line, due to oscillations of the spring in the indicator.

Fig. 10 represents what is called a stroke card. The indicator

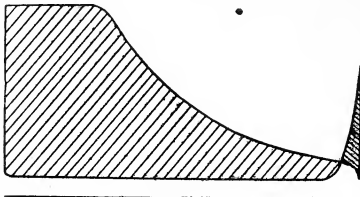


Fig. 10.

shows us the pressure on one side of the piston for a revolution. When we calculate the horse-power from a card, we are assuming that the back pressure and compression line on the other side of the piston are the same as shown on the card. This

may or may not be the case. In calculating the total horse-power for the two ends of the cylinder, any error from this cause affecting the calculation for one end of the cylinder, will be nearly balanced by an opposite error in the calculations for the other end, so that the final result is practically correct. If it were not for the piston-rod making the area of one side of the piston smaller than on the other, there would be absolutely no error arising from this. The stroke card shows the pressure on opposite sides of the piston at all points of the stroke. The difference between the lines at any point is the effective push per square inch. This card is constructed by using the steam and expansion lines of the card from one end, and the back pressure and compression lines for the same stroke, from the card taken on the other end. In constructing diagram for very accurate work, the ratio of the areas of the two sides of the piston have to be considered: the pressure above the atmosphere for one side being multiplied by this ratio. It will be seen that up to the point of cut-off, the difference of pressure, or effective pressure, is nearly constant; this difference grows less, due to the drop along the expansion curve, till at the point where the two lines cross, the pressure on the two sides balances. Beyond this point, the pressure exerted to hold the piston back

is greater than that exerted to push it ahead. The energy stored in the fly-wheel during the first part of the stroke is given out here near the end of the stroke to help the engine over the dead point.

STEAM CHEST CARDS.

By attaching one indicator to the steam chest of an engine, and another to one end of the cylinder, it can be seen whether the pipes and ports are of sufficient size. A sloping steam line on an indicator card may be due to too small a steam pipe, or too small steam ports, or to both of these combined. This does not apply, of course, to engines using throttling governors.

Fig. 11 shows the effect of too small steam pipe. When steam is admitted to the cylinder, there is a

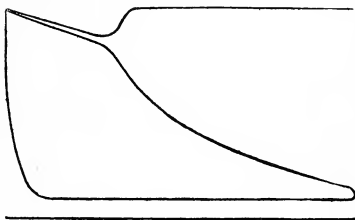


Fig. 11. Steam Chest on Forward Stroke.

drop in pressure in the chest. This drop becomes greater in amount as the speed of the piston increases. At cut-

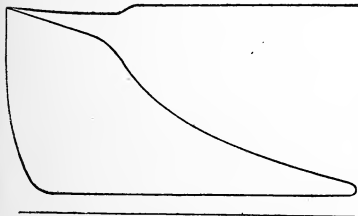


Fig. 12. Steam Chest Card on Forward Stroke.

off, the flow of steam into the cylinder stops, then the pressure in the chest reaches boiler pressure. If there is no great drop in the line on the steam chest card, and a considerable drop in the steam line of the card, it would mean that the ports are

too small. Such a case is shown by Fig. 12.

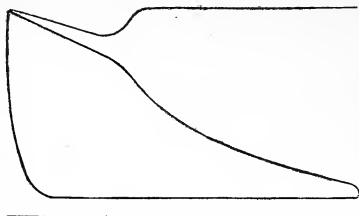
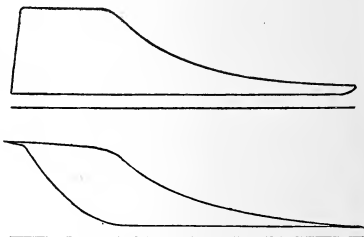


Fig. 13. Steam Chest Card on Forward Stroke.

If there is a drop in the chest line up to cut-off, and a still greater drop in the steam line of the card, it would indicate that both the steam ports and the steam pipe were too small. Fig. 13 shows such a case.

ECCENTRIC OUT OF PLACE.

Figs. 14, 15, 16, and 17, show cards taken from a Corliss Engine having the eccentric out of adjustment. Similar cards would be obtained from any engine having all the valves moved by one eccentric. The plain slide valve and the locomotive, especially in full gear, would give similar cards for the same derangements of eccentric.



Figs. 14 and 15.

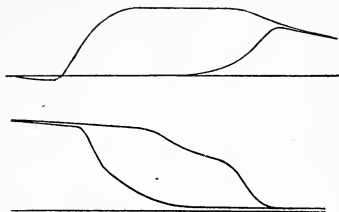
Fig. 14 was taken with the eccentric a trifle less than 90° ahead of the crank, or about 20° behind where it belongs on this particular engine.

Fig. 15 shows the eccentric moved too far ahead of the crank.

By comparison with Fig. 9, it will be seen that moving the eccentric back makes all the events of the stroke, such as admission, release and compression and cut-off, in the case of engines without automatic cut-off governor, come later; while moving the eccentric ahead brings these events earlier.

Figs. 16 and 17 are similar to **Figs. 14 and 15**, the only difference being that eccentric is moved a greater distance out of place.

In **Fig. 16** the admission is very late. Release does not occur until after the piston has started on the return stroke, the steam, until released, being compressed back along the expansion curve. This compression is always a trifle below the expansion line,



Figs. 16 and 17.

due to the fact that some of the steam has condensed in the interval between the end of the stroke and the release.

Fig. 17 shows too much compression and too early a release. Steam is compressed above boiler pressure in the cylinder, when the valve lifts and the steam escapes into the chest.

Cards like **Figs. 14 and 15** are very common.

ECCENTRIC CARDS.

As small distances near the ends of the indicator cards represent a large angular motion of the crank, the events occurring at the ends of the card are so squeezed together that it is hard to tell from the card just what any peculiarity in the lines may be due to. The eccentric rod working the valves of the engine will be moving at its greatest speed when the crank is near the centers and the piston near the ends of the stroke; since the eccentric is about 90° ahead of the crank. If the motion of the indicator drum is taken from the eccentric rod instead of the cross-head, the card will be changed in shape, compression and release coming near the middle of the card, and being spread out over considerable length, the cut-off, expansion and back pressure lines coming near the ends of the card.

Fig. 18 gives a steam card drawn, assuming that the expansion and compression lines are hyperbole. The eccentric card for this

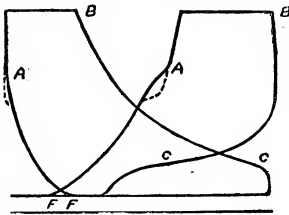


Fig. 18.

had been plotted, and corresponding points marked with the same letters. The

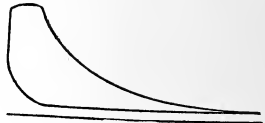


Fig. 19.

compression curve, extending from *F* to *A*, is a double curve. Admission occurs at *A*, cut-off at *B*, release at *C*, and compression at *F*.

Figs. 19 and 20 show cards taken from an engine having tight valves and a tight piston. Corresponding points on the two cards

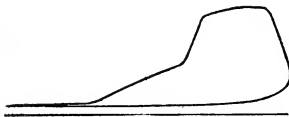


Fig. 20.

are lettered the same. For a cut-off later than half stroke the steam line on the eccentric card doubles on itself, as shown in Figs. 21 and 22.

The peculiar bend shown by the dotted lines on com-

pression curve of the steam card, Fig. 18, is developed on the eccentric card into a well marked flat place. Evidently this represents a loss of pressure at this point, which may be attributed to one or more of three causes: first, leakage by the piston; second, leakage by the exhaust valves; third, a rapid condensa-

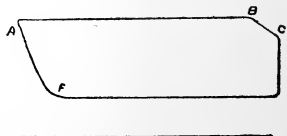


Fig. 21.

tion of steam. If a leakage, it is probable that there is steam blowing by all through the stroke. Near the end of the stroke the piston is moving at so slow a rate that the leakage overbalances the compression. It frequently happens that the pressure drops off at the end of compression, making the upper end of the compression line resemble an inverted letter *U*. If the leakage is by the piston, it will appear or may be made to appear near release, as will be explained later. The effect of compressing steam is to dry it, or, if dry already, to superheat it. While it may be possible in some cases for some of the drop here to be due to condensation, in the majority of cases leakage is the trouble.

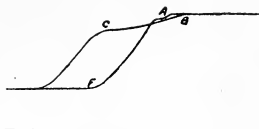


Fig. 22.

Fig. 23 shows the effect of a bad leakage by the piston. This leakage is made evident by the appearance of the upper end of

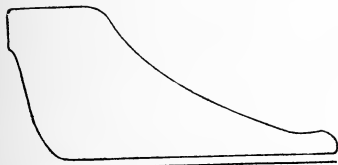


Fig. 23.

the compression curve and by the increase in pressure along the expansion line just before release. By referring to the stroke card, it will be seen that near this point the pressures on the opposite side of the piston are

the greater, so that the leakage is now into the side on which the card is being taken. Unless compression on one side comes earlier than release on the other side, this method would fail. In most engines the valves are set so that compression does come earlier, and all four valve engines can be easily set so as to delay release on one end, and to hasten compression on the other end. In the case of a Corliss engine, this means simply

the changing the length of the rods leading from the wrist plate to the valve arm. This change can be made with the engine running. It is possible that a card like Fig. 23 might be obtained from a four-valve engine having a leaky steam valve on one end and a leaky exhaust valve on the other end.

Fig. 24 represents the head end and the crank end cards taken from a plain slide valve engine. The valve has equal steam laps and equal exhaust laps. The only trouble in this case

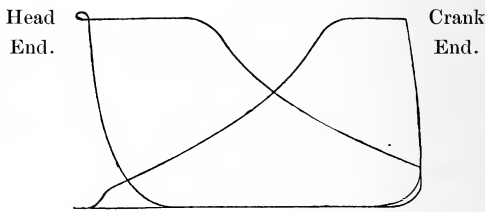


Fig. 24.

is that the valve spindle is too short. Shortening the valve spindle decreases the outside lap of the valve and increases the inside lap for the head end side, and increases the outside lap and decreases the inside lap for the crank end side. As will be seen by the cards, the head end has the cut-off lengthened, the release delayed, and the compression hastened; the crank-end has the cut-off shortened, the release hastened, and the compression delayed. If the valve spindle were too long the cards shown would be interchanged, the crank end card being the one marked head end.

THE STEAM ENGINE INDICATOR.

Benefits derived and information ascertained from its use. — The benefits derived, and the information ascertained from the use of the steam-engine indicator are varied and important.

“The office of the indicator is to furnish a diagram of the action of the steam in the cylinder of an engine during one or more revolutions of the crank, from which is deduced the following data: Initial pressure in cylinder; piston stroke to cut-off; reduction of pressure from commencement of piston stroke to cut-off; piston stroke to release; terminal pressure; gain in economy due expansion; counter pressure, if engine is worked, non-condensing; vacuum as realized in the cylinder, if engine is worked, condensing; piston stroke to exhaust closure, usually reckoned from zero point of stroke; value of cushion; effect of lead and mean effective pressure on the piston during complete stroke. The indicator diagram, when taken in connection with the mean area and stroke of piston and revolution of crank for a given length of time, enables us to ascertain the power developed by engine; and when taken in connection with the mean area of piston, piston speed and ratio of cylinder clearance, enables us to ascertain the steam accounted for by the engine.

“The mean power developed by engine compared with the steam delivered by boilers, furnishes cost of power in steam, and when compared with the coal, furnishes cost of the power in fuel.

“The diagram also enables us to determine with precision the size of steam and exhaust ports necessary, under given conditions, to equalize the valve functions; to measure the loss of pressure between boiler and engine; to measure the loss of vacuum between condenser and cylinder; to determine leaks into and out of the cylinder; to determine relative effects of jacketed and unjacketed cylinders; and to determine effects of expansion in one cylinder, and in two or more cylinders.”

TO TAKE A DIAGRAM.

Connecting-cord.—The indicator should be connected to the engine cross-head by as short a length of cord as possible. Cord

having very little stretch, such as accompanies the instrument, should be used; and in cases of very long lengths, wire should be used. The short piece of cord connected with the indicator is furnished with a hook; and at the end of the cord, connected with the engine, a running loop can be made by means of the small plate sent with each instrument; by which the cord can be adjusted to the proper length, and lengthened or shortened as required.

Selecting a spring.—It is not advisable to use too light a spring for the pressure. Two inches are sufficient for the height of diagram, and the instrument will be less liable to damage if the proper spring is used. The gauge pressure divided by 2 will give the scale of spring to give a diagram two inches high at that pressure.

To attach a card.—This may be done in a variety of ways, either by passing the ends of it under the spring clips, or by folding one end under the left clip, and bringing the other end around under the right; but, whatever method is applied, care should be taken to have the card rest smoothly and evenly on the paper drum. Now attach the cord from the reducing motion to the engine; but be certain the cord is of the proper length, so as to prevent paper drum from striking the inner stop in drum movement on either end of the stroke.

Tension of drum spring.—The tension of the drum spring should be adjusted according to the speed of the engine; increasing for quick running, and loosening for slower speeds.

The steam should not be allowed into the indicator until it has first been allowed to escape through the relief on side of cock, to see if is clean and dry. If clean and dry, allow it into the indicator, and allow piston to play up and down freely.

Before taking diagram, turn the handle of cock to a horizontal position, so as to shut off steam from piston, and apply pencil to the paper to take the atmospheric line.

In applying pencil to the card, always use the horn-handle screw, to regulate pressure of pencil upon paper to produce as fine a line as possible. After the atmospheric line is taken, turn on steam, and press the pencil against card during one revolution.

When the load is varying, and the average horse-power required, it is better to allow the pencil to remain during a number of revolutions, and to take the mean effective pressure from the card.

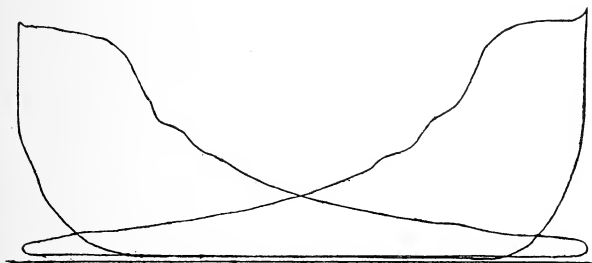


Fig. 25.

Fig. 25 was taken from a Russell engine 13" x 20", running 205 revolutions per minute, boiler pressure 98 lbs., scale of indicator 60 lbs. Duty, electric lighting.

After sufficient number of diagrams have been taken, remove the piston, spring, etc., from the indicator, while it is still upon the cylinder; allow the steam to blow for a moment through the indicator cylinder; and then turn attention to the piston, spring, and all movable parts, which may be thoroughly wiped, oiled and cleaned. Particular attention should be paid to the springs, as their accuracy will be impaired if they are allowed to rust; and great care should be exercised that no grit or substance be introduced to cut the cylinder, or scratch the piston. Be careful

always not to bend the steel bars or rods. The heat of the steam blown through the cylinder of the indicator will be found to have dried it perfectly, and the instrument may be put together with the assurance that it is all ready for use when required. Other items of precaution should be borne in mind. Any engineer can easily repeat this operation without further instruction.

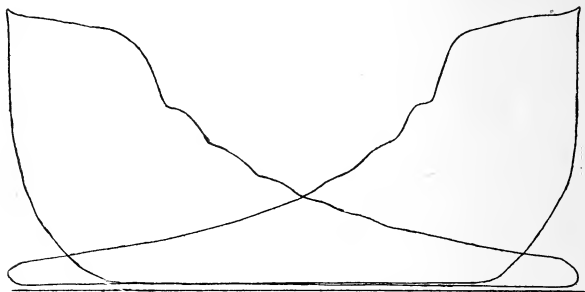
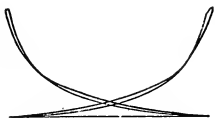
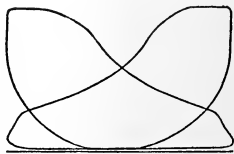


Fig. 26.

Fig. 26 was taken from a Russell engine 16" x 24", running 157 revolutions per minute, boiler pressure 70 lbs., scale of indicator 40 lbs. Duty, flouring mill.



FRICTION INDICATION.

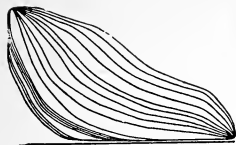


FULL LOAD INDICATION.

HARRISBURG IDEAL SIMPLE SINGLE VALVE ENGINE.

Fig. 27.

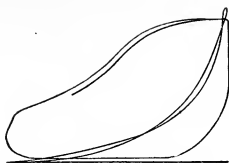
Fig. 28.



GRADUATED LOAD INDICATION.

HARRISBURG IDEAL SIMPLE SINGLE VALVE ENGINE.

Fig. 29.



EXTREME LOAD VARIATION INDICATION.

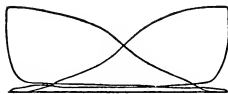
Fig. 30.



HIGH PRESSURE INDICATION.

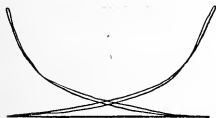
HARRISBURG IDEAL COMPOUND SINGLE VALVE ENGINE.

Fig. 31.



LOW PRESSURE INDICATION.

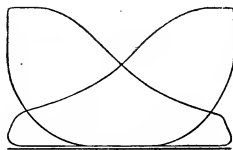
Fig. 32.



FRICTION INDICATION.

HARRISBURG STANDARD SIMPLE SINGLE VALVE ENGINE.

Fig. 33.



FULL LOAD INDICATION.

Fig. 34.



FRICTION INDICATION.

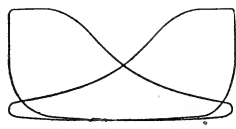
HARRISBURG STANDARD SIMPLE FOUR-VALVE ENGINE.

Fig. 35.



FULL LOAD INDICATION.

Fig. 36.



HIGH PRESSURE INDICATION.

HARRISBURG STANDARD COMPOUND FOUR-VALVE ENGINE.

Fig. 37.



LOW PRESSURE INDICATION.

Fig. 38.

Figs. 27, 28, 29, 30, 31, 32, 33, 34, 35, 36, 37 and 38 are cards taken from the Harrisburg Ideal and Standard Engines. An engineer will see from these cards the kind of card he should get from a high speed engine of this class.

Fig. 39 is from a Frick Corliss Engine, driving a Frick Compressor: —

Steam Cylinder	19" x 28".
Steam	95 lbs.
Revs.	58
Cond. Press.	164 lbs.
Back Press.	27 lbs.

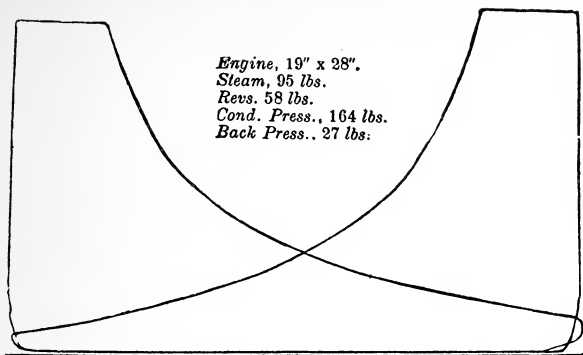


Fig. 39.

INDICATOR DIAGRAMS FROM 50-TON "ECLIPSE" MACHINE.

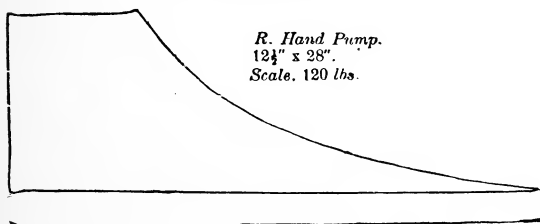


Fig. 40.

Fig. 40 is R. Hand Pump. 12½" x 28". Scale, 120 lbs.

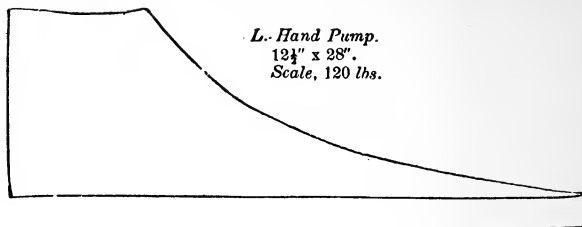


Fig. 41.

Fig. 41 is L. Hand Pump. 27 $\frac{1}{2}$ " x 28". Scale, 120 lbs.

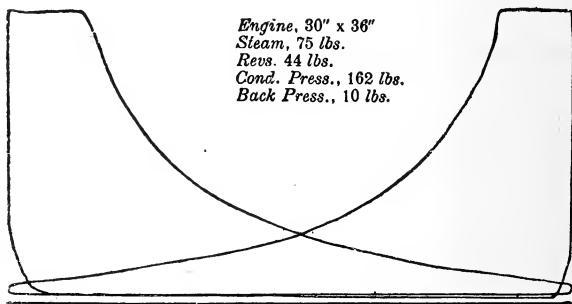


Fig. 42.

Figs. 42, 43 and 44 are diagrams from a 100-ton "Eclipse Machine."

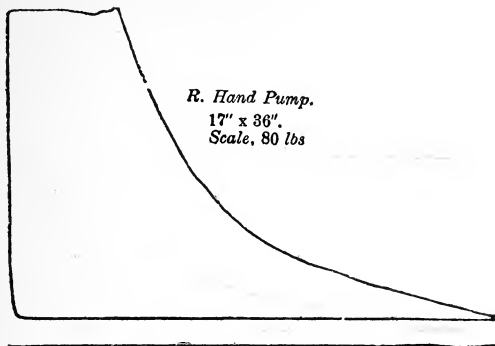
INDICATOR DIAGRAMS FROM 100-TON "ECLIPSE"
MACHINE.

Fig. 43.

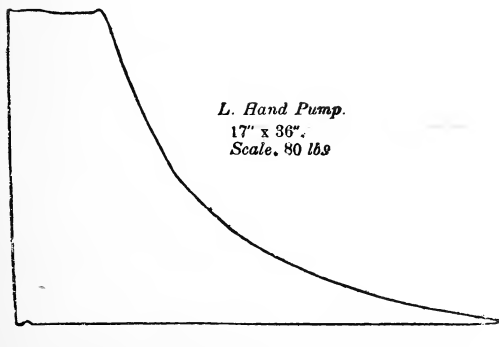
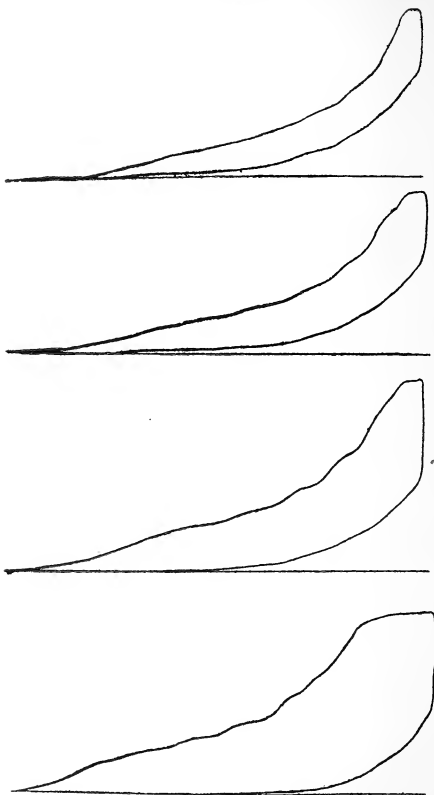
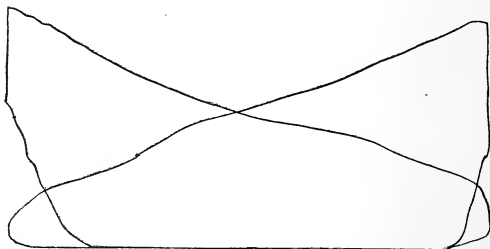
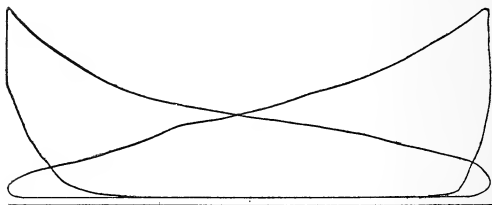
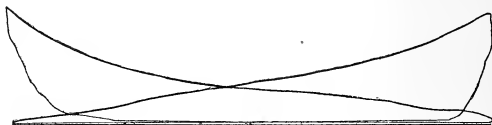
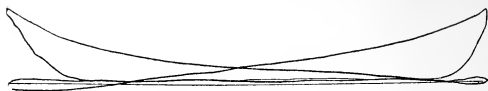


Fig. 44.



It will be interesting to note that when the eccentric is simply moved forward or backward around the shaft by the action of the governor, all the events of the stroke — admission, release, cut-off and compression — will be hastened or retarded together; but if the eccentric be so designed that the governor will shift it across the shaft instead of around it, the admission and release will be effected differently, and in the opposite direction from the cut-off and compression. If, for example, the cut-off is made to occur earlier in the stroke, the compression will occur earlier also, but the admission and release will occur later instead of earlier. By combining the two movements of the eccentric and having the governor move it partly around and partly across the shaft, it is possible to keep the admission and release nearly constant, while the cut-off and compression vary. This result is attained to a certain extent in the best single-valve engines. Besides these two types, there are numerous other styles of engines in which the point of cut-off is varied automatically. Instead of a shaft governor with a shifting eccentric, a weighted pendulum governor is sometimes employed to operate the link, or radius rod of some one of the various link motions. Sometimes there are separate admissions and exhaust valves, the former being under the control of a shaft governor, and the latter operated by a fixed eccentric, so that the points of admission and cut-off only are varied, while the points of release and compression, which depend upon the exhaust valve, remain fixed. There are a great many modifications of the Corliss engine, as originally constructed by Geo. H. Corliss, and there are many engines which, while not resembling the Corliss engine, have some arrangement whereby the cut-off valves are tripped.

On pages 432 and 434 is a collection of diagrams which illustrate very nicely the peculiarities and difference in the action of throttling and automatic engines. The four diagrams on page 432 were taken from a Ball automatic, in an electric light



station. The first diagram was taken late in the afternoon when the engine was started and before any load was thrown on to the machine, and the three succeeding cards were taken at intervals later in the evening as the number of lights increased and the load became heavier. Two or three important points are to be noticed in connection with these diagrams. First, the initial pressure of the steam at the point of admission is very nearly the same in all four cards, the slight variations being due chiefly to a variation in the boiler pressure. Second, the length of the cut-off increases with the load. The compression also becomes later as the cut-off lengthens, and while there is also a change in the points of admission and release, it is not as marked as the changes in cut-off and compression, for reasons that have already been explained.

Taking the cards on page 434, we have four excellent examples of the action of a throttling engine. These cards are from a Dickson engine, taken at the same station and under the same conditions as the Ball engine cards, with the exception that in this case both head and crank-end diagrams were taken on the same cards, while only the head end diagrams from the Ball engine are shown. The two sets of diagrams are well adapted for comparison, because both engines are of the single-valve type, with the valve moved by one eccentric.

The points to be noted are, first, that the points of cut-off are the same, namely at about $\frac{3}{4}$ stroke, in all the throttling cards, and second, that the power of the engine is increased by the action of the governor in opening a throttle valve wider, allowing steam to enter the cylinder at higher pressure.

It was stated at the outset that automatic regulation is the most approved method for regulating the speed of steam engines at the present time. It is generally believed and it is probably true, that automatic engines give better economy than throttling engines and that they regulate a little more closely. It will readily be seen that when the governor of the automatic engine

changes position, it measures out just the quantity of steam that will be required to keep the engine within the speed limits during the following stroke. The effect of this regulation, moreover, is felt at one point in the stroke only — the point of cut-off — so that any change in the governor up to the time when the piston nears the point of cut-off will produce an immediate change in the quantity of steam admitted. In the throttling engine, on the other hand, the regulation is effected during the whole stroke up to the point of cut-off, and the full effect of any change of the governor cannot be felt until the next stroke. With regard to the relative economy of the two types, it should be kept in mind that the throttling engine is generally of cheap construction, has large clearance, a single, unbalanced slide-valve that does duty for both entering and exhaust steam and aside from the throttling feature, is inferior to the average automatic engine. It is reasonable to suppose, therefore, that at least a part of the large steam consumption generally attributed to the throttling engine is due to its inferior design and construction and not to its method of governing.

For example, take the case of the Ball and the Dickson engines, from which I have shown cards. They both have a single slide-valve, but the former runs at higher speed than the latter and its valve is balanced, so that for these reasons it would be expected to be a little more economical. We should not expect, however, that a test would show any decided superiority that could be attributed to the method of governing. If we were to compare the average throttling engine with the most approved type of automatic engine, like the Corliss, we should find that the efficiency of the latter was much higher. The gain, however, would be due to a large extent to the small clearance spaces, separate steam and exhaust valves, and other important features of the Corliss engine, rather than to its automatic cut-off. It is not the purpose to discuss here why these features give improved

economy over the single valve, but simply call attention to the fact that they exert an important influence. The exact influence which the throttling or automatic features exert apart from the general constructive features of the engine is hard to determine. It is known that high-pressure steam is more economical to use than low pressure steam and the automatic engine, which preserves nearly the boiler pressure up to the point of cut-off, gains on this account. On the other hand, it is known that the most economical point of cut-off for a non-condensing engine is about one-third stroke, and when it becomes very much less than this there is a serious drop in the economy. A very short cut-off with high-pressure steam produces so great a variation in the temperature during one stroke of the piston that the cylinder condensation becomes excessive. For very light loads, therefore, it would be better to throttle the steam than to shorten the cut-off.

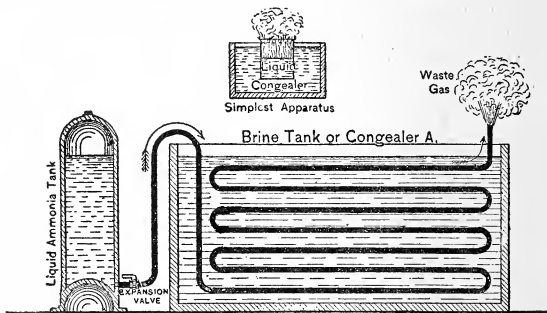
It is necessary for all engines to have a reserve of power and hence the cut-off of throttling engines must come late in the stroke. If it were early in the stroke, there would not be enough reserve power with the reduction in the pressure of the steam that is necessary with this type. The late cut-off produces poor economy when the load is heavy, because there will then be a high terminal pressure, and a large amount of heat, corresponding to this pressure, will be thrown away. A throttling engine therefore, may be expected to do better at light loads than at heavy ones, and in fact, may do a little better at light loads than the automatic engine. If a throttling engine could be run so as not to vary much from its most economical load, and could be designed to have the good features of the best automatic engines, with the cut-off at an earlier period in the stroke, it would probably be nearly or quite as well as the automatic engine. Under the conditions that they have to run, however, the automatic engine will keep the lead, although, as explained above, its superiority is not due entirely to the automatic feature.

CHAPTER XVI.

MECHANICAL REFRIGERATION.

About the first thing asked by persons who are becoming interested in the subject of refrigerating and ice-making is, "Tell me how the thing is done?"

Mechanical refrigeration, primarily, is produced by the evaporation of a volatile liquid which will boil at low temperature, and by means of a special apparatus the temperature and desired amount of refrigeration is placed under control of the operator.



Elemental Refrigerating Apparatus.

Fig. 1.

The simplest form of refrigerating mechanical apparatus consists of three principal parts: *A*, an "evaporator," or, as sometimes called, a "congealer," in which the volatile liquid is vaporized; *B*, a combined suction and compressor pump, which

sucks, or properly speaking, "aspirates" the gas discharged by the compressor pumps, and under the combined action of the pump pressure and cold condenser, the vapor is here reconverted into a liquid, to be again used with congealer. You now see the function of the compressor pumps and condensers.

PRINCIPLES OF OPERATION.

The action of all refrigerating machines depends upon well-defined natural laws that govern in all cases, no matter what type of apparatus or machine is used, the principle being the same in all; while processes may slightly vary, the properties of the particular agent and manner of its use affecting, of course, the efficiency or economic results obtained.

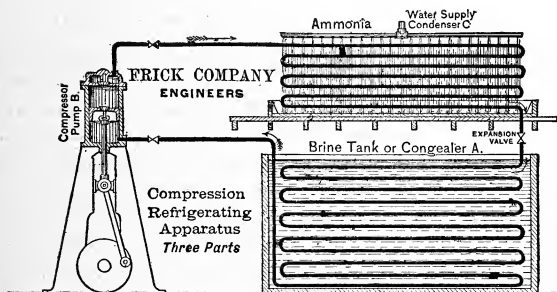


Fig. 2.—Outline drawing of mechanical compression system

OPERATION OF APPARATUS.

(See Fig. 2.) The apparatus being charged with a sufficient quantity of pure ammonia liquid, which we will, for simplicity, assume to be stored in the lower part of the condenser *C*, a small cock or expansion valve controlling a pipe leading to the congealer

or brine tank *A*, is slightly opened, thus allowing the liquid to pass in the same office as a tube or flue in steam boiler and having precisely the same function, it may be called heating or steam-making service. The amount of water capable of being boiled into steam in a boiler depends upon the square feet of heating surface, temperature of fire and pressure of steam; and the same is true of the capacity of heating surface presented by the coils in the evaporator. The heat is transmitted through the coils from surrounding substance to the ammonia liquid, which is boiled into a vapor the same as water is boiled into steam in a steam boiler; as previously explained, the heat thus becomes cooler; the amount taken up and made negative being in proportion to the pounds of liquid ammonia evaporated.

FUNCTION OF THE PUMP AND CONDENSER.

The office of the compressor, pump and condenser is to reconvert the gas after evaporation into a liquid, and make the original charge of ammonia available for use in the same apparatus, over and over again. It will appear to the reader, after having carefully followed the text, that the pump and condenser might be dispensed with, but these conditions may only be economically realized when the, at present, expensive ammonia liquid can be obtained in great quantities and at less cost than the process of reconvertng the vapor into a liquid by compression machinery and condenser on the spot.

WHAT DOES THE WORK.

The real index of the amount of cooling work possible is the number of pounds of ammonia evaporated between the observed range of temperature. To make the above clear, we will add that each pound of ammonia during evaporation is capable of storing up a certain quantity of heat, and that the simplest forms

of refrigerating apparatus might consist, as shown by engraving, of two parts, to wit: A congealer and a tank of ammonia. In this apparatus the ammonia is allowed to escape from the tank into the congealer as fast as the coils therein are capable of evaporating the liquid into a gas. When completely evaporated the resulting vapor is allowed to escape into the atmosphere, which means it is wasted, the supply being maintained by furnishing fresh tanks of ammonia as fast as contents are exhausted. This process, while simple, would be tremendously expensive, costing at the rate of about \$200 per ton, refrigerating or ice-melting capacity. To recover this gas and reconvert to a liquid on the spot in a comparatively inexpensive manner, is the object to be obtained.

MECHANICAL COLD EASILY REGULATED.

This being under the control of the cock or valve leading from the condenser (called an expansion valve). As the gas begins to form in the evaporator, the compressor pump B is set in motion at such a speed as to carry away the gas as fast as formed, which is discharged into the condenser under such pressure as will bring about a condensation and restore the gas to the liquid state; the operation being continuous so long as the machinery is kept in motion.

UTILIZING THE COLD.

To utilize the cold thus produced for refrigerating, two methods are in use, the first of which is called the brine system; the second is known to the trade as the direct expansion system, both of which I will now proceed to explain at some length.

BRINE SYSTEM.

In this method, the ammonia evaporating coils are placed in a tank which is filled with strong brine made of salt, which is well known not to freeze at temperature as low as zero. This is the brine

tank or congealer *A*. The evaporating or expansion of the ammonia in these coils robs the brine of heat, as heretofore explained, the process of storing cold in the brine going on continuously and being regulated, as required, at the gas expansion valve. To practically apply the cold thus manufactured, the chilled brine or non-freezing liquid is circulated by means of a pump through coils of pipe which are placed on the ceilings or sides of the apartments to be refrigerated, the process being analogous to heating rooms by steam.

THE BRINE COOLS THE ROOMS.

The cold brine in its circuit along the pipes becomes warmer by reason of taking up the heat of the rooms, and is finally returned to the brine tank, where it is again cooled by the ammonia coils, the operation, of course, being a continuous one.

DIRECT EXPANSION SYSTEM.

By this method, the expansion or evaporating coils are not put in brine tanks, but are placed in the room to be refrigerated, and the ammonia is evaporated in the coils by coming in direct contact with the air in the room to be refrigerated, no evaporating tank being used.

RATING OF THE MACHINE IN TONS CAPACITY.

For the information of the unskilled reader, I will state that machines are susceptible of two ratings; that is, either their capacity is given in tons of ice they will produce in one day (24 hours), called ice-making capacity; or they are rated equal to the cooling work done by one ton of ice-making per day (24 hours), called refrigerating capacity.

DIFFERENCE IN THESE RATINGS.

Ordinarily the ice-making capacity is taken at about one-half of the refrigerating capacity, but this is only approximate, and

the tons of ice a refrigerating machine will make depend upon the initial temperature of the water to be frozen.

UNIT OF CAPACITY.

The unit of capacity is one ton of ice made from water at 32° Fahr., into ice at 32° , per day, which is equal to 284,000 lbs. of water cooled one degree, or 284,000 heat units, and is the tonnage basis for refrigerating capacity as well as ice made from water at 32° .

THE PREPARATION OF BRINE.

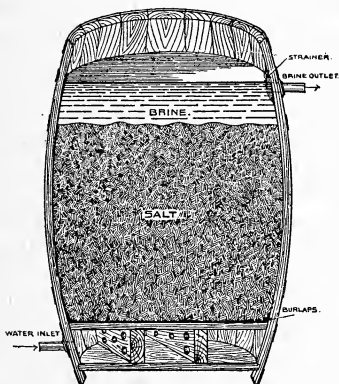


Fig. 1.

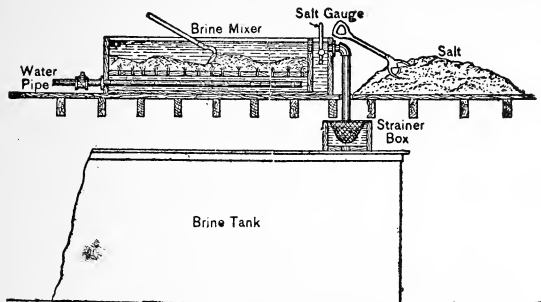
There are two methods in general use, which I will explain. Fig. 1 shows one of the methods, which consists of allowing water to percolate through a body of salt.

Take a large water-tight barrel or cask, and fit a false bottom

or wooden grating six or eight inches above the bottom ; this can be made of strips of wood about an inch square, and placed not over one-half inch apart. This false bottom should be supported by two strips of boards, each six inches in width, placed on edge and nailed to the bottom. These boards should have several holes bored near their bottoms to permit a free passage of water. The water inlet should be below the false bottom. A single thickness of burlap should be stretched across the top of the false bottom and tacked to sides of barrel. The outlet pipe for the brine should be four or five inches below the top of the barrel. The water is supplied at the bottom from a convenient hose or faucet. The supply pipe should be of about $1\frac{1}{4}$ in. diameter ; and the outlet pipe about $1\frac{1}{2}$ in. diameter. If it is necessary to make brine faster than can be accomplished with one barrel, fit up two or more extra barrels. To make brine, fill the barrel above the false bottom with salt and turn on the water. The salt dissolves rapidly and more must be shoveled in on top. The barrel must be kept full of salt or the brine will not be of full strength. No stirring is necessary. Keep skimming off all waste matter rising to the top. The brine outlet should be provided with a strainer of some kind to prevent chips, etc., from running out with the brine. Brine should not be made any stronger than is necessary to prevent it from freezing.

Fig. 2 is the other method of brine-making. This method is a water-tight box, say four feet wide, 8 feet long and 2 feet high, with perforated false bottom and compartment at end. Locate the brine-maker at a point above the brine tank. Connect the space under the false bottom with your water supply, extending the pipe lengthwise of the box, being perforated at each side to insure an equal distribution of water over the entire bottom surface ; use a valve in water supply pipe. Near the top of the brine-maker, at end compartment, put in an overflow with large strainer to keep back the dirt and salt, and connect with this a pipe, say three

inches in diameter, with salt catcher at bottom, leading into the brine tank. Use a hoe or shovel to stir the contents. When all is ready, partly fill the box with water, dump the salt from the bags into



Complete Brine Mixing Arrangement.

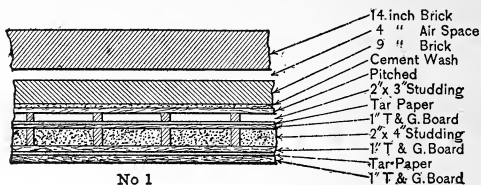
Fig. 2.

on the floor alongside and shovel into brine-maker or dump direct from the bags into the brine-maker as fast as it will dissolve. Regulate the water supply to always insure the brine being of the right strength as it runs into the brine tank. This point must be carefully noticed. Filling the brine tank with water and attempting to dissolve the salt water directly therein is not satisfactory, as quantities of salt settle on the tank bottom coils, forming a hard cake. It is a good plan, when desired to strengthen the brine, to suspend bags of salt in the tank, the salt dissolving from the bags as fast as required; or the return brine from the pumps may be allowed to circulate through the brine-maker, keeping same supplied with salt.

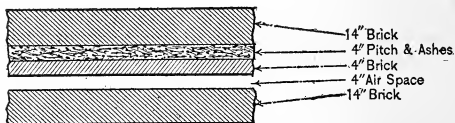
INSULATION OF BUILDINGS.

The insulation of buildings used for the preservation and storage of substances subjected to mechanical refrigeration, is a

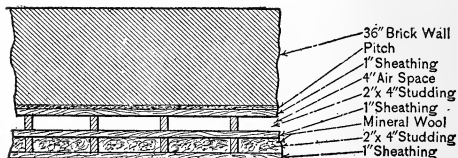
INSULATING BUILDINGS AND COLD STORAGE ROOMS.



No 1



No 2



No 3

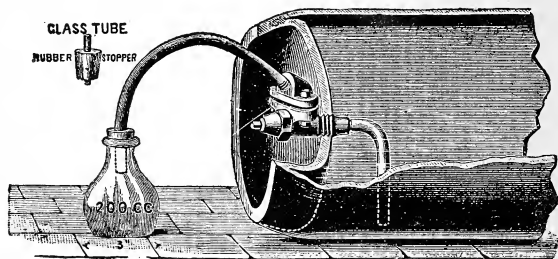
Various Approved Methods.

matter of vital importance, when viewed from an economic standpoint. It is true that by employment of a large surplus of refrigerating power, poor insulation with its entailed great loss of negative heat is wastefully overcome, and a certain amount of cooling work can be accomplished; but this is a bad way to reach a result; it is like pumping out a leaky ship and keeping everlastingly at it, when the best way is to stop the leak and be done with the pumping — it is a preventable loss. Poor insulation is like paying interest on borrowed capital, which is earning nothing for the borrower, a never-ceasing and useless drain upon the machinery and pocket-book of the user.

PERFECT INSULATION.

Perfect insulation is when there is absolutely no transfer of heat through the walls of a building; but this is scarcely possible. If it were, once cooling of the contents of a room would suffice; for there being no loss, they would continue at the same temperature for an indefinite period. If all articles placed in the room thereafter were previously cooled to the temperature of the room before placing therein, no work need be done thereafter in the room itself. A large percentage of the actual work of a refrigerating machine is required to make up for transfer of heat through the walls, floors and ceilings occasioned by improper insulation, and the amount may be experimentally determined by proper instruments. Owing to difference in construction, exposure and insulation of building, you will find a great difference in economy of performance and work done by the same machine in use by different parties in the same line of business; and what a given machine and apparatus will do in one place is no certain guide for another place somewhat similar; the insulation, exposure, and method of handling the business are mainly responsible for the difference.

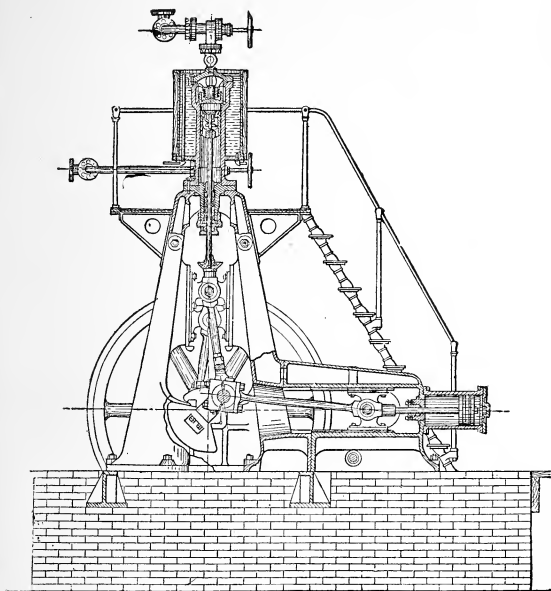
As shown by the engraving, screw into the ammonia flask a piece of bent one-quarter inch pipe, which will allow a small bottle to be placed so as to receive the discharge from it. This test bottle should be of thin glass with wide neck, so that quarter-inch pipe can pass readily into it, and of about 200 centimeters capacity. Put the wrench on the valve and tap it gently with a hammer. Fill the bottle about one-third full and throw sample out in order to purge valve, pipe and bottle. Quickly wipe off moisture that has accumulated on the pipe, replace the bottle and open



Testing for Water by Evaporation.

valve gently, filling the bottle about half full. This last operation should not occupy more than one minute. Remove the bottle at once and insert in its neck a stopper with a vent hole for the escape of the gas. A rubber stopper with a glass tube in it is the best, but a rough wooden stopper, loosely put in, will answer the purpose. Procure a piece of solid iron that should weigh not less than eight or ten pounds, pour a little water on this and place the bottle on the wet place. The ammonia will at once begin to boil, and in warm weather will soon evaporate. If any residuum, pour it out gently, counting the drops carefully. Eighteen drops are about equal to one cubic centimeter, and if the sample taken

amounted to 100 cubic centimeters, you can readily approximate the percentage of the liquid remaining.



Sectional View of 10-ton Refrigerating Machine, regular pattern. Frick Company's Eclipse Refrigerating Machine, with Placer Slide-Valve Throttling Machine.

LUBRICATION OF REFRIGERATING MACHINERY.

It is well to speak of this, for the reason that it is an important subject; and some users of machinery think that a cheap, low

grade of oil is really the cheapest. To disabuse their minds of this idea and suggest the necessity of high grade oils, both on the score of economy and to keep the machinery at all times in efficient running order, is the object of this article. First-class refrigerating machinery calls for the use of at least three different kinds of oil, Nos. 1, 2 and 3, each of high grade: —

No. 1. For use in the steam cylinder, and is known in the trade as cylinder oil. This ranges in price from 50c. to \$1 per gallon. Good cylinder oil should be free from grit, not gum up the valves and cylinder, should not evaporate quickly on being subjected to heat of the steam, and when cylinder head is removed, a good test is to notice the appearance of the wearing surfaces; they should be well coated with lubricant which, upon application of clean waste, will not show a gummy deposit or blacken. Use this oil in a sight feed lubricator with regular feed, drop by drop.

No. 2. For use of all bearing and wearing surfaces of machine proper — an oil that will not gum, not too limpid, with good body, free from grit or acid and of good wearing quality, flowing freely from the oil cups at a fine adjustment without clogging, and a heavier grade should be used for lubricating the larger bearings.

No. 3. For use in compressor pumps. This oil should be what is called a cold test, or zero oil, of best quality.

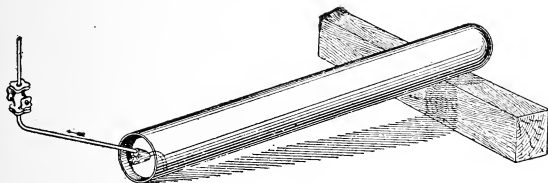
Best paraffine oil is sometimes used; as also a clear West Virginia crude oil. This oil, when subjected to a low temperature, should not freeze.

EFFECTS OF AMMONIA ON PIPES.

Ammonia has no chemical effect upon iron; a tank, pipe or stop-cock may be in constant contact with ammonia for an indefinite time and no action will be apparent. The only protection, therefore, that ammonia-expanding pipes require is from corrosion on the outer surface. As long as the pipes are covered

with snow or ice, corrosion does not occur; the coating of ice thoroughly protects them from the oxidizing effect of the atmosphere; but alternate freezing and thawing requires protected surfaces, which are best obtained by applying a coat of paint every season.

Expansion coils having to withstand but a maximum working pressure of thirty pounds per square inch, are constructed with such absolute security, in whole and in detail, as to make them one of the most perfect pipe constructions on a large scale ever applied in practice.



POSITION OF TANK TO BE EMPTIED.

TO CHARGE THE SYSTEM WITH AMMONIA.

Position of the tank should be as shown, the outlet valve pointing upwards and the other end of the tank raised 12" to 15". The connection between the outlet valve of the tank and the inlet cock of the system should be a $\frac{3}{8}$ " pipe. In charging, open valve of the tank cautiously to test connection; if this is tight, open valve fully; start machine and run slowly till tank is empty. The tank is nearly empty when frost begins to appear on it; run the machine till suction gauge reaches atmospheric pressure. If it holds at this pressure when machine is stopped, the tank is empty; if not, start up again. In disconnecting, close the valve on the tank first, the inlet cock of the system. Weigh tank

before and after emptying; each standard tank contains from 100 to 110 pounds of ammonia.

PROCESS OF MECHANICAL REFRIGERATION.

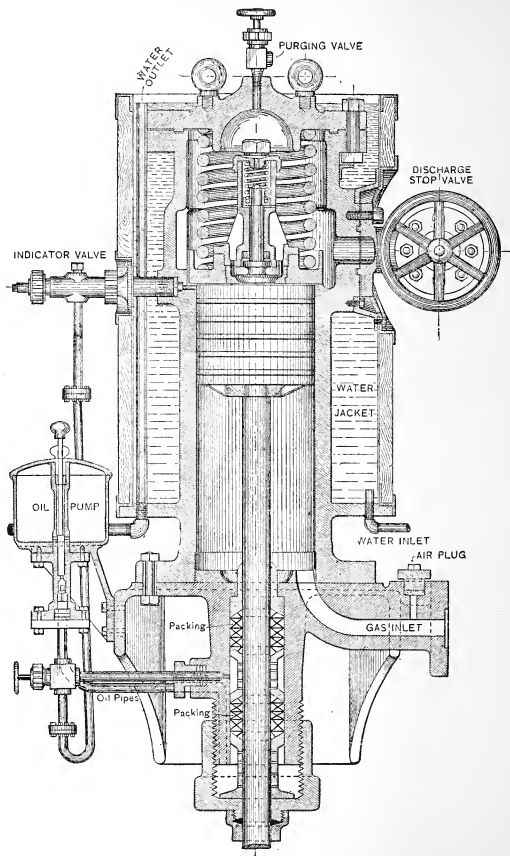
The process of mechanical refrigeration is simply that of removing heat, and mechanism is necessary, because the rooms and articles from which the heat is to be removed are already as cold, or colder than their surroundings, and consequently, the natural tendency is for the heat to flow into them instead of out of them. The fact that a body is already *cold* does not prevent the removal of more heat from it and making it still colder. The term cold describes a sensation and not a physical property of matter; the coldest bodies we commonly meet with are still possessed of a large quantity of heat, part of which, at least, can be abstracted by suitable means. The only means by which heat can be removed from a body is to bring in contact with it a body colder than itself. This is the function that ammonia performs in mechanical refrigeration. It is so manipulated as to become colder than the body we wish to cool. The heat thus abstracted by it is got rid of by such further manipulation that (while still retaining the heat it has absorbed) it will be hotter than ordinary cold water, and therefore, part with its heat to it. Ammonia thus acts like a sponge. It sops up the heat in one place and parts with it in another, the same ammonia constantly going backward and forward to fetch and discharge more heat. The complete cycle of operation comprises three parts: —

1st. *A compression side*, in which the gas is compressed.

2d. *A condensing side*, generally consisting of coils of pipe, in which the compressed gas circulates, parts with its heat and liquefies.

3d. *An expansion side*, consisting also of coils of pipe, in which the liquefied gas re-expands into a gas, absorbs heat, and performs the refrigerating work.

In order to render the operating continuous, these three sides or parts are connected together, the gas passing through them in the order named. The liquefied gas is allowed to flow into the expansion or evaporating coils, where it vaporizes and expands under a pressure varying from 10 to 30 pounds above that of the atmosphere, when ammonia is the agent in use. The gas then passes into the compressor, is compressed and forced into the condensers, where a pressure from 125 to 175 pounds per square inch usually exists; here liquefaction takes place and the resulting liquefied gas is allowed to flow to a stop-cock having a minute opening, which separates the compression from the expansion side of the plant. The expansion side consists of coils of pipe similar to those of the condensing side, but used for the reverse operation, which is the absorption of heat by the vaporization of liquefied gas instead of the expulsion of heat from it, as in the former operation. Heat is conducted through the expansion or cooling coils to, and is absorbed by, the vaporizing and expanding liquefied gas within such coils, for the reason that they are connected to the suction or low pressure side of the apparatus from which the compressors are continually drawing the gas and thereby reducing the pressure in said coils, as already stated, to a pressure of 10 to 30 pounds above the atmosphere; it being kept in mind that liquefied ammonia in again assuming a gaseous condition, has the power or capacity of reabsorbing, upon its expansion, a large quantity of heat. The liquefied gas entering these coils through the minute openings of the stop-cock, above referred to, is relieved of a pressure of 125 to 175 pounds, the amount requisite to maintain it in a liquid condition, when it begins to boil, and in so doing passes into the gaseous state. To do this it must have heat, which can be supplied only from the substance surrounding the pipes, such as air, brine, wort, etc. As a natural result the surrounding substances are reduced in temperature, or cooled. It is apparent from the foregoing that



The above is a Sectional Cut of the "Eclipse" Compressor.

if the expansion coils are placed in an insulated room, that room will be refrigerated; also, if brine or wort is brought in contact with the surface of the coils, they also will be reduced in temperature; and that brine so cooled can be used to refrigerate an insulated room by simply forcing it to circulate through pipes or gutters suspended in the same. Either of the above methods can be applied to the refrigeration of breweries, packing-houses, etc., and for the manufacture of ice, the same gas being used over and over again to perform the same cycle of operations.

THE COMPRESSOR PUMPS.

The most important feature of a refrigerating machine is the compressor pump. To some, the highest efficiency of performance (other things being, such as proper application and proportion of the steam engine driving the same, with the lowest obtainable loss of friction in transmission of power to the pump) is the pump which receives the fullest charge of gas and most perfectly expels the same; this is the most efficient and will do the most work.

THE DE LA VERGNE HORIZONTAL COMPRESSOR.

This compressor is of an entirely new design, embodying all the improvements suggested by experience up to date, and having, moreover, many original features.

Particular attention is directed to the following points: —

The valves are all in the body of the compressor.

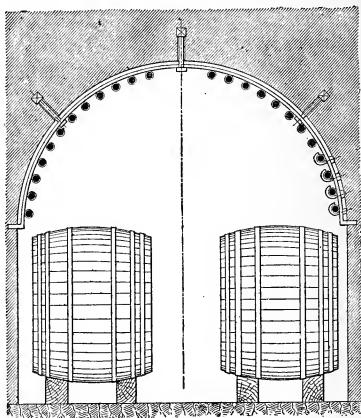
No pipe joints have to be broken to remove the valves or the cages.

The delivery valves are so placed as to allow a free and early draining of the cylinder, if liquid should be present.

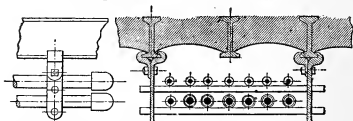
The valves are so arranged and provided with such safety

devices as to render it impossible for them to get inside the cylinder under any circumstances.

The stuffing-box is effectually sealed, without producing undue friction.



PIPE ARRANGEMENT FOR VAULTS.
Showing method of supporting from Ceiling.

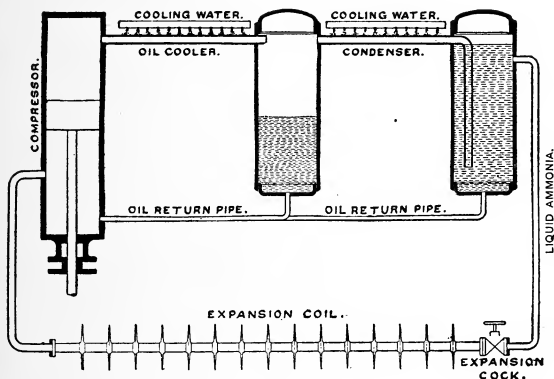


Flat Pipe Coils Suspended from Ceiling on Iron Floors — Beams for Storage and Fermenting Rooms.

DIAGRAM OF DE LA VERGNE SYSTEM.

The diagram on page 457 is seen to be extremely simple in conception; ammonia, gas and oil are received into the com-

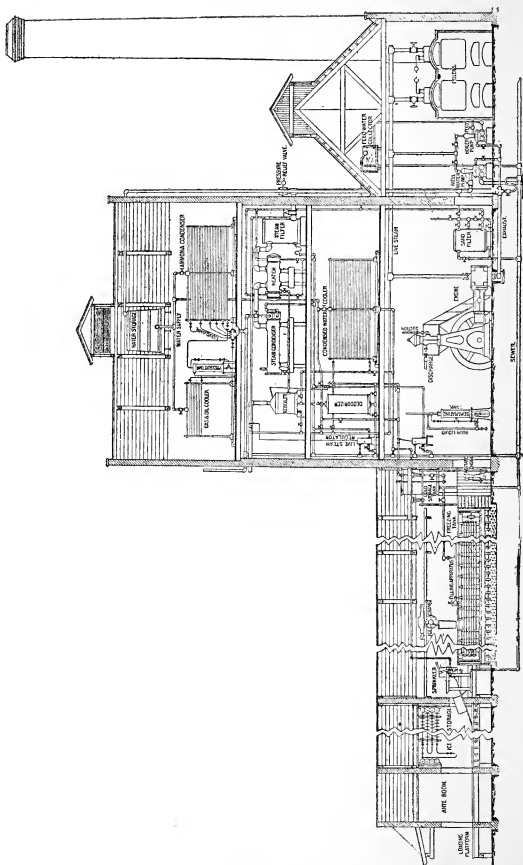
pressor, from which they are discharged together into the cooler. The cooled oil drops into the first tank while the gas continues into the condenser, where it is liquefied and collects in the second tank. The liquid ammonia is taken off from a point near the top of the second tank. If a little oil is taken over from the condenser it is conveyed by a pipe, as shown, to a point near the bottom



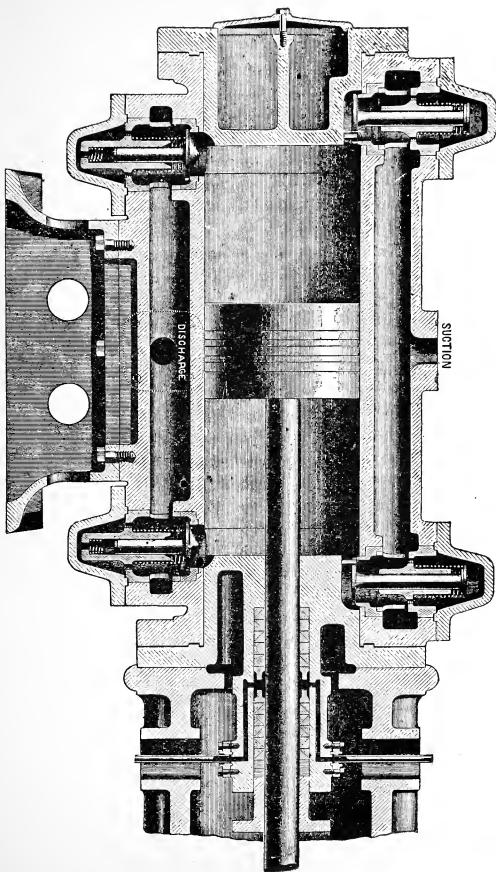
of the second tank, where it remains, since it is heavier than liquid ammonia, and cannot rise to get into the liquid pipe of the ammonia supply. The liquid ammonia is passed through the expansion cock into the expansion coil, where it boils into vapor which is drawn off into the compressor to pass around again in the order above described.

RATING MACHINES FOR ICE-MAKING.

Refrigerating machines are rated by the effect they produce equivalent to the melting of a corresponding amount of ice. Now the melting of one pound of ice is equivalent to the absorbing of



De La Vergne Ice-Making Plant, Complete.



Sectional View of Double-Acting Horizontal Compressor.

142 units of heat. In making ice from water, we have, however, to remove more than 142 units. We have first of all to reduce the water to 32° before we are ready to produce ice. If the water is at 82° this means the removal 50 heat units. Moreover, we cannot make ice with economy without going to a temperature much lower than 32° . The ice when formed may have a temperature of 18° , and the specific heat of ice being 0.5 this means the

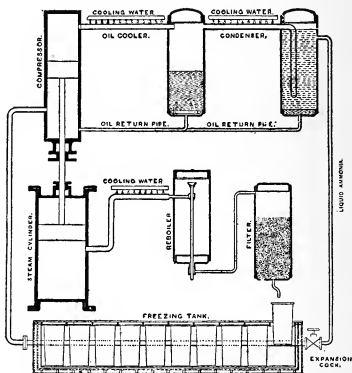
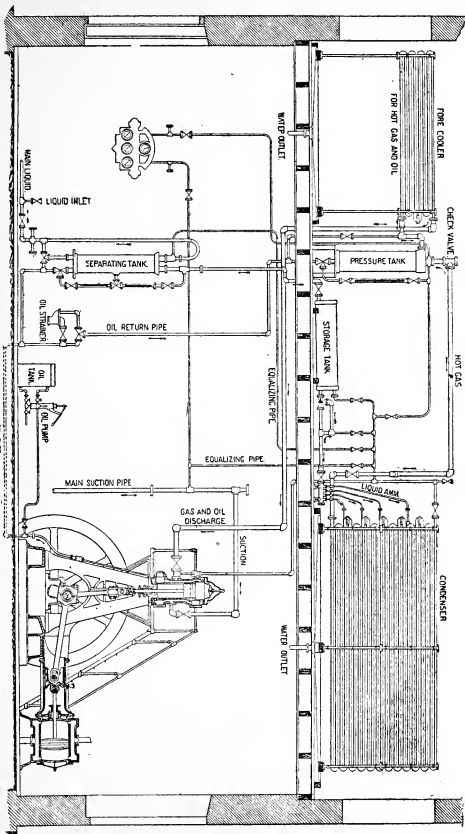


DIAGRAM OF THE DE LA VERONE ICE-MAKING SYSTEM.

The above cut shows, in diagrammatic form, the general outline of the process of ice-making with cans.

removal of 7 more heat units. In other words, we have to remove 199 heat units instead of 142 to produce a ton of ice. Thus a 200-ton machine which would easily produce a refrigerating effect equal to the melting of 200 tons of ice would only produce 142 tons of actual ice. This proportion is still further reduced by the inevitable losses attending the use of large freezing tanks and the handling of the ice.



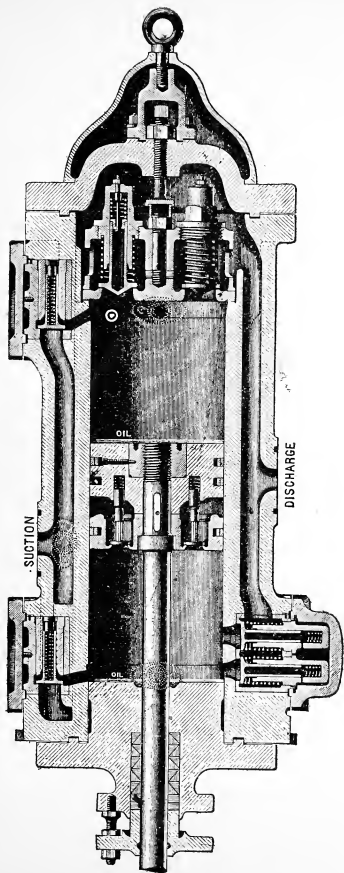
A Complete Refrigerating Plant, De La Vergne Compressor.

COMPLETE CYCLE STANDARD DE LA VERGNE VERTICAL MACHINE.

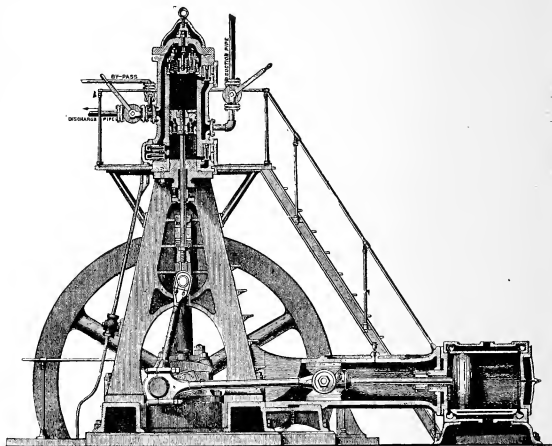
The cut on preceding page shows the engine-room connections for the double acting vertical compressor complete with Corliss engine. The course of the gas can be very readily followed: After being discharged from the compressor it rises to the *fore cooler*, where the oil is cooled and deposited in the *pressure tank*. The ammonia gas goes on to the *condenser*, which it enters at the bottom. As fast as the liquid ammonia collects in the condenser, it is drawn off at different levels in the manner already described in connection with the condensers. From the storage tank it falls into the separating tank, where any remaining oil is trapped, and the anhydrous ammonia passes into the rooms to be cooled by way of the *main liquid pipe*.

The sectional view on following page, represents one of the De La Vergne Double Acting Vertical Compressors, as arranged for use with oil, as a sealing, lubricating and cooling agent. Two passages, marked "suction" and "discharge," respectively, connect the compressor with the pipe system. On the up stroke, gas flows through the lower suction valve into the space behind the moving piston, while the gas above the piston, after being compressed to the condenser pressure, is discharged through the upper valves (in the loose head) into the discharge passage. On the down stroke, gas flows into the cylinder through the upper suction valves, and the gas below the piston is compressed and passes through the lower discharge valves into the discharge passage. The piston in its downward course, closes successively the openings of these two discharge valves. When the lower is closed, however, the upper one communicates with the chamber in the piston, and the gas and oil still remaining below the piston are discharged through the valves into the chamber and out by the upper discharge valve. The oil being injected directly into

Sectional View of De La Vergne Double-Acting Vertical Compressor.



the compressor after the compression of the full cylinder of gas has commenced, does not reduce the capacity of the machine.



The above is a cut of the De La Vergne Double Acting Compressor, driven by a Corliss Engine. Both the compressor and engine cylinder, affording an opportunity of observing the relative positions of the pistons in each.

The oil for "cooling, sealing and lubricating" is brought to the compressor by the pipe running along the back of the "A" frame. The pipe marked "By-pass" is used when any portion of the pipe system in the engine house is to be independently exhausted of gas.

CHAPTER XVII.

USE AND ABUSE OF THE STEAM-BOILER.

Steam-boilers.— A steam-boiler may be defined as a close vessel, in which steam is generated. It may assume an endless variety of forms, and can be constructed of various materials. Since the introduction of steam as a motive power a great variety of boilers has been designed, tried and abandoned ; while many others, having little or no merit as steam generators, they have their advocates and are still continued in use. Under such circumstances, it is not surprising that quite a variety of opinions are held on the subject. This difference of opinion relates not only to the form of boiler best adapted to supply the greatest quantity of steam with the least expenditure of fuel, but also to the dimensions or capacity suitable for an engine of a given number of horse-power ; and while great improvements have been made in the manufacture of boiler materials within the past fifteen years, yet the number of inferior steam-boilers seem to increase rather than diminish. It would be difficult to assign any reasonable cause for this, except that, of late years, nearly the whole attention of theoretical and mechanical engineers has been directed to the improvement and perfection of the steam-engine, and practical engineers, following the example set by the leaders, devote their energies to the same object. This is to be regretted, as the construction and application of the steam-boiler, like the steam-engine, is deserving of the most thorough and scientific study, as on the basis of its employment rest some of the most important interests of civilization. Until quite recently, the idea was very generally entertained that the purely mechanical skill required to enable a person to join

together pieces of metal, and thereby form a steam-tight and water-tight vessel of given dimensions, to be used for the generation of steam to work an engine, was all that was needed; experience has shown, however, that this is but a small portion of the knowledge that should be possessed by persons who turn their attention to the design and construction of steam-boilers, as the knowledge wanted for this end is of a scientific as well as of a mechanical nature. As the boiler is the source of power and the place where the power to be applied is first generated, and also the source from which the most dangerous consequences may arise from neglect or ignorance, it should attract the special attention of the designing and mechanical engineer, as it is well known that from the hour it is set to work, it is acted upon by destroying forces, more or less uncontrollable in their work of destruction. These forces may be distinguished as chemical and mechanical. In most cases they operate independently, though they are frequently found acting conjointly in bringing about the destruction of the boiler, which will be more or less rapid according to circumstances of design, construction, quality of material, management, etc. The causes which most affect the integrity of boilers and limit their usefulness are either inherent in the material, or due to a want of skill in their construction and management; they may be enumerated as follows: —

First, inferior material; second, slag, sand or cinders being rolled into the iron; third, want of lamination in the sheets; fourth, the overstretching of the fiber of the plate on one side and puckering on the other in the process of rolling, to form the circle for the shell of a boiler; fifth, injuries done the plate in the process of punching; sixth, damage induced by the use of the drift-pin; seventh, carelessness in rolling the sheets to form the shell, as a result of which the seams, instead of fitting each other exactly, have in many instances to be drawn together by bolts, which aggravates the evils of expansion and contraction when the

boiler is in use ; eighth, injury done the plates by a want of skill in the use of the hammer in the process of hand-riveting ; ninth, damage done in the process of calking.

Other causes of deterioration are unequal expansion and contraction, resulting from a want of skill in setting ; grooving in the vicinity of the seams ; internal and external corrosion ; blowing out the boiler when under a high pressure and filling it again with cold water when hot ; allowing the fire to burn too rapidly after starting, when the boiler is cold ; ignorance of the use of the pick in the process of scaling and cleaning ; incapacity of the safety-valve ; excessive firing ; urging or taxing the boiler beyond its safe and easy working capacity ; allowing the water to become low, and thus causing undue expansion ; deposits of scale accumulating on the parts exposed to the direct action of the fire, thereby burning or crystallizing the sheets or shell ; wasting of the material by leakage and corrosion ; bad design and construction of the different parts ; inferior workmanship and ignorance in the care and management. All these tend with unerring certainty to limit the age and safety of steam boilers. On account of want of skill on the part of the designer and avarice on the part of the manufacturer, or perhaps both reasons, boilers are sometimes so constructed as to bring a riveted seam directly over the fire, the result of which is that in consequence of one lap covering the other, the water is prevented from getting to the one nearest the fire, for which reason the lap nearest the fire becomes hotter and expands to a much greater extent than any other part of the plate ; and its constant unequal expansion and contraction, as the boiler becomes alternately hot and cold, inevitably results in a crack. Such blunders are aggravated by the scale and sediment being retained on the inside, between the heads of the rivets, which should be properly removed in cleaning.

The tendency of manufacturers to work boilers beyond their capacity, especially when business is driving, is too great in this

country ; and no doubt many boiler explosions may be attributed to this cause. Boilers are bought, adapted to the wants of the manufactory at the time, but, as business increases, machinery is added to supply the demand for goods, until the engine is overtaken, the boiler strained and rendered positively dangerous. Then again, it not unfrequently occurs that engines in manufactories are taken out and replaced by those of increased power, while the boilers used with the old engine are retained in place, with more or less cleaning and patching, as the case may require. Now, it is evident to any practical mind that boilers constructed for a twenty-horse power engine are ill adapted to an engine of forty-horse power, more especially if those boilers have been used for a number of years. In order to supply sufficient steam for the new engine, with a cylinder of increased capacity, the boiler must be worked beyond its safe working pressure, consequently excessive heating and pressure greatly weaken it and endanger the lives of those employed in the vicinity.

The danger and impracticability of using boilers with too limited steam-room may be explained thus: Suppose the entire steam-room in a boiler to be six cubic feet, and the contents of the cylinder which it supplies to be two cubic feet; then at each stroke of the piston one-third of all the steam in the boilers is discharged, and consequently, one-third of the pressure on the surface of the water before that stroke is relieved; hence, it will be seen that excessive fires must be kept up in order to generate steam of sufficiently high temperature and pressure to supply the demand. The result is that the boilers are strained and burned. Such economy in boiler power is exceedingly expensive in fuel, to say nothing of the danger. Excessive firing distorts the fire-sheets, causing leakage, undue and unequal expansion and contraction, fractures, and the consequent evils arising from external corrosion. Excessive pressure arises generally from a desire on the part of the steam-user to make a boiler do double the work for

which it was originally intended. A boiler that is constructed to work safely at from fifty to sixty pounds was never intended to run at eighty and ninety pounds; more especially if it had been in use for several years. Boilers deteriorated by age should have their pressure decreased, rather than increased.

One of the first things that should be done in manufacturing establishments would be to provide sufficient boiler power and, in order to do this, the work to be done ought to be accurately calculated and the engine and boilers adapted to the results of this calculation. Steam users themselves are frequently to blame for the annoyances and dangers arising from unsafe boilers and those of insufficient capacity. For motives of false economy they are too easily swayed in favor of the cheaper article, simply because it is cheap, when they should consider they are purchasing an article which, of almost all others, should be made in the most thorough manner and of the best material. In view of the fearful explosions that occur from time to time, every steam user should secure for his use the best and safest. The object of a few dollars as between the work of a good, responsible maker and that of an irresponsible one, should not for one moment be entertained.

It is very bad policy for steam-users to advertise for estimates for steam-boilers, or to inform all the boiler-makers in the town or city that a boiler or boilers to supply steam for an engine of a certain size is needed, because in this way steam-users frequently find themselves in the hands of needy persons, who, in their anxiety to get an order, will sometimes ask less for a boiler than they can actually make it for; consequently, they have to cheat in the material, in the workmanship, in the heating-surface and in the fittings. As a result, the boiler is not only a continual source of annoyance, but, in many instances, an actual source of danger. The most prudent course, and in fact the only one that may be expected to give satisfaction, is to contract with some responsible

manufacturer that has an established reputation for honesty, capability and fair dealing, and who will not allow himself to be brought in competition with irresponsible parties for the purpose of selling a boiler. There are thousands of boilers designed, constructed and set up in such a manner as to render it utterly impossible to examine, clean or repair them. Generally, in such cases, in consequence of imperfect circulation, the water is expelled from the surface of the iron at the points where the extreme heat from the furnace impinges, and, as a result, the plates become overheated and bulge outward, which aggravates the evil, as the hollow formed by the bulge becomes a receptacle for scale and sediment. By continued overheating, the parts become crystallized and either crack or blister; this, if not attended to and remedied, will eventually end in the destruction of the boiler. Many boilers, to all appearance well made and of good material, give considerable trouble by leakage and fracture, owing to the severe strains of unequal expansion and contraction induced by the rigid construction, the result of a want of skill in the original design.

DESIGN OF STEAM-BOILERS.

It has become a general assertion on the part of writers on the steam-boiler that the most important object to be attained in its design and arrangement is thorough combustion of the fuel. This is only partially true as there are other conditions equally important, among which are strength, durability, safety, economy and adaptability to the particular circumstances under which it is to be used. However complete the combustion may be, unless its products can be easily and rapidly transferred to the water, and unless the means of escape of the steam from the surfaces on which it is generated is easy and direct, the boiler will fail to produce satisfactory results, either in point of durability or economy of fuel.

Strength means the power to sustain the internal pressure to which the boiler may be subjected in ordinary use, and under careful and intelligent management. To secure durability, the material must be capable of resisting the chemical action of the minerals contained in the water, and the boiler ought to be designed so as to procure the least strain under the highest state of expansion to which it may be subjected — be so constructed that all the parts will be subjected to an equal expansion, contraction, push, pull and strain, and be intelligently and thoroughly cared for after being put in use. These objects, however, can only be obtained by the aid of a knowledge of the principles of mechanics, the strength and resistance of materials, the laws of expansion and contraction, the action of heat on bodies, etc. The economy of a steam boiler is influenced by the following conditions: cost and quantity of the material, design, character of the workmanship employed in its construction, space occupied, capability of the material to resist the chemical action of the ingredients contained in the water, the facilities it affords for the transmission of the heat from the furnace to the water, etc. The safety of any structure depends on the designer's knowledge of the principles of mechanics, the resistance of materials and the action of bodies as influenced by the elements to which they are exposed; and in the case of steam boilers, the safety depends on the judgment of the designer, the quality of the material, the character of the workmanship and the skill employed in the management. Safety is said to be incompatible with economy, but this is undoubtedly a mistake, as an intelligent economy includes permanence and seeks durability. Adaptability to the peculiar purposes for which they are to be used is one of the first objects to be sought for in the design and construction of any class of machines, vessels or instruments, and it is undoubtedly this that gave rise to the great variety of designs, forms and modifications of steam boilers in use at the present day, which are, with very

few exceptions, the result of thought, study, investigation and experiment.

FORMS OF STEAM BOILERS.

According to the well-known law of hydrostatics, the pressure of steam in a close cylindrical vessel is exerted equally in all directions. In acting against the circumference of a cylinder, the pressure must, therefore, be regarded as radiating from the axis, and exerting a uniform tensional strain throughout the inclosing material.

Familiarity with steam machinery, more especially with boilers, is apt to beget a confidence in the ignorant which is not founded on a knowledge of the dangers by which they are continually surrounded; while contact with steam, and a thoroughly elementary knowledge of its constituents, theory and action, only incline the intelligent engineer and fireman to be more cautious and energetic in the discharge of their duties. Many regard steam as an incomprehensible mystery; and although they may employ it as a power to accomplish work, know little of its character or capabilities. Steam may be managed by common sense rules as well as any other power; but if the laws which regulate its use are violated, it reports itself, and often in louder tones than is pleasant. If steam-boilers in general were better cared for than they are, their working age might be greatly increased. Deposits of incrustation, small leaks and slight corrosion, are too often neglected as matters of little consequence, but they are the forerunners of expensive repairs, delay and disaster.

SETTING STEAM-BOILERS.

While engineers differ very much in opinion respecting the best manner of setting boilers, they all readily allow that the results obtained, as regards economy of fuel and the generation of steam,

depend in a great measure on the arrangement of the setting. Particularly is this the case with horizontal tubular boilers, and there have been numerous plans introduced to obtain a maximum of steam with a minimum of fuel. Some of the most practical designs and best laid plans are frequently rendered useless for want of knowledge on the part of those whose duty it is to execute or carry them out. This has perhaps been more frequently the case as regards the setting of steam boilers than any other class of machines, as it is customary for owners of steam boilers to depend too much on the knowledge of masons and bricklayers; consequently, a great many blunders have been made which necessitated changes in the size of gratebars, alteration of brickwork, alteration of flues, chimney, etc., with a list of other annoyances, such as insufficiency of steam, poor draught, or something else. In setting or putting in boilers, all the surface possible should be exposed to the action of the heat of the fire, not only that the heat may be thus completely absorbed, but that a more equal expansion and contraction of the structure may be obtained. Long boilers are often hung by means of loops riveted to the top of them and connected to crossbeams and arches resting on masonry above them, by means of hangers. This is a very mischievous arrangement, unless turn-buckles, or some other contrivance, are used to maintain a regular strain on all the hangers, as long boilers exposed to excessive heat are apt to lengthen on the lower side and relieve the end hangers of any weight; consequently, the whole strain is transmitted to the central hanger, which has a tendency to draw the boiler out of shape—in many instances inducing excessive leakage, rupture, and, eventually, explosion.

DEFECTS IN THE CONSTRUCTION OF STEAM BOILERS.

The following cuts illustrate some of the mechanical defects that impair the strength and limit the safety and durability of

steam boilers. All punched holes are conical, and unless the sheets are reversed after being punched, so as to bring the small sides of the holes together, it will be impossible to fill them with the rivets. Fig. 1 shows the position of the rivet in the hole without the sheets being reversed; and it will be observed that, as very little of the rivet bears against the material, the expansion and contraction of the boiler have a tendency to work it loose. It is apparent that such a seam would not possess over one-third the strength that it would if the holes in the sheets

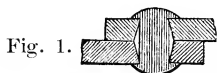


Fig. 1.

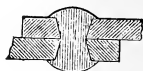


Fig. 2.

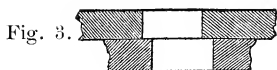


Fig. 3.

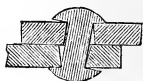


Fig. 4.

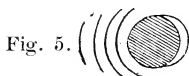


Fig. 5.



Fig. 6.

were reversed and thoroughly filled with the rivet, as shown in Fig. 2. Fig. 3 represents what is known in boiler-making as a blind-hole, which means that the holes do not come opposite each other when the seams are placed together for the purpose of riveting. Fig. 4 shows the position of the rivet in the blind-hole after being driven. It will be observed that the heads of the rivet, in consequence of its oblique position in the hole, bear only on one side, and that even the bearing is very limited, and through the expansion and contraction of the boiler, is liable to

work loose and become leaky. Such a seam would be actually weaker than that represented in Fig. 1. Fig. 5 shows the metal distressed and puckered on each side of the blind-hole in the sheets, which is the result of efforts on the part of the boiler-maker, by the use of the drift-pin, to make the holes correspond for the purpose of inserting the rivet. Fig. 6 shows the metal broken through by the same means. Now, it will be observed that nearly all the above defects are the result of ignorance and carelessness, showing a want of skill in laying out the work, as well as a want of proper appliances for that purpose. The evils arising from such defects are greatly aggravated by the fact that they are all concealed, frequently defying the closest scrutiny, and are only revealed by those forces which unceasingly act on boilers when in use. Such pernicious mechanical blunders ought to be condemned, as they are always the forerunners of destruction and death. There can be no reason why boilers should not be constructed with the same degree of accuracy, judgment and skill as is considered so essential for all other classes of machinery.

IMPROVEMENTS IN STEAM-BOILERS.

Until quite recently the steam boiler has undergone very little improvement. This arose, perhaps, from the fact that men of intelligence and mechanical genius directed their thoughts and labors to something more inviting and less laborious than the construction of steam boilers. Consequently, that branch of mechanics was left almost entirely to a class of men that had not the genius to rise in their profession or improve much in anything they attempted. As a result ignorance, stupidity and a kind of brute force were the predominant requirements in the construction of the steam boiler; but within the past few years this state of things has been changed, as some very important improvements have been made, not only in the manufacture of the material of which boilers are made, but also in the mode of constructing

them. The imposing, powerful and accurate boiler machinery in use at the present time is an evidence that the attention of eminent mechanics and manufacturers is directed to the steam boiler, and that in the future its improvement will keep pace with that of the steam engine.

Boiler-plate is now rolled of sufficient dimensions to form the reams for boilers of any diameter with only one seam, obviating the necessity of bringing riveted seams in contact with the fire, as was usually the case in former times. In the manner of laying off the holes for the rivets, accurate steel gauges have taken the place of the old-fashioned wooden templet, thereby removing the evils induced by blind-holes, and obviating the necessity of using the drift-pin. So, also, in the method of bending the sheets to form the requisite circle — with a better class of machinery, the work is now more accurately performed. The old process of chipping is, in nearly all the large boiler-shops, superseded by planing the bevels on the edge of the sheet, preparatory to calking. Recent improvements in “calking” have resulted in perfect immunity from the injuries formerly inflicted on boilers in that process. In most establishments of any repute in this country, riveting is done by machinery, which is (as is well known to all intelligent mechanics) very much superior to hand-riveting. It is only small shops that enter into rivalry to secure orders and build cheap boilers, using poor material and an inferior quality of mechanical skill, that use the same old crude appliances — in many cases the merest makeshifts — that were in use a quarter of a century ago, and constructed without regard to any of the rules of design that are considered so essential in appliances for the construction of all other classes of machinery. Every engineer should inform himself on the subject of the safe working pressure of boilers, and when he finds the limit of safety has been reached, he should promptly inform his employer and use his influence to have the boiler worked within the bounds of safety.

CARE AND MANAGEMENT OF STEAM-BOILERS.

No class of men are intrusted with greater responsibilities, none hold in their keeping more important interests of life and property, than those having the charge of steam-boilers. A mistake in judgment at a critical point, or a careless neglect of duty may cause, and has often resulted in, terrible destruction to life and property. The most skillful and best-informed engineers, and those best versed in steam matters, are the ones who most fully appreciate its dangers, and who are also most willing to learn all they can relative to any new points of interest, danger or safety. In the management of steam-boilers there are certain rules that must be observed, and to insure faithfulness, the owners of boilers should secure the services of intelligent men — ignorance and carelessness have been the occasion of too many accidents, and great destruction of life and property has not unfrequently been the result of employing cheap help. In the care and management of steam-boilers men should be employed who know at least something of the nature of the power with which they have to deal; men who understand the use of the various attachments on steam-boilers; men of good sound judgment who have, if not a thorough, at least a practical knowledge of the strength of iron, of its capabilities to resist pressure, and who know beyond what limits they should not allow pressure to accumulate. It will be poor consolation to the owner of a steam-boiler, after his property has been destroyed by a terrible explosion, to congratulate himself on the fact that he saved a few dollars a month in the wages of his engineer, by employing a careless or incompetent man. But if those who neglect and abuse steam-boilers were the only ones to suffer from explosions, carelessness and mismanagement would be less a matter of public concern; but when the lives of hundreds are often thus exposed to danger, it should be the aim of every steam-user to do his

utmost to render the use of steam in his establishment safe, as, after an explosion, where persons have been killed or maimed for life, the public verdict is very severe, and no right-minded man would wish to covet any man's experience or reflections who has laid himself open to public censure by neglecting to do what might have prevented so serious a disaster. A very mischievous practice exists in various parts of the country in reference to starting fires under steam-boilers preparatory to raising steam. This duty is intrusted to ignorant watchmen, who are too often the agents of disaster. These men are instructed to light the fire at a certain hour, and comply with their orders without exercising the least judgment on the subject. Numerous instances are on record where watchmen have started the fires under steam-boilers and raised steam before discovering that there was insufficient water in the boilers, thus incurring the risk of burning the boilers, if not actually ruining them. No person ought to be permitted to meddle in any way with the steam-boiler, except those who are skilled in the management of them and who are fully conversant with the properties of steam. Thousands of lives are lost and much valuable property destroyed through the ignorance of those left temporarily in charge of steam-boilers. It may seem strange, but it is no less true, that, notwithstanding the numerous fatal explosions that have occurred, resulting from defects which could not have escaped the notice of a competent inspector, many of the users of steam-power appear to be indifferent as to the condition of their boilers. They would rather incur the risk of an explosion than stop their works one day in the year that their boilers may be thoroughly examined. Even then, many of them will not be at the trouble or expense of having the boilers properly cleaned and the flues swept, without which a satisfactory examination is impossible.

In the majority of cases, boilers are not cleaned half as often as they should be. When the water is hard and scale accumulates

on the sides or flues of the boiler, solvents are very often resorted to to remove the scale. After the scale has been thrown down, it is frequently allowed to remain there and form a heavy conglomerate coating, which prevents the water from coming in contact with the iron, the result of which is that the parts of the boilers exposed to the direct action of the fire are cracked, bulged or burned through.

The first duty of an engineer or fireman when he enters his boiler-room in the morning is to try the boiler gauge-cocks and ascertain if there is a sufficient supply of water. Many boilers have been badly injured from neglect of this precaution. Fires are often replenished and when well started, attention is directed to the water in the boiler. If from any cause during the night, the water has escaped, the result may be a burnt sheet, or probably still more serious injury. Too much reliance should never be placed on self-acting apparatus, such as gongs, floats, steam or alarm whistles for regulating the height of the water in steam-boilers, as, even if they act with certainty, they provide only against one or two contingencies, while the dangers to which steam boilers are exposed are numerous.

The glass water-gauge, though one of the simplest, most beautiful and useful attachments of the steam-boiler, should not be relied upon altogether to show the level of the water in the boiler.

The gauge-cocks should be kept clean and in constant use, as they furnish the most reliable means of ascertaining the height of the water in a steam-boiler.

The furnace should never be allowed to remain open longer than is sufficient to clean and replenish the fire, as the contraction of the tubes and flues, induced by the cooling down of the furnace, has a very mischievous effect on all parts of the boiler exposed to the cold draught.

The feed-water should be sent into the boiler as hot as pos-

sible, as, if it be forced in at a low temperature, it will impinge on that portion of the boiler with which it comes in contact, and, as a result of the continual expansion and contraction induced by the varying temperature of the water, the boiler is liable to crack and become leaky. If, from neglect or any other cause, the water in the boiler should become dangerously low, the fire doors and damper should be immediately thrown open for the purpose of admitting the cold air to the heated plates, and the fire withdrawn as soon as possible. Under such circumstances, no attempt should be made to introduce cold water into the boiler, or disturb the safety-valve, as either might be attended with disastrous results.

The safety-valve should always be moved before the fire is started to get up steam, for the purpose of ascertaining if it is in good working order. It should also be raised whenever the boiler is being filled with cold water in order to allow the air to escape, as air has a tendency to retard the influx of the water, and also to occupy the steam-room when steam is raised. Air also interferences with the uniform expansion of the boiler.

All new boilers should be thoroughly examined before being filled with water, to ascertain if there are any tools, wood, lamps, greasy waste, etc., left behind by the boiler-makers, that would be liable to be carried into connections or cause the boiler to foam.

In getting up steam in boilers just filled with cold water, or that have been out of use for some time, the fire should be allowed to burn modestly at first, in order to admit of the slow and uniform expansion of all parts of the boiler; as, when the fire is allowed to burn rapidly from the first start, some parts become expanded to their utmost limits, while others are as yet nearly cold, thereby subjecting the boiler to fearful strains induced by unequal expansion and contraction, which frequently results in leakage, fracture and sagging of the shell or flues.

When boilers are laid up or out of use, even if it be for a few days, they should be opened, cleaned and thoroughly examined to ascertain if any of the stays or braces have become loose, slack or disconnected. Before being closed up, all gaskets for man and hand-holes, and grumets for mud-holes, should be painted with a coating of black lead and tallow, to protect their seats from deterioration induced by the chemical action of the sulphur in the gun-packing, now so universally used for the joints of steam-boilers.

When the weight is once fixed on the lever of a safety-valve, at the right point to retain the safe working pressure, the extra length of the lever should be cut off.

The feed-supply and the firing should be as steady and regular as possible, as frequent and extreme alterations of temperature, especially with boilers carrying a high pressure, or irregularities of any kind, have a very injurious effect.

Ashes should never be allowed to accumulate around the water-legs of fire-box boilers, or the water-bottom of any boiler, as wet ashes, like any other lye, corrodes and eventually destroys the iron.

Boiler-flues should never be allowed to become choked with ashes, nor the shells to become coated with soot, as it very much impairs the efficiency of the heating surface and induces a wasteful consumption of fuel. The flues and tubes of boilers should be swept out at least once a week. This is a very important object in point of economy, as, when the flues become choked with ashes, it requires an extra expenditure of fuel to generate the necessary quantity of steam. Care and attention to little matters in managing steam-boiler fires will not only add to the working age of a boiler, but save materially in the consumption of fuel.

Boilers should never be filled with cold water while they are hot, as it causes contraction of the seams and stays, often

inducing fracture of the stays or leakage in the seams and tubes, The tubes of boilers being generally of thinner material than the shell, cool and contract sooner. For this reason the boiler should never be filled with cold water while the tubes are hot.

When two or more boilers are connected by feed-pipes, the stop valves on each should be shut off when not working, as the water is liable to escape from one to the other on account of variation in the pressures; and, as a consequence, when the water in one is up to, or even above the proper level, the tubes or flues in the other are very often destitute of water.

When, in consequence of leakage, accumulations of salt occur in the flues or tubes of marine boilers, they should be removed as soon as possible and the tubes thoroughly swept, or, if need be, bored out with a flue-scraper; otherwise, the parts covered with the accumulation will be apt to be burned through. In some cases it is necessary to direct a steam jet on the place affected for the purpose of softening the deposit.

When flues become so leaky that it is impossible to make them tight in the tube-sheet by calking, this object can be effected by cast or wrought-iron ferrules or expanders driven into the end of the tube. This arrangement, however, is only an alternative, as it interferes with the free escape of the gases from the furnace and diminishes the draught.

One of the most common causes of deterioration in steam boilers and also of leakage of the seams and under side, and at the junctions of the tubes and tube-sheets, is the reckless practice of blowing out the boiler while still hot and filling it again with cold water. Under such circumstances, the contraction of the crown-sheet, tube sheets and tubes is so rapid and unequal that, if persisted in, the result is the ruin of the boiler.

When an engine is stopped, if the steam should increase to an excessive pressure, the safety-valve should not be moved, as any sudden release of the steam might be attended with risk; it is

better to open the furnace door, cover the fire with fresh fuel and turn on the feed-water; this will have a tendency to lower the temperature and keep up the circulation in the boiler, so essential to safety when the steam is shut off and a hot fire in the furnace. Many boilers have exploded just as the engine was starting after having stood still for some time; this arose, doubtless, from the fact that the plates directly around and in contact with the fire became overheated in consequence of the circulation becoming enfeebled or entirely suspended after the steam was shut off. As soon as the engine was started and the pressure lessened, the water on the surface of the overheated plates flashed into steam of tremendous elastic force.

When boilers are to be cleaned they should be allowed to stand for several hours and cool before the water is run out; the deposit of mud and scale will then be found to be quite soft, and can be easily removed or washed out with a hose from all accessible parts. There is a very erroneous impression existing among engineers and steam-users, that blowing out a boiler under a high pressure has a tendency to remove the mud or deposit; this, however, is a mistake, as the contraction of the different parts of the boiler, induced by so sudden changes of temperature, has a tendency to induce leakage of the seams and round the rivets and ends of the tubes. It is a very general impression among engineers and firemen and receives encouragement from those who sell nostrums for the prevention and removal of scale, that so long as the mud or deposit is retained in the soft or slushy state, it can do the boiler no harm. This is undoubtedly a mistake, as it retards the escape of the heat from the fire to the water, inducing overheating, which is generally followed by cracking and blistering of the plates and leaking at the seams. It is not uncommon in factories to have two boilers for the same engine, in order that one may be out of use while the other is working; but while this is an accommodation, it is not always economy, as boilers wear

out faster when not in use, by oxidizing and corroding, than if moderately worked. It will be found more economical to work with extra boiler room than to have one or more standing idle, as it will tend to prevent priming; besides, the furnaces will be more economically worked with a thick fire than with a thin one, and more of the heat will be absorbed by allowing it to accumulate, thereby maintaining a high temperature in the furnace with slow combustion. Never neglect to blow out, examine and clean boilers when solvents are used to prevent and remove scale; because, boilers under such circumstances require as much, if not more care than if no solvent or compound is used, as all that can be accomplished at best by such agents, is to loosen and throw down the scale, which if not removed will be apt to form into a hard conglomerate on the bottom of the boiler, preventing the water from coming into contact with the iron; the result is, the plates are burnt through and the boiler permanently ruined.

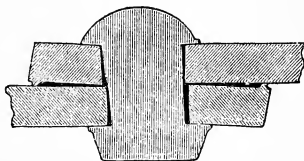
It is a matter of regret that too often, firemen and engineers are laggards in the issues of that real intelligence which ought to be carried out as effective traits of character, indispensable to the credit of their profession. Too often a loose indifference to correct rules is displayed by them, which shows that they have failed to perceive their own advantages.

CALKING.

The object of calking is to bring together the seams of a boiler, after riveting, so that they may be perfectly steam and water-tight. This is done by using a sharp tool ground to a slight angle. The edge of the plates being first chipped or planed to an angle of about 110° , the calking-tool is then applied to the lower edge of the chipped or planed angle, in order to drive or upset the edge, thus bringing the plates together and rendering the joint, to all appearances, perfectly steam-tight and able to resist the internal pressure brought to bear upon this particular point.

The purely mechanical skill required to enable a person to join together pieces of metal and thereby form a steam-tight and water-tight joint, was all that was heretofore considered necessary, as it had been almost universally thought that little more than this was needed, and that, provided the joint was tightly and well calked, or, in other words, "made a good job of," was all that was required. But, unfortunately, this is but a small portion of the knowledge that should be possessed by persons who turn their attention to this subject, and experience has shown that persons engaged in this kind of employment should possess a very different kind of knowledge, otherwise the best efforts of the manufacturer of the material and of the boiler-maker will be rendered useless.

It is well known that the use of a hammer on wrought-iron will granulate or harden it to such an extent as to make it almost as hard as steel. Now, the angled tool before mentioned, through its action (in the process of calking) upon the lower edge of the chipped plate, causes a granulation of that plate; while the under one is much softer, in consequence of not being exposed to the action of the tool, consequently, the skin, or outer surface of the softer material is indented or cut.



Ordinary Method of Calking.

A boiler may be constructed by parties of high repute, be made of the best material, and to all appearance, be capable of standing any test that may be applied to prove its safety, and yet its durability may be very limited, or it may collapse or explode soon after being put in use, for a simple reason that a cause existed from the very first which could not be seen, and which no test could point out, and that cause was the grooving or indentation made by the calking, which became larger and larger through

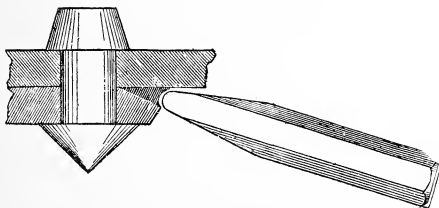
corrosion, expansion and contraction, thus rendering the plates unfit to resist the strain, which must eventually induce rupture or explosion, resulting in loss of life and destruction of property. This tendency to weaken the plates of steam-boilers by the present mode of calking, may be illustrated by very familiar examples.

When a blacksmith desires to break his bar of iron to a given length, he first cuts around the bar, weakening it. The breaking is then easily accomplished — frequently with one blow. A glazier similarly uses his diamond. Now, if a bar of iron which has not been cut, be taken and submitted to blows, in a majority of cases it will bend to a right angle or more without showing any fracture. The explanation of this is, that by cutting a channel through the outer layer of fiber, the strain is confined to the point where the channel is cut. The fiber on either side, to the depth of the channel, is not acted upon at all and exercises no influence as a protection to the underlying layers of fiber. Hence, when the blow is received, the effect is confined to the channel, and the fiber, having little or no opportunity to protect itself, breaks short off. These illustrations are perfectly analogous to that of the cutting or indentation made by the old-fashioned calking-tool.

On examination, steam-boilers are frequently found to be fractured along the edge of the outer lap of the sheet, both transversely and longitudinally, in consequence of a channel being entirely cut through the skin by the calking-tool, thus rendering the plate weak at the point of the greatest strain. The force to act is ever present; the iron is already strained, as by bending a sheet of iron to make a required circle, the fibers of the iron composing the outer circumference must, necessarily, be stretched; and, by imperfect bending, will be stretched laterally as well as longitudinally, while the fibers of the iron composing the inner circumference are upset, and if badly welded in the act

of manufacture, pucker, thereby exposing the inside particles of the iron to the corrosive action of the acids in the water, producing honey-combing. Thus, everything is ready for the cutting or grooving to be made — both the strain on the outer and the puckering on the inner circumference. It then becomes only a mere question of time as to the result.

Very few except those familiar with the laws of steam, have any idea of the immense pressure exerted on the shells of steam-boilers under pressure; and when we consider that this immense pressure is brought to bear along the lap of the joints — the points deviating farthest from the true cylindrical form — the importance of having the iron not only of good quality, but free from the defects induced by inferior calking, must at once be admitted. Immense sums of money have been expended in experiments, with the object of ascertaining, if possible, the cause of boiler explosions, which if conducted by competent persons, might have proved in many instances to be the result of a mischievous system of calking.



Connery's Concave Calking.

The above cut represents an improved method of calking, which is acknowledged by competent parties to be one of the most important improvements ever made in the construction of steam-boilers. It is the invention of James W. Connery, fore-

man of the boiler department at the Baldwin Locomotive Works, Philadelphia, and is known as Connery's Concave Calking. By this method the dangers to life and property induced by the old system of calking are entirely obviated, as even the uninitiated cannot dent or gall the plates with Connery's Patent Calking, the importance of which will be appreciated by all steam users, more especially when it is known that it is impossible for even the most skillful boiler-maker to calk a boiler with the old-fashioned calking-tools without permanent injury to the plates.

TESTING MACHINES.

There is at present in this country a great need of cheap, simple and reliable machinery for the purpose of testing the tensile strength of metals, particularly boiler-plate; as it is of great importance to steam users and the public to know exactly what strain iron of a certain kind or quality will bear without permanent set or fracture. When a boiler explodes, it is of great service to be able to test the tensile strain of the metal torn asunder, that some idea of the force exerted may be estimated, and also to know whether iron that has been subjected to heavy strains for a number of years has become "fatigued," or weakened. There are few machines in this country adapted to this business, and these are very expensive. The expense attending their construction, and the comparatively little use to which they are put, have, without doubt, stood in the way of their construction. If manufacturers and users of iron and other metals fully appreciated their value, they would be more frequently met with. The materials for machines should be tested; and a proper understanding of the exact strength which this material will sustain, would, no doubt, often lead to improvement in design and construction. In some cases the whole machine would be lighter, while in others it would possess proportions better adapted to sustain the heavy strains to which it may be subjected.

PUNCHED AND DRILLED HOLES FOR BOILER SEAMS.

Punching rivet holes, according to experiments, is in itself a cause of weakness. Not only is the section of the plate in the line of the strain reduced by the area of the holes, but the plate between the holes is not so strong per square inch as the solid plate. The excessive strain of the punch appears to disturb the molecular arrangement of the metal and to start fractures, which in case of stay-bolts, often radiate in every direction, allowing corrosion to take place, and ultimately causing the bolts to pull out of the plate.

In the process of punching, from a want of accuracy in laying off the holes, through ignorance or neglect of workmen, the holes do not come opposite, sometimes half their diameter; they are then drifted until the sheet is fractured and the material partly destroyed. This habit cannot be too much reprehended, and the use of drift pins, although considered indispensable by many good boiler-makers, is productive of great evils. As a result, when the rivets are driven, it is almost impossible to make them fill the holes, and consequently an undue strain will come upon some of the rivets, while upon others there will be very little. In that case, there is danger of shearing off the rivet upon which the extra strain comes, inducing a strain upon the adjoining holes and thus starting a rupture, which will ultimately result in the destruction of the boiler.

The usual arguments in favor of punching are the saving from one-third to one-sixth of time and labor, as compared with drilling — a most conclusive argument with the manufacturer; but it is argued on the other hand, that the positions of the holes marked off from the overlapping plate can be preserved more faithfully with the drill than with the punch. This, doubtless, is a very strong argument, as it is well known that half blind holes are the bane of boiler-making. But it must be understood that

the quality of the plate has an important influence on its manner of bearing the severe treatment it undergoes at the hands of the punching machine. Inferior and badly refined plates, being brittle, suffer to a much greater extent than those of better and more ductile quality. In fact, punching a hole at the usual distance from the edge (one diameter clear) in an inferior plate will often produce fracture.

The violence done to the plate may be seen more clearly by considering the force requisite to punch it. It has been found by experiment, that the resistance of a wrought-iron plate to punching is about the same as its resistance to tearing by a tensile strain. Recent experiments authorized by the United States Government, at the Washington Navy Yard, establish the fact that drilled holes for boiler seams are nineteen per cent stronger than holes that are punched. From this it is obvious that the rivet holes for all longitudinal seams of steam boilers should be drilled. The curvilinear seams, being subjected to only about half the strain of the longitudinal, might be punched. It is also worthy of note that, while the punched plate is weaker than the drilled plate, the rivets in the punched holes do not shear so easily as those in the drilled holes. This is probably due to the edges of the drilled holes being sharper and more compact, and consequently, more capable of shearing than the edges left by a punch.

Experiments on drilled and punched holes have shown conclusively that rivets in drilled holes, subject to shearing strain, were about four per cent weaker than rivets in punched holes, under similar strain, and that the sharp edges of the drilled holes have a greater tendency to nip off the rivets than the rounded edges of the punched holes. In comparing the strength of punched and drilled work, it was found, first, that drilled plates are 19 per cent stronger than punched; second, that rivets are 4 per cent stronger in punched holes than drilled; third, that there is a difference of 15 per cent in favor of drilled work.

The following table shows the result of experiments on strips of boiler-iron cut from the same plate, two being punched and two drilled, with one-inch holes, having a sectional area at the reduced part of $1\frac{1}{2}$ square inches.

BREAKING WEIGHT IN TONS.

Experiment.	Drilled Bar.	Punched Bar.	Difference in Tons.	Difference per cent in favor of drilled.
1st	30 $\frac{1}{2}$	26	4 $\frac{1}{2}$	17
2nd	31 $\frac{1}{2}$	26	5 $\frac{1}{2}$	21
Mean	31	26	5	19

The following are the results of experiments to test the difference in value between rivets in punched holes and similar rivets in drilled holes:—

$\frac{5}{8}$ inch Rivets in Drilled Holes.

First, single shear = 26 tons per square inch.
double shear = 39.2 tons.

Second, single shear = 24.4 tons per square inch.
double shear, experiment failed.

$\frac{5}{8}$ inch Rivets in Punched Holes.

First, single shear = 27.2 tons per square inch.
double shear = 45.6 tons.

Second, single shear = 26 tons per square inch.
double shear, experiment failed.

It is generally assumed that plates of fair quality having a tenacity of 42,000 lbs. per square inch, cannot be relied upon to bear more than 32,000 to 34,000 lbs. per sq. inch of section left between holes in ordinary steam-tight riveted joints, which would be equivalent to about 24 and 20 per cent loss of strength. This is about a maximum loss for hard plates of average quality; but

many soft plates do not suffer more than from 5 to 10 per cent loss of strength; with the holes punched a whole diameter, clear of the edge and at the second row of rivets, in double-riveting, do not suffer so much. The damage by punching diminishes as the distance of the hole from the edge increases; consequently, some boiler-makers who prefer punching to drilling, have their plates cut about half an inch larger than their finished size, in order to keep the holes at a safe distance from the edge in punching; the surplus material being afterwards either chipped or planed off.

The engineer's duty, in the performance of the daily routine, involves the application of the laws of nature in various ways. To build a fire intelligently is a chemical experiment, involving a knowledge of the principles of combustion. The production of steam and its use as a motive power, depend upon other laws equally important and interesting.

STRENGTH OF RIVETED SEAMS.

The strength of a riveted seam depends very much upon the arrangement and proportion of the rivets; but with the best design and construction, the seams are always weaker than the solid plate, as it is always necessary to cut away a part of the plate for the rivet holes, which weakens the holes in three ways: 1st, by lessening the amount of material to resist the strains; 2d, by weakening that left between the holes; 3d, by disturbing the uniformity of the distribution of the strains. The first cause of weakness will appear obvious on the inspection of an ordinary boiler-seam, owing to the fact that 44 per cent of the original strength of the material had to be removed by the punch or drill to make way for the rivets. The second cause of the reduction of strength is owing to the injury sustained by the plates during the process of drilling and punching. The third cause of weakness is owing to the fact that if

one or more holes are made in a plate of any material, and it is then subjected to a tensile strain, the strain instead of being equally distributed through the section left between the holes, will be greatest in that part of the metal nearest to it. The strength of boiler seams may be calculated by taking the area in square inches, of the metal between the holes, and multiplying it by the ultimate strength of the metal after the holes are punched. Single riveted seams being equal to 56 per cent of the original strength, and double riveted seams 70 per cent.

COMPARATIVE STRENGTH OF SINGLE AND DOUBLE RIVETED SEAMS.

On comparing the strength of plates with riveted joints, it will be necessary to examine the sectional areas taken in a line through the rivet-holes, with the section of the plates themselves. It is obvious that in perforating a line of holes along the edge of a plate, we must reduce its strength. It is also clear that the plate so perforated will be to the plate itself nearly as the areas of their respective sections, with a small deduction for the irregularities of the pressure of the rivets upon the plate; or, in other words, the joint will be reduced in strength somewhat more than in the ratio of its section through that line to the solid section of the plate. It is also evident that the rivets cannot add to the strength of the plates, their object being to keep the two surfaces of the lap in contact. When this great deterioration of strength at the joint is taken into account, it cannot but be of the greatest importance that in structures subject to such violent strains as boilers, the strongest method of riveting should be adopted. To ascertain this, a long series of experiments was undertaken by Mr. Fairbairn. There are two kinds of lap-joints, single and double-riveted. In the early days of steam-boiler construction, the former were almost universally employed; but the greater strength of the latter has since led to their general adoption for

all boilers intended to sustain a high steam pressure. A riveted joint generally gives way either by shearing off the rivets in the middle of their length, or by tearing through one of the plates in the line of the rivets.

In a perfect joint, the rivets should be on the point of shearing just as the plates were about to tear; but, in practice, the rivets are usually made slightly too strong. Hence, it is an established rule to employ a certain number of rivets per linear foot, which for ordinary diameters and average thickness of plate, are about six per foot or two inches from center to center; for larger diameters and heavier iron, the distance between the centers is generally increased to, say $2\frac{1}{8}$ or $2\frac{1}{4}$ inches; but in such cases it is also necessary to increase the diameter of the rivet, for while $\frac{5}{8}$, or even $\frac{1}{2}$ inch rivets will answer for small diameters and light plate, with large diameters and heavy plate, experience has shown it to be necessary to use $\frac{3}{4}$ to $\frac{7}{8}$ rivets. If these are placed in a single row, the rivet holes so nearly approach each other that the strength of the plates is much reduced; but if they are arranged in two lines, a greater number may be used, more space left between the holes and greater strength and stiffness imparted to the plates at the joint. Taking the value of the plate before being punched, at 100, by punching the plate it loses 44 per cent of its strength; and, as a result, single-riveted seams are equal to 56 per cent, and double-riveted seams to 70 per cent of the original strength of the plate. It has been shown by very extensive experiments at the Brooklyn Navy Yard, and also at the Stevens Institute of Technology, Hoboken, N. J., that double-riveted seams are from 16 to 20 per cent stronger than single-riveted seams — the material and workmanship being the same in both cases:

Taking the strength of the plate at	100
The strength of the double-riveted joint would then be . . .	70
The strength of the single-riveted would be	56

HAND AND MACHINE-RIVETING.

The two methods most generally employed in uniting the riveted seams of steam-boilers are what are termed machine and hand-riveting. In the former process, the rivet is upset with a single blow; while, in the latter, the material is spread or distributed by a series of blows from hand-hammers. In the process of hand-riveting, the heads are rarely finished till the iron is cool enough to crystallize or crack under the head by the heavy blows of the hammer, and if the material be not of superior quality, will frequently snap off under rough usage.

The evil of the rivet not filling the hole well is sometimes aggravated in hand-work by the blows being dealt on the circumference of the point, in order to form a shoulder speedily to resist the hammering, instead of letting them fall dead on the point, which should tend to make the rivet first fill the hole before the shoulder is formed. The advantage of machine riveting is that the machine upsets the rivet and closes up the hole better than hand-riveting, as the dead heavy pressure is exerted through the whole mass of the rivet, and the effect is not concentrated upon the point, as it must be with a succession of light, sharp blows from a hammer. Then again, as the piston of the machine is not limited in its movements, it will follow the rivet home, drawing the plates well together, filling the holes, and making the work equally good, whether the rivet is half an inch too long or half an inch too short, thus accomplishing what no workman could possibly do.

In machine-riveting the heading is done on the "capping" system, thus gathering the metal together instead of scattering it, as is the case with the hand-hammer. When it becomes necessary to take work apart where the rivets have been driven, it is shown that the holes are thoroughly filled, and it is also found almost impossible to dislodge the rivets from the holes, while the

holes were not more stretched than if the riveting had been done by hand. The shearing strain is less on machine-riveted joints than on those riveted by hand, on account of the compactness of the rivets in the holes and the great friction between the sheets at the laps, induced by the power of the machine. Another great advantage of steam-riveting is its quickness and cheapness, while the rivets and plates are left soft and free from crystallization. The general conclusion drawn from practical experience and observation is, that for good, sound boiler-work *machine-riveting* is the best.

COUNTER-SUNK RIVETS.

Counter-sunk rivets are generally tighter than any other form of rivet, because counter-sinking the hole is really facing it; and the counter-sunk rivet is, in point of fact, made on a faced joint. But counter-sinking the hole also weakens the plate, inasmuch as it takes away a portion of the metal and should only be resorted to where necessary — such as around the fronts of furnaces, the flanges inside of combustion chambers, and the bottom flanges of steam chests. In these places it is by no means detrimental; but no part of the shell of a boiler, except those already mentioned, should be counter-sunk.

RIVETS.

The rivet is the means most generally, if not altogether, employed for uniting the seams of steam boilers; and it may be taken, as a rule, that in any but the best class of work, the rivet is stronger than the plate section between the holes. In old boilers, particularly, the plates at the joints are generally found to be much more brittle than the rivets, and the rivets will escape corrosion where the plate may suffer severely. It has been found by experiment that the strength of rivets of various sizes and descriptions in ordinary riveted work averaged 37,640 lbs.

for single shear, and 34,000 lbs. for double shear per square inch of sectional area. The shearing strength of iron rivets with thin steel plates has been found to be less than with plates of the same strength. This is probably due to the harder steel cutting into the iron of the rivet. The average of eight experiments with steel plates and iron rivets gave 37,000 lbs. per square inch. The strength of riveted seams may be calculated by multiplying the area in square inches of one rivet by the number of rivets, and the product by the strength of the metal to resist shearing.

The following formulas, equivalent to those of the British Board of Trade, are given for the determination of the pitch, distance between rows of rivets, diagonal pitch, maximum pitch, and distance from centers of rivets to edge of lap of single and double riveted lap joints, for both iron and steel boilers:—

Let p = greatest pitch of rivets, in inches ;

n = number of rivets, in one pitch ;

p_d = diagonal pitch, in inches ;

d = diameter of rivets, in inches ;

T = thickness of plate, in inches ;

V = distance between rows of rivets, in inches ;

E = distance from edge of plate to center of rivet, in inches.

TO DETERMINE THE PITCH.

Iron plates and iron rivets —

$$p = \frac{d^2 \times .7854 \times n}{T} + d.$$

Example: First, for single-riveted joint—

Given, thickness of plate (T) = $\frac{1}{2}$ inch, diameter of rivet (d) = $\frac{7}{8}$ inch. In this case, $n = 1$. Required, the pitch.

Substituting in formula, and performing operation indicated.

$$\text{Pitch} = \frac{\left(\frac{7}{8}\right)^2 \times .7854 \times 1}{\frac{1}{2}} + \frac{7}{8} = 2.077 \text{ inches.}$$

For double-riveted joint —

Given, $t = \frac{1}{2}$ inch, and $d = \frac{13}{16}$ inch. In this case, $n = 2$.

Then —

$$\text{Pitch} = \frac{(\frac{13}{16})^2 \times .7854 \times 2}{\frac{1}{2}} + \frac{13}{16} = 2.886 \text{ inches.}$$

For steel plates and steel rivets: —

$$p = \frac{23 \times d^2 \times n}{28 \times T} + d.$$

Example, for single-riveted joint: Given, thickness of plate = $\frac{1}{2}$ inch, diameter of rivet = $\frac{15}{16}$ inch. In this case, $n = 1$.
Then —

$$\text{Pitch} = \frac{23 \times (\frac{15}{16})^2 \times .7854 \times 1}{28 \times \frac{1}{2}} + \frac{15}{16} = 2.071 \text{ inches.}$$

Example, for double-riveted joint: Given, thickness of plate = $\frac{1}{2}$ inch, diameter of rivet = $\frac{7}{8}$ inch. $n = 2$. Then —

$$\text{Pitch} = \frac{23 \times (\frac{7}{8})^2 \times .7854 \times 2}{28 \times \frac{1}{2}} + \frac{7}{8} = 2.85 \text{ inches.}$$

FOR DISTANCE FROM CENTER OF RIVET TO EDGE OF LAP.

$$E = \frac{3 \times d}{2}.$$

Example: Given, diameter of rivet (d) = $\frac{7}{8}$ inch; required, the distance from center of rivet to edge of plate.

$$E = \frac{3 \times \frac{7}{8}}{2} = 1.312 \text{ inches,}$$

for single or double riveted lap joint.

FOR DISTANCE BETWEEN ROWS OF RIVETS.

The distance between lines of centers of rows of rivets for double, chain-riveted joints (V) should not be less than twice the diameter of rivet, but it is more desirable that V should not be

less than $\frac{4d + 1}{2}$.

Example under latter formula: Given, diameter of rivet = $\frac{7}{8}$ inch, then —

$$V = \frac{(4 \times \frac{7}{8}) + 1}{2} = 2.25 \text{ inches.}$$

For ordinary, double, zigzag-riveted joints,

$$V = \frac{\sqrt{(11p + 4d)(p + 4d)}}{10}.$$

Example: Given, pitch = 2.85 inches, and diameter of rivet = $\frac{7}{8}$ inch, then —

$$V = \frac{\sqrt{(11 \times 2.85 + 4 \times \frac{7}{8})(2.85 + 4 \times \frac{7}{8})}}{10} = 1.487 \text{ inches.}$$

DIAGONAL PITCH.

For double, zigzag-riveted lap joint. Iron and steel.

$$p_d = \frac{6p + 4d}{10}.$$

Example: Given, pitch = 2.85 inches, and $d = \frac{7}{8}$ inch, then —

$$p_d = \frac{(6 \times 2.85) + (4 \times \frac{7}{8})}{10} = 2.06 \text{ inches.}$$

MAXIMUM PITCHES FOR RIVETED LAP JOINTS.

For single-riveted lap joints, maximum pitch = $(1.31 \times T) + 1\frac{5}{8}$.

For double-riveted lap joints, maximum pitch = $(2.62 \times T) + 1\frac{5}{8}$.

Example: Given a thickness of plate = $\frac{1}{2}$ inch, required, the maximum pitch allowable.

For single-riveted lap joint, maximum pitch = $(1.31 \times \frac{1}{2}) + 1\frac{5}{8} = 2.28$ inches.

For double-riveted lap joint, maximum pitch = $(2.62 \times \frac{1}{2}) + 1\frac{5}{8} = 2.955$ inches.

The following tables, taken from the handbook of Thomas W. Traill, entitled "Boilers, Marine and Land, their Construction

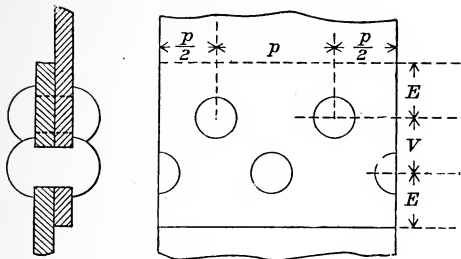
and Strength," may be taken for use in single and double riveted joints, as approximating the formulas of the British Board of Trade for such joints:—

IRON PLATES AND IRON RIVETS.

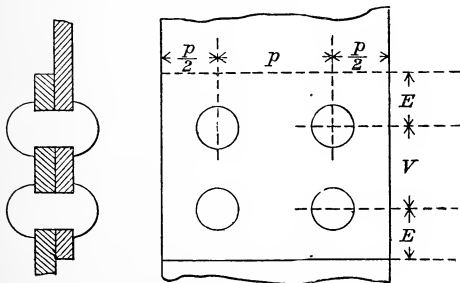
DOUBLE-RIVETED LAP JOINTS.

Thickness of plates.	Diameter of rivets.	Pitch of rivets.	Center of rivets to edge of plates.	Distance between rows of rivets.	
				Zigzag riveting.	Chain riveting.
<i>T</i>	<i>d</i>	<i>p</i>	<i>E</i>	<i>V</i>	<i>V</i>
5	8	2.272	.937	1.145	1.750
6	8 $\frac{1}{2}$	2.386	.984	1.202	1.812
6	9	2.500	1.031	1.260	1.875
6	9 $\frac{1}{2}$	2.613	1.078	1.317	1.937
6	10	2.727	1.125	1.374	2.000
6	10 $\frac{1}{2}$	2.826	1.171	1.426	2.062
6	11	2.886	1.218	1.465	2.125
6	11 $\frac{1}{2}$	2.918	1.265	1.504	2.187
6	12	3.013	1.312	1.544	2.250
6	12 $\frac{1}{2}$	3.079	1.359	1.585	2.312
6	13	3.146	1.406	1.626	2.375
6	13 $\frac{1}{2}$	3.215	1.453	1.667	2.437
6	14	3.284	1.500	1.709	2.500
6	14 $\frac{1}{2}$	3.355	1.546	1.751	2.562
6	15	3.426	1.593	1.794	2.625
6	15 $\frac{1}{2}$	3.498	1.640	1.836	2.687
6	16	3.571	1.687	1.879	2.750
6	16 $\frac{1}{2}$	3.645	1.734	1.923	2.812
6	17	3.718	1.781	1.966	2.875
6	17 $\frac{1}{2}$	3.793	1.828	2.009	2.937
6	18	3.867	1.875	2.053	3.000
6	18 $\frac{1}{2}$	3.942	1.921	2.096	3.062
6	19	4.018	1.968	2.140	3.125

ZIGZAG RIVETING.



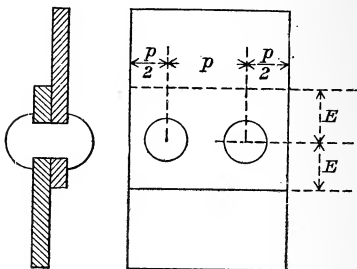
CHAIN RIVETING.



IRON PLATES AND IRON RIVETS.

SINGLE-RIVETED LAP JOINTS.

SINGLE-RIVETED LAP JOINTS.

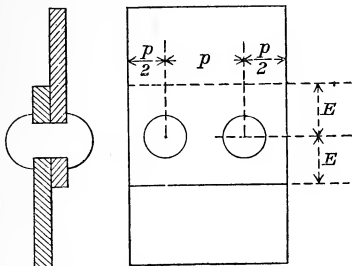


Thickness of plates.	Diameter of rivets.	Pitch of rivets.	Center of rivets to edge of plates.
T	d	p	E
$\frac{1}{4}$	$\frac{5}{8}$	1.524	.937
$\frac{3}{8}$	$\frac{1}{2}$	1.600	.984
$\frac{1}{2}$	$\frac{3}{4}$	1.676	1.031
$\frac{5}{8}$	$\frac{7}{8}$	1.753	1.078
$\frac{3}{4}$	1	1.829	1.125
$\frac{7}{8}$	$1\frac{1}{8}$	1.905	1.171
1	$1\frac{1}{4}$	1.981	1.218
$1\frac{1}{8}$	$1\frac{3}{8}$	2.036	1.265
$1\frac{1}{4}$	$1\frac{1}{2}$	2.077	1.312
$1\frac{3}{8}$	$1\frac{5}{8}$	2.120	1.359
$1\frac{1}{2}$	$1\frac{3}{4}$	2.164	1.406
$1\frac{5}{8}$	$1\frac{7}{8}$	2.210	1.453
$1\frac{3}{4}$	2	2.256	1.500
$1\frac{7}{8}$	$2\frac{1}{8}$	2.304	1.546
2	$2\frac{1}{4}$	2.352	1.593
$2\frac{1}{8}$	$2\frac{3}{8}$	2.400	1.640
$2\frac{1}{4}$	$2\frac{1}{2}$	2.450	1.687
$2\frac{3}{8}$	$2\frac{5}{8}$	2.500	1.734
$2\frac{1}{2}$	$2\frac{3}{4}$	2.550	1.781
$2\frac{5}{8}$	$2\frac{7}{8}$	2.601	1.828
$2\frac{3}{4}$	3	2.652	1.875
$2\frac{7}{8}$	$3\frac{1}{8}$	2.703	1.921
3	$3\frac{1}{4}$	2.755	1.968

STEEL PLATE AND STEEL RIVETS.

SINGLE-RIVETED LAP JOINTS.

SINGLE-RIVETED LAP JOINTS.



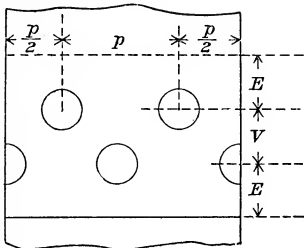
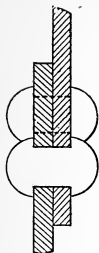
Thickness of plates.	Diameter of rivets.	Pitch of rivets.	Center of rivets to edge of plates.
<i>T</i>	<i>d</i>	<i>P</i>	<i>E</i>
1/4	1/16	1.562	1.031
9/32	3/32	1.633	1.078
5/16	3/16	1.704	1.125
11/32	7/32	1.775	1.171
3/8	1/8	1.846	1.218
13/32	9/32	1.917	1.265
7/16	1/4	1.988	1.312
15/32	5/16	2.036	1.359
1/2	3/8	2.071	1.406
9/16	7/16	2.108	1.453
5/8	1	2.146	1.500
11/8	1 1/32	2.186	1.546
3/4	1 1/16	2.227	1.593
7/8	1 3/32	2.269	1.640
1 1/8	1 1/4	2.312	1.687
1 1/4	1 5/16	2.356	1.734
1 3/8	1 3/8	2.400	1.781
1 1/2	1 7/16	2.445	1.828
1 5/8	1 1/2	2.500	1.875
1 3/4	1 9/16	2.562	1.921
1 7/8	1 5/8	2.623	1.968
2	1 3/4	2.687	2.015
2 1/8	1 7/8	2.750	2.062

STEEL PLATE AND STEEL RIVETS.

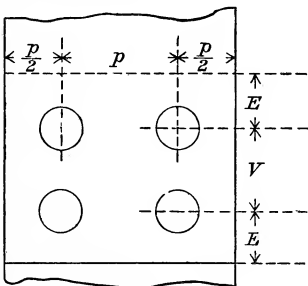
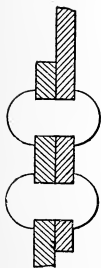
DOUBLE-RIVETED LAP JOINTS.

Thickness of plates.	Diameter of rivets.	Pitch of rivets.	Center of rivets to edge of plates.	Distance between rows of rivets.	
				Zigzag riveting.	Chain riveting.
<i>T</i>	<i>d</i>	<i>P</i>	<i>E</i>	<i>V</i>	<i>V</i>
$\frac{5}{16}$	$\frac{11}{16}$	2.291	1.031	1.187	1.875
$\frac{11}{32}$	$\frac{11}{32}$	2.395	1.078	1.240	1.937
$\frac{3}{8}$	$\frac{3}{8}$	2.500	1.125	1.295	2.000
$\frac{13}{32}$	$\frac{7}{16}$	2.604	1.171	1.349	2.062
$\frac{7}{16}$	$\frac{7}{16}$	2.708	1.218	1.403	2.125
$\frac{15}{32}$	$\frac{7}{16}$	2.803	1.265	1.453	2.187
$\frac{1}{2}$	$\frac{7}{8}$	2.850	1.312	1.487	2.250
$\frac{17}{32}$	$\frac{9}{16}$	2.900	1.359	1.522	2.312
$\frac{9}{16}$	$\frac{9}{16}$	2.953	1.406	1.558	2.375
$\frac{19}{32}$	$\frac{3}{4}$	3.008	1.453	1.595	2.437
$\frac{5}{8}$	1	3.064	1.500	1.631	2.500
$\frac{21}{32}$	$1\frac{1}{32}$	3.122	1.546	1.669	2.562
$\frac{23}{32}$	$1\frac{1}{16}$	3.181	1.593	1.707	2.625
$\frac{25}{32}$	$1\frac{3}{32}$	3.241	1.640	1.745	2.687
$\frac{27}{32}$	$1\frac{1}{8}$	3.302	1.684	1.784	2.750
$\frac{29}{32}$	$1\frac{5}{32}$	3.364	1.734	1.823	2.812
$\frac{31}{32}$	$1\frac{3}{16}$	3.427	1.781	1.863	2.875
1	$1\frac{1}{2}$	3.490	1.828	1.902	2.937
$\frac{33}{32}$	$1\frac{1}{4}$	3.554	1.875	1.942	3.000
$\frac{35}{32}$	$1\frac{9}{32}$	3.618	1.921	1.981	3.062
$\frac{37}{32}$	$1\frac{5}{16}$	3.683	1.968	2.021	3.125
$\frac{39}{32}$	$1\frac{11}{32}$	3.748	2.015	2.061	3.187
1	$1\frac{3}{8}$	3.814	2.062	2.102	3.250

ZIGZAG RIVETING.



CHAIN RIVETING.



STRENGTH OF STAYED AND FLAT BOILER SURFACES.

The sheets that form the sides of fire-boxes are necessarily exposed to a vast pressure, therefore, some expedient has to be devised to prevent the metal at these parts from bulging out. Stay-bolts are generally placed at a distance of $4\frac{1}{2}$ inches from center to center, all over the surface of fire-boxes, and thus the expansion or bulging of one side is prevented by the stiffness or rigidity of the other. Now, in an arrangement of this kind, it becomes necessary to pay considerable attention to the tensile strength of the stay-bolts employed for the above purpose, since the ultimate strength of this part of the boiler is now transferred to them, it being impossible that the boiler plates should give way unless the stay-bolts break in the first instance. Accordingly, the experiments that have been made by way of test of the strength of stay-bolts, possess the greatest interest for the practical engineer. Mr. Fairburn's experiments are particularly valuable. He constructed two flat boxes, 22 inches square. The top and bottom plates of one were formed of $\frac{1}{2}$ inch copper, and of the other, $\frac{3}{8}$ inch iron. There was a $2\frac{1}{2}$ inch water-space to each, with $\frac{1}{16}$ inch iron-stays screwed into the plates and riveted on the ends. In the first box the stays were placed five inches from center to center, and the two boxes tested by hydraulic pressure. In the copper box, the sides commenced to bulge at 450 lbs. pressure to the sq. in.; and at 810 lbs. pressure to the sq. in. the box burst, by drawing the head of one of the stays through the copper plate. In the second box, the stays were placed at 4-inch centers; the bulging commenced at 515 lbs. pressure to the sq. in. The pressure was continually augmented up to 1,600 lbs. The bulging between the rivets at that pressure was one-third of an inch; but still no part of the iron gave way. At 1,625 lbs. pressure the box burst, and in precisely the same way as in the first experiment — one of the stays drawing through the

iron plate and stripping the thread in plate. These experiments prove a number of facts of great value and importance to the engineer. In the first place, they show that with regard to iron stay-bolts, their tensile strength is at least equal to the grip of the plate.

The grip of the copper bolt is evidently less. As each stay, in the first case, bore the pressure on an area or $5 \times 5 = 25$ square inches, and in the second on an area $4 \times 4 = 16$ sq. inches, the total strains borne by each stay were, for the first, $815 \times 25 = 20,375$ pounds on each stay; and for the second, $1,625 \times 16 = 26,000$ lbs. on each stay. These strains were less, however, than the tensile strength of the stays, which would be about 28,000 lbs. The properly stayed surfaces are the strongest part of boilers, when kept in good repair.

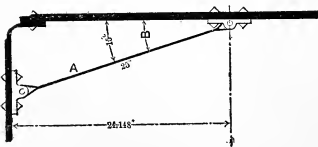
BOILER-STAYS.

Advantage is usually taken of the self-supporting property of the cylinder and sphere, which enables them, in most cases, to be made sufficiently strong without the aid of stays or other support. But the absence of this self-sustaining property in flat surfaces necessitates their being strengthened by stays or other means. Even where a flat or slightly dished surface possesses sufficient strength to resist the actual pressure to which it is subjected, it is yet necessary to apply stays to provide against undue deflection or distortion, which is liable to take place to an inconvenient degree, or to result in grooving, long before the strength of plates or their attachments is seriously taxed. Boiler stays, in any case, are but substitutes for real strength of construction. They would be of no service applied to a sphere subject to internal pressure; and the power of resistance would be exactly that of the metal to sustain the strain exerted upon all its parts alike. The manner in which stays are frequently employed renders them a source of weakness rather than an element of strength. When

the strain is direct the power of resistance of the stay is equal to the weight it would sustain without tearing it asunder; but when the position of the stay is oblique to the point of resistance, any calculation of their theoretic strength or value is attended with certain difficulties. All boilers should be sufficiently stayed to insure safety, and the material of which they are made, their shape, strength, number, location and mode of attachment to the boiler, should all be duly and intelligently considered. Boiler stays should never be subjected to a strain of more than one-eighth of their breaking strength. The strength of boiler stays may be calculated by multiplying the area in inches between the stays by the pressure in pounds per square inch.

Rule for finding the strain allowed on a diagonal boiler head brace or stay; also rule for finding the number of stays required for a certain size crown sheet.

A — Iron stays should not be subjected to a greater stress than from 7,000 to 9,000 pounds per square inch of section, and if they are located obliquely, the diameter will need to be increased an amount that depends on the angle of the stay to the shell. Find the area in square inches to be supported by the stay, and multiply it by the pressure per square inch, multiply the product by the length of the diagonal stay, and divide the result by the perpendicular length from the flat surface to the end of the stay. The quotient will be the stress on the stay, and to obtain the diameter, divide the stress by the allowable stress per square inch



of section, and the quotient by .7854. The square root of the last quotient will be the diameter of the stay.

Thus, in the accompanying diagram, we wish to find the diameter of the diagonal stay

A, which supports an area 6" x 8" or 48 square inches. The

length of the stay is 25", and the perpendicular distance between the stayed surface and the end of the stay is 24.148". The boiler pressure is 100 pounds gauge, so that the pressure on the surface supported will be 40×100 or 4,400 pounds. We multiply 4,800 by 25 and divide the product by 24.148", which gives 4,970, nearly. The quotient of 4,970, divided by 7,000, equals .701; .701, divided by .7854 equals .8925, and the square root of this is .95 or .95", the diameter of a stay that will support 48 square inches in the position shown.

A convenient formula for finding the diameter of oblique stays is,

$$D \text{ equals } 1.13 \sqrt{\frac{A P}{L \cos B}}$$

D equals diameter of the stay.

A " area in square inches to be supported.

P " pressure per square inch.

L " safe load per square inch of stay action.

B " angle between the shell and the stay.

Using the preceding problem as an example and referring to the same diagram, we have angle *B* equal to 15°, and all the other dimensions as previously given. Therefore,

$$D \text{ equals } 1.13 \sqrt{\frac{48 \times 100}{7000 \times .96593}}$$

The diameter of the stay, when the above is simplified, is .9526", or practically 1". A rule for finding the pitch of stays for any flat surface is given below.

1. A safe formula for the strength of stayed flat surfaces is that given by Unwin's machine design. When the spacing of the stays is desired, assuming that it is the same in each direction, we have,

$$a \text{ equals } 3 t \sqrt{\frac{f}{2 p}}$$

where a equals spacing of stays or rivets in inches, f equals safe working strength of the plate, t equals thickness of plate, and p equals boiler pressure. Expressed as a rule, this reads: Divide the safe strength of the plate by twice the pressure; extract the square root of the quotient and multiply the final result by three times the thickness of the plate. The result will be the spacing of the rivets in inches. For example, boiler pressure 100 pounds, plate 1/2 inch thick, safe strength of plate, 10,000 pounds per square inch; $2p$ equals 2×100 equals 200; $f/2p$ equals $10000/200$ equals 50; $\sqrt{50}$ equals 7.02; $3t$ equals $3/2$ equals 1-1/2 equals 1.5; 7.02×1.5 equals 10.5 for the spacing. In making such a calculation care must be exercised not to assume too high values for the strength of the plate. It is not safe to count on more than 60,000 pounds for the strength of steel plates and 40,000 for iron. The working strength must be taken not higher than 1/6 of this, or 10,000 for steel and 6,600 for iron, and lower values still would be better, say 9,000 for steel and 6,000 for iron.

2. **The safe** pressure for a boiler to carry, so far as the flat, stayed surfaces are concerned, may be found from the above formula by transposing it a little, as follows:—

$$p \text{ equals } \frac{9 t^2 f}{2 a^2}$$

Now, applying this to the above example, we have p equals $\frac{9 \times 5^2 \times 10000}{2 \times 110.25}$ which equals $\frac{9 \times .25 \times 2500}{2 \times 110.25}$ and which after reduction equals $\frac{22500}{220.50}$ equals 102, or substantially the pressure assumed in the first example.

RIVETED AND LAP WELDED FLUES.

The following table shall include all riveted and lap-welded flues exceeding 6 inches in diameter and not exceeding 40 inches in diameter not otherwise provided by law.

TABLE OF STEAM PRESSURE PER SQUARE INCH ALLOWABLE ON RIVETED AND LAP-WELDED FLUES MADE IN SECTIONS. — Continued.

Thickness of material required.	Greatest length of sections allowable, 30 inches.												
	Greatest length of sections allowable, 3 ft.					Least thickness of material allowable.							
	.31 inch.	.32 inch.	.33 inch.	.34 inch.	.35 inch.	.36 inch.	.37 inch.	.38 inch.	.39 inch.	.40 inch.	.41 inch.	.42 inch.	.43 inch.
Over 20 and not over 21 inches.	Over 21 and not over 22 inches.	Over 22 and not over 23 inches.	Over 23 and not over 24 inches.	Over 24 and not over 25 inches.	Over 25 and not over 26 inches.	Over 26 and not over 27 inches.	Over 27 and not over 28 inches.	Over 28 and not over 29 inches.	Over 29 and not over 30 inches.	Over 30 and not over 31 inches.	Over 31 and not over 32 inches.	Over 32 and not over 33 inches.	Over 33 and not over 34 inches.
Pounds pres- sure.	Pounds pres- sure.	Pounds pres- sure.	Pounds pres- sure.	Pounds pres- sure.	Pounds pres- sure.	Pounds pres- sure.	Pounds pres- sure.	Pounds pres- sure.	Pounds pres- sure.	Pounds pres- sure.	Pounds pres- sure.	Pounds pres- sure.	Pounds pres- sure.
31-inch.	126	131	125	121	120	117	116	115	115	114	112	112	110
32-inch.	131	129	122	121	119	117	116	115	115	114	112	112	110
33-inch.	135	129	126	125	123	122	121	118	118	117	112	112	110
34-inch.	139	132	126	125	123	122	121	118	120	119	112	112	110
35-inch.	143	137	130	130	129	124	119	115	124	117	112	112	110
36-inch.	147	141	134	133	129	124	119	115	124	117	112	112	110
37-inch.	151	145	138	137	132	127	123	118	124	117	112	112	110
38-inch.	155	149	146	144	135	130	126	121	124	118	112	112	110
39-inch.	159	152	146	144	139	133	129	124	124	118	112	112	110
40-inch.	163	156	150	148	144	137	132	127	124	118	112	112	110
41-inch.	167	160	153	151	145	140	135	130	126	122	118	112	110
42-inch.	164	157	150	148	143	138	133	128	124	122	118	112	110
43-inch.	160	153	146	144	140	135	130	125	121	118	112	112	110
44-inch.	157	150	143	141	137	132	127	122	118	114	112	112	110
45-inch.	151	144	137	135	131	126	121	116	112	114	112	112	110
46-inch.	146	139	132	130	126	121	116	111	107	114	112	112	110

For any flue requiring more pressure than is given in table, the same will be determined by proportion of thickness to any given pressure in table to thickness for pressure required, as per example: A flue not over 19 inches diameter and 3 feet long, requires a thickness of .39 of an inch for 176 pounds pressure; what thickness would be required for 250 lbs. pounds pressure?

$$176 : .39 :: 250 : .5539,$$

or a thickness of .554 inch.

Or, if .39 inch thickness gives a pressure of 176 lbs., what will .554 inch thickness give?

$$.39 : 176 :: .554 : 250 \text{ pounds required.}$$

And all such flues shall be made in sections, according to their respective diameters, not to exceed the lengths prescribed in the table and such sections shall be properly fitted one into the other and substantially riveted, and the thickness of material required for any such flue of any given diameter shall in no case be less than the least thickness prescribed in the table for any such given diameter; and all such flues may be allowed the prescribed working steam pressure, if in the opinion of the inspectors, it is deemed safe to make such allowance. And inspectors are therefore required, from actual measurement of each flue, to make such reduction from the prescribed working steam pressure for any material deviation in the uniformity of the thickness of the material, or for any material deviation in the form of the flue from that of a true circle, as in their judgment the safety of navigation may require.

Riveted and lap-welded flues of any thickness of material, diameter, and length of sections prescribed in the table, may be made in sections of any desired length, exceeding the maximum length allowed by the table, by reducing the prescribed pressure

in proportion to the increased length of section, according to the following rule: —

Rule. — Multiply the pressure in the table allowed for any prescribed thickness of material and diameter of flue by the greatest length, in feet, of sections allowable for such flue, and divide the product by the desired length of sections, in feet, from center line to center line of rivets, in the circular seams of such sections, and the quotient will give the working steam pressure allowable.

Example. — Taking a flue in the table 24 inches in diameter, required to be made in sections not exceeding 2.5 feet in length, and having a thickness of material of .44 of an inch, and allowed a pressure of 157 lbs., and it is desired to make this flue in sections 5 feet in length.

Then we have

$$\frac{157 \times 2.5}{5} = 78.5 \text{ lbs. pressure allowable.}$$

THICKNESS OF MATERIAL REQUIRED FOR TUBES AND FLUES NOT OTHERWISE PROVIDED FOR.

Tubes and flues not exceeding 6 inches in diameter, and made of any required length; and

Lap-welded flues required to carry a working steam pressure not to exceed 60 lbs. per square inch, and having a diameter not exceeding 16 inches, and a length not exceeding 18 feet; and

Lap-welded flues required to carry a steam pressure exceeding 60 lbs. per square inch, and not exceeding 120 lbs. per square inch, and having a diameter not exceeding 16 inches and a length not exceeding 18 feet, and made in sections not exceeding 5 feet in length, and fitted properly one into the other, and substantially riveted; and

All such flues shall have a thickness of material according to their respective diameters, as prescribed in the following table: —

Outside diameter.	Thickness.	Outside diameter.	Thickness.	Outside diameter.	Thickness.
<i>Inches.</i>	<i>Inch.</i>	<i>Inches.</i>	<i>Inch.</i>	<i>Inches.</i>	<i>Inch.</i>
1	.072	3 $\frac{1}{4}$.120	9	.180
1 $\frac{1}{4}$.072	3 $\frac{1}{2}$.120	10	.203
1 $\frac{1}{2}$.083	3 $\frac{3}{4}$.120	11	.220
1 $\frac{3}{4}$.095	4	.134	12	.229
2	.095	4 $\frac{1}{2}$.134	13	.238
2 $\frac{1}{4}$.095	5	.148	14	.248
2 $\frac{1}{2}$.109	6	.165	15	.259
2 $\frac{3}{4}$.109	7	.165	16	.270
3	.109	8	.165		

Tubes, water pipes and steam pipes, made of steel manufactured by the Bessemer process, may be used in any marine boiler when the material from which pipes are made does not contain more than .06 per cent of phosphorus and .04 per cent of sulphur, to be determined by analysis by the manufacturers, verified by them, and copy furnished the user for each order tested; which analysis shall, if deemed expedient by the Supervising Inspector-General, be verified by an outside test at the expense of the manufacturer of the tubes or pipes. No tube increased in thickness by welding one tube inside of another, shall be allowed for use.

Seamless copper or brass tubes, not exceeding three-fourths of an inch in diameter, may be used in the construction of water tube pipe boilers or generators, when liquid fuel is used. There may also be used in their construction copper or brass steam drums, not exceeding 14 inches in diameter, of a thickness of material not less than five-eighths of an inch, and copper or brass steam drums 12 inches in diameter and under, having a thickness of material not less than one-half inch. All the tubes and drums referred to in this paragraph shall be made from ingots or blanks drawn down to size without a seam. Water-tube boilers or gen-

erators so constructed may be used for marine purposes with none other than liquid fuel.

Lap-welded flues not exceeding 6 inches in diameter may be made of any required length without being made in sections. And all such lap-welded flues and riveted flues not exceeding 6 inches in diameter may be allowed a working steam pressure not to exceed 225 lbs. per square inch, if deemed safe by the inspectors.

Lap-welded flues exceeding 6 inches in diameter and not exceeding 16 inches in diameter, and not exceeding 18 feet in length, and required to carry a steam pressure not exceeding 60 lbs. per square inch, shall not be required to be made in sections.

Lap-welded and riveted flues exceeding 6 inches in diameter and not exceeding 16 inches in diameter, and not exceeding 18 feet in length, and required to carry a steam pressure exceeding 60 lbs. per square inch, and not exceeding 120 lbs. per square inch, may be allowed, if made in sections not exceeding 5 feet in length and properly fitted one into the other, and substantially riveted.

On all boilers built after July 1st, 1896, a bronze or brass-seated stop-cock or valve shall be attached to the boiler between all check valves and all steam and feed pipes and boilers, in order to facilitate access to connections. Where such cocks or valves exceed $1\frac{1}{2}$ inches in diameter, they must be flanged to boiler. The stop-valves attached to main steam-pipes may, however, be made of cast-iron or other suitable material. The date referred to above applies to this paragraph only.

All copper steam-pipes shall be flanged to a depth of not less than four times the thickness of the material in the pipes, and all such flanging shall be made to a radius not to exceed the thickness of the material in such pipes. And all such pipes shall have a thickness of material according to the working steam pressure

allowed, and such thickness of material shall be determined by the following rule: —

Rule.— Multiply the working steam pressure in pounds per square inch allowed the boiler by the diameter of the pipe in inches, then divide the product by the constant whole number 8000, and add .0625 to the quotient; the sum will give the thickness of the material required.

Example.— Let 175 lbs. = working steam pressure per square inch allowed the boiler,

5 inches = diameter of the pipe,

8000 = a constant.

Then we have: —

$$\frac{175 \times 5}{8000} + .0625 = .1718 + \text{thickness of material in decimals of an inch.}$$

The flanges of all copper steam pipes over three inches in diameter shall be made of bronze or brass composition, and shall have a thickness of material of not less than four times the thickness of material in the pipes plus .25 of an inch; and all such flanges shall have a boss of sufficient thickness of material projecting from the back of the flange a distance of not less than three times the thickness of material in the pipe; and all such flanges shall be counter-bored in the face to fit the flange of the pipe; and the joints of all copper steam pipes shall be made with a sufficient number of good and substantial bolts to make such joints at least equal in strength to all other parts of the pipe.

The terminal and intermediate joints of all wrought iron and homogeneous steel feed and steam pipes over 2 inches in diameter and not over 5 inches in diameter, other than on pipe or coil boilers or steam generators, shall be made of wrought iron, homogeneous steel, or malleable iron flanges, or equivalent material; and all such flanges shall have a depth through the bore of not

less than that equal to one-half of the diameter of the pipe to which any such flange may be attached; and such bores shall taper slightly outwardly toward the face of the flanges; and the ends of such pipes shall be enlarged to fit the bore of the flanges, and they shall be substantially beaded into a recess in the face of each flange. But where such pipes are made of extra heavy lap-welded steam pipe, the flanges may be attached with screw threads; and all joints in bends may be made with good and substantial malleable iron elbows, or equivalent material.

All feed and steam pipes not over 2 inches in diameter may be attached at their terminals and intermediate joints with screw threads by flanges, sleeves, elbows, or union couplings; but where the ends of such pipes at their terminal joints are screwed into material in the boiler, drum or other connection having a thickness of not less than $\frac{1}{2}$ inch, the flanges of such terminal joints may be dispensed with. Where any such pipes are not over one inch in diameter and any of the terminal ends are to be attached to material in the boiler or connection having a thickness of less than $\frac{1}{2}$ inch, a nipple shall be firmly screwed into the boiler or connection against a shoulder, and such pipe shall be screwed firmly into such nipple. And should inspectors deem it necessary for safety, they may require a jam nut to be screwed onto the inner end of any such nipple.

The word "terminal" shall be interpreted to mean the points where steam or feed pipes are attached to such appliances on boilers, generators or engine, as are placed on such to receive them.

All lap-welded iron or steel steam-pipes over 5 inches in diameter, or riveted wrought-iron or steel steam-pipes over 5 inches in diameter, in addition to being expanded into tapered holes and substantially beaded into recess in face of flanges, as provided in preceding paragraph for steam and feed-pipes exceeding 2 inches and not exceeding 5 inches in diameter, shall be substantially and

firmly riveted, with good and substantial rivets, through the hubs of such flanges; and no such hubs shall project from such flanges less than 2 inches in any case.

Steam-pipes of iron or steel, when lap-welded by hand or machine, with their flanges welded on, shall be tested to a hydrostatic pressure of at least double the working pressure of the steam to be carried and properly annealed after all the work requiring fire is finished. When an affidavit of the manufacturer is furnished that such test has been made and annealed, they may be used for marine purposes.

STEAM BOILER ECONOMY.

It is estimated that there are about 14,000 heat units in a pound of good bituminous coal. A heat unit is equal to 772 foot pounds, so that if all the heat units in a pound of coal could be converted into work, we should have $14,000 \times 772$ less $33,000 \times 60$ equal 5.56 horse-power if exerted in one hour. The ordinary coal consumption is from six to twelve pounds of coal per horse-power, while with boilers of the most approved design and the very best high pressure expansion engines, a duty of one-horse power for $3\frac{1}{2}$ lbs. of coal would be considered a remarkably good showing. Now if all the heat units in $3\frac{1}{2}$ lbs. of coal could be converted into work without loss, we should get instead of one horse-power, 19.46 horse power; such a result, or anything approaching it, can never be obtained, but that there is a great room for improvement, no one will deny. There is too wide a range even between $3\frac{1}{2}$ lbs. and 12 lbs. of coal per horse-power, and the engineer who will sit down and be satisfied with such extravagant waste as a consumption of 12 lbs. of coal per horse power, is dishonest to his employer and untrue to himself, perhaps not intentionally, but thoughtlessly so.

The first steps in economic boiler practice, is that they should

be kept scrupulously clean both inside and out; one-sixteenth of an inch of scale deposited on the inside of a boiler will reduce the conductivity of the sheets, probably 15 per cent. Soot is a perfect non-conductor, and $\frac{1}{16}$ " deposited on the heating surface of the boiler will reduce its conductivity fully 15 per cent more. Steam at eighty lbs. pressure will escape into the atmosphere at a velocity of nearly 1,900 feet per second, so that it is easy to see that a small leak, either in the joints of the steam pipes or in the seams of the boiler, or around the rivets, might carry off a great many heat units, thus making another tax on the coal pile. "The concern is rich; they can stand it." This statement is heard pretty often, and it is safe to assume that the man who makes it is an unprofitable one to have in a plant. It may be that a belt is being mended and the speaker has made a mistake, making necessary eight or ten feet of new belt. He makes the statement to ease his conscience, but it does not pay for the piece of new belting. A side of lace leather gets neglected, or is thrown over a steam-pipe when repairs are being made. Next day steam is admitted to the circulation, the lacing is ruined, and the firm "stand it" just because a man was careless. A breakdown occurs, caused by neglect of a moment's work on a set-screw with a monkey-wrench. Again, the "concern can stand it," for "they are rich." It is evident that the man who makes it has no money invested in manufacturing, and it is also evident that he don't realize that the "concern" is growing poorer every day he is kept in their employ. There is no profit in keeping such a man, more than there is in maintaining any other nuisance. When an employee, be he superintendent or day laborer, is heard to pass his mistakes lightly because the "concern is rich and can stand it," it is high time a change was made. That man never made the "concern" rich; neither will he help them retain their present standing. He is a weed and must be weeded out.

INSTRUCTIONS FOR FIRING.

In estimating the relative merits of different steam-engines, it is generally assumed that the fuel is burned under conditions with which the men who supply coal to the furnaces have nothing whatever to do. In short, that any man who can throw coal on a fire and keep his bars clean must be as good as any other, however well qualified. But this conclusion is totally erroneous, as it is within the experience of nearly every engineer and steam-user, that many engines now in operation throughout the country consume twice as much fuel per horse-power, as is required for those that are more economically managed.

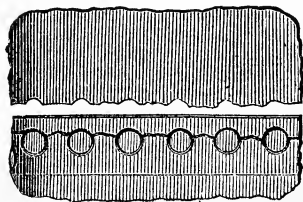
The use of a more improved class of steam-engines involves the necessity of employing more skillful and careful attendants; not that the work is more difficult, as less coal has to be thrown into the furnace, but because a careless or unskillful fireman can counteract all the ingenuity displayed in the improvement, construction and management of the engine. Consequently, every engineer should be required to prepare himself for the duties of his profession by serving as a fireman for a certain time, otherwise, he cannot be expected to be able to instruct his fireman in the manner of firing best calculated to insure the most satisfactory and economical results.

There have not been, heretofore, that attention and thought devoted to the examination of the subject of the economy of fuel which the magnitude of the interest involved and its importance, in a national point of view, render it worthy of. The saving of one pound of water per horse-power per hour for ten hours a day, in an engine of 100 horse-power, assuming that the boiler evaporates seven pounds of water per pound of coal, which would make a saving of 1,000 pounds of water per day, which would require the consumption of 143 lbs. of coal — $22\frac{1}{2}$ tons a year — the cost of which would be, at the ordinary price of coal, over \$125.

PULSATION IN STEAM-BOILERS.

Pulsation in steam-boilers, though not discernible to the eye, as in animated nature, goes on intermittently in some boilers whenever they are in use. It is induced by weakness and want of capacity in the boiler to supply the necessary quantity of steam, and sometimes is caused by the boiler being badly designed, thereby admitting of a great disproportion between the heating-surface and steam-room. Boilers are frequently found in factories that were originally not more than of sufficient capacity to furnish the necessary quantity of steam, but, as business increased, it became necessary to increase the pressure and also the speed of the engine; or, perhaps to replace it with a larger one, which has to be supplied with steam from the same boiler. The result is, each time the valve opens to admit steam to the cylinder, about one-third of the whole quantity in the boiler is admitted, thus lowering the pressure; the next instant, under the influence of hard firing, or, perhaps, a forced draught, the steam is brought to the former pressure, and so on; this lessening and increasing the pressure continues while the engine is in motion, which has an effect on the boiler similar to the breathing of an animal.

The strains induced by this pulsation are transmitted to the weakest places, viz., the line of the rivet holes, and that marked



by the tool in the process of calking; the result is, the plate is broken in two, as shown in the above cut. The manner in which the break takes place may be illustrated by filing a small nick, or drilling a small hole, in a piece of hoop or band-iron, and then bending back

and forth, when it will be discovered that the material will break just at that point, however slight the nick or small the hole may be. Pulsation is frequently very severe in the boilers of tug-boats when commencing to start a heavy tow, and also in locomotives when starting long trains. Some frightful explosions of the boilers of tug-boats and locomotives have occurred under such circumstances. Pulsation, if permitted to continue, is sure to effect the destruction of the boiler. It is always made manifest by the vibrations of the pointers on steam-gauges, or an unsteadiness in the mercury column. It may be remedied, to a certain extent, by adding a larger steam-dome, but this has a tendency to weaken the boiler and render it more unsafe. The only sure preventive of such a silent and destructive agent is to have the boiler of sufficient capacity in the first place.

LOCATION OF STEAM-BOILERS.

No class of machines are oftener injudiciously located, or show by their location a greater disregard for the convenience and comfort of those who tend them than steam-boilers. It is quite common to find boilers stowed away in dark, damp, and out-of-the-way places, although there may be an abundance of unoccupied room in the same establishment; and also to find boilers so situated that it is utterly impossible to examine or repair them, and very difficult and laborious to fire them. Even in many instances where boilers are located in light and airy places, they are sunk several feet below the surface of the ground on which they ought to stand, although there may be thousands of cubic feet of unoccupied space above them. Such ignorance and recklessness can only be accounted for by the fact that for years an idea has generally prevailed among owners of steam-boilers that any location or out-of-the-way place was good enough for a steam-boiler, and that any kind of care, after it was located, was sufficient to manage it.

The steam-gauge, like the safety-valve, is a means of indicating the approach of danger; though silent, it is no less an impressive monitor. It does not speak, but by moving its steady hand on the face of the dial, it "points" to the danger. With a good safety-valve, good gauge-cocks, correct steam-gauge, competent inspection and careful attendance, there need be little fear of steam-boiler explosions.

STEAM-GAUGES.

The object of the steam-gauge is to indicate the steam pressure in the boiler, in order that it may not be increased far above that at which the boiler was originally considered safe; and it is as a provision against this contingency that a really good gauge is a necessity where steam is employed, for no guide at all is vastly better than a false one. The most essential requisites of a good steam-gauge are, that it be accurately graduated, and that the material and workmanship be such that no sensible deterioration may take place in the course of its ordinary use. The pecuniary loss arising from any considerable fluctuation of the pressure of steam has never been properly considered by the proprietors of engines. If steam be carried too high, the surplus will escape through the safety-valve, and all the fuel consumed to produce such excess is so much dead loss. On the other hand, if there be at any time too little steam, the engine will run too slow, and every lathe, loom, or other machine driven by it, will lose its speed and, of course, its effective power in the same proportion. A loss of one revolution in ten at once reduces the productive power of every machine driven by the engine ten per cent, and loses to the proprietor ten per cent of the time of every workman employed to manage such machine. In short, the loss of one revolution in ten diminishes the productive capacity of the whole concern ten per cent, so long as such reduced rate continues; while the expenses of conducting the shop (rent, wages,

insurance, etc.) all run on as if everything was in full motion. A variation to this amount is a matter of frequent occurrence, and is, indeed, unavoidable, unless the engineer is afforded facilities to prevent it. A very little reflection will satisfy any one that it must be a very small concern, indeed, in which a half-hour's continuance of it would not produce a result more than enough to defray the cost of a very expensive instrument to prevent it. If the engineer, to avoid this loss, keeps a surplus of steam constantly on hand, he is constantly wasting the steam, and consequently, fuel, thus incurring another loss, which, though less alarming than the first, will yet be serious and render any instrument most desirable which can prevent it. It is, therefore, of great importance to the proprietors of engines to have an instrument which can constantly indicate the pressure in the steam-boilers with accuracy. This would enable the engineer to keep his steam at a constant pressure, thus avoiding waste of fuel on the one hand, and the still more serious loss of the productive power of the shop on the other. An instrument, therefore, constantly indicating the pressure of steam, reliable in its character, and, with ordinary care, not subject to derangement, is evidently a desideratum both to the engineer and proprietor. The importance of such an instrument, as a preventive of explosion, and of the frightful consequences to life and limb and ruinous pecuniary results of such disaster, is obvious on the slightest consideration; but the value of the instrument, in the economical results of its daily use, is by no means properly appreciated.

GRATE-BARS.

Perfect combustion is the starting-point in the generation of steam; the conversion of coal and air into heat must be the first process, and the second is to apply the heat with full effect to the boiler. The oxygen of the air is the only supporter of combustion; and the rate of combustion produced and the amount of

heat generated in the furnace, depend on the quantity of air supplied; and the quantity of air admitted depends on the size of the opening through which it passes. Then, as a matter of course, the grate-bars offering the least obstruction to the air passing through them, and affording the largest area for the air combined, with an equal distribution of the same, must be the best adapted for the purposes of combustion. The failure of grate-bars is due mainly to three different causes — breaking, warping and burning out; consequently, grate-bars, to be durable and efficient, should have a narrow surface exposed to the fire, the spaces for admitting the air being numerous and well distributed. The metal constituting the bar should be distributed in the best possible manner, to relieve the grate from all undue strain arising from unequal expansion and contraction; there should also be considerable depth, in order that the lower edges may keep cool and prevent the possibility of warping or twisting. Grate-bars of good design and proportions are frequently ruined by being exposed to a white heat whenever a fresh fire is started; whereas, by distributing a thin layer of fresh coal over their surface before the shavings and wood are applied, they may be preserved intact for years. The grate-bar has not heretofore received the consideration from engineers and steam-users which its importance, in an economical point of view, so eminently deserves.

REPAIRING STEAM-BOILERS.

The principal causes of loss and danger in the use of the steam-boiler, arise from delay in making timely repairs, and also from the judicious manner in which the repairing is done. It is often thought that the a botch will do just as well as a more skilled and costly mechanic; this is a mistake, as nowhere is the ready command of resources, knowledge of the adaptability of means to ends, skill of eye and hand, common sense and sound judgment,

which go to make up an accomplished mechanic, more necessary than in repairing, inasmuch as it is not the same old routine day after day, by which men become mere machines instead of original thinkers, which is required, as every job varies in some particular from every other, and each must be repaired in a different way. It requires brains as well as manual skill to do this kind of work in a creditable manner, and every owner of a steam-boiler or steam engine will find it good policy to put his repairing in the hands of a practical mechanic. It is both good policy and economy to repair as soon as anything is out of order; this is particularly true in the case of steam-boilers, as when allowed to run along as they will, or until they are considered dangerous, aside from the danger, it is often found impossible to render them safe or serviceable again. A defect which would have cost but a trifle to repair in the first place, owing to neglect, frequently necessitates the replacing of the whole boiler. When putting a patch on a boiler, the defective parts should be cut out, and the part cut out should be as nearly round as circumstances will permit; a square hole should never be cut in any boiler, but when of necessity it has to be done, rounded corners should be left. When it becomes necessary to put a new sheet on an old boiler, it is advisable to have the new plate a little thinner than the old one, and it should be so arranged that the calking may be done on the new iron. After repairing a boiler it should always be tested with cold water. Never place the edge of the laps towards the fire, unless they are considerable distance from it. Cracks running from hole to hole in boiler seams are more dangerous than those that run towards the center of the plate or outer edge of the lap. Short cracks may be prevented from extending by drilling a hole in the end so as to completely drill out the crack, and then inserting a rivet in the hole. Whenever a leak occurs under a lap or seam round any rivet, stay-bolt or base entering the steam room or water

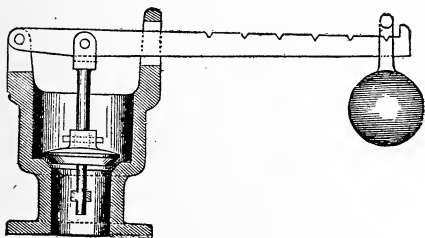
space of a boiler, stop it immediately and have it repaired, as the plate in the neighborhood of the leak wastes away very rapidly.

SAFETY-VALVES.

The form and construction of this indispensable adjunct to the steam boiler are of the highest importance, not only for the preservation of life and property, which would, in the absence of that means of "safety" be constantly jeopardized, but also to secure the durability of the steam-boiler itself. And yet, judging from the manner in which many things called safety-valves have been constructed of late years, it would appear that the true principle by which *safety* is sought to be secured by this most valuable adjunct is either not well understood, or is disregarded by many engineers and boiler-makers.

Boiler explosions have in many cases occurred when, to all appearances, the safety-valves attached have been in good working order; and coroners' juries have not unfrequently been puzzled, and sometimes guided to erroneous verdicts by scientific evidence adduced before them, tending to show that nothing was wrong with the safety-valves, and that the devastating catastrophes could not have resulted from overpressure, because in such case the safety-valve would have prevented them. It is supposed that a gradually increasing pressure can never take place if the safety-valve is rightly proportioned and in good working order. Upon this assumption, universally acquiesced in, when there is no accountable cause, explosions are attributed to the "sticking" of the valves, or to "bent" valve-stems, or inoperative valve-springs. As the safety-valve is the sole reliance, in case of neglect or inattention on the part of the engineer or fireman, it is important to examine its mode of working closely. Safety-valves are usually provided with a spindle or guide-pin, attached to the under side, and passing through a cross-bar within the boiler, directly under the seating of the valve, which may be seen in

the cut below. Now, it is evident that if this guide-pin becomes bent from careless handling, the safety-valve may be rendered almost inoperative, and, instead of releasing the pressure at the point indicated, it will turn sideways, and allow only a small aperture for the escape of steam, and, further, it will not return perfectly to its seat; hence, a leaky valve is the result, and to overcome this difficulty, ignorant engineers and firemen generally resort to extra weighting; and it is not uncommon to find double or treble the weight



corresponding to the pressure required in the boiler. Another difficulty is that the safety-valve levers sometimes get bent, and the weight, consequently, hangs on one side of the true center; this, it will be seen, causes the valve to rest more heavily on one side than on the other, and the greater the added weight the greater the difficulty. The seats of safety-valves should be examined frequently to see that no corrosion has commenced; as valves, especially if leaky, become corroded and often *stick fast*, so that no little force is required to raise them. If, when a safety-valve is properly weighted, it should be found leaking, do not put on extra weights, but immediately make an examination, and in all probability the seat or guide-pin will be found corroded, or there will be foreign matter between the valve and its

seat. By taking the lever in the hand and raising it from its seat a few times, any substance that may have kept it from its seat will be dislodged; or it may turn out on examination that the lever had deviated from some cause from a true center. Such difficulties can be easily righted, but extra weight should never be added, as it only aggravates the trouble instead of remedying it. When the weight of the safety-valve is set on the lever at safe working pressure, or at the distance from the fulcrum necessary to maintain the pressure required to work the engine, any extra length of lever should then be cut off as a precaution, to prevent the moving out of the weight on the lever, for the purpose of increasing the pressure, as, while the lever remains sufficiently long, the weight can be increased to a dangerous extent without attracting any attention; while if the lever is cut off at the point at which the safe working pressure is designated, any extra increase of pressure can only be accomplished by adding more weight to the lever, which is tolerably sure to attract the attention of some one interested in the preservation of the lives and property of persons in the immediate vicinity.

The bolts that form the connection between the lever, fulcrum and valve-stem should be made of brass, in order to prevent the possibility of corrosion, "sticking" or becoming magnetized, as it is termed; and for the same reason, the valve and seat should be made of two different metals. When safety valves become leaky they should be taken out and reground on their seats, for which purpose pulverized glass, flour of emery, or the fine grit or mud from grinding stone troughs are the most suitable material; but whether they leak or not, they should be taken apart at least once a year and all the working parts cleaned, oiled and readjusted. The safety-valve is designed on the assumption that it will rise from its seat under the statical pressure in the boiler, when this pressure exceeds the exterior pressure on the valve, and that it will remain off its seat sufficiently far to permit all the

steam which the boiler can produce to escape around the edges of the valve. The problem then to be solved is: What amount of opening is necessary for the free escape of the steam from the boiler under a given pressure? The area of a safety-valve is generally determined from formulæ based on the velocity of the flow of steam under different pressures, or upon the results of experiments made to ascertain the area necessary for the escape of all the steam a boiler could produce under a given pressure. But as the fact is now generally recognized by engineers that valves do not rise appreciably from their seats under varying pressures, it is of importance that in practice the outlets round their edges should be greater than those based on theoretical considerations. The next point to be considered is how high any safety valve will rise under the influence of a given pressure. This question cannot be determined theoretically, but has been settled conclusively by Burg, of Vienna, who made careful experiments to determine the actual rise of safety-valves above their seats. His experiments show that the rise of the valve diminishes rapidly as the pressure increases.

TABLE SHOWING THE RISE OF SAFETY-VALVES, IN PARTS OF AN INCH, AT DIFFERENT PRESSURES.

Lbs.	Lbs.	Lbs.	Lbs.	Lbs.	Lbs.	Lbs.	Lbs.	Lbs.
12	20	35	45	50	60	70	80	90
$\frac{1}{36}$	$\frac{1}{48}$	$\frac{1}{54}$	$\frac{1}{65}$	$\frac{1}{86}$	$\frac{1}{86}$	$\frac{1}{132}$	$\frac{1}{168}$	$\frac{1}{168}$

Taking ordinary safety-valves, the average rise for pressures from 10 to 40 pounds is about $\frac{1}{40}$ of an inch, from 40 to 70 pounds about $\frac{1}{80}$, and from 70 to 90 pounds about $\frac{1}{120}$ of an inch. The following table gives the result of a series of experiments made at the Novelty Iron Works, New York, for the purpose of determining the exact area of opening necessary for

safety-valves, for each square foot of heating surface, at different boiler pressures.

TABLE.

Pressure in Boiler in pounds above the atmosphere.	Area of Orifice in Sq. In. for each Sq. Ft. of Heating Surface.	Pressure in Boiler in pounds above the atmosphere.	Area of Orifice in Sq. In. for each Sq. Ft. of Heating Surface.	Pressure in Boiler in pounds above the atmosphere.	Area of Orifice in Sq. In. for each Sq. Ft. of Heating Surface.
0.25	.022794	10	.005698	70	.001015
0.5	.021164	20	.003221	80	.000892
1	.018515	30	.002244	90	.000796
2	.014814	40	.001723	100	.000719
3	.012345	50	.001398	150	.000481
4	.010582	60	.001176	200	.000364
5	.009259				

TABLE OF COMPARISON BETWEEN EXPERIMENTAL RESULTS AND THEORETICAL FORMULAE.

Boiler Pressure, 45 pounds.			Boiler Pressure, 75 pounds.		
Heating Surface.	Area of opening found by experiment.	Area of opening according to formulæ.	Heating Surface.	Area of opening found by experiment.	Area of opening according to formulæ.
Sq. Ft.	Sq. Ins.	Sq. Ins.	Sq. Ft.	Sq. Ins.	Sq. Ins.
100	.089	.09	100	.12	.12
200	.180	.19	200	.24	.24
500	.45	.48	500	.59	.59
1000	.89	.94	1000	1.20	1.18
2000	1.78	1.90	2000	2.40	2.37
5000	4.46	4.75	5000	6.00	5.95

Now, if we compare the area of openings, according to these experiments, with Zeuner's formula, which is entirely theoretical, it will be observed that the results from the two sources are almost identical, or so nearly so as not to make any material difference. In the absence of any generally recognized rule, it is customary for engineers and boiler-makers to proportion safety-valves according to the heating surface, grate-surface, or horse-power of the boiler. While one allows one inch of area of safety-valve to 66 square feet of heating surface, another gives one inch area of safety-valve to every four horse power; while a third proportions his by the grate-surface — it being the custom in such cases to allow one inch area of safety-valves to $1\frac{3}{4}$ square feet of grate-surface. This latter proportion has been proved by long experience and a great number of accurate experiments, to be capable of admitting of a free escape of steam without allowing any material increase of the pressure beyond that for which the valve is loaded, even when the fuel is of the best quality, and the consumption as high as 24 pounds of coal per hour per square foot of grate-surface, providing, of course, that all the parts are in good working order. It is obvious, however, that no valve can act without a slight increase of pressure, as, in order to lift at all, the internal pressure must exceed the pressure due to the load.

The lift of safety-valves, like all other puppet-valves, decreases as the pressure increases; but this seeming irregularity is but what might be required of an orifice to satisfy appearances in the flow of fluids, and may be explained as follows: A cubic foot of water generated into steam at one pound pressure per square inch above the atmosphere, will have a volume of about 1,600 cubic feet. Steam at this pressure will flow into the atmosphere with a velocity of 482 feet per second. Now, suppose the steam was generated in five minutes, or in 300 seconds, and the area of an orifice to permit its escape as fast as it is generated be re-

quired 1600 divided by 482×300 will give the area of the orifice, $1\frac{2}{5}$ square inches. If the same quantity of water be generated into steam at a pressure of 50 pounds above the atmosphere, it will possess a volume of 440 cubic feet and will flow into the atmosphere with a velocity of 1791 feet per second. The area of an orifice, to allow this steam to escape in the same time as in the first case, may be found by dividing 440 by 1791×300 , the result will be $\frac{3}{25}$ square inches, or nearly $\frac{1}{8}$ of a square inch, the area required. It is evident from this that a much less lift of the same valve will suffice to discharge the same weight of steam under a high pressure than under a low one, because the steam under a high pressure not only possesses a reduced volume, but a greatly increased velocity; it is also obvious from these considerations, that a safety-valve, to discharge steam as fast as the boiler can generate it, should be proportioned for the lowest pressure.

RULES.

Rule.— For finding the weight necessary to put on a safety-valve lever when the area of valve, pressure, etc., are known: Multiply the area of valve by the pressure in pounds per square inch; multiply this product by the distance of the valve from the fulcrum; multiply the weight of the lever by one-half its length (or its center of gravity); then multiply the weight of valve and stem by their distance from the fulcrum; add these last two products together, subtract their sum from the first product, and divide the remainder by the length of the lever; the quotient will be the weight required.

EXAMPLE.

Area of valve, 12 in.	65	13	8
Pressure, 65 lbs.	12	16	4
	780	78	32
Fulcrum, 4 in.			

Length of lever, 32 in.	4	13
Weight of lever, 13 lbs.		
	3120	208
Weight of valve and stem, 8 lbs.	240	32
	32)2880	240
	90 lbs.	

Rule for finding the pressure per square inch when the area of valve, weight of ball, etc., are known: Multiply the weight of ball by length of lever, and multiply the weight of lever by one-half its length (or its center of gravity); then multiply the weight of valve and stem by their distance from the fulcrum. Add these three products together. This sum, divided by the product of the area of valve, and its distance from the fulcrum, will give the pressure in pounds per square inch.

EXAMPLE.

Area of valve, 7 in.	50	12	6
Fulcrum, 3 in.	30	15	3
	1500	60	18
Length of lever, 30 in.	180	12	
Weight of lever, 12 lbs.	18	180	7
Weight of ball, 50 lbs.			
Weight of valve and stem, 6 lbs.			
	21)1698		3
	80.85 lbs.		21

Rule for finding the pressure at which a safety-valve is weighted when the length of the lever, weight of ball, etc., are known: Multiply the length of lever in inches by the weight of ball in pounds; then multiply the area of valve by its distance

from the fulcrum ; divide the former product by the latter ; the quotient will be the pressure in pounds per square inch.

EXAMPLE.

Length of lever, 24 in.	52	7
Weight of ball, 52 lbs.	24	3
	208	21
Fulcrum, 3 in.	104	
Area of valve, 7 in.	21)1248	
	59.42	lbs.

The above rule, though very simple, cannot be said to be exactly correct, as it does not take into account the weight of the lever, valve and stem.

Rule for finding center of gravity of taper levers for safety-valves: Divide the length of lever by two (2); then divide the length of lever by six (6), and multiply the latter quotient by width of large end of lever less the width of small end, divided by width of large end of lever plus the width of small end. Subtract this product from the first quotient, and the remainder will be the distance in inches of the center of gravity from large end of lever.

EXAMPLE.

Length of lever	36 in.	
Width of lever at large end	3 "	
Width of lever at small end	2 "	
36 divided by 2 = 18 minus 1.2 = 16.8 in.	36 divided by 6 =	
5 × 1 = 6 divided by 5 = 1.2.		
Center of gravity from large end, 16.8 in.		

The safety-valve has not received that attention from engineers and inventors which its importance as a means of safety

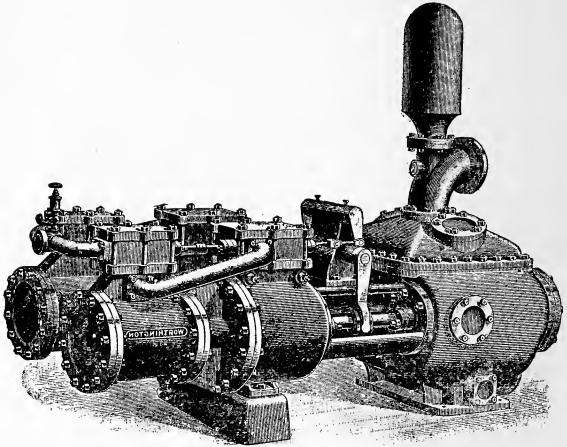
so imperatively deserves. In the construction of most other kinds of machinery, continual efforts have been made to secure and insure accuracy; while in the case of the safety-valve, very little improvement has been made either in design or fitting. It is difficult to see why this should be so, when it is known that deviations from exactness, though trifling in themselves, when multiplied, not only affect the free action and reliability of machines, but frequently result in serious injury, more particularly in the case of safety-valves.

Safety-valves should never be made with rigid stems, as, in consequence of the frequent inaccuracy of the other parts, the valve is prevented from seating, thereby causing leakage; as a remedy for which, through ignorance or want of skill, more weight is added on the lever, which has a tendency to bend the stem, thus rendering the valve a source of danger instead of a means of safety. The stem should, in all cases, be fitted to the valve with a ball and socket joint, or a tapering stem in a straight hole, which will admit of sufficient vibration to accommodate the valve to its seat. It is also advisable that the seats of safety-valves, or the parts that bear, should be as narrow as circumstances will permit, as the narrower the seat the less liable the valve is to leak, and the easier it is to repair when it becomes leaky.

All compound or complicated safety-valves should be avoided, as a safety-valve is, in a certain sense, like a clock — any complication of its parts has a tendency to affect its reliability and impair its accuracy.

It has been too much the custom heretofore for owners of steam boilers to disregard the advice and suggestions of their own engineers and firemen, even though men of intelligence and experience, and to be governed entirely by the advice of self-styled experts and visionary theorists.

CHAPTER XVIII.

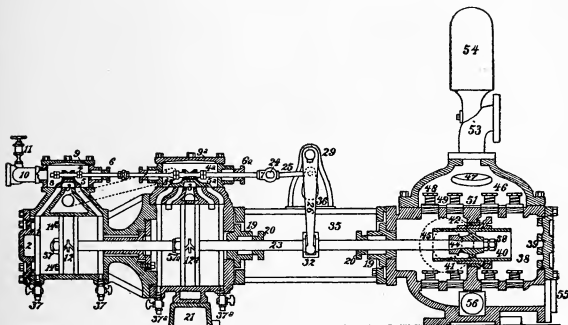


The Worthington Compound Pump.

THE WORTHINGTON COMPOUND PUMP.

In the arrangement of steam cylinders here employed, the steam is used expansively, which cannot be done in the ordinary form. Having exerted its force through one stroke upon the smaller steam piston, it expands upon the larger during the return stroke, and operates to drive the piston in the other direction. This is, in effect, the same thing as using a cut-off on a crank engine, only with the great advantage of uniform and steady action upon the water.

Compound cylinders are recommended in any service where the saving of fuel is an important consideration. In such cases, their greater first cost is fully justified, as they require 30 to 33 per cent less coal than any high-pressure form on the same work.

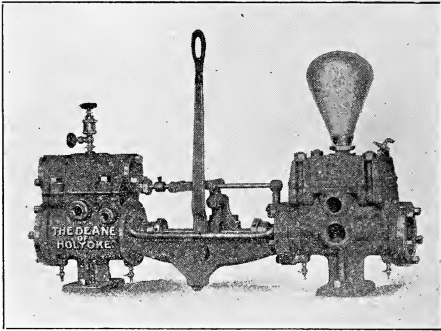


The above illustration is a sectional view of the Worthington Compound Pump — This cut shows the steam valves properly set.

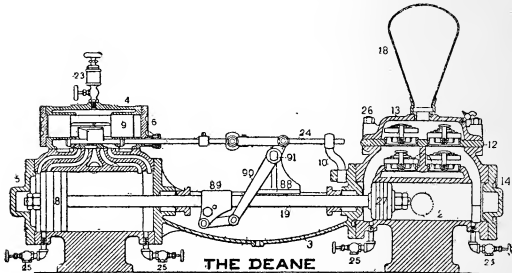
On the larger sizes, a condensing apparatus is often added, thus securing the highest economical results.

Any of the ordinary forms of steam pumps can be fitted with compound cylinders.

It should be remembered that, as the compound use less steam their boilers may be reduced materially in size and cost, compared with those required by the high-pressure form. This principle of expansion without condensation cannot be used with advantage where the steam pressure is below 75 lbs.



The Deane Pump.

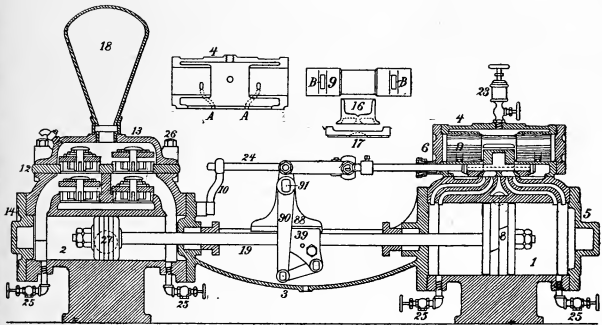


The above is a sectional view of the

DEANE DIRECT ACTING STEAM PUMP.

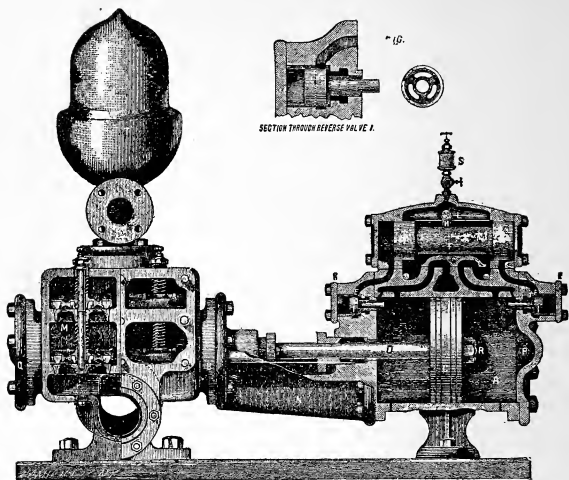
The operation of the steam valves.—In the Deane Steam Pump a rotary motion is not developed by means of which an

eccentric can be made to operate the valve. It is, therefore, necessary to reverse the piston by an impulse derived from itself at the end of each stroke. This cannot be effected in an ordinary single-valve engine, as the valve would be moved only to the center of its motion, and then the whole machine would stop. To overcome this difficulty, a small steam piston is provided to move the main valve of the engine. In the Deane Steam Pump, the lever 90, which is carried by the piston rod, comes in contact



This cut shows the valves properly set.

with the tappet when near the end of its motion, and by means of the valve-rod 24, moves the small slide-valve which operates the supplemental piston 9. The supplemental piston, carrying with it the main valve, is thus driven over by steam and the engine reversed. If, however, the supplemental piston fails accidentally to be moved, or to be moved with sufficient promptness by steam, the lug on the valve-rod engages with it and compels its motion by power derived from the main engine.



SECTIONAL VIEW OF
"THE CAMERON" STEAM PUMP

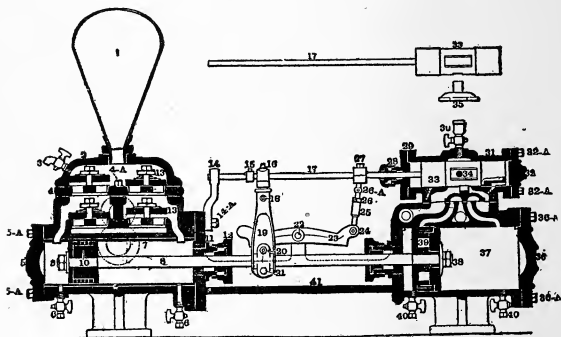
The above is a sectional view of the steam end of a Cameron pump.

Explanation: *A* is the steam cylinder; *C*, the piston; *D*, the piston rod; *L*, the steam chest; *F*, the chest piston or plunger, the right-hand end of which is shown in section; *G*, the slide valve; *H*, a starting bar connected with a handle on the outside; *I I* are reversing valves; *K K* are the bonnets over reversing valve chambers; and *E E* are exhaust ports leading from the ends of steam chest direct to the main exhaust, and closed by the reversing valve *I I*; *N* is the body piece connecting the steam and water cylinder.

Operation of the Cameron Pump: Steam is admitted to the steam chest, and through small holes in the ends of the plunger; *F* fills the spaces at the ends and the ports *E E* as far as the reversing valves *II*; with the plunger *F* and slide valve *G* in position to the right (as shown in cut), steam would be admitted to the right-hand end of the steam cylinder *A*, and the piston *C* would be moved to the left. When it reaches the reversing valve *I* it opens it and exhausts the space at the left-hand end of the plunger *F*, through the passage *E*; the expansion of steam at the right-hand end changes the position of the plunger *F*, and with it the slide valve *G*, and the motion of the piston *C* is instantly reversed. The operation repeated makes the motion continuous. In its movements, the plunger *F* acts as a slide valve to shut off the ports *E E*, and is cushioned on the confined steam between the ports and steam chest cover. The reversing valves *II* are closed immediately the piston *C* leaves them, by pressure of steam on their outer ends, conveyed direct from the steam chest.

Operation. — Supposing the steam piston *C* moving from right to left: When it reaches the reversing valve *I* it opens it and exhausts the space on the left-hand end of the plunger *F*, through the passage *E*, which leads to the exhaust pipe; the greater pressure inside of the steam chest changes the position of the plunger *F* and slide valve *G*, and the motion of the piston *C* is instantly reversed. The same operation repeated at each stroke makes the motion continuous. The reversing valves *II* are closed by a pressure of steam on their large ends, conveyed by an unseen passage direct from the steam chest. When a pump is first connected, remove the bonnets *K K* and valves *II* and blow steam through to remove any dirt, oil or gum that may be lodged in the steam ports. Take valve *F*, valve *G* and *II* out and wipe off with clean waste, and then oil and put back. Then see that the packing is not too tight. When a Cameron pump has been run a long time, the plunger *F* becomes worn and leaks enough steam to

cause the valve F' to become balanced. The effect of this is, the pump will remain on the end; to overcome this, take out plunger F' , or piston, as it is called by some, and drill the little hole that you will find in the ends of same a little larger, say about one-fourth larger; that will increase the pressure on both ends of plunger F' ; as soon as the piston comes in contact with valve I the steam is exhausted to exhaust pipe.



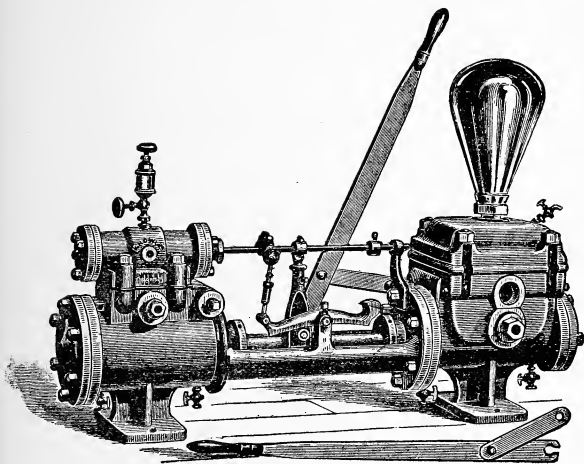
The above is a sectional cut of

THE KNOWLES DIRECT ACTING STEAM PUMP.

Explanation of steam valves, etc. — The Knowles, in fact, all first-class direct acting steam pumps, is absolutely free from what is termed a “dead center,” when in first-class order.

This feature in the Knowles Pump is secured by a very simple and ingenious mechanical arrangement, *i. e.*, by the use of an auxiliary piston which works in the steam chest and drives the main valve. This auxiliary or “chest piston,” as it is called, is driven backward and forward by the pressure of steam, carrying

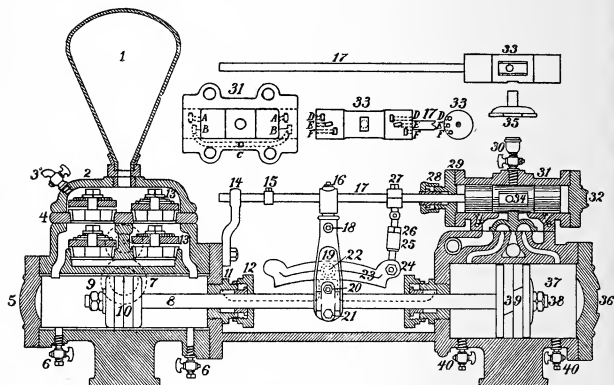
with it the main valve, which valve, in turn, gives steam to the main steam piston that operates the pump. This main valve is a plain slide valve of the *B* form, working on a flat seat. The chest piston is slightly rotated by the valve motion; this rotative movement places the small steam parts, *D*, *E*, *F* (which are located in



The Knowles Direct Acting Steam Pump.

the under side of the said chest piston), in proper contact with corresponding parts *A B* cut in the steam chest No. 31. The steam entering through the port at one end and filling the space between the chest piston and the head, drives the said piston to the end of its stroke and, as before mentioned, carries the main slide valve with it. When the chest piston has traveled a certain distance, a port on the opposite end is uncovered and steam there enters, stopping its further travel by giving it the necessary

cushion. In other words, when the rotation motion is given to the auxiliary or valve driving piston by the mechanism outside, it opens the port to steam admission on one end, and at the same time opens the port on the other end to the exhaust.



This cut shows the valves properly set.

Operation of the Knowles Pump is as follows: The piston rod, with the tappet arm, moves backward and forward from the impulse given by the steam piston. At the lower part of this tappet arm is attached a stud or bolt, on which there is a friction roller. This roller coming in contact with the "rocker bar" at the end of each stroke, operates the latter. The motion given the "rocker bar" is transmitted to the valve rod by means of the connection between, causing the valve rod to partially rotate. This action, as mentioned above, operates the chest piston, which carries with it the main slide valve, the said valve giving steam to the main piston. The operation of the pump is complete and

continuous. The upper end of the tappet arm does not come in contact with the tappets on the valve rod, unless the steam pressure from any cause, should fail to move the chest piston, in which case the tappet arm moves it mechanically.

NOTICE.

1. Should the pump run longer stroke one way than the other, simply lengthen or shorten the rocker connection (part 25) so that rocker bar (part 23) will touch rocker roller (20) equally distant from center (22).

2. Should a pump hesitate in making its return stroke, it is because rocker roller (20) is too low and does not come in contact with the rocker bar (23) soon enough. To raise it, take out rocker roller stud (20A), give the set screw in this stud a sufficient downward turn, and the stud with its roller may at once be raised to proper height.

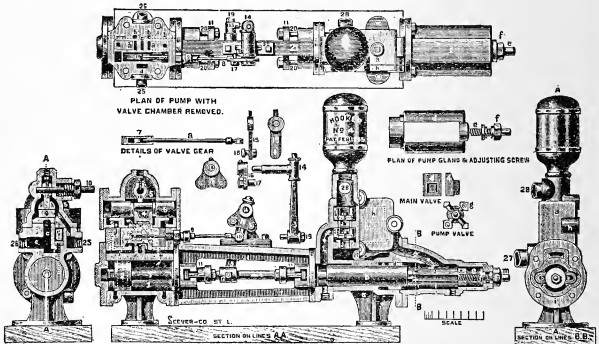
3. Should valve rod (17) ever have a tendency to tremble, slightly tighten up the valve rod stuffing box nut (28). When the valve motion is properly adjusted, tappet tip (16) should not quite touch collar (15) and clamp (27). Rocker roller (20), coming in contact with rocker bar (23) will reverse the stroke.

Operation and construction of the

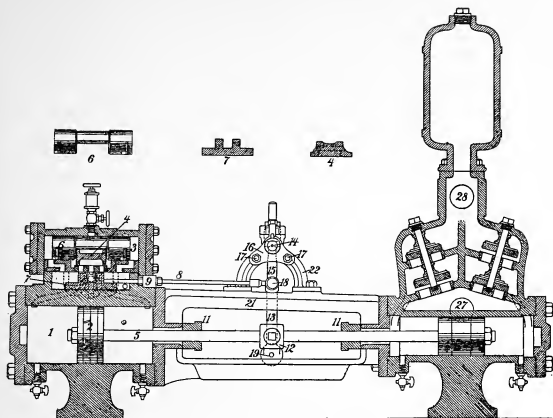
HOOKER DIRECT-ACTING STEAM-PUMP.

The parts being in position, as shown, the steam on being admitted to the center of the valve chamber, brings its pressure to bear on the main and supplemental flat slide valve 4 and 7, and also within the recess in the center of the supplemental piston 6. The recess incloses the main valve 4, so that this valve will move with the supplemental piston whenever the steam is supplied to

and exhausted from each end of this piston. The live steam passes through the left-hand ports $A^1 B^1$, driving the main piston 2 to the right, and the exhaust passes out through the right-hand ports A and C under the cavity in the main valve 4 to the atmosphere. As the main piston nears the right hand port, the valve lever 13, which is attached to the piston rod 3, brings the dog 17, in plate 16, in contact with the valve arm 15, and moves the supplemental valve 7 to the right, thus supplying live steam to the



right of the supplemental piston 6, and exhausting from the left through the ports $e e$. As the supplemental piston incloses the main valve, this valve is carried with it to the left. Steam now enters the right-hand ports $A B$ and is exhausted from the left-hand main port A . The engine commences its return stroke and the operation just described becomes continuous. As the main piston (2) closes the main port (A) to the right, it is arrested on compressed exhaust steam. The main valve 4 having closed the auxiliary ports (B) leading to that end of the main cylinder, the



This cut shows the steam valves properly set.

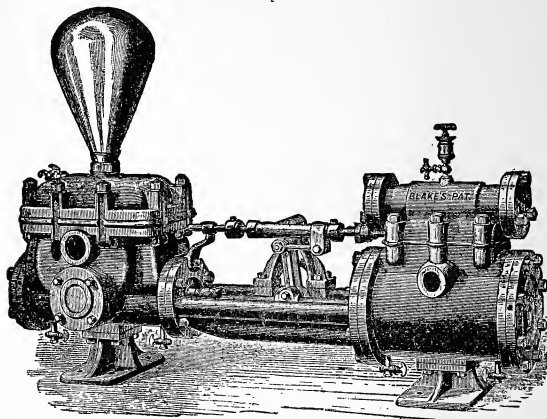
steam being supplied through both the main and auxiliary ports, but released through the main ports only.

BLAKE STEAM PUMP.

Description of the Blake Steam Pump.—The Blake Steam Pump is absolutely positive in its action; that is to say, the operation at the slowest speed under any pressure, is perfectly continuous, and the pump is never liable to stop as the main valve passes its center, if the pump is in good order. An ingenious and simple arrangement is used in the Blake Pump to overcome the “dead center,” as will be seen from the engravings.

Operation of the Blake Steam Pump.—The main or pump driving piston *A* could not be made to work slowly were the main valve to derive its movement solely from this piston; for

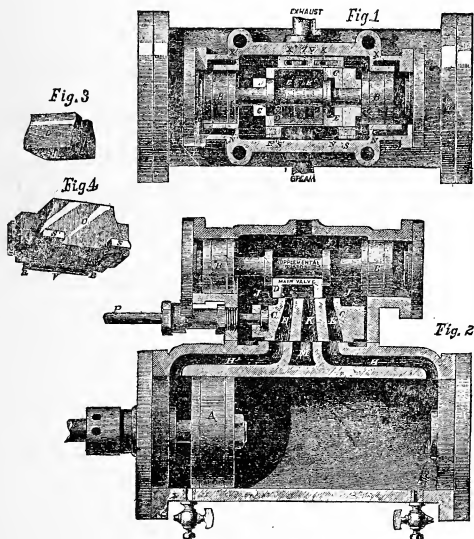
when this valve had reached the center of its stroke, in which position the ports leading to the main cylinder would be closed,



The Blake Steam Pump.

no steam could enter the cylinder to act on said piston, consequently, the latter would come to rest, since its momentum would be insufficient to keep it in motion, and the main valve would remain in its central position or "dead center." To shift this valve from its central position and admit steam in front of the main piston (whereby the motion of the piston is reversed and its action continued), some agent independent of the main piston must be used. In the Blake Pump, this independent agent is the supplemental or valve-driving piston *B*. The main valve, which controls the admission of steam to, and the escape of steam from, the main cylinder, is divided into two parts, one of which, *C*, slides upon a seat on the main cylinder, and, at the same time, affords a seat for the other part,

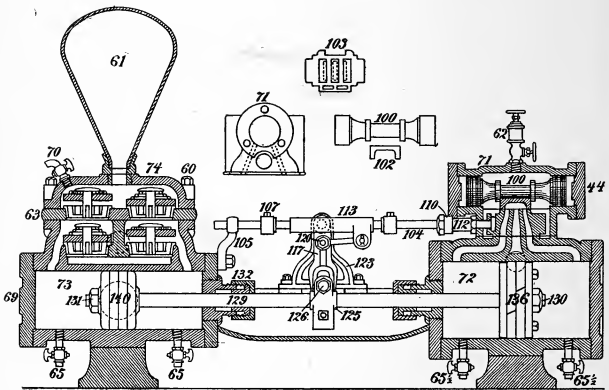
D, which slides upon the upper face of *C*. As shown in the engraving, *D* is at the left-hand end of its stroke, and *C* at the opposite, or right-hand end of its stroke. Steam from the steam-chest *J* is, therefore, entering the right-hand end of the main cylinder through the ports *E* and *H*, and the exhaust is escaping through the ports *H*¹ and *E*¹, *K* and *M*, which causes the



Sectional views of steam cylinder, valves, etc.,
of the Blake Steam Pump.

main piston *A* to move from right to left. When this piston has nearly reached the left-hand end of its cylinder the valve motion

(not shown) moves the valve-rod *P*, and this causes *C*, together with its supplemental valve *R* and *S S*¹ (which form, with *C*, one casting) to be moved from right to left. This movement causes steam to be admitted to the left-hand end of the supplemental cylinder, whereby its piston *B* will be forced toward the right, carrying *D* with it to the opposite or right-hand end of its stroke; for the movement of *S* closes *N* (the steam port leading to the



This cut shows the valves properly set.

right-hand end), and the movement of *S*¹ opens *N*¹ (the port leading to the opposite, or left-hand end). At the same time the movement of *O* opens the right-hand end of the cylinder to the exhaust through the exhaust ports *X* and *Z*. The ports *C* and *D* now have positions opposite to those shown in the engravings, and steam is, therefore, entering the main cylinder through the ports *E*¹ and *H*¹, and escaping through the ports *H*, *E*, *K* and *M*, which will cause the main piston *A* to move in the op-

posite direction, or from left to right, and operations similar to those already described will follow, when the piston approaches the right-hand end of its cylinder. By this simple arrangement the pump is rendered positive in its action; that is, it will instantly start and continue working the moment steam is admitted to the steam chest. The main piston *A* cannot strike the head of the cylinder, for the main valve has a head; or, in other words, steam is always admitted in front of said piston just before it reaches either end of its cylinder, even should the supplemental piston *B* be tardy in its action and remain with *D* at that end, toward which the piston *A* is moving; for *C* would be moved far enough to open the steam port leading to the main cylinder, since the possible travel of *C* is greater than that of *D*. The supplemental piston *B* cannot strike the heads of its cylinders, for in its alternate passage beyond the exhaust ports *X* and *X*, it cushions on the vapor intrapped in the ends of this cylinder.

MISCELLANEOUS PUMP QUESTIONS.

Q. What is a pump? A. It is hard to get a definition that will cover the whole ground. A pump may be said to be a mechanical contrivance for raising or transferring fluids; and as a general thing consists of a moving piece working in a cylinder or other cavity; the device having halves for admitting or retaining the fluids.

Q. What two classes of operations are included in the term "raising" fluids? A. They may be raised by drafting or suction, from their level to that of the pump; they may be raised from the level of the pump to a higher level.

Q. Do pumps always "raise" by either method, from one level to a higher one, the liquid which they transfer? A. No; in many cases the liquid flows by gravity to the pump; and in some it is delivered at a lower level than that at which it is received.

Q. Where a pump is not used for raising a liquid to a higher level, for what is it generally used? A. To increase or decrease its pressure.

Q. What classes of liquids are handled by pumps? A. Air, ammonia, lighting gas, oxygen, etc.

Q. Name some liquids which are handled by pumps? A. Water, brine, beer, tan liquor, molasses, acids and oils.

Q. Where it is not specified whether a pump is for gas or for liquid, which is generally understood? A. Liquid.

Q. What gas is most frequently pumped? A. Air.

Q. What liquid is generally understood if none other is specified for a pump? A. Water.

Q. Can pumps handle hot and cold liquids? A. Yes; though cold are easier handled than hot.

Q. What is the difference between a fluid and a liquid? A. Every liquid is a fluid; every fluid is not a liquid. Air is a fluid; water is both a fluid and a liquid. Every liquid can be poured from one vessel to another.

SUCTION.

Q. What causes the water to rise in a pump by so-called suction? A. The unbalanced pressure of the air upon the surface of the liquid below the pump, forces the water up into the suction pipe when the piston is withdrawn from the liquid.

Q. How much is the pressure of the atmosphere? A. At the sea level about 14.7 lbs. per square inch, or 2096.8 lbs. per square foot.

Q. In what direction is this pressure exerted? A. In every direction equally.

Q. What tends to prevent the water from being lifted? A. The force of gravity, which is the result of the attraction of the earth.

Q. In what direction does the force of gravity act? A. In radial lines towards the center of the earth.

Q. With what force does this gravity act? A. That depends upon the substance upon which it is acting.

Q. Why do you refer to the level of the sea in speaking of the pressure of the air and the weight of water? A. Because the air pressure becomes less as, in rising above the sea level, we recede from the center of the earth, and the weight of a given quantity of water or any other substance becomes less than it is at the level of the sea, as we approach to or recede from the center of the earth.

Q. How is it that the weight of any substance becomes less if you go either above or below the sea level? A. The farther you go from the earth, the less its attraction and the less a given body will weigh upon a spring balance. The farther down into the earth you go, the nearer you get to the center of the earth, at which, there being attraction upon all sides, any body would weigh nothing. Going from the surface of the earth towards its center, then, a body weighs less and less upon a spring balance.

Q. Why do you specify a spring balance? A. Because in weighing by counterpoise, both the body to be weighed and the counterpoise by which it is weighed, would change their weights in the same proportion, as the position with regard to the center of the earth was changed.

Q. What are the causes which principally prevent pumps from lifting up to the normal maximum? A. Friction; leakage of air into the suction, chokes in the suction pipe.

Q. Can a liquid be "drafted" without the expenditure of work? A. No; in drafting a liquid to the full height to which it can be drafted, at least as much power must be expended as would lift the same weight of liquid that height by any mechanical means; only the amounts of friction being different.

Q. Then what advantage is there in having a pump draft its

water to the full possible height, over having it force the water the full height? A. Convenience in having the pump higher up.

Q. Can a pump throw water higher or farther, with a given expenditure of power, where it flows in, than where it must draft its water? A. Yes; on the same principle that it can throw farther or force harder when the water is forced to its suction side than where it merely flows in.

Q. What is the use of the suction chamber? A. To enable the pump barrel to fill where the speed is high; to prevent pounding, when the pump reverses.

Q. Upon what does the lifting capacity of a pump depend? A. When the pump is in good order its lifting capacity depends mainly upon the proportion of clearance in the cylinder and valve chamber to the displacement of the piston and plunger.

Q. Which will lift further, an ordinary piston pattern pump or a plunger pump? And why? A. Other things being as nearly equal as they can be made between these two pumps, the piston pump will lift the farther of the two, because the plunger pump has the most clearance.

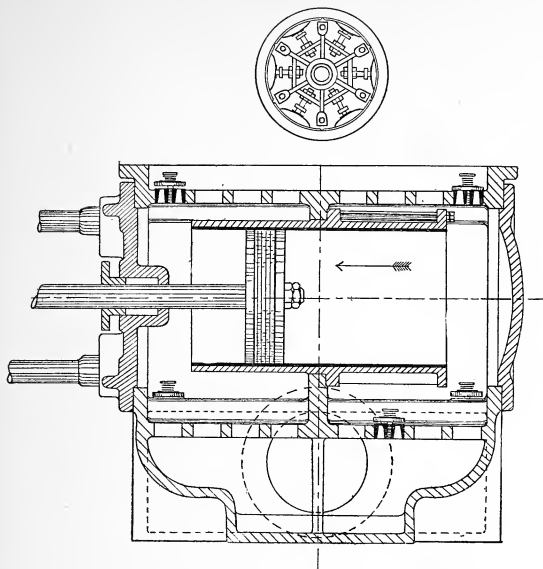
Q. What is the advantage of the suction chamber? A. To assist the pump in drafting, especially at high speed.

Q. What is the advantage of the air chamber? A. To make the stream steady.

Q. What difficulty is sometimes met with in using an air chamber? A. Where the pressure is very great sometimes the air is absorbed by the water, and thus the cushion is destroyed.

FORCING.

Q. What will be the volume of the air in the air chamber of a force pump, when the pump is forcing against a head of 33.8 feet? A. It will be reduced to half its ordinary volume, because it will be at the pressure of two atmospheres.



The above cut shows a pump with a removable cylinder or liner, and is packed with fibrous packing set out by adjustable set screws and nuts. This style of a pump is the best for small water-works or elevators, or where a pump is used where the water is muddy or sandy.

To find the horse power necessary to elevate water to a given height: Multiply the total weight of the water in pounds by the height in feet and divide the product by 33,000 (an allowance of 25 per cent should be added for water friction, and a further allowance of 25 per cent for loss in steam cylinder.)

The heights to which pumps will force water when running at

100 piston speed per minute, and the suction and discharge pipes being of moderate length, will be found by dividing the area of the steam cylinder by the area of the pump cylinder, and multiplying this product by the average steam pressure carried in the boiler, and to this product add 40 per cent; the quotient is the height to which water will be forced.

Example: To what height will an 8-inch steam cylinder, with 5-inch water cylinder force water, with 80 lbs. steam boiler pressure when running at 100 piston feed speed per minute?

8 in. area = 50.26

5 in. area = 19.63

19.63)50.26

2.56

.80

204.80

Add 40 per cent = 81.92

286.72 = height answer.

An allowance must be made where long pipes are used.

The capacity of pumps is reckoned at 100 piston feet per minute, which speed can be considerably increased if desired.

For feeding boilers, a speed of 25 to 50 piston feet per minute is most desirable.

A gallon of water, U. S. Standard, weighs $8\frac{1}{3}$ lbs. and contains 231 cubic inches.

A cubic foot of water weighs $62\frac{1}{2}$ lbs. and contains 1,728 cubic inches, or $7\frac{1}{2}$ gallons.

Doubling the diameter of a pipe increases its capacity four times.

Friction of liquids in pipes increases as the square of the velocity.

To find the area of a piston, square the diameter and multiply by .7854.

Boilers require, for each nominal horse-power, about one cubic foot of feed water per hour.

In calculating horse power of tubular or flue boilers, consider 15 square feet of heating surface equivalent to one nominal horse-power.

To find the pressure in pounds per square inch of a column of water, multiply the height of a column in feet by .434. Approximately, we say that every foot of elevation is equal to one-half lb. pressure per square inch; this allows for ordinary friction.

The area of the steam piston, multiplied by the steam pressure, gives the total amount of pressure that can be exerted. The area of the water piston, multiplied by the pressure of water per square inch, gives the resistance. A margin must be made between the power and the resistance to move the pistons at the required speed — say from 20 to 40 per cent, according to speed and other conditions.

To find the capacity of a cylinder in gallons: Multiplying the area in inches by the length of stroke in inches will give the total number of cubic inches; divide this amount by 231 (which is the cubical contents of a gallon of water) and quotient is the capacity in gallons.

To find quantity of water elevated in one minute running at 100 feet of piston feet per minute: Square the diameter of water cylinder in inches and multiply by 4.

Example: Capacity of a five-inch cylinder is desired. The square of the diameter (5 inches) is 25, which, multiplied by 4, gives 100, which is gallons per minute, approximately.

Q. "What is the reason that a steam pump of the horizontal double acting type should throw an intermitting stream under pressure, like the stream from milking a cow, only not quite so bad as that? I have tried valves of different sizes, with different amount of rise, springs or valves of different tension, different

kinds of packing in water piston, and different sized water port or passages, without any apparent difference." A. Steam pumps of the horizontal double-acting type are not alone in throwing an intermitting stream. The same thing shows up in vertical single-acting pumps; and all horizontal double-acting pumps do not so behave. The steam fire engine shows that no type of pump is exempt from "squirting."

Q. How may this squirting be lessened? A. By increasing the suction valve area; by giving more suction chamber and more air chamber.

* * * * *

Q. What is a sinking pump? A. One which can be raised and lowered conveniently, for pumping out drowned mines, etc.

Q. Into what main general classes may reciprocating cylinder pumps be divided? A. Into single acting and double acting.

Q. What is a single acting reciprocating pump? A. One in which each reciprocation or single stroke in one direction causes one influx of fluid, and each reciprocation or single stroke in the opposite direction causes one discharge of fluid. In other words, the pump, as regards its action, is single ended.

Q. What is a double acting reciprocating pump? A. One in which each end acts alternately for suction and discharge. Reciprocation of the piston in one direction causes an influx of fluid into one end of the pump from the source, and a discharge of fluid at the opposite end; on the return stroke the former suction end becomes the discharge end. In other words, the pump is double ended in its action; or is "double-acting."

Q. What is the special advantage of having double-acting pump cylinders? A. The column of water is kept in motion more constantly, and hence there is less jar; smaller column pipes may be used.

* * * * *

Q. How may those pumps which are driven by steam against a

steam piston be divided? A. Into those which have a fly wheel and those which have no fly wheel.

Q. Into what classes may those pumps which are driven by steam, without a fly wheel, be divided? A. Into direct acting and duplex.

Q. What is the advantage of a fly wheel steam pump? A. Steadiness of action; the capability of using the steam expansively.

Q. What are the disadvantages of fly wheel pumps? A. Great weight; inability to run them very slowly without gearing down from the fly wheel shaft, as the wheel must run comparatively rapidly.

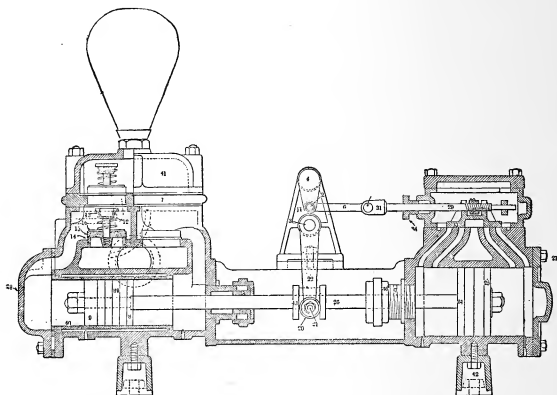
Q. What is a direct-acting steam pump? A. One in which there is no rotary motion, the piston being reversed by an impulse derived from itself at or near the end of each stroke. There is but one steam cylinder for one water cylinder; the valve motion of the steam cylinder being controlled by the action of the steam in that cylinder.

HOW TO SET THE STEAM VALVES ON A DUPLEX PUMP.

The steam valves on Duplex pumps generally have no outside lap, consequently, when in its central position, it just covers the steam ports leading to the opposite ends of cylinder.

By lost motion is meant, the distance a valve-rod travels before moving the valve, if the steam-chest cover is off; the amount of lost motion is shown by the distance the valve can be moved back and forth before coming in contact with the valve-rod nut. The object of lost motion is to allow one pump to almost complete its stroke before moving the valve of its fellow engine. As the steam piston is nearing the end of its stroke, it moves the valve of its fellow engine, admitting steam and starting its fellow engine as it lays down its own work; in other words,

the other picks it up. The amount of lost motion required is enough to allow each piston to complete its stroke; in other words, if there was no lost motion, as each piston would pass the center of their travel, they would move the valve of their fellow engine, and the result would be a very short stroke.



This cut shows the steam properly set.

To set the steam valves, move the steam piston towards the steam cylinder head until it comes in contact with the head; mark with a scribe on the piston-rod at the face of the stuffing-box follower on steam end; then move the piston to its contact stroke on the opposite end and make another mark on the piston-rod, exactly half way between the face of the stuffing-box follower on the steam end, and the first mark. Then move the piston back until the middle mark is at the face of piston-rod stuffing-box follower on the pump end. This operation brings the piston exactly in the middle of the stroke. Then take off the steam

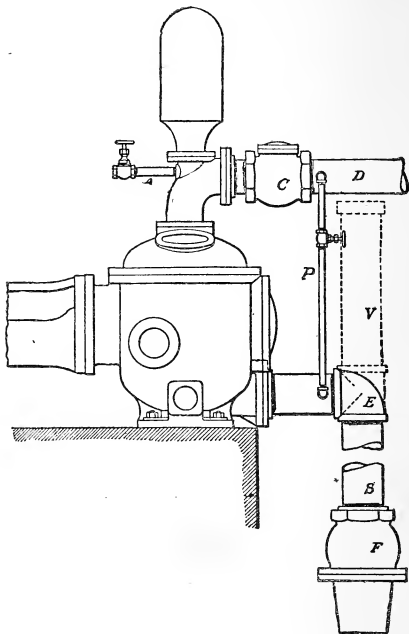
chest cover, place the slide-valve in the center, exactly over the steam ports. Place the slide-valve nut in exact center between the jaws of the slide-valve, screw the valve-rod through the nut until the eye on the valve-rod head comes in line with the eye of the valve-rod link; slip the valve-rod head pin through head and the valve is set. Repeat the same operation on the other side of the pump. Where a pump is fitted with four hexagon valve-rod nuts, two either end of the slide-valve, instead of one nut in the center of the valve, set and lock these hexagon nuts at equal distances from the outer end of the slide-valve jaws, allowing a little lost motion, varying from $\frac{1}{2}$ " on high-pressure pumps, to, say, $\frac{1}{4}$ " on low service pumps, on each side of valve; if the steam piston hits the head, take up some of your lost motion; if the steam piston should not make a full stroke, give more lost motion.

THE BEST MANNER OF ARRANGING PIPE CONNECTIONS.

For the purpose of showing good arrangement, the above cut is presented.

On long lifts it is necessary to provide the suction pipe *S* with a foot-valve *F*. By the use of a foot-valve, the pipe and cylinders are constantly kept charged with water, allowing the pump to start without having to free itself and the suction pipe of air. In case of a long lift, the vacuum chamber *V* is also essential. This may be readily constructed by using a tee in place of the elbow *E*, extending the suction pipe and placing a cap upon the top. In order to keep the water back when the pump is being examined or repaired, a gate valve should be placed in the delivery pipe. It sometimes happens that, either purposely or through a leak in the foot-valve, the suction chamber becomes empty. For the purpose of charging the suction pipe and cylinder a "charging pipe" *P* is placed *outside* the check valve, connecting the delivery pipe *D* with the suction. In order that

the pump, in starting, may free itself of air, a check valve *C* and a "starting pipe" *A* should be provided. This pipe may be



ARRANGEMENT OF PIPE CONNECTIONS.

led to any convenient place of discharge. After the pump has started, the valve in the starting pipe should be closed gradually. Faulty connections are generally the cause of the improper action

of a pump. Great care should, therefore, be taken to have everything right before starting. A very small leak in the suction will cause a pump to work badly.

Q. What is the peculiarity of the duplex type? A. There are two steam cylinders and two water cylinders; the piston of one of these cylinders works the valve of the other cylinder, and *vice versa*. Neither half can work alone. This name is entirely arbitrary.

Q. How would you call a pumping machine in which there are two steam cylinders, each operating a water cylinder in line with it; each half being a perfect pumping machine independent of the other side? A. A "double" pump.

Q. Can a direct acting steam pump use steam expansively? A. Not to any extent; in fact, there would be danger of sticking upon the centers in most cases, if there was lap and expansion.

Q. What is the reason that a single cylinder engine cannot well reverse itself without a fly wheel, by means of the ordinary single *D* valve? A. Because when the valve was at mid-travel, both parts of the valve seat would be closed by the valve faces, and neither exhaust nor admission take place.

Q. What means are employed in a direct acting steam pump to move the valve? A. A small supplementary piston is used; this supplementary piston being actuated by the main piston in any one of several different ways.

Q. What are the principal ways of working the supplementary piston from the main piston? A. (1) The main piston strikes the tappet of a small valve, which opens an exhaust passage in one end of the cylinder, containing a supplementary piston, and having live steam pressing upon both ends of the supplementary piston; (2) by the main piston striking a rod passing through the cylinder head, and moving a lever which controls the motion of the part of the main valve to which is attached the valves which moves the supplementary piston; (3) the main piston rod carries a tappet arm, which twists the stem of the supplementary piston,

thus uncovering ports which cause its motion ; (4) a projection upon the main piston rod engages the stem and operates the valve which moves the supplementary piston, but if that valve should not, by means of its steam passages, cause quick enough or sure enough motion of the supplementary piston, a lug upon this stem moves the supplementary piston.

Q. In the first of these four classes, what is the principal element in the valve motion? A. A difference in area between the eduction port of the supplemental piston and its education ports.

Q. What is the principal feature in the second class? A. A regular slide valve letting steam upon alternate ends of the supplemental piston.

Q. In the third class, what is the main feature? A. A twisting motion in the supplemental piston.

Q. In the fourth class, what is the principal feature? A. Movement of the supplemental piston by steam controlled by a slide valve, and by the mechanical action of the slide valve itself if its steam distribution is defective.

Q. What are the objections to most pumps of the direct acting type? A. The unbalanced condition of the auxiliary pistons in the exhaust side, causing a loss of steam when the parts are worn, the choking up of the small ports for the auxiliary pistons, by the gumming and caking of the oil therein.

Q. Can the ordinary direct acting steam pump use steam expansively? A. No.

Q. How may this be done? A. By compounding.

Q. What is to be taken into consideration in the use of compound steam pumps? A. That they are designed for a certain range of pressure — say from 80 to 120 pounds boiler pressure, and will do their best work between these pressures.

Q. Have all direct-acting steam pumps intermittent valve motion? A. No ; there are some which have continuous valve motion.

Q. In most direct-acting steam pumps, are the auxiliary piston heads made together or in separate pieces? A. Together.

Q. They are in contact with the steam in the chest? A. Yes.

Q. What should be said about the location of a pump? A. It should be as near the source of supply as is convenient.

Q. What may be said about convenience in repairs? A. The pump should have room left upon all sides; and upon both ends equal to its length, for the removal of the piston rods in case of repairs.

Q. If the floor is not strong enough, how may a good foundation be made? A. By digging two or three feet into the ground and building up the proper height with stone or brick laid in strong cement, with a cap stone.

Q. What may be said about suction pipes? A. They must be as large as possible; the longer they are the greater in diameter they should be; they should be as straight as possible, and as free from bends and valves; they must be air-tight; they must not be allowed to get obstructed by foreign substances.

Q. What may be said about the area of strainer holes? A. They should have an aggregate area about five times that of the suction pipe.

Q. Where are foot valves necessary? A. Upon long suction or high lifts.

Q. Should two pumps take their suction from one pipe? A. It should be avoided, unless the pipe is very large; and in case both suction should be arranged so that one of the pumps should not have to draft at right-angles to the flow of water going to the other pump.

Q. What arrangement should be made where it is necessary to have two pumps draft from one suction? A. There should be a Y connection.

Q. What is a good way to reduce the friction in suction pipes where there are many bends? A. To use bends of wrought-

iron pipe of as long a radius as possible, instead of cast-iron elbows.

Q. What may be said about the lower end of the suction pipe?

A. It should generally have a strainer; and if the lift is over 12 to 15 feet, should have a foot valve.

Q. What is a good thing to do with the discharge pipe near the pump? A. To put a valve in it near the pump, to keep the water in the pipe when the water end is to be opened for inspection or repairs.

Q. What provision should be made for priming the pump? A. There should be a pipe with a stop valve in it connected from the discharge pipe beyond this check valve, or from some other source of supply, to the suction pipe, for the purpose of priming the pump.

Q. When the pump is in position for piping, what care should be taken? A. That the pipes are of proper length, so as not to bring any undue strain upon them in connecting them to the pump, as in that case they will be liable to give trouble by breaking or working the joints loose and leaking.

Q. Does any pipe have an effective diameter as great as its nominal diameter? A. No; because the sides retard the flow of the liquid; there is a neutral film of liquid which practically does not move.

Q. Upon what does the thickness of this film of liquid depend?

A. Upon the viscosity (commonly miscalled the "thickness") of the liquid; upon the roughness, material and diameter of the pipe; the pressure, etc.

Q. When long lines of pipe are used, should the diameter of the pipe be the same all the way along, or should there by sections be decreasing diameter, as the distance from the pump increases?

A. Most emphatically, the pipe diameter should remain constant clear out to the end.

TAKING CARE OF A PUMP.

Q. What can be said about taking care of a pump? A. In places where an inferior grade of labor is employed, oil and dirt are sometimes found covering the steam chest and pump to the depth of an inch in thickness; stuffing boxes are allowed to go leaky and get loose; the valve motion is never looked after; lost motion is never taken up, and the pump will be let run in a slipshod way for months, until some accident occurs. This will sometimes exist in places where the engine is well taken care of.

Q. Should not as good care be taken of a steam pump as of an engine? A. Yes. It is a steam engine, and the fact that it has generally but little adjustability, should not render it liable to lack of care.

Q. What is a very common thing for pump runners to do when anything happens? A. To condemn the pump at once without finding out the cause of the trouble.

Q. What is one reason of this? A. The man who understands an ordinary engine, will often become quite perplexed when he examines the steam end of a direct acting steam pump, because he does not comprehend the principal feature of its construction—that all direct acting steam pumps which have no fly wheels and cranks, must generally have an auxiliary piston in order to carry them over the “dead center.” A direct acting steam pump is really a double engine; a plain, flat slide valve admitting steam to a small piston, which in turn operates the main valve, which gives steam by the usual arrangement to the main piston.

Q. What would save firemen and engineers much trouble with steam pumps? A. If they would take the trouble to examine their pumps carefully, and find out the way their valves were arranged and actuated.

Q. Upon what does the successful performance of a pump

depend, in great measure? A. Upon its proper selection from among the many patterns differing from each other in size, proportion and general arrangement.

Q. What may be said about the selection of pumps? A. Pumps are often selected improperly for their work. As an illustration, a man who wishes to use a circulating pump for a surface condenser, where the water pressure upon the pump cylinder will never exceed 5 to 10 pounds, will buy a pump intended for boiler feed work, and having its steam cylinder about three times the area of its pump cylinder.

Q. What will be the result in such a case? A. There will be little or no pressure in the steam cylinder when working on the condenser; and while there is pressure sufficient to move the main piston, there is not enough to operate the auxiliary piston with positiveness.

Q. In ordering a pump, or in asking estimates, what information should be given? A. In ordering a pump, it is to the interest of the purchaser to fully inform the maker or seller on the following questions: 1st. For what purpose is the pump to be used? What is the average steam pressure? 2d. What is the liquid to be pumped; and is it hot or cold, clear or gritty, fresh, salt, alkaline or acidulous? 3d. What is the maximum quantity to be pumped per minute or hour? 4th. To what height is the liquid to be lifted by suction, and what is the length and diameter of the suction pipe, and the number of elbows or bends? 5th. To what height is the liquid to be pumped, and what is the length and size of discharge pipe?

Q. How can an engineer familiarize himself with the direction of the auxiliary steam and exhaust passages? A. By means of a piece of wire.

Q. What is the special thing to look after in duplex pumps? A. That all packings are adjusted uniformly on both sides.

Q. What would be the result of having the packings different

upon the two sides of a duplex pump? A. The machinery would run unsteadily.

Q. If a pump works badly, what should be about the first thing to look at? A. The connections.

Q. When a pump is first connected, what should be done? A. It should be blown through to remove dirt; if it be of the class which will permit of removing the bonnets and blowing through, that should be done.

Q. What pump piston speed is recommended for continuous boiler feeding service? A. About 50 feet per minute.

Q. What may be said about the care and use of steam pumps of all kinds? A. It is important that the pump be properly and thoroughly lubricated; that all stuffing-box, piston and plunger packings be nicely adjusted; not so tight as to cause undue friction; nor so slack as to leak badly.

Q. In which end of a steam-pumping machine is there most likely to be trouble? A. In the water end.

Q. If a pump slams and hammers in its water end, is it necessarily defective in its water cylinder? A. No; it may be that there is no suction chamber, or not enough; or sometimes it slams because the suction pipe is not large enough.

Q. What are very common defects in cheap grades of pumps? A. Too little valve area in the pump end; too great lift for the valves.

Q. What are the principal causes of pumps refusing to lift water from the source of supply? A. Among these may be mentioned leaky suction pipes, worn out pistons, plungers, packings or water valves; rotten gaskets on joints in piping or pump; and sometimes a failure to properly prime the pump as well as the suction pipe.

Q. What is one great cause of a pump refusing to lift water when first started? A. It often happens that a pump refuses to lift water while the full pressure against which it is expected to

work is resting upon the force valves, for the reason that the air within the pump chamber is not dislodged, but only compressed, by the motion of the plunger. It is well, therefore, to arrange for running without pressure until the air is expelled and water follows; this is done by placing a valve in the delivery pipe and providing a waste delivery, to be closed after the pump has caught water.

Q. Sometimes when starting, the water may not come for a long time; what is the best thing to do in this case? A. First, open the little air cock, which is generally located in the top of the pump, between the discharge valves and the air chamber, to let off any accumulation of air which may there be confined under pressure. Very often, by relieving the pump of this air pressure, it will pick up its water by suction and operate promptly.

Q. What precaution must be taken in priming the pump? A. The air cock, which should be provided at the top of the pump, should be opened to allow the escape of the air from the suction pipe and from the pump, and then the valve in the priming pipe should be opened. The pump should then be started slowly, as it aids in more completely filling the pump cylinders, which otherwise, might not occur and the pump might fail to lift water.

Q. Is there any advantage in having air in the suction? A. Sometimes a small amount of air let into the suction will cause less jarring when the duty is very heavy.

Q. What may be said about pumping hot water? A. Where the hot water is very hot, it should gravitate to the pump, instead of an attempt being made to draft it.

Q. In the plunger pumps, what is about the only wearing part of the water end? A. The packing of the plunger stuffing-boxes.

Q. How can a pump be prevented from freezing? A. By having draining cocks and opening them when the pump is idle.

Q. What may be said about leather piston packing for water cylinders? A. For cold water, or sandy, gritty water, the leather packing has many points to commend it; it makes a tight piston, and one that is the least destructive to pump cylinders.

Q. What is the best way to handle the square packing mostly employed, which is composed of alternate layers of cotton and rubber? A. Cut the lengths a trifle short, then there will be room for the packing to swell and not cause too much friction. I have known pistons where this precaution has not been taken to be fastened so securely in the cylinder by the swelling of the dry packing, that full steam pressure could not move them.

Q. What is the remedy in such a case? A. Remove the follower, take out the different layers of packing and shorten their lengths.

Q. What is the reason that some soft waters corrode pipes so often? A. Because they contain a large proportion of oxygen.

Q. Will a pump with a 6" water cylinder and a 6" steam cylinder force water into a boiler, the discharge from water cylinder being 4" diameter; boiler pressure, 80 lbs.? A. A pump with a 6" water cylinder and 6" steam cylinder will not force water into the boiler which supplies it, no matter what the steam pressure, nor what the size of discharge pipe. It will not move. The pressures would be equalized and there would be nothing to overcome friction of steam and water in pipes and cylinder. The foregoing case supposes that the water is to be lifted to the pump; or at least that there shall be no head; also, that there shall be no fall from pump to boiler. If there were sufficient head or fall to overcome all the various frictions, and no lift, the pump would apparently work; but really, the water piston would be dragging the steam piston along.

Q. How may acids be pumped? A. By what is known as blowing up; that is, by employing a pump to put pressure upon

the acid in a closed vessel, thereby forcing it through a pipe placed in the bottom of the vessel.

Q. In case any wearing part of a pump gets to cutting, what should be done? A. If it is not practicable to stop the pump nor to reduce its speed, the part which is getting damaged should be given very liberal oiling.

Q. What is the best oil for this purpose? A. That depends on the nature of the cutting surfaces, and on the pressure therein; the mineral oils are generally more cooling than others, although they have less body to resist squeezing.

CALCULATING THE BOILER FOR A STEAM PUMP.

The amount of work which a boiler has to do is very easy of determination. Given the largest number of gallons which a pump will be required to pump per minute, and the height in feet from the surface of the well from which the water is drawn, to the point of discharge, you can easily tell by multiplying by 10—the weight in pounds of one gallon—the number of foot pounds of power consumed per minute in lifting the water, adding a certain percentage for friction of the machine and of water in the pipe, we have the total number of foot pounds consumed per minute, and this divided by 33,000 will be the horse power consumed.

The allowance for friction will vary with the style, size and condition of the pump, the size of the pipe, and, above all, the manner in which the pipe is connected up, the number of right angle turns, etc.

This may be arrived at in another way. A column of water 2.3 feet in height exerts a pressure of one pound. Allowing the .3 for friction, we can, by dividing the total left in feet by two, get at the pressure per square inch, which is being exerted against the water piston or plunger, and multiplying by the number of

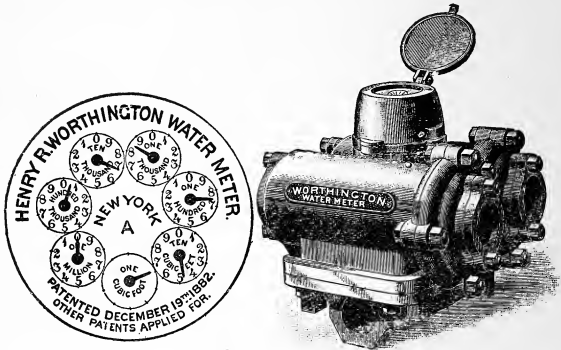
square inches in that piston gives the total pressure against which the pipe is working. This multiplied by the piston speed in feet minutes, and divided by 33,000, will give the lift in horse power. In this case, as in the other, the lift must be calculated from the surface of the supply, and not from the pump, when the pump is lifting its supply. If the water flows to the pump it must be calculated from the height of the water cylinder. An allowance of, say, 25 per cent, should be made above the horse power thus shown, in order to provide for contingencies, and to be on the safe side.

In selecting a boiler to do this load, it must be borne in mind that a boiler which is sold for a certain horse power, is supposed to be able to furnish that power in connection with a good steam engine, and they are not apt to be overrated. Now, the steam pump as usually built, does not approach in economy the ordinary steam engine, and, therefore, a boiler which will develop twenty-five horse power in connection with a good engine would be too small for a pump which was required to do the same amount of work. The evaporation of 30 pounds of water per hour from feed at 100 degrees Fahr. into steam of 70 lbs. pressure, has been adopted by several authorities as a horse power. Any good automatic cut-off will run on this amount of water, and if an estimate can be made of the comparative performance of the pump under consideration, a close approximation to the desired size of boiler can be made.

THE WORTHINGTON WATER METER.

The counter registers cubic feet; one foot being $7\frac{48}{100}$ gallons, United States standard. It is read in the same way as registers of gas meters. The following example and directions may be of use to those unacquainted with the method: If a pointer is between two figures, the smaller one must invariably be taken. Suppose the pointers of the dials to stand as in the engraving.

The reading is 6,874 cubic feet. From the dial marked ten we get the figure 4; from the next, marked hundred, the figure 7; from the next, marked thousand, the figure 8; from the next,



marked ten thousand, the figure 6. The next pointer being between ten and 1, indicates nothing. By subtracting the reading taken at one time, from that taken at the next, the consumption of water for the intermediate time is obtained.

CAPACITY OF TANKS IN U. S. GALLONS.

DIAMETERS.

	5 ft.	5½ ft.	6 ft.	6½ ft.	7 ft.	7½ ft.	8 ft.	8½ ft.	9 ft.	9½ ft.	10 ft.	11 ft.
5 ft.	734	888	1057	1241	1439	1652	1880	2122	2379	2768	2937	3554
5 ft. 6 in.	808	977	1163	1365	1583	1817	2068	2334	2617	3045	3231	3910
6 ft.	881	1066	1269	1489	1727	1983	2256	2546	2855	3322	3525	4265
6 ft. 6 in.	955	1155	1374	1613	1871	2148	2444	2759	3093	3599	3819	4621
7 ft.	1028	1244	1480	1737	2015	2313	2632	2971	3331	3875	4112	4976
7 ft. 6 in.	1100	1332	1586	1861	2159	2478	2820	3183	3569	4152	4406	5332
8 ft.	1175	1421	1692	1986	2303	2643	3007	3395	3907	4429	4700	5687
8 ft. 6 in.	1248	1510	1797	2110	2446	2809	3196	3607	4045	4706	4993	6042
9 ft.	1322	1599	1903	2234	2590	2974	3384	3820	4283	4983	5287	6398
9 ft. 6 in.	1395	1688	2008	2358	2734	3139	3572	4032	4521	5259	5581	6753
10 ft.	1468	1766	2114	2482	2878	3304	3760	4244	4758	5536	5874	7108

TANKS.

Length of Stave.....ft.	6	5	5	8	6	6	10	7	8	8	10	12
Diam. of Bottom.....ft.	6	7	7	6.	8	8	6	8	9	9	8	8
Number of Hoops.....ft.	5	4	4	7	5	5	8	6	7	7	8	9
Capacity in Gallons.....	1017	1197	1197	1480	1890	1890	1890	2268	3339	3370	3370	4126
Length of Stave.....ft.	8	10	10	12	10	10	14	12	10	10	14	14
Diam. of Bottom.....ft.	10	9	9	9	10	10	9	10	12	12	10	10
Number of Hoops.....ft	7	8	8	9	8	8	9	9	8	8	10	10
Capacity in Gallons.....	4126	4284	4284	5229	5292	5292	6174	6457	7623	7623	7623	7623

CAPACITY OF SQUARE CISTERNS IN U. S. GALS.

	5×5	5×6	5×7	5×8	5×9	5×10	6×6	6×7	5×8	6×9	6×10
5 ft..	935	1122	1309	1496	1683	1870	1346	1571	1795	2020	2244
5½ ft..	1028	1234	1440	1645	1851	2057	1481	1728	1975	2221	2469
6 ft..	1122	1346	1571	1795	2019	2244	1615	1885	2154	2423	2693
6½ ft..	1215	1459	1702	1945	2188	2431	1750	2042	2334	2625	2917
7 ft..	1309	1571	1833	2094	2356	2618	1884	2199	2513	2827	3142
7½ ft..	1403	1683	1963	2244	2524	2800	2019	2356	2693	3029	3366
8 ft..	1496	1795	2094	2393	2693	2992	2154	2513	2872	3231	3592
8½ ft..	1589	1907	2225	2543	2861	3179	2288	2670	3052	3433	3816
9 ft..	1683	2020	2356	2693	3029	3366	2423	2827	3231	3635	4041
9½ ft..	1776	2132	2487	2842	3197	3553	2558	2984	3412	3837	4265
10 ft..	1870	2244	2618	2992	3366	3470	2692	3142	3591	4039	4489

	6×11	6×12	7×7	7×8	7×9	7×10	7×11	7×12	8×8	8×9
5 ft..	2468	2693	1832	2094	2356	2618	2880	3142	2394	2693
5½ ft..	2715	2962	2016	2304	2592	2880	3168	3456	2633	2962
6 ft..	2962	3231	2199	2513	2827	3142	3456	3770	2872	3231
6½ ft..	3209	3500	2382	2722	3063	3403	3744	4084	3112	3500
7 ft..	3455	3770	2565	2932	3298	3665	4032	4398	3351	3770
7½ ft..	3702	4039	2748	3141	3534	3927	4320	4712	3590	4039
8 ft..	3949	4308	2932	3351	3770	4189	4608	5026	3830	4308
8½ ft..	4196	4577	3115	3560	4005	4451	4896	5340	4069	4578
9 ft..	4443	4847	3298	3769	4341	4712	5184	5655	4308	4847
9½ ft..	4689	5116	3481	3979	4576	4974	5472	5969	4548	5116
10 ft..	4936	5386	3664	4188	4712	5236	5760	6283	4788	5386

WEIGHT OF WATER.

1 cubic inch.....	.03617	pound.
12 cubic inches.....	.434	pound.
1 cubic foot (salt).....	64.3	pounds.
1 cubic foot (fresh).....	62.5	pounds.
1 cubic foot.....	7.48	U. S. Gallons.

NOTE. — The center of pressure of a body of water is at two-thirds the depth from the surface.

To find the pressure in pounds per square inch of a column of water, multiply the height of the column in feet by .434. Every foot elevation is called (approximately) equal to one-half pound pressure per square inch.

SHOWING U. S. GALLONS IN GIVEN NUMBER OF CUBIC FEET.

Cubic Feet.	Gallons	Cubic Feet.	Gallons.	Cubic Feet.	Gallons.
0.1	0.75	50	374.0	9,000	67,324.6
0.2	1.50	60	448.8	10,000	74,805.2
0.3	2.24	70	523.6	20,000	149,610.4
0.4	2.99	80	598.4	30,000	224,415.6
0.5	3.74	90	673.2	40,000	299,220.7
0.6	4.49	100	748.0	50,000	374,025.9
0.7	5.24	200	1,496.1	60,000	448,831.1
0.8	5.98	300	2,244.1	70,000	523,636.3
0.9	6.73	400	2,992.2	80,000	598,441.5
1	7.48	500	3,740.2	90,000	673,246.7
2	14.9	600	4,488.3	100,000	748,051.9
3	22.4	700	5,236.3	200,000	1,496,103.8
4	29.9	800	5,984.4	300,000	2,244,155.7
5	37.4	900	6,732.4	400,000	2,992,207.6
6	44.9	1,000	7,480.0	500,000	3,740,259.5
7	52.4	2,000	14,961.0	600,000	4,488,311.4
8	59.8	3,000	22,441.5	700,000	5,236,363.3
9	67.3	4,000	29,922.0	800,000	5,984,415.2
10	74.8	5,000	37,402.6	900,000	6,732,467.1
20	149.6	6,000	44,883.1	1,000,000	7,480,519.0
30	224.4	7,000	52,363.6		
40	299.2	8,000	59,844.1		

From the above any cubic feet reading can readily be converted into U. S. gallons, as follows:

How many gal'ons are represented by 53,928 cubic feet?

$$50,000 \text{ cubic feet} = 374,025.9 \text{ gallons.}$$

$$3,000 \text{ " " " " } = 22,441.5 \text{ " "}$$

$$900 \text{ " " " " } = 6,732.4 \text{ " "}$$

$$20 \text{ " " " " } = 149.6 \text{ " "}$$

$$8 \text{ " " " " } = 59.8 \text{ " "}$$

$$53,928 \text{ cubic feet} = 403,409.2 \text{ gallons.}$$

SHOWING COST OF WATER AT STATED RATES PER 1000 GALLONS.

Number of Cubic Feet.	COST PER 1000 GALLONS.							
	5 Cents.	6 Cents.	8 Cents.	10 Cents.	15 Cents.	20 Cents.	25 Cents.	30 Cents.
20	\$0.007	\$0.009	\$0.012	\$0.015	\$0.021	\$0.030	\$0.037	\$0.045
40	0.015	0.018	0.024	0.030	0.045	0.060	0.075	0.090
60	0.022	0.027	0.036	0.045	0.066	0.090	0.112	0.135
80	0.030	0.036	0.048	0.060	0.090	0.120	0.150	0.180
100	0.037	0.049	0.060	0.075	0.111	0.150	0.187	0.224
200	0.075	0.090	0.120	0.150	0.225	0.299	0.374	0.449
300	0.112	0.135	0.180	0.224	0.336	0.449	0.561	0.673
400	0.150	0.180	0.239	0.299	0.450	0.598	0.748	0.898
500	0.188	0.224	0.299	0.374	0.561	0.748	0.935	1.122
600	0.224	0.269	0.359	0.449	0.673	0.898	1.122	1.346
700	0.262	0.314	0.419	0.524	0.786	1.047	1.309	1.571
800	0.299	0.350	0.479	0.598	0.897	1.197	1.496	1.795
900	0.337	0.404	0.539	0.673	1.011	1.346	1.683	2.020
1,000	0.374	0.449	0.598	0.748	1.122	1.496	1.870	2.244
2,000	0.748	0.898	1.197	1.496	2.244	2.992	3.740	4.488
3,000	1.122	1.346	1.795	2.244	3.366	4.488	5.610	6.732
4,000	1.496	1.795	2.393	2.992	4.488	5.984	7.480	8.976
5,000	1.870	2.244	2.992	3.740	5.610	7.480	9.350	11.220
6,000	2.244	2.692	3.590	4.488	6.732	8.976	11.220	13.464
7,000	2.618	3.141	4.189	5.236	7.854	10.472	13.090	15.708
8,000	2.992	3.590	4.787	5.984	8.976	11.938	14.961	17.953
9,000	3.366	4.039	5.385	6.732	10.098	13.464	16.831	20.197
10,000	3.74	4.488	5.984	7.480	11.122	14.961	18.701	22.441
20,000	7.48	8.976	11.968	14.961	22.443	29.992	37.402	44.882
30,000	11.22	13.46	17.95	22.44	33.664	44.88	56.10	67.32
40,000	14.96	17.95	23.94	29.92	44.885	59.84	74.10	89.77
50,000	18.70	22.44	29.92	37.40	56.103	74.80	93.50	112.20
60,000	22.44	26.92	35.90	44.88	67.323	89.76	112.20	134.64
70,000	26.18	31.41	41.89	52.36	78.543	104.72	130.90	157.08
80,000	29.92	35.90	47.87	59.84	89.766	119.68	149.61	179.53
90,000	33.66	40.39	53.85	67.32	100.986	134.64	168.31	201.97
100,000	37.40	44.88	59.84	74.80	111.22	149.61	187.01	224.41
200,000	74.81	89.76	119.68	149.61	224.43	299.22	374.02	448.82
300,000	112.20	134.64	179.53	224.41	336.64	448.83	561.03	673.24
400,000	149.61	179.53	239.37	299.22	448.85	598.44	748.05	897.66
500,000	187.01	224.41	299.22	374.02	561.03	748.05	935.06	1122.07
600,000	224.41	269.29	359.06	448.83	673.23	897.66	1122.07	1346.49
700,000	261.81	314.18	418.90	523.63	785.43	1047.27	1309.08	1570.88
800,000	299.22	359.06	478.75	598.44	897.66	1196.88	1496.10	1795.32
900,000	336.62	403.94	538.59	673.24	1009.86	1346.49	1683.11	2019.73
1,000,000	374.02	448.83	598.44	748.05	1122.06	1498.10	1870.12	2244.15

LOSS BY FRICTION OF WATER IN PIPES.

This table shows the loss in pounds pressure per square inch for each 100 feet in length due to friction, when discharging the given quantities of water per minute.

Gals. per Minute.	SIZES OF PIPES — INSIDE DIAMETER.															
	$\frac{3}{4}$ Inch.	1 Inch.	1 $\frac{1}{4}$ Inch.	1 $\frac{1}{2}$ Inch.	2 Inch.	2 $\frac{1}{2}$ Inch.	3 Inch.	4 Inch.	6 Inch.	8 Inch.	10 Inch.	12 Inch.	14 Inch.	16 Inch.	18 Inch.	
5	3.3	0.84	0.31	0.12												
10	13.0	3.16	1.05	0.47	0.12											
15	28.7	6.98	2.38	0.97	0.42											
20	50.4	12.3	4.07	1.66	0.42											
25	78.0	19.0	6.40	2.62	0.21	0.10										
30		27.5	9.15	3.75	0.91											
35		37.0	12.4	5.05												
40		48.0	16.1	6.52	1.60											
45			20.2	8.15												
50			24.9	10.0	2.44	0.81	0.09									
55			56.1	22.4	5.32	1.80	0.74									
75				39.0	9.46	3.20	1.31	0.33	0.05							
100																
125					14.9	4.89	1.99									
150					21.2	7.0	2.85	0.69	0.10							
175					28.1	9.46	3.85									
200					37.5	12.47	5.02	1.22	0.17							
250						19.66	7.76	1.89	0.26	0.07						
300						28.06	11.2	2.66	0.37	0.09	0.03	0.01				
350							15.2	3.65	0.50	0.12	0.05	0.02				
400							19.5	4.73	0.65	0.16	0.06					
450							25.0	6.01	0.81	0.20	0.07	0.03				
500							30.8	7.43	0.96	0.25	0.09	0.04	0.017	0.009	0.005	
750									2.21	0.53	0.18	0.08	0.062	0.036	0.020	
1000									3.88	0.94	0.32	0.13	0.062	0.036	0.020	
1250										1.46	0.49	0.20	0.135	0.071	0.040	
1500										2.09	0.70	0.29	0.185	0.071	0.040	
1750											0.95	0.38	0.234	0.123	0.071	
2000											1.23	0.49	0.234	0.123	0.071	
2250												0.63	0.362	0.188	0.107	
2500												0.77	0.362	0.188	0.107	
3000												1.11	0.515	0.267	0.150	
3500													0.697	0.365	0.204	
4000													0.910	0.472	0.263	
4500														0.593	0.333	
5000														0.730	0.408	

SHOWING HOW WATER MAY BE WASTED.

GALLONS DISCHARGED PER HOUR THROUGH VARIOUS SIZED ORIFICES
UNDER STATED PRESSURES.

Head in Feet.	Pounds pressure per square inch.	Diameters of Orifices in Inches and Fractions of an Inch.									
		$\frac{1}{4}$ inch	$\frac{3}{8}$ inch	$\frac{1}{2}$ inch	$\frac{5}{8}$ inch	$\frac{3}{4}$ inch	1 inch	$1\frac{1}{4}$ inch	$1\frac{1}{2}$ inch	$1\frac{3}{4}$ inch	2 inch
20	8.66	300	720	1260	1920	2760	4920	7380	11100	15120	19740
40	17.32	450	960	1800	2760	3960	6720	10920	15720	21360	27960
60	25.99	540	1200	2160	3480	4800	8580	13380	19200	26220	34260
80	34.65	620	1380	2460	3840	5580	9840	15480	22260	30300	39540
100	43.31	690	1560	2760	4320	6240	11040	17280	24900	33900	44280
120	51.98	780	1780	3000	4740	6840	12120	18960	27240	37440	48480
140	60.64	816	1860	3300	5100	7320	13020	20160	29460	39080	52320
150	64.97	840	1920	3420	5280	7620	13560	21180	30480	41460	54120
175	75.80	900	2040	3660	5700	8220	14640	22800	32880	44940	58560
200	86.63	960	2220	3900	6120	8760	15600	25020	35880	47880	62580
235	101.79	1080	2460	4320	8280	11160	17100	26760	38520	52260	68460

The pressure or head of water is taken at the orifice, no allowance being made for friction in the pipe. In practical calculations to determine the height which water can be thrown, the head consumed by the friction of the water in flowing from the source to the orifice must be considered.

IGNITION POINTS OF VARIOUS SUBSTANCES.

Phosphorus ignites at	150°	Fahr.
Sulphur	500°	"
Wood	800°	"
Coal	1000°	"
Lignite, in the form of dust, ignites at	150°	"
Cannel Coal,	200°	"
Coking Coal,	250°	"
Anthracite,	300°	"

CONTENTS IN CUBIC FEET AND IN U. S. GALLONS.

(FROM TRAUTWEIN)

Of 231 cubic inches (or 7.4805 gallons to a cubic foot); and for one foot of length of the cylinder. For the contents for a greater diameter than any in the table take quantity opposite one-half said diameter, and multiply it by 4. Thus, the number of cubic feet in one foot length of a pipe 80 inches in diameter is equal to $8.728 \times 4 = 34.912$ cubic feet. So also with gallons and areas.

Diameter in inches.	For 1 foot in length.			Diameter in inches.	For 1 foot in length.			Diameter in inches.	For 1 foot in length.		
	Diameter in decimals of a foot.	Cubic feet, also area in square feet.	Gallons of 231 cubic inches.		Diameter in decimals of a foot.	Cubic feet, also area in square feet.	Gallons of 231 cubic inches.		Diameter in decimals of a foot.	Cubic feet, also area in square feet.	Gallons of 231 cubic inches.
5-16	.0208	0003	.0026	7	.5625	.2485	1 859	19	1 583	1 969	14.73
	.0260	.0005	.0040		.5833	.2673	1 999		1 625	2 074	15 52
	.0313	.0008	.0057		.6042	.2868	2 144	20	1.666	2.182	16.32
7-16	.0365	.0010	.0078		.6250	.3068	2 295		1.708	3.292	17.15
	.0417	.0014	.0102		.6458	.3275	2 450	21	1 750	2 405	17 99
9-16	.0469	.0017	.0129		.6667	.3490	2 611		1 792	2.521	18 86
	.0521	.0021	.0159	8	.6875	.3713	2 777		1 833	2.640	19.75
11-16	.0573	.0026	.0193		.7083	.3940	2 948	22	1 875	2 761	20 65
	.0625	.0031	.0230		.7292	.4175	3 125		1.917	2.885	22.58
13-16	.0677	.0031	.0270		.7500	.4418	3 305	23	1 958	3 012	31 53
	.0729	.0042	.0312		.7708	.4668	3 492		2 000	3 142	23 50
15-16	.0781	.0048	.0359		.7917	.4923	3 682	24	2 083	3 409	25 50
1	.0833	.0055	.0408		.8125	.5185	3 879	25	2 166	3.637	27 58
	.1042	.0085	.0638	10	.8333	.5455	4 081		2 250	3.976	29.74
	.1250	.0123	.0918		.8542	.5730	4 286	28	2 333	4.276	31 99
	.1458	.0168	.1250		.8750	.6013	4 498	29	2 416	4 587	34 31
2	.1667	.0218	.1632		.8958	.6303	4 714	30	2 500	4.909	36.72
	.1875	.0276	.2066	11	.9167	.6600	4 937		2 583	5.241	39.21
	.2083	.0341	.2550		.9375	.6903	5 163	32	2 666	5 585	41.78
	.2292	.0413	.3085		.9583	.7213	5 395	33	2 750	5 940	44.43
3	.2500	.0491	.3673		.9792	.7530	5 633	34	2 833	6 305	47.17
	.2708	.0576	.4310	12	1 Foot.	7854	5 876	35	2 916	6.681	49.98
	.2917	.0668	.4998		1.012	8523	6 375	36	3 000	7.069	52.88
	.3125	.0767	.5738	13	1.083	.9218	6 895		3 083	7.468	55 86
	.3333	.0873	.6528		1 125	.9940	7 435	38	3 166	7.876	58.92
4	.3542	.0985	.7370	14	1.167	1.069	7 997		3 250	8 296	62.06
	.3750	.1105	.8263		1.208	1.147	8 578	40	3 333	8 728	65.29
	.3958	.1231	.9205	15	1.250	1 227	9 180		3.416	9.168	68.58
5	.4167	.1364	1.020		1 292	1 310	9 801	42	3.500	9 620	71 96
	.4375	.1503	1 124	16	1.333	1 396	10 44		3 583	10 084	75.43
	.4583	.1650	1 234		1 375	1.485	11.11	44	3 666	10.560	79.00
	.4792	.1803	1.349	17	1 417	1.576	11.79		3 750	11.044	82.62
6	.5000	.1963	1.469		1 458	1 670	12 50	46	3 833	11 540	86.32
	.5208	.2130	1.594	18	1.500	1.767	13.22		3.916	12 048	90.12
	.5417	.2305	1.724		1.542	1.867	13.97	48	4 000	12 566	94.02

CHAPTER XIX.

THE INJECTOR AND INSPIRATOR.

The energy of motion of a body is well known to be the product of its mass by the half square of its velocity; hence, it is possible to communicate to a body of little weight a large amount of energy by moving it fast enough, and in fact, the energy of motion would only be limited by the speed which can be given the body. In this way a small weight of steam flowing from an orifice into a properly shaped jet of water is condensed, while the velocity of the steam is greater than if flowing into air; the energy thus communicated is made sufficiently great by increasing the weight of steam, which can be done by increasing the area of the steam way, until we find such jet pumps adapted to many purposes. There are, however, two which are of interest to us in this connection, the well-known injector and inspirator, with the large family of lifting and non-lifting varieties, all differing in details as to form of nozzles, area of passages, distances between nozzles, and that class of instruments in which, after a certain energy and velocity have been reached, the operation is repeated. These might be called "consecutive" instruments. The illustrations in this book show some of the simplest and adjustable kinds. Within a few years the principle of increase of energy by increase of mass or velocity has been applied by increasing the mass of steam used until we find that not only can a few pounds weight of steam put into a boiler a good many more pounds of water at a much higher temperature than it had, but that in a non-condensing engine it is possible, by using the exhaust in part, to put into the boiler at a much higher pressure

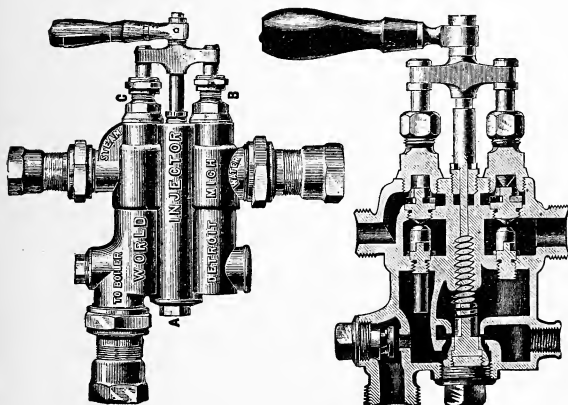
and temperature, a weight of water which is still greater than that of the steam moving it.

When the injector first made its appearance it was, by many, considered as almost a paradox, especially by those who looked at the question as one of hydrostatics only. That steam from a boiler could put water back into it at the same pressure, and overcome the friction of the passages without the aid that a steam pump had of a difference of piston areas, was to them a puzzle. The use of exhaust steam at atmospheric pressure for the purpose of putting water into a boiler at a pressure of 150 lbs. per square inch, would be to such minds utterly incomprehensible. The use of an injector and inspirator, has this to recommend them, that the feed-water cannot be introduced into the boiler cold or nearly so, but must be warmed by contact with the steam, and the value of this has been already shown. In small boilers where no heater is used, an exhaust injector is better than a pump, and so is an ordinary injector; but the former includes in itself an exhaust heater, saving a portion of heat from the exhaust, besides taking the power as heat also; while, with the common injector, the heat for power and raising temperature are both derived from the live steam in the boiler. The latter portion of heat is, of course, directly returned to the boiler without loss, but that for power is necessarily expended. As to the amount of power used by pump and injector compared with each other, it would seem that the pump is most efficient. There have been many comparative trials of pump and injector, but the results have usually been unsatisfactory from contained discrepancies.

RANGE OF THE INSPIRATOR AND INJECTOR.

The steam pressure at which an injector will start and the highest steam pressure at which it will work constitute what is termed the "range" of an injector, and the inspirator varies with the vertical lift and the temperature of the feed water.

It must also be borne in mind that the same style of construction in an injector and inspirator, while it confines them to about a specific range between its lowest starting and highest working points, permits of variation as to what the lowest starting point shall be. A style of construction which gives a range (on say a 2-foot lift) of 25 lbs. to 155 lbs. would permit of a range of 35 lbs. to 165 lbs. (in fact, to a little higher than 165 lbs.). Different manufacturers, therefore, vary as to the starting point in their standard machines — aiming to cover the range which they deem most desirable. Nearly all have adopted about 25 lbs. on a 2-foot lift, as lowest starting point.



The World.

POSITIVE OR DOUBLE TUBE INJECTORS.

As before stated, this class of injector is provided with two sets of tubes or jets, one set adapted to lift the water and deliver it to

the second set, which forces the water into the boiler. By this arrangement, it is apparent that inasmuch as the lifting jets supply a proportionate amount of water with varying steam pressures, a wider range is obtainable than with an automatic injector. In the following cases, it is better to use the double tube injectors: —

1. Where the feed water is of too high a temperature to be handled by the automatic injectors.

2. When a great range of steam variation is accompanied by the condition of a long lift.

The World Injector is one of the best and most popular of the double tube type of injectors. It is entirely self contained. It is supplied even with its own check valve and operated entirely by a single lever, a quarter of a turn of which starts the lifting, after which the completion of the single revolution sets the injector working to boiler.

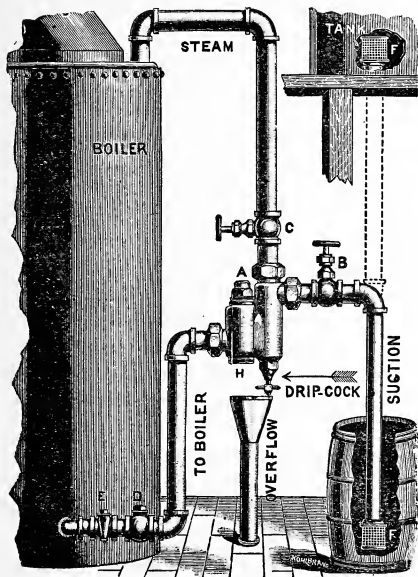
GENERAL SUGGESTIONS FOR PIPING-UP INJECTORS AND INSPIRATORS AND SUGGESTIONS THAT SHOULD BE CAREFULLY FOLLOWED WHEN MAKING PIPE CONNECTIONS.

Steam. — Connect steam pipe with highest parts of boiler and never connect with a steam pipe used for any other purpose. I would recommend a globe valve being placed in the steam pipe next to boiler which can be closed in case it is desired to take off the injector. At all other times it can be left open. When the steam connection is made, be sure and take off the injector before the steam is turned on the machine. Then blow out the steam pipe with at least forty pounds steam, which will remove all dirt and scale.

Suction. — This pipe must be tight, and if there is a valve in it the stem must be well packed.

To test the suction pipes for leaks, plug up the end of the pipe

and then screw on a common iron cap on the overflow; or if you do not have one, unscrew cap *X*, and place a piece of wood on top of valve *P*; replace the cap and the wood will hold the valve from rising; then turn on the steam which will locate all leaks.



All pipes, whether steam, suction or delivery, must be of the same or greater size than the corresponding branch of each injector. Have all piping as short and as straight as possible, and especially avoid short turns.

If any old pipe is used, see that it is not partially filled or stopped up with rust.

If the injector or inspirator has to lift the water very high or draw it very far, have the suction pipe a size or two larger than called for by the suction branch of the injector or inspirator.

Have the water supply (suction) pipe independent of any other connection. The suction pipe must be absolutely air tight; the slightest leak, in most cases, will prevent the injector or inspirator from forcing water in the boiler.

Always place a globe valve in the suction pipe as close to the injector as possible, and place it so that it will shut down against the water side and see that the stem is packed tight.

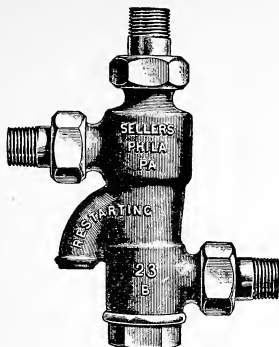
When using the injector or inspirator as NON-LIFTING, put two globe valves in the suction, one close to the injector, the other as far from it as you can conveniently, keeping the one farthest from the injector or inspirator tolerably close throttled. This will surely repay you for your trouble. The check valve may be next to boiler with a valve between it and boiler, the further from injector the better. If the injector forces through a heater, place check valve between injector and heater. Also place a valve between heater and check valve so you can take check valve out if necessary.

Size of pipes. — If injector or inspirator has over 10 feet lift, or a long draw, use suction pipe from strainer to valve a size larger than the connection on injector, reducing when you reach the valve.

In all other cases, use for all pipes same size as injector connection.

Blow-off. — Always blow out steam thoroughly BEFORE CONNECTING INJECTOR, so as to remove any dirt, rust or scale that may be in the pipes.

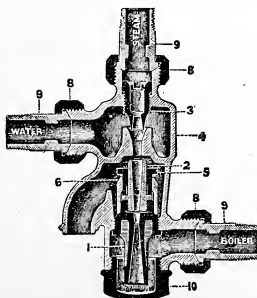
Caution. — The suction pipe must be ABSOLUTELY TIGHT throughout. To make sure that it is so, test the suction as directed.



Outside view of Sellers' Injector.

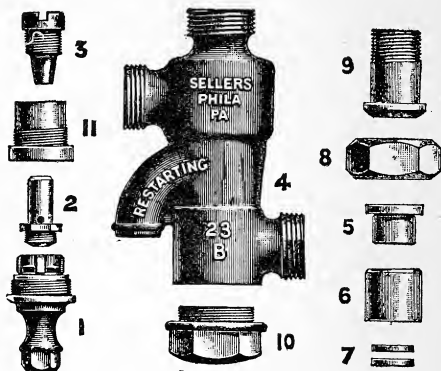
An *outside view* of the Sellers' Restarting Injector is given in the above figure. The branches for steam, water supply and delivery to the boiler are conveniently arranged, so that all the pipes may be placed close against the boiler wall. The overflow

Sectional View.



Sectional view of Sellers' Injector.

is directly under the water branch and can be provided with a drip funnel and discharge pipe, without bending or springing the other pipe connections. The steam nozzle and delivery tubes are screwed into the body and do not depend upon the pressure of the steam or of the delivery to hold them in place, so there is no



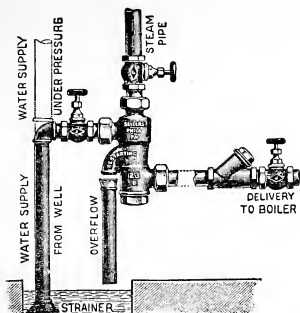
The above shows the different parts of Sellers' Injector.

danger of leakage at these important shoulders. The body and tubes are constructed of the best bronze and are designed to give the longest service with the least amount of attention and repair.

DIRECTIONS FOR CONNECTING INJECTORS.

(See page 588.)

Position.— Place the injector in a vertical position and as near the water as may be convenient to operate, for if the steam pressure is high and the lift and drag long, a larger size injector at a higher price will be required, than with a reduced lift.



The above cut shows method of connecting Sellers' Injector.

DIRECTIONS FOR CONNECTING AND OPERATING THE HANCOCK INSPIRATOR.

"Stationary" Pattern.—Connect as shown by cut above steam, suction and delivery. For full instructions, see page 588.

For a lift of 5 ft., 15 lbs. steam pressure is required.

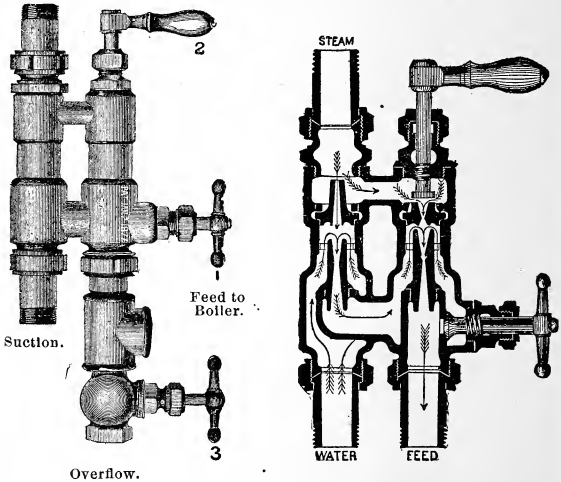
"	"	10	"	20	"	"	"	"
"	"	15	"	25	"	"	"	"
"	"	20	"	35	"	"	"	"
"	"	25	"	45	"	"	"	"

Operation.—Open overflow valves Nos. 1 and 3; close forcer steam valve No. 2 and open the starting valve in the steam pipe. When the water appears at the overflow, close No. 1 valve; open No. 2 valve one-quarter turn and close No. 3 valve. The inspirator will then be in operation.

NOTE.—No. 2 valve should be closed with care to avoid damaging the valve seat. When the inspirator is not in operation, both overflow valves Nos. 1 and 3 should be open to allow the

water to drain from it. No adjustment of either steam or water supply is necessary for varying steam pressures, but both the temperature and quantity of the delivery water can be varied by increasing or reducing the water supply. The best results will be obtained from a little experience in regulating the steam and water supply. If the suction pipe is filled with hot water, either

Steam. **THE HANCOCK STATIONARY INSPIRATOR.**



cool off both it and the inspirator with cold water, or pump out the hot water by opening and closing the starting valve suddenly. To locate a leak in the suction pipe, plug the end, fill it with water, close No. 3 valve and turn on full steam pressure. Examine the suction pipe and the water will indicate the leak. If the inspirator does not lift the water properly, see if there is a leak in

the suction pipe. Note if the steam pressure corresponds to the lift as above specified, and if the sizes of pipe used are equal in size to inspirator connections. If the inspirator will lift the water, but will not deliver it to the boiler, see if the check valve in the delivery pipe is in working order and does not "stick." Air from a leak in the suction connections, will prevent the inspirator from delivering the water to the boiler, even more than it will in lifting it only. If No. 1 valve is damaged, or leaks, the inspirator will not work properly. No. 1 valve can be easily removed and ground.

To remove scale and deposits from inspirator jets or parts, disconnect the inspirator and plug both the suction and delivery outlets with corks. Open No. 2 valve and fill the inspirator with a solution of one part muriatic acid and ten parts water. Allow this solution to remain in the inspirator over night, then wash it thoroughly in clear water.

NOTE. — It is not generally necessary to return an inspirator for repairs. The repair parts required can be ordered and the inspirator readily put in order.

METROPOLITAN AUTOMATIC INJECTORS.

RANGE.

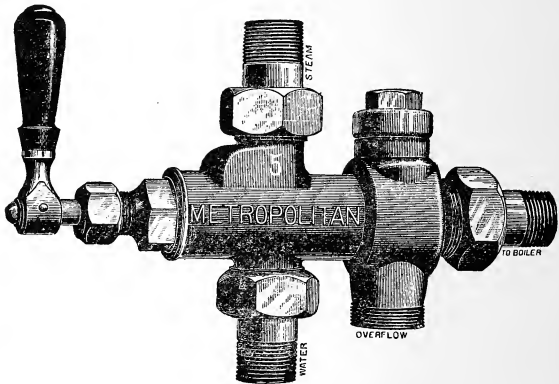
Starting-point. — When it is used as a non-lifter, or is placed on a short lift of 2 or 3 feet, about 25 lbs. steam pressure will be required to start it. As the lift is increased it will require a higher steam pressure to start it.

On a 10-foot lift, about 35 pounds steam pressure will be required, and on a 15-foot lift, about 45 pounds steam pressure.

Limit high. — The highest steam pressure at which an injector will work depends upon the temperature of the feed water and the length of the lift. With cold feed water this injector will work up to 140 lbs. steam pressure when used on

a short lift of 2 or 3 feet; up to 120 lbs. on a 10-foot lift, and up to 100 lbs. on a 15-foot lift. As the temperature of feed water is increased, these steam pressures will be still further reduced.

Hot feed water.—It is impossible to handle very hot feed water with an automatic injector.



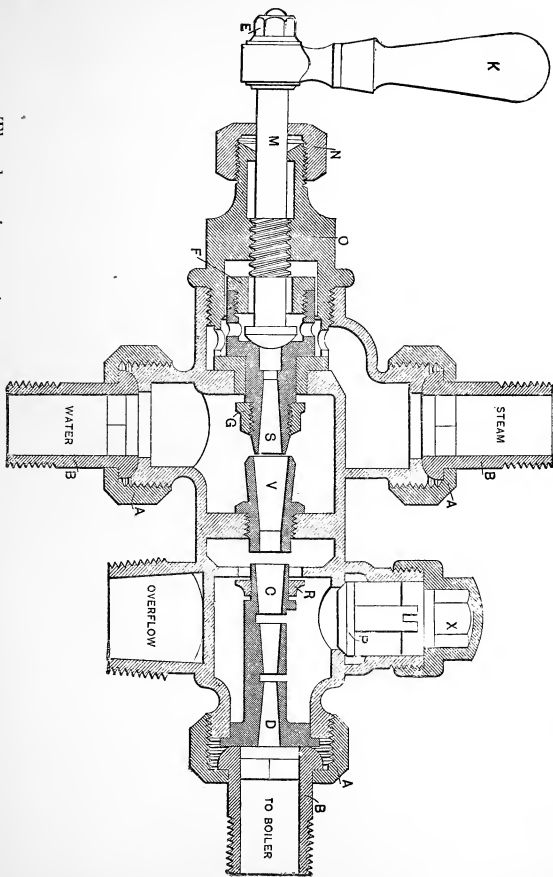
Metropolitan.

When the lift is short, with a steam pressure of 65 lbs., this injector will take feed water at about 120° Fahr., and with 100 lbs. steam pressure, at 100° to 105° Fahr.

On a long lift, the temperature of feed water must be less than the above figures.

DIRECTIONS FOR CONNECTING AND OPERATING.

Connections.—Connect the injector so that the boiler connection of the injector is horizontal, the steam connection on top and the water suction below.



The above is a section cut of the Metropolitan Automatic Injector.

When lifting. — If more than 10 feet of suction pipe is used, it should be one or two sizes larger than the injector fittings, and should be reduced at the injector. Never use a foot valve in the suction pipe.

When non-lifting. — Place a globe valve in the suction pipe.

The overflow is threaded so a pipe can be screwed on it. I would advise using a short pipe, not larger than overflow connection, not over four feet long, and it must be free from elbows or short turns, with the end open to allow the free escape of steam.

Operation. — To start the injector: Pull the lever back until the resistance of the main steam valve is felt. This lifts the water. As soon as the water is lifted, pull the lever back as far as it will go with one steady motion. The injector will then be feeding.

To start. — Open steam valve about one-half turn.

To stop. — Close steam valve.

NOTE. — Should steam pressure be over 80 lbs. or should the lift be over 10 feet, open steam valve full. Should injector be placed under a heavy water pressure, the globe valve in suction pipe should be throttled.

Do not expect good results if there is a leak, no matter how slight it may be.

CAUSES OF INJECTORS NOT WORKING.

WHEN THE INJECTOR LIFTS BUT WILL NOT FORCE THE WATER.

Should part or all the water run out of the overflow in a solid body, without showing any steam, look for a slight leak in the suction pipe. Test pipe for leaks as per instructions; examine the combining tube; be sure that the slots and small drill holes in it are not clogged and that the tube is not stopped up. The auxiliary tube on the combining tube must move freely. See that the check valve will raise freely and that the delivery pipe is not clogged or contracted in any way.

IF WATER AND STEAM COME OUT OF THE OVERFLOW TOGETHER.

The suction pipe or the strainer may be clogged. A loose lining in the suction hose. A large leak in the suction pipe. Too high steam on a long lift; too hot water supply. A loose disc in the globe valve in the suction pipe, might be the causes.

IF THE INJECTOR REFUSES TO LIFT THE WATER.

The trouble may be: A very large leak in the suction pipe; too long a lift; suction pipe stopped up; strainer stopped up; too hot water supply; overflow valve stuck; combining tube stopped up; auxiliary check stuck; too long a pipe on overflow. By unscrewing the steam plug *O* the steam jet *S* is removed. The section jet *V* is screwed into the injector; it will not wear out in years, and when it is necessary to renew it, the injector should be returned for a general overhauling. The combining tube *CD* is removed by unscrewing the delivery coupling, when it will drop out. Be careful that the ring *R* is not lost; also, that it is on the tube in the position as shown in sectional cut. If the water used is limy, the tubes should be cleaned frequently by placing them in a solution of ten parts of water to one part of muriatic acid, until the deposit is removed.

RANGE.

This injector will start with 15 lbs. steam pressure, when used as a non-lifter, or on a short lift up to four feet.

For a 10-foot lift, 25 lbs. steam pressure will be required.

For a 15-foot lift, 30 lbs. steam pressure will be required, and for a 20-foot lift, about 40 lbs. steam pressure will be required.

When used on a short lift it will work at all steam pressures without any regulation up to 225 lbs. When used on a long lift, the limit high will be reduced, and when used on a

20-foot lift, it will work up to 150 pounds steam pressure. The above data is based on cold feed water.

Hot feed water.— This is the weak point of nearly all makes of injectors. This injector will handle hot feed water and still retain its strong qualities.

When lifting a short distance, or used as a non-lifter, it will take feed-water at 145° Fahr. to 150° Fahr., with steam pressures up to 100 lbs. At 140° Fahr., with a steam pressure of 125 lbs. At 130°, with a steam pressure of 150 lbs., and at 120° Fahr., with a steam pressure of 180 lbs. As the lift is increased the temperature of feed water must be lower than the above figures.

A FEW HINTS ON THE SELECTION OF AN INJECTOR OR INSPIRATOR.

In buying an injector or inspirator, the purchaser should always consider the working conditions, or in other words, the work required of an injector or inspirator.

WORKING CONDITIONS.

By “working conditions,” I refer particularly to:—

1. Range of steam pressure (lowest starting pressure—highest working pressure).
2. Temperature of supply water.
3. “Lifting or non-lifting;” if lifting, vertical distance of injector above water level; if non-lifting, height of water level above injector or inspirator, or amount of pressure in the water main.

The conditions determine not only the style or type of inspirator or injector desirable, but also affect materially the size required. Low steam pressure reduces capacity, i. e., the amount of water the injector or inspirator will deliver. Hot water limits steam pressure and reduces capacity. Long lift limits steam pressure and reduces capacity.

Types of injectors and inspirators are of two distinct types, **AUTOMATIC** and **POSITIVE**; the **Positive** are more often called "DOUBLE TUBE."

The **Automatic** injector has an overflow which opens and closes through the action of the injector itself, and usually, only a single set of jets. A **positive** or **double tube** injector, has an overflow that is mechanically closed, and has two sets of jets — one set for lifting the water, the other for forcing to boiler.

HOW TO CONNECT A WORLD INJECTOR.

Connect horizontally to steam, to supply water (suction pipe), and to boiler. Blow out the steam pipe before connecting, to avoid getting dirt, scale or lead into the injector.

DIRECTIONS FOR OPERATING WORLD INJECTOR.

See that the injector is shut off when put on — the handle being turned as far to the right as it will go. Turn handle to the left one-quarter turn; when the water appears at the overflow, turn the handle slowly to the left as far as it will go and the injector will be working to the boiler. If steam is high and lift long, the injector will lift the water better if the handle is turned a little less than a quarter of a turn, until water appears at overflow — then start to boiler as above. Open the valves in steam and suction pipes before starting.

DIRECTIONS FOR OPERATING U. S. AUTOMATIC INJECTOR.

TO START.

Open suction valve *B*; turn on full head of steam. If water runs out of overflow, regulate the water by means of valve *B*.

TO STOP.

Close steam valve.

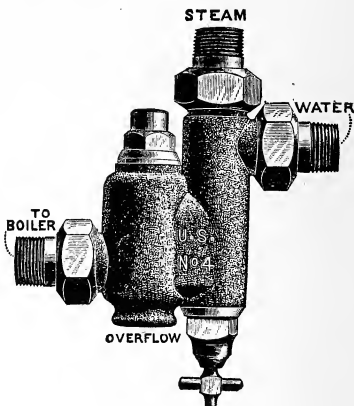
TO PREVENT FREEZING.

Open drip-cock in bottom of injector.

In case of any trouble ALWAYS test the suction pipe in manner directed.

TO REMOVE DIRT.

Sediment or scales from injector, dirt, etc., are removed by unscrewing the cap from bottom of injector; take out the de-

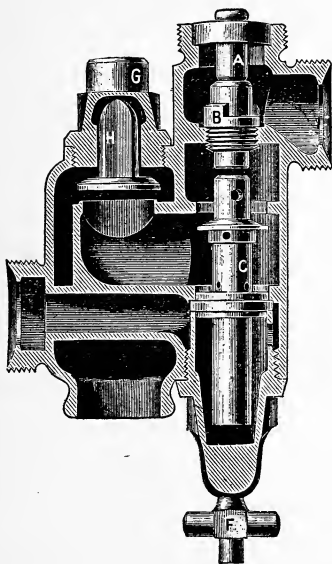


livery tube and clean it out on the inside; look through it and be sure it is clean before you replace it. To replace it, insert the lower end in the hollow of the cap, then screw on the cap and the tube will be in its proper position. To clean the supply chamber, disconnect the injector, take out steam jet and clean the chamber.

NOTE. — In replacing parts of injector, see that all surfaces are perfectly clean.

HOW TO TAKE LIME OUT OF INJECTOR AND DELIVERY TUBES.

Mix one part of muriatic acid to ten parts of soft water, and let the tubes remain in the mixture over night.



The above is a section cut of U. S. Automatic Injector.

TO PREVENT HEATING THE SUCTION PIPE.

When not in use, keep valve in suction pipe closed, and drip-cock open.

TO DISCOVER CAUSE OF DIFFICULTIES.**WHEN INJECTOR FAILS TO GET THE WATER.**

1. The supply may be cut off by: (a) Absence of water at the source. (b) Strainer clogged up. (c) The suction pipe, hose or valve stopped up; or if a hose is used, its lining may be loose (a frequent cause of trouble).

2. A large leak in the suction (note that a small leak will prevent injector from working, but not from getting the water).

3. Suction pipe or water very hot. Open drip-cock, turn steam on slowly, then shut it off quickly. This will cause the cool air to rush into the suction pipe and cool it off. Repeat if necessary.

4. Lack of steam pressure for the lift; or, in some instances, too much steam pressure. If the steam pressure is very high, the injector will get the water more readily if the steam is turned on slowly and the drip-cock left open until the water is got.

IF THE INJECTOR GETS THE WATER BUT DOES NOT FORCE IT TO THE BOILER.

1. No globe valve on the suction with which to regulate the water, or else the supply water not properly regulated.

2. Dirt in delivery tube.

3. Faulty check valve.

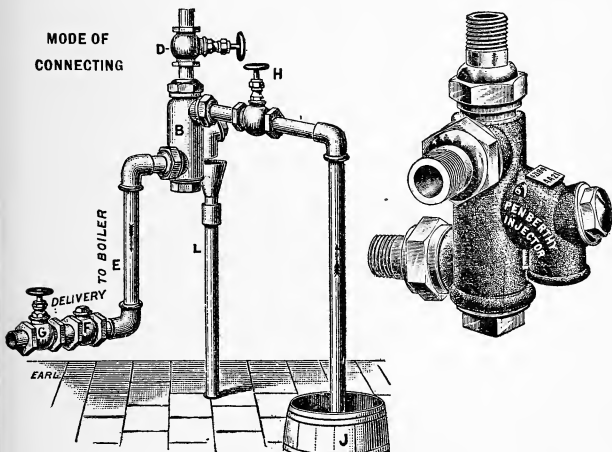
4. Obstruction between injector and check valve, or between check valve and boiler.

5. Small leak in suction pipe admitting air to the injector along with the supply water. It is ten to one this is the cause of the difficulty every time.

6. Be sure you understand the directions for starting before you condemn the injector.

IF THE INJECTOR STARTS BUT "BREAKS."

1. Supply water not properly regulated. If too much water, the waste or overflow will be cool; if too little, the water will be very hot.
2. Leaky supply pipe admitting air to the injector. It is ten to one this is the cause of difficulty. The suction must be air tight; test as directed.

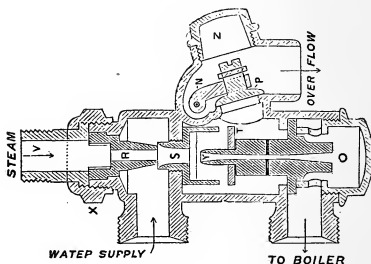


The above illustration shows the mode of connecting the Penberthy Injector.

3. Dirt or other obstruction, such as lime, etc., in delivery tube.
4. Connecting steam pipe to pipe conducting steam to other points besides the injector, or not having suction pipe independent.

5. Sometimes a globe valve is used on the suction connection that has a loose disc, and after starting the disc is drawn down, thus partially closing the valve; it is, of course, equivalent to giving the injector too little water. To remedy this, take the globe valve off and reverse it end for end.

To clean.—To clean injector, unscrew plug *O*, and the removable jet *Y* (which rests in it) will follow the plug out. Turn on steam (not less than forty pounds) and all dirt will be blown out. Examine all passages and drill holes and see that no dirt or scale has lodged in them. Replace jet by setting it in the plug (which acts as a guide) and screw into place tightly. Be careful not to bruise any jets, and use no wrenches on body of injector.



To test for leaks.—Plug up end of water supply pipe, then fit a piece of wood into cap *Z*, so that when screwed down it will hold the valve *P* in place, then turn on steam and it will locate leak. *Do not fail to do this in case of any trouble.*

TO START AND STOP INJECTOR.

To start.—Open full the globe valve in water supply first, and then globe valve in steam pipe *wide open*. If water issues from overflow, throttle the valve *H* until discharge stops. Reg-

ulate injector with water supply valve, *not by steam valve*. When water supply is above the injector, in starting open *steam valve first*.

To stop.— Close the steam valve. The water valve *H* need not be closed unless the injector is used as a non-lifter, or lift is considerable.

PRICE LIST, CAPACITY, HORSE POWER, ETC.

Size.	Price.	Pipe Connections.			Capacity per Hour. 1 to 4 ft. lift, 50 to 75 lbs. Pressure.		Horse Power.
		Steam.	Suction.	Delivery, in.	Maximum.	Minimum.	
OO.	\$16 00	3/8	3/8	3/8	80 gal.	55 gal.	4 to 8
A.	18 00	1/2	1/2	1/2	120 "	70 "	8 to 10
AA.	20 00	5/8	5/8	5/8	165 "	90 "	10 to 15
B.	25 00	3/4	3/4	3/4	250 "	135 "	15 to 25
BB.	30 00	7/8	7/8	7/8	340 "	165 "	25 to 35
C.	40 00	1	1	1	475 "	300 "	35 to 50
CC.	45 00	1 1/4	1 1/4	1 1/4	575 "	350 "	50 to 60
D.	55 00	1 1/2	1 1/2	1 1/2	750 "	400 "	60 to 95
DD.	60 00	1 3/4	1 3/4	1 3/4	920 "	500 "	95 to 120
E.	75 00	2	2	2	1300 "	700 "	120 to 165
EE.	90 00	2 1/2	2 1/2	2 1/2	1740 "	900 "	165 to 230
F.	110 00	3	3	3	2270 "	1100 "	230 to 290
FF.	125 00	4	4	4	2820 "	1400 "	290 to 365

CHAPTER XX.

SOME PRACTICAL QUESTIONS USUALLY ASKED OF ENGINEERS WHEN APPLYING FOR LICENSE.

Q. If you were called on to take charge of a plant, what would be your first duty? A. To ascertain the exact condition of the boiler and all its attachments (safety-valve, steam-gauge, pump, injector) and engine.

Q. How often would you blow off and clean your boilers if you had ordinary water to use? A. Twice a month.

Q. What steam pressure will be allowed on a boiler 50" diameter, $\frac{3}{8}$ " thick, 60,000 T. S. $\frac{1}{6}$ of tensile strength factor of safety? A. One-sixth of tensile strength of plate, multiplied by thickness of plate, divided by one-half of the diameter of boiler, gives safe working pressure.

Q. How much heating surface is allowed per horse-power by builders of boilers? A. 12 to 15 feet for tubular and flue boilers.

Q. How do you estimate the strength of a boiler? A. By its diameter and thickness of metal.

Q. Which is the best, single or double riveting? A. Double riveting is from 16 to 20 per cent stronger than single.

Q. How much grate surface do boiler-makers allow per horse-power? A. About $\frac{2}{3}$ of a square foot.

Q. Of what use is a mud drum on a boiler, if any? A. For collecting all the sediment of a boiler.

Q. How often should it be blown out? A. Three or four times a day, in the morning before starting, and at noon.

Q. Of what use is a steam dome on a boiler? A. For storage of dry steam.

Q. What is the object of a safety-valve on a boiler? A. To relieve pressure.

Q. What is your duty with reference to it? A. To raise it once a day and see that it is in good order.

Q. What is the use of a check valve on a boiler? A. To prevent the water from returning back into the pump or injector which feeds the boiler.

Q. Do you think a man-hole in the shell on top of a boiler weakens it any? A. Yes, to a certain extent.

Q. What effect has cold water on hot boiler plates? A. It will crack or fracture them.

Q. Where should the gauge cock be located? A. The lowest gauge cock ought to be placed about 2 inches above the top row of flues.

Q. How would you have your blow-off located? A. In bottom of mud drum or boiler.

Q. How would you have your check valve arranged? A. With a stop cock between check and boiler.

Q. How many valves are there in a common plunger force pump? A. Two or more — a receiving and a discharge valve.

Q. How are they located? A. One on the suction side, the other on the discharge.

Q. How do you find the proper size of safety valves for boilers? A. Three square feet of grate surface is allowed for one inch area of spring-loaded valves, or two square feet of grate surface to one inch area of common lever valves.

Q. Give the reasons why pumps do not work sometimes? A. Leak in suction, leak around plunger, leaky check valve, or valves out of order, or lift too long.

Q. How often ought boilers to be thoroughly examined and tested? A. Twice a year.

Q. How would you test them? A. With hammer and with hydrostatic test — using warm water.

Q. Describe the single acting plunger pump ; how it gets and discharges its water? A. The plunger displaces the air in the water pipe, causing a vacuum, which is filled by the atmosphere forcing the water therein ; the receiving valve closes and the plunger forces the water out through the discharge valve.

Q. What is the most economical boiler feeder? A. An Exhaust Injector.

Q. What economy is there in the Exhaust Injector? A. From 15 to 25 per cent saving in fuel.

Q. Where is the best place to enter the boiler with the feed water? A. Below the water level, but so that the cold water cannot strike hot plates. If injector is used, this is not so material, as the feed water is always hot.

Q. What are the principal causes of priming in boilers? A. Too high water, not steam room enough, misconstruction, engine too large for boiler.

Q. How do you keep boilers clean, or remove scale therefrom? A. The best "scale solvent" and "feed water purifier" is an honest, intelligent engineer who will regularly open up his boilers and clean them thoroughly.

Q. If you found a thin plate what would you do? A. Put a patch on it.

Q. Would you put it on the inside or outside? A. Inside.

Q. Why so? A. Because the action that has weakened the plate will then set on the patch, and when this is worn it can be replaced.

Q. If you found several thin places, what would you do? A. Patch each and reduce the pressure.

Q. If you found a blistered plate? A. Put a patch on the fire side.

Q. If you found a plate on the bottom buckled? A. Put a stay through center of buckle.

Q. If you found several of the plates buckled? A. Stay each and reduce the pressure.

Q. What is to be done with a cracked plate? A. Drill a hole at each end of crack, caulk the crack and put a patch over it.

Q. How do you change the water in the boiler when steam is up? A. By putting on more feed and opening the surface skimmer or blow-off valve.

Q. If the safety valve was stuck how would you relieve the pressure on the boiler if the steam was up and could not make its escape? A. Work the steam off with engine after covering fires heavy with coal or ashes, and when the boiler is sufficiently cool, put safety valve in working order.

Q. If water in boiler is suffered to get low, what may be the result? A. Burn top of combustion chamber and tubes, perhaps cause an explosion.

Q. If water is allowed to get too high, what result? A. Cause priming, perhaps cause breaking of cylinder covers or heads.

Q. What are the principal causes of foaming in boilers? A. Dirty and impure water.

Q. How can foaming in boilers be stopped? A. Close throttle and keep closed long enough to show true level of water. If that level is sufficiently high, feeding and blowing off will usually suffice to correct the evil.

Q. What would you do if you should find your water gone from sight very suddenly? A. Draw the fires and cool off as quickly as possible. Never open or close any outlets of steam when your water is out of sight.

Q. What precautions should you take to blow down a part of the water in your boiler while running with a good fire? A. Never leave the blow-off valve, and watch the water level.

Q. How much water would you blow off at once while running? A. Never blow off more than one gauge of water at a time while running.

Q. What general views have you in regard to boiler ex-

plosions — what is the greatest cause? A. Ignorance and neglect are the greatest causes of boiler explosions.

Q. What precautions should the engineer take when necessary to stop with heavy fires? A. Close dampers, put on injector or pump, and if a bleeder is attached, use it.

Q. Where is the proper water level in boilers? A. A safe water level is about $2\frac{1}{2}$ inches over top row of flues.

Q. What is an engineer's first duty on entering a boiler-room? A. To ascertain the true water level.

Q. When should a boiler be blown out? A. After it is cooled off — never while it is hot.

Q. When laying up a boiler what should be done? A. Clean thoroughly inside and out; remove all oxidation and paint places with red lead; examine all stays and braces to see if any are loose or badly worn.

Q. What is the last thing to do at night before leaving the plant? A. Look around for greasy waste, hot coals, matches, or anything which could fire the building.

Q. What would you do if you had a plant in perfect working order? A. Keep it so, and let well enough alone.

Q. Of what use is the indicator? A. The indicator is used to determine the indicated power developed by an engine, to serve as a guide in setting valves and showing the action of steam in the cylinder.

Q. How would you increase the power of an engine? A. To increase the power of an engine, increase the speed, or get higher pressure of steam; use less expansion.

Q. How do you find the horse-power of an engine? A. Multiply the speed of piston in feet per minute by the total effective pressure upon the piston in pounds, and divide the product by 33,000.

Q. Which has the most friction, a perfectly fitted, or an imperfectly fitted valve or bearing? A. An imperfect one.

Q. How hot can you get water under atmospheric pressure with exhaust steam? A. 212° .

Q. Does pressure have any influence on the boiling point? A. Yes.

Q. Which do you think is the best economy, to run with your throttle wide open or partly shut? A. Always have the throttle wide open on a governor engine.

Q. At what temperature has iron the greatest tensile strength? A. About 600° .

Q. In what position on the shaft does the eccentric stand in relation to the crank? A. The throw of the eccentric should always be in advance of the crank pin.

Q. About how many pounds of water are required to yield one horse-power with our best engines? A. From 25 to 30.

Q. What is meant by atmospheric pressure? A. The weight of the atmosphere.

Q. What is the weight of atmosphere at sea level? A. 14.7 pounds.

Q. What is the coal consumption per hour per indicated horse-power? A. Varies from $1\frac{1}{2}$ to 7 lbs.

Q. What is the consumption of coal per hour on a square foot of grate surface? A. From 10 to 12 lbs.

Q. What is the water consumption in pounds per hour per indicated horse-power? A. From 25 to 60 lbs.

Q. How many pounds of water can be evaporated with one pound of best soft coal? A. From 7 to 10 lbs.

Q. How much steam will one cubic inch of water evaporate under atmospheric pressure? A. One cubic foot of steam (approximately).

Q. What is the weight of a cubic foot of fresh water? A. $62\frac{1}{2}$ lbs.

Q. What is the weight of a cubic foot of iron? A. 486.6 lbs.

Q. What is the weight of a square foot of one-half inch boiler plate? A. 20 lbs.

Q. How much wood equals one ton of soft coal for steam purposes? A. About 4,000 lbs. of wood.

Q. What is the source of all power in the steam engine? A. The heat stored up in the coal.

Q. How is the heat liberated from the coal? A. By burning it — that is, by combustion.

Q. Of what does coal consist? A. Carbon, hydrogen, nitrogen, sulphur, oxygen and ash.

Q. What are the relative proportions of these that enter into coal? A. There are different proportions in different specimens of coal, but the following shows the average per cent: Carbon, 80; hydrogen, 5; nitrogen, 1; sulphur, 2; oxygen, 7; ash, 5.

Q. What must be mixed with coal before it will burn? A. Atmospheric pressure.

Q. Of what is air composed? A. It is composed of nitrogen and oxygen in the proportion of 77 per cent nitrogen to 23 of oxygen.

Q. What parts of the air mix with what parts of coal? A. The oxygen of the air mixes with the carbon and hydrogen of the coal.

Q. How much air must mix with coal? A. 150 cubic feet of air for every pound of coal.

Q. How many pounds of air are required to burn one pound of carbon? A. Twelve.

Q. How many pounds of air to burn one pound of hydrogen? A. Thirty-six.

Q. Is hydrogen hotter than carbon? A. Yes, $4\frac{1}{4}$ times hotter.

Q. What part of the coal gives out the most heat? A. The hydrogen does part for part, but as there is so much more of carbon than hydrogen in the coal, we get the greatest amount of heat from the carbon.

Q. In how many different ways is heat transmitted? A. Three, by radiation, by conduction and convection.

Q. If the fire consisted of glowing fuel, show how the heat enters the water and forms steam? A. The heat from the glowing fuel passes by radiation through the air space above the fuel to the furnace crown; there it passes through the iron of the crown by conduction; there, it warms the water resting on the crown, which then rises and parts with its heat to the colder water by conduction till the whole mass of water is heated; then the heated water rises to the surface and parts with its steam, so a constant circulation is maintained by convection,

Q. Of what does water consist? A. Oxygen and hydrogen.

Q. In what proportion? A. Eight of oxygen to one of hydrogen, by weight.

Q. What are the different kinds of heat? A. Latent heat, sensible heat and sometimes, total heat.

Q. What is meant by latent heat? A. Heat that does not affect the thermometer and which expends itself in changing the nature of a body, such as turning ice into water or water into steam.

Q. Under what circumstances do bodies get latent heat? A. When they are passing from a solid state to a liquid state, or from a liquid to a gaseous state.

Q. How can latent heat be recovered? A. By bringing the body back from a state of gas to a liquid, or from that of a liquid to that of a solid.

Q. What is meant by a thermal unit? A. The heat necessary to raise one pound of water at 39° Fn. 1° Fahr.

Q. If the power is in coal, why should we use steam? A. Because, steam has some properties which make it an invaluable agent for applying the energy of the heat to the engine.

Q. What is steam? A. It is an invisible elastic gas generated from water by the application of heat.

Q. What are the properties which make it so valuable to us?

A. 1. The ease with which we can condense it. 2. Its great expansive power. 3. The small space it occupies when condensed.

Q. Why do you condense the steam? A. To form a vacuum and so destroy the back pressure that would otherwise be on the piston, and thus get more useful work out of the steam.

Q. What is vacuum? A. A space void of ail pressure.

Q. How do you maintain a vacuum? A. By the steam used being constantly condensed by the cold water or cold tubes, and the air pump is constantly clearing the condenser out.

Q. Why does condensing the used steam form a vacuum? A. Because a cubic foot of steam at atmospheric pressure shrinks into about a cubic inch of water.

Q. What do you understand by the term horse-power? A. A horse-power is equivalent to raising 33,000 lbs. one foot per minute, or 550 lbs. raised one foot per second.

Q. How do you calculate the horse-power of tubular or flue boilers? A. For tubular boilers, multiply the square of the diameter by length and divide by 4. For flue boilers, multiply the diameter by length and divide by 4; or multiply area of grate surface in square feet by $1\frac{1}{2}$.

Q. What do you understand by lead on an engine's valve? A. Lead on a valve is the admission of steam into the cylinder before the piston starts its stroke.

Q. What is the clearance of an engine as the term is applied at the present time? A. Clearance is the space between the cylinder head and the piston head, with ports included.

Q. What are considered the greatest improvements on the stationary engine in the last forty years? A. The governor, the Corliss valve gear, and the triple compound expansion.

Q. What is meant by triple expansion engine? A. A triple expansion engine has three cylinders, using the steam expansively in each one.

Q. What is a condenser as applied to an engine? A. The condenser is a part of the low-pressure engine, and is a receptacle into which the exhaust enters and is there condensed.

Q. What are the principles which distinguish a high-pressure from a low-pressure engine? A. Where no condenser is used and the exhaust steam is open to the atmosphere.

Q. About how much gain is there by using the condenser? A. 17 to 25 per cent, where cost of water is not figured.

Q. What do you understand by the use of steam expansively? A. Where steam admitted at a certain pressure is cut off and allowed to expand to a lower pressure.

Q. How many inches of vacuum give the best results in a condensing engine? A. Usually considered 25".

Q. What is meant by a horizontal tandem engine? A. One cylinder being behind the other, with two pistons on same rod.

Q. What is a Corliss valve gear? A. (Describe the half moon, or crab-claw gear, or oval-arm gear with dash pots.)

Q. From what cause do belts have the power to drive shafting? A. By friction or cohesion.

Q. What do you understand by lap? A. Outside lap is that portion of valve which extends beyond the ports when valve is placed on the center of travel; and inside lap is that portion of valves which projects over the ports on the inside or towards the middle of valve.

Q. What is the use of lap? A. To give the engine compression.

Q. Where is the dead center of an engine? A. The point where the crank and the piston rod are in the same right line.

Q. In what position would you place an engine to take up any slack motion of the reciprocating parts? A. Place the engine in the position where the least wear takes place on the journals. That is, in taking up the wear of crank-pin brasses, place the engine on either dead center, as when running, there is little wear

upon the crank-pin at these points. If taking up the cross-head pin brasses — without disconnecting and swinging the rod — place the engine at half stroke, which is the extreme point of swing of the rod, there being the least wear on the brasses and cross-head pin in this position.

Q. What benefits are derived from using fly-wheels on steam engines? A. The energy developed in the cylinder while the steam is doing its work, is stored up in the fly-wheel, and given out by it while there is no work being done in the cylinder — that is, when the engine is passing the dead centers. This tends to keep the speed of the engine shaft steady.

Q. Name several kinds of reducing motions, as used in indicator practice? A. The pantograph, the pendulum, the brumbo pulley, the reducing wheel.

Q. How can an engineer tell from an indicator diagram whether the piston or valves are leaking? A. Leaky steam valves will cause the expansion curve to become convex; that is, it will not follow hyperbolic expansion, and will also show increased back pressure. But if the exhaust valves leak also, one may offset the other, and the indicator diagram would show no leak. A leaky piston can be detected by a rapid falling in the pressure on the expansion curve immediately after the point of cut-off. It will also show increased back pressure. A falling in pressure in the upper portion of the compression curve shows a leak in the exhaust valve.

Q. What would be the best method of treating a badly scaled boiler, that was to be cleaned by a liberal use of compound? A. First, open the boiler up and note where the loose scale, if any, has lodged. Wash out thoroughly and put in the required amount of compound. While the boiler is in service, open the blow-off valve for a few seconds, two or three times a day, to be assured that it does not become stopped up with scale. After running the boiler for a week, shut it down, and when the

pressure is down and the boiler cooled off, run the water out and take off the hand-hole plates. Note what effect the compound has had on the scale, and where the disengaged scale has lodged. Wash out thoroughly and use judgment as to whether it is advisable to use a less or greater quantity of compound, or to add a small quantity daily. Continue the washing out at short intervals, as many boilers have been burned by large quantities of scale dropping on the crown sheets and not being removed.

Q. What is an engineer's first duty upon taking charge of a steam plant? A. The first duty of an engineer assuming charge of a steam plant is to familiarize himself with his surroundings, ascertain the duty required of each and every piece of machinery contained therein, and in just what condition each one is. Let us discuss it at length, assuming that when just engaged he is informed as to the nature of the work required of the plant in question, namely: Whether it is a heating plant, electric lighting, hydraulic or electric elevator, power station, or any other kind of the various steam plants in existence. Of course, a great deal depends upon the size and kind of plant under consideration and the number of men employed, hours in operation, and some other things in general which most engineers know of. He should first see just what his plant contains "from cellar to garret," so to speak; whether all that is contained has to run continually, or almost so, and what can be depended on in case anything should suddenly become deranged or give out entirely. Next, he should ascertain the general condition of everything, going over each portion in turn, as time and opportunity permit, and conclude from what he has seen how much longer it may be run safely and economically. It will be remembered that a piece of machinery may be run safely and yet not with economy. So, if he should wait for the safety limit to be reached, without taking other things into consideration, he might wait

a long time and in so doing waste many dollars of his employer's money before it was thought necessary to renovate, repair or renew. In going over everything, examining each part critically, it would be well to make copious notes, and, I might add, sketches, to which the engineer can again refer. It sometimes happens that engineers, in making an examination of machinery, do not take dimensions or make sketches of certain parts which have to be repaired, or perhaps renewed, thinking that the next time the apparatus is looked at will do for that. Now, it sometimes happens that the "next time" is the time when some accident occurs, finding you unprepared, causing confusion, in the midst of which the making of sketches and taking of dimensions cannot be thought of. All such should be done at the first opportunity, and spare parts of the different machinery should be kept on hand, especially in the case of a plant which has only the machinery which is constantly in use. Another point of importance to which an engineer should give attention, is to ascertain the quantity and kind of supplies which are on hand, that he may know when to make requisition for more, and so not run short, as he otherwise might do. It is also important to see what tools the plant contains and upon what you can depend in case of the break-down of any part of the machinery. Of course all the above cannot be done in one day, but no time should be lost in doing all these things as early as possible, for the sooner you get all the particulars and details of your plant at your "fingers' ends," the lighter will be your own labors, and the more free will your mind be to think and act intelligently for the emergencies of the future. Therefore, by performing this first duty as early and thoroughly as possible, the succeeding ones will be comparatively easy to handle and perform, for the reason that you will be prepared for them.

Q. Define and explain the difference between sensible and latent heat? A. The difference between sensible and latent heat

is explained thus: Sensible heat may be measured with a thermometer, that is, it affects the mercury in a thermometer, causing it to rise in the stem so that the degree of heat may be measured on the graduated scale affixed. Latent heat does not affect the thermometer. Bodies get latent heat when they are passing from a solid state to a liquid state, and also when passing from a liquid to a gaseous state; and moreover, this latent heat can be recovered by bringing a body back from a gaseous to a liquid state, and from liquid to solid. Water is most commonly seen under the three forms of matter just mentioned, namely, solid, ice; liquid, water; gaseous, steam. The following method has been used to explain how latent heat exists: A quantity of powdered ice is placed in a vessel and brought into a very warm room. As long as it remains as ice, it may be any degree of heat below 32° Fahr., but the instant it begins to melt, owing to the heat of the room, a thermometer placed in it will record 32° Fahr. The thermometer will continue at 32° as long as there is any ice in the vessel, but just as soon as the last piece of ice has melted it will begin to rise, and continue to do so until the water boils, when it will stand at 212° ; but although the water goes on receiving heat after this, the instrument will stand at 212° until all the water has boiled away. Now, a great amount of heat must have entered the water since the ice began to melt, but it has no effect on the thermometer, which continues at 32° , as noted above; the heat that has so entered is called "the latent heat of water." The heat that has entered the water from boiling till it all becomes steam is called the "latent heat of steam." The latent heat of water has been found to be 143° Fahr. and the latent heat of steam, at the pressure of the atmosphere, is 966° , or commonly stated at 1000° Fahr. This is the way the above was determined: A quantity of water at a temperature of 32° Fahr. is made to boil, and the time taken to do so noted; in this case, it took one hour. The water must be kept boiling until it has all evaporated,

and the time noted from boiling till evaporation, which in this case will be $5\frac{1}{3}$ hours. Therefore,

Temperature of boiling point,	212°
Temperature of water at first,	32°
Heat that has entered the water in one hour,	180°
Number of hours boiling,	$5\frac{1}{3}$
	900
	60
	960°

From this we see that the heat necessary to form steam, instead of being only 212°, must be $966° + 212° = 1178°$, or $5\frac{1}{2}$ times as great. Therefore, if it were not for latent heat, we would require to burn $5\frac{1}{2}$ times the amount of coal that we now do to generate steam. The sensible and latent heats alter with the pressure, but as the sensible increases the latent decreases, and, roughly speaking, the total heat, or the sum of the two, is the same. In connection with the foregoing questions, I would recommend the reader to spend a little time in looking over the "steam tables," and make comparisons between the different quantities noted therein. By so doing he will get an exact knowledge of the properties of saturated steam.

Q. Explain the term "clearance," as used in connection with an engine cylinder? A. There are two kinds of clearance, steam clearance and piston clearance. Steam clearance means the space or volume which exists between the piston and the valve, when the piston is exactly at the beginning of the stroke and the crank is on the dead center. This volume can be found by taking careful and exact measurements and making calculations from them, but a more correct way is to fill the space with water, noting the quantity used, and so make calculations to find the cubic con-

tents. The cubic contents of the clearance space is a certain percentage of the total volume of the cylinder itself and such clearance is expressed as so much per cent. This clearance causes a small loss of steam each stroke, owing to the difference between the initial and compressive pressure. Piston clearance is the space between the piston and cylinder head when the crank is on the dead center. This clearance is necessary to prevent the cylinder head being knocked out, in case of an unusual quantity of water gaining entrance to the cylinder while the engine is running at its usual speed; and also to admit of the crank-pin and wrist-pin brasses being keyed up at certain intervals. The way to find the piston clearance of an engine is as follows: First, disconnect the wrist-pin end of the connecting rod from the cross-head, and with a bar push back the cross-head until the piston strikes the cylinder head; then make a mark with a scriber or sharp chisel, on both the sides of the cross-head and on the guide in which the cross-head runs; these marks must be exactly in line with each other while the piston is in the above stated position. Next, move the piston to the other end of the cylinder till it strikes the head, and make a mark on the guide similar to that on the other end, using the same mark which was made on the cross-head. The new mark must also be in line with this, as at the first mentioned end. You now have a mark at each end of the guide, which represents the place at which the piston strikes the cylinder head, when they alternately coincide with the mark on the cross-head itself. Now, connect the rod to the cross-head again and place the engine or crank on the center. Next, produce or extend the mark on the cross-head to the guide, this time using a pencil instead of a chisel and scriber. The distance between the new pencil mark and the first mark made on the guide is the amount of piston clearance which exists at that end of the cylinder. Repeat the operation on the other end and you will obtain the clearance existing there. If these clear-

ances are not equal, as indicated by the marks, make them so by the means provided for in the design of the piston rod and crosshead. After the clearance has been equalized, the pencil marks may be obliterated and marks similar to the first ones may be cut in, thus leaving a permanent mark which can be seen while the engine is running, and from which can be determined whether the clearance is lessening, and at which end.

Q. What is the pressure of the atmosphere at the sea level, and how determined? A. The pressure of the atmosphere is generally spoken of as 15 lbs. per square inch, but as the pressure of the atmosphere is constantly varying at any one spot, corrections have to be made according to the reading of a barometer. Generally speaking, 14.7 lbs. is as nearly correct as engineers require it. The pressure of the atmosphere can be ascertained by the following experiment: Take a glass tube about 33 inches long, having a bore equal to a square inch in section. Let one end of the tube be closed in or capped, so that it can contain a fluid. Then fill it with pure mercury, carefully expelling any air bubbles. When it is full, cover the open end of the tube with a piece of glass and invert the whole tube. Place the open end into a cup of mercury, the surface of which is subject to the pressure of the air, and then withdraw the piece of glass. The mercury in the tube will drop about three inches and then stop. When it has ceased to fall, again cover the end of the tube with the glass. Lift the tube out of the cup and remove the glass so that the mercury may run out into a scale-pan provided for that purpose. Upon actually weighing the mercury lately contained in the tube, it will be found to weigh 14.7 lbs. The mercury will stop falling in the tube at 30 inches, or at the sea level. Hence, we know that the atmosphere balances, or exerts a pressure of 14.7 lbs. per square inch at the sea level.

Q. Upon what does the efficiency of a surface condenser depend? A. The efficiency of a surface condenser depends upon:

1st, the proper amount of cooling surface; 2d, the rapidity with which the water is made to circulate through the tubes; 3d, the water being made to flow in an opposite direction to the steam. The temperature of the circulating water also has a bearing on the question, as it is obvious that the colder the water the more effective it will be in condensing the steam.

Q. A feed pump has a steam cylinder of 6 inches in diameter, and water cylinder of 4 inches diameter; assuming the steam pressure carried to be 80 lbs. per square inch throughout the stroke, what will be the balancing pressure per square inch against the water piston, friction being entirely neglected, and gauge pressure being used? A. In this question, we first find the area, the number of square inches contained in the steam piston. Thus: The diameter = 6 in. and $6^2 \times .7854 =$ the area. Worked out it appears thus: 6^2 means that 6 is to be squared, or multiplied by itself, or $6 \times 6 = 36$ circular inches, and 36 circular inches multiplied by the constant $.7854 = 28.27$ square inches area contained in the steam piston. Since the pressure is stated to be 80 lbs. per square inch, then $28.27 \times 80 =$ total pressure on the piston in pounds, or 2261.60 lbs. Now, we will find the area of the water piston, which is 4 inches in diameter, $4^2 \times .7854 = 12.5664$ square inches contained in the water piston. Therefore, the water piston, with an area of 12.56 sq. in., has to have a resistance against which it will act of 2261.60 lbs., in order to balance the pressure against the steam piston. Hence, the pressure per square inch can be found by dividing 2261.60, or 2261.60 divided by 12.56 = 180 lbs. per square inch, the balancing pressure on the 4-inch water piston.

Q. State what you consider a good standard of strength for steel boiler plate? A. The American Boiler Makers' standard, as used, is as follows: Tensile strength, from 55,000 to 65,000 lbs. per square inch section; elongation in 8 inches, 20 per cent for plates $\frac{3}{8}$ inch thick and under; 22 per cent for plates $\frac{3}{8}$ to $\frac{3}{4}$

inches; 25 per cent for plates $\frac{3}{4}$ inch and under; the specimen test piece must bend back on itself when cold, without showing signs of fracture; for plates over $\frac{1}{2}$ inch thick, specimens must withstand bending 180° (or half way) round a mandrel $1\frac{1}{2}$ times the thickness of the plate. The chemical requirements are as follows: Phosphorus, not over .04 per cent; sulphur, not over .03 per cent.

Q. What is meant by the heating surface of a boiler? A. The heating surface of a boiler is that surface of plates or tubes on one side of which is water, and on the other hot gases. It has been decided that the surface next the water shall be reckoned, the value to be given in square feet. In a fire tube, or tubular boiler, it will include the part of the shell above the fire-box (usually about one-half of it), the tubes and such part of the back-tube sheet as is below the back arch and not taken up by the tube ends. For a water-tube boiler, the heating surface will include the tubes, such part of the headers as are in contact with the hot gases, and the lower part (about one-half) of the steam drum. In calculating the heating surface, none should be taken which has steam on one side and hot gases on the other, as such parts tend to superheat the steam, and are known as superheating surfaces.

Q. What is a boiler horse-power? A. A boiler horse-power has been recently defined as the evaporation of $34\frac{1}{2}$ pounds of water per hour from a feed water temperature of 212° Fahr. into steam at a temperature of 212° Fahr., and at a pressure of one atmosphere. Under these conditions each pound of water evaporated will take up 966 heat units, and the $34\frac{1}{2}$ lbs. will take $34\frac{1}{2} \times 966 = 33,327$ heat units per hour. Hence, to find the horse-power of a boiler, it is necessary to find the heat units delivered per hour to the water and divide that number by 33,327.

Q. What will be the heating surface of a fire-tube boiler 6 feet in diameter, having 150 tubes 3 inches in diameter and 15

feet long? A. Each tube will have a heating surface equal to its outside area, since the water is on the outside of the tubes. The area of a cylinder 3 in. in diameter and 15 ft. long will be the circumference times the length; 3 in. = $\frac{1}{4}$ ft. and the circumference = $3.1416 \times \frac{1}{4} = .7854$ ft.; this, times the length 15 ft. = 11.78 sq. ft. for one tube: for 150 tubes, it will be 150 times that = 1767 sq. ft. The lower half of the shell is usually considered as heating surface. The circumference of a circle 6 ft. in diameter is $6 \times 3.1416 = 18.85$ ft. and the area of the shell = $18.85 \times 15 = 282.75$ sq. ft. Half this will be 141.37 sq. ft. For the back end or tube plate, the total area will be the diameter squared times $.7854 = 6^2 \times .7854 = 28.27$ sq. ft.; $\frac{2}{3}$ of this will be below the arch, and $\frac{2}{3}$ of $28.27 = 18.85$ sq. ft. From this must be subtracted the area of the ends of the tubes. The end area of one tube is $(\frac{1}{4})^2 \times .7854 = .049$ sq. ft., and for 150 tubes it is 150 times that, or 7.35 sq. ft. The heating surface of the tube plate will then be 18.85 minus 7.35 = 11.5 sq. ft. The front tube plate is not considered, because the gases are cooled too much to be effective by the time they have passed through the tubes. The total heating surface is $1767 + 141.37 + 11.5 = 1919.87$ sq. ft.

Q. On what does the efficiency of a boiler depend? A. The efficiency of any piece of machinery is the ratio of the energy made useful to that furnished. The object of the boiler is to make steam; hence, the energy *used* is that which has gone into the steam. The proportion of the heat generated in the furnace which is transferred to the steam, will depend on the thickness of the plates of the boiler, on their condition as to cleanliness, on the amount of time during which the gases are in contact with the plates in their passage from furnace to chimney, on the completeness with which all parts of the gases are brought in contact with the plates, and on the temperature of the hot gases. Evidently, heat will pass through a thin plate more readily than through a thick one, and more

readily through a clean plate than through one on which a non-condensing coating of soot or scale has formed; the more time available for the transfer of heat, the greater will be the amount transferred; the more complete the contact between plates and gases, the more opportunity will there be for the transfer of heat, and the higher the temperature of the gases, the more rapidly will the heat be transferred. To have a boiler efficient, it is necessary to have plenty of heating surface, so that the hot gases will have time for contact, to keep the plates clean, to have good circulation of the gases, and to keep their temperature high by preventing radiation and allowing as little air to enter the furnace as is needed for good combustion. The efficiency of the furnace, that is, the ratio of the heat generated in the furnace to that contained in the coal, is a separate matter, though often the two are lumped together. It depends on the adaptation of the furnace to the kind and size of coal used, on the size of the combustion chamber and on the proper firing of the coal.

Q. On what its satisfactory working? A. In order to work satisfactorily, a boiler must not only be efficient, but must make steam rapidly, must make dry steam, must be easily fired and cleaned, and must be capable of standing a considerable amount of forcing without serious priming. To get rapid steam making, it is necessary to have good circulation of the water in the boiler; to get dry steam, plenty of steam space is needed, so that the steam may circulate slowly and allow the water to drop out of it; easy firing means a low fire door of good size, and a rather short grate; easy cleaning means accessible parts, good sized man-holes, good sized and well placed hand-holes, a large blow-off and a short boiler; the prevention of priming when carrying an overload is a difficult matter; the tendency to such an occurrence depends largely on the feed-water used; plenty of steam space and good circulation are helpful, but some waters will foam in spite of all precautions.

Q. Suppose a slide valve cutting off at $\frac{3}{4}$ stroke, and a $\frac{5}{8}$ cut-off is desired, how would you proceed? A. Put on a new valve with more outside lap. This would require a greater travel of the valve, consequently, I would increase the throw of the eccentric, also.

Q. Which requires the greater outside lap, cutting off at $\frac{9}{16}$ of the stroke, or cutting off at $\frac{7}{8}$? A. Cutting off at $\frac{9}{16}$. The earlier the cut-off, the greater should be the outside lap.

Q. Are all plain slide valves made alike, as regards the exhaust cavity of the valve? A. No; sometimes they are made "line and line" inside, that is, the width of the exhaust cavity is equal to the distance between the inner edges of the two steam ports; and again, the width of the exhaust cavity is made greater or less than this distance, according as an earlier or later release is desired.

Q. What is the effect of giving inside lap to a slide valve? A. It delays the release and increases the compression.

Q. What is the effect of giving inside lead to a slide valve? A. It gives an early release and decreases the compression.

Q. Suppose a simple slide valve engine with a fly-ball governor, and the governor belt should break or slip off, what would happen? A. If it were a plain governor the engine would race; but if a governor with an automatic stop, the engine would slow down and stop.

Q. What two forces are opposed to each other in a case of fly-ball governor? A. Centrifugal force, tending to throw the balls away from the governor staff, and the force of gravity, tending to draw the balls to the staff.

Q. What other name is given to a fly-ball governor? A. It is also called a throttling governor, because the steam in passing through the governor valve is throttled, choked, or wire-drawn.

Q. Are all fly-ball governors throttling governors? A. No; the governor of a Porter-Allen engine and those of all Corliss

engines, while of the fly-ball type, are not throttling governors, because the steam does not pass through them.

Q. If the governor shaft of a fly-ball governor on a plain slide-valve engine should break, could the engine be run? A. Yes; by regulating the speed of the engine by hand at the throttle-valve.

Q. Describe an automatic cut-off engine? A. In this class of engines, as the load on the engine becomes greater or less, the steam entering the cylinder is cut off later or earlier, and it is done through a fly-ball governor in the case of a Corliss engine, or through a shaft-governor or regulator in the case of a high-speed engine.

Q. In an automatic cut-off high-speed engine with shaft-governor, is the eccentric fastened to the shaft? A. It is not. It is so arranged as to move freely across the shaft, in order to permit the center of the eccentric to approach or to recede from the center of the shaft, according as the load on the engine decreases or is increased. And herein lies the chief difference between a plain slide-valve and an automatic cut-off slide-valve engine.

Q. If the connecting rod of an engine had box liners at both ends and in taking it down the liners were all mixed up, how could the length of the rod from center to center of boxes be found? A. Put the cross-head in the middle of its stroke — after finding the piston stroking points — and then measure from the center of the cross-head wrist to the center of the main shaft. If the piston clearance at both ends of the cylinder is known, the piston may be pushed to the crank end of the cylinder until it touches the head, and the distance from the center of the cross-head wrist to the center of the main shaft found, to which should be added the length or throw of the crank, and also the piston clearance at the crank end of the cylinder.

Q. But suppose it were more convenient to push the piston to the head end of the cylinder, what then? A. Find the distance

from the center of cross-head wrist to center of main shaft and deduct the throw of the crank, and also the clearance.

Q. How is the length of the valve stem and of the eccentric rod found for a plain slide valve engine having a rock shaft? A. If the motion of the slide valve is parallel with the motion of the piston, the length of the valve stem may be found by measuring in a horizontal line from the center of the valve seat to the center of the rock shaft; and for the eccentric rod by measuring from the center of the rock shaft, horizontally, to the center of the main shaft, which would include one-half the yoke.

Q. What is a direct, and also an indirect valve motion? A. When there is no rock shaft between the eccentric and the valve to compound the motion, it is called "direct," and when a rock shaft intervenes, it is called an "indirect" valve motion.

Q. Is the valve motion of a Corliss engine direct or indirect? A. It is direct.

Q. How so; it has a rock shaft between the eccentric and the wrist plate? A. Even so, it is a direct valve motion; because all connections to the rock-shaft arm are above the center of the shaft, consequently, the motion is simple and not compound.

Q. When is an engine said to "run under," and when to "run over?" A. When the crank pin is above the center of the main shaft and the pin moves towards the cylinder, the engine is said to "run under;" and when it moves away from the cylinder, the engine is said to "run over."

Q. What is meant by lead of valve, and what is it for? A. Lead is the amount that the port is open to steam when the crank is on its center. It is given in order to allow the full pressure of steam to come on the piston at the beginning of the stroke, and to provide a cushion for the piston.

Q. Could not cushion for the piston be obtained in some other manner? A. Yes, by producing compression by an early closing of the exhaust.

Q. Suppose a slide valve had $\frac{3}{4}$ " lap and no lead, and it was desired to give it $\frac{1}{32}$ " lead, how should it be done? A. By moving the eccentric.

Q. Why could it not be done by altering the length of the eccentric rod? A. Because the eccentric rod does not establish the amount of lead; it simply equalizes the lead given by moving eccentric.

Q. How would you test the piston of a steam engine to see whether it was steam-tight or not? A. Put the crank on the outboard center; remove the cylinder head on the head end; block the cross-head and admit steam to the crank-end of cylinder and note the effect. The fly-wheel, or the cross-head may be securely blocked and the piston tested in this manner at different points in the stroke.

Q. Why are two eccentrics and two wrist plates put on some Corliss engines? A. One eccentric is for the induction valves to lengthen the range of the cut-off; the other for the exhaust valves to admit of early release, without excessive compression. With a Corliss engine having but one eccentric, the limit of cut-off is at less than one-half stroke, but with two eccentrics the cut-off may be still later in the stroke, and still release the steam at the proper time.

Q. What is meant by a "blocked up" governor on a Corliss engine? A. When the safety stop is "in" the governor is said to be blocked up.

Q. With a blocked up governor, suppose the main driving belt should break, what would be the result? A. The engine would race and would, perhaps, be wrecked.

Q. What is meant by the fire line of a horizontal cylindrical boiler? A. It is the height to which the shell is exposed to the action of the flames.

Q. How high should the fire line be run? A. It may be run as high as the lower gauge cock water level, although it is frequently run no higher than the top row of flues.

Q. What causes a chimney or smoke-stack to draw? A. The difference in the temperature of the air inside the chimney and that outside. The air inside expands and exerts less pressure than the outside air, which rushes in to equalize the pressure.

Q. What does the amount of grate surface determine? A. It determines the amount of coal that can be burned per hour, and consequently, the amount of steam that can be generated.

Q. What is the object in giving a slide valve outside lap? A. To save steam by cutting off the flow of steam into the cylinder before the piston reaches the end of its stroke. For example: With 24 in. stroke of piston and $\frac{5}{8}$ cut-off, the flow of steam to the piston is cut off when the piston has moved 15 inches and it is driven the remaining 9 inches by the expansive force of the steam.

Q. What amount of refrigerating water is required for a condenser? A. For a surface condenser about 50 times, and for a jet condenser 30 times the amount of water evaporated in the boiler; more or less than these quantities being required according to the temperature of the exhaust steam.

Q. Suppose your condenser was out of order and undergoing repairs, could you run the engine? A. Yes; by attaching an exhaust pipe to the engine and exhausting into the atmosphere.

Q. With a lever safety valve, should the end of the valve stem upon which the lever rests, be square or concave? A. Neither one; it should be pointed, so that the lever will always bear directly on a line with the center of the valve stem.

Q. What is the proper proportion of a safety valve lever? A. About 7 to 1; that is, if the distance from the center of the valve to the fulcrum is 1 inch, the distance from the center of the valve to the end of the long arm of the lever should be about 7 inches.

Q. How should the grates be set in a boiler furnace? A. They should be set level, because this plan will enable the fire-

mán to more easily carry a bed of fuel of uniform depth ; besides, it is less laborious to clean the fire than when the grates are lower at the bridge wall.

Q. What is momentum? A. It is the product of the mass or bulk of a moving body, taken in pounds or tons, multiplied by the velocity of the moving mass, generally taken in feet per second.

Q. Will an injector work at the same steam pressure when it lifts the water as when the water flows to it under pressure? A. No ; when the water flows to an injector under pressure it will work down to the lowest steam pressures, but when lifting the water it requires a steam pressure of ten pounds or over to work the injector.

Q. What is the greatest height to which an injector will lift water? A. That depends upon the starting steam pressure. There are injectors that will lift water two feet with 10 lbs. steam pressure, five feet with 30 lbs., and from 12 to 25 feet with 60 lbs. and over.

Q. If the pulley on the main shaft of an engine driving a fly-ball governor be reduced in diameter, what effect will it have on the speed of the engine? A. The speed of the engine will be increased.

Q. Which is the greater, the bursting or the collapsing pressure of a boiler tube? A. A boiler tube will collapse under less pressure than would be required to burst it.

Q. Should a horizontal externally fired boiler be set level or with a pitch? A. It is customary to set such a boiler one inch lower at the end to which the blow-off pipe is attached, in order to drain the boiler readily.

Q. In a slide valve engine with a connecting rod, will the valve cut off the same at both ends of the stroke if it has equal lap and lead? A. No ; owing to the angularity of the connecting rod.

Q. Is it proper to close the damper with a banked fire? A. The damper should never be closed tightly while there is fire in

the furnace, as gas is liable to collect under the boiler and in the flues and produce an explosion.

Q. Which is the most economical, high or slow piston speed, and why? A. High piston speed, because there is less loss due to the condensation of steam owing to the cooling of the cylinder during expansion, and after the steam is exhausted at the ends of each stroke.

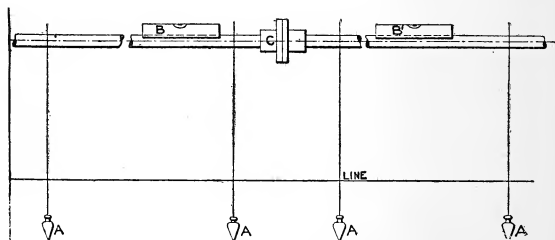
Q. Is there any danger of a well-fitted and tightly-keyed fly-wheel coming loose? A. Yes; water in the cylinder by producing a heavy jar would tend to loosen a fly-wheel and frequently reversing an engine under a load and high speed, would tend to produce the same effect

CHAPTER XXI.

INSTRUCTIONS FOR LINING UP EXTENSION TO LINE SHAFT.

The erection of a line shaft, or an extension to one, is a job that should have the services of a competent millwright or machinist, as it is one calling for experience and considerable skill.

I will, however, give you some pointers on how to proceed. A linen line or fine wire should be stretched beneath the shaft and parallel to it, and extending beyond the termination of the extension.



To set the line parallel to the main line shaft, hang the plumb-bobs *A A* over the shaft, as shown in the sketch, and then adjust the line until it just touches the lines supporting the bobs, without disturbing their position. If the plumb-bobs trouble you by swaying, set pails of water so that the bobs will be immersed; this will stop the swaying without destroying their truth. The plumb-bobs may just as well be old nuts or similar pieces of iron,

as the regulation type, since the result will be exactly the same. After getting the line adjusted to the desired position, suspend the plumb-bobs A^1A^1 along the direction of the extension, so that their supporting cords will just touch the line without disturbing it. The new section of the shaft is now brought in position sideways until it also touches the cords of the plumb-bob A^1A^1 , which, of course, locates it parallel with the main shaft in a horizontal plane. To get it to the right height, enter the shaft coupling of the new part into coupling of the main shaft, and then adjust until the shaft shows level when tested with an accurate spirit level. A level suitable for this work should be of iron and planed on the under side with a V-groove, which will always locate it parallel with the shaft when testing it. Before leveling the new part of the shaft, it will be necessary to try the shaft already in position, as it may not be level. If found "out" it should be leveled, but sometimes this will not be possible or feasible, in which case it will be necessary to set the new part at the same inclination. To do this, test the main shaft and find how much it is out, and adjust the level by strips of paper until it shows "fair." The paper should be secured to the level by glue or other means and used on the new shaft in that condition, always keeping the level with the "packed" end pointing in the same direction. After getting the new part in position, it is well to test it before connecting it to the main part; that is, it should be turned by hand to determine if the frictional resistance is excessive or not. After connecting with the main part, it is not a bad idea to test it again by hand, if possible. With a long shaft it may be necessary to disconnect the further sections and remove the belts from the connected machines. In this way a fair idea of the frictional resistance may be obtained. As before stated, this work requires experience and skill, and should properly be done by one thoroughly competent for the work; for, while his services may seem a trifle expensive, it will usually be found to pay better in the

long run, as the frictional resistance of an improperly lined shaft will quickly consume coal enough to pay the difference.

SIMPLICITY IN STEAM PIPING.

In building steam power plants, and especially in arranging the piping connections for them, simplicity is a characteristic the value of which is often too little appreciated. It should be borne in mind that extra valves and duplicate piping mean a very considerable amount of capital lying at waste to meet a contingency which may, in all probability, never arise, not to speak of the care and attention required to keep piping and valves which are rarely used in shape for service. Another point which ought to be realized in the design of piping, is that every square foot of uncovered surface, as in flanges and the like, causes the loss of about one dollar per year in condensation of steam, and each square foot of uncovered surface represents the loss of nearly one-quarter of this amount. The principle of construction is to design the piping with the utmost simplicity possible; without any double connections, put it up so that no accidents can happen to it. It is argued that this is impossible, but it is equally impossible to insure absolute immunity against "shut downs," of greater or less duration, by any amount of duplex connections, for even the blowing out of a single gasket can blow down a whole battery of boilers before a 12-inch valve can be closed and another opened. With the more extensive introduction of high-pressure valves and fittings, it is possible, by proper design, to reduce the liability to accident very nearly to the point of absolute safety, and by the introduction of one or two extra valves, it is generally possible to divide the plant into sections, any one of which can, if occasion demands, be operated independently. No fixed rules can be laid down and the line between absolute simplicity and necessary complexity must be drawn separately for each plant with due regard to the work it has to perform, but it

should be remembered that the more simple a plant can be made to accomplish the work with absolute reliability, the greater the achievement in economy of first cost, and in availability and economy of operation.

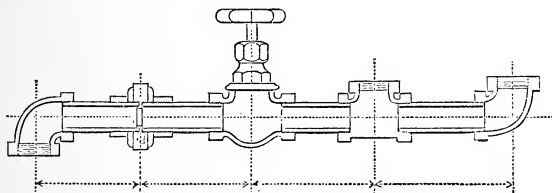


Diagram Showing Screwed Valve and Fittings

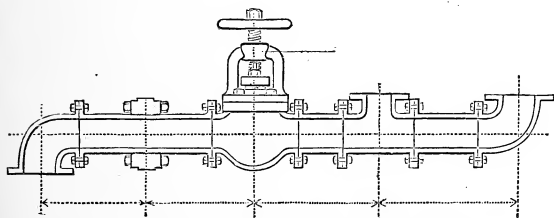


Diagram Showing Flanged Valve and Fittings

CUTTING PIPE TO ORDER.

In placing orders for pipe, a diagram should be made, according to above cuts. Great care should be taken in making a diagram for large pipe; all measurements should be from centers. When flanged fittings are used, state if desired drilled, and if with bolts and gaskets complete. Also state if you desire the

fittings made up tight, and mark such pieces at point joint is desired, on diagram.

FEED-WATER REQUIRED BY SMALL ENGINES.

Pressure of Steam in Boiler, by Gauge.	Pounds of Water per Effective Horse-power per Hour.	Pressure of Steam in Boiler, by Gauge.	Pounds of Water per Effective Horse-power per Hour.
10	118	60	75
15	111	70	71
20	105	80	68
25	100	90	65
30	93	100	63
40	84	120	61
50	79	160	58

HEATING FEED-WATER.

Feed-water, as it comes from the wells or hydrants, has ordinarily a temperature of from 35° in winter to from 60 to 70° in summer. Much fuel can be saved by heating this water by the exhaust steam, whose heat would otherwise be wasted. Until quite recently, only non-condensing engines utilized feed water heaters but lately they have been introduced with success between the cylinder and the air-pump in condensing engines. The saving in fuel due to heating feed-water is given on page 644.

RATING BOILERS BY FEED-WATER.

The **rating** of boilers has, since the Centennial, in 1876, been generally based on 30 pounds feed water per hour per horse-power. This is a fair average for good non-condensing engines working under about 70 to 100 pounds pressure. But different

pressures and different rates of expansion change the requirements for feed water. The following table gives Prof. R. H. Thurston's estimate of the steam consumption for the best classes of engines in common use when of moderate size and in good order:—

WEIGHTS OF FEED WATER AND OF STEAM.

NON CONDENSING ENGINES.—R. H. T.

Steam Pressure.		Lbs. per H. P. per Hour. — Ratio of Expansion.					
Atmos- phere.	Lbs. per sq in.	2	3	4	5	7	10
3	45	40	39	40	40	42	45
4	60	35	34	36	36	38	40
5	75	30	28	27	26	30	32
6	90	28	27	26	25	27	29
7	105	26	25	24	23	25	27
8	120	25	24	23	22	22	21
10	150	24	23	22	21	20	20

CONDENSING ENGINES.

2	30	30	28	28	30	35	40
3	45	28	27	27	26	28	32
4	60	27	26	25	24	25	27
5	75	26	25	25	23	22	24
6	90	26	24	24	22	21	20
8	120	25	23	23	22	21	20
10	150	25	23	22	21	20	19

Small engines having greater proportional losses in friction, in leaks, in radiation, etc., and besides receiving generally less care

in construction and running than larger ones, require more feed water (or steam) per hour.

FEED-WATER HEATERS.

Inattention to the temperature of feed water for boilers is entirely too common, as the saving in fuel that may be effected by thoroughly heating the feed water — by means of the exhaust steam in a properly constructed heater — would be immense, as may be seen from the following facts: A pound of feed water entering a steam boiler at a temperature of 50° Fahr., and evaporating into steam of 60 lbs. pressure, requires as much heat as would raise 1157 lbs. of water 1 degree. A pound of feed water raised from 50° Fahr. to 220° Fahr. requires 987 thermal units of heat, which if absorbed from exhaust steam passing through a heater, would be a saving of 15 per cent in fuel. Feed water at a temperature of 200° Fahr., entering a boiler, as compared in point of economy, with feed water at 50° , would effect a saving of over 13 per cent in fuel; and with a well-constructed heater there ought to be no trouble in raising the feed water to a temperature of 212° Fahr. If we take the normal temperature of the feed water at 60° , the temperature of the heated water at 212° and the boiler pressure at 20 lbs., the total heat imparted to the steam in one case is 1192.5° minus $60^{\circ} = 1132.5^{\circ}$; and in the other case, 1192.5° minus $212^{\circ} = 980.5^{\circ}$, the difference being 152° , or a saving of $152/1132.5 = 13.4$ per cent. Supposing the feed water to enter the boiler at a temperature of 32° Fahr., each pound of water will require about 1200 units of heat to convert it into steam, so that the boiler will evaporate between $6\frac{2}{3}$ and $7\frac{1}{2}$ lbs. of water per pound of coal. The amount of heat required to convert a pound of water into steam varies with the pressure, as will be seen by the following table: —

TABLE SHOWING THE UNITS OF HEAT REQUIRED TO CONVERT ONE POUND OF WATER, AT THE TEMPERATURE OF 32° FAHR., INTO STEAM AT DIFFERENT PRESSURES.

Pressure of Steam in lbs. per Sq. In. by Gauge.	Units of Heat.	Pressure of Steam in lbs. per Sq. In. by Gauge.	Units of Heat.
1	1,148	110	1,187
10	1,155	120	1,189
20	1,161	130	1,190
30	1,165	140	1,192
40	1,169	150	1,193
50	1,173	160	1,195
60	1,176	170	1,196
70	1,178	180	1,198
80	1,181	190	1,199
90	1,183	200	1,200
100	1,185		

If the feed water has any other temperature the heat necessary to convert it into steam can easily be computed. Suppose, for instance, that its temperature is 65°, and that it is to be converted into steam having a pressure of 80 lbs. per square inch. The difference between 65 and 32 is 33; and subtracting this from 1181 (the number of units of heat required for feed water having a temperature of 32°), the remainder, 1148, is the number of units for feed water with the given temperature. Yet it must be understood that any design of heater that offers such resistance to the free escape of the exhaust steam as to neutralize the gain that would otherwise be obtained from its use, ought to be avoided, as the loss occasioned by back pressure on the exhaust, in many instances, counteracts the advantages derived from the heating of the feed water.

FEED-WATER HEATERS.

Feed-water heaters are a most important feature of a good steam plant. First, by utilizing the heat of the exhaust steam

from the engine or waste gases in chimney, the feed water may be heated to about 210° Fahr., with ease, before entering boilers, by this means saving fuel and increasing capacity of boiler. Second. By heating the water, the boilers are protected from serious and unequal strain, as the difference of temperature between incoming water and outgoing steam may be kept about 110° (210° to 320°). Third. Every heater must necessarily be a water purifier, as the mud and lime are eliminated, to some degree at least, before the water reaches the boiler by heat.

TABLE — SHOWING GAIN IN USE OF FEED WATER HEATER. PERCENTAGE OF HEAT REQUIRED TO HEAT WATER FOR DIFFERENT FEED AND BOILING TEMPERATURES, AS COMPARED WITH A FEED AND BOILING TEMPERATURE OF 212°.

Boiling Point. Fahr.	Initial Temperature of feed water.										
	32°	50°	68°	86°	104°	122°	140°	158°	176°	194°	212°
212	1.19	1.17	1.15	1.13	1.11	1.10	1.08	1.06	1.04	1.02	1.00
230	1.20	1.18	1.16	1.14	1.12	1.10	1.08	1.06	1.04	1.02	1.01
248	1.20	1.18	1.16	1.14	1.13	1.11	1.09	1.07	1.05	1.03	1.01
266	1.21	1.19	1.17	1.15	1.13	1.11	1.09	1.07	1.06	1.04	1.02
284	1.21	1.20	1.18	1.16	1.14	1.12	1.10	1.08	1.06	1.04	1.02
302	1.22	1.20	1.18	1.16	1.14	1.12	1.11	1.09	1.07	1.05	1.03
320	1.22	1.21	1.19	1.17	1.15	1.13	1.11	1.09	1.07	1.05	1.03
338	1.23	1.21	1.19	1.17	1.15	1.14	1.12	1.10	1.08	1.06	1.04
356	1.23	1.22	1.20	1.18	1.16	1.14	1.12	1.10	1.08	1.06	1.04
374	1.24	1.22	1.20	1.18	1.17	1.15	1.13	1.11	1.09	1.07	1.05
392	1.24	1.23	1.21	1.19	1.17	1.15	1.13	1.11	1.09	1.07	1.06
410	1.25	1.23	1.22	1.20	1.18	1.16	1.14	1.12	1.10	1.08	1.06
428	1.25	1.24	1.22	1.20	1.18	1.16	1.14	1.12	1.11	1.09	1.07

There are two distinct types of heaters in which heat is derived from exhaust steam. These are known as closed and open heaters. Each has its advantages and disadvantages. The closed heater is constructed so that the water is forced under pres-

sure through tubes or chambers surrounded by the exhaust steam, the heat being transmitted through the walls of the tubes and chambers. The open heater is a vessel in which the feed water comes into direct contact with the exhaust steam, by spraying or intermingling. The heated water is pumped hot into the boiler. The closed heater has the advantage of permitting the water to pass through the pump cold and in that state is easily handled. To pump hot water from an open heater requires special care in piping and packing the feed-pump. The closed heater, being a purifier (if any lime is present in water, a portion is bound to be precipitated by heat), should be cleaned, a job about as difficult as cleaning a boiler; or blown out, which is never a satisfactory method. In the precipitation of lime by heat, carbonic acid gas is set free and chemists say that this gas in a nascent state (just being born) attacks iron and brass. Whatever the cause, experience has demonstrated that ordinary wrought iron, steel and brass, corrode under this action. The open heater, being usually a large chamber, is accessible for cleaning out, and if made with ordinary care will last a long time. A leak in it is not a serious matter, while a leak in the closed heater means a waste of hot water into the exhaust pipe. The open heater has, at times, been the cause of serious mishaps. In it the steam and water mix; with any stoppage in exit of feed-water, there is danger of flooding the cylinder of the steam engine through exhaust pipe, causing a wreck. The more modern forms of these heaters and the experience obtained in their use have reduced this difficulty to a minimum.

WATER.

Pure water at 62° F. weighs 62.355 pounds per cubic foot, or $8\frac{1}{3}$ lbs. per U. S. gallon; 7.48 gallons equal 1 cu. ft. It takes 30 lbs., or 3.6 gal. for each horse-power per hour. It would be difficult to get at the total daily horse-power of steam used in the

U. S., but it reaches into the billions of gallons of feed water per day. The importance of knowing what impurities exist in most feed waters, how these act on a boiler and how they may be removed is, therefore, patent to every intelligent engineer. I give, therefore, the thoughts of some prominent investigators on the subject.

Prof. Thurston says:—

“Incrustation and sediment are deposited in boilers, the one by the precipitation of mineral or other salts previously held in solution in the feed-water, the other by the deposition of mineral insoluble matters, usually earths, carried into it in suspension or mechanical admixture. Occasionally also, vegetable matter of a glutinous nature is held in solution in the feed water, and, precipitated by heat or concentration, covers the heating surfaces with a coating almost impermeable to heat, and hence, liable to cause an overheating that may be very dangerous to the structure. A powdery mineral deposit sometimes met with is equally dangerous, and for the same reason. THE ANIMAL AND VEGETABLE OILS AND GREASES CARRIED OVER FROM THE CONDENSER OR FEED WATER HEATER ARE ALSO VERY LIKELY TO CAUSE TROUBLE. Only mineral oils should be permitted to be thus introduced, and that in minimum quantity. Both the efficiency and safety of the boiler are endangered by any of these deposits.

“The amount of the foreign matter brought into the steam boiler is often enormously great. A boiler of 100 horse-power uses, as an average, probably a ton and a half of water per hour, or not far from 400 tons per month, steaming ten hours per day; and even with the water as pure as the Croton at New York, receives 90 pounds of mineral matter, and from many spring waters a *ton*, which must be either blown out or deposited. These impurities are usually either calcium carbonate or calcium sulphate, or a mixture; the first is most common on land, the second at sea. Organic matters often

harden these mineral scales and make them more difficult of removal.

“The only positive and certain remedy for incrustation and sediment, once deposited, is periodical removal by mechanical means at sufficiently frequent intervals to insure against injury by too great accumulation. Between times, some good may be done by special expedients suited to the individual case. No one process and no one antidote will suffice for all cases.

“Where carbonate of lime exists, sal-ammoniac may be used as a preventive of incrustation, a double decomposition occurring resulting in the production of ammonia carbonate and calcium chloride—both of which are soluble, and the first of which is volatile. The bicarbonate may be in part precipitated before use by heating to the boiling point, and thus breaking up the salt and precipitating the insoluble carbonate. Solutions of caustic lime and metallic zinc act in the same manner. Waters containing tannic acid and the acid juices of oak, sumach, logwood, hemlock, and other woods, are sometimes employed, but are apt to injure the iron of the boiler, as may acetic or other acid contained in the various saccharine matters often introduced into the boiler to prevent scale, and which also make the lime-sulphate scale more troublesome than when clean. Organic matter should never be used.

“The sulphate scale is sometimes attacked by the carbonate of soda, the products being a soluble sodium sulphate and a pulverulent insoluble calcium carbonate, which settles to the bottom like other sediments and is easily washed off the heating surfaces. Barium chloride acts similarly, producing barium sulphate and calcium chloride. All the alkalies are used at times to reduce incrustations of calcium sulphate, as is pure crude petroleum, the tannate of soda and other chemicals.

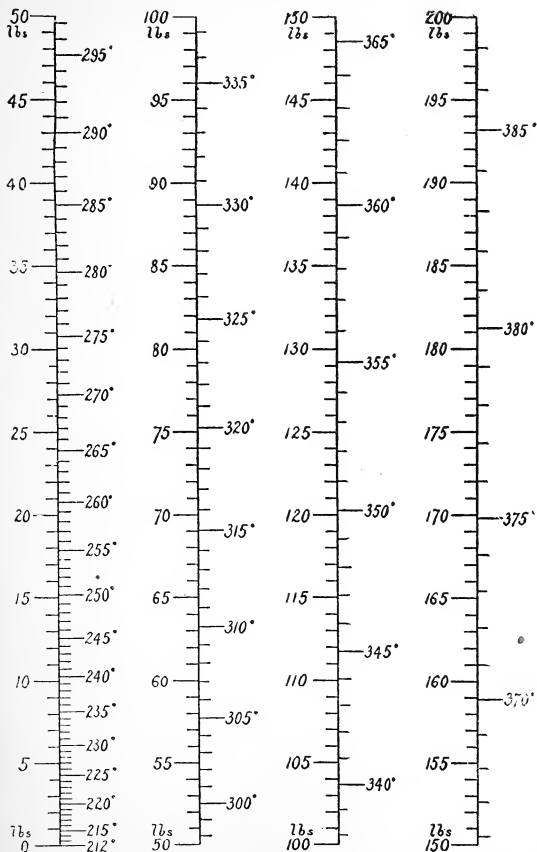
“The effect of incrustation and of deposits of various kinds, is to enormously reduce the conducting power of heating surfaces ;

so much so, that the power, as well as the economic efficiency of a boiler, may become very greatly reduced below that for which it is rated, and the supply of steam furnished by it may become wholly inadequate to the requirements of the case.

“ It is estimated that $\frac{1}{16}$ of an inch (0.16 cm.) thickness of hard ‘ scale ’ on the heating surface of a boiler will cause a waste of nearly one-eighth of its efficiency, and the waste increases as the square of its thickness. The boilers of steam vessels are peculiarly liable to injury from this cause where using salt water, and the introduction of the surface condenser has been thus brought about as a remedy. Land boilers are subject to incrustation by the carbonate and other salts of lime and by the deposit of sand or mud mechanically suspended in the feed-water.

THE TEMPERATURE AND PRESSURE OF SATURATED STEAM.

The accompanying diagram and explanation, taken from that excellent publication, *The Locomotive*, will be found much more convenient for reference than steam tables. The description says that one of the most fundamental and best known facts in steam engineering is that saturated steam has a certain definite temperature for each and every definite pressure; and in all books on steam we find tables of corresponding temperatures and pressures, by the use of which we are enabled to find out what the temperature of the steam is when we know what the pressure is, and *vice versa*. For accurate work these tables are all right; but when (as is usually the case) we do not need to know either the temperature or the pressure with any very great precision, a diagram which presents the facts directly to the eye is much more convenient. Such a diagram is presented herewith. On the left-hand side of each vertical line I have marked the pressures, and on the right-hand side of the same lines I have marked the corresponding temperatures. The pres-



COMPARATIVE DIAGRAM SHOWING THE TEMPERATURE AND PRESSURE OF SATURATED STEAM.

tures are all gauge pressures, that is, they represent the direct gauge reading or pressure above that of the atmosphere. The temperatures are on the Fahrenheit scale. The diagram is based upon Prof. Cecil H. Peabody's steam tables, and we have assumed that the average atmospheric pressure is 14.70 pounds per square inch.

A few examples will make the use of the diagram clear: (1) What is the temperature of saturated steam when its pressure, above the atmosphere, is 75 pounds per square inch? Ans. We find 75 pounds on the left-hand side of the second vertical line, and looking on the other side of the line we see that the corresponding temperature is just a fraction of a degree less than 320 degrees Fahr. (2) What is the temperature of saturated steam when its pressure, above the atmosphere, is 197 lbs. per square inch? Ans. We find 197 lbs. on the left-hand side of the last vertical line. It is not marked in figures, but 195 is so marked, and 197 is two divisions higher than 195. Looking opposite to 197 we see that the corresponding temperature is about half way between 386 degrees and 387 degrees. Hence, we conclude that the temperature of saturated steam at the given pressure is about $386\frac{1}{2}^{\circ}$. (3) When the temperature of saturated steam is 227° , what is its pressure? Ans. We find 227° on the right-hand side of the first line, two divisions above 225° ; and looking opposite to it, we see that the gauge pressure corresponding to this temperature is almost exactly five pounds. (4) When the temperature of saturated steam is 363° , what is its pressure? Ans. We find 363° on the right-hand side of the third vertical line, three divisions above 360° , and looking on the other side of the vertical line, we see that the corresponding gauge pressure is about $144\frac{1}{2}$ lbs. to the square inch.

SOMETHING FOR NOTHING.

In the first place, it should be remembered that in mechanics the measure of work done is the foot pound, a term which defines

itself. A foot pound of work is the amount of energy required to lift one pound one foot high. A foot pound, therefore, is the product of force and distance, force being simply a push or a pull. A machine can be made to increase the acting force, as is seen in the case of a crane, where the weight lifted is much greater than the force applied at the handle by the operator. It is also possible to increase the distance moved by some part of a machine, but it must be done by applying a greater force as in the case of a steam engine, where the distance moved by the belt is greater than the space passed over by the piston, but the total pressure of the steam against the piston is greater than the effective pull exerted by the belt.

In both the crane and the steam engine, however, the applied force multiplied by the distance through which it moves in a given time, must be enough greater than the product of the force at the crane hook or the rim of the fly-wheel, and the distance through which it moves to make up for the loss through friction in the machine itself. The foot pounds of work done by any machine whatever must always be less than the foot pounds put into the machine in the same length of time. A study of this principle and of the methods of applying it, is all that is necessary to enable one to decide upon the soundness of the claims made for any power multiplying device. A British Thermal Unit (B. T. U.) is the amount of heat required to raise the temperature of a pound of water 1° Fahr., and its dynamic value is 778 lbs. raised to a height of one foot.

STEAM-BOILER INSPECTION.

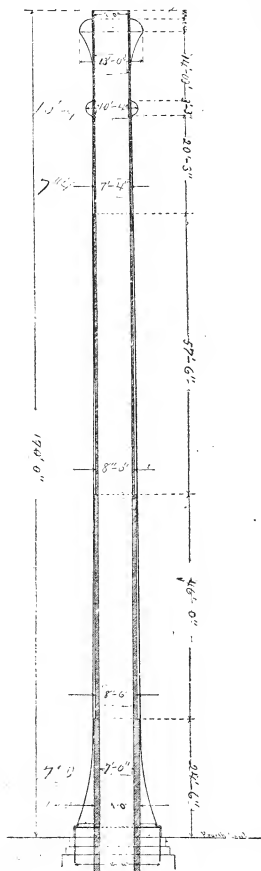
It is asserted, on reliable authority, that the proportion of boiler explosions and ruptures, as compared with the number of boilers in use, exceeds the number of fires in buildings as compared with the number of buildings in the country. It is estimated that there are upwards of 100,000 steam-boilers in use

in this country; the number of explosions annually is from 125 to 150, but when to these are added the ruptures, collapsed flues, ripped seams, etc., the number of disasters is increased to 900 or 1,000, making one per cent of the whole number in the country damaged more or less annually. The use of steam-power is increasing the world over and it will continue to increase until some new motor, more effective and less expensive, is discovered. Therefore, intelligent and thorough boiler inspection is one of the imperative necessities of the age. The manufacturer or steam-user, from a press of business, or a want of that practical knowledge which is only attained in any pursuit by close study and observation, is unable to attend or give directions in all the details involved in the care and management of his steam-boilers. For a very small consideration he can avail himself of the advantages to be derived from the inspection and insurance of steam-boilers, by placing his boilers under the care of responsible and reliable parties who will do everything that can be done to insure safety. The experience of the past in the care and management of steam-boilers has shown the necessity of such a system, as it not only gives additional security from the effects of boiler explosions, but also refutes the false and absurd theories which have tended to divert the attention of engineers and owners of steam-boilers from that watchfulness so essential to their care and management, by inducing the belief that no amount of care on their part will avail against certain mysterious agents at work within their boilers. Another advantage of intelligent and practical steam-boiler inspection is that it gives the engineer an opportunity to inform himself on many points of vital importance, by conversing with one who, from making a special business of boiler-inspections, has become thoroughly versed in all matters pertaining to boilers and their attachments; consequently, every engineer and fireman should afford boiler inspectors every facility to make a thorough

examination of the boilers in their charge. They should give them all the information and facts relating to the same, as it may not only be the means of saving their own lives but of many others, as well as much valuable property. It is the duty of all engineers, steam-users and those who take an interest in the lives and property of their fellow-men, to encourage careful, thorough and intelligent steam-boiler inspection, which, to be efficient, must have a pecuniary interest involved in its operations, as those who sustain no loss, either of time, means or salary, are apt to become derelict of duty.

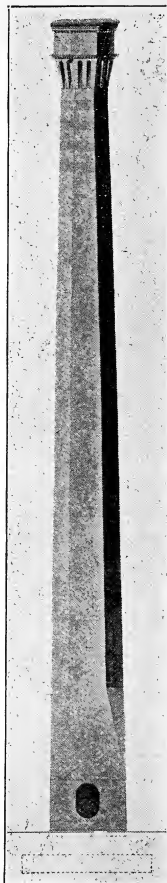
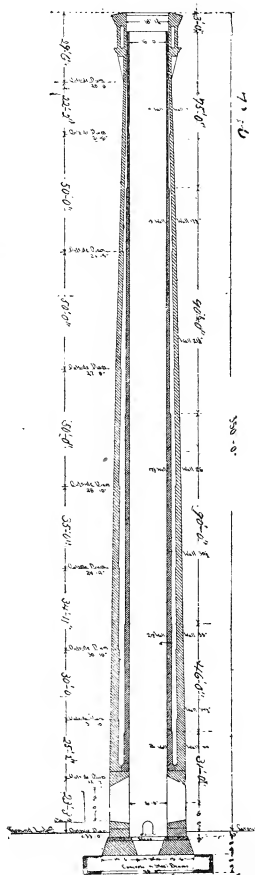
CHIMNEYS.

Chimneys are required for two purposes: 1st, to carry off obnoxious gases; 2d, to produce a draft, and so facilitate combustion. The first requires size, the second height. Each pound of coal burned yields from 13 to 30 pounds of gas, the volume of which varies with the temperature. The weight of gas to be carried off by a chimney, in a given time, depends on three things — size of chimney, velocity of flow and density of gas. But as the density decreases directly as the absolute temperature, while the velocity increases with a given height, nearly as the square root of the temperature, it follows that there is a temperature at which the weight of gas delivered is a maximum. This is about 550° above the surrounding air. Temperature, however, makes so little difference that at 550° above the quantity is only 4 per cent greater than at 300° . Therefore, height and area are the only elements necessary to consider in an ordinary chimney. The intensity of draft is, however, independent of the size, and depends upon the difference in weight of the outside and inside columns of air, which varies nearly as the product of the height into the difference of temperature. This is usually stated in an equivalent column of water, and may vary from 0 to possibly 2 inches. After a height has been reached to produce draft of sufficient



intensity to burn fine, hard coal, provided the area of the chimney is large enough, there seems no good mechanical reason for adding further to the height, whatever the size of the chimney required. Where cost is no consideration, there is no objection to building as high as one pleases; but for the purely utilitarian purpose of steam-making, equally good results might be attained with a shorter chimney at much less cost. The intensity of draft required varies with the kind and condition of the fuel and the thickness of the fires. Wood requires the least, and fine coal or slack the most. To burn anthracite slack to advantage, a draft of $1\frac{1}{4}$ inch of water is necessary, which can be attained by a well-proportioned chimney 175 feet high. Generally, a much less height than 100 feet cannot be recommended for a boiler, as the lower grades of fuel cannot be burned as they should be with a shorter chimney.

The proportioning of chimneys is very largely a matter of experience and judgment. Various rules have been formulated for this purpose, but they all vary more or less. A chimney must have sufficient cross-section to easily carry off the products of combustion, and be high enough to produce sufficient draft for complete and rapid combustion. Where there is a choice between a high narrow stack and a lower wide one, the nature of the fuel should decide the matter; as a rule, the taller stack is preferable. The amount of fuel to be burnt per square foot of grate per hour has been increasing in modern practice; therefore, the old rules do not fit the case any more. Then again, it makes a difference how many boilers are to run into the same chimney. The heaviest work of the chimney is immediately after firing, since the friction through the fresh coal is greater and the temperature less than some minutes later. But it would be bad practice to fire all boilers or all doors simultaneously. Hence, the second boiler does not require as much area as the first; say, 75 per cent will do. After that there comes the additional consideration that as



the diameter of the stack increases, the friction in stack and breeching decreases rapidly. Therefore, for the third and each succeeding boiler, 50 per cent of the first area will suffice. But as more are added, the height should be increased, more especially if the horizontal flue from boiler to stack increases in length, as it usually will. A good rule is to make the height 25 times the diameter, with possibly a gradual decrease in the ratio to 20 times the diameter for the larger chimneys. Thus a 4-foot diameter would call for 100-feet height, and a 5-foot, for 120-feet, a 6-foot for 140-feet, and a 10-foot for 200-feet height.

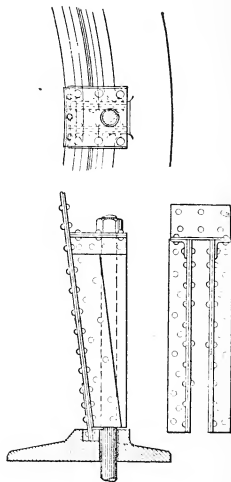
TABLE OF SIZES OF CHIMNEYS.

Height.	Diameter and Nominal Horse Power.													
	20"	26"	30"	34"	36"	40"	44"	50"	54"	58"	60"	64"	72"	78"
70 ft.	40	60
80 ft.	50	75	100	130	150	175	200
90 ft.	120	150	175	200	225	300
100 ft.	250	340	375	430	500	600	750	930
110 ft.	360	400	455	550	650	825	990
120 ft.	425	500	600	700	900	1050

IRON CHIMNEY STACKS.

In many places iron stacks are preferred to brick chimneys. Iron chimneys are bolted down to the base so as to require no stays. A good method of securing such bolts to the stack is shown in detail in the figure on page 658. Iron stacks require to be kept well painted to prevent rust, and generally, where not bolted down, as here shown, they need to be braced by rods or wires to surrounding objects. With four such braces attached to an angle iron ring at $\frac{2}{3}$ the height of stack, and spreading laterally at

least an equal distance, each brace should have an area in square inches equal to $\frac{1}{1000}$ the exposed area of stack (dia. \times height) in feet. Stability or power to withstand the overturning force of



Holding down Bolts and Lugs.

the highest winds, requires a proportionate relation between the weight, height, breadth of base, and exposed area of the chimney. This relation is expressed in the equation

$$C \frac{dh^2}{b} = W,$$

in which d equals the average breadth of the shaft; h = its height; b = the breadth of base — all in feet; W = weight of CHIMNEY IN LBS., and C = a coefficient of wind pressure per

square foot of area. This varies with the cross-section of the chimney, and = 56 for a square, 35 for an octagon and 28 for a round chimney. Thus a square chimney of average breadth of 8 feet, 10 feet wide at base and 100 feet high, would require to weigh $56 \times 8 \times 100 \times 10 = 448,000$ lbs., to withstand any gale likely to be experienced. Brickwork weighs from 100 to 130 lbs. per cubic foot; hence, such a chimney must average 13 inches thick to be safe. A round stack could weigh half as much, or have less base.

Engineers over the country have been discussing whether or not more steam is used when an engine is made to run faster without changing either the cut-off or the back pressure. Some, strange as it may seem, have actually held to the opinion that, since the cut-off is not changed, no more steam is used, and hence, if it were possible to make an engine run faster without changing the cut-off, it would be doing more work than before without any increase in the consumption of steam. Of course, this is wrong. The speed of an engine, almost any engine, may easily be increased without changing the cut-off, and when this is done, the engine will do more work and will use more steam. It is utterly impossible to get something for nothing out of a steam-engine, or out of any engine or appliance. The only way in which a steam-engine can be made to do more work without using more steam is to increase its efficiency. And when everything else is kept the same and the speed only of an engine increased, the efficiency is very slightly increased. The condensation is decreased with an increase of speed, but the decrease would be so slight for most cases that it would hardly be worth considering. When an engine is cutting off at a certain part of the stroke, it uses at every stroke a certain weight of steam which depends upon the initial pressure of the steam, clearance volume of the engine and the point of cut-off. If the engine makes 400 strokes per minute (200 revolutions, if a double acting engine) the weight of steam used will be

400 times the weight used in one stroke; but if the engine be made to make 500 strokes per minute, the weight of steam used per minute will be, neglecting the small difference in condensation, 500 times the weight used in one stroke.

HOW TO INCREASE THE SPEED, OR INCREASE THE POWER OF A CORLISS ENGINE.

There are three ways in which this can be done. Take, for example, a 24" x 48" simple Corliss engine making 70 revolutions per minute, the boiler gauge pressure 80 lbs. per square inch, one-quarter cut-off, or cut-off 12 inches from the beginning of the stroke; the mean effective pressure, say about 42 lbs. per sq. in., the governor pulley on the main shaft 10 inches in diameter, the pulleys on the governor shaft 7 in. in diameter, and the friction of engine, cylinder, clearance, condensation, etc., left entirely out of the question. It is desired to increase the speed of this engine to 80 revolutions per minute, and in this manner increase its horse-power.

First method. — Regardless of piston rod, the area of the piston is 452.4 square inches, nearly. The piston speed of this engine is 560 feet per minute, and its horse-power 322, nearly.

Thus: $\frac{452.4 \times 42 \times 560}{33000} = 322$. So that the horse-power of this engine at 70 revolutions per minute is 322, nearly, and this is what the manufacturer's catalogue gives. Now, in order to get 80 revolutions per minute, take the 7-inch pulley off the governor shaft, and put in its place an 8-inch pulley. Thus: 70:80::7:8. Then, the governor balls will revolve in the same relative plane that they did before, and the cut-off will remain the same; that is, at one-quarter, or 12 in. of the stroke. Thus, 7:10::70:100. And 8:10::80:100. So the governor balls make 100 revolutions per minute, both before and after making the change.

Now, with the engine speeded up to 80 revolutions per minute, we get 46 more horse-power. Thus: Piston speed equals 640 feet per minute. Then, $\frac{452.4 \times 42 \times 640}{33000} = 368$ horse-power, nearly. And 368 minus 322 = 46. Now, it would appear that we are getting 46 horse-power more for nothing, but such is not the case. For, $\frac{452.4 \times 12 \times 2 \times 70}{1728} = 439.8+$, or nearly 440 cubic ft. of steam per minute, at 80 lbs. boiler pressure, are required to develop 322 horse-power. And, $\frac{452.4 \times 12 \times 2 \times 80}{1728} = 502.6+$ or nearly 503 cubic ft. of steam per minute, at 80 lbs. boiler pressure, are required to develop 368 horse-power. Then, 503 minus 440 = 63 cubic feet more of steam at 80 lbs. boiler pressure, which means more water evaporated per minute and more coal burned per hour.

Second method. — Retain the same engine speed and the same cut-off, but increase the boiler pressure from 80 to 90 lbs. Then 80:90::42:47+, call it 48 lbs. mean effective pressure. Then, $\frac{452.4 \times 48 \times 560}{33000} = 368$ horse-power, nearly, the same as before, and as given in the manufacturer's catalogue. We are now using 440 cubic feet of steam per minute at 90 lbs. pressure, with an increase of 6 lbs. M. E. P.; consequently, more coal per hour must be burned.

Third method. — Retain the same boiler pressure, that is 80 lbs., and weight the governor so as to make the balls revolve in a lower plane in order to give a later cut-off. Thus, 322:368:: $\frac{1}{4}$: $\frac{2}{7}$. That is, the cut-off must take place at about $\frac{2}{7}$ of the stroke instead of at $\frac{1}{4}$. Then, $\frac{1}{4}$: $\frac{2}{7}$::42:48. That is the M. E. P. will be 48 lbs. per square inch with a cut-off at $\frac{2}{7}$ of the stroke. Then, $\frac{452.4 \times 48 \times 560}{33000} = 368$ horse-power, the same as

before. But, $\frac{2}{7}$ of 48 = $13\frac{5}{7}$, or 13.71 inches nearly, so that, instead of cutting off at 12 inches with 80 lbs. boiler pressure, we are cutting off at 13.71 inches and using 63 cubic feet more steam per minute. Thus, $\frac{452.4 \times 13.71 \times 2 \times 70}{1728} = 503$, nearly.

And, 503 minus 440 = 63, that is, we must use 63 cubic feet more of steam per minute at 80 lbs. boiler pressure, in order to get 46 more horse-power, which means the evaporation of more water per minute, and the burning of more coal per hour.

HOW TO INCREASE THE HORSE-POWER OF AN ENGINE HAVING A THROTTLING GOVERNOR.

There are three ways in which this can be done, also. We will take, for example, a plain slide-valve engine 10 x 16 inches, making 150 revolutions per minute, with $\frac{9}{16}$ cut-off, and M. E. P. say $31\frac{1}{2}$ lbs. per square inch, with a boiler pressure of 60 lbs. by gauge. The governor pulley on the main shaft 6 inches in diameter, and the pulley on the governor shaft 4 inches in diameter. The horse-power of this engine is about 30.

Thus, $\frac{16 \times 2}{12} = 2\frac{2}{3}$ ft., and $150 \times 2\frac{2}{3} = 400$ ft., the piston speed.

Then, $\frac{10 \times 10 \times .7854 \times 31.5 \times 400}{33000} = 30$ horse-power, nearly.

It is now desired to run the engine at 180 revolutions per minute in order to develop 6 horse-power more. In order to obtain these results, the governor pulley must be enlarged, so as to make the governor balls revolve in the same plane at 180 revolutions per minute, that they now do at 150 revolutions. Thus, 4:6::150:225, that is, the governor balls are now making 225 revolutions per minute. And 150:180::4:4.8. Consequently, the governor pulley must be increased to 4.8 inches in

diameter. Then, $4.8 : 6 :: 180 : 225$, that is, the governor balls, after the change, making the same number of revolutions as before. At 180 revolutions per minute, the piston speed is 480 feet per minute. Thus, $\frac{16 \times 2}{12} = 2\frac{2}{3}$. And, $180 \times 2\frac{2}{3} = 480$.

Then, $\frac{78.54 \times 31.5 \times 480}{33000} = 36$ horse-power, nearly. It might

seem from the above that we are getting 6 horse-power more for nothing; but such is not the case. For, cutting off at $\frac{9}{16}$ is equivalent to cutting off at 9 inches of the stroke.

Then, $\frac{78.54 \times 9 \times 2 \times 150}{1728} = 123$ cubic ft., nearly.

And, $\frac{78.54 \times 9 \times 2 \times 180}{1728} = 147$ cubic feet, nearly. And,

147 minus $123 = 24$. So that for 6 horse-power more, we are using 24 cubic feet more of steam per minute, at 31.5 lbs. M. E. P., which means more water evaporated per minute and more coal burned per hour.

If the boiler pressure may be safely increased, we can get 6 horse-power more out of the engine without increasing its speed, by running the boiler pressure up to 75 lbs. by gauge. Thus 75 lbs. boiler pressure would give about 37.8 lbs. M. E. P. with $\frac{9}{16}$ cut-off. Then, $\frac{78.54 \times 37.8 \times 400}{33000} = 36$ horse-power, nearly.

In this case no change should be made in the governor, nor in the speed of the engine. We can also get 6 horse-power more out of this engine by cutting off later, say at $\frac{5}{8}$, in order to get 37.8 lbs. M. E. P. But a later cut-off is not desirable, because it is not economical of steam, and besides, it would require a new valve, new eccentric, or a change in the length of a rocker arm, if not a change of the valve-seat, because the travel in the valve would have to be increased.

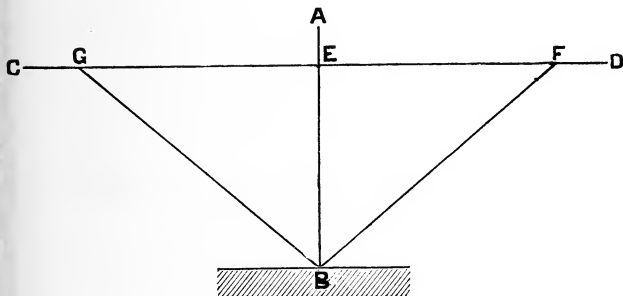
HOW TO INCREASE THE HORSE-POWER OF AN ENGINE HAVING A SHAFT GOVERNOR.

Suppose it is desired to increase the speed of the engine from 250 to 275 revolutions per minute, cutting off at $\frac{1}{4}$ stroke. In this case the governor springs should be so adjusted that the throw of the eccentric will be the same at 275 revolutions that it was at 250 revolutions. This will require an increased consumption of steam per minute at the same initial cylinder pressure as before making the change, consequently more fuel will be required. If the speed of the engine is not to be changed, an increase of the horse-power may be obtained by increasing the initial cylinder pressure, if the condition of the boiler will so permit. Or, the initial cylinder pressure may remain unchanged and the governor springs and levers so adjusted as to give a later cut-off, say at $\frac{3}{8}$ or $\frac{7}{16}$ of the stroke, or whatever may be required to offset the increased permanent load, the speed of the engine remaining unchanged. Any one of the changes above described would necessitate an increased consumption of fuel.

HOW TO LINE THE ENGINE WITH A SHAFT PLACED AT A HIGHER OR A LOWER LEVEL.

We will suppose the latter shaft not yet in place, but to be represented by a line tightly drawn. From two points as far apart as practicable, drop plumb lines nearly, but not quite, touching this line. Then by these strain another line parallel with the first, and at the same level as the center line of the engine, and at right angles with this stretch another representing this center line, and extend both each way to permanent walls on which their terminations, when finally located, should be carefully marked, so they can at any time be reset. The problem is to get the latter line exactly at right angles with the former. Everything depends upon the accuracy with which this right

angle is determined. It is done by the method of right-angled triangles. There are two ways of applying this method. In the first, one end of a measuring line is attached to some point of line No. 1, and its other end is taken successively to points on line No. 2 on opposite sides of the intersection, as illustrated in the following figure, in which AB is a portion of line No. 1, and CD of line No. 2, the direction of which is to be determined. BF and BG are the same measuring line fixed at B , and applied to the line CD successively at the points F and G . The dis-



tances BF and BG being, therefore, the same, when EF is equal to EG , the lines AB and CD are at right angles with each other. In the second, application is made of the law that the square of the hypotenuse of a right-angle triangle is equal to the sum of the squares of the other two sides. Thus $3^2 + 4^2 = 5^2$. So if the above figure $EB = 4$, $EF = 3$, and $BF = 5$, the angle at E is a right-angle. Any unit of measure may be used, a foot is generally the convenient one; so any multiple of these numbers may be taken; as, for example, 6, 8 and 10. Respecting the comparative advantages of these two ways, the situation will often determine which is to be preferred. In the former, the diagonal

being the same line, fixed at *B* and brought successively to the points *F* and *G*, its length is immaterial, though generally the longer the better; and the only point to be determined is the equality of *E F* and *E G*, which may be compared with each other by marks on a rod. In the latter, the proportionate lengths, 3, 4 and 5, or their multiples, must be exactly measured. It is better adapted to places where a floor is laid and the measurements can be transferred by trammels. The result should be verified by repeating the operation on the opposite side of the intersection at *E*, and when so verified we have, in fact, the first process, without the additional and unnecessary trouble of determining the relative lengths of the lines. Care should be taken when a measuring line is used, to avoid errors from its elasticity. On this account, a rod is often employed. Points on the lines are best marked by tying on a white thread.

HOW TO LINE THE ENGINE WITH A SHAFT TO WHICH IT IS TO BE COUPLED DIRECT.

In this case, it is supposed that the engine bed and the bearings for the shaft are already approximately in position. They are leveled by a parallel straight edge and a spirit level. To line them horizontally, a line must be run through the whole series of bearings and continued to a permanent wall at each end, and its terminating points, when determined, carefully marked, as already directed. A piece of wood is tightly set in each end of each bearing and the surfaces of these are painted white or chalked. Then the middle of each piece being found by the compasses, two fine lines are drawn across it, equally distant from the middle, and having between them a space a little wider than the thickness of the line. This being then strained, nearly touching those blocks, or, if long, having its sag supported by them, the two marks on each block must be seen, one on each side of the line, with the line of white between.

HOW TO SET A SLIDE VALVE IN A HURRY.

Open your cylinder cocks; then open the throttle slightly, so as to admit a small amount of steam to the steam-chest. Roll your eccentric forward in the direction the engine runs, until steam escapes from the cylinder cock at the end where the valve should begin to open. Now screw your eccentric fast to the shaft. Roll your crank to the next center and ascertain if steam escapes at the same point, at the opposite end of the cylinder. If so, ring your bell and go ahead. You are all right and can run until an opportunity occurs to you to open your steam-chest and examine your valve.

DO YOU DO THESE THINGS?

A writer in a contemporary asks and answers the following pertinent questions: —

Do you take a squirt-can in one hand and project a stream of oil as far as you can throw it, in order to save going to the oil hole itself?

If you do, don't do it any more; willful waste is downright robbery.

Do you use an oil can at all for oiling, except on emergency, or for the moment?

If you do, don't do it any more, for much better lubrications can be had by automatic apparatus.

Do you keep an old tin coffee pot full of suet on the steam-chest, and every time you have nothing else to do, pour a dipperful into the steam-chest?

If you do, stop it and get a sight-feed cup, which will save you the labor of slushing the cylinder and save the cylinder and valve-seats, the piston and follower, and all other places touched by the grease.

Do you feed the boiler until the water is out of sight in the glass, then shut off the feed, put in a big fire and sit down in a dark corner with a four-horse brier pipe and smoke, until you happen to think that maybe the water is low?

If you do these things you should notify the coroner that some day his services will be needed, but it is better to cease the practice mentioned before the coroner comes.

Do you stop leaks about the boiler as fast as they occur, or do you wait until the places sound like a snake's den before you stir?

If you do, you waste heat, which is the same word as money, only differently spelled. Every jet of hot water leaking from a steam boiler is just so much money thrown away, and if it was your money you would be bankrupt in a short time, in some boiler rooms.

Do you take a screw wrench and yank away at a bolt or nut under steam pressure?

If you do, there will come a time, sooner or later, when you will do so once too often, and either kill yourself or some one else. Bolts and nuts are liable to strip or break if tampered with under pressure, and they never tell any one beforehand when they are going to do it.

Do you attempt to stop pounding in the engine by laying for the crank-pin as it comes round, and trying to hit the key once in a while?

If you do, ask the strap and neck of the connecting-rod how he likes it, when you don't hit the key and do hit the oil cup?

Do you pack the piston by taking it out of the cylinder, laying it on the floor, setting out the rings, and then when the piston will not go into the cylinder, try to batter it in with a four-foot stick of cordwood?

If you do, you should reform, and pack the piston in the cylinder where it belongs, being sure to get it central by measuring from the lathe center in the end of the piston rod.

Do you put a new turn of packing on top of the old, hard-burned stuff when the piston rod leaks steam?

If you do, you will have a scored piston rod and broken gland bolts some day. Packing under heat and pressure gets so hard that it cuts like a file when left in the stuffing box, and as one begins to leak all the old stuff should be pulled out and new put in its place.

Fig. 1.

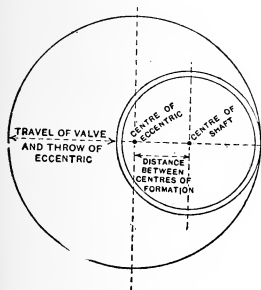
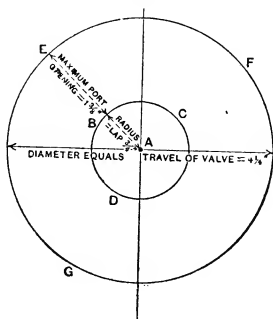


Fig. 2.



The travel of a slide valve is found as follows: 'The maximum port opening at the head end, plus the maximum port opening at the crank end, plus the lap at the head end, plus the lap at the crank end. Therefore — $1\frac{3}{8}'' + 1\frac{3}{8}'' + \frac{3}{4}'' + \frac{3}{4}'' = 4\frac{1}{4}''$, the required travel of valve. Incidentally, it may be well to mention that the travel of a valve may also be obtained from the eccentric, by subtracting the thin part of the eccentric and from the thick part as per Fig. 1, or again, by taking twice the distance between the center of rotation and center of the eccentric. This distance on the eccentric is the full valve travel, and is termed the "throw" of the eccentric. In the above question, the travel may also be

found by the aid of the diagram, Fig. 2, which is explained as follows: From the center A , with a radius of $\frac{3}{4}$ inch (lap), describe a circle $B C D$. From any point in the circumference, say B , lay off the distance $B E$ equal to the maximum port opening, $1\frac{3}{8}$ " ; from the center A , with a radius $A E$, describe the circle $E F G$; the diameter of the circle $E F G$ is equal to the travel of the valve, which is $4\frac{1}{4}$ ". Let the readers try this with another set of figures, to prove the correctness of the diagram.

Table of Heating Surface in Square Feet.

Diam. of Boiler in inches	24	30		34	36	38	40	42	44	48	
$\frac{3}{4}$ Heating surface of shell per foot of length.	4.19	5.24		5.93	6.28	6.63	6.98	7.73	7.68	8.38	
Diameter of Tube or Flue in inches.	2	2 $\frac{1}{2}$	3	3 $\frac{1}{2}$	4	4 $\frac{1}{2}$	5	6	7	8	
Whole External Heating surface per foot length.	.524	.655	.785	.916	1.05	1.18	1.31	1.57	1.83	2.09	
50	52	54	56	58	60	62	64	66	68	70	72
8.73	9.08	9.42	9.77	10.12	10.47	10.82	11.17	11.52	11.87	12.22	12.57
9	10	11	12	13	14	15	16	17	18		20
2.36	2.62	2.88	3.14	3.40	3.66	3.93	4.19	4.45	4.71		5.24

CHAPTER XXII.

HORSE-POWER OF GEARS.

To determine the horse-power which any gear-wheel will transmit, four facts are required to be known: —

1st. The kind of wheel, whether spur, bevel, spur mortise, or bevel mortise. 2d. The pitch. 3d. The face. 4th. The velocity of pitch circle in feet per second.

Generally, the fourth fact is not known. It can be found if the pitch diameter of the wheel in inches and the number of revolutions per minute are given, for it can be obtained from them by the following rule: —

Rule. — Given the pitch diameter in inches and the number of revolutions per minute; to find the velocity of pitch line in feet per second.

First, multiply the pitch diameter (in inches) by the number of revolutions per minute. Second, divide the product thus found by 230. The quotient is the velocity required.

Example. — What is the velocity of the high pitch diameter of a gear-wheel in feet per second, the pitch diameter = 43 inches, the revolutions per minute = 125?

$$43 \times 125 \text{ divided by } 230 = 23.4 \text{ feet per second.}$$

Table 1 shows the greatest horse-power which different kinds of gears of 1-inch pitch and 1-inch face will safely transmit at various pitch-line velocities. To find the greatest horse-power which any other pitch and face will safely transmit, the following rule can be used: —

Rule. — Given, the pitch (in inches), face (in inches), velocity of pitch circle (in feet per second), and kind of gear; to find the greatest horse-power that can be safely transmitted.

First. Find the horse-power in Table 2, which the given kind

of wheel with 1-inch pitch and 1-inch face will transmit at the given velocity. Second. Multiply the pitch by the face. Third. Multiply the horse-power found by the product of pitch by face. The final product is the horse-power required.

Example. — What is the greatest horse-power that a bevel-wheel, 43" pitch diameter, 2" pitch, 6" face, and 125 revolutions per minute will safely transmit?

From previous example, we have found the pitch-line velocity to be 23.4 feet per second, which is nearest to a velocity of 24 feet per second in Table 1.

First, the horse-power which a bevel wheel of 1" pitch and 1' face will transmit is (from table) at this velocity 4.931.

Second, the product of pitch by face is $2 \times 6 = 12$.

Third, $12 \times 4.931 = 59.17$ horse-power. Answer.

Whenever it is desirable to know about the average horse-power that any wheel will transmit, $\frac{2}{3}$ or $\frac{1}{2}$ of the results obtained by the rule above should be taken.

TABLE 1. — TABLE SHOWING THE HORSE-POWER WHICH DIFFERENT KINDS OF GEAR WHEELS OF ONE INCH PITCH AND ONE INCH FACE WILL TRANSMIT AT VARIOUS VELOCITIES OF PITCH CIRCLE.

1	2	3	4	5
Velocity of pitch circle in ft. per sec.	Spur Wheels.	Spur Mortise Wheels.	Bevel Wheels.	Bevel Mortise Wheels.
2	1.338	.647	.938	.647
3	1.756	.971	1.227	.856
6	2.782	1.76	1.76	1.363
12	4.43	3.1	3.1	2.16
18	5.793	4.058	4.058	2.847
24	7.052	4.931	4.931	3.447
30	8.182	5.727	5.727	4.036
36	9.163	6.314	6.414	4.516
42	10.156	7.102	7.102	4.963
48	10.083	7.680	7.680	5.411

NOTE. — When velocities are given, which are between these in Table, the horse-power can be found by interpolation.

Thus, the horse-power for spur wheels at 14 feet velocity is found as follows: —

$$\left. \begin{array}{l} 14 \text{ minus } 12 = 2 \\ 18 \text{ " } 12 = 6 \end{array} \right\} 5.793 \text{ minus } 4.43 = 1.363.$$

Then $\frac{2}{6}$ of $1.363 = .454$ and $.454 + 4.43 = 4.884$ horse-power.

TABLE 2. — SHAFTING. — HORSE-POWER TRANSMITTED BY VARIOUS SHAFTS, AT 100 REVOLUTIONS PER MINUTE UNDER VARIOUS CONDITIONS.

1	2	3	4	1	2	3	4
Diameter of Shaft.	Line Shafts.	Shaft as a Prime Mover.	Shafts Under Slight Bending Strain.	Diameter of Shaft.	Line Shafts.	Shaft as a Prime Mover.	Shafts Under Slight Bending Strain.
$\frac{1\frac{5}{16}}{1\frac{3}{8}}$.7	.4	1.3	$3\frac{1\frac{1}{8}}{1\frac{5}{8}}$	40.	20.	80.
$1\frac{3}{8}$	1.3	.7	2.6	$3\frac{1\frac{3}{8}}{1\frac{7}{8}}$	49.	25.	97.
$1\frac{7}{8}$	2.4	1.2	4.7	$4\frac{7}{8}$	70.	35.	139.
$1\frac{1}{8}$	3.8	1.9	7.6	$4\frac{9}{8}$	96.	48.	192.
$1\frac{5}{8}$	5.8	2.9	11.5	$5\frac{7}{8}$	126.	64.	256.
$2\frac{3}{8}$	8.3	4.2	16.6	$5\frac{5}{8}$	167.	84.	334.
$2\frac{7}{8}$	11.5	5.8	23.	$6\frac{5}{8}$	266.	133.	532.
$2\frac{1}{8}$	15.5	7.8	31.	$7\frac{5}{8}$	399.	200.	797.
$2\frac{5}{8}$	20.	10.	40.	$8\frac{5}{8}$	570.	285.	1139.
$3\frac{1}{8}$	26.	13.	51.	$9\frac{5}{8}$	783.	392.	1566.
$3\frac{7}{8}$	33.	17.	65.				

This table states the horse-power that various sizes of shafts will safely transmit at 100 revolutions per minute under various conditions.

Prime movers are those shafts in which the variation above and below the average horse-power transmitted is great, also where the transverse strain due to belts or heavy pulleys is large, such as jack-shafts, crank-shafts, etc.

DIAMETER OF SHAFTS FOR SINGLE BELTS.

To find the horse-power for any shaft for any speed different from 100, multiply suitable number for size of shaft given in table by the actual speed of shaft, and divide by 100.

Example. — What horse-power will a line-shaft $2\frac{15}{16}$ " diameter transmit, speed 160 revolutions per minute?

20×160 divided by $100 = 32$ horse-power.

SHOWING DIAMETER OF SHAFTS FOR SINGLE BELTS OF VARIOUS WIDTHS, THE DISTANCE BETWEEN HANGERS IMAGINED 1 FOOT.

1	2	1	2
Diameter of Shaft.	Width of Belt in Inches.	Diameter of Shaft.	Width of Belt in Inches.
$\frac{15}{16}$ "	5"	$3\frac{3}{16}$ "	211"
$1\frac{3}{16}$ "	11"	$3\frac{7}{16}$ "	264"
$1\frac{7}{16}$ "	19"	$3\frac{11}{16}$ "	326"
$1\frac{11}{16}$ "	31"	$3\frac{15}{16}$ "	398"
$1\frac{15}{16}$ "	47"	$4\frac{3}{16}$ "	569"
$2\frac{3}{16}$ "	68"	$4\frac{15}{16}$ "	785"
$2\frac{7}{16}$ "	94"	$5\frac{7}{16}$ "	1048"
$2\frac{11}{16}$ "	126"	$5\frac{15}{16}$ "	1365"
$2\frac{15}{16}$ "	165"		

This table may be used to find the largest size belt any shaft will carry safely, when the kind of belt, the position of the pulley on shaft, and the distance between bearings are known.

Rule. — Given: single belt, pulley quarter-way from bearing diameter of shaft and distance between bearings.

Divide number in column 2 (opposite to size of shaft) by span in feet.

Example. — Single belt, pulley quarter-way from bearing, $2\frac{15}{16}$ " shaft, 8 ft. span.

165 " divided by $8 = 21$ ", width of single belt.

If pulley is situated half-way between bearings, divide by twice the span.

Example. — Single belt, pulley half-way between bearings, $2\frac{15}{16}$ " shaft, 8 ft. span.

$$2 \times 8 = 16. \quad 165 \text{ divided by } 16 = 10\frac{1}{2}" , \text{ width of belt.}$$

Rule. — Given: double belt, pulley quarter-way from bearing, diameter of shaft, and distance between bearings.

Divide number in column 2 (opposite to size of shaft) by twice the span in feet.

Example. — Double belt, pulley quarter-way from bearing, $3\frac{7}{16}$ " shaft, span 10 feet.

$10 \times 2 = 20$. 264 divided by 20 = 13", width of belt. If pulley is situated half-way between bearings, divide by four times the span.

Example. — Double belt, pulley half-way between bearings, $3\frac{7}{16}$ " shaft, span 10 feet.

$$10 \times 4 = 40. \quad 264 \text{ divided by } 40 = 6\frac{1}{2}" , \text{ width of belt.}$$

To allow for weight of pulley, divide weight by 100 and the quotient is equivalent to a single belt of that width; that is, a pulley weighing 1,200 lbs. would strain the shaft as much as a 12" single belt.

BELTING.

To ascertain horse-power which belts will transmit, multiply width of belt by diameter of pulley (in inches), by revolutions of pulley (per minute), by number in table (corresponding to the pull the belt can exert per inch of width).

Example. — 10" single horizontal belt, 36" pulley, 200 revolutions, pull taken at 50 lbs.

$$10" \times 36" \times 200 \times 0.0004 = 28.8 \text{ horse-power.}$$

The pulls which belts 1" wide will transmit are as follows: —

Single horizontal belts (pulleys nearly same diameter)	50 lbs.
Double " " " " "	100 "
Single vertical " " " " "	40 "
Double " " " " "	60 "

Single belts (large to very small pulleys)	10 lbs.
Double " " " "	15 "
Quarter twist, single belts	25 "
" " double "	40 "

CENTRIFUGAL FORCE.

The centrifugal force of a body depends upon its weight W in pounds; distance R in feet it is from the center of rotation, and the number of revolutions N it makes about that center each minute and equals $\frac{WRN^2}{2933}$.

Multiply the weight in pounds by radius in feet, by square of number of revolutions, and divide by 2933 = centrifugal force in pounds.

HORSE-POWER OF IRON AND STEEL SHAFTS.

FOR GIVEN DIAMETER AND SPEED.

Diameters of Shaft, in Inches.	Revolutions per Minute.									
	100	125	150	175	200	225	250	300	350	400
1¼	2.4	3.1	3.7	4.3	4.9	5.5	6.1	7.3	8.5	9.7
1½	4.3	5.3	6.4	7.4	8.5	9.5	10.5	12.7	14.8	16.9
1¾	6.7	8.4	10.1	11.7	13.4	15.1	16.7	20.1	23.4	26.8
2	10.0	12.5	15.0	17.5	20.0	22.5	25.0	30.0	35.0	40.0
2¼	14.3	17.8	21.4	24.9	28.5	32.1	35.6	42.7	49.8	57.0
2½	19.5	24.4	29.3	34.1	39.0	44.1	48.7	58.5	68.2	78.0
2¾	26.0	32.5	39.0	43.5	52.0	58.5	65.0	78.0	87.0	104.0
3	33.8	42.2	50.6	59.1	67.5	75.9	84.4	101.3	118.2	135.0
3¼	43.0	53.6	64.4	75.1	85.8	96.6	107.3	128.7	150.3	171.6
3½	53.6	67.0	79.4	93.8	107.2	120.1	134.0	158.8	187.6	214.4
3¾	65.9	82.5	97.9	115.4	121.8	148.3	164.8	195.7	230.7	243.6
4	80.0	100.0	120.0	140.0	160.0	180.0	200.0	240.0	280.0	320.0
4½	113.9	142.4	170.8	199.3	227.8	256.2	284.7	341.7	398.6	455.6
5	156.3	195.3	234.4	273.4	312.5	351.5	390.6	468.7	546.8	625.0
5½	207.9	260.0	311.9	363.9	415.9	459.9	520.0	623.9	727.9	830.0
6	270.0	337.5	405.0	472.5	540.0	607.5	675.0	810.0	945.0	1080.0
6½	343.3	429.0	514.9	600.7	686.5	772.4	858.0	1029.0	1201.0	1372.0
7	428.8	535.9	643.1	750.3	847.5	964.7	1071.9	1286.0	1500.0	1695.0
8	640.0	800.0	960.0	1120.0	1280.0	1440.0	1600.0	1920.0	2240.0	2560.0

WHEEL GEARING.

The **pitch** line of a wheel is the circle upon which the pitch is measured, and it is the circumference by which the diameter, or the velocity of the wheel, is measured. The pitch is the arc of the circle of the pitch line, and is determined by the number of teeth in the wheel. The true pitch (chordial), or that by which the dimensions of the tooth of a wheel are alone determined, is a straight line drawn from the centers of two contiguous teeth upon the pitch line. The line of centers is the line between the centers of two wheels. The radius of a wheel is the semi-diameter running to the periphery of a tooth. The pitch radius is the semi-diameter running to the pitch line. The length of a tooth is the distance from its base to its extremity. The breadth of a tooth is the length of the face of wheel. The teeth of wheels should be as small and numerous as is consistent with strength. When a pinion is driven by a wheel, the number of teeth in the pinion should not be less than eight. When a wheel is driven by a pinion, the number of teeth in the pinion should not be less than ten. The number of teeth in a wheel should always be prime to the number of the pinion; that is, the number of teeth in the wheel should not be divisible by the number of teeth in the pinion, without a remainder. This is in order to prevent the same teeth coming together so often as to cause an irregular wear of their faces. An odd tooth introduced into a wheel is termed a hunting-tooth or cog.

TO COMPUTE THE PITCH OF A WHEEL.

Rule. — Divide the circumference at the pitch-line by the number of teeth.

Example. — A wheel 40 in. in diameter, requires 75 teeth; what is its pitch?

$$\frac{3.1416 \times 40}{75} = 1.6755 \text{ in.}$$

TO COMPUTE THE CHORDIAL PITCH.

Rule. — Divide 180° by the number of teeth, ascertain the sin. of the quotient, and multiply it by the diameter of the wheel.

Example. — The number of teeth is 75 and the diameter 40 in. ; what is the true pitch ?

$$\frac{180}{75} = 2^\circ 24' \text{ and sin. of } 2^\circ 24' = .04188, \text{ which } \times 40 = 1.6752 \text{ in.}$$

TO COMPUTE THE DIAMETER OF A WHEEL.

Rule. — Multiply the number of teeth by the pitch, and divide the product by 3.1416.

Example. — The number of teeth in a wheel is 75, and the pitch 1.675 in. ; what is the diameter of it ?

$$\frac{75 \times 1.675}{3.1416} = 40 \text{ in.}$$

TO COMPUTE THE NUMBER OF TEETH IN A WHEEL.

Rule. — Divide the circumference by the pitch.

TO COMPUTE THE DIAMETER WHEN THE TRUE PITCH IS GIVEN.

Rule. — Multiply the number of teeth in the wheel by the true pitch, and again by .3184.

Example. — Take the elements of the preceding case.

$$75 \times 1.6752 \times .3184 = 40 \text{ in.}$$

TO COMPUTE THE NUMBER OF TEETH IN A PINION OR FOLLOWER TO HAVE A GIVEN VELOCITY.

Rule. — Multiply the velocity of the driver by its number of teeth, and divide the product by the velocity of the driven.

Example. — The velocity of a driver is 16 revolutions, the number of its teeth 54, and the velocity of the pinion is 48 ; what is the number of its teeth ?

$$\frac{16 \times 54}{48} = 18 \text{ teeth.}$$

2. A wheel having 75 teeth is making 16 revolutions per minute. What is the number of teeth required in the pinion to make 24 revolutions in the same time?

$$\frac{16 \times 75}{24} = 50 \text{ teeth.}$$

TO COMPUTE THE PROPORTIONAL RADIUS OF A WHEEL OR PINION.

Rule.— Multiply the length of the line of centers by the number of teeth in the wheel for the wheel, and in the pinion for the pinion, and divide by the number of teeth in both the wheel and the pinion.

TO COMPUTE THE DIAMETER OF A PINION, WHEN THE DIAMETER OF THE WHEEL AND NUMBER OF TEETH IN THE WHEEL AND PINION ARE GIVEN.

Rule.— Multiply the diameter of the wheel by the number of teeth in the pinion, and divide the product by the number of teeth in the wheel.

Example.— The diameter of a wheel is 25 in., the number of its teeth 210, and the number of teeth in the pinion 30; what is the diameter of the pinion?

$$\frac{25 \times 30}{210} = 3.57 \text{ in.}$$

TO COMPUTE THE CIRCUMFERENCE OF A WHEEL.

Rule.— Multiply the number of teeth by their pitch.

TO COMPUTE THE REVOLUTIONS OF A WHEEL OR PINION.

Rule.— Multiply the diameter or circumference of the wheel or the number of its teeth, as the case may be, by the number of its revolutions, and divide the product by the diameter, circumference, or number of teeth in the pinion.

Example.— A pinion 10 in. in diameter is driven by a wheel

2 ft. in diameter, making 46 revolutions per minute; what is the number of revolutions of the pinion?

$$\frac{2 \times 12 \times 46}{10} = 110.4 \text{ revolutions.}$$

TO COMPUTE THE VELOCITY OF A PINION.

Rule. — Divide the diameter, circumference or number of teeth in the driver, as the case may be, by the diameter, etc., of the pinion.

WHEN THERE IS A SERIES OR TRAIN OF WHEELS AND PINIONS.

Rule. — Divide the continued product of the diameter, circumference, or number of teeth in the wheels by the continued product of the diameter, etc., of the pinions.

Example. — If a wheel of 32 teeth drive a pinion of 10, upon the axis of which there is one of 30 teeth, driving a pinion of 8, what are the revolutions of the last?

$$\frac{32}{10} \times \frac{30}{8} = \frac{960}{80} = 12 \text{ revolutions.}$$

Ex. 2. — The diameters of a train of wheels are 6, 9, 9, 10 and 12 in.; of the pinions, 6, 6, 6, 6, and 6 in.; and the number of revolutions of the driving shaft or prime mover is 10; what are the revolutions of the last pinion?

$$\frac{6 \times 9 \times 9 \times 10 \times 12 \times 10}{6 \times 6 \times 6 \times 6 \times 6} = \frac{583200}{7776} = 75 \text{ revolutions.}$$

TO COMPUTE THE PROPORTION THAT THE VELOCITIES OF THE WHEELS IN A TRAIN WOULD BEAR TO ONE ANOTHER.

Rule. — Subtract the less velocity from the greater, and divide the remainder by one less than the number of wheels in the train; the quotient is the number, rising in arithmetical progression from the less to the greater velocity.

Example. — What should be the velocities of three wheels to produce 18 revolutions, the driver making 3?

18 minus 3 = $\frac{15}{2} = 7.5$ = number to be added to velocity of the driver = $7.5 + 3 = 10.5$ and $10.5 + 7.5 = 18$ revolutions. Hence, 3, 10.5 and 18 are the velocities of the three wheels.

GENERAL ILLUSTRATIONS.

1. A wheel 96 inches in diameter, having 42 revolutions per minute, is to drive a shaft 75 revolutions per minute, what should be the diameter of the pinion?

$$\frac{96 \times 42}{75} = 53.76 \text{ in.}$$

2. If a pinion is to make 20 revolutions per minute, required the diameter of another to make 58 revolutions in the same time. 58 divided by 20 = 2.9 = the ratio of their diameters. Hence if one to make 20 revolutions is given a diameter of 30 in., the other will be 30 divided by 2.9 = 10.345 in.

3. Required the diameter of a pinion to make $12\frac{1}{2}$ revolutions in the same time as one of 32 in. diameter making 26.

$$\frac{32 \times 26}{12.5} = 66.56 \text{ in.}$$

4. A shaft having 22 revolutions per minute, is to drive another shaft at the rate of 15, the distance between the two shafts upon the line of centers is 45 in.; what should be the diameter of the wheels?

Then, 1st, $22 + 15 : 22 :: 45 : 26.75$ = inches in the radius of the pinion.

2d. $22 + 15 : 15 :: 45 : 18.24$ = inches in the radius of the spur.

5. A driving shaft, having 16 revolutions per minute, is to drive a shaft 81 revolutions per minute, the motion to be communicated by two geared wheels and two pulleys, with an intermediate shaft; the driving wheel is to contain 54 teeth, and the

driving pulley upon the driven shaft is to be 25 in. in diameter ; required the number of teeth in the driven wheel, and the diameter of the driven pulley. Let the driven wheel have a velocity of $\sqrt{16 \times 81} = 36$ a mean proportional between the extreme velocities 16 and 81.

Then, 1st, $36 : 16 :: 54 : 24 =$ teeth in the driven wheel.

2d. $81 : 36 :: 25 : 11.11 =$ inches diameter of the driven pulley.

6. If, as in the preceding case, the whole number of revolutions of the driving shaft, the number of teeth in its wheel and the diameters of the pulley are given, what are the revolutions of the shafts?

Then, 1st, $18 : 16 :: 54 : 48 =$ revolutions of the intermediate shaft.

2d. $15 : 48 :: 25 : 80 =$ revolutions of the driven shaft.

TO COMPUTE THE DIAMETER OF A WHEEL FOR A GIVEN PITCH AND NUMBER OF TEETH.

Rule. — Multiply the diameter in the following table for the number of teeth by the pitch, and the product will give the diameter at the pitch circle.

Example. — What is the diameter of a wheel to contain 48 teeth of 2.5 in. pitch?

$$15.29 \times 2.5 = 38.225 \text{ in.}$$

TO COMPUTE THE PITCH OF A WHEEL FOR A GIVEN DIAMETER AND NUMBER OF TEETH.

Rule. — Divide the diameter of the wheel by the diameter in the table for the number of teeth, and the quotient will give the pitch.

Example. — What is the pitch of a wheel when the diameter of it is 50.94 in., and the number of its teeth 80?

$$\frac{50.94}{25.47} = 2 \text{ in.}$$

PITCH OF WHEELS.

A TABLE WHEREBY TO COMPUTE THE DIAMETER OF A WHEEL FOR A GIVEN PITCH, OR THE PITCH FOR A GIVEN DIAMETER.

From 8 to 192 teeth.

No. of Teeth.	Diameter.	No. of Teeth.	Diameter.	No. of Teeth.	Diameter.	No. of Teeth.	Diameter.	No. of Teeth.	Diameter.
8	2.61	45	14.33	82	26.11	119	37.88	156	49.66
9	2.93	46	14.65	83	26.43	120	38.2	157	49.98
10	3.24	47	14.97	84	26.74	121	38.52	158	50.3
11	3.55	48	15.29	85	27.06	122	38.84	159	50.61
12	3.86	49	15.61	86	27.38	123	39.16	160	50.93
13	4.18	50	15.93	87	27.7	124	39.47	161	51.25
14	4.49	51	16.24	88	28.02	125	39.79	162	51.57
15	4.81	52	16.56	89	28.33	126	40.11	163	51.89
16	5.12	53	16.88	90	28.65	127	40.43	164	52.21
17	5.44	54	17.2	91	28.97	128	40.75	165	52.52
18	5.76	55	17.52	92	29.29	129	41.07	166	52.84
19	6.07	56	17.8	93	29.61	130	41.38	167	53.16
20	6.39	57	18.15	94	29.93	131	41.7	168	53.48
21	6.71	58	18.47	95	30.24	132	42.02	169	53.8
22	7.03	59	18.79	96	30.56	133	42.34	170	54.12
23	7.34	60	19.11	97	30.88	134	42.66	171	54.43
24	7.66	61	19.42	98	31.2	135	42.98	172	54.75
25	7.98	62	19.74	99	31.52	136	43.29	173	55.07
26	8.3	63	20.06	100	31.84	137	43.61	174	55.39
27	8.61	64	20.38	101	32.15	138	43.93	175	55.71
28	8.93	65	20.7	102	32.47	139	44.25	176	56.02
29	9.25	66	21.02	103	32.79	140	44.57	177	56.34
30	9.57	67	21.33	104	33.11	141	44.88	178	56.66
31	9.88	68	21.65	105	33.43	142	45.2	179	56.98
32	10.2	69	21.97	106	33.74	143	45.52	180	57.23
33	10.52	70	22.29	107	34.06	144	45.84	181	57.62
34	10.84	71	22.61	108	34.38	145	46.16	182	57.93
35	11.16	72	22.92	109	34.7	146	46.48	183	58.25
36	11.47	73	23.24	110	35.02	147	46.79	184	58.57
37	11.79	74	23.56	111	35.34	148	47.11	185	58.89
38	12.11	75	23.88	112	35.65	149	47.43	186	59.21
39	12.43	76	24.2	113	35.97	150	47.75	187	59.53
40	12.74	77	24.52	114	36.29	151	48.07	188	59.84
41	13.06	78	24.83	115	36.61	152	48.39	189	60.16
42	13.38	79	25.15	116	36.93	153	48.7	190	60.48
43	13.7	80	25.47	117	37.25	154	49.02	191	60.81
44	14.02	81	25.79	118	37.56	155	49.34	192	61.13

TO COMPUTE THE STRESS THAT MAY BE BORNE BY A TOOTH.

Rule. — Multiply the value of the material of the tooth to resist transverse strain, as estimated for this character of stress, by the breadth and square of its depth, and divide the product by the extreme length of it in the decimal of a foot.

TO COMPUTE THE NUMBER OF TEETH OF A WHEEL FOR A GIVEN DIAMETER AND PITCH.

Rule. — Divide the diameter by the pitch, and opposite to the quotient in the following table is given the number of teeth.

TEETH OF WHEELS.

Epicycloidal. — In order that the teeth of the wheels and pinions should work evenly and without unnecessary rubbing friction, the face (from pitch line to top) of the outline should be determined by an epicycloidal curve, and the flank (from pitch line to base) by an hypocycloidal. When the generating circle is equal to half the diameter of the pitch circle, the hypocycloid described by it is a straight diametrical line, and consequently the outline of a flank is a right line and radial to the center of the wheel. If a like generating circle is used to describe face of a tooth of other wheel or pinion respectively, the wheel and pinion will operate evenly.

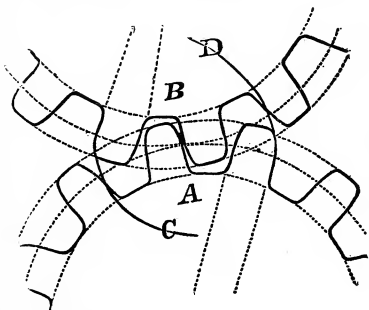
Involute. — Teeth of two wheels will work truly together when surfaces of their face is an involute; and that two such wheels should work truly, the circles from which the involute lines for each wheel are generated must be concentric with the wheels, with diameters in the same ratio as those of the wheels.

Curves of teeth. — In the pattern shop, the curves of epicycloidal or involute teeth are defined by rolling a template of the generating circle on a template corresponding to the pitch line, a scriber on the periphery of the template being used to define

the curve. Least number of teeth that can be employed in pinions having teeth of following classes, are: involute, 25; epicycloidal, 12; staves or pins, 6.

CONSTRUCTION OF GEARING.

If the dimensions of two wheels are determined, as well as the size of the teeth and spaces, the wheel is drawn as shown in figure. The starting-point for the division of the wheels is where the two pitch circles meet in *A*. It is advisable to determine the exact diameters of the wheels by calculation, if the difference between them is remarkable; for any division upon two circles of unequal size by means of a divider,

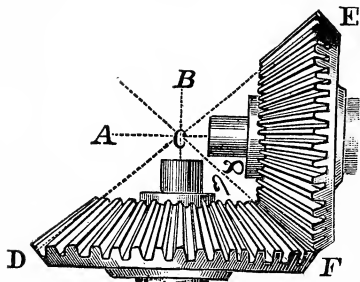


is incorrect, because the latter measures the chord instead of the arc. From the point *A* we construct the epicycloid *C*, by rolling the circle *A* upon *B*, as its base line. That short piece of the epicycloid, from the pitch line to the face of the tooth, is the curvature for that part of the tooth and the wheel *B*. This curvature obtained for one side of the tooth, serves for both sides of it, and also for all the teeth in the wheel. The lower part of the tooth, or that inside the pitch-line, is immaterial to the working of the wheel; this may be a straight line, as shown by the dotted lines which are in the direction of the diameters, or may be a curved line, as is seen in the wheel *A*. This line must be so formed as not to touch the upper or curved part of the tooth. The root of

the tooth, or that part of it which is connected with the rim of the wheel, is the weakest part of the tooth, and may be strengthened by filling the angles at the corners. The curvature for the teeth in the wheel *A* is found in a similar manner to that of *B*. The pitch circle *A* serves now as a base line, and the circle *B* is rolled upon it, to obtain the circle *D*. This line forms the curvature for the teeth of *A*, and serves for all the teeth in *A* — also for both sides of the teeth. In most practical cases the curvature of the teeth is described as a part of a circle, drawn from the center of the next tooth, or from a point more or less above or below that center, or the radius greater or less in strength than the pitch of the wheel. Such circles are never correct curves, and no rule can be established by which their size and center meets the form of the epicycloid.

BEVEL WHEELS.

If the lines *CA* and *BC* represent the prolonged axes, which are to revolve with different or similar velocities, the position and sizes of the wheels for driving these axes are determined by the distance of the wheels from the point *C*. The diameters of the wheels are as the angles *a* and *b* and inversely as the number of revolutions. These angles are, therefore, to be determined before the wheels can be drawn.



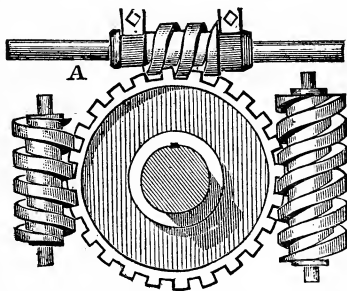
By measuring the distances from *C* to the line *E*, or from *C* to *F*, the sizes of the wheels are determined. These lines *E*, *F* and *D*, *F*, are the diameters for the pitch lines; from them the form

of the tooth is described on the beveled face of the wheel. If the form of the tooth is described on the largest circle of the wheel, all the lines from this face run to the point *C*, so that when the wheel revolves around its axis, all the lines from the teeth concentrate in the point *C*, and form a perfect cone. Curvature, thickness, length and spaces are here calculated as on face wheels; the thickness is measured in the middle of the width of the wheel.

WORM-SCREW.

If a single screw *A* works in a toothed wheel, each revolution of the screw will turn the wheel one cog; if the screw is formed of more than one thread, a corresponding number of teeth will be moved by each revolution.

With the increase of the number of threads, the side motion of the wheel and screw is accelerated; and when the threads and number of teeth are equal, an angle of 45° is required for teeth and thread, provided their diameters also are equal. This motion causes a great deal of friction and



it is only resorted to where no other means can be employed to produce the required motion. In small machinery, the worm is frequently made use of to produce a uniform, uninterrupted motion; the screw, in such cases, is made of hardened steel and the teeth of the wheel are cut by the screw which is to work in the wheel. If the form of the teeth in the wheel is not curved and its face is concave so as to fit the thread in all points, the screw will touch the teeth but in one point and cause them to be liable to breakage.

PROPORTIONS OF TEETH OF WHEELS.

Tooth.—In computing the dimensions of a tooth, it is to be considered as a beam fixed at one end, the weight suspended from the other, or face of the beam; and it is essential to consider the element of velocity, as its stress in operation, at high velocity with irregular action, is increased thereby. The dimensions of a tooth should be much greater than is necessary to resist the direct stress upon it, as but one tooth is proportioned to bear the whole stress upon the wheel, although two or more are actually in contact at all times; but this requirement is in consequence of the great wear to which a tooth is subjected, the shocks it is liable to form lost motion when so worn as to reduce its depth and uniformity of bearing, and the risk of the breaking of a tooth from a defect. A tooth running at a low velocity may be materially reduced in its dimensions compared with one running at high velocity and with a like stress. The result of operations with toothed wheels, for a long period of time, has determined that a tooth with a pitch of 3 inches and a breadth 7.5 inches will transmit, at a velocity of 6.66 feet per second, the power of 59.16 horses.

TO COMPUTE THE DEPTH OF A CAST-IRON TOOTH.

1. When the stress is given.

Rule.—Extract the square root of the stress, and multiply it by .02.

Example.—The stress to be borne by a tooth is 4886 lbs.; what should be its depth?

$$4886 \times .02 = 1.4 \text{ in.}$$

2. When the horse-power is given.

Rule.—Extract the square-root of the quotient of the horse-power divided by the velocity in feet per second, and multiply it by .466.

Example. — The horse-power to be transmitted by a tooth is 60, and the velocity of it at its pitch-line is 6.66 feet per second; what should be the depth of the tooth?

$$\frac{60}{6.66} \times .466 = 1.398 \text{ in.}$$

TO COMPUTE THE HORSE-POWER OF A TOOTH.

Rule. — Multiply the pressure at the pitch-line by its velocity in feet per minute, and divide the product by 33,000.

CALCULATING SPEED WHEN TIME IS NOT TAKEN INTO ACCOUNT.

Rule. — Divide the greater diameter, or number of teeth, by the lesser diameter or number of teeth, and the quotient is the number of revolutions the lesser will make, for one of the greater.

Example. — How many revolutions will a pinion of 20 teeth make, for 1 of a wheel with 125?

$$125 \text{ divided by } 20 = 6.25 \text{ or } 6\frac{1}{4} \text{ revolutions.}$$

To find the number of revolutions of the last to one of the first, in a train of wheels and pinions: —

Rule. — Divide the product of all the teeth in the driving by the product of all the teeth in the driven; and the quotient equals the ratio of velocity required.

Example 1. — Required the ratio of velocity of the last, to 1 of the first, in the following train of wheels and pinions, viz.: pinions driving — the first of which contains 10 teeth, the second 15, and third 18. Wheels driven, first teeth 15, second 25, and third 32. $\frac{10 \times 15 \times 18}{15 \times 25 \times 32} = .225$ of a revolution the wheel will make to one of the pinion.

Example 2. — A wheel of 42 teeth giving motion to 1 of 12, on which shaft is a pulley of 21 inches diameter, driving 1 of 6;

required the number of revolutions of the last pulley to 1 of the first wheel. $\frac{42 \times 21}{12 \times 6} = 12.25$ or $12\frac{1}{4}$ revolutions.

NOTE. — Where increase or decrease of velocity is required to be communicated by wheel-work, it has been demonstrated that the number of teeth on each pinion should not be less than 1 to 6 of its wheel, unless there be some other important reason for a higher ratio.

WHEN TIME MUST BE REGARDED.

Rule. — Multiply the diameter or number of teeth in the driver by its velocity in any given time, and divide the product by the required velocity of the driven; the quotient equals the number of teeth or diameter of the driven, to produce the velocity required.

Example 1. — If a wheel containing 84 teeth makes 20 revolutions per minute, how many must another contain, to work in contact, and make 60 revolutions in the same time?

$$80 \times 20 \text{ divided by } 60 = 28 \text{ teeth.}$$

Example 2. — From a shaft making 45 revolutions per minute and with a pinion 9 inches diameter at the pitch-line, I wish to transmit motion at 15 revolutions per minute; what, at the pitch-line, must be the diameter of the wheel?

$$45 \times 9 \text{ divided by } 15 = 27 \text{ inches.}$$

Example 3. — Required the diameter of a pulley to make 16 revolutions in the same time as one of 24 inches making 36.

$$24 \times 36 \text{ divided by } 16 = 54 \text{ inches.}$$

The distance between the centers and velocities of two wheels being given, to find their proper diameters: —

Rule. — Divide the greatest velocity by the least; the quotient is the ratio of diameter the wheels must bear to each other. Hence, divide the distance between the centers by the ratio $+ 1$; the quotient equals the radius of the smaller wheel; and subtract

the radius thus obtained from the distance between the centers; the remainder equals the radius of the other.

Example. — The distance of two shafts from center to center is 50 in. and the velocity of the one 25 revolutions per minute, the other is to make 80 at the same time; the proper diameters of the wheels at the pitch line are required.

80 divided by 25 = 3.2, ratio of velocity, and 50 divided by 3.2 + 1 = 11.9, the radius of the smaller wheel; then 50 minus 11.9 = 38.1, radius of larger; their diameters are 11.9 x 2 = 23.8 and 38.1 x 2 = 76.2 in.

To obtain or diminish an accumulated velocity by means of wheels and pinions, or wheels, pinions and pulleys, it is necessary that a proportional ratio of velocity should exist, and which is thus attained; multiply the given and required velocities together; and the square root of the product is the mean or proportionate velocity.

Example. — Let the given velocity of a wheel containing 54 teeth equal 16 revolutions per minute, and the given diameter of an intermediate pulley equal 25 in., to obtain a velocity of 81 revolutions in a machine; required the number of teeth in the intermediate wheel and diameter of the last pulley.

$\sqrt{81 \times 16} = 36$ mean velocity; 54×16 divided by 36 = 24 teeth, and 25×36 divided by 81 = 11.1 in., diameter of pulley.

TABLE OF THE WEIGHT OF A SQUARE FOOT OF SHEET IRON IN POUNDS AVOIRDUPOIS.

No. 1 is $\frac{5}{16}$ of an inch; No. 4, $\frac{1}{4}$; No. 11, $\frac{1}{8}$, etc.

No. on wire gauge,	1	2	3	4	5	6	7	8	9	10	11	12
Pounds avoird.,	12.5	12	11	10	9	8	7.5	7	6	5.68	5	4.62
No. on wire gauge,	13	14	15	16	17	18	19	20	21	22		
Pounds avoird.,	4.31	4	3.95	3	2.5	2.18	1.93	1.62	1.5	1.37		

SCREW-CUTTING.

In a lathe properly adapted, screws to any degree of pitch, or number of threads in a given length, may be cut by means of a leading screw of any given pitch, accompanied with change wheels and pinions; coarse pitches being effected generally by means of one wheel and one pinion with a carrier, or intermediate wheel, which cause no variation or change of motion to take place; hence, the following: —

Rule. — Divide the number of threads in a given length of the screw which is to be cut, by the number of threads in the same length of the leading screw attached to the lathe, and the quotient is the ratio that the wheel on the end of the screw must bear to that on the end of the lathe spindle.

Example. — Let it be required to cut a screw with 5 threads in an inch, the leading screw being of $\frac{1}{2}$ inch pitch, or containing 2 threads in an inch; what must be the ratio of wheels applied?

5 divided by 2 = 2.5, the ratio they must bear to each other. Then suppose a pinion of 40 teeth be fixed upon for the spindle; $40 \times 2.5 = 100$ teeth for the wheel on the end of the screw.

But screws of a greater degree of fineness than about 8 threads in an inch are more conveniently cut by an additional wheel and pinion, because of the proper degree of velocity being more effectively attained, and these, on account of revolving upon a stud, are commonly designated the stud-wheels, or stud-wheel and pinion; but the mode of calculation and ratio of screw are the same as in the preceding rule. Hence, all that is further necessary is to fix upon any three wheels at pleasure, as those for the spindle and stud-wheels; then multiply the number of teeth in the spindle-wheel by the ratio of the screw and by the number of teeth in that wheel or pinion which is in contact with the wheel on the end of the screw; divide the product by the stud-wheel in contact with the spindle-wheel, and the quotient is the number of teeth required in the wheel on the end of the leading screw.

Example. — Suppose a screw is required to be cut containing 25 threads in an inch, and the leading screw, as before, having two threads in an inch, and that a wheel of 60 teeth is fixed upon for the end of the spindle, 20 for the pinion in contact with the screw-wheel, and 100 for that in contact with the wheel on the end of the spindle; required the number of teeth in the wheel for the end of the leading screw.

$$25 \text{ divided by } 2 = 12.5, \text{ and } \frac{60 \times 12.5 \times 20}{100} = 150 \text{ teeth.}$$

Or suppose the spindle and screw wheels to be those fixed upon, also any one of the stud-wheels, to find the number of teeth in the other.

$$\frac{60 \times 12.5}{150 \times 100} = 20 \text{ teeth, or } \frac{6 \times 12.5 \times 20}{150} = 100 \text{ teeth.}$$

Transmission of Power by Manilla Rope. Horse-power Transmitted.

Feet per minute	1000	1500	2000	2500	3000	3500	4000	4500	5000
Diameter of Rope . . . $\frac{3}{4}$	$1\frac{3}{4}$	$2\frac{3}{4}$	$3\frac{1}{2}$	$4\frac{1}{2}$	$5\frac{1}{2}$	$6\frac{1}{2}$	7	8	9
“ “ . . . 1	$3\frac{1}{4}$	$4\frac{7}{8}$	$6\frac{1}{2}$	8	10	11	13	15	16
“ “ . . . $1\frac{1}{4}$	$5\frac{1}{8}$	$7\frac{1}{2}$	$10\frac{1}{4}$	13	15	18	20	23	26
“ “ . . . $1\frac{1}{2}$	$7\frac{1}{2}$	11	15	18	22	26	30	34	37
“ “ . . . $1\frac{3}{4}$	10	15	20	25	30	35	40	45	50
“ “ . . . 2	13	$19\frac{1}{2}$	26	33	39	46	52	59	65

Decimal Equivalents of One Foot by Inches.

$\frac{1}{4}$	$\frac{1}{2}$	$\frac{3}{4}$	1	2	3	4	5
.0208	.0417	.0626	.0833	.1667	.2500	.3333	.4167
6	7	8	9	10	11	12	
.5000	.5833	.6667	.7510	.8333	.9167	1.000	

TABLE OF TRANSMISSION OF POWER BY WIRE ROPES.

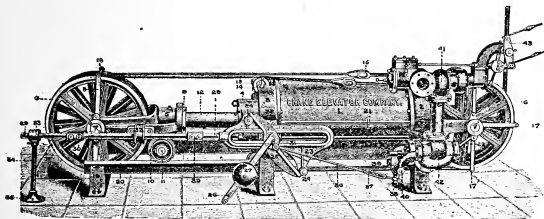
This table is based upon scientific calculations, careful observations and experience, and can be relied upon when the distance exceeds 100 feet. We also find by experience that it is best to run the Wire Rope Transmission at *the medium number of revolutions* indicated in the table, as it makes the best and smoothest running transmission. If more power is needed than is indicated at 80 to 100 revolutions, choose a larger diameter of sheave.

Diameter of Sheave in ft.	Number of Revolutions.	Diameter of Rope.	Horse-Power.	Diameter of Sheave in ft.	Number of Revolutions.	Diameter of Rope.	Horse-Power.
3	80	$\frac{3}{8}$	3	7	140	$\frac{1}{2}$	35
3	100	$\frac{3}{8}$	$3\frac{1}{2}$	8	80	$\frac{1}{2}$	26
3	120	$\frac{3}{8}$	4	8	100	$\frac{1}{2}$	32
3	140	$\frac{3}{8}$	$4\frac{1}{2}$	8	120	$\frac{1}{2}$	39
4	80	$\frac{3}{8}$	4	8	140	$\frac{1}{2}$	45
4	100	$\frac{3}{8}$	5	9	80	$\frac{9}{16}$	47
4	120	$\frac{3}{8}$	6	9	100	$\frac{9}{16}$	48
4	140	$\frac{3}{8}$	7	9	120	$\frac{9}{16}$	58
5	80	$\frac{7}{16}$	9	9	140	$\frac{9}{16}$	69
5	100	$\frac{7}{16}$	11	10	80	$\frac{11}{16}$	73
5	120	$\frac{7}{16}$	13	10	100	$\frac{11}{16}$	82
5	140	$\frac{7}{16}$	15	10	120	$\frac{11}{16}$	84
6	80	$\frac{1}{2}$	14	10	140	$\frac{11}{16}$	61
6	100	$\frac{1}{2}$	17	12	80	$\frac{11}{16}$	68
6	120	$\frac{1}{2}$	20	12	100	$\frac{11}{16}$	80
6	140	$\frac{1}{2}$	23	12	120	$\frac{11}{16}$	85
7	80	$\frac{9}{16}$	20	12	140	$\frac{11}{16}$	96
7	100	$\frac{9}{16}$	25	14	80	$1\frac{1}{8}$	102
7	120	$\frac{9}{16}$	30	14	100	$1\frac{1}{8}$	112
						$1\frac{1}{8}$	119
						$1\frac{1}{8}$	93
						$1\frac{1}{8}$	99
						$1\frac{1}{8}$	116
						$1\frac{1}{8}$	124
						$1\frac{1}{8}$	140
						$1\frac{1}{8}$	149
						$1\frac{1}{8}$	173
						$1\frac{1}{8}$	141
						$1\frac{1}{8}$	148
						$1\frac{1}{8}$	176
						$1\frac{1}{8}$	185

CHAPTER XXIII.

HYDRAULIC ELEVATORS.

The purpose of these pages is to furnish such instructions and information as will be of use to engineers in the welfare of elevator machinery. To accomplish this end, cuts and sectional views of cylinders and valves of the different types of elevator machinery made by the different elevator companies, are herein produced,

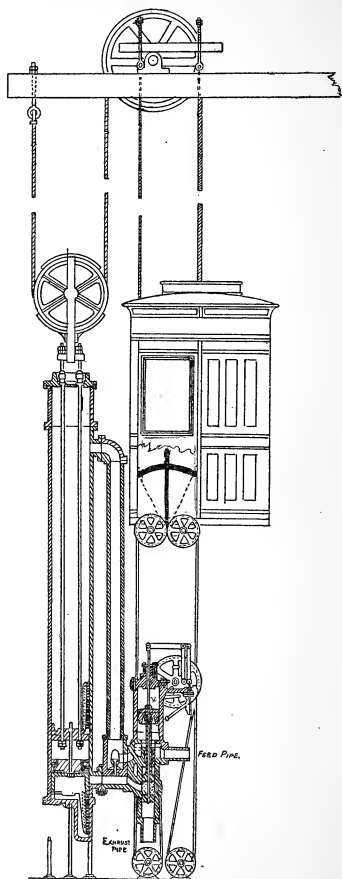


HORIZONTAL HYDRAULIC PASSENGER MACHINE.

so as to make the different elevators plain to the engineer. It must be borne in mind that the one point of paramount importance for the successful operation of an elevator is proper care and management; a lack of thorough knowledge of the machine and lack of attention in this respect shortens the life of the machine and often makes extensive repairs necessary.

HOW TO PACK HYDRAULIC VERTICAL CYLINDER ELEVATORS.

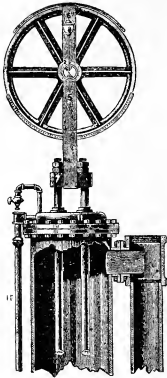
Packing vertical cylinder piston from top.—Run the car to the bottom and close the gate valve in the supply pipe. Open the air cock at the head of the cylinder, and also keep open the



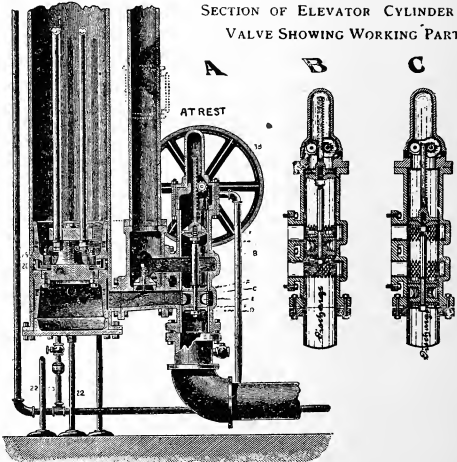
Showing how to set the rope on the lever elevator; the sheaves want to be on the center of the travel, as shown.

valve in the drain pipe from the side of the cylinder long enough to drain the water in the cylinder down to the level of the top of the piston. Now remove the top head of the cylinder, slipping it and the piston rods up out of the way, and fasten there. If the piston is not near enough to the top of the cylinder to be accessible, attach a rope or small tackle to the main cables (not the counter-balance cables) a few feet above the car, and draw them down sufficiently to bring the piston within reach. Remove the bolts in the piston follower by means of the socket wrench furnished for that purpose. Mark the exact position of the piston follower before removing it, so that there will be no difficulty in replacing it. On removing the piston follower you will find a leather cup turned upwards, with coils of $\frac{5}{8}$ -inch square duck packing on the outside. This you will remove and clean out the dirt; also clean out the holes in the piston through which the water acts upon the cup. If the leather cup is in good condition, replace it, and on the outside place three new coils of $\frac{5}{8}$ -inch square duck packing, being careful that they break joints, and also that the thickness of the three coils up and down does not fill the space by $\frac{1}{4}$ inch, as in such case the water might swell the packing sufficiently to cramp it in this space, thus destroying its power to expand. If too tight, strip off a few thicknesses of canvas. Replace the piston follower and let the piston down to its right position. Replace the cylinder head and gradually open the gate valve in the supply pipe, first being sure that the operating valve is on the down stroke or it is so the car is coming down. As soon as the air has escaped before closing the air cock to make sure the air is all out of the cylinder, make a few trips, and the elevator is ready to run.

Packing the vertical cylinder valves.—To pack the valve, run the car to the bottom and close the gate valve in the supply pipe. Then throw the operating valve for the car to go up, open the air cock at the head of the cylinder and the valve in the drain pipe at the bottom, and the water will drain out of the cylinder.



SECTION OF ELEVATOR CYLINDER AND VALVE SHOWING WORKING PARTS.



OTIS VERTICAL HYDRAULIC PASSENGER AND FREIGHT MACHINE.

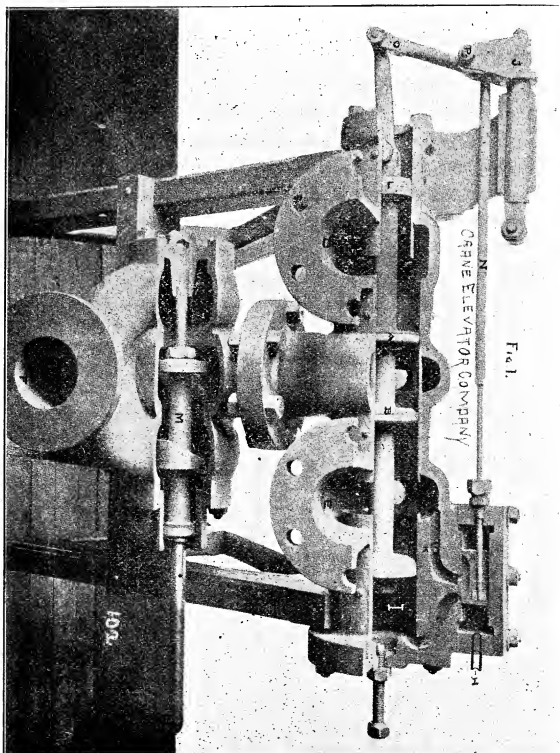
A shows the position of the valve at rest. *B* shows the position of the valve when the car is going up or hoisting. *C* shows the position of the valve when the car is coming down or lowering.

When the cylinder is empty, reverse the valve for the car to run down, so as to let the water out of the circulating pipe. In cases of tank pressure, where the level of the water in the lower tank is above the bottom of the cylinder, the gate valve in the discharge pipe will have to be closed as soon as the water in the cylinder is on a level with that in the tank, allowing the rest to pass through the drain pipe to the sewer. As soon as the water has all drained off, take off the valve cap and remove the pinion shaft and sheave, marking the position of the sheave and the relation which the teeth on the pinion bear to the teeth on the rack before removing. You can now take out the valve plunger and put the new cup leather packings on in the same position as you find the old ones. Replace all the parts as first found. Before refilling the cylinder, close the valves in the drain pipes, but leave the air cock at the head of the cylinder open and be careful that the operating valve is in position for the car to go down. Gradually open the gate valve in the supply pipe. When the cylinder has filled with water and the air has escaped, close the air cock and open the gate valve in the discharge pipe.

Packing piston rods. — Close the gate valve in the supply pipe. Remove the followers and glands to the stuffing boxes and clean out the old packing. Repack with about eight turns of $\frac{1}{4}$ inch flax packing to each rod, and replace glands and followers. Screw down the followers only tight enough to prevent leaking.

Packing Otis Vertical Piston from bottom. — Remove the top stop-button on hand rope and run the car up until the piston strikes the bottom head in cylinder. Secure the car in this position by passing a strong rope under the girdle or crosshead and over the sheave timbers. When secured, close the gate valve in the supply pipe, open the air cock at the head of the cylinder, and throw the operating valve for the car to go up. Also open the valve in the drain pipe from the side of the cylinder, and from the lower head of the cylinder, thus allowing the water to drain

out of the cylinder. When the cylinder is empty, throw the valve for the car to descend in order to drain the water from the circulating pipe. In case of tank pressure, where level of water in lower tank is above the bottom of the cylinder, the gate valve in the discharge pipe will have to be closed as soon as the water in the cylinder is on a level with that of the tank, allowing the rest to pass through the drain pipe to the sewer. When the water is all drained off, remove the lower head of the cylinder, and the piston will be accessible. Remove the bolts in the piston follower by means of the socket wrench, which is furnished for that purpose. Before removing the piston head, mark its exact position, then there will be no difficulty in replacing it; also be careful and not let the piston get turned in the cylinder, so as to twist the piston rods. On removing the piston follower, you will find a leather cup turned upwards, with coils of $\frac{5}{8}$ in. square duck packing on the outside. This you will remove and clean out the dirt; also clean out the holes in the piston, through which the water acts upon the cups. If the leather cup is in good condition, replace it and on the outside place three new coils of $\frac{5}{8}$ inch square duck packing, being careful that they break joints and also that the thickness of the three coils up and down does not fill the space by $\frac{1}{4}$ inch, as in such case the water might swell the packing sufficiently to cramp it in this space, thus destroying its power to expand. If too tight, strip off a few thicknesses of canvas. Replace the piston follower and cylinder head, and the cylinder is ready to refill. Close the valves in the drain pipes, leave the air cock open at the head of the cylinder and the operating valve in the position to descend, and open gate valve in the discharge. Slowly open the gate valve in the supply pipe, allowing the cylinder to fill gradually and the air to escape at the head of the cylinder. When the cylinder is full of water, leave the air cock open and put the operating valve on the center. Make a few trips before closing the air valve. The car can then be untied, the stop button reset and the elevator is ready to use.



The above cut is the Auxiliary Valve for Crane Hydraulic Passenger Elevators.

The operation of this valve is explained as follows: *D* represents the supply inlet; *E*, the discharge outlet; *F*, the opening

to the cylinder; *G*, the pilot valve; *H*, the pilot valve supply pipe to the motor cylinder; *N* and *J*, the attachment by which the valve is operated. Fig. 1 represents the valve on centers, or the car at rest at any floor between limits of travel. It will be noticed in cut that the plunger heads *A* and *B* are on either side of the central opening. The water is then entirely cut off from the machine and the pilot valve covers the port *C*. To start the car up, water is admitted to the cylinder *I* through the inlet *D*. This is accomplished by pushing on the connection in which opens the port *C* in the pilot valve *G*, allowing the water in the motor cylinder *I* to flow into the discharge *E*. The flow is regulated by the screw *K*. The pressure in the motor cylinder *I* being relieved, the valve plunger moves to the right under the difference in pressure upon the plunger *A* and *L*, *L* being of smaller diameter than *A*. Supply is thus admitted to the cylinder through *F*. To start the car down, pull on the connection *J*. The port *C* in the pilot valve chest is opened, allowing water from the pilot supply *H* to flow into the motor cylinder *I*. The pressure on head forces the plunger *B* to move to the left. Water is thus allowed to pass out from *F* to the discharge *E*. If a slow movement of the car is desired, connection *J* is removed to the right or left for either up or down, and only enough to open the main valve slightly to give the desired speed. This speed is maintained by the lever *O* being moved on its fulcrum *P*, thus necessitating the valve *G* covering port *C*.

AUTOMATIC STOP VALVE.

The stop valve *M* is opened automatically by the machine as the elevator starts from the top or bottom landing, giving free flow of water to the cylinder. As the car reaches the upper or lower limit of travel, the valve is automatically closed, so that the car stops gradually at the terminals.

OTIS GRAVITY WEDGE SAFETY.

1. Under the car is a heavy hardwood safety plank, on each end of which is an iron adjustable jaw, inclosing the guide on the guide post. In this jaw is an iron wedge, withheld from contact with the guide in regular duty. Under the wedge is a rocker arm, or equalizing bar, with one of the lifting cables attached independently at each extremity. The four lifting cables, after being thus attached, pass over a wrought iron girdle at the top of the car. Each cable carries an equal strain, and the breakage of any one cable puts the load on the other cables, which throws the rocker out of equilibrium and forces the wedges on both sides instantly and immovably between the iron jaws of the safety plank and the side of the guides, stopping the car. It may be raised to any position by the unbroken cables, though it cannot be lowered until a new cable is put on.

2. Any cable will always stretch before it breaks, which will throw the equalizing safety-bar out of equilibrium and force the wedges on both sides into position. *No other safety device will give warning in advance.*

CARE OF HALE ELEVATORS.

Keep the guide springs on the girdle above, and the safety plank below the car adjusted, so that the car will not wobble, but not tight enough to bind against guides. When cables are drawing alike, the equalizing bars on a passenger elevator should be horizontal, and the set screws free from contact with the finger shaft, but adjusted so that one of them will come in contact with the finger shaft when the equalizing bar is tipped a certain amount either way. If the safety wedges should be thrown in, or rattle, when descending, the cause would be from the stretching or breaking of one of the cables, the action of the governor, or from weakness of either the spring on the finger shaft,

safety-wedge or gummy guides. In the first case, if occasioned by the cable stretching, the cable should be examined thoroughly, and if it shows weakness, a new one put on, otherwise, it can be shortened up, as stated above. In the second case, the car had probably attained excessive speed and the governor simply performed its proper function. In the third case, new springs should be put on and the guides kept clean, for it often happens that the guides are so dirty that the springs cannot well prevent the wedges catching. All the safeties should be kept clean and in good order, so that they will quickly respond when called upon to perform their duty. To loosen the wedges when thrown in, throw the valve for the car to ascend. If the wedges are thrown in above the top landing, remove the button on the hand cable and run the car up until the piston strikes the bottom of the cylinder. If this is not sufficient to loosen the wedges, the car will have to be raised by a tackle. Keep all nuts properly tightened.

If **traveling** or auxiliary sheave bushing is worn so that sheave binds, or the bushing is nearly worn through, turn it half round, and thus obtain a new bearing. If it has been once turned put in a new bushing. See that the piston rods draw alike. If they do not, it can be discerned by trying to turn the rods with the hand, or by a groaning noise in the cylinder. However, this groaning may also be caused by the packing being worn out, in which case the car would not stand stationary. See that all supports remain secure and in good condition.

WATER FOR USE IN HYDRAULIC ELEVATORS.

In **hydraulic** elevator service little heed is usually given to the quality of water with which the system is operated. Much loss of power by friction and many dollars spent annually in repairs can be avoided by a little thought and action on this subject. In order to prove the truth of this statement, one has only to obtain

two samples of water, one of soft water and the other of what is commonly known as hard water. For example, take rain water as the first sample and water from the well as the second. Now rub your hands briskly together while holding them immersed in one, and then in the other of these samples. You will instantly realize that the quality of water used in elevator service has much to do with the efficiency of the hydraulic machinery. Water from the service pipes of the city water-works always contains more or less sand and other gritty substances, in suspension, and this grit acts much the same on the packing and metal parts of the apparatus as does a sand blast. Some engineers, having realized the evil effects of water in the state that it is generally used, have attempted to remedy the matter by replacing the water which is lost by leakage or evaporation by the addition of the water which is discharged from the steam traps of the plant; and as this has been distilled, it is almost chemically pure — thus the man who uses distilled water in an elevator system instead of the water containing grit, is simply getting out of one difficulty into another.

It is a well-known fact in chemistry that pure water is a solvent for every known substance, and will especially attack iron to a large degree. Whenever it is practicable, the water for elevator use should be passed through a filter to remove grit before being allowed to pass into the surge tank. In many cases, however, it would be difficult for the engineer to convince the owner of the advisability of buying and installing a filter for this purpose. A simple and somewhat inexpensive remedy is within reach of all — the plentiful use of soap will obviate many of the evil effects of hardness of the water, will double the life of the packing, will reduce the loss by friction, and will, to a large extent, prevent the chattering of the pistons, making the elevators run much smoother. In laboratory practice, the degree of hardness or softness of water is determined by the amount of pure

soap that is necessary to mix with the water to form a lather, or to precipitate a certain quantity of carbonate of lime and other substances. This same action, on a larger scale, takes place when soap is introduced into an elevator tank, and while the oily portion of the soap forms an emulsion with the water, of great lubricating properties, the gritty matter is precipitated and can be gotten rid of through means of a blow-off in the bottom of the tank. The cheapest and most convenient form in which to obtain soap for this purpose, is the soap powder extensively manufactured by various firms and which can be purchased for about four cents per pound. In a plant of six elevators, with usually a storage capacity of some 8,000 gallons, it is a good practice to use about twenty pounds of this soap each week. The soap should be at first dissolved in about ten times its weight of boiling water, and when cold it will form a stiff soft soap. The practice of putting the refuse oil collected from the drip pans is of little value; it will not mix with the water, but floats on the surface. It rarely gets low enough to enter the suction pipes of the pumps, and has little or no tendency to precipitate the solid matter that is held in suspension in the water.

If **car** settles, the most probable cause is that the valve or piston needs repacking. If packing is all right, then the air valve in the piston does not properly seat. If the car springs up and down when stopping, there is air in the cylinder. When there is not much air, it can often be let out by opening the air cock and running a few trips, but when there is considerable air, run the car to near the bottom, placing a block underneath for it to rest upon, then place the valve for the car to descend. While in this position, open the air cock and allow the air to escape. This may have to be repeated several times before the air is all removed.

Keep the cylinder and connections protected from frost. Where exposed, the easiest way to protect the cylinder is by an

air-tight box, open at the bottom, at which point keep a gas jet burning during cold weather. Where there is steam in the building, run a coil near the cylinder. Keep stop buttons on hand cable properly adjusted, so that the car will stop at a few inches beyond either landing, before the piston strikes the head of the cylinder. Regulate the speed desired for the car by adjusting the back stop buttons, so that the valve can only be opened either way sufficiently to give this speed. Occasionally try the governor to see that it works properly. Keep the machinery clean and in good order.

ELEVATOR INCLOSURES AND THEIR CARE.

Elevator inclosures, while intended for protection to passengers, are often carelessly neglected and are often a source of danger, unless looked after and taken care of in a proper manner. It is of the utmost importance that no projection of any kind shall extend into the doorways for clothing of passengers to catch on, thus endangering their lives. The door should move freely to insure their action at the touch of the operator. See that all bolts and screws are tight, and replace at once all that fall out, otherwise, the doors and panels may swing into the path of the elevator cage and be torn off, and probably injure some one, thus placing the owner liable to damages. Elevator doors that are automatic in their closing are the best, but all operators should be held strictly responsible for accidents occurring from the carelessness of leaving doors open. All inclosures should be equipped with aprons above the doors to the ceiling and as close to the cage as possible, to prevent passengers from falling out or extending their person through to be caught by ceilings or beams in the elevator shaft. As a rule, proprietors of buildings take a pride in keeping their inclosures and cars in a neat condition, as they are considered an ornament to the building for the purpose for which they are intended, and no expense is spared in the

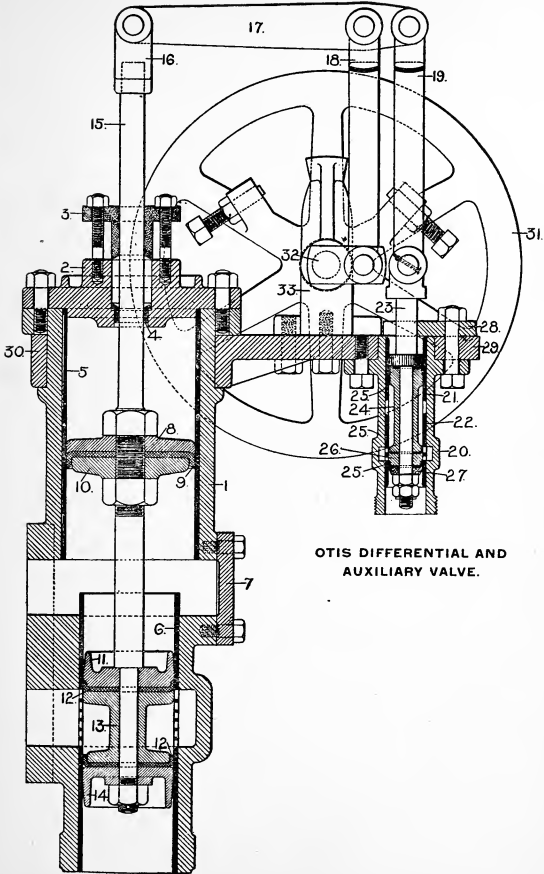
line of art; so it is recommended that they be kept free from dampness. Dust with a feather duster and use soft rags for cleaning. Never use any gritty substance, soaps or oils. If they become damaged, have the maker repair and relacquer them.

DIRECTIONS FOR THE CARE AND OPERATION OF THE ELECTRIC ELEVATORS.

Whenever the attendant wishes to handle the machine to clean, adjust, repair or oil it, he should see that the current is shut off at the switch, and thus prevent all possibility of accident.

Cleaning.—Keep the entire machine clean. Clean the commutator and other contacts and brushes carefully with a clean cloth and keep them free from grease and dirt. If the face of the rheostat on which the rheostat arm brushes work becomes burnt, clean with a piece of fine sand-paper (No. 0), or if necessary use a fine file. Keep all contacts smooth. Try the rheostat arm when cleaning to be sure that it moves freely off contacts.

Oiling.—Oil the drum shaft bearings with good heavy oil. Oil the worm and gear by filling the chamber around them with a mixture of two parts of good castor oil and one part good cylinder oil. Keep this chamber filled to the top of worm or mark on gauge glass, adding a little each day as it is used. The end thrust bearings of the machine are automatically oiled from this chamber. This should be drawn off every two or three months and replaced by fresh oil. Oil the motor bearings with dynamo oil. These are automatically oiled, but should occasionally be supplied with fresh oil. Lubricate the commutator, rheostat face, drum switch and contacts VERY SPARINGLY with a cloth moistened with oil. Care should be taken not to supply too much oil to these parts. Keep the oil dash-pot, if any, sufficiently filled with oil to allow the rheostat arm to move quickly on to the first contact and to retard this movement beyond this contact. The best oil for this purpose is fish oil, or some thin oil that is not readily



OTIS DIFFERENTIAL AND
AUXILIARY VALVE.

affected by changes in temperature. If an air dash-pot is used, keep it slightly oiled so as to keep the packing soft. Keep all parts of the elevator, including sheaves, guides, cables, etc., clean and well oiled.

Operating.— Before switching the current on to the machine, be sure that the operating lever is in its central position. To ascend, draw the lever the full throw to the *up*. To descend, draw the lever the full throw to the *down*. To run at slow speed, bring the lever toward the center according to the speed desired. To stop, bring lever to slow speed when within four feet of landing, and to its central position when close to it. In this way, the operator can make accurate stops. When starting (machines on which the solenoid is used) if the current is admitted to the motor too rapidly, thereby starting the car with a jerk, or momentarily dimming the lights on the circuit, check the speed with which the resistance is cut out of the armature circuit by slightly easing off the weight which acts in opposition to the core of the small solenoid. This solenoid controls a valve in the dash-pot and thereby regulates its speed in proportion to the current passing. If a governor starter is used and the current is admitted too rapidly, tighten the governor spring on the armature shaft, or close the vent in air dash-pot. If the car refuses to ascend with a heavy load, immediately throw the lever to the center and reduce the load, as in all probability it is greater than the capacity of the elevator. If it refuses to ascend with a light load, throw the lever to the center and have the fusible strip examined. If, in descending, the car should stop, throw the lever to the center and examine safeties, fusible strip and machine, and before starting, be sure that the cables have not jumped from their right grooves. If the car refuses to move in either direction, throw the lever on the center and have the fusible strips examined. Never leave the car without throwing the lever to the center. If the car should be stalled

between floors, it can be either raised or lowered by raising the brake and running it by turning the brake-wheel by hand. Such a stoppage might be caused by the current being shut off at the station, undue friction in the machine, too heavy a load, fuses burnt out, or a bad contact of the switches, binding posts or electrical connections. If the car by any derangement of cables or switch cannot be stopped, let it make its full trip, as the automatic stop will take care of it at either end of the travel. The bearings should be examined occasionally to insure no heating and proper lubrication.

General directions. — Have the machine examined occasionally by someone well posted in electric motors and elevators. The attendant should inspect the machine often. All brushes and switches should be sufficiently tight to give a good contact, but no tighter. None of the brushes should spark when in their normal position. When the brushes become burnt dress with sandpaper or file, or, if necessary, replace with new ones. If brushes spark, dress with sandpaper or file to a good bearing, and, if necessary, set up springs, but do not make the tension such as to interfere with their ready movement. Adjust commutator brushes gradually for least sparking. These should be close to the central position. Contacts and brushes should be kept clean and smooth and lubricated sparingly. While replacing a fusible strip, be sure that main switch is open, and be careful not to touch the other wire with your tool or otherwise, as such contact would be dangerous. Never put in a larger fuse than the one burnt. Inspect the worm and worm-wheel occasionally through hand-holes in casing, to see that they are well lubricated, and that no grit gets into the oil. They should show no wear. The stuffing box on the worm shaft should be only tight enough to keep the oil from leaking out of the worm chamber. Be sure that all parts are properly lubricated, and that none of the bearings heat. To make sure that the car and machinery run

freely, lift brake lever and then rotate worm shaft by pulling on the brake wheel. The empty car should ascend without any exertion. Keep operating cables properly adjusted. Open main switch when the elevator is not in service.

STANDARD HOISTING ROPE WITH 19 WIRES TO THE STRAND.

IRON.

Table No.	Diameter.	Circumference in inches.	Weight per foot in lbs. of rope with hemp center.	Breaking strain in tons of 2000 lbs.	Proper working load in tons of 2000 lbs.	Circumference of new Manila rope of equal strength.	Minimum size of drum or sheave in feet.
1	2 $\frac{3}{4}$	6 $\frac{3}{4}$	8.00	74	15	14	13
2	2	6	6.30	65	13	13	12
3	1 $\frac{3}{4}$	5 $\frac{1}{2}$	5.25	54	11	12	10
4	1 $\frac{5}{8}$	5	4.10	44	9	11	8 $\frac{1}{2}$
5	1 $\frac{1}{2}$	4 $\frac{1}{4}$	3.65	39	8	10	7 $\frac{1}{2}$
5 $\frac{1}{2}$	1 $\frac{3}{8}$	4 $\frac{3}{8}$	3.00	33	6 $\frac{1}{2}$	9 $\frac{1}{2}$	7
6	1 $\frac{1}{4}$	4	2.50	27	5 $\frac{1}{2}$	8 $\frac{1}{2}$	6 $\frac{1}{2}$
7	1 $\frac{1}{8}$	3 $\frac{1}{2}$	2.00	20	4	7 $\frac{1}{2}$	6
8	1	3 $\frac{1}{8}$	1.58	16	3	6 $\frac{1}{2}$	5 $\frac{1}{4}$
9	$\frac{7}{8}$	2 $\frac{3}{4}$	1.20	11.50	2 $\frac{1}{2}$	5 $\frac{1}{2}$	4 $\frac{1}{2}$
10	$\frac{3}{4}$	2 $\frac{1}{4}$	0.88	8.64	1 $\frac{3}{4}$	4 $\frac{3}{4}$	4
10 $\frac{1}{4}$	$\frac{3}{8}$	2	0.66	5.13	1 $\frac{1}{4}$	3 $\frac{3}{4}$	3 $\frac{1}{2}$
10 $\frac{1}{2}$	$\frac{1}{16}$	1 $\frac{5}{8}$	0.44	4.27	$\frac{3}{4}$	3 $\frac{1}{2}$	2 $\frac{3}{4}$
10 $\frac{3}{4}$	$\frac{1}{2}$	1 $\frac{1}{2}$	0.35	3.48	$\frac{1}{2}$	3	2 $\frac{1}{4}$
10a	$\frac{1}{16}$	1 $\frac{3}{8}$	0.29	3.00	$\frac{3}{8}$	2 $\frac{3}{4}$	2
10 $\frac{7}{8}$	$\frac{1}{8}$	1 $\frac{1}{4}$	0.26	2.50	$\frac{1}{4}$	2 $\frac{1}{2}$	1 $\frac{1}{2}$

Operating Cable or Tiller Rope, $\frac{3}{4}$ in. diam.; $\frac{5}{8}$ in. diam.; $\frac{1}{2}$ in. diam.; $\frac{3}{8}$ in. diam.

Cables, and how to care for them. — Wire and hemp ropes of same strength are equally pliable. Experience has demonstrated that the wear of wire cables increases with the speed. Hoisting ropes are manufactured with hemp centers to make them more pliable. Durability is thereby increased where short bending

occurs. All twisting and kinking of wire rope should be avoided. Wire rope should be run off by rolling a coil over the ground like a wheel. In no case should galvanized rope be used for hoisting purposes. The coating of zinc wears off very quickly and corrosion proceeds with great rapidity. Hoisting cables should not be spliced under any circumstances. All fastenings at the ends of rope should be made very carefully, using only the best babbitt. All clevises and clips should fit the rope perfectly. Metal fastenings, where babbitt is used, should be warmed before pouring, to prevent chilling. Examine wire ropes frequently for broken wires. Wire hoisting ropes should be condemned when the wires (not strands) commence cracking. Keep the tension on all cables alike. Adjust with draw-bars and turn-buckles provided.

Leather cup packings for valves. — Leather for cups should be of the best quality, of an even thickness, free from blemish and treated with a water-proof dressing. The cups should be of sufficient stiffness to be self-sustaining when passing over perforated valve lining. When ordering cups, the pressure of water carried should be specified, as the stiff cups intended for high-pressure would not set out against the valve lining when low pressure is used.

Water. — Water for use in hydraulic elevators should be perfectly clear and free from sediment. A strainer should be placed on the supply pipe and water changed every three months, and the system washed and flushed.

Closing down elevators. — If an elevator is to be shut down for an indefinite period, run the car to the bottom and drain off the water from all parts of the machine; otherwise, a freeze is likely to burst some part of the machinery. If the machine is of the horizontal type, grease the cylinder with a heavy grease; if vertical, the rods should be greased. Oil cables with raw linseed oil.

LUBRICATION FOR HYDRAULIC ELEVATORS.

The most effectual method of lubricating the internal parts of hydraulic elevator plants where pump and tanks are used, is to carry the exhaust steam drips from the foot of the pump exhaust pipe to the discharge tank, thus saving the distilled water and cylinder oil. This system is invaluable when water holding in solution minerals is used, as these minerals greatly increase corrosion. Horizontal machines operated by city pressure are best lubricated with a heavy grease applied either mechanically or by means of a piece of waste on the end of a pole. The former method serves as a constant lubricator, while in the latter case, greasing is often neglected, and in consequence packing lasts but a short time.

Lubrication of worm gearing.—Oils with a body, such as cylinder and castor oils, are best suited to the purpose. A composition of two parts castor to one part cylinder oil of the very best quality, makes a desirable lubricant, for the following reasons: cylinder oil being heavy with ample body, on becoming warm runs freely to the point of contact between the worm and the gear and lubricates readily. On the other hand, castor oil when cool, or only slightly warm, retains its body and makes an excellent lubricant. Upon becoming heated, castor oil thickens, thus rendering it objectionable. By the combination, efficient lubrication is obtained at all temperatures.

Lubrication of cables.—A good compound for preservation and lubrication of cables is composed of the following: Cylinder oil, graphite, tallow and vegetable tar, heated and thoroughly mixed. Apply with a piece of sheepskin with wool inside. To prevent wire rope from rusting, apply raw linseed oil.

Lubrication of guides.—Steel guides should be greased with good cylinder oil. Grease wood strips with No. 3 Albany grease or lard oil. Clean guides twice a month to prevent gumming.

Lubrication of overhead sheave boxes.— In summer use a heavy grease. In winter, add cylinder oil as required.

BELTS AND HOW TO CARE FOR THEM.

The work required of an elevator belt is most severe and we might say extraordinary character, running as it does over a large to a small pulley and beneath an idler, so situated as to give the small pulley as much belt surface as possible. The belt runs forward and backward as the cage descends and ascends, thereby causing a certain amount of slip. It is imperative that a belt performing such service should be of the very best quality. The following are the specifications: The stock should be strictly pure oak-tanned, cut in such a manner that the center of the hide will form the center of the belt. Each piece should have all stretch thoroughly removed. The belt should be short lap, none of the pieces to exceed 4' 2" in length, including the laps. Lock lap should be made, which makes a perfect splice. Under no circumstances should a straight lap be used. The cement should be of the very best quality and pliable to such an extent that it will allow for the short turn taken by the belt in passing under the idler and around the small pulley. As a precaution against laps coming apart from accident or other cause, belts should be riveted, as the rivets will hold lap together until defect may be seen and remedied. Owing to the high speed, laced belts should never be used, as the laces are sure to be cut by running over the small pulleys. Castor oil makes a very reliable dressing for belts. It renders them pliable, thus improving the adhesive qualities.

USEFUL INFORMATION.

To find leaks in elevator pressure tanks in which air is confined, paint round the rivet heads with a solution of soap and the leak will be found wherever a bubble or suds appear. To ascertain the number of gallons in cylinders and round tanks, multi-

ply the square of the diameter in inches by the height in inches and the product by .0034 = gallons. Weight of round iron: Multiply the diameter by 4, square the product and divide by 6 = the weight in pounds per foot. To find the weight of a casting from the weight of a pine pattern, multiply one pound of pattern by 16.7, for cast-iron, and by 19 for brass. Ordinary gray iron castings = about 4 square inches to the pound.

Water.—A gallon of water (U. S. Standard) contains 231 cu. in. and weighs $8\frac{1}{3}$ lbs. A cubic foot of water contains $7\frac{1}{2}$ gal. or 1728 cu. in. and weighs $62\frac{1}{2}$ lbs. A "Miner's inch" is a measure for the flow of water and is the amount discharged through an opening 1 inch square in a plank 2 in. in thickness, under a head of 6 in. to the upper edge of the opening; and this is equal to 11,625 U. S. gal. per minute. The height of a column of fresh water, equal to a pressure of 1 lb. per sq. in., is 2.31 feet. A column of water 1 ft. high exerts a pressure of .433 lbs. per sq. in. The capacity of a cylinder in gallons is equal to the length in inches multiplied by the area in inches, divided by 231 (the cubical contents of one U. S. gal. in inches). The velocity in feet per minute, necessary to discharge a given volume of water in a given time, is found by multiplying the number of cu. ft. of water by 144 and dividing the product by the area of the pipe in inches.

Decimal Equivalents of an Inch.

1-16	1-8	3-16	1-4	5-16	3-8	7-16	1-2
.0625	.125	.1875	.25	.3125	.375	.4375	.5
9-16	5-8	11-16	3-4	13-16	7-8	15-16	
.5625	.625	.6875	.75	.8125	.875	.9375	

CHAPTER XXIV.

THE DRIVING POWER OF BELTS.

The average strain or tension at which belting should be run, is claimed to be 55 pounds for every inch in width of a single belt, and the estimated grip is one-half pound for every square inch of contact with pulley, when touching one-half of the circumference of the pulley. For instance a belt running around a 36-inch pulley would come in contact with one-half its circumference, or $56\frac{1}{2}$ inches, and allowing a half-pound per inch, would have a grip $28\frac{1}{4}$ pounds for each inch of width of belt.

MECHANICAL PROBLEMS AND RULES.

Problem 1. To find the circumference of a circle or a pulley: —

Solution. Multiply the diameter by 3.1416; or, as 7 is to 22 so is the diameter to the circumference.

Problem 2. To compute the diameter of a circle or pulley: —

Solution. Divide the circumference by 3.1416; or multiply the circumference by .3183; or as 22 is to 7, so is the circumference to the diameter, equally applicable to a train of pulleys, the given elements being the diameter and the circumference.

Problem 3. To find the number of revolutions of driven pulley, the revolution of driver, and diameter of driver and driven being given: —

Solution. Multiply the revolutions of driver by its diameter, and divide the product by the diameter of driven.

Problem 4. To compute the diameter of driven pulley for any desired number of revolutions, the size and velocity of driver being known: —

Solution. Multiply the velocity of driver by its diameter and divide the product by the number of revolutions it is desired the driven shall make.

Problem 5. To ascertain diameter of driving pulley: —

Solution. Multiply the diameter of driven by the number of revolutions you desire it shall make, and divide the product by the number of revolutions of the driver.

6. Rule for finding length of belt wanted: Add the diameters of the two pulleys together, divide the result by two, and multiply the quotient by $3 \frac{1}{7}$. Add the product to twice the distance between the centers of the shafts, and you have the length required.

FOR CALCULATING THE NUMBER OF HORSE-POWER WHICH A BELT WILL TRANSMIT, ITS VELOCITY AND THE NUMBER OF SQUARE INCHES IN CONTACT WITH THE PULLEY BEING KNOWN.

Divide the number of square inches of belt in contact with the pulley by two, multiply this quotient by velocity of the belt in feet per minute and divide amount by 33,000; the quotient is the number of horse-power.

Example. — A 20-inch belt is being moved with a velocity of 2,000 feet per minute, with six feet of its length in contact with the circumference of a four-foot drum; desired its horse-power. 21×72 equal 1,440, divided by two, divided by 720 \times 2,000 equal 1,440,000 divided by 33,000 equal $43\frac{2}{3}$ horse-power.

Rule for finding width of belt, when speed of belt in feet per minute and horse power wanted are given:—

For single belts. — Divide the speed of belt by 8. The horse-

power wanted divided by this quotient, will give the width of belt required.

Example. — Required the width of single belt to transmit 100 horse-power. Engine pulley 72" in diameter. Speed of engine, 220 revolutions per minute.

8)4143 (speed of belt per minute).

518)100/00 (horse-power wanted).

19" width of belt required.

For double belts. — Divide the speed of belt in feet per minute by 560. Divide the horse-power wanted by this quotient for the width of belt required.

Example. — Required the width of double belt to transmit 500 horse-power. Engine pulley 72" in diameter. Speed of engine, 220 revolutions per minute.

560)4143 (speed of belt per minute).

74)500/00 (horse-power wanted).

67½" width of belt required.

EXTRACTS FROM ARTICLES ON BELTS.

BY R. J. ABERNATHEY.

Although there is not near as much known in general about the power of transmitting agencies as there should be, still it seems that almost any other method or means is better understood than belts.

One of the chief difficulties in the way of a better knowledge of the belting problem, is the relation that belts and pulleys bear to each other. The general supposition, and one that leads to many errors, is that the larger in diameter a pulley is, the greater its holding capacity — the belt will not slip so easily, is the belief. But it is merely a belief, and has nothing to sustain it, unless it be faith, and faith without work is an uncertain factor. I would

like here to impress upon the minds of all interested, the following immutable principles or law : —

1. The adhesion of the belt to the pulley is the same — the arc or number of degrees of contact, aggregate tension or weight being the same — without reference to width of belt or diameter of pulley.

2. A belt will slip just as readily on a pulley four feet in diameter, as it will on a pulley two feet in diameter, provided the conditions of the faces of the pulleys, the arc of contact, the tension, and the number of feet the belt travels per minute are the same in both cases.

3. A belt of a given width and making two thousand, or any other given number of feet per minute, will transmit as much power running on pulleys two feet in diameter as it will on pulleys four feet in diameter, provided the arc of contact, tension and conditions of pulley faces all be the same in both cases.

It must be remembered, in reference to the first rule, that when speaking of tensions, that aggregate tension is never meant unless so specified. A belt six inches wide, with the same tension, or as taut as a belt one inch wide, would have six times the aggregate tension of the one inch belt. Or it would have six times the force to slip the six inch belt as it would the one inch. I prefer to make the readers of this, practical students. I want them to learn for themselves. Information obtained in that way is far more valuable, and liable to last much longer.

In order that the reader may more fully understand whether or not a large pulley will hold better than a small one, let him provide a short, stout shaft, say three or four feet long and two inches in diameter. To this shaft firmly fasten a pulley, say 12 in. in diameter, or any other size small pulley that may be convenient. The shaft must then be raised a few feet from the floor and firmly fastened, either in vices, or by some other means, so that it will not turn. It would be better, of course, to have

a smooth-faced iron pulley, as such are most generally used. So far as the experiment is concerned, it would make no difference what kind of a pulley was used, provided all the pulleys experimented with be of the same kind, and have the same kind of face finish. When the shaft and pulleys are fixed in place, procure a new leather belt and throw it over the pulley. To one end of the belt attach a weight, equal, say, to forty pounds — or heavier, if desired — for each inch in width of belt used; let the weight rest on the floor. To the other end of the belt attach another weight, and keep adding to it until the belt slips and raises the first weight from the floor. After the experimenter is satisfied with playing with the 12 in. pulley, he can take it off the shaft and put on a 24 in., a 36 in., or any other size he may wish; or, what is better, he can have all on the shaft at the same time. The belt can then be thrown over the large pulley and the experiment repeated. It will then be found if pulley faces are alike, that the weight which slipped the belt on the small pulley will also slip it on the large one. The method shows the adhesion of a belt with 180 degrees contact, but as the contact varies greatly in practice, it is well enough to understand what may be accomplished with other arcs of contact. But, after all, many are probably at a loss how to account for some observations previously made. They have noticed that when a belt at actual work slipped, an increase in the size (diameter) of the pulleys remedied the difficulty and prevented the slipping.

A belt has been known to refuse to do the work allotted to it, and continue to slip over pulleys two feet in diameter, but from the moment pulleys were changed to three feet in diameter there was no further trouble. These observed facts seem to be at variance with and to contradict the results of the experiments that have been made. All, however, may rest assured that it is only apparent, not real.

The resistance to slippage is simply a unit of useful effect (or

that which can be converted into useful effect). The magnitude of the unit is in proportion to the tension of the belt. The sum total of useful effect depends upon the number of times the unit is multiplied. A belt 6 inches wide and having a tension equal to 40 lbs. per inch in width, and traveling at the rate of 1 foot per minute, will raise a weight of 240 lbs. 1 foot high per minute. If the speed of the belt be increased to 136.5 feet per minute, it will raise a weight of 33,000 lbs. per minute, or be transmitting 1 horse-power. The unit of power transmitted by a belt is rather more than its tension, but to take it at its measured tension is at all times safe, and 40 to 45 lbs. of a continuous working strain is as much, perhaps, as a single belt should be subjected to. A little reflection will now convince the reader that a belt transmits power in proportion to its lineal speed, without reference to the diameter of the pulleys. Having arrived at that conclusion, it is then easy to understand why it is that a belt working over 36-inch pulley will do its work easy, when it refused to do it and slipped on 24-inch pulleys. If the belt traveled 800 feet per minute on the 24-inch pulleys, on the 36-inch it would travel 1,200 feet, thus giving it one-half more transmitting power. If, in the first instance, it was able to transmit but 8 horse-power, in the second instance it will transmit 12 horse-power. All of which is due to the increase in the speed of the belt and not to the increase in the size of the pulleys; because, as has been shown, the co-efficient of friction, or resistance to slippage, is the same on all pulleys with the same arc of belt contact.

There is no occasion for elaborate and perplexing formulas and intricate rules. They serve no useful purpose, but tend only to mystify and puzzle the brain of all who are not familiar with the higher branches of mathematics, — and it is the fewest number of our every-day practical mechanics who are so familiar. In all, or nearly all treatises on belting, the writer will tell you that at 600, 800 or 1,000 feet per minute, as the case may be, a belt one

inch wide, will transmit one horse-power; and yet, when we come to apply their rules in practice, no such results can be obtained one time in ten. The rules are just as liable to make the belt travel 400, 1,000 or 1,600 per minute per horse-power as the number of feet they may give as indicating a horse-power.

I have adopted, and all my calculations are based upon the assumption that a belt traveling 800 feet per minute, and running over pulleys, both of which are the same diameters, will easily transmit one horse-power for each inch in width of belt. A belt under such circumstances would have 180 degrees of contact on both pulleys without the interposition of idlers or tighteners.

The last proposition being accepted as true and the basis correct, the whole matter resolves itself into a very simple problem, so far as a belt with 180 degrees contact is concerned. It is simply this: If a belt traveling 800 feet per minute transmit one horse-power, at 1,600 feet, it will transmit two horse-power; or if 2,400 feet, three horse-power, and so on. It is no trouble for any one to understand that, if he understands simple multiplication or division.

It is not, however, always the case that both pulleys are the same size, and as soon as the relative sizes of the pulleys change, the transmitting power of the belt changes; and that is the reason why no general rule has ever, or ever will be made for ascertaining the transmitting capacity of belts under all circumstances. When the pulleys differ in size, the larger of the two is lost sight of — it no longer figures in the calculations — the small pulley, only, must be considered. To get at it, the number of degrees of belt contact on the small pulley must be ascertained as nearly as possible and use for a guide, for getting at the transmitting power, the next established basis below. Of course, the experimenter can make a rule for every degree of variation, but it would require a great many, and is not necessary. I use five divisions, as follows: —

For 180 degrees useful effect	100
For 157 $\frac{1}{2}$ " " "92
For 135 " " "84
For 112 $\frac{1}{2}$ " " "76
For 90 " " "64

The experimenters may find that my figures are under obtained results, which is exactly what they are intended to be, more especially at the 90 degree basis. I wish to make ample allowance.

To ascertain the power a belt will transmit under the first-named conditions: Divide the speed of the belt in feet per minute by 800, multiply by its width in inches and by 100. For the second, divide by 800, multiply by width in inches and by .92. Third place, divide by 800, multiply by width in inches and by .84. Fourth place, divide by 800, multiply by width in inches and by .76. Fifth place, divide by 800, multiply by width in inches and by .64. As an example: What would be the transmitting power of a 16-inch belt traveling 2,500 feet per minute by each of the above rules?

1st: 2,500 divided by 800 equal 3.125 x 16 & 100 equal 50 h. p.
2d: 2,500 " 800 " 3.125 x 16 & .92 equal 46 "
3d: 2,500 " 800 " 3.125 x 16 & .84 equal 42 "
4th: 2,500 " 800 " 3.125 x 16 & .76 equal 38 "
5th: 2,500 " 800 " 3.125 x 16 & .64 equal 32 "

As I have said, if the degrees of contact come between the divisions named above, in order to be on the safe side, calculate from the first rule below it, or make an approximate as they like.

If the above lesson is studied well and strictly used, there can be no excuse for any mechanic putting in a belt too small for the work it has to do, provided he knows how much there is to do, which he ought, somewhere near at least.

HORSE-POWER TRANSMITTED BY LEATHER BELTS.

DRIVING POWER OF SINGLE BELTS.

Speed in Feet per Minute.	Width of Belt in Inches.								
	2	3	4	5	6	8	10	12	14
	H. P.	H. P.	H. P.	H. P.	H. P.	H. P.	H. P.	H. P.	H. P.
400	1	1½	2	2½	3	4	5	6	7
600	1½	2¼	3	3¾	4½	6	7½	9	10½
800	2	3	4	5	6	8	10	12	14
1,000	2½	3¾	5	6¼	7½	10	12½	15	17½
1,200	3	4½	7	7½	9	12	15	18	21
1,500	3¾	5¾	7½	9½	11½	15	18¾	22½	26½
1,800	4½	6¾	9	11¼	13½	18	22½	27	31½
2,000	5	7½	10	12½	15	20	25	30	35
2,400	6	9	12	15	18	24	30	36	42
2,800	7	10½	14	17½	21	28	35	42	49
3,000	7½	11¼	15	18¾	22½	30	37½	45	52½
3,500	8¾	13	17½	22	26	35	44	52½	61
4,000	10	15	20	25	30	40	50	60	70
4,500	11¼	17	22½	28	34	45	57	69	78
5,000	12½	19	25	31	37½	50	62½	75	87

For Driving Power of Shultz Belting, add 33 per cent.

DRIVING POWER OF DOUBLE BELTS.

Speed in Feet per Minute.	Width of Belts in Inches.								
	6	8	10	12	14	16	18	20	24
	H. P.	H. P.	H. P.	H. P.	H. P.	H. P.	H. P.	H. P.	H. P.
400	4¼	5¾	7¼	8½	10	11½	13	14½	17½
600	6½	8¾	11	13	15	17½	19½	22	26
800	8½	11½	14½	17½	20½	23	26	29	34½
1,000	11	14½	18¼	21½	25½	29	32½	36	43½
1,200	13	17½	22	26	30½	34½	39	44	52½
1,500	16¼	21¾	27¼	32½	38	43½	49	54½	65½
1,800	19½	26	32¾	39	45½	52	59	65½	78½
2,000	21¾	29	36½	43½	50½	58	65½	72½	87
2,400	26	34¾	44	52½	60½	69½	78½	88	105
2,800	30½	40½	51	61	71	81	91½	102	122
3,000	32½	43½	54½	65½	76	87½	98	108	131
3,500	38	50¾	63½	76	89	101	114	127	153
4,000	43½	58¼	72¾	87	101	116	131	145	174
4,500	49	65	82	98	114	131	147	163	196
5,000	54½	72¾	91	109	127	145	163	182	218

For Driving Power of Shultz Double Belting, add 33 per cent.

Example. — Required the width of a single belt, the velocity of which is to be 1,500 feet per minute; it has to transmit 10 horse-power, the diameter of the smaller drum being four feet with five feet of its circumference in contact with the belt.

33,000 x 10 equal 330,000, divided by 1,500 equal 220, divided by 5 equal 44, divided by 6 equal $7\frac{1}{2}$ inches, the required width of belt.

Directions for calculating the number of horse power which a belt will transmit. Divide the number of square inches of belt in contact with the pulley by two; multiply this quotient by the velocity of the belt in feet per minute; again we divide the total by 33,000 and the quotient is the number of horse-power.

Explanations. — The early division by two is to obtain the number of pounds raised one foot high per minute, half a pound being allowed to each square inch of belting in contact with the pulley.

Example. — A six-inch single belt is being moved with a velocity of 1,200 feet per minute, with four feet of its length in contact with a three-foot drum. Required the horse-power.

64 x 48 equal 288, divided by 2 equal 144 x 1,200 equal 172,800, divided by 33,000 equal, say, $5\frac{1}{4}$ horse-power.

It is safe to reckon that a double belt will do half as much work again as a single one.

Hints to users of belts. — 1. Horizontal, inclined and long belts give a much better effect than vertical and short belts.

2. Short belts require to be tighter than long ones. A long belt working horizontally increases the grip by its own weight.

3. If there is too great a distance between the pulleys, the weight of the belt will produce a heavy sag, drawing so hard on the shaft as to cause great friction at the bearings; while, at the same time, the belt will have an unsteady motion, injurious to itself and to the machinery.

4. Care should be taken to let the belts run free and easy, so

as to prevent the tearing out of the lace holes at the lap; it also prevents the rapid wear of the metal bearings.

5. It is asserted that the grain side of a belt put next to the pulley will drive 30 per cent more than the flesh side.

6. To obtain a greater amount of power from the belts the pulleys may be covered with leather; this will allow the belts to run very slack and give 25 per cent more durability.

7. Leather belts should be well protected against water and even loose steam and other moisture.

8. In putting on a belt, be sure that the joints run with the pulleys, and not against them out.

9. In punching a belt for lacing, it is desirable to use an oval punch, the larger diameter of the punch being parallel with the belt, so as to cut out as little of the effective section of the leather as possible.

10. Begin to lace in the center of the belt and take care to keep the ends exactly in line and to lace both sides with equal tightness. The lacing should not be crossed on the side of the belt that runs next the pulley. Thin but strong laces only should be used.

11. It is desirable to locate the shafting and machinery so that belts shall run off from each other in opposite directions, as this arrangement will relieve the bearings from the friction that would result where the belts all pull one way on the shaft.

12. If possible, the machinery should be so planned that the direction of the belt motion shall be from the top of the driving to the top of the driven pulley.

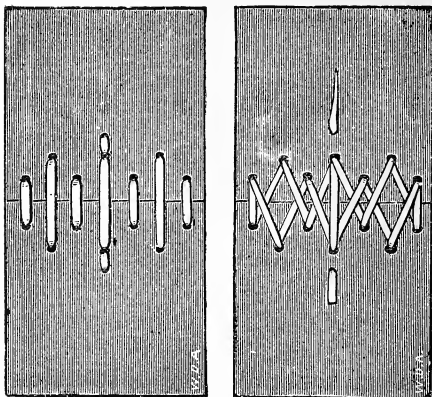
13. Never overload a belt.

14. A careful attention will make a belt last many years, which through neglect might not last one.

DIRECTIONS FOR ADJUSTING BELTING.

In lacing cut the ends perfectly square, else the belt will stretch unevenly. Make two rows of holes in each end; put the

ends together and lace with lace leather, as shown in the cuts below. For wide belts, in addition, put a thin piece of leather or



rubber on the back to strengthen the joint, equal in length to the width of the belt, and sew or rivet it to the belt. In putting on belting, it should be stretched as tight as possible, and with wide belts, this can be done best by the use of belt clamps.

Melting Points of Metals and Solids.

	Deg. Fahr.		Deg. Fahr.
Antimony melts at.....	951	Platinum melts at.....	4580
Bismuth "	476	Potassium "	135
Brass "	1900	Saltpeter "	600
Cadmium "	602	Steel "	2340 to 2520
Cast Iron "	1890 to 2160	Sulphur "	225
Copper "	1890	Silver "	1250
Glass "	2377	Tin "	420
Gold "	2250	Wrought Iron "	2700 to 2880
Lead "	594	Zinc "	740
Ice "	32	Aluminum "	1260

CHAPTER XXV.

CAPACITY OF AIR COMPRESSORS.

To ascertain the capacity of an air compressor in cubic feet of free air per minute, the common practice is to multiply the area of the intake cylinder by the feet of piston travel per minute. The free air capacity of the compressor, divided by the number of atmospheres, will give the volume of compressed air per minute. To ascertain the number of atmospheres at any given pressure, add 15 lbs. to the gauge pressure; divide this sum by 15 and the result will be the number of atmospheres. The above method of calculation, however, is only theoretical and these results are never obtained in actual practice, even with compressors of the very best design working under the most favorable conditions obtainable. Allowances should be made for losses of various kinds, the principal losses being due to clearance spaces, but in machines of poor design and construction other losses occur through imperfect cooling, leakages past the piston and through the discharge valves, insufficient area and improper working of inlet valves, etc. The writer has seen compressors where losses through imperfections and improper working conditions ranged from 15 to 25 per cent, while under favorable conditions and with the average compressor, the loss averages from 8 to 12 per cent. So that to get sufficiently accurate results in finding capacity of the compressor, subtract 12 per cent from above computation, which gives nearly accurate figures. The following table will be found useful for quickly ascertaining the capacity of an air compressor, also to find the cubical contents of any cylinder, receiver, etc. The first column

is the diam. of cylinder in inches. The second shows the cubical contents in feet, for each foot in length.

Contents of a Cylinder in Cubic Feet for Each Foot in Length.

Diam. Inches.	Cubic Contents.	Diam. Inches.	Cubic Contents.	Diam. Inches.	Cubic Contents.	Diam. Inches.	Cubic Contents.	Diam. Inches.	Cubic Contents.
1	.0055	6	.1963	11	.6600	20	2.182	36	7.069
1 $\frac{1}{4}$.0085	6 $\frac{1}{4}$.2130	11 $\frac{1}{4}$.6903	20 $\frac{1}{2}$	2.292	37	7.468
1 $\frac{1}{2}$.0123	6 $\frac{1}{2}$.2305	11 $\frac{1}{2}$.7213	21	2.405	38	7.886
1 $\frac{3}{4}$.0168	6 $\frac{3}{4}$.2485	11 $\frac{3}{4}$.7530	21 $\frac{1}{2}$	2.521	39	8.296
2	.0218	7	.2673	12	.7854	22	2.640	40	8.728
2 $\frac{1}{4}$.0276	7 $\frac{1}{4}$.2868	12 $\frac{1}{4}$.8523	22 $\frac{1}{2}$	2.761	41	9.168
2 $\frac{1}{2}$.0341	7 $\frac{1}{2}$.3068	13	.9218	23	2.885	42	9.620
2 $\frac{3}{4}$.0413	7 $\frac{3}{4}$.3275	13 $\frac{1}{2}$.9940	23 $\frac{1}{2}$	2.885	43	10.084
3	.0401	8	.3490	14	1.069	24	3.012	44	10.560
3 $\frac{1}{4}$.0576	8 $\frac{1}{4}$.3713	14 $\frac{1}{2}$	1.147	25	3.142	45	11.044
3 $\frac{1}{2}$.0668	8 $\frac{1}{2}$.3940	15	1.227	26	3.400	46	11.540
3 $\frac{3}{4}$.0767	8 $\frac{3}{4}$.4175	15 $\frac{1}{2}$	1.310	27	3.687	47	12.048
4	.0873	9	.4418	16	1.396	28	3.976	48	12.566
4 $\frac{1}{4}$.0985	9 $\frac{1}{4}$.4668	16 $\frac{1}{2}$	1.485	29	4.587
4 $\frac{1}{2}$.1105	9 $\frac{1}{2}$.4923	17	1.576	30	4.909
4 $\frac{3}{4}$.1231	9 $\frac{3}{4}$.5185	17 $\frac{1}{2}$	1.670	31	5.241
5	.1364	10	.5455	18	1.767	32	5.585
5 $\frac{1}{4}$.1503	10 $\frac{1}{4}$.5730	18 $\frac{1}{2}$	1.867	33	5.940
5 $\frac{1}{2}$.1650	10 $\frac{1}{2}$.6013	19	1.969	34	6.305
5 $\frac{3}{4}$.1803	10 $\frac{3}{4}$.6303	19 $\frac{1}{2}$	2.074	35	6.681

To find the capacity of an air-cylinder, multiply the figures in the second column by the piston travel in feet per minute. This applies to double-acting air cylinders. In the case of single-acting air cylinders, the result should be divided by 2.

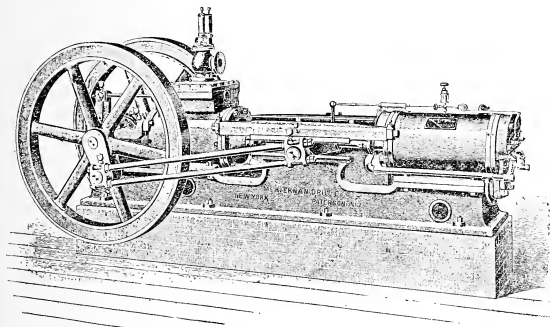
THE MCKIERMAN DRILL COMPANY'S AIR COMPRESSOR.

The air-cylinder and water-jacket are one complete casting. The heads are made with hoods and provision made for cool air in-take.

The atmosphere valves are bronze, of poppet form. Therefore, there is no vacuum and the cylinder fills absolutely with free air. The valves are closed by mechanical means.

The discharge valves are self-acting, are made of bronze. All of them are free to inspection without removal or disturbance of other parts.

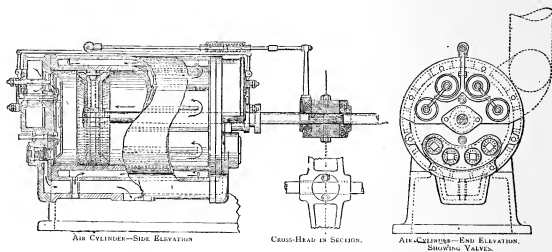
The cooling apparatus, or heat-preventing device, is extremely effective. Water jacket completely surrounds the cylinder, water



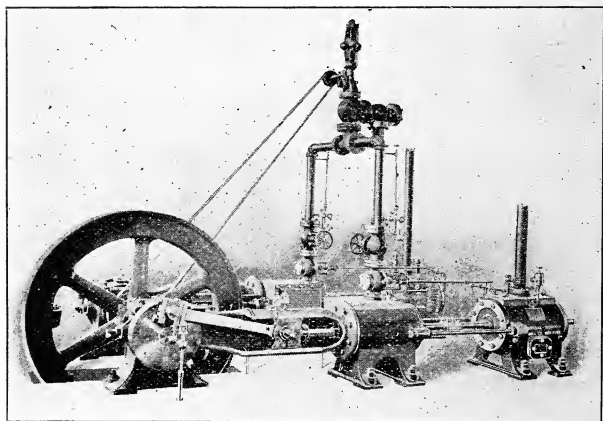
is forced to wash the walls and is kept in rapid motion from bottom to top, from end to end, absorbing heat rapidly. It enters the jacket at bottom, flows from end to end, around partitions, back and forth and up. Follows natural laws in absorbing, retaining and dispelling the heat of air.

Regulation of pressure and speed is entirely automatic. The regulating device is the only one by which the air weighs the steam admitted to the cylinder. Throttle may be thrown wide open at start, then the regulator takes absolute control, governing the speed from highest to lowest rate, varying the speed for

variable amounts of air which may be required and in such manner as to keep the pressure constant.



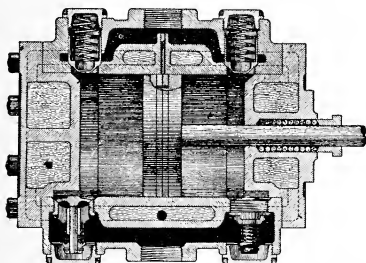
The Bennett Automatic Air Compressor.



Ingersoll-Sergeant Air Compressor.

INGERSOLL-SERGEANT AIR COMPRESSOR.

This engine, a cut of which is shown above, is fitted with Ingersoll-Sergeant Air Compressor Cylinders, and in connection with the Pohlé Air Lift System, has double the supply of water, using only one-half the fuel previously required. The steam cylinders are of the Duplex Corliss condensing type and connecting tandem, one on each side are two Ingersoll-Sergeant Air Cylinders and two Conover Water Cylinders. When the engine



SECTIONAL VIEW OF AIR CYLINDER WITH VERTICAL LIFT VALVES, USED CLASS "E" AND "F" COMPRESSORS.

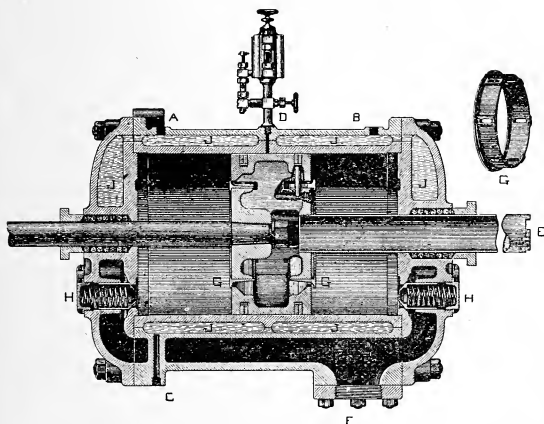
is in operation, the air cylinders raise the water by the Pohlé Air Lift System, from the wells to a tank at the surface, and from there it is taken by the water cylinders and forced to the stand-pipe. The cost of this combination compares favorably with the old plan of using separate compressors and water pumps, each with their own steam cylinders, and the saving in attendance, friction and foundation commends its use. The engines run at a fixed moderate speed and the regulation of the air and water is effected by passing the water from suction to discharge when the tank is too low and by mechanically unloading the air cylinders

with a pressure regulator when the tank is too full. The regulation is done mechanically, with floats at the top and bottom of the receiving tank. This combination can also be furnished with Straight Line Compressors; the advantage of the Duplex is that should it be necessary, the one side of the engine can be disconnected and the other side made to do the work.

As will be seen, the inlet valves which are on the lower side of the cylinder are offset, thus preventing their being sucked into the cylinder and wrecking the compressor. They are made out of a solid piece of steel and are extremely durable, because they are placed vertically, work in a bath of oil and do not slide on their seats. Both the inlet and discharge valves, being in the cylinder, allow the heads to be thoroughly water-jacketed, and this is an important feature when it is remembered that the heat of compression is greatest at the end of the stroke. The cylinder is, therefore, completely water-jacketed. The valves are arranged so that the air can be taken from outside of the engine room, which increases the efficiency of the machine 8 to 15 per cent, and are easily accessible.

The two inlet valves are located in the piston, and, with the tube, are carried back and forth with the piston. The valve on that face of the piston which is toward the direction of movement is closed, while the one on the other face is open. This is exactly as it should be in order to force out the compressed air from one end of the cylinder while taking in the free air at the other; when the piston has reached the end of its travel there is, of course, a complete stop while the engine is passing the center, and an immediate start in the other direction. The valve which was open immediately closes. There is no reason for its remaining open any longer, and it closes at exactly the right time, its own weight being all that is necessary to move it. The valve on the other side is left behind by the piston and the free air is admitted to that end of the cylinder for compression on the

return stroke. No springs are used, and there is none of the throttling of the incoming air, and none of the clattering or hammering so noticeable with poppet-valves. As there is nothing to make the valve move faster than the piston, it stays behind until the piston stops, leaving the port wide open for the admission

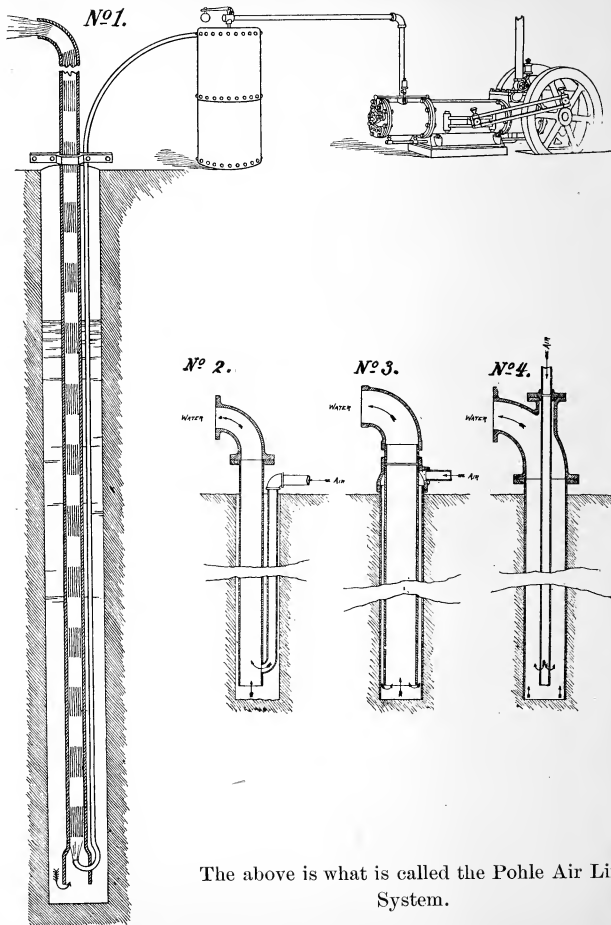


DETAILS OF PISTON INLET AIR CYLINDER.

A.—Circulating Water Inlet. D.—Oil Hole for Automatic Oil Cup. G.—Piston Inlet Valve
 B.—Circulating Water Outlet. E.—Air Inlet (through piston inlet pipe). H.—Discharge Valve
 C.—Water Jacket Drain Pipe. F.—Air Discharge (showing flange). J.—Water Jacket.

Sectional Cut of Ingersoll & Sargeant Single Compressor.

of air. It is well known that while the fly-wheel and, of course, the crank, rotate at a uniform speed, the movement of the piston is not uniform, but gradually increases in speed from the start till the crank has reached half-stroke, when it gradually slows up till the crank is on the center, and at this moment of full stop the valve gently slides to its seat.



The above is what is called the Pohle Air Lift System.

The illustrations on page 736 shows the method of pumping water by air. A compressor in connection with the air-lift system of pumping water by direct air pressure. The pump consists of a water pipe and an air pipe, the latter discharging the air into the former at its bottom, through a specially designed foot-piece. The natural levity of the air compared with the water, causes it to rise and, in rising, to carry the water with it in the form of successive pistons, following one another. This system of pumping has found a large range of application and is of peculiar service in connection with deep well pumping. For this purpose, the absence of mechanical parts many feet below the surface, offers a commanding advantage. Method No. 1 and No. 2 is almost alike, consisting of placing the air and water pipes alongside of one another in the well, connecting them at the bottom with an end piece. Method No. 3 consists of placing a water discharge pipe into the well; the air passing down into the well through the annular space between the well casing and the water pipe. Method No. 4 consists in using the well casing as the water discharge pipe, and simply putting an air pipe down into the well, with a specially designed foot-piece attached at the bottom through the air escapes.

CHAPTER XXVI.

THE WATER TUBE SECTIONAL BOILER.

The water tube sectional boiler has been a growth of many years and of many different minds. There are some two and a half million horse-power in daily service in the United States alone, and the number is rapidly increasing. Large orders for this type of boiler have often been repeated, adding proof that its principles are correct and appreciated by those having them in use and in charge. This being the case, purchasers should note well the points of difference in the various water tube boilers claiming their attention, and particularly see that the claims made for them are embodied in their actual construction. The general principles of construction and operation of this class of steam boilers are now well known to engineers and steam users. In selecting a water tube boiler there are several vital points to be considered: —

First. Straight and smooth passages through the headers of ample area, insuring rapid and uninterrupted circulation of the water.

Second. The baffling of the gases (without throttling or impeding the circulation of the water) in such a way that they are compelled to pass over every portion of the heating surface.

Third. Sufficient liberating surface in the steam drums to insure dry steam, with large body of water in reserve to draw from.

Fourth. Simplicity in construction; accessibility for cleaning and inspection.

Fifth. A header, which in its design provides for the unequal expansion and contraction.

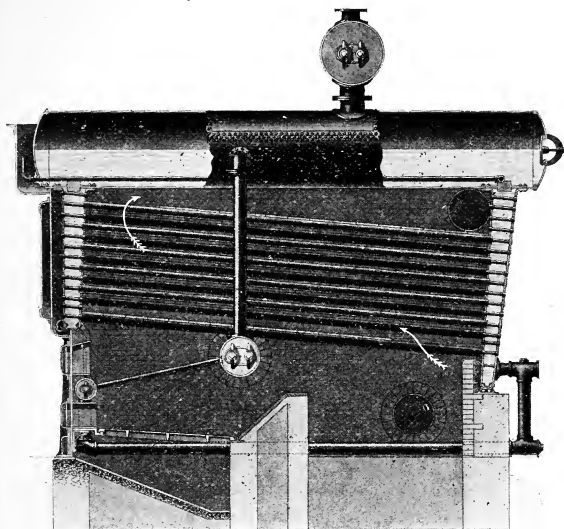


Illustration above is that of a Horizontal Safety Water Tube Boiler, manufactured by the John O'Brien Boiler Works Company, of St. Louis, U. S. A.

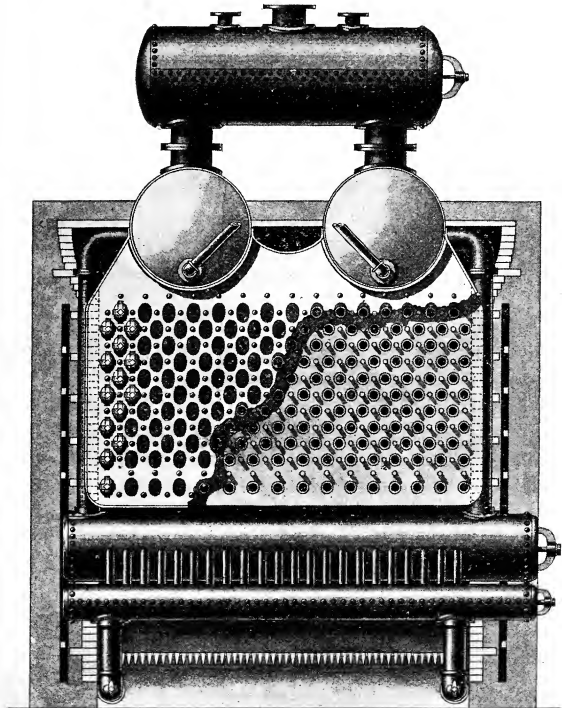
Down draft furnace. — A great many of these boilers are fitted with the down draft furnaces, and the above illustration shows the style of same, together with the manner in which they are connected.

A full and complete description of these furnaces is given on page 771.

Description. — In construction, this type of boiler consists

simply of one front and one rear water leg or header, made approximately rectangular in shape, overhead combination steam and water drum or drums and the circulating water tubes, as shown in cut, which extend between and connect both the front and rear headers being thoroughly expanded into the tube sheets. The tubes are inclined on a pitch of one inch to the foot and the rear header being longer than the front one, the overhead drum connecting both headers lies perfectly level when the boiler is set in position. The connection of the headers with the combined steam and water drum is made in such a manner as to give practically the same area as the total area of the tubes, so there is no contraction of area in the course of circulation; and extending between and connecting the inside faces of the two water legs, which form end connections between these tubes and two combined steam and water drums or shell, placed above and parallel with them, also a steam drum above these, assures absolutely dry steam and a large steam space, also a large water space. The water legs are made larger at the top, about 11 inches, and at the bottom about 7 inches, which is a great advantage, allowing the globules of steam to pass quickly up the water legs to the steam and water drums. The water, as it sweeps along the drums, frees itself of steam; then it goes down the back connection until it meets the inclined tubes, meeting on its passage a gradually increasing temperature, till the furnace is again reached, where the steam formed on the way is directly carried up in the drum as before. The tubes extend through the tube sheets into which they are expanded with roller expanders; opposite the end of each and in the head plates is placed a hand-hole of slightly larger diameter than the tube, and through which it can be withdrawn. It will be noted that the throat of each water leg is $1\frac{1}{3}$ times the total tube area. The rapid and unimpeded circulation tends to keep the inside surface clean and floats the scale-making sediment along until it reaches the back

water leg, where it is carried down and settles in the bottom of leg, where it is blown off at regular intervals.



Steadiness of water level. — The large area of surface at water line and the ample passages for circulation, secure a steadiness

of water level unsurpassed by any boiler. This is a most important point in boiler construction and should always be considered when comparing boilers. The water legs are stayed by hollow stay-bolts of hydraulic tubing of large diameter, so placed that two stays support each tube and hand-hole and are subjected to only very slight strain. Being made of heavy material, they form the strongest parts of the boiler and its natural supports. The water legs are joined to the shell by flanged and riveted joints and the drum is cut away at these two points to make connection with inside of water leg, the opening thus made being strengthened by special stays, so as to preserve the original strength. The shells are cylinders with heads dished to form part of a true sphere. The sphere is everywhere as strong as the circular seam of the cylinder, which is well known to be twice as strong as the side seam; therefore, the heads require no stays. Both the cylinder and the spherical heads are, therefore, free to follow their natural lines of expansion when put under pressure.

The illustration on page 741 plainly shows the formation of the front water leg or header in this type of water tube boiler.

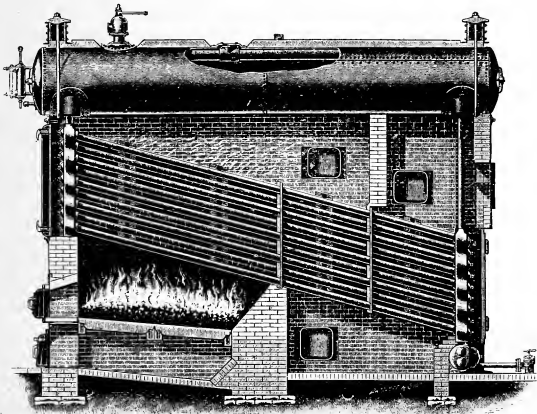
It will be seen that the hand plates are all oval in shape, allowing each one to be removed from its respective hole; also, the manner of bracing with hollow stay-bolts is shown.

Note that the feed pipes for supplying furnace are equipped with oval hand plates to facilitate cleaning.

Walling in. — In setting the boiler, its front water leg is placed firmly on a set of strong, cast-iron columns bolted and braced together by the door frames and dead-plates and forming the fire front. This is the fixed end. The rear water legs rest on rollers which are free to move on cast-iron plates firmly set in the masonry of the low and solid rear wall. Thus the boiler and its walls are each free to move separately during expansion or contraction, without loosening any joints in the masonry.

On the lower, and between the upper tubes, are placed light

fire-brick tiles. The lower tier extends from the front water leg to within a few feet of the rear one, leaving there an upward passage across the rear ends of the tubes for the flame. The upper tier closes into the rear water leg and extends forward to within a few feet of the front one, thus leaving an opening for the gases in front. The side tiles extend from side walls to tile bars and close up to the front water leg and front wall, and leave open the final uptake for the waste gases.



DESCRIPTION OF THE BABCOCK & WILCOX WATER TUBE BOILER.

Construction.—This boiler is composed of lap-welded, wrought iron tubes, placed in an inclined position and connected with each other and with a horizontal steam and water drum by vertical passages at each end, while a mud-drum is connected to the rear

and lowest point in the boiler. The end connections are in one piece for each vertical row of tubes, and are of such form that the tubes are "staggered" (or so placed that each row comes over the spaces in the previous row). The holes are accurately sized, made tapering, and the tubes fixed therein by an expander. The sections thus formed are connected with the drum, and with the mud-drum also by short tubes expanded into bored holes, doing away with all bolts, and leaving a clear passage-way between the several parts. The openings for cleaning opposite the end of each tube are closed by hand-hole plates, the joints of which are made in the most thorough manner, by milling the surfaces to accurate metallic contact, and are held in place by wrought iron forged clamps and bolts. They are tested and made tight under a hydrostatic pressure of 300 lbs. per square inch, iron to iron, and without rubber packing, or other perishable substances. The steam and water drums are made of flange iron or steel, of extra thickness, and double riveted. They can be made for any desired pressure, and are always tested at 50 per cent above the pressure for which they are constructed. The mud drums are of cast-iron, as the best material to withstand corrosion, and are provided with ample means for cleaning.

Erection. — In erecting this boiler, it is suspended entirely independent of the brickwork, from wrought iron girders resting on iron columns. This avoids any straining of the boiler from unequal expansion between it and its inclosing walls, and permits the brickwork to be repaired or removed, if necessary, without in any way disturbing the boiler. All the fixtures are extra heavy and of neat designs.

Operation. — The fire is made under the front and higher end of the tubes and the products of the combustion pass up between the tubes into a combustion chamber under the steam and water drum; from thence they pass down between the tubes, then once more up through the spaces between the tubes, and off to the

chimney. The water inside the tubes, as it is heated, tends to rise towards the higher end, and as it is converted into steam, the mingled column of steam and water being of less specific gravity than the solid water at the back end of the boiler, rises through the vertical passages into the drum above the tubes, where the steam separates from the water and the latter flows back to the rear and down again through the tubes in a continuous circulation. As the passages are all large and free, this circulation is very rapid, sweeping away the steam as fast as formed, and supplying its place with water; absorbing the heat of the fire to the best advantage; causing a thorough commingling of the water throughout the boiler and a consequent equal temperature, and preventing to a great degree, the formation of deposits or incrustations upon the heating surfaces, sweeping them away and depositing them in the muddrum, whence they are blown out. The steam is taken out at the top of the steam-drum near the back end of the boiler after it has thoroughly separated from the water, and to insure dry steam a perforated dry-pipe is connected to the nozzle inside the drum.

Efficient circulation of water. — As all the water in the boiler tends to circulate in one direction, there are no interfering currents; the steam is carried quickly to the surface, all parts of the boiler are kept at a nearly equal temperature, preventing unequal strains, and by the rapid sweeping current, the tendency to deposit sediment on the heating surface is materially lessened.

Quick steaming. — The water being divided in many small streams, in thin envelopes, passing through the hottest part of the furnace, steam may be rapidly raised in starting, and sudden demands upon the boiler may be met by a quickly increased efficiency.

Dryness of steam. — The large disengaging surface of the water in the drum, together with the fact that the steam is delivered at one end and taken out at the other, secures a thorough

separation of the steam from the water, even when the boiler is forced to its utmost. No part of a boiler not exposed to water on the one side should be subjected to the heat of the fire upon the other, as the unavoidable unequal expansion necessarily weakens the metal, and is a serious source of danger. Hence, a boiler which makes dry steam is to be preferred to one that dries steam which has been made wet.

Energy losses which occur on the way from furnace to engine.—The engine starts and the lights are turned on, or elevators start or the steam is turned on in the building, whichever it may be. Here we have a cause and its effect standing, respectively, at the head and foot of a long series of operations. With the history of these operations the engineer is most deeply concerned. Let us trace, then, some of the steps which lead from the fireman and the coal which he throws on the fire. We must at the start clearly understand that it is with energy and work, and the history of their journey from the coal to the engine, that we are concerned. These words energy and work, or more especially the first, may suggest mechanics and mathematics, but we shall have small use for either in this discussion, except in the most form. In any event the word energy is simply the name of the capacity for doing work, and the engineer, if any one, should surely be acquainted with such a capacity in any and all its forms. Thus a lump of coal represents simply a certain amount of energy or the capacity to do a certain amount of work, and the whole engineer's duties in the engine-room exists simply in order that as much as possible of the energy may actually be converted into the desired work. Unfortunately this result so easy to state in words requires a long series of transformations or changes of form and transportations or changes of place, in all of which more or less is lost by the way. In fact the engineer's life is one long struggle against the tendency of energy to escape in some way or other, and so to avoid the transformation into useful work. Energy and work are,

in fact, such peculiar commodities that it is next to impossible to effect any change either of form or place without some loss, and quite impossible to effect certain of the changes which are necessary without any serious loss. It is the history of these changes and losses which befall the energy on its way from coal to the engine that we are now to examine. Let us first understand that coal is not energy, neither does it by itself possess energy. It is simply a substance whose union with oxygen results in liberating energy, — from where we will not here ask, that is another story. It is enough for the engineer to know that when coal unites with oxygen, or burns, as we commonly say, energy is liberated in the form of heat, and it is then his duty to use it as best he may. The burning or combustion is accomplished in the boiler furnaces, where the oxygen supplied by the air unites with the carbon and hydrogen in the fuel, and heat energy is set free. Suppose now that we start with one pound (1 lb.) of good coal, then experience shows us that if this pound of coal were perfectly and completely burned, and so all the heat available from it were liberated there would be about 14,000 heat units, that is 14,000 times as much as the heat required to raise 1 pound of water 1 degree, or more exactly, from 62 to 63 degrees Fahr. Now let us call this amount of heat 100 per cent, this amount we must then consider as our total available energy, our entire stock in trade; it is evident then that the first step should be the complete combustion of the fuel, for if it is not complete a corresponding loss will result. If the energy is not liberated it can never be used. If it is lost here it can never be gained. As a matter of fact, however, it is impossible to obtain absolutely complete combustion and it is just here that the first loss comes in. A little of the fuel may fall unburned through the grate into the ash-pit. A little in the form of dust and small bits may be carried by a strong draught, either unburnt or only partially burnt, through into the tubes and chimney, still another small portion may escape as smoke, which consists almost entirely of

very fine particles of unburnt carbon formed from the gases which are distilled away from the coal in the process of combustion. Still another portion of these gases may escape entirely unchanged and unconsumed. Again another portion of the energy may escape with a particular gas containing partly burned carbon. Chemistry teaches us that carbon and oxygen in burning may unite in two ways. One of them forms what is called carbon monoxide, and gives about 4,450 heat units per pound of carbon. The other forms what is called carbon dioxide, and gives 14,500 heat units per pound of carbon. Hence whatever carbon escapes in the form of carbon monoxide is only partly burned and we may consider it as carrying away over two-thirds of the energy which should be ours, and which would be by a complete combustion. These losses in the furnace are due, therefore, to poor firing and incomplete combustion. To reduce them to the smallest possible limit the fireman must know his business, and be willing to properly attend to it. In addition there must be provided by proper design, the necessary supply of air both above and below the grate, together with such other arrangements as experience may show are needed for good combustion with the fuel in hand. Still try as we may there will be some loss. Through good care and good design it may be reduced to perhaps not more than 2 or 3 per cent or even less. With carelessness and poor design however it may reach a very serious amount, 5 to 30 per cent being no unusual figure for such conditions. For illustration we will take this loss at 4 per cent then the remaining part will likewise represent the total amount of heat actually liberated. In the present case this amount is 96 per cent of the whole. This fraction is usually called the efficiency of the furnace, that is if we consider it the office of the furnace to liberate all of the heat by complete combustion then the fraction which is actually liberated is naturally called the furnace efficiency. In the present case this would be then 96 per cent.

We next consider that the furnace should pass this heat over to the boiler heating surface, whose office it is to transfer it through into the water on the other side. This is one of the series of changes to which the energy is to be subjected. It is still retained in the form of heat, but is to be given from the hot gas to the water which it transforms into steam. This change is effected simply because water or steam is more convenient than hot gas for use in an engine for obtaining mechanical work. It is the office, then, of the heating surface, to pass the heat from the hot gas formed by the combustion of the coal through into the water. This, however, cannot be completely accomplished, and here comes in the second loss. A part of the heat, instead of getting through the heating surface, goes up the chimney with the escaping gases, and so gets away into the outside air and thus beyond all reach of use in the formation of steam. Another and much smaller part escapes by radiation out in the fire room. These losses of heat it is impossible wholly to avoid. It would be necessary to prevent all loss of heat by radiation into the fire rooms and to reduce the temperature of the products of combustion in the chimney to that of the outside air. The latter especially cannot be done, for a variety of reasons. In the first place the temperature cannot be reduced below that of the steam and water in the boiler, because heat always flows naturally from a hot body to a cooler one, and it will therefore flow from the gas to the water only so long as the latter is the cooler of the two. Actually, the temperature of the escaping gases will be much higher than the steam, because, in the first place, sufficient heating surface to reduce them nearly to the same temperature could hardly be afforded; and again, aside from the strength of the draught, it is depending on the temperature of the hot gas in the chimney and for a satisfactory rate of combustion it is necessary to discharge the products of combustion at temperature of from 500° to 700° . This loss is one, therefore, which exists in the very nature of things and in the usual

case cannot be reduced below from 20 to 25 per cent. No definite figure can be given for the loss of radiation in the fire room, but it would be very small, and, in any ordinary case, quite inconsiderable in comparison with that which we have just discussed.

In the present case, for illustration we will take this second series of losses at 24 per cent, reckoned on the original basis, this will be 74 per cent of the whole. Then the amount of heat energy which traverses the heating surface and takes part in the formation of steam is 73 per cent of the whole. This is usually called the efficiency of the heating surface, and would here equal 76 per cent. The total loss to this point is 27 per cent. We now come to the third step in our series of operations. The steam, carrying with it the heat energy which it has received, is to be transported along a pipe and given over to the engine. A part of the heat escapes, however, by radiation from the boiler and steam-pipe resulting in the condensation of part of the steam back into water again. Here, then, is another loss whose amount will depend on the length of the pipe, and whether bare or covered with non-conducting material. By properly covering the boiler and pipe with non-conducting material this loss may be reduced to a very small amount, while with a long bare pipe it may become considerable. In the present case we will take the amount at one per cent of the heat in the steam. This referred to the original amount as a base, will be 1 per cent of 72 per cent, or 0.73 per cent. The remainder represents the energy which finally reaches the steam chest and is handed over to the engine, amounting to $73 - 0.72$ or 72.27 per cent. Now all the losses to this point, the amount of which will be $4 + 23 + 0.73$ or 27.73 per cent. We come now to the fourth step in our history, involving the most important of the various operations and the most serious of all the losses. The energy which has been so far in the form of heat is now to be transformed into mechanical work in the engine. In effecting this a most serious loss necessarily occurs; this

comes about in two ways. First, when heat is transformed into mechanical work even the most perfect engine possible is unable to effect the change without a loss. Second, the actual steam engine falls short of attaining the possibilities of the ideally perfect engine. With such an engine the fraction of the heat which can be changed into work is expressed by the difference between the highest and lowest temperatures of the steam or other working substance for the numerator, and the highest temperature plus 460.7 for the denominator. Thus, for example, if the steam enters at a temperature of 350° , and exhausts at a temperature of 130° ; the fraction is $220 \div 810.7$, or about 27 per cent, that is, only about one-quarter of the heat is transformed into work, nearly three-quarters being utterly lost in the operation. And this is the very best that could be done between these temperature limits by the most ideally perfect engine possible, practically such an engine cannot be built. In fact, the actual engine is only able to realize from 60 to 80 per cent of the efficiency of the ideally perfect engine. This gives, then, from 15 to 20 per cent as the engine efficiency for good practice with triple or quadruple expansion engines using from, say, 17 to 22 lbs. steam per 1 H. P. per hour. This covers the range of what may be called good practice. This loss, then, of from 80 to 85 per cent of all the heat coming to the engine is due partly to the very nature of the operation, and partly to our inability to realize the most favorable condition. Increase of pressure, decrease of clearance, may all tend towards a reduction of this loss, but at the very best the amount of improvement which can be hoped for is but slight in comparison with the amount of the loss itself. In the present case, for illustration, we will suppose that the loss at the engine is 83 per cent of the heat provided by the steam, this referred to the original amount as a base, will be 83 per cent of 72.27 per cent, or 60 per cent. This amount transformed into mechanical work developed in the cylinders

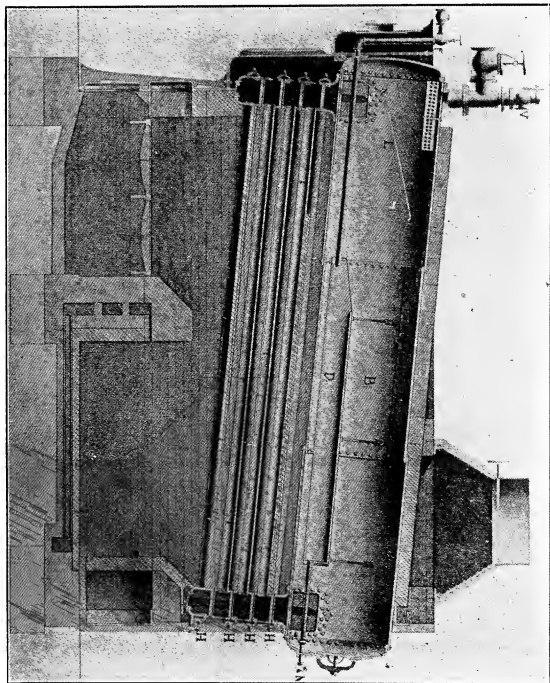
amounting to $72.27 - 60 = 12.27$ per cent. The total loss known is $4 + 23 + 73 + 60 = 87.73$ per cent; 12.27 per cent represents the efficiency of the whole operation. I have only followed the steam to the engine. There are losses in large plants, such as office building and manufacturing plants, for instance; in the heating this loss is familiar to us all. What, then, is the final result, 12.27 per cent saved out of 100 available at the start. This seems like a disheartening result, but should never be the attitude of the engineer. He must realize that these losses are the result of the laws of nature, as we are at present enabled to interpret them. He is not to blame himself for inability to overcome a law of nature, but rather only for neglect to make the most of the possibilities under these laws as they are understood. Let us, then, as engineers, realize our duties and privileges in this light, and within the limitations which surround us work for the decrease of this constant chain of losses which invariably attend every operation with energy.

DESCRIPTION OF THE HEINE SAFETY BOILER.

The boiler is composed of lap-welded wrought-iron tubes extending between and connecting the inside faces of two "water legs," which form the end connections between these tubes and a combined steam and water drum or "shell" placed above and parallel with them. (Boilers over 200 horse-power have two such shells.) These end chambers are of approximately rectangular shape, drawn in at top to fit the curvature of the shells. Each is composed of a *head plate* and a *tube sheet* FLANGED ALL AROUND AND JOINED AT BOTTOM and sides by a butt strap of same material, strongly riveted to both. The water legs are further stayed by hollow stay-bolts of hydraulic tubing of large diameter, so placed that two stays support each tube and hand-hole and are subjected to only very slight strain. Being made of heavy metal, they form the strongest parts of the boiler and its natural supports. The

water legs are joined to the shell by flanged and riveted joints, and the drum is cut away at these two points to make connection

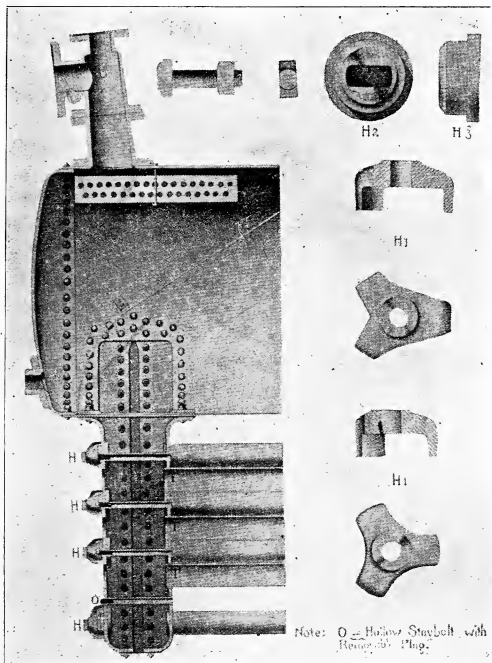
A Sectional View of the Heine Safety Boiler.



with inside of water leg, the opening thus made being strengthened by bridges and special stays so as to preserve the original strength.

The shells are cylinders with heads dished to form parts of a true sphere. The sphere is everywhere as strong as the circle seam of the cylinder, which is well known to be twice as strong as its side seam. Therefore, these heads require no stays. Both the cylinder and its spherical heads are, therefore, free to follow their natural lines of expansion when put under pressure. Where flat heads have to be braced to the sides of the shell, both suffer local distortions where the feet of the braces are riveted to them, making the calculations of their strength fallacious. This they avoid entirely by their dished heads. To the bottom of the front head a flange is riveted, into which the feed-pipe is screwed. This pipe is shown in the cut with angle valve and check valve attached. On top of shell, near the front end, is riveted a steam nozzle or saddle, to which is bolted a tee. This tee carries the steam valve on its branch, which is made to look either to front, rear, right or left; on its top the safety valve is placed. The saddle has an area equal to that of stop valve and safety valve combined. The rear-head carries a blow-off flange of about same size as the feed flange, and a manhead curved to fit the head, the manhole supported by a strengthening ring outside. On each side of the shell a square bar, the tile-bar, rests loosely in flat hooks riveted to the shell. This bar supports the side tiles, whose other ends rest on the side walls, thus closing the furnace or flue on top. The top of the tile-bar is two inches below low water line. The bars rise from front to rear at the rate of one inch in twelve. When the boiler is set, they must be exactly level, the whole boiler being then on an incline, i. e., with a fall of one inch in twelve from front to rear. It will be noted that this makes the height of the steam space in front about two-thirds the diameter of the shell, while at the rear the water occupies two-thirds of the shell, the whole contents of the drum being equally divided between steam and water. The importance of this will be explained hereafter.

The tubes extend through the tube sheets, into which they are expanded with roller expanders; opposite the end of each and in the head-plates, is placed a hand-hole of slightly larger diam-



eter than the tube, and through which it can be withdrawn. These hand-holes are closed by small cast-iron hand-hole plates, which, by an ingenious device for locking, can be removed in a

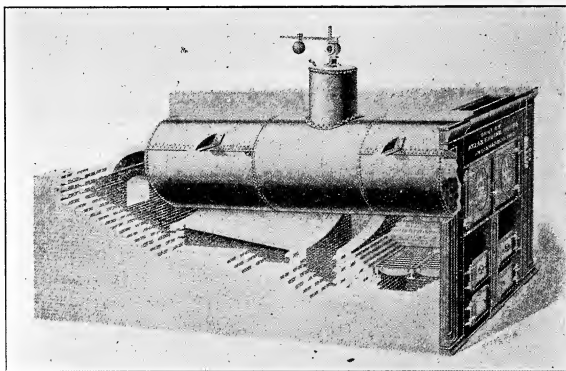
few seconds to inspect or clean a tube. The accompanying cut shows these hand-hole plates marked *H*. In the upper corner one is shown in detail, H^2 being the top view, H^3 the side view of the plate itself, the shoulder showing the place for the gasket. H^1 is the yoke or crab placed outside to support the bolt and nut. Inside of the shell is located the mud drum *D*, placed well below the water line, usually parallel to and 3 inches above the bottom of the shell. It is thus completely immersed in the hottest water in the boiler. It is of oval section, slightly smaller than the manhole, made of strong sheet-iron with cast-iron heads. It is entirely inclosed except about 18 inches of its upper portion at the forward end, which is cut away nearly parallel to the water line. Its action will be explained below. The feed-pipe *F* enters it through a loose joint in front; the blow-off pipe *N* is screwed tightly into its rear-head, and passes by a steam-tight joint through the rear-head of the shell. Just under the steam nozzle is placed a dry pan or dry pipe *A*. A deflection plate *L* extends from the front head of the shell, inclined upwards, to some distance beyond the mouth or throat of the front water leg. It will be noted that the throat of each water leg is large enough to be the practical equivalent of the total tube area, and that just where it joins the shell it increases gradually in width by double the radius of the flange.

Erection and walling in.—In setting the boiler, its front water leg is placed firmly on a set of strong cast-iron columns, bolted and braced together by the door frames, deadplate, etc., and forming the fire front. This is the fixed end. The rear water leg rests on rollers, which are free to move on cast-iron plates firmly set in the masonry of the low and solid rear wall. Wherever the brickwork closes in to the boiler, broad joints are left which are filled in with tow or waste saturated with fireclay, or other refractory but pliable material. Thus the boiler and its walls are each free to move separately during expansion or con-

traction without loosening any joints in the masonry. On the lower, and between the upper tubes, are placed light fire-brick tiles. The lower tier extends from the front water leg to within a few feet of the rear one, leaving there an upward passage across the rear ends of the tubes for the flame, etc. The upper tier closes in to the rear water leg and extends forward to within a few feet of the front one, thus leaving the opening for the gases in front. The side tiles extend from side walls to tile bars and close up to the front water leg and front wall, and leave open the final uptake for the waste gases over the back part of the shell, which is here covered above water line with a rowlock of firebrick resting on the tile bars. The rear wall of the setting and one parallel to it arched over the shell a few feet forward, form the uptakes. On these and the rear portion of the side walls is placed a light sheet-iron hood, from which the breeching leads to the chimney. When an iron stack is used, this hood is stiffened by *L* and *T* irons so that it becomes a truss carrying the weight of such stack and distributing it to the side walls.

Longitudinal section of Heine Boiler and its operation.—The boiler being filled to middle water line, the fire is started on the grate. The flame and gases pass over the bridge wall and under the lower tier of tiling, finding in the ample combustion chamber space, temperature and air supply for complete combustion, before bringing the heat in contact with the main body of the tubes. Then, when at its best, it rises through the spaces between the rear ends of the tubes, between rear water leg and back end of the tiling, and is allowed to expand itself on the entire tube heading surface without meeting any obstruction. Ample space makes leisurely progress for the flames, which meet in turn all the tubes, lap round them, and finally reach the second uptake at the forward end of the top tier of tiling, with their temperature reduced to less than 900° Fahrenheit. This has been measured here, while wrought iron would melt just above the lower tubes at

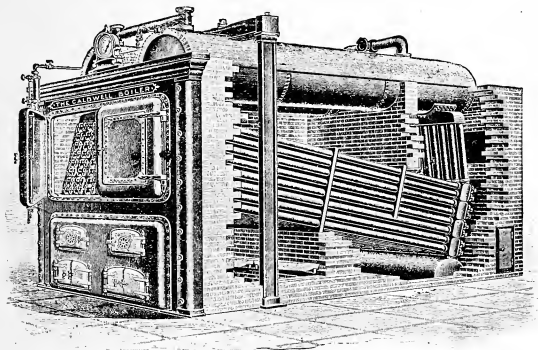
rear end, showing a reduction of temperature of over 1,800° Fahr. between the two points. As the space is studded with water tubes, swept clean by a positive and rapid circulation, the absorption of this great amount of heat is explained. The gases next travel under the bottom and sides of shell and reach the uptake at just the proper temperature to produce the draft required. This varies, of course, according to chimney, fuel required, etc. With boilers running at their rated capacity, 450° Fahrenheit are



· A furnace that is used in the East a great deal.

seldom exceeded. Meanwhile, as soon as the heat strikes the tubes, the circulation of the water begins. The water nearest the surface of the tubes becoming warmer, rises, and as the tubes are higher in front, this water flows towards the front water leg where it rises into the shell, while colder water from the shell falls down the rear water leg to replace that flowing forward and upward through the tubes. This circulation, at first slow, in-

creases in speed as soon as steam begins to form. Then the speed with which the mingled current of steam and water rises in the forward water leg will depend on the difference in weight of this mixture, and the solid and slightly colder water falling down the rear water leg. The cause of its motion is exactly the same as that which produces draft in a chimney.



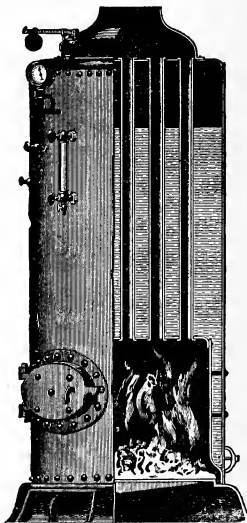
THE CALDWELL WATER TUBE SAFETY BOILER.

CIRCULATION IN THE CALDWELL BOILER.

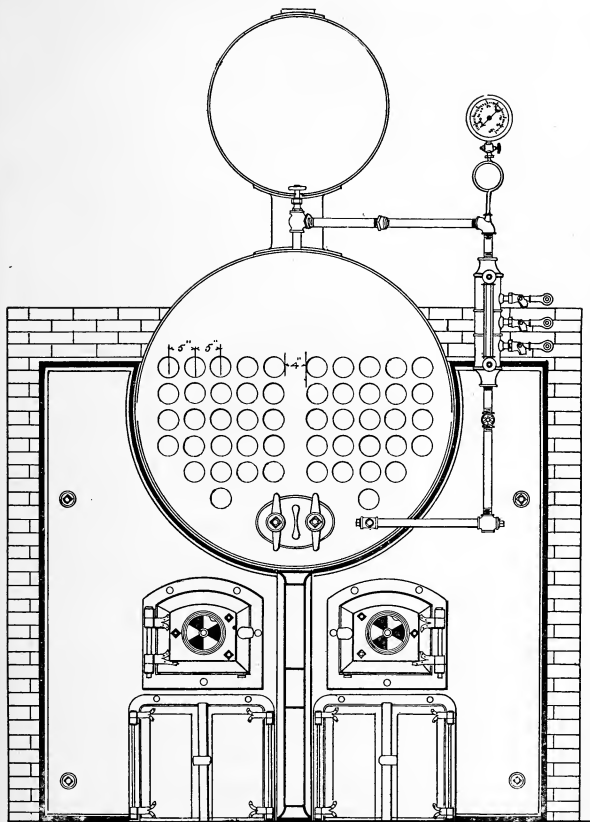
The inclination of the water tubes over the furnace, insures a rapid circulation of the water in one direction, so that there are no conflicting currents in the boiler. The globules of steam pass quickly up the front water legs to the steam and water drum. The water as it sweeps along the drum, frees itself of steam; then it goes down the back connection tubes and back water legs, and then along the incline tubes, meeting on its passage a gradually increasing temperature, till the furnace is again reached, where the steam formed on the way is directly carried up in the drum as before. The rapid and unimpeded circulation tends to

keep the inside surface clean, and floats the scale-making sediment along till it reaches the back water legs, where it is carried down and settles into the mud-drum, from where it can be blown off at regular intervals. Circulation is obtained in this boiler by the header casting being quadrangular, and not rhomboidal. This admits each header exactly over the others, connecting each to each with two expanded nipples of four inch diameter, thus making the areas of tubes to nipples 8 to 1, and securing a straight water-way for the water to rush along to the steam and water drum.

Plain Vertical Tubular Boiler



This cut shows the place for gauge cocks and water glass in an upright boiler.



The above cut shows the water-column in its proper place.

Table of Pressures allowable on Boilers made since February 28, 1872, by the United States Government.

Diameter of boiler.	Thickness of plates.	45,000 tensile strength, 1-6, 7,500.		50,000 tensile strength, 1-6, 8,333.3.		55,000 tensile strength, 1-6, 9,166.6.		60,000 tensile strength, 1-6, 10,000.		65,000 tensile strength, 1-6, 10,833.3.		70,000 tensile strength, 1-6, 11,666.6.	
		Pressure.	20 per cent additional.	Pressure.	20 per cent additional.	Pressure.	20 per cent additional.	Pressure.	20 per cent additional.	Pressure.	20 per cent additional.	Pressure.	20 per cent additional.
36 inches.....	.1875	78.12	93.74	86.8	104.16	95.48	114.57	104.16	124.99	112.84	135.4	121.52	145.82
	.21	87.5	105	97.21	116.65	106.94	128.33	116.66	139.99	126.38	151.65	136.11	168.33
	.23	95.83	114.99	106.47	127.76	117.12	140.54	127.77	153.92	138.41	166.09	149.07	178.88
	.25	104.16	124.99	115.74	138.68	127.31	152.77	138.88	166.65	150.46	180.55	162.03	191.43
	.26	108.33	129.99	120.37	144.44	132.4	158.88	144.44	173.32	156.48	187.77	168.51	202.21
	.29	120.83	144.99	134.25	161.11	147.68	177.21	161.11	193.33	174.53	209.43	187.96	225.55
	.3125	130.2	156.24	144.67	173.6	159.14	190.96	173.6	208.32	188.07	225.68	202.5	243.04
	.33	137.5	165	152.77	183.32	168.05	201.66	183.33	219.99	198.61	238.33	213.88	256.65
	.35	145.83	174.99	162.03	194.43	178.23	213.87	194.44	233.32	210.64	252.76	226.84	272.20
	.375	156.25	187.5	173.61	208.33	190.97	229.16	208.33	249.99	225.69	270.83	243.05	291.66
38 inches.....	.1875	74.01	88.81	82.23	98.67	90.46	108.54	98.68	118.41	106.9	128.28	115.13	138.16
	.21	82.89	99.46	92.1	110.52	101.31	121.57	110.52	132.62	119.73	143.67	128.93	154.71
	.23	90.78	108.93	100.87	121.04	110.96	133.15	121.05	145.26	131.13	157.35	141.22	169.46
	.25	98.68	118.41	109.64	131.56	120.61	144.73	131.57	157.83	142.54	171.04	153.5	184.20
	.26	102.63	123.15	114.03	136.83	125.43	150.51	136.84	164.2	148.34	177.88	159.64	191.56
	.29	114.47	137.36	127.19	152.62	139.91	167.89	152.63	183.15	165.95	198.42	178.06	213.67
	.3125	123.35	148.02	137.06	164.46	150.76	180.91	164.47	197.36	178.17	213.8	191.88	230.25
	.33	130.26	156.31	144.73	173.67	159.2	191.04	173.68	208.41	188.15	225.78	202.62	243.14
	.35	138.15	165.78	153.5	184.21	168.85	202.62	184.21	221.05	199.56	239.47	214.91	257.89
	.375	148	177.60	164.73	197.67	180.91	217.09	197.36	236.83	213.81	256.57	230.26	276.31
40 inches.....	.1875	70.31	84.37	78.12	93.74	85.93	103.11	93.75	112.5	101.56	121.87	109.37	131.24
	.21	78.75	94.50	87.49	104.98	96.24	116.48	106	126	113.74	136.48	122.49	146.98
	.23	86.25	103.5	95.83	114.99	105.41	126.49	116	136	124.58	149.49	134.16	160.99
	.25	93.75	112.5	104.16	124.99	114.58	137.49	125	150	135.41	162.49	145.83	174.99
	.26	97.5	117	108.33	129.99	119.16	142.99	130	156	140.83	168.99	151.66	181.99
	.29	108.75	130.5	120.83	144.99	132.91	159.49	145	174	157.08	188.49	169.16	202.99
	.3125	117.18	140.61	130.2	156.24	143.22	171.86	156.25	187.45	169.37	203.12	182.29	218.74
	.33	123.75	148.5	137.49	164.98	151.24	181.48	165	198	178.74	214.48	192.49	230.98
	.35	131.25	157.5	145.83	174.99	160.41	192.49	175	210	189.58	227.49	204.16	244.99
	.375	140.62	168.74	156.24	187.48	171.87	206.24	187.5	225	203.12	243.74	218.74	262.48

42 inches.....
 44 inches.....
 46 inches.....
 48 inches.....
 54 inches.....

1875	66.96	80.35	74.40	89.28	81.54	98.20	89.28	107.13	96.72	116.06	104.16	124.99
.21	75	90	83.32	99.99	91.66	109.99	100	120	108.33	129.99	116.66	139.99
.23	82.14	98.56	91.23	104.51	100.39	120.46	109.52	131.42	118.66	142.38	127.77	153.32
.25	89.28	107.13	99.2	119.04	109.12	130.94	119.04	143.84	128.96	154.75	138.88	166.65
.26	92.85	111.42	103.17	123.8	115.49	136.18	123.8	148.56	149.12	160.94	144.44	173.32
.29	103.57	124.28	115.07	138.08	126.57	151.85	138.09	165.7	149.6	179.52	161.11	193.33
.3125	111.6	133.92	125	148.8	136.4	163.68	148.74	178.56	161.2	193.44	173.61	208.28
.33	117.85	141.42	130.94	157.12	141.04	172.84	157.14	188.56	170.23	204.27	183.33	219.99
.35	125	150	138.88	166.65	152.77	183.82	166.66	199.99	180.55	216.66	194.44	233.32
.375	133.92	160.7	148.8	178.56	163.68	196.40	178.57	214.28	198.45	232.14	208.33	249.99
.375	133.92	160.7	148.8	178.56	163.68	196.40	178.57	214.28	198.45	232.14	208.33	249.99
.4125	141.42	172.84	157.14	188.56	170.23	204.27	188.56	216.66	204.27	233.32	219.99	253.32
.45	150	183.82	166.66	199.99	180.55	216.66	199.99	233.32	216.66	249.99	233.32	266.65
.4875	158.33	192.85	175.07	208.28	188.56	216.66	208.28	233.32	216.66	249.99	233.32	273.32
.525	166.65	204.27	183.82	219.99	196.40	224.27	219.99	249.99	224.27	253.32	249.99	280.28
.5625	175.07	214.28	193.44	233.32	208.33	249.99	233.32	266.65	233.32	266.65	266.65	286.65
.6075	183.82	224.27	204.27	249.99	219.99	266.65	249.99	280.28	266.65	280.28	280.28	293.32
.6525	192.85	233.32	216.66	266.65	233.32	280.28	266.65	293.32	280.28	293.32	293.32	300.28
.6975	201.94	242.38	228.96	280.28	249.99	300.28	280.28	300.28	300.28	300.28	300.28	306.65
.7425	210.94	251.48	241.48	293.32	266.65	316.66	293.32	316.66	316.66	316.66	316.66	323.32
.7875	219.99	260.58	254.48	306.65	280.28	333.32	306.65	333.32	333.32	333.32	333.32	340.28
.8325	228.96	269.68	267.48	320.28	293.32	350.28	320.28	350.28	350.28	350.28	350.28	346.65
.8775	237.96	278.78	280.48	333.32	306.65	366.65	333.32	366.65	366.65	366.65	366.65	353.32
.9225	246.96	287.88	293.48	346.65	320.28	383.32	346.65	383.32	383.32	383.32	383.32	360.28
.9675	255.96	296.98	306.48	360.28	333.32	400.28	360.28	400.28	400.28	400.28	400.28	366.65
1.0125	264.96	306.08	319.48	373.32	346.65	416.66	373.32	416.66	416.66	416.66	416.66	373.32
1.0575	273.96	315.18	332.48	386.65	360.28	433.32	386.65	433.32	433.32	433.32	433.32	380.28
1.1025	282.96	324.28	345.48	400.28	373.32	450.28	400.28	450.28	450.28	450.28	450.28	386.65
1.1475	291.96	333.38	358.48	413.32	386.65	466.65	413.32	466.65	466.65	466.65	466.65	393.32
1.1925	300.96	342.48	371.48	426.65	400.28	483.32	426.65	483.32	483.32	483.32	483.32	400.28
1.2375	309.96	351.58	384.48	440.28	413.32	500.28	440.28	500.28	500.28	500.28	500.28	406.65
1.2825	318.96	360.68	397.48	453.32	426.65	516.66	453.32	516.66	516.66	516.66	516.66	413.32
1.3275	327.96	369.78	410.48	466.65	440.28	533.32	466.65	533.32	533.32	533.32	533.32	420.28
1.3725	336.96	378.88	423.48	480.28	453.32	550.28	480.28	550.28	550.28	550.28	550.28	426.65
1.4175	345.96	387.98	436.48	493.32	466.65	566.65	493.32	566.65	566.65	566.65	566.65	433.32
1.4625	354.96	397.08	449.48	506.65	480.28	583.32	506.65	583.32	583.32	583.32	583.32	440.28
1.5075	363.96	406.18	462.48	520.28	493.32	600.28	520.28	600.28	600.28	600.28	600.28	446.65
1.5525	372.96	415.28	475.48	533.32	506.65	616.66	533.32	616.66	616.66	616.66	616.66	453.32
1.5975	381.96	424.38	488.48	546.65	520.28	633.32	546.65	633.32	633.32	633.32	633.32	460.28
1.6425	390.96	433.48	501.48	560.28	533.32	650.28	560.28	650.28	650.28	650.28	650.28	466.65
1.6875	399.96	442.58	514.48	573.32	546.65	666.65	573.32	666.65	666.65	666.65	666.65	473.32
1.7325	408.96	451.68	527.48	586.65	560.28	683.32	586.65	683.32	683.32	683.32	683.32	480.28
1.7775	417.96	460.78	540.48	600.28	573.32	700.28	600.28	700.28	700.28	700.28	700.28	486.65
1.8225	426.96	469.88	553.48	613.32	586.65	716.66	613.32	716.66	716.66	716.66	716.66	493.32
1.8675	435.96	478.98	566.48	626.65	600.28	733.32	626.65	733.32	733.32	733.32	733.32	500.28
1.9125	444.96	488.08	579.48	640.28	613.32	750.28	640.28	750.28	750.28	750.28	750.28	506.65
1.9575	453.96	497.18	592.48	653.32	626.65	766.65	653.32	766.65	766.65	766.65	766.65	513.32
2.0025	462.96	506.28	605.48	666.65	640.28	783.32	666.65	783.32	783.32	783.32	783.32	520.28
2.0475	471.96	515.38	618.48	680.28	653.32	800.28	680.28	800.28	800.28	800.28	800.28	526.65
2.0925	480.96	524.48	631.48	693.32	666.65	816.66	693.32	816.66	816.66	816.66	816.66	533.32
2.1375	489.96	533.58	644.48	706.65	680.28	833.32	706.65	833.32	833.32	833.32	833.32	540.28
2.1825	498.96	542.68	657.48	720.28	693.32	850.28	720.28	850.28	850.28	850.28	850.28	546.65
2.2275	507.96	551.78	670.48	733.32	706.65	866.65	733.32	866.65	866.65	866.65	866.65	553.32
2.2725	516.96	560.88	683.48	746.65	720.28	883.32	746.65	883.32	883.32	883.32	883.32	560.28
2.3175	525.96	569.98	696.48	760.28	733.32	900.28	760.28	900.28	900.28	900.28	900.28	566.65
2.3625	534.96	579.08	709.48	773.32	746.65	916.66	773.32	916.66	916.66	916.66	916.66	573.32
2.4075	543.96	588.18	722.48	786.65	760.28	933.32	786.65	933.32	933.32	933.32	933.32	580.28
2.4525	552.96	597.28	735.48	800.28	773.32	950.28	800.28	950.28	950.28	950.28	950.28	586.65
2.4975	561.96	606.38	748.48	813.32	786.65	966.65	813.32	966.65	966.65	966.65	966.65	593.32
2.5425	570.96	615.48	761.48	826.65	800.28	983.32	826.65	983.32	983.32	983.32	983.32	600.28
2.5875	579.96	624.58	774.48	840.28	813.32	1000.28	840.28	1000.28	1000.28	1000.28	1000.28	606.65
2.6325	588.96	633.68	787.48	853.32	826.65	1016.66	853.32	1016.66	1016.66	1016.66	1016.66	613.32
2.6775	597.96	642.78	800.48	866.65	840.28	1033.32	866.65	1033.32	1033.32	1033.32	1033.32	620.28
2.7225	606.96	651.88	813.48	880.28	853.32	1050.28	880.28	1050.28	1050.28	1050.28	1050.28	626.65
2.7675	615.96	660.98	826.48	893.32	866.65	1066.65	893.32	1066.65	1066.65	1066.65	1066.65	633.32
2.8125	624.96	670.08	839.48	906.65	880.28	1083.32	906.65	1083.32	1083.32	1083.32	1083.32	640.28
2.8575	633.96	679.18	852.48	920.28	893.32	1100.28	920.28	1100.28	1100.28	1100.28	1100.28	646.65
2.9025	642.96	688.28	865.48	933.32	906.65	1116.66	933.32	1116.66	1116.66	1116.66	1116.66	653.32
2.9475	651.96	697.38	878.48	946.65	920.28	1133.32	946.65	1133.32	1133.32	1133.32	1133.32	660.28
2.9925	660.96	706.48	891.48	960.28	933.32	1150.28	960.28	1150.28	1150.28	1150.28	1150.28	666.65
3.0375	669.96	715.58	904.48	973.32	946.65	1166.65	973.32	1166.65	1166.65	1166.65	1166.65	673.32
3.0825	678.96	724.68	917.48	986.65	960.28	1183.32	986.65	1183.32	1183.32	1183.32	1183.32	680.28
3.1275	687.96	733.78	930.48	1000.28	973.32	1200.28	1000.28	1200.28	1200.28	1200.28	1200.28	686.65
3.1725	696.96	742.88	943.48	1013.32	986.65	1216.66	1013.32	1216.66	1216.66	1216.66	1216.66	693.32
3.2175	705.96	751.98	956.48	1026.65	1000.28	1233.32	1026.65	1233.32	1233.32	1233.32	1233.32	700.28

Table of Pressures allowable on Boilers made since February 28, 1872, by the United States Government. — Continued.

Diameter of boiler.	Thickness of plates.	45,000 tensile strength, 1-6, 7,500.		50,000 tensile strength, 1-6, 8,333.3.		55,000 tensile strength, 1-6, 9,166.6		60,000 tensile strength, 1-6, 10,000.		65,000 tensile strength, 1-6, 10,833.3.		70,000 tensile strength, 1-6, 11,666.6.	
		Pressure.	20 per cent additional.	Pressure.	20 per cent additional.	Pressure.	20 per cent additional.	Pressure.	20 per cent additional.	Pressure.	20 per cent additional.	Pressure.	20 per cent additional.
54 inches.....	.3125	86.8	104.16	115.75	127.30	138.66	150.46	162.03	173.88	185.88	197.99	209.99	221.99
	.33	91.65	109.99	122.22	134.43	146.66	158.88	171.10	183.33	195.55	207.77	219.99	232.22
	.35	97.22	116.66	129.62	142.58	155.54	168.50	181.47	194.43	207.39	220.35	233.31	246.27
	.375	104.16	124.99	138.88	152.77	166.65	180.55	194.43	208.32	222.22	236.11	250.00	263.89
	.1875	46.87	56.24	62.49	68.74	75.00	81.25	87.50	93.75	100.00	106.25	112.50	118.75
	.21	52.5	63	69.99	76.99	84	91	98	105	112	119	126	133
	.23	57.5	69	76.65	84.32	92.00	99.67	107.34	115.01	122.68	130.35	138.02	145.69
	.25	62.5	75	83.32	91.65	99.99	108.33	116.66	125.00	133.33	141.66	150.00	158.33
	.26	65	78	86.66	95.32	103.99	112.66	121.33	130.00	138.66	147.33	156.00	164.66
	.29	72.5	87	96.65	106.33	116.00	125.66	135.33	145.00	154.66	164.33	174.00	183.66
60 inches.....	.3125	78.12	93.74	104.16	115.75	127.30	138.66	150.46	162.03	173.88	185.88	197.99	209.99
	.33	82.5	99	109.99	120.83	132	143.88	155.88	167.88	179.88	191.88	203.88	215.88
	.35	87.5	105	116.66	128.32	140.66	152.66	164.66	176.66	188.66	200.66	212.66	224.66
	.375	93.75	112.5	124.99	137.49	150	162.49	174.99	187.49	200	212.49	224.99	237.49
	.1875	42.61	51.13	56.8	62.49	68.17	73.85	79.53	85.21	90.89	96.57	102.25	107.93
	.21	47.72	57.26	63.63	69.99	76.35	82.71	89.08	95.44	101.81	108.17	114.53	120.89
	.23	52.27	62.72	69.69	76.65	83.62	90.59	97.56	104.52	111.49	118.46	125.43	132.40
	.25	56.81	68.17	75.75	83.32	90.89	98.47	106.04	113.62	121.19	128.77	136.34	143.91
	.26	59.09	70.9	78.78	86.66	94.53	102.42	110.31	118.20	126.09	133.98	141.87	149.76
	.29	69.30	79.08	88.87	96.66	104.45	112.24	120.03	127.82	135.61	143.40	151.19	158.98
66 inches.....	.1875	71	85.2	94.69	104.16	113.62	123.09	132.56	142.03	151.50	160.97	170.44	179.91
	.3125	83.33	99.99	116.66	133.33	150.00	166.66	183.33	200.00	216.66	233.33	250.00	266.66
	.35	79.56	95.47	106.05	117.66	129.27	140.88	152.49	164.10	175.71	187.32	198.93	210.54
	.375	85.22	102.26	113.62	125.00	136.38	147.76	159.14	170.52	181.90	193.28	204.66	216.04
	.1875	39.06	46.87	43.4	47.74	52.08	56.42	60.76	65.10	69.44	73.78	78.12	82.46
	.21	43.75	52.5	58.33	64.16	69.99	75.82	81.65	87.48	93.31	99.14	104.97	110.80
	.23	47.91	57.49	63.88	70.27	76.66	83.05	89.44	95.83	102.22	108.61	115.00	121.39
	.25	52.08	62.49	69.44	76.38	83.32	90.26	97.20	104.14	111.08	118.02	124.96	131.90
	.26	54.16	64.99	72.21	79.44	86.66	93.88	101.10	108.32	115.54	122.76	130.00	137.22
	.29	60.41	72.49	80.54	88.60	96.66	104.71	112.77	120.83	128.89	136.95	145.01	153.07
72 inches.....	.3125	60.41	72.49	80.54	88.60	96.66	104.71	112.77	120.83	128.89	136.95	145.01	153.07
	.33	64.16	77.14	86.33	95.50	104.66	113.83	122.99	132.16	141.33	150.50	159.66	168.83
	.35	68.17	81.65	91.65	101.65	111.65	121.65	131.65	141.65	151.65	161.65	171.65	181.65
	.375	72.22	86.66	96.66	106.66	116.66	126.66	136.66	146.66	156.66	166.66	176.66	186.66
	.1875	46.87	56.24	62.49	68.74	75.00	81.25	87.50	93.75	100.00	106.25	112.50	118.75
	.21	52.5	63	69.99	76.99	84	91	98	105	112	119	126	133
	.23	57.5	69	76.65	84.32	92.00	99.67	107.34	115.01	122.68	130.35	138.02	145.69
	.25	62.5	75	83.32	91.65	99.99	108.33	116.66	125.00	133.33	141.66	150.00	158.33
	.26	65	78	86.66	95.32	103.99	112.66	121.33	130.00	138.66	147.33	156.00	164.66
	.29	72.5	87	96.65	106.33	116.00	125.66	135.33	145.00	154.66	164.33	174.00	183.66

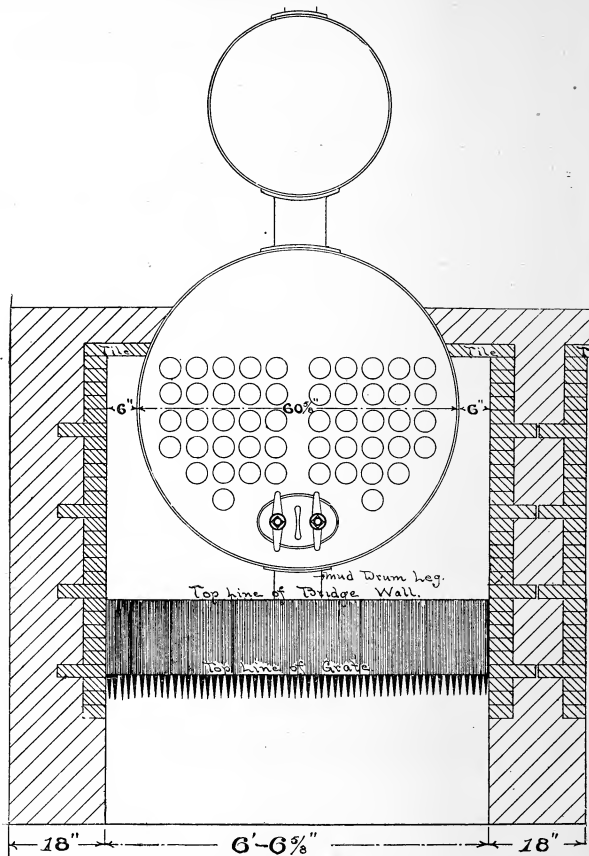
.3125	65.10	78.12	72.33	86.8	79.57	95.48	86 R	104.16	94.03	112.83	101.27	121.52
.33	68.75	82.5	76.35	91.65	84.02	100.82	91.66	109.99	99.3	119.16	106.94	128.32
.35	72.91	87.49	81.01	97.21	89.11	106.93	97.22	116.66	105.32	126.38	113.42	136.1
.375	78.12	93.74	86.8	104.16	95.48	114.57	104.16	124.99	112.84	135.43	121.52	145.82
.1875	36.05	43.21	40.06	48.07	44.07	52.87	48.07	57.68	52.08	62.49	56.08	67.29
.21	40.38	48.45	44.87	53.84	49.35	59.22	53.84	64.60	58.33	69.99	63.82	75.38
.23	44.23	53.07	49.14	58.96	54.05	64.86	58.95	70.76	63.88	76.65	68.80	82.56
.25	48.07	57.68	53.41	64.09	58.76	70.5	64.4	76.92	68.44	83.32	74.78	89.73
.26	50	60	55.55	66.66	66.11	78.33	66.66	79.99	72.22	86.66	77.77	93.82
.29	55.76	66.91	61.96	74.35	68.16	81.79	74.35	89.22	80.55	96.66	86.75	104.1
.3125	60.09	72.1	66.77	80.12	73.45	88.14	80.12	96.14	86.8	104.16	93.48	112.17
.33	63.46	76.15	70.51	84.61	77.56	93.07	84.61	101.53	91.66	109.99	98.71	118.45
.35	67.3	80.76	74.78	89.73	82.26	98.71	89.73	107.68	97.22	116.66	104.70	125.61
.375	72.11	86.53	80.12	96.14	88.14	105.76	105.76	115.38	104.16	124.99	112.17	134.6
.1875	33.48	40.17	37.2	44.68	40.32	49.1	44.61	53.56	48.86	58.08	52.08	62.49
.21	37.5	45.15	41.66	49.99	45.83	54.99	50.75	60	54.16	64.99	58.38	69.99
.23	41.02	49.22	45.63	54.75	50.19	60.22	54.75	63.71	59.32	71.18	63.88	76.66
.25	44.64	53.56	49.6	59.52	54.56	65.47	59.52	74.22	64.48	77.37	69.44	83.32
.26	46.42	55.7	51.58	61.89	56.74	68.08	61.9	74.28	67.05	80.46	72.22	86.66
.29	51.78	62.13	57.53	69.03	63.29	75.94	69.04	82.84	74.8	89.76	80.55	96.66
.3125	55.8	66.96	62	74.4	68.2	81.81	74.4	89.28	80.6	96.72	86.8	104.16
.33	58.92	70.7	65.47	78.56	72.02	86.42	78.57	94.28	85.11	102.13	91.66	109.99
.35	62.5	75	69.44	83.32	76.38	91.65	83.33	99.99	90.27	108.32	97.22	116.66
.375	66.96	80.35	74.4	89.28	81.84	98.2	89.28	107.13	96.72	116.06	104.16	124.99
.21	35	37.5	34.72	41.66	38.19	45.82	41.66	49.99	45.13	54.15	48.68	58.33
.23	38.33	45.99	38.88	46.65	42.77	51.32	46.66	56.99	45.55	54.44	48.68	58.33
.25	41.66	49.99	42.59	51.10	46.85	56.22	51.11	61.33	55.37	66.44	59.62	71.54
.26	43.33	51.99	48.14	55.74	50.92	61.1	55.55	66.66	60.18	72.21	64.81	77.77
.29	48.33	57.99	53.7	64.44	59.07	68.55	64.44	77.32	69.32	82.59	75.1	89.88
.3125	52.08	62.49	57.86	69.43	63.65	76.38	69.44	83.32	75.23	90.27	81.01	97.21
.33	55	66	61.11	73.33	67.22	80.66	73.33	87.99	79.44	95.32	85.55	102.66
.35	58.33	69.99	64.81	77.77	71.29	85.51	77.77	93.32	84.25	101.1	90.72	108.88
.375	62.5	75.14	68.44	83.32	76.38	91.65	83.33	99.99	90.27	108.32	97.22	116.66
.1875	29.29	35	32.55	39.06	35.8	42.96	39.06	46.87	42.31	50.77	45.57	54.68
.21	32.91	39.37	36.45	43.74	40.1	48.12	43.75	52.5	47.39	56.86	51.04	61.24
.23	35.93	43.11	39.93	47.91	43.92	52.7	47.91	57.49	51.9	62.28	55.9	67.08
.25	39.06	46.87	43.4	52.08	47.74	57.28	52.08	62.49	56.42	67.67	60.76	72.91
.26	40.62	48.74	45.14	54.16	49.65	59.58	54.16	64.99	58.78	70.53	63.19	75.82
.29	45.31	54.37	50.34	60.4	55.38	66.45	60.41	72.49	65.45	78.54	70.48	84.57
.3251	51.56	61.87	54.25	65.1	59.67	71.6	65.1	78.12	70.52	84.62	75.95	91.14
.33	53.82	65.8	57.29	68.74	63.02	75.62	68.75	82.5	74.47	89.36	80.27	96.24
.35	54.68	65.61	60.76	72.91	66.83	80.19	72.91	87.49	78.99	94.78	85.06	102.07
.375	58.58	70.29	65.1	78.12	71.61	85.93	78.12	93.74	84.63	101.55	91.14	109.6

78 inches

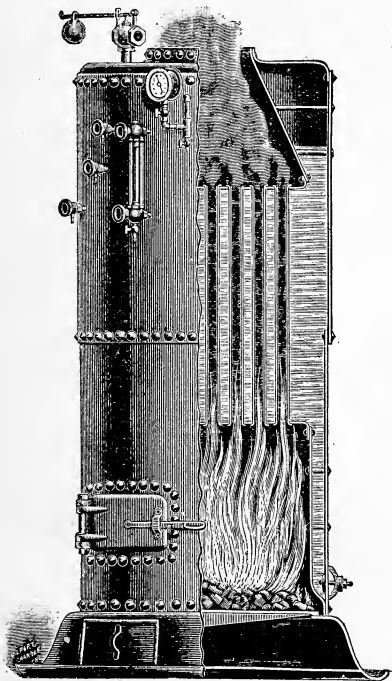
84 inches

90 inches

96 inches



The above cut shows the proper place for closing in the boiler on the side — also the space between side of boiler and side walls.



The above cut shows the proper place for gauge-cocks in a submerged tube boiler.

THE AMOUNT OF MATERIAL REQUIRED TO BRICK UP BOILERS OF DIFFERENT SIZE.

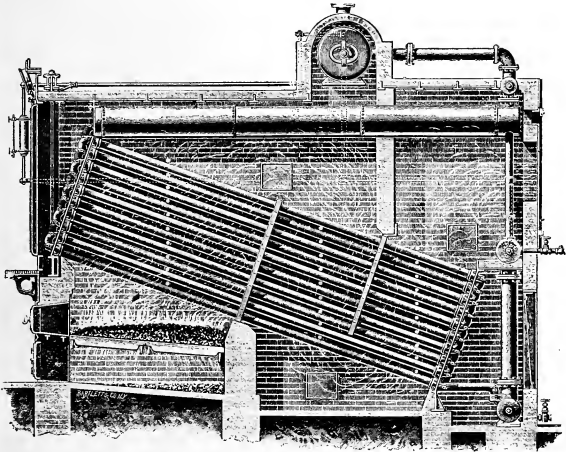
Size of Boiler.	Thickness of Walls.	Red Brick.	Fire Brick. Fire Clay $\frac{1}{2}$ lb. to each brick.	Lime.	S. Tile. 6" Tile.	Sand. Yds.	Cement for concrete footing 2 ft. and 2 ft. thick under all walls.
72"x22'	18"	10.500	2.500	18 bu.	88	8	9 bbl.
72"x20'	18"	10.000	2.300	18 bu.	80	8	8 bbl.
72"x18'	18"	9.500	2.200	17 bu.	72	7	8 bbl.
60"x20'	18"	9.500	2.200	17 bu.	80	7	8 bbl.
60"x18'	18"	9.000	2.000	16 bu.	72	7	8 bbl.
54"x20'	18"	8.700	1.900	15 bu.	80	6	8 bbl.
54"x18'	18"	8.000	1.800	15 bu.	72	6	8 bbl.
54"x16'	18"	7.500	1.700	14 bu.	64	6	7 bbl.
48"x18'	18"	7.500	1.600	14 bu.	72	6	7 bbl.
48"x16'	18"	7.200	1.500	14 bu.	64	5	7 bbl.
42"x18'	18"	7.000	1.400	12 bu.	72	5	7 bbl.
42"x16'	18"	6.500	1.300	12 bu.	64	4	7 bbl.

If 13" wall $\frac{1}{4}$ less on Red Brick.

CIRCULATION IN THE ROOT BOILER.

Let us refer to the view on page 769, showing the side elevation. There it will be seen how the hot gases from the fire rise above the grate and course their way along the three turns they are obliged to take before reaching the chimney, giving up heat on their journey. This heat, be it remembered, is constantly being reinforced by the burning gases, which have such excellent opportunities given them to burn to completion in the air spaces between the tubes through which they pass. What effect is produced by this constant bathing of the tubes with this heat? And also, what is the effect of the intense heat of radiation from the bed of glowing fuel, striking against the lower tubes in the front part of the boiler? Of course, it will be seen at once that this heat is constantly being robbed of its intensity, passing

through the metal of these tubes and heating the water inside. As this water becomes hotter and hotter, its density (or mass per cubic foot) decreases, and we find that the long column of water in the rear of the boiler, which is much colder and heavier than the water in the tubes, naturally falls by gravity to the bottom, and as it does so, it necessarily compels the lighter water contained in



SIDE ELEVATION OF ROOT IMPROVED BOILER.

the tubes to pass upwards. By this means, the hot water in all the inclined tubes passes, as long as the heat is applied, up along these tubes until it reaches the front headers, and there finding an uninterrupted passage from the bottom to the top, it ascends directly along these courses until it reaches the overhead drums, into which it is discharged, carrying with it the bubbles of steam which have been formed in the tubes below. There, in these over-

head drums, its finds a chance to allow these bubbles to disengage themselves from the water and rise to the top of the drum, which is always reserved as a steam space.

The course of the circulating water.—Next, let us follow the course of this water which is now deprived of the bubbles of steam which entered with it in the front end of the overhead drums. At the rear of these drums, outlet pipes will be seen connecting them to a lower drum placed across the width of the boiler, into which is introduced the feed water. This colder feed water must necessarily reduce the temperature of the circulating water it finds here, and by this means the density of the water is increased. Thus, being heavier, the water falls to the lower part of the boiler, of course, forcing the lighter water in the tubes to ascend; and as this cooled water falls from the feed drum, the distinct downward current being so positively established, the water from the rear of the overhead drums must necessarily follow it down through the rear “down take pipes,” connecting them to the feed drum. We now find this mixture of feed and circulating water descending in a continuous and uninterrupted stream from the feed drum to the mud drum, which is located beneath it, and from there, after leaving behind its mud, etc., which enters with the feed water, passing thus cleansed from the extreme top of this mud drum through the “goose-neck” connecting pipes and entering the bottom of each one of the rear vertical sections. No one can fail to understand that with the water level in this boiler far above the top of these rear sections, the water *must* necessarily rise and fill them to the very top, and so furnish an ample supply to each and every one of the inclined tubes; and it will also be noticed that the tubes nearest to the fire (and thus subjected to the greatest deteriorating effects) receive first their supply of the coolest water, which affords them the greatest protection, while the upper tubes, the farthest removed from the fire’s intense heat, receive their supply last. This is all exactly as it

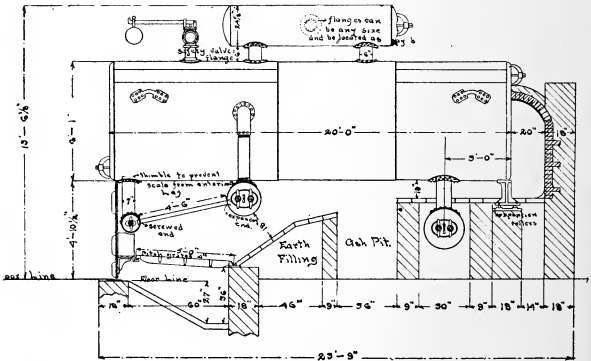
should be. The circulating water is ready to pass over the course I have already followed, the course defined and pointed out by nature's laws. The reader will now be able to picture to himself the course of circulation actually taking place in the Root Boiler. He will see that by this means a new supply of water is constantly being delivered to all the tubes, where it is cut up into small bulks and thus subdivided, is brought into contact with the currents of heated gases rising from the fire, and they in turn are broken up as they impinge against the tubes and swirl around them. This most effective arrangement leads to a quick absorption of heat and a rapid generation of steam, and after this steam is generated and delivered with the circulating water into the overhead drums, it finds there the largest possible liberating surface to disengage itself from the water, a surface which is almost as large as the floor space occupied by the boiler itself; and with this unsurpassed liberating surface, one cannot fail to see that the steam has ample chance to disengage itself quietly from the water without regard to any sudden demand which may be made upon the boiler for steam. This, evidently, has much to do with the dryness of the steam delivered.

HAWLEY'S DOWN DRAUGHT FURNACE.

The down draught furnace made a good smoke record, even with overworked boilers, doing variable work, and with a marked economy in fuel. My experience with the down draught furnace, I feel safe in saying that smoke from boiler furnaces can now be abated by practical means, without hardship, no matter what the type of boiler.

Directions for firing the Hawley's Down Draught Furnace. — When firing the Hawley furnace, throw the coal evenly over the entire grate surface, from 6 to 8 inches in depth, a little heaviest at the rear end of the furnace. Do not put in too much coal — burn more air; and economize with your fuel and

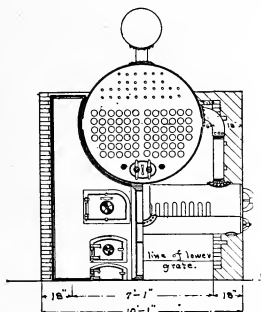
do not pile up the coal in front near the door. Never fire any fresh coal on the lower grates; let in air below the lower grates. When poking the fire, run the slice-bar down between the water grates and back the full length of the grates; then raise the slice-bar and gently shake the coal, and then pull it out without stirring up the fire. Never turn the fire over so that black coal gets down upon the water grates, unless there is a large clinker to remove. Never give the top grates a general cleaning, so as to leave a portion of the grates uncovered and the remainder with a hot fire on them, as this causes an uneven expansion in the different tubes forming the water grates, and is liable either to bend the tubes or strip off the threads where they enter the drums. When the top fire becomes clogged with clinkers so that you can-



Hawley's Down Draught Furnace.

not keep up steam, run in the slice-bar and raise the clinkers to the top of the fire; remove the large clinkers, leave the small ones alone, and put on a fresh fire. The lower grates must have proper

attention. The coals must be raked over evenly and all holes filled up, particular care being taken that the grates are perfectly covered all over. If considerable coals have accumulated on the



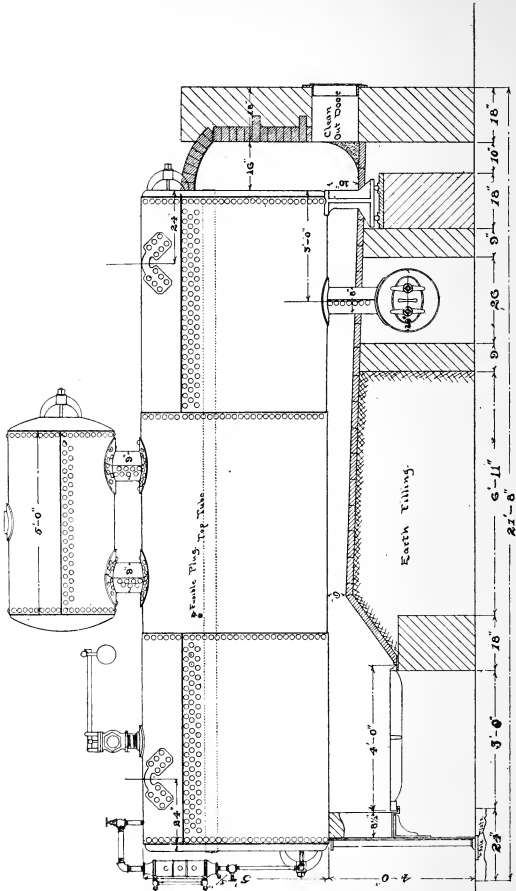
View of the Hawley's Down Draught Furnace.

lower grates and the air spaces are closed with ashes or clinkers, the slice-bar must be used and the clinkers raised up and turned over and the larger ones removed. It is best to remove the clinkers every two or three hours, leaving the coals to burn up.

SPECIFICATIONS FOR ONE SIXTY-INCH HORIZONTAL SIX-INCH FLUE BOILER.

General directions.— There will be one boiler 20 feet long from out to out of heads and 60 inches inside diameter.

Material, quality, thickness, etc.— Material in shell of the above named boiler to be made of homogeneous flange steel $\frac{5}{16}$ " thick, having a tensile strength of not less than 60,000 lbs. to



The above cut shows a good form of furnace for a long boiler.

the square inch of section, with not less than 56 per cent ductility, as indicated by contraction of area at point of fracture under test, or by an elongation of 25 per cent in length of 8 inches. Heads must be $\frac{1}{2}$ " thick and of the same quality of steel as that in the shell. All plates and heads must be plainly stamped with the maker's name, and tensile strength.

Tubes, size, number and arrangement.—The boiler must contain 18–6" lap-welded flues, riveted to the heads with $10\frac{1}{2}$ " rivets in each head; said flues must be made of charcoal iron of the best American make, standard thickness, equal to the National Tube Works Company's make. All flues must have at least 3 inch clear space between them, and not less than 3 inches between flues and shell. All flanging of heads must be free from flaws or cracks of any description, and properly annealed in an annealing oven before riveting to the boiler. If 4-inch flues are wanted in place of 6-inch, the boiler must have 44 best lap-welded tubes, 4" in diameter and 20 feet long, set in vertical and horizontal rows, with a clear space between them, vertically and horizontally of $1\frac{1}{4}$ ", except the central vertical space, which is to be 4 inches. Holes for tubes to be neatly chamfered off on the outside. Tubes to be set with a dudgeon expander, and beaded down at each end.

Riveting.—The longitudinal seams of the boiler must be above the fire line, and have a TRIPLE row of rivets; all rivets to be $\frac{3}{4}$ " in diameter; and all rivets to be of sufficient length to form upheads equal in size to the pressed heads of same. The rivets in the longitudinal seams must be spaced $3\frac{1}{4}$ " apart from center to center, and the rows of same to be pitched $2\frac{3}{16}$ " apart from center to center, so as to give an efficiency of the joint of $\frac{7.6}{100}$ per cent of the solid plate. Transverse seams to be single riveted with same size rivets as those in the longitudinal seams pitched 2" apart from center to center. Care must be taken in punching and drilling holes that they may come fair in

construction; the use of a drift-pin to bring blind, or partially blind holes in line will be sufficient cause for the rejection of the boiler.

Calking.—The edges of the plates to be planed and beveled before making up the boilers, and the calking to be done with round nose tools, pneumatically driven; no split or wedge calking will be allowed.

Bracing.—There must be 22 braces in the boiler, one inch area at least, be nine above the flues on the front head and nine similar ones on the back head, none of which shall be less than 3' 6" long, made of good refined iron and securely riveted to the heads; the other end to be extended to the shell of boiler and riveted thereto with two $\frac{7}{8}$ " rivets. Care must be exercised in the setting of them, so they may bear uniform tension. There must be two braces below flues, one on each side of manhead, and riveted to the heads with two $\frac{7}{8}$ " rivets. The back end of brace to be extended backward to side of shell and riveted thereto by means of two $\frac{7}{8}$ " rivets; and two braces in back end above flues, one on each side and riveted the same as the other two below flues.

Manholes.—The boiler to have two manholes of the Hercules or Eclipse pattern, same to be of size 10" x 15", one located in front head, beneath the flues, and the other in rear head above the flues, and each to be provided with a lead gasket, grooved lid, two yokes and two bolts. The proportion of the whole to be such as will leave it as strong as any other portion of the head of like area.

Steam drum.—The boiler must be provided with one steam drum 30" in diameter by 5' in length, shell plates of which are to be $\frac{5}{16}$ " thick and heads $\frac{1}{2}$ " thick, of the same quality of material as that in the boiler. The heads must be bumped to a radius so as to give as near as practicable equal strength as to that in the shell without bracing. The longitudinal seams of the drum are

to be doubly riveted with $\frac{11}{8}$ " diameter rivets, pitched $2\frac{7}{8}$ " apart from center to center, so as to give an efficiency of the joint of $\frac{74}{100}$ per cent of the solid plate.

Manhole in drum. — The drum must be provided with Hercules or Eclipse Patented Manhole, same to be of size 10" x 15", located in the center of one head, and to be provided with a grooved lid, lead gasket, two yokes and two bolts. The proportion of the whole to be such as will leave it as strong as any other portion of the head of like area.

To attach to boilers. — The steam drum must be attached to the boiler by means of two flange steel connecting legs, 8" in diameter by 12" in length, and securely riveted to boiler and steam drum shell.

Mud drum. — Boiler must be provided with one mud drum 24" in diameter and of sufficient length so that each end may come flush with the outside of the boiler walls on each side; the quality and thickness of steel to be the same as that specified for the steam drum, and all seams to be single riveted; said mud drum to be provided with one Hercules or Eclipse Patent Manhole in one end, and to be of size 9" x 14", supplied with a grooved lid, lead gasket, two yokes and two bolts.

To attach to boiler. — The mud drum is to be attached to boiler by means of 8" diameter steel connecting leg, about 16" in length, properly riveted to boiler and mud drum shells.

Flanges. — The boiler to have one 8" wrought steel flange riveted on top of steam drum; one wrought steel flange 4" in diameter, about 5 feet from front end of boiler for safety valve one 2"; wrought steel flange on after end of boiler over the center of mud leg for supply pipe — all flanges to be threaded; 2" hole in mud drum for blow-off; also 2 $1\frac{1}{4}$ " holes, one on top of boiler and one on end near bottom of boiler for water column.

Fusible plugs. — To have two fusible plugs; one inserted in shell from inside on second sheet, or about 5' from forward end, 1

inch above flues ; one plug inserted in top of flue, not more than three feet from after end.

Trimnings. — Furnish one 4" spring or dead weight safety valve, 4" diameter ; one water combination column ; provide same with two $1\frac{1}{4}$ " valves for the steam and water connections between the boiler and column, and one $\frac{1}{2}$ " valve for blow-pipe ; said blow-pipe to be connected with ashpit ; said combination barrel to be 4" diameter, 18" long, and made of cast-iron. Also, furnish one water gauge having a $\frac{3}{4}$ " x 15" Scotch glass tube, bodies polished with wood wheels and guards, rods, bodies threaded $\frac{3}{4}$ " ; three gauge cocks $\frac{3}{4}$ " register pattern, polished brass bodies ; one steam gauge with 10" dial ; one 2" brass feed valve with 2" check valve ; one 2" globe valve for blow-off from mud drum ; also one asbestos packed stop-cock for same, so as to insure against the possibilities of a leak through the blow-pipe. Water column to have crosses in place of ells. Crosses to have brass plugs.

Castings, grates, doors, etc. — The boiler must be provided with a heavy three-quarter fire front of neat design, having double firing and ashpit doors, anchor bolts for anchoring fire fronts in place, heavy deadplates, a full set of fire liners 9" deep for supporting firebrick on end, front and rear bearing bars ; a full set of ordinary grate bars 4 ft. long, soot door and frame for cleaning out rear ashpit ; a full set of skeleton arch plates ; 12 heavy buck staves $9\frac{1}{2}$ ' long, provided with tie rods, nuts and washers, heavy back stand with plate and expansion rollers ; also furnish wrought plates to cover mud drum.

Fire tools. — Furnish in addition to above two sets of fire tools consisting of two pokers, two hoes, two slice-bars, two claws, and one six inch flue brush with $\frac{1}{2}$ " pipe for handle.

Breeching. — Boiler must have a breeching fitted to front head and fastened thereto by means of bolts, stays and suitable pieces of angle iron, bent to conform to circle of boiler. The underside of breeching is to run across the head between the lower flues and

the manhole, leaving the manhole freely exposed; the sides of breeching are to be made of $\frac{3}{16}$ " steel, the front and doors of $\frac{1}{8}$ " steel; said doors to be hung by means of strap hinges, provided with suitable fastenings so as to give free access to all flues when open.

Uptake and damper.—An uptake having an area of 1221 square inches must be fitted to top of breeching. Said uptake must be of convenient form for attaching to a stack 40" in diameter and provided with a close-fitting damper having a steel hand attachment, so that same may be operated conveniently from the boiler room floor.

Smoke stack.—There is to be provided for the above boiler one smoke stack 40" in diameter by 90 feet in height, half of which is to be made of No. 8, and the other half of No. 10 best black sheet steel throughout, and supplied with two sets of four guy rods, each consisting of $\frac{3}{8}$ " galvanized wire cable guy strand with turn buckles for same.

In general.—The above-mentioned boiler must be made of strictly first-class material and workmanship throughout, and subject to a hydrostatic pressure of 150 pounds to the square inch of section before leaving the works of the manufacturer.

Painting boiler breeching.—Smoke stack and boiler front, steam and mud drum, and all trimmings, to have two good coats of coal tar.

Masonry.—Boiler to be set in good substantial masonry, of hard burned brick and good mortar, made of clean, sharp sand and fresh burned lime. Walls to be 18" thick. The outside walls to be laid up of selected hard burned brick, with close joints struck smooth and rubbed down. The sides, end and bridge walls, and boiler front, to have a foundation of 24" wide and 12" deep, laid in Portland cement. The ash pit to be paved with hard burned brick set on edge firmly, imbedded in Portland cement. For a distance of seven feet in front of the boiler and

continuing across entire width of front of boiler setting to be paved with hard burned brick set on edge, firmly imbedded in sand. The walls to be carried up to the full height and a row-lock course of brick 4" thick to be carried over top of boiler from side wall to side wall, extending the whole length of boiler, and the entire arch to be plastered over on the outside with mortar. The bridge walls to be 24", carried up to within 6" of under side of boiler. The top of bridge wall to be of fire brick and made in the form of an inverted arch, conforming to the shell of the boiler. The space under boiler and back of bridge wall to the back end of boiler, to be filled in with earth or sand and the top paved with brick, and tapering from bridge wall back to back end to 12" at back end, and in a similar form and shape, that is, inverted arch. The uptake for returning the smoke and heat at back end of boiler, to be arched over from rear wall against the back head of boiler 2" above the tubes, the arch being made of arch fire brick, and backed up with red brick. Fire box to be lined throughout with first quality fire brick, dipped in fire clay with close joints and fire brick rubbed to place, from a point 2" below grates, to where it safes in against boiler, and to be continued fire brick as far back as the rear end of setting and across rear end of same; it being the intent that all interior surfaces of the setting with which the heat comes in contact, shall be faced with fire brick. Every sixth course to be a header course.

Smoke connections. — The connection from boiler to chimney to be made of No. 12 black iron, with cleaning door and damper in same.

I N D E X.

- A permanent magnet, 1 to 2.
- Two-bar magnet, 3 to 6.
- A magnet needle, 3.
- Magnetic lines of force, 6.
- Lines of force, 6 to 14.
- The principles of electromagnetic induction, 14 to 22.
- The armature cores, 23 to 27.
- The simplest type of armature winding, 27 to 29.
- Two-pole generators and motors, 27 to 30.
- The general arrangement of the field and armature in a two-pole machine, 31 to 33.
- The reason brushes are set different on motors than on dynamos, 36 to 37.
- Multipolar machines, 38 to 39.
- Setting the brushes on a four-pole machine, 40.
- Setting the brushes on an eight-pole machine, 41.
- The lap and wave winding for four-pole machine, 42 to 46.
- Switch-board distributing circuits and switch-board instruments, 47.
- Generators of the constant potential, 47 to 48.
- The switch-board arranged for two generators of the shunt type, 49 to 51.
- Switch-board for three-wire system, 56 to 57.
- To wire a large building with a lighting and power system, 58 to 60.
- The ammeters, 61.
- Circuit breakers, 62 to 63.
- Motors and their connections, 64 to 73.

- Instructions for installing and operating slow and moderate speed generators and motors, 74 to 85.
- Brush setting, 75 to 78.
- Before starting a dynamo, 78.
- Care of commutators, 78 to 79.
- Directions for starting dynamos, 79 to 81.
- Switching dynamos into circuit, 82.
- Dynamos on parallel, 82 to 83.
- Directions for running dynamos and motors, 83 to 84.
- Personal safety, 85.
- Why commutator brushes spark and why they do not spark, 86 to 101.
- Heating in dynamo or motor, 101 to 103.
- The effect of the displacement of the armature, 103 to 110.
- Noise in dynamos, 110 to 112.
- Table carrying capacity of wires, 113 to 116.
- Instructions for installing and operating apparatus for arc lighting Brush system, 117 to 167.
- T. H. system, 168 to 209.
- The selection of an engine, 210 to 215.
- The gain by expansion, 216.
- A governor, 216 to 217.
- What is a fly-wheel, 217 to 218.
- What is a horse-power, 218.
- Care and management of a steam engine, 218 to 228.
- To find the dead center of an engine, 228 to 230.
- How to line an engine, 231 to 236.
- The work of the steam engine, 237 to 240.
- Setting the valve on the Russell engine, 240 to 249.
- Directions for setting up, adjusting and running the improved Corliss steam engine, 250 to 255.
- Condensers, 255 to 257.
- Corliss engine regulation, 257.

- The Porter-Allen steam engine — how to care for it and set the valves, 258 to 272.
- Specifications for centrally balanced Centrifugal Inertia Governor, 273 to 274.
- Setting the valve on the Armington & Sims Automatic Engine, 275.
- The care and management of Harrisburg Engine, 276 to 281.
- How to set the valve on the McIntosh & Seymore Engine, 281 to 282.
- Instructions for starting and operating Ideal Engine, 282 to 292.
- Points on starting and running a Westinghouse Compressed Engine, 292 to 309.
- Some points on cylinders, in locating, 309 to 313.
- Setting a plain slide valve with a link motion, 313 to 318.
- Plain slide valve, 318 to 322.
- A successful engineer, 323.
- Education for steam engineers, 323 to 324.
- Taking charge of a steam power plant, 325 to 328.
- Economy in steam plants, 330 to 331.
- Priming in steam boilers, 332.
- Condensing engines, 332 to 334.
- High pressure steam, 335 to 337.
- Using steam full stroke, 338 to 339.
- Slide-valve engines, 340.
- Regular expansion engines, 341.
- Automatic engines, 342 to 343.
- The Gardner Spring Governors, 344 to 347.
- The force of steam and where it comes from, 348 to 350.
- The energy stored in steam boilers, 350 to 351.
- Special high pressure boilers, 351.
- Type of boilers, 352.
- The water tube boilers, 352.
- Horse-power of boilers, 352 to 353.

- The rating of boilers, 354.
The working of boilers, 355 to 356.
Code of rules for boiler tests, 357 to 364.
Importance of the boiler, 365 to 368.
Definitions as applied to boilers and boiler materials, 369 to 370.
Heat and steam, 370 to 375.
Selection of a boiler, 376 to 379.
Boiler trimmings, 380 to 386.
Care and management of a boiler, 387 to 392.
Water for use in boilers, 392 to 402.
A few remarks on the indicator, 402 to 437.
The indicator, 402.
The use of the steam engine indicator in setting valves and the investigation of some of the defects brought out by the indicator, 404.
Diagram analysis, 405 to 411. }
Theoretical curve, 411 to 416. }
Steam chest cords, 417 to 419. }
Eccentric cords, 419 to 422. }
Benefits derived from a steam indicator, 422 to 423. }
To take a diagram, 423 to 437. }
Mechanical refrigeration, 438. }
Principles of operation, 439. }
Operation of apparatus, 439. }
Function of the pump and condenser, 440. }
What does the work, 440. }
Mechanical cold easily regulated, 441. }
Utilizing the cold, 441. }
Brine system, 441. }
Direct expansion system, 442. }
Rating of the machine in tons capacity, 442. }
Difference in these ratings, 442. }
Unit of capacity, 443. }

- The preparation of brine, 443 to 445.
Insulation of buildings, 445 to 446.
Perfect insulation, 447.
A few tests for ammonia, 448.
Testing for water by evaporation, 448.
Lubrication of refrigerating machinery, 445 to 450.
Effects of ammonia on pipes, 450.
To charge the system with ammonia, 451.
Process of mechanical refrigeration, 452 to 453.
A sectional cut of the Eclipse Compressor, 454.
The compressor pumps, 455.
The De La Vergne horizontal compressor, 455.
Pipe arrangements for vaults, showing method of supporting from ceiling, 456.
Diagram of De La Vergne system, 456 to 460.
 ating machines for ice-making, 457.
A complete ice-making plant, 458.
A sectional view of the De La Vergne double-acting horizontal compressor, 459.
A complete refrigerating plant De La Vergne compressor, 461 to 462.
Sectional view of De La Vergne double-acting vertical compressor, 463 to 464.
Use and abuse of the steam boiler, 465 to 470.
Design of steam boilers, 470 to 471.
Forms of steam boilers, 472.
Setting steam boilers, 472 to 473.
Defects in the construction of steam boilers, 473 to 475.
Improvements in steam boilers, 476.
Care and management of steam boiler, 477 to 484.
Calking a steam boiler, 484 to 488.
Testing machine for testing boiler plate, 488.
Punched and drilled holes for boiler seams, 489 to 492.

- Strength of riveted seams, 492.
- Comparative strength of single and double riveted seams, 493 to 494.
- Hand and machine riveting, 495 to 496.
- Counter-sunk rivets, 496.
- Rivets, 496 to 500.
- Iron plates and iron rivets, 500.
- Zigzag riveting, 501.
- Chain riveting, 501.
- Iron plates and iron rivets, single-riveted lap joints, 502.
- Steel plates and steel rivets, single-riveted lap joints, 503.
- Steel plate and steel rivets, double-riveted lap joints, 504 to 505.
- Strength of stayed and flat boiler surfaces, 506.
- Boiler stays, 507 to 510.
- Riveted and lap welded flues, 510 to 514.
- Thickness of material required for tubes and flues, 514 to 519.
- Steam boiler economy, 519 to 520.
- Instructions for firing, 521.
- Pulsation in steam boilers, 522.
- Location of steam boilers, 523.
- Steam gauges, 524.
- Grate bars, 525.
- Repairing steam boilers, 526 to 527.
- Safety valves, 528 to 537.
- The Worthington compound pump, 538.
- A sectional view of the Worthington compound pump, 539.
- The Deane direct acting steam pump and a sectional view of a Deane pump, 540.
- A cut showing the valves properly set on a Deane direct acting pump, 541.
- A sectional view of the Cameron steam pump, 542.
- The operation of the Cameron steam pump, 543.
- A sectional view of Knowles steam pump, 544 to 545.

- A cut showing the valves properly set on the Knowles direct acting steam pump, 546.
- The operation of the Knowles direct acting pump, 546 to 547.
- Hooker direct acting steam pump operation, 547 to 548.
- A cut showing the valves properly set, 549.
- Blake direct acting steam pump, 549 to 552.
- A cut showing the valves properly set, 552.
- Miscellaneous pump questions, 553 to 574.
- A sectional view of a piston packed pump with a removable cylinder or liner packed with fibrous packing set out by adjustable set screws and nuts, 557.
- How to set the steam valves on a Duplex pump, 561 to 562.
- A good arrangement for connections for a pump where it pumps from a cistern or well, 564.
- Taking care of a pump, 569.
- Calculating a boiler for a steam pump, 574 to 575.
- How to read a water meter, 575 to 576.
- Table of decimal equivalents of the 8ths, 16ths, 32ds and 64ths of an inch, 577.
- Latent heat of liquids under a pressure of 30 inches of mercury, 577.
- Capacity of tanks in U. S. gallons, 578.
- Capacity of square cisterns in U. S. gallons, 579.
- Weight of water, 579.
- Showing U. S. gallons in given number of cubic feet, 580.
- Showing cost of water at stated rates per 1,000 gallons, 581.
- Loss by friction of water in pipes, 582.
- Showing how water may be wasted, 582.
- Ignition points of various substances, 583.
- Contents in cubic feet and in U. S. gallons, 584.
- The injector and inspirator, 585 to 607.
- Practical questions usually asked of engineers when applying for license, 608 to 635.

- How to line up an extension to line shaft, 636 to 637.
- Simplicity in steam piping, 638 to 639.
- Cutting pipe to order, 639.
- Feed water required by small engines, 640.
- Heating feed water, 640.
- Rating boilers by feed water, 640.
- Weights of feed water and of steam, 641.
- Feed-water heaters, 642.
- Table showing the units of heat required to convert one pound of water at the temperature of 32° Fahr. into steam at different pressures, 643.
- Table showing gain in use of feed water heaters, and percentage of heat required to heat water for different feed and boiling temperatures, as compared with a feed and boiling temperature of 212°, 644 to 645.
- Pure water, 645 to 648.
- The temperature and pressure of saturated steam, 648 to 650.
- Something for nothing, 650 to 651.
- Steam boiler inspection, 651 to 652.
- Chimneys, 653 to 659.
- Changing the speed of an engine without changing the cut-off, 659.
- How to increase the speed, or increase the power of a Corliss engine, 660 to 662.
- How to increase the horse-power of an engine having a throttling governor, 662 to 663.
- How to increase the horse-power of an engine having a shaft governor, 664.
- How to line the engine with a shaft placed at a higher or a lower level, 664 to 666.
- How to line the engine with a shaft to which it is to be coupled direct, 666.
- How to set a slide valve in a hurry, 667.
- Do you do these things, 667 to 668.

- How to get the travel of a slide valve, 669.
Table of heating surface in square feet, 670.
Horse-power of gears, 671.
Diameter of shafts for single belts, 674.
Belting, 675.
Centrifugal force, 676.
Horse-power of iron and steel shafts for given diameters and speeds, 676.
Wheel gearing, 677.
Rule to compute to pitch of a wheel, 677.
To compute the chordial pitch, 677.
To compute the diameter of a wheel, 677.
To compute the number of teeth in a wheel, 677.
To compute the diameter when the true pitch is given, 677.
To compute the number of teeth in a pinion or follower to have a given velocity, 678.
To compute the proportional radius of a wheel or pinion, 678.
To compute the diameter of a pinion when the diameter of the wheel and number of teeth in the wheel and pinion are given, 678.
To compute the circumference of a wheel, 678.
To compute the revolutions of a wheel or pinion, 679.
Teeth as wheels, 684.
Construction of gearing, 685.
Bevel wheels, 686.
Worm screw, 687.
Proportions of teeth of wheels, 686.
To compute the depth of a cast-iron tooth, 686.
To compute the horse-power of a tooth, 689.
Calculating speed when time is not taken into account, 689.
When time must be regarded, 690.
Table of weight of a square foot of sheet iron in pounds avoirdupois, 691.

Screw cutting, 692 to 693.

Transmission of power by Manila rope, horse-power transmitted, 693.

Decimal equivalents of one foot by inches, 693.

Table of transmission of power by wire ropes, 694.

How to pack hydraulic vertical cylinder elevators, 695 to 697.

How to set the hand cable on a lever machine, 696.

How to pack vertical cylinder valves, 697.

A sectional view of Otis vertical hydraulic elevator and valve chamber, and packing same, 698 to 700.

Sectional view of the Crane auxiliary and main valve, and operation of same, 701 to 702.

Otis gravity wedge safety, 702.

Care of Hale elevators, 703 to 704.

Water for use in hydraulic elevators, 704.

To compute the velocity of a pinion when there is a series or train of wheels and pinions, 680.

To compute the proportion that the velocities of the wheels in a train would bear to one another, 680.

General illustrations, 681.

To compute the diameter of a wheel for a given pitch and number of teeth, 681.

To compute the pitch of a wheel for a given diameter and number of teeth, 682.

Pitch of wheels, a table whereby to compute the diameter of a wheel for a given pitch or the pitch for a given diameter from 8 to 192 teeth, 683.

To compute stress that may be borne by a tooth, 684.

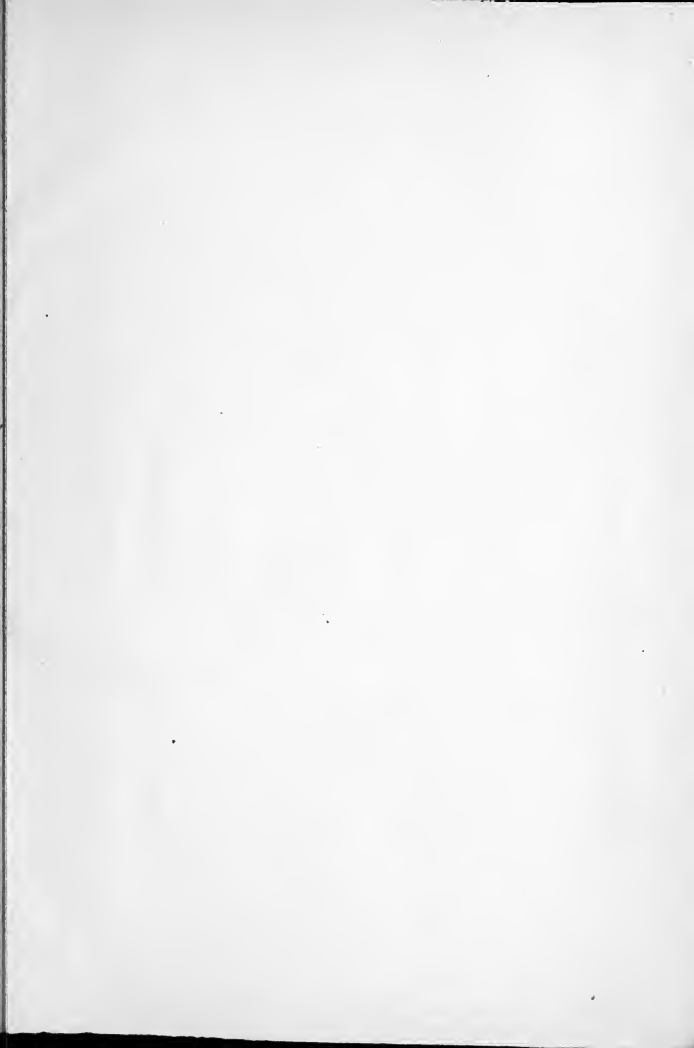
To compute the number of teeth of a wheel for a given diameter and pitch, 684.

Elevator inclosures and their care, 707.

Directions for the care and operation of the electric elevators, 708 to 713.

- Otis differential and auxiliary valve, 709.
- Standard hoisting rope with 19 wires to the strand — iron, 712.
- Cables, and how to care for them, 712.
- Lubrication for hydraulic elevators, 714.
- Belts, and how to care for them, 715.
- Useful information, 715.
- Decimal equivalents of an inch, 716.
- The average strain or tension at which belting should be run, 717.
- Mechanical problems and rules on belting, 717 to 719.
- Extracts from articles on belts, by R. J. Abernathey, 719 to 724.
- Horse power transmitted by leather belts, 725 to 727.
- Directions for adjusting belting, 727.
- Melting points of metals and solids, 728.
- Capacity of air compressors, 729 to 732.
- Contents of a cylinder in cubic feet for each foot in length, 730.
- The McKierman Drill Company's Air Compressor, 730 to 732.
- The Bennett Automatic Air Compressor, 732.
- Ingersoll-Sergeant Air Compressor, 733 to 735.
- The Pohle Air-Lift system, 736 to 737.
- The water tube sectional boiler, 738.
- The John O'Brien water tube boiler, a full and complete description of same, 739 to 743.
- A sectional view and description of the Babcock & Wilcox water tube boiler, 743 to 746.
- Energy losses which occur on the way from furnace to engine, 746 to 752.
- A description of the Heine Safety boiler, 752 to 758.
- A good style of furnace that is used in the East, 758.
- Circulation in the Caldwell boiler, 759.
- Plain vertical tubular boiler, 760.
- A cut showing the place for the water column, 761.
- Safe working pressure for boilers, 762 to 765.
- A cut showing the space between boiler and wall of same, 766.

- A cut showing where to put the gauge cocks in a submerged tube boiler, 767.
- The amount of material required to brick up boilers of different sizes, 768.
- The Root boiler, 768 to 771.
- The Hawley's Down Draught Furnace, 771 to 773.
- Specifications for one sixty-inch horizontal six-tube boiler, 773 to 780.





LIBRARY OF CONGRESS



0 021 225 361 3