

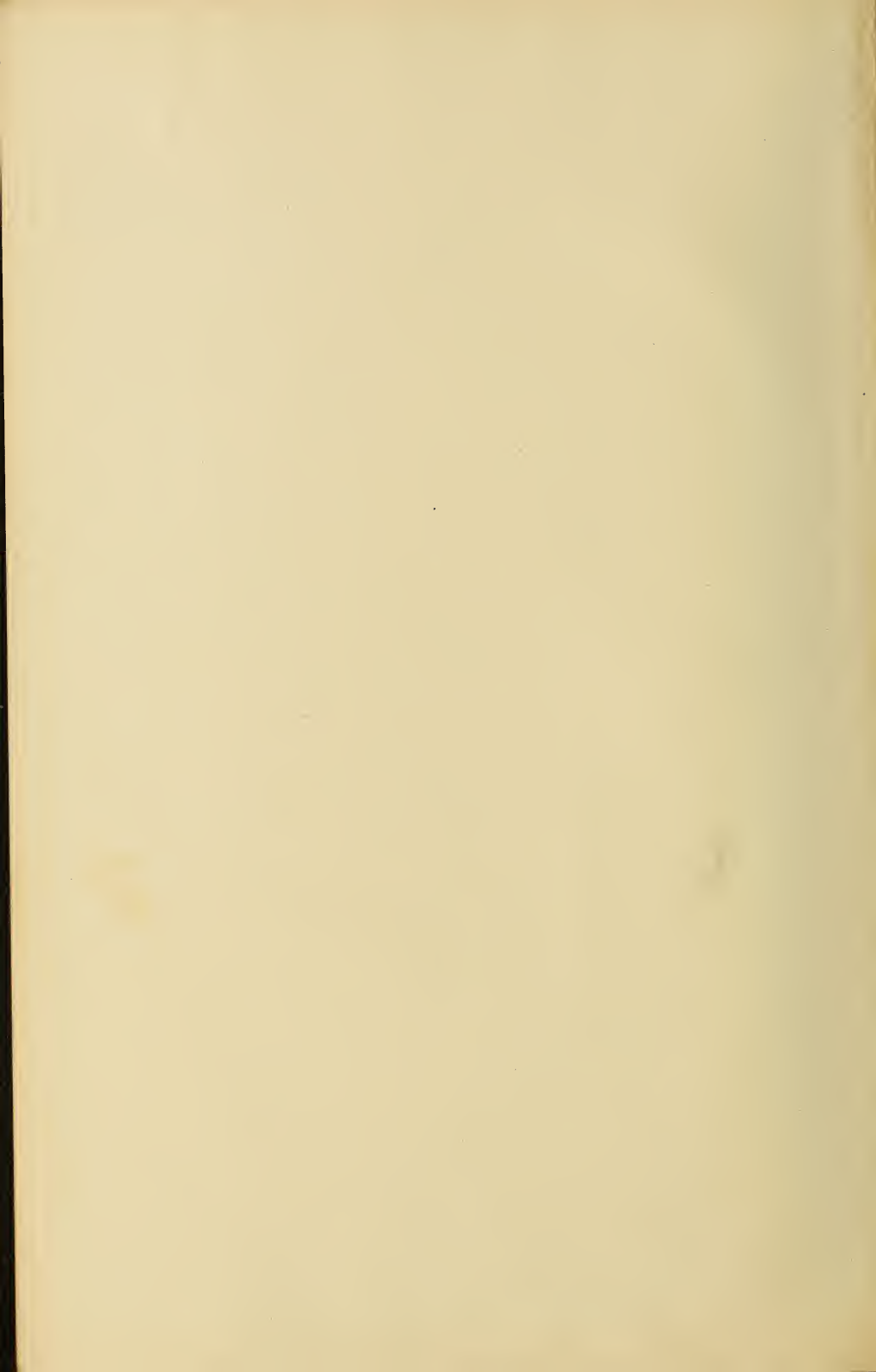

Class TA 153

Book .B3



CIVIL ENGINEERING TYPES
AND DEVICES

CIVIL ENGINEERING TYPES

AND

DEVICES

*A CLASSIFIED AND ILLUSTRATED INDEX OF PLANT,
CONSTRUCTIONS, MACHINES, MATERIALS, MEANS
AND METHODS ADOPTED AND IN USE IN
CIVIL ENGINEERING WORKS OF
EVERY CLASS.*

FOR THE USE OF
CIVIL ENGINEERS, DRAUGHTSMEN, STUDENTS,
BUILDERS AND CONTRACTORS.

With 1,760 Illustrations.

BY
T. W. BARBER, M. INST. C. E..

AUTHOR OF "THE ENGINEER'S SKETCH-BOOK OF MECHANICAL MOVEMENTS", ETC.,
"THE REPAIR AND MAINTENANCE OF MACHINERY," "THE PORT OF LONDON AND
THE THAMES BARRAGE," ETC., ETC.



NEW YORK:
D. APPLETON AND COMPANY.
MCMXV.

TA153
.B3

STEPHEN AUSTIN & SONS, LTD.,
PRINTERS, HERTFORD.

229885
16

9.7.5. Me. 25, '16,

PREFACE.

THE object aimed at in this work is the collection and classification in one handy volume of all the known devices and methods in use in every branch of civil engineering work, in the form of sketches, or brief drawings and descriptions, sufficient to enable an engineer to make a selection without overloading the matter with detail, which every competent engineer can readily design for himself.

There are numerous published works dealing with special branches of engineering, or parts of such, in full detail, which may be consulted for details; but no general illustrated index such as is presented in the following pages.

It is hoped that this index may be of the same service to the active civil engineer as the *Engineer's Sketch-book* has proved to be to the mechanical engineer.

T. W. BARBER.

CONTENTS.

SECTION.	PAGE.
1 Foundations: wet and dry	2
2 Masonry and brickwork	8
3 Drainage	12
4 Motive-power	16
5 Bridges and girders	18
6 Iron buildings	44
7 Wood framing	46
8 Columns, struts, and ties	52
9 Anchorages	58
10 Constructional steelwork	62
11 Floors and partitions	66
12 Roof coverings	72
13 Roads and streets	72
14 Rolled iron and steel bars and plates	74
15 Materials of construction other than iron and steel	84
16 Retaining walls	86
17 Railways: earthworks	92
18 ,, permanent way	96
19 ,, signalling and telegraphs	108
20 ,, stations	110
21 ,, tunnels and culverts	116
22 Carriages and rolling stock for road and rail	120
23 Tramways	128
24 Canals, aqueducts	134
25 Heating and ventilation	140
26 Plate work	144
27 Gas supply	150
28 Hydraulics	152
29 Sea and river structures	160
30 Irrigation	174
31 Docks, harbours	176

SECTION.	PAGE.
32 Lighthouses, buoys, beacons, moorings	182
33 Disposal of refuse, etc.	184
34 Tanks and containers	186
35 Mines, wells	188
36 Fencing	192
37 Staging and false works	196
38 Hoisting machinery	202
39 Submarine engineering	214
40 Opening bridges	216
41 Roofs	220
42 Concrete and reinforced concrete	234
43 Dams and weirs	240
44 Water supply	244

CIVIL ENGINEERING TYPES
AND DEVICES

FOR THE USE OF

CIVIL ENGINEERS, DRAUGHTSMEN, STUDENTS,
BUILDERS, AND CONTRACTORS.

Section 1.—FOUNDATIONS: WET AND DRY.

(See also Sections 16, 17, 29.)

- 1 **Concrete bed or base** for a large building on uncertain ground. Soft places are strengthened by piling.

- 2-9 **Cylinder or caisson foundations for bridge piers, etc.**
The groups of cylinders are connected by horizontal frames and capped with girder framing to form a base for the masonry or steel arches.

- 10 **Vertical section of a cylinder caisson** lined with brickwork or concrete. The bottom edge is bevelled to enter the ground, and, where necessary, the cylinder is loaded inside or on top to force it down as the material is excavated.

- 11 **Sinking a pile in soft ground** or sand by water-jet from a pump.

- 12 **Elevation of a cylinder base for a bridge pier.**

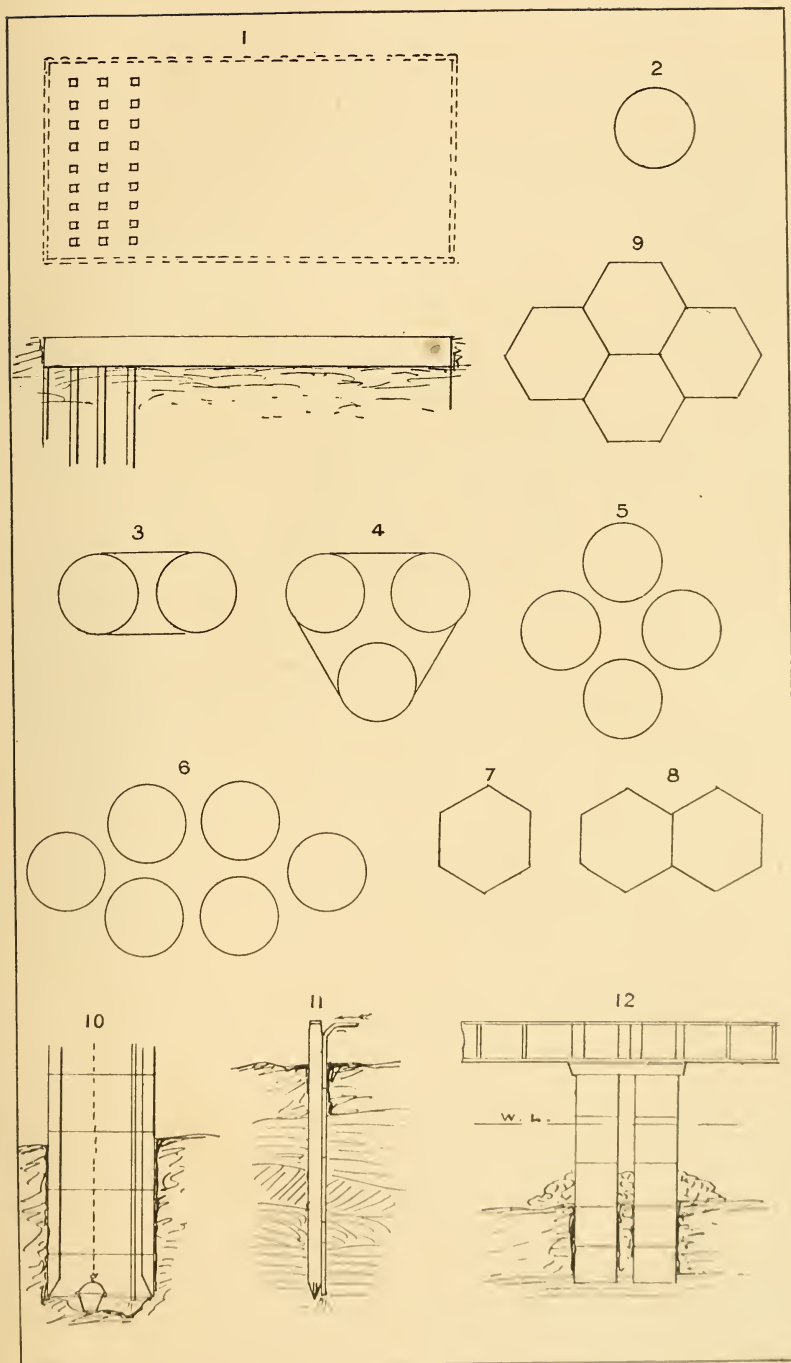

- 13 **Elongated caisson for a bridge pier**, sunk in the same way as No. 10.
- 14 **Retaining wall with apron**, supported by sheet piles. (See also Section 16.)
- 15 **Caisson sunk by compressed air** and air-locks in water, or strata heavily charged with water.
- 16, 17 **Iron piles sunk by water pressure** in soft strata or sand.
- 18 **Iron cylinder sunk to the rock** as a working pit or caisson in which to fix a column founded on the rock.
- 19 **Screw pile foundation for a wall**. Each pair of piles is connected by a top girder on which the wall is founded.
- 20 **Another form of caisson** (as No. 13) lined with masonry.
- 21 **Concrete or sand piles**. (See Section 42.) Sand piles are formed in holes prepared by a driven pile or jumper (see Nos. 1-10, Section 41) and filled with sand.

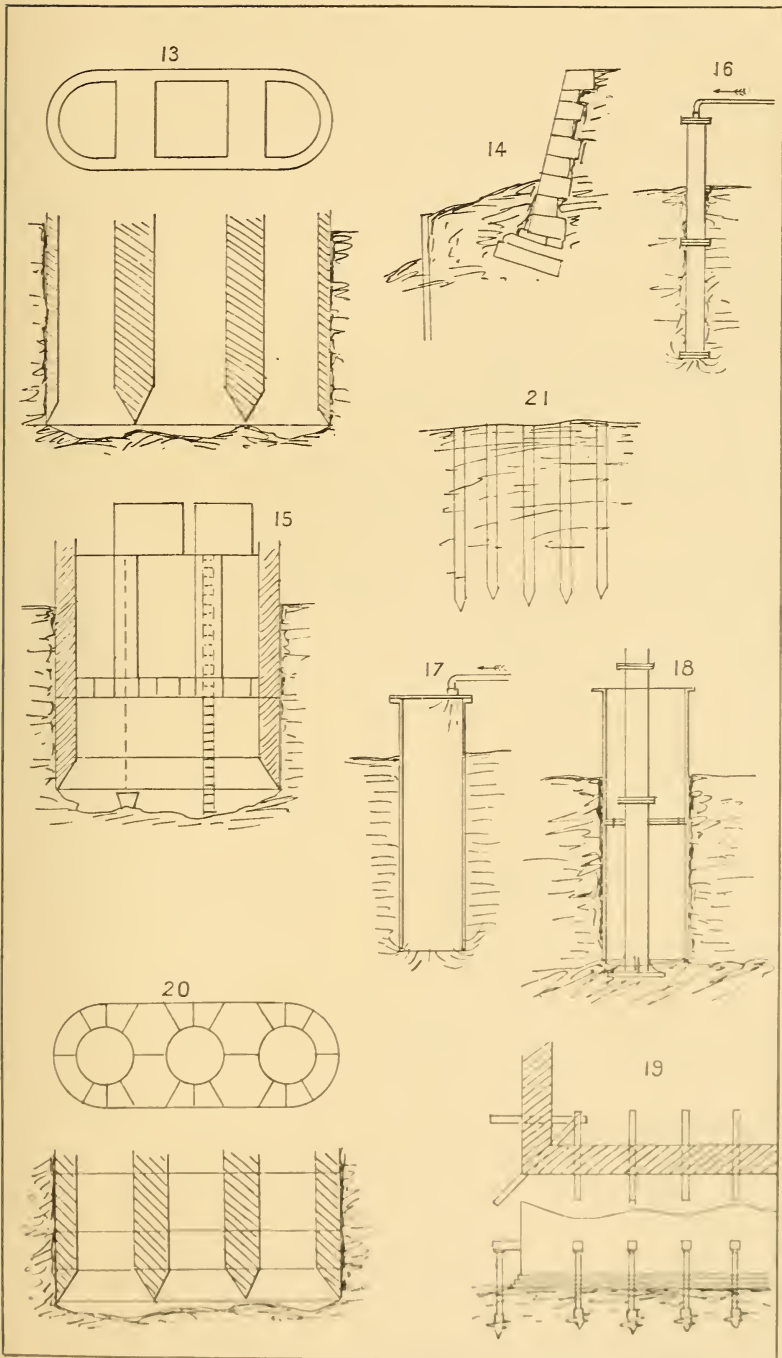

22 **Concrete and stepped footing for a wall.**

23 Ditto, **battered**, for a retaining wall.

24 **Concrete pile.** (See Section 42.)

25 **Footing of wall founded on piles.**

26 **Wall footing on longitudinal timbers** resting on piles.

27 **Retaining or sea wall, with stone apron** to protect the footing from the wash of the sea.

28 **Wall on girders, supported by screw piles.**

29 **Relieving arch** over a soft place in a foundation.

30 **Invert arch** to spread the load of piers between openings evenly on the foundation.

31 **Flange-footed pile,** sunk generally by water, as No. 16.

32 Ditto, with flat flange.

33 **Hollow screw pile,** with serrated cutting edge.

34 **Hollow flat-flange pile,** with radial scrapers to facilitate sinking as the pile is revolved.

Holes for posts or trees are sometimes made by blasting with small sticks of dynamite or powder cartridges sunk in holes jumped in the ground.

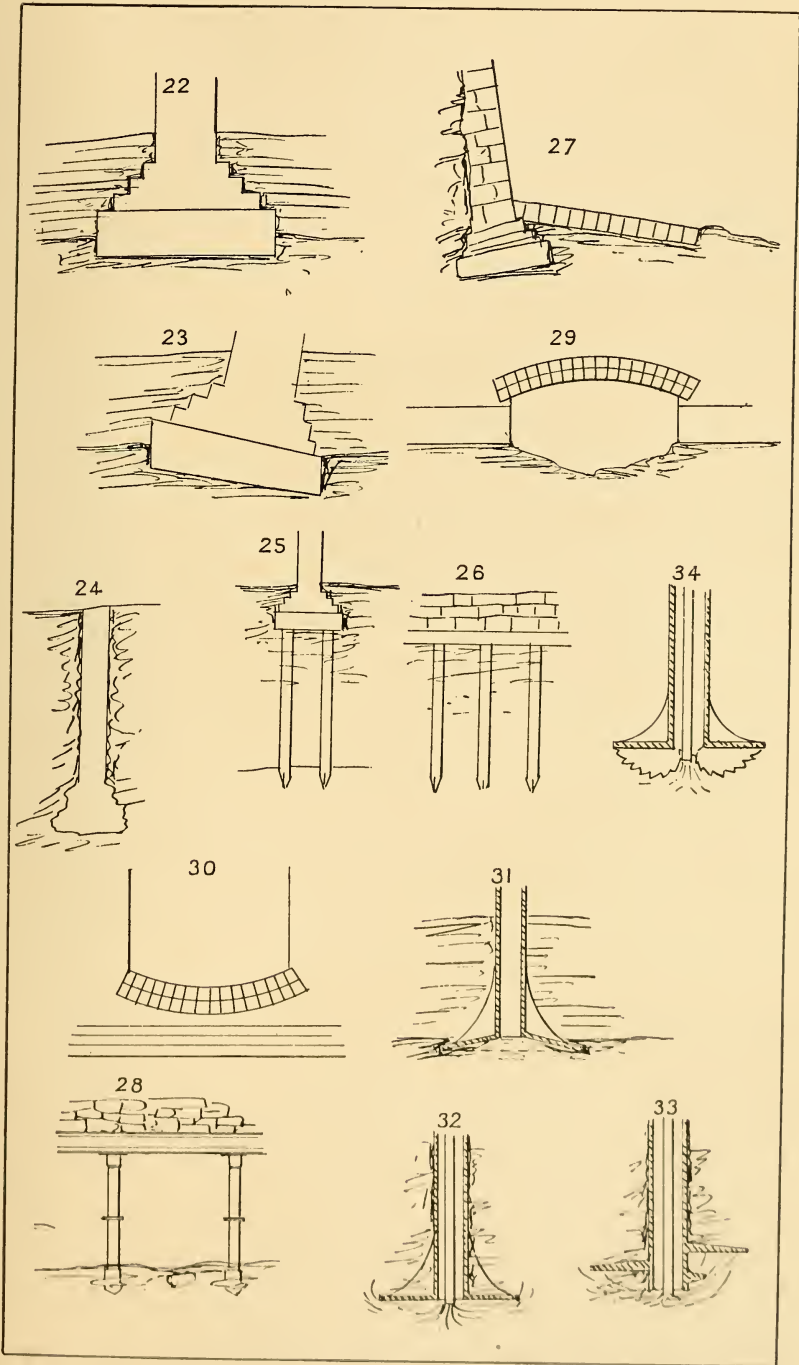

Section 2.—MASONRY AND BRICKWORK.

- 1 Section of random rubble stone wall.
- 2 Ditto, in courses.
- 3 Ditto, coursed rubble wall.
- 4 Brick wall with ashlar face.
- 5 Squared stone wall.
- 6 Ditto, backed by brickwork.
- 7-11 Various forms of hollow or rusticated joints in masonry or ashlar.
- 12-16 Sections of brick walls from half brick to $2\frac{1}{2}$ bricks thick.
- 17 Flemish bond in wall face.
- 18 English bond in ditto.
- 19-22 Plans of bonding in $1\frac{1}{2}$ brick walls.
- 23 Ditto in 2 brick wall.
- 24 Elevation of face of random rubble wall, No. 1.
- 25 Ditto, in courses, No. 2.
- 26 Ditto, coursed rubble wall, No. 3.
- 27 Ditto, of ashlar and masonry walls, Nos. 4-6.

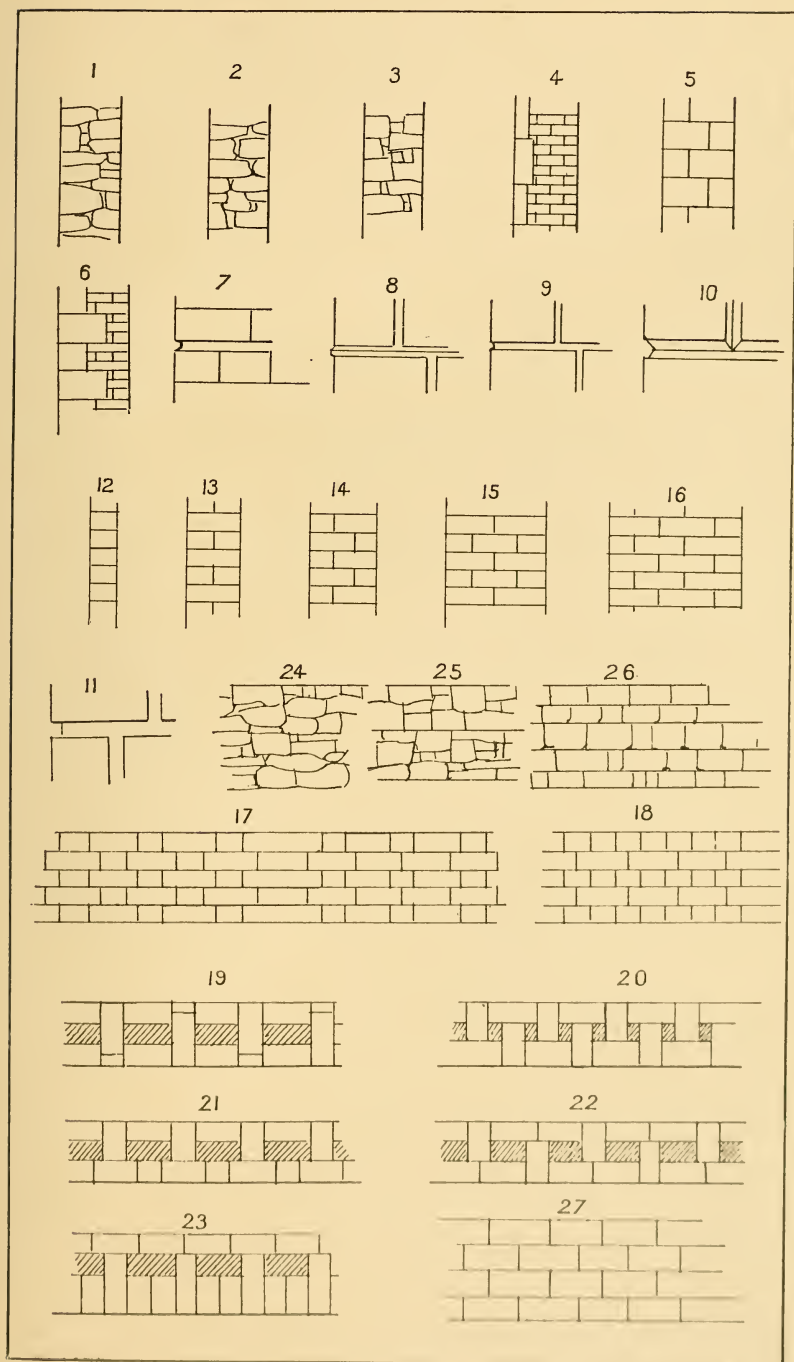

- 28 Face of squared masonry wall.
- 29 Toggle bed joint in masonry wall.
- 30-2 Other forms of toggle-jointed masonry.
- 33 Toggle-joints in arched masonry.
- 34 Relieving arch over a pair of windows.
- 35 Slab wall tongued and grooved.
- 36 Wood partition faced with concrete or fibrous plaster
slabs secured by nails. (See Section 11.)
- 37-43 Copings for boundary walls.
- 44-5 Corbels, brick or stone; angular or straight.

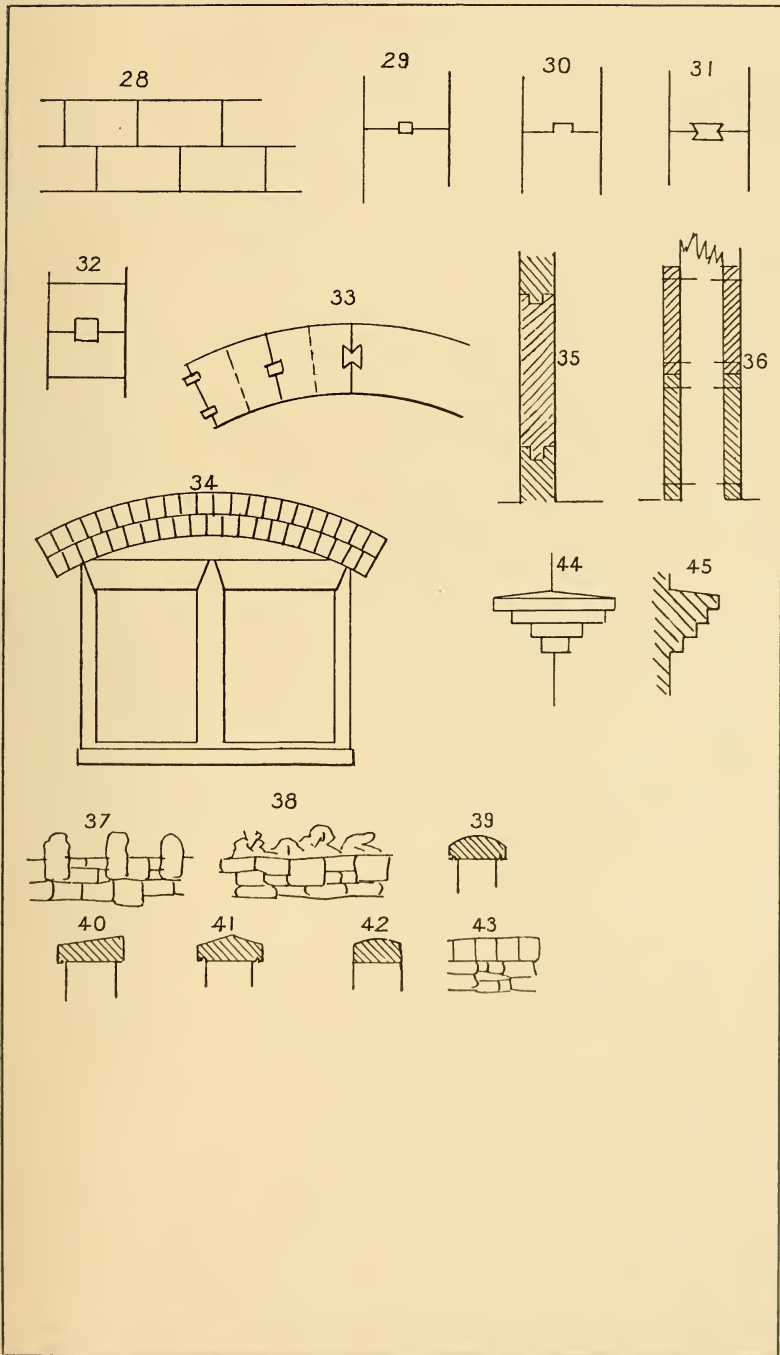

Section 3.—DRAINAGE.

Land drains naturally to streams and rivers.

- 1-5 **Glazed earthenware drain-pipes.**
- 6 **Drain-pipe bedded in concrete.**
- 7 **Cleaning branch and eye** for a drain-pipe, with box and cover.
- 8 **Inspection chamber**, brick in cement, with cast-iron cover and frame and open junctions.
- 9 **Smaller inspection box** : the drain may have a branch and cover as shown or open half-round pipe as No. 8.
- 10-12 **Open, half-round, and closed junctions** for inspection chambers.
- 13-16 **Land drains** : subsoil drains.
- 17 **Open canal or cut drain** for surface water.
- 18 **Stonework box drain.**
- 19 **Circular stonework drain.**
- 20 **Oval ditto.**
- 21 **Egg oval brick sewer.**

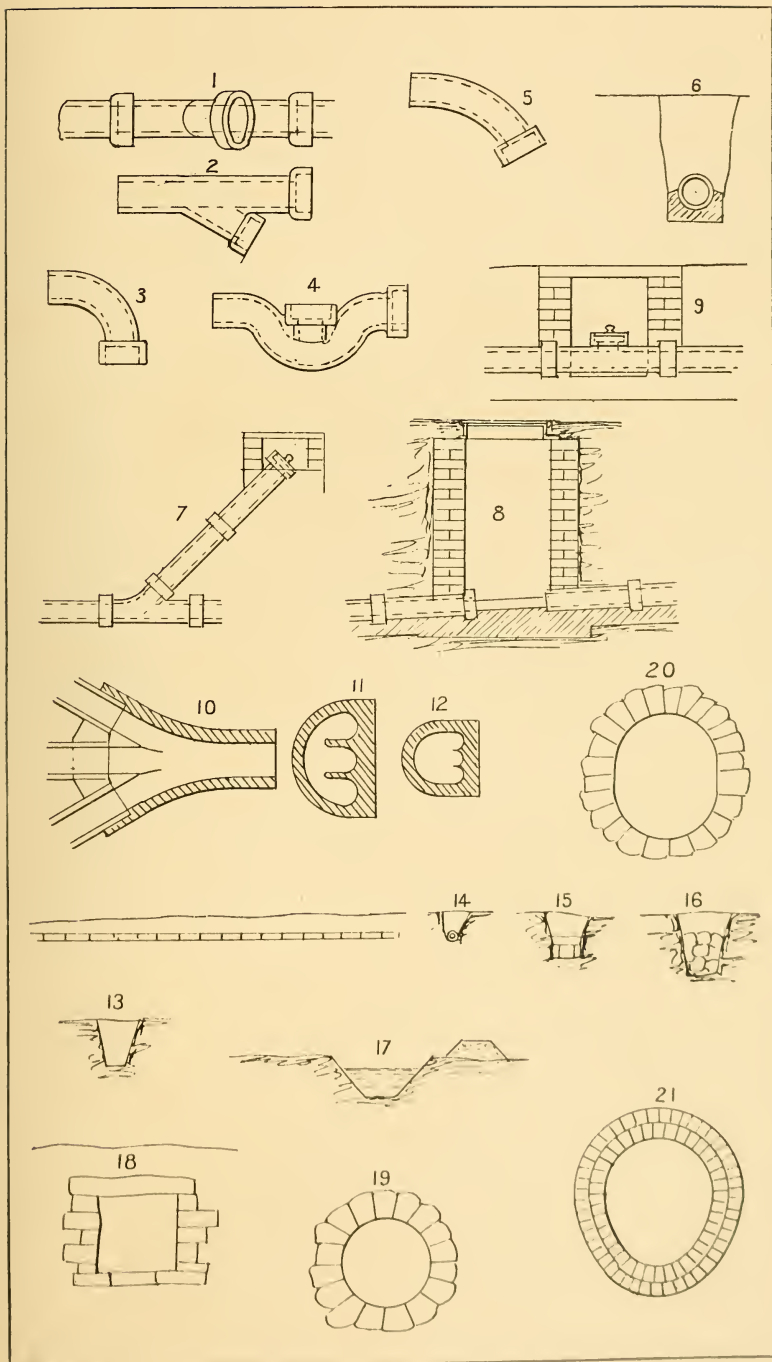

14 CIVIL ENGINEERING TYPES AND DEVICES.

- 22 **Arched brick sewer** on flat brickwork base.
- 23 **Egg oval drain** on concrete base.
- 24 **Another form of ditto.**
- 25 **Main sewer** in an earthen embankment.
- 26 **Cast-iron pipe sewer** lined with brick or concrete and carried across a river or stream on steel girders.
- 27-30 **Forms of surface traps** in general use.
- 31 **Pedestal closet-pan and trap** with flush pipe. There are numerous varieties of this type.
- 32 **Trap and cleaning eye combined.**
- 33 **Draining marsh land** or lake by syphon carried over an embankment wall.

Separate sewers are sometimes used for surface and domestic drainage.

Marshes are drained into rivers and streams by open drains intersecting the marsh and emptying into a main drain usually inside and parallel to the river wall. From this drain the water is run through sluices in the wall at low tide.

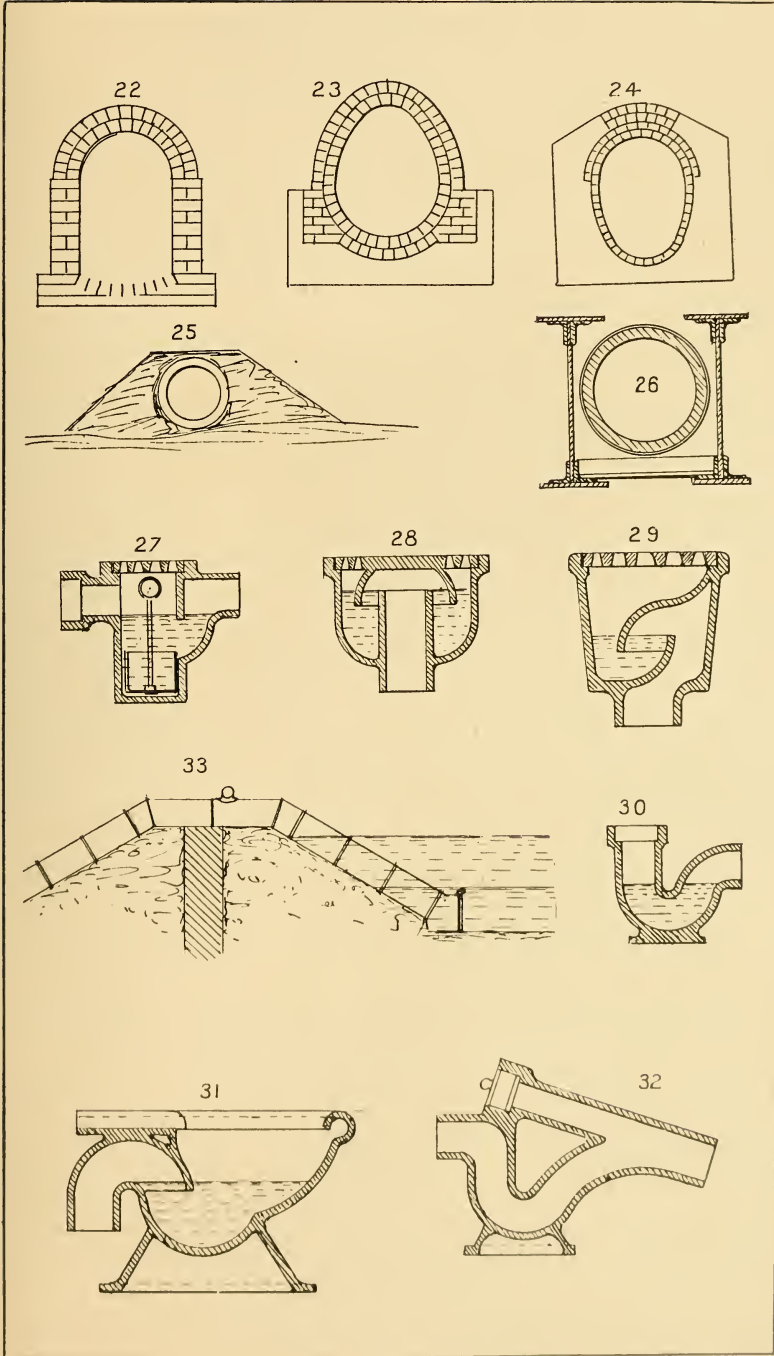

Section 4.—MOTIVE-POWER.

It is assumed that all physical energy is derived more or less directly from the sun, whose rays combine : 1, heat ; 2, light ; 3, actinic or chemical power.

Heat may be obtained—

- a* By direct use of the sun's rays.
- b* From any combustible material.
- c* From chemical reaction.

Light does not separately develop power.

Chemical reactions are employed to develop heat, combustion, contraction, or expansion, as means of developing power.

From the foregoing elementary physical sources the following are the practical sources of our power for mechanical purposes :—

- Electrical power.
- Magnetic power.
- Tidal motion.
- Falling water.
- Descending weights.
- Wave motion.
- Wind.
- Expansion of air or other gases.
- Steam.
- Explosives.
- Fuels, hydrocarbons, etc.

These are employed in producing power by the following apparatus or motors :—

Electric motors driven from a dynamo, battery, or accumulator.

Magnetic power cannot be employed continuously as a motor, as its work is restricted to attraction.

Tidal motion can be utilized to drive any kind of wheel, see Water Wheels, Section 28. It can also be stored in a reservoir, driving a water engine as it flows in and out on the flood and ebb : or a floating vessel may, by its rise and fall, communicate motion to machines.

Falling water ; for machines employed to utilize, see Water Wheels, Turbines, Water-pressure Engines, etc., Section 28.

Descending weights must first of course be raised, absorbing as much power in raising as they give out in falling, neglecting friction. Clockwork, water, or compression of a spring, and multiplying pulleys are the apparatus employed to utilize this form of energy.

Wave motion is too uncertain and erratic to be a practicable source of power. Rocking air-compressing chambers, rocking pumps, etc., have obtained some small measure of success.

Wind, windmills.

Expansion of air and gases. Ascending currents of hot air from a fire are used to drive a light screw motor, fan, etc. Hot-air engines, see Ryder's patent and numerous others, which act by alternate expansion and contraction of air by heating and cooling. Air compressed in an accumulator or reservoir is employed to give motion to multiplying pulleys or an air engine.

Expansion of liquids, other than water (by heat), into the gaseous form. Engines in which the fuel is burnt under pressure and the total products of combustion employed (with or without steam) to drive a motor.

Steam is in reality one of the last-mentioned sources of power; it is employed by direct pressure on a piston or ram; or to produce direct rotary motion also in the jet pump; or injector; or by direct pressure on a body of water contained in a closed vessel, as in the pulsometer, steam accumulator, etc.

Explosives are substances which, by application of flame, heat, percussion, etc., suddenly assume the gaseous form, thus increasing their bulk many hundred times, usually in a small fraction of a second of time. A second class comprises explosive mixtures of gases, such as hydrogen and oxygen, carburetted hydrogen, and air. Some attempts have been made to employ explosive substances to drive engines in various ways, but with no permanent success. The second class of explosive mixtures of gases is largely employed in the gas engine, petroleum engine, and their varieties.

Fuels, hydrocarbons, etc., are employed to evaporate water into steam; to expand air or other gases, or convert liquids into gases; and also by vaporization to supply gas for use in numerous forms of gas and oil engines.

Hot-air motor. A current of hot air passing up a flue revolves an air turbine.

Naphtha engines are gas engines employing the vapour of naphtha and air as an explosive mixture, instead of that of petroleum (oil engine) or carburetted hydrogen gas (gas engine).

Section 5.—BRIDGES AND GIRDERS.

(For details of girders, booms, struts, and ties see Sections 8 and 10.)

MASONRY BRIDGES.

- 1 Semicircular arch.
- 2 Elliptical arch.
- 3 Gothic arch.
- 4 Byzantine arch.
- 5 Moorish arch.
- 6 Skew arch bridge.
- 7 Lintel over door or window.
- 8 Flat brick arch.
- 9 Semi-arch.
- 10 Three-hinge arch bridge.

TIMBER BRIDGES.

- 11 Simple pile and girder bridge or gantry.
- 12 Pile and girder bridge or gantry with struts.
- 13 Horizontal stepped-timber girder bridge.
- 14 Timber girder bridge with double struts and masonry piers.

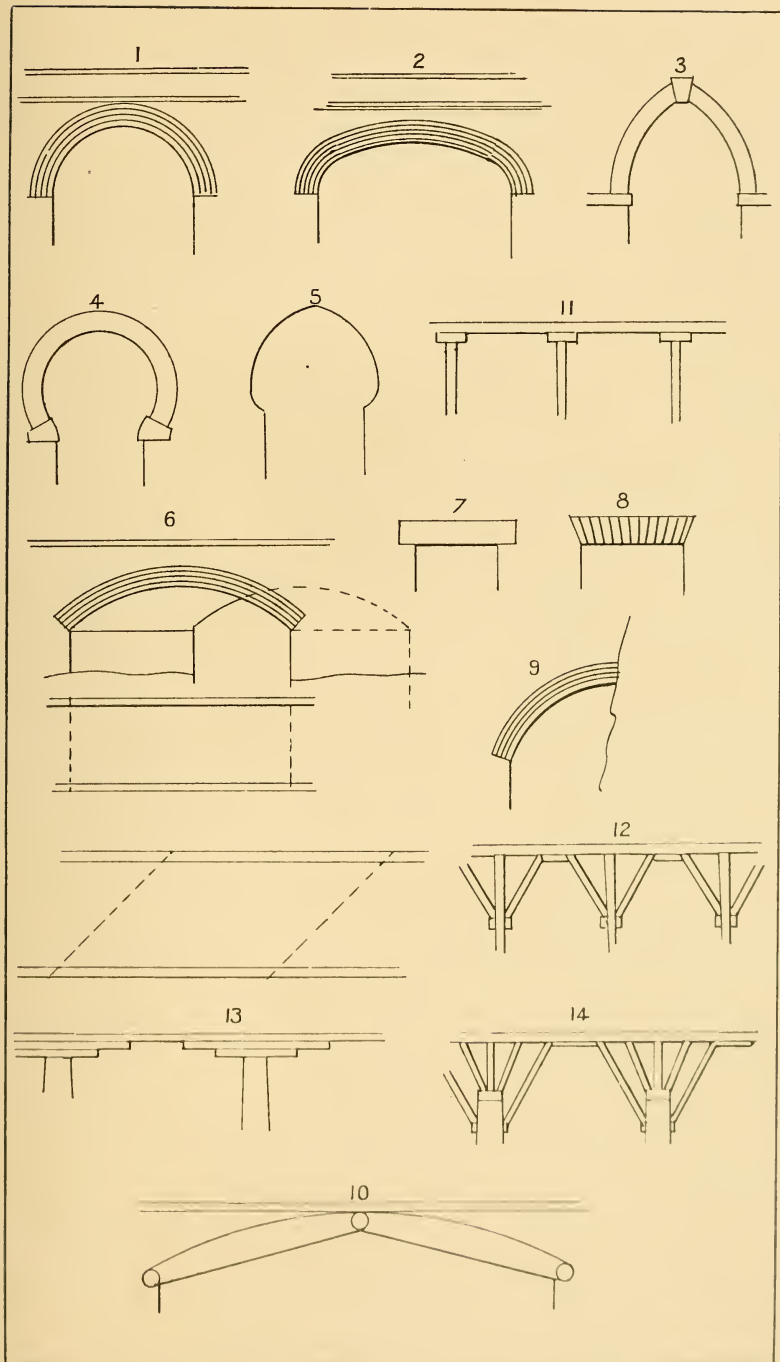

- 15 **Horizontal stepped-timber girder** on masonry piers.
- 16 **Braced timber girder**, double strutted and carried on masonry piers.
- 17 **Similar bridge**, but on double pile piers.
- 18-22 **Timber-braced girder bridges**. The bracing may be wholly wood or wholly or partly steel.
- 23-4 **Arched timber bridges**, braced.
- 25 **Timber-braced girder** with vertical steel ties.
- 26 **Timber arch bridge** with laminated arch and radial struts.
- 27 **Combined bowstring and horizontal braced girder bridge**.

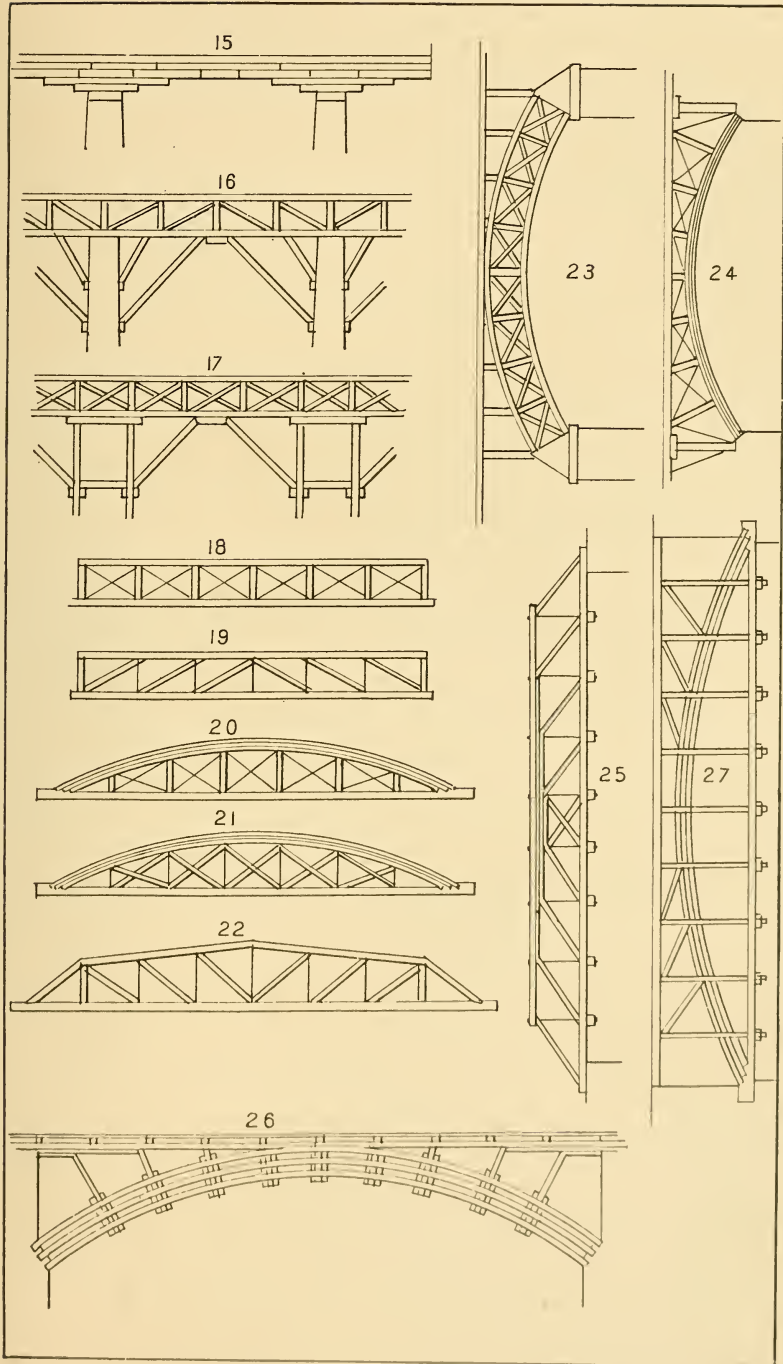

22 CIVIL ENGINEERING TYPES AND DEVICES.

28 **Timber gantry or viaduct** with timber wings to support an embankment or abutment.

29 **Cross section of** ditto.

30-2 **Cast-iron bridges.**

CAST-IRON BRIDGES.

33-4 **Cast-iron braced girders.**

35-41 **Cross sections** of various types of **cast-iron girders.**

42 **Cast-iron girder with parallel flanges.**

43 Ditto, **with curved top flange.**

44 **Cast-iron fish-bellied girder** with steel truss rods.

45 **Cast-iron girder** with steel truss rods.

STEEL GIRDERS.

46-8 **Sections of rolled steel girders.**

49-51 Sections of built-up girders formed of rolled girders, channels, angles, and plates.

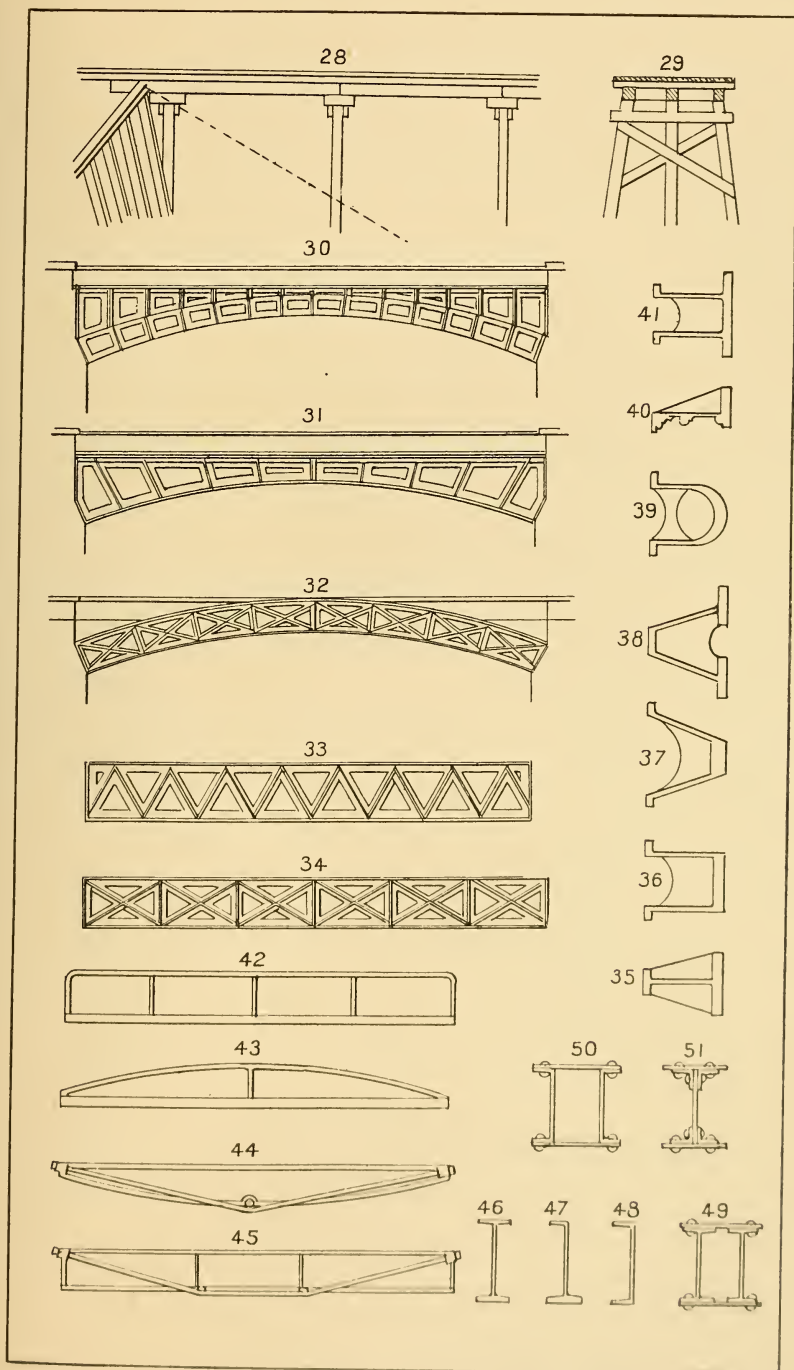

52-3 **Sections of built-up girders**, formed of rolled girders, **L** irons, and plates.

54-7 **Sections of pressed steel troughs** for bridge floors. Small bridges are frequently constructed of troughs across the span as girders.

58-61 **Bulb and U steel girders.**

62 **Plate girder with parallel flanges.**

63 Ditto, **with fish-belly bottom flange.**

STEEL BRIDGES.

64-6 **Braced girders with horizontal flanges.**

67 **Lattice girder.**

68-9 **Warren girders.**

70-4 **Bowstring braced girders.** In No. 74 the dotted lines show a method of strengthening the top flange sometimes employed.

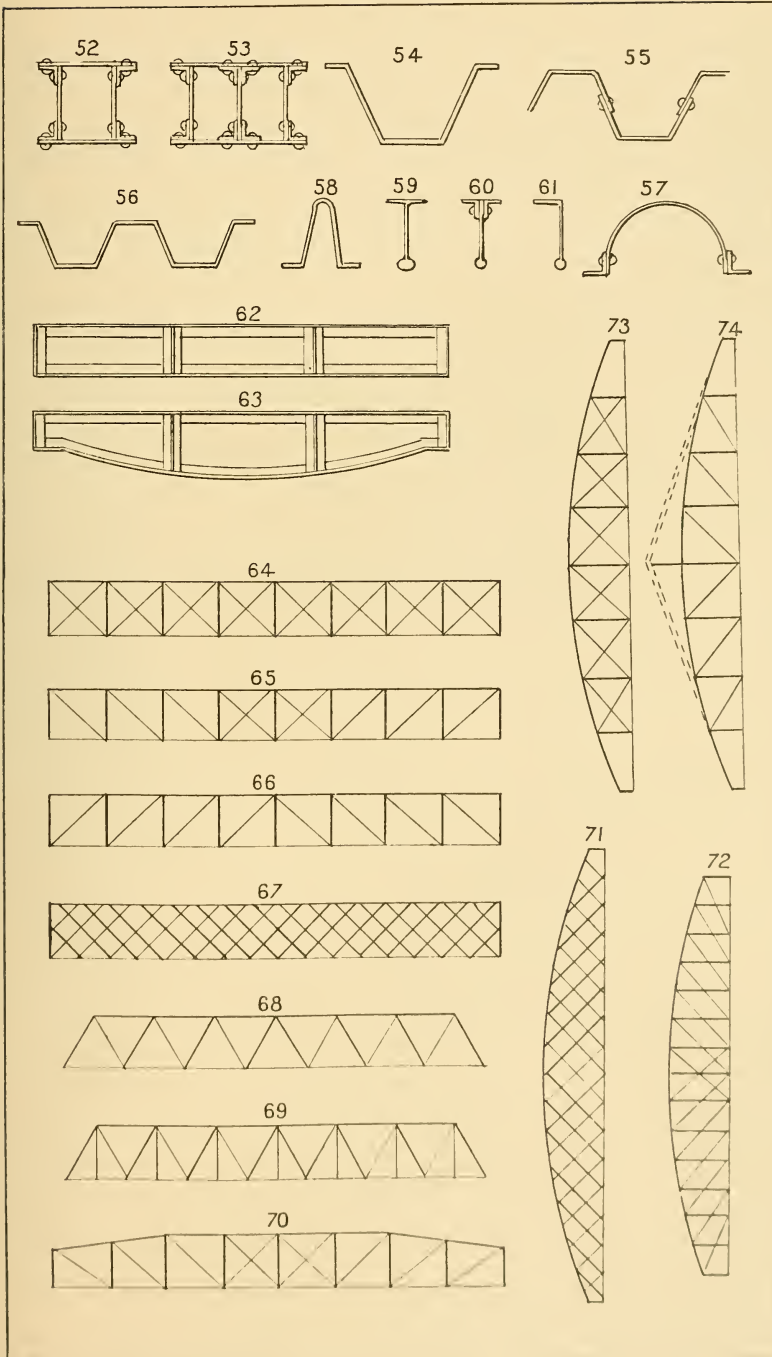

75-8 **Braced arched girders.**

79 **Combined horizontal and Warren type bowstring girder.**

80 **Bowstring and fish-belly braced Warren type girder.**

81-3 **Braced arched girders.**

84-5 **Bowstring girder bridges.**

86 **Trussed braced girder.**

87 **Diagonal braced American type girder.**

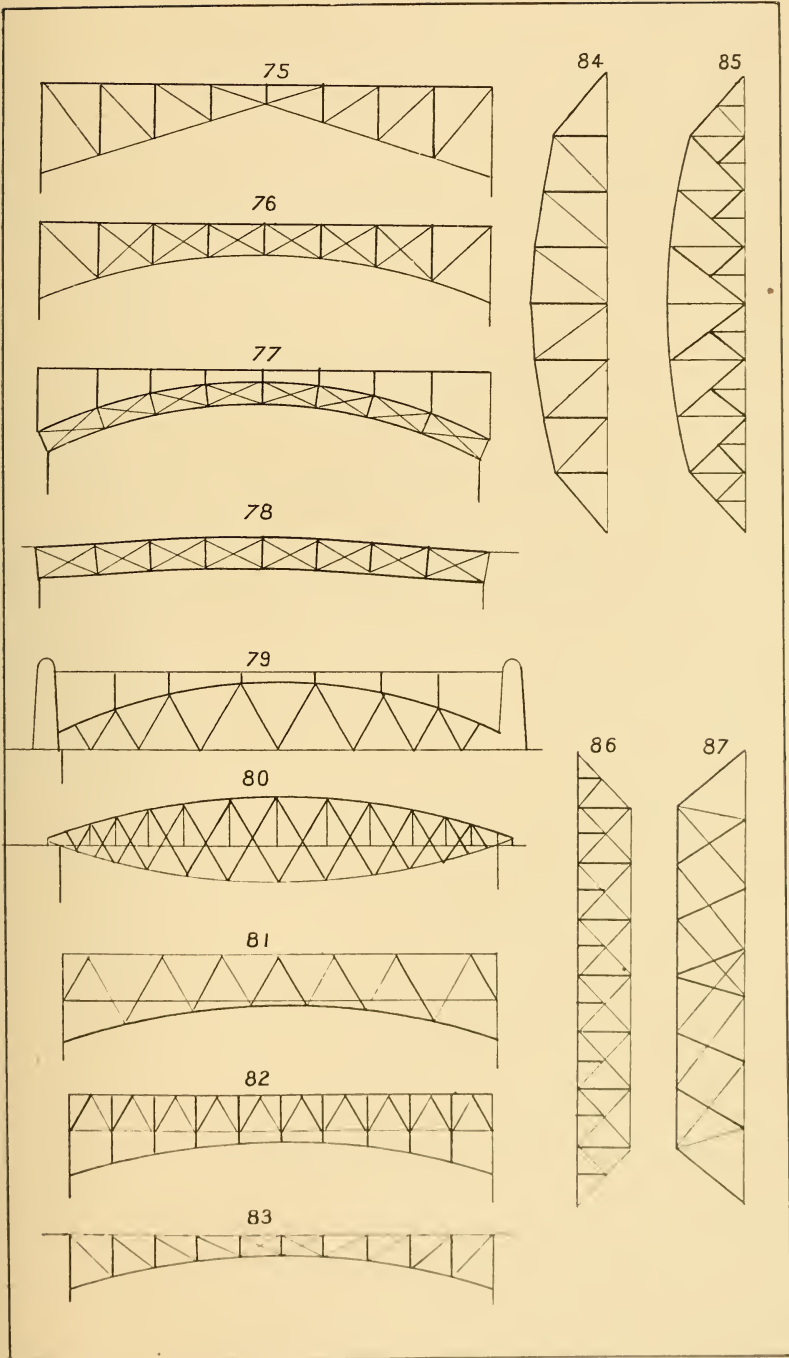

88-9 Trussed braced girders.

SUSPENSION BRIDGES.

90 Ordinary catenary suspension bridge with vertical ties.

91 Suspension bridge with braced horizontal boom.

92 Ditto with diagonal and vertical ties.

93 Ditto with braced catenary.

94 Ditto with diagonal ties.

95 Ditto with braced catenary.

96 Ditto with counterbraced vertical ties (or struts).

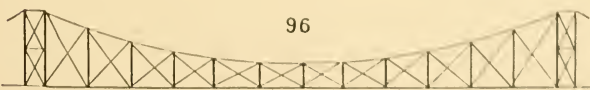
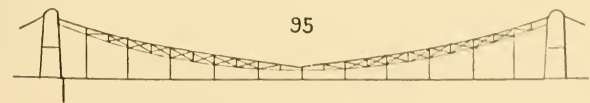
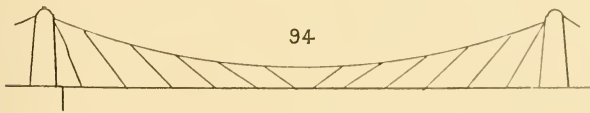
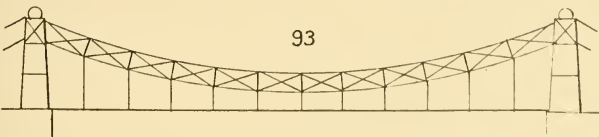
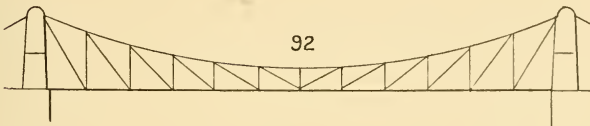
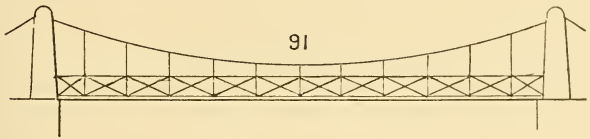
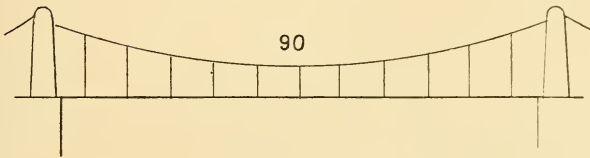
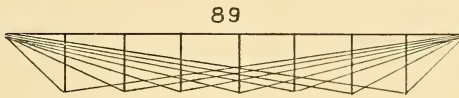
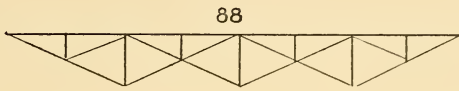

97 **Suspension bridge** with Warren type bracings.

98-9 **Cantilever bridges** with central girder.

100-1 **Braced arch bridges.**

102 **Centre and two-side spans, cantilever** continuous.

103-5 **Braced arch bridges.**

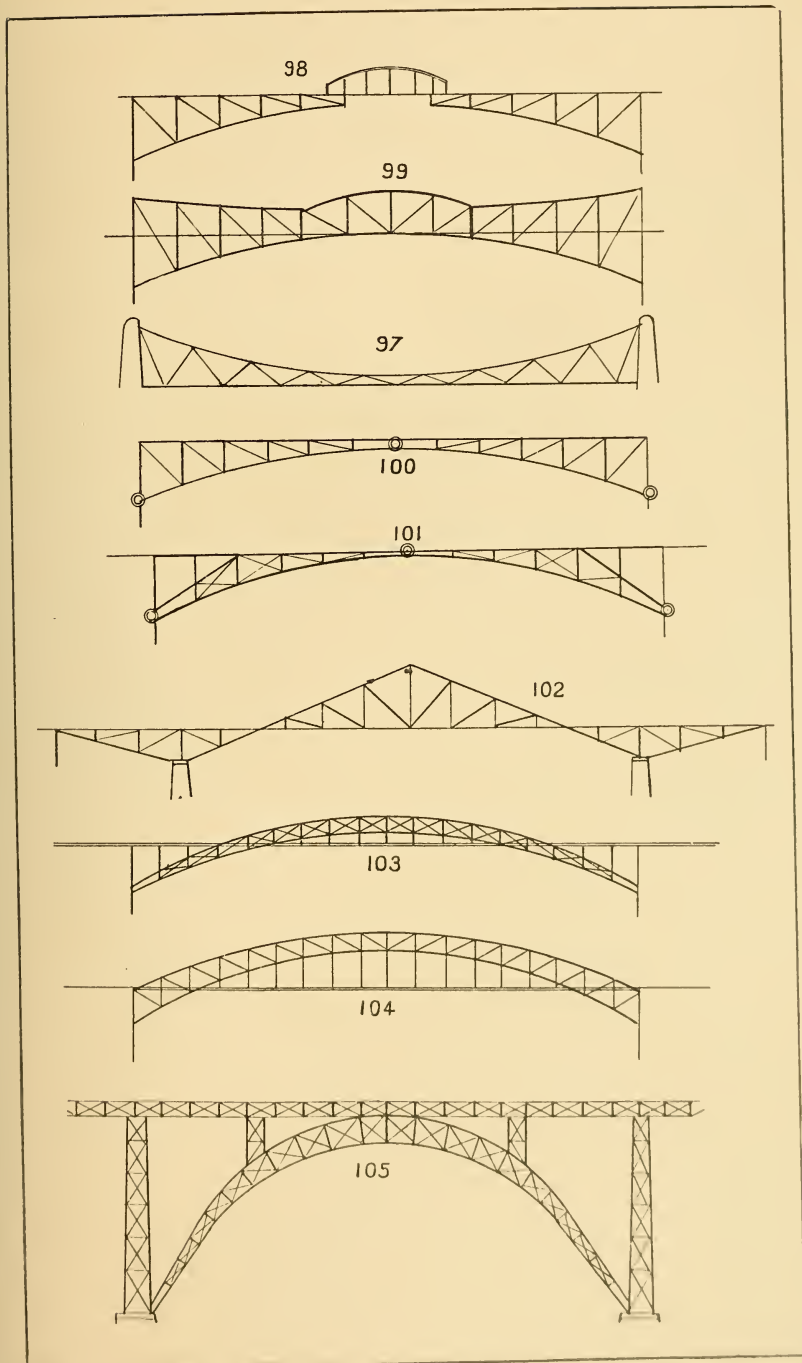

- 106 **Braced arch bridge** with two side spans.
- 107 **Arched centre span** and two semi-arch side spans.
- 108 **Double cantilever bridge** with diagonal pier struts and central girder.
- 109 **Another form of the last.**
- 110 **Bowstring tubular plate girder bridge** with tubular top boom.
- 111 **Braced bowstring girder** with tubular top boom.
- 112-13 **Sections** of the last two.

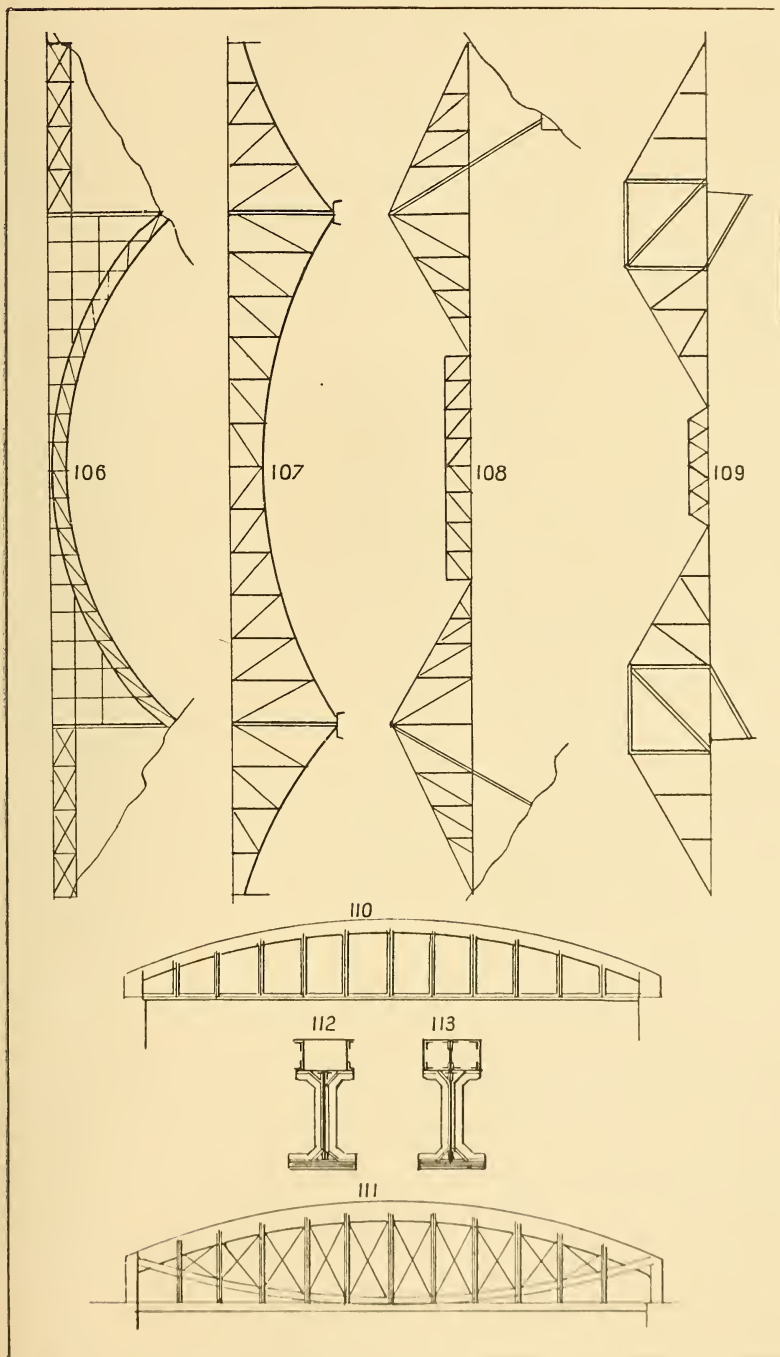

- 114 **Double cantilever bridge** with vertical and diagonal bracing and central girder.

In the last three types the roadway is carried on the lower horizontal boom.

- 115 Ditto with horizontal top boom forming the roadway.

- 116 Ditto with arched top and bottom booms.

- 117 Ditto with arched bottom boom.

In the last two types the roadway is carried on the vertical braces.

- 118 **Combined horizontal and bowstring bridge** with vertical ties.

- 119 **Tubular plate girder bridge.**

- 120 **Section of the last** with cellular top boom.

- 121 Ditto with stiffened top boom.

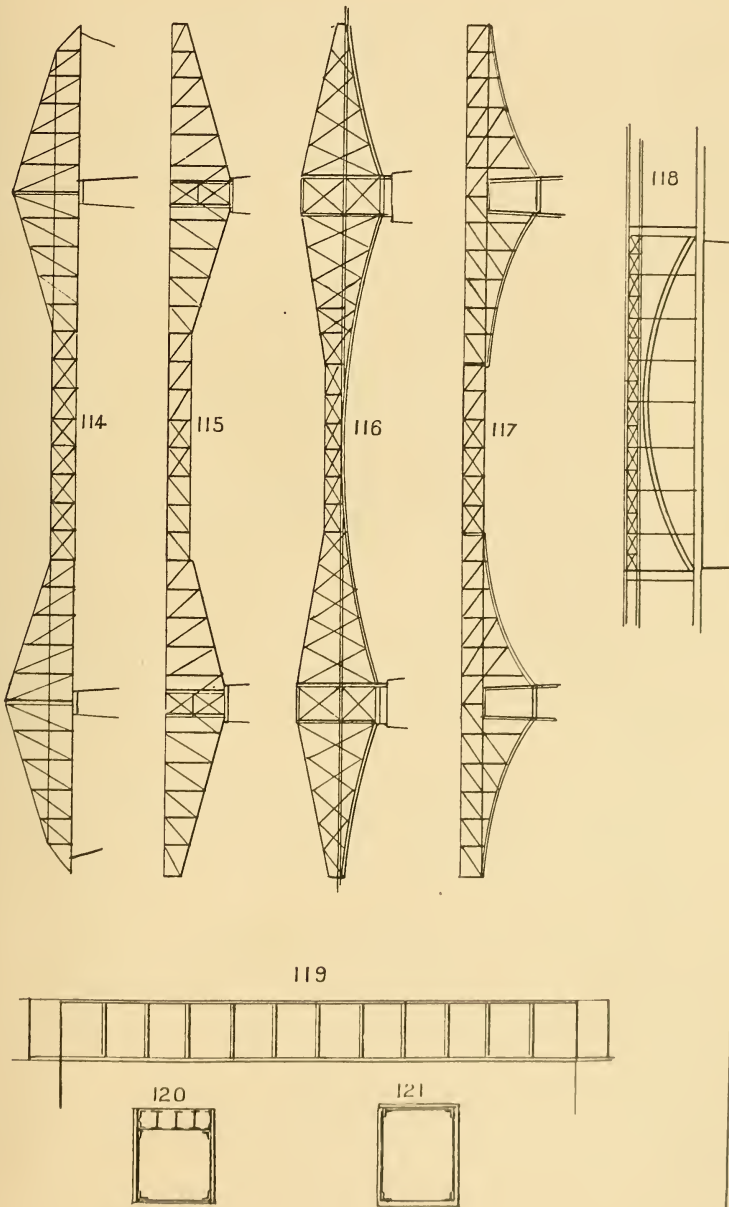

122 **Lattice girder.**

BRIDGE FLOORS.

123 **Longitudinal plank flooring** on rolled cross girders.

124 **Longitudinal plank floor**, covered with asphalt and ballast, banked for a curved line of sleeper railway.

125 **Transverse flat or trough plates**, covered with asphalt, old bricks, and ballast for sleeper railway.

126 **Plate cross girders** carrying longitudinal rail sleepers and rolled joists.

127 **Longitudinal section of floor** constructed of rolled cross girders with arched brick filling, carrying asphalt and ballast for a sleeper railway.

128 **Transverse troughs** (see Nos. 54-6) filled with ballast for a sleeper railway.

129 Ditto carrying longitudinal sleeper railway.

130 **Longitudinal troughs** carrying longitudinal sleeper railway.

131 Ditto on arched plates riveted to longitudinal rolled girders carried on cross girders.

132 **Plate girders**, transverse and longitudinal, supporting plank flooring and longitudinal rail sleepers.

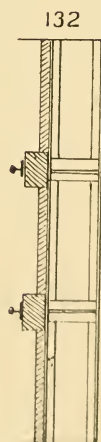
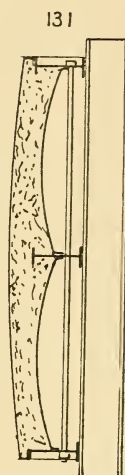
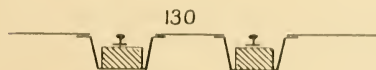
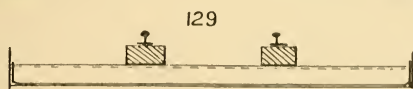
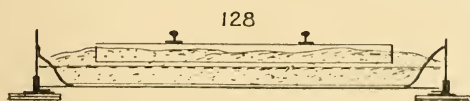
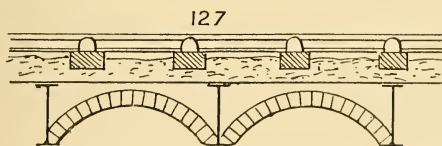
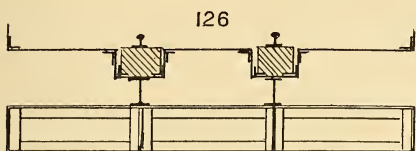
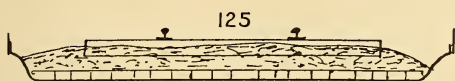
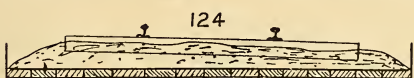
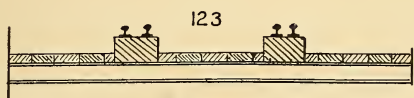
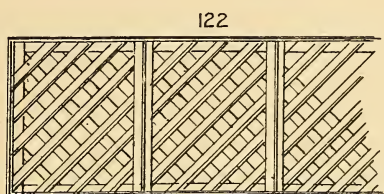

- 133 **Longitudinal sleepers** supported in longitudinal troughs carried by cross girders.
- 134 **Transverse rolled girders** supporting arched plates and ballast for a railway.
- 135 **Carriage roadway and two footways of wood or granite setts** with concrete channels, carried on planking and longitudinal girders, with concrete arched filling.
- 136 Ditto with cast-iron channels laid on three thicknesses of planking on cambered cross girders.
- 137 **Cambered roadway of wood or granite setts** on cast-iron plates and longitudinal rolled girders.
- 138 Ditto on arched steel plates and cross girders.
- 139 **Sleeper railway** on longitudinal plank floor carried on cross girders.
- 140 **Sleeper railway banked** for a curved line on ballast and longitudinal trough plates and sloping cross girders.
- 141 **Double line of flange rails on plank floor** supported on four longitudinal sleepers and cross girders.
- 142 **Transverse section of a girder bridge** having transverse arched top bracing.

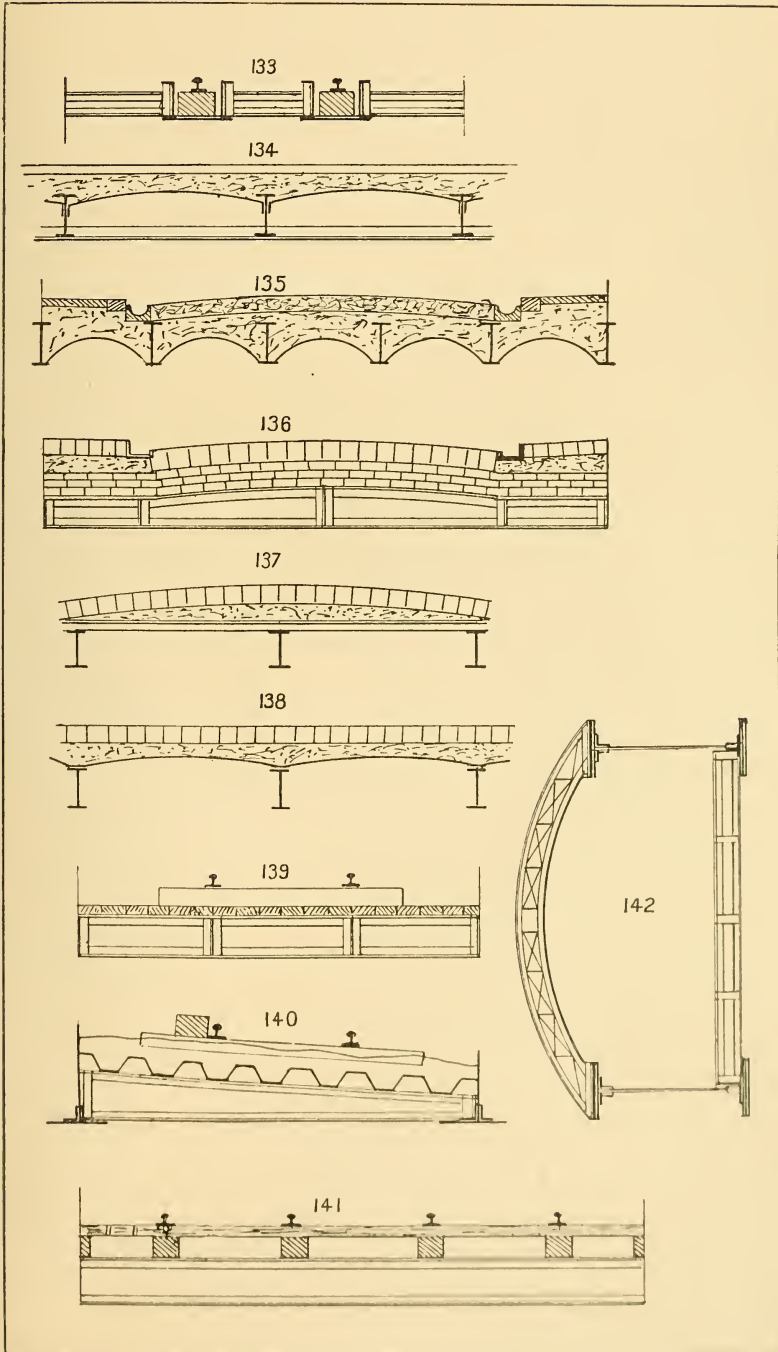

143 **Bowstring plate girder.**

144 **Arched plate girder.**

145 **Plan of girder bridge** with diagonal wind bracing.

146-8 **Sections of plate girders.**

149-50 **Platwork and T standard parapet.**

151-2 **Tube rail bridge parapet**, with cast- or wrought-iron standards.

153-4 **Cast-iron panelled parapet.**

143

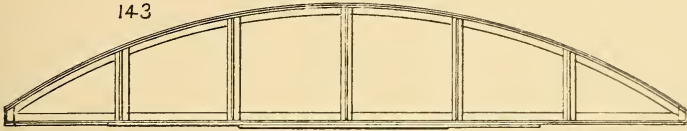

144



145

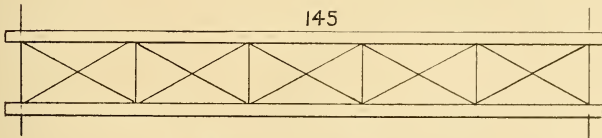

146



147

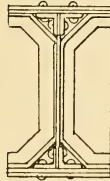

148

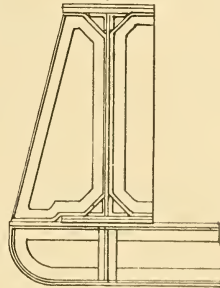

149



150

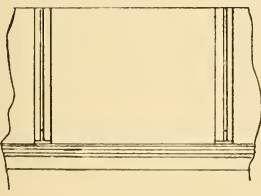

151



152

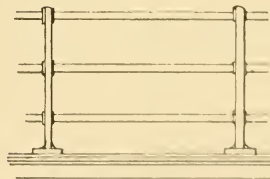

153



154

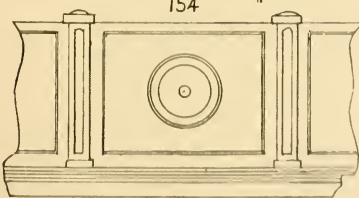

155-7 **Elevation plan and section of light rope suspension bridge.**

158-9 **Braced bridge** of triangular cross section.

160 **Type of railway crossing footbridge** in timber or steel.

161 **Pontoon bridge** on boats, pontoons, rafts, or barrels.

Reinforced concrete girders. (See Section 42.)

Bridge parapets. (See Section 36.)

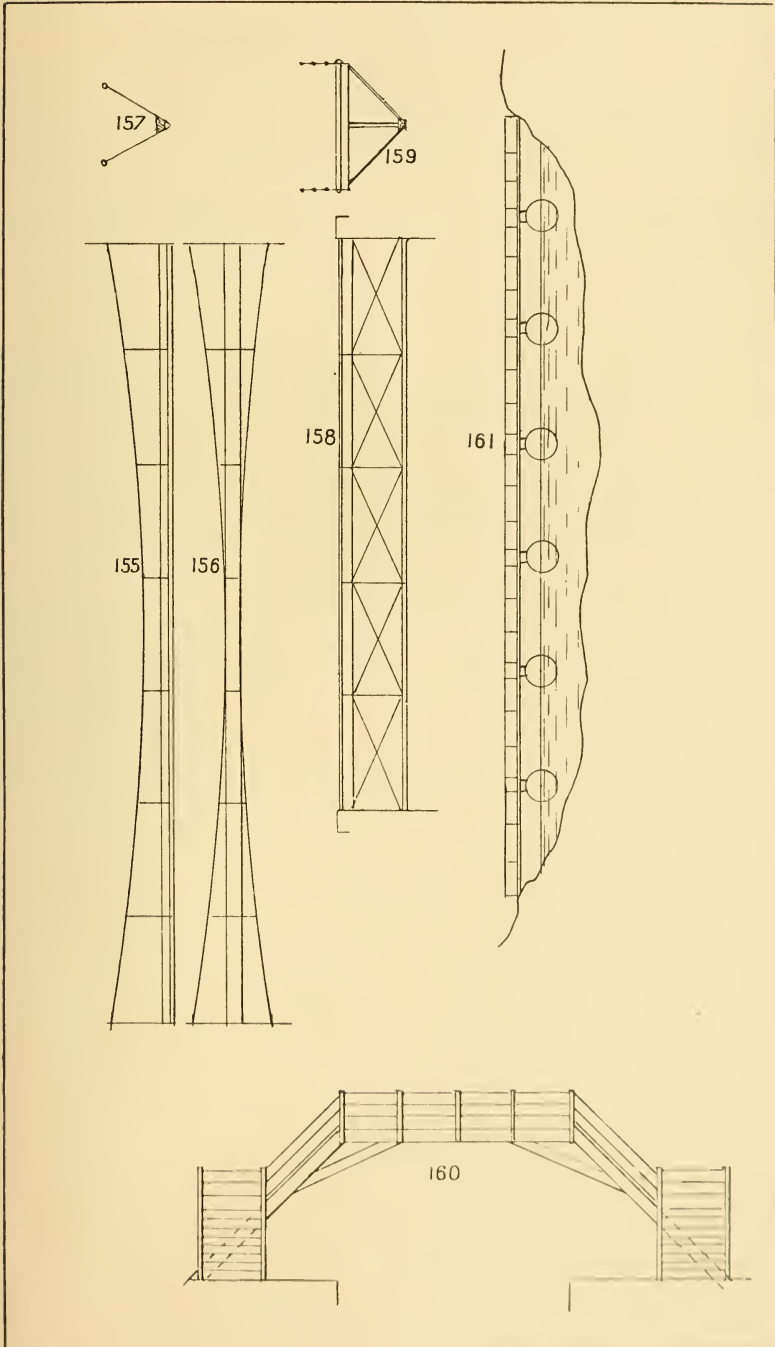

Section 6.—IRON BUILDINGS.

(For details of steelwork see Section 10; for iron roofs see Sect. 41.)

- 1 **Galvanized corrugated iron or steel building** with arched roof (see Section 41) and walls framed of **T** and **L** irons.
- 2 **Iron shed** (any type of roof, see Section 41) carried on cast-iron or steel columns (see Section 8), and either open sides or wood or corrugated steel filling on framing.
- 3 **Side elevation of side of iron building.**
- 4 Ditto **of open side building.**
- 5 Ditto, ornamented in cast iron.
- 6 **Details of iron buildings** with **H** columns and corrugated sides.

Corrugated iron dwellings, bungalows, sheds, stables, schools, chapels, and other buildings are of very varied design and do not require illustration. They are generally lined inside with matched boarding, or studding covered with fibrous plaster, and the fire-places, flues, and chimneys built of brickwork with wood or concrete floors. Such buildings are frequently made to take apart and pack for export, and are easily erected on a shallow concrete wall foundation.

Steel frame and masonry buildings. Steel frames are now commonly employed for all large buildings, the brickwork, masonry, and reinforced concrete walls, floors, and partitions being constructed to enclose the steel framing. (See Section 42.)

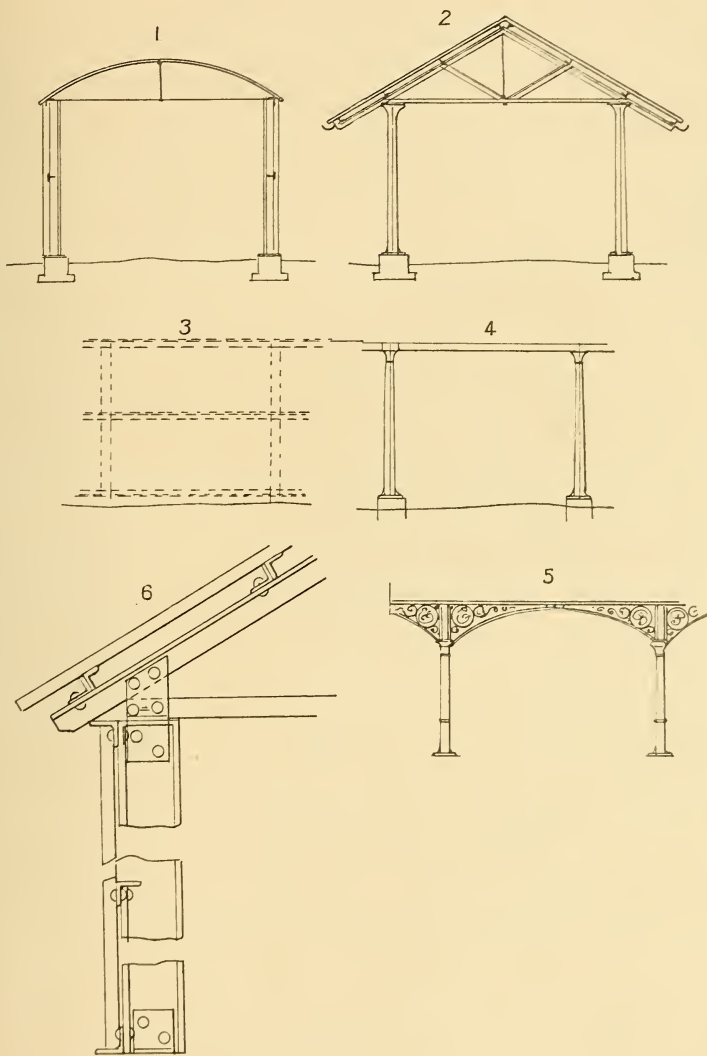

Section 7.—WOOD FRAMING AND STRUCTURES.

(For wood bridges see Section 5 ; wood fencing, see Section 36 ; wood roofs, see Section 41.)

1-7 **Junctions of crossing** or right-angled timbers.

8-10 **Junctions of rafters and principals.**

11 **Rafter and wall-plate or purlin.**

12 **Crossing of girder and tie beam.**

13, 14 **Post and girder junctions.**

15, 16 **Scarfig longitudinal timbers.**

17, 18 Ditto, **notched**, for tensile strains.

19-21 **Scarfs with keys and bolts.**

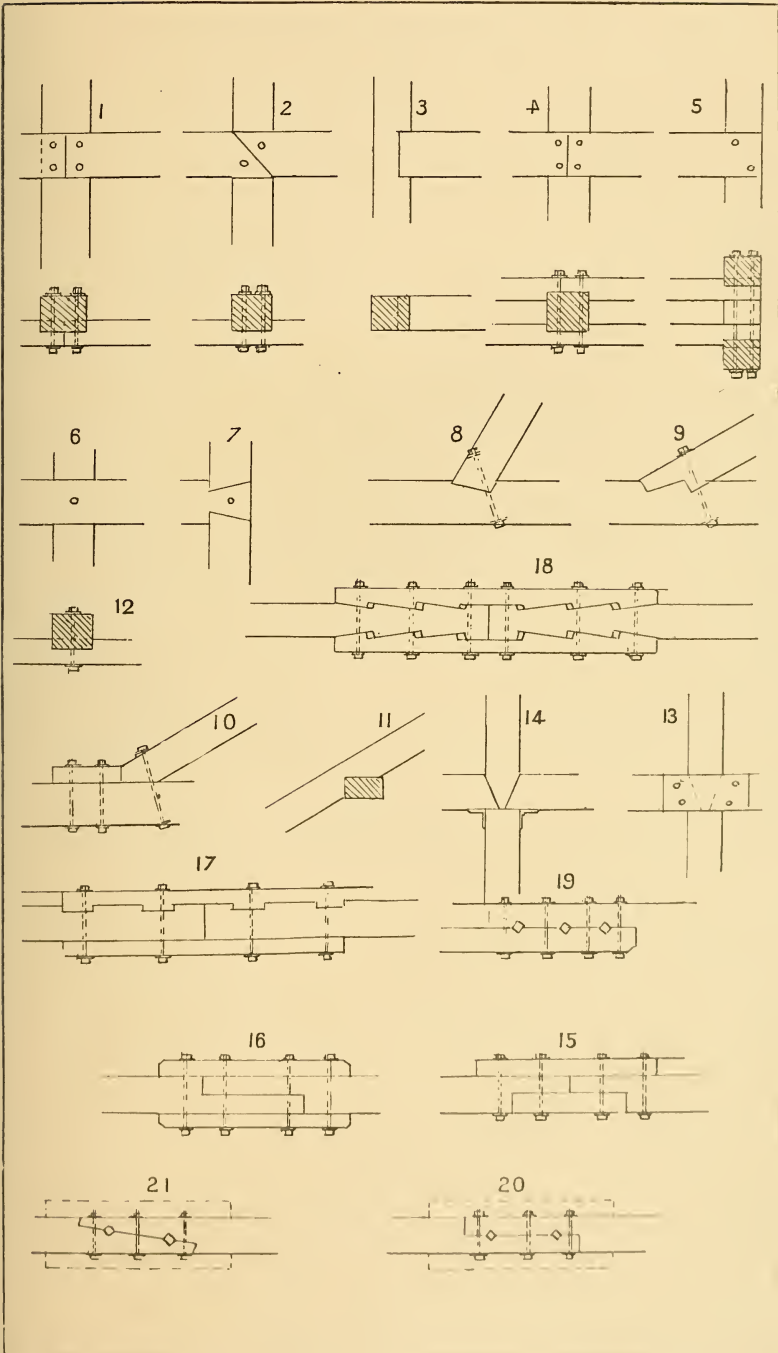

- 22-3 **Other scarf joints**, keyed or notched.
- 24-5 **Post and girder junctions** with struts and head-pieces.
- 26-8 **Laminated arch.** (See Section 5.)
- 29 **Junction of rafter, purlin, and queen post.**
- 30 **Junction of purlin, queen post, and rafter.**
- 31 **Queen post and principal.**

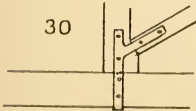
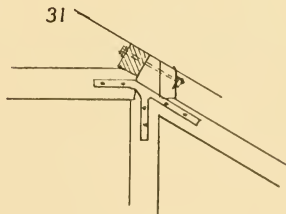
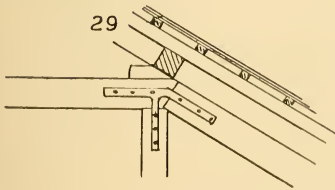
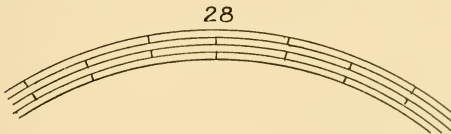
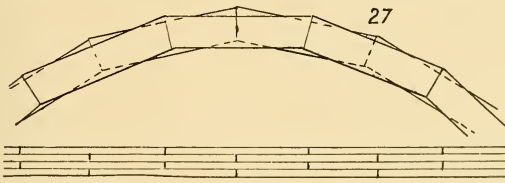
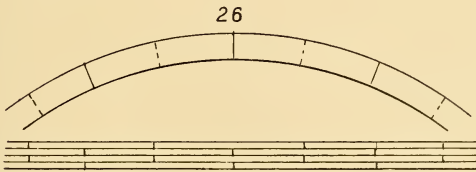
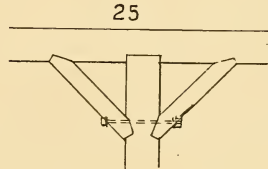
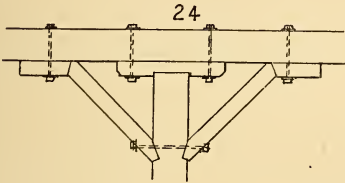
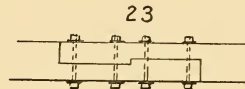
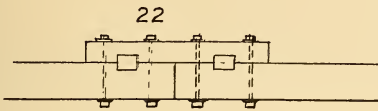

32 **Junction of principal, rafters, and king-rod** in cast-iron sockets.

33-4 **Scarf joints.**

35-9 **Matched or outside boardings.**

Buildings wholly of wood are frequently used, and in some cases constructed to take apart for packing for export, bolts, nuts, and screws being used for the disjointed parts.

Wood pile structures. (See Sections 29, 37.)

Wood dams and weirs. (See Section 43.)

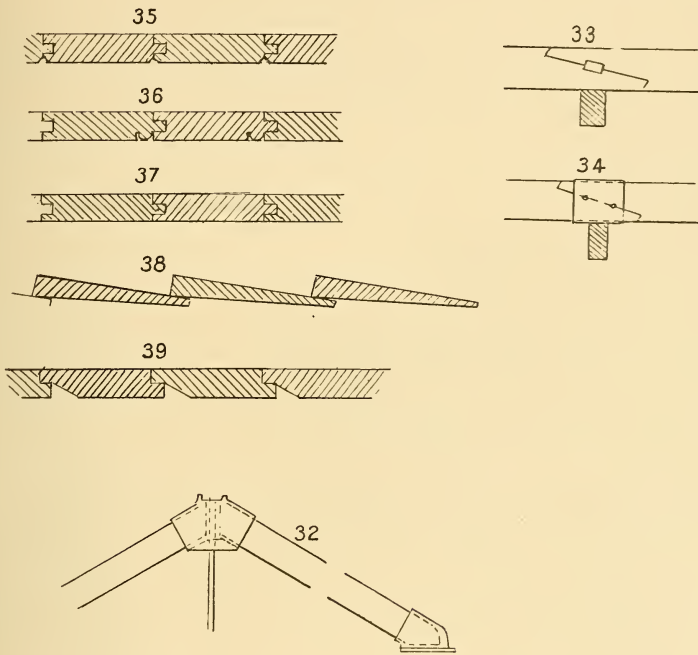

Section 8.—COLUMNS, STRUTS, AND TIES.

(For wood columns and struts see Section 7; for reinforced concrete columns see Section 42.)

- 1-3 **Cast-iron round column and base.**
- 4 Ditto, but cross-shaped section.
- 5-7 **Cast-iron H section column** and foot.
- 8 **Cast-iron round column** with stiffening ribs.
- 9-11 **Fluted square cast-iron column** with round core.
- 12-14 **Wall pilaster columns.**
- 15, 16 **Box or raised bases** for cast-iron column.
- 17 **Steel tube column** fixed in cast-iron base.
- 18 **Upper floor junction** of cast-iron columns and steel girders.
- 19 **H steel column or strut.**
- 20 Ditto, with two plates.
- 21-2 **Built-up steel columns or struts.**
- 23 **Double flat bar tie** with cast-iron distance pieces.
- 24-7 **Built-up open steel columns or struts.**

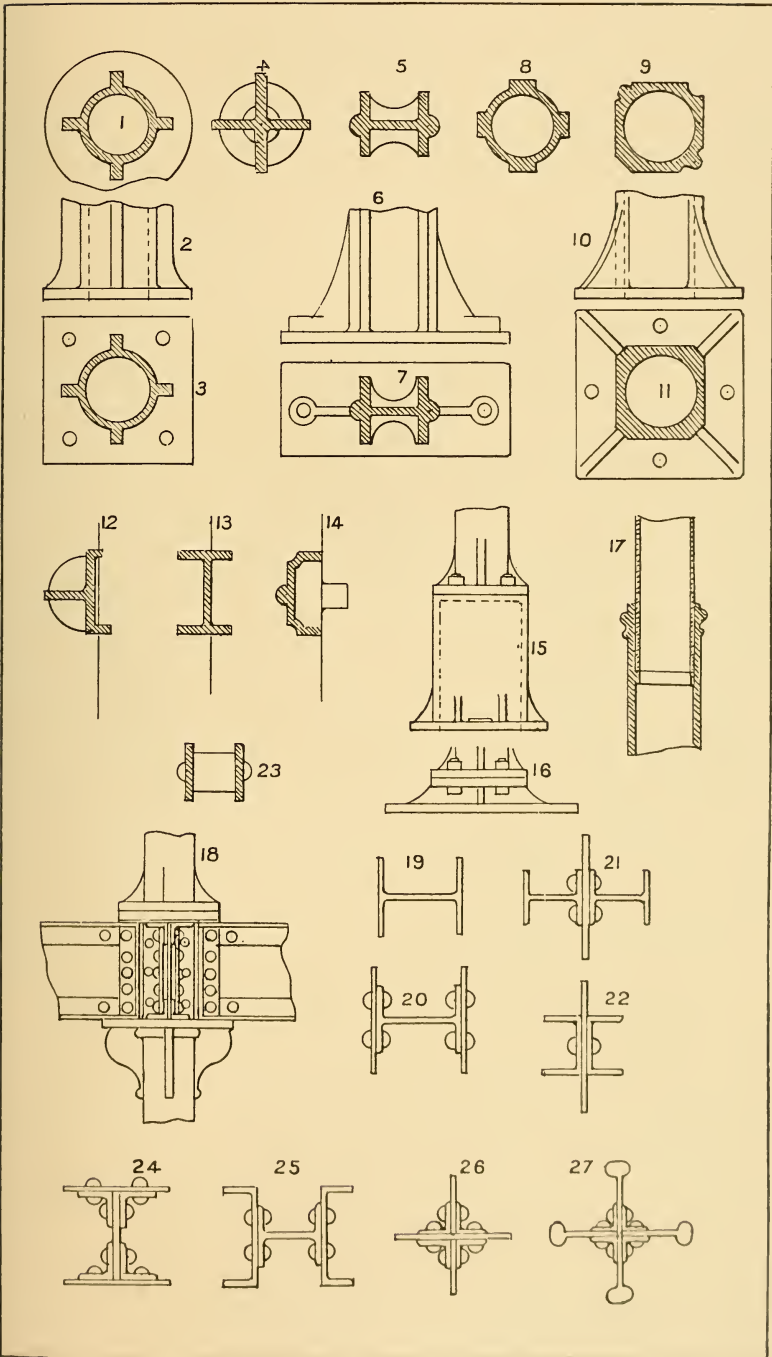

28-9 **Box-form built steel columns.**

30 **Double channel bar strut** stiffened with cast-iron distance pieces.

31 **Double T and plate strut.**

32-8 **Hollow or box-form steel columns** for heavy loads.

39 **Cross steel strut.**

40 **Double channel and H bar steel strut.**

41 **Box-form steel column** for heavy loading.

42-5 **Steel lattice columns.**

46 **Double H steel column** with cast-iron distance pieces.

47-8 **Built-up steel columns.** For high-class buildings these and the girders and flooring are usually covered with terracotta hollow blocks, as No. 47.

49 **Box- or lattice-form steel column.**

50-1 **Built lattice column.**

52-3 **Column** formed of four round steel bars, connected by cross-shaped horizontal braces.

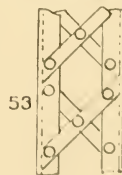
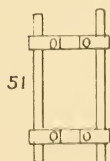
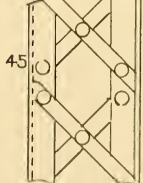
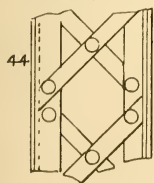
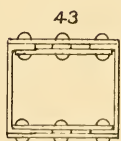
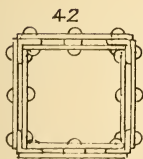
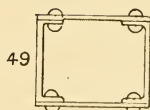
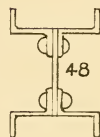
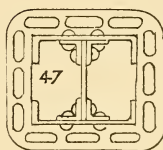
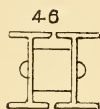
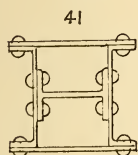
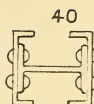
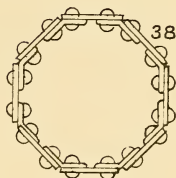
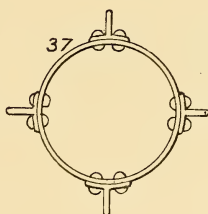
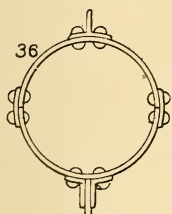
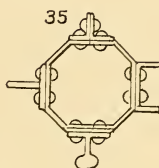
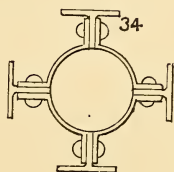
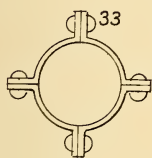
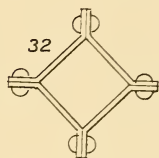
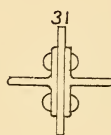
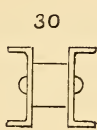
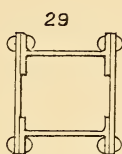
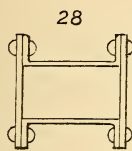

54 **Section of two box-form steel columns**, joined by transverse plates or stays.

55 **Elevation of head** of last-named.

56-7 **Double H lattice steel-tapered column.**

58-9 **Double L steel lattice column or strut.**

60-3 **Cast-iron columns.**

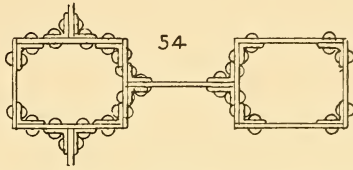
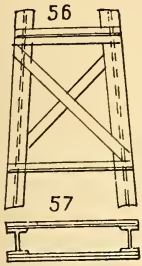

54

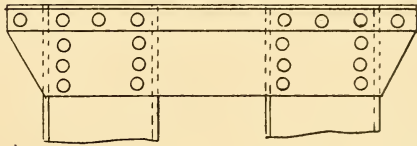

55

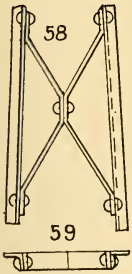

58

59

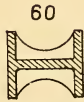

60

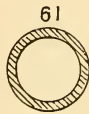

61

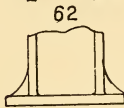

62

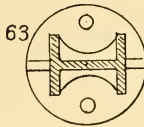

63

Section 9.—ANCHORAGES.

- 1 **Rope pulley anchor truck**, which grips by sinking its wheels in the soil ; employed for ploughing tackle.

- 2 **Anchor plate**, buried in the ground below a mass of masonry, for attaching guys, tie-rods, etc. Sometimes a frame or plate laid on the ground and ballasted is the method used.

- 3 **Screw mooring**. (See Section 39.) Screwed into the ground.

- 4 **Heavy stone** sunk in the ground and having a ring attached ; or a mass of concrete similarly placed. Used for guy ropes, tie-rods, and foundation bolt attachments.

- 5 **Grapnel**.

- 6 **Mushroom anchor**.

- 7 **Double fluke anchor**.

- 8 **Martin's patent anchor**, with swivelling flukes. Several other patent anchors are modifications of this.

- 9 **Anchorage for suspension bridge** chains with rolling expansion bearing.

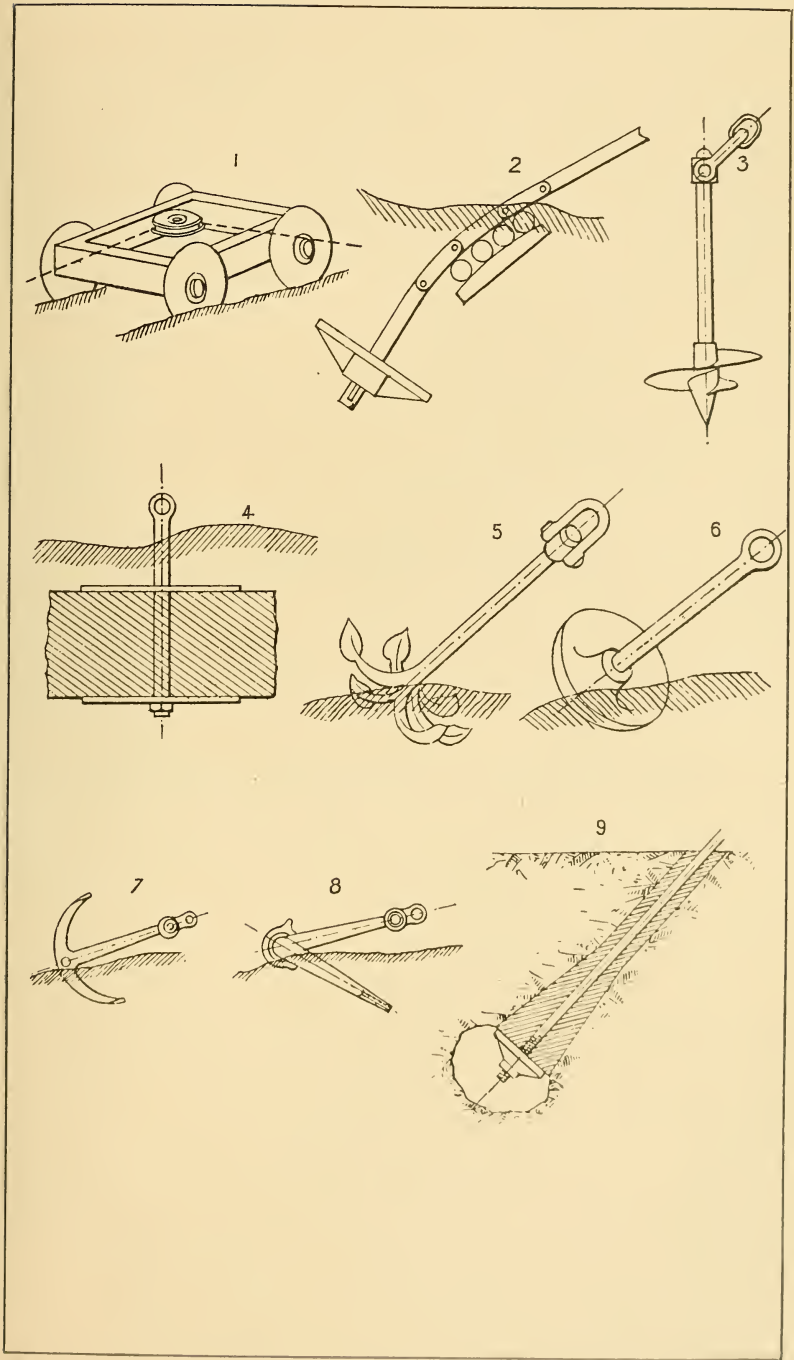

10 **Anchorage for suspension bridge.**

Anchored concrete roof. (See Section 42.)

Anchored buoys and moorings. (See Section 32.)

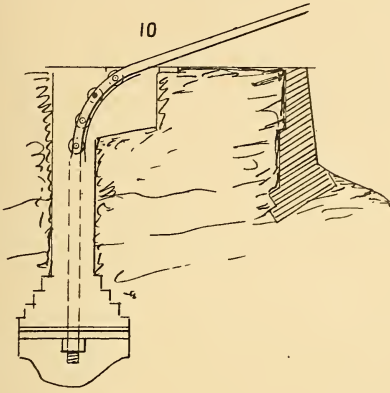

Section 10.—CONSTRUCTIONAL STEELWORK.

(See also Sections 4, 5, 6, 8, 12.)

- 1-6 **Details of junctions** of roof bracings with principal ties.
- 7 **Crossing of two T bars.**
- 8-11 **Roof bracings**, junctions of braces with principal ties.
- 12-14 **Cap of steel column.**
- 15-17 **Roof principals**, wall junctions.
- 18-27 **Sections of top booms** of steel-braced or plate girders.
- 28-30 **Sections of box-form top booms** of steel-plate girders.

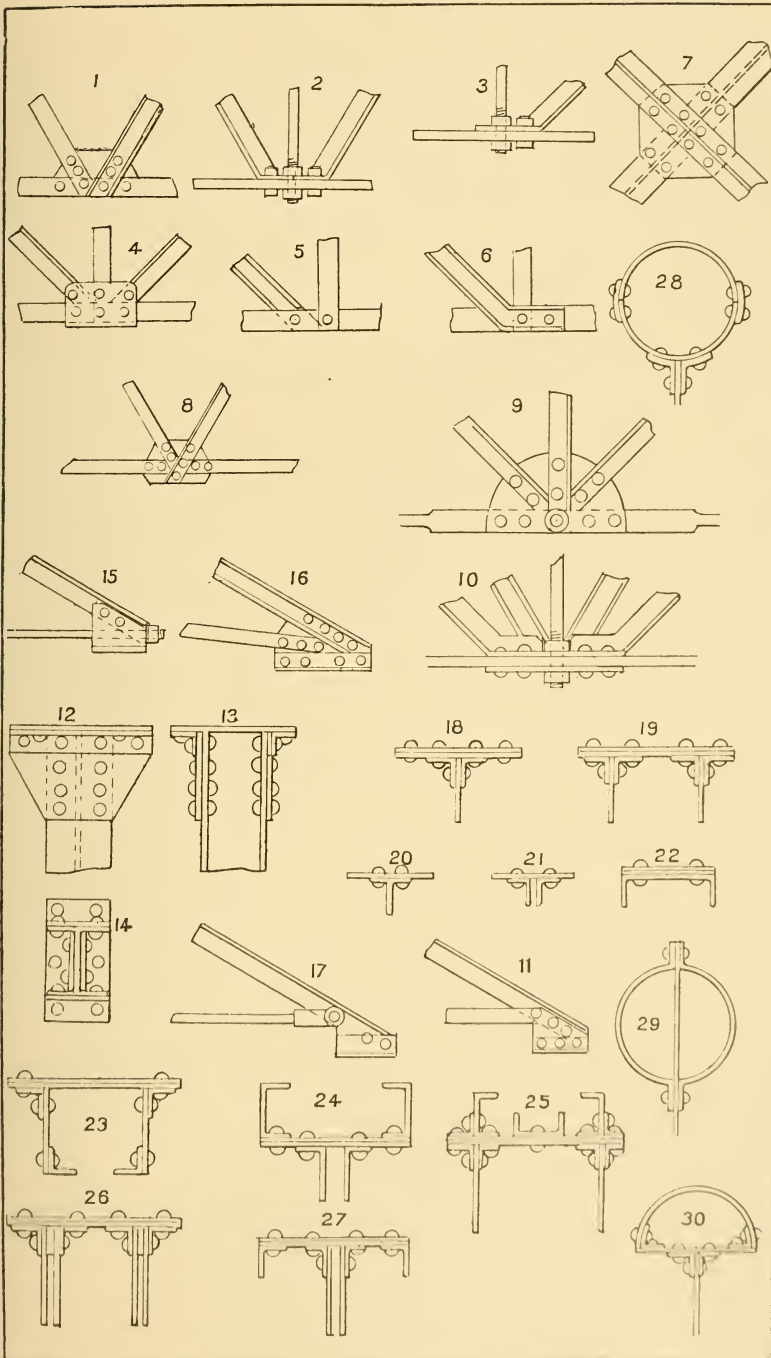

- 31-2 **Sections of box-form top booms** of steel-plate girders.
- 33 **Section of bottom boom** of braced girder, formed of four plates separated by distance pieces, and showing bearings for cross girders.
- 34 Ditto, formed of two channel bars, with transverse plate stiffeners.
- 35 **Box-form top boom** of plate girder.
- 36 **Section of bottom boom** of braced girder with two plates and transverse plate stiffeners, showing suspension of cross plate girders.
- 37-42 **Sections of struts** or compression members of bracing.
(See also Section 8.)
- 43-4 **Roof principals**, column bearings.
- 45 **Cross section of plate girder.**
- 46-9 **Side elevations of plate girders.**
- 50-1 **Junction of cross girders** on bottom trough-shaped boom of braced girder.

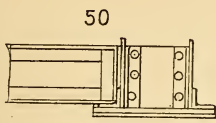

50

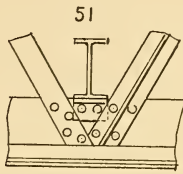

51

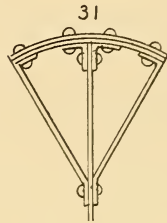

31

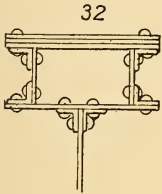

32

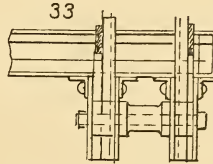

33

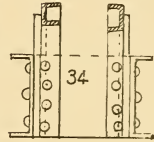

34



39

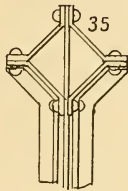

35

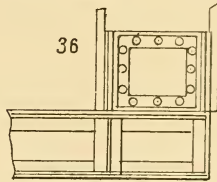

36

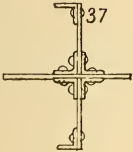

37

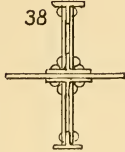

38

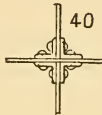

40



41

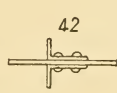

42

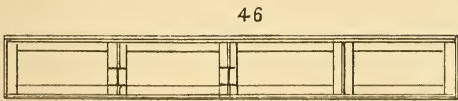

46



45

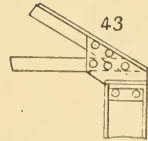

43

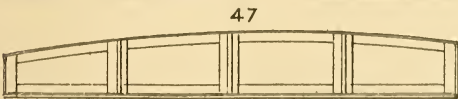

47



48

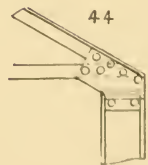

44

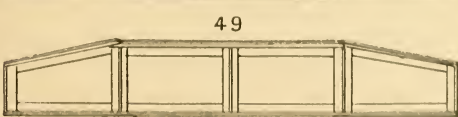

49

Section 11.—FLOORS AND PARTITIONS.

Bridge floors. (See Section 5.)

Reinforced concrete floors. (See Section 41.)

- 1 **Ordinary joist floor,** boarded.
- 2-3 **Floor boardings,** various types.
- 4 **Double boarding.**
- 5 **Parquet, cement or asphalt on boarding.**
- 6 **Wood brick floor** bedded on sand or asphalt, on close
boarding.
- 7 **Girder and joist floor,** boarded.
- 8 **Cross section** of last-named.
- 9 **H steel joists** and concrete floor, covered with asphalt, wood
bricks, cement, stone slabs, or tiles, bedded on cement.
- 10 Ditto, covered with concrete, stone, or slate slabs.
- 11 Ditto, brick arches, and concrete floor, finished either in cement,
tiles, etc.

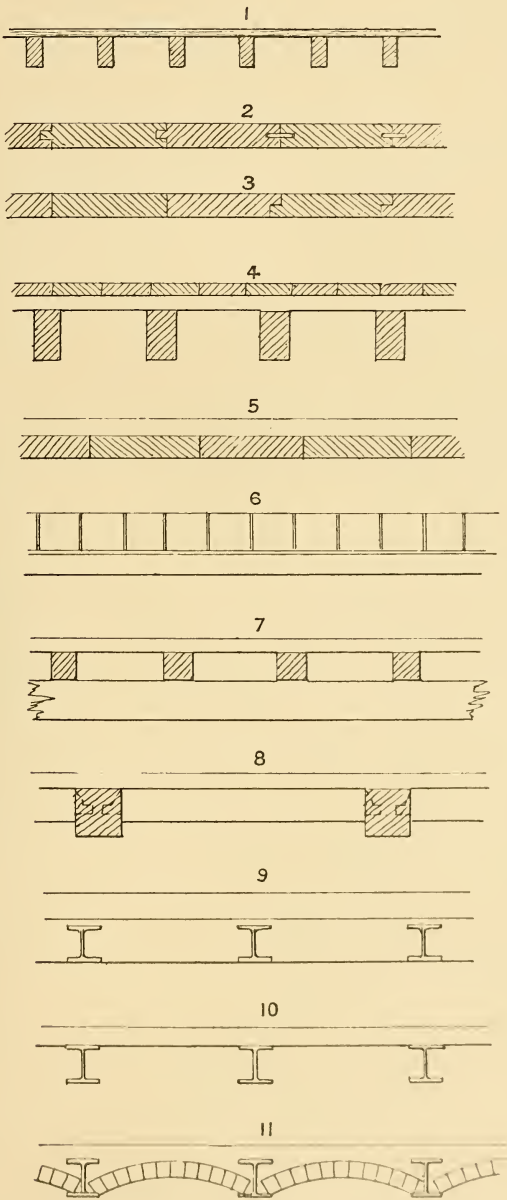

- 12 **H steel joists** and concrete with flat soffit to take a plaster ceiling ; coverings may be as No. 9.
- 13 **Reinforced concrete floor** on **H** steel joists. (See Sect. 41.)
- 14 **H steel joists** with concrete arches and any covering, as No. 9.
- 15 Ditto, with hollow brick arches and concrete and any covering, as No. 9.
- 16 Ditto and concrete on iron cross bars.
- 17, 18 **Sections** of ditto.
- 19-21 **Similar floor**, but with channel-shaped earthenware bearers on steel cross bars.
- 22 **H steel joists** with concrete filling, covered with wood boarding on crossed strips.
- 23 Ditto, connected by diagonal bars with concrete filling ; any covering, as No. 9.
- 24 Ditto, carrying on their bottom flanges concrete slabs supporting an ordinary wood joist and boarded floor, as No. 1.
- 25 **L (or H) bar joists** filled between by arches formed of interlocked hollow bricks ; coverings may be of any kind, as No. 9. Ceilings below formed of ceiling strips and plaster.

12

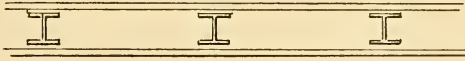

13

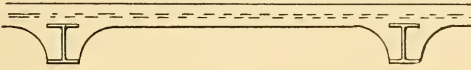

14

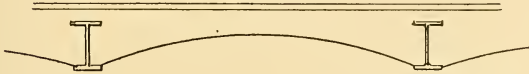

15

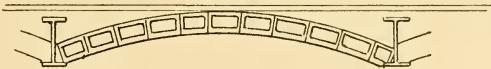

16

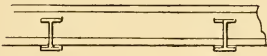

17



18



19

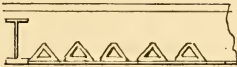

20

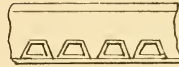

21

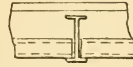

22

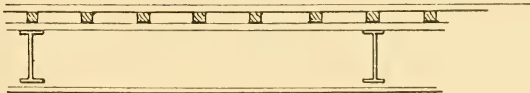

23

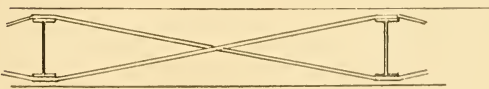

24

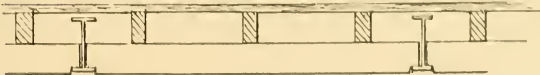

25



- 26 **H steel joists** filled between by hollow brick lumps serrated on underside for a ceiling and covered with concrete and any finish, as No. 9.
- 27 Ditto, filled with flat arches of toggle-jointed arch bricks : any covering, as No. 9.
- 28 Ditto, flat arches of hollow arch bricks, and concrete or other covering.
- 29 **Steel trough floor** (see Section 5), filled with concrete in which wood floor strips are bedded to take wood boarding, as Nos. 2, 3.
- 30 **Another form** of No. 28.
- 31 **Close wood joisting**, tongued below for ceiling plaster.

Partitions. (See Section 2, Nos. 35, 36, and Section 41.)

Brick partitions are usually of half brick or brick on edge, in mortar or cement.

Ordinary partitions are of wood scantlings covered with lath and plaster, matched-boarding, fibrous plaster slabs, lath and cement, etc.

26



27



28



29

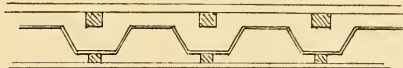

30

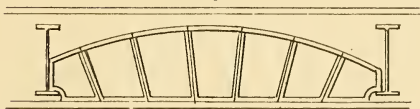

31



Section 12.—ROOF COVERINGS.

Thatch. Formed of reeds laid on a bed of straw and fastened down by ash spears, galvanized wires, etc.

Slates. Laid on laths or close boarding, made in many sizes, secured by zinc or copper nails, and unprotected places covered by lead or zinc flashings.

Tiles. Hollow (pan) or flat; concrete tiles; secured usually by fillets on the underside, which hook on to wood laths.

Wood shingles. Split boards laid to lap as slates, sometimes held down by stones, but usually nailed down to boards, laths, or purlins.

Boarding. Various sections, as Nos. 1-3, Section 11, tarred or covered with tarred canvas, "rubberoid" sheeting, tarred felt, "Willesden" paper, sheet zinc, or lead.

Concrete (reinforced) with wire or expanded steel netting. (See Section 41.)

Glass, in frames or as glass slates.

Galvanized corrugated steel. (See Section 6.)

Galvanized flat sheets laid on boarding. Zinc or copper sheets.

Section 13.—ROADS AND STREETS.

1 **Macadam road,** consists of rough stone base about 1 foot deep, with a 6 in. layer of broken stone and a little fine ballast; rolled down by heavy roller.

2 **Tarmac road;** similar to No. 1, but the upper surface is saturated with coal tar.

3 **Wood brick paved road,** laid on asphalt, above 9 in. to 1 ft. of concrete.

4 **Granite cubes,** laid on concrete or hard rolled rough broken stone.

5 **Gravel road,** formed of 3 in. of gravel on broken stone base, for light traffic.

6 **Tramway road.** (See Section 23.)

Asphalt roads are formed of $1\frac{1}{2}$ to 2 in. of Limmer or Val de Travers or other natural asphalt on concrete base.

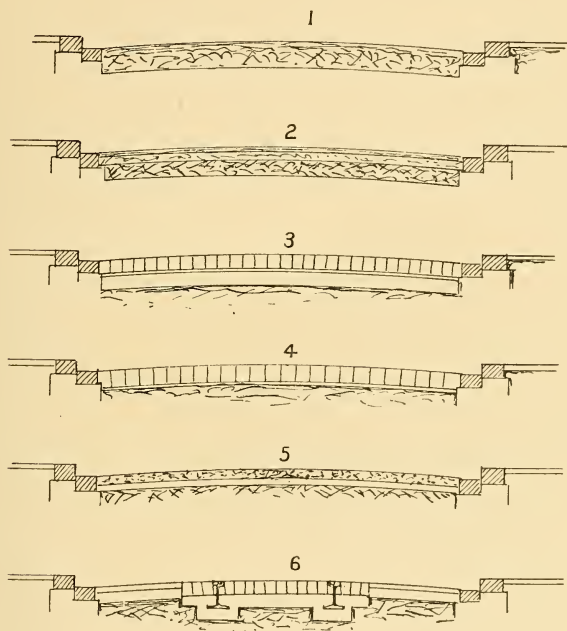

Section 14.—ROLLED IRON AND STEEL BARS, PLATES, ETC., USED IN CONSTRUCTION.

The following memoranda relate only to such materials as are required in connexion with machinery or mechanical constructions, and are intended to supply particulars of the dimensions of the manufactured or raw material, giving the sections manufactured and the limits as to size available for incorporation in any design under consideration.

Rolled iron and steel bars are manufactured as below :—

Rounds, from $\frac{3}{16}$ to $7\frac{3}{4}$ in. diameter and up to 18 ft. long.

Squares, from $\frac{3}{16}$ to 6 in. square, and up to 18 ft. long.

Flats, from $\frac{1}{2}$ to 14 in. wide, and up to 18 ft. long.

L iron sections are made from $\frac{3}{4}$ by $\frac{3}{4}$ in. up to 14 by $3\frac{3}{4}$ in., or to $12\frac{1}{2}$ united inches, with equal or unequal flanges, and up to 30 ft. long: but the acute, obtuse, and round angled sections are not usually stocked.

T irons, from 1 by 1 in. up to 12 united inches, or to 9 by 4 in., and up to 30 ft. long.

Rolled girder iron, from 3 in. deep to 20 in. deep by 10 in. flanges, and to 36 ft. long in hundreds of sections.

Zore girders, from 3 to 8 in. deep, and to 24 ft. long.

Channel iron, from $\frac{3}{4}$ to 12 in. wide, and to 25 ft. long.

Convex iron, from 1 to 6 in. wide, and up to 20 ft. long.

Cope iron, from 1 to 4 in. wide, and to 20 ft. long.

- 1 **Half-round iron**, from $\frac{1}{2}$ to 4 in. wide, and to 20 ft. long.
- 2 **Funnel ring iron**, from $3\frac{1}{2}$ by $\frac{3}{16}$ in. to 8 by $\frac{9}{16}$ in. wide, and up to 18 ft. long.
- 3 **Jackstay iron.**
- 4 **Half round groove iron.**
- 5 **Double-headed rail**, 30 to 60 ft. long.
- 6 **Flanged rail.**
- 7 **Bridge rail.**
- 8 **Bulb angle iron.**
- 9 **Bulb girder iron.**
- 10 **Bulb angle iron.**

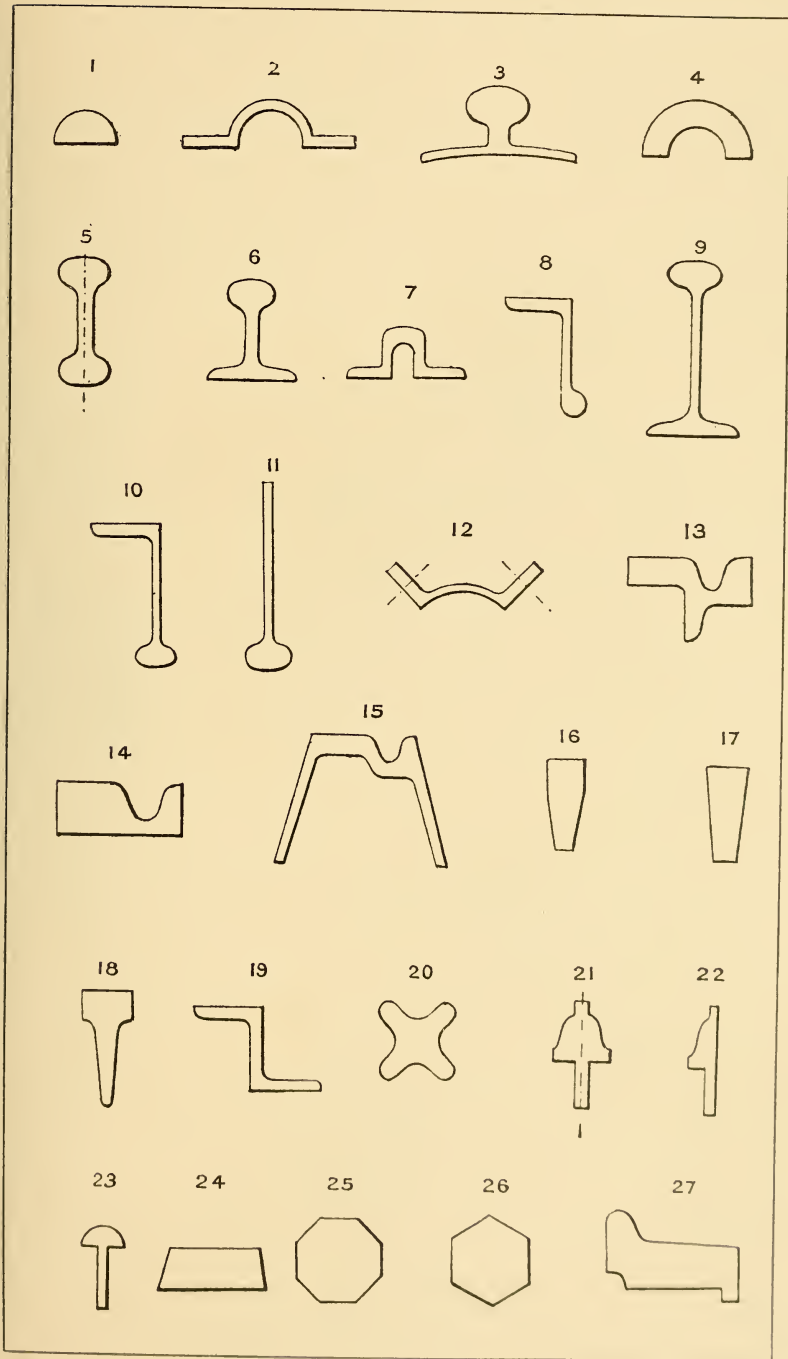

- 11 **Bulb web plate.**
- 12 **Column iron.**
- 13 **Tram plate.**
- 14 **Ditto.**
- 15 **Tramway rail.**
- 16-18 **Firebar iron.**
- 19 **Double angle iron.**
- 20 **Cross iron.**
- 21-3 **Casement bars.**
- 24 **Fire bearer iron.**
- 25 **Octagon iron.**
- 26 **Hexagon.**
- 27 **Tyre bar.**
- 28-9 **Bevelled flat iron.**
- 30 **Trough iron.** Used for bridge flooring, fire-proof floors, etc.
- 31 **Double convex iron.**
- 32-3 **Tramplate iron.**
- 34-5 **Chair or sleeper iron.**
- 36 **Oval iron.**
- 37-9 **Round edged flats.**
- 40 **Segment round iron.**
- 41 **Round edged convex iron.**
- 42 **Bevelled flat iron.**
- 43 **Bevel edge flat iron.**
- 44 **Bevelled flat iron.**
- 45 **Round edged hollow convex iron.**
- 46 **Taper edged hollow convex iron.**
- 47 **Boiler tube expansion ring iron.**
- 48 **Moulded flat bar.**

In addition to the above, iron ornamental mouldings are rolled with moulded and relief ornaments in bars, from $\frac{5}{8}$ to $2\frac{3}{4}$ in. wide, and up to 16 or 18 ft. long. Also plain mouldings similar in sections to those used in joinery.

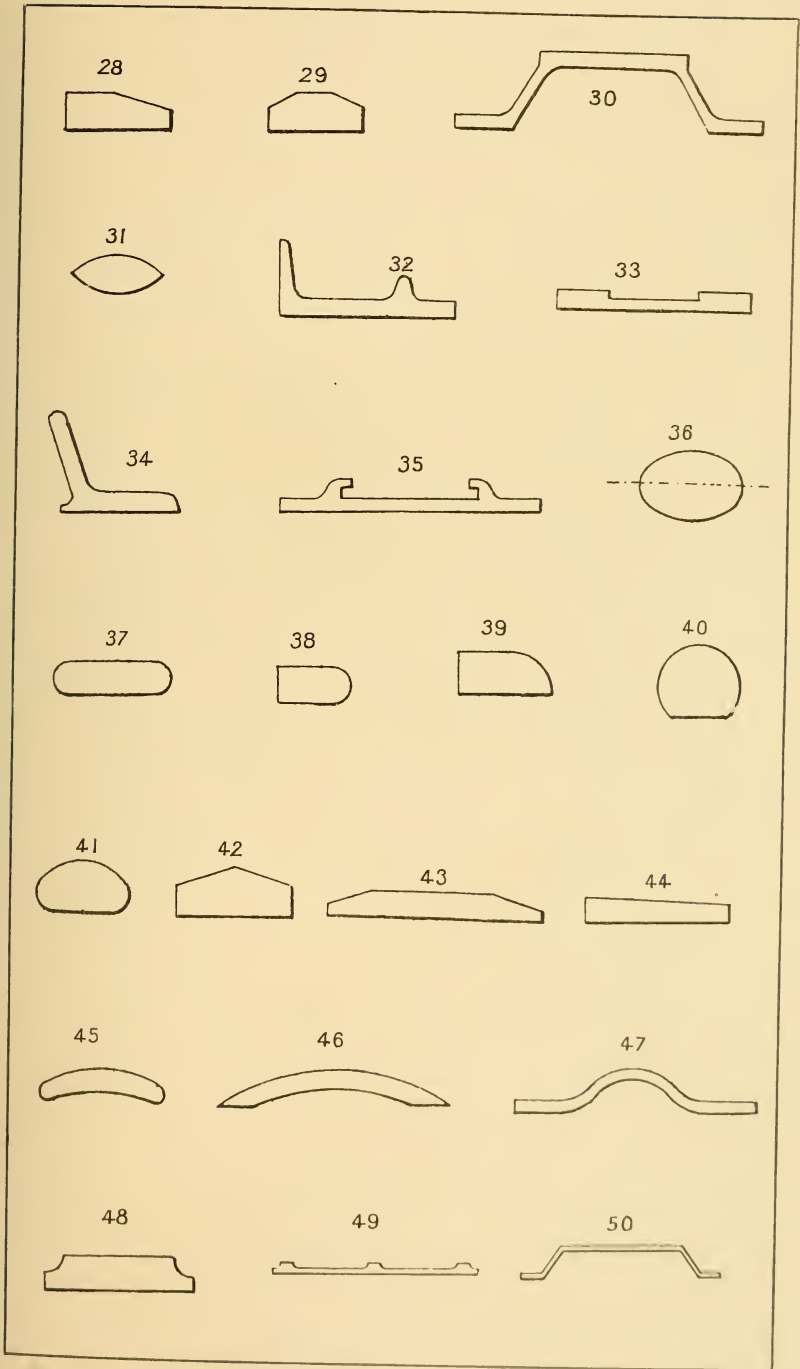

Plates (iron and steel) are manufactured from $\frac{1}{8}$ to $\frac{3}{4}$ in. thick ordinary. Thicker plates are rolled to order up to 20 in. thick.

Stocked sizes of ordinary plates are 4 by 2 ft. up to 14 ft. by 4 ft. 6 in.

Strips from 7 to 22 in. wide, and up to 30 ft. long.

Chequered plates, with diamond, oval, or square recessed patterns, are made 6 by 2 ft. up to 8 ft. by 3 ft. 6 in.

Sheets, plain, in thicknesses from No. 10 w.g. to No. 36 w.g., and from 6 by 2 ft. to 10 by 4 ft.

Corrugated sheets, plain or galvanized, from No. 16 to No. 26 w.g., and from 6 by 2 ft. to 9 by 2 ft.

Tinned sheets, same as above.

Cold rolled sheets ,, ,,

Planished sheets ,, ,,

Lead-coated sheets ,, ,,

Tin plates, terne plates, 14 by 20 in., 17 by $12\frac{1}{2}$ in., 15 by 11 in., 14 by 10 in., 24 by 20 in., 28 by 10 in., 28 by 20 in.

Hoops, $\frac{5}{8}$ to 7 in. wide, and from No. 8 to No. 24 w.g.

49 **Ribbed plate or tram plate.**

50 **Trough plate for flooring bridges, etc.**

51 **Round iron.**

52 **Square iron.**

53 **Flat bar iron.**

54-8 **Angle irons.**

59 **Rolled joists.**

60 **Fore girder.**

61 **Round angled L iron.**

62-3 **Tee iron.**

64 **Channel iron.**

65-6 **Tyre iron.**

Iron and Steel Plates.—It is essential to possess some knowledge of what sizes and weights are obtainable at ordinary prices, because it is frequently desirable to utilize the largest available, in order to save the cost of making joints. Frequently joints are made by riveting, not because they are wanted at all, but simply because they cost less than single plates would do. Information of this kind is only to be

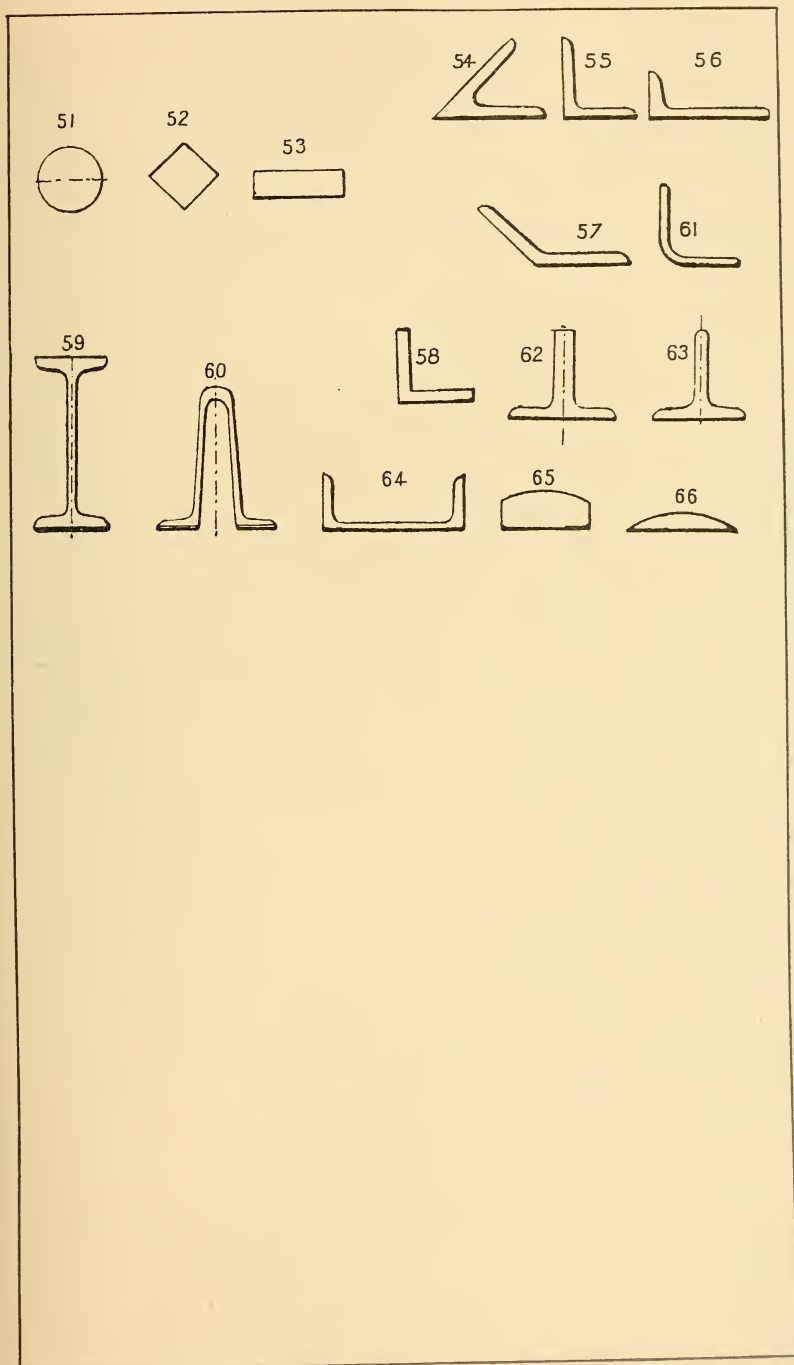

obtained from the price lists of the iron and steel manufacturers, which are supplied to the trade.

The meaning of "maximum dimensions" is thus: Taking a $1\frac{1}{2}$ in. plate, for example, the maximum dimensions of which are given in a list as 40 ft. in length by 10 ft. in width, it is not possible to get a plate measuring 40 by 10 ft., for that would make a united area of 400 ft., and the list limit is 150 ft. area. But the area can be taken out either in length or in width, within the limiting length of 40 ft. and width of 10 ft. *The maximum area divided by any length in feet not exceeding the maximum, will give the maximum width for that length; and the maximum area divided by any width in feet not exceeding the maximum, will give the maximum length for that width.* Thus, 150 ft. area divided by the maximum length, i.e. 40, gives 3 ft. 9 in. width of plate. Or 150 ft. divided by the maximum width, i.e. 10, gives 15 ft. length of plate. And for anything over these maximum dimensions special quotations have to be made. But no plate can be rolled to contain the *greatest* length and the *greatest* width at the same time.

Again, in reference to "extras", many points have to be borne in mind. Thus, as regards *shape*, any departure from the rectangular form is an extra, as tapered plates, sketches, i.e. any irregular outlines, and also circles. The extra, under this head, may be about 25s. per ton. As regards *thickness*, plates under $\frac{1}{4}$ in. thick are an extra, rated at from 10s. to 20s. per ton more. As regards *width* and *length*, quite special terms are made, amounting to 5s. perhaps on each 3 in., a serious item. And as regards *weight*, steel plates over about 40 cwt. are charged extra, at the rate of about 5s. per 5 cwt.

To give examples: The Steel Company of Scotland roll steel plates from $\frac{1}{16}$ to $1\frac{1}{2}$ in. thick, and from an area in the first case of 30 ft. to 150 ft. in the latter. The thicknesses advance by thirty-seconds in thickness up to $\frac{3}{16}$ in., by sixteenths up to $\frac{1}{2}$ in., and by eighths up to $1\frac{1}{2}$ in. The following table will give an idea of their limiting sizes, which may be taken as fairly typical of steel plates in general. It will be seen that I have included only a few of the thicknesses named above.

MAXIMUM.

Thickness.	Length.	Width.	Area.	Thickness.	Length.	Width.	Area.
in.	ft. in.	ft. in.	ft.	in.	ft. in.	ft. in.	ft.
$\frac{1}{8}$	22 0	5 0	50	$\frac{3}{4}$	40 0	9 3	140
$\frac{1}{4}$	33 0	6 3	90	1	40 0	10 0	150
$\frac{3}{8}$	38 0	7 4	100	$1\frac{1}{4}$	40 0	10 0	150
$\frac{1}{2}$	40 0	8 3	110	$1\frac{1}{2}$	40 0	10 0	150

David Colville & Sons roll plates from $\frac{1}{4}$ to $1\frac{1}{2}$ in. in thickness with an area of 80 ft. in the first and 140 ft. in the last; other sizes intermediate. But by special arrangement plates $\frac{1}{4}$ in. thick can be rolled to 140 ft. area, and $1\frac{1}{2}$ in. of 170 ft. Thirty hundredweight is the limit of weight in ship plates, and 40 in boiler plates. Plates up to $6\frac{1}{2}$ tons weight each can be rolled at special prices. It is impossible to roll plates exactly to weight, and it is usual to allow a deviation of from $2\frac{1}{2}$ to 5 per cent *over* weight for boiler plates, and under or over for ordinary plates.

The Parkhead Steel Works roll $\frac{1}{16}$ in. plates to a maximum area of 36 ft., $\frac{1}{4}$ in. plates to 70 ft., $\frac{1}{2}$ in. plates of 110 ft., $\frac{3}{4}$ in. plates of 140 ft., 1 in. plates of 150 ft., and $1\frac{1}{4}$ in. plates of 150 ft. area. The limiting weights are 20 cwt. for ship plates, and 40 cwt. for boiler plates. Above these 5s. per 5 cwt., or part of the same, is charged.

The Weardale Iron and Coal Company roll steel plates from $\frac{1}{4}$ to $1\frac{1}{2}$ in. thick, with a maximum area of 60 ft. in the first, and 120 ft. in the second; 30 ft. is the maximum length, and 8 ft. the maximum width. Circular plates are also rolled from 5 ft. 6 in. diameter of $\frac{1}{4}$ in. thick, to 8 ft. 6 in. diameter in $1\frac{1}{2}$ in. thick. All ordinary thicknesses, also intermediate between these, are rolled.

The limiting weights and dimensions of the steel plates of Bolekow, Vaughan & Co. are 18 cwt. 80 sq. ft. in area, 23 ft. in length, and between 12 and 60 in. in width. Extras are, for every hundredweight, or part of the same, above 18 cwt., 10s.; for every foot, or part of a foot, above 23 ft. in length, 5s.; for every square foot above 80 sq. ft., 1s.

John Brown & Co., Sheffield, roll steel plates from $\frac{1}{8}$ to $1\frac{1}{4}$ in. in thickness. A few selected thicknesses are given below.

Thickness.	Length.		Width.		Area.	Thickness.	Length.		Width.		Area.
in.	ft.	in.	ft.	in.	ft.	in.	ft.	in.	ft.	in.	ft.
$\frac{1}{4}$	30	0	6	0	72	$\frac{3}{4}$	40	0	9	6	180
$\frac{3}{8}$	35	0	6	9	120	1	40	0	9	6	180
$\frac{1}{2}$	40	0	8	0	130	$1\frac{1}{4}$	40	0	9	6	180

Circular and square plates of the same thicknesses can be rolled as follows:—

Thickness.	Diameter.		Square.	Thickness.	Diameter.		Square.
in.	ft.	in.	ft.	in.	ft.	in.	ft.
$\frac{1}{4}$	6	6	6	$\frac{3}{4}$	10	6	9
$\frac{3}{8}$	7	0	7	1	10	6	9
$\frac{1}{2}$	8	3	8	$1\frac{1}{4}$	10	6	9

The Dalzell Steel Works of David Colville & Sons make a difference in the extras in the case of steel boiler and of ship plates. Ordinary prices are charged to 84 in. wide in boiler plates, but to 72 in. only in ship plates. Above that they charge 5s. per ton for every 3 in., or part of 3 in. So in weight, 40 cwt. is the limit for boiler plates, and 30 cwt. for ship plates; over those 5s. per ton is charged for every 5 cwt., or part of 5 cwt. Circular plates for boiler ends and crowns are rolled by David Colville & Sons, who supply at ordinary prices the following: $\frac{3}{4}$ in. thick, 9 ft. 10 in. diameter: $\frac{1}{8}$ in., 9 ft. 6 in.; $\frac{5}{8}$ in., 9 ft.; and $\frac{9}{16}$ in., 8 ft. 6 in.

As a sample of the usual limiting sizes of iron plates, I give the following: It consists of a few selected Snedshill plates rolled by the Lilleshall Company, one of the most favourably known Shropshire houses. They roll iron sheets and boiler plates from $\frac{1}{16}$ to 1 in. in thickness, advancing by thirty-seconds to $\frac{3}{16}$ in., and by sixteenths to 1 in.

Thickness.	Length.	Width.	Area.	Thickness.	Length.	Width.	Area.
in.	ft. in.	ft. in.	ft.	in.	ft. in.	ft. in.	ft.
$\frac{1}{16}$	30 0	5 0	5	$\frac{1}{8}$	30 0	6 0	80
$\frac{1}{8}$	30 0	5 6	7	$\frac{3}{16}$	30 0	6 0	80
$\frac{1}{4}$	30 0	6 0	8	1	30 0	6 0	80

It will be observed that the limiting sizes of iron are much less than those of steel.

The Butterly Company roll both iron and steel plates. The limiting weights and dimensions are as follows: For iron boiler quality, 8 cwt., above that the extra prices are 20s., 40s., 60s., 80s. respectively, from 8 to 10 cwt., 10 to 12 cwt., 12 to 14 cwt., and 14 to 16 cwt. respectively. For bridge quality 10 cwt. is the limit, and extras are 20s. and 40s., from 10 to 12 cwt., and from 12 to 16 cwt. respectively. Area 60 ft., and for every 10 ft. or part above that, 20s.: length 25 ft.: width 4 ft. 6 in.: over those various extras, ranging from 20s. to 80s.

Wire: of various sections, manufactured in hard iron, soft iron, soft steel, hard steel, tempered steel, piano wire, covered wire (wound with either cotton, silk, gutta-percha, flax, etc.), or copper wire. Also brass, copper, lead, zinc, and other metal wire, hard or soft; tinned iron wire, galvanized iron wire, tinned brass wire, coppered iron wire, lead-coated iron wire.

Pipes and tubes of wrought iron, either butt or lap welded, or solid drawn, are made in four qualities or strengths: (1) gas tube: (2) steam or water tube: (3) boiler flue tube: (4) hydraulic tube. These are manufactured from $\frac{1}{4}$ to 3 in. internal diameters:

boiler flue tubes to 9 in. diameter, but much larger sizes can be made to order.

Solid drawn steel tubes are made up to 10 in. diameter; larger sizes are made to order.

Special steel or wrought-iron pipes, flanged with **L** iron, are made up to 4 ft. diameter with welded joints, and welded steel or wrought-iron socket and spigot pipes up to 24 ft. diameter.

Cast-iron pipes are made in the following strengths:—Rain-water pipes, hot-water pipes, gas mains, water mains, hydraulic mains for high pressure, and the thicknesses of metal vary according to the pressures. Diameters from $1\frac{1}{2}$ in. up to 4 ft., and lengths usually 6 and 9 ft.

Castings are made in cast iron of various mixtures, according to strength, toughness, or hardness required, and of any weight up to 20 tons. Chilled-iron castings are made for hard wear, as in crusher rolls, etc., but cannot be machined; they are usually ground smooth by a grindstone or emery wheel.

Steel castings are made in either Bessemer, Siemens-Martin, Thomas-Gilchrist, or in crucible steel, the latter being most relied upon. They require annealing to soften them sufficiently for machining.

Wrought-iron castings, Mitis metal, etc., are also obtainable, but malleable cast-iron castings are most relied upon for toughness, the process having now attained great perfection, but is not applicable to very thick castings.

Pressed iron or steel forgings of simple forms are now obtainable at low prices. Also drop forged articles of almost any shapes.

Forgings in wrought iron and steel can now be made to almost any size, shape, and weight, and are replacing many structures formerly made of cast iron or built up.

Other metals employed are copper, brass, tin, zinc, phosphor-bronze, lead, antimony, bismuth, pewter, Muntz metal, aluminium, sodium, potassium, platinum, gold, silver, nickel, and a great variety of the bronzes, which are valuable compounds varying in tenacity and hardness from the hardest steel to that of soft copper. Most of the above are manufactured into wire, sheets, tubes, rods, etc., and can in addition be cast into any form from a crucible. Copper can be forged but not welded; joints in it are generally brazed or soldered.

Section 15.—MATERIALS OF CONSTRUCTION OTHER THAN IRON AND STEEL.

Timber. Yellow, white, and red pine in logs, deals, and battens; logs up to about 3 ft. diameter by 35 to 40 ft. long; deals, 9 in., 10 in., and 11 in. wide, and from $1\frac{1}{2}$ to 4 in. thick—battens and scantlings of all sizes smaller than deals—a few wide deals are imported up to 22 in. wide. Spruce and fir, sycamore, pear-tree, willow, poplar, etc.

India-rubber, manufactured into sheets, with or without canvas insertion of single, double, or treble thickness, up to 36 in. wide and to $\frac{1}{2}$ in. thick; cord $\frac{1}{8}$ to 1 in. diameter; tubes, plain, or with canvas insertion or wire coiled inside or outside, from $\frac{1}{4}$ to 4 in. bore usually in 30 and 60 ft. lengths. Washers, rings, rollers, strips, belts, and moulded articles of every form.

Gutta-percha is manufactured into similar articles.

Leather. Most of the varieties are manufactured from the skins of oxen, sheep, goats, deer, horses, dogs, hogs, and seals, and the larger skins are divided into butts, shoulders, cheeks, and bellies, the dimensions depending of course upon the size of the animals. Ox hides are the largest and kid skins the smallest in general use.

For mechanical purposes ox hide, raw or tanned, is chiefly used, as for valves, seatings, belts, piston leathers, etc. Sheep skins can be obtained either strained, half-strained, or unstrained; the first are hard and comparatively stiff, the last-named soft and pliable as cloth. Other soft varieties are goats' skins and chamois leather. There are many imitations of leather, but they are rarely employed in mechanical constructions.

Vulcanized fibre is often used for similar purposes to leather, as for valves, seatings, joints, etc. It is made in two varieties, medium and hard, and in sheets up to 1 in. thick.

Ebonite. A hard, black, horny substance, moulded into any required shape.

Papier mâché. Solid paper, moulded from pulp into any required form.

Asbestos, in sheets, cord, packing of various sections, loose fibre, millboard, etc.

Ivory, from tusks and teeth.

Bone.

Vegetable ivory ; nuts about the size of eggs.

Packings for glands, etc., are made of cotton, hemp, and other fibres, asbestos, india-rubber, etc., in round, square, and other sections.

Section 16.—RETAINING WALLS.

(See also Sections 17, 29, 31, 42.)

- 1 **Retaining wall with cambered face** and footing founded on concrete.
- 2 **Surcharged retaining wall** ; otherwise as No. 1.
- 3-5 Ditto, arched in plan.
- 6 **Vertical retaining wall** with counterforts.
- 7-8 Plans of ditto with buttresses or counterforts on face.
- 9 Ditto with diagonal anchor ties.

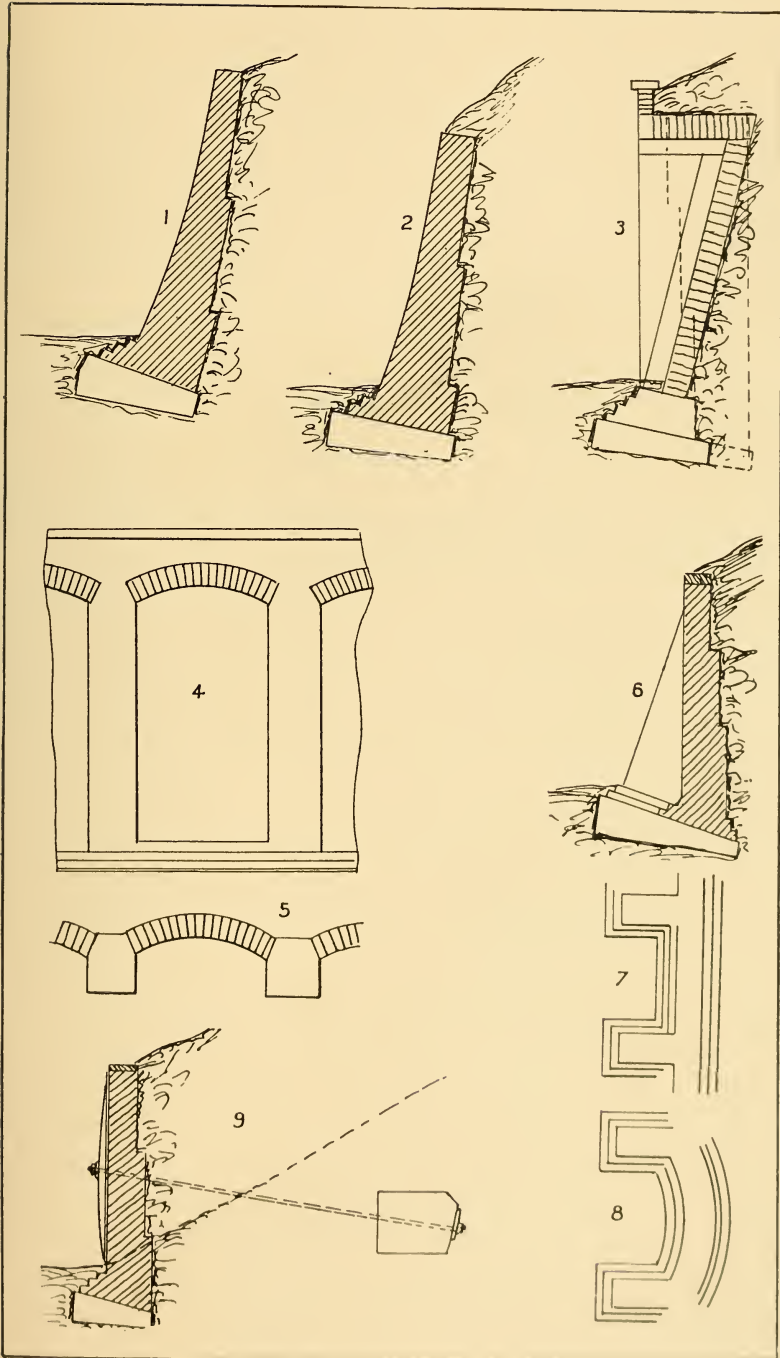

- 10 **Piles and planking** with anchor ties.
- 11 **Piles, walings, and sheet piling**, with or without anchor ties.
- 12 **Railway cutting with retaining walls**, strutted across by cast-iron or steel girder struts.
- 13 **Retaining wall** to support upper strata.
- 14 **Masonry bridge** with wing retaining walls.
- 15 **Plan of wing walls.**
- 16 **Retaining bank** formed of clay and fascines.
- 17 **Vertical retaining wall** with diagonal anchor ties.

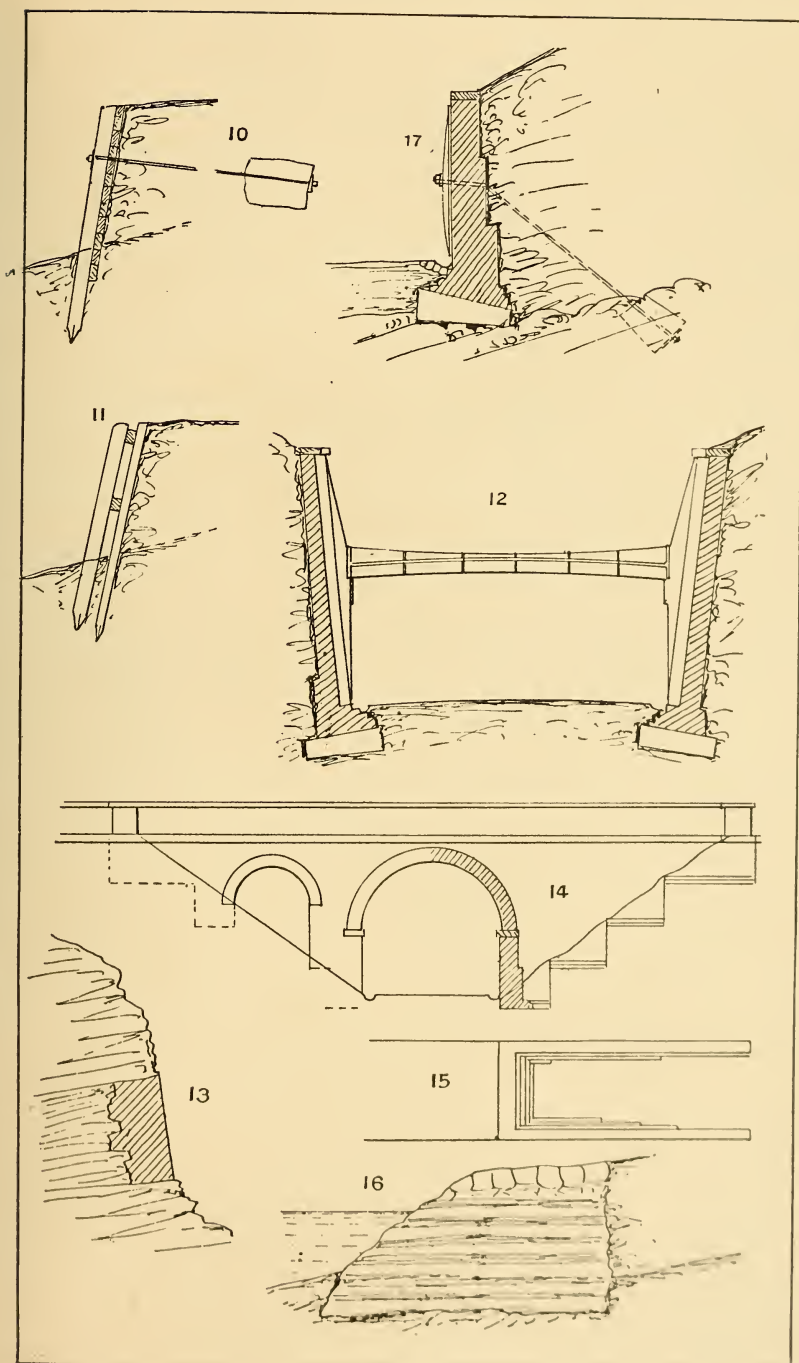

18, 19 **Masonry bridge** to carry a road over a railway. The plan shows two forms of splayed wing walls to support the embankment of roadway.

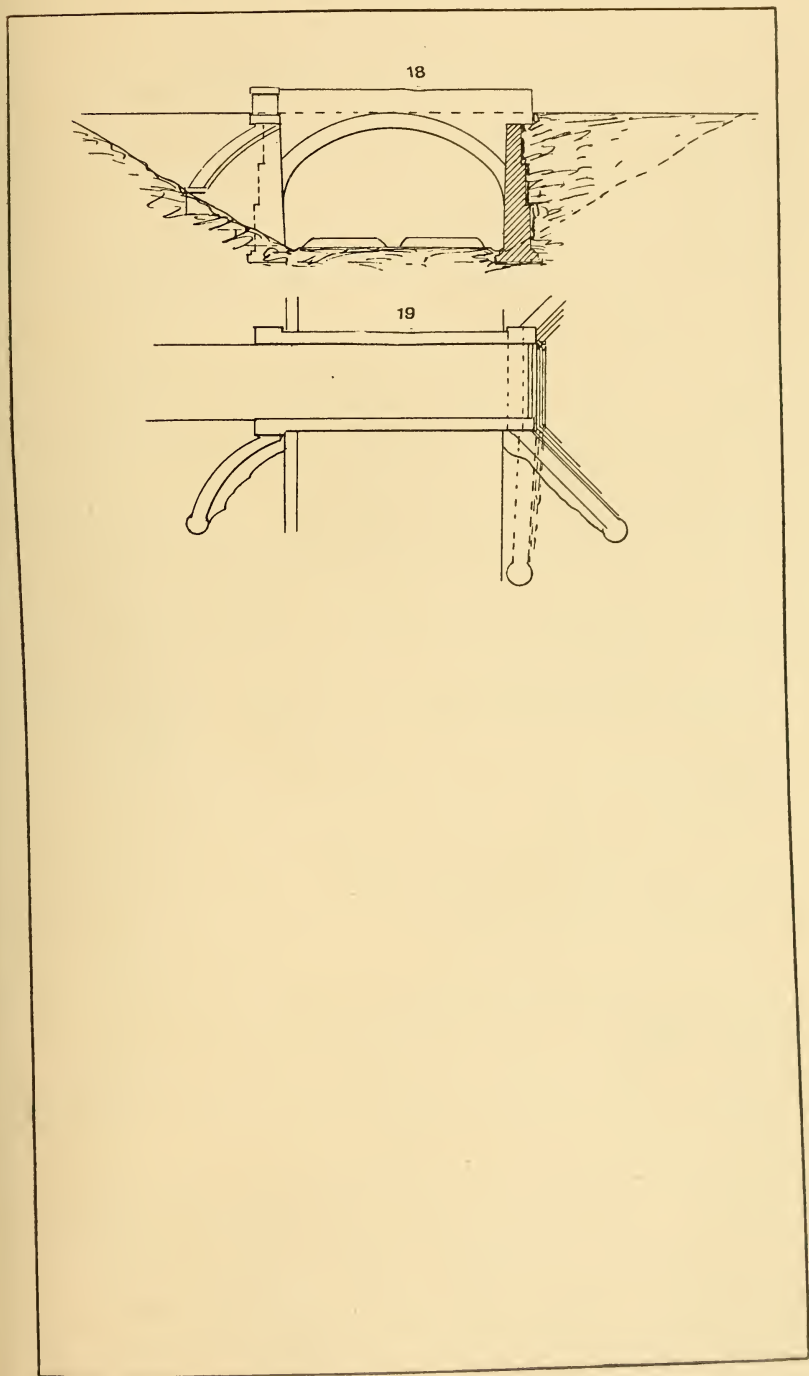

Section 17.—RAILWAYS, EARTHWORKS.

- 1 **Railway embankment on level ground.**
- 2 Ditto, **on sloping ground.**
- 3 Ditto, ditto, with retaining wall.
- 4 Ditto, ditto, with pitched water-side slope.
- 5 **Trenched toes to an embankment** to prevent slipping.
- 6 **Embankment founded on mattresses** or fascines on a peat base.
- 7 **Embankment across a mud bank.** The embankment sinks into the mud and raises it on both sides until an equilibrium is attained.
- 8 **Embankment constructed from a "borrow" pit.**
- 9 **Embankment supported by retaining walls** on both faces, with or without cross tie-rods.
- 10 **Earth drains** laid in a bank in wet situations.
- 11 **Railway cutting in level ground.**
- 12 Ditto, **in inclined rocky strata.**
- 13 Ditto, **in sloping ground.**
- 14 Ditto, **in level rock strata.**
- 15 **Cut and cover cutting in rocky strata.**
- 16 Ditto, **in soft ground,** with retaining walls and girder super cover.
- 17 **Cutting in ground** with upper strata rock and under strata soft. The latter kept up by retaining walls, supported where necessary by invert arches.
- 18 **Cutting in sloping ground** with surface catch drains above the cutting.

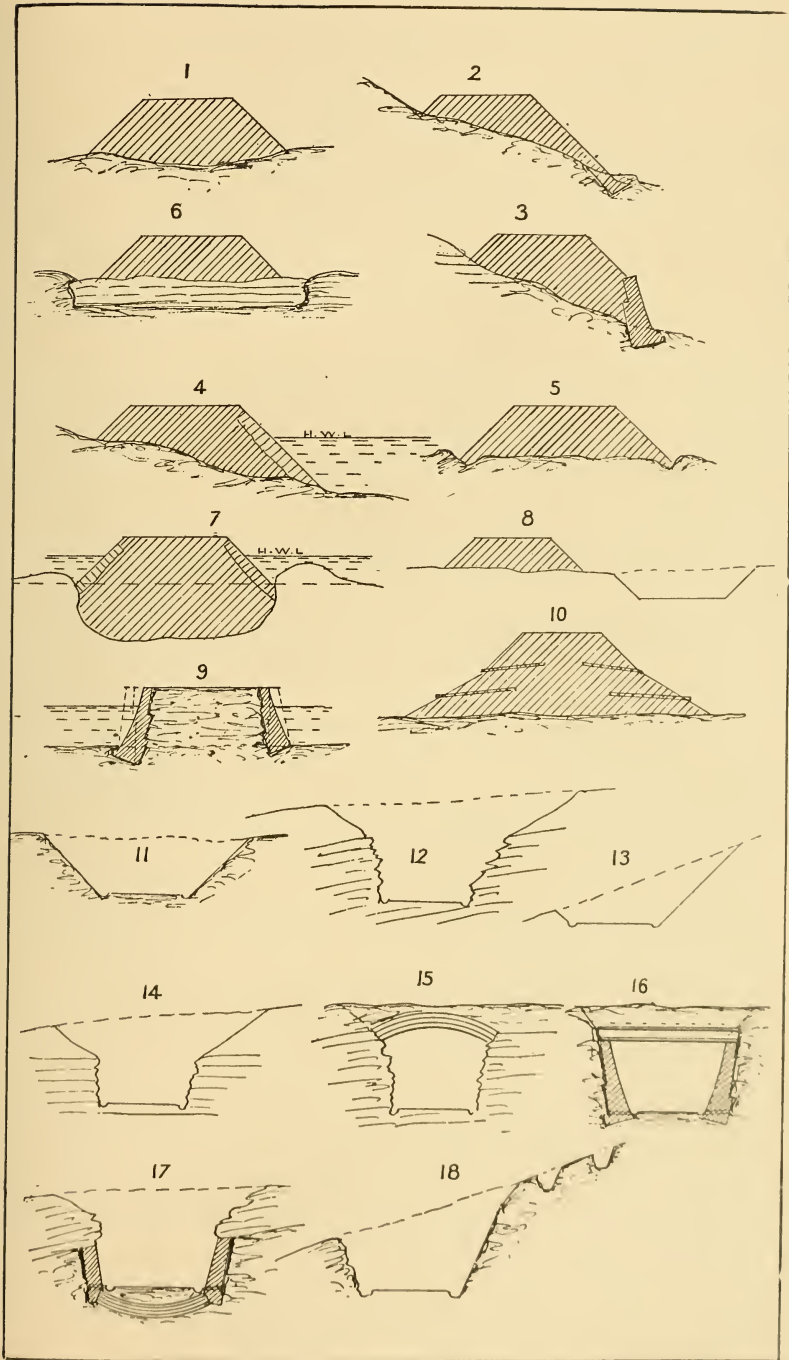

- 19 **Cutting as cut and cover** on steep slope liable to landslides or boulders.
- 20 **Bench cutting in cliff face.** Soft strata are held up by a retaining wall and a parapet wall built on outer edge.
- 21 Ditto with outer wall and parapet.
- 22 **Face tunnel in rock cliff** with side openings.
- 23 **Bench cutting and retaining wall.**
- 24 **Cutting with retaining wall** to hold up loose upper soil.
- 25 **Retaining wall** to support upper rock strata.
- 26 **Bench cutting** protected by a snow shed.
- 27 **Road crossing** under an embanked railway. The road to be lowered to provide sufficient headway.
- 28 **Benched out toes** for foot of an embankment of soft earth.
- 29 **Trenches or surface drains** on the slope of a cutting, with masonry foot drain to keep the slope dry.
- 30-4 **Sections of side drains** for cuttings.
- 35 **Embankment across a marsh,** laid on mattresses or fascines with a core of dry material.
- 36 **Embankment over ground** subject to floods.

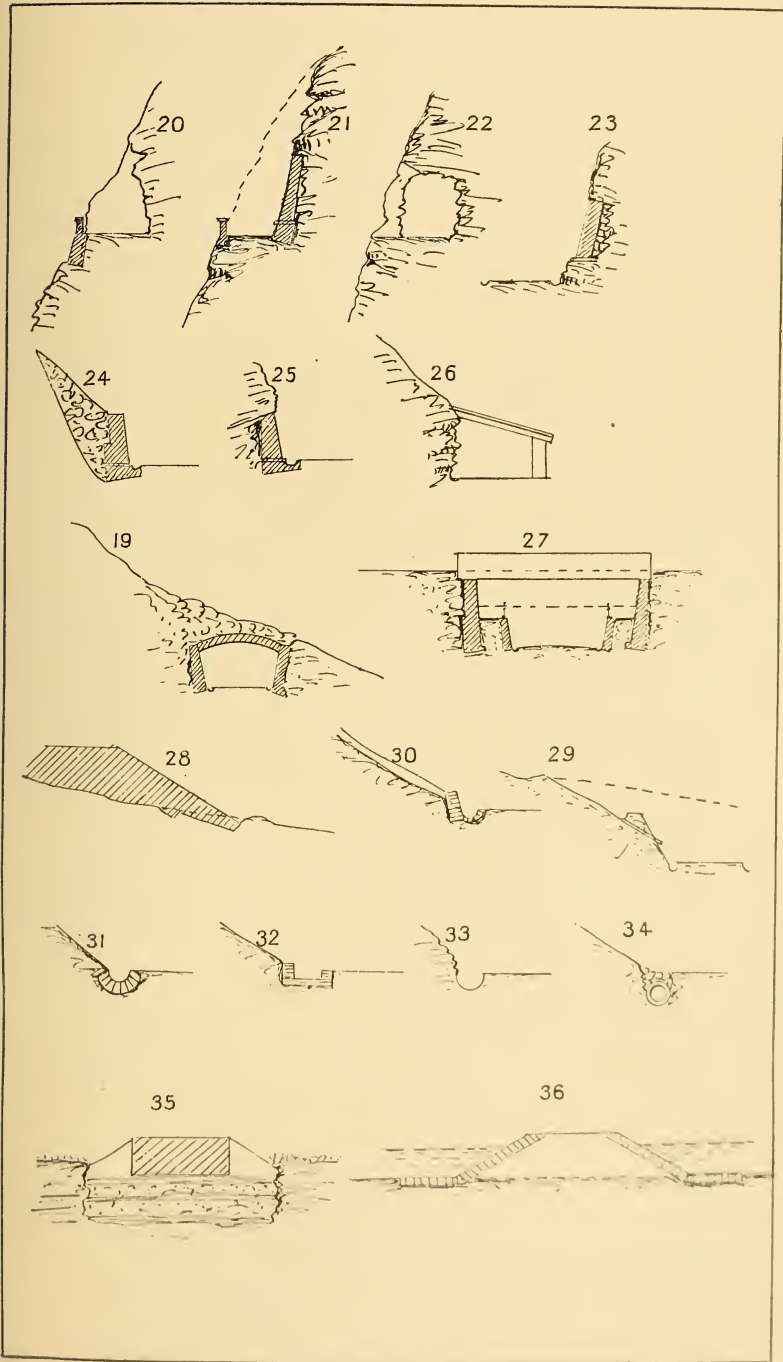

Section 18.—RAILWAYS: PERMANENT WAY.

(Tramways, Permanent Way, see Section 23.)

- 1 **Single line sleeper road** on embankment.
- 2 **Double head rails** on chairs and sleepers.
- 3 **Flanged rails spiked to sleepers.**
- 4 Ditto, **on bearing plates spiked to sleepers.**
- 5 Ditto, **on steel sleepers.**
- 6 Ditto, **on flat bar sleepers.**
- 7 Ditto, ditto, turned up at the ends.
- 8 Ditto, **on longitudinal sleepers**, with transverse timbers and tie bolts.
- 9 Ditto, **on plates and sleepers**, canted inwards to correspond with the cone angle of the wheel tyres.
- 10 **Double head rail and guard rail** in one chair.
- 11 **Flanged rail on a dished plate** with flat bar cross tie.
- 12 **Wood guard rail** to a flanged rail.
- 13-16 **Rail spikes and bolts.**
- 17 **Flanged rails on plates** and embedded stones, concrete blocks, or a longitudinal concrete bed.
- 18 **Street tramway.** (See Section 23.)
- 19 **Sleeper railway** laid between stone side walls and drains.
- 20 **Mountain rack railway** with horizontal rack and steel sleepers, usually anchored as No. 23.

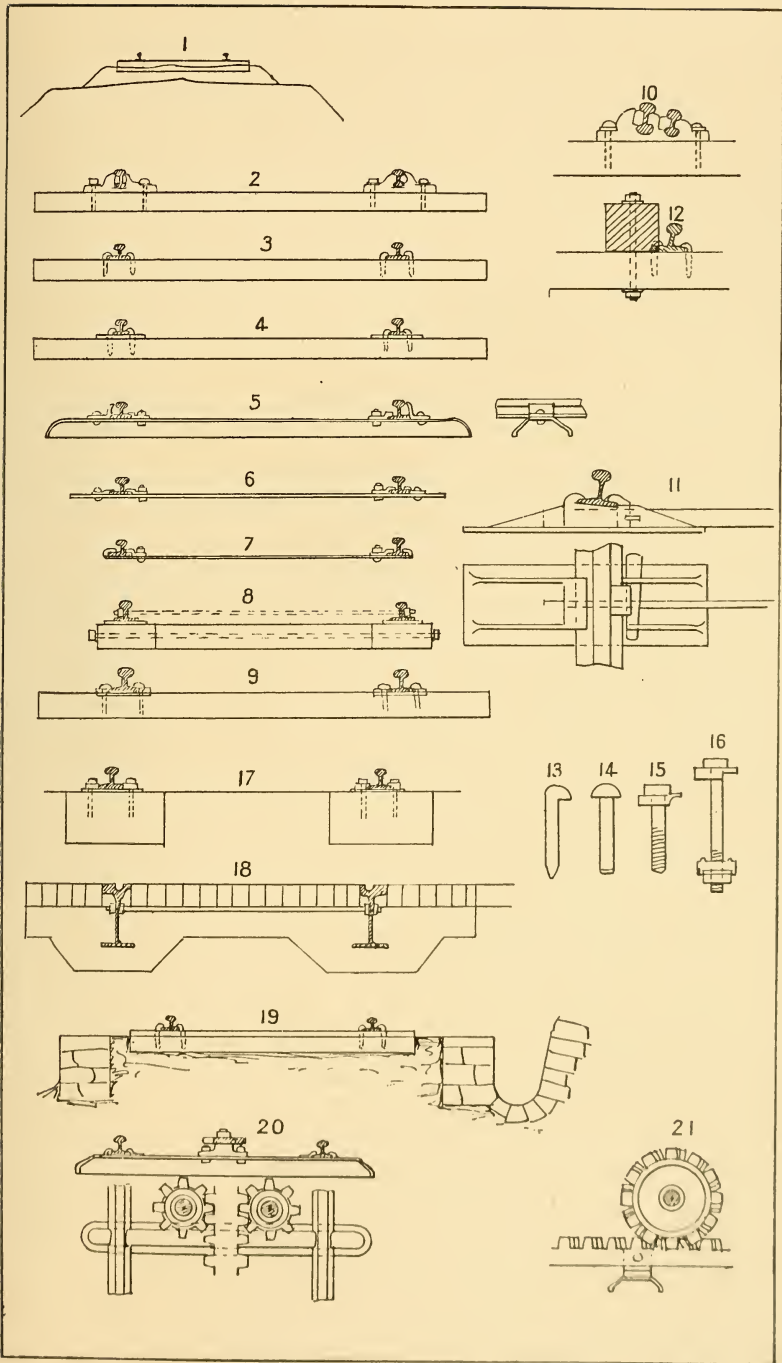

- 21, 21a **Mountain rack railway** with central triple vertical racks ; steel sleepers bolted down to a masonry permanent bed or anchored as No. 23.
- 22 **Street tramway** for overhead trolley system. (See Section 23.)
- 23 **Mode of anchoring mountain rack railway** permanent way to masonry bed.
- 24 **Flanged rail and bearing plate.**
- 25 **Double head rail on steel sleeper** with steel chair and wood key.
- 26 **Flanged rail with combined chair and fishplate.**
- 27 Ditto, with coach screw, spike or bolt fastening to wood sleeper.
- 28 **Flanged rail on longitudinal steel sleeper.**
- 29 **Bridge rail** on ditto.
- 30 **Saddle rail on longitudinal V timber sleeper.**
- 31 **Barlow rail.**
- 32 **Double head rail** with splayed sleeper plates.
- 33 **Flanged rail with combined chair and fishplate.**
- 34 **Double head rail** with ditto.
- 35 **Double head rail and fishplate,** ordinary section.

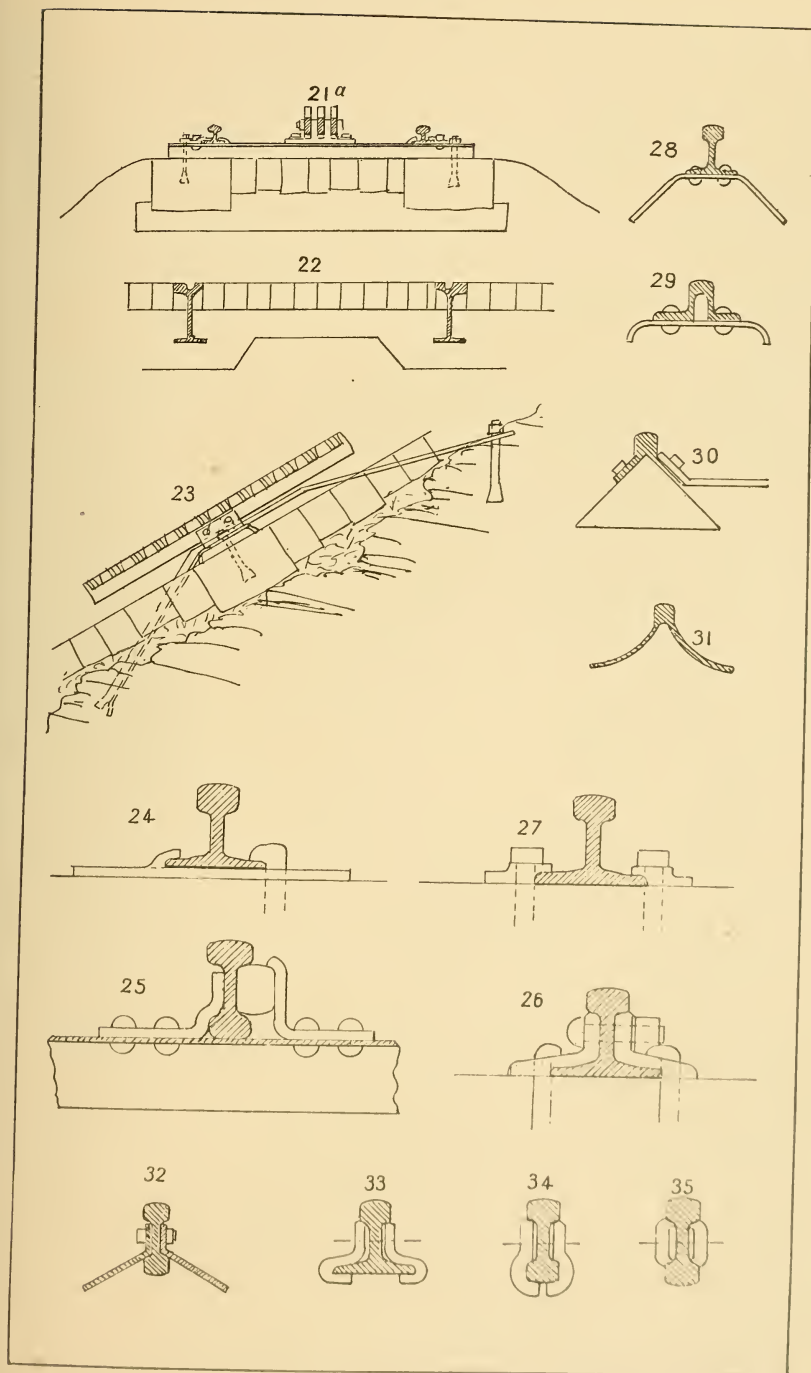

- 36 Double head rail in bent flat bar chair.
- 37 Flanged rail on bearing plate.
- 38 Anchorage for railway on a steep incline.
- 39 Centre grip rail for steep inclines.
- 40 Single line turnout.
- 41 Single line double switch turnouts.
- 42 Double line single turnouts and crossings.
- 43 Double line double switch turnouts and crossings.

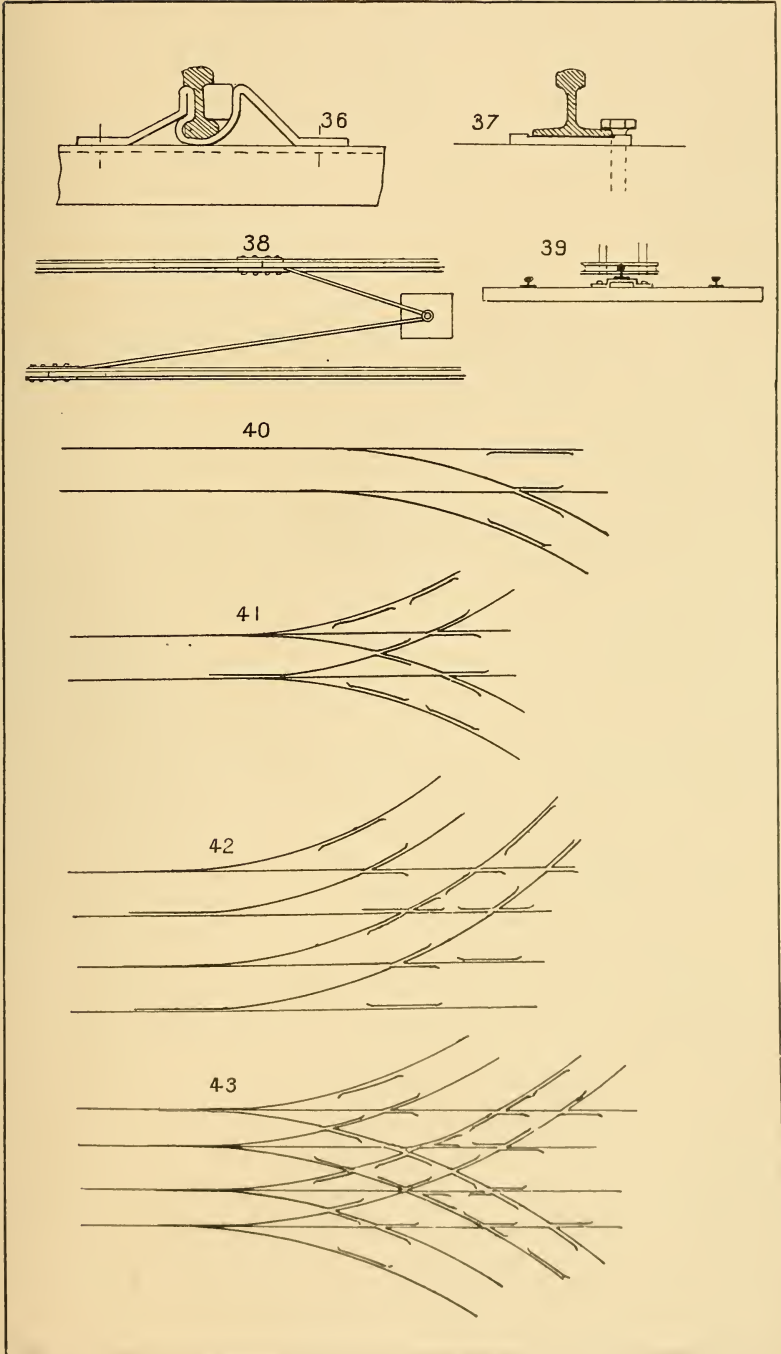

- 44 Cross-over to double line.
- 45 Double cross-over and crossings.
- 46 Crossings of single lines with switches.
- 47 Ditto, without switches.
- 48 Plan of switches to shed lines.
- 49 Plan of cross-over turnout on skew bridge.
- 50 Ditto, under main lines.

44

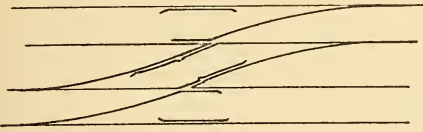

45

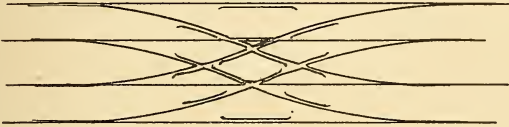

47



46

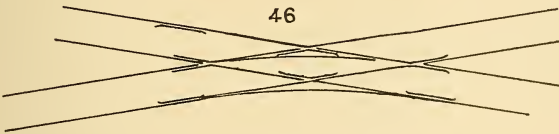

48

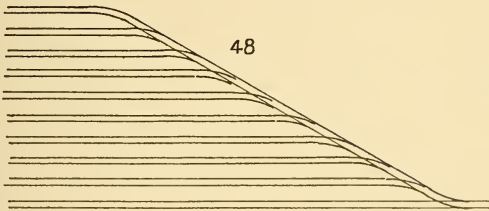

49

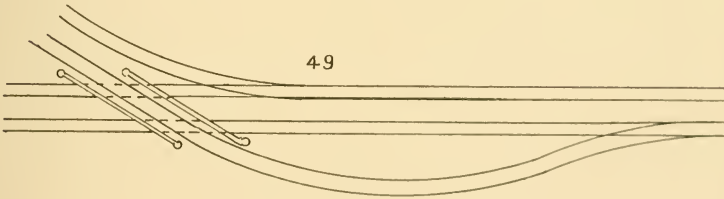

50

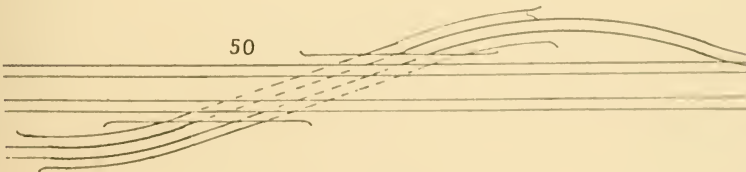

51 **Road over a bridge.**

52 Ditto, on skew.

53 **Level crossing.**

54 **Under bridge or "cattle creep".**

55 **Plan of a double line through station.**

56 **Plan of a four line through station** and goods sidings.

57 **Plan of a single line through station** and goods sidings.

58 **Set of turntables** on four lines of rails in a goods yard.

59 **Traverser table** or transferrer.

60 **Buffer stop** formed of double-headed rails.

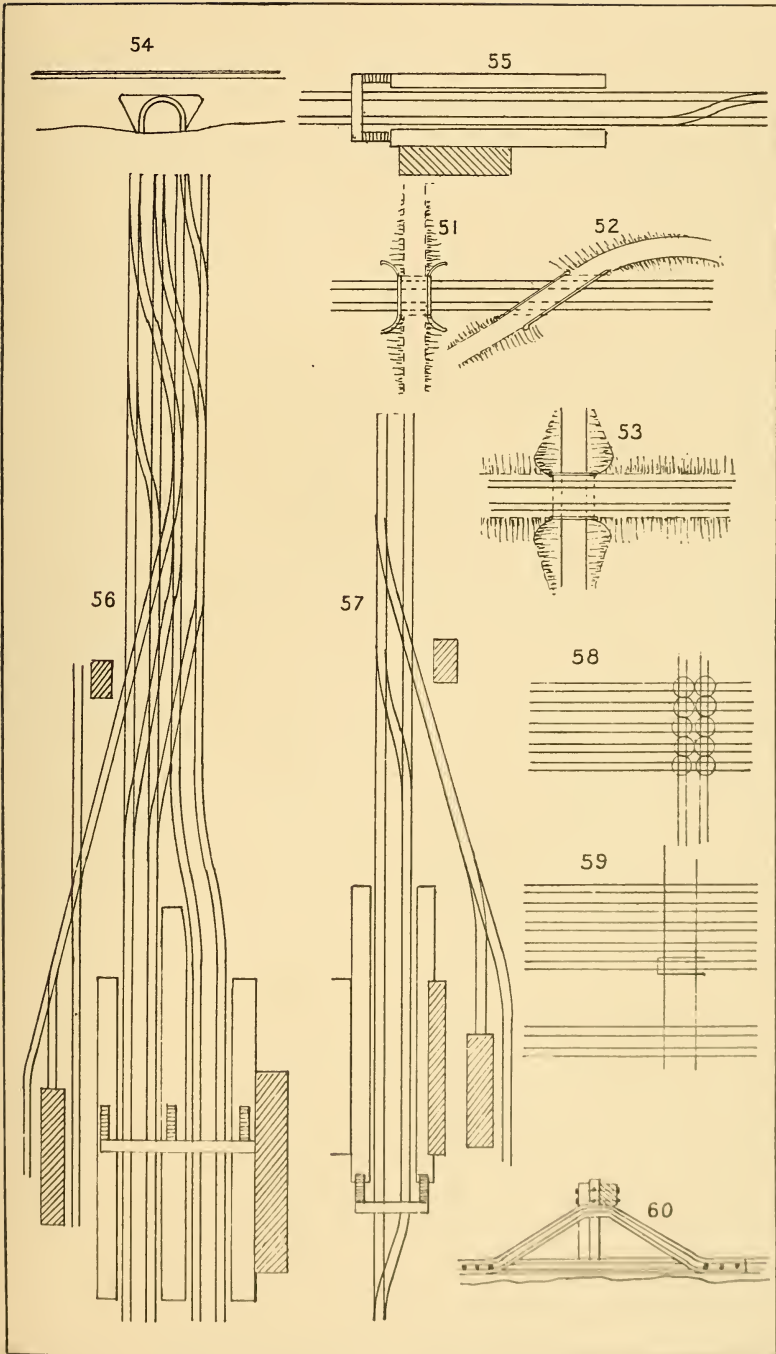

61-3 **Buffer stops.**

64 **Turntable.**

65 **Section** of ditto and foundation.

66 **Turntable on a hydraulic pivot.**

67 **Traverser table.**

68 **Section** of ditto.

In **railway repair shops** large power traversers are provided to move carriages under repair sideways from one line or workshop to another. These are driven by electric motor, shafting, or hand winch gear.

The sector table is a traverser hinged to a pivot at one end, carrying one pair of rails which can be turned to connect with either of two lines of rail. Object: to transfer the engine of an arrival train to the next line of rails instead of employing cross-over rails, which require a considerable length of line.

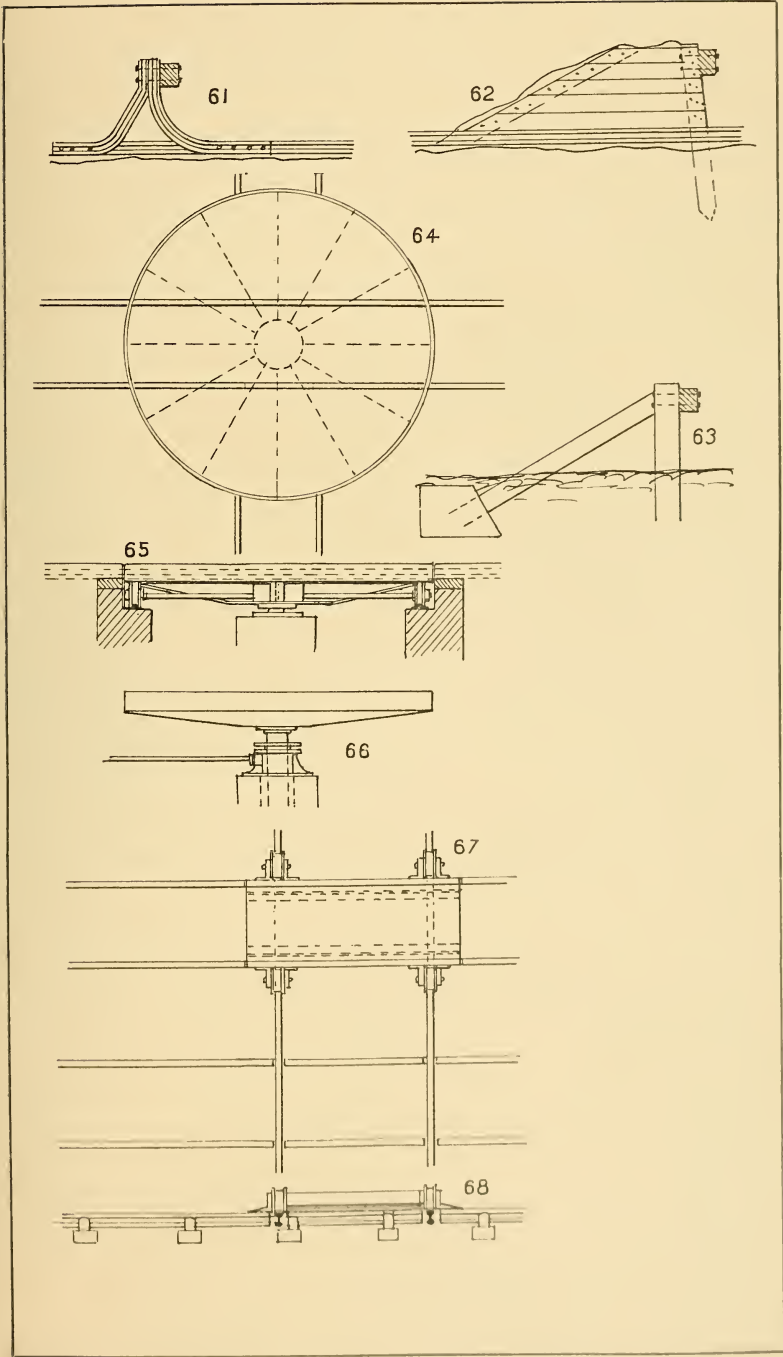

Section 19.—RAILWAYS: SIGNALLING, TELE-
GRAPHS, ETC.

Signals are now invariably semaphores by day and lamps by night, and these are placed at elevations at which they can be seen by drivers at certain standard distances, all signal arms for each line pointing to the left. They comprise: Starting signals, generally at the forward end of the train platform; home signals, placed near to the rear end of a station; distant signals, placed about 1,000 yards behind the home signals (these have notched arms); advanced starting signals, placed about 300 yards in front of the starting signal; disc signals, for sidings and goods lines.

Hand lamps with coloured movable glasses, and coloured flags are also used for casual signalling.

Signal cabins are placed close to the station, and in positions and at elevations commanding a view of all the signals and lines. A range of point and signal levers in the signal cabin gives the signalman control of all the signals and points of the station, and these are interlocked so that improper movements of the signals or points cannot be made.

The signal cabins are in telegraphic communication with the cabins of other stations, from which and to which messages are transmitted.

Signals are operated from the cabins by stout wire connexions running over small grooved pulleys. **Points** are operated by stiff rod connexions, either of tube or channel iron, running over small guide wheels. Compensating levers are fixed in long lines of rods and wires to compensate for expansion and contraction due to temperature.

Gas, oil, or electric lighting is applied to the signal lamps.

In fogs detonators are used by fogmen placed where they can receive the cabin signals; also in some cases the men use miniature semaphores operated from the signal cabin, as well as hand lamps and flags.

Trains carry distinctive head and rear signals in the form of coloured plates by day and at night lamps, to indicate the destination of the train, and every train carries a white light in front and a red one in rear to warn other trains as to its position on the line.

Telephones are also used for communication from signal cabins to other signal cabins and their stations.

Telegraphs connect all signal cabins with each other, by which the movements of trains are telegraphed ahead, and there are special telegraph devices by which the proper working of the signals can be confirmed to the signalman though he may not be able to see the signals themselves.

Other telegraphic devices connect with and in some cases control the working of trains in goods yards and certain locking devices.

Section 20.—RAILWAYS: STATIONS.

Plans of stations are always adapted to the site and circumstances; no general plans can be of any service. The following are details of general interest:—

- 1 **Section of railway platform** with stone coping and asphalt or paved surface.
- 2 Ditto, of wood planking on a sleeper wall.
- 3 Ditto, of sleepers edged with **L** iron.
- 4 Ditto, of rolled joists and concrete with timber coping.
- 5, 6 **Low platforms**, much used in America and Europe.
- 7 **Platform of wood for a station** on an embankment.
- 8 **Water crane**.
- 9 **Type section of a small goods shed**.
- 10 Ditto of **a small engine shed** with inspecting pit.

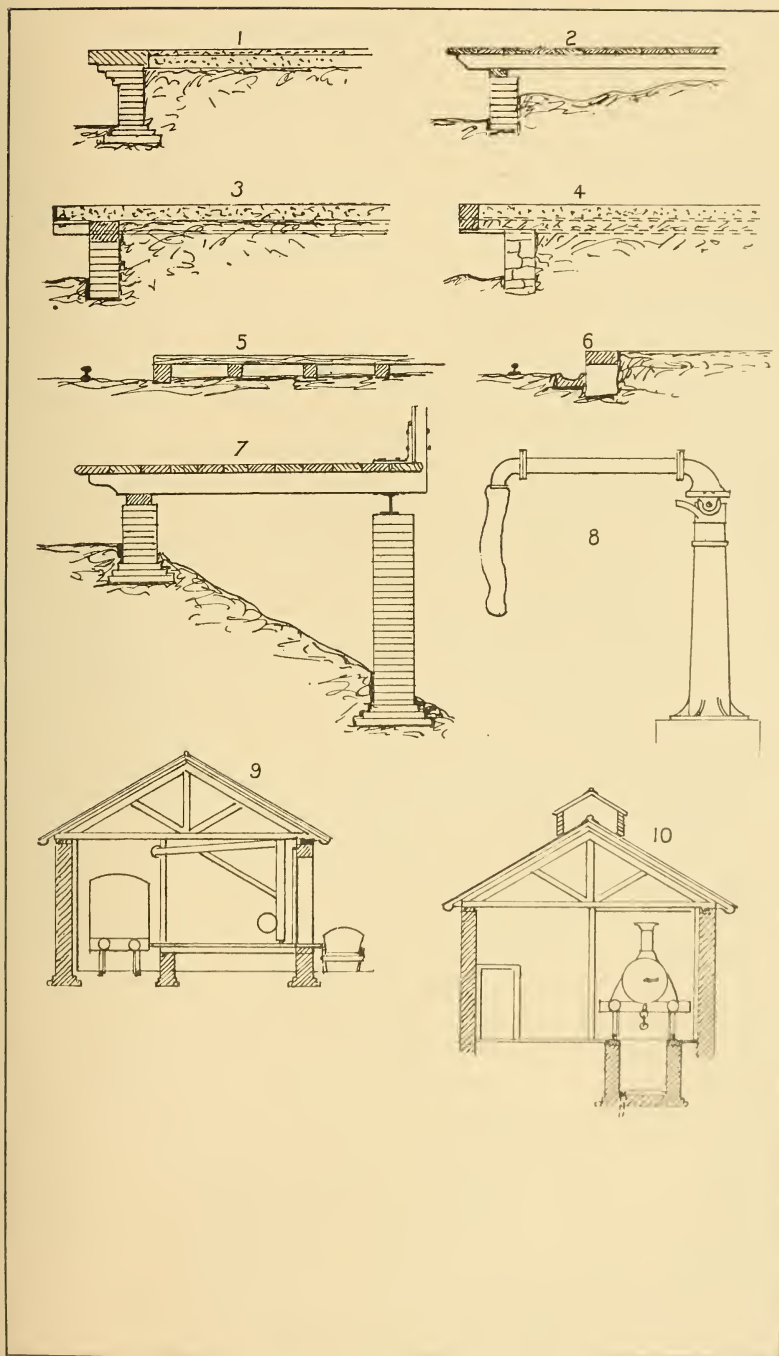

- 11 **Plan of circular engine shed** for eleven engines with central turntable.
- 12 **Plan of rectangular engine shed** and turntables.
- 13 **Repairing or inspection pits** in engine houses and carriage repair shops.
- 14 **Hydraulic lifting table**, used in inspection pits for removing and refixing axles, etc.
- 15 **Hydraulic or power capstan**, used for hauling wagons and carriages about sidings.

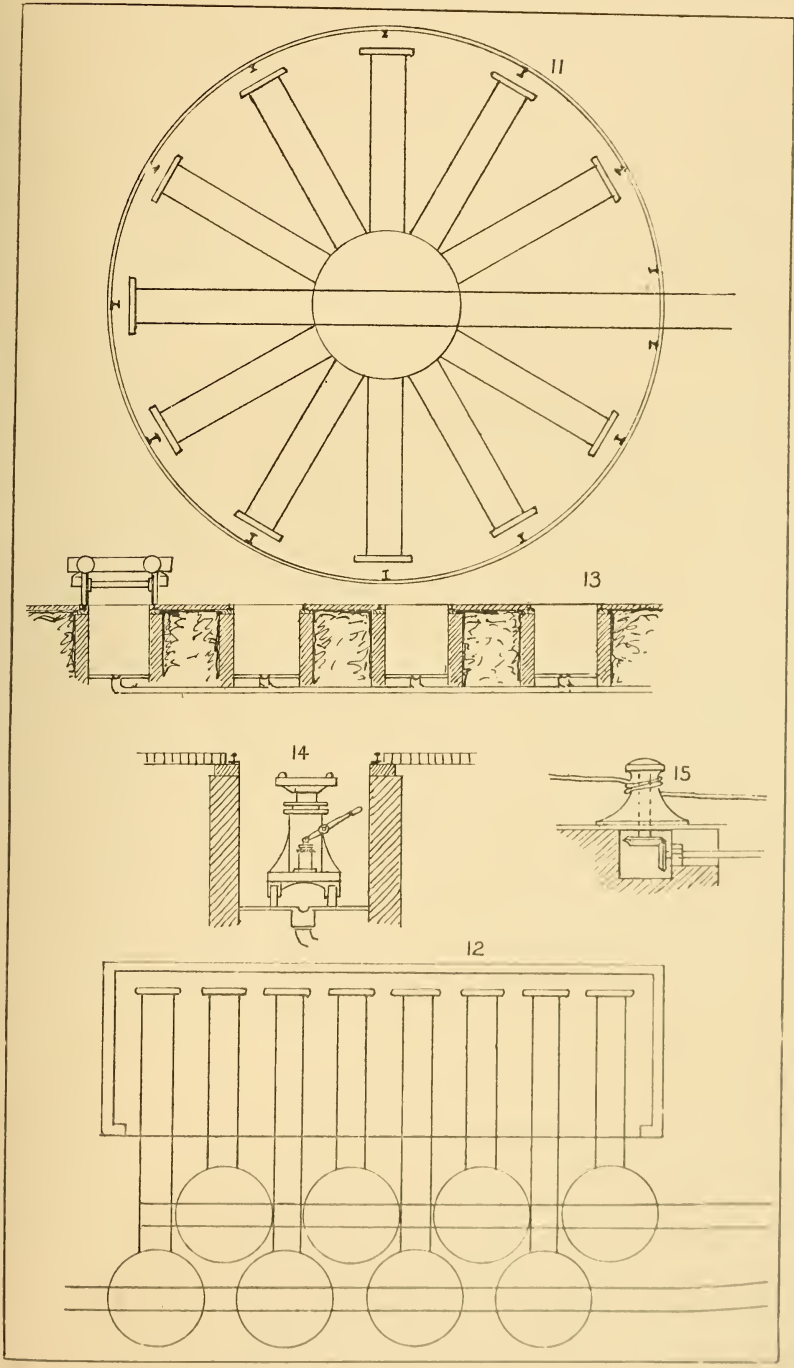

- 16 **Body lifting machine**, used in carriage repair shops: consists of four standards with vertical screws and jaws driven simultaneously by underground shafting. A similar machine, but with overhead shafting and hand-rope pulley, is sometimes employed: also an overhead traveller with four lifting chains.
- 17 **Snow or boulder shed**, to protect a line from avalanches or falling stones.
- 18 **Another form** of the last-named.
- 19 **Under syphon** to carry a water or gas main under a railway.

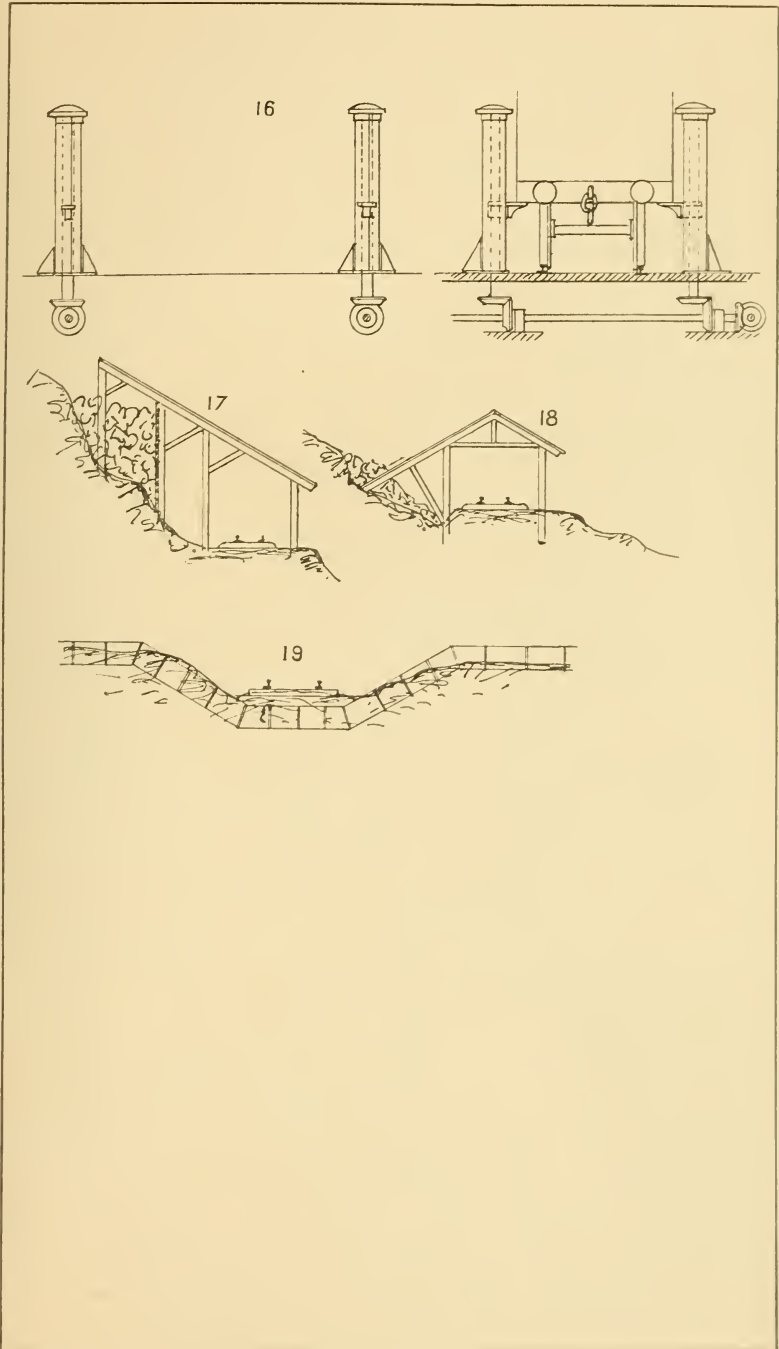

Section 21.—RAILWAYS: TUNNELS AND
CULVERTS.

(See also Section 3.)

- 1 **Section of tunnel in hard rock.**
- 2 Ditto, **in rock**, with arched head, the upper part not being safe to stand alone.
- 3 Ditto, where only the lower strata are hard enough to stand without support.
- 4 Ditto, with the upper part hard rock and side walls carried up to the rock.
- 5 Ditto, in soft soils, lined throughout and with invert arch.
- 6 **Elliptical arch tunnel** for two lines of rail. The above are the types generally in use, but there are numerous variations of these sections in use in different countries.
- 7 **Double tunnel** for two lines of railway or two carriage roads, with connecting openings. Double tunnels are, however, generally driven separately in the same way as single ones, but with connecting headings at intervals.
- 8 **Iron tube tunnel**, circular, with large diameter section to provide space for a station platform, etc.
- 9 **Tunnel or subway** for sewers and pipe mains.
- 10-15 **Sections** showing mode of driving a tunnel in soft ground by headings. This is the ordinary method employed, but in different strata several other systems are in use.

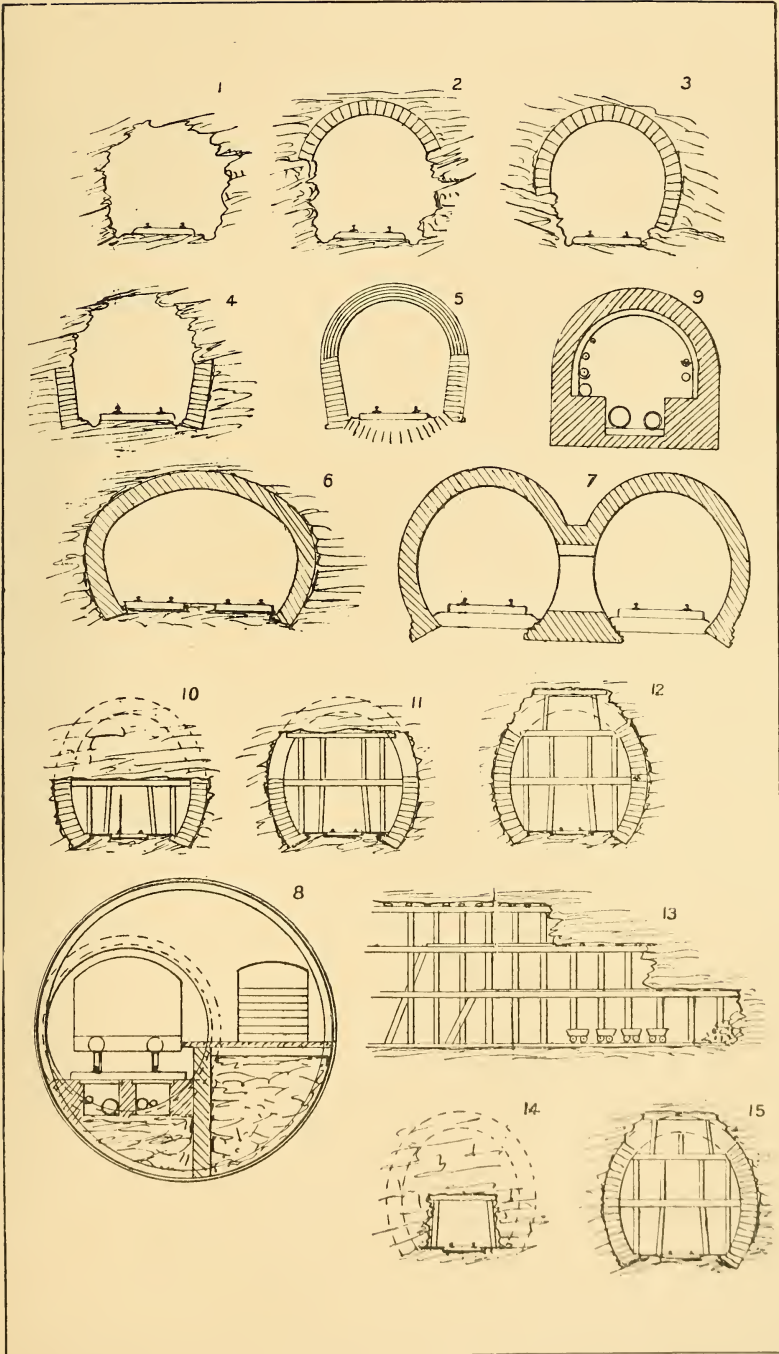

- 16, 17 **Belgian and German methods** of tunnel driving.
- 18 **Concrete or masonry culvert.**
- 19 **Oval culvert in concrete** or masonry.
- 20 **Simple rough stone culvert.**
- 21 **Pipe culvert**, earthenware or concrete.
- 22 **Arch and invert culvert.**
- 23 **Arch top concrete culvert.**
- 24 **Large culvert** constructed as an underbridge, with wing walls.
- 25 **Circular concrete culvert.**
- 26 **Section of railway embankment** with culvert under.
- 27 **Tube tunnel** of cast iron in sections.

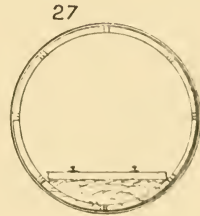
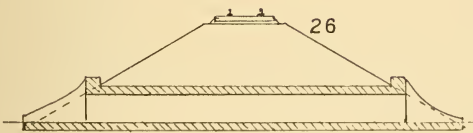
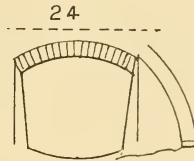
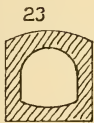
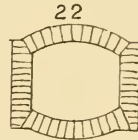
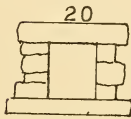
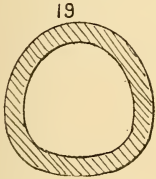
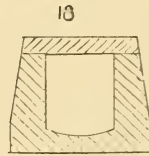
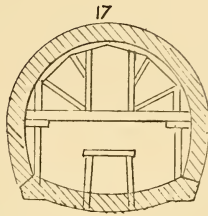
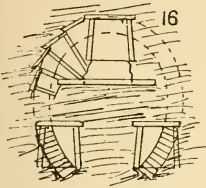

Section 22.—CARRIAGES AND ROLLING STOCK FOR ROAD AND RAIL.

(See also Tramways, Section 23.)

The design and details of these must always be suited to circumstances. We only propose here to indicate the various types of under-framing and wheels in use, and to give sketch sections of bodies or cars for different purposes.

UNDER-FRAMES.

- 1 **Two-wheel suspension car** for single rail or wire rope, used commonly on some kinds of cranes. (See Section 18.)
- 2-5 **Three-wheel cars.** See also the various types of tricycles in use.
- 6-9 **Various forms of four-wheel under-frames,** with and without swivelling bogies.
A car with four wheels arranged as No. 9, but with the leading and trailing wheels slightly raised off the ground, is used as a goods car or hand truck, and is very readily swivelled about, running, of course, actually on three wheels only.
- 10 **Five-wheel under-frame,** with and without swivelling bogies.
- 11, 12 **Plans of six-wheel cars,** with swivelling gear for curves; the centre pair having end play, swivel the leading and trailing axles by means of the jointed stays.
- 13 **Plan of four-wheel car,** with swivelling gear for curves.
- 14-16 **Six-wheel cars,** the latter with leading and trailing swivelling bogies.

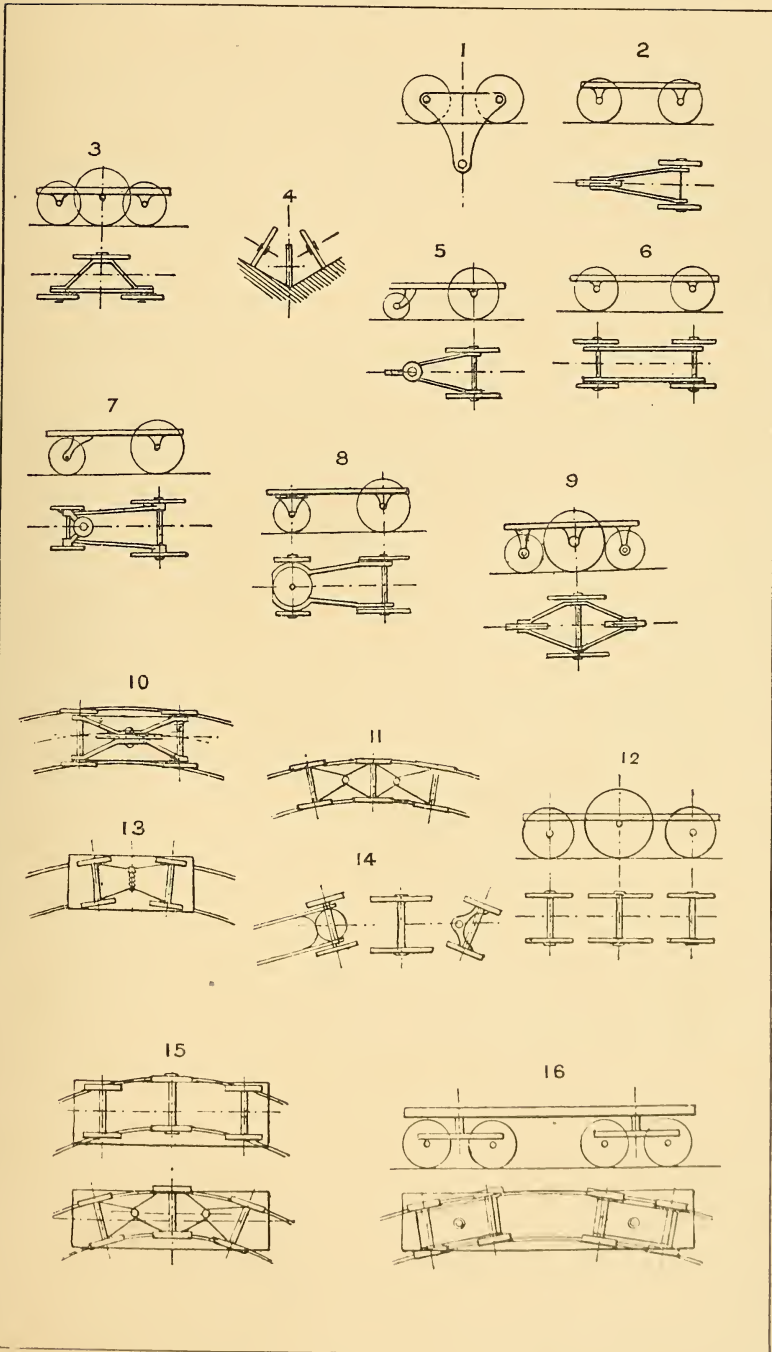

- 17 **Ten-wheel truck**, with two bogies and sliding middle axle.
- 18 **Twelve-wheel ditto**, with three bogies, the centre one to have transverse movement on curves.
- 19-28 **Sections of cars** for railways and tramways, with various arrangements of seating, etc.
- 29, 30 **Hopper wagons**.
- 31 **Side tip car**.
- 32 **End tip cart**.
- 33 **End tip wagon**.

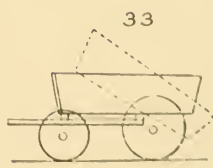
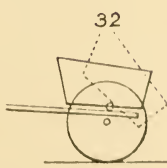
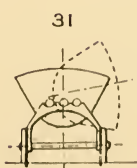
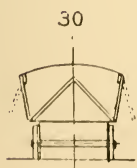
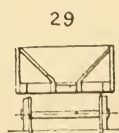
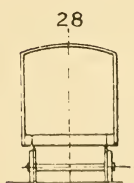
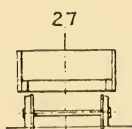
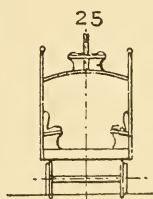
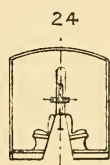
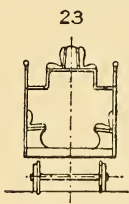
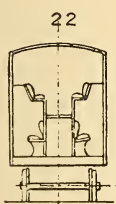
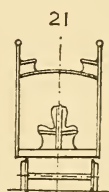
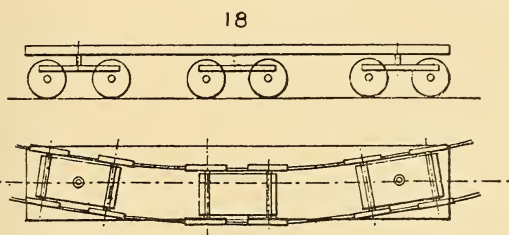
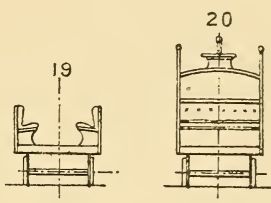
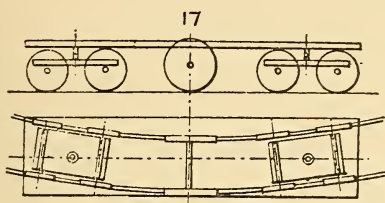

34 **Furniture wagon.**

35 **Grafton's patent side tip wagon.**

36 **Long truck for boilers, etc.**

37 **Incline car for passengers.**

38 **Segmental swivelling bearings**, used instead of a swivelling bogie and centre-pin.

39 **Hudson's patent tip wagons**, with three centres.

40 **Hopper wagon**, with central discharge.

41 **Swivelling gear for car wheels.**

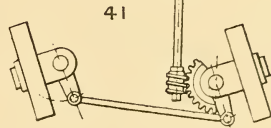
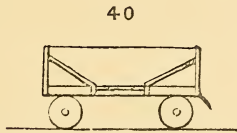
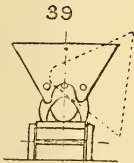
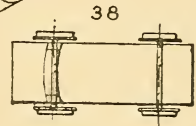
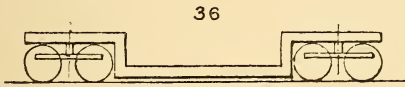
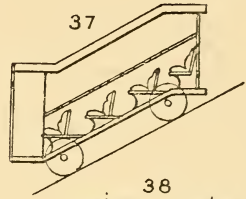
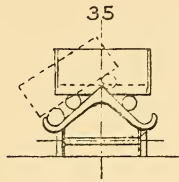
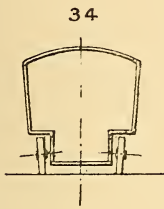

35 **Equalizing buffers and springs.**

36-8 **Hopper bottom wagons** for 20 to 40 tons loads on double bogie trucks.

39, 40 **Cross sections** of two types of hopper bottom wagons.

41 **Double axles** to allow of independent running of the inner and outer wheels around curves.

42 **Divided axle** for same purpose as No. 41.

43 **Expanding (leather) vestibule** to railway vestibule cars.

44 **Close buffers** for made-up trains.

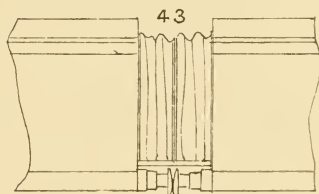
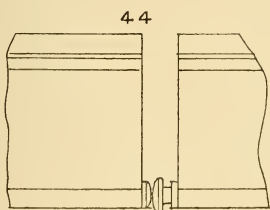
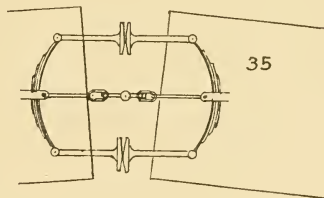
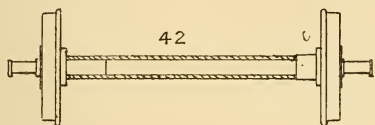
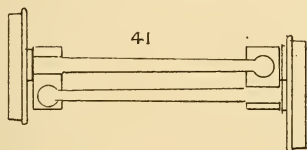
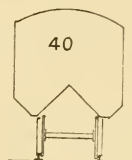
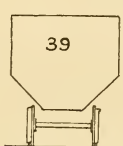
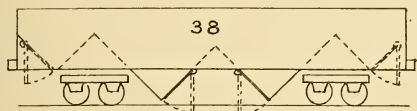
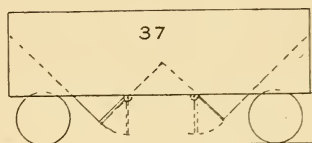
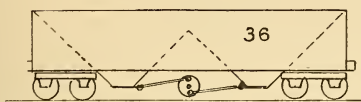

Section 23.—TRAMWAYS.

- 1 **Tramway permanent way**, with transverse flat bar ties.
(See No. 512.)
- 2 **Permanent way**, with rails laid on longitudinal concrete beds.
- 3 Ditto, with connected concrete beds and wood, brick, or granite cube paving.
- 4 **As last described**, but with rails resting on cast-iron chairs embedded in the concrete base.
- 5 **Sleeper line** embedded in concrete.
- 6 **Steel rope conduit line**, with central conduit formed in a concrete bed and steel frames to support and connect the rails and the central plough slot.
- 7 **Electric conduit line**, with steel tube conduit and conductor bars.
- 8 **Arrangement of the rope pulleys** on a curve.
- 9 **American section** of top flange rail.
- 10 **Saddle rail**.
- 11 **Plan of tramway switch**.
- 12 **Plan of tramway crossing**.
- 13, 14 **End views** of electric railway cars for both side and central current conductors.

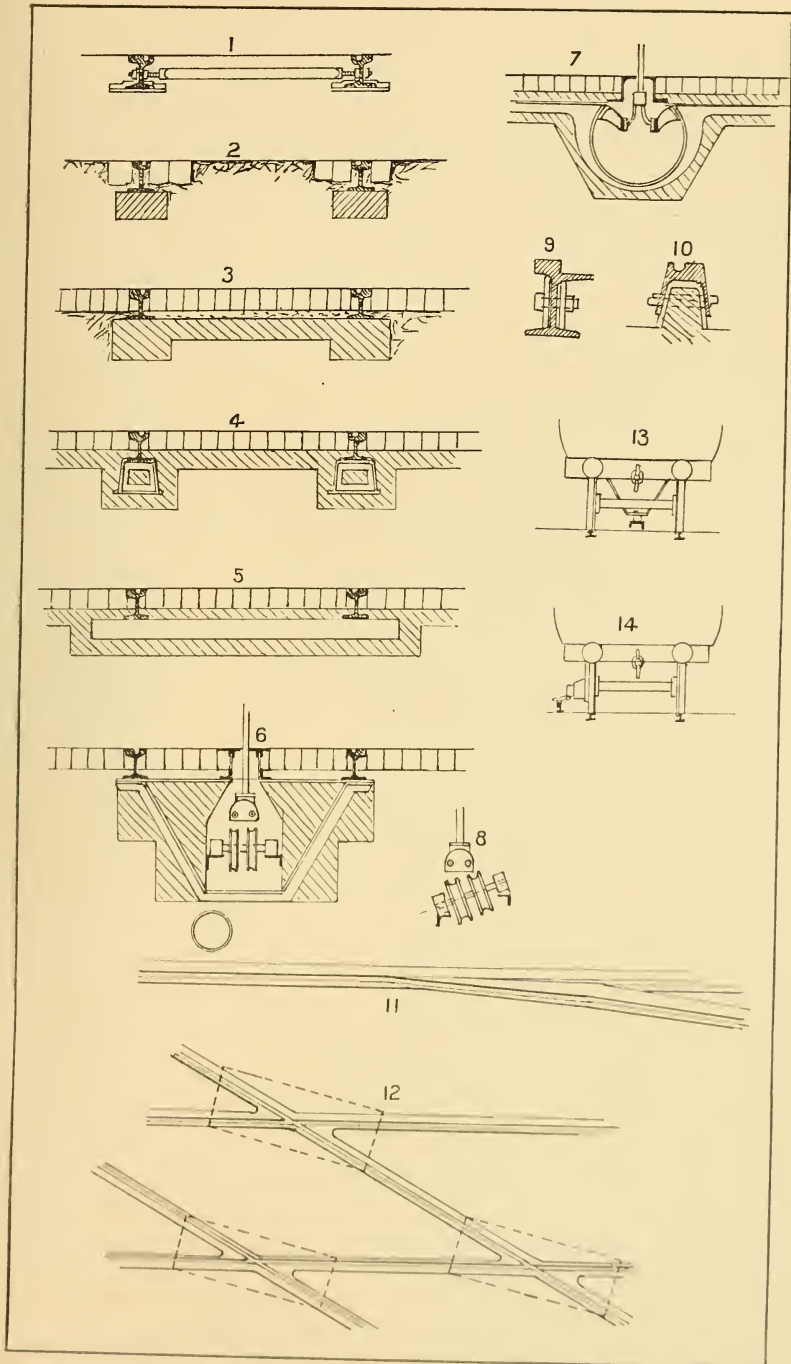

- 15-17 **Tramway turnouts** on single lines.
- 18 **Electric railway side conductor rail** with wood protection, showing current collector on the carriage under-frame.
- 19 **Another form** of protected conductor rail with under contact.
- 20-1 **Overhead trolley** wires and standards for single and double lines. For double lines single standards are sometimes used fixed between the lines in the 6 ft. way, with two trolley arms.
- 22 **Three wire catenary electric trolley conductor** for overhead electric railway.
- 23 **Cross section** of ditto.
- 24-7 **Varieties of trolley arms.**

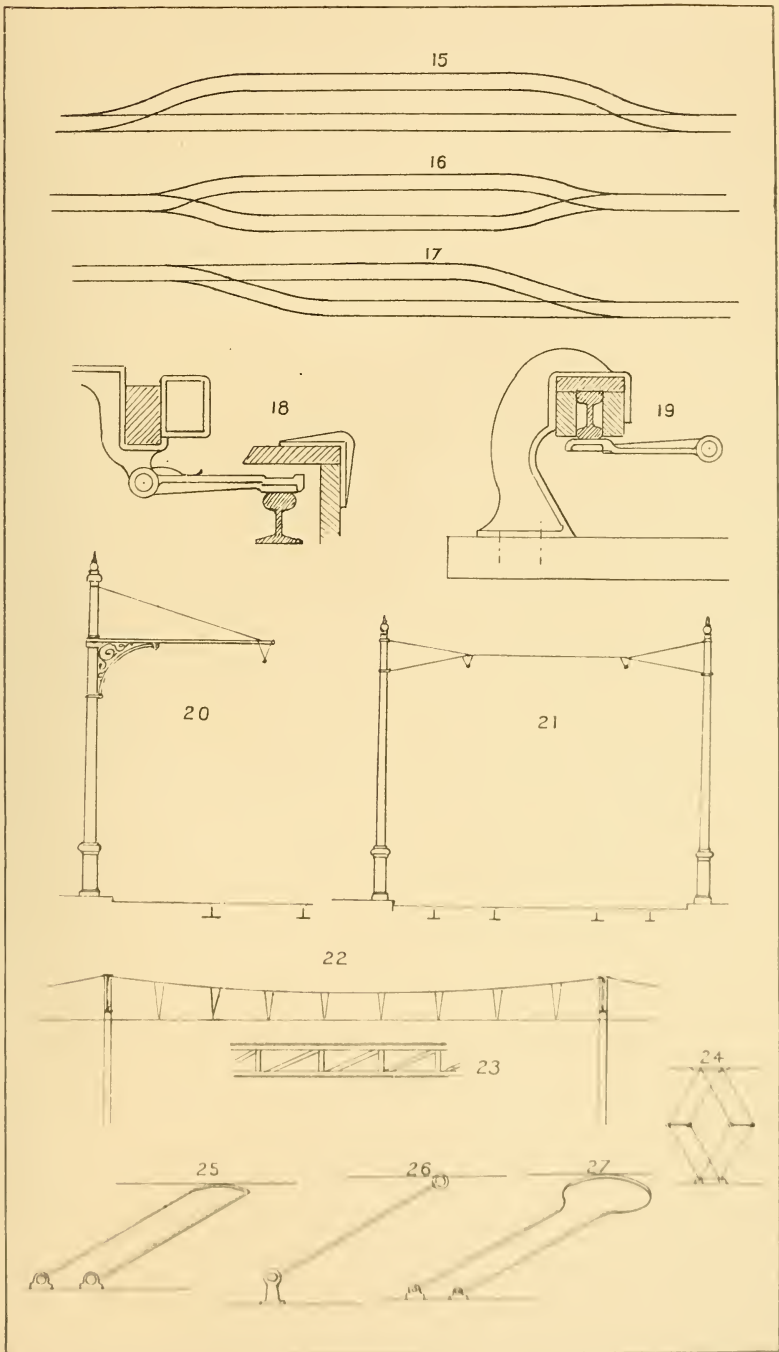

- 28 **Plan of overhead wiring** at a four street tramway junction.
- 29 Ditto, at a street corner.
- 30 **Open side tramcar** on short wheel base truck.
- 31 **Closed tramcar** on radial three axle long wheel base truck
(Barber's patent).
- 32 **Long tramcar** on double bogie truck.

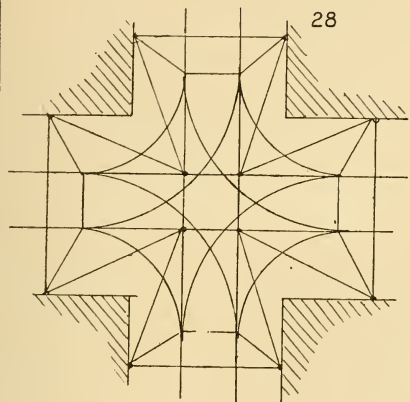

28

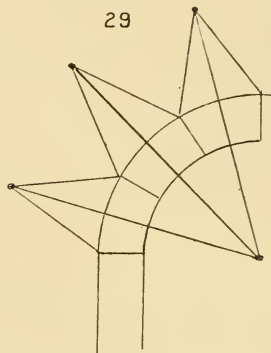

29

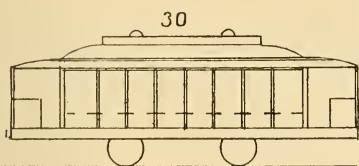

30

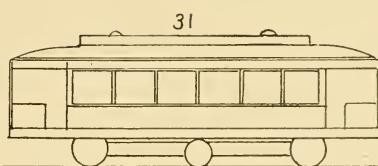

31

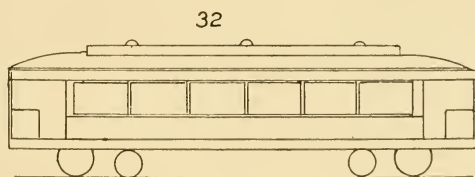

32

Section 24.—CANALS ; AQUEDUCTS.

- 1, 2 **Canal bank** with clay puddle lining and earth filling.
- 3 Ditto, with vertical puddle trench.
- 4 **Canal cut on sloping ground**, the outer bank pitched with concrete, stone, or a clay slope.
- 5 **Canal** lined wholly with impervious stone or other material.
- 6 **Canal cut in soft ground** with clay puddle trenches on each bank, carried down to the clay or other impervious strata below.
- 7 **Canal on a bench** in rock, with outer masonry wall.
- 8 **Canal with masonry walls** on both banks.
- 9 **Semicircular iron canal** or aqueduct in concrete or earth bank.
- 10 **Aqueduct in concrete.**
- 11 **Circular masonry aqueduct** on concrete base.
- 12 **Circular concrete aqueduct** or drain in an earthen embankment.
- 13 **Canal tunnel** with masonry lining and towing-path.
- 14 **Circular canal tunnel.**
- 15, 16, 18-21 **Methods of protecting canal banks** from erosion.
- 17 **Boat incline** at side of a canal lock.

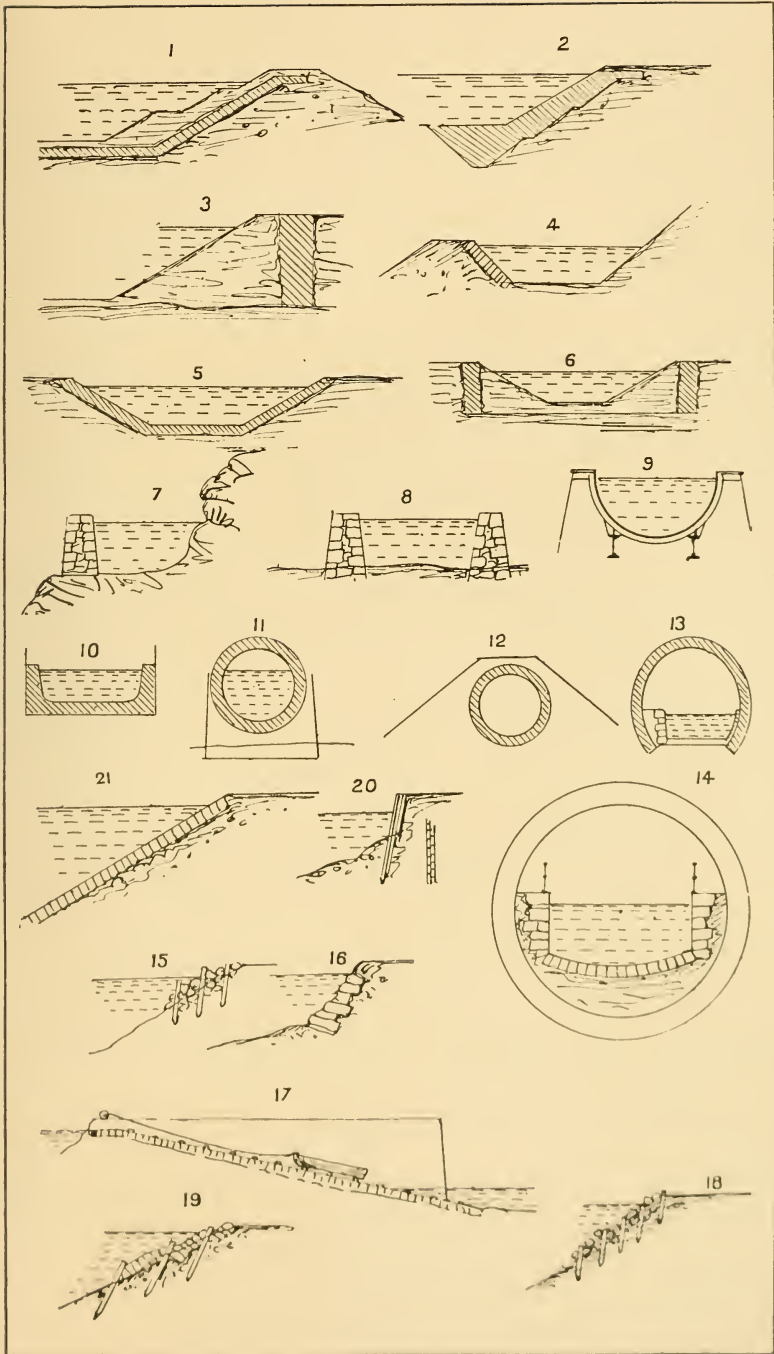

- 22 **Canal overflow** used to drive a water-wheel.
- 23 **Canal or aqueduct** carried on a girder bridge with concrete lining.
- 24 **Masonry arched aqueduct.**
- 25 **Series of canal locks,** longitudinal section.
- 26 **Canal tunnelled in rock** with towing-path.
- 27 **Plan of lock** and stepped or terraced weirs for overflow.
- 28 **Canal dredger** with discharge shoots on both banks.
- 29 **Canal grab dredger machine** travelling on rails on a canal bank.

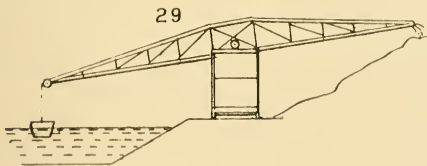
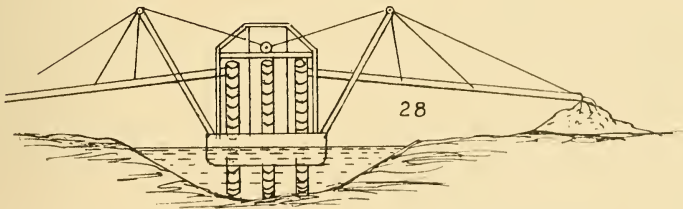
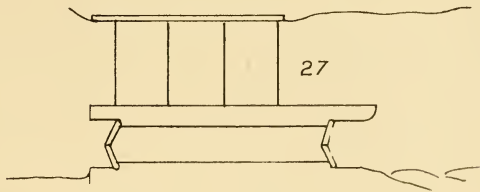
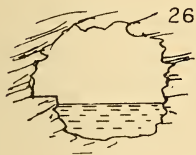
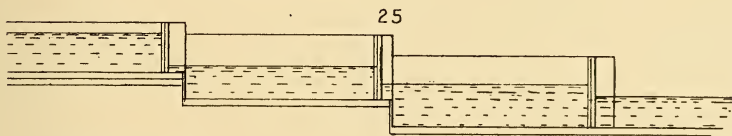
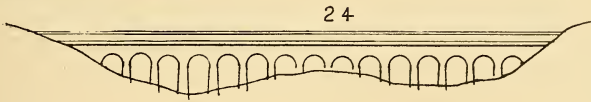
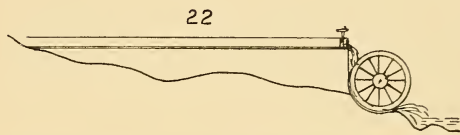
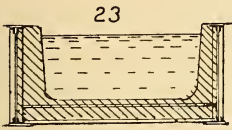

30 **Canal or river dredger** with discharge conveyor shoot.

31 **Canal lift**, consisting of three (or more) hydraulic cylinders in wells carrying a barge float provided with water gates at each end.

32 **Canal lift** of five pneumatic cylinders in wells; the cylinders are raised by filling the wells with water, and lowered by running off the water from the wells.

Other forms of canal lift comprise incline lifts, in which the barge float is carried up the incline by rope or hydraulic haulage, or two barge floats are employed on the principle of the water balance lift.

33, 34 **Masonry arched aqueduct** or canal.

Water supply to a canal is obtained either from springs, a river, stream, or lake, or is obtained by pumping from a river or from wells.

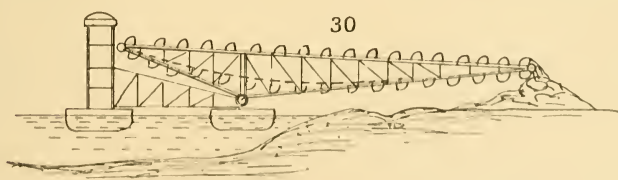
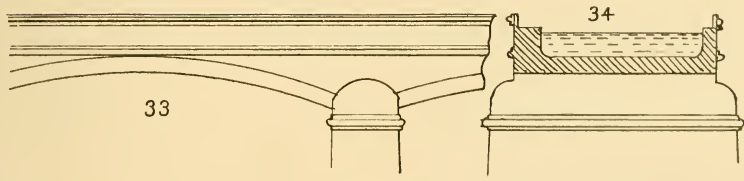
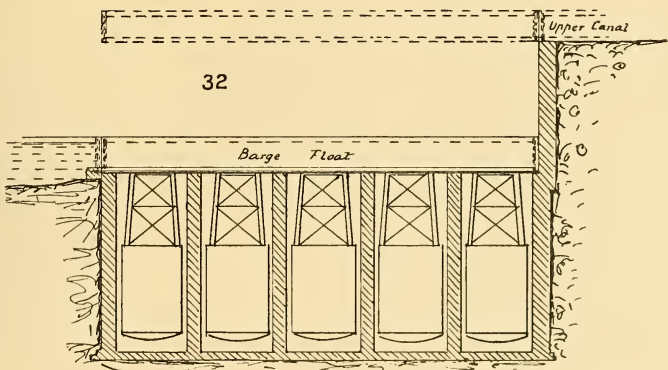
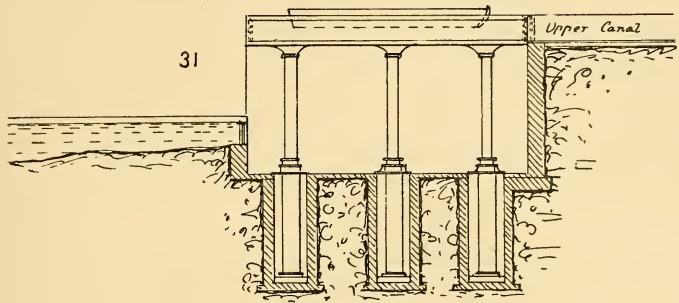

Section 25.—HEATING AND VENTILATION.

- 1 **Dutch cylindrical close stove.**
- 2 **Close stove** used in North of Europe. Also made in cylindrical form ornamented with tiles, etc.
- 3 **Heating system by hot water boiler**, circulating pipes, and radiators. Steam is also similarly used instead of hot water. Gas radiators are filled with water and heated by Bunsen jets.
- 4 **Hot air furnace** for a large building. The air is heated by circulating around the hot smoke flues.
- 5 **Hot water system** by circulation through pipes carried round rooms, passages, etc.
- 6 **Ventilating skylight.**
- 7 **Ventilating Louvre roof.**
- 8 **Circular slotted glass ventilator.**
- 9, 10 **Ventilating sash.**
- 11 **French windows.**
- 12 **Pedestal central heating stove.** The flue is carried down and under the floor.
- 13 **Ordinary double sashes.**
- 14 **Ventilating a room** by a pilaster inlet pipe taking its air from outside and an upper flap opening into a flue or the open air.

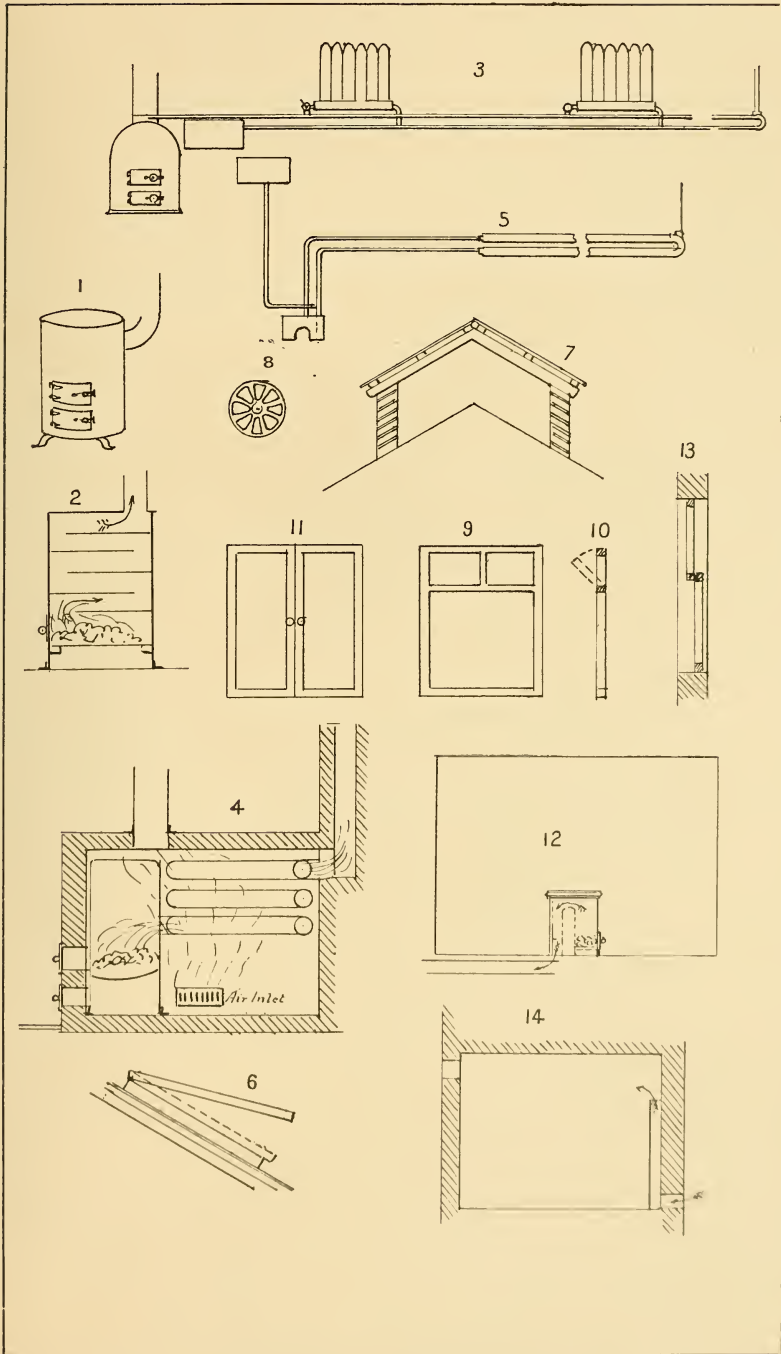

- 15 **Ventilating fan.** Usually driven by a small electric motor.
- 16 **Open grate and flue** with air inlet from outside the building.
- 17 **Ventilating shaft** to which flues are taken from the upper part of any number of apartments.
- 18 **Chandelier ventilation** for a large hall.
- 19 **Ventilating flue** and flap valve.
- 20 **External air inlet** to a room.
- 21 **Ventilating collectors and flues** between floor and ceiling.
- 22 **Slot and slide ventilator.**
- 23 **Series of frieze flap ventilators** for carriages, operated by a rod.
- 24 **Gas heating close cylinder stove** and hot air flues led into the open air.

Horizontal flues are sometimes carried round a room behind the skirting with gratings at intervals to supply hot air or fresh cold air.

Electric stoves and heaters, usually by large incandescent lamps and reflectors.

Anthracite slow combustion close stoves are much used for apartment or central heating, one charge of coal usually lasting twenty-four hours.

Mining ventilation is either by upcast shaft and furnace, in conjunction with doors placed in the headings to direct the air current; or by large fans driven by an engine or electric motor.

Railway carriages are heated by steam radiators placed beneath the seats, or by hot water bottles. The steam is supplied from the locomotive.

Gas heating by gas stoves—open or close—or by gas radiators, similar to No. 3.

Steam heating by supply pipes and radiators similar to No. 3, the condensed water being run off by a return pipe.

Steam ovens of sheet-iron in box form, having a steam space all round into which live steam is admitted, and from which the condensed water is drained off by a tap.

Geysers are gas Bunsen burners enclosed in a case, with water-spray circulated through the hot gases.

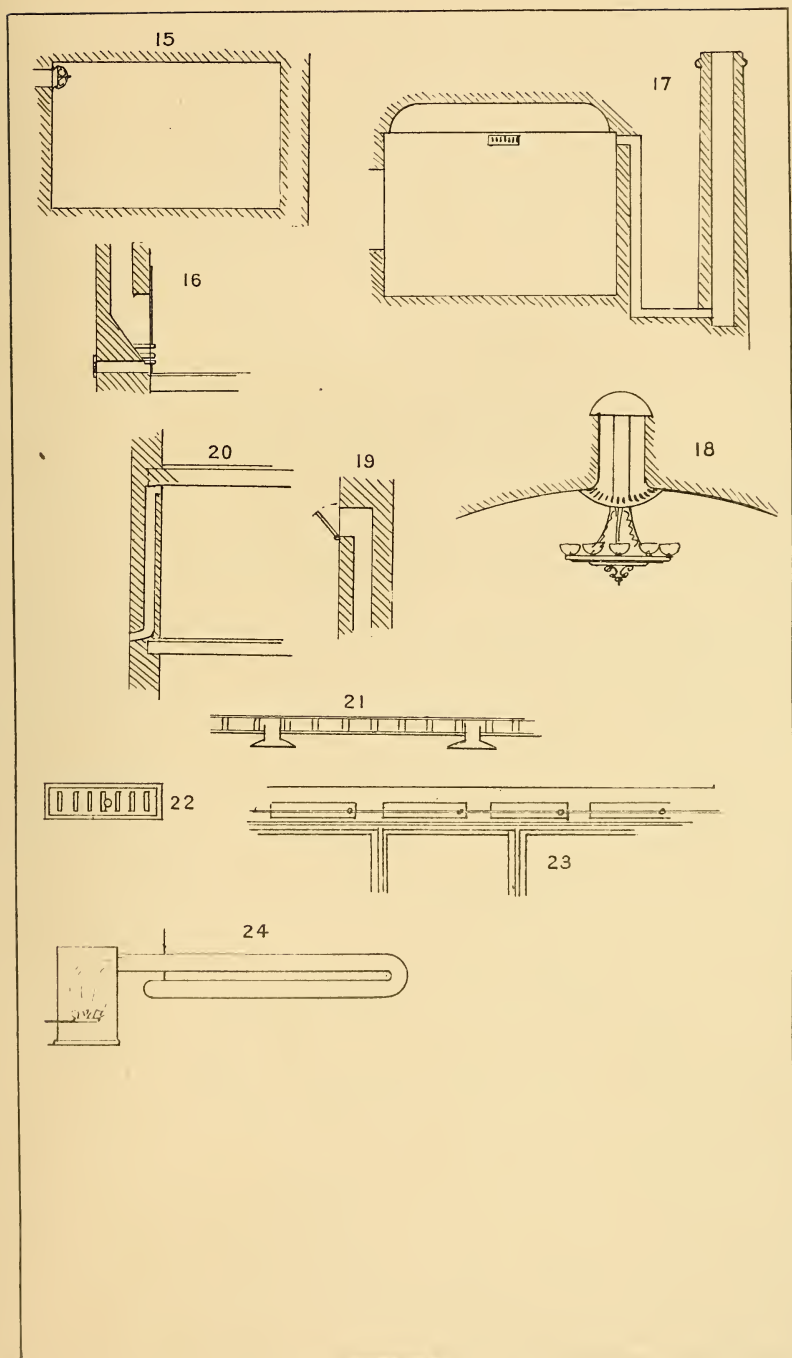

Section 26.—PLATE WORK.

- 1 Single riveted lap joint.
- 2 Double riveted lap joint.
- 3 Single riveted butt joint.
- 4 Double butt joint.
- 5 T-iron butt joint.
- 6-9 Angle or edge seams.
- 10 Transverse tubular seam.
- 11, 12 Reducing ring seams.

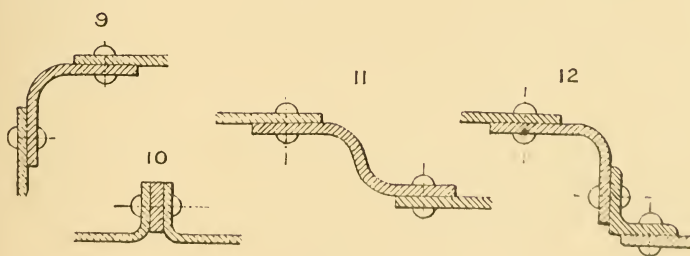
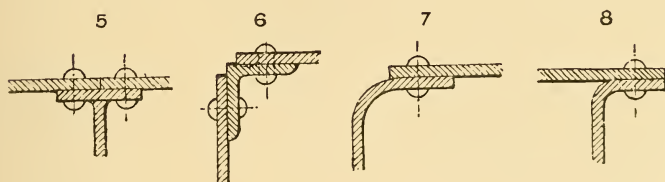
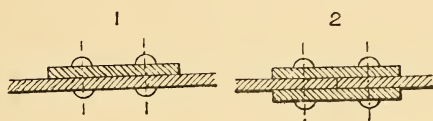

13 **Reducing ring seam.**

14-17 **Bottom seams** round water spaces, fire-boxes, etc.

18 **Expansion hoop joint** in boiler flues, etc.

19, 20 **Fire-box stays.**

21 **Gusset stay** for flat ends.

Flat bar, tube, and round iron stays are also much used to stay flat surfaces in boilers and tanks.

In household boilers it is usual to weld all the seams, thus avoiding **L** iron and other riveted work.

Flue tubes in boilers are stayed also by cross tubes inserted at intervals, such as Galloway's patent conical cross tubes.

22-3 **Cover plates** to carry tensile strains over joints in plates, **L** irons, etc.

24-8 **Various forms of joints** employed, etc., not subject to much strain.

29 **Junction** of **L** or **T** iron and plate.

30 **Gusset junction** for **L** or **T** iron and tie bars.

31 **Mode of joining laps** of four plates at corner in boiler work.

32 **Junction of flat bar** and **L** or **T** iron.

33 **Dished plate seam.**

34-40 **Seams** employed for sheet metal work.

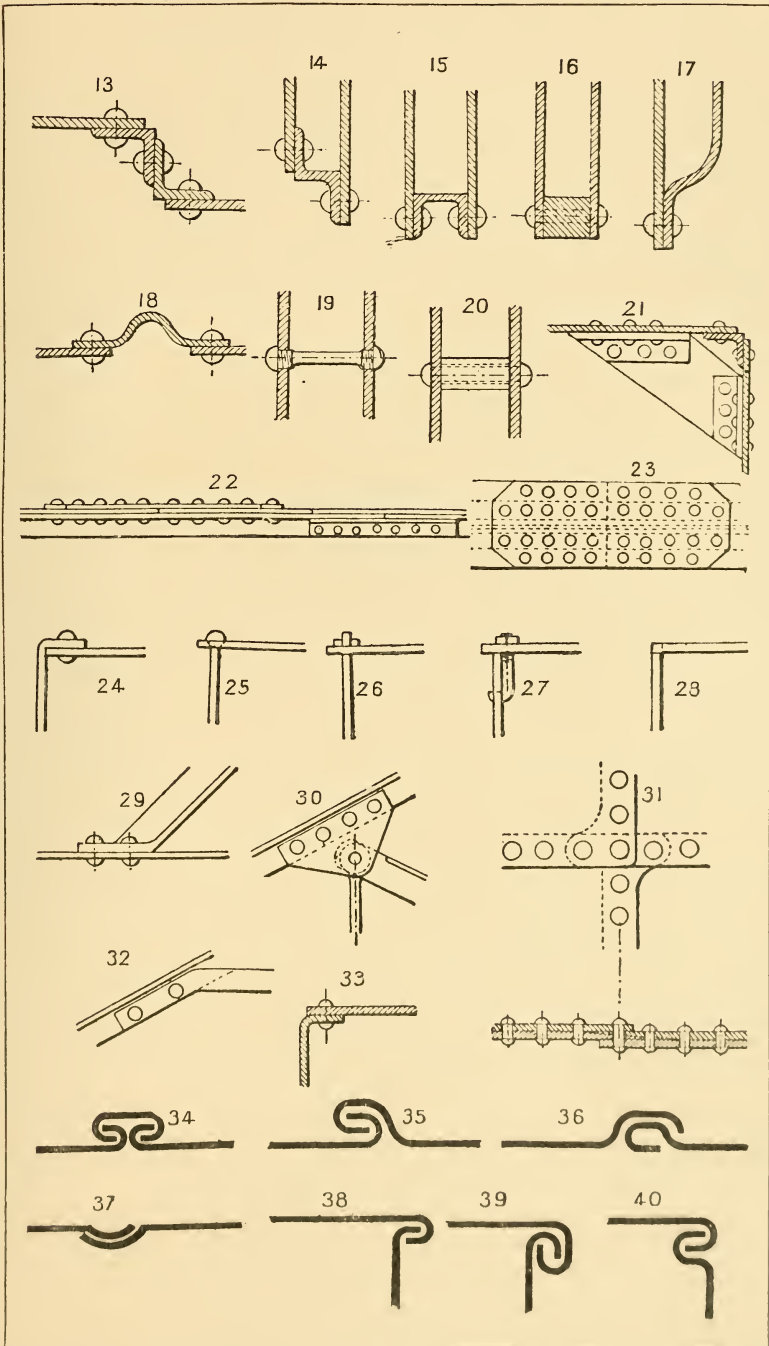

41 }
42 } **Bottom seams:** No. 44 is strengthened by a thick wire ring.
43 }
44 }
45 }

46-7 **Intermediate seams,** or diaphragms.

48 **Elbow seam.**

49 **Folded pipe seam.**

PLATE AND BAR JOINTS.

50 **Junction of T iron,** plate and **T** or **L** iron verticals.

51 **Gusset plate** corner stiffener.

52 **Plate end** for a tie-rod.

53 **H iron junction,** as in a floor framing.

54 **Gusset plate junction** for a braced framing.

55 **Gusset plate junction** for **H** girders of equal depths.

56 **Plate edge joint.** The circular cover is rolled (hot or cold) down over the thickened edges of plates.

(See also Sections 5, 6, 10, 14.)

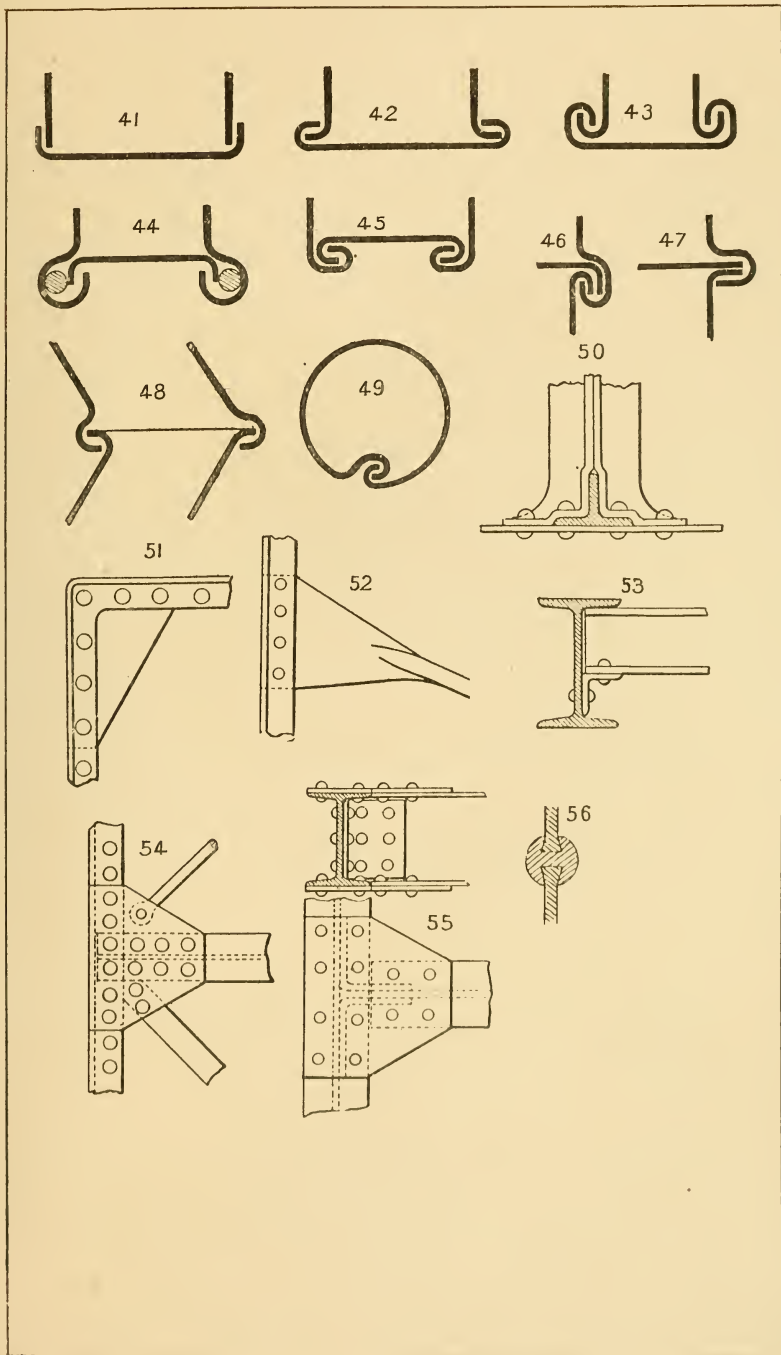

Section 27.—GAS SUPPLY.

- 1 **Type section of a gas house** showing general arrangement of retort bench, elevators, drawing and charging machine, hydraulic mains, etc. The gas is further conveyed through a condenser and purifiers to the gasometer. There are many varieties of this type.

- 2 **Ordinary type of gasometer**, consisting of a cylindrical plate-iron domed vessel, the lower part of which dips into an annular water space. The gasometer is guided by rollers bearing against vertical rails attached to iron columns, which are braced together. The weight of the gasometer is adjusted to give the standard pressure of gas required in the mains.

- 3-6 **Sections of gas retorts** of fireclay.

- 7 **Longitudinal section of a gas retort** with iron front and cover.

Oxygen, hydrogen, and other gases are compressed into steel bottles (see Section 34) and used for lighting and other purposes, usual pressure 1,200 lb. per square inch.

“**Mond**” gas, **water gas**, acetylene gas, and several varieties of petroleum spirit and other gases are manufactured and employed for heating, lighting, and gas-engine driving.

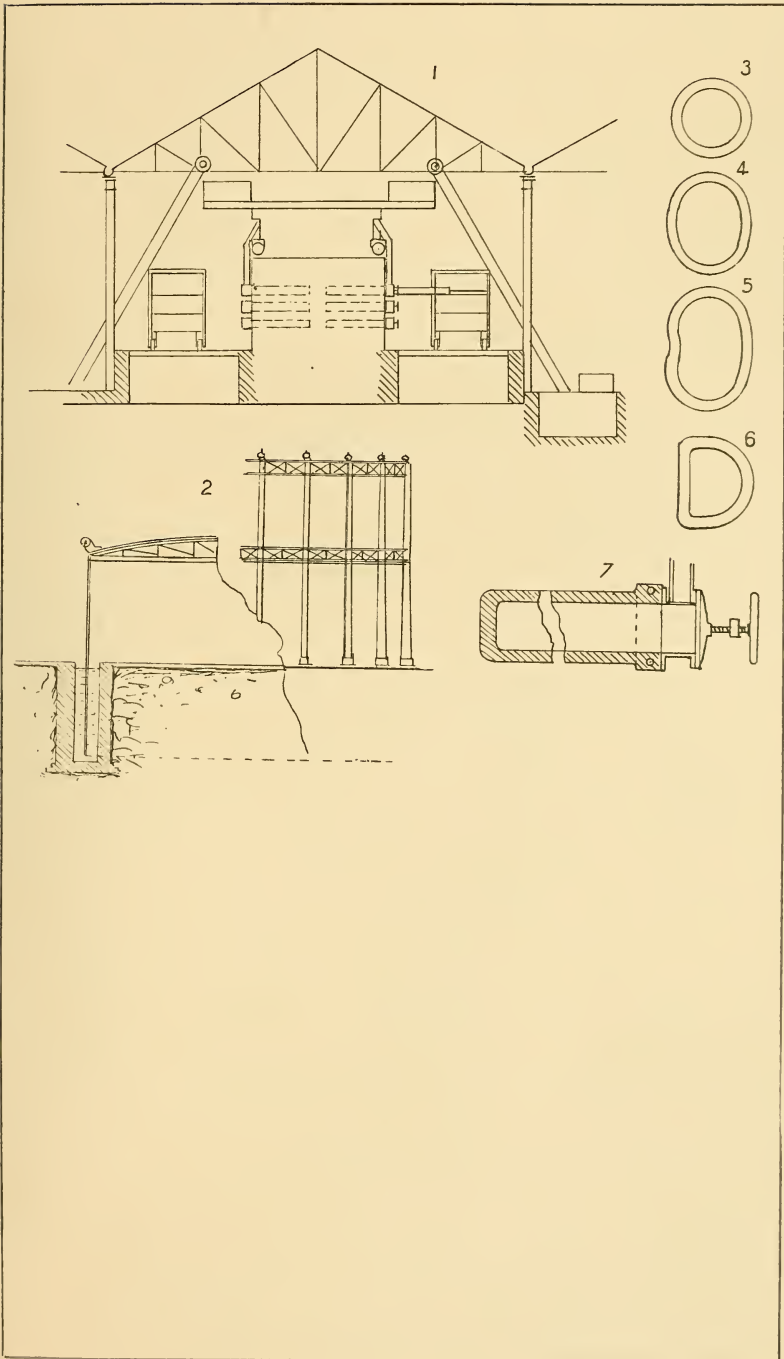

Section 28.—HYDRAULICS.

- 1 **Water-lifting wheel** for irrigation.
- 2 **Water-lifting lever trough** for irrigation.
- 3 **Water chain-bucket lift.**
- 4 **Archimedian screw water lifts.**
- 5 **Chain pump.**
- 6 **Water-lifting wheel.**
- 7 **Self-acting water pressure pump.** The movement of the piston reverses the inlet pressure valve.
- 8 Ditto.
- 9 **Hydraulic ram.**
- 10 **Water wheel and pump.**
- 11-15 **Types of vertical pumping engines.**
- 16-18 **Types of horizontal pumping engines.**

Hydraulic accumulator. (See Section 44.)

Water supply. (See Section 44.)

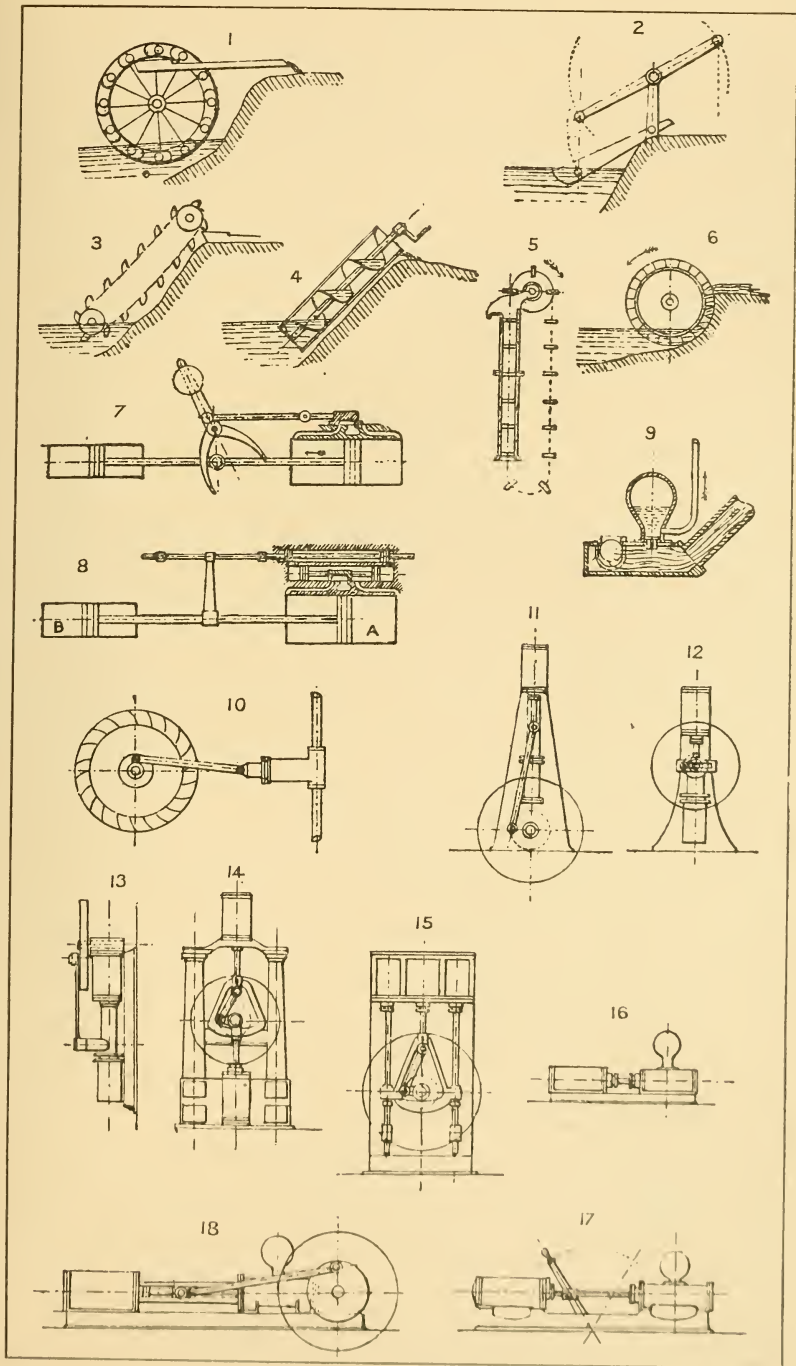

19-21 Horizontal compound pumping engines.

22-3 Horizontal pumping engines.

24 Vertical parallel movement mine pump compound.

25 Turbine.

26 Jet wheels.

27 Pelton wheel.

28 Plan of turbine bucket.

29 Tide wheel on a float.

30 Undershot jet wheel.

31 Tide screw motor wheel.

32 Water motor with variable gate.

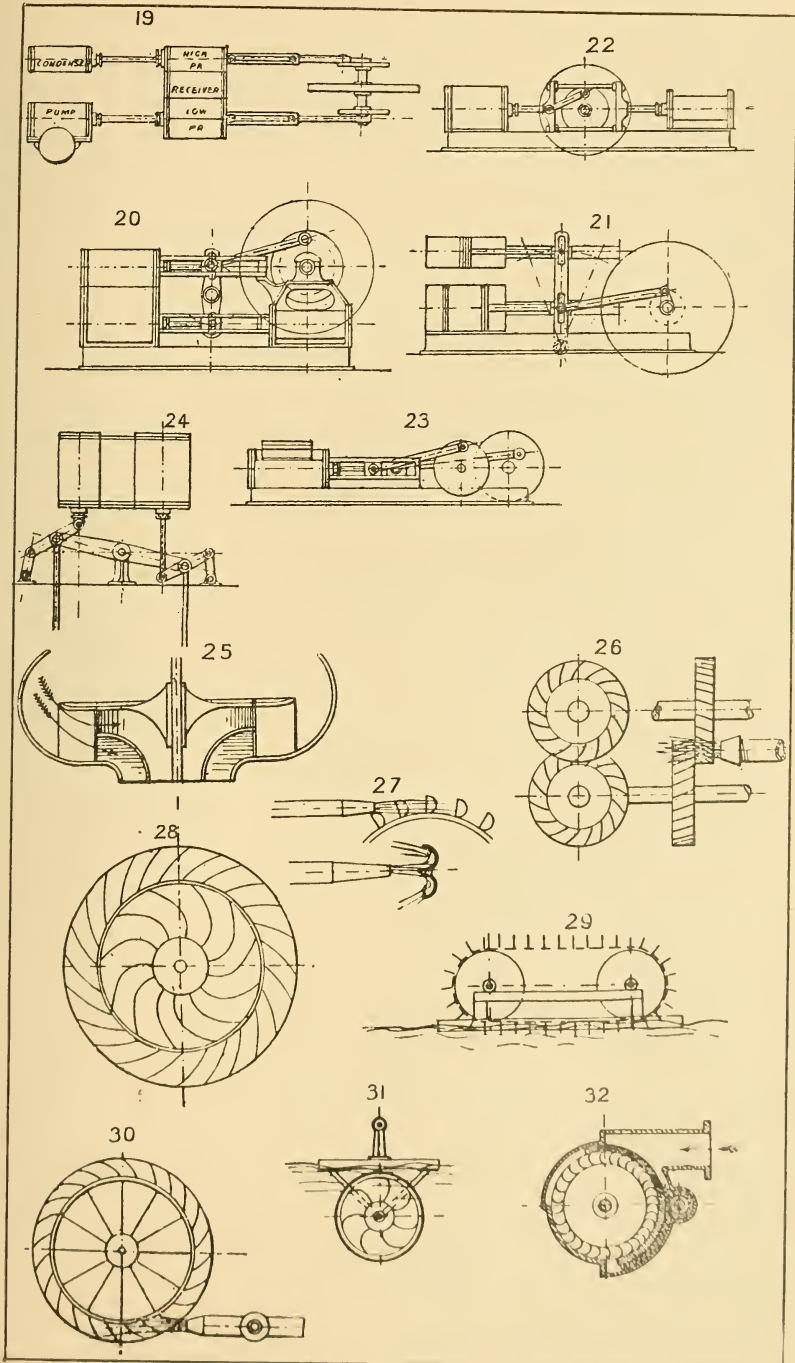

- 33 Breast wheel.
- 34 Overshot wheel.
- 35 Ditto, reverse flow.
- 36 Internal bucket undershot wheel.
- 37 Submerged air motor wheel.
- 38 Diagonal wheel.
- 39 Tide wheel.
- 40 Flutter wheel: high fall.
- 41 Horizontal wheel.
- 42 Internal breast wheel.
- 43 Reaction jet wheel.
- 44 Undershot wheel.
- 45-8 Various forms of plain and ventilated wheel buckets.
- 49 Plan of turbine.
- 50-1 Turbines.

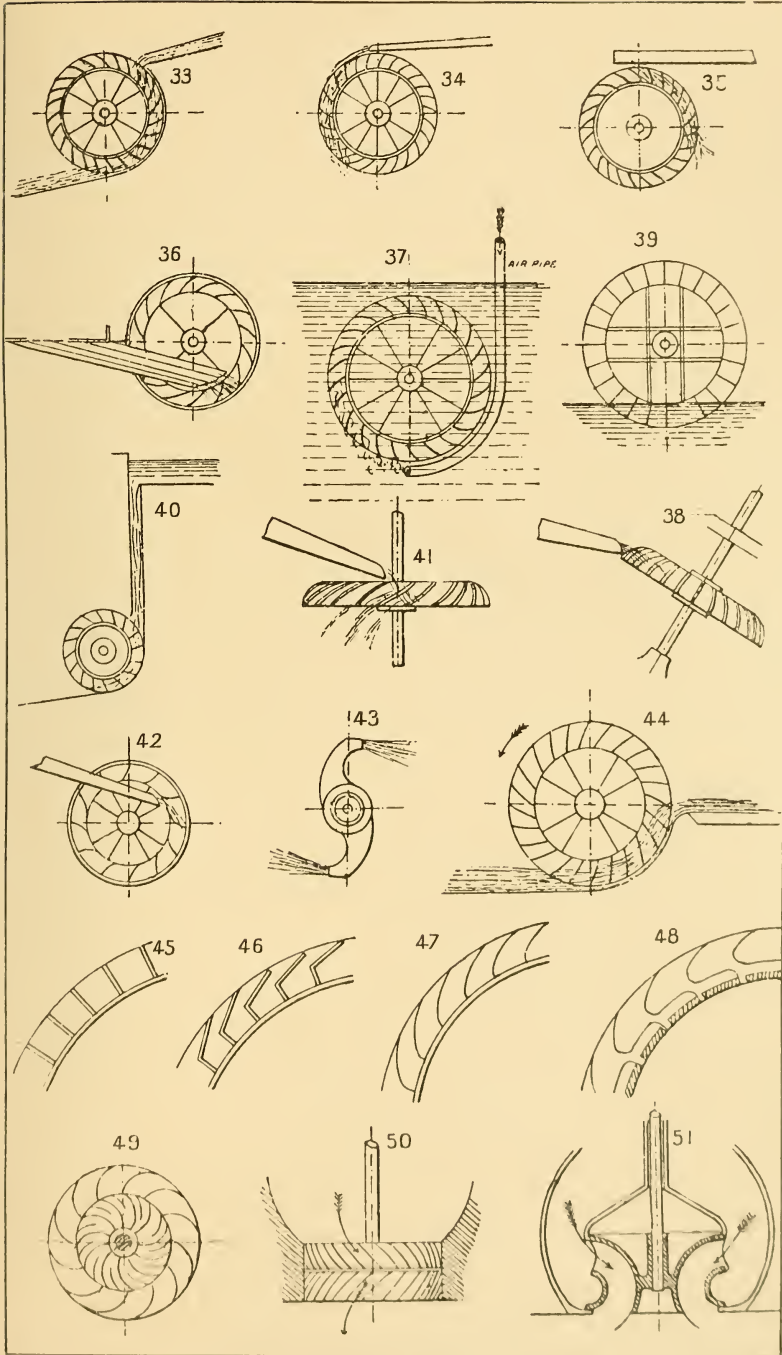

- 52-4 **Sections of water flumes** to convey streams to water wheels or turbines.
- 55 **Flume on staging** with down shoot or pipe to a turbine.
- 56 **Pipe main for pressure water** to a wheel, turbine, or other motor.
- 57 **Hydraulic timber shoot** to convey logs to a river or lake.

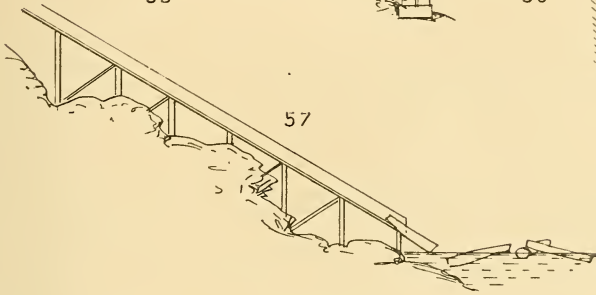
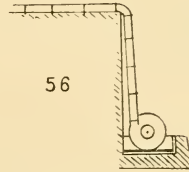
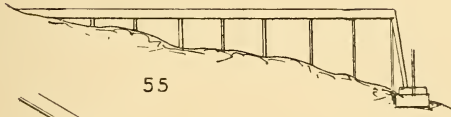
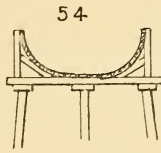
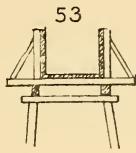
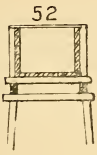

Section 29.—SEA AND RIVER STRUCTURES.

(See also Sections 31, 32.)

- 1 **Sections of flood banks** or river walls to prevent flood overflows.
- 2 **Training groynes** placed on river banks to confine the main stream and assist scour.
- 3 **Bottom groynes or walls** for a similar purpose.
- 4 **Section of training bank** or groyne.
- 5 **Floating booms** placed to direct the main stream.
- 6 **Training banks** to confine a main stream.
- 7 **Plan of a curved training bank.**
- 8-9 **Arrangements of training banks** in a river or estuary to direct the stream and assist scour.
- 10 **River wall with pitched slope**, puddle trench, and inner surface drain and outfall sluice.
- 11-13 **Sections of upright walls** as protective works.
- 14 **Rough stone foreshore wall.**

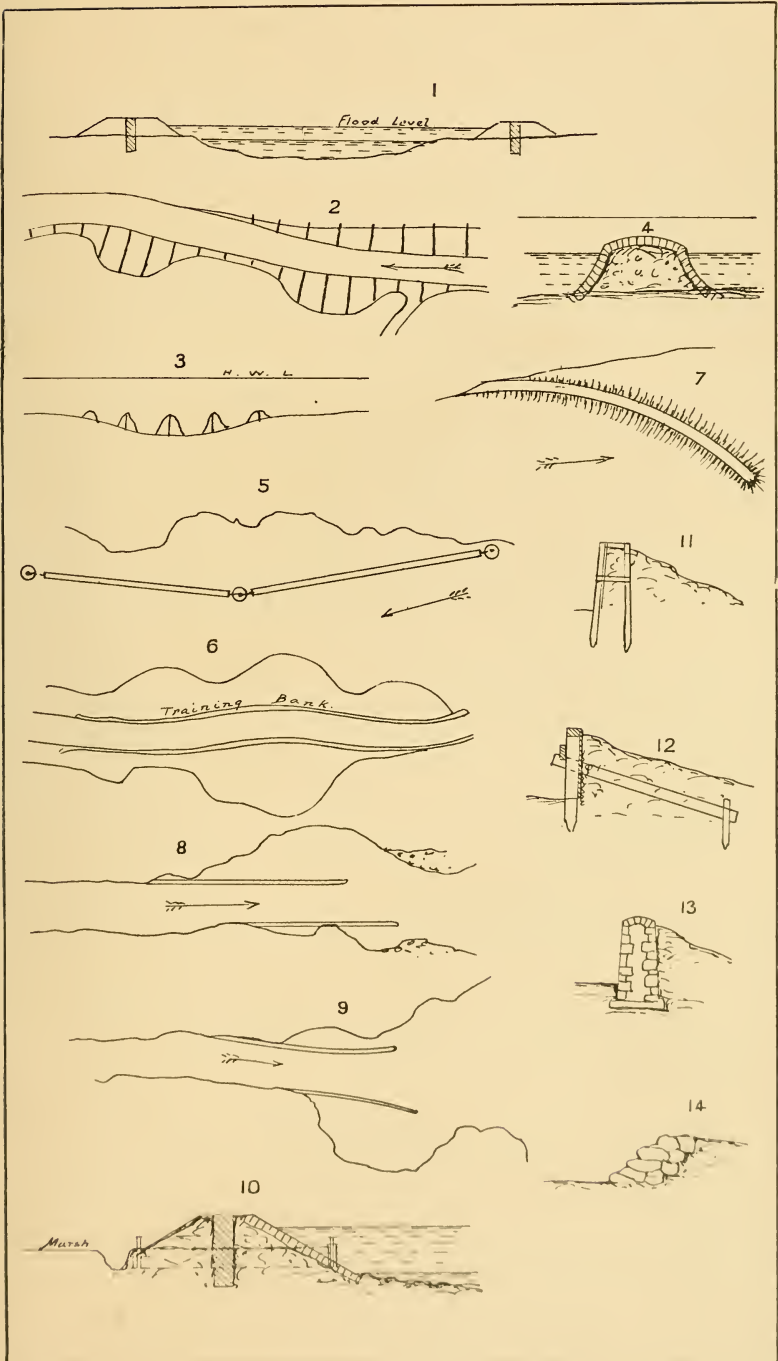

- 15 **River training bank.**
- 16 Ditto for reclamation of bay or creek.
- 17 **Plan of groynes on a foreshore,** timber, masonry (or concrete), also pipe drain groyne.
- 18-21 **Foreshore protective works** of masonry pitching, timber, or rubble stone.
- 22 **Section of timber groyne** with old rail struts and concrete foundation blocks.
- 23 **Curved river or sea wall** in masonry or concrete.
- 24 **Breakwater with parapet.**
- 25 **Wharf wall with timber jetty.**
- 26 **Concrete block breakwater** on rubble base.
- 27 Ditto **with sloping blocks.**
- 28 **Concrete block and rubble breakwater.**

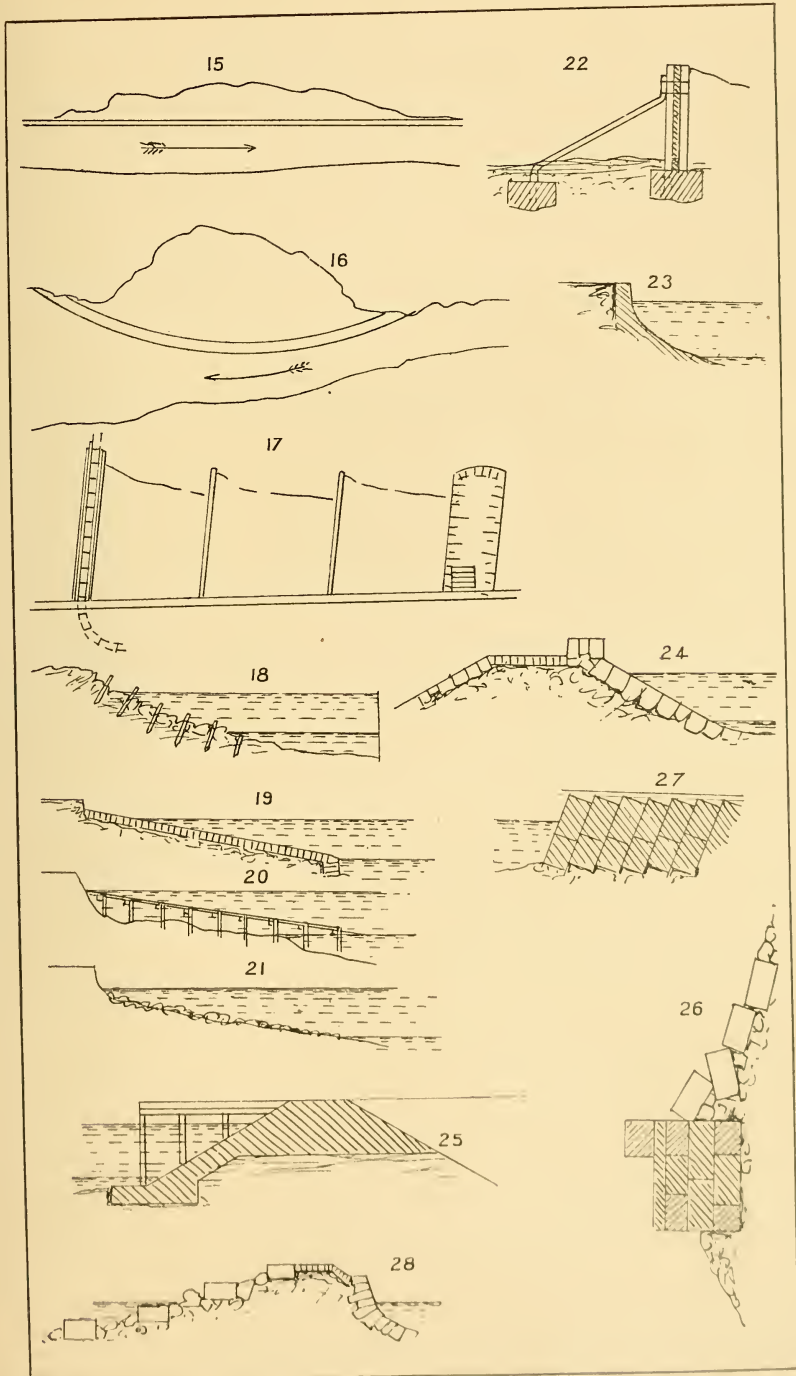

- 29 **Pitched slope and block toe breakwater.**
- 30 **Concrete block breakwater** on rubble mound, with mass concrete parapet.
- 31-3 **Foreshore protective banks** and works.
- 34 **Foreshore protected by sedge** or reeds, mattresses, piles, ballast or rubble stones.
- 35 **River wall terraced and pitched.**
- 36 Ditto **with concrete slope** and quay and piled footing.
- 37 Ditto **with concrete slope and footing.**
- 38 Ditto **of concrete faced with stone.**
- 39 Ditto **of concrete with stone facing.**
- 40 Ditto **of rubble stone and cribwork** backed by clay wall and sand piling.
- 41 **River foreshore** protected by fascine mats floated into position and sunk with stone or clay loading.
- 42-4 **Timber and rubble groyne.** Section elevation and plan.

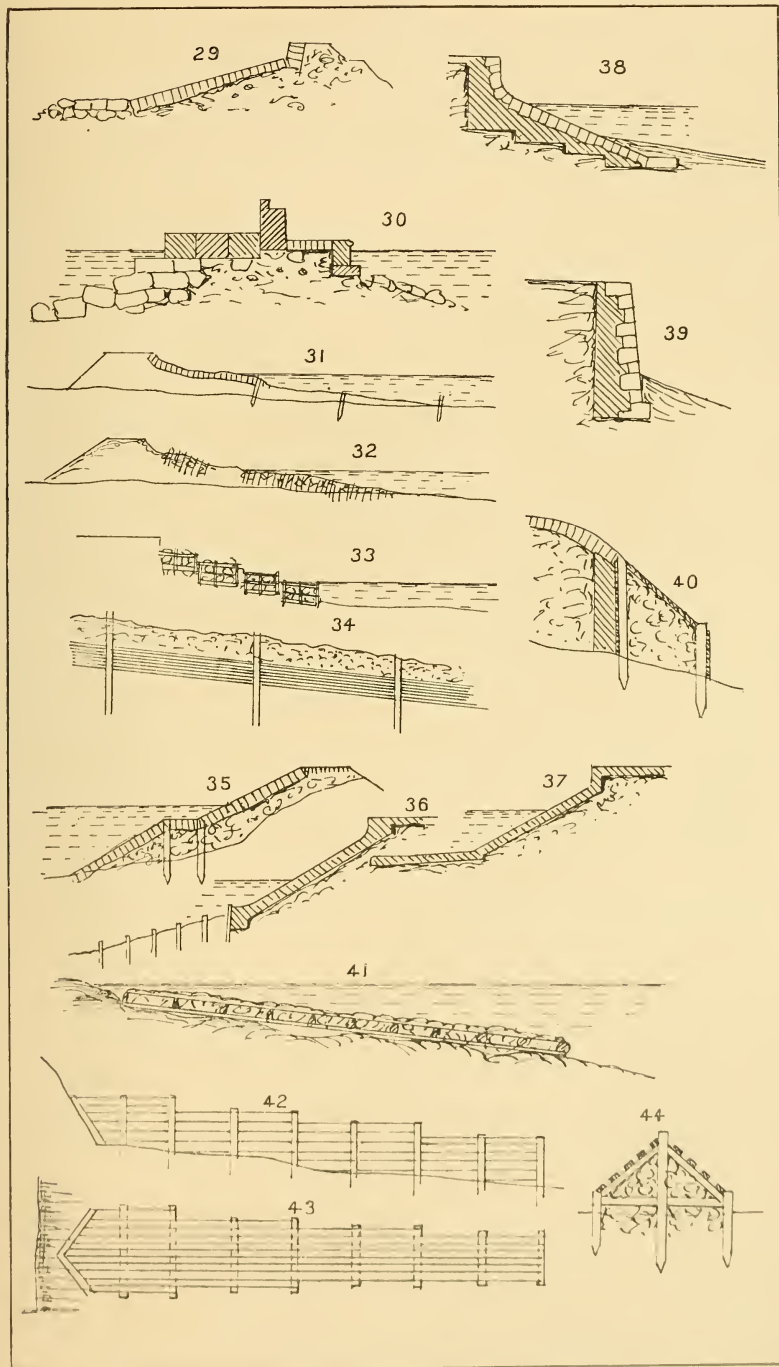

- 45 **Groyne constructed of piles**, stakes, and rubble stones.
- 46 **Foreshore wall of fascines** and stones, with stakes.
- 47 Ditto **of stakes** and wattles.
- 48 **Timber and rubble cribwork**, with planked face.
- 49 **Concrete block breakwater** on a rubble mound.
- 50 **Terraced breakwater** of rubble with pitched slopes.
- 51 **Concrete block breakwater** filled with rubble and with rubble toe.
- 52 **Sea wall of concrete** with masonry top section.
- 53 **Masonry sea walls.**
- 54 **Sheet pile river wall.**
- 55 **Mass concrete breakwater** laid in boxing with fender piles.
- 56 **Breakwater** constructed of fascines and stone footing, clay and sand filling, and concrete or masonry upper section.
- 57 **Block concrete breakwater** with loose block toe.
- 58-61 **Sections of sea or river walls.**

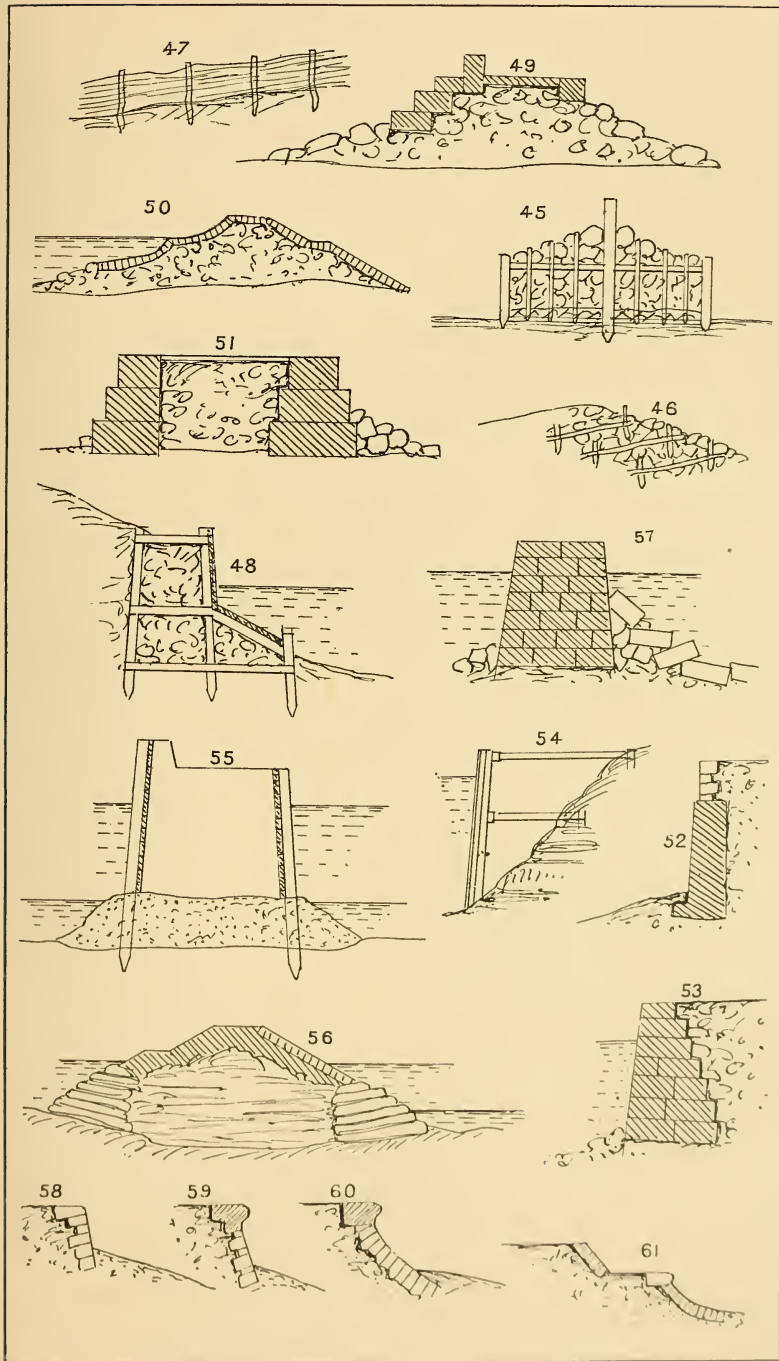

- 62 Breakwater formed of a concrete box base with superstructure of concrete blocks and mass concrete top with subway and parapet.
- 63 **Concrete breakwater** built on a timber cribwork base.
- 64 **Concrete block breakwater** on a mass concrete base.
- 65-6 **Reinforced concrete box breakwater** on a rubble base, finished with mass concrete upper section.
- 67 **Circular concrete fort**, built as a caisson and sunk in position on levelled foundation.
- 68 **Cribwork base for wall** or breakwater.
- 69 **Coffer-dam**, formed of three rows of close piling filled with rammed clay.
- 70 **Timber jetty on a river wall** with stone pitching.
- 71 Masonry sea wall.
- 72 Foreshore protection of stakes and stones.
- 73-4 **Sea wall of concrete caissons**, keyed together, carrying a superstructure of mass concrete.
- 75 **Sea wall on concrete caissons** sunk by water pressure pipe and sand pump, superstructure of masonry.

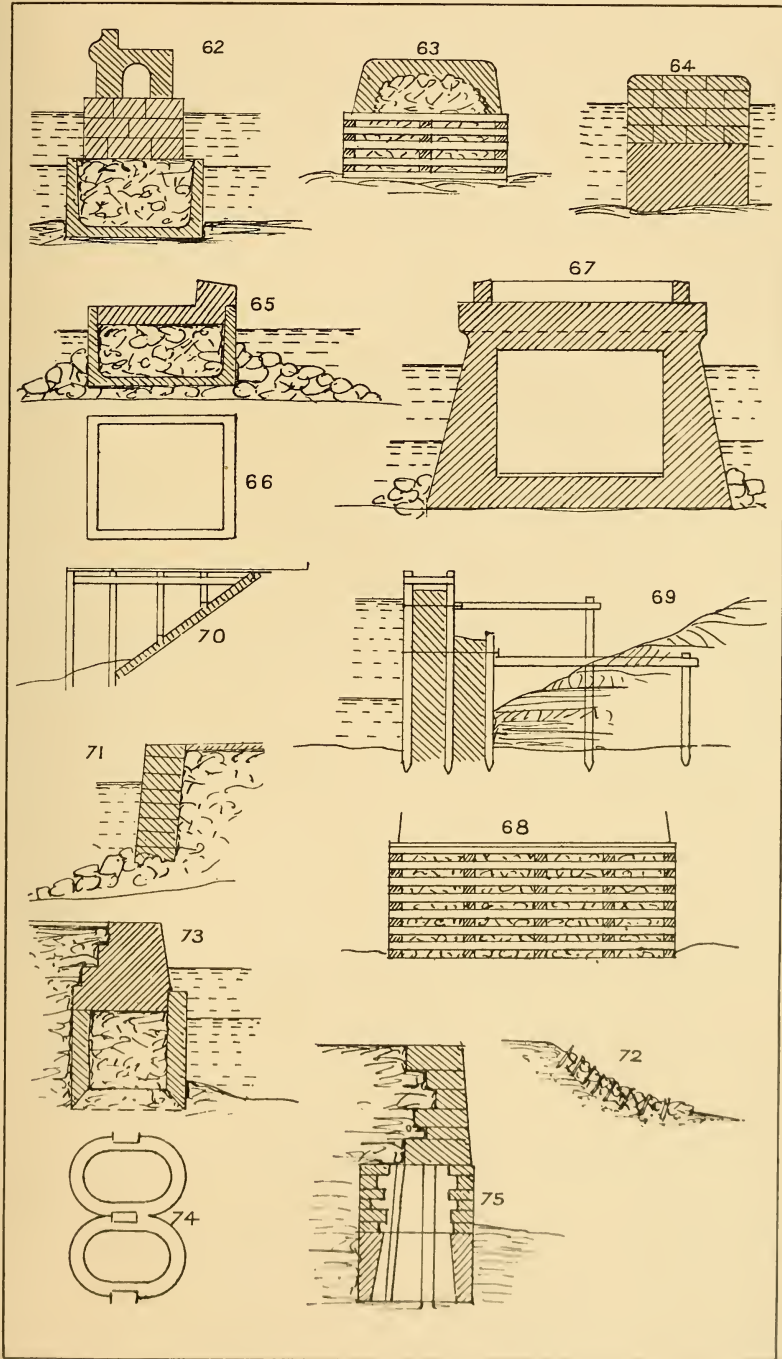

76 **Wharf wall** built forward into a river on a pile foundation.

77 **Cast-iron pile and panel sheet piling** for a river wall.

78 **Oval caisson** and key, sheet piling.

79-81 **Sections of interlocked steel sheet piling.**

82-5 **Sections of piers or jetties.**

86 **Type plan of a sea pleasure pier** with pavilions.

87 **Timber jetty.**

88 **River floating pier** with bowstring girder connecting stage.

89-90 **Long tidal incline on floats** or dumb lighters. The incline is in section maintained at any angle by side levers with varying leverage.

91 Breakwater or training wall faced with pitched stonework.

92 **Cantilever jetty** to project to a deep water berth.

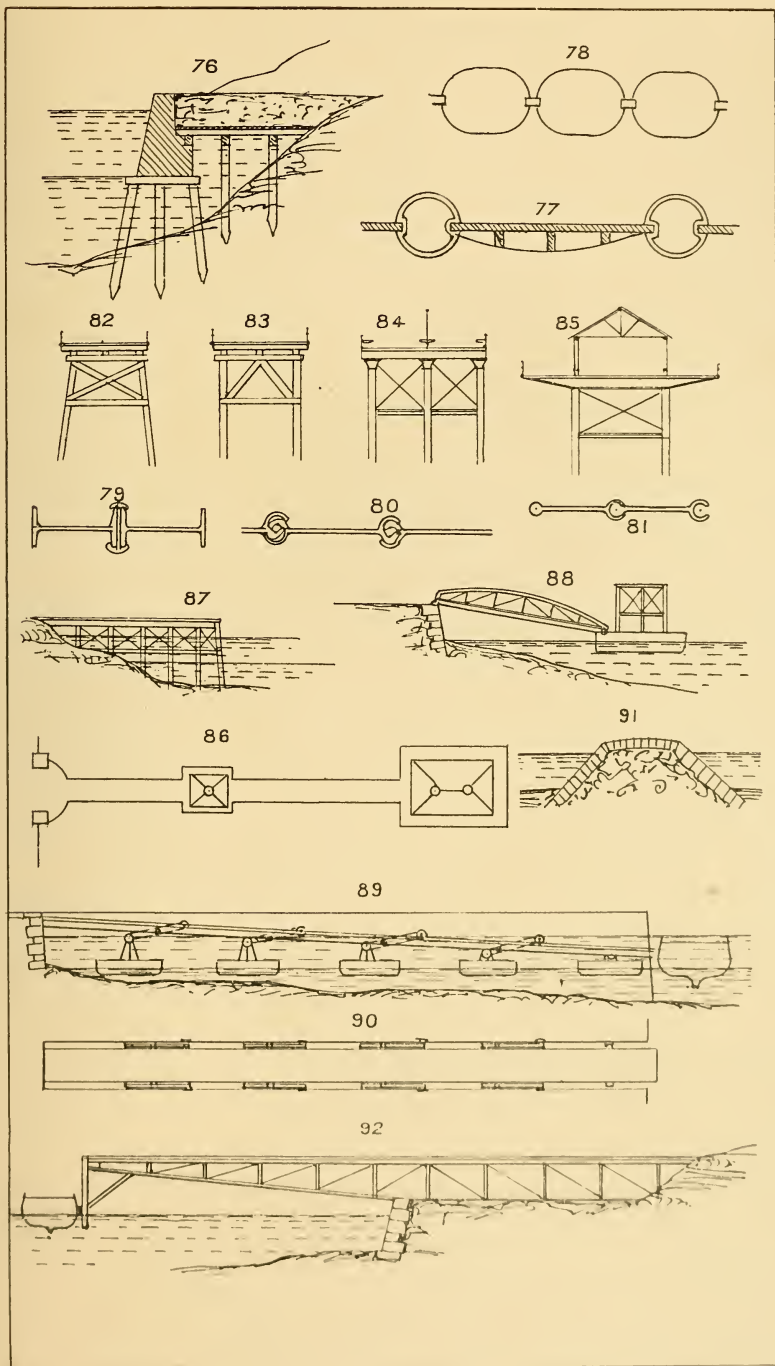

93 **Light or bell buoy.**

94-101 **Sections and elevations** of various types of wharf walls.

102 **Concrete wharf wall** faced with stone.

103 **Rubble stone mound breakwater** or training bank.

104-5 **Breakwaters on rubble base.**

106 **Breakwaters** at entrance to a river.

107-8 Section of coal-shoot jetty for loading barges, etc.

109-10 **Steel sheet pile wharf walls.**

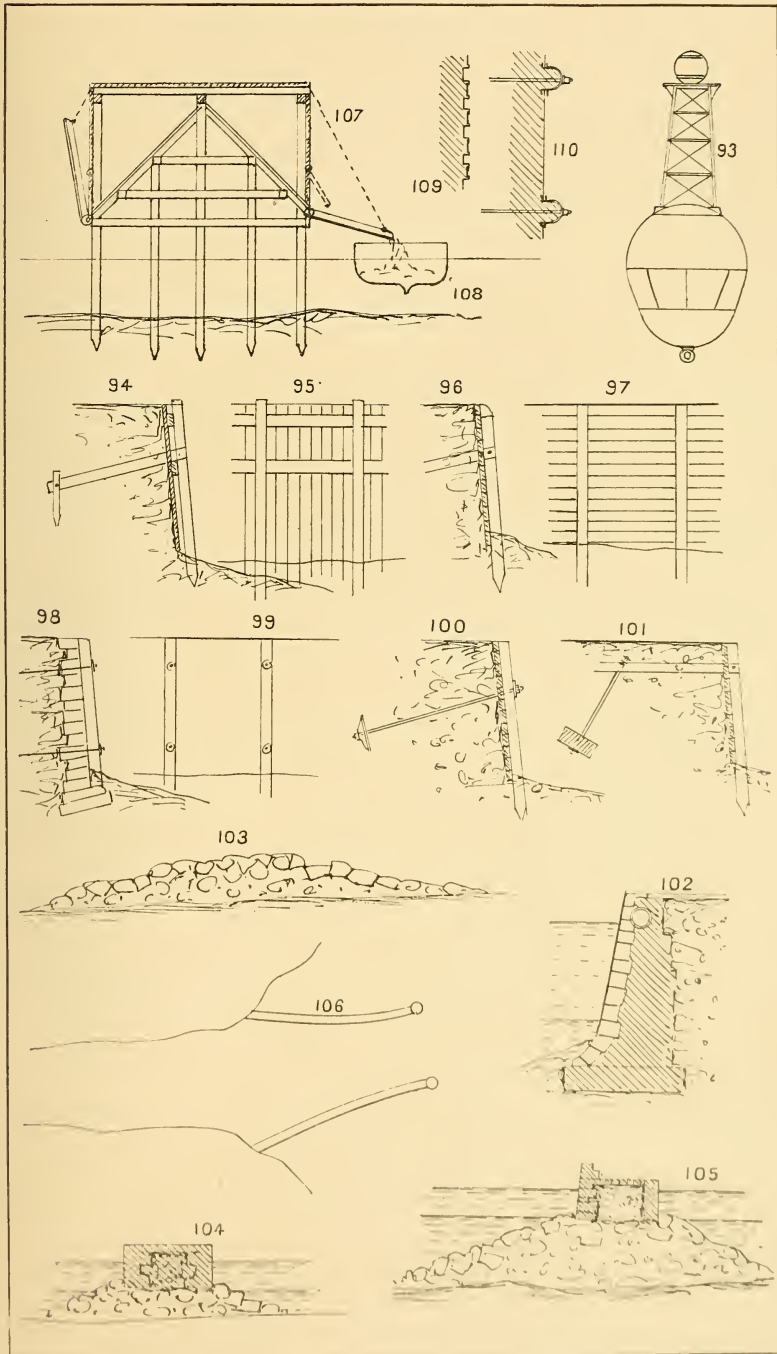

Section 30.—IRRIGATION.

The artificial supply of water to crops in places where the rainfall is either insufficient or unseasonable.

SOURCES OF SUPPLY.

Rainfall : The run off being collected in reservoirs, or led by canals to dry areas. Rain-water is superior to that from wells.

Springs : Led to reservoirs, or irrigation canals, or channels.

Wells : These generally require pumping or some equivalent water-raising machinery.

Artesian wells : The water is directed into canals or storage reservoirs.

Streams : From mountains or hills, dammed at suitable points, and led to irrigation canals or channels.

Rivers : Usually require dams or weirs (Section 43) to raise the water to a sufficient head to supply low-lying areas by canals. Sometimes the water is pumped up to a sufficient head.

Lakes : Fed by streams from elevated catchment areas are natural irrigation reservoirs. Their level is often raised by a dam to augment the storage and give a greater head of supply.

Artificial reservoirs : Generally constructed by throwing a dam across a valley (Section 44) in which a stream or river runs down from high ground.

DISTRIBUTION.

Canals : Fitted with sluices to regulate the flow (Section 24).

Branch canals : Smaller in cross section.

Distributaries and field channels.

All these are laid with a slight fall calculated to give the required maximum flow ;. and the flow is controlled by simple gates or sluices.

Aqueducts (Section 24).

Section 31.—DOCKS, HARBOURS.

(See also Sections 29, 39.)

- 1-6 **The plan of a harbour** is always dependent on the form and character of the coastline, the depths of water, tides, tidal range, and prevailing winds, as also the tonnage and other characteristics of the shipping. No general rules are possible, so that the plans sketched merely indicate general outlines of breakwaters adopted for varying coast outlines.
- 7 **Sluicing basin** on a tidal coast at entrance to a dock or harbour, filled at high water and used at low water to scour the approach to the locks.
- 8 **Type plan of a dock** with outer tidal harbour and inner basins and locks. Most docks are variations of this type adapted to the local conditions.

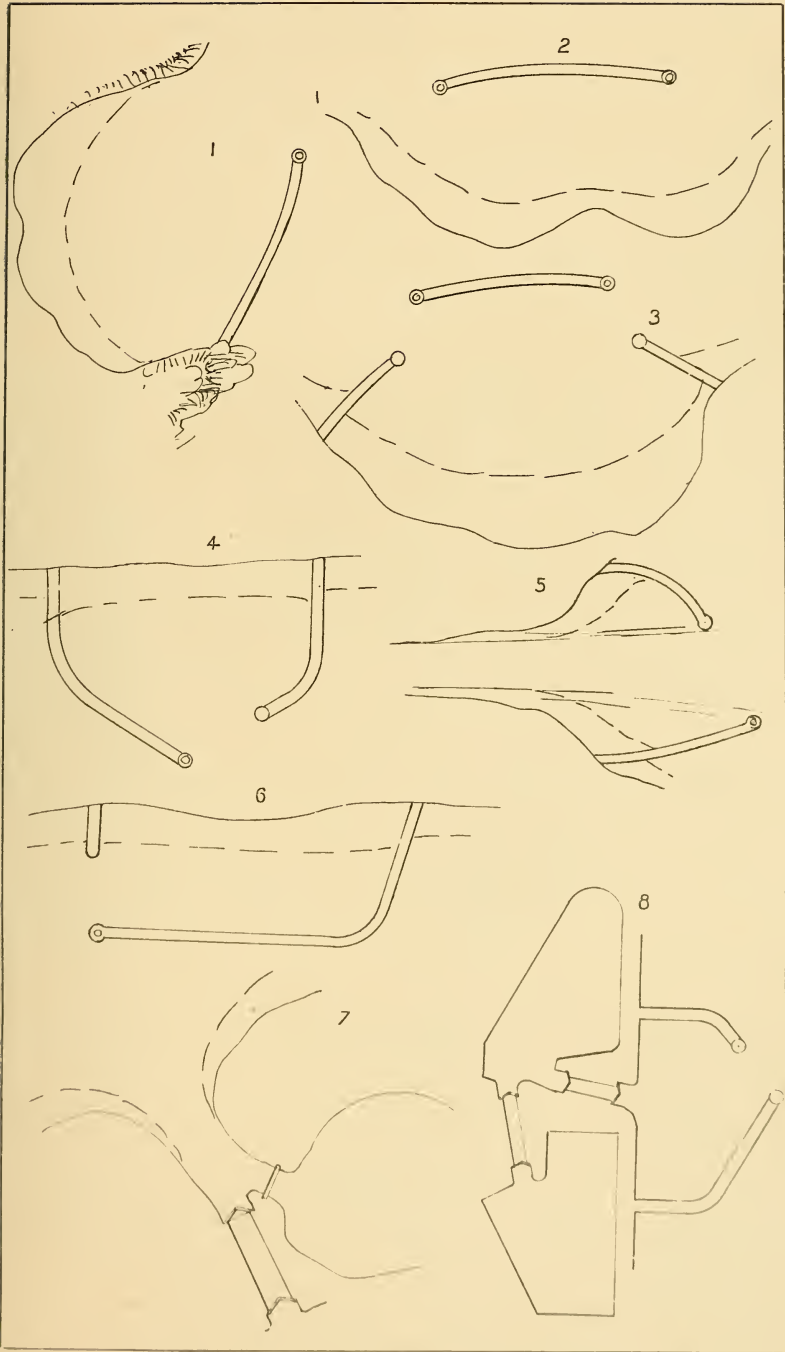

- 9-11 **Type plans of locks** with cylinder, swing, and sliding gates. No. 10 is the common form.
- 12 **Pair of locks** opening direct into a river, with concrete apron outside and scouring culverts, gates, and sluices to keep the approach to the locks clear of silt.
- 13 **Section of floating dock.** Consists of a rectangular water-tight steel base, capable of carrying the heaviest vessel to be dealt with, and side framings on each side containing workshops, platforms, cranes, and other repairing plant.
- 14 **Floating dock as last,** but with one side framing only.
- 15-18 **Sections of harbour piers** or jetties in timber and stone work.
- 19-21 **Horizontal sections of lock gates** in wood and steel.

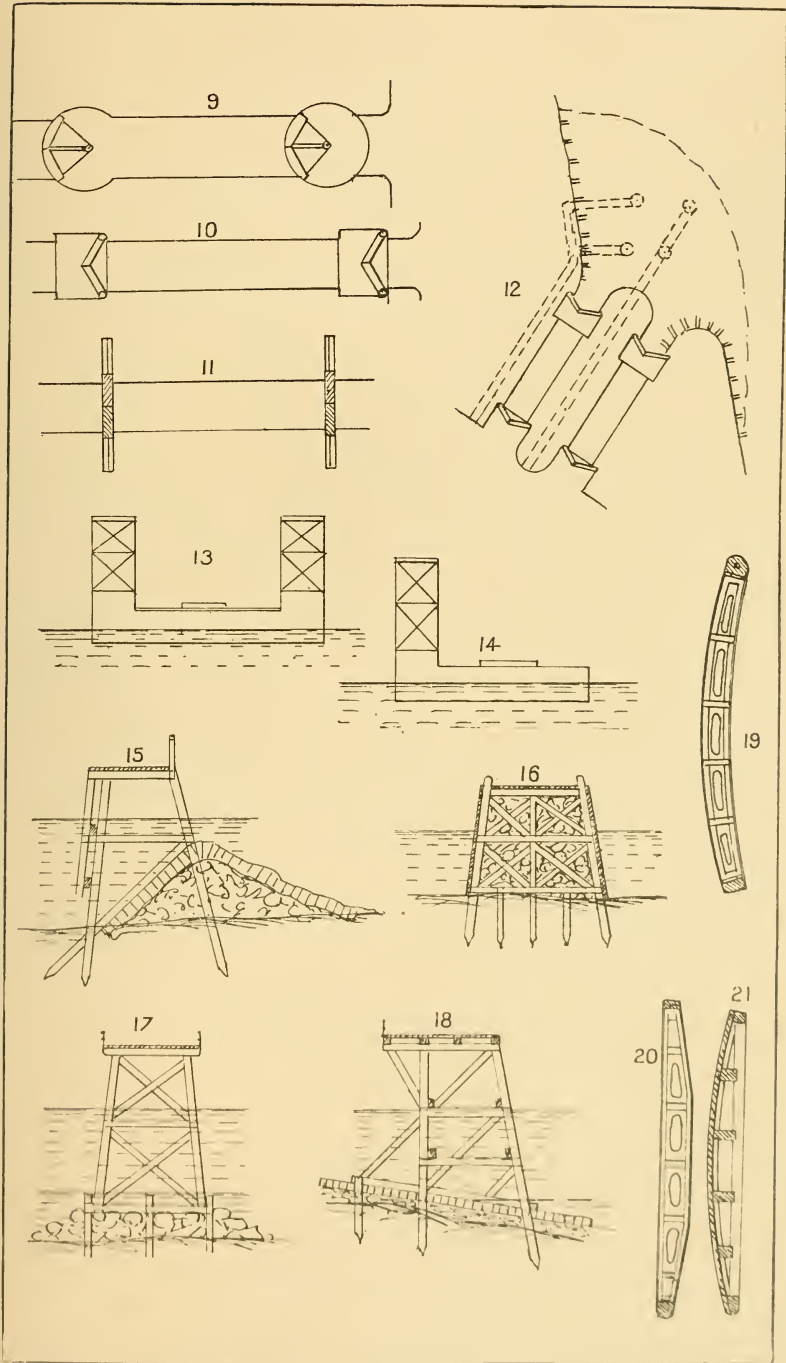

- 22-3 **Type plan of repairing slips** and graving dock, showing three slips branching from a floating dock, opening into a river or harbour.
- 24-7 **Block plans** of types of river jetties; 26 and 27 contain barge docks to provide berths for barges receiving goods direct from ship or jetty.
- 28 **Another plan of double jetty** with stepped berths on the inner sides.
- 29 **Plan of pair of locks** with sluicing openings, culvert, and sluice gate.
- 30 **Lock caisson**, used in place of gates and floated into position.
- 31 **Balanced swing landing-stage.**

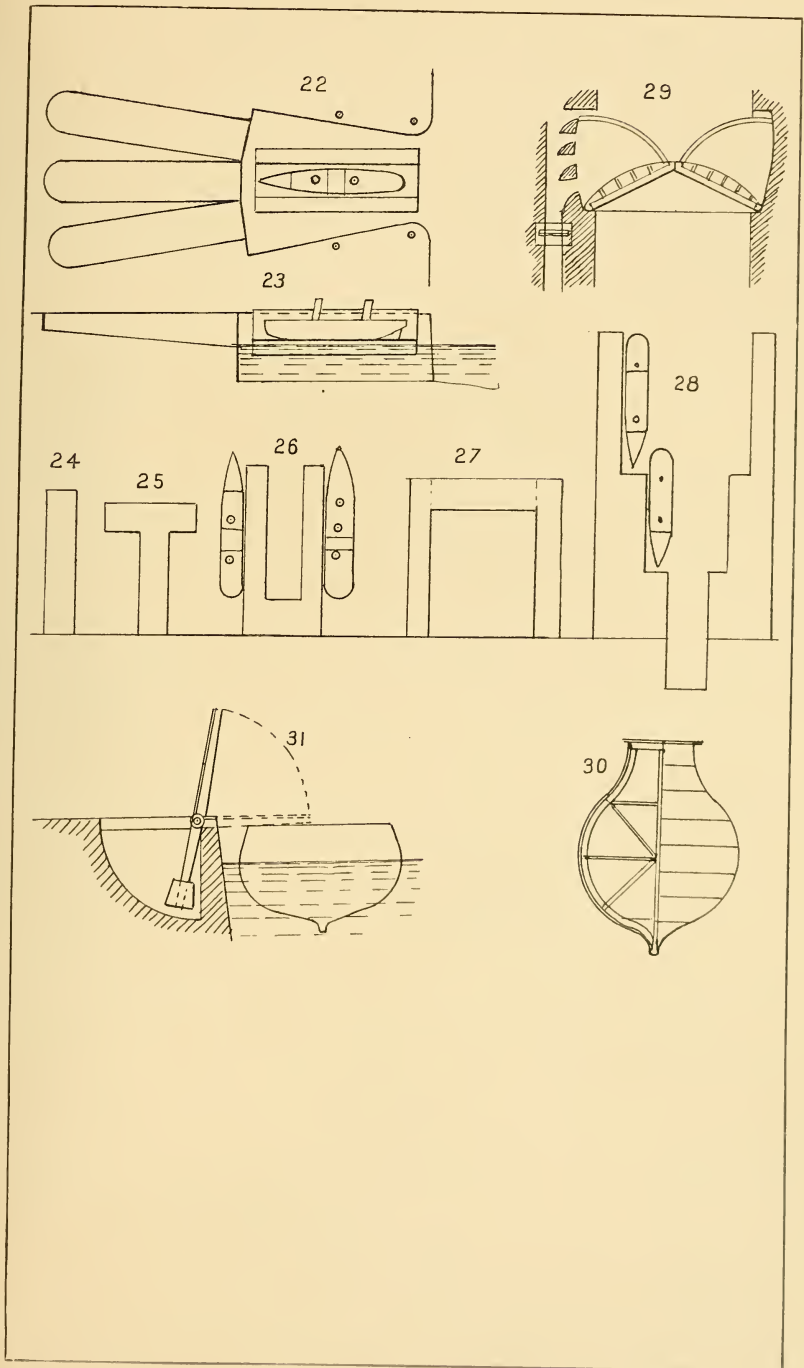

Section 32.—LIGHTHOUSES, BUOYS, BEACONS, MOORINGS.

- 1-6 **Various forms of buoys**, with and without cages or bells, used to mark channels or sunken rocks or shoals, and their form and colour varied to indicate their purpose.
- 7-10 **Beacons** for similar purposes, usually fitted with screws and screwed into the sea bottom. (See also Section 30.)
- 11 **Lighthouse of tower form** of cast-iron plates, with gallery and lantern on stone or concrete base. The light-rooms, stores, and lightkeepers' rooms are all in the interior with a spiral stair to the lantern.
- 12 **Screw pile sea lighthouse** with upper platform carrying the stores, and living-rooms. This type is often fixed to rock foundation by special rock-boring screws.
- 13 **Masonry lighthouse** of the Eddystone type, built on a rock which is exposed at low water. All the stores and living-rooms are in the interior of the tower. The masonry is usually toggled or dovetailed together.
- 14 **Masonry lighthouse** for a headland or elevated position with short tower, gallery, and lantern. The stores and dwellings are in the adjoining building.
- 15 **Cylindrical caisson foundation** for a lighthouse as No. 30. The caisson is filled with concrete and may be protected by a mound of rubble.
- 16 **Screw pile lighthouse** for a shoal or sunk rock, with large platform and iron building containing the stores and dwellings.

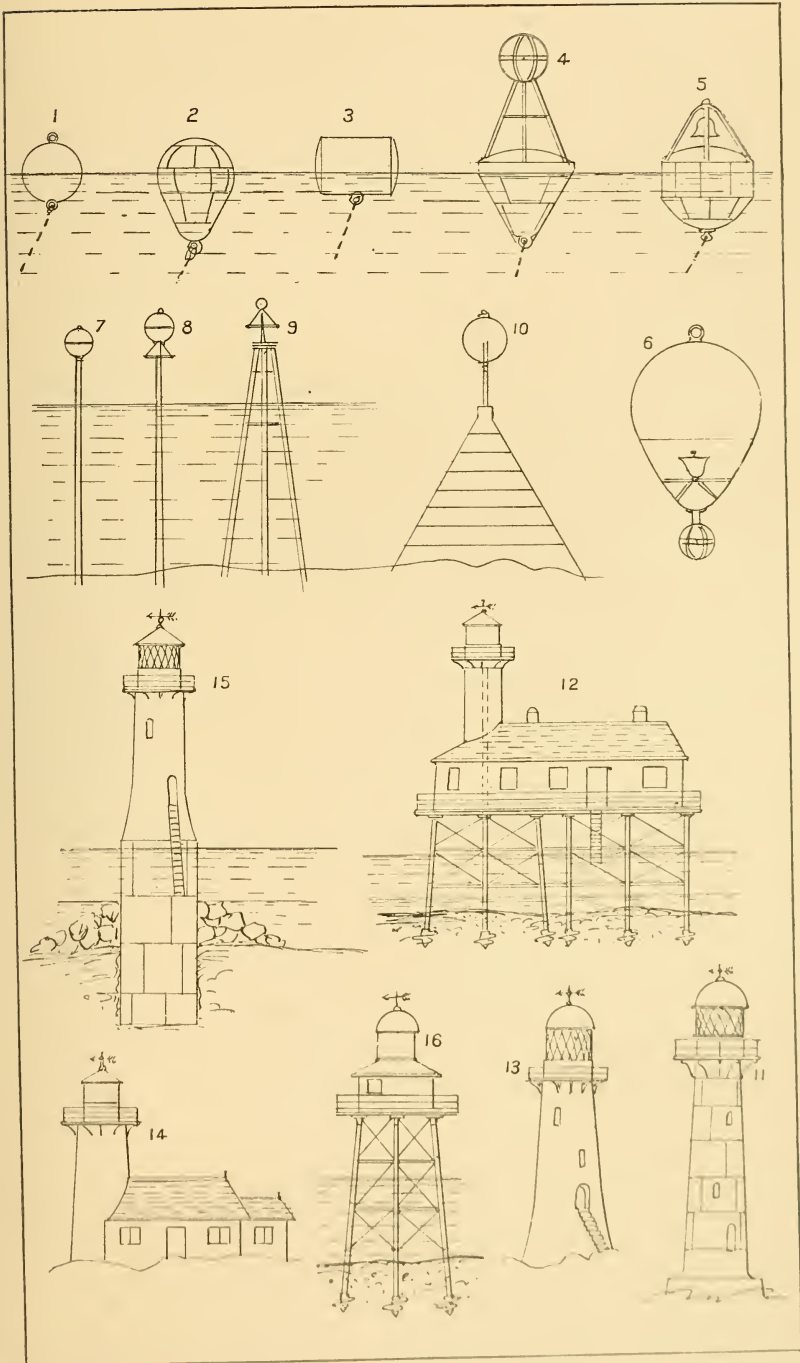

Section 33.—DISPOSAL OF REFUSE, ETC.

Town refuse : Is ordinarily conveyed by collecting vehicles to municipal destructors and burned.

Destructors are of two classes—

1. Low temperature furnaces ; the products of combustion escaping into the atmosphere.
2. High temperature ; the hot gases being utilized to generate steam in boilers, the power being applied to municipal services, as electricity production, pumping sewage or water, gasworks power, etc.

The remaining clinker and ash are used for road-making, concrete and mortar mixing.

Tipping refuse on land : Usually on low land which needs raising or levelling and not too near to dwellings.

As manure : The refuse is seldom of a quality suitable for manuring, although much of it is so used.

Street sweepings are, however, good and valuable as manure.

Trades wastes from paper mills, bleach works, wool cleaning, chemical works, tanners and leather works, bleachers and dyers, etc.

The wastes are treated : 1, *chemically* to recover useful constituents, or combine them into saleable substances. 2, by *precipitation* in tanks or reservoirs. The liquor is chemically or

bacterially treated to form an innocuous effluent, and discharged into a stream or sewer. The sludge is treated chemically or dried for use as a manure, and in most cases considerable quantities of valuable by-products are obtained from both the liquors and the precipitates.

Drainage (see Section 3) carries away a very large proportion of town and domestic refuse from streets, house drains, roofs, open yards, closets, and sinks.

Section 34.—TANKS AND CONTAINERS.

- 1 **Railway water crane** and tank.

- 2-6 **Plans of cast-iron or steel tanks** of various forms.

- 7 **Tubular heating tank.**

- 8 **Square wrought-iron tank.**

- 9 **Circular cast-iron tank.**

- 10 **Evaporating or heating tank**, containing numerous sloping shelves.

- 11 **Similar tank**, vertically arranged.

- 12 **Similar tank** with diagonal shelves or diaphragms.

- 13 **Saddle tank.**

- 14 **Hot-water tank.**

- 15 **Steel gas bottle** for high pressure.
(See also Section 44.)

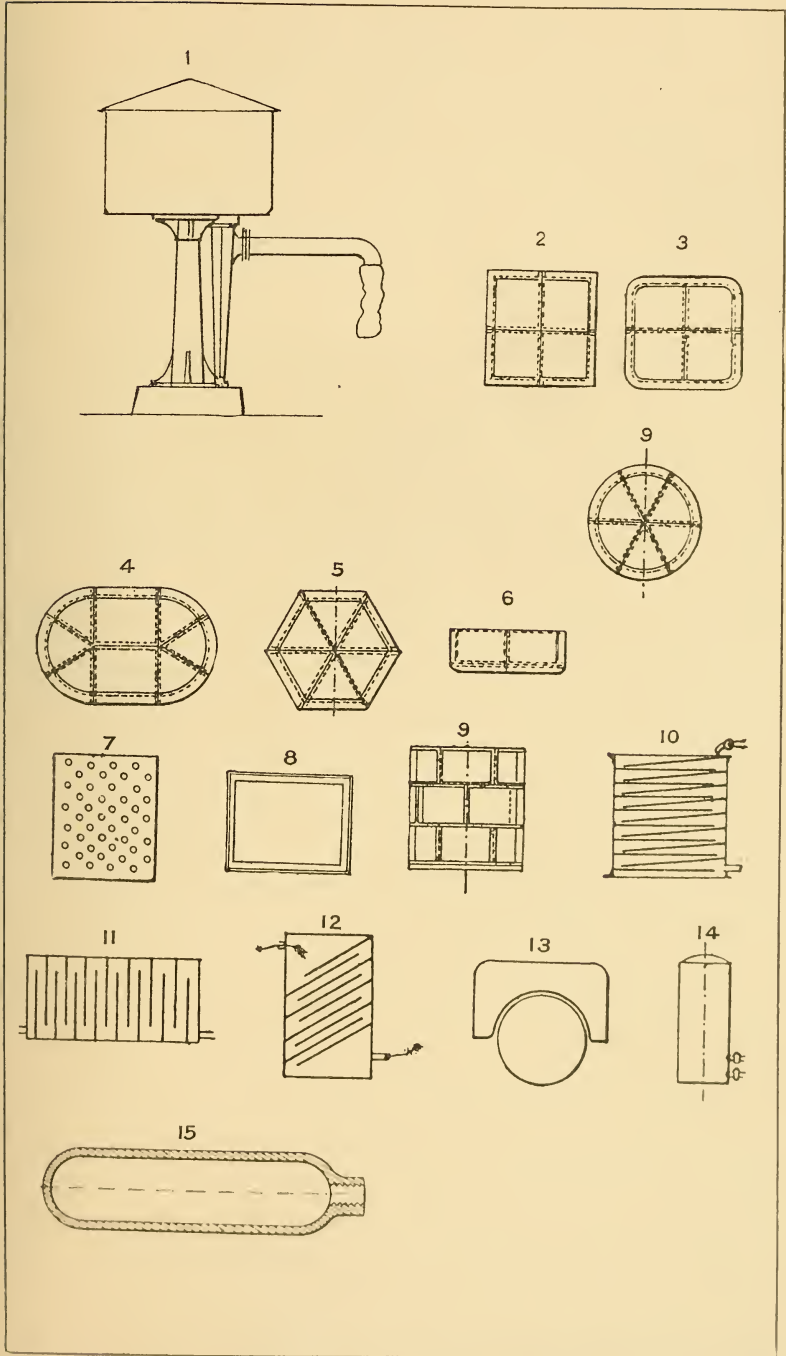

Section 35.—MINES AND WELLS.

Ventilating mines. (See Section 25.)

- 1 **Plan of circular mine shaft.** There are usually six cage guide timbers framed together, also pump rods, rising main, and pipes for compressed air, etc.
- 2 **Plan of elliptical mine shaft** with similar fittings.
- 3 **Mode of sinking shafts or wells** by cast-iron or steel cylinders, sometimes lined internally with brickwork and loaded to assist sinking. The soil and water are removed from the interior by hoisting and pumping. (See Section 1.)
- 4 **Well sinking** by cylindrical brick cylinder. The lower section, penetrating water-bearing strata, is built with holes or in dry brickwork. The cylinder is loaded to assist sinking.
- 5 **Well sinking** by cast-iron or steel cylinder.
- 6 **Brick-lined well** in soft ground continued down into rock or hard strata without a lining.
- 7 **Mode of timbering a shaft** for sinking in soft strata.
- 8 **Another method**, permitting the top diameter to be maintained throughout.
- 9 **Coal or mineral washer.**
- 10 Ditto, and separator.

Tube wells, put down singly or in groups or series, are tubes with the lower lengths perforated and driven down to water-bearing strata. An internal suction pipe is used for pumping, and several wells may be connected to one pump.

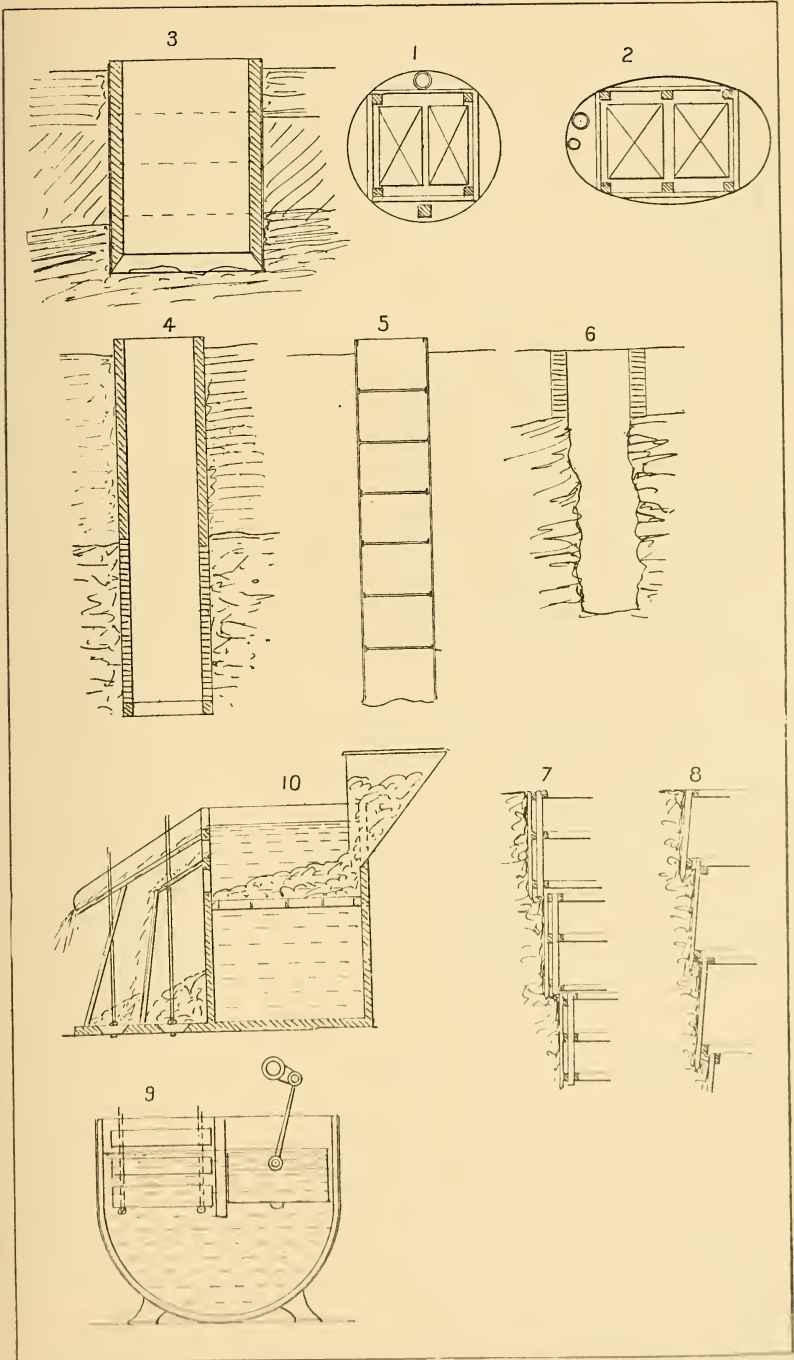

- 11 **Mine-cage governing gear** to control speed of cage.
- 12 **Cage safety gear**; kept out of action by the pull of the hoisting rope.
- 13 **Another method.**
- 14 **Cage safety hook**, detaches the cage if drawn too high.
- 15-16 **Cage indicators for winding engines.**
- 17 **Section of cage rope pulley.**
- 18-19 **Cage safety gears**, as No. 12.
- 20-1 **Horizontal winding engines.**

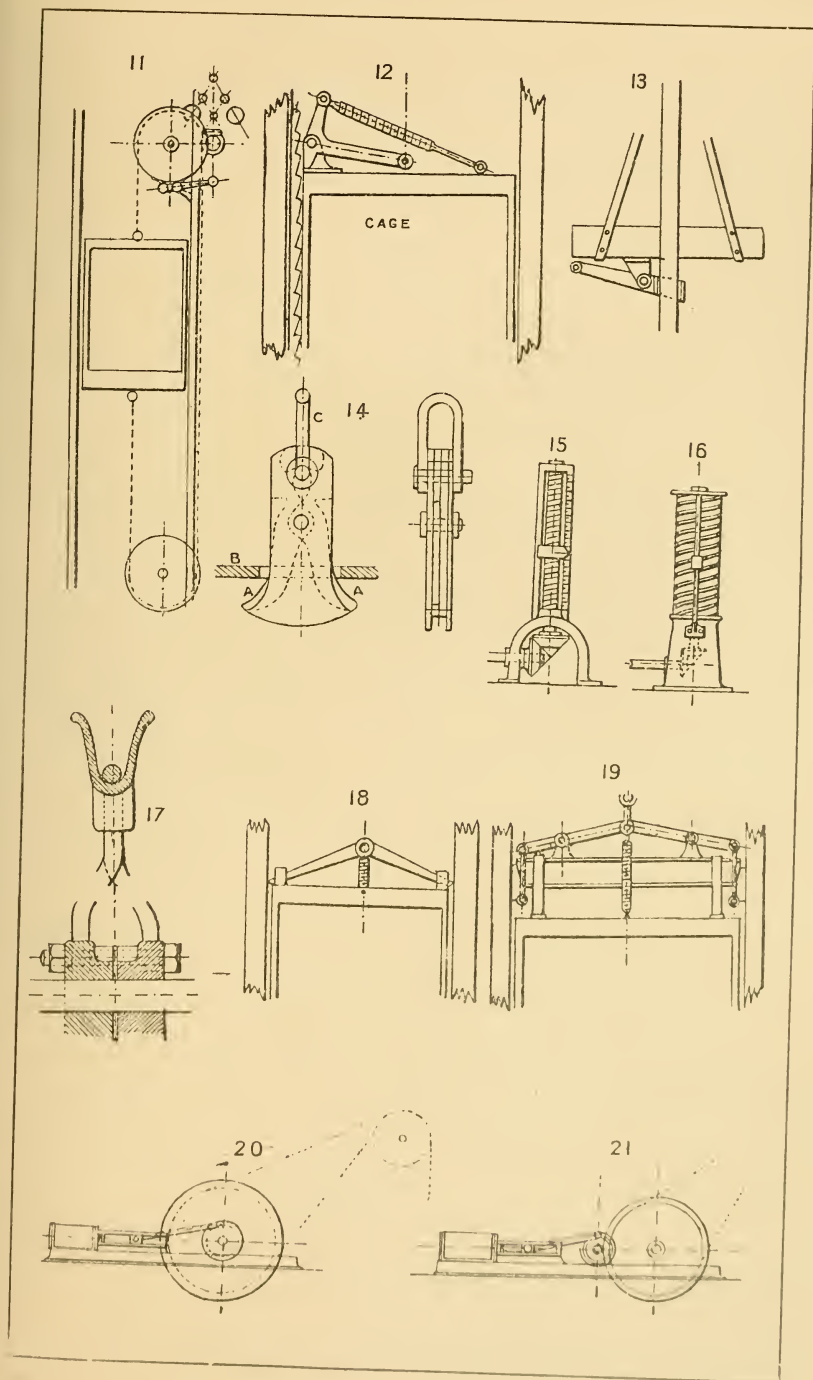

Section 36.—FENCING.

- 1 **The common sod hedge.**
- 2 **Thickset hedge.**
- 3-4 **American rail fence, laid zigzag.**
Tree stumps and roots are also placed close together to form a rough fence.
- 5 **Split post and wire fence.** The uprights are woven in with the wires, so that the fence can be rolled up for carriage.
- 6 **Open or close pale and rail fence.**
- 7 **Ditto, with triangular rails.**
- 8 **Lattice and rail fence.**
- 9 **Post and three-rail fence** for cattle.
- 10 **Five-wire fence** with wood posts. Varieties of this fence have from three to seven wires, the lower wires thicker than the upper; also iron standards as Nos. 19, 20.
- 11 **Three-rail split-rail fence.** The rail ends have bevelled ends to lap in the post mortises.
- 12 **Two-rail fence** with lattice upright or diagonal panels.
- 13 **Rustic fence** formed of tree branches.
- 14 **Galvanized corrugated sheet-iron fence**

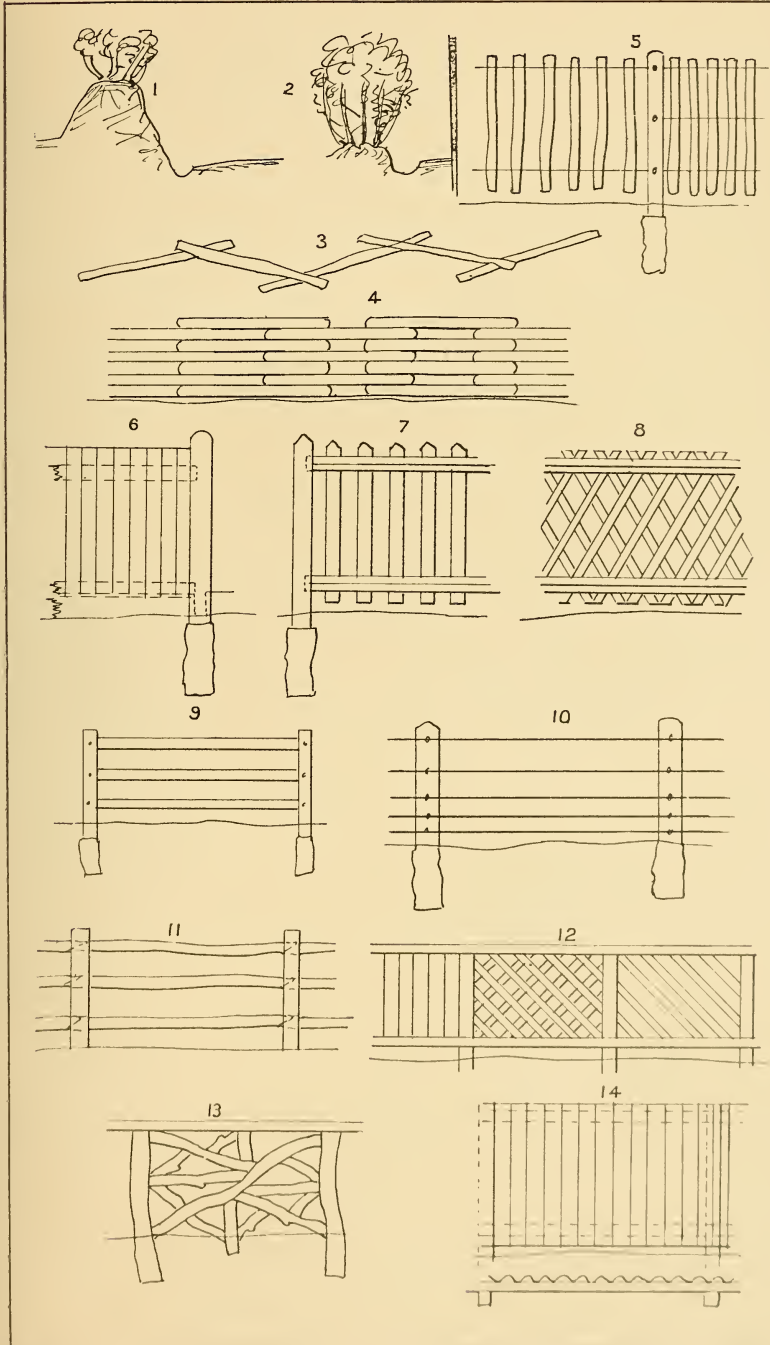

- 15 **Three-tube fence** with cast (or other) posts. The tubes are usually ordinary gas-pipes, galvanized and joined by the ordinary unions.
- 16 **L iron rail fence**, with **T** iron (or wood) posts.
- 17 **Tube fence** with wood posts.
- 18 **Garden fence** of stout wire, with **L** or **T** iron posts.
- 19 **Post and strut** with footplates for the ground.
- 20 **T or L iron posts and struts** and mode of fixing to a bridge girder.
- 21-2 **Panelled brick boundary wall.**
- 23-9 **Various forms of stone copings** for masonry or brick boundary walls.
- 30 **Stone open parapet** with turned balusters.
- 31 **Rolling gates** for bridge or level crossing.

Fencing posts are also made of reinforced concrete or vitrified clay or shale, also many sections of steel or iron bars and tubes.

Holes for fencing posts are sometimes blasted by small sticks of dynamite (40%) sunk in holes jumped in the ground, or bored by a screw auger.

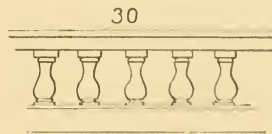
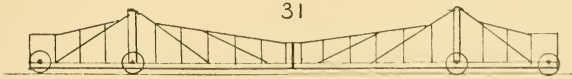
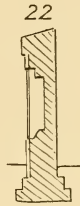
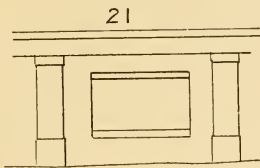
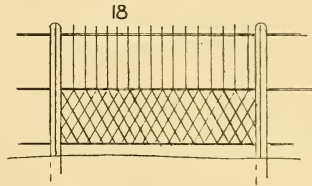
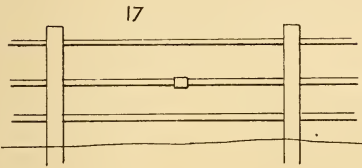
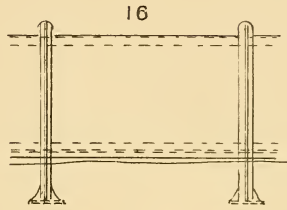
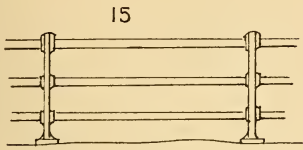

Section 37.—STAGING AND FALSE WORKS.

(Forms, etc., for reinforced concrete work, Section 41.)

- 1 **Centering for a semicircular arch** with side supports.
- 2 Ditto, with four supports.
- 3 Ditto, with side supports.
- 4 **Centering for an elliptic arch** supported on corbels.
- 5 **Braced centering** for an elliptic arch with striking wedges at the springing.
- 6 **Strutted centering for a flat arch.**
- 7, 8 **Braced centerings for elliptic arches.**
- 9 **Centering for a segmental arch,** supported on a braced centre framing.
- 10, 11 **Temporary timber viaduct.**

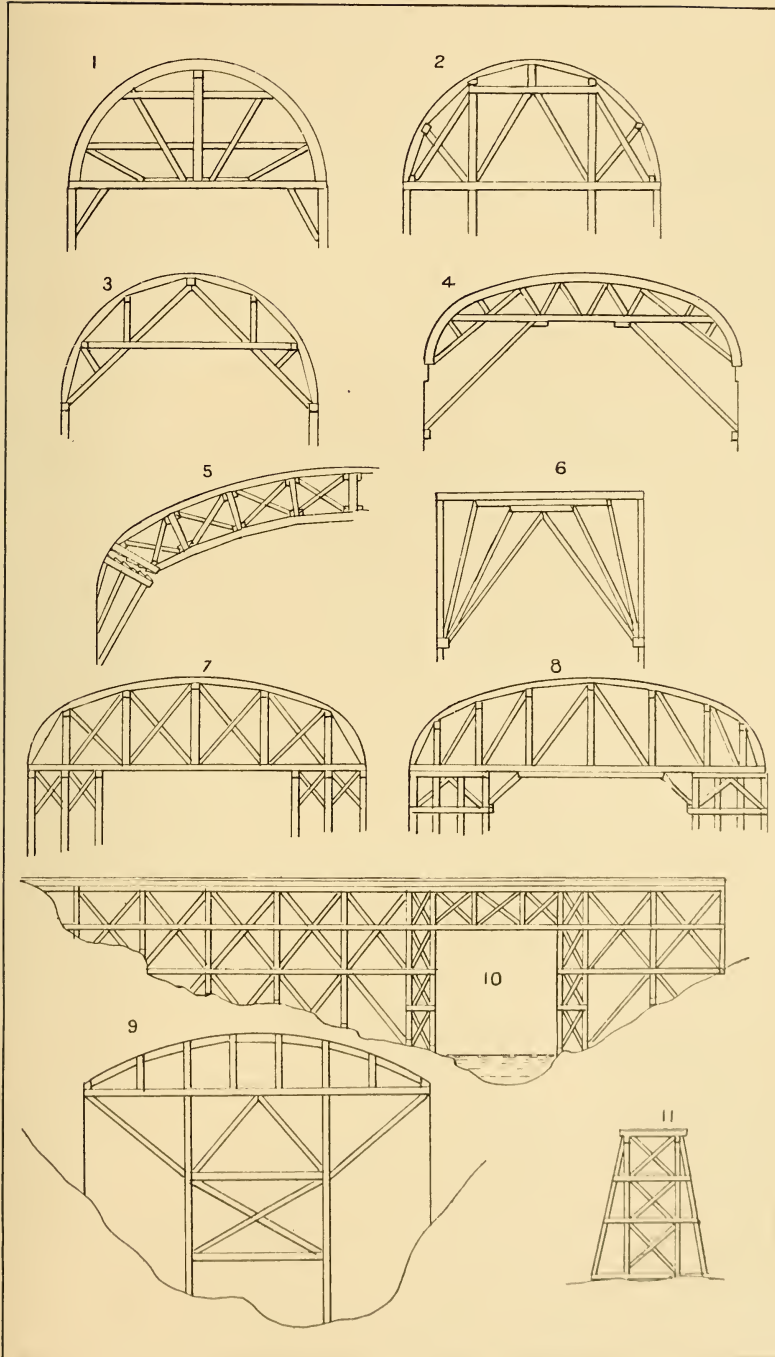

- 12 **Centerings for a high girder viaduct** of long spans, with masonry piers.
- 13 **Centering for long-span girder viaduct**, with travelling crane for constructing the girders.
- 14, 15 **Ordinary builders' scaffold** for house building ; formed of poles, putlogs, and planks, and reached by ladders, materials being hoisted by a rope pulley or winch.
- 16 **Continental builders' scaffold** of poles, planks, and putlogs, reached by incline stages, the materials being carried or wheeled up the inclines.

The centerings shown are types of which there have been very many varieties designed and used. Every country has its own designs of centerings.

- 17 **Travelling stage** for use inside a railway station or other building, to clean or repair skylights, etc.
- 18 **Floating barges and stage** to carry a cylinder caisson into position.

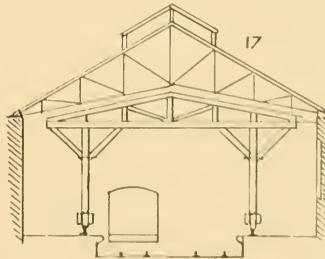
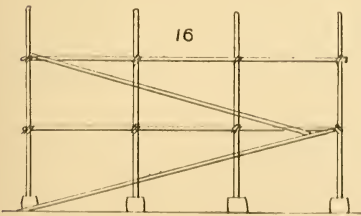
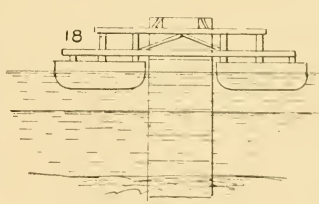
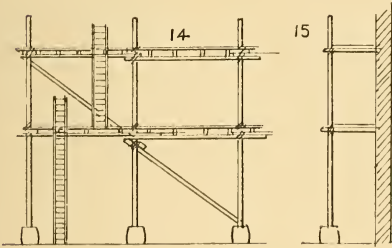
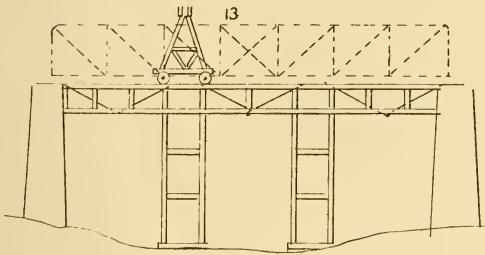
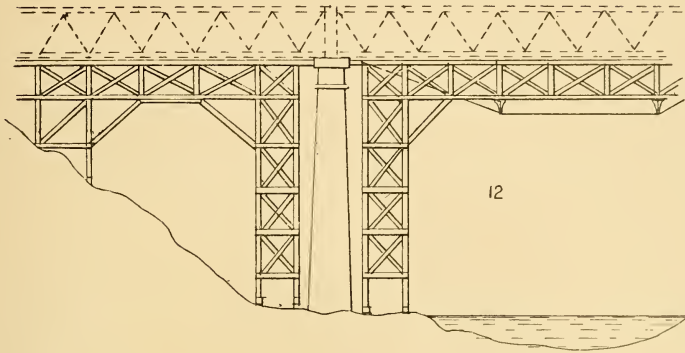

- 19 **Floats and stages** to carry a long girder and deposit it in position in a tidal river.
- 20 **Staging and capstan** used for screw piles.
- 21 **Floats to carry a caisson** or cylinder to its site.

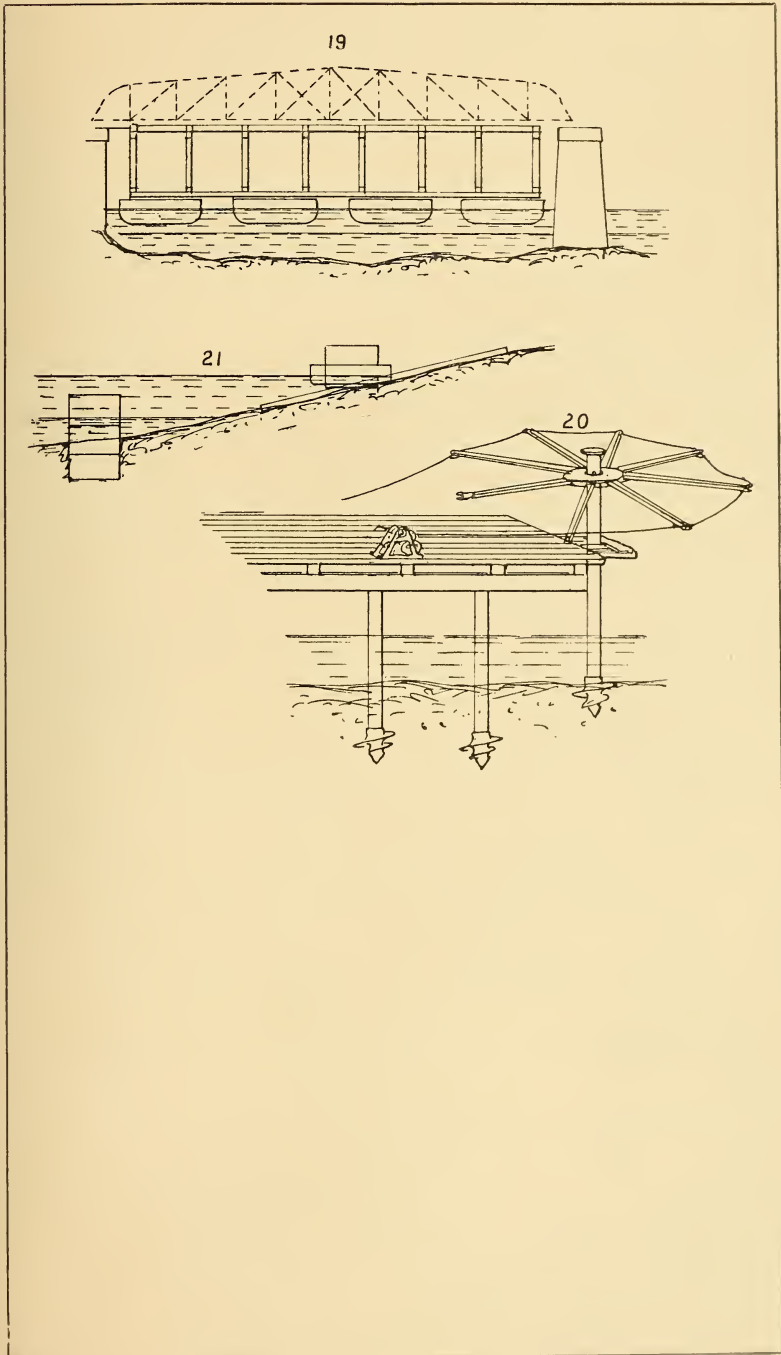

Section 38.—HOISTING MACHINERY.

- 1 **Is a common type of wharf crane**, but with the post, revolving in a footstep and base plate ; this gives a better base than where the post is fixed in a base plate.
- 2 **Has no post**, but a revolving frame and base plate with front and back friction rollers and a centre pin.
- 3 **Post and jib in one piece**, usually of wrought iron. A balance weight is fixed at **A** to balance the overhanging jib.
- 4 **Swing derrick crane**, generally of wood. The jib turns three-fourths of a circle, and the two guys are fixed at an angle of 90° apart, and well secured by anchoring or loading : often made with very long jib for builders' work, and mounted on three tall framed stages to enable the crane to reach every part of a building.
- 5 **Wharf crane**, with centre tension bolt instead of crane post. In this arrangement there is a vertical tension on the centre bolt and thrust on the foot of jib.
- 6 **Warehouse wall crane.**
- 7 **Warehouse wall crane, with high jib-head.**
- 8 **Whip crane**, chiefly used in goods sheds. The barrel is sometimes worked by an endless handrope as shown, and sometimes by a second rope and drum with a hand crank.
- 9 **Portable hand crane**, with balance weight. The balance weight can be shifted in or out to balance the load.
- 10 **Foundry crane**, sometimes with travelling carriage on the jib, as No. 11.
- 11 **Swing bracket crane** and traveller, usually formed of flat bars on edge ; used only for light loads, for smiths' shops, etc.
- 12 **Wharf derrick**, to turn an entire circle, similar to No. 4, but employed for heavy loads.
- 13 **Floating derrick.**
- 14 **Light balance crane.**

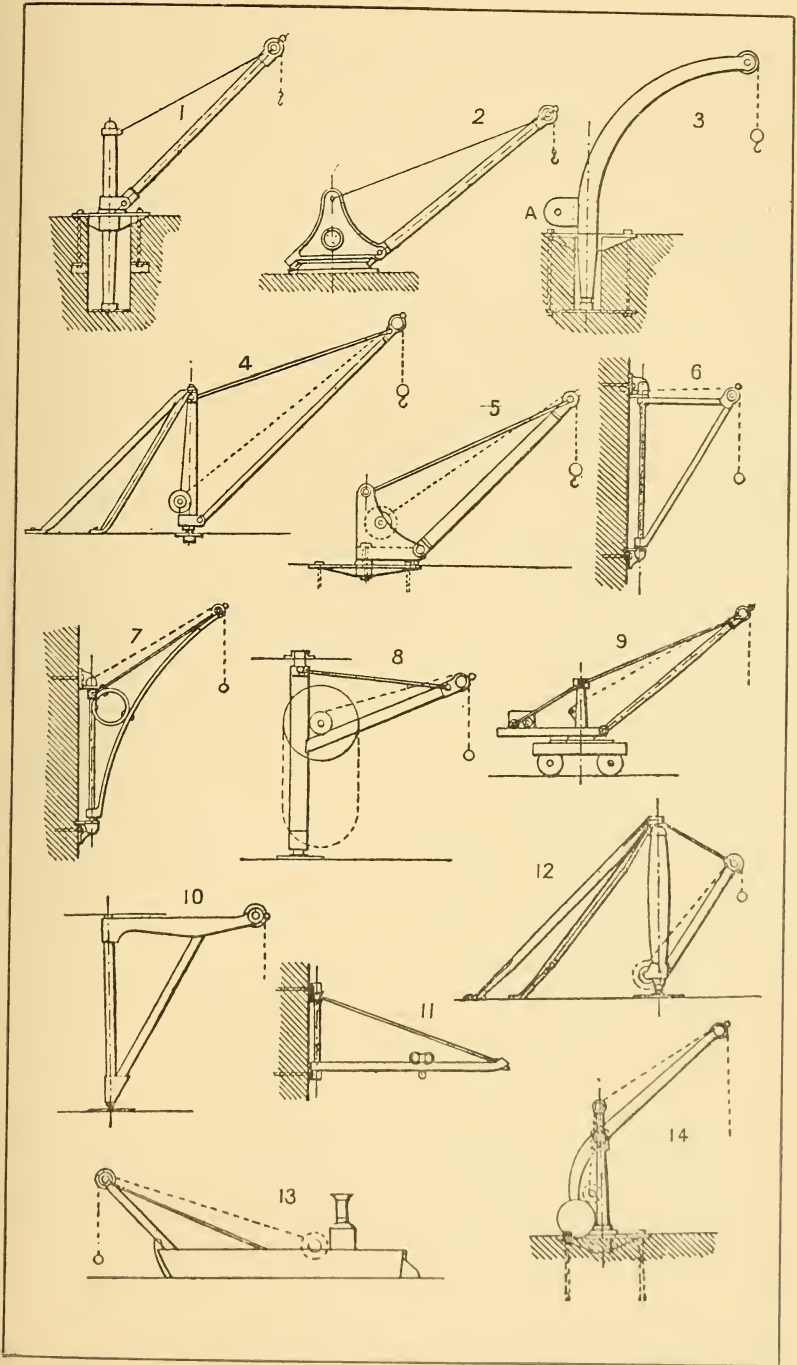

- 15 **Trussed jib crane**, with centre tension bolt.
- 16 **Simple derrick and winch**, with two or three guy ropes ;
for temporary purposes only, and may be easily shifted about.
- 17 **Sheers and winch**.
- 18 **Tripod and winch**.
- 19 **Sheers with screw adjustment** to back leg. This design
is adopted for very heavy lifts, such as loading heavy
machinery, shipping-masts, boilers, etc.
- 20 **Four-guy derrick and winch**, used for fixing columns,
bases, masonry, etc.
- 21 **Fixed post steam crane**, for wharfs, piers, jetties, harbour
works, etc.
- 22 **Portable steam crane**, very largely used on wharfs, piers,
etc., and sometimes fitted with travelling gear in addition to
hoisting and slewing motions.
- 23 **Wharf crane**, with fixed engine, centre bolt, and trussed arched
jib. This is a very good type, as the ground is kept clear for
goods, etc., and of course all motions, hoisting, lowering, and
slewing are controlled from the crane above ground by hand
levers.
- 24 **Hydraulic wharf crane**, with fixed post. The common type
universally used in docks, etc., with the ordinary form of
multiplying hydraulic cylinder and chain gear: the valve for
controlling its movements is operated by hand levers ex-
tending up through slots in the floor; the slewing is performed
by a separate cylinder and chain gear, with a distinct con-
trolling lever.

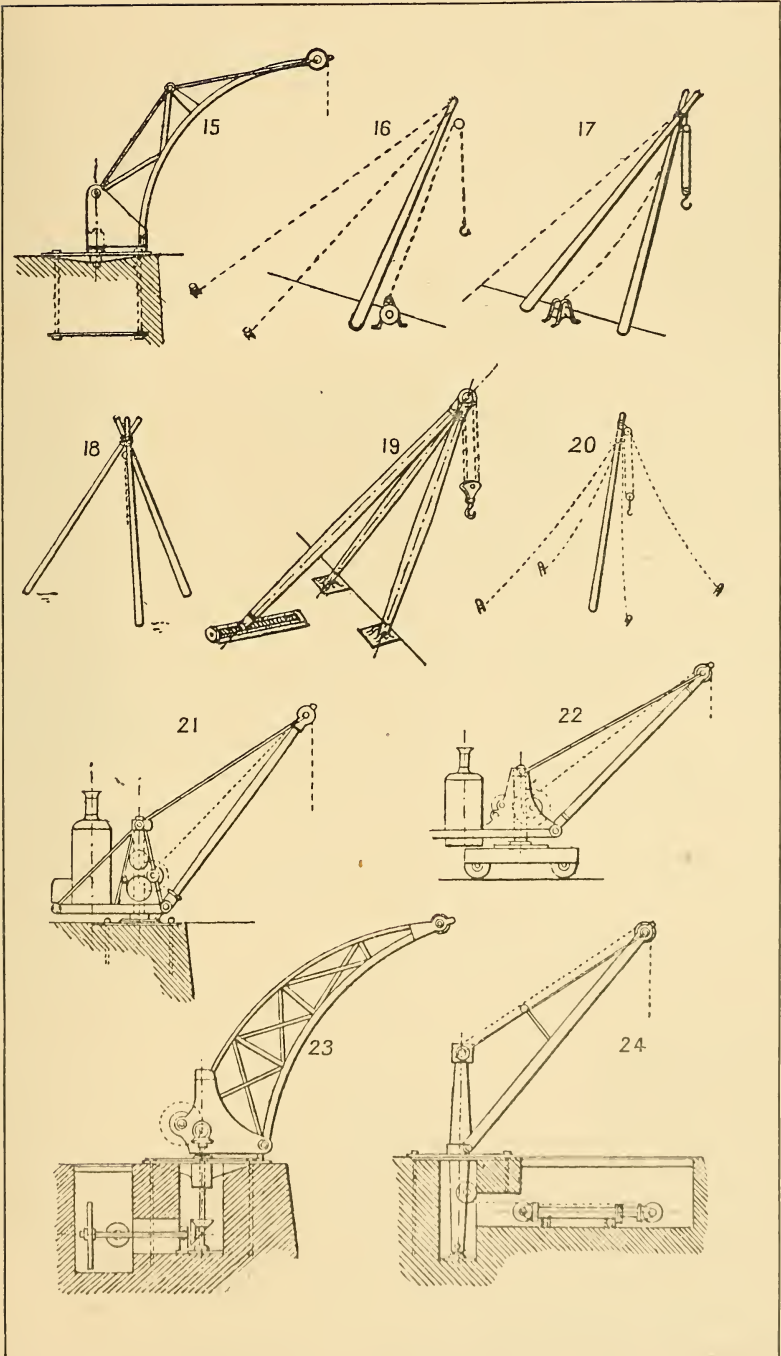

- 25 **Hydraulic short lift ram, centre crane, and traveller**, employed chiefly to raise the ingots out of the casting pits of Bessemer steel works. The ram is of course subject to severe cross strains, and many designs provide an overhead guide or support for the ramhead.
- 26 **Automatic balance crane**, portable or fixed: the position of the fulcrum varies with the load.
- 27 **Steam multiplying cylinder crane**, in which the ram is forced out by steam pressure, acting either directly or by an intervening body of water.
- 28 **Breakwater swing crane**.
- 29 **Overhanging travelling crane**, for use on breakwaters, etc.
- 30 **Overhead hydraulic travelling goliath**, to span a railway: has slewing motion and a balanced jib.
- 31 **Single rail crane** with top guide rail.
- 32 **Overhead traveller** on gantry.
- 33 **Goliath**.
- 34 **Steam overhead crane**, with carriage to span a railway. Largely used on dock wharves, etc., as they have a high lift and do not encumber or encroach on valuable quay space.
- 35 **Hydraulic cylinder post crane**; sometimes adopted instead of the type No. 24.

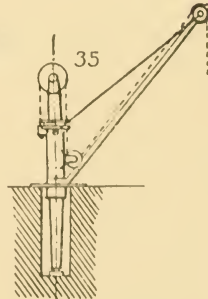
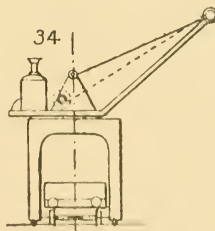
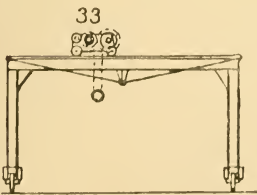
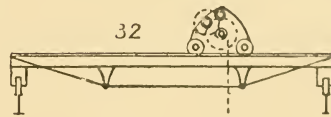
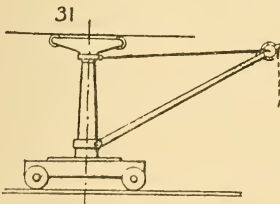
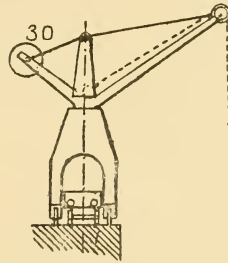
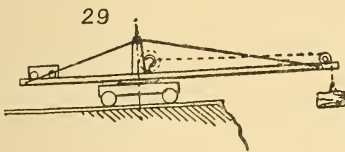
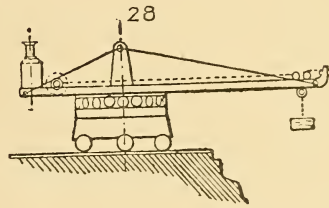
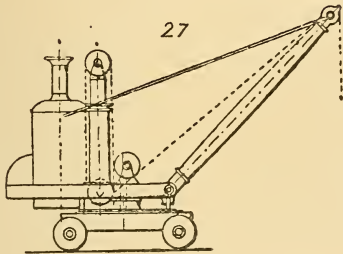
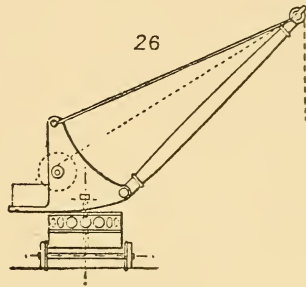
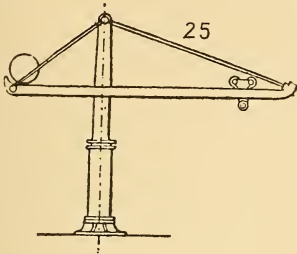

- 36 **Heavy hydraulic crane**, with suspended cylinder ; employed for work of the very heaviest type.
- 37 **Ship's davit**.
- 38 **Balanced jib post crane**, no tie-rod. The weight must be sufficiently heavy to balance the jib and load.
- 39 **Hydraulic strut jib crane**. The load is raised by raising the jib.
- 40 **Overside dock crane**, for discharging from ships into barges. The overhang being very great in this design, it must be provided with a heavy frame or balance weight.
- 41 **Wagon tip crane**, for loading vessels.
- 42 **Double sheave** 4 to 1 purchase for crane jib.
- 43 **Crane with rising jib**.
- 44 **Suspended travelling hand crane**.
- 45 **Basement crane**, projected diagonally upward when in use. The winch is a fixed one.
- 46 **Loophole crane**, projected horizontally when in use by a hand-rope gear working a pinion and rack, or by a chain wound upon a barrel.
- 47 **Travelling wharf crane** to span a railway.

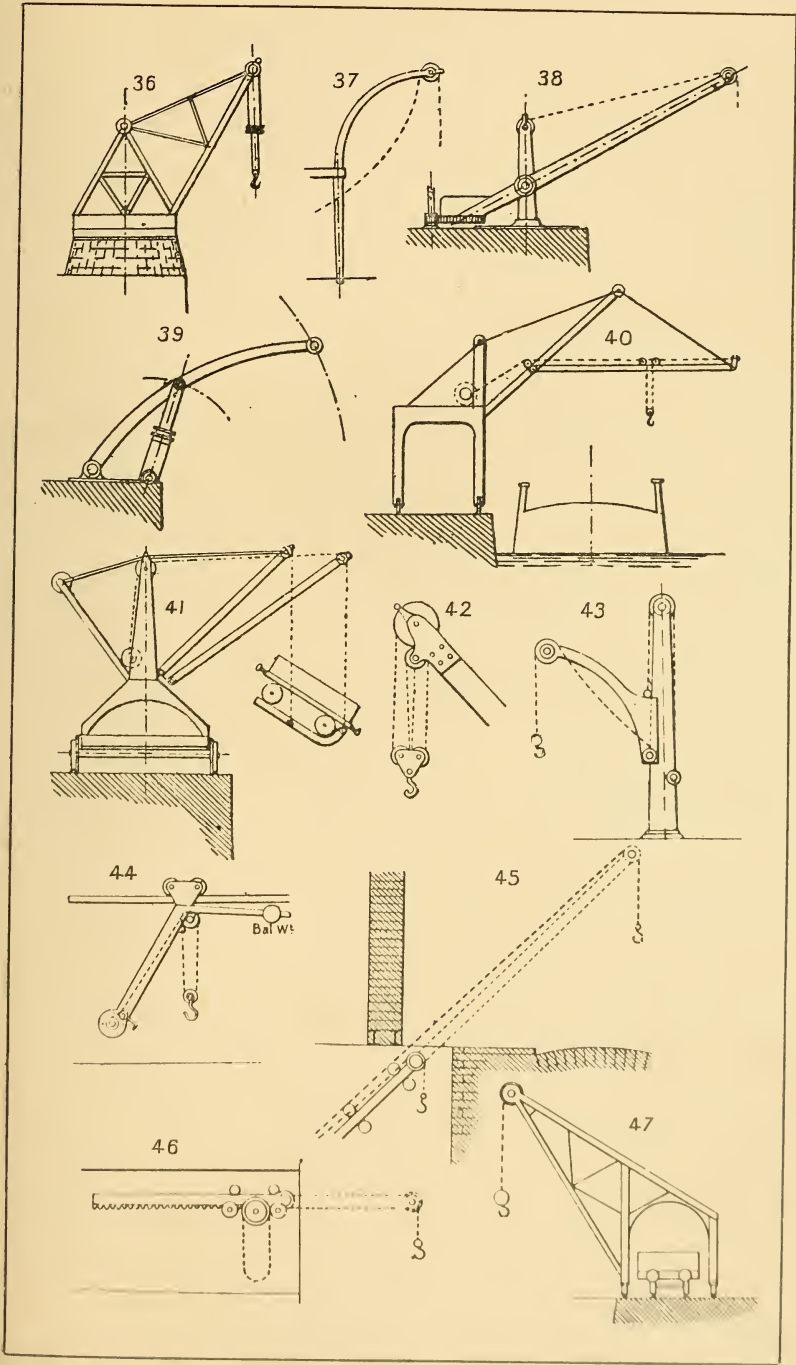

- 48 **Wharf goliath**, with swinging beam and traveller.

- 49 **Gantry crane** or **transporter** to unload from a vessel and deliver into trucks.

- 50 **Roof traveller crane**.

- 51 **Wharf crane** with elevated inner rail.

- 52 **Transporter**.

- 53 **Gantry crane**.

- 54 **Long jib wharf crane** to reach over two or three vessels.

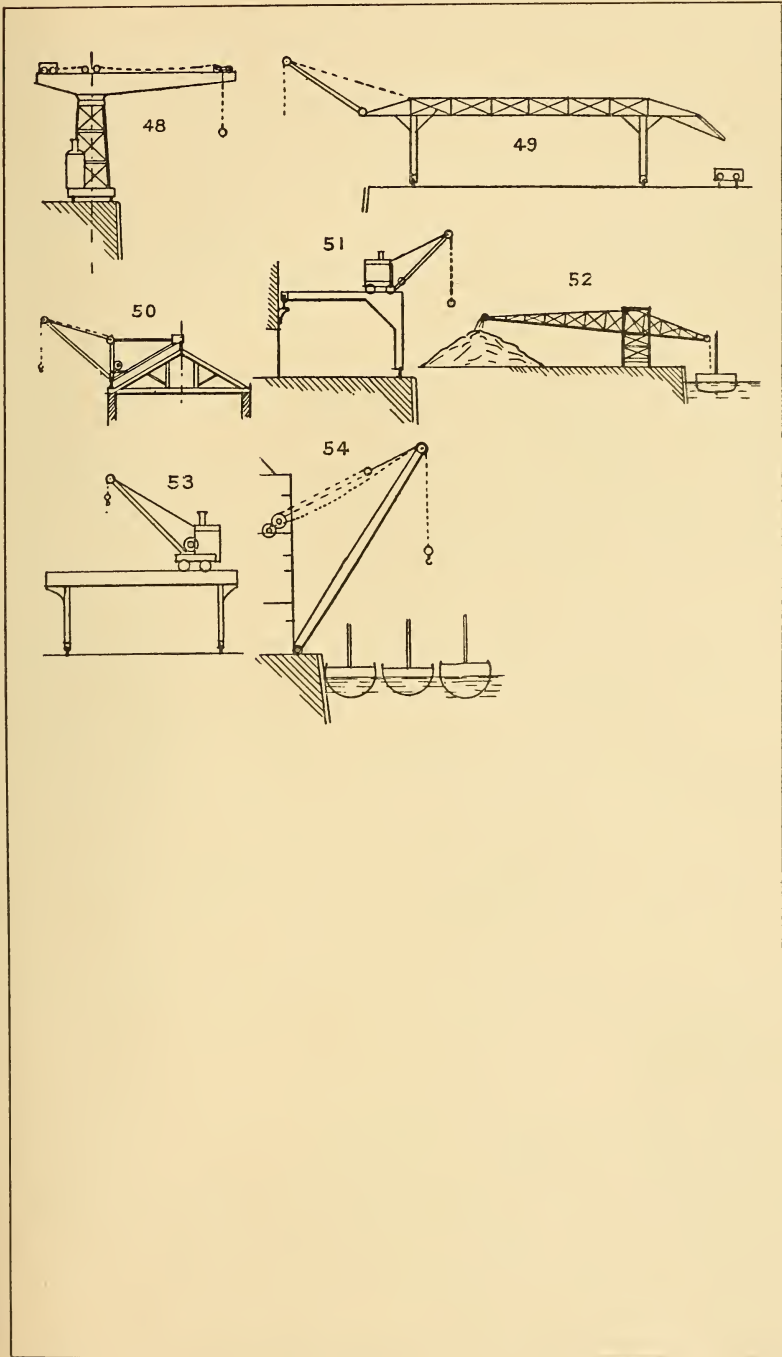

- 56 **Travelling crane** or **goliath** running on rails laid on the ground.
- 57 **Overhead type travelling crane**, running on overhead girders, with staging and derrick for fixing roof principals.
- 58 **Jetty or pier pile-driving travelling stage** and steam hoisting engine.
- 59 **Jetty or wharf end crane.**
- 60 **Travelling hydraulic wagon**, hoisting, tipping, and discharging stage.
- 61 **Revolving cantilever crane.**
- 62 **Wharf crane with jointed jib** for quick discharging.
- 63 **Travelling transporter** for unloading coal, etc., and depositing it in heaps.

Builders' steam derrick cranes, as No. 4, for high and extensive buildings are mounted on a triangular platform raised above the building on three framed timber piers on towers braced together and fixed inside the building.

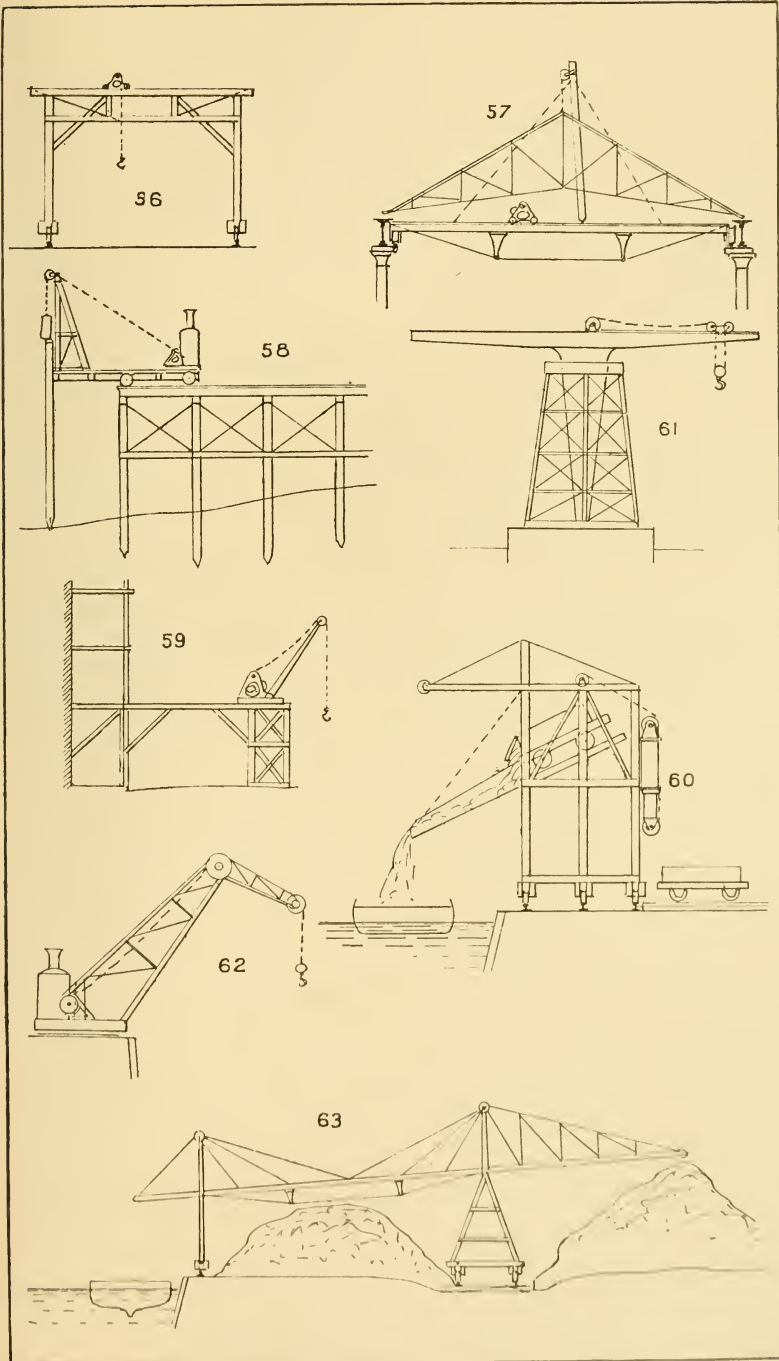

Section 39.—SUBMARINE ENGINEERING.

(See also Sections 29, 30, 32, 39.)

- 1 **Canal dredger**, with one, two, or three sets of chain buckets. The material is usually fed into a side trough or conveyor and dumped on the canal bank, or shot into drop-bottom barges and deposited in deep water. (See Section 24 and Nos. 6, 7.)
- 2 **Bottom dredger** for deepening a harbour or river or removing shoals. The material is shot into barges with drop bottoms and sunk in deep water.
- 3 **Water or compressed air injector jet suction.** Dredger for sand or mud bottom. Has a pipe line to convey the material to the shore.
4. 5 **Submarine tube tunnel** and mode of laying on prepared or pile foundation and afterwards covered with concrete in mass in form of a bank.
- 6 **Canal dredger**, discharging on to a bank tip.
- 7 **Canal bank chain bucket dredger**, travelling on a railway laid on the canal bank.
- 8 **Dolphin**, a group of piles braced together used as a protection to a pier.
- 9 **Ground chain moorings and screws** for harbour buoys.

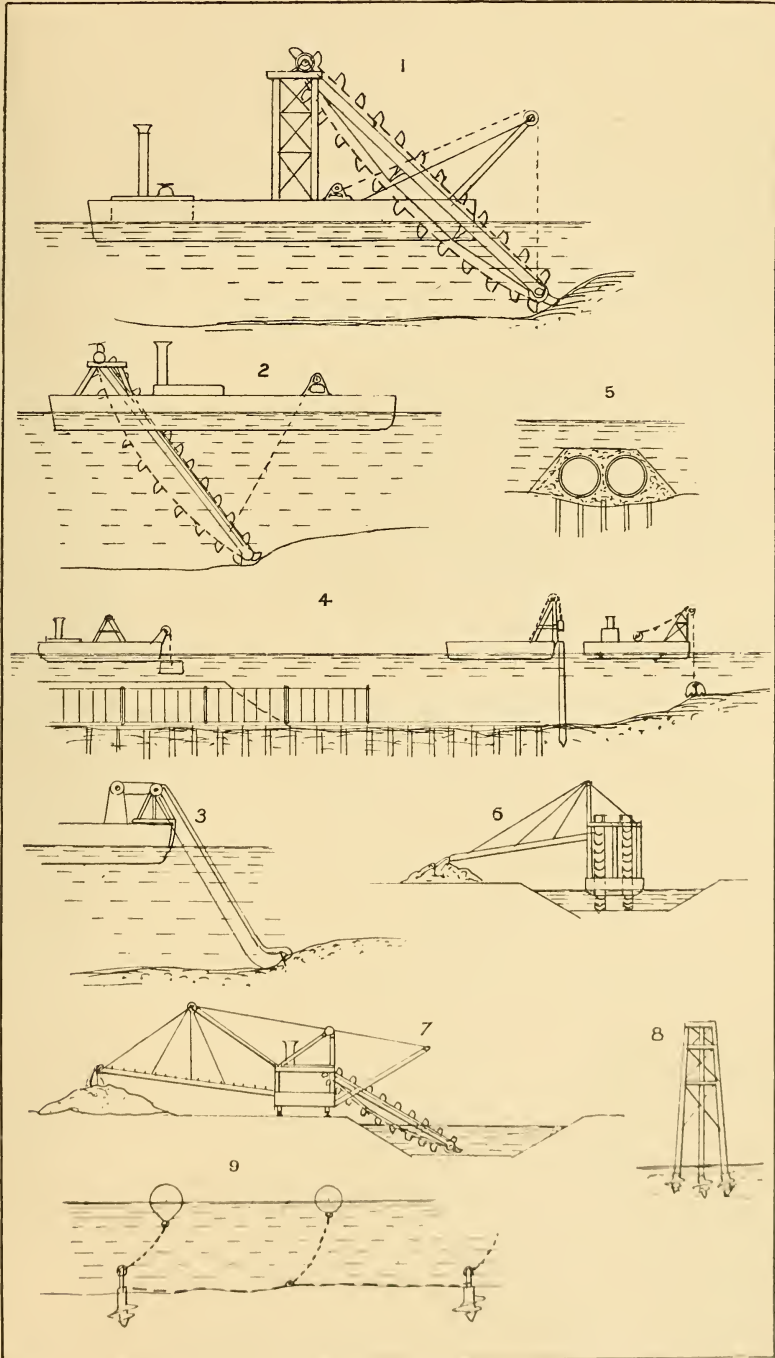

Section 40.—OPENING BRIDGES.

- 1 **Balanced lifting bridge** for short spans.
- 2 **Rolling and lifting bridge**, with balance weight for short spans.
- 3-4 **Single swing bridge**, supported on a strut frame fitted with rollers running on a curved rail on the bottom.
- 5 **Double balanced lifting bridge**, with overhead fixed bridge to be used when the lower bridge is open to the river.
- 6 **Swing bridge on a turntable**, carried by an air float.
- 7 **Lifting bridge**, with winch gear, usually balanced.
- 8 **Double swing bridge** on a central pier, giving two openings.
When open it is protected from drifting vessels by dolphins or pile tenders.

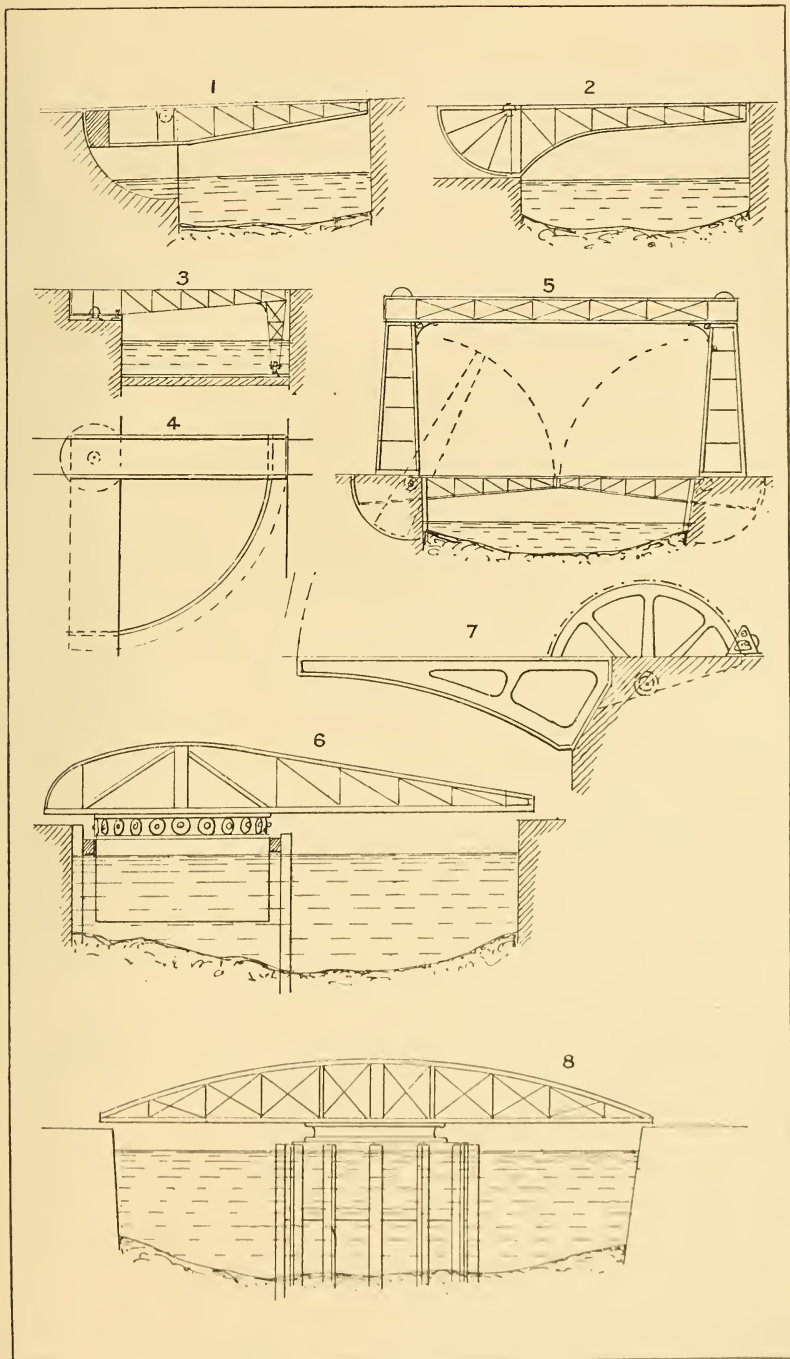

- 9 **Transporter bridge.**

- 10 **Single swing bridge** on a turntable.

- 11 **Double swing bridge** on central caisson pier.

- 12 **Telescopic bridge at Queen's Ferry, Chester.** The central opening span is balanced by weights and runs back on rollers under the floor of fixed side span. The central floor is hinged to swing arms and falls far enough to pass under the floor of the fixed span.

- 13 **Rolling bridge with lateral approach.**

- 14 **Balanced lifting bridge.**

- 15 **Double-leaf lifting bridge.** The lifting beams have balance weights on their inner ends.

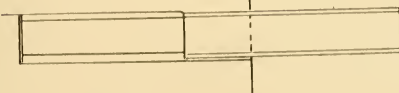
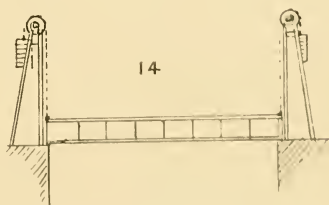
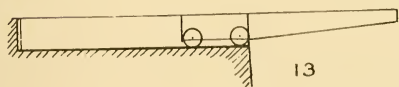
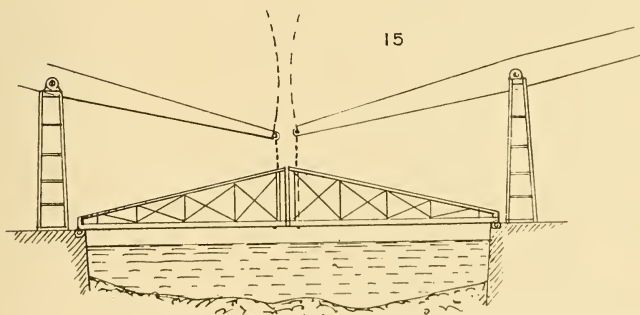
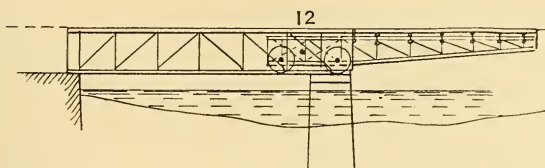
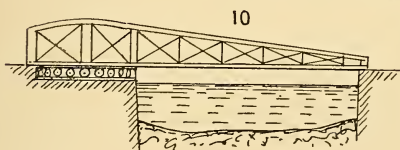
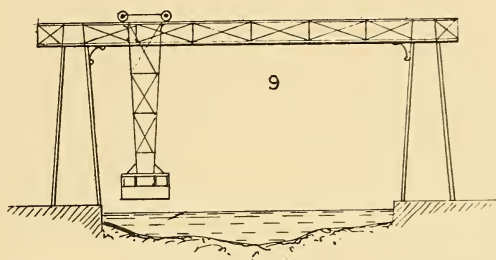

Section 41.—ROOFS.

TIMBER ROOFS.

- 1 Simple triangular truss with king rod (or post).
- 2-3 Queen post trusses.
- 4-5 Church roof trusses.
- 6 Gothic arch truss.
- 7-8 Church roof trusses.
- 9-10 Arched roof trusses, framed and braced.
- 11 Framed truss with arched laminated tie.
- 12, 13 Laminated arch truss.

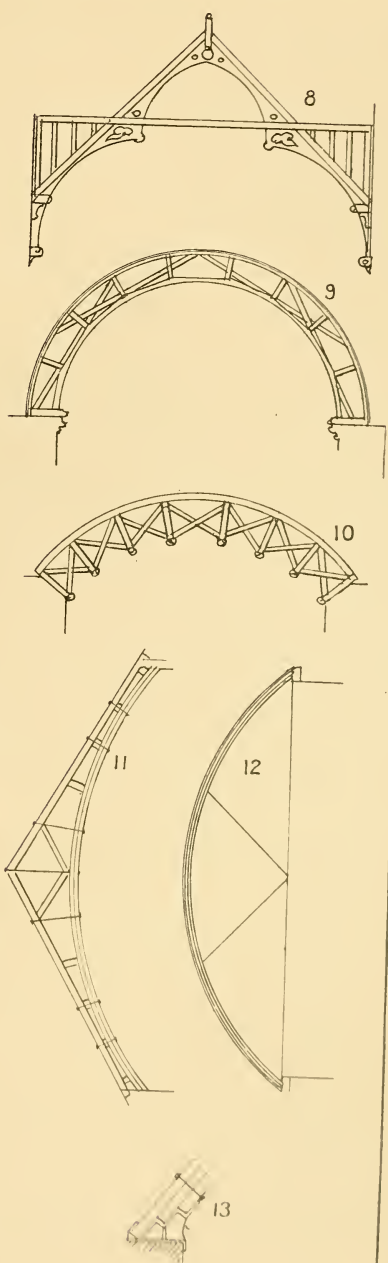
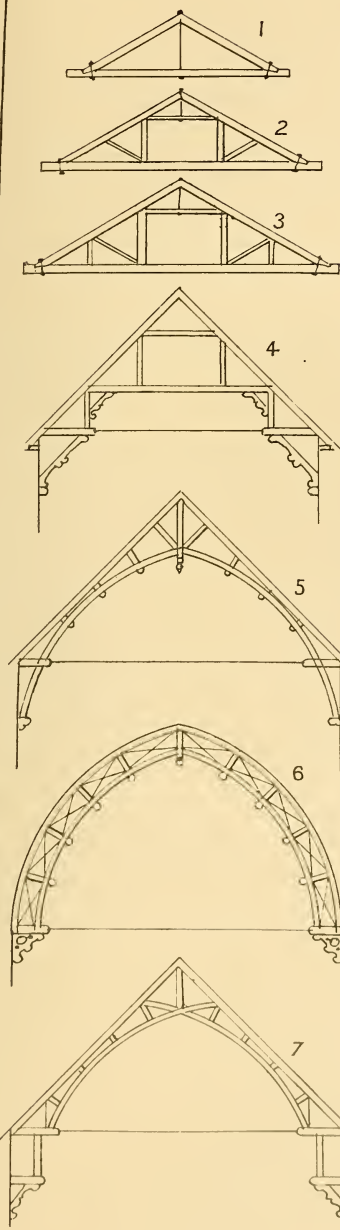

14, 15 **Simple triangular trusses.**

16 **High-pitch roof truss.**

17 **Arched and framed truss** with horizontal tie.

18 **Mansard truss.**

19 **Truss with arched tie**, ornamented.

20 **Framed truss** with Gothic openwork spandrels.

STEEL ROOFS.

21 **Arched T iron principal** with horizontal rod tie.

22 **Simple triangular truss.**

23 **Triangular truss** with one bracing.

24 Ditto with eight panels.

25 **Arched or bowstring truss** with eight panels.

26 Ditto with cambered tie-rod.

27 **Triangular truss** with cambered tie-rod.

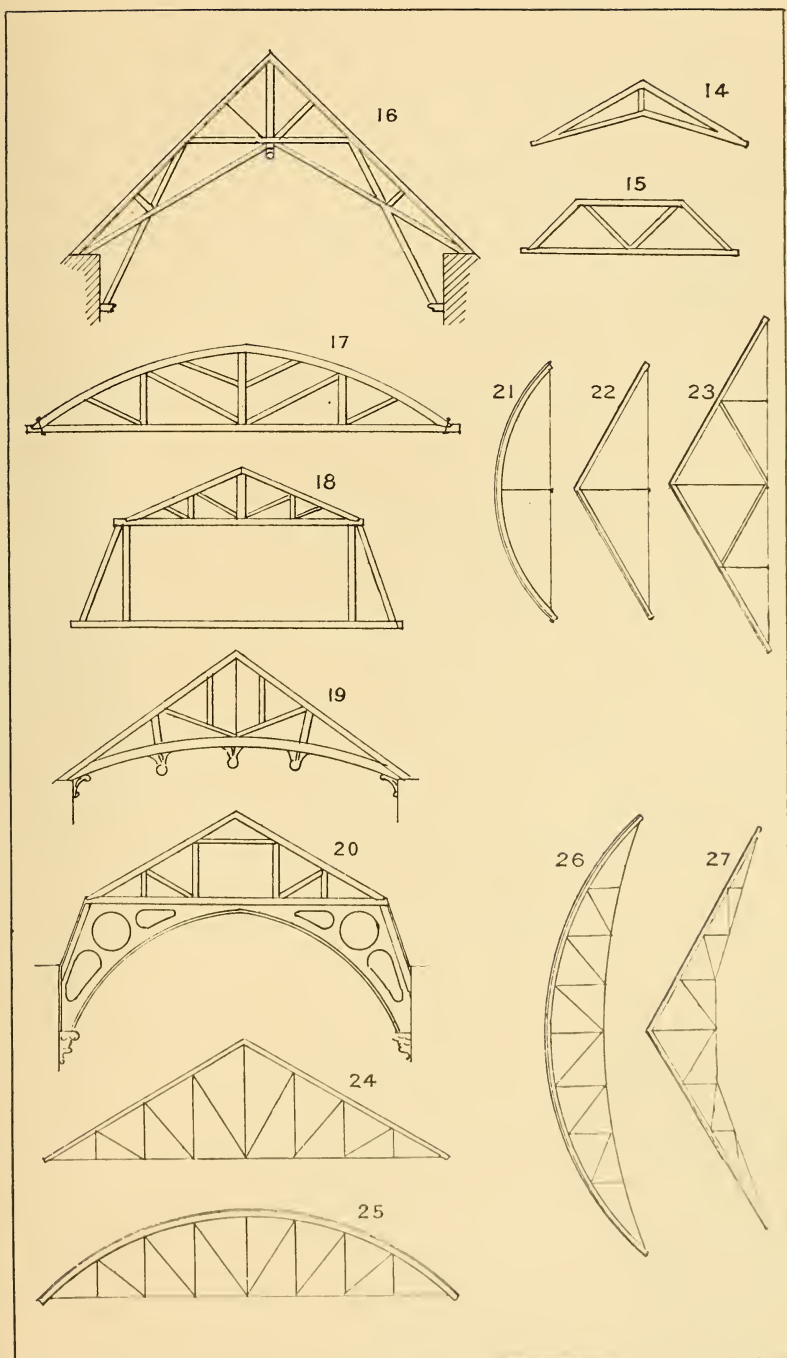

- 28 Triangular truss, another form.
- 29, 30 Ditto with compound truss bracing.
- 31 Arched corrugated sheet-iron roof, simple type.
- 32 Compound triangular truss.
- 33 Six panel triangular truss.
- 34 Triangular roof in three bays with four supports.
- 35 Braced segmental arch truss.
- 36 Three hinge braced Gothic arch truss.
- 37 Semicircular braced arch truss.
- 38 Ditto.
- 39 Triangular truss with counter-braced principals.
- 40 Ditto with central headway.

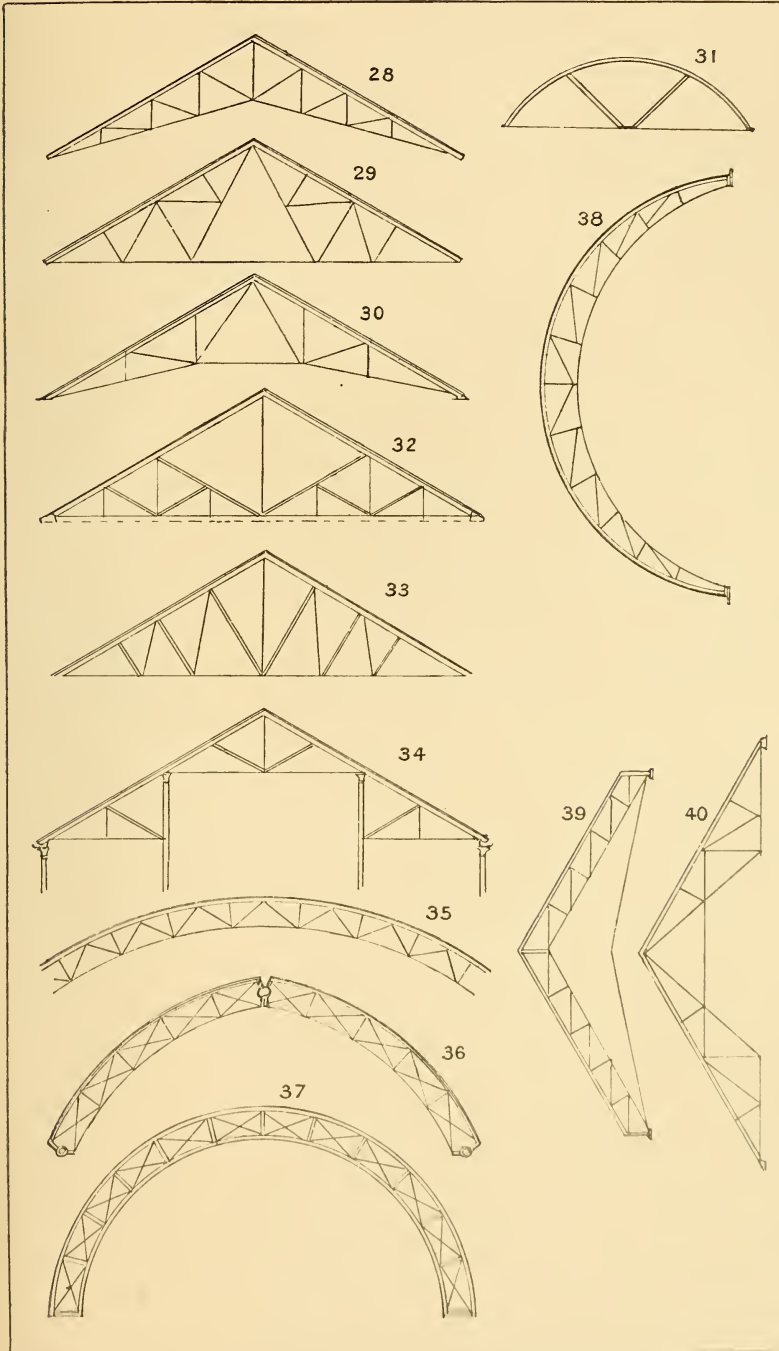

41 Mansard type triangular truss.

42-3 **Station roof** with elliptic tie and ventilator.

44 **Three-hinge roof.**

45 **Double cantilever roof** on single column.

46 **High-pitched roof with arched ties.**

47 **Compound truss Mansard type.**

48 Ditto.

49 **Three-hinge compound truss** with outside cantilevers as a station roof.

50 **Station roof with outside cantilevers.**

51-2 Cantilever roofs supported from a wall.

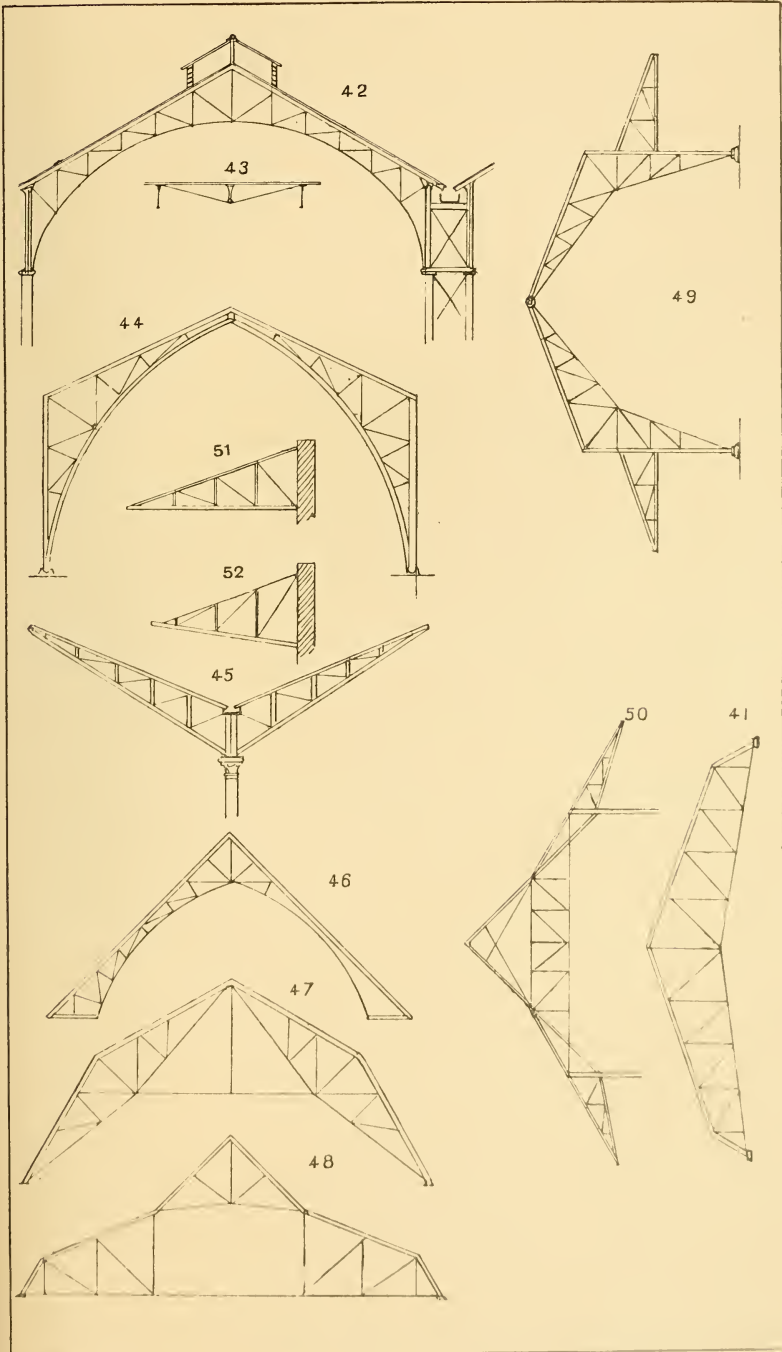

- 53 **Station roof** with outside cantilevers.
- 54 Ditto with overhanging eaves.
- 55 **Roof** formed of four triangular bays carried on parallel braced main girders.
- 56 **Triangular roof with cantilever eaves.**
- 57 **Three-bay station roof** on two columns.
- 58 **Station roof** over two platforms carried on rolled girders reaching the entire width.
- 59 **Double platform station roof** with central gutter supported on double columns.
- 60 **Station roof** of central arched bay and two cantilevers.
- 61 **Factory or shed roof** in several bays. The steep slopes are of glass and face the north to avoid sun-glare.
- 62-3 **Roof** formed of one or more short spans placed transversely and carried on arched girders.
- 64-5 **Sections of ventilators** with louvres.

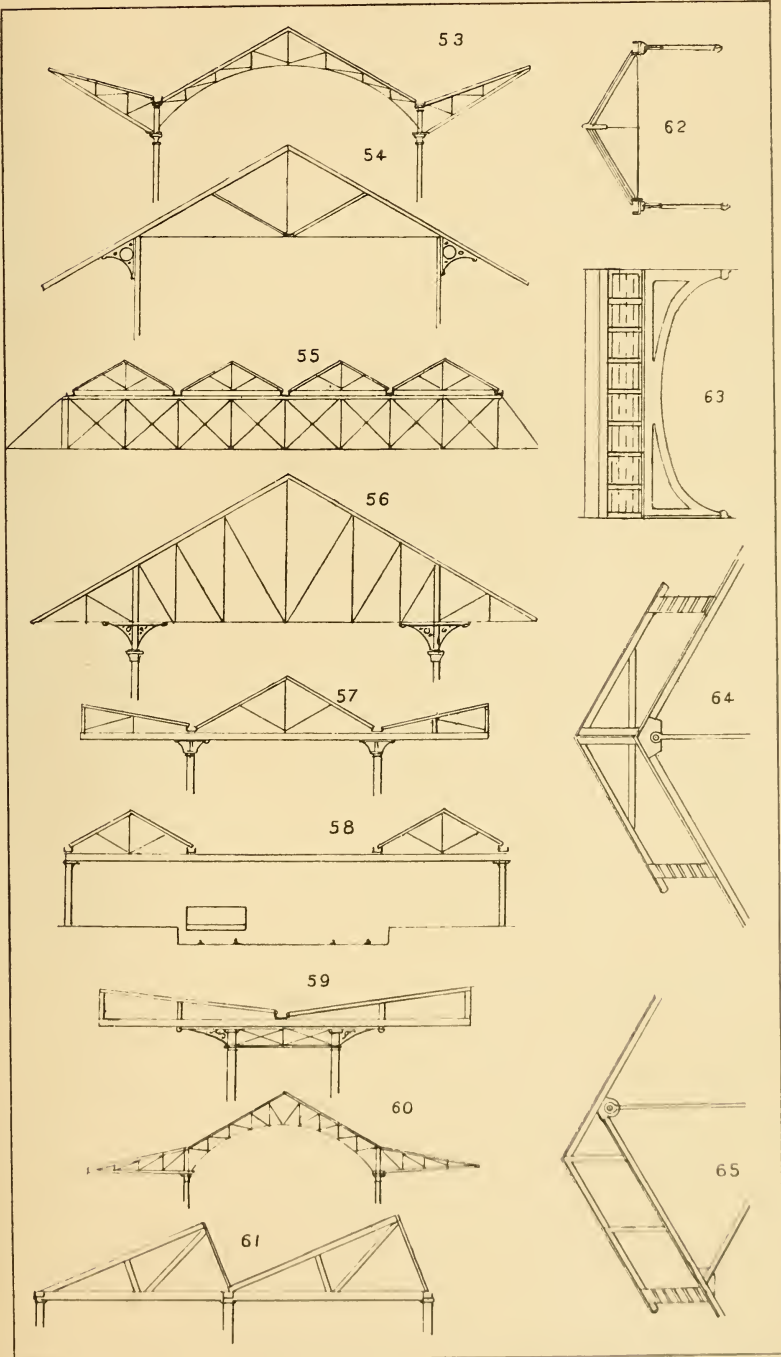

- 66 **Arched roof** on rolled girder principals.
- 67 **Roof of two or more bays** carried on longitudinal braced or plate girders.
- 68 **Arched station roof** covered only over the platforms.
- 69 **Cast-iron three-bay platform roof** on two columns.
- 70 **Platform roof of wood** on two columns with central gutter.
- 71 **Triangular platform roof** on double columns.
- 72 Ditto on single column and wall.
- 73-9 **Platform roofs** supported from walls.
- 80 **Theatre front pavement roof**, usually of glass and highly ornamental.

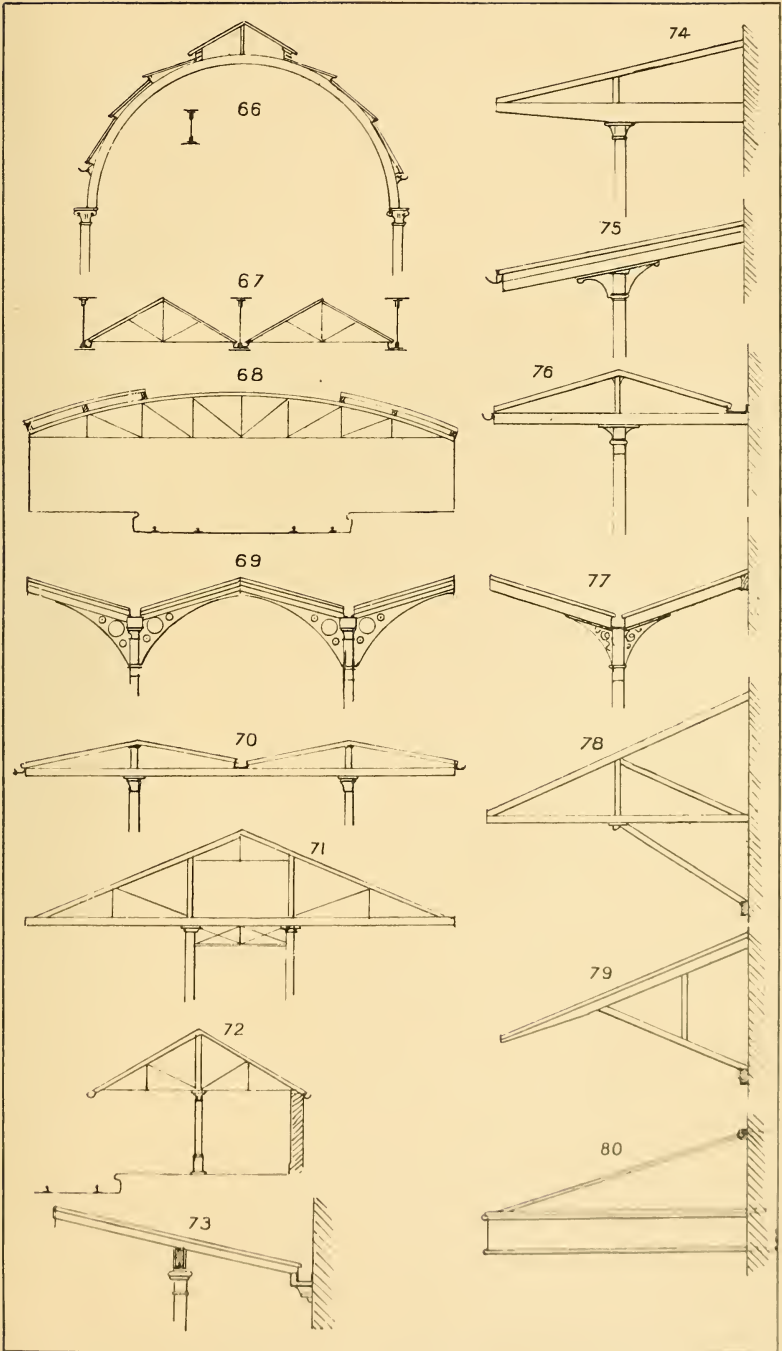

81-3 **Cantilever platform roofs**, steel framed.

84-5 **Typical details** of a triangular truss framing and wall or column supports; 85 is an elevation of a trussed purlin. (See also Sections 6 and 10.)

86 **Junction of principal** and tie bar.

87 **Junction of tie bar** and diagonals.

88 **Junction of principal**, tie bar, and steel column.

89 **Section of iron and wood roof** and gutter at support.

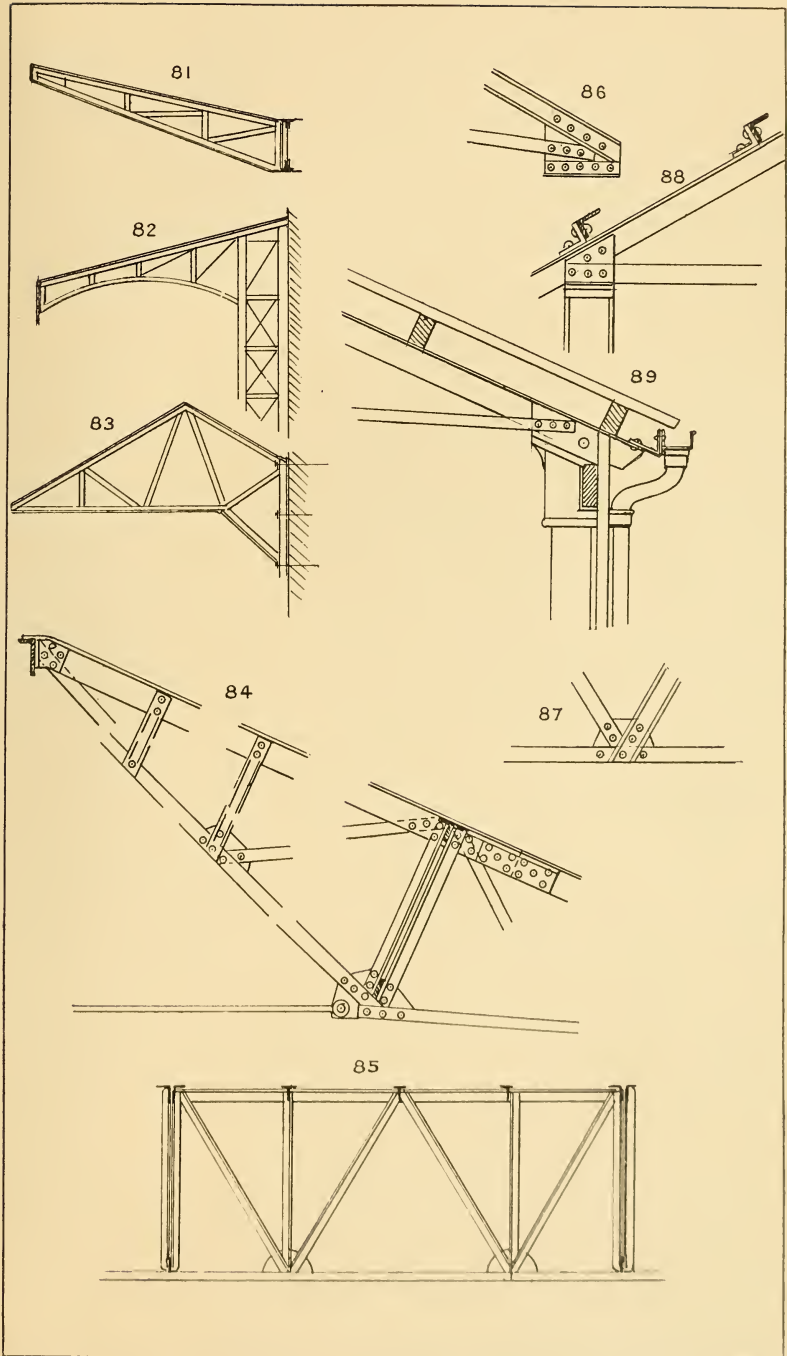

Section 42. — CONCRETE AND REINFORCED
CONCRETE.

- 1, 2 **Section and elevation of square concrete pile** reinforced with four steel rods and horizontal ring ties.
- 3, 4 **Circular pile** similarly reinforced.
- 5, 6 **Forms for circular and square piles.**
- 7-10 **Iron rammers for "Compressol" piles.** With No. 7 a hole is made in the ground by repeated rammings, compressing the soil around the hole. Stones are then dropped in and rammed into the foot of the hole and the hole filled with concrete.
- 11 **Form** (hinged together) **for a square pile** or column.
- 12 **Wall forms** with various forms of ties. There are many kinds of ties of special make in use.
- 13 Ditto showing insertion of wood bricks or fillets.
- 14 **Plan of angle or quoin forms.**
- 15, 16 **Foundation bed** of concrete for a building on concrete piles.
- 17 **Form** for a square column.
- 18-20 **The "Kahn" trussed reinforcement bar** for a main girder.
- 21-2 **Grooved bar** to take splayed truss rods fixed in the grooves.
- 23 **Triangular wire mesh reinforcement.**
- 24 **Corrugated bar** for ditto.

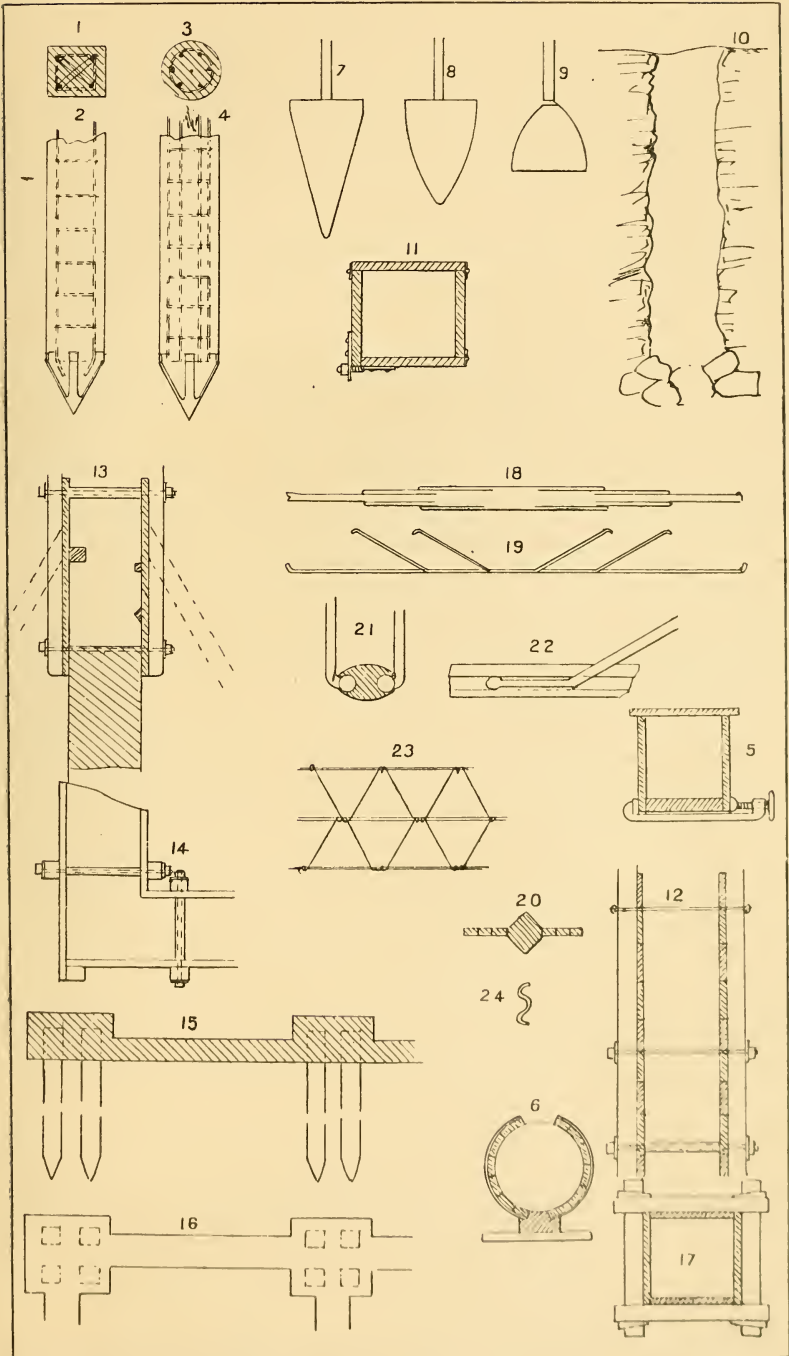

- 25-7 **Type of forms for a floor**, with joists and girders, supported on columns; all in reinforced concrete.
- 28-30 **Sections of reinforced concrete floors** and joisting.
- 31-4 **Floor girder; square section** showing various styles of reinforcement.
- 35 **Reinforced concrete casing** to the piles of a pier, subject to abrasion by sea beach.
- 36 **Concrete arch bridge**, reinforced, with suspended temporary staging or forms.
- 37 **Another form** of reinforced concrete arch bridge.
- 38-9 **Reinforced concrete arch and spandril bridge**. The arch is in three ribs.
- 40-4 **Various types** of notched and corrugated or twisted reinforcement rods.
- 45 **Reinforced concrete column top** with girder joists and floor.

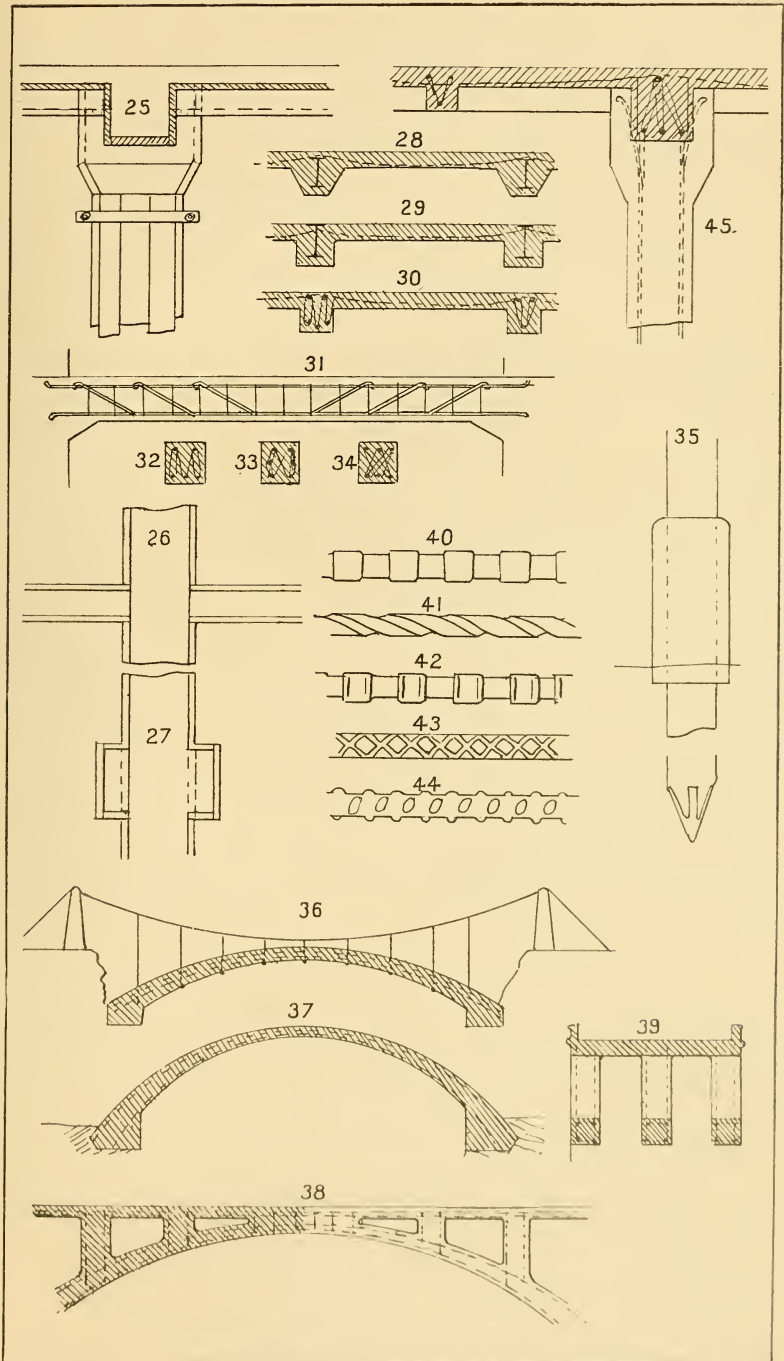

46 **Reinforced concrete roof** arch and side walls, in which the thrust is taken by anchored tie bars.

47-8 **Concrete slab partitions.**

49, 50 **Reinforced retaining wall** with toe and back buttresses.

51 **Another form of reinforced concrete retaining wall.**

52 **Reinforced concrete battered retaining wall** with long toe and projecting heel.

53-4 **Reinforced concrete hollow dam** or weir with transverse partitions and openings.

Prevention of freezing of concrete by additions of solutions of calcium chloride or common salt; said to improve the concrete by rendering it more impermeable.

Expanded steel is also extensively used for reinforcement of concrete in floors, roofs, partitions, walls, etc.

Concrete hollow building blocks of various shapes are used instead of stone or brick for walls and partitions.

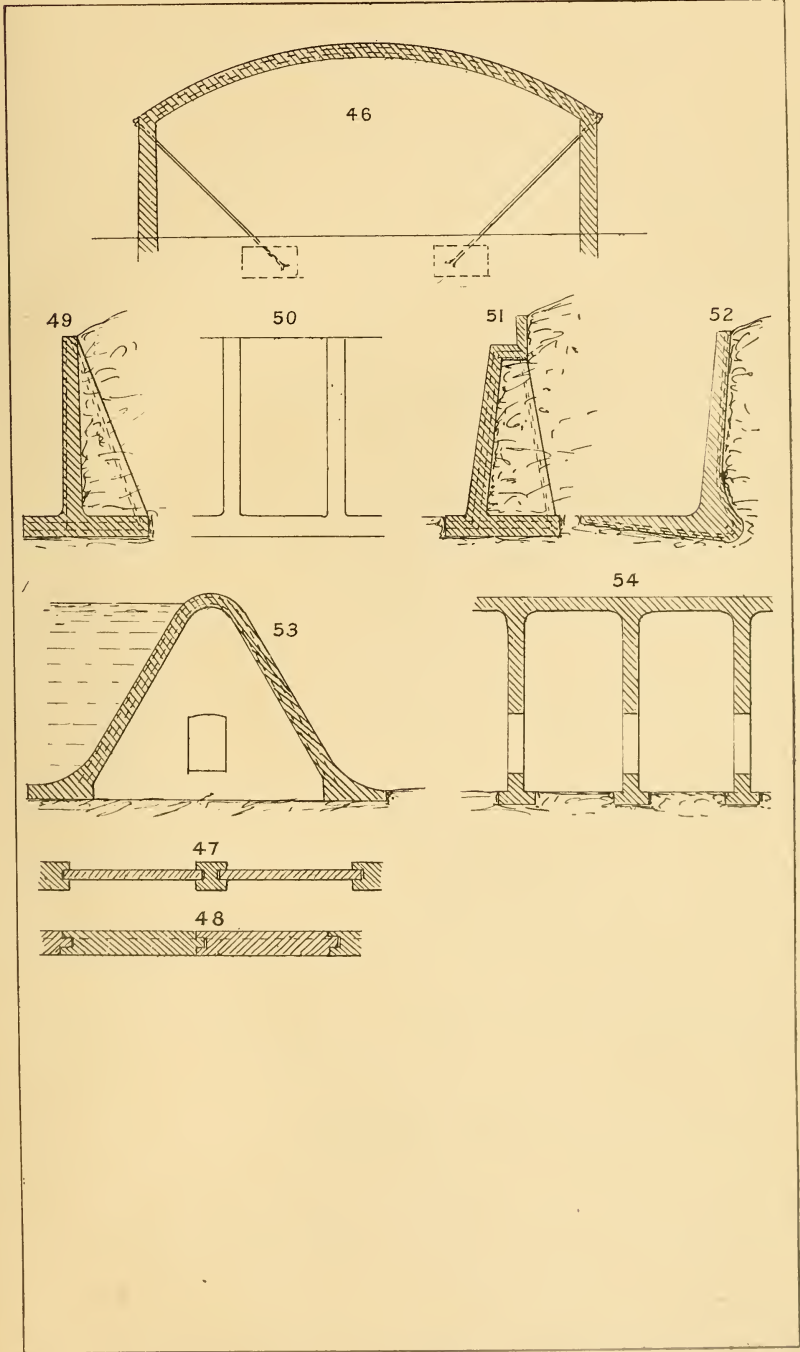

Section 43.—DAMS AND WEIRS.

(See also Sections 29, 30.)

- 1 **“Gerard” shutter dam**, operated by a hydraulic ram.
- 2 **Fish pass.**
- 3 **“Stoney” sluices and dam** with balanced rising sluice gates.
- 4 **Balanced sliding dam or sluices.**
- 5, 6 **Arched gravity dam** in masonry or concrete.
- 7 **Drum weir**, balanced by the water pressure.
- 8 **Earthen dam** with puddle wall. (See Sections 44, 24, and 29.)
- 9 Ditto with puddle face and pitched slope.
- 10-12 **Timber gravity dams.**
- 13, 14 **Pitched stone dam and sluices.**
- 15 **Irrigation weir** with adjustable sluices and over-bridges.
- 16 Rubble stone dam.

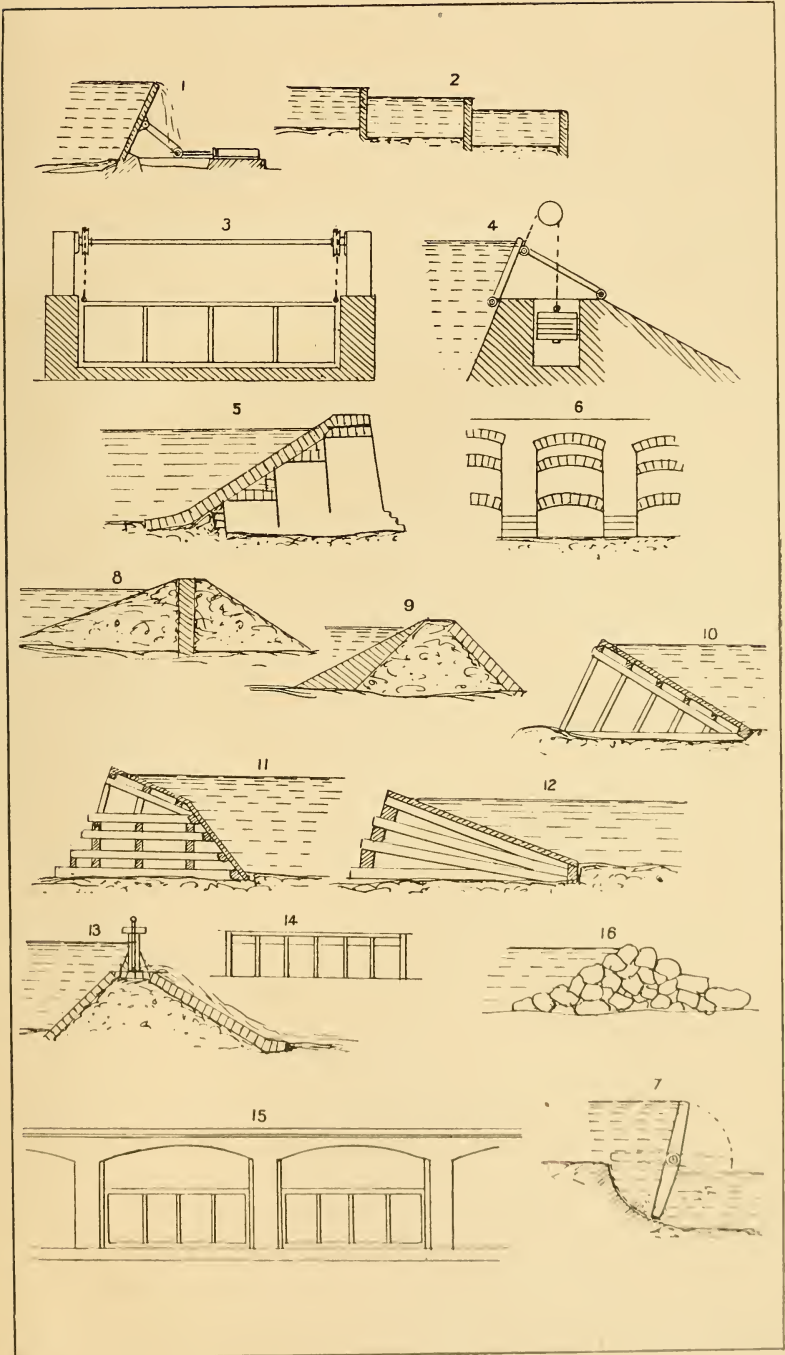

- 17 **Standard type** of concrete or masonry dam.
- 18 **Vertical wall dam**, usually arched in plan as No. 22.
- 19 **Concrete spillway**.
- 20 **Earthen spillway** with puddle wall and pitched slopes.
- 21-2 **Plans of dams**, straight and arched.
- 23 **Masonry dam** with rubble core or hearting.
- 24 **Series of dams** to divide a stream into pools.

Many rivers have been "canalized" by the construction of dams and locks with spillways or weirs for the overflow.

Some large rivers, such as the Charles, at Boston, have been dockized by the construction of a dam with locks for shipping.

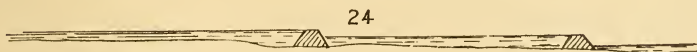
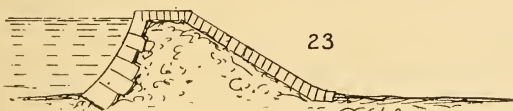
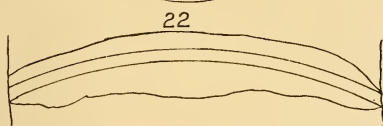
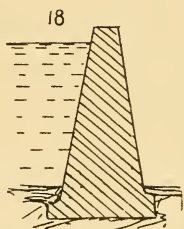
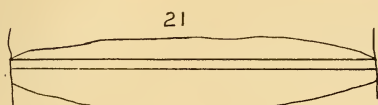
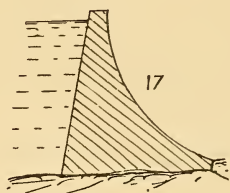
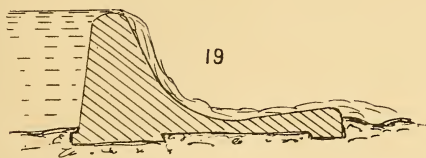

Section 44.—WATER SUPPLY.

- 1 **Reservoir wall** of concrete with earth filling.
- 2 Ditto with puddle wall and foundation.
- 3 **Reservoir wall** faced with pitched stonework with puddle wall and earth bank.
- 4 **Filter bed** lined with concrete and with puddle wall and foundation. The bed is formed of loose bricks covered with layers of sand and gravel.
- 5 **Elevated tank** for water supply.
- 6 **Stand pipe** to give an hydraulic head to the supply pipes.
- 7, 8 **Sections of covered reservoirs.**
- 9 **Syphon supply main** from a reservoir.
- 10 **Reservoir water tower** and culvert, containing the service main, inlets, and valves, reached from the reservoir bank by a bridge.
- 11 **Hydraulic high-pressure accumulator** weighted with cast-iron sections. These are sometimes substituted by a steel cylindrical case, loaded with ballast, etc.

Hydraulic high-pressure water for lifts, etc., is supplied in special high-pressure mains in London, etc., at pressure of 700 lb. per square inch.

For details of pipes, valves, pumps, pumping-engines, and other plant see the *Engineer's Sketch-book*.

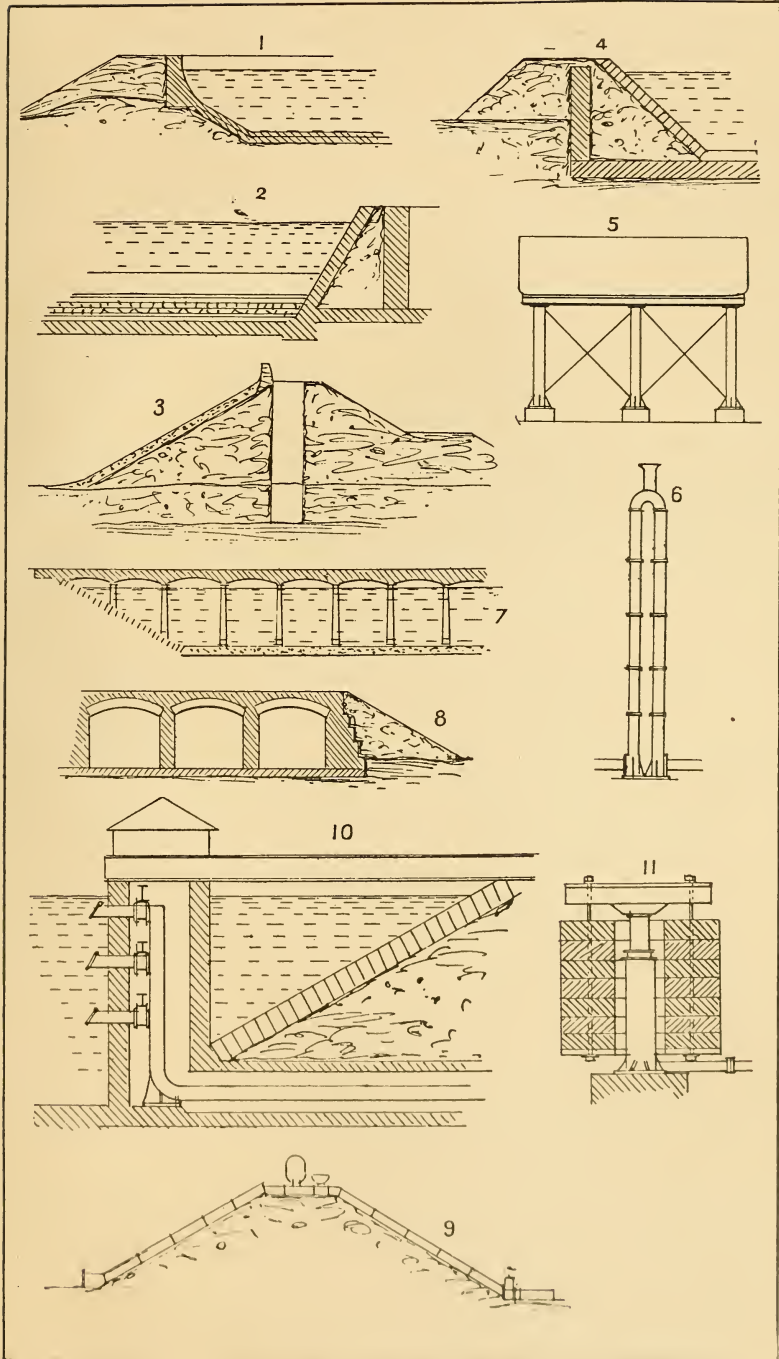

BOOKS FOR CIVIL ENGINEERS

132 pages, with Illustrations. Demy 8vo. Cloth. Net 5s.

SEWERAGE OF SEA-COAST TOWNS

By HENRY C. ADAMS, A.M.Inst.C.E., M.I.Mech.E., A.M.I.E.E.,
M.R.San.Inst., etc.

330 pages. Illustrated by 150 Diagrams and Working Drawings. Royal 8vo. Cloth.
Net 10s. 6d.

SEWERAGE SYSTEMS THEIR DESIGN AND CONSTRUCTION

A Practical Treatise upon the Principles of the Design, Construction, and
Maintenance of Town Sewerage Systems, with Examples of existing Works.

By HUGH WATSON, A.M.Inst.C.E.

With numerous Plates and Illustrations. Super-royal 8vo. Buckram. £1 5s.

WATER SUPPLY of TOWNS and the CONSTRUCTION of WATERWORKS

A Practical Treatise for the use of Engineers and Students of Engineering.

By W. K. BURTON, A.M.Inst.C.E.,

Late Consulting Engineer to the Tokyo Waterworks.

THIRD EDITION, REVISED.

Edited by ALLAN GREENWELL, F.G.S., A.M.Inst.C.E.

JUST PUBLISHED. 250 pages, with 24 Photographic Plates. Demy 8vo. Net 7s. 6d.

WATER SUPPLIES

Their Purification, Filtration, and Sterilisation

A Handbook for the use of Local and Municipal Authorities.

By SAMUEL RIDEAL, D.Sc. (Lond.),

*Fellow of University College, London; Fellow of the Institute of Chemistry; Public Analyst for the Metropolitan
Borough of Chelsea; Author of "Disinfection and Disinfectants".*

And ERIC K. RIDEAL, B.A. (Cantab.), Ph.D. (Bonn).

With Plates and Tables.

64 pages. 15 full-page Plates. 4to. Cloth. Net 12s.

A GRAPHICAL HANDBOOK OF REINFORCED CONCRETE DESIGN

By JOHN HAWKESWORTH, C.E.

Consisting of a series of Plates showing graphically, by means of plotted curves, the required design for Slabs, Beams, and Columns, under various conditions of external loading, together with practical examples explaining the methods of using each Plate. With an Appendix containing the requirements of the Building Code of New York City in regard to Reinforced Concrete.

LONDON: CROSBY LOCKWOOD & SON



LIBRARY OF CONGRESS



0 028 118 853 7