

RING SPINNING FRAMES
FOR
COTTON

CATALOG No. 70

H & B AMERICAN MACHINE CO.
PAWTUCKET, R. I.
U. S. A.

SPECIAL
COLL
TS
1583
.R56
1900z

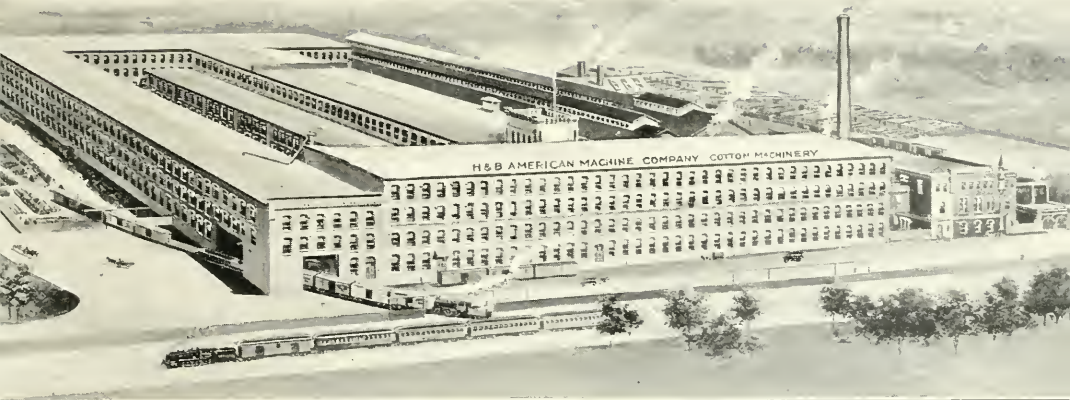

MAIN OFFICE AND WORKS

H & B AMERICAN MACHINE COMPANY

PAWTUCKET, R. I.

BOSTON OFFICE:
161 DEVONSHIRE STREET

SOUTHERN OFFICES:

1201-1203 JOHNSTON BUILDING
CHARLOTTE, N. C.

815 C & S NATIONAL BANK BUILDING
ATLANTA, GA.

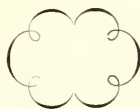

Manufacturers of

COTTON MILL MACHINERY

UMass Dartmouth

PREFACE

This booklet has been prepared to describe the H & B Ring Spinning Frame for cotton. On the following pages are illustrated various parts and assembled units together with a description which we have endeavored to make complete and concise.

The H & B Ring Spinning Frame has merited an enviable reputation, and in our latest model are incorporated not only all of the excellent features of the old Model "A" frame, but also every modern improvement in ring spinning. No effort has been spared to give to the trade the best that can be produced.

Practically all orders for our ring spinning frames now specify H & B Four-Roller High Draft. This system is simple in design and efficient in operation.

With all of our equipment goes the maximum service that can be given. The experience, knowledge, and information, carefully preserved in our records and throughout our organization, are freely offered to the trade.

H & B AMERICAN MACHINE COMPANY

RING SPINNING

The chief aim in spinning is to produce a good yarn, so termed according to its evenness, strength, and elasticity.

Evenness depends upon twist and the cross-sectional distribution of the fibres. This resolves itself into good roving and proper drafting.

Strength is dependent upon the quality and staple of the cotton, parallelization, amount of twist, and the number of fibres present in any cross-section of the yarn.

Elasticity depends, apart from twist, upon the character of the fibre, its preparatory treatment, and the tension under which the yarn is kept while being wound on the bobbin.

The ring spinning frame is a comparatively simple machine, and for this reason many important factors are sometimes neglected. Top rolls must be nicely covered and kept in good condition. Middle rolls are as important as front rolls, and consequently, worn rolls should not be used. Accurate roller settings are essential to good spinning. Roving guides should be smooth and must be kept clean. The thread board, if set too low, may cause chafed yarn; and if set too high, may stretch and weaken the yarn. Rings should be carefully watched and kept in good condition. Spindles should be kept clean and well oiled; they must be accurately plumbed at all times. Only first-grade oils should be used. Only good bobbins, well fitted, should be used. The frame must be well leveled and bolted to the floor. Care should be given to the tape tension device. Fluted steel rolls should be scoured several times a year. Top roll weight levers should be kept level at all times. Guide wires must be accurately set. The ring rail and rings should be cleaned and scoured at frequent intervals. New frames should be generously oiled and carefully watched until they are broken in.

Above are only some of the outstanding points to be observed, and serve to illustrate the care that is required to obtain the best results in spinning yarn.

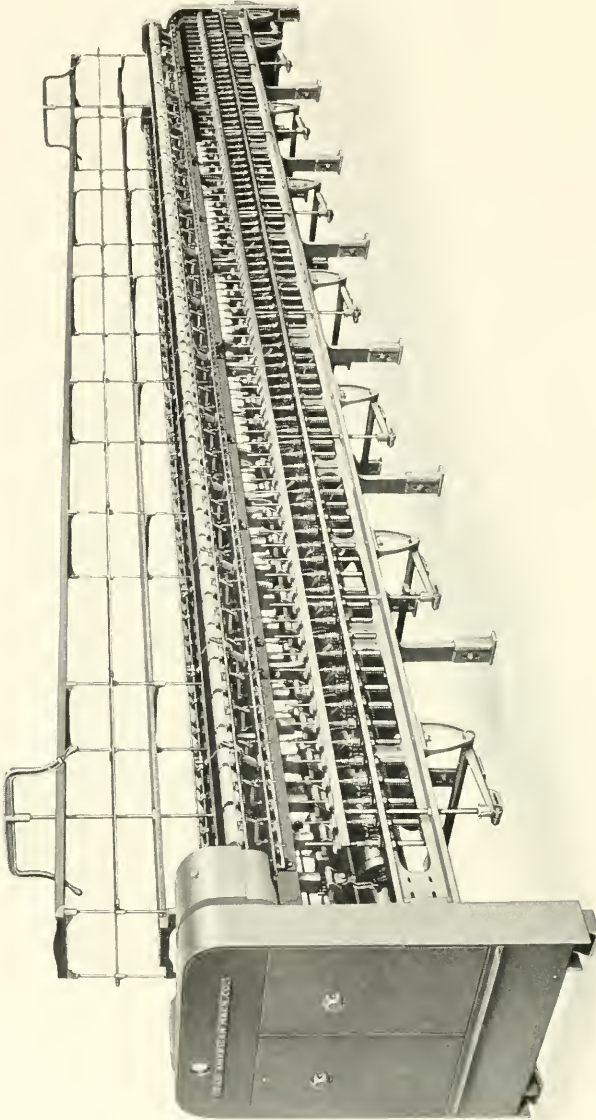

MODEL "B" RING SPINNING FRAME

RING SPINNING FRAME

Model "B"

On the opposite page is an illustration of our latest model Ring Spinning Frame. This machine is entirely new throughout and combines the many fine features of our older model with our new and improved design. The box head has been redesigned, as has also the builder motion. The gearing arrangement has been materially changed. The chain drive to the builder motion has been replaced by an upright shaft for worm and worm gear; all change gears and adjustments are easily and quickly made. Careful attention has been given throughout to provide a spinning frame completely adaptable to all classes of work. Characteristic of H & B machinery, this frame is exceptionally rugged, and vibration is eliminated; at the same time all parts are designed to insure light running.

This machine is built in two widths — 36 inches and 39 inches — of one height only, but adjustable for any traverse from 5 to 8 inches.

LARGE PACKAGE FRAME

The large package frame is alike in every respect to our regular model, except that it has been designed for larger rings, heavier spindles, and longer traverses. This machine is an outstanding development as regards spinning-room practice, demanding the attention of every up-to-date spinner. This model is built in one width only — 39 inches — and of one height, but adjustable for any length of traverse from 7 to 10 inches. Rings up to $3\frac{1}{2}$ inches diameter can be supplied.

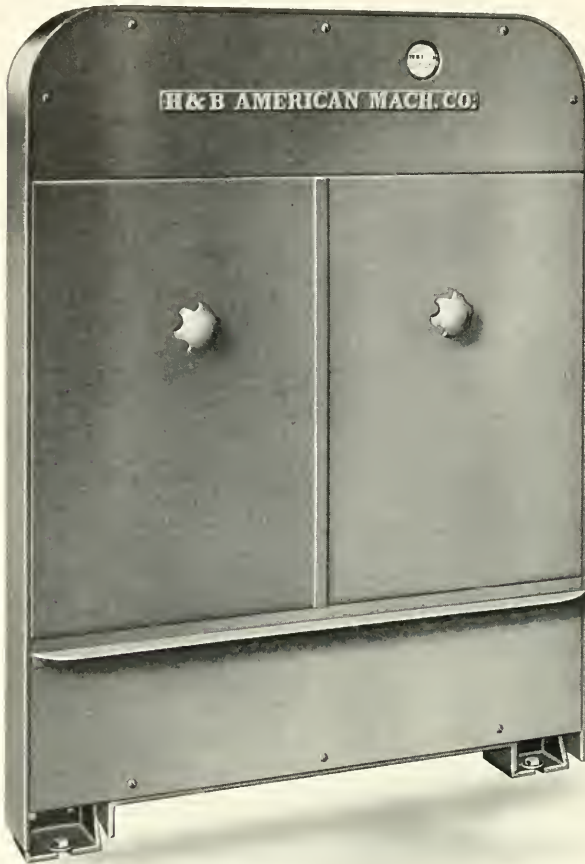

BOX HEAD

*Showing the Doors and Panels which
Enclose the Gearing*

The Box Head is of new design and presents an unusually attractive appearance. It is so designed as to eliminate the possibility of fly, waste, or dirt accumulating therein and causing damage to the gearing and bearings.

The upper part is provided with a combined panel and name plate of neat design. The lower part is also fitted with a panel extending the full width of the head, while the larger central portion is fitted with two doors. These doors are so hinged that when opened they swivel around to the side of the frame, out of the way. This latter feature requires less space than the old-fashioned hinged doors and is more convenient than the sliding panel arrangement. A handle of simple design is provided, and the easy operation of these doors makes it possible to turn this handle by a grip of the fingers. When opened, these doors give full access to all necessary change gears. A safety locking device is provided so as to prevent accidents.

The head end is fitted with two adjustable feet designed to appear as a part of the head itself. These feet consist of a shoe, a jack screw for easy leveling, and suitable bolts for clamping.

The Foot End is of rugged design with wide webbing and double ribs. A three-point suspension is provided for the cylinder bearing, and an anti-draft panel closes the lower part of the foot end. Slots are provided to allow for adjustment of the spindle rails, also for the attaching of such outrigger supports as the particular type of drive may require. The foot end is fitted with adjustable feet, neatly designed and readily adjusted for leveling the frame by means of a jack screw.

The Samsons are made to conform with the general design of the framework and to give a strong, rigid support to the machine. These samsons are slotted to allow for the adjustment of the spindle rails. They are accurately milled for these rails and also the roller beams. Adjustable feet with jack screws are also provided on the samsons so that the frame can be easily leveled even under the most difficult circumstances.

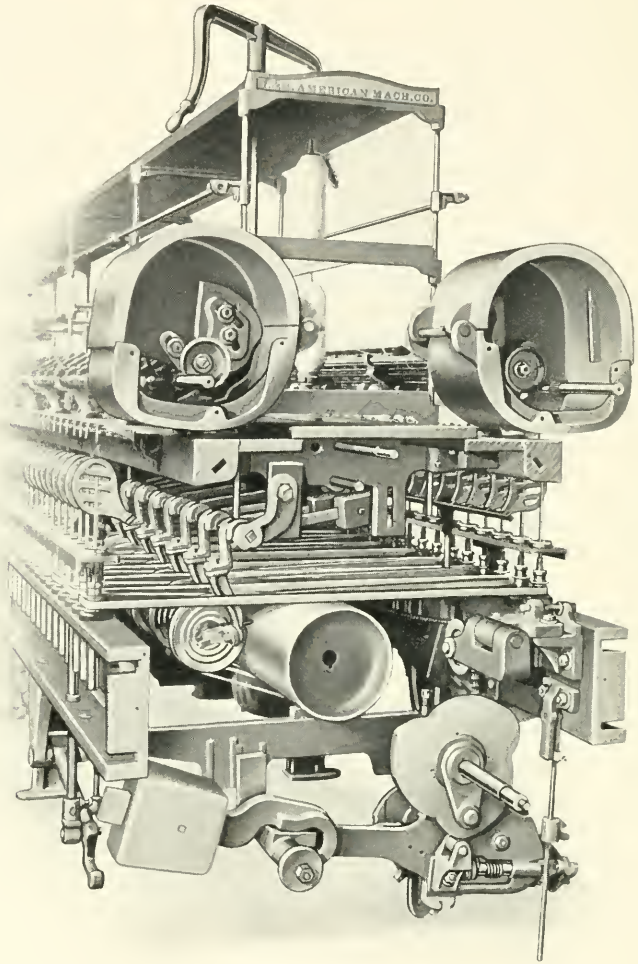

FRAMEWORK

Showing Cylinder, Tape Drive, Builder Motion, and Creel

The Framework is of regular construction with angle roller beams and box-type spindle rails. These beams, together with the head end, foot end, and samsons, are exceptionally heavy, and their mode and care of assembly make this machine free from vibration. All units such as the creel, rolls, gearing, builder motion, cylinder, ring rails, spindles, and drive are designed to insure light running. These units are strong and are firmly attached to the frame, so as to withstand high speeds and to reduce wear to a minimum. No spinning frame now on the market offers a more solid construction and careful workmanship.

The Builder Motion is shown in the illustration on the opposite page. It is designed for warp wind or filling wind. We can furnish a combination builder which can be used for either warp or filling wind. An adjustable bottom forming attachment is furnished when specified. Various types of bunch builders are easily attached. The builder is driven by means of a train of spur gears, embodying the use of a change or lay gear by means of which the speed of the wave motion can be regulated and the filling wind finely adjusted. The builder-motion cam is driven by means of a worm and worm gear enclosed in the head end; the thrust is carried on a special ball bearing and collar. Thus, practically all backlash is eliminated from the cam motion.

The Creel, shown in the illustration on the opposite page, is of usual construction and is made either one or two stories for either single or double roving. It is easily adjusted to suit any length of roving bobbin. The layout allows for the removal and replacement of bobbins without interference with adjacent bobbins. The bottom and middle creel boards are metal-bound to protect the edges from wear. The ends of the creel are firmly braced and supported by adjustable creel-end castings and upright rods.

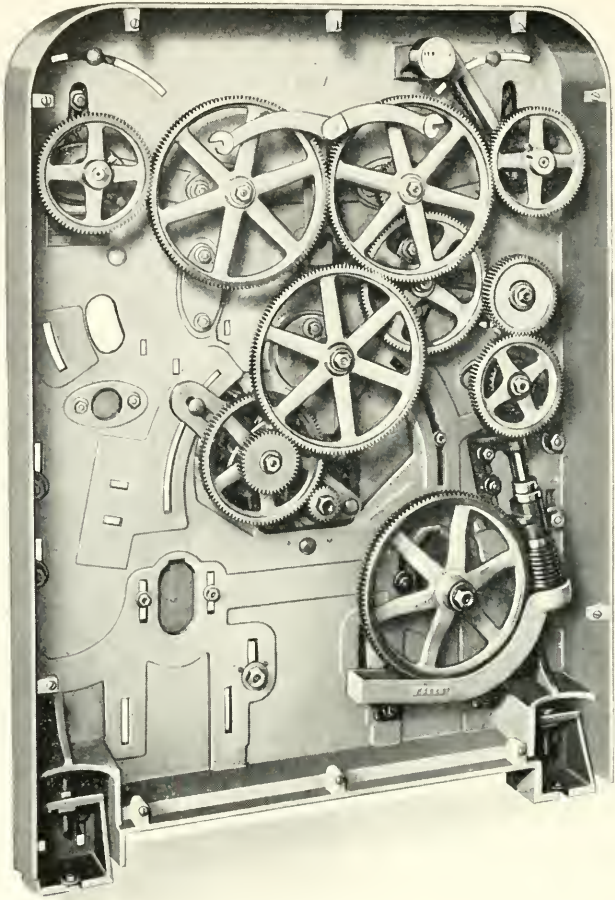

GEARING
Showing Builder-Motion Drive

The Gearing is totally enclosed within the head end or beneath the draft gear covers. All spur gears are accurately cut on up-to-date machinery and the worm gears hobbled on special machines. All gears are made with extra wide face, and gear shaft bearings are of ample length and size. The bearings are oiled from the outside of the frame through tubes conveniently located and fitted with Gits oil cups. When specified the frame can be equipped with an Alemite system of oiling. When the reversible tape drive is used a reversing gear is added so that the rolls can be driven through either of the large intermediate gears. This arrangement is simple and convenient. Helical jack and cylinder gears provide a very quiet head end.

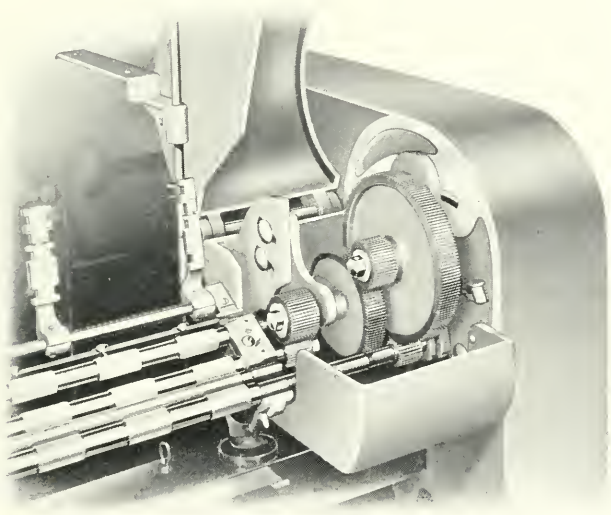

DRAFT GEARING

The Draft Gearing is totally enclosed by a neatly designed bonnet. The arrangement of both the draft and twist gearing allows for a very large range of draft and twist. Special alloy steel, heat treated, is used in the manufacture of these gears.

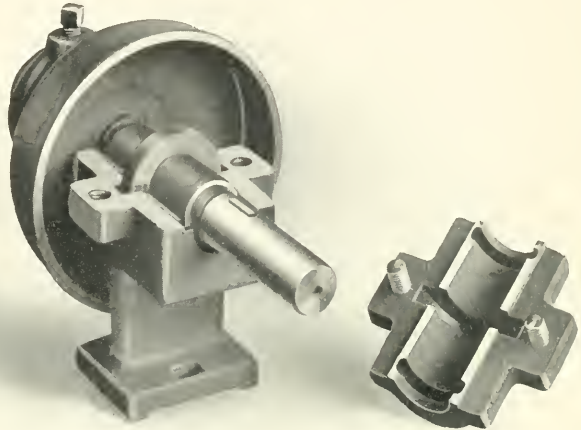

CYLINDER BEARING AND CAP; ALSO CYLINDER HEAD

The **Cylinder Bearings**, as shown in the illustration, consist of a cast-iron box fitted with a phosphor bronze bushing. These bearings are of the self-oiling type, thus insuring ample lubrication at all times. They are provided with oil pipes and Gits oil cups and can be readily oiled outside the frame. The illustration also shows our improved type of cylinder head.

Ball or roller bearings are furnished when specified.

The Locking Device is attached to the back of the head end and is operated by the shipper handle through the shipper rod connections. When the electric push button is used for starting and stopping the frame, this device is operated through an electrical switch. When either of the head-end doors is open, the frame cannot be started, and when the frame is in operation these doors cannot be opened. This prevents accidents while changing gears and also while running.

The Cylinders are made of extra heavy tin and are doubly reinforced with special lock joints. They are furnished in sizes from 7 inches to 10 inches in diameter. They are made in short lengths, giving strength, durability, and freedom from vibration. All cylinders are tested and balanced at high speed to insure alignment and smooth running. The short lengths tend to diminish the humming noise. The cylinder bearings, of ample size, are of the self-oiling type. When desired, special ball or roller bearings can be furnished. The cylinder shafts are made of high-grade shaft steel and are accurately turned and ground.

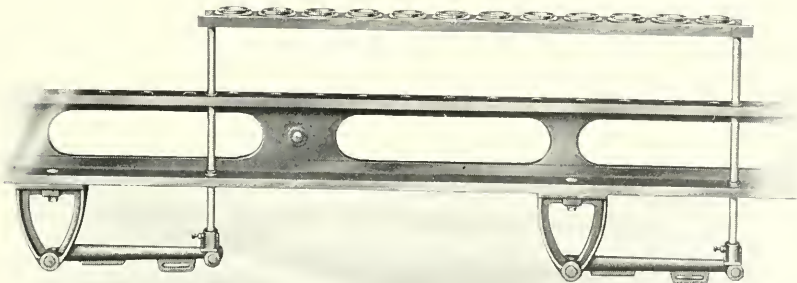

RING RAIL
Showing Supports and Rocker Arms

The Ring Rails are made with a deep flange extending the full length under the front side, giving strength and rigidity. They are made in short lengths and supported at the ends; this arrangement reduces the possibility of vibration and allows for easy removal.

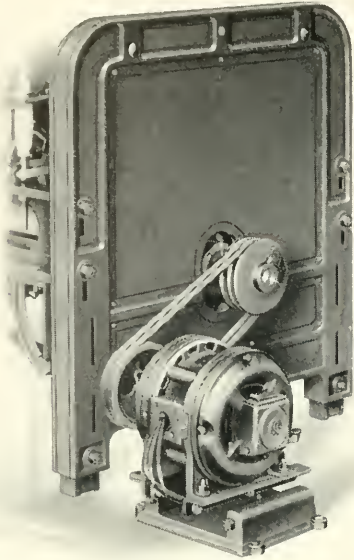

MOTOR DRIVE
Foot End

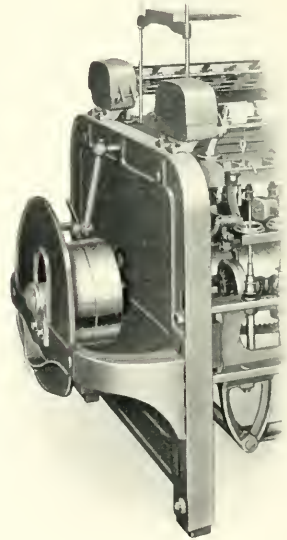

BELT DRIVE
Foot End

The Ring Rail Lifting Rods are of ample size and are made of quality steel, nicely ground. They are provided with cast-iron bushings set in the spindle rail. These bushings are accurately line-reamed, thus preventing the possibility of binding. A neat shoe is attached to the lifting rod, allowing for easy leveling of the ring rails and insuring a positive movement transmitted from the wave shaft.

The Driving Pulleys are made in sizes from 7 inches to 24 inches in diameter and from $2\frac{1}{8}$ inches to $4\frac{1}{8}$ inches wide. The loose pulley runs on a cast-iron sleeve which is part of the ring oiling box. This sleeve is drilled and grooved to allow oil to pass from the box to the pulley bearing. Moccasin or similar type bushings are furnished when specified. This type of bushing is practically self-oiling. Driving pulleys are generally located at the foot end of the frame, but can be located at the geared end if preferred.

The driving shaft, made from high-grade crucible analysis steel, is unusually large and is supported at its outer end by a substantial outboard bearing. The outrigger can be easily removed when necessary.

Individual Motor Drive is now generally adopted throughout the industry. We furnish any standard arrangement. The motor is preferably set on a heavy and well-designed cross girt which is supported by two strong brackets, securely fastened to the foot end of the frame. In addition to these two supports a bracket is sometimes fixed in the center underneath the cross girt and firmly attached to the foot end or the floor. This bracket serves not only as a support, but prevents any side motion which the motor might make, especially when starting. Various types of switches are used, and brackets are provided for practically any style.

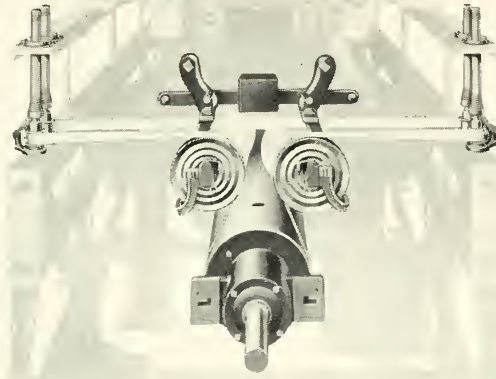

REVERSIBLE TAPE DRIVE
Patented

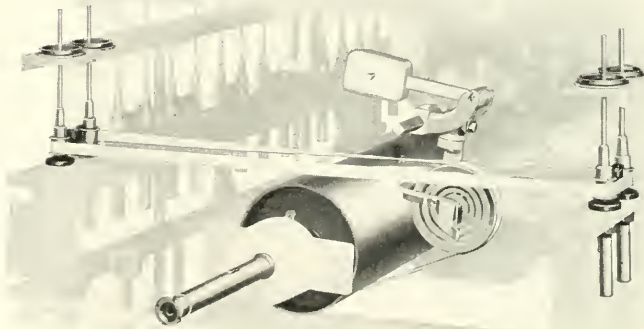

REGULAR TAPE DRIVE

The Tape Drive insures a steady, even speed of the spindle and a uniform twist in the yarn. This drive is now practically standard on all makes of spinning frames.

The Tension Device is of the swing type and is supported on a heavy square steel bar. This device is provided with an adjustable weight, giving the right amount of tension for driving. The pulley is exceptionally well made and runs in oilless wood bearings.

The Reversible Tape Drive (H & B Patent) is one of the latest improvements in the ring spinning frame. The important feature of this drive is our combination double-acting tension device. It is so designed that the weight operates on one pulley only, the off running pulley. When the direction of twist is changed, the weight automatically works on the opposite pulley. This arrangement eliminates the need for excessive weighting such as is required when both pulleys act independently. Where formerly it took from two to three hours to change a frame from one twist to the opposite twist, with this arrangement the whole job requires only a few minutes. It is necessary only to swing the reversing gear to the opposite side and at the same time adjust the motor control mechanism so as to reverse the motor. This device provides an excellent drive for the spindle and makes for a more flexible frame.

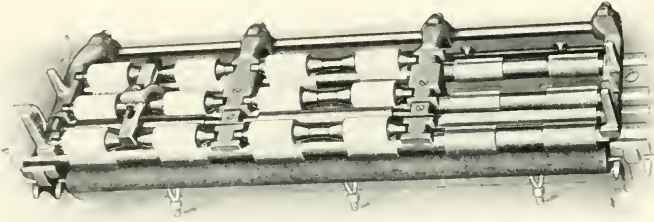

TOP AND BOTTOM ROLLS, CAP BAR
AND TRUMPET ROD
High-Draft Arrangement

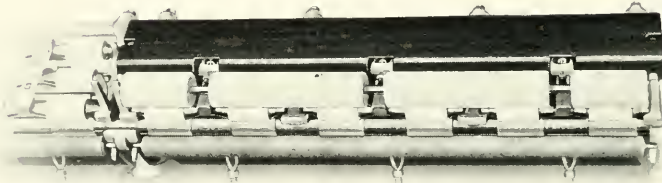

SECTION OF ROLLS SHOWING
TOP CLEARERS
High-Draft Arrangement

The Roll Stands are of ample width to insure long life, both to the roll stands and the roll necks. They are nicely machined and are provided with adjustable slides for setting the rolls.

The Fluted Rolls are made of special crucible analysis steel. The front line is casehardened to prevent damage to the flutes and insure long life to the roll necks. The middle and back lines can be furnished with hardened necks and squares, but we prefer to furnish them semi-casehardened all over. Our fluted rolls have irregular fluting, which effectively prevents any fluting of the leather-covered top rolls. A generous space is allowed between the roll-stand bearings and the fluted bossing, so that oil from the bearings is not easily carried to the bosses and the leather-covered top rolls. Each boss is accurately ground to pass the test of limit gauges, allowing a variation of .0015" either side of the standard.

The Top Rolls are generally furnished solid, but loose boss rolls can be furnished when desired. These rolls are furnished with either leather or cork covering. When preferred, we are prepared to furnish the self-weighted arrangement in place of the lever weighting.

The Cap Bars are made with steel backs and cast-iron fingers, well fitted and machined. They are so built that the trunnions of the top rolls project above the cap bar, permitting the easy removal of waste. They are of the independent type and can be removed individually without interference with the adjacent bars. Ample clearance is allowed between the ends of the cap bars.

The Top Clearers generally furnished are the flat, stationary type for our regular three-line roll frames. For our Four-Line Roll High-Draft arrangement we usually furnish a revolving clearer for the front line of rolls.



Light Gravity Band Drive



Light Gravity Tape Drive



Medium Gravity Tape Drive



Heavy Gravity Tape Drive



Extra Heavy Gravity Tape Drive

The Spindles furnished are of the standard H & B type. Tape-driven spindles are furnished on about every order now, but band drive can be supplied when desired. H & B spindles have always been noted for their durability and light running. They are made with large oil reservoirs and are so constructed as to prevent the throwing of oil. They are made in four standard sizes as illustrated above. Whirl diameters are made to suit requirements, although the larger diameters are recommended for better driving qualities, more uniform twist, and less end breakage. When ordered, the H & B Clutch Spindle can be supplied.

H & B spindles are made from the best materials; the blades are specially treated and tempered. They are made with all the knowledge and skill we have acquired in half a century of experience in spindle manufacture. We are prepared to furnish roller bearing spindles when ordered, or we can supply any of the other well-known makes.

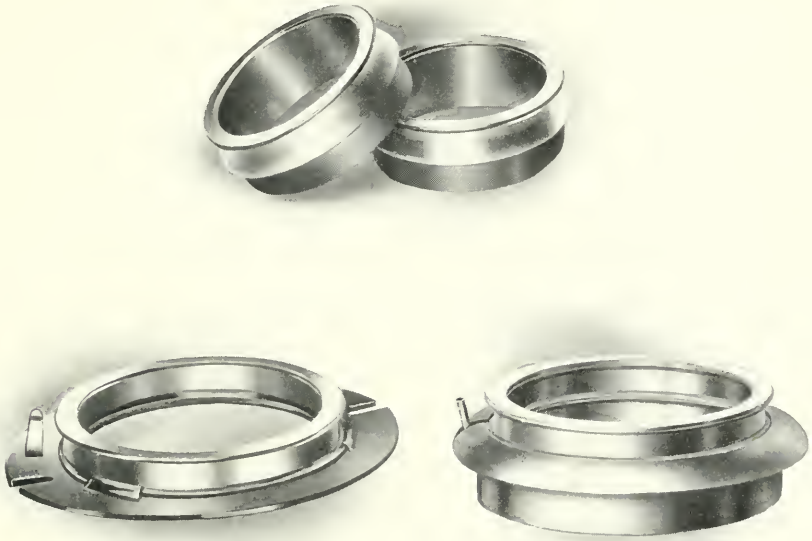

RINGS

The Rings, manufactured in our own shop, are made from tested steel. Many years of manufacture have given us a knowledge and skill which enable us to produce rings of unrivaled quality. Methods of finishing, hardening, and polishing have been developed so as to produce a hard ring of satin finish, thus giving to the traveler the best bearing for speed and wear.

Sizes of Spinning Ring Flanges

No. 1	Flange is	4/32" wide
No. 2	" "	5/32 " "
No. 2 $\frac{1}{2}$	" "	11/64" " "
No. 3	" "	6/32" " "

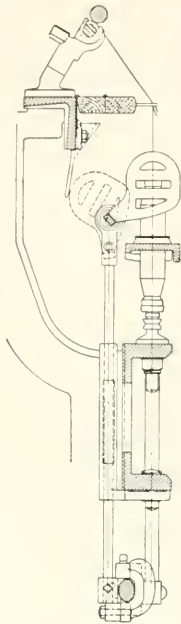

The Separators usually furnished when required are the H & B Automatic Type. These separators are simple, light, and rigid. They have few parts and are easily kept clean. The separators travel up and down with the ring rail mid-way between the ring rail and the thread board. These separators are operated by a lifter rod supported by a bracket on the wave shaft arm. This bracket can be adjusted to vary the travel. The separators are readily tipped back for doffing, and a guard attached to the roller beam knocks them back into position if the frame is started while they are tipped back.

SEPARATORS

Automatic Type

We also furnish the fixed type of separators. This type, as illustrated, is attached to the ring rail by means of a bracket. They can be tipped back in the same manner as the type above described. This style is always in a constant position relative to the ring rail.

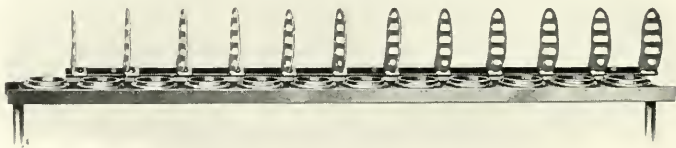

SEPARATORS

Attached to Ring Rails

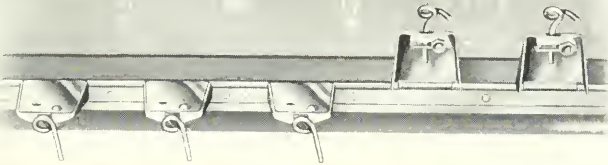

METALLIC THREAD BOARDS

The Thread Boards furnished on practically all orders are the metallic type of our own manufacture. Any style of guide wire can be supplied. These guides can be easily and accurately adjusted and firmly locked in position. Traversing thread boards are furnished when required or when specified. We generally recommend this type for extra long traverses.



TRAVERSE MOTION

The Trumpet Rod Traverse Motion is of the variable type, giving equal wear for nearly the full width of the roll boss. A simple adjustment is provided so that the length of the traverse can be easily altered.

The Trumpet Rods are made of hot-drawn steel and are equipped with brass trumpets which are easily and readily adjusted while the frame is in operation.

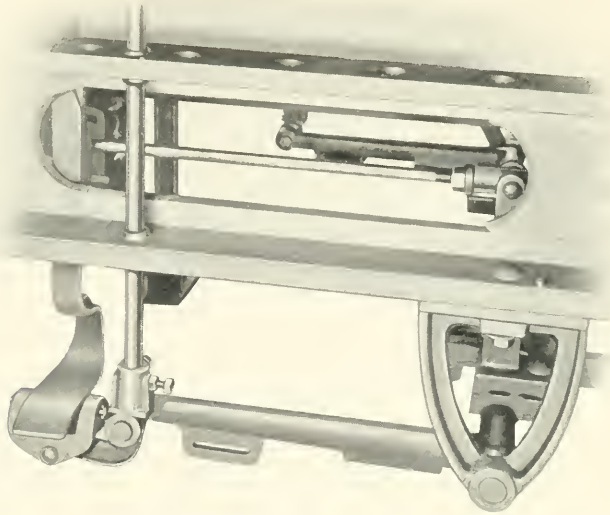

DOFFER LOCKING DEVICE



H & B HANK CLOCK

The Doffer Locking Device is attached to the arm of the wave shaft at the geared end of the machine. This device is simple in design and easily operated. A knee bracket with a foot pad at the lower end and a notch at the upper end is attached to a bracket on the wave shaft finger. When the operator steps on this pad, the upper portion is brought against the spindle rail, the weight of the operator lowers the rail, and as it reaches its low position the notch at the upper part of the bracket catches under the spindle rail. The rail is thus held down in position for doffing. It is easily released in the same manner.

The H & B Hank Clock is furnished when desired. This clock registers the hanks and decimal parts of a hank delivered by the front roll. It is entirely enclosed, making it free from dust and dirt, and is so designed as to prevent unauthorized adjustments. This clock is neatly fitted and geared inside the head end with the face plainly visible through an opening in the upper panel.

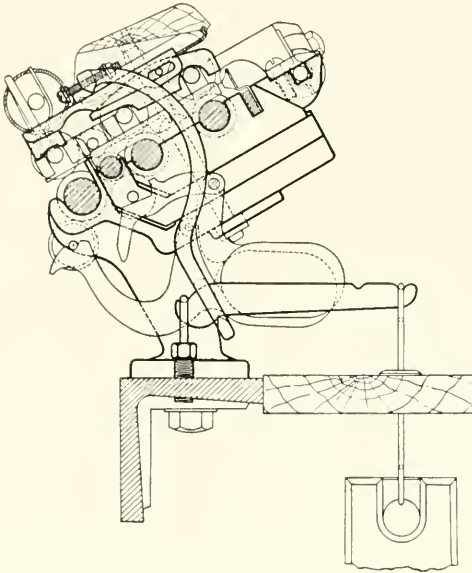

CROSS-SECTIONAL VIEW

Showing Rolls, Saddle, Stirrup, Weighting, and Clearers

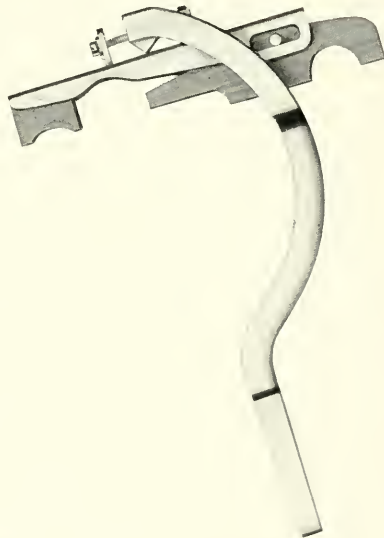

**COMBINED OILLESS WOOD BEARING SADDLE
AND STIRRUP**

H & B FOUR-ROLLER SYSTEM OF LONG DRAFT

For well over a century three-roller regular draft spinning, with no fundamental changes in principle, has been universally accepted as standard by the cotton industry. The reason for this general acceptance and protracted use has been its practical simplicity. It has been easy to clean and care for and has produced a yarn of good commercial quality with an investment and maintenance cost that is commensurate with the results obtained. This record of achievement by three-roller spinning is reason enough for retaining its simplicity features, in any attempt to improve on its efficiency.

This fact was our guiding principle in determining on a four-roller long-draft system to meet the demands of the cotton industry for lower manufacturing costs with equal or improved quality. However, for the benefit of those who demand more particular evidence of the need for simplicity in a long-draft system it is only necessary to consider the following facts.

In any long-draft system, more fly is thrown off by the drawing rollers than in regular draft, due to the use of a coarser hank roving, or to the elimination of the roving frames, where normally some of the fly is deposited. Admitting this fact, the need then for a mechanism that can be easily cleaned becomes axiomatic.

H & B Four-Roller Long Draft meets every requirement for simplicity to an exceptional degree. In short, its maintenance cost is about the same as that of a three-roller system, and it also compares very favorably with the latter as to ease of cleaning. It can be stated with equal certainty that the investment cost is commensurate with the results obtained.

The secret of H & B Four-Roller Long Draft efficiency is that it effectually controls a large percentage of the shorter fibres as well as the long fibres, and yet permits sufficient freedom to effect proper distribution.

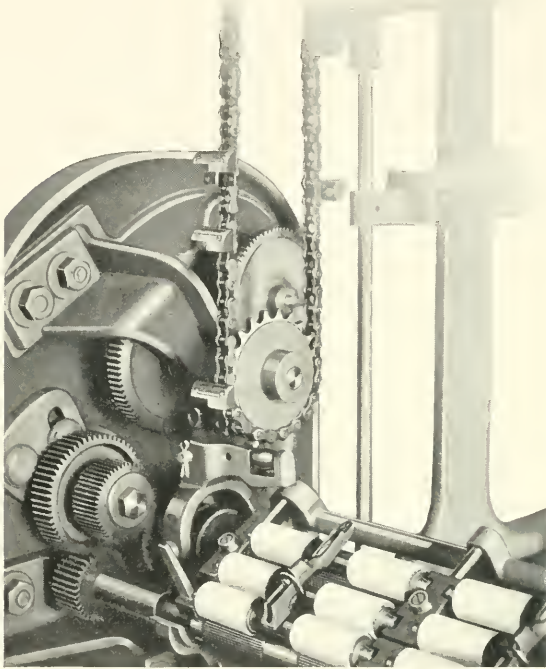

ATTACHMENT
FOR
SLUB YARN AND HIMALAYA YARN

ATTACHMENT
FOR
SLUB YARN AND HIMALAYA YARN

For the manufacture of Slub Yarn and Himalaya Yarn we have developed a most satisfactory unit which can be applied easily to existing frames. It is a simple gearing and clutch mechanism combined with a ratchet device contained within the crown gear at the head end of machine.

A pattern chain, which is shown in the illustration, operates to engage and disengage the clutch. The operation of this clutch causes the middle and back lines of rolls to speed up, thus producing a heavier yarn than is being spun through the regular draft gearing at the head end. The pattern chain allows for various lengths and spacings of the coarser yarn, thus providing for the development of various cloth patterns.

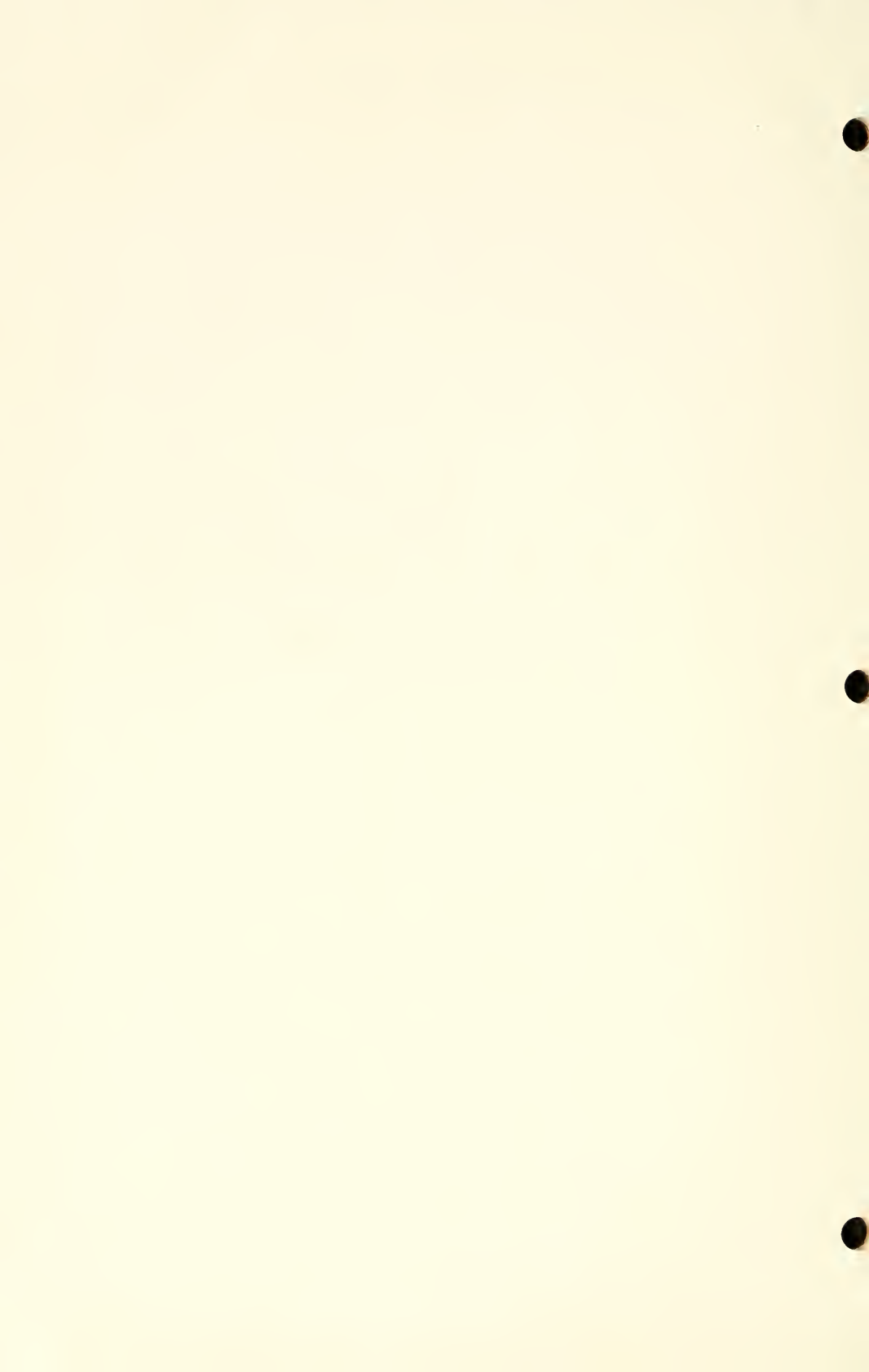





PRINTED IN THE U.S.A.