

UNIVERSITY OF TORONTO



3 1761 00475143 4





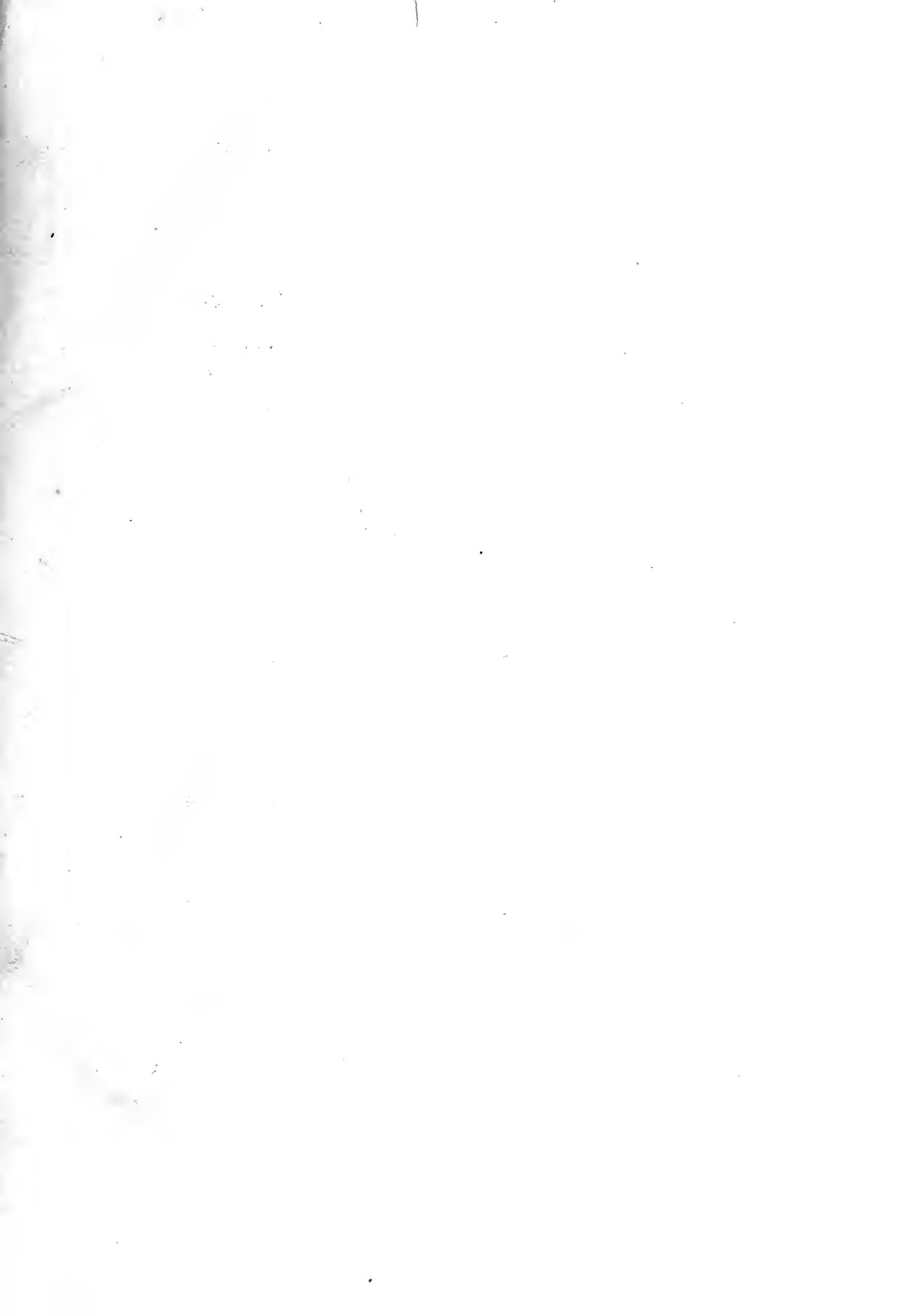

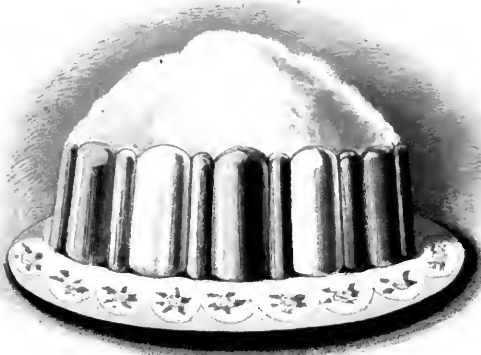

1



2



3



4



5

Cassell's Household Guide. Plate III.

1. Open Jelly with whipped cream.

2 Yorkshire Pie and Aspic Jelly.

3. Trifle, Ices and Jellies around.

4. Christmas Pudding.

5 Jelly of two colours.

CASSELL'S
HOUSEHOLD GUIDE:

BEING

A Complete Encyclopædia

OF

DOMESTIC AND SOCIAL ECONOMY,

AND FORMING

A Guide to Every Department of Practical Life.

VOLUME II.

With Numerous Illustrations.

LONDON:
CASSELL, PETTER, AND GALPIN,
LUDGATE HILL, E.C.;

AND 596, BROADWAY, NEW YORK.

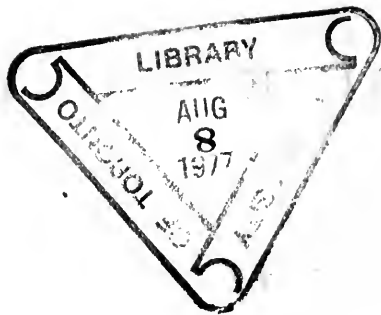

TX
145
C37
v2

CASSELL'S HOUSEHOLD GUIDE.

HOUSEHOLD DECORATIVE ART.

IMITATION IVORY AND JET ORNAMENTS FOR THE TABLE, ETC.

ON page 368 of Vol. I. we gave instructions for making sealing-wax; in the present article we propose to point out a new use for that material by which imitation coral, ivory, jet, and frames for photographs, &c. &c. may be very readily manufactured.

The process demands no particular skill, the materials are of the cheapest, and the result will be sure to gratify the eye and serve as novel and attractive household ornaments. The card-case, shown in our illustration, is but one of the many things amateurs may make in this way, and few would be found to guess the very simple process by which the original of that drawing was produced. By this plan elegant boxes and pretty card-cases, also ornamental stands, can be easily made. If a casket is well-shaped and cleverly done, it will be found worth placing under a glass case.

Secure a number of seals, all of one colour. Fix them, with strong gum tragacanth, to the box you wish to ornament, arranging them at intervals with good taste. Melt a quantity of sealing-wax of the same shade all over the spaces between. Only a little of the sealing-wax need be put on at a time, and stamp it close together all over with a watch-key. If the seals are gummed on, a little margin of paper should be left all round them. The new sealing-wax, overspreading this, secures them permanently. If the dies of the seals can be borrowed, the seals can be made upon the box, which is an improvement. Seals may be made by holding stout cardboard over the flame of a candle, holding a stick of wax again on the top of that till it melts, and working it round and round on the card till enough is spread. The card must be gently moved about above the candle.

Another way is to melt a quantity of wax in a pipkin in the oven, and ladle a spoonful out—using a little iron tea-spoon—for each seal. It is very desirable that these seals should look dead—not shining. To effect this, damp the seal by passing it lightly and quickly over the tongue, and then dip it momentarily in very finely-powdered paint. For red seals, to imitate coral, use vermilion; for black, to imitate jet, lamp-black;

for pale buff, to imitate ivory, white; pale sea-green imitates Egyptian turquoises, which are rather streaky; azure, lapis lazuli; and bright green, malachite. But these pale and bright colours are more difficult to manage: red and black will be found the safest colours. For cameos, use brown or grey sealing-wax, and dip the seal in white powder paint. In stamping the ground, which will be made of brown wax, dip the watch-key every time in the white powder. This will give a mixed effect that is very good. The watch-key must be a large one. For seals, choose coats of arms, coronets, municipal and companies' seals, or large and handsome subjects, such as heads, classical figures, &c. A die-sinker could lend material aid for this sort of work. Seals may be obtained by taking casts from medals, cameos, and ladies' ornaments. It is not at all difficult to take such casts. Oil the object to be copied. Mix plaster of Paris into a thick paste, with a knife



and some water. Fill a pill-box with it, and press the cameo, previously oiled, on the plaster, as if to make a seal. Leave it till dry; then remove it, and tear the pill-box from the cast. If a pill-box is too small, cut a strip of card, and sew it together in the right form. Modellers' clay may be used in the same way. Fill your box with it, and stamp it with your object, first oiled or wetted. Leather card-cases are used for the seals. Many other useful and ornamental articles may be made or decorated in a similar way.

HOUSEHOLD CHEMISTRY.

FOOD (continued).

Digestion.—We have seen that food, before it can answer any useful purpose in the body, must pass into the condition of blood. It is blood which carries nourishment to the organs of the body; it is in the blood that a great portion, if not the whole, of the materials of the body are burnt. For this reason, substances which cannot be converted into blood, cannot possibly act as food. Coals and wood, for example, in spite of their heat-producing powers, cannot be used as food; and there are constituents in many foods, especially in those which the lower animals consume, which are incapable of conversion into blood, and which are therefore removed from the body unchanged. It is therefore evident that, before we can judge of the fitness of a substance for food, we must take careful account of its suitability for conversion into blood. And this is the more necessary because, even among those substances which do undergo this process in the body, there are remarkable differences in the ease with which it takes place. Some are converted very easily and rapidly; some only with great difficulty and after a considerable time; and although during perfect health, and with a fair amount of exercise, almost any kind of diet may often be used with impunity, it is very frequently necessary to avoid all food that is not easily assimilated. It is, in fact, a wise general rule that the organs of digestion and assimilation should not be forced to do unnecessary work.

These considerations render it necessary to study, with some little care, the changes which food undergoes in the body, from the time when it enters the mouth to the time when it is incorporated with the blood. The apparatus provided for effecting these changes is singularly beautiful and elaborate. It has been studied, with the minutest care, by physiologists and anatomists, but even now there is very much about it that we do not understand. The changes produced by it are partly mechanical and partly chemical; mechanical in as far as the food is ground into a pasty condition, favourable for further changes; and chemical in that it is acted upon by various liquids, which completely change its nature, liquefy it, and prepare it for its last change into blood.

Changes in the Mouth.—By the assistance of the tongue, the food is brought under the action of that active little mill, the teeth. For proper digestion, it is highly desirable that the teeth should do their office properly. If they are not equal to the task, or if food is swallowed before they have properly performed it, the digestive organs will have more to do, the subsequent processes will take longer, and will, too often, be imperfectly effected after all. The miseries of *indigestion* very frequently have their origin in imperfect mastication; and we shall all do well to remember the simple lesson, that rapid feeding almost always leads to bad digestion. Children, in particular, should never be hurried over their meals, but should be encouraged to spend as much time as possible in the agreeable process of munching. Persons whose teeth are weak or imperfect should be very careful to mince their food as finely as they can before they eat it. They can in this way imitate, to a certain extent, the action of the teeth.

Besides the grinding, a certain chemical change is effected, in the mouth, on some constituents of food. As soon as the food enters the mouth, the fluid called the *saliva* is poured forth profusely from certain little glands which are provided for the purpose. This fluid not only moistens the food, and enables it to assume a semi-fluid state; it also, in virtue of a peculiar substance called *ptyaline* which it contains, converts a great portion of the starch of the food into a kind of sugar. Sugar is soluble, whereas starch is insoluble; and we therefore see that one portion of the food is brought into the liquid state even in

the mouth. The sweet taste of bread which has been masticated for a minute or two can be distinctly perceived.

Changes in the Stomach.—From the mouth, the food passes directly into the stomach. This is a bag open at both ends. Its walls consist partly of bands of muscle, and by the action of these the food is churned round and round, from end to end of the stomach, making the complete circuit once in every two or three minutes, or even oftener. When empty, the stomach contains only a thin neutral or alkaline fluid; but as soon as the food enters, a large quantity of a highly acid liquid, called the *gastric juice*, issues from little glands in the walls of the stomach, and mixes with it. And now the process to which the name *digestion* is often limited, begins. The gastric juice contains a substance called *pepsine*, which, when mixed with acid, has a most remarkable power of dissolving the flesh-forming elements of food. The fibrine of flesh, for instance, which is insoluble in water, rapidly passes into solution in the stomach; and that this is really a chemical change is proved by the fact that pure pepsine, slightly acidulated, will dissolve hard-boiled eggs and pieces of meat when gently warmed with them for a few hours in a glass vessel. The fact is so well known, that artificial pepsine, prepared from the stomachs of pigs and sheep, is now sold as a medicine for persons of weak digestion, and is found to be highly valuable in some cases. The acid of the gastric juice appears to consist of hydrochloric acid, commonly called spirit of salt, and lactic acid, the acid of sour milk. The hydrochloric acid is entirely formed from common salt, which shows how absolutely necessary it is that salt should be present in the food we eat. The time which this liquefying process occupies in the stomach varies considerably with the constitution of the individual and the nature of the food. The chemical action of the gastric juice is entirely confined to the flesh-formers, so that starch, sugar, and fat pass unchanged through the stomach, except in as far as they are more thoroughly broken up and macerated. The flesh-formers in some kinds of food are much more easily digested than in others, a fact which is indicated by common experience as well as by scientific inquiry. Much of the difference is due to the condition in which the substance is presented in the food; thus caseine is much more easily digested in milk than in the compacter form of cheese; but there are other points of difference which are not so easily explained. A good deal of our knowledge on this important subject is due to the observations of Dr. Beaumont on a highly curious case which he had the good fortune to meet with. A young man named St. Martin, a Canadian, was the victim of an accident by which a hole of considerable size was made in his stomach. He recovered, and regained his ordinary health; but, strange as it may appear, the hole did not close, but to the end of his life his stomach remained in direct communication with the external air. Dr. Beaumont, when he examined him, found that he could see distinctly what was going on inside his stomach, and could put things in and take them out with perfect ease. Fortunately, this remarkable opportunity of making experiments was not lost. Dr. Beaumont watched very carefully the time required for the digestion of different articles of food, observed the accumulation of the gastric juice, the motions of the stomach, and other points of the greatest interest to physiology. Among the articles observed, tripe and soused pigs' feet were digested most easily. They were liquefied in an hour, whereas beef and mutton took from two hours and three-quarters to four hours, while pork required five hours and a quarter, and boiled tendon five hours and a half.

Experiments and observations made by other physiologists agree in the main with those of Dr. Beaumont, but great difficulty attends the inquiry, and it cannot be doubted that different individuals differ very much in their digestive powers. Nevertheless, the general character of

the chief articles of food in this respect can be judged of with tolerable certainty.

Changes in the Intestines.—The action of the gastric juice converts the food into a creamy fluid called *chyme*. As fast as this is formed, it passes onward through the orifice in the stomach into the intestine, which is simply a membranous tube about twenty-five feet long, that twists about in a most complicated manner through the lower portion of the abdomen. In this organ, further important changes are effected in the chyme. It will be remembered that a portion of the starchy constituents of the food are converted into sugar in the mouth. The remaining portion is not changed by the gastric juice, but is reserved for the further changes of the intestine. In a similar manner the gastric juice converts the greater portion, but not the whole, of the flesh-formers into solution. And, lastly, the fat has not undergone any chemical change either in the mouth or stomach. Chyme may therefore be regarded as a complex mixture, containing unaltered flesh-formers, fat and starch, all in a state of fine division, besides the food which has already undergone chemical change.

At about four inches below the orifice of the stomach, a small side tube—a kind of branch pipe—throws into the intestine from time to time the fluids which have been prepared in two important organs, the liver and pancreas (or sweetbread). Another fluid, called the *intestinal juice*, is prepared in little glands situated in the walls of the upper part of the intestine, and is also poured into it, so that the chyme is subjected to the chemical action of at least three liquids—the bile, the pancreatic juice, and the intestinal juice. The functions of the bile are not yet satisfactorily made out. Possibly it assists in neutralising the acid of the gastric juice, and probably it tends to prevent putrefactive processes from going on in the intestine. It is often produced in too great quantity, and is then apt to find its way back into the stomach and interfere very unpleasantly with the process of digestion. The operation of the pancreatic juice is better understood. It contains a peculiar principle, called *pancreatine*, which has the power of changing starch to sugar, but which appears to be mainly intended for the preparation of the fat or oil of the food. Its effect on fat is very remarkable. The fat is not altered in its chemical nature, but is broken up, as it were, into very minute particles, in which state it can readily pass into the blood. If the pancreatic fluid be shaken up with oil or melted fat, the oil will no longer rise to the surface on standing, but remain intimately mixed with the fluid. Such a mixture is called an *emulsion*, and pancreatic emulsion, or even pancreatine itself, mixed with malt-flour, is now sometimes used in medical practice.

The intestinal juice is an even more remarkable liquid than any of the preceding, for it appears to combine the powers of all of them. It is scarcely inferior to gastric juice in its power of dissolving the flesh-formers, and scarcely inferior to saliva and the pancreatic fluid in its action on starch. We must, therefore, regard it as intended by Nature to make up for any deficiencies in the operation of the other fluids; as an agent of economy, to prevent as far as possible the waste of useful food. It is well known that it is possible for small quantities of food to be absorbed and converted into blood without any assistance from either mouth, stomach, liver, or pancreas. This compensating power must be ascribed to the intestinal juice, which is therefore one more of those wonderful provisions for possible events which are so common in the animal body, and which Paley used with such force and eloquence in evidence of the personal sovereignty of God.

Conversion of Food into Blood.—By these various means all the useful part of our food is converted either into the liquid state or, in the case of fat, into an emulsion which is

almost like a liquid. To complete the history we have in hand, it is only necessary to consider how this liquefied food passes into, and becomes a part of, the blood. There are two distinct means by which this absorption is effected. In both cases the liquid food passes out through the walls of the intestine, but there is a well-marked difference in the apparatus provided in each of them. The inside of the intestine, for a considerable distance down from the stomach, is studded with tiny elevations like pimples, which might readily pass unnoticed by any except a close observer. They are called *villi*, and they are really beautiful and most elaborate structures. Each one contains a network of fine blood-vessels and a system of thin transparent tubes, which form part of a greater system that pervades the whole body. This is called the *lymphatic* system. The tubes composing it appear to be designed to carry to the blood everything which is necessary to its life. The lymphatics which take their origin in the villi are called *lacteals*. Some portion of the digested food, and notably the fat, passes through the villi into the lacteals. The lacteals carry it through a series of glands in which it is further elaborated, and from thence, when the process of preparation is finished, it is poured into the blood.

But it is only a portion of the chyme which is carried into the blood through the agency of the villi. A great deal passes through the walls of the intestine directly into the *capillaries*, or minute blood-vessels which surround it on all sides. This portion, however, has to undergo a further preparation before it assumes the perfect form of blood. The blood carrying this nutritive matter in solution is carried to the *liver*. It appears nearly certain that this large organ acts in a similar manner to the lymphatic glands. In it the liquid food is, as it were, vitalised—concocted into living blood—and thenceforward takes its place in the general circulation. Of the way in which these last changes are effected we know very little. It belongs to the most obscure regions of physiology; but whatever the mechanism, we know the final result. The food, moistened, ground, assimilated and absorbed, is at length elaborated into blood, and poured into the great torrent to replace the constant loss which it is undergoing. The further changes of the blood belong to a different and not less important chapter in physiology.

PATCHWORK.—II.

THE advantages of making patchwork, besides the useful purposes it is put to—and, indeed, to be reckoned before those purposes—are its moral effects. Leisure must either be filled up by expensive amusements, “mischievous,” or by listless idleness, unless some harmless useful occupation is substituted. Patchwork is, moreover, useful as an encourager of perfection in plain work, because it must be very neatly sewn, especially if made of silk pieces and sewn with white sewing silk. The ordinary sewing is used, and the ordinary running to quilt it. So patchwork often plays a noble part, while needlework is encouraged and brought to perfection, and idle time is advantageously occupied.

A common pattern in patchwork is shown in Fig. 1. To make this work, cut cards two inches square, or smaller if wished, and cover them with all the available strips of ribbon or silk you can procure—scraps left over from dressmaking, ends of ribbon, pieces begged from friends and dressmakers. When you have a bag full, sort them into light, dark, and half-tints. Then join them as shown in Fig. 1—A the light, B the dark, C the half-tint. When all your pieces are thus joined, proceed to unite these clusters. At D, the light square of another cluster comes; at E a dark square will come; at F a half-tint. You will find, when joined, the colours will run diagonally—

that is slanting—A D light, E B dark, and so on, in stripes, as it were.

There are various ways of making patchwork. One of the most usual is to form stars or boxes. To form the stars, cut diamonds of light cotton or chintz, a little larger than the diagram (Fig. 2), and cut cardboards the same size as the diagram. Neatly tack the chintz over the card. When you have eight of these, all of light chintz, sew four round the four sides of a dark one, and insert four more by the points, which must each be sewn on two sides to the four already sewn on; this makes a star. Join a row of these stars by the extreme points, making them all of light chintz, with dark centres; then make a row of stars of dark chintz, and sew to them, so as to form a row beneath the first row. Repeat again, light and then dark, till you have as many as you wish; the effect will be alternate stars—dark and light. This pattern may be agreeably varied by always working a light diamond into the centre of a dark star, and a dark diamond into the centre of a light one.

In forming stars, the light ones may be of all sorts of colours, always about equal in light tone, and the dark also equally varied; or the patchwork may be arranged in colours—say, the light stars all yellow, with blue centres; the dark all crimson, with green centres.

Another variation may be made in this way:—White star and azure centre; maize star and violet centre; Havannah star and bright-green centre. Place these alternately to the end of the row. Second row: Blood-red, with emerald-green centre; dark green, with scarlet or pink centre; violet, with golden-yellow centre. Repeat these to the end of the row.

Add another row like the first, only reverse the positions, thus: Havannah star, maize star, white star. For the fourth row, reverse the second, thus: violet star, green star, red star. The cushion or quilt is completed by repetitions of the same pattern, filling in the edges by half-stars. If it is used for a quilt, it is best to add a border of some kind or a cord all round, made of silk or worsted. Such quilts or cushions are very handsome. To form a quilt, a blank diamond of white satin may be left in the centre, the size of the other patchwork diamonds, and upon it the monogram or arms of the family worked in embroidery, with coloured silk. This diamond should be inserted last, to keep it clean, and covered with tissue paper. Line the quilt throughout, with first wadding, and then silk of any favourite colour, of course one of the colours used in the patchwork.

Quilt it by running it between the diamonds in lines both ways, crossing. Such a quilt as this can hardly be made of scraps—the materials must be purchased; but it forms a beautiful present, and is very handsome for use. It is specially suitable for a wedding gift.

All patchwork, even for cushions, looks richer if quilted and wadded, though it is not generally done. For this purpose it is best made without cardboard, which is difficult, as card helps very materially to the keeping shape. Card requires the quilt to be extra thickly wadded, to raise it well for cushions.

Useful and neat-looking counterpanes in patchwork for upper rooms may be made in this way. The ornamental counterpane may be made in any of the ways presently described. It may even be mere squares, set as squares, or obliquely as diamonds, and sewn together without order; or it may be a handsome pattern of stars, &c., or appliqué work. When it is finished, take all the old blankets and flannel petticoats to spare, wash them clean, and dry and air them well. Cut out all the best portions, and join together.

You may make them two or three thick. Line with a sheet of cheap unbleached calico, first soaked, or even an old sheet neatly patched. Spread the sheet on the floor. Tack on blanket No. 1; then blanket No. 2; then blanket No. 3; lastly, the ornamental quilt. Run them all together, following the joints of the patchwork, in regular lines, first all one way, and then across. If the top is of appliqué work, instead of quilting across, run all round the border of every device with strong thread, taking the stitches right through the whole mass.

A sewing machine would prove a useful friend for such thick quilting.

We have also seen old counterpanes and quilts in mere rags tacked together, placed between a patchwork quilt and a sheet, or breadths of calico joined, tacked to them and quilted. Of necessity such arrangements are as warm and comfortable as they are thrifty.

Many ladies make patchwork quilts in this way:—They take two old silk dresses of their own, or beg two from friends. In the days when plain dresses were worn, the skirts were simply unpicked, split in halves, and run together alternately, wadded, lined, and quilted. Now dresses

are gored, join the gores of two dresses of well-contrasting colours, as is shown in Fig. 3. About six breadths joined is sufficient. For a border, join four breadths, two and two, and then make a length of them, and cut in halves with the scissors. Add this all round, either by sloping the corners to fit like a picture frame, or by putting it on as a frill. The former way is best for a large bed: we recommend this for one side of a silk quilt.

For the other side, cut up two dresses into diamonds, and make stars—light stars with dark centres, and dark with light centres; or, if both colours are equally dark, by reversing them.

The two quilts may now be run together. To make them warmer, one or two more old silk dresses or linings—very thin or dyed ones may be used—can be run together in breadths and tacked between; then all quilted together with some light-coloured silk, and a cord or fringe used as a border. Such silk quilts have the merit of being light and warm. Down put between the outer pieces instead of more silk is also excellent, and in farmhouses easily obtained from the geese. Or one silk patchwork quilt of old skirts may be lined with a plain piece of chintz.

The silk skirts, after they have been unpicked, should be thoroughly cleansed before they are made up; which may be done by adding to soft soap 1 lb., honey $\frac{1}{2}$ lb., gin 1 quarter; mix in a pipkin; spread the silk on a clean

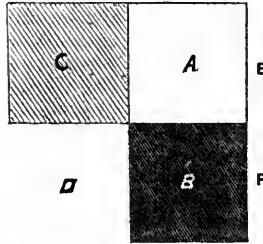

Fig. 1.

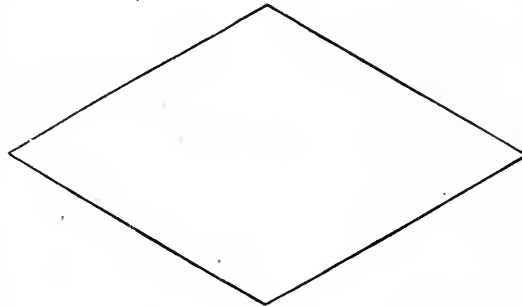

Fig. 2.

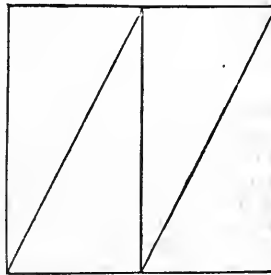

Fig. 3.

board, and rub with a soft brush and the mixture. An old hair-brush, well washed, is suitable; or a nail-brush. Have a pan of cold water and a clean sheet ready. When the silk breadth is sufficiently scoured, rinse quickly in the water—do not wring; lay on the sheet; fold it up. This takes out enough of the wet to prevent the colour running. Hang up at once to dry on a horse or line. When nearly dry, iron. Violet and mauve are generally restored to colour, if faded, by putting soda or ammonia in the rinsing water. A small piece should be tried first, as it does not invariably succeed. Salt for blue, vinegar for green (two dessert-spoonfuls and two quarts of water), sugar of lead for black; a little blue, well mixed, for white; saucer pink, well mixed, for pink. Iron on the wrong side.

Let black silk dry completely, and afterwards moisten slightly with a piece of black silk dipped in boiling water poured on ammonia, half a quarter to a piece the size of a large walnut.

Bordering for counterpanes can very well be made by cutting triangular pieces six inches wide, and joining them together. They should be light and dark, and dovetailed together.

We have seen a very neat patchwork quilt made of alternate borders of chintz and dimity. The centre was a square of chintz twelve inches wide each way. Round this was a border of dimity in four straight pieces, joined, and four inches deep. A second border of chintz was five inches deep, and a third border of dimity six inches deep. A fourth border was composed of triangles of dimity and chintz, dovetailed together; the dimity upwards, and measuring seven inches deep when completed; two chintz triangles met at each corner. A fifth border of dimity, nine or ten inches deep, was completed by a chintz border fourteen inches deep. The whole was lined with a sheet of unbleached calico, and quilted together in diamonds.

COOKING.

EGGS.

THERE are in this world a few common things which never fail to inspire the thoughtful mind with unceasing wonder and admiration. One of these, which falls within the scope of our subject, on account of the immense service it renders in cookery, is water.

The expansion and contraction of water at different temperatures is comparatively trifling—a property of great importance to everything that lives. To appreciate fully the value of what *is*, we may sometimes imagine what *might be* instead. For instance, what a blessing it is to the human race, to the animate world, to all organised nature, that water is not as expansible as oil! Great heats would cause rivers to overflow, animals to be smitten with apoplexy, sap-vessels to be burnt, making every plant one wound, while seas, in summer, would inundate the coasts which had the misfortune to bound them. There is no fundamental reason, no primary cause, why water should *not* be as expansible as oil. Happily, it is not so; on the contrary, the slight variation of which it is susceptible, tends to our advantage and convenience.

Pure water is at its greatest density, or heaviest, at 39° of Fahrenheit, that is, at seven degrees above the freezing point. If the temperature changes, *either way*, the water expands. From the maximum density up to the boiling point, the expansion amounts to four one-hundredth parts of its volume—a mere nothing. If it cool *below* its maximum density, it still expands up to the freezing point. Consequently, water which is near the point of freezing, is lighter than water that is only just a trifle warmer. It therefore rises and floats on the surface, allowing the warmer stratum to sink. Water still further expands *at* its conversion into ice. Although easily heated, water is a bad conductor of heat; that is, it does not readily part

with heat. In water kept constantly boiling, it is the *ebullition* from the bottom of the pot which causes our viands to cook so speedily. A leg of mutton simply plunged into boiling water and there left, without being set over a fire or on a hot iron stove, would take a long time even to get warm through. Rumford fixed a plate of ice at the bottom of a glass vessel, and then poured in cold water enough to cover it to the depth of a quarter of an inch, on the top of which he poured boiling water in considerable quantity. The heat was so slowly transmitted from the boiling water to the ice, that, at the end of two hours, only half of it was melted; but if, instead of fixing the ice at the bottom, it is allowed to swim on the surface, it is rapidly melted by the rising of the particles of hot water from the bottom of the vessel up to the top. This experiment shows us what consequences we should have to suffer were our rivers and lakes to freeze from the bottom, as just now supposed. In the temperate zones the larger masses of water would become perennial glaciers, which no summer heat could liquefy.

The two grand essentials for the possibility both of animal and vegetable existence, are *air* and *water*. Without them, without water especially, we cannot conceive the presence of life. A perfectly dry body would necessarily be a stiff and motionless mummy. Now, so great is the attraction or affinity of these two grand essentials of life for each other, that water absolutely free from air, and air absolutely deprived of watery vapour, can only be obtained by the employment of the most potent chemical agents.

Another remarkable quality, if we think of it, is the smallness of the range of temperature in which water assumes its three different forms of ice, liquid water, and steam—in each of which forms it is useful, and none of which are really difficult to obtain. This range, between freezing and boiling water has been divided by French philosophers into one hundred degrees, whence the scale is called "Centigrade." Its only inconvenience is that the degrees are too large to express slight variations of temperature; for *that* purpose Fahrenheit's scale is preferable. This is the range under *ordinary* circumstances; under special conditions, it is extensible. The change from a liquid to a solid state may be retarded by keeping the vessels which contain the water (deprived of air) in perfect repose.

An egg is another common thing which approaches the marvellous. It is neither alive nor dead, but possesses a latent vitality which may be called forth under the prescribed conditions. By consuming an egg you do not take life; you merely prevent its development. Nevertheless, this faint vital spark has the conservative force of actual life. An egg containing a fertile embryo will keep longer than one which has none. Harvey's grand principle, "*Omne vivum ex ovo*"—"Every thing living comes from an egg," has received confirmation from more recent investigations. The traditions and legends respecting eggs are strange and numerous.

The very form and contour of an egg are remarkable, and most suitable for their purpose and destination, being bounded and contained in one direction by a circle, in another by an irregular ellipse. The latter curve is more elegant, because more varied than the regular oval, so called from *ovum*, an egg. It is the tapering of the smaller end which gives to an egg its graceful shape. Sir Thomas Browne's acuteness led him to the conclusion "that the sex is discernible from the figure of eggs, or that cocks or hens proceed from long or round ones, as many contend, experiment will easily frustrate." In fact, it has been copied and re-copied from quarto to octavo, through duodecimo and pamphlet, that small round eggs produce female and long pointed ones male chicks. But the truth is, that to every hen belongs an individual peculiarity in the form, colour, and size of the egg she lays, which never

changes during her whole lifetime, so long as she remains in health, and which is as well known to those who are in the habit of taking her produce as the handwriting of their nearest acquaintances. While writing this, there lies before us an egg with a curious wrinkle or fold in the shell about the middle. Every egg laid by that hen has it. Some hens lay smooth, cream-coloured eggs, others rough, chalky, granulated ones. There is the buff, the snow-white, the spherical, the oval, the pear-shaped, and the emphatically egg-shaped egg.

In speaking of eggs in cookery, hens' eggs are understood, because they are the only ones to be had all the year round. Ducks' eggs are common enough in early summer; they are larger, but less delicate for eating than hens'. At that season turkey and goose eggs are too valuable for hatching to be used as food. The former, especially, can be procured in autumn, when there is no chance of rearing the chicks obtained from them. Both are excellent. The only objection to a goose's egg is its inconvenient size. During a limited period, and in a few localities—as in certain parts of Yorkshire and Norfolk—the eggs of a few species of seagulls are taken and sold. They have a peculiar flavour, which to many persons is very agreeable. But they must be regarded as an occasional luxury rather than as a common article of diet. They are the *game* of eggs. The supply, which is much restricted, has greatly fallen off of late years, and will speedily be reduced to nothing unless stringent measures are taken for the preservation of the parent birds.

The best practical way of preserving eggs is to smear them, as soon as laid, with some substance, as butter, which will close the pores, and so prevent evaporation, and to turn them afterwards occasionally on the shelf on which they lie. The pores may also be closed by giving them two or three dips in boiling water. Packing them in bran or wheat answers for a time. Sawdust—if they remained long in it—would communicate the flavour of the wood from which it is made. Eggs pickled in lime-water and salt do not stink (excuse the word, but we must sometimes be plain), but they are not otherwise to be recommended. The best way of having fresh eggs during the dead months of the year is to rear pullets early in spring, and feed them well all the summer long. Towards the close of the year they will begin to lay small but very acceptable eggs.

A fresh egg should feel heavy in the hand; if it shakes, if it floats or stands upright in water, if it cracks suddenly with a slight explosion on being put into boiling water, it is not fresh. A clear healthy-looking shell is a sign of freshness; but the shell is deceptive. Preserved eggs are fished out of their tub, wiped, and then rubbed with a little silver-sand, to give them a natural-looking roughness. A fresh-laid egg takes half a minute longer to boil than a stale one. "A new-laid egg yields a soft coagulum by boiling; but when, by keeping, a portion of the water has transuded, so as to leave a void space within the shell, the concentrated albumen affords a firm coagulum."—*Ure*.

The really good ways of cooking eggs are not in reality numerous, unless we include all the eatables in which eggs are part of the ingredients. For instance, there may be reason in roasting eggs, but there is more reason in not roasting them. A roasted egg is mostly burnt, bad flavoured, cracked, and leathery. Of the boasted 366 ways of dressing eggs, many are distinctions with little difference. We shall here give only the simplest and the best.

Eggs Boiled in the Shell.—We feel inclined to imitate Swift's "Advice to Servants," and tell you how many ways there are of boiling eggs badly; one of which, very frequently practised, is to put them into a saucepan without enough water to cover them. But we reserve those curious receipts for the present. There are two ways of

boiling an egg well. First, drop it gently, without cracking it, into boiling rain or river water, and let it boil three minutes and a half, for which you ought to have the help of an egg-glass. Secondly, drop the egg into boiling rain or river water; set the saucepan on the side of the stove, so as to keep hot, without ever boiling again; let the egg remain there five minutes. For this, if there are not five-minute egg-glasses, there ought to be, because, for epicures as well as for invalids, this mode of boiling an egg to be soft in the shell is by far the best. *Hard* eggs are quite a different affair.

An egg is a good example of the different way in which the different substances which serve as our food are acted on by heat. "Put it on the fire in a saucepan, with cold water; let it heat gradually and slowly; and you will find that the yolk is set *before* the white, and also before the water boils. The white becomes fixed soon afterwards, and at the temperature of scarcely boiling rain-water. You will, therefore, employ quite a moderate degree of heat for sauces thickened with yolk of egg, while a very little more heat will serve for dishes composed of the whites and yolks together. You understand why, if baked custards, rice-puddings, and the like, *boil* in their baking-dish, they are ruined, running into whey; why boiled custards and creams containing eggs should be done in a *bain-marie*, or jar immersed in a saucepan of hot water; why an omelette, left long enough in the pan to get penetrated by the heat of the butter in which it is fried, becomes leathery. Quick boiling converts the white of eggs into something very like gutta-percha, even though the yolk is not yet hard."

Poached eggs, on the contrary, in which it is desirable to set the white speedily, in order to keep them whole and shapely, should be dropped not only into boiling water, but into water hotter than ordinary boiling water, *i.e.*, quite fresh water. Now the boiling of water may be delayed (that is, it may be made to get hotter before it comes to a boil) by dissolving in it any solid body less volatile than itself, such as *common salt*, when eleven or twelve degrees higher of Fahrenheit are required to produce ebullition. This is why plunging fish into boiling salt and water renders it firmer by suddenly coagulating the albumen. The greater heat so obtained also cooks vegetables more thoroughly. And the same hot liquid is best for poaching eggs; they come out of their bath with smooth and clean, instead of ragged and untidy jackets.

The reader, in perusing our directions to boil eggs in the shell in *rain* or *river* water, may possibly have asked what could it matter in *what* water an egg was boiled, so long as it is protected by the shell? He now sees the reason why, and that the direction was not an unmeaning crotchet. Rain or distilled water, we may add, is the least hot of boiling waters at the same level above the sea, and therefore the most suitable to keep the white of the boiled egg digestibly soft. Boil an egg in oil, and it will come out of it with the white like a ball of ivory, if not a roasted chestnut.

Poached Eggs.—Set a stewpan of salt and water on the fire; when it boils, take an egg in your hand, break the shell partly through on the edge of the saucepan, open it adroitly with your two thumbs, and let the egg slip into the water without breaking the yolk; and so on, till you have as many eggs in the stewpan as will boil without touching—*Ude* says "never more than four at a time." When cooked to the degree approved, take them out with a slice, let each one drain a moment, and lay it on a small buttered toast just large enough to receive it.

Some cooks put a dust of pepper and half a teaspoonful of vinegar on each egg.

Poached eggs may be served on a bed of chopped cabbage, spinach, *purée* of sorrel, &c.

Eggs may be poached, or fried in salt and water, in a

frying-pan; they are delicate done in that way, but are flat and outspread, and want the pleasing plumpness of the properly poached egg. Ude directs: "As soon as they are done, take them out one at a time, and throw them into cold water. When you have poached the number you want, pare them well. Then with your finger rub them gently over in the water, that they may be very neat and white. They must be very soft." With all due deference to the departed *chef*,* we prefer a little less unnecessary slopping and handling.

Fried Eggs.—When your frying-pan is well wiped out, do not be afraid of putting a good lump of butter in it. When that is melted and hot, break your eggs into it, as many as the pan will hold without their touching each other. As they fry, raise their edges with a knife or slice, give them a slight shake to make them shift their places in the pan, and ladle a little of the hot butter over the yolk of each. They are spoiled by turning them and frying hard; also by being served on a cold dish. You may put on the top of each a dust of pepper and salt, and a drop of vinegar.

If you have to serve a dish of bacon and eggs, fry the bacon *first*; firstly, because it takes a little longer to do; secondly, because the fat that comes away from it will help to fry your eggs.

Eggs done in their Dish.—Take a strong earthen or a metal dish. Butter its inside well. Break into it, without damaging the yolks, as many eggs as it will hold without their lying one upon the other. On the top of each drop pepper, salt, and a little bit of butter. Set them into the oven of your stove, or in an American oven before the fire; watch their progress, and as soon as the butter is all melted, and the whites well set, serve. The heat of the dish will cook them a little more *after* they are taken from the oven. Eggs so done are often preferable to fried eggs. They are free from the tough brown under-surface to which the latter are liable, which also is indigestible, even when it is rather crisp than horny.

Hard-boiled Eggs (an American discovery).—For boiling an egg hard, five minutes are sufficient; but for boiling *mealy*, which is the most digestible condition next to the three-minutes-and-a-half rule, allow one hour. For salads, always boil one hour. An egg boiled one hour is a very different thing to one which has been boiled five minutes.

Scrambled Eggs (American).—Put in a spider enough sweet butter to oil the bottom of the pan. Put in a dozen eggs without breaking the yolks, add a bit of butter as big as a walnut, season with very little salt and pepper. When the whites harden a little, stir the egg from the bottom of the spider, and continue to do this until cooked to suit the family. The yolks and whites, when done, should be separate, though stirred together, and not mixed like beaten eggs.

Scrambled eggs and mashed eggs (which are much the same thing, only done with meat gravy) may be served on squares of hot buttered toast; which toast will be made more relishing if slightly spread with anchovy sauce, or with potted beef, cheese, or fish. They are transitional forms, marking the passage of eggs into omelettes.

Beating Eggs.—This is best done with rods of wood in a shallow, flat-bottomed pan; bestow the beating with short, quick, downward strokes, without moving the elbow, which should be kept close to the side. When the foaming and bubbles disappear, and the beaten eggs assume the appearance which has been well described as that of a rich boiled custard, your task will have been very well accomplished. Kent's egg-beater is an excellent little instrument which greatly facilitates this process.

* The title by which a head man-cook is addressed or spoken of in France. Its full meaning is *chef de cuisine*, head of the kitchen.

ANIMALS KEPT FOR PROFIT.—CATTLE.

MANAGEMENT OF A COW ON A SMALL OCCUPATION— VIZ., THE FAMILY OR COTTAGER'S COW.

IN a previous article we have described the treatment of dairy cows on ordinary farms, and under good ordinary farm management. But cows are often kept under other circumstances; and there are two cases in particular in which the maintenance of from one to three cows becomes a very desirable object, and to which we shall therefore devote the present paper. The one is that of a family living in a suburban or country neighbourhood, with an acre or two of ground, and perhaps a number of children; the other is that of the cottager who rents a small allotment, varying from half an acre to two acres, as an addition to his other scanty resources. In the one case it is desirable to have an abundant supply of milk and other dairy produce for family consumption, at a moderate cost, but of the best quality; in the other we believe that where sufficient assistance can be rendered by the cottager's family, his greatest return for the land he rents will be obtained by keeping a cow.

It is obvious that the best system of management in the two cases may differ widely under some circumstances, while in others they may be nearly the same. One very simple remark may, however, be made at the outset. If only one cow be kept, as she must always be allowed to run dry for six or eight weeks before calving, and exchanging animals yearly would cause both loss and inconvenience, it is obvious that for some time every year there will be no supply. And as, moreover, there is very little more trouble connected with two cows, so far as milking and attendance goes, than with one, it is better, where possible, to keep two. The surplus produce may almost always be readily disposed of, even by a gentleman's family, without in the least losing *caste*, and the convenience of thus securing a constant supply is very great.

The object and system of the cottager are both very simple. He is not so much concerned with the relative total cost of different modes of management, or in balancing rent of land against saving in labour; but his constant aim is to spend as little *actual money* as may be, either in rent or anything else, while on the other hand he gets through the cow the utmost possible cash return for the *labour* of himself or family. He has, in fact, to substitute labour for capital, and this can best be done by stall-feeding combined with spade husbandry.

A tight, warm cowshed, or stall, constructed so as to give perfect ventilation, as already described, or in any other method that will avoid draught, is essential. For the sake of warmth, in winter the back of the cottage will obviously be the best locality, for warmth will not only promote health, but *save food*. Great care should be bestowed on the shed, for the cottager's cow must, unless there be common rights available, pass nearly all her time in the stall. A liquid manure tank and a well-lined dung pit should also be provided, in which not only the drain from the stall, but all the sewage and slops of the house should be received—for nothing must be wasted, and every ounce will be needed to keep up the produce of the land. In fact, the amount of success will depend almost entirely upon the economy of every possible kind of manure which can be procured, and its judicious application to the land—which must be devoted entirely to the raising of heavy green and root crops in a judicious succession—adapted to the season. However small the allotment, therefore, it will be divided into several portions in order that the successive crops may vary. The variety is large—rye-grass, clover, tares, lucerne, sainfoin (where the soil suits), cabbages, carrots, beet, turnips, mangold, &c. &c., may all be employed according to the soil and other circumstances, which must be carefully considered, and

the succession arranged accordingly, so as to get the utmost weight of produce without, on the one hand, exhausting the soil, or, on the other, having to purchase artificial manure, which the cottager cannot usually afford, though the expense would generally be well repaid.

There are many ways in which land can be economised when the manure is well husbanded. For instance, supposing young cabbages are planted out in the autumn, instead of placing them close they may be pricked out in rows a full yard apart, with a good half yard between the plants. Then in the spring, either turnips or mangolds can be sown between the rows, and the two crops will provide a most valuable succession of food. There will be first the thinnings of the root-crops; then the cabbages will be cut, taking every *alternate* plant first, in order to relieve the ground rapidly and equally. Long before they are exhausted there will be two or three gatherings of mangold *leaves*; and last of all the roots themselves, of which mangolds in good season will last any time they can be possibly kept. By these and other similar expedients a cow can be easily maintained on half an acre of land.*

Hay must be sparingly used, and should be provided from the rye-grass or other green crops; but a portion of straw will generally have to be purchased to dilute the succulent food, and should be cut up into chaff, as already described, and mixed with the roots pulped or shredded small. Occasionally, if a friendly farmer or miller will take it on fair terms, wheat must be sown to refresh the land after the root-crops. In that case straw will be ready provided, and the price of the wheat, if required, can be devoted to the purchase of mangolds or swedes. The object steadily to be pursued throughout is, by the highest farming, and economy of both stable and house sewage, to make labour take the place of capital. The capacity of land under deep spade husbandry, and well managed, can hardly be believed; but for further information on these subjects, and on the judicious succession of crops on a small plot of land, we must refer to the papers on Cottage Farming.

* The management of the cow or cows themselves (we again repeat our advice, if possible, to keep *two*) is very simple. Early every morning the stall must be *thoroughly* cleaned out, sprinkling some of M'Dougall's or other disinfectant about if needful, and a small quantity of clean dry litter supplied. The cottager should never use straw for this if possible, being too valuable as food and to make manure, but endeavour to supply its place by dry leaves, rushes, fern, or other similar substances; if indeed the floor of the shed be smooth and hard, any at all may be dispensed with. Then she must be milked; after which she deserves her breakfast, which will vary according to the food in use at that time. It is only needful to observe that green food should never be given *wet*, but be cut some hours, and then given in very moderate quantities at a time. Many a cow has killed herself by over-eating in a clover-field. The drinking trough should also be filled with clean water which has stood some time, and be *kept* full. After breakfast the animal must be well curried and scrubbed with a hard brush; this, and proper feeding, will keep her in health if she never leaves her stall. Still, if there be a small orchard or yard in which she can take exercise in mild seasons, it is better; but all this will depend on circumstances. A walk by the roadside will also afford exercise, and often some amount of food; though it is shocking training for a child to send it out with nothing to do but "looking after the cow," as we have too often seen.

* Cobbett, as is well known, maintained that a cow and a pig could be kept on a *quarter* of an acre. And the first year, while the land is *fresh*, it might perhaps be done; but we are quite sure the half acre we name is about the least quantity that will be realised in practice, and for a continuance; and it will require good management to do that.

HOUSEHOLD AMUSEMENTS.—XII.

WE return, for variety's sake, to the miscellaneous games, from which a selection may be made for the amusement of a mixed company.

Buz.—This is a forfeit game, and partakes of the nature of an arithmetical exercise. The party repeat in order any number of figures, from one to fifty, or one to one hundred, as may be agreed upon, but every seven that occurs, and every multiple of seven, is represented by the word "Buz!" Thus, the first player says "One," the next "Two," and so on until the seventh, who must say "Buz!" instead; he who has "fourteen" in his turn must also repeat "Buz," and the same with those who come to seventeen, twenty-one, twenty-seven, &c. It is not so easy to avoid mistakes, when the figures are being quickly repeated round the circle, as may be imagined. Every time "seven" occurs as part of the number, as in twenty-seven and thirty-seven, the players may be sufficiently on their guard; but they will generally be found tripping thoughtlessly as the multiples of seven, such as forty-two and fifty-six, come in order, and so there will be no lack of forfeits. Seventy-one is called "Buz-one," and seventy-seven "Buz-buz."

The Knight of the Whistle.—This is a sort of modified "blindman's buff," played, however, without a bandage over the eyes, and without the romping element which sometimes makes that well-known game objectionable. A small whistle is suspended from the coat-collar or the dress of one of the party by a piece of twine or thread, about half a yard long, which hangs down between the shoulders. The "knight" or the "lady" of the whistle, as the case may be, then stands in the centre or walks slowly round the circle of the company; some one, watching an opportunity, seizes the whistle and blows it shrilly, when the knight immediately turns to detect the offender, and if he hits upon the right person, the latter must take his place. As the player turns to find out one whistler, another gives a blow, and thus the game proceeds merrily until some one, less dexterous than the rest, is caught.

Catch the Ring.—This is another modern invention, which is considered an improvement on the boisterous game of "hunt the slipper," and is therefore taking its place. The players are seated in a circle or semicircle, and hold a string, on which a finger-ring is placed. One of the company undertakes the task of finding this ring, which is passed rapidly along the string from hand to hand, as the players see an opportunity of moving it unobserved. If the first player can at any moment pounce upon the ring, the person in whose possession it may be is called on to take his place, and, if so agreed on, to pay a forfeit in addition.

Scandal.—This is a more intellectual game, and while amusing enough, serves at the same time to point a moral, as it illustrates the growth of scandal, or the variations which arise in a story, when commonplace facts are repeated from mouth to mouth. The player seated at one end of the room whispers something to his next neighbour, who repeats it as nearly as he can remember it, and again in a whisper, to the person seated by his side. So the tale passes from end to end of the room, and when it reaches the last person, the latter has to repeat the story aloud; the first player then gives his original version, and much amusement is usually created by the difference between the two. In starting the tale, it is well to introduce some word or words which are capable of being taken in more senses than one, as this affords the more opportunity for variation. The following may be taken as an example:—

Player No. 1 commences, we will suppose, by whispering to No. 2 that, "Mr. Smith went the other day to see old Mr. Bayly. His wife has broken her leg, and is very bad; she will not live a week."

No. 2 passes this on to No. 3, as follows: "Mr. Smith went the other day to see old Bayly, and his wife broke her leg; she is very bad, and can't live a week."

No. 3 to No. 4: "Mr. Smith went a few days ago to the Old Bailey, and his wife's leg was broken; she is very bad, and will die in a week."

No. 4 to No. 5: "Mr. Smith went a short time ago to the Old Bailey, for breaking his wife's leg; he is a very bad man, but will die in a week."

No. 5 to No. 6: "Mr. Smith is a very bad man, and has been tried at the Old Bailey for breaking his wife's leg. He is to be hanged for it next Monday."

Thus, by gradual alterations and additions, the story undergoes a complete transformation by the time it comes to the last player.

Consequences.—At this game the players are seated round a table, and each writes a few words on a piece of paper, which is then folded down and passed on to the next in turn, no one seeing what has previously been written. When the round is completed, the paper is read through by one of the company. The following is usually the order observed in the writing:—First player, set down an adjective applicable to a lady; second, the name of a lady, either present or otherwise, as previously agreed; third, something descriptive of a gentleman; fourth, the gentleman's name; fifth, the place where they met; sixth, the time of meeting; seventh, what she said to him; eighth, his reply; ninth, the consequence; tenth, what the world said. This joint concoction, when it comes to be read aloud, is something of the following kind, the connecting links being supplied by the reader:—

"(1) The charming (2) Miss Emmeline Fullalove (3), and the haughty (4) Lord Tom Noddy (5) met at a pic-nic party (6) on the fifth of November. She remarked, (7) 'What a figure of fun you are!' and he replied, (8) 'Delighted, I'm sure!' The consequence was (9) they were married, of course; and the world said (10) it served them right."

For the especial benefit of the young folks, we will add to these games a description of

The Performing Shadows.—Some figure is cut out from cardboard, and two threads by which it may be moved are attached to the back and front; or, if preferred, one of those jumping figures with elastic strings, which are sold at the toy-shops, may be used for the purpose. A sheet is suspended before the audience, who are seated in a darkened room; the sheet itself is darkened, by placing a paper or other screen upon it in those parts where the figure is not intended to appear. The figure is hung just behind the sheet, and two or more of the company then take candles in their hands and go behind the figure. It is, of course, necessary to rehearse the performance once or twice beforehand, so as to adjust the lights to produce the effect. Each candle, properly held, throws a distinct shadow upon the curtain, and several figures, therefore, appear to be moving upon it. The movements, if necessary, may be managed by additional strings carried to the darkened sides of the sheet.

A sufficient idea of the means employed, and the result, will be obtained from the accompanying illustrations.

PRINCIPLES OF GOOD TASTE IN HOUSEHOLD FURNITURE AND DECORATION.

INTRODUCTION.

IT is a mistaken notion that the tasteful decoration of a house is necessarily a very expensive matter. This idea is so far from being correct that it is doubtful whether greater want of taste and ignorance of the true principles of decorative art are not more frequently betrayed in cases where there has been lavish expenditure than where the expense has been somewhat limited. The truth is that the chief beauty of decoration by no means consists in the costliness of the material, but rather in the taste and propriety manifested in its design and application.

The beauty of a statue or picture is a quality which was imparted to it by the sculptor or painter himself, and does not belong to the marble or pigment. The marble may, indeed, lend some additional beauty to the statue, but this is a mere trifle compared with the artistic qualities of the work itself. And so, in the decoration of a house, the beauty and elegance will almost entirely depend upon the taste and refinement shown in the *beauty of form, the harmonious combination of colour, the fitness of each article of furniture for its special office, and the adaptation of the ornament to the particular purpose to which it is applied.* We lay down these rules, then, as general principles which should be observed by all who desire to furnish their homes tastefully. Knowing, however, how difficult it is to convey with clearness the meaning of rules in matters of taste, we shall endeavour to explain each of these principles, and show each application to the purposes of household decoration.

First, with regard to *Fitness, or Propriety.* It should be the first consideration in all decorative works that the object itself is the principal, and that the ornamentation should be subservient to it. No excellence in the ornament can possibly justify its misapplication. Decoration is the handmaid of architecture, and the entire scheme of household decoration should be governed by the construction of the building and the uses of its several parts. Both the dimensions and character of the furniture, as well as its quantity, quality, and enrichments, as also the wall and floor decorations of each room, should be regulated, in the first place, by the size and proportion of the room and its intended use.

Cumbrous furniture in a small room is quite as objectionable as spare furniture in a large one; and broad and opaque curtains or blinds which obstruct the light where there is only one window in the room, and dark and sombre wall papers in bedrooms, or staring patterns and brilliant colours on walls where it is intended to hang pictures—these and all other arrangements which are inconsistent with the construction and use of the room are to be carefully avoided.

But besides the fitness or propriety which is to be observed in the general scheme of decoration so as to adapt it to the structure and use of each part of a dwelling, there should also be a fitness in the design of every individual object by which it is made to harmonise with

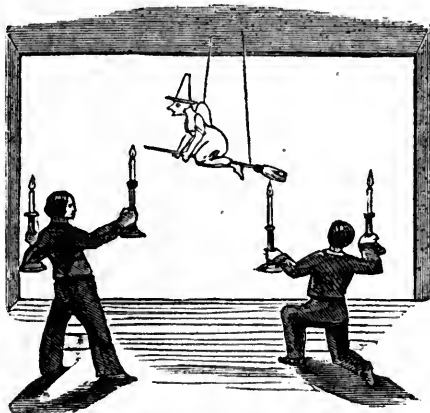

BEHIND THE CURTAIN.



BEFORE THE CURTAIN.

those surrounding it, and by which it is adapted to the special use for which it is intended.

This principle we shall explain further hereafter, by showing its application to special features of household decoration; but, before doing so, we wish to say a few words concerning *Form and Colour*.

In writing on the principles of decorative art, perhaps nothing is more difficult than to lay down rules relating to beauty of form; nothing seems less reducible to laws, or more entirely dependent upon taste; and the only means of acquiring an appreciation of beauty in the contours of objects, or in the combinations of forms in surface decoration, seems to be, by becoming familiar with such ornamental forms as, having stood the test of ages, are still acknowledged to be beautiful. This acquisition, however, is not within the reach of all; but we believe that with the growing taste amongst manufacturers and art-workmen, and also on the part of the purchasers themselves, and the more general diffusion of art-principles by the agency of Schools of Art, there exists among our readers that degree of good taste which will unhesitatingly separate the ugly and deformed from that which is beautiful, and in many cases will as unmistakably select the forms which are most elegant.

In our articles on *Furniture* in Vol. I., the various kinds of woods, and the construction of the various objects of household furniture are considered, and the adaptability or unsuitableness of each pointed out. But as to whether our table should be oblong or square, round or elliptical (unless one of these is peculiarly adapted to the shape of the room), is clearly a matter not so easily reducible to rule, and may safely be left to the furnisher's own taste. We may, however, state one general rule which may safely be followed, and that is, to be careful not to choose extravagant forms or designs, such as attract by their very eccentricity or striking novelty; but rather to select those which are graceful from their simplicity.

Whenever ornamental art has sought to become beautiful by being extravagant, it has invariably degenerated into a vulgarity of style. We may mention, for example, Roman ornament, which was little else than Greek made more "loud," and vulgarised at the sacrifice of that chasteness and simplicity which characterised the art of the Greeks. And the same degeneracy is observable in late Gothic art arising also from extravagance of design.

The rule just stated is equally applicable to *Colour*, and it is much the safest plan in the selection of wall-papers, table-covers, carpets, hearth-rugs, floor-cloths, &c., to choose such as have neither strikingly glaring colours, nor large and attractive forms.

The primary colours, blue, red, and yellow, should be sparingly used in their pure state, being confined to small spots or details; the greater masses consisting of the secondary colours, green, orange, and purple, or the tertiary colours and greys.

In adopting a scheme of colour, the general effect of the room should be first considered, and each detail be subordinated to the whole. The large masses, such as the wall and floor, should be of colours suitable for backgrounds to the brighter colours intended to be introduced in chimney and sideboard ornaments, book-covers, anti-macassars, pictures, and other details which will be arranged throughout the room.

The harmony of *Colour*, unlike that of *Form*, is governed by a few fixed laws which are easily understood. The chief of these is, that each of the three primary colours, blue, red, and yellow, harmonises best with a colour composed of the other two, which is called its complementary. Thus blue harmonises best with orange, yellow with purple, and red with green. Browns and greys, and such colours as are still farther removed from the primaries than their complementaries orange, green, and purple, are very agreeable as forming the general mass, or back-

ground, in an arrangement of colour, and are less likely to interfere with, or "kill," more important details. The secondaries might then be judiciously introduced in the pattern on this background—be it wall-paper or carpet—and even the primaries in small masses, but these should be used sparingly and with great caution, lest they interfere with the more important features of the decoration of the room, to which carpet and wall-paper ought to be subordinated.

In accordance with the above rule, then, if the prevailing colour of the carpet were green, the table-cover, curtains, &c., would harmonise best if they inclined most to red. But what has just been said should be borne in mind—that the primaries are best confined in their pure state to the objects and ornamental details to which the general masses serve as backgrounds.

It is better, therefore, in the case we have chosen, that the red should not be too positive, but subdued—say inclining towards purple (*i.e.*, containing some blue in its composition), while the green should incline in the opposite direction, having more yellow in it. Then the bright spots and small masses of the primary colours, being introduced in the border ornaments of table-cloth and curtains, in anti-macassars, border of hearth-rug, &c., would "stand out" and have their proper value.

Nothing contributes so much to the elegance of a room as a pleasing arrangement of colour, while nothing is so offensive to those of refined taste as inharmonious jumble of hues thrown together in a room, where each one "kills" its neighbour, and all struggle for supremacy, and where the parts that ought to be least observed stand out in greatest prominence.

But we think that where the above principle is followed the result will be highly pleasing and satisfactory.

In the following articles upon this subject we intend to treat in detail of the various articles of furniture and household decoration, so as to illustrate clearly and practically the principles here laid down.

HOME GARDENING.

BROCCOLI.

BROCCOLI, like the borecole or kale, is a sub-variety of the *Brassica oleracea* tribe. There are of this a considerable variety, all of which have, no doubt, arisen or sprung from the old white and purple, either by accidental or pre-meditated impregnation; and it is to one—or, perchance, both—of these two sources that we owe the present existence of so many new sorts. The common characteristic of broccoli is its hardier constitution to stand the winter, and the colour of the flower and leaves. This plant is considered more palatable in proportion as it approaches to a pale or white colour, so that the white kinds are preferable to the purple ones, only they are not so hardy to stand the winter. We shall here enumerate such as are most commonly grown in gardens round and about London, almost every one of which requires somewhat different treatment in its culture.

The Purple Cape.—This has a close compact head, of a beautiful purple colour; the leaves are nearly entire, erect, concave, lobed at bottom, and much waved, regularly surrounding the head. The mid-rib and veins are stained with purple, which declares it to be the true sort. In growing, the head is exposed to view, not very large, and as it enlarges, the projecting part of the flower shows a greenish-white mixed with the purple colour. When boiled, the whole flower or head becomes green.

Culture.—This must be sown according to the season at which it is required for table; if in August and September, the seed must be sown in May. If they are required for table early in spring, the seed must be sown in July or August. If wanted for table in June and July, the seed must be sown in September, and the plants preserved

through the winter in frames, in the same manner as you would do cauliflowers. By good management, this sort may be had at table every day nine months out of the twelve. It is too tender to depend upon to stand the winter. It grows from twelve to eighteen inches high, and should be planted about two feet asunder in every direction. The seed must be sown broadcast, very thinly, in a bed of light earth, and when the plants have from eight to ten leaves, they must be finally planted out where they are to remain in rows two feet apart, and the same distance asunder in the rows. It delights in a sandy loam, previously prepared by digging and manuring. The manure should be frequently turned over before applied, and every sort of grub picked out, otherwise the roots of the plants will suffer by them. The ground will have to be kept constantly clear of weeds by hoeing, and it will likewise be necessary to draw earth to the stems of the plants as they progress in growth. The second crop must be treated in precisely the same manner as the first, only that if any remain uncut that are in perfection when frost approaches, they should be taken up with as much soil adhering to their roots as possible, and put in flower-pots large enough to hold the roots, which must be fastened in the pots, and a little water given them. In this state they must be placed in a shed, and occasionally covered with mats, if danger from frost is apprehended; and they will thus keep good for several weeks. The third crop must be sown in September, as already stated, and the plants preserved in frames, as advised for cauliflowers.

The Green Cape differs very little from the preceding, except in the colour, and the heads as well as the whole plant being in general larger. The leaves are long and narrow, much resembling those of the cauliflower; they are but little waved, and consequently have a smooth appearance. The head somewhat resembles the cauliflower, is of a greenish-white colour, and is usually covered with the leaves. These two sorts have a strong tendency to degenerate and run much into each other, yet they are quite distinct, and the greatest possible care should be taken, in saving the seed, that the plants are true, and all others kept from running to seed near them, which is a circumstance frequently happening, and that through neglect in not pulling other crops of the different varieties up when over, and before they run to seed. This advice will apply likewise to all other sorts.

Culture.—Same as the Purple Cape.

Grange's Early.—The leaves of this variety are broader and shorter than those of the Green Cape; they are lobed at bottom, but not much waved; they have long foot-stalks, the veins and mid-ribs are of a whitish green, and the head quite white.

Culture.—This sort should be sown at three different times, from the beginning of May to the end of June, and afterwards treated as the others above mentioned. It will produce full heads from Michaelmas to Christmas.

The Green Close-headed Winter.—This is a much-esteemed sort, apparently a seedling from the Green Cape, as it succeeds it in coming into use. The plants are dwarf, leaves numerous, spreading, moderately indented, much waved, and large, and the veins are white; the flower strongly resembles the Green Cape in appearance, and does not rise to any great height.

Culture.—This is esteemed the more on account of its continuing to bear throughout the winter. The time for sowing the seed is in May, and when the plants are grown sufficiently large, let them be planted from one and a-half to two feet distant both from row to row and from plant to plant. Should the weather prove favourable, they will be fit for gathering from the beginning of November to the end of February.

Early Purple.—This is also a much-esteemed kind, and when true is of a deep-purple colour, and close-headed at first, but it afterwards branches, and is apt to become

green and too much branched, especially in light land. The plants grow strong and from two to three feet high; the leaves are of a purplish-green colour, much indented, spread out wide, but not long, though the stalks are so; and the head is quite open from the leaves.

Culture.—The seed should be sown in April for producing heads in November and throughout the winter, which they will do, provided the season is mild. If sown in June, abundance of heads and sprouts will be produced in March and April. The plants should be put out in rows three feet apart, and the same distance asunder in the rows.

Early White.—The heads of this sort are of a clear white, and of close texture; the leaves erect, concave, light green, and nearly entire.

Culture.—The seed of this variety should be sown any time between the months of February and March, on a slight hotbed, and when the plants are about three inches high they should be pricked out into beds of light earth, three or four inches apart in every direction, and defended from frost and bleak winds by a covering of long litter or mats. In April these plants may be put out in rows two and a-half feet apart and two feet distant in the rows, and be well supplied with water in dry weather. They will produce fine large heads from the beginning of November to Christmas, provided the season is open and mild.

Dwarf Brown Close-headed.—From its appearance you would take it to be a seedling from the Sulphur-coloured, yet it differs from it by being fit for use earlier, as well as in the shape and colour of the head. The leaves are much shorter and broader than the latter, not much waved, dark green, with white veins; they grow upright, and do not cover the head at all. When the crowns first appear they are green, but soon change to large handsome brown heads.

Culture.—Seed of this variety should be sown in April, and it will come to perfection in March and April following. The plants, as soon as large enough for putting out, should be planted in rows two feet apart, and the same distance asunder in the rows.

DOMESTIC MEDICINE.

BRONCHITIS (*continued*).

Causes.—Cold, raw, or damp weather is one of the principal causes of this common English disease. Very healthy and active people may be a good deal out in the cold without getting bronchitis, but for people that are weakly, or unable to move about briskly, or who are at all liable to bronchitis, the cold east winds are fraught with danger. Cold is especially bad for those who live for the most part in hot rooms, and only go out into the cold for a short time; and while free exposure of the body by healthy people, well clad, to cold is not an unhealthy thing, draughts or currents of air blowing upon a portion of the body are unhealthy, and liable to be followed by bronchitis or other forms of cold.

But it is not all people that take bronchitis. There are some constitutions which are more liable to it than others, and some people inherit it. It has been lately ascertained that gouty and rheumatic people are more liable to bronchitis than others. People with diseases of the heart also are apt to suffer from bronchitis. So also people of an asthmatic tendency generally have more or less bronchitis associated with their asthma. This brings us to say a few words on

Bronchitis associated with Asthma.—In this case there is an almost habitual shortness of breath. Partly by the act of constant coughing, and partly by reason of some fault in the tissue of the air-cells of the lungs themselves, in consequence of which it is less elastic, the walls of the air-cells break, and the cells run one into the other. More than this, they do not contract well upon the air

which is received, so as to expel it, nor upon any phlegm which they contain, so as to expel it. A very little cold, or very little extra exertion, throws such persons into a state of great embarrassment for want of breath, and they are liable to more or less sudden and acute attacks of asthma, in which they have to gasp for breath. (See the subject of asthma.)

Bronchitis connected with certain Trades—Certain trades or callings are apt to cause bronchitis by irritating the bronchial tubes. Amongst others, that of a chaff-cutter; a grinder of stones or metals; of a stone-mason; of a machine-tender; of paper-stainers. It is very probable, too, that many people more than we think get bronchitis from irritating particles or substances in the air, such as dust, odours of different kinds, the air of badly-ventilated rooms heated by gas, &c. &c.

Treatment.—Persons who are subject to bronchitis should take care of themselves in winter and spring. Those who can afford it would do well to spend these unfriendly seasons in more equable climates than ours, and to betake themselves to Nice, Cannes, or Mentone, or several of such places in rotation, in the first few months of the year. Or, if this be inconvenient, to Torquay, or Bonchurch, or Ventnor. But we write mainly for those who cannot leave the place they live in, and who must make the best of it. Let them avoid being out at nights in winter and spring, partly because the night air is very cold, and partly because to be out much at night often implies loss of sleep, which makes the body liable to take cold. Flannel should be worn next the skin. In very cold weather the bedroom should have a fire in it a few hours before going to bed, and old people should be treated to comforts which younger ones do not need, remembering that to be over sixty in cold winters is to be in greater risk than when younger.

Persons liable to bronchitis should also live regularly as regards eating and drinking. They should live well, but should be careful not to exceed in the use of wine, beer, porter, and all such things. All these suggestions are rather with a view to prevention than cure.

As to medical treatment, if the case is severe, it will be right to send for a doctor; if only mild, the effect of a little domestic treatment may be tried. The patient should keep in a comfortable room, taking plenty of gruel or similar warm and nourishing food. If the appetite is not bad, then ordinary food may be taken.

It is difficult to prescribe for cases of bronchitis, which may be so trifling in degree as to be only a common cold, or so severe as to put life in risk. For milder attacks in grown-up people the following may be taken:—

Ipecacuanha wine	80 minims.
Spirits of nitre	2 drachms.
Syrup of squills	$\frac{1}{2}$ ounce.
Syrup of poppies	$\frac{1}{4}$ ounce.
Peppermint water	8 ounces.

Mix. An ounce to be taken every four or six hours.

But if the cough is severe, or accompanied with feverish-

ness, or with great debility, or with great difficulty of breathing, then it will be proper to have immediate advice. The disease is of more consequence in old persons, or those who have diseases of the heart, or are in any way delicate.

THE WORK-TABLE.

HOW TO DRESS A BABY'S BERCEAUNETTE.

THE handsomest way of dressing a berceauette for a baby is with muslin and lace, lined with silk; a sky-blue is the colour generally preferred for an infant. A berceauette is a wicker-work cradle, with a movable head of several rows of skeleton cane, and without rockers. Some muslin, such as milliners now use for bonnet linings and to bind the edges of bonnet wires, is required to line the inside of the berceauette; it is a thin, soft kind of calico, quite free from dress. With this first cover the sides of the berceauette inside, tacking it quite over the edge. Cover this with blue saracenet, but do not fix it down inside. Next cover the movable head, take a pattern of it in tissue paper, stretched to its full size, and allowing a tuck for every cane. Cut a piece of silk and a



Fig. 2.

piece of book-muslin, twice as long as the pattern and half as wide again; tack these together, and run tucks large enough to hold the canes at regular intervals. Unfasten the canes from one side of the berceauette, and slip them through the tucks. Draw the muslin and silk on the canes, after the manner represented in the illustration. Sew down the canes securely again with a packing needle and twine. Make two flounces, of equal

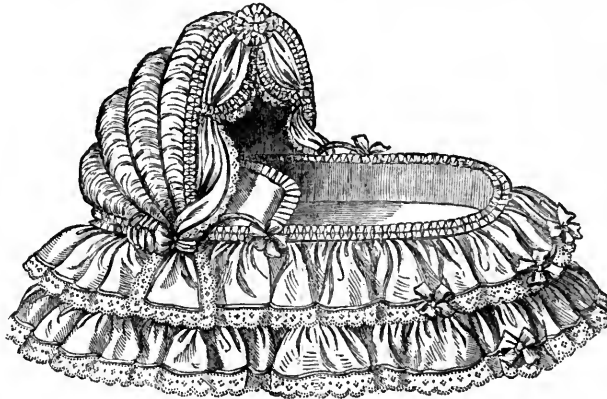

Fig. 1.

size of the blue silk, and hem one edge. Make corresponding flounces of book-muslin, and edge them with Valenciennes lace. Draw a muslin and a silk flounce together on a cotton cord; fix it round the berceauette half way up; fix the other flounce in the same way round the upper edge. The lining inside is raised whilst these flounces are put in, so as not to stitch through it. Now they are on, tack the lining down inside, and cut a piece of the blue saracenet the size of the bottom of the berceauette, tack some lining to it, run in the edges, and tack it well to the bottom of the berceauette.

Make book-muslin curtains, edging them with lace, and the upper ones with a ruche of blue satin ribbon. Edge the front of the hood with a ruche. Place a ruche all round the edge of the berceauette. Loop back the curtains with rich bows of satin ribbon; place a few bows on the flounces and sides, and a rosette at the top of the hood, in the way shown in the woodcut. The pillow should be edged with a muslin frill, trimmed with lace. Fig. 1 is from a tastefully-arranged, well-made berceauette which we saw at Mrs. Adley Bourne's, 37, Piccadilly.

You may cover a berceauette under book-muslin: the outside of the body of it is entirely of pink glazed lining, pulled tight. Line the inside, also, with pink glazed muslin, but not tacked down to the bottom, so that it can be raised to admit of the flounces being fixed. The best way is to remove the canes of the head, and double a piece of

glazed muslin right over both sides of the berceauette, letting the join come at the back of the head. Cut a piece of book-muslin, twice as long as the canes of the head, and half as wide again as the hood will be, to allow for drawing and puffing. Cut the lining the same. Run tucks at intervals; put the canes through; draw the muslin and lining. Refix the canes as a hood, and draw the muslin and lining to the back of the berceauette. Make two muslin flounces, trimmed and edged with inch-wide imitation Valenciennes, headed by very narrow pink satin ribbon. Draw the flounces at the top on cotton cord. The upper flounce laps an inch over the under one, which comes half way up the side. Allow an inch extra in the width of each flounce for the "sitting out," as it is called, of it. Thus each flounce measures an inch more than half the width of the berceauette, without allowing for a hem and turning at the top; the Valenciennes measuring the other inch. Each flounce should be twice as large round as the berceauette. Add the muslin curtains, edged with lace and ribbon—ruching round the head and edge, upper curtain, and the bows and rosette displayed in the illustration.

When chintz is used instead of muslin, a stone-coloured ground with some small, pretty pattern on it, such as a little pink rosebud and green leaf, is pretty. A stone ground is softer and more harmonious than white. Pink glazed lining is used inside the berceauette only. The hood is drawn of chintz lined with pink. The flounces are of chintz only, each two inches wider than half the width of the berceauette, and twice as large round. Make the curtains of chintz, lined with pink. The ruches and bows should be of pink satin ribbon, about two inches wide: mauve, green, and maize look pretty, but almost all people prefer blue or pink for babies.

HOW TO MAKE A HAT FOR A BABY BOY.

Procure a turban shape in buckram. Cover the crown with muslin lining with white satin strained tightly over it first with pins, and then tacked strongly with narrow silk braid. Work the centre scroll first (as shown in our illustration); two rows of braid straight each side of it; two scrolls again on either side the straight braid, and again two rows of straight braid beyond that. Line the hat with white sarcenet, tacked over the outside edge, left loose inside, hemmed with a cord, and drawn up to fit. The lining is a straight piece, wide enough for the purpose, and run together. Trim the edge of the hat all round with rows of ruches of white satin ribbon. They must be very full and very close—if of the right width three will be sufficient. Cut an oval of buckram, stiff net, or thin card. For the cockade, make rich bunches of two-inch wide white satin ribbon at each end, and cross them with a loop or buckle of three rows of ruching. Place this on one side of the hat. Behind arrange a bow and ends of satin ribbon. At the sides there must be strings, each ornamented at the top with a handsome rosette of the white satin ribbon. The hat may also be made of black velvet, black braid, and black satin ruching, and trimming. If black is chosen, then make the bunches of bows each side of the rosette of scarlet satin ribbon, and the rosettes on the strings of black satin, with a few bows of scarlet in the centre. All the rest, including the strings and bows behind, of black.

INMATES OF THE HOUSE—DOMESTIC.

THE LADY'S MAID (concluded).

To Clean Trinkets.—All jewels not "set clear," i.e. with a backing of gold or other metal, may be washed in the following way:—Brush them with soap and water, and a very soft tooth-brush. If mounted in silver, a little gilders' whitening will be necessary, as for plate. Rinse them in clean water, and then shake them about in box-

wood sawdust till they are quite dry, which may be seen by the sawdust no longer adhering to them. Do not handle them with the bare fingers, but use some silver paper. Box-wood sawdust is used by jewellers for the above purpose, and may be had at any rule-maker's; it is cheap, and sold by the pint. Filigree ornaments may be cleaned in the same way as described; likewise gold chains and bracelets. Ornaments not set clear should only be cleaned on the surface with very little if any moisture.

To Wash Hair.—The head should be held over a large basin of lukewarm water, in which a third of a packet of Manby's washing powder has been dissolved. Then rub the hair with a piece of pale yellow soap, moistening it with the water in the basin till a good lather is produced. Have at hand a can of lukewarm water. Pour the latter over the hair, collected in a bunch at the top of the head. When all traces of the lather are removed envelop the head, for a few minutes, in a coarse, dry towel. Having squeezed out as much moisture as possible, rub the hair plentifully with pomatum, or plain hair-oil. Wring the hair in a dry cloth, comb it out, and leave it to hang over the shoulders to dry. The above is a most expeditious mode of cleaning and drying long hair.

To Wash Hair-Brushes.—Use no soap, but a little washing-powder in lukewarm water. Very little moisture is necessary, if brushes be rubbed one against another; only the bristles should be wetted. If possible, set them in the sun, bristles downward, to dry. Many persons never wash their brushes, but simply rub them daily in a box containing dry flour.



Fig. 1.



Fig. 2.

An excellent hair brush has recently been introduced by John Gosnell and Co., of Three King Court, Lombard Street, which requires less frequent cleaning, and is in many respects very superior to those in ordinary use. Figs. 1 and 2 will show the special character of this admirable improvement, and the way in which the hairs are arranged in different lengths.

Combs should never be washed in water. Small brushes are sold for the purpose.

Hair washes, as a general rule, are not necessary if the hair be periodically washed and daily dressed with care. A mixture of one pennyworth of borax, half a pint of olive oil, and a pint of boiling water, is a popular wash with many who do not approve of washing the head.

Pomatum for the Hair composed of animal fat is to be preferred to that made of vegetable oil. Beef marrow or lard, reduced to the desired consistency with olive oil, and scented with any perfume, is the basis for all good home-made pomatums. As a general rule, the pomatum sold at hair-dressers is strongly scented enough to bear the addition of as much again of the above compounds without additional scent. We give a Swiss receipt, which has the credit of really stimulating the growth of the hair when advanced age does not offer a serious impediment. It is cheap, simple, and above all innocuous, which cannot be said of many similar preparations:—Into an earthen vessel put sixpennyworth of sweet unsalted pork lard, recently melted, or as the cooks say, "tried" down. Set this over the fire in a shallow saucepan of boiling water. As soon as the lard is liquid, shake into it a pennyworth of powdered camphor; mix well with a spatula or small wooden spoon; then add four

dessert-spoonfuls of good old Jamaica rum; stir again. After the water in the saucepan has boiled a minute or two, take out the vessel containing the pomade, and keep stirring till nearly set. The quantities we have stated could be increased, but it is better to use it fresh and fresh. This pomade should be well rubbed into the skin at the roots of the hair, every day for the first fortnight, and every other day the second. It is better to use it in the morning than in the evening, because perspiration at night and the contact of the pillow might tend to weaken its efficacy. There is no need to be afraid of the smell of the camphor, as it very speedily evaporates.

To remove Grease Spots from Silk.—Take a few folds of blotting-paper, and pass a moderately heated iron over the spot, removing the blotting-paper, and replacing it with fresh as soon as soiled. If any colouring has been in the grease with which the silk is stained, a little benzole, as used by artists, may be applied to the spot after the grease is removed. Before making any experiments on valuable silks it is well to try the means proposed on a piece of the same material, having just caused a stain of the kind requiring to be removed.

To Revive Black Silk.—This may be done by many means; but the following is the most simple plan, and answers well:—First remove all the grease spots in the way described above. Then spread the silk on a clean ironing-board, and sponge it with nearly a dry sponge dipped in a mixture of beer and water and ammonia, in the proportion of a pint of cold water to a teacupful of stout or porter, in which has been dissolved a lump of salts of ammonia as big as a hazel nut. Avoid streaking the silk when applying the mixture, and each fold, as finished, should be rolled on a roller. When nearly dry, take the silk off the roller, shake it out, and roll it again, repeating the rolling and shaking, till the silk is quite dry. *Do not, on any account, use an iron,* and the silk will thus look nearly as good as new.

To Keep Silk.—In using white paper for wrapping silks, remember that if the paper has been bleached with chloride of lime, it will have a tendency to impair the colour. Silk should not be kept folded up long before it is "made up," as this would tend to decrease its durability, by causing it to cut or split, especially if the silk has been stiffened with gum.

To Clean Kid Gloves.—Put the gloves on a wooden hand, sold for the purpose, of the size required, and rub the spots with a little stale bread. If the gloves are greasy they will require benzole applied with flannel. A very useful substitute is Price's Sherwoodole, sold at most dyers and scourers. White satin shoes may be cleaned in the same way.

To Clean Tweed Cloth Cloaks and other Woollens.—Spread the garment on a clean dresser, and rub the soiled places with a square of prepared pipe-clay, used dry. Then pass the clay all over the garment, till quite covered with a white dust. Fold the garment into a compact form, and beat it with some plaited canes till the dust makes its way through from the centre folds. Afterwards shake the material, and brush off the remaining dust with a soft clothes-brush. The above plan is especially excellent for all grey-coloured cloths, children's knickerbockers, and the like.

To Clean White Satin Shoes.—Rub them lengthways of the satin with a piece of new white flannel dipped in spirits of wine. If but slightly soiled, they are readily and easily cleaned by simply rubbing them with stale bread. To keep thin light slippers in shape, fold them over lengthways or sideways, tie together, and put them away in a covered box or bag, as already recommended.

The Teeth require to be kept particularly clean rather than the application of mouth-washes and elaborate dentifrices. The more simple the ingredients used the better. Unless recommended by a good dentist, all tooth

powders reputed to have beautifying effects should be used with caution. Washing the teeth night and morning is the best preservative of their beauty and soundness.

Artificial Teeth have already received attention in another section of this work. Speaking of these, we ventured, on page 173, to warn our readers against advertising dentists. In this warning, we had in view a large section of that class depending more upon their advertisements than upon the quality of the articles they supply; but, in common justice, we ought to have added that advertising has now become so common with most trades and professions that many of the most respectable practitioners do not hesitate to adopt it.

Nails.—The finger-nails should be trimmed to the shape of the finger-ends, leaving them moderately long, but not projecting beyond the tips of the fingers. Nails should not be cleaned with sharp-pointed scissors and pins—a soft nail-brush is the right means. If the hands and nails have become unusually soiled, they should be rubbed with a little sweet oil or pomatum before washing with soap, and afterwards cleaned in tepid water. In wiping the hands, the "crescent" of the nails should be preserved by gently pressing it back with the towel.

We may here state that the washing of fine laces, blonds, &c., belongs to a lady's-maid's place.

COTTAGE FARMING.

ARTIFICIAL MANURES.

THE manufacture of artificial manures—although only recently commenced—is now one of the most prospering and important branches of British industry. Woollen rags have for long been chopped up—sufficiently small, for being sown over the land—very largely in the hop gardens of Kent. Guano began to be used sparingly, by way of experiment, in the early part of the present century. The "bone rubbish" of Sheffield and Birmingham was given away to farmers; but farmers soon began to scramble for the refuse, which the bone and ivory turners very naturally obviated by charging a sufficiently high price for their "rubbish." This led to the use of crushed bones; but the demand of the farmers outstripped the supply from such limited resources; whilst the old plan of using rags, bones, and guano, was not found to be the most economical. The former gave rise to a brisk trade in rags, and bones—home and foreign—and the latter to improvements in preparing them for the land. On an average of several years past, about twenty patents are annually applied for for improvements of this kind. The high price of Peruvian guano and bones next gave rise to the manufacture of the salts of ammonia, soda, potash, and lime, and to the making of them in various ways as "specific manures," to suit different crops and soils, with all the animal and vegetable refuse matter that can be collected; the trade at the present time being ramified over the whole surface of the globe in procuring the raw materials of this modern manufacture.

To the cottage farmer, artificial fertilisers are of still greater use than they are to the large farmer, inasmuch as his manurial resources are more limited, whilst his cow-dung and pig-dung are inferior in quality. The cottager is thus interested in a twofold sense. In the first place he has to improve the contents of his manure pit, and secondly, he has to purchase specific manures for different crops to make up for the deficiency of the home supply.

Agricultural Salt, or rough common salt, costs from 20s. to 30s. per ton, according to purity. It is one of our best and cheapest alkaline manures, and should be much more largely used than it now generally is by small farmers. To plants indigenous to the sea-shore, as mangold-wurzel,

cabbage, &c., its liberal use is essentially necessary to their successful growth, as will afterwards be shown when we come to treat of growing such crops; but besides supplying food directly to plants, salt acts, when strewed over the cottager's manure pit, as a deodoriser, thus preventing the waste of ammonia. It also destroys insect life, which is far more prevalent in dunghills than is generally imagined; thus converting into manure what otherwise would have been destructive both to the manure itself, and to the crops to which it is applied. Salt, also, kills wire-worms and slugs in the land, is a powerful absorbent of moisture and ammonia when present in the atmosphere, and promotes a healthy decomposition of animal and vegetable matter in the manure pit, compost heap, and soil. It also improves the quality of the straw and grain of cereal crops. It is equally effective in killing insect life in compost heaps, and in promoting a healthy decomposition; whereas, without salt, much dry rot and mouldiness take place, and hence waste of fertilising matter. About 1 cwt. of salt to the cubic yard of manure or compost, a thin sprinkling at a time, is the usual allowance to the latter when being turned. Applied to old meadows or pastures in moist weather or before a shower, salt destroys effete vegetable matter and moss—converting them into manure; thereby setting up a fresh green growth, much relished by stock. It is better, however, to mix it with other fertilisers, as superphosphate, muriate of potash, or wood ashes—when wood is burned by the cottager—and sulphate of ammonia in equal quantities, and in repeated small doses in the spring time, rather than in one heavy top-dressing. One cwt. of salt should be mixed with 1 cwt. of guano. Some give 2 cwt. of salt to 1 cwt. of superphosphate, and 1 cwt. of salt to 2 cwt. of lime.

Nitrate of Soda fluctuates in price from 14s. to 18s. per cwt. About 1 cwt. is the usual allowance per acre; so that mixed with an equal quantity of common salt, it is generally considered a cheap manure, as it acts immediately when applied to corn crops in early spring, forcing up very rapidly in growing weather a vivid green leaf. It improves the quality of hay and straw—the crop standing up better than when grown without it. Nitrate of soda forms a valuable mixture in improving cow or pig dung, or making compound manures.

Nitrate of Potash (Saltpetre) is a powerful fertiliser, but its price, 23s. to 25s. per cwt., owing to its employment in less peaceful arts, prevents its being much used.

Muriate of Potash costs from £8 to £9 per ton, or 80 per cent. base, or from 8s. to 9s. per cwt. It is now extensively used in supplying the potash of fertilisers, and promises to be equally useful in supplying potash to the manure and compost heaps of the cottage farmer, or for top-dressings along with common salt. The supply is almost unlimited, and should it remain at the present price it will be very largely used.

Wood Ashes supply sulphate, carbonate, and muriate of potash, and where the cottager burns wood the dry ashes should be carefully stored for mixing with his cow manure, or for compost and top-dressings. Most of our cultivated plants—as wheat and beans—contain a large per-centage of potash, and when they do not find a sufficient supply in the manure, the straw of the former becomes unhealthy, and will then fail to yield corn, while the latter is liable to the attacks of the “bean-fly.” And, besides supplying food directly to plants, wood-ashes, like common salt, destroy insect life, absorb moisture from the atmosphere, and produce a healthy decomposition of animal and vegetable matter in the soil. Wood ashes also contain, in addition to the above salts of potash, earthy phosphates which further enhance their manurial value.

Sulphate of Ammonia costs from 14s. to 17s. per cwt. It is a more valuable fertiliser than either of the other two alkaline salts, soda and potash. There are other salts of

ammonia—as the carbonate, lactate, muriate, nitrate, and phosphate—but the sulphate is that upon which the farmer and manure manufacturer chiefly rely for an artificial supply of ammonia. It is sometimes sown broadcast in the spring-time at the rate of from one to two cwt. per acre to young wheat; but it is much more economical to mix it with other manures deficient of ammonia, as common salt, superphosphate, muriate of potash, and cow-dung. Like the other alkaline fertilisers, it is noxious to insect life, absorbs moisture from the atmosphere, and promotes a healthy decomposition of animal and vegetable matter in the compost heap and in the soil.

Carbonate of Lime is largely used in agriculture, chiefly in a calcined form, when slacked in hydrate of lime. Some calcareous soils contain a sufficient supply for plants, but others are deficient, and to these it is applied at the rate of from 30 to 300 bushels of shells from the kiln per acre. Heavy clay soils require the larger quantity, light soils the lesser. The different plans of applying it will subsequently be described. As a manure, it not only supplies food directly to plants, but corrects sourness, destroys insect life, and brings into action the dormant organic and mineral properties of soils.

Carbonate of Lime is also applied to land in the form of chalk, calcareous gravel, and sand clay-marl and shell-marl fertilising substances, so well known in the localities where they are found as to render any description of them unnecessary. They are seldom carted to a distance. Where clayey marl is found under the surface, it is supplied by labourers at the rate of 1,000 to 5,000 barrowsfull per acre, and at a cost of a halfpenny per barrowfull; and this indicates the cottager's plan of operation, which is both claying and marling.

Sulphate of Lime (Gypsum) is a cheap mineral manure, costing from 30s. to 40s. per ton when delivered in quantity. When bought in small quantities, it costs from 1s. 9d. to 2s. 6d. per cwt. As a specific manure, it is sown at the rate of from two cwt. to three cwt. per acre, on sainfoin and clover in spring. In the United States of America it is used to beans, peas, and indeed to most crops at the time of sowing, under the name of “plaster.” Much of its success depends upon the nature of the land to which it is applied. Its peculiar action is rather singular, for it produces the most beneficial effect when sown on a calm, moist day, so as to form a thin film or crust on the leaves. It is chiefly used, however, as a deodoriser in stables, cow-houses, and piggeries, where it converts the carbonate of ammonia into sulphate of ammonia, and the sulphate of lime into carbonate of lime, the sulphuric acid and carbonic acid changing places. It has been suggested to whiten the leaves of turnips with gypsum-powder, on moist mornings, for the purpose of arresting the ravages of the turnip-fly. In piggeries it not only prevents the escape of ammonia, but corrects the noxious character of the manure, of which we shall afterwards treat.

Coprolites are obtained chiefly from Suffolk crag and Cambridgeshire chalk. Unground they cost from £2 10s. to £3 per ton, and yield about 60 per cent. phosphate of lime, so that it is cheaper than bone-phosphates; but it must be borne in mind that it contains no ammonia. It improves cow and pig dung.

CLEANING CLOTHING AND UPHOLSTERY.

It is almost remarkable that an art so constantly in requisition as the cleaning of ladies' dresses and other articles of wearing apparel is so little understood. It is rather a costly process when done by tradespeople, and how frequently we hear ladies say, “Oh! this or that is not worth cleaning; I shall give it away!” In the interest of those who have to make the most of everything, and

who know well that every penny saved is a penny gained, we are anxious to give our own personal experience of cleaning. Many fancy dresses worth but 4d. or 6d. a yard look equal to new when cleaned as described.

Woollen and Fancy Fabrics.—There is one way to clean all woolen and fancy fabrics that comprise mixtures of wool and silk, or wool and cotton. In the first place, we recommend that the dress should be *entirely* unpicked, and every breadth separated. First, it makes up again in such a very superior manner, looking fresh and new. Secondly, a whole skirt is heavy to manage; but single breadths any lady unaccustomed to washing can easily manage. Thirdly, delicate colours, or colours mixed with white, are apt to run if too long in the process, or if mixed together.

Fabrics given to fray much, and the bodies of which may therefore become too small to re-make if unpicked, must have the sleeves taken out, and the tops and arm-holes over-cast, all trimming, bones, and hooks and eyes removed. When dry enough for mangling, open the shoulder-seams of the body first, to lay it flat for pressure. French merino, llama, serge, linsey, mohair, alpaca, plaid dresses, poplins, &c., come under the heading of woollen and fancy fabrics.

Take a quantity of soap, and shave it up, and place it in a saucepan, which must be filled with water. Set it on the fire till completely melted. It is impossible to tell the quantity of soap required for a dress, or cloak, or jacket. It depends on three things—the size of the garment, the thickness of the material, and how dirty it may be. Melt half a pound of soap in eight quarts of water—that is, two gallons. Pour about two quarts into a separate tub, and add four quarts of water. Beat it up into a lather, and set it close to the fire to keep warm. This is the rinse.

Pour the rest of the melted soap into another tub for the wash. If possible, keep them both about the same heat. They should not be used hot or cold, but about as warm as a lady's hand can conveniently bear. The quicker the articles are cleaned the better. Take the body first, if whole, or the pieces of it if separate. Do not attempt to clean two pieces at once. Put the first into the wash, squeeze it in and out, and knead it a little. It generally will come clean almost instantaneously. When you see it is clean, squeeze it slightly out of the wash, and rinse it in the rinsing-suds. Squeeze it out again, but only *very slightly*, and be sure *not to wring it*. Hang it up dripping wet on a line in or out of doors. After the body, clean the sleeves separately, then each breadth separately, taking the dirtiest first. After a time the soap becomes exhausted. You may know when it is exhausted by one of two symptoms, or by both. If it no longer continues to cleanse the articles put in it, it has become too dirty for use; if, from being thick and creamy at first, it becomes quite watery, you have absorbed all the soap out of the water in the articles cleaned. In either case, more soap must be melted. It does not take long to do this, and the temporary suspension of labour is not serious. After a little experience, the operator will be able to judge about the quantity needed for any job. If the soap in the wash coagulates too much while in use, a little warm water must be added and well mixed by hand, but it should not be rendered too thin. Soap is by no means to be rubbed on any article. When the rinse becomes dirty, a fresh rinse is needed. But on no account

must plain water be used for a rinse—only suds. Many prefer a rinse stronger than the quantities above mentioned, namely, as much of the melted soap to only its own quantity of water—two quarts.

Also, on no account must the articles to be cleaned be wrung or much squeezed. One of the arguments against cleaning or washing fancy materials is that they look puckered afterwards, and are sometimes shrunk. The puckering is caused by wringing or squeezing; the shrinking by rinsing in water. Cashmere and woolen goods also shrink and wrinkle if so treated, and the wrinkles cannot be removed by mangling.

When very nearly dry, fold the pieces together, lay them between clean cloths (white)—white lining will do—and send them to the mangle, with a request that they may lie in all night. Articles of different colours must not be folded together. White and coloured or parti-coloured materials must not be too damp when mangled, lest they run; still, if over-dry they will not press smooth. Where a mangle is not available, put the articles to be pressed between the two mattresses of a bed, and sleep on them. The slight dampness in them cannot come through the thickness of a mattress or feather-bed. After the pieces

have been mangled, spread a fine clean sheet or cloth on a blanket on a table, and iron each piece with a rather hot iron—cashmere and fancy fabrics on the wrong side, alpacas on the right. Be sure the iron is clean. Hang the pieces on a couple of towel-horses at the fire to dry them.

To clean Delicate-coloured Fabrics.—If the fabrics to be cleaned are of very delicate colours, or chintz colours, or in fact are such as are likely to run, use curd-soap to clean them. Have a clean sheet or two ready, and as each piece is rinsed in the suds, lay it in the sheet, and

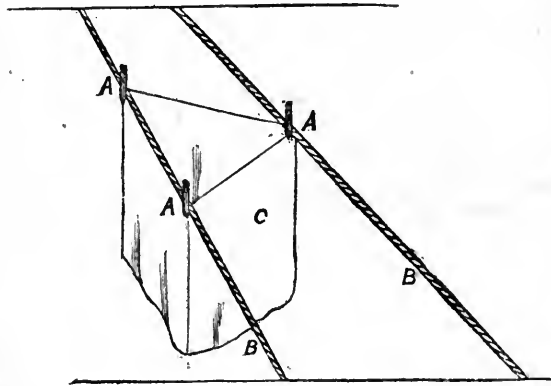

Fig. 1.

fold it up. When the first sheet is full, roll it from the last-used end, take out the first piece of the cleaned articles, and hang it up on a line by pegs or pins, or near a brisk fire. Take each out as you think it has had time to dry a little, and treat it the same.

When skirts are washed whole, they must be dried by being pinned by the hem between two lines, triangular-wise, like Fig. 1. B and B represent two clothes-lines across a garden or room, C the skirt, and A A A the three places where it is secured by pegs.

Any good yellow soap may be used for stout or strong fabrics; but money is not saved by using inferior soap. All soap contains water; the best has the least in it. The inferior soaps have more or less, according to their value, so that really by purchasing the best soap you have more soap when dissolved for your money than if using a cheaper kind, much of which turns to water. The saving is considerable. In cleaning, never use any soda.

To clean White Cashmere, White Llama, or White Alpaca.—Prepare a wash and a rinse as already described. If the articles are much soiled, prepare two rinses. Blue the rinses as usual. Clean the white articles piece by piece, as already described, and rinse in the blue water. As they are not squeezed out except very slightly, the quantity of soap retained in the articles out of the rinse will cause them to look much too blue. This need cause no alarm. Hang them at once on a line, if possible out of doors; it makes the white a better colour. The soap and blue will evaporate during the process of drying. We recommend the use of curd soap.

THE HOUSEHOLD MECHANIC.

GAS METERS.

IN our opening remarks upon the subject of gas, we promised to devote a chapter to that of meters, which promise we now fulfil. Considering the very general use of gas meters, it is somewhat surprising to find how very little is known of their general construction. This want of knowledge often leads to absurd mistakes; extravagant burning, loss by leakage, and errors of management, are often attributed to the meter, whereas they are the fault of the consumer. It is with the view of enabling every one to understand the construction and working of his meter, that we now propose to describe and illustrate these indispensable adjuncts to every household where convenience and comfort are studied. The name of this apparatus implies its use; it is a meter or measurer of the gas consumed at the burners, and answers to the pint or quart pot in which the publican measures his beer, only that the gas meter is naturally more complicated in its construction. The actual measurement of gas, however, by the meter, is as simple and as positive as the measurement of liquids by the most ordinary operation. In the early days of gas lighting there

was not a very great success, and in 1817 was superseded by the meter of Mr. John Malam, which formed the basis of the meters at present in use.

The gas meters now in general use are of two kinds, and are known as "wet" and "dry" meters. We shall describe these in the order in which we have placed them—the wet meter first. This apparatus consists of a hollow circular case, a little more than half filled with water. Inside this case is a hollow drum or wheel which revolves on a horizontal axis. The drum is divided into four compartments by radiating divisions, each compartment being of a known capacity, and having an inlet and outlet for the gas. The drum is revolved by the pressure of the gas entering from the main, and each revolution is recorded by suitable mechanism on indicating dials; and thus the exact quantity of gas consumed is made known. Such, in general terms, is the wet meter; let us now proceed to explain its details by the aid of the accompanying illustrations. Fig. 3 is a wet meter, with the side of the casing removed, by which means we see its action clearly. A is the outer casing, and B the drum or measure which revolves on the axle C. The partition plates D D, which divide the drum into

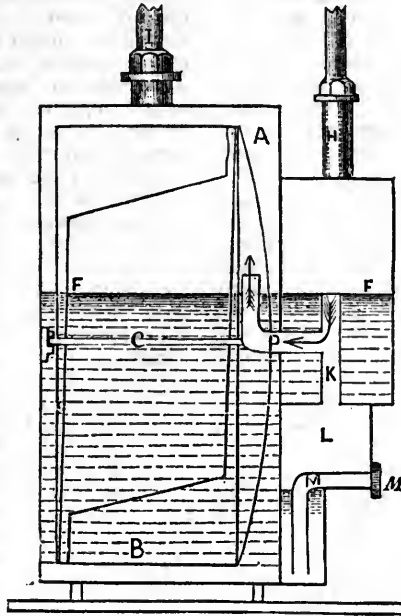

Fig. 1.

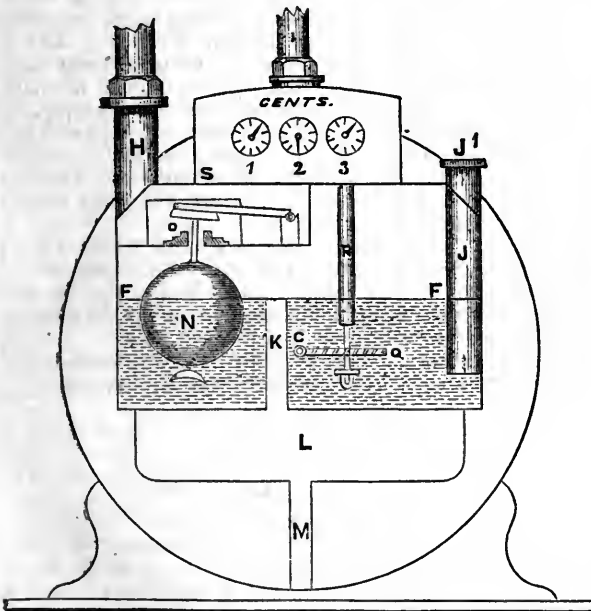

Fig. 2.

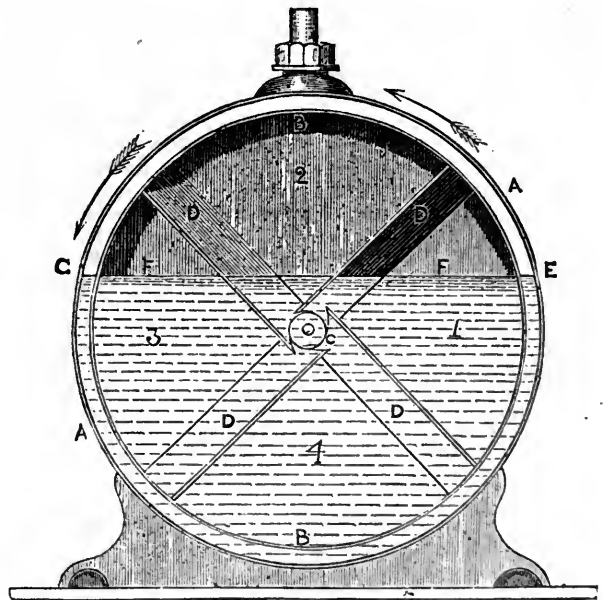

Fig. 3.

were no such things as gas meters, the gas being supplied direct from the street main, and the consumer paying according to the number of burners in his house. This was a very vague and unsatisfactory method of supplying gas, and soon led to the invention of a meter by Mr. Samuel Clegg, whose name will ever be associated with the history of gas lighting. Mr. Clegg's meter, however,

four chambers 1, 2, 3, 4, are placed at a slight angle with the axle, in order that they may offer as little resistance as possible to the surface of the water. The passages for the ingress and egress of the gas are attached to each of the chambers, and are opened and closed in succession by the revolving motion of the drum through the water.

The action of the meter is as follows:—The gas is

made to enter the measuring chambers in succession at the side E of the drum. It presses between the surface of the water F and the side of the partition D in chamber 1, which, being turned in the direction of the arrows, is gradually filled with gas. Chamber 2 is full of gas, chamber 3 being nearly empty, whilst chamber 4 is quite so. Both the inlet and outlet of chamber 2 are now closed by the water; but as the gas enters chamber 1, it expels the contents of chamber 3, at the side G of the drum. Chamber 2 follows, and its outlet being opened, the gas is also expelled. The drum continuing to revolve, it follows that each chamber in succession receives a supply of gas from the company's main, and delivers it into the consumer's pipes. Now, if each of these four chambers be of such a size as to contain one-fourth of a cubic foot of gas, it follows that for every revolution of the drum one cubic foot will be delivered to the consumer. The number of these revolutions being accurately recorded—as we shall presently show—the exact quantity of gas used is correctly registered. The actual capacity of each chamber is not the same in every meter, but varies with the quantity of gas to be consumed from them. Meters for the supply of gas to five burners, or five-light meters as they are termed, have drums which contain one-fourth of a cubic foot of gas; those for ten lights, half a foot; and so on in proportion up to the largest size made.

At Fig. 1 we give a sectional view of a meter taken at right angles to Fig. 3, and in which we see the measuring chambers in side view. B is the drum in its casing A, the water-line being shown at F as before. Attached to the front of the case is a rectangular box, on which is seen the pipe H, by which the gas enters the meter. The pipe by which the measured gas leaves the meter is seen to the left at I. Fig. 2 is a front view, with the casing removed, showing the arrangement of the measuring apparatus, also the filling and overflow pipes for the supply and adjustment of the water. The pipe through which the water is supplied is seen at J¹ (Fig. 2); and the first operation is to fill the meter with water to the required height through this pipe. If too much water is poured in, it flows out by the pipe K, the mouth of which is placed exactly at the height at which the water in the meter should stand. The surplus water runs into the waste-box L, and is drawn off by the pipe M, which is fitted with a screw plug for that purpose. In the box is a float, N, similar to that used in water cisterns, and at the top of its spindle is a valve, O, connected with a lever. If there is not enough water in the meter the float falls, and, closing the valve, obstructs the passage of the gas to the drum. We, however, assume the water to be at the right level; the gas then enters by the pipe H, and, the valve being open, it passes by the bent tube P (Fig. 1), in the direction of the arrows, to the hollow drum or measure B, and is delivered from the chambers 1, 2, 3, 4, Fig. 3, on the other end or back of the wheel.

We now come to the arrangement for measuring the gas consumed. This is seen in Fig. 2, where C is a continuation of the axle carrying the measuring drum B. On the end is a worm, or screw, working in the toothed wheel Q; as the drum revolves, it communicates motion to a spindle which passes upwards, through the casing R, to the box S, in which the recording apparatus works. On the face of this box are three dials, 1, 2, 3, each divided up into ten parts, and the pointers of which are actuated by a train of wheel-work, in connection with the worm-wheel gear at Q. The dial 3 shows the number of hundreds of feet of gas that have been consumed. When the pointer has travelled once round the dial, 1,000 feet of gas will have been consumed; and, by an arrangement of multiplying-gear, this will be shown on dial No. 2, the pointer of which will have passed through one division. When 10,000 feet of gas have been used, the pointer of No. 2 will have completed the circle, and the pointer of No. 1 will have passed over one division. In this way it is very easy to tell how much

gas has been burned, the dial 3 indicating hundreds of cubic feet, No. 2 thousands of feet, and No. 1 tens of thousands. A very simple method of ascertaining the consumption is as follows:—Assuming the meter to have started from zero with all the pointers at 0, and assuming we find that pointer No. 1 has just passed the figure 5 on the dial, that No. 2 has just passed the figure 4, and that No. 3 has just passed the figure 3, we place these figures on paper in their order, and they show 543. Now, if we add two cyphers (00) to these figures, they will show 54,300, and we thus know that fifty-four thousand three hundred cubic feet of gas have been consumed since the meter was started.

The wet meter is open to several objections, the first of which is that the house may sometimes be placed suddenly in total darkness by the extinction of the gas. This arises from the water in the meter getting too low, which it is liable to do, owing to evaporation and other causes. As this usually happens at night, a gas-fitter is not always to be found, and if the consumer is ignorant of the construction of the meter, he must obtain light from other sources, and wait till the morning for the defect to be remedied. But we will show him the remedy so that he can promptly correct the evil. The main tap must be turned off, and the tap of one of the burners opened. The screw-plugs J¹ and M must be removed, and a small quantity of water poured gently into the meter through the pipe J. When water is seen to issue from the orifice of the pipe M, the screw plugs must be replaced, the gas turned on from the main, and the burners re-lit, when all will go on steadily. It is to be observed, that under no circumstances should a light be carried near the meter whilst the operation of filling is going-on, or a dangerous explosion may occur. And this leads to the notice of a second objection to which the wet meter is open. In order that any water which may be condensed in the service pipes, from the evaporation of the water in the meter, may be returned to the meter again, and not stop in the pipes and choke them, the meter must be placed in the lowest possible situation. This is generally an underground cellar, or some similarly dark and inaccessible place, so that to get a sight of it a light must be used, and, if there should be an escape of gas, an explosion is imminent. But these evils, although bad, are not the worst to which the wet meter is subject. A third and very fatal objection is, that in severe frosty weather, if this meter is exposed to its influence, the water freezes and gas cannot be obtained at all. It is true there is a remedy for this, which consists in pouring a little boiling water into the tube J, and which melts the ice and allows the apparatus to work again. But it is clear that the wet meter, although highly ingenious, has serious drawbacks, and these drawbacks point out the necessity for a more perfect instrument. This we have in the dry meter, to the description of which we shall devote another paper.

COOKING.

OMELETTES AND CUSTARDS.

Cheese Omelette.—If an omelette is merely to serve as a side-dish or slight addition to a dinner, an egg and a half for each person will be enough; but if it is to be the main-stay—perhaps the only hot dish, as at breakfast or luncheon—two eggs per head will not be too large an allowance. Take white or yellow cheese in preference, and grate or chop it fine. The quantity will depend on the strength of its flavour. Better put in too little than too much, in order to keep the omelette delicate. Chop fine a leaf or two of parsley, and, if you have it, one of chervil. Break your eggs into a bowl, beat them well together with a fork, but not too much or to a froth. Mix in your chopped-up cheese and herbs with a pinch of salt and the slightest dust of pepper. Your frying-pan (an earthen one does

well for omelettes) being ready, with a good lump of butter melted in it, give a final stir to your beaten eggs, to mix all equally, before pouring into the pan. As it fries keep shaking it, raising the edges all round with your slice. When the upper surface is nearly set, fold the omelette in two, making it nearly the shape of an apple turnover. After half a minute, turn it; and after another half minute serve on a hot dish. Omelettes should never be overdone, but should be juicy and only semi-solid in the middle. This omelette resembles in flavour the old-fashioned dish called rammakins, or ramequins (a descendant of the still more ancient Welsh rabbit), but is lighter and gives less trouble. It may be presented at the same complacent moment—*i.e.*, towards the close of a pleasant dinner.

Omelette, with Cheese.—Grate your cheese, chop your herbs, and beat your eggs, as before; season the same. Mix the *herbs only* with the eggs. Put the cheese into a small saucepan, moisten with a spoonful of milk, cream, or stock, and warm the cheese through over a gentle heat. Fry as before. Just before folding the omelette, put the cheese into the middle, just as you would put the apple into an apple turnover. After folding your omelette, with the cheese snug in its place, finish off and serve as above directed. Mustard should be at hand, to be eaten, if liked, with either of these omelettes.

Plain Omelette.—The same as the preceding, omitting the cheese and the herbs.

Sweet Herb Omelette.—The same as the preceding, with any or all of the following herbs, chopped very fine, mixed in small quantities with the eggs before frying:—parsley, chervil, and chives, most usual; onions, shallots, thyme, sage.

Kidney Omelettes.—Veal: Cold roast kidney, if underdone, answers exceedingly well. Slice very thin, or chop into quite small dice, a piece about the size of a turkey's egg. Put a little cold veal gravy—or, if you have none, stock—in a saucepan over the fire, with a bit of butter and a dust of flour. Work them into a smooth sauce. Season with lemon-peel, lemon-juice, salt, pepper, and grated nutmeg. Into this put your kidney, to get warm through without ever coming to a boil. Make a plain omelette: before folding it, take the slices of kidney out of the sauce with a spoon, or small slice, draining the sauce away from them. Put them in the middle of the omelette, then fold the omelette and finish it. Lay it in the middle of an oval dish, made very hot, and pour the boiling sauce round, not over it. Mutton and beef: One mutton kidney, or a piece of beef kidney of equal dimensions, will suffice for an omelette of five or six eggs. Slice the kidney, raw, very thin. Put it into a saucepan with a table-spoonful of gravy, or stock, half a glass of red wine, a dessert-spoonful of mushroom catchup, and a dust each of flour, pepper, and salt. Stew these together, stirring continually, until the kidney is done. You must not let it boil, or it will be hard and leathery. While still tender and juicy, put it in the middle of your omelette, and pour the sauce round the latter, as directed above.

Bacon or Ham Omelette.—Take the required quantity of cooked ham or bacon, fat and lean together, and mince it tolerably fine. It is usual to mix this addition to an omelette throughout its substance, as was directed for sweet herb omelette, instead of putting it altogether in the middle. For *that*, it would require to be stewed in some sauce, and it would not be easy to propose a suitable one for ham and bacon. But, in nearly every case, the cook is at liberty to choose between the two methods. Even cold kidney and meat, minced, may be mingled with the eggs before frying. It is evident, however, that any ragoût is best deposited altogether in the centre of the omelette just before it is folded. There is no definable limit to the articles with which this kind of omelette may be made—

young green peas, while still a rarity; the tips of asparagus, small mushrooms, shrimps, prawns, oysters, and bits of lobster-flesh, are all excellent in their turn.

Salmon Omelette.—Fish omelettes, in like manner, may either have the particles of fish dispersed through their substance or be served together in a ragoût. We prefer the latter mode, except with such ingredients as the flesh of red herring, bloaters, kippered salmon, &c., which are analogous to ham and bacon. Fish omelettes, too, have the advantage that, as the quantity of fish needed is small, and must be cooked in some way previous to putting it into the omelette, cold remains will mostly serve very well, and so be turned to good account in an elegant shape. For an omelette of six eggs, take cold salmon equal in quantity to three hens' eggs. If you have any cold lobster, shrimp, or oyster-sauce, or even plain melted butter, put just enough in a saucepan to warm the fish in, which you will have separated into flakes, preferring the fatty, or belly parts. Add more butter; season delicately with lemon-juice, nutmeg, and pepper, keeping the ragoût as thick as may be, as you have no use for surplus sauce. Put this ragoût in the middle of your omelette, and finish off as in other cases. Have ready heated a hollow oval dish; in the middle of this put a good lump of butter, with which chopped parsley has been incorporated. Lay the omelette on this and serve. The butter, melting beneath the omelette, will make the only sauce required. All fish omelettes should have a liberal allowance of butter: both inside and out.

Sweet Omelette (plain).—While beating your eggs, throw in a few grains of salt and a good sprinkling of pounded lump sugar. You may further flavour with any delicate aromatic that goes well with sweets; with essence of lemon, vanilla, rose-water, orange-flower water, noyau, or curaçoa. This omelette, when fried, should be laid on the naked heated dish, with nothing under or around it. Dust over it a good coating of sugar. Herring-bone the top with a red-hot iron rod that has been wiped with damp canvas after taking out of the fire; or set it a minute under a red-hot salamander, to convert part of the sugar into candy.

Rum Omelette.—Proceed as before, only flavour with a tablespoonful of rum, and be liberal with the sugar mixed with the eggs. Warm half a tumbler of rum in a saucepan. When the omelette is laid in the heated dish, pour the rum round it, and set light to and serve it.

Preserve or Jam Omelettes.—Proceed as before; flavour your eggs with nothing but sugar—at least, with nothing that would disaccord with the kind of jam you use. For a strawberry omelette, you might flavour with orange-flower water; and for an apple marmalade omelette, with essence of lemon. Before folding the omelette, lay in the middle two or three tablespoonfuls of any jam you prefer or have—strawberry, raspberry, black currant, gooseberry, apricot, greengage, orange marmalade, cranberry, &c. &c. All these omelettes, as well as the preceding, should be sugared, and partially candied by heat, on the top.

Deville's Omelette (Indian) is a contradiction, a union of opposites, a combination of the soft with the strong, of the smooth with the fiery. Under its smooth placid face it conceals the fiercest of tempers, and we cannot help regarding it as an unfair trap for unwary eaters. Mix up with your eggs, chopped parsley, mint, chives, or young green onions, salt, and cayenne. In the inside put any highly-curried ragoût. If you have any mulligatawny soup, pour a ladleful of it, hot, round your omelette, as usual.

N.B.—In serving a large party of guests with omelette, it is better to make several middle-sized ones than to attempt an unusually large one, which would not be cooked equally throughout. From five to seven eggs make the most manageable omelette; more are less easy to turn out neatly. This plan likewise gives you the

opportunity of sending up a variety of omelettes; the different ingredients are so easily prepared and introduced. Soyer applies and carries out the idea in his *Macedoine*, or medley of omelettes, though he only makes a diversity of sweet ones. "Instead of making one with eight eggs, make four," he advises, "with two eggs each, of different kinds of preserves." Serve on the same dish, sugar over, &c., as before. A medley of fish omelettes would be equally agreeable, if served in harmonious companionship. For four kinds take, say, salmon, sole, lobster, and oysters. The only extra trouble would be the making of four different fish stews in four different saucepans. The only sauce needed is a good lump of butter well worked in chopped parsley laid at the bottom of the hot dish. The contents of each omelette could be indicated by laying on the top of each, by way of tickets, one oyster (cooked), a flake of salmon, a morsel of lobster, and a bit of sole; and the choice offered would please most people, ladies especially. Fish omelettes are particularly acceptable and light at a

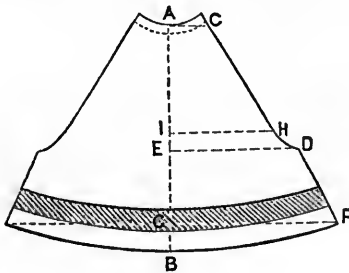

Fig. 2.

sociable supper, on returning from a concert or a theatre.

Omelettes Soufflées.—These are baked, not fried, and are placed on the table in the same dish in which they are cooked. Therefore, if you have a deep silver or plated dish, use it; if not, a tin one. Butter the inside of your dish, to prevent, in some measure, the omelette from sticking to it. Have a couple of salad-bowls, and a dozen eggs. Break the yolks into one bowl and the whites into another. To the yolks put a pinch of salt, a teaspoonful of flour, three-quarters of a pound of finely-pounded sugar, and orange-flower water or vanilla to taste. Beat up these well together; then beat the whites to a froth; then put the two together, and beat up again. Pour the whole into your dish, and set it into a smart oven. As soon as it is well risen, and nicely brown on the top, it is done. Dust the top with sugar. Set it on the table with the speed of magic; it is one of the things which cannot wait. Before you can discuss its merits, it is gone. To prevent its catching a fatal cold, you may wrap it in a blanket on its way from the kitchen to the dining-room.

Gardeners' Omelette (à la Fardinère).—Make a rich ragout with all sorts of vegetables, salading, herbs, green peas, French beans, &c., or whatever the season offers you. Beat up half this ragout with a dozen eggs, and with the mixture make, in the usual way, either a couple of omelettes or one large one. Pour the rest of your ragout into a heated dish, and serve your omelettes on the top of it.

THE REARING AND MANAGEMENT OF CHILDREN.

CLOTHING FOR CHILDREN OF SIX YEARS (*continued*).

Paletot for a Child of from Four to Six Years old.—A useful paletot for walking may be made for a child of four years old, instead of a pelisse. The pattern we give is equally suitable for a girl or boy, and may be worn two years, at four and five years of age, and for a small child of six years. Making it for a child of six, allow half an inch wider every way on each piece, and one inch longer on each piece. These loose jackets, which are made ample, allow of considerable latitude in use. We shall describe this as composed of English broadcloth, fine make, usually known as "lady's cloth." The broadest part of this paletot measures 26 inches. The trimming is piece velvet, and must be put on last. It is lined with fine black alpaca. The pattern, however, may be used to make a jacket, lined or unlined, in any fancy material, to match a spring dress, or



Fig. 10.

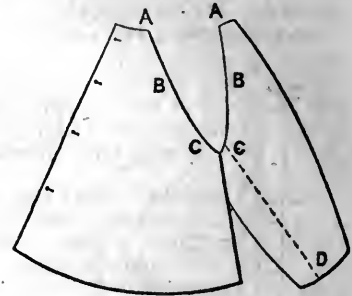

Fig. 7.

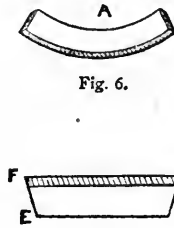

Fig. 6.



Fig. 5.

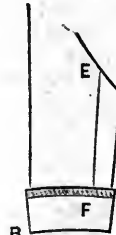

Fig. 3.

together and lined. From the line at A to B, the measure is $15\frac{1}{2}$ inches; from C to D, the front, 14 inches; from E to D, $15\frac{1}{4}$ inches; from F to G, 10 inches; from H to F, $9\frac{1}{2}$ inches; from F to E, $8\frac{1}{2}$ inches; from I to C, 3 inches. The line on the shoulder, it will be seen, is an exact slope from A to H, and from H to F there is but a slight hollow for the lower part of the armhole of the sleeve. This is the peculiarity of the pattern, which the sleeve itself will explain. Allow an inch to turn in down the fronts, C to D, to make double button-holes. Fig. 2 is the back, which is cut double. If a narrow fancy material is used, the back must be joined up the centre, and half an inch allowed for a mantua-maker's seam or stitching. The cloth is cut double on the straight. There is no allowance for shoulder and side turnings. A quarter of an inch is sufficient. The measure is taken from the half of the back. From A to B the length is $17\frac{1}{2}$ inches; from C to A, the neck, $2\frac{1}{2}$ inches. The shoulder slope, like the front one, is, from C to H, $7\frac{3}{4}$ inches; from H to I the measure is $6\frac{1}{2}$ inches. There is a marked curve for

in alpaca, silk, muslin, velvet, or velveteen. There is a variation from the common jacket in the way the sleeve is put in, which is supposed to give a more graceful slope to the shoulders. It is rather more difficult to master, but there need be no difficulty in accomplishing it with a moderate amount of patience. There is no allowance for turnings in these directions. First cut the fronts separately, like Fig. 1. The trimming is added when the paletot has been joined

the lower part of the arm, and although D is barely an inch below H, the measure from D to E is 9 inches. From F to G measures $11\frac{1}{2}$ inches; the space from G to B (the curve of the back of the jacket below a straight line) is $2\frac{1}{2}$ inches. Now the curiously-cut sleeve must be described. Fig. 3 shows its shape joined; Fig. 4 displays the sleeve as it is cut out. Mark the design by the measurement given on paper, and cut it out before cutting the cloth. In Fig. 4, A to B is on the cross—that is to say, the sleeve is cut on the cross; so, although the line is straight at first, it gives to the bend of the arm, and when worn the sleeve assumes the curve of a coat-sleeve. Measure, on paper, A to B in Fig. 4, 17 inches; C to D (both sides), 7 inches; from C to C, $12\frac{1}{2}$ inches; from D to D, 11 inches. Cut the cuff (Fig. 5) 2 inches wide, 11 inches from E to E, and 12 inches from F to F. The collar, Fig. 6, is $2\frac{3}{4}$ inches wide, 12 round the neck on the inner curve, and 17 inches outside. The pocket is 2 inches wide and 4 inches long. Cut the black silk velvet for trimming the front and edge of the paletot $2\frac{1}{2}$ inches (the half for turning) wide, on the cross; join the

the lining at the side seams. Put the seamless or right side of the cloth to the seamless or right side of the alpaca. Run the alpaca to the fronts of the cloth, both sides (C to D in Fig. 1); then turn them, as you turn a sleeve or a pocket. Turn in an inch of the cloth (from C to D, Fig. 1), both sides, to make a wide front hem. The alpaca will now be the same size as the cloth. The seams of the alpaca under the arm will meet the cloth seams under the arm. Tack them together there; then tack the alpaca down at the shoulders to the cloth, and tack the edges all round a quarter of an inch in. Run the sleeve-lining, insert it, having turned the seams outside to face the cloth ones, and leave no seams visible in the jacket when finished. Tack the upper part of the sleeve-lining that forms the shoulders down to the jacket shoulders, half an inch in; then turn in the edge a little, and hem it down, taking the stitches through the lining only, and not through the cloth. Next turn in the edge of the cloth all round the skirt of the jacket a very little; tack it down; turn in the alpaca a little more, and hem it to the cloth. Lay the velvet down the front

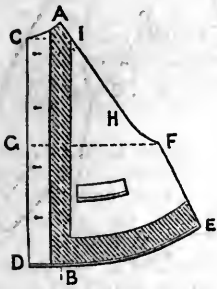

Fig. 1.

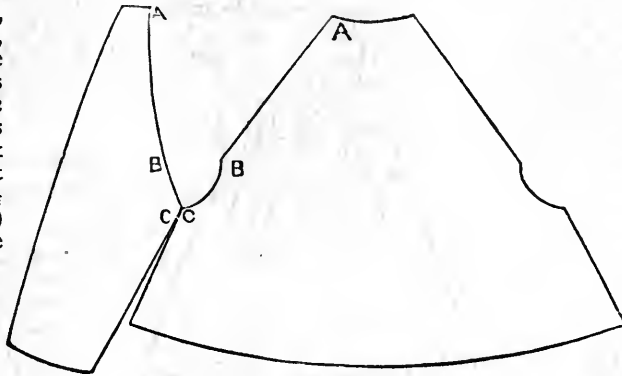

Fig. 8.

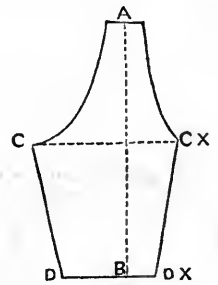

Fig. 4.

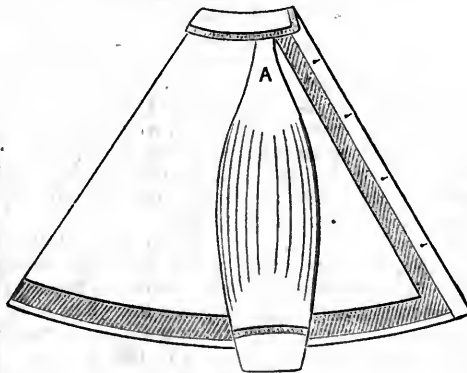

Fig. 9.

breadths. To trim the collar, cuffs, and pocket, $1\frac{1}{2}$ inch wide—the half to turn in. In fine black alpaca for the lining, cut two fronts, a back, and a pair of sleeves. Cut the fronts of the alpaca an inch narrower than the paper pattern you have taken from our description; that will be 2 inches narrower than the cloth, which you allowed an inch wider than your pattern for a hem.

To Line the Jacket.—Stitch each sleeve together from C to D. Run neatly the alpaca lining together. The sleeves have, of course, been cut reversed, and the seams of both are placed more towards the front than towards the back. For instance, the side C X and D X of each sleeve is towards the front (Fig. 4). Fig. 3 shows how the sleeve is placed, viewing it from the front, and the seam coming from E to F. Join the cloth back and fronts of the paletot by the side seams under the arms, stitching them; that is, F to E of Fig. 1 to D to F in Fig. 2. Leave the shoulders open. Now join the cloth sleeves to the paletot. Fig. 7 shows how the sleeve is joined to the front of the shoulders, A to A, B to B, C to C. The dotted line from C to D shows the sleeve join. The other side of the sleeve is united to the back, as shown in Fig. 8, A to A, and B to B, and C to C. Fig. 9 shows the paletot completed. A marks where the sleeve is let in, forming also the shoulder-piece. Having proceeded so far, next run

of the jacket, and tack it, as shown in Fig. 1, from A to B. It is just turned in each side, and hemmed down invisibly with fine black silk. Tack it round the edge, leaving nearly half an inch projecting. The upper edge is turned in and hemmed to the cloth. The part of a half-inch projecting is turned over on the wrong side, a little bit turned in, and hemmed down to the lining. Next put the velvet on the collar, as you put it on the edge of the paletot.

Place the collar on the paletot the way it is worn, and stitch the raw edge of the inner circle of the collar and lining (A, Fig. 6) to the raw edge of the paletot at the neck. Turn the join down. Hem a narrow (three farthings a yard) black sarcenet ribbon to the collar just above the stitching, and over the join-down inside the paletot, by a second row of hemming at the other edge. Form the cuffs with velvet, as the collar was done. Run them to the cloth of the sleeve. Turn in the edge of the alpaca lining, or hem it over them. Then turn back the cuffs over the sleeves. Edge the lower part of the pocket with velvet, as the cuffs and collar are edged. Turn in the raw edge at the sides, and hem it down invisibly. Turn in the raw edge at the top, and stitch it to the jacket. Tack it on before stitching it. There are four button-holes worked round with tailors' twist, and four large buttons sewn on the opposite side. This completes the paletot.

A FEW WORDS ABOUT DYEING.—II.

SINCE the publication of "A few Words about Dyeing" (p. 360, vol. i.), we have been able to make further experiments with the aniline dyes; and additional information has also been placed at our disposal through the courtesy of Messrs. Judson and Son.

We mentioned in our former article that cotton goods were usually found the most difficult to dye. We now recommend that if cotton or mixed fabrics are to be dyed, the colours used should be violet or mauve; a greater or lesser extent of success may be attained in others, but with these alone the *amateur* will reach *certain* results. In using aniline dyes on faded articles which have previously been coloured, it will be well that the darker hues, such as magenta, violet, crimson, or black, should be employed. Goods which bear a pattern in black and white, in spots or stripes, as a shepherd's plaid, for instance, will dye to excellent effect in *any* colour. Thus a lady's Garibaldi jacket, with black ground and faded pattern, may be thoroughly restored by using a sixpenny bottle of violet or magenta in a pailful of boiling water. The use of a little starch is recommended, as it fixes the dye more thoroughly; rinsing afterwards in clean cold water is also advisable.

Precisely the same mode of treatment will apply to most articles of clothing—such as opera-cloaks, berouses, jackets, scarfs, handkerchiefs, petticoats, &c. We have already advised the use of plenty of water; this must be insisted on; all articles will expand in the bath, and it is necessary that full space should be allowed for them to do so. If any dirt or grease is present it should be removed before immersion by thorough washing. A *little* tartaric acid added to the bath, when green, blue, or canary are used, will both increase brilliancy and economise dye.

Articles on which Judson's dyes have been used will bear exposure to any ordinary amount of washing; but the use of soda is not advisable.

Much has recently been said by one of our contemporaries on the injurious effects which might be expected to arise from the use of brilliantly coloured flannels next the skin, on account of the poisonous ingredients used in dyeing them. The aniline dyes need not be dreaded; they are perfectly innocuous; so much so that they are even used by confectioners for colouring jellies and similar matters with complete impunity.

The process being so clean and simple, there appears no reason why every lady should not be her own dyer, or why dyeing day should not, in every well-regulated family, be as common, and much more agreeable, than washing day. Any young lady could begin her experiment on a ribbon or feather, following the directions already given, in a basin of water, and proceed afterwards to larger articles of dress in a bread-pan or foot-bath. The thing would be worth trying from motives of economy; and much more real amusement would result from it than from many of the melancholy recreations to which young ladies of the present day are condemned.

In addition to their use as dyes, we find that these fluids are applied to a curious variety of purposes. Those who delight in such vanities, which are an abomination to ourselves, can use them as coloured inks. Such of our lady readers as practise illumination, will find them, from their brilliancy, valuable for that purpose; and to the designers of stained glass windows they are likely to prove of great importance, since by their means something of the lustre of actual glass is to be attained in the preliminary paper cartoons. Architects and engineers employ them as flat washes on their plans and sections; photographic colourists tint photographs with them; we are not aware that artists have painted with them as yet. The edges of books may be coloured with

them in a pretty manner, by pressing the volume tightly together and laying on the fluid lightly and quickly with a soft brush. Deal may be stained with them to imitate oak, mahogany, satinwood, or ebony. We have seen croquet-balls stained with them, and two advantages are gained over the old method of painting: the balls are much prettier, and the colour is in no danger of coming off. Lucifer match makers employ them to tinge the ends of their matches. In paper making an almost imperceptible quantity of the dye is added to the pulp to give freshness—"life," as it is technically called—to white papers, on the same principle that the laundress puts blue to linen; indeed, in getting up lace and similar delicate articles the magenta, which gives a faint pink tinge, is used in preference to blue. For staining leather they answer well. Many other uses might be mentioned; but one of the most curious which has come to our knowledge is that recently adopted by a proprietor of hackney carriages: when the linings of his vehicles become faded, he stains them, without removing, with these dyes, and they look fresh and bright again; and the otherwise necessary expense of re-lining is thus avoided.

HOUSEHOLD DECORATIVE ART.

CASTING IN PLASTER.

CASTING a medallion will be found extremely simple, and needs no special directions. It may, however, be observed that if, after making the mould, water be poured round the edges and carefully worked between the mould and model, it is possible to remove the latter uninjured, and two or more casts may thus be procured from the same original.

The mould of a bust, like that of a vase, must be cast in two pieces. It may be done by placing strips of clay across the top of the head, past the ears, and down the neck to the shoulders. By this method the portions are nearly equal, and are most easily freed from clay and washed; but the disadvantage of two ugly seams down the neck attends it. Another plan is shown on p. 353, vol. i., which leaves a seam on the hair alone, where it is scarcely perceptible. In this the circular piece on the back of the head is moulded first—the strips of clay being supported by wire or wooden skewers stuck into the model.

When it is removed an opening is made, through which, and the bottom of the bust, the clay may be extracted and the mould washed without much difficulty. After a bust has been freed from the mould it should be mounted on a small circular pedestal, which may be bought for 1s. from any plaster-figure moulder. We should scarcely advise a lady to undertake the casting of a life-size bust; the labour is considerable, and a professional moulder may be employed.

The particular branch of casting, of which we have treated, is technically known as "waste-moulding," because the mould is always destroyed in the process. The method given is sometimes varied on delicate models of ornament, by making the inner mould of wax, which is melted, instead of chipped off. But this is scarcely simple enough for the amateur. From the wax or plaster waste-mould *one* cast only can be obtained. When a *number* of copies are required, a mould is sometimes made of gelatine; but usually what is known as "piece-moulding" is resorted to.

On the cast obtained from a waste-mould a second mould is formed, composed of a number of small pieces of plaster, so fitted that they can be removed without breaking. These are put together, filled with plaster, and again removed any number of times. In this way the plaster "images," sold by Italians in the streets, are made. The process is not uninteresting, but we cannot

spare space for description, and it scarcely belongs to our present subject.

Plaster models are liable to suffer from dust if not covered with glass, but they may always be made to look fresh and new by painting white. The method adopted by sculptors is, first to brush the plaster over with linseed oil to stop absorption, then to paint it with fine white-lead, mixed first with turpentine and a little oil, and afterwards with turpentine alone. Great care should be taken, and the paint "stippled" on, so as to leave a dead surface. The thinnest possible film of paint only should be applied.

Plaster of Paris is made by burning gypsum or alabaster; it is sold of three qualities—coarse, fine, and superfine. In small quantities, it is commonly purchased by the bag of 14, or the half-bag of 7 lbs.; coarse may be had of any oil and colourman, and will cost fivepence per bag; fine and superfine must be bought from a plaster-figure moulder; the former will cost 1s.; the latter 1s. 6d. per bag. Superfine need only be used for such delicate work as will be protected from dust—a small vase, for instance, which will be placed under a glass shade; or a medallion, which will be framed and glazed.

Let us presume that the bracket before described has been modelled ten inches high, eight broad, and with a projection of six inches; and proceed to cast it. Half a bag of fine plaster and a bag of coarse will be required. Take a basin, two-thirds full of water, to which add enough colouring matter to tinge it slightly—nothing answers the purpose better than ink. To this sprinkle in fine plaster, till it begins to rise above the surface, then stir with a spoon, for a few seconds, thoroughly breaking and mixing all lumps: any air-bubbles or impurities which rise must be skimmed off. When mixed, the consistency should be that of cream. Then with the spoon throw the liquid plaster over the surface of the model (which should previously have been sprinkled with water): to expel air-bubbles, and to force the plaster into the hollows, blow it with a pair of bellows. Continue to throw on plaster till a coat, of a quarter of an inch thick, covers every part of the model. All this must be done quickly, as the plaster, if fresh and good, soon hardens. The inner mould is now made, and about five minutes must be allowed for it to become hard; when it is firm to the touch, take some water, in which a little clay has been mixed, and spread lightly over with a brush. More—but this time coarse—plaster must now be mixed in the same manner; but in this and subsequent operations, no colour need be used; apply it as before, till an outer mould, of three-fourths of an inch thick, has been formed over the inner one; in this, to give greater strength, it is usual to imbed pieces of stout iron-wire. Half an hour should be allowed to elapse, during which the mould will become thoroughly hardened; and the model and mould must then be loosened from the wooden frame; which may be done by pouring water round the edges, and pulling gently, so as to allow it to penetrate between. The clay must then be cut in pieces and picked from the mould, which should afterwards be washed perfectly clean with soap and water; a soft sponge and brush may be employed. The mould is now ready to be filled. Fine plaster must be mixed and poured in, and the mould shaken from side to side, in such a manner as will spread it equally over all parts. Repeat this till the coat of plaster is one-third of an inch thick; then substitute coarse for fine plaster, and go on till the thickness is about an inch. It will be well, while the plaster is soft, to insert two loops of stout copper-wire into the top of the bracket, by which it may afterwards be hung up. No clay-water must be used between the fine and coarse plaster in filling the mould. When the cast is thoroughly hardened, remove the mould by chipping it off with a mallet and blunt chisel. The outer shell of coarse plaster must be first removed;

this may be broken off in large pieces by a few strokes, as the film of clay between it and the inner mould will prevent its adhering closely; but removing the inner portion will demand more time and care; this must be chipped in small pieces, or there will be danger of breaking off portions of the model at the same time. The value of using colour in the inner mould will now be seen, since it will enable the brilliantly white model beneath to be clearly distinguished when reached, and thus prevent any danger of its being clipped by mistake. The mould will be found to leave the model with sufficient freedom, for liquid plaster does not adhere to solid plaster which has previously been thoroughly saturated with water, though it does closely to such as has been slightly wetted: a mould must therefore be always well soaked, if any length of time passes between washing and filling it. In the process of chipping off the mould, no slight pleasure can be promised to the amateur while he sees his work, in a new material—solid, hard, and dazzlingly white—gradually emerging. When the mould is cleared away, some defects will probably appear. If any portions of the model are broken off, they may be stuck on again with a little liquid plaster. If there are holes from air-bubbles or slips of the chisel, they may be filled with plaster which has been allowed partially to set, and has then been mixed with more water. Projections may be scraped down, and rough surfaces smoothed with sand-paper. A useful steel tool for plaster-work may be bought at tool-maker's and hardware shops for ninepence, one end of which is a spatula for mending, and the other serrated for scraping. It is possible, when a model has been but roughly worked in the clay, to give much finish to it in the plaster; sometimes this course is desirable, but it should, as a rule, be avoided. Good modellers usually give all the finish they intend in the clay, and beyond repairing accidents, leave the plaster untouched, since equal softness and delicacy are not to be attained in the latter material.

In our directions for making a vase we recommended that a block of plaster should be cast, from which a "core" might be turned. This may be done by taking a suitable lump of clay, making in it a cylindrical hole of the required diameter and depth, and filling it with plaster. When the ornamental parts are finished, and the vase fit for casting, the plaster core must be thoroughly saturated with water and a little soap brushed on the bare parts. Thin strips of clay must then be cut and placed round it, as in Fig. 2, page 345, vol. i., dividing the surface into two equal parts. The strips of clay must be fitted closely to the model, and well supported from the side to be moulded last, or they may give way when the plaster is applied. A mould must then be formed on one half, in the same manner as upon the bracket. When hard, remove the strips of clay. Wash a little clay-water over the edges thus exposed, and mould the other half. The mould will thus be in two equal pieces, which can be separated as soon as hard by a stroke of the chisel at the joint. The plaster core can be removed whole, and will again serve for use. The clay forming the ornamental parts (which will generally leave the core and remain in the mould) must be picked out, and the mould washed. If there are handles, to strengthen them copper-wire must be placed along the hollows which indicate their positions in the mould. The two halves must then be tightly bound together, and filled by pouring in plaster through the bottom of the mould, which will be open. Cast thus, there will be no opening at top, and the vase will serve for appearance only. If, however, it is destined to hold wax, leather, or other artificial flowers, no difficulty will be found in closing the bottom of the mould with plaster and making an aperture—through which to fill—at the top instead. Plaster, being highly porous, will not hold water; and if

the vase be intended for real flowers, recourse must be had to the following expedient:—Get a glass phial, of suitable size, and, when the mould is well covered with plaster, insert it, cementing it firmly in its place by pouring plaster round. Thus treated, our amateur vase will be fit for any of the ordinary duties of its kind.

ORNAMENTAL SOAP.

WE believe that most people are aware that scented soap is bad for the skin, as well as more expensive than plain. There is no better soap, even for children's delicate skins, than the "primrose;" a quarter of a pound of this, which costs 2½d., or a quarter of a pound of the best yellow soap, cuts into three nice squares for use; the price of it is 5d. a pound. Curd soap, which costs 8d. a pound, looks much nicer than the yellow. Cut it into very even squares of three-quarters of an inch thick. One of these, with care, will last a person who takes a daily bath, about three weeks. To make the soap nicer to use, round off the corners, A B C D, in Fig. 1; then just shave away the angles along the sides, from A to B, from B to C, and so on all round; trim the other side the same way. You may finish off by lightly scraping off all marks of the cuts. For a more ornamental piece, cut off the corners deeper, as shown in Fig. 2. Then slant off the side E, from F to G, and with a second cut from H to I, to make it look like Fig. 3, in a facet. Scrape gently away the sharp edges of the cuts. You can then set a motto on it, by pricking it with a pin, as Fig. 4, or scratching letters on it, as Fig. 5. Take a fine-pointed camel's-hair brush, and charge it well with vermilion, very slightly moist. Colour every one of the dots of the A in Fig. 4, the M, the X, the Y and U. The small dots in the corners are green, the large, red. Colour all the other letters in green. For Fig. 5, draw a camel's-hair brush full of vermilion or carmine through the scratched letters of the words "welcome," and "dear friend." Use cobalt blue for the letters that form the word "here." But a still better way of ornamenting the soap is to draw the letters on it with a brush charged with the colour thickly, and not wet, using the point, without any previous scratching or pricking. Just lightly sketch the outline of the letters with the brush, to get them regular; then follow the design you may have decided upon with cobalt blue, and raise it in relief by adding the dark lines at the back of the letter with indigo. The words may be painted in carmine or vermilion, and relieved with ivory black; or painted in emerald green, relieved by Hooker's green, No. 2, a deep, rather blue, leaf-green; the second colour must not be added till the first is dry. Any device—birds, flowers, garlands, landscapes, tessellated designs—may be painted on soap in the same way. Curd soap offers a pure white ground to manipulate on. Where some graceful little gift is wanted, nothing could please better than one of these unexpectedly

laid on the toilette. Suppose a friend or relative comes on a visit—"Welcome here, dear Aunt," "Welcome home, Papa," "Welcome, Annie;" or on a birthday or wedding anniversary, "Many happy returns of the day." On a guest leaving, pack in their box or portmanteau secretly, a cake bearing, "*Au revoir*" (to meet again). There need be no waste in thus cutting soap; all the fragments should be gathered into a safe receptacle, and used up in the wash-tub, to make a lather. Some people prefer soap cut in inch and a half thick slices, and these cut across in the middle; the edges should be rounded as already described. For common use, a quantity of soap should be cut and stored away; it is wasteful to use it newly bought. After the cakes have been cut some time, they darken, do not waste in the water, and are pleasanter to use. Soap to be painted should be fresh cut, because it gets dark and dingy in time, from being kept.

PATCHWORK.—III.

THERE is another way of making patchwork, and pieces for the purpose may be procured from upholsterers or linendrapers. Our illustration is a good example of this. Amongst the pieces we will suppose one containing a handsome group of flowers, roses and geraniums, on a pale green ground. There is just a single bouquet, about eighteen inches square. This will do for the centre. There is also a long strip, exhibiting a closely clustered garland of roses on a green ground. This may have come off a striped chintz, and the stripes may have been of such garlands of roses. There is just enough to go round the centre group. The slopes at the corner are cut, and the pieces being reversed, the slope out of one corner makes the projection of the other. But for this our chintz would be insufficient. Next we have a large piece of sprigged chintz. We can put this so that the sprigs go in stripes. We make a second border of this, and have a little over. We have another pretty piece of roses on a green ground. It will cut into four exact squares, so we cut it into four exact squares. We have some striped chintz and some dotted chintz, and we cut these into oblongs. One light dotted between two striped ones fits

each side of the counterpane, and the squares of roses fit the corners; for our oblongs have been cut the width of the corner pieces, only longer.

We next cut a number of large diamonds alternately of a coloured chintz with a single rose in the centre, and a coloured chintz with a small pattern in it. These we filled each side with half-squares of chintz, with small leaves on it. The corners had dove-tail pieces fitted in. Round this a border of striped chintz was put, and the counterpane was finished. It was lined with breadths of cheap calico (2½-ell wide) joined. The edge was hemmed. Lace was put all round it, and a washing gimp to head the lace. Every join of the patchwork was then run, so as to join it to the lining. This quilt really looked handsome till it needed washing, when if sent to be cleaned and calendered it would again look equal to new. It was light, and



Fig. 5.



Fig. 3.

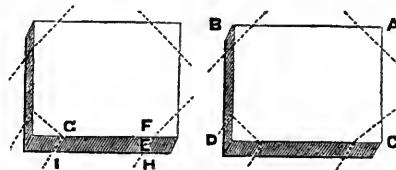

Fig. 2.

Fig. 1.

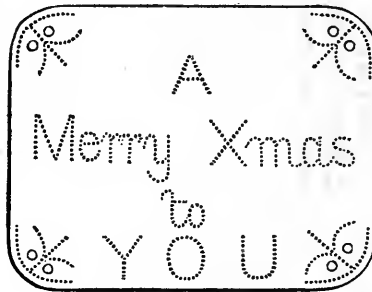
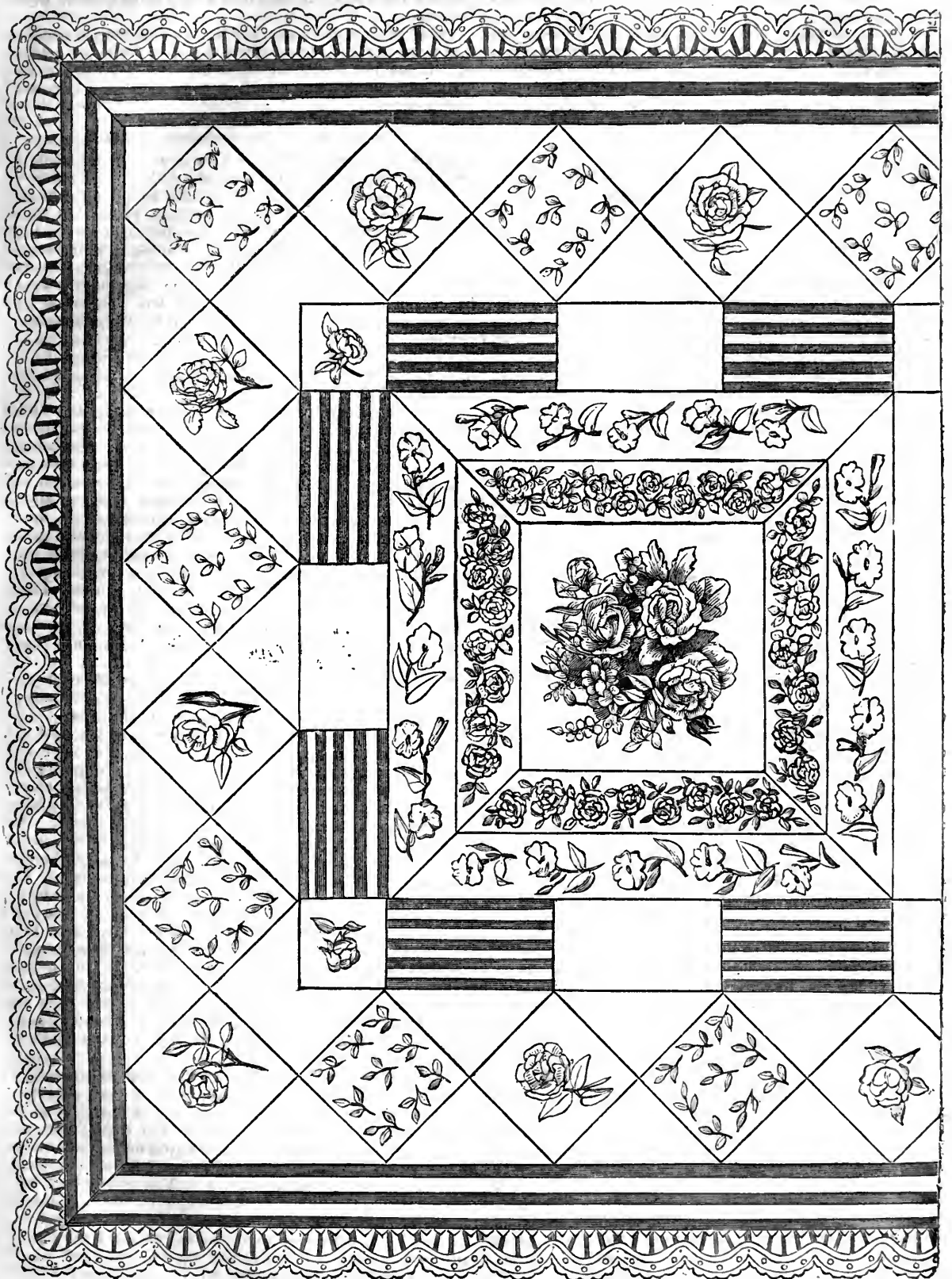

Fig. 4.



for that reason preferred by many. Such a quilt may be used unlined.

Cushions in patchwork are all made by tacking the patchwork over one side of the cushion, and a lining of silk or velvet, with the edge turned in, on the other. Then the edges are neatly sewn together, and a cord put all round. Chair and ottoman covers are made with or without the cord, according to circumstances.

ANIMALS KEPT FOR PLEASURE AND PROFIT.—THE HORSE.

BREEDING AND BREAKING (*concluded*).

Expenses.—As we shall have occasion to enter into this question in another place, we can only say here that it is almost impossible to breed an ordinary hack or harness horse so as to make it pay. The great variation in the price of hay and oats, the value of the land on which you breed, the short loss of the services of the mare, the fees, and the circumstances of each individual breeder, are so different, that we have found it impossible to give here even an approximation to the expenses.

Every one of our readers must, however, in this case calculate for himself the cost, which he can do far more easily than we can; the rent of the land, the buildings, the wages of labour, the quantity and quality of food, the physic, and the breaking, must be set down fairly. We believe that it is far cheaper to buy. In round numbers, we do not think any sort of decent hack and harness horse, at four years old, which is as early as he can come into moderate work, can be reared, at the lowest rate, for less than sixty pounds; and, were it not for the long prices that are frequently obtained for worthless animals, and the uncertainty attending the business of breeding as a trade, there would be no middling horses to be met with. We have ourselves had personal experience of this matter, and can, therefore, with perfect safety affirm that out of four, bred from one of the best hackney mares by a thoroughbred horse, two did not reach half their cost of breeding.

Rarey's Method is ineffectual for giving a mouth, and is therefore impracticable. His principle, simply stated, is as follows: Horses are not vicious, but timid; when once certain that they will not be injured they become obedient. This obedience, however, proceeds from submission to acknowledged superiority; and therefore it is necessary that man should assert it. Hence Rarey's method of breaking colts or of taming vicious horses. He first partially disables them by tying up one foreleg; and, having lifted up the other by means of a strap which he holds in his hand, he contends with the horse till exhaustion takes place, which it does in fifteen or twenty minutes at the outside. As the horse is then lying on his side, panting and secured, nothing remains but to put on saddle or harness, to sit upon him, stand upon him, lie down by his side, open umbrellas, fire pistols, and perform any number of tricks upon him whatever. Seeing that none of these performances injure him, he will not, on rising, object to them, nor, in all probability, dispute again man's superiority.

This, we have excellent reasons for believing, was Rarey's secret, this his principle; and we confess, as far as our experience of it went, it was a correct one. The horse could be saddled, sat upon, and harnessed *in one day*, but he could neither be ridden nor driven, for he had no mouth.

Our own experience was the same with a most mischievous mule, at three years old reputedly untamable. In twenty minutes, by this system, we brought him from a loose box following us like a dog. A lady volunteered to ride him at once, to which he patiently submitted; but he could not be guided, as he had no mouth. But he

carried his burden quietly like a dog as long as we went before.

In another section we shall treat of the harness-room, and point out more particularly the special characteristics of various bits, including that used by Mr. Rarey for colts, and two more of simple construction from our own saddle-room.

HACKS, AND SOME HARNESS HORSES.

Hack and Harness Horse.—This is, as its name implies, the most generally useful horse that we have. He answers two purposes, and should be equally adapted for both. This subserviency to a double purpose makes him less easy to meet with, though a sort of prejudice or absence of fashion makes him cheaper to buy. The fact is, that certain qualities are abandoned in both characters, and the needy man takes the best he can get, without haggling for what he cannot expect—perfection in the two. The class of horse we have undertaken to describe here has no name beyond that which we have given to him, unless we choose to call him the Roadster. The persons with whom he is most in use are the upper class of tradesmen, who combine pleasure with profit; professional men living a short distance from London, and driving to their station and back daily; farmers who ride or drive to market; salesmen of various descriptions; and clergymen who feel compelled to keep something to take themselves and their families about the country, and are loth to spend money on more valuable horses. The hack and harness horse answers the purpose of all such as keep a dog-cart or four-wheeler, be it of what description it may, and with whom economy is a great consideration. Before, therefore, appealing to any whose specific employment requires a horse of particular class, as the agriculturist, the soldier, or the man of pleasure, we give the preference to those whose apparent want is the least limited by a speciality, as we shall thereby be most likely to meet the more common requirements of our readers.

Price.—We have said that this is essentially a cheap horse, as pertaining to the majority. The price of every kind of horse has risen immensely in the last thirty years; and although the ordinary horse of which we now speak could then be bought anywhere for £20 or £25, that is not the case now—he will cost at least one-third more. After having told you, therefore, what qualities you most require in him, you will be able to abstract those which are less needful.

Qualities.—You must not look for beauty, that is quite beyond your figure; but let your first essential be soundness of legs and feet, and constitution: as he is to be used upon our roads, and to be ridden sometimes long distances, sometimes short ones, to stand in all sorts of stables, and wait in all sorts of weathers for the profit of his master: these things are essentials. We are to presume, too, that the grooming, in some cases, will be less elaborate and the exercise less regular than in higher establishments. It is a great point to have a horse whose legs will stand in the stable without swelling for a day or two, as well as one who does not lame himself with his work. The action of such a horse should not be very high and "gaudy"—leave that for Rotten Row and the muddy lanes of the provinces. Let it be long; he will get over the ground more quickly, and with less jar to his feet. Excepting in the case of a doctor's horse, which is exceptional, you should eschew riding or driving at a great pace. Eight miles an hour is quite enough for a horse that can do ten: he will go more pleasantly, and last all the longer. You can always be called ten minutes earlier in the morning; and ten minutes makes a great deal of difference in a five-mile drive. Nothing hurts a horse so much as overpacing him. You must be careful to have nothing wrong with his wind; and take care that he is safe, which will be ascertained by the way he puts his foot down, rather than by the height he lifts

it up. He should put it down quite flat, the heel almost appearing to touch the ground first. You must look also to his shoulders; and though you cannot expect much for your money, they need not be upright, if you intend him ever for the saddle. You will best ascertain this by a trial. The shoulder should be oblique, and clothed in such a manner with muscle as to prevent the saddle from slipping forward. Reject any horse that requires to be ridden with a crupper. If you cannot expect those handsome round quarters and well set-on tail which you so much envy in the horses of ladies and gentlemen of fashion, you can have them of a plainer but equally serviceable build. The hips may be a trifle ragged, and the tail set on low, and if you have length and power in the thighs, your horse will have far better points, though somewhat more angular ones, than those of your neighbours. In fact, it will be your business to look for separate and detached excellencies, rather than for a more elegant development of form.

Vices.—Besides this, what we call the moral qualities of the horse will have something to do with his value. Avoid active vices, such as bad temper, kicking, and rearing, as these are expensive faults. He may break your servant's collar-bone or your own, and in harness destroy your only vehicle. As to a little roughness of going or hardness of mouth, when obedient and good-tempered in the main, you must not be too particular. All such imperfections may be much modified by management—*i.e.*, by biting and handling on your part, and, above all, by patience. There is an old saying, to a great extent true, that "it requires two to make a puller." Undoubtedly the rider or driver is as often in fault as the horse. Some horses are apt to shy a little, and will not suit timid riders (we do not recommend them in harness, as they are apt to shy in narrow places or in crowded thoroughfares). Now, in five cases out of six, the practice of this fault may be evaded by attention. When the inclination exhibits itself, or when any obstacle occurs likely to provoke it, either *take no notice at all*, or play with the bit, *turning the horse's head away*—in other words, *distract his attention*. Many poor men ride good-looking and good horses by such means as these at a low price, but it requires some apprenticeship to the business to do so.

You must not be led away by the notion of inexperienced or "faddy" persons, that harness is incompatible with the saddle. It does no injury whatever to a saddle-horse to drive him; the only thing to guard against is the giving him too heavy a weight behind him, as he is apt to throw himself too much on to his shoulders. We had almost said that light work in a two-wheeled carriage improves a hack or a hunter—it certainly does them no harm. "Experto credite." We have tried it with very high-class horses, and without any deterioration of style or safety.

Age.—There is an old saying, "Do not look a gift horse in the mouth," highly applicable to our present chapter. If you go to market for a cheap horse, you must not be very particular about his age. We can give you some very correct "wrinkles" on this point. One of the great recommendations in a dealer's yard is "age." "See, sir," says the dealer, "he is just five off," as he puts his fingers into his mouth, and exhibits his teeth to a gentleman to whom, it is a hundred to one, he might as well have exhibited his tail. Now it would be far better to buy a horse of nine, if you could be tolerably certain that he was no more, and his legs were still hard and good. In the first case, it must be a toss-up whether he will stand work or not; in the second, it is an ascertained fact that he has done so. If you can be sure of your young horse, you will have so many more years of his services; but you will have to pay so much the more for him. When the tooth-mark is really gone, which is the case at eight years old, excepting to very good judges the horse is no longer a dealer's horse; he is said to be of any age, and may be bought

well worth the money. We sold a mare fourteen years old, six years ago, because we thought she must soon decline, though there were then no symptoms of it; we sold her to carry a lady of light weight to hounds. She is now twenty, and is just as good as at fourteen; we should like to buy her back, but we know her positive age, and she is not for sale. The most notable marks of *too great age* are length of tooth, change of colour and interspersion of grey hairs in the coat, deep indentations over the eyes, a hanging of the nether lip, a sinking away of the muscles behind the shoulders, and leanness of head, which gets handsomer towards middle age. If the horse has been hardly used, we may add, roundness of legs, fulness of fetlock joints, and marks of work on his limbs. He may be perfectly sound for all that, but you had better not buy him.

Size.—The height of the horse we have been describing should not be less than 14 hands 3 inches, nor more than 15 hands 2 inches; this will answer all your purposes—the minimum for saddle, the maximum for harness. The reason why the bigger horse is better for harness is that weight is a requisite, while for riding, activity is the great desideratum. In either case he should be compact, and his appearance should betoken endurance. With one horse you cannot afford to keep him to look at; and he should be able to do your work every day in the week excepting on Sunday. The day's rest will be found highly advantageous to him, so that the Sabbath will be not only a religious, but a politic, cessation from labour.

Paces.—You do not want a galloper, and the walk and trot are by far more important than even a canter. Those are the paces which will last the longest. Writers who follow a lead without a reason, have told us that the trot is a taught or acquired pace. This is a mistake. A wild horse in the desert, frightened, and anxious to avoid intrusion, starts away in a gallop; the same horse excited by something unusual, and approaching to investigate it, comes up in a trot. Have these persons never seen a foal trotting by the side of the dam? If you get a horse of this class, which can walk four miles an hour and trot nine easily, you should be well satisfied. Books talk of considerably more, but books are as fallacious as other statistics.

Sex.—This is a question with some persons, therefore we think it right to give an opinion on it. In some cases we should prefer a mare, in this we do not. Geldings are much better for harness, or rather are safer. In other respects the mare is better—she is capable of more work, and is usually cheaper. Farmers give them the preference for another reason—that they can give them rest and breed from them in case of accident. This latter suggestion is useful only to men living out of town, and having accommodation for such emergencies. However, mares have gone in harness to the end of their lives without showing the slightest irritability or nervousness; there are hundreds of such instances. But there are many others which have gone quietly for many years, and in their old age have turned kickers or runaways. Our own stable alone furnishes us with no less than three examples. Highly-bred mares are apt to be irritable during certain seasons; but every man knows how many risks he is prepared to run. It must not be forgotten, that in the event of proving unsuitable, a mare is less saleable than a horse. No man objects to a gelding if he be a good one; but we have frequently heard men say, "I would not have a mare at any price."

Market.—The most available market for the purchase of this useful class of horse is by private information among your friends. You must be prepared to "pick one up" as you can, that for some reason (which you will not know) does not suit his present owner. You cannot go with thirty or even forty pounds in your hand and ask for the animal you want. A respectable dealer, who has an object in serving you, will frequently pick one up for you, and

sometimes manages to produce one from the recesses of his yard, but he does not profess to deal in anything so low. With provincial dealers you will have an excellent chance of finding what you want, for they take them in exchange from the farmers, who buy of them, and with whom there is always a deal on hand. We advocate another mode, which has more risk—Tattersall's, or Aldridge's, or a respectable auction mart; for as it is certainly the worst place in England to sell a horse of inferior class, so it must be the best to buy one. You get no trial, and can only judge by your eye, nor can you tell yourself perhaps much about his imperfections; but you can take a veterinary surgeon with you the day before the sale, and use your own or a friend's judgment as to shape and make.

We know of many good horses bought in those yards for very little money. A man must sell what he does not want, and his usual mode of doing so is by auction. Of all things in the world avoid an advertisement, unless under very exceptional circumstances. We shall give a few words of advice, further on, on the "coping" system, as the methods of low dealing are called. It would be a little out of place to do so just here, as we have other horses to describe, and we could scarcely do full justice to the subject. What we do say now is, have nothing to do with anything belonging to "officers going abroad, clergymen's widows who have been in better circumstances, or men giving up riding on account of health." Suspect any horse that looks twice its price, and is in the care of a family coachman in mourning, who talks about his poor dear missus, "who was so uncommon fond of the horse to be sure, it nigh broke her heart to part with him." But, above all, beware of that tender-hearted lady who does not want the value of the horse, but would not mind allowing him to go "into a good home, and into hands that would value an old favourite, at a merely nominal price;" and never deposit money with a man in a mews while you ride his horse out for an hour's trial.

The poor man can dispense with beauty, high action, youth, quality, pace, and manners; his horse must have no vices, though he may have some shortcomings, and no unsoundness, though he may have some blemishes. Good and handsome horses are sold for inadequate prices when they have been down and the fall has left a scar. The proverb says that "a horse who has been down once will be sure to fall again," as though he had been much pleased with the transaction. We care nothing about proverbs. He will tumble down again in the same hands, most likely; but if the horse is a good mover, and otherwise desirable, we recommend the purchaser to risk forty pounds to get the worth of eighty. The same may be said of a horse with only one eye. Accidents of various kinds produce blemishes, which may be easily distinguished from unsoundness; and though we do not recommend splints, curbs, thoroughpin, or roaring, they do not of necessity detract from a horse's value for some work, although they may be, and frequently are, accompanied by unequivocal signs of disease. To enumerate every phase of blemish would far exceed our limits, but the purchaser can well understand our meaning by the instances already given. There is one thing with which it is difficult to dispense, if a horse is to do much or continuous work, and that is "breeding." He ought to have it on one side or the other.

DOMESTIC MEDICINE.

BOILS.

THIS is a very common complaint; and though not a very deadly one, is a very troublesome one. The disease is familiar to everybody, and consists of a round, hard, red swelling, which comes to a white point, and comes gradually to contain matter. Boils are very painful. They

seldom occur singly, but come in numbers, one following another, sometimes perhaps for weeks together. Generally they contain something more than soft fluid matter, in the shape of a core, which is the remains of inflammation of the tissue below the skin. The harder they are, the more painful are they.

Causes.—It must be allowed that the exact cause of these boils is not yet ascertained. Some doctors say they arise from weakness, and give large quantities of food and wine and beer. But it often seems as if the patients who have boils were no weaker than other people, except in so far as boils have made them weaker by pain and loss of sleep. It is very doubtful, in the first place, whether mere weakness is the cause of boils, and, in the second, whether taking lots of wine and beer in diet is the way to get rid of them. Occasionally they occur in connection with general disorders of the system which can only be recognised by a medical man.

Treatment.—A common mistake is to poultice boils too much. The warmth of the poultice generally causes a few more spots, which may each become a boil. When the first appearances of a boil present themselves, it is well to dab or touch the part with a little pale brandy. This often causes the boil to disperse or keeps it smaller than it otherwise would be. If they are very hot, hard, and painful, a poultice should be applied for a day or two. They should be often bathed with warm water. A good application after the poultice is a little turpentine-ointment mixed with lard—say one part to eight parts. This should be spread on lint the size of the boil, and all covered over with a large piece of cotton wadding, or, better still, with medicated wool. This is a light, comfortable, dry dressing. The diet should be good; but it is very doubtful whether much beer or wine is an advantage, and, as a rule, much sugar and sweet wines should be avoided. Worry should also be avoided. Air, exercise, and change are good. Various remedies have been recommended; but it is doubtful whether they do much good. One of the best is arsenic, and that can only be given by a medical man.

CARBUNCLE.

Carbuncle is a very common complaint, and a very painful and disagreeable one. Occasionally it is a fatal one, but it is right to say that it is not so fatal as people think it, and that in point of fact, though now and again people die of a carbuncle, the rule is that they don't die. There are some complaints that get a bad name. For that matter they deserve a bad name, but not such a bad one as they get, and carbuncle is a disease in point. Let us try to explain

What a Carbuncle is.—It is something larger, flatter, and harder than a boil. The skin is red, swollen, and hard. At the same time, it is more or less painful and tender on pressure. The pain is of an aching or throbbing nature. After a few days the skin, at one or more points, gets thin and breaks without discharging much matter; but through the little holes or perforations there appears a creamy-looking substance, of some toughness and consistence. This is the core. It represents the tissue below the skin, which is that most affected in carbuncle. This becomes inflamed, and the inflammation of it is somewhat slow—it extends over several days. It destroys the life of the bit of tissue affected, so that it has to come out. This is what is meant when we speak of the core coming out. Now the severity and importance of any case of carbuncle turns, for the most part, on two points: first, on the extent of the skin that is inflamed; and secondly, on the constitutional state of the patient. Of the latter it takes a medical man to judge; for there are occasionally in persons with off-recurring carbuncles, errors of the urine, and other errors of health which require a skilled hand to detect them. Still there is one point of which the patient and his friends may judge—that is, whether the carbuncle is large or

small. And a sensible opinion may be formed as to the patient's general health, by observing his appetite, his strength, his sleep, and all the points that go to make up health. Coincidentally with carbuncles—which occur chiefly on the back, back of the neck, thighs, or arms—there is generally a considerable amount of weakness. The aching pain prevents sleep, and the patient becomes temporarily good for very little. The appetite may be so poor as to make solid food distasteful to the patient, or impossible to be eaten.

Causes.—Some books have a very simple explanation of carbuncle, and of all other things. They say that the cause of carbuncle is *weakness*. But every one can see that there are lots of weak people who have not carbuncle, and many people who have carbuncle are not particularly weak. The fact is, mere weakness is not the cause of carbuncle. Mr. Syme well remarks, "It is said that carbuncle depends upon a weak, impoverished state of the system, while it is notoriously met with more frequently in the opposite one of redundant nourishment. The truth is, it arises from neither, but from a deranged state of health common to both, which may result from anxiety and distress of mind, want of sufficient exercise, or, in short, any circumstance disturbing the mode of life." There is generally some impure condition of the blood, or some lowered condition of nervous energy, or some subtle error of health which a doctor alone can detect and rectify.

Treatment.—Unless a carbuncle is very small, or happens to a patient on the sea, or in some remote part, he will do well to take medical advice at once. This is especially necessary in elderly patients, or those whose health is evidently impaired. We can only indicate a few points of treatment for those unfortunately beyond the reach of medical advice. The first instinct is to poultice a carbuncle, and this unquestionably soothes it, and may be done for a short time with a bread poultice; but only for a short time—that is, a day or two. Too much poulticing soddens a part and relaxes it. It has this further objection, that the moisture of it is apt to beget little spots about the margin, and these may become little carbuncles. After this period a dressing of the following kind may be applied with advantage :—

Turpentine ointment of the Pharmaco- pœcia	¼ part.
Spermaceti ointment	¾ part.
Mix.					

Take a piece of lint the size of the carbuncle or a little larger, spread the above ointment upon it, and apply this over the inflamed skin. Then get a large piece of cotton wool, large enough to extend far beyond the lint on all sides, and cover it over all. This dressing generally suits carbuncles well. It is pleasant to the patient, except perhaps at first, when it may smart a little.

Until very lately, it has been considered necessary to make a cross incision into carbuncles, and sometimes when they are very tense and painful, or when they contain a good deal of fluid pus, it is right to cut them; but ordinarily this is not necessary. They do quite well with the above dressing, and with a proper diet.

This brings us to an important question—the diet of patients having carbuncle. The fashion has been too much stuffing of such patients. Now, the fashion is much more rational—that is, to feed them pretty well without stimulating them too much. If the patient's appetite is not much affected, the nearer he keeps to his ordinary diet the better. If it is much affected, then he may live on beef tea and milk until the appetite for more solid food returns.

As regards stimulants, in the first stage of the carbuncle they are not generally good; in the later ones they may be so, but not in large quantities. As a rule the

sweeter wines are to be avoided. If the patient is able, and the carbuncle does not prevent, there is no reason why he should not take a little air and exercise. Only it will be found that he is shakier than usual, and unable to take his ordinary walks.

As to Medicine.—The bowels should be properly open, but there is no good in purging, and the following medicine may be taken :—

Quinine	12 to 18 grains.
Tincture of perchloride of iron	1 drachm.
Simple syrup	1 ounce.
Water to make up	6 ounces.			

Mix. One table-spoonful to be taken three times a day in water.

The carbuncle is only an expression of something wrong in the blood or the system, and every wise person will go to the best doctor within his reach to find out what that something is.

At any rate he will do this if the complaint recurs frequently. If more than one carbuncle happens, or if different parts of the body are affected, it is a proof that the cause is not local, but general, and requires skilled consideration.

ODDS AND ENDS.

Fancy-work with Leaves.—Vases and dinner ornaments may be very prettily filled with leaves properly preserved. Brackets may be made to resemble carving, and also picture-frames. The bright tints of autumnal leaves are excellent for the purpose. Gather a good assortment, which may comprise every tint from crimson to scarlet, from scarlet to yellow, and from yellow to green. The red beech and the sumach are very useful, so are the oak and ferns. Smooth every leaf on the wrong side with a hot iron, holding it down a minute or two. Any leaves that are not flat must be soaked in water first. Then oil them over on the right side. Next, take a number of fine wire stems, and fix every leaf to a stem. Lay the leaf over the wire, which should extend the entire length of the leaf, to support it. The leaf is attached by its stalk to the artificial stem. Use the fine green-covered reel wire, necessary in wax-flower making, for this. Afterwards cover the stems with green tissue paper or brown Berlin wool, and join them together in sprays. The individual leaves on each spray must be of the same kind and colour. Afterwards mix and arrange the sprays according to taste. Oak-leaves and acorns, gummed on a cardboard frame, make good brackets, boxes, and picture-frames. Acorns and other berries used in this way ought first to be cut in half.

Screens of Feathers.—Cut two rounds of cardboard by the help of a bow pencil, or by a cheese or pudding plate. Cover one with feathers; commence by sewing the feathers round the edge, letting them project like a fringe, and taking the stitches through or over the stall's; continue by making a second row within the last, and so on till the whole card is finished. A rosette of ribbon or a large button may be placed in the middle. Cover the other circle of card with silk, and paste the two together. A handle must be added afterwards. A banner-screen, to hang from the mantelpiece or bracket hangings, can be made by sewing feathers on calico in patterns, and lining it. A pretty screen can be made by covering a small round with silk, embroidering it, and edging a larger circle with peacocks' feathers, putting the small one in the centre.

Diet.—There is scarcely a malady which can be named which either does not originate from the neglect of diet, or is not increased by it, until the disease at length bids defiance even to temperance itself and to all prescription.—*Dr. Fothergill.*

HOME GARDENING.

BROCCOLI (*continued*).

The Tall Large-headed Purple.—This sort grows three feet high, and produces large purple heads.

Culture.—This sort should be sown towards the end of March, and it will be found useful in the March and April following. These plants should be put in three feet asunder in every direction.

The Cream Coloured.—This variety exceeds all others in size; it is of a cream colour, and has a very firm and compact head; it has large broad leaves with white veins, they spread widely, but the small centre leaves cover the flower.

Culture.—The seeds of this sort should be sown about the middle of April, and the plants will come to perfection in the February and March following. It grows low; but, nevertheless, the plants should be put out at from two and a half to three feet asunder in every direction.

The Sulphur Coloured is a valuable sort and very hardy. It produces a fine, compact, conical, sulphur-coloured head, sometimes slightly tinged with purple. The leaves are much indented, and of a bluish-grey colour, and they have long footstalks.

Culture.—The seed of this kind should be sown in April, and it will be in perfection that time twelve months. Two feet apart in every direction will be a sufficient distance for them to grow well.

The Spring White or Cauliflower Variety.—This sort grows strong and robust, has large, flat, narrow leaves, with thick veins. The leaves encompass the head so closely as nearly to render it invisible when fit to cut, which is a trait greatly in its favour, especially in frosty weather, which is not at all uncommon in spring.

Culture.—The seeds of this variety should be sown in March or thereabouts, and if finally planted out on good ground they will produce fine large white heads the following year, during the months of March and April.

The Late Dwarf Close-headed Purple.—This is the latest purple broccoli. The plants seldom rise above a foot in height. The flower at first shows small and green, but soon changes and enlarges, and forms a close, conical, purple head. The leaves are short, small, and of a dark green colour, with white veins deeply indented, and forming a regular radius round the flower, which gives the whole plant a beautiful appearance.

Culture.—The seed of this variety should be sown in April, and they will be ready for use in April and May in the following year. The plants, as soon as large enough, should be put out from one foot and a half to two feet apart in every direction.

The Latest Green or Siberian.—This is the latest and most hardy of all the broccolis, as the severest winter will not destroy it. The leaves are narrow, long, and indented, with a tinge of purple colour in the stems.

Culture.—Seed of this variety should be sown about the second or last week in April, and they will be ready for the table about May in the following year. These plants should be put out about two feet apart in every direction. We will sun up with a few remarks on the propagation and general culture of all the varieties mentioned. The seed-bed should be rich mould, well dug, and the seed sown immediately after, as unless it be got into the ground before the soil becomes dry, the result becomes a mere lottery. The seed should be sown thin, and the bed or beds covered with mats, in order to keep them regularly moist until the plants have arrived at a size to need no further care of this description. When such is the case, the covering may be removed, and the plants watered occasionally, according as the season proves dry or moist. Should the weather be moist at the time the plants are ready for transplanting, they should be turned out into

their final situation at once, rather than into beds to be again removed, as we have invariably found such a course causes them to produce premature heads, which, of necessity, are inferior both in size and quality. Any one acquainted with this vegetable must be aware that it is subject to a disease called the club, which is caused by an insect intruding itself into the root. This insect is frequently found in old, or, we should rather say, imperfectly tilled land, or which would perhaps be better understood if termed neglected land; and the best method of clearing the ground of this pest is to trench it two spades deep, turning the top or old surface to the bottom, and the bottom spit, or spadeful, to the top, so that the ground will gain, as it were, a new surface, and, in all probability, the grub will be buried for ever with the old one.

CHOOSING A TRADE.

METAL WORKING.

CLOSELY connected with watchmaking, to which we devoted our last paper, is the business of the brass-founder and metal-worker.

Brass, which is not itself a metal, but is formed of a mixture or alloy of about two parts of copper and one of zinc, is the common material for the parts of clocks, watches, and small machinery, as well as for a vast number of articles of daily use. It is remarkably durable, admits of a fine polish, and will not rust on exposure to air.

A very fine quality of brass for the best kind of castings is made from three parts of best copper, a little scrap of brass, a little tin, and two parts of spelter. The brass as delivered to the founder is cast into plates, which are either broken up for re-casting, or rolled into sheets. It has been mentioned that nearly all the various portions of the works of clocks and watches are now made by machinery, and the mechanical processes of this manufacture are brought to such perfection, that all the parts fit with comparative accuracy when they are put together, each of them being numbered according to size. It is impossible, in such a delicate piece of mechanism as a watch, to ensure correctness, however, until they are finished and adapted to each other by hand; and when machinery has done its best, the forge, the hammer, and the fine file are requisite in the operation of perfectly fitting the works.

In these and in similar manufactures, the various pieces are made by means of dies, which cut or stamp the metal into the required shape. Lathes for turning, drills, and other mechanical appliances, set in motion, either by the foot acting on a treadle and wheel, or by steam power moving a fly-wheel and balance, are also requisite.

The business of the brass-founder is sometimes required for casting the first rough shapes of the larger work, and that of the smith for forming the different parts on the anvil by the skilful use of the hammer.

Indeed, the smithy, with its forge and hammers, is an essential part of the brass-founder's establishment; and though no description can well be given of the art of smiths' work, which entirely depends on manual skill and dexterity, it is a necessary part of the trade.

The first operation is, of course, the making of the brass itself in the smelting or mixing houses—large workshops fitted with furnaces, where the metal is melted in crucibles made either of Stourbridge clay, or of *plumbago*, which is, in fact, pure blacklead, and, though more expensive, is better and more durable than earthen pots.

When the brass is made, it is run off into hollows formed in fine sand, and when cool comes out in the shape of short thick bars, which are called ingots. These ingots are the raw material of the brass-founder, and when he has to make a casting, they are carried to the furnaces, where a number of pots or crucibles of greyish clay, in shape some-

thing like tall flower-pots, are ready to receive them. The ingots are first placed across the tops of these pots, in order that they may expand with the heat, and in about twenty minutes sink down melted under the fierce glow of the fire, which turns the grey clay to a red colour.

When the brass is reduced to a liquid mass, a kind of flaming vapour hovers over the crucibles—a vapour of a sea-green colour, streaked with other brilliant hues—and by that time the workman is ready to begin the casting by transferring the melted alloy to the mould.

The mould is composed of two iron frames, like broad and deep slate frames, called *flasks* or casting-boxes. One of these is placed on a flat board rather larger than itself, and is then rammed full of a peculiar kind of red sand, which is sometimes allowed to retain a little moisture, though this is dangerous, since, when the molten brass is poured in, it is likely to explode if too damp.

The sand having been pressed in a firm mass, the surface is made level with a scraper or blade of metal; a little loose sand is sprinkled over it, and another board being put on the top, the frame is turned over. The surface which was the under, and is now the upper side, is dusted over with bean-flour or brickdust and fine sand, to fill any interstice, and prevent raggedness in the casting. The pattern, which is made either in wood or metal, is then laid on the surface of the mould. This pattern represents just *half* the intended casting—that is to say, it is like the casting cut in half *edgewise*, and the upper surface of it is flat, the lower, or pattern surface, being pressed into and imbedded in the sand; and a large channel is made down the centre from a hole in the edge of the frame, to the main hollow made by the pattern, with several smaller channels leading to various parts of the pattern. The large channel is called the “ridge,” the smaller ones “ingates;” and they serve not only to receive the metal, but to allow the air to escape. The surface is then made quite smooth. Of course, the other iron frame or flask has been treated in just the same way, and has received the other half of the pattern; so that when the two frames, each resting on its board, are brought face to face, the whole pattern is formed by the hollow impression in each half of the mould, just as you might press the palm of your hand on a lump of soft clay and the back of your hand on another lump, and then, by bringing the two lumps together quite evenly, have the hollow shape of a hand in the middle. When the sand has become a little firm by standing for a time, the patterns are removed, the two flasks or moulds are brought near the furnace and slightly baked, and are then brought together and firmly fastened by pins in one frame which fix into holes in the other. The complete mould is then placed in a slanting position against a bank of sand or a brick bench, with the opening or hole in the side upwards, and the casting begins. A man stands on the edge of the furnace, which is generally a square flat fire-hole, like a French stove, but with brick covers to the aperture. These covers he takes off, and the green flame immediately rushes up from the pots, one of which he lifts out with a pair of tongs, and holds it while the dross and scum from the surface is removed, after which he passes it to the pourer, who fills the mould, the resistance of the sand to the hot metal causing a series of muffled reports like the bouncing of a chestnut from a red-hot bar. When the castings are small, there may be several in one mould; but large work, of course, requires a mould to itself, or even several moulds for different portions of the casting that are afterwards joined.

Of course, this method refers only to solid castings; but, as we all know, most ornamental metal-work is hollow, and so are many vessels and household implements made of brass or iron. The question, then, is, how are these hollow castings made? Well, the process is rendered simple enough by the use of what are called “cores.”

These cores are, in fact, solid patterns made a little smaller than the real patterns, so that when they are placed in the hollows made by the real pattern, when it is pressed into the mould of sand, they do not quite fill the space.

This process is called “reversing,” and the inner or hollow side is called the reverse. It is accomplished as follows:—A mould is made from one already prepared of wax, and the impression from that mould is hardened so that another model or mould can be taken from that also. Thus there is a difference in size between the two patterns corresponding to the thickness of the wax. One of these patterns is the hollow mould, and the other the core mould, and when they are brought together there is as much space between the surface of the core and the surface of the hollow, as represents the thickness of metal required. When the melted brass is poured in, it flows between them, and the casting comes out a hollow half of the entire pattern. You may easily see that if you covered the outside of a teacup with wax, and then outside that wax modelled another teacup in clay, the first cup would stand inside the last one, with the difference of the thickness of the wax model between the outer surface of one and the inner surface of the other.

The casting now being complete, it is “laid out” on an iron bowl filled with pitch, where it sticks while the little lumps or ragged edges are removed by files and cutters; after which it is taken to the bench of the chaser, who engraves and ornaments it still further with his tools, which are mostly gravers—small, bevel-pointed chisels which will cut the metal. The various parts, as well as some work which is cast in halves, have then to be soldered together by a workman sitting at a furnace, where he heats the work and then solders it by the aid of a blow-pipe composed of a double tube, the inner one supplying gas, and the outer one air blown through it by a pair of bellows, and so mingling with the gas as to make the heat more intense. The action of the fire on the brass, however, forms a kind of scale, which has to be removed by dipping the casting in diluted aquafortis, then in a still stronger solution of the same acid, and lastly in the acid itself. Its colour is then restored to a pale primrose, after which it is generally subjected to the operation of revolving wire-brushes. The parts of the pattern intended to be bright are then burnished by rubbing with a small steel tool.

HOUSEHOLD AMUSEMENTS.—XIII.

CARDBOARD MODELLING.

MANY beautiful little objects may be made by skilful modelling in cardboard. We have seen coaches and carriages so exactly built in this slight material by clever boys as to be worthy, and to obtain a place under glass shades as ornaments. At the present moment we give our readers directions for making a miniature brougham (Fig. 1). First of all, cut out of cardboard two pieces like Fig. 2, as far as the dotted line A. Cut out the windows entirely. At B, cut out the upper end and sides, half cut through the lower end, and turn the piece down to hold the seat by-and-by.

Next cut out Fig. 3, half cutting through the straight outline each side with a sharp penknife, and also the dotted lines across. As it is necessary to be very exact in the form, it is necessary to measure again, from the sides cut out, if the piece is right. The figures will show where it is intended to fix Fig. 3 to Fig. 2. The bit beyond J turns in. Then cut out Fig. 4 the same way, taking out the windows entirely, but cutting the double line at 5 on the three sides only, half cutting the dotted line, and turning it in to hold the seat. The figures will show how to join Fig. 4 to Fig. 2. Next cut

Fig. 6 in the same way. The lettering will show how this is to be joined to Fig. 2.

The bits at the sides, notched, and half cut through at the straight lines, are to fix the pieces together, and are always turned inside.

But before joining, the inside must be fitted up. Glaze all the windows with thin mica, which can be bought in Oxford Street, and is called the Crystal Medium; or use white gelatine, such as covers crackers. Then line the sides, within a little space of the edge, with rich silk: leave room for the notched edges to be gummed on. Line the narrow side-pieces also, notched edges, and all. Of course, the spaces for the windows are cut out, and the edges touched with thick gum at once to prevent their fraying.

After gumming on the silk, place the pieces in a book, and press them twenty - four hours.

When the silk is quite dry and firm on the card, cut out the notches nicely with fine scissors; then join all the pieces together. It is best only to gum on one, and let this dry till next evening; or else, in fixing on a second, the first is displaced. But keep the work in progress in a box or basket with a lid for safety. It may be tied together with cotton till firm. Or the inside may be lined after the body is joined, before adding the roof.

When the body of the coach is complete, and the top, painted black inside, is put on (Fig. 7), cut out two wheels of each size (Figs. 8 and 9).

Rub up a quantity of lamp-black water-colour, a little indigo or prussian blue, and a very little yellow. This makes an invisible green, and mix it with gum. Colour the brougham and wheels all over with this, except the top, which must be black with a *very little* blue in it, to make the black intenser; also the rail of the seat. The seat should have been cut in card, and placed on, and lined, as also the 5 to 6 (Fig. 2), with very dark silk.

The colour must be dense and even. Do not touch the same place a second time whilst wet, because that displaces the colour and causes a patch. Let it dry, and paint and re-paint till quite satisfactory. Then, for a last coat, mix some gum with water, and go all over the carriage once more. This gives the effect of varnish.

Lastly, when all is dry, with a sable brush well charged with vermilion and gum, and a very fine point, draw a

minute line all round the windows, and at the line which divides the side; also round the centre of the wheels, and down the centre of each spoke. A little Chinese white from a bottle may be used first for this purpose, and when dry the vermilion coloured over it.

To fix on the lamps, make the lamps first, and then shape a square of very fine wire—one to hold each (see Fig. 10), and slip it through a pin-hole at A and B in Fig. 4, before that piece is joined on to the brougham. Turn the ends of the wire opposite ways inside.

With the same fine wire make two pairs of springs the sizes of Figs. 11 and 12: the join in the wire must be concealed. The best place for it is A in Fig. 12, and B in Fig. 11. The ends can then be pressed inside the

brougham, and turned both ways. There are two springs of each size: Fig. 12, for the back, should be fastened on at A and B (Fig. 6) before it is joined to the sides, and after it is lined and pressed. The front ones may be joined after the brougham is made up.

The two front wheels are joined together, and the two back wheels together on two wires long enough, which is best ascertained by measurement. Crook the first end, make a pin-hole, and fix the first wheel, after slipping it on the wire to the crook, with a drop of thick gum, which must be let

consolidate. The other wheel is slipped on, and a crook made afterwards. When both are firm (the next evening), take a needle charged with fine black silk, and tie the wires that join the wheels firmly to each of the springs—the front-wheel wire to the two front springs, and the back-wheel wire to the back ones. Put a drop of gum on each of these to fix them.

The lamps want very careful making. Cut from the card Fig. 5, taking out the small squares entirely. The little pieces at the sides of the sloping lines at A A A A and B B B B, are to be half cut through to join the lamp; so are the dotted lines. Glaze the lamp with gelatine inside, in four small panes. Cut out rather larger than Fig. 5 (see Fig. 1). Make it up, and join; leave it to dry till the next day. Then paint it like the brougham. In making the brougham, before joining it, red silk blinds, half down, can be put to all the windows. A foot-mat for the coachman on the box can be made of plush of a bright colour. Put on the roof last of all.

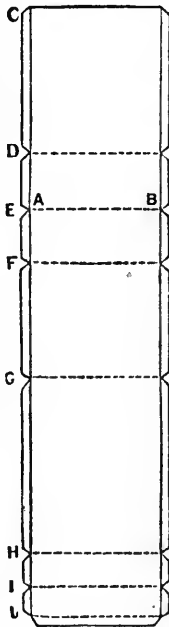

Fig. 6.



Fig. 5.

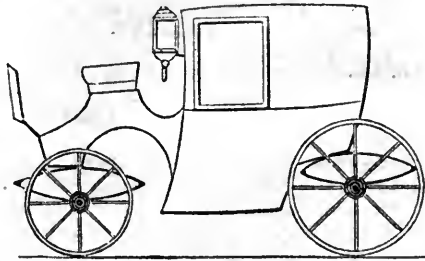

Fig. 1.

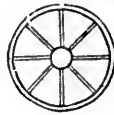

Fig. 9.

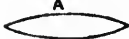

Fig. 12.

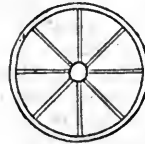

Fig. 8.

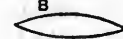

Fig. 11.

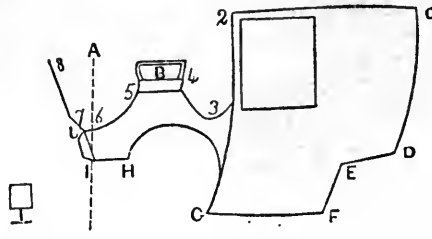

Fig. 2.

Fig. 10.



Fig. 7.

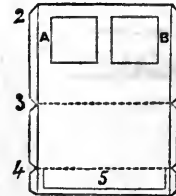

Fig. 4.

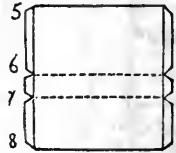

Fig. 3.

THE HOUSEHOLD MECHANIC.

GARDEN FURNITURE AND DECORATIONS (continued).

IN most gardens may be found a great square seat or "settle," capable of seating four or five persons. It is

covered as recommended for the chair. The back and seat may also be finished in the same manner; or, if a lighter effect be desired, the split branches may be interlaced, as at Fig. 8, and the ends being well secured, this will be found to yield a strong, though somewhat elastic, support.

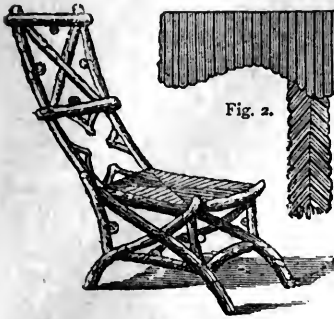

Fig. 1.

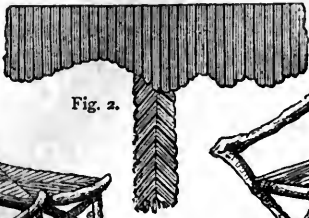

Fig. 2.

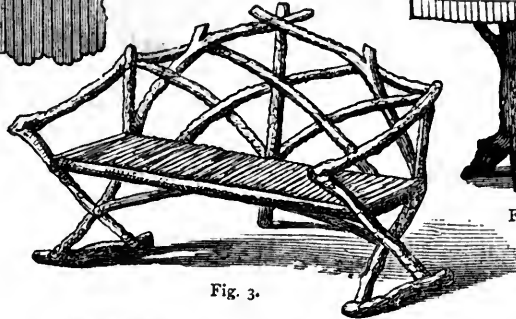

Fig. 3.



Fig. 4.

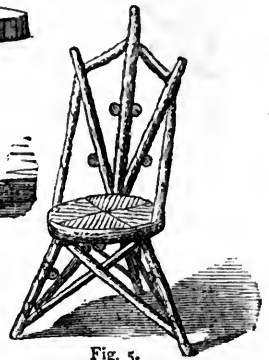

Fig. 5.

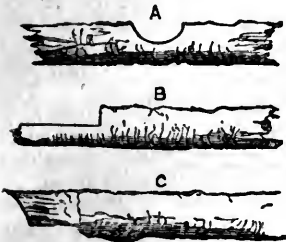

Fig. 6.

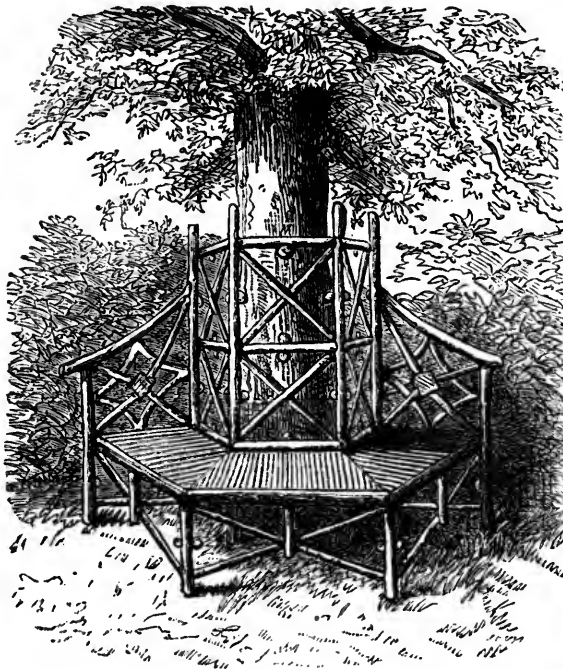

Fig. 13.

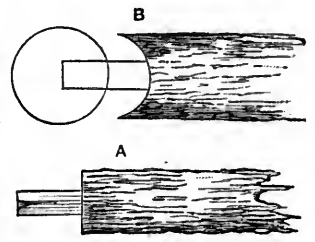

Fig. 12.

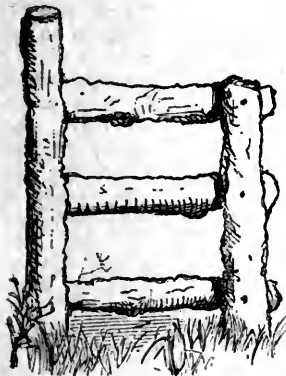

Fig. 7.

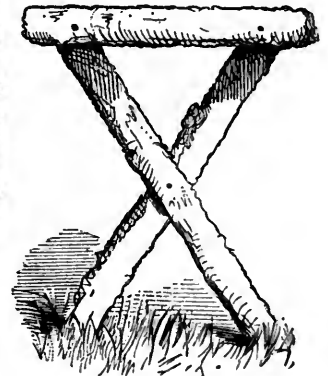

Fig. 11.

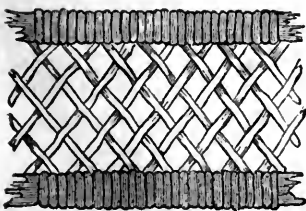

Fig. 8.

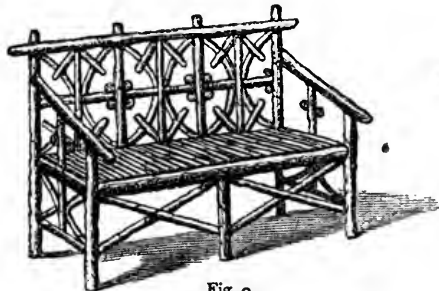

Fig. 9.

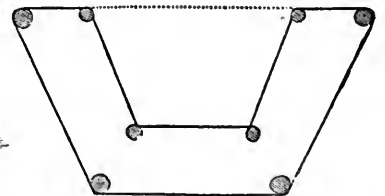

Fig. 10.

generally exceedingly plain and ugly; but by proceeding as we have described already, it may be converted into a respectable piece of garden furniture. It will be best to begin by cutting out all the bars not absolutely required in order to keep it together, when the frame should be

A very pretty rustic table (Fig. 2) may in this manner be made of an old pillar table which may have found its way into the lumber-room. The pillar and top should be of a good thickness, to allow of secure fastening for the branches used in decoration; and the ends of the cross

pieces, used for the edges of the top, may be cut to any pattern, so as to form a graceful outline. The top itself may be covered as described for the seat of the chair. In all these matters, much will depend upon the taste of the workman; and one great charm of amateur work in this direction is, that you feel the result is due to individual taste, and that your work is not of the stereotyped kind which would produce fifty chairs or tables exactly similar in design and workmanship.

But although the plans we have mentioned will be found easy to carry out, and a great improvement upon the ordinary formal lines which are met with in garden furniture, far better results may be obtained when branches can be put into the required places while retaining their natural outlines. To effect this is a matter of some difficulty; but perseverance and patience will be sure to succeed. In this case, the frames of the work will have to be made, and we will now show how this is to be done. As it will be best to commence with something tolerably easy of construction, we will take, as an example, a rustic seat without a back.

Some branches of trees, of about three inches in diameter, must be procured; and, for ease of construction, they should be tolerably straight. Having cut these off into four lengths, of about two feet each, they should be laid across each other in the form of the letter X, as shown in Fig. 11. These should then be marked at the place where they intersect each other, and cut out—or, as it is technically called, “halved”—one into the other, by cutting away a portion of each, as shown at A, Fig. 6. The two parts may then be secured by nailing. A pair of these crosses will be required; and when made, they must be “halved” into the transverse piece used to support the branches which form the seat, as at B, Fig. 6, which should be about twenty inches from the ground. For the seat, five branches should be selected, as nearly of the same diameter as those forming the supports as possible, and of the length which the seat is required to be when finished. To secure these to the crosses, they should be cut as shown at C, in Fig. 6, and well nailed. The two outer rails should be fixed first, and the centre ones cut in to fit. All the branches forming the seat should be as nearly as possible of the same curvature, or the work will look too irregular. When the seat is formed, the whole will require bracing, and this may be done by cutting two branches to reach from the place where each cross intersects to the centre of the seat—to the middle rail of the five. These, like the other parts, must be strongly secured by means of good wrought-iron nails. We may here remark that what are commonly known as chisel-pointed nails will be found the most suitable for this kind of work, and that they should always be bored for with the gimlet, and driven with the chisel point across the grain of the wood, which will prevent it splitting.

To construct a rustic seat with back and elbows is a rather more difficult operation; but, beside the extra comfort of such a seat, its very pretty appearance will quite repay the trouble involved.

We will suppose that it is desired to make a seat of a similar shape to that shown in profile, Fig. 7. The branches having been selected—and they should not exceed three inches in diameter—they may be cut off to the required length. The ends, forming the support of the seat, should first be put together as shown in the diagram. The readiest way of effecting this will be by means of a modification of the ordinary mortice and tenon joint, as at A, Fig. 12. The place of junction being determined upon, the centre of the mortice should be marked upon the uprights, and a hole of about one and a quarter inches bored quite through with a stock and centre-bit. The next thing will be to prepare the rails, by forming a tenon at each end. To effect this, the

wood should be cut (at the same distance from the end as the diameter of the uprights) so as to leave a part uncut in the centre equal to the size of the hole or mortice. The wood should then be cut away with a chisel so as to leave a pin, or tenon, which may next be fitted to the mortice. When this is done, the rail will require fitting at the shoulder to the shape of the uprights, somewhat as at B, Fig. 12. All these joints being made, and the work being ready to put together, the rails may be inserted into the uprights; and when the joints are made to fit, they may be secured by splitting the ends of the tenons with a chisel, and inserting a wedge, which should be driven tightly in. This will fix the whole firmly together.

The ends being made, two tolerably straight branches should in like manner be fitted into them, to form the front and back rails of the seat; and a third, to form the top of the back. This latter need not be straight, but may be selected of any curve, according to taste. The back and the seat may be filled in with smaller branches, as the fancy may suggest; and should the frame not be sufficiently rigid, a couple of braces may be added under the seat. All these may be secured by nailing, and the morticing and tenoning confined simply to the frame.

Of course, it is not intended that the constructor should confine himself to the forms of chair or seat which we have selected: but we give these illustrations because they allow of a clearer description of the principles of their construction. Neither do we suggest that they should be made of straight branches, except when straightness is required—for the more varied and irregular they are, the better.

A very pretty rustic table may be made out of the stump of a small uprooted tree, if the roots have not been cut off too near the trunk. One should be selected of some four or five inches in diameter, and having at least three outspreading roots attached. These should be cut as shown in the diagram, Fig. 4, so as to stand firmly upon the ground, and bring the trunk of the tree as nearly upright as possible. Now, if a section of a larger tree can be obtained, of the size required for the top, and about three inches in thickness, and having the bark on round the edges, it may be nailed to the top, and the table will be complete. If, however, this cannot be obtained—and it is somewhat difficult at times to procure so large a piece perfectly sound—the top may be made of rough boards, and the edges covered with bark, bradded on; while the upper surface may be finished with smaller branches, as suggested for the chair in the first of these articles. A curved branch or two, placed under the top, and secured to the pillar, will render the table much more steady, and vastly improve its appearance.

In Fig. 13 is shown a seat, intended to go half round the base of a tree standing at the edge of a lawn, backed by a hedge or shrubbery. Fig. 10 is the ground plan of this seat. In this, and in Fig. 1, fir or larch are also chiefly employed; in Fig. 5 oak bangles form the principal materials. Figs. 9 and 3 are light and movable croquet-seats; they are made of thin tough sticks; birch or hazel are most appropriate.

It will at once occur to the ingenious reader that there are many ways in which these ideas may be carried out. In fact, working with such varied forms as the branches of trees in their natural shape, it is well nigh impossible to produce two articles exactly alike; and this alone is sufficient to show how infinitely superior in appearance, and artistic natural effect, such garden furniture will be, when compared with the ordinarily angular and incongruous-looking combinations of right-lines and square surfaces, which are too frequently met with where such things are most certainly out of place.

COOKING.

OMELETTES, CUSTARDS, AND PUDDINGS.

Omelette Soufflée, in a Mould.—Take a large mould, of simple form; butter the inside well throughout. Break six eggs, putting the yolks and whites into separate basins. To the yolks add three tablespoonfuls of pounded sugar, one of arrowroot, four macaroons broken to crumbs, a salt-spoon of salt, a dessert-spoonful of grated candied citron-peel, and the same quantity of candied orange-flowers, if you can get them. Beat all these well together; then beat your whites of egg to a froth, mix the beaten yolks with them, and beat again. Pour these into your buttered mould, not filling it more than half full. If you have any beaten eggs left, put them into a second mould, to make a second omelette. Set into a gentle oven; when done, turn it out on to a piping hot dish, dust with sugar, and serve with the remembrance that time, tide, and *omelettes soufflées* wait for no man. This makes a pretty dish to set before no matter whom. It is as handsome as it is good. Its complexion should remind you of the shivering sand in Wilkie Collins' "Moonstone."

Onion Omelette.—Fry lightly in butter a few sliced white onions. When they are nearly done enough, moisten with cream, and season with salt, pepper, and nutmeg. Mix them up with half-a-dozen beaten eggs, and finish off your omelette in the usual way.

Anchovy Omelette.—This omelette is fashioned in a different way to the preceding. By the same mode a variety of articles may be enclosed, both savouries and sweets. Take half-a-dozen salted anchovies; steep them in warm water a quarter of an hour to freshen them a little. Cut off the flesh in strips. The fillets of anchovy, bottled in oil, sold at Italian warehouses, answer perfectly. Fry thin slices of bread, cut them into small squares, and on each square lay a bit of anchovy. Beat up, rather more than for an ordinary omelette, a dozen eggs; season with pepper and salt. With half the quantity make a large, flat, thin omelette, like a pancake. Do not turn it, but lay it on a hot dish. Over its surface distribute your bits of fried bread and anchovy. With the remainder of your eggs make another omelette like the first. Lay it over the other, with the under-side uppermost. Set it a few minutes before the fire, or in a gentle oven, to make the two surfaces adhere, and serve with any savoury sauce that suits your taste.

Italian Eggs (à l'Italienne).—Break seven or eight eggs into a saucepan, with a bit of butter in it. Add the juice of a lemon, a glass of white wine, enough pounded sugar to make them decidedly sweet, a pinch of salt, and any approved flavouring, as orange-flower water or curaçoa. Then proceed exactly as with scrambled or mashed eggs. When they are set without being hard, pile them on a hot dish, dust them well with sugar, and candy it a little, either under a salamander or with a red-hot fire-shovel.

Spun Eggs (Œufs en Filigramme).—The French name of this preparation is not quite so correctly composed as "telegram," first coined and circulated by the *Times*. Never mind. The dish will pass; let the word pass also. Make a syrup of sugar, white wine, and water, in a rather wide stew-pan, that is not too shallow. Beat together eight fresh eggs, with a dessert-spoonful of flour or arrowroot. Take a cullender or strainer, whose holes are about the diameter of a strip of vermicelli. Set it over the hot syrup, and through it force the eggs, making them issue in threads, which, falling into the syrup, will be immediately set and hardened—poached, in fact. On taking them up, let them drain a minute, and pile them on a dish. They may be served either hot or cold, or used to garnish other sweet dishes. This is one of the things which, in former days, housekeepers in country mansions used to lock themselves inside their still-rooms to make,

for fear the kitchen-maid (or perhaps their mistress) should steal the secret.

Eggs as Snow (Œufs à la Neige).—Set a pint of milk, or more, on the fire in a shallow stew-pan, sweeten liberally with sugar, flavour with a couple of bay-leaves, and any other approved aroma—vanilla, orange-flower water, or rose-water. Separate the whites and the yolks of six eggs. Beat the whites to a froth, with a little pounded sugar. When the milk boils, poach in it, one by one, table-spoonfuls of this froth, turning them over with a ladle or slice until they are equally done all round. The dish will be handsomer if you vary their size, making some twice as big as others. As they are done arrange them on a large dish, grouping the biggest in the middle. When all the frothed whites are thus disposed of, set the stew-pan of milk on the side of the stove. First mix a small quantity of the milk (after it has cooled a little) with the egg yolks, and then thicken with them what remains. Pour this amongst and around (not over) your snowy froth. Serve cold. Sweet biscuits or sponge-cakes are often eaten with it. Few things that give so little trouble make so elegant a supper dish. If you have not yet tried it, please to do so. Executed on a large scale, it may even figure as a centre dish.

Baked Custard.—Take as many eggs as will fill your dish level when laid in it in their shells. Beat them together; sweeten liberally, for a custard with too little sugar is very insipid; add a small pinch of salt. Flavour with whatever you like—brandy, rum, liqueurs, essence of lemon, vanilla, rose-water, or orange-flower water; either of the last three are the most delicate. Then add as much new milk as will fill your dish nearly to the brim. Stir all together; grate a little nutmeg on the top. Set it into a *very* gentle oven. Watch, and take out without shaking it, as soon as it is fairly set.

Baked Custard, in a Crust.—Butter the inside of a cylindrical cake-tin. Line it with thin pie-crust, not too rich with butter, and set it into the oven till the crust is nearly baked enough. Then pour into it a custard made as above, but with a smaller proportion of milk, to render it stiffer. Bake gently. On taking out, set it in a cool place to stand all night. Just before serving, take it out of the tin, and set it on its dish. Custards with crusts may be made small and shallow, in tin patty-pans, or earthen saucers. Such custards are especially suitable for juvenile entertainments. Children are so delighted at having a whole pie, dumpling, or custard, all to themselves! Custards, made as above, are excellent cooked in small cups *with covers to them*, in a shallow saucepan of boiling water, or steamed in a steamer fitted to the top of the saucepan.

Chocolate and Coffee Custards are made by incorporating chocolate with, or adding strong coffee to, the milk which enters into the custard.

Boiled Custards.—The proportions of milk and eggs employed depend on the degree of consistency required. Four eggs to a pint of new milk do nicely. Sweeten, flavour, after thorough mixing, and stir slowly and continually over a gentle fire; or better, in an earthen vessel plunged in a saucepan of boiling water. When sufficiently thickened, pour into cups or glasses, grate a little nutmeg over their surface, and drop a ratafia on the top of each. Some recommend the leaving out a certain number of whites of egg from custards. If you *want* them for any other purpose, that is all very well; otherwise it is wasteful and needless. The grand secret of making good custards is (besides sufficient sweetness) *the application of very gentle heat*. Custards made with arrowroot being impostors, have no right to appear in the society of eggs.

Eggs in Paper Cases.—Make little square trays of white paper, three inches square, with an edge three-quarters of an inch high. Smear them with butter. Mix together grated bread crumbs, chopped parsley, and green onions,

pepper and salt, a dust of nutmeg, and butter. Put some of this at the bottom of each case, and on it break an egg as you would for frying or poaching, keeping the yolk entire. On the top of each egg drop more of the mixture; set them, on a dish, into a gentle oven, and serve as soon as the whites are set.

Lemon Tarts or Tartlets.—Rub three ounces of sugar, in lumps, over the rind of a fine fresh lemon, so as to absorb the essential oil. Then over this sugar squeeze the juice of the lemon. Crush the sugar; add to it two raw eggs and two ounces of warmed butter. Mix well together. Make a light, thin, puff-paste, and with it line your tart or patty-pans. Give the mixture another good stirring-up. Pour it over the paste in the pans, and bake in a tolerably brisk oven.

Counsellor's Pudding (Excellent).—Butter the inside of a mould thickly; stick the inside all over as regularly as you can with dried cherries or raisins halved and stoned; at the bottom place in order a few macaroons and ratañas. Then line the sides with slices of sponge cake, and fill the remaining space three-quarters full with sponge cake, sponge biscuits, and bits of rich plum cake. If you have not the latter at hand, you can sprinkle a few washed currants amongst the former. Mix together, half milk half eggs, as much as will soak the cake and fill the mould; flavour with orange-flower water and sugar, or a glass of liqueur, as noyau, &c. When the soaking is complete and the mould quite full, cover the top with buttered paper, tie down closely with a cloth, and boil for an hour. When turned out of the mould upon a dish, pour round it a sauce made of rich melted butter, sweetened with sugar, coloured pink with fruit syrup, and flavoured with a glass of the same liqueur that was used for the pudding.

Italian Pudding.—This pudding may be made in several ways, but that we like best is the one described beneath:—Boil in milk the crumb of two penny rolls for a quarter of an hour, taking care that it neither burns nor boils over. Put it into a bowl, and when it is no more than milk-warm, stir into it the yolks of three eggs. Beat their whites to a froth, and stir them in also, with half a pound of pounded sugar, and a few currants and Malaga raisins. Put it into a shape or basin smeared with caramel or burnt sugar, or merely with butter. Set this in a shallow saucepan or hot water bath, and boil it an hour. On turning it out of the shape, pour over it some sweet sauce with a glass of white wine in it, or you may pour rum round it, and set light to it just before serving.

THE HOUSE.

WATER SUPPLY (continued).

IN the construction of every form of well or water reservoir great care should be taken to prevent the inflow or percolation of impure water, the result of surface accumulation. It not unfrequently happens that persons settling, and establishing themselves in a new locality will, on sinking an experimental well pit, be deceived by the quantity of water given off by upper layers of soil, and also imagine, because copious humidity is found to exist in such shallow deposits, that a regular and constant supply may be counted on. Such anticipations will, however, in all probability prove vain, as it is only after the falling of rain or snow that these superficial alluvial beds pour out their stores of moisture; which are in the majority of cases contaminated by a host of impurities, decomposed animal and vegetable matter amongst them.

Sewage overflowing the bounds set up for its control, soaks into the earth, and flows slowly but surely to the lowest point; and should this low level or depression chance to be the newly-constructed well, a store of liquid poison, instead of wholesome water, is the result. Shallow or unlined wells should never be used in thickly populated neighbourhoods. Yet it is from the stores of moisture poured out in the shape of rain, snow, or hail, and widely scattered over the land, that our most valuable and important sources of pure water are supplied. Spring water, then, may be said to be originally of surface origin, that is if we regard the sea, lakes, rivers, and marshes as being the main sources

from which rain clouds and mists draw their supply; these, after reaching the earth as before described, and entering the superficial deposits in the form of water, flow onward on the surface of solid or unbroken strata, until some jointed or naturally cleft rock, series of gravel beds, or other formation through which water can pass is met with. Ever downwards, seeking the lowest point, the earth streams flow, until per-

chance some widely stretched clay deposits are by them undermined; then, between this impenetrable crust of clay, which now covers the subterranean streams, and some hard and unyielding formation below, an accumulation of water takes place; fresh supplies from above, pressing with vast weight and power on the pent-up and imprisoned volume of fluid, as it lays deeply buried beneath its mighty earth seal, causes it to penetrate and explore each crack and crevice, fill each natural cave and hollow nook in the rock, until at length, an upward cleft



Fig. 1.



Fig. 2.



Fig. 3.

being found, the bubbling liquid crystal leaps joyously to light, and wells forth amongst the green water-weeds and tufted rushes—a spring. And it is with a view to the artificial formation of that which rock, earth, and clay-bound water seeks, that man brings his skill and ingenuity to bear in the prosecution of deep well borings. Nature, in the exercise of her marvellous and inscrutable chemistry, frees the water, in its passage through the deeply buried sands and shingles, of its earth-formed impurities; and, in their stead, communicates a number of qualities, both mineral and gaseous. Thus we find the water of certain springs celebrated for some peculiar medicinal virtue; whilst others are thermal from the action of volcanic heat acting far down in the earth's secret recesses.

The following are some of the most noteworthy gases and mineral solutions found in spring water. Sulphuretted hydrogen, carbonic acid gas, nitrogen, sulphate of lime, muriate of soda, carbonate of lime, carbonate of iron, silica, &c.; and it is to the presence or absence of certain of these combinations that water owes its fitness or unfitness for use in a great number of arts and manufactures.

The difference between that which is called hard or spring water, and soft or rain water, is caused by the presence of some mineral held in solution by the former. A noteworthy example of the quantity of mineral which is borne by our ordinary London water, can be found by examining the interior of a tea-kettle which has been some time in use. Filters are intended to perform on a small scale that which Nature carries out in the subterranean gravel beds—viz., to get rid of animal and vegetable impurities. Chemists have found that charcoal by its antiseptic qualities, aids the process by removing impure gases. It must however be borne in mind that it is not merely a passing contact with carbon which renders water free from fœtid contamination. To be efficient as a purifier charcoal must be in sufficient quantity, and in contact with the liquid under treatment. It must be also remembered that the process of filtration, as commonly carried out, does not free the water from such mineral salts as it may hold in solution. Mineral waters may be as clear as crystal, and yet be highly charged with the oxide of some metal, in combination with an acid, constituting what is called a *salt*. Nothing short of chemical reagents or distillation will render water so charged, perfectly pure; no filtering apparatus yet designed by human ingenuity will, when charged with sea water, give forth fresh. Yet it is occasionally found that wells sunk in natural sand beds near the sea will yield water sufficiently freed from saline contamination to quench thirst, and thus prolong human life. An interesting instance of this wise provision of Nature for the wants of man, was communicated to us a short time since by an engineer officer in the service of the United States of America. During the late war it so happened that he, with some of his men, had to remain some time on one of the sandy “keys” or islands in the Caribbean Sea. On the supply of fresh water falling short, a number of ordnance packing-cases, with holes bored in them, were sunk to some depth in the moist sand. In a short time water but slightly brackish was collected for use.

Those who dwell far from the haunts of men have not the same reason to dread surface water as the resident in cities, towns, or villages. Rivers, rivulets, ponds, marshes, and waterholes are all sources of water supply to the inhabitant of our rural districts and the partially settled regions beyond our colonial townships. Water for the supply of the wants of domestic animals is a most important consideration, either at home or abroad, when new and little-known lands are about being taken possession of. The presence of flags, rushes, sedge grass, and other plants loving a moist situation, will not unfrequently lead

the searcher to a spot where, by the expenditure of a little labour in digging, a tolerable supply of water may be husbanded up. Should the climatic be warm a number of heavy thorn branches should be cut and then arranged as a protection against the rays of the sun and the attacks of stray animals. A small well of drinking water may be formed for the use of labourers or settlers by digging out the earth in a moist place by the aid of a sharp stick, trowel, or large knife. Remove all the loosened stones and gravel with the hand, until the pit is about the size of a wine decanter, and shoulder deep. When the water flows into the bottom of the pit thus prepared, form a ball of small twigs just large enough to admit of being forced to the bottom of the hole. Then take any hollow tube of moderate size—a piece of gas pipe, an old gun-barrel, or a bamboo cane with the knobs removed, will do. Thrust the lower end of this into the twig ball, and let the upper end project above the level of the surface earth. Then fill in the pit with that which has been removed to form it. When water is wanted, suck at the tube, and it will flow into the mouth.

In raising water from makeshift wells, either for household use or to supply cattle, it is well to bear in mind the principle of the balance lever (Fig. 2) made use of in the East. By this arrangement a very large quantity of water can be raised to the surface by the expenditure of very little labour, and without damaging the banks or margins of the ponds or wells. We have found these contrivances simple, as they are also of the greatest value. It not unfrequently happens, that water for cooking purposes, drinking, and the supply of cattle, sheep, and horses, has to be drawn from the same pool; it is then a good plan to prepare a filtering cask. This may be made from any common beer, wine, or spirit barrel. To prepare it for use, first bore a number of holes in its bottom with a gimlet or red-hot iron; then place a few heavy stones in it, in order to give weight. Over the stones deposit a thick layer of charcoal; then a layer of clean rough sand or small pebbles; then another layer of charcoal, followed by one of sand, and so on until the cask is about half filled. When the upper layer is made even, lay the upper head of the barrel on it, drive thick wedges of wood between the edge of the head and sides of the barrel until all is quite firm; then with your gimlet bore a number of holes in the upper head. A cask thus fitted may be placed in the pond, with its upper rim within a few inches of the surface, just under the dipper of the lever, and as the water fills the upper compartment, it will be sufficiently purified for all practical purposes. Fig. 1 gives a sectional view of the barrel water strainer, when charged for use. This arrangement not only filters and purifies the water, but removes from it the larvæ and eggs of water insects.

Some of our readers might be dependent on the waters of the sea for fresh water to supply the wants of daily life with during a disaster at sea. In such a case as this we say, “despair not,” for perfectly wholesome water, in considerable quantities, can be obtained. Fig. 3 represents a makeshift water-still, consisting of a tea-kettle, musket-barrel, and a gallon jar. The kettle cover should fit very tightly with a bit of linen cloth or thin canvas round its joint. The kettle, A, being about half filled with sea water, is placed well back on the fire, so that the spout discharges freely into the musket-barrel, B, which is covered with cloths saturated with cold water, and discharges its condensed water into a hole broken through the side of the jar C, which is kept cool by being placed in the tub of water D. As the pure water collects in the jar it may be from time to time poured out for use. Many quarts of excellent drinking water may be procured in a day by the use of the arrangement we have described.

There are yet remaining several matters relating to water, its obtainment and management; these we must reserve for consideration in our next paper.

THE REARING AND MANAGEMENT OF CHILDREN.

MORAL INFLUENCE—OBEDIENCE.

IN the preceding chapters we have described the mode of management best adapted to the bodily wants of young children, but it is also necessary to suggest means for the healthy culture of the mental and moral faculties of childhood. For although the growth of the mind may not make visible progress in the same proportion as is observable in the tiny frame, the same steady development towards maturity is, nevertheless, taking place continually, resulting in a healthy or unsound condition of mind, according to the amount of culture bestowed. For this culture the long period of helplessness which characterises babyhood is especially favourable. A mother, as the being nearest and dearest to the almost unconscious infant, should act not only as the appointed guardian of its bodily welfare, but should also extend her care and effort to the proper development and culture of its mind. By its parent's smile or frown, an infant reads, as from a book, signs of approval or reproof of every act committed. Instinctively, little children turn towards their mother on all occasions of doubt, and unhesitatingly they guide their course by the mute expression they observe on her face.

This golden opportunity of maintaining a natural influence is too valuable to be lightly regarded, or carelessly risked. From the commencement, therefore, it is desirable that a mother should seize every occasion of turning it to good account. In all her actions towards her babe, she should ever bear in mind that *example* is the most impressive mode of teaching, and that if she constantly does what is right in the presence of her child, a true principle of conduct is imparted without need of verbal explanation.

There is not a single duty which a mother discharges towards her babe which may not be rendered the medium of conveying the highest principles of morality. In feeding, washing, dressing, and amusing an infant, so many lessons may be taught by the number of restraints that may have to be imposed. The child must also be made to understand that at certain times and in certain places it may not do what at other times or in other places it may do; and it is by withholding or granting things coveted that the ruling influence of the mother's mind is most forcibly felt.

A contrary course of conduct is unfortunately liable to be pursued by parents, who, either from excessive fondness; impatience, or want of intelligence, habitually give their little ones all they ask for. No more effectual mode of spoiling a child can be pursued than by so doing. By thus inverting the order of things, and making themselves instead of their rulers, slaves to their children, they create a double misery—neither themselves nor the children are happy.

It is commonly believed that no harm can come of letting a child have its own way, so long as it is a mere babe. But this is a serious delusion. As soon as a child is of an age to express its wants, whether by one means or another, it is old enough to be brought into habits of obedience. *Obedience is the first lesson to be taught*, and very sensible are all well-managed babes of its meaning. No harsh words, no impatient gestures, need be added to enforce the rule, which consists simply in not doing as the babe demands, if it be not the right time and the proper place for the desired gratification.

Taking food as an example. If children were left to their own choice, they would be eating and drinking perpetually of whatever came in their way, till the stomach could no longer retain the improper substances. Wholesome food would be rejected for more palatable sweets and dainties. Before long, depraved tastes would be confirmed. Much the same misfortune sometimes befalls

over-fed children of the wealthy, notwithstanding the care bestowed in other respects on their nurture; and an impaired constitution is the result. Food, then, becomes alike a means of bodily nourishment and of discipline of the mind. The quality of the food, and the hour at which it is taken, are matters for the parent to decide, to the best of her judgment. Having done so, any fretful impatience on the part of the child should be unheeded. If in a fit of passion the usual meal should be refused, no attempts at persuasion should be wasted, but, after a reasonable time for recovery from any disappointment experienced, the objectionable repast should be put aside, and the child's attention turned to something else. Hunger is an eloquent pleader, and if the refusal has merely sprung from disappointment at not having something else, signs of craving appetite will soon appear. Then it will be time to re-offer the original nourishment, which, in all probability, will be greedily consumed. If, upon observation, it is found that the repetition of the same kind of food is repulsive, the reason should be sought in the health of the child, or in the mode of preparing the meal.

With respect to the *time* of feeding, irregularity should be guarded against, by not giving children scraps to eat between meals; neither should they be exposed to the sight of tempting food at unsuitable times.

Another early opportunity of implanting a spirit of obedience will be found in the impulsive habit which little children have of seizing whatever they desire to possess. This habit requires great firmness in checking, and a determination on the parent's part to risk a flood of tears rather than let the coveted article remain in the child's possession. Added to the danger which results to little children from letting this habit of snatching have sway, the destruction of property is liable to be very great. Consequently, a mother should be on the watch to convey a notion that certain prohibited articles are hurtful. By shaking her head, looking gravely, and saying, slowly, "No, no," at such times, a child will soon learn that something is wrong. If the child ceases in his attempt, he will have understood the meaning of a very important word. If, however, the intelligence is not yet sufficiently strong, the object should be removed out of sight, the mother firmly reiterating the refusal, and looking the child in the face while she does so. By repeating this process a very few times, the meaning will become plain, and you will see that the child understands it. Should the child, however, repeat the attempt, the prohibition should be repeated, and the consequences of the child's taking the responsibility should be suffered to appear. Touching fire, candles, heated irons, kettles of hot water, and innumerable articles of a similarly injurious nature, can hardly be prevented in a nursery; therefore, if, after a fair understanding of the prohibition, a child persists in the attempt, a slight burn, or bruise, or scald, may prove a merciful suffering. On such occasions, sympathy at the infant's pain should be tempered with reproof, making him understand that when he was told not to do the deed, you knew it would hurt him.

By the above and various other simple means, obedience receives practical and easy illustration, even in infancy.

With children of more advanced age, the force of reasoning should be employed, to render acts of obedience less painful to perform. Those who have charge of the young should always bear in mind that they are dealing with beings liable to be impelled by impetuous passions into acts of danger, of which, from want of experience, they do not realise the extent. Adults, having passed through the ordeal of youth, know the punishment which an uncurbed spirit is apt to bring on its possessor. They have bought their experience dearly, perchance, from having had no guiding hand to direct their course. The result of this experience should be to caution young people against preventable danger. In all warnings—especially

where schoolboys are concerned—the truth should be plainly spoken, right and wrong made unmistakably clear, and forgiveness freely given, whenever, from waywardness or indiscretion, the youthful wanderer has diverged from the prescribed path. Children that from their cradles have been accustomed to look upon their parents as their truest and most indulgent guides, are seldom wanting in confidence towards them, when, through disobedience, they have unhappily become entrammelled in difficulties.

COTTAGE FARMING.

ARTIFICIAL AND OTHER MANURES (*continued*).

Bone Phosphate.—The finer quality of bones, fit for cutlery and other purposes, cost from £12 to £16 per ton. Inferior sorts, for manure, bone-ash, and charcoal, from £5 to £7 per ton; crushed, from £7 to £8 per ton; dissolved bones, from £6 10s. to £7 per ton; bone-dust, about 20s. per quarter. Most of the bones collected in South America are calcined and imported in the form of bone-ash, and cost from £5 to £6 per ton (70 per cent. phosphate). Phosphate of lime, in a soluble form, is obtained in the manufacture of gelatine from horn-piths. It is, in some places, termed “precipitate phosphate,” in others “bone flour,” and sells at £5 10s. to £6 per ton.

Phosphoric Rock (Apatite) is imported from Estremadura, Spain, and from Canada, and the United States (Charleston). The latter only yields 60 per cent. phosphate; but, being easily worked, sells readily at 45s. per ton, or 55 per cent. base. The chief supplies, however, of the manure manufacturer are from Spain, and the superphosphate made from it sells at from £5 to £6 10s. per ton.

Phosphate of Lime was discovered in 1854, in the form of a hard crust, on rocky islets within the tropics. It is guano from which the ammonia and soluble properties are washed away. The insoluble phosphate of lime which thus remains, contains one equivalent less of base than the phosphate of lime in bones, and hence with sulphuric acid is readily converted into a soluble superphosphate. The salts of ammonia, prepared by a patented process, are added, forming a compound fertiliser, known in the market as phospho-guano, which sells at from £12 to £12 10s. per ton.

Sulphuric Acid for dissolving bones, costs three farthings per pound. One pound will dissolve three pounds of crushed or broken bones, saturated in three pounds of boiling water, by measure rather more than a quart. A quart weighs 2½ lbs., a gallon 10 lbs.

Guano is the excrement of sea-fowl, deposited in great abundance on some of the rocky islands of the Pacific belonging to Peru. That from Chinchu, known in the market as Peruvian guano, is the best, and sells at £10 to £14 per ton. There are a great many inferior qualities imported from other places, besides artificial imitations comparatively worthless, so that the cottage farmer, to avoid being imposed upon, should only purchase from manufacturers or agents on whom he can place implicit confidence. And this market rule applies to all the artificial fertilisers noticed before.

Specific Manures for different kinds of crops, as wheat, barley, oats, grasses, mangold-wurzel, and turnips, are now sold by the principal manure manufacturers ready for use, at prices varying from £6 to £12 per ton, according to the degree of concentration. The two articles which regulate price are the per-centage of ammonia and superphosphate.

Cow-dung.—It has been estimated, from experiment, that a milk cow will yield annually about nine tons of solid excrement, and about 2,600 gallons of urine. In Flanders the small farmers value the latter, the urine of a milk cow, at forty shillings yearly. The former makes a poor “cold

manure,” the nitrogenous matter and phosphates of the food going to enrich the milk and repair the wear and tear of the system, which is great in a good milker. The urine is richer according to analysis, but in practice it proves defective when applied net to the land. The more advisable plan is to mix the solid and liquid together, adding ashes and earth along with the other manures from the piggeries, with one hundredweight of common salt to every cubic yard, and then allow the whole to undergo fermentation. Sulphate of ammonia, superphosphate and muriate of potash, may be added at the time of application, as the different crops require; but of this more afterwards, under each crop, as wheat, &c.

Pig-dung is colder than cow-dung. It also possesses odorous properties noxious to most of the cultivated crops. Thus, applied to grass lands the grass would give the milk of cows a bad taste. The urine is similar. Much, however, depends upon the kind of food consumed. But however cleanly fed, the manure should be thoroughly fermented with salt and gypsum, until its noxious properties are corrected, which will readily be ascertained by the change of smell.

PRINCIPLES OF GOOD TASTE IN HOUSEHOLD FURNITURE AND DECORATION.

WALL PAPER.

IN selecting a few special features of the interior decorations of a house, with the view of illustrating the application of the principles we have laid down, we cannot choose, in the first place, a more important subject than that of *wall papers*.

The wall paper, except in rooms which are over-crowded with furniture, generally constitutes the largest portion of the interior decoration of a house, since it extends over the largest surface; and although it is never, in any tastefully-furnished room, the principal feature, it is certainly one of the most important parts of the enrichment, and will invariably be the means of enhancing the appearance of the whole apartment, or of completely destroying the harmony of the general effect.

The wall paper should bear the same relation to the furniture and persons in the room as the background of a picture bears to the figures and principal objects represented. Unimportant as the background to a picture may appear, it is by no means the least important part, or the easiest to manage, but often occasions the artist much trouble and anxiety before he is able to produce a satisfactory result. And it is neither an unimportant nor a simple matter to choose a wall paper which shall be exactly suitable as a background to the contents of an apartment.

We have known artists who obtained their backgrounds by mixing together all the colours on their palette which they had used in the figures and objects forming the subject of the picture. Such a combination, they contended, produced the most suitable background, giving the greatest value to the principal parts, and harmonising most completely with their colours. This may perhaps be a crotchet of the artist's, but it undoubtedly contains some truth, and is highly suggestive to the decorator. It recognises the principle we have already laid down; viz., that the wall paper should be chiefly of secondary, tertiary, and grey colours; and that the primaries, if introduced pure at all, should be confined to spots or small spaces.

There is no objection to introducing the primaries, so long as they are used sparingly; indeed, by this means, the effect will generally be improved, just as the artist's background, formed in the manner described, will not have so pleasing an effect if the colours be equally mixed, and it be painted of one unbroken grey, as it will if the colours be “broken,” and put on in an irregular manner—

the tone of the mass being grey, while here and there a few touches of brighter colours appear.

When primary colours are introduced largely in the furniture of a room, a very rich and pleasing effect is produced by using the primaries in combination in *small*

being woven together in small masses, producing a very pleasing appearance.

In such combinations, however, great caution must be exercised, lest one colour be unduly prominent. It may be well to bear in mind, when the primaries are thus used



Fig. 1.

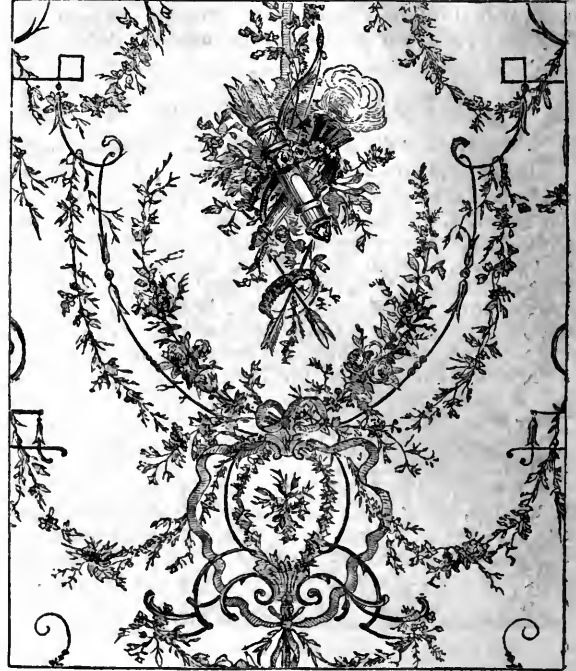

Fig. 2.



Fig. 3.



Fig. 4.

masses in the wall paper, or in the carpet, or even in both. Wall papers of a small design, and coloured with blue, red, and gold, so arranged as to mingle at a little distance, and have the effect of a "neutralised bloom," serve as admirable backgrounds where, in the furniture, bright draperies and richly-coloured objects occur. In carpets and hearthrugs a similar effect is sometimes produced by a motley of colours—red and blue, or all the primaries,

in juxtaposition, that they are not equally powerful, but that their relative forces are represented by the figures 3, 5, and 8. Yellow, being the most powerful, should bear the proportion of 3 to 5 of red, which is the next, and to 8 of blue, which is the least forcible. If these proportions are departed from, the predominance of a colour should be regulated by the colours of the objects which are to come before them and be relieved by them.

In order, then, that the wall paper may be subordinate and retiring, all *strong contrasts* must be avoided, whether of *colour* or of *form*. Sometimes, when there is no violent contrast of colour, the forms are so distributed as to catch

the surface at regular distances. There is no objection to this method, so long as there is not too great a difference between the tone of the unit and that of the ground. But too often it happens that the wall looks as if it had been



Fig. 5.



Fig. 6.



Fig. 7.

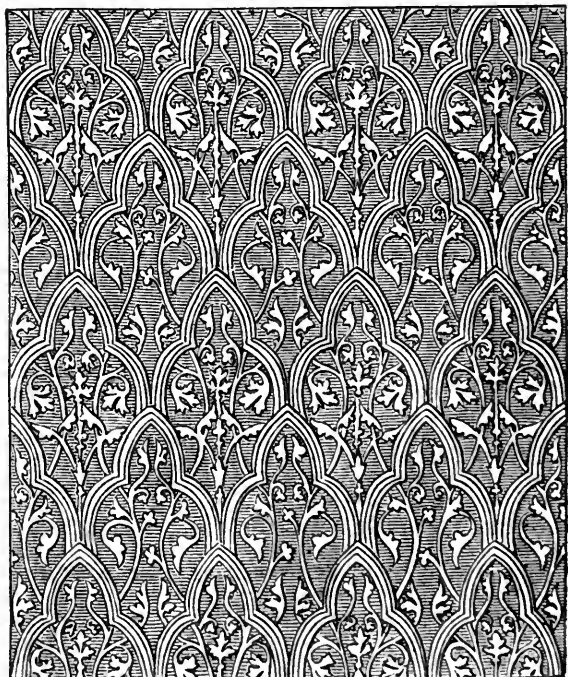

Fig. 8.

the eye at once, and stand out in marked relief. This is frequently owing to the isolation of detail, and more especially to the contrast of *light and dark*. Sometimes we find one form—the unit of the design—repeated over

stuck all over with dark patches, and, no matter what may be in front of the wall paper, these patches persist in catching the eye first. Fig. 3 is an example of this kind, in which, however, two different forms or groups are

repeated in alternation. It will be observed that the general effect is "spottiness," owing to the isolation of the groups, and the great contrast between their dark tone and the light ground.

We give another illustration of this treatment in Fig. 6, which is taken from a superior French wall paper. Here the spottiness is not so marked, because the dark masses are somewhat blended into the background by trailing foliage of an intermediate tone; and there is also much that is tasteful in the design; but there is therefore only the greater reason for regret that the effect is spoiled by the masses of dark, which, at a distance, would present an unpleasant "patchy" appearance.

It may be well to remark here that much more flagrant examples might be given of this objectionable treatment, but we have purposely selected our specimens of false taste from amongst the best of their kind; while our illustrations of good taste are not given as the best which could be chosen, but as being well adapted to exemplify the particular good quality under consideration. It appeared to us better, in giving illustrations of false taste, thus to choose designs which, in other respects, were meritorious, than to select, as we might have done, such as possess no quality to recommend them.

Sometimes *stripes* instead of spots are repeated, and with an equally, or even more, disagreeable effect than that of "spottiness," arising from the marked contrast of the stripes with the ground. This contrast is occasionally so striking as to have the effect (when the stripes are upright) of enclosing the room with posts, or (when crossed) with lattice-work.

All such marked contrasts are to be carefully avoided, especially in a bedroom, where, in case of sickness, such papers being constantly before the eye, are exceedingly annoying and distracting.

These disagreeable effects are easily avoided by choosing a paper in which the ornament is blended with the background by its similarity of tone—that is, by its being but little lighter or darker than the general tone. Fig. 7 is an example of this kind, in which the ornament is just sufficiently lighter to "tell out" from the ground. It will not matter if the most rigid geometric forms constitute the basis of the design, for so long as this delicate contrast of tone is preserved, the effect will be agreeable. Figs. 4 and 8 afford good illustrations of this treatment. In each case the basis of the design consists of a geometric arrangement after the manner of some Moresque wall enrichments, and this is filled in with a design composed of vegetable forms conventionally treated; the tone of the ground being but little different from the tone of the ornament.

Having considered the wall paper with regard to its suitability as a background to the principal features of the room, we have also to consider its adaptation to the special purpose to which it is to be applied. And here we remark *two general principles* which should be observed in the design of all wall paperings. First, that the surface of the wall being upright, *the ornament should be designed for an upright position*. If it consist of a repeated symmetrical unit, such unit should be bi-symmetrical—that is, have its right and left halves corresponding; or, if the arrangement be irregular (as in some paper-hangings in which vegetable forms are treated as if trained against an upright surface), there should still be a decided adaptation in the design to its upright position. Secondly, *the ornament should be adapted for the enrichment of the flat surface of a wall*; therefore, light and shadow, and everything which conveys the impression of relief, or interferes in any way with this flatness, should be avoided. We will not go so far as to say that therefore floral and animal forms, and objects of still-life, may not be represented; but we do say that if such represen-

tations be introduced, they should be treated in a manner suitable to the *flatness* of the wall surface. We can explain our meaning best by giving examples of the right and wrong treatments of natural forms.

In Fig. 1, a sort of trellis-work is imitated, and some leaves and flowers are represented as advancing in front of it, and others as receding some distance behind it; while some stand out in high relief, and others are cast in deep shadow. Indeed, it is an attempt at the literal imitation of foliage climbing up trellis-work. All such treatments are highly objectionable. It is not literal imitation of natural forms that is wanted, but an ornamental treatment of them suitable for the enrichment of a flat and upright surface.

Fig. 2 is a tasteful specimen of French design, in which the imitation of natural forms and artificial objects is skilfully managed, and the design and treatment are much less objectionable than in Fig. 1. But there are indications of perspective, foreshortening, and relief suggested in the light and shade, and these are inconsistent with the purpose of wall decoration. Patterns are far preferable in which the treatment is perfectly flat (as in Figs. 4, 5, and 8), and without even such indications of light and shadow or of different distances of the forms, as suggested by darker tones for the near objects, and fainter tones for those farther off, as in Figs. 1 and 2.

HOME GARDENING.

BROCCOLI (*continued*).—BRUSSELS SPROUTS.—CABBAGES.

The Latest Green or Siberian.—This vegetable delights in a loamy soil, as in such it is generally found to come more true in kind, and turns out considerably hardier when planted without dung. Dry soap-ashes, dug into the ground in large quantities, will be found a good preservative against the club, as well as a good manure. Soot is also a valuable assistant to this end. It is evident broccoli grow larger and finer on the ground where they are first planted than when they are taken up and replanted; but, notwithstanding all this, it is better to have less than trust too much to the former method, and get none at all. Therefore, we recommend you to take up the latter sorts about the beginning of November, with as much soil to their roots as possible, and lay them in the ground in a sloping direction towards the north, with their heads a few inches above ground, and about eighteen inches distant from each other in every direction. The crown of the plant, by being thus laid low, will soon be covered with snow, and protected thereby from severe frosts; it also becomes tougher in fibre, and hardier, by the check received in its last removal. In cutting broccoli, five or six inches of stalk and leaves should be retained along with the head. After cutting, most of the sorts produce fine sprouts from the stems, which should be gathered when ready, and are, when boiled, little inferior to asparagus.

Brussels Sprouts.—This plant produces an elongated stem from which proceed small heads, resembling miniature cabbages, each being from one to two inches in diameter, the whole ranged spirally along the stem, the main leaves of which drop off early. The top of the plant resembles the savoy when planted late. It has a small heart of little value. The sprouts are used as winter greens.

Culture.—This plant is raised from seed, which should be sown from the end of March to the end of April, on an open border, possessing a favourable aspect. They require the same treatment in every respect as the Borecole, with this exception, that they need not be planted so wide either between or in the rows. The sprouts may be gathered at any time after they are large enough. Seed may be saved in the same manner as from any other of the cabbage tribe.

The Cabbage.—This plant is too well known to every one to render any description necessary, save that of saying it produces firm compact heads, varying in size, according to the soil in which they are grown, from three to fifteen inches in diameter, and from two to twenty pounds in weight. The varieties of this plant or vegetable are numerous; but as there is so much sameness in many of the sorts, we intend merely to describe a few which we consider to be an acquisition, and they are as follows:—Early York, Battersea, Sugar Loaf, Early Imperial, Early Fulham, Drumhead, and East Newk of Fife. For the first early crops in May and June, the Early York, Battersea, and Fulham are the best in our opinion; and for later supplies the Imperial, Drumhead, and East Newk of Fife. The latter cabbage when true is one of the best in cultivation; but it is a very difficult sort to get hold of. Attention should be paid to the time of sowing, or, in other words, seed should be got into the ground about the second or third week in August, neither sooner nor later; for, if sown sooner many plants will run up to seed before they are any size, and if sown later will not acquire sufficient strength to enable them to stand over the winter so well as if advanced a little in growth. Should it prove to be the case that winter will destroy the greater part of the autumn-sown plants, as it frequently does, a succession should be sown about the first week in February, or as soon after as possible, weather permitting; the same sorts may also be sown at this season as in August. If a few could be raised on a slight hotbed, great advantage would be obtained, and we see no reason why it should not be done in nine cases out of ten. For successional summer and autumn crops, a little seed of the Early York, Imperial, Battersea, Fulham, and Sugar Loaf may be sown with advantage. Many of the larger kinds should also be sown at the same time for cabbaging between the months of September and December.

Culture.—All the sorts are propagated from seed annually, and for a bed of the earliest kind, four feet wide and twenty long, two ounces of seed will be required, and for the larger and later kinds, one ounce of seed will be sufficient for a bed the same size. The soil most suitable for seed beds—that is to say, the beds in which these plants are to be raised—is light, but not very rich, loam, and the situation open and free. Each sort should be sown separate as a matter of course, and as regular as possible, and the seed raked lightly and evenly in; and, provided the weather be hot and dry, it will be necessary to administer a little water, and also to shelter the plants with mats, until such time as the seedlings have made their appearance above ground, in order to keep the soil moist, as well as to prevent the feathered tribe from “reaping where they did not sow,” or, in other words, from feasting on the seeds. The mats must be taken off as soon as the plants are fully up; otherwise they would be drawn up long-shanked and weak. It will likewise be necessary to give a moderate watering whenever such an operation be deemed necessary. As regards transplanting, we can only say that when the plants have three or four leaves they should be transplanted, either into nursery beds of good rich soil, four or five inches apart in every direction, and immediately watered to settle the soil to the roots, or into their final situation, which is decidedly the best when an early crop is desired. Plant each sort separate in good rich mellow ground, well open and exposed to the sun, in rows eighteen inches apart, and the same distance asunder in the rows. Let them be inserted with a dibble, setting the stems quite down to the leaves, and close the soil fast about each plant—a portion of the work much too frequently neglected; for, where they are not made fast, and the ground is subject to snails, slugs, and other vermin, as most land is more or less, such plants are sure to be attacked, generally below the surface of the soil.

DOMESTIC MEDICINE.

COLIC.

THIS disease consists in a painful contraction of the intestines. It is not an unfamiliar complaint, and it comes on so irregularly, and is withal so often amenable to domestic treatment, that we may properly discuss it here. It is characterised by sharp twisting or griping pain in the belly, similar to that which follows the taking of opening medicine. It is often accompanied with more or less flatulence and distension of the bowels. There may or there may not be vomiting. Generally the bowels are confined rather than otherwise. The skin is cool, or cold, and the pulse is not quickened.

Causes.—These vary. Sometimes it comes on without any apparent cause, when it may be due to cold; but generally, it may be traced to some irritating articles of diet, such as veal or pork, or green vegetables, or unripe fruit, or other acid or irritating substance. Constipation may be the cause of it, the accumulation of matters that should have been removed irritating the intestine.

Treatment.—This will vary according to the cause. If any improper food has been unwisely taken, it should be got rid of either by vomiting or by a little mild purging. If the food has been taken quite recently, warm water taken freely will tend either to bring it off the stomach, or to allay the pain; if food has been taken some time previously to the pain setting in, a mild laxative, such as the following, may be taken in water:—

Powdered rhubarb	10 to 20 grains.
Magnesia	10 to 20 grains.
Powdered ginger	2 grains.

Hot fomentations should be applied over the stomach. If the pain is very severe, five to ten minims of tincture of opium may be taken in peppermint water, by an adult. If the pain persists longer, or there is any doubt about its real nature, advice should be taken.

A COMMON COLD.

This is one of the most common and familiar diseases which the body is subject to—if, indeed, it can be called a disease. It is a fair specimen of what we may call a case for domestic treatment, as doctors neither care much to be consulted, nor patients to consult, about a matter generally so simple. And in another sense it is scarcely a disease; it is the equivalent, in the physiological condition of the body, of the meteorological condition of the place, of the spot upon which we happen to be living when we catch cold. For all this, a common cold is a great nuisance and inconvenience, and we shall say a few words to illustrate the nature, the causes, and the treatment of it.

Nature and Symptoms.—A cold in the head is a congestion or an inflammation of the mucous membrane of the nose, the back of the nose, the eyes, and the air-cells connected with the roof of the nostrils; it may extend to the back of the throat and the chest, or beginning in the chest and throat, it may extend from them to the head. In the throat or chest it causes soreness, or coughing, with a general feeling of chilliness. In the head it is known by sneezings; by great discharge from the nose, first of thin watery fluid which saturates the handkerchief in no time, and then of a thicker and more yellow matter which doctors call *pus*, more or less freely intermixed with mucus. In many cases there is a sense of tightness and dull aching across the forehead, which arises from the swollen condition of the mucous membrane that lines the nostrils and the air-cells at the root of the nose, and between the eyes. There is, of course, every variety in the amount and severity of this congestion or inflammation of the mucous membrane of the nose and neighbouring parts, which constitutes a cold, and in the

quickness with which different persons throw it off. In some it is a trifling affair, lasting for a day or forty-eight hours; in others, it does not entirely go away, but remains, more or less, for days or weeks.

ANIMALS KEPT FOR PROFIT.—CATTLE.

MANAGEMENT OF A COW ON A SMALL OCCUPATION—VIZ., THE FAMILY OR COTTAGER'S COW (*continued*).

WHEN we have added that the animal should be sold or fatted off in good time, before she becomes unprofitable, we have said all that we think is needful concerning the cottager's cow. But we cannot omit to remark, that much good might often be done by assisting a labouring man thus to start a miniature farm, and aiding him with judicious advice in the management of it. Of course, it is indispensable to success that he either have much of his own time at command, or that his family can render sufficient help in the shape of labour; without this, even the free gift of a cow could only do harm. But if the experiment succeeds, as it ought to do in the right circumstances, an incalculable amount of good will be done. Not only will any mere money the cottager realises be richly earned, but the cropping of his land to such an extent as is needful to success will demand forethought and intelligence of a very high order, and can hardly fail to give habits of method and economy in other matters, which will go far to make the man a valuable member of society, and may affect all his future life. It will not do, however, to pursue this subject further.

For the *family dairy* the best method of management will generally be very different. In this case there is usually an orchard or small paddock in which the cow can be grazed, and a good lawn in front of the house; while such incessant labour as we have been considering, in order to save any actual expenditure of money, will probably be felt to be neither necessary nor desirable. But even here there may be a good or a bad system of keeping a cow.

We must still suppose a shed or stall with the conditions already described; but the management will vary somewhat according to the extent of pasturage. If it be abundant and of good quality, the cow or cows will be turned out to grass after milking, and only tied up at dark, through all the summer months; or, indeed—if a rude shed be provided for shelter to which they have constant access—may remain in the paddock altogether until the approach of colder weather makes return to the more sheltered stall advisable. A portion of the grass, if extensive, or the whole if limited, must however be preserved for hay; and if there be *enough* of this, very little winter food will need to be purchased. If the cows have to be stalled while the hay is growing, or at other times when the pasturage may run short, the cuttings from the lawn will help out the supply; and in some cases this simple plan of depending almost entirely upon pasture and hay will give the least trouble, and may be the best for that reason, though hay is upon a farm the most expensive food a cow can have. Or the animal may be kept stalled, and fed with cut grass, which does not involve a great deal of trouble, and saves very much pasture. The truly

excellent manure made on the stall-fed system will be very valuable in the garden, while the pasture is easily kept up to the mark by a slight dressing of artificial manure or bones. On such a system, with the purchase of a little straw, and a few turnips if needed, and perhaps a little oilcake, a cow or two may be kept with the minimum amount of trouble, and the produce will generally exceed the expenses.

If the pasturage be more limited, however, in fact unless there be about *three* acres of *good* grass for each cow, such a system of grass feeding will not answer; the milk will fall off; and in the early spring the cows will be pictures of Pharaoh's lean kine. But even here two methods are available, if labour and garden ground be at command. The pasturage or cut grass may be supplemented by green crops or roots grown on the cottager's system; or, if neither be at disposal, turnips or mangolds, and straw, can always be purchased. The latter plan will be a little more expensive, but will give scarcely any trouble, as it will be only necessary to pulp the needful quantity of straw, chaff, and roots daily, and feed the cows on this as described in a former paper.

In all these cases a little oilcake may be added at discretion, but with judgment. Many cows, chiefly common breeds used to spare diet, never repay it; the choicer breeds often repay it nearly double; and, as in the case of the farmer, care should be taken that, when running dry before calving, the food is lowered by diminishing the roots or green food and oilcake, and increasing straw.

But there is yet one more set of circumstances in which it is sometimes advisable to keep a cow. We allude to the frequent case of a large family, having *no* pasture, and *no* ground either which can be devoted to food for the animal, or very little; but having, perhaps, a small garden which can profitably use all the manure, room for a stall, and accessible markets; while the *impossibility* of getting genuine milk makes it highly desirable for the children's sake to try the experiment. And it can be done. Large dairies in London are maintained, where all the food is *bought* and all the cows are stall fed, at a considerable profit; and the same system will avail in the circumstances we describe, though, of course, less method and attention will affect the results. There will, in fact, be only seldom a small profit, more frequently the receipts will about balance expenses, and generally there may be a small loss; but this will often be cheerfully borne for the sake of the advantages to be gained.

The staple food in this case will be still chaff and roots, which may either be pulped and mixed together, or the chaff may be given separately, well steamed, with about 4 lbs. of rape or other oilcake and 2 lbs. bran daily mixed in it, and the whole well steamed; 1 to 2 lbs. bean or Indian meal added will keep the cows in good condition. The steamed chaff must be given, as much as they will eat; and when they have finished, from 30 to 40 lbs. green food and roots per day should be put in the troughs, of course a portion only after each meal of chaff. Such liberal feeding is expensive; but will give a good yield of milk in return; and that is followed by several very successful dairy managers. A small portion of hay should always be given morning and evening, and the roots helped with cut grass from the lawn or other sweet green food whenever

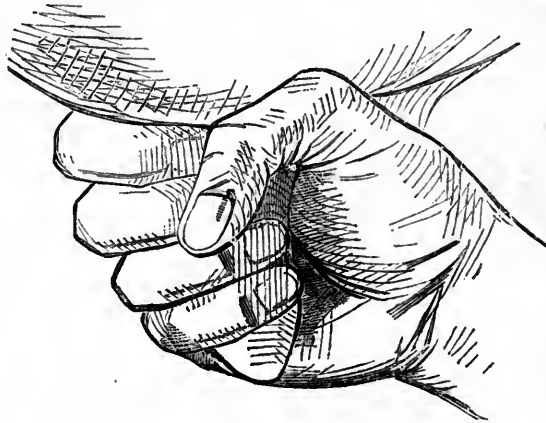

Fig. 1.

possible. Grains also are a valuable resource, and are always used by the London dairy-keepers; but must be used with moderation, or the milk will be thin and watery.

Roots, especially mangold or turnips, are sometimes said to cause bad tasted butter or even milk. This will seldom be the case if the cows are put on root diet *gradually*, and if the roots be only given *after* milking, never within some hours before. If any taste be still perceived, a little saltpetre as before advised, or a tablespoonful per gallon of milk of a weak solution (half-ounce to one gallon of water) of chloride of lime, will effectually remove it.

For such stall-feeding, the great experience of the London dairymen is a sufficient proof that the best breed is a cross of the shorthorn with the old Yorkshire cow. For pasturage the best family cow we believe to be the Breton; but this breed has hardly been yet tested as a stall-feeding cow.

It may be well, in concluding this paper, to say a few words about *milking* a cow. We have already remarked that it is of the greatest consequence *all* the milk be drained from the udder; if this be not done the quantity steadily diminishes, and, moreover, the last milk is nearly twice as rich as the first; that is, the same quantity of it will make almost double the quantity of butter. Even the method of milking will influence the yield, and we believe disappointment and disgust in amateur cow-keeping to have been not seldom caused by allowing some favourite child, as a treat, "to milk the cow." It must be borne in mind, that if the yield be once deteriorated by an ignorant milker, although a clean hand may bring back a portion, the cow never recovers fully till she has had another calf. Hence the milking should always be kept in the same hands, for cows will never stand quietly to be milked by anyone they fear or dislike, and their restlessness injures the quality—to say nothing of the great risk of their kicking it over. The legs may be tied certainly, but a cow which requires this will seldom give satisfaction. It is the gentle quiet cow, in the hands of a really good milker, which can alone be *expected* to repay her cost.

It is difficult to describe the process, though it may be easily learnt by most persons with a little teaching. The teat operated upon should be enclosed between the fingers and the palm of the hand, by no means tightly, but a little more so towards the tip of the teat than higher, while the upper part of the hand and the thumb actually include the part of the udder itself next the teat. Then the whole hand is passed downwards, the thumb and forefinger gently squeezing the teat between them as they go. (See Fig. 1.) The utmost gentleness and tenderness must be observed; and anyone, observing this caution, can scarcely fail with ordinary intelligence to become a good milker. Still, for the reason we have stated, it is advisable that only *one* should meddle with the cow; for, if otherwise, though all might learn perfectly, the cow would be spoiled for that season during the process. In case of no one being able to milk the cow safely, the *milking machine* may be adopted, which has been used on large farms with great success.

THE HOUSEHOLD CARE OF BOOKS.

To the question, "What should be done with books?" the most obvious answer is, that they should be thoroughly read; which is perfectly true, and we entirely agree with it. But books are not merely vehicles for information; they are also articles of decoration and furniture, and as such, require some consideration at our hands. They have so much become a necessity in modern life, that no room looks complete unless books are present, and no one who cares for their contents can be wholly indifferent to their outward appearance. It is of the bodily (so to speak), and not of the mental, part of books that we are about to treat.

As a general rule, books should never be allowed to lie

about. More injury is done by carelessness in this respect than by much reading. When one is done with, it is always easy to replace it on the shelf. They suffer much from dust, and should be exposed to it as little as possible. A foot of glass costs but twopence, and will secure twenty-five ordinary octavo volumes; it should always be used to protect small collections. In large collections, where this is impossible, dwarf curtains of leather or some cheaper substitute, hanging from the shelf above to the tops of the volumes, prevents the passage of dust. They should be allowed to fall as low as possible without hiding the titles, and it is found a good plan to slit them half way up at intervals of two or three inches, which admits of the volumes being taken out and replaced readily. Another expedient is a roller-blind in front of large book-shelves. This can be drawn down at night and secured at bottom with a padlock, and the books thus saved from the worst dust—that caused by the housemaid in the morning, as also from the literary researches of the same individual, which would, if made, be inevitably with dirty fingers.

Few things are more annoying to those who have proper feelings of respect for books than to see such as are intended for grown persons used as toys by children. Children should have their own books; enough are published at sufficiently low prices for all ages. Little children delight in pictures. Give them picture-books lined with calico, which they cannot tear, as they will do if tearing be possible. When they are old enough to feel an interest in stories, give them story-books. Children, as a rule, are sufficiently appreciative, and will not injure such as they understand and love; but on no account let them make free with your own books. As a matter of discipline alone this is well—that the child should confine itself to those things proper for it.

As magazines are to most of us almost as necessary as daily bread—being, indeed, the only form in which literature is practically available to persons actively engaged—we must devote a few lines to them. In the first place, the first reader has no right to disfigure them by careless cutting; a proper paper-knife is a cheap luxury, and within the reach of all. Neither should they, when read, be left lying about, to be soiled and tumbled by the careless hands of children and servants. A particular shelf always can and ought to be devoted to their reception, and when the volume is completed let them at once be bound. There are few magazines for which cheap cloth cases are not published, and any periodical worth taking in is worth the expense necessary to its preservation. A quantity of unbound magazines is always found to be in the way; numbers are always liable to be lost, and a whole set thus rendered incomplete and worthless.

Of such acts of vandalism as turning down the corner of a page, or laying a book open with its face to the table to keep a place, we could wish it were unnecessary to speak. Of those who persist in so-doing we can only ask, "Is there no such thing as paper, that you may insert a slip?" In the case of books wanted for frequent reference, it has been found convenient to paste little slips of paper at the more important sections or passages, with a sufficient projection beyond the margin to admit of the leading word of the passage or section being written. Much time and trouble may be saved by this simple plan in making references.

Thus far we have dealt only with the preservation of books. What has been said may seem simple and common-place, but these little things are quite important enough to be worth mention and attention. We shall now speak of books which have already suffered damage from age, carelessness, or accident, and first as regards their interiors.

Removing Ink Spots.—Ink spots or writing may be removed by applying spirits of salts, diluted with five or six times their bulk of water, which must be washed off

with clean water a minute or two afterwards; or a solution of oxalic acid, citric acid, or tartaric acid will answer the same purpose. Neither of these will affect the printing.

Iron-mould Spots may be removed by applying first a solution of sulphuret of potash, to render the iron soluble, and afterwards one of oxalic acid.

Grease Spots.—To remove grease spots, lay powdered pipe-clay on both sides of the paper, and apply an iron, as hot as it can be made without scorching the book. This is also good for taking grease stains from coloured leather bindings. Another plan is to moisten the spot with ether, and treat the paper in the same manner as above, with the hot iron between sheets of white blotting-paper. When the grease has been extracted, all trace of stain can be removed by drawing a brush, dipped in rectified spirits of wine, over the spot, and more particularly round its edges. This will not affect common or printer's ink.

Bleaching the Paper.—If the paper has become yellow through age, water-stains, or other causes, it may be bleached by immersion in a bath of oxy-muriatic acid or chlorine, and afterwards well rinsing in clean water. Ordinary ink-marks will be removed by this, but not the printers' ink.

"Dogs' Ears."—In old books which have been much dog-eared and ill-used, the paper is often found in a very weak and flimsy condition. To strengthen it, make a solution in the proportion of one quart water, one ounce isinglass, and a quarter pound alum. With a camel-hair pencil moistened in this, damp the weak parts of the leaves and carefully spread out the dog-ears and creases. Then place a piece of clean paper to keep each leaf separate, and when the leaves are somewhat dried, press them. This of course requires patience; only a few leaves can be done at a time.

Torn Leaves.—If the leaves are torn, it will be necessary to mend with paste and paper. Bookbinders' paste is made of wheat-flour boiled till the starch is converted into gum, with one-sixth of powdered alum; gum-arabic or glue is sometimes added to give greater strength. In case the paper is torn away at the margin, slips may be pasted on. If old paper to match the colour of the book is not at hand, new paper may be stained with weak coffee to the required tone. Should the printed matter be torn across in such a manner as to render it necessary to paste paper over it, ordinary tracing-paper should be used, which will allow the type to appear.

INMATES OF THE HOUSE.—LEGAL.

HUSBAND AND WIFE.

OF private relations subsisting between human beings, the first in importance is that of master and servant—the second, that of marriage; which, in the words of a great lawyer, includes the reciprocal right and duties of husband and wife. What this right is, and what these duties are, it will be in this paper our task to discuss. In the first place, however, it will be necessary to state how and by whom marriage may be contracted.

The English law looks upon marriage in no other light than as a civil contract; and the law applies to it generally the ordinary principles which attach to other contracts, allowing it to be good and valid in all cases in which the parties, at the time of making it, were, in the first place, *willing* to contract, secondly, *able* to contract, and lastly, *did* contract in the proper forms required by law.

The first proviso we need not discuss.

As to the second, all persons are able to contract marriage, unless they labour under some particular disabilities and incapacities.

The first of these disabilities is a prior marriage, of

which marriage the husband or wife is still alive. The second is want of age. The latter proviso holds good in all other contracts on account of the imbecility of judgment in the parties contracting. The age fixed by law for consent to matrimony, is fourteen in males and twelve in females, and supposing a marriage contracted by persons under these ages respectively, either of them upon coming to the age of consent aforesaid, may disagree and declare the marriage void, but if at the age of consent they continue to agree together, they need not be married again.

What is above stated must be understood as applying solely to the actual marriage contract; but a promise to marry—which, like other contracts, will give a right of action for damages in case of its breach—is not binding unless the party who makes it be of full age, viz., twenty-one. And when two persons, one of full age and the other under, enter into a contract of this kind, the former is liable to an action for damages if it be broken, whilst against the minor under similar circumstances no action will lie.

Another incapacity arises from want of reason, without which the matrimonial contract is not valid; this will, however, not be cause for divorce if the insanity arises after marriage; so that as the law stands, the marriage of a lunatic, unless in a lucid interval, is absolutely void. As, however, it was found difficult to prove the exact state of the party's mind at the actual celebration of the nuptials, a statute was passed by which the marriages of all lunatics or persons under frenzies—if found so by a commission appointed for that purpose, or committed to the care of trustees, by an Act of Parliament—were declared void.

A fourth incapacity is in respect of proximity of relationship; that is, the fact of the parties being within the prohibited degrees of consanguinity. These degrees, however, are too well known to require more than the mere mention of them. Any two persons, therefore, not labouring under any of these disabilities, may contract themselves in marriage, provided that they do so in conformity with the law. We will now inquire what the law on this head is.

The different modes by which the marriage contract may be entered into, are by *banns*, by *special licence*, by the *ordinary's* or *surrogate's licence*, by the *superintendent registrar's certificate with licence*, or by his *certificate without licence*. These we will explain in turn.

An Act passed in the reign of George IV.,* prescribes, previous to a marriage, the publication of the banns upon three successive Sundays in the church or chapel where the ceremony is to be solemnised, or instead of this, a licence from the ecclesiastical authority to marry without banns—that is, either a "special" licence from the Archbishop of Canterbury, or a "common" licence from the ordinary of the place or his surrogate; at the same time it ordains that no licence shall be granted to marry in any church or chapel, unless one of the parties has had his or her usual place of abode in the parish to which the church or chapel belongs for fifteen days immediately preceding; that all ministers are forbidden to solemnise marriages more than three months after the complete publication of the banns, or grant of licence; that the marriage, whether by banns or licence, shall be in a church or public chapel where banns may be lawfully published, and shall take place between eight and twelve in the forenoon (except in the case of a special licence), and shall be solemnised by a person in holy orders, and before not less than two credible witnesses. Moreover, as it is deemed expedient that no facilities shall be given to persons under the age of twenty-one to intermarry without the consent of parents or guardians, the Act also orders that, in the case of the publication of banns of a person under the age of

* 4 Geo. IV., c. 76.

twenty-one not being a widow or widower, if the parent or guardian openly express his dissent at the time they are published, the publication shall be void. It also enacts that no licence to marry without banns shall be granted, unless oath shall be first made by one of the parties, that he or she believes there is no impediment of kindred or alliance, or of any other lawful cause; and, moreover, that one of the parties to the contract has, for the space of fifteen days immediately preceding, had his or her usual place of abode within the parish in which the marriage is to take place; and that when one of the parties is under twenty-one, that the consent of the person whose consent is required, has been obtained, or that there is no person living who has authority to give such consent. The consent required by the Act must be given by the father, or if he be dead, by the appointed guardian. If there be no guardian, then by the mother if she is unmarried, and if there be no mother unmarried, then by any guardian appointed by the Court of Chancery.

Although these formalities are prescribed by the law, and in case of their neglect penal consequences may ensue, the marriage is not necessarily void which is not concluded precisely according to the provisions above related. In the following cases, however, the marriage will be void:—If any person shall intermarry without due publication of banns in any other place than a church or chapel where banns may be lawfully published, unless by special licence; or shall intermarry without due publication of banns, or without a licence from a person who has authority to publish or grant such banns or licence; or shall consent or acquiesce in the solemnisation of marriage by any person who is not in holy orders. The statute, however, applies only to those who commit such errors wilfully, and with full knowledge that what they do is against the law.

By *Special Licence*, it must be understood, a marriage may take place at any hour and at any place.

We have now to consider how a marriage may be contracted by means of the *Superintendent Registrar's Certificate without Licence*.

Notice must be given by the person intending to be married by this means to the superintending registrar of the district within which both the persons about to marry have dwelt for not less than seven days; or if they have lived in different districts for that time, then to the superintending registrar of each district. This notice will be entered in a book called the "Marriage Notice Book" (which may be seen by any one), particularising the church or other building in which the marriage is to be solemnised. The person giving the notice must add that he or she believes that there is no lawful impediment; that both parties have lived in the district for seven days previously; and that consent to the marriage from the person (if any) required by law has been obtained. This notice is placed in the registrar's office for twenty-one days after it has been entered in the notice-book, during which time any one who has authority, may forbid the issue of a certificate that the marriage has been duly entered, by writing the word "forbidden" opposite the entry in the notice-book. If, however, no such impediment has been made after the expiration of twenty-one days, the registrar may issue his certificate, which expresses that notice of the intending marriage in such a church or building has been duly entered, and that it has not been forbidden by any authorised person; for which certificate the registrar receives the fee of one shilling. Then the marriage may take place at any time within three months from the entry of the notice, in the church or registered building specified. The parties to the contract may, however, if they choose, be married at the *office* of the superintendent registrar, when the ceremony must take place in his presence and in that of some registrar of the district, and before two other witnesses, with open doors and between eight and

twelve in the forenoon, in which ceremony no *religious service* may be read.

A person desirous of being married by the *superintendent registrar's certificate with licence*, is to give notice and obtain a certificate as in the former case, with these distinctions:—

If both persons do not dwell in the same district, notice need not be given to the superintendent registrar of each district, but only to the superintendent registrar of the district in which one of them resides. The notice must state that the person making it has lived for fifteen, not seven days, in the district in which the notice is given.

The notice is not hung up in the office, and the certificate may be granted at the expiration of one day, instead of twenty-one days, after the entry of the notice.

Such are the various methods by which marriage may be contracted. We will now discuss the rights of husband and wife with respect to property.

Unless the property which a wife may possess at the time of her marriage be settled on her, the husband becomes the absolute owner of her personal property; *i.e.*, her property other than freehold estates, and this personal property he may dispose of as he wills, and after his death his wife will have no claim to it. The wife may, however, claim as her own, her necessary clothing, and all gifts of jewels and trinkets presented to her by relations and friends upon or after her marriage, and these she may dispose of as if she were unmarried, and they cannot be touched by her husband or his creditors, unless her husband survives her, and they are otherwise undisposed of. She may also claim her *paraphernalia*—that is, her wearing apparel and jewels suitable to her station in life; but gifts of jewellery from her husband made before or after marriage, she cannot claim until his death. During his life he may sell, pawn, or otherwise dispose of such articles, and although he cannot leave them to any one by will, they are liable to his debts both before and after his death.

The husband is absolute owner during his wife's life of her *leasehold* property, although he cannot dispose of it by will; so if he dies before her it will revert to her, whilst if he survives her it will become his absolutely.

If the wife is possessed of freehold property at the time of her marriage which has not been settled distinctly upon her, the husband has what is called a freehold interest in it during their joint lives; that is, he is sole tenant, and can lease, mortgage, or otherwise dispose of them to the extent of his interest in them. In such cases if he survives his wife, and has had issue by her capable of inheriting the property, he is tenant for the rest of his life in all her freehold estates. Such cases, however, occur rarely, as it is usual for a settlement to be drawn up on behalf of the lady before her marriage.

Now all settlements must be in writing, as well as all agreements for a settlement. Settlements may be made before marriage or after marriage, and the latter may be made in pursuance of an agreement for a settlement made before marriage. A settlement made before marriage in consideration of (*i.e.*, with a view to) marriage, holds good against every claim; it cannot be impeached (unless it can be proved to have been drawn up in a fraudulent manner), even by creditors of the husband or wife. The same law applies to a settlement made after marriage, if drawn up in pursuance of an agreement for a settlement entered into before marriage.

A settlement made after marriage, unless in pursuance of an agreement beforehand, cannot bar the claims of existing creditors, nor those of subsequent ones, if it is made with the intention of defeating their future claims; if, however, it be made without fraudulent intention by a husband not indebted at the time, the settlement will bar the claims of subsequent creditors, unless the husband becomes bankrupt within the space of two years afterwards.

A settlement made by the husband on the wife after marriage *without* a prior agreement, is valid only when it is made for what the law terms a *valuable consideration*; for instance, supposing the husband obtained possession of property to which his wife was equitably entitled, or received a sum of money paid by her relations as an addition to her portion, he would be able to settle an equivalent sum of money on her which would hold valid against his creditors.

If a husband dies without having previously made a will, and in absence of a settlement, the wife is entitled to a life interest in the freehold lands and houses which he possessed; if he dies without a will and without issue, she is entitled to one half of his personal property; that is, property in money, goods, &c.; if, however, he dies without a will, but leaves issue, she is entitled only to a third part.

Such is a brief synopsis of the law as regards property, the next step to be discussed is, how far a husband is liable for debts contracted by his wife.

The husband (unless he is an infant) upon his marriage takes upon himself all his wife's debts and liabilities, but he is not liable for bills or bonds given before marriage *without value*; on her death, however, if they have not been recovered in a court of law, his liability ceases. If the husband dies before the wife, she is then liable for all contracts made before her marriage.

So long as the married couple live together, the wife is presumed to have her husband's authority to make contracts for the supply of articles, &c., suitable to her and his station in life. If, however, he is in the habit of supplying such articles, &c., to his wife, and this fact is known to their tradespeople, either by notice from him or otherwise, the husband is not bound to pay debts contracted for such articles.

If a wife leaves her home with her husband's consent, or by reason of his ill-usage, and without misconduct on her part, and he makes her no allowance, he is liable for necessaries supplied to her even by those tradesmen whom he has warned against her. When a husband and wife are living apart, it is the business of the tradespeople to inquire into the circumstances of the case before trusting the wife, as a husband is by no means bound to give notice to them of the separation. A husband may give authority to his wife to act as his agent, as he may to any other person, and in this capacity she may collect rents, pay money, sign cheques, draw bills, &c., for which he will be answerable until he revokes the authority.

By an old custom of London, a wife carrying on a business in the City without any interference from her husband, may be sued for all her debts and contracts as if she were single; and although the same liability is incurred by a wife whose husband is outlawed or convicted of felony, he can claim the earnings of her own personal labour after his punishment has expired. Hard as this case may be, if a husband deserts his wife and leaves her destitute, she may obtain an order from a police magistrate, or from the justices in petty sessions, or from the Divorce Court, to protect any money or property which she may earn or acquire after the desertion, against her husband or his creditors; that is, provided that she is supporting herself by her own industry. If, however, she allows him to return after the order has been given, he may claim the money or property she has acquired.

It used to be laid down in old law books, that it was allowable for a husband to administer moderate correction to his wife; for as he had to answer for her misconduct, the law thought it reasonable to entrust him with the power of restraining her by domestic chastisement; now-a-days, however, such a proceeding on the part of the husband is never tolerated, and an ill-treated wife may obtain security of the peace against her husband, or otherwise a husband against his wife. In cases of the wife's gross misconduct, the husband can restrain her liberty.

ODDS AND ENDS.

To clean Oilcloth.—Sweep off the dust; wipe with a clean flannel; wet over with milk; rub with a dry cloth until bright. This is a simple and effectual method.

To take out Ink Stains from Mahogany.—Oil of vitriol with water, in the proportions of one of the first to about two of the last, may be used for this purpose. Dip a feather into it, just touch the stains with the end of the feather, and *at once* rub it quickly off. In most cases the ink stains will be removed with it; if this, however, should not be the case, repeat the process. If the vitriol is not at once rubbed away, there is a probability of its merely substituting one defect for another—a white mark for a dark stain.

To clean Paint.—There is a very simple method to clean paint that has become dirty, and if our housewives should adopt it (says the *Scientific American*) it would save them a great deal of trouble. Provide a plate with some of the best whitening to be had, and have ready some clean warm water and a piece of flannel, which dip into the water and squeeze nearly dry; then take as much whitening as will adhere to it, apply it to the painted surface, when a little rubbing will instantly remove any dirt or grease. After which wash the part well with clean water, rubbing it dry with a soft chamois. Paint thus cleaned looks as well as when first laid on, without any injury to the most delicate colours. It is far better than using soap, and does not require more than half the time and labour.

Jewellers' Doublets, &c.—Under the name of "doublets" are included certain partial or complete imitations of real gems. Inexperienced persons frequently purchase these doublets as genuine sapphires, rubies, emeralds, &c. Some of them have the top of the stone genuine and the under part glass—the two being so skilfully joined by cement that the division cannot be seen. Formerly doublets were sometimes made of glass, cut to resemble real stones, but formed of two pieces, between which colouring matter was introduced. More frequently, or, at all events, more successfully, two pieces of crystal were joined and set to imitate particular gems. In other cases a doublet consists of the upper portion genuine, and the lower of some inferior stone, rendering it very difficult to detect the fraud. Ordinary purchasers may be easily imposed upon by these imitations, and even dealers are sometimes deceived. Where glass is used and can be got at, a file will act on it, which is not the case with real gems. In certain cases, doublets can be detected by holding them up to the light and looking at them edge-wise, poised between the finger and thumb. But since these counterfeits are so numerous and valueless, as compared with genuine jewels, it is desirable that purchasers of costly rings and the like should have a written warranty with them. Real stones, when set with a back, have very frequently placed under them coloured foil to increase their beauty or to improve their colour. There are cases in which a piece of white crystal is backed with foil or colouring matter, so as to resemble something more valuable. We knew a case in which a gentleman who purchased of a London jeweller a so-called carbuncle ring, washed his hands with the ring on, and on drying them found it absolutely colourless. It was merely a piece of crystal, coloured at the back. Stones not of good colour are often "improved" by being set in silver, even when set open, or by being put in a setting which has been previously painted or enamelled. By such means the dealers obtain a greater price for their stones than they are actually worth, although real. To be forewarned is to be forearmed, and all purchasers of jewellery will be wise narrowly to inspect what is offered them for sale. Caution is, under such circumstances, the only safeguard against loss and annoyance.

THE HOUSEHOLD MECHANIC.

GAS METERS (continued).

The Dry Meter.—The radical defects in the wet meter, to which we have alluded, were discovered at a very early period of its adoption in practice. Various improve-

ments have, therefore, been introduced in its construction, with a view to remedying these defects. The basis of the evil being the water, attention was turned at an early stage to the construction of a meter which should work without that element, and the result has been the production of the dry meter. This meter is made of various forms, and consists of chambers separated from each other by partitions. Generally there are two, although some makers use three chambers. Each chamber is divided into two parts by a flexible partition which moves backwards and forwards, bellows-fashion, its motion being regulated by valves beautifully contrived for the purpose. The dry meter is largely employed by all the London and provincial gas companies, they are almost exclusively used in the United States, and are now becoming general on the Continent. The first dry meter was patented by Mr. Malam, in 1820, and consisted of a series of bellows combined on a shaft, but the plan

was never carried out in practice. Since Malam's patent, Croll and Richards, in 1844, and several subsequent inventors, have brought the dry meter to perfection. Among those who have been successful in perfecting the dry gas meter is Mr. Thomas Glover, of St. John's Street, Clerkenwell, whose meter we have se-

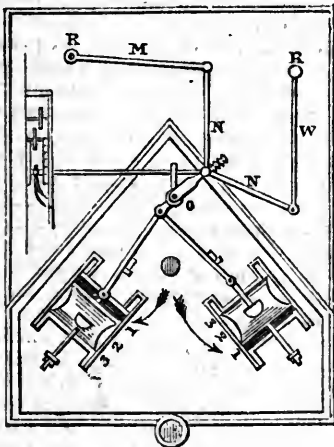

Fig. 2.

lected for illustrating our present description. This meter was invented in 1844, since which time upwards of 350,000 have been made, of various sizes, ranging from the smallest capacity up to those for registering 30,000 cubic feet per hour. One of these meters for supplying 3,000 lights was used in the Exhibition in Hyde Park, in 1851, and also in that of 1862. At Fig. 1 we give a front view of Messrs. Glover and Co.'s dry meter, the outer casing being removed to show the interior of the apparatus. Fig. 3 represents a side view of the interior parts of the

meter, whilst Fig. 2 shows the valve plate or upper portion of the meter.

Before proceeding to describe this apparatus, it will be as well to explain its general principles. These will be best understood by a reference to the action of the ordinary house bellows. By raising the upper leaf of this imple-

ment, an exhausting power is produced in the interior, and the external air raises the valve in the lower leaf and enters the body. Upon pressing the upper leaf down, the valve is closed, and the air is expelled through the nozzle of the bellows. If an arrangement were attached to the upper leaf for registering the number of times it had been raised and depressed, and if we knew the exact cubical contents of the bellows, we should be able to ascertain the quantity of air which had passed through them. Now, in the dry gas meter we have the bellows reproduced in a different shape, the gas being measured by the alternate expansion and contraction of the chambers. Referring to Fig. 1, we first notice the inlet pipe I, by which the gas passes to the interior of the meter E, being the outlet pipe by which it is conveyed to the burners after it has passed through and has been measured by the meter. The index which registers the quantity of gas used is seen at T on the top of the meter. Bearing

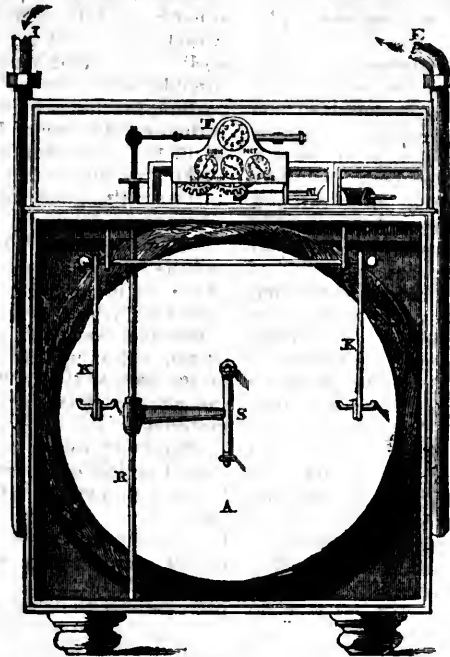

Fig. 1.

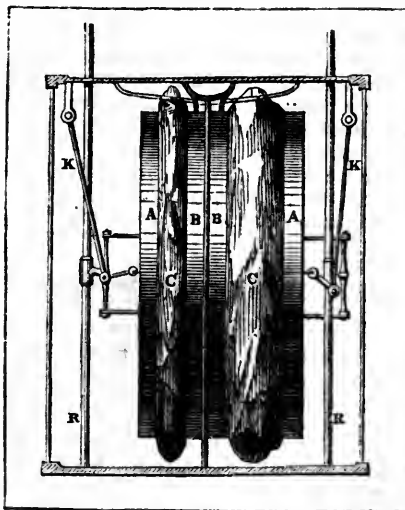

Fig. 3.

in mind the bellows-like action to which we have referred, we will now turn to Fig. 3, where we see a fixed vertical plate dividing the meter down the centre, and preventing gas passing from one side to the other. To the centre plate are attached rings, B B, to the edges of which are fixed flexible bands, C C, which are also united to the rims of the discs, A A. These discs move alternately backwards and forwards; at each motion they receive and discharge their cubical contents of gas. The two valves, through which the gas passes to and from the measuring apparatus, are shown at Fig. 2; they are termed D valves, and the gas is received and discharged through openings at 1, 2, 3. The discs A A are fitted with jointed levers, which communicate motion to the vertical rods R R. These rods in their turn give motion to the arms M, W (Fig. 2), each of which arms describes a segment

in mind the bellows-like action to which we have referred, we will now turn to Fig. 3, where we see a fixed vertical plate dividing the meter down the centre, and preventing gas passing from one side to the other. To the centre plate are attached rings, B B, to the edges of which are fixed flexible bands, C C, which are

of a circle. The connecting rods, N N, are attached to these arms, and they impart a rotary motion to the double crank O. This crank gives motion to the two D valves, which alternately admit and remit the gas to and from the chambers of the meter. K K is a parallel motion which ensures the true working of the rods and levers. The valves are so arranged that whilst one chamber is receiving gas, the other is discharging its contents. The gas, acting as the motive power, passes through one valve into one chamber, which it fills, and, by means of the mechanism we have described, the second valve is opened just as the first valve closes. The second chamber now begins to fill, and the first to have its contents expelled through another passage in the valve. A continuous and steady flow of gas is thus maintained, as both chambers are alternately filled and emptied. The space through which the discs A A travel defines the cubical area in which the gas is measured, and the capacity is adjusted with such accuracy, that precisely the same quantity of gas is received and discharged at each alternate opening and closing of the chamber. The index T is worked by a spiral wheel fixed on the crank spindle O. The index itself is similar to that of the wet meter, consisting of a simple train of wheels and pinions with pointers working round three dials, and indicating in the same way as that already described.

The action of the dry meter will be seen from the foregoing description to be somewhat similar to that of a steam engine. This resemblance is certainly striking when compared with the horizontal cylinders of a locomotive engine. Here the motion of the piston answers to that of the disc in the dry meter, the slide valves being used in the one case for steam, and in the other for gas, both serving the purpose of giving motion. The slide valve arrangement in the meter is highly ingenious. Having three apertures, one of them leads to the inside, and the other to the outside of the chamber, whilst the third communicates with the exit pipe from each chamber. On the whole, it will be seen that the dry gas meter possesses some very important advantages over the wet meter. It entirely dispenses with the use of water, so that it is not liable to derangement in frosty weather. When once adjusted, it gives no further trouble, and the gas in passing through it takes up no additional moisture to increase the risk of annoyance from deposit of water in the pipes. It does not require periodical attention, as does the wet meter, and there is no fear of a sudden extinction of the lights from an insufficiency of water.

INMATES OF THE HOUSE.—DOMESTIC.

LAUNDRY-MAID—WASHING AT HOME.

THE practice of washing at home, although greatly fallen into disuse amongst the middle class of housekeepers generally, is much to be commended, not only on the score of pocket economy, but also on sanitary grounds. The obstacles which are supposed to exist at the present time against the practice have but to be fairly confronted to be found of a very unreal character. The chief point to ascertain is whether the money spent in putting washing out cannot be better spent in other ways. Of course, if expense be no object, people have a right to indulge their inclination; but if the laundress's weekly bill can only be met by stinting food, and limiting the changes of linen to the most absolute requirements of cleanliness, then it becomes a serious question whether some personal sacrifice of comfort ought not to be endured for the sake of a substantial gain.

The invention of washing-machines has done much to obviate the main objection raised against washing at home, inasmuch as the time and labour saved by their use is reduced very considerably; but there still remains the preju-

dice to overcome in favour of its being more "genteel" to put all washing out. This false notion, in fact, is at the root of the general disinclination to resume a custom which certain obstacles may have caused to be relinquished, but which have no longer justly tenable grounds.

Like many other persons, the writer was induced, in a moment of weakness, to discontinue the labour of washing in her household, at a time when there was some difficulty in replacing a servant who had been accustomed to the work. From that hour, to resume the task appeared impossible, until the well-established reputation of certain washing-machines induced her to remodel her household, in the express view of having all the family linen washed at home; and after nearly six years' experience of the working of the washing-machine the writer has no reason to revoke the good opinion originally entertained of this substitute for manual labour. This is not the place to describe the process of washing by machinery particularly, and the instance is merely cited to point the direction in which an important matter of household reform may be accomplished.

Whether household washing be performed by machinery or not, a thorough knowledge of the process is necessary on the part of the mistress of a household, in order that the work may be dispatched without waste of time and material.

The day before a wash is intended, all the dirty linen should be looked up, sorted, and entered in a book, with the same precision as is observed when things are sent out. Any articles that are in excess—owing to the state of the weather or what not—should be thoroughly dried, folded, and put away, under lock and key, till a convenient season. Saturday afternoon is the best time for the above preparation; the clothes can then remain in soak till Monday, which greatly facilitates the removal of stains, &c.

All the best white linen should be put in a separate pan, or tub, and coarse things in another. Sufficient lukewarm, or cold soda and water should then be poured over the clothes.

Coloured things, flannels, and woollen materials should *not* be laid in soak. These require washing separately, piece by piece, when the work is in progress. Pocket-handkerchiefs should be first rinsed out, and the water thrown away before they are put in with the rest of the things.

The next arrangement to make should consist in shredding fine yellow soap into a jar capable of containing sufficient liquid, according to the amount of washing to be done. About a pound of soap to a gallon of water is a good proportion; no soda should be added. Having poured boiling water on the soap, cover the jar and set it aside on the kitchen stove, or range, till Monday morning, when the soap will be found to be melted to a jelly. When lukewarm, take some of this soap-jelly, and mix it in the water in which the clothes are to be washed. By this means a fine lather is easily produced without waste. About a pint of soap jelly to an ordinary tub of water will be sufficient. The clothes will require but trifling rubbing with hard soap in the very soiled places.

It is a good plan to begin a wash with the flannels. No soap is required for them beyond the jelly described, except for the cotton bands and tapes. Each article should be washed separately in moderately warm (not hot) water. Having washed them in one water, rinse them in clean warm suds, shake them out, and hang them on the lines at once. Never rinse flannels or woollens in plain water. By doing so they become harsh and shrink.

The water in which the flannels have been rinsed is excellent for the first washing of the white things. If too dirty for that purpose, it should be poured on the coarse things, having first taken them out of the cold soak.

The white things will require two washings, rubbing soap on the stained places, if required. The second water should be used for the first process of rubbing less im-

portant articles. By the time the white things are washed, the copper should be ready for the boiling process. The water should only be lukewarm when the clothes are put in, as boiling water fixes the stains instead of loosening them. The water in the copper should contain a fair proportion of soap jelly and about two ounces of soda. From ten minutes to a quarter of an hour after the clothes have been at boiling heat, they should be taken out and plunged into plenty of cold water for rinsing. Having been wrung out of the rinsing water, they should next be put into clean blue water, one by one, passing each piece swiftly through the water to prevent the blue from settling into those unsightly streaks which are afterwards so difficult to remove. There is no waste of time in this precaution, because each article has to be wrung out separately, even if a basketful of linen be tossed into the blue water at the outset. Directly the clothes are blued and wrung, they should be shaken out and put upon the lines.

Apropos of "hanging-out." Before putting up the lines, they should be passed through a coarse cloth; to remove any dust or soils from the gravel-paths, &c. All articles set in a band should be slightly festooned from the bottom hem—never from the band. Sheets and table-cloths should be hung with the short side towards the wind, to enable the air to blow the folds apart. Shirts should be suspended from the bottom hem. A good many pegs are necessary to hang things out well, and the laundry-maid should be careful not to place the pegs at the corners, without first doubling the corners. Stockings should each have a peg, and should be turned inside out before being put on the lines. Wooden pegs are best.

Flannels and woollen materials, set in bands or pleats, require a different mode of hanging from linen things. The latter should be hung with the fulness downwards, as described, but flannels should always be suspended with the fulness at the top.

Gentlemen's waistcoats and trousers require care in being washed at home. Each article, if woollen, should be washed singly, as described for flannels. After having been rinsed in suds, the garment should be simply squeezed tolerably dry, not wrung. The legs of trousers should be pulled straight before hanging on the lines, and waistcoats thoroughly shaken. Trousers and waistcoats should be hung out in a breezy shady place, the former being suspended by the pegs at the band at the back, and the latter by a couple of pegs at the back lining. *Piqué* waistcoats, &c., require the same management as other materials of the same kind.

THE HOUSEHOLD CARE OF PICTURES.

THERE are few households that do not possess some pictures. Many households contain pictures of great interest, often of considerable value; sometimes, indeed, as it has turned out, of unknown value. Scarce two years ago the Government bought a picture, which is now to be seen in the National Gallery, for which they gave the large sum of £2,000. This had been long in an obscure household, without the owners knowing anything of its national interest or value. The picture in question is the "Entombment," by Michael Angelo.

Some brief and explicit directions, therefore, upon the nature of pictures, and the care they require to preserve them, will, no doubt, be welcome to our readers. The subject is one which has never been treated as of household interest, and yet it is one of universal importance. With those who make it a point to treasure works of art, it is a topic which they are sure to appreciate; and even to those who only take a commercial view of their pictorial gems, it is of consequence. From whatever point of view pictures are regarded, whether for instruction, inspiring the spectator with noble thoughts, or as elevating and

refining the taste, or as a graceful means of decoration, the importance of keeping them in good condition is the same.

If we may judge by experience, great ignorance is prevalent in the majority of households as to the nature of pictures and what they are for. Many persons seem to imagine, that, unlike other things, pictures require no care; this is a great error. These very same householders would be distressed at dirty walls, ceilings, curtains, or chimney-glasses; and do not fail to cover up the frames of the pictures to save them from the destruction of flies. They cannot, however, apparently realise the fact that the paintings themselves require care, though of another kind. Dirt can be seen readily enough on the glass of the windows and on the mirrors. It is often noticed how soon the dust, smoke, and exhalations of gas form a filmy deposit upon such objects, but it is not noticed how exactly the same thing happens to the surface of the pictures. It is very evident, upon reflection, that pictures require periodically some attention in the way of cleaning. It is true it is the habit of some households to dust the pictures among other things; but dusting with a feather brush by no means suffices for any length of time. Damp, combining with dust, smoke, and gas, form an incrustation on the pictures which a warmer atmosphere dries on, and a feather brush will not remove.

In any case, then, whatever the subject, its true value can only be realised when the various hues of colour, gradations of tints, and carefully modelled forms can be perfectly seen. When obscured in any way, or disfigured by damages, they cease, more or less, to represent the appearance of the subject painted by the artist. Take, as an instance, a landscape representing an early frosty morning. The atmosphere would be clear, everything distinctly seen, even to the remotest distance, the appearance of the scene rather cool and bluish. Obscured, however, by a dirty yellowish accumulated film or discoloured varnish, it is impossible to tell what time of year is represented, much less what time of day. The distances can now no longer be discerned, and all the delicate tints of the sky and verdure are lost—the whole scene wears a monotonous, uninteresting, undiscernible look. Take the case of the portrait of a young damsel by Gainsborough or Greuze. Originally it was all freshness and brightness. Covered with the discoloration consequent on neglect, where are now all the radiant distinctions of youth? Under the dirt and damp of years its best and most attractive features or points might just as well never have been delineated. All pictures that are thus neglected, soon become reduced to one common level. And even if the pictures on the wall are only placed there for the purpose of ornamentation and that of enlivening the apartment, they no longer serve these purposes, by reason of their decaying conditions; they tend rather to sadden the appearance of the room, giving it a dull, dark, unattractive appearance.

In speaking of the household care of pictures—which is the care that pictures ordinarily require to keep them in a proper condition—it is necessary the reader should thoroughly understand what the nature of pictures is. This can be best explained by a brief summary of the materials of which pictures are composed, and the reasons which induced painters to choose such materials.

Very early pictures were not painted with oil colours, but with colours mixed with size of some description, or the white of eggs, and which are called tempera pictures. It can be well understood that such colours were very dangerous to clean. It being found by experience, however, that pictures did want cleaning, the painters came to consider how they could use colours so that they would bear cleaning. About the year 1420 a Flemish artist named Van Eyck found out that if the colours were ground in oil, instead of the glutinous medium at that time used,

they would bear cleaning even with water. So regardful were painters that their works might be cleaned, when they required it, that the use of oil colours soon became common in every country where the process was known. And although oil colours also possessed an advantage of treatment and effect of which the tempera colours did not admit, the primary cause of their adoption was that they would wash. The painters knew that by the use of oil they insured to future generations the opportunity of viewing their works as they intended them to be seen. From this it will be obvious that the necessity of cleaning pictures was understood at a very early period. Now, although oil pictures will bear washing, it must not be imagined that by this is meant that they will bear the application of soap and water. It only means that they would bear the application of water to the surface of the painting without causing the injury to the colours it would occasion in the case of tempera pictures. The principal ingredient of oil colours, of course, is oil, and therefore the use of soap is dangerous to them. If we want to cleanse oil out of a bottle we put a little soda into it and shake it up, and the soda combining with the oil makes a little lather of soap. Now, soda or some similar alkali being present in soap, it is liable to assimilate with the oil of the paint on the picture, and make a lather of the colour itself. Again, all early pictures were painted on wood. But wood was found to be liable to warp and split from the effect of both heat and damp; and it was, moreover, found that small worms established themselves in the timber, from which it was impossible to dislodge them. They bored thousands of little holes in the wood, and often through the paint itself, until they caused the whole picture to be as rotten as tinder. When such was the case, there was no help which could save the picture from perishing. At last some painters, the founders of the Venetian School, discovered that they could adapt canvas for use in painting as readily as wood, that canvas did not warp and split; also that it was not so suddenly affected by damp and heat, that the colours were not so liable to chip off; that worms did not congregate in it; and, the greatest advantage of all, that it could, when rotten from damp or age, be renewed. This latter advantage was a great desideratum, and no doubt eventually induced its general use among all nations.

It will be seen therefore from this that it has long been acknowledged that pictures even require re-lining at certain periods. By re-lining is meant new canvases fastened at the back of the pictures. Old pictures on timber can also be transferred from the wood to a canvas, and it is owing to this fact that the finest works of Raffaele, Titian, and other great old masters are still in existence, and capable of being enjoyed by the present generation.

There is one more thing it is necessary to draw the attention of the reader to, that he may quite understand the composition and nature of pictures; this is, the preparation which is intermediate to the paint and the substance painted on, and admits of the colours being successfully laid on the canvas or wood. In the case of panels, it is a composition generally of size and whiting, and therefore very easily affected by water. Great attention must therefore be paid, even in applying water to the front of a panel painting, that the surface of the colour is unbroken, or it will penetrate to the ground, and quickly rot it, causing the paint to peel off. In canvas pictures, the preparation partakes more of an oily nature, in consequence of the flexibility of the material. It is therefore not so easily affected by water.

From the facts that have been stated, it will be understood that pictures will suffer from exactly those things that would individually affect the materials of which they are composed. Thus damp is always more or less fatal to pictures. The wood absorbs the moisture, which then

soon attacks the preparation and rots it, causing the paint to peel off in a similar manner to the penetration of water from the front, only on a larger scale. In the case of canvas, it being of a more perishable nature than wood, the damp soon causes it to decay, eventually completely breaking up the picture.

Great heat also causes serious injury to paintings. It warps the panels, and blisters and cracks the paint. Many householders do not seem to understand this. They will quickly notice blisters arising on the street-door, and feel greatly distressed thereat. They will hold consultations with the builder, and house-painter, and friends on this dire calamity, and seek their advice as to what is best to be done in such cases, and yet they never heed the blisters on their pictures. They generally understand that as the blisters on the street-door occur in summer-time, and on very hot days, that the mischief is occasioned by the heat of the sun; but they seem totally unable to carry this deduction as far as the dining-room chimney-piece, or walls of the staircase, upon which the sun may shine fiercely. It never seems to strike them that the blisters on the pictures hanging there, result from exactly the same cause—namely, too great heat. The composition of painted street-doors and pictures on panel is as nearly similar as possible. We have the wood first, then some preparation or other over the surface to be painted on, to prevent the drying in of the colours, and then the paint itself. The direct rays of the sun falling through the landing window upon the picture, and the heat from a large fire in the dining-room acting on the paint, have just the same effect as the sunshine on the street-door. First the paint is softened, and then it blisters and cracks.

The action of heat from a fire can be seen in the case of a house-painter cleaning the paint off a shutter or door. He holds a heated iron before it to soften the paint while he scrapes it off.

Pictures require to be hung in a good light. Light is the very life of colours. In dark places the colours fade, and in modern pictures become obscured by a film of exuded oil. When pictures are found to have faded, or become covered with the yellow stain of oil, the only safe remedy for the evil is to place them in the hands of a conservator, who will expose the pictures carefully to the sunshine, until the fading colours become revived or the oily film is dissipated. It must be borne in mind that too powerful solar rays will themselves cause some colours to fade; so some experience and judgment are required, or the pictures may be injured in a new way. Extremes of every kind are therefore dangerous to pictures. An equable, dry temperature, and a fair good light, are the conditions under which pictures are best preserved. Damp walls are too often the cause of the decay of many paintings. Pictures ought therefore really to be lined behind with a material lately found efficacious to protect them from this source of injury. Another way is to fasten pieces of cork at the four corners of the frames, to keep them somewhat away from the wall, and allow a current of air to pass behind them. They should also be occasionally dusted behind; for the dust accumulating at the back of the picture, and falling between the strainer and the canvas, becomes a great receptacle of damp, the dust absorbing it and retaining it.

We will now speak more particularly of the attentions the front of the pictures require, and those that are within the possibility of householders to administer. It is now becoming much the practice to protect the fronts of valuable pictures with glass. Many persons object to this plan from the difficulty it occasions, in some situations, of inspecting the picture. Anything which prevents the spectator from properly viewing a picture is undoubtedly an evil; but the question arises, which is the greater evil—the destruction of the picture, or incurring a difficulty in contemplating

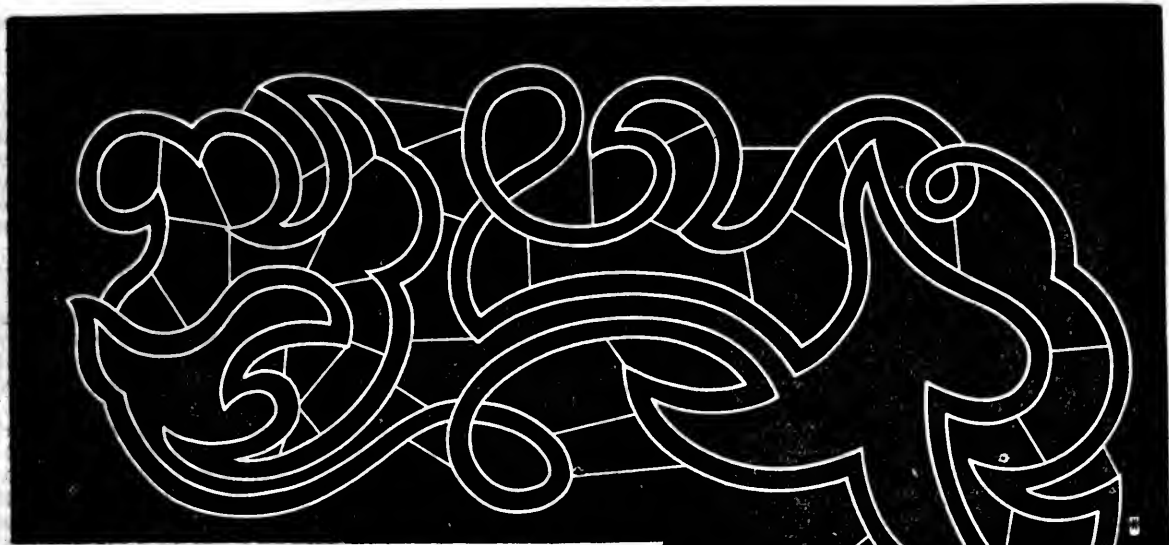

it? Charles Dickens jocularly commented on the practice of glazing pictures in *All the Year Round*. He related how he had heard so much of the celebrated Chandos portrait of Shakespeare, in the National Portrait Gallery, that he went there to see it, and, after placing himself directly in front of it, he raised his eyes and saw an exquisite portrait—of himself. This objection to glass is not without grounds; but it is more than counter-balanced by its advantages.

POINT LACE WORK.—IV.

THE accompanying design is for a piece of lace to be turned over the edge of the square-cut bodice at present so fashionable for *demi-toilette*, and worn in Paris even in full dress. It presents a striking contrast, when worked, to our two last designs, inasmuch as it should be done with the narrowest point lace braid having an open edge, and the filling-in stitches with the finest thread. After the braiding is completed, a row of open over-cast must be worked into the open outer edge of the braid, as in the pattern given on p. 225, vol. 1., then the spaces within the leaves may be filled in, either with the fancy stitches, described in our two last papers, varied according to the worker's taste, or entirely with open over-cast, as in our first design, which will be found to have an excellent effect. A very fine braid with holes at intervals and an open edge (*vide b*, Fig. 3, p. 225, vol. i.) would look extremely well, and we cannot sufficiently impress upon our readers the great importance of using the finest lace-cotton for these open stitches and over-cast, as the great beauty of this design consists in its being executed in very fine materials, so as to imitate the most delicate old lace. The bars should also be fine, and with or without the dot upon them; we rather prefer them plain, but this is a matter of taste. A very beautiful appearance might be given to this pattern, by working not only the edge of the braid in open over-cast, but also the whole of the ground, as it were, leaving out the bars altogether, and filling in the leaves with fancy stitches, so that no part would be left entirely open. This might, doubtless, be rather tedious, but the effect would be an ample repayment for the time and trouble spent on the work. That part of the design marked thus * * joins on to that marked thus † † and the portion between the stars and crosses is repeated until a sufficient length is worked to reach to the back of the top of the bodice,

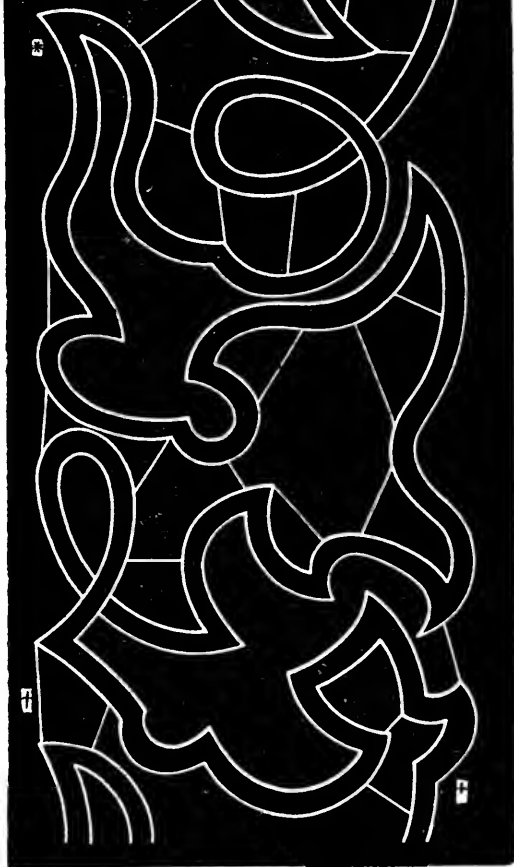

when the pattern must be reversed by tracing it from the wrong side (which can be easily done by holding it against the window), and then worked to the front of the bodice again, where it opens. In tacking the lace to the dress, a slight degree of fulness must be allowed in bringing it round the back of the throat, so as to suit it to the shape.

We hope to give in our next article on this subject a design for a pocket handkerchief border, and probably some new fancy stitches.

HOUSEHOLD CHEMISTRY.

FOOD (*continued*).

Animal Food.—The bodies of beasts, birds, and fishes of very various kinds are made serviceable for the food of man. We may leave reptiles out of the question; for, although snakes are said by some who have tried them to be good eating, they are not very likely to come into general use.

The most important of the four-footed beasts which are slaughtered for food are, as every one knows, the ox (and calf), the sheep, and the pig. The bodies of these animals are generally divided into the carcase proper, which consists of the parts usually called the flesh, or, in other words, the voluntary muscles and the bones; and the *offal*, under which name are included the head, feet, tail, and skin, and all the internal organs, such as the heart, lungs, liver, sweetbread or pancreas, stomach, &c. It will be seen that the word *offal*, when used in this technical sense, does not necessarily mean something offensive. On the contrary, most parts of the *offal* make good food, when properly treated. The stomach of the ox or calf, when carefully cleansed, constitutes *tripe*, an excellent and most digestible article of food; and, with the exception of the skin, which is only used as food when it cannot advantageously be converted into leather, all the above-named parts of the animal supply common and well-known dishes to the dinner-table. The proportion which the *offal* bears to the carcase varies in different animals. In oxen and sheep, it is generally about two to three; but in fat pigs, the carcase sometimes weighs five times as much as the *offal*.

Almost all parts of the animal body—*offal* as well as carcase—contain *fat*. We have already seen that this is a highly valuable form of food. It yields more heat, during its combustion, than any other article of food; and it is therefore, although useless for the repair of the tissues, the best kind of fuel that the body can consume. One ounce of beef fat will, in burning, yield heat enough to raise 352 tons a foot high, whereas an ounce of lean beef could only raise 55 tons to an equal height.

The greater part of the fat of the body generally exists in the solid state, and it is familiar to everybody that its amount is subject to enormous variation. The animal body has the power of storing up fat, sometimes to a most wonderful extent. If the animal has plenty of food, and does but little work, the store of fat increases, as though Nature were providing for future wants. If food is withheld, the bulk of the animal rapidly diminishes, and the store of fat is the first to disappear. An instance is recorded of a fat pig who was buried in his sty by a fall of earth, and remained without any food but water for more than five months. During that time he had, in fact, been living on his own fat, and had, consequently, lost 120 lbs. in weight.

The fat stored up in this manner in the body, is partly due, no doubt, to the fat of the food, but there is direct proof that it can be, and is formed in the body from other articles of food, and particularly from sugar and starch. The system of diet from which Mr. Banting derived so much benefit, and which is now generally known as the Banting system, consists simply in avoiding as much as possible those articles of food which contain much sugar, starch, or fat. We shall return to this subject when we come to the consideration of dietary scales.

The extent to which the fat of an animal may be increased by feeding, is well illustrated by the wonderful specimens sent every year to the Cattle Show. The poor brutes sink under the mass of fat with which they have been burdened. Each is nearly all fat, for although the other constituents of the body do increase to a small extent during the fattening process, this increase is as

nothing compared with the enormous development of fat which takes place. As the fat of an animal increases, the quantity of water diminishes, for fat appears, to some extent, to take the place of water. Two eminent English agricultural chemists, Messrs. Lawes, and Gilbert, have made some elaborate experiments upon this subject, and to their researches almost all our knowledge upon it is due. They analysed, with the most rigid care, the whole of ten beasts of different kinds, some of which had been fattened and some not. They found that veal, although taken from a fat calf, was the leanest and most watery of all ordinary meats. Its carcase contained only 17 parts in 100 of fat, and 62 of water, whereas in a fat ox the proportions were 35 of fat and 46 of water, and in a very fat sheep, 55 of fat, and only 33 of water. Highly fattened pork is the driest and the fattest of all meat, and in dry bacon there are sometimes 73 parts of fat, and only 15 of water in every 100 parts.

The proportion of flesh-formers to heat-givers in animal food depends almost entirely upon the extent to which the beast has been fattened. Fat being a heat-giver, the greater its quantity the smaller will be the proportion of flesh-former. In the carcase of the calf and half-fat ox Lawes and Gilbert found about 17 per cent. of flesh-formers, whereas in that of the very fat sheep there was only 9 per cent. Indeed, the most remarkable point elicited by these researches was, that in those parts of the animal which are consumed as food by man there is, taking the average, a larger proportion of heat-givers to flesh-formers than there is in wheaten bread; so that, taking into account the fat that is either eaten with it, or in the form of suet, lard, dripping, &c., we may hazard the startling assertion that flesh is less flesh-forming than bread. Nevertheless, it is only right to add that it is still doubtful, in spite of chemical analysis, whether the vegetable flesh-formers are really quite equal to the animal ones in power. The natural craving of the whole human race for flesh appears to teach that a proper proportion of it in our diet is advantageous, and those who have tried the dangerous experiment of vegetarianism have almost always suffered from it more or less.

It will, of course, be understood that what has been said above about the high proportion of fat in meat is only true if we take a fair average. In particular joints or dishes the amount of fat is often very small. Lean beef, for instance, contains in 100 parts only 4 of fat, together with 19 of flesh-formers, 72 of water, and 5 of mineral salts. The heart, liver, kidneys, &c., likewise contain very little fat.

With these facts in our possession, it is curious to observe the accurate manner in which human experience, unaided by science, has in many cases arranged the articles of food which should be eaten together. With lean beef we eat potatoes, consisting almost entirely of starch; with veal we eat melted butter and fat bacon. With bacon we eat beans or peas, rich in flesh-formers; and over our beans we pour melted butter. Salt was mingled with flour in making bread long before it was known to be necessary for the gastric juice, and we conclude dinners, in which the flesh-formers are often too predominant; with fruits and farinaceous puddings. Butter is the natural complement to bread, and also to cheese. Poultry and many kinds of fish are deficient in fat. The cook, sublimely ignorant of chemistry though he be, has yet learnt to serve the first with bacon, and to fry the latter with fat, or to cover it with butter.

And if the rude and undirected art of man has succeeded so well in mingling together the necessary ingredients of food, Nature, we may be sure, has been far more successful. No chemistry, and no cooks, nothing but the blind promptings of instinct, are required to teach the lower animals how to arrange their *cuisine*. The dog finds in flesh, the ox finds in grass, and the bird finds in seeds,

worms, and caterpillars, all the elements necessary to their life. And that important liquid, milk, which constitutes the sole nourishment of so many young animals, is a perfect example of well-balanced food. It contains flesh-formers, fat, sugar, salts, and water, all exactly in the most suitable proportions, and all in the form best fitted for easy digestion. We shall have more to say about this wonderful liquid hereafter.

Nature of Flesh.—We have already said that what is ordinarily called flesh consists of the muscles of the animal. The muscles are the machines of the body, or, to speak more exactly, the separate acting parts of the great machine. They do the whole work of the body. They are generally divided into the voluntary and involuntary muscles, according as the will has or has not the power of control over them. The voluntary muscles are for the most part grouped about the bones, and by their contractions produce movements of the skeleton. They constitute the great bulk of the flesh. Among the involuntary muscles, the heart is by far the most important.

The structure of one of the voluntary muscles is, as might be expected, very complex. The fibres that we see in flesh are in reality little bundles of smaller fibres, held together by a kind of delicate web. The smaller fibres are themselves bundles of still smaller fibres, enclosed in the tube-like sheath of membrane. These minute fibres have the power of contracting, that is, of becoming shorter and thicker, under the stimulus of the nerves. The contraction of the whole muscle is produced by the contraction of the separate fibres composing it, so that the contracted muscle is, like the fibres, shorter and thicker than the same muscle in the uncontracted state. How the contraction is produced we do not know. All that we know is that the nerves are the sole agents in effecting it, and that the force exerted to produce it is derived, as we have before seen, from animal oxidation. The fibres are composed of a substance very similar to the fibrine of blood. It is, of course, a flesh-former.

Between the fibres a delicate net-work of the minute blood-vessels, called *capillaries*, is disposed. Through these vessels, the blood which is to supply both nourishment and force to the fibres is constantly passing. The capillaries are supplied by the larger blood-vessels, called arteries, and discharge into the veins. These larger vessels run between the muscles, and may frequently be observed in carving a joint.

All the muscles are supplied with *nerves*, which appear like white threads, varying in size according to the size of the muscle. The terminations of the nerves, if they have any terminations—which is very doubtful—consist of extremely fine filaments. The larger muscles are also supplied with the thin vessels called *lymphatics*, which appear to be intended to carry back to the blood the compounds produced by the gradual destruction of the muscle, and also any excess of nutrient matter which may remain after its repair has been provided for. Muscles also contain fat, generally to the extent of about 3 per cent: the exact quantity is, however, subject to much variation.

Lastly, we must consider the liquid portion of the muscle. The substance of the muscle is permeated throughout with a liquid generally known as the "juice of flesh," which is retained in it when the muscle is cut, just in the same way as water is retained in a sponge. The juice can easily be pressed out, and it has been frequently and very carefully analysed. The greater part of it consists of water, but there are a number of curious compounds besides, held in solution by the water. Some of them are similar to the albumen of white of egg, and therefore belongs to the class of flesh-formers. Others are heat-givers; sugar, and even a kind of starch having been

recognised, besides fat. Another large class of substances are found, which are believed to arise from the destruction of the muscle. These all suffer further oxidation before they leave the body, and must therefore be classed with the heat-givers. Lastly, the juice contains *mineral salts*, which, as we have before seen, are constituents of all wholesome food.

ANIMALS KEPT FOR PLEASURE AND PROFIT.—THE HORSE.

HACK AND HARNESS HORSES.

THE *Omnibus Horse and Machiner* is of a kind nearly approaching that which we have called the hack and harness horse, being neither of a high class nor agricultural, but larger. This is, therefore, a convenient place for introducing him, leaving the covert and park hack to come later in the series. The coach horse was a quicker, higher-bred horse than this, being usually an off-cast from a gentleman's stud, or a half worn-out thoroughbred one of more substance than common. His place has been taken by the machiner, a horse of considerable size and power, used in the vans which carry goods in and about large towns and their suburbs. These horses are bred in Lincolnshire and Yorkshire, and the North of England generally, and are descended from the Cleveland Bay in a remote degree, that breed in its purity being almost extinct. These horses are active as well as strong. They could not be bred for sale as omnibus horses, but are the rougher produce of the breeder's yard, failing, from coarseness or want of action and form, to make either carriage horses or hunters. Breeders take the rough with the smooth, and fortunately the latter help to pay for the former, or we could have no cheap horses at all. These horses require just the points of those we have been describing, but, as they are never ridden, their shoulders may be much less oblique, and they should stand at least three inches or a hand higher. On good roads they can draw heavy loads as much as seven miles an hour. Wholesale tradesmen of every description know how good many of these machiners prove to be, and how valuable is a combination of activity with strength. Troop horses and the mounted police horses are from the same counties, and are bred in the same way by thoroughbred country sires from half-bred mares. Their price is low, from £25 to £35; but they are delivered at three years old, and are selected from capability to carry weight, which requires different conformation from that required for drawing it. The latter can always do something towards paying their way by light agricultural work, where the soil is not heavy, as they may be yoked at two years old. The Life Guards' troopers are splendid specimens of the cross between the thoroughbred horse and our best cart-bred mares. We give two illustrations of these useful but moderately-priced hack and harness horses.

Cart Horses.—We reach a point now, which, including horses purely agricultural, ought to be of very great interest to us. Although the agricultural horse is limited, indeed, in proprietorship to only one exclusive class of persons—not by any means the case with most other horses—he has an importance in the eyes of the world equivalent in its way to the interest which the bread-winner of the family, or the working bees of the social hive, are calculated to excite. The Creator teaches us all that we have to depend upon one another. He showers His blessings upon us somewhat in the proportion in which we labour for them. He makes no class independent of another; and so provident is He in the dispensation of His gifts, that He makes even the beasts of the field available for our comfort and support. There is a noble lesson of gratitude to be learnt from the spectacle of a fine team of horses employed in agricultural labour, not only for the

benefit of their immediate owner, but as a channel through which the necessities of life become ours. We do not mean that we can never see these handsome animals with- one of his expenses ; for as they are kept by the produce of the land they till, and the hay and corn they carry, he is less particular in taking a full account of their keep than

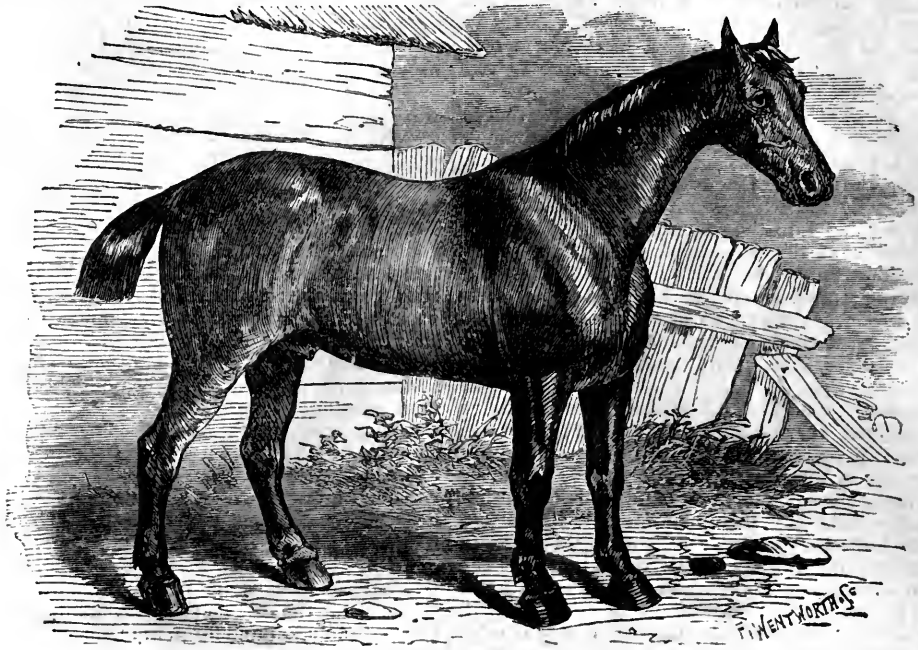

HACK HORSE.

out such considerations, but such considerations enhance their value in the abstract in the mind of a thoughtful man, and impart no fictitious value to one of the most those who pay for it in hard money. Among other general details of the agricultural or cart horse, we must not forget that it is the horse which pre-eminently pays for breeding.

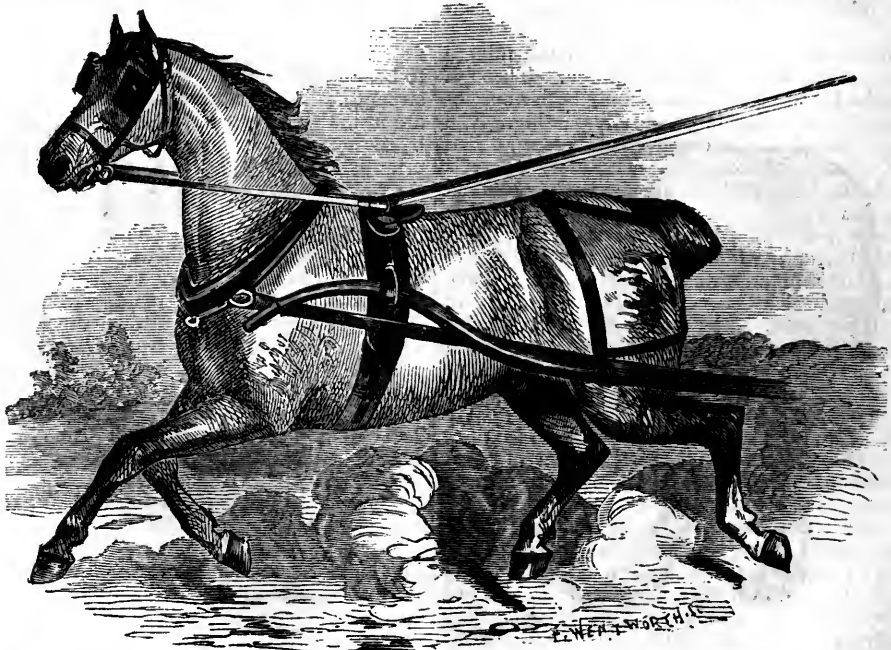

HARNESS HORSE.

patient and one of the handsomest and most useful of his species. The farmer himself is not unfrequently forgetful of the value of his horses, and seldom sums up honestly their real cost to him. He is apt to make light of them as It is cheap to generate, it is hardy to keep, it is early self-supporting, and after it has done more than enough to remunerate its breeder on his farm, it is as valuable as the middling samples of higher-class horses which we see in

ordinary use. The cart horse may be worked moderately from two years old on light land, and for a few hours; and at four, five, or six, according to circumstances, will still be

generally belongs to mixed breeds, and, whether from inadvertency or from intention, there seem to be more of this class unassignable to a pure breed than any other. In the

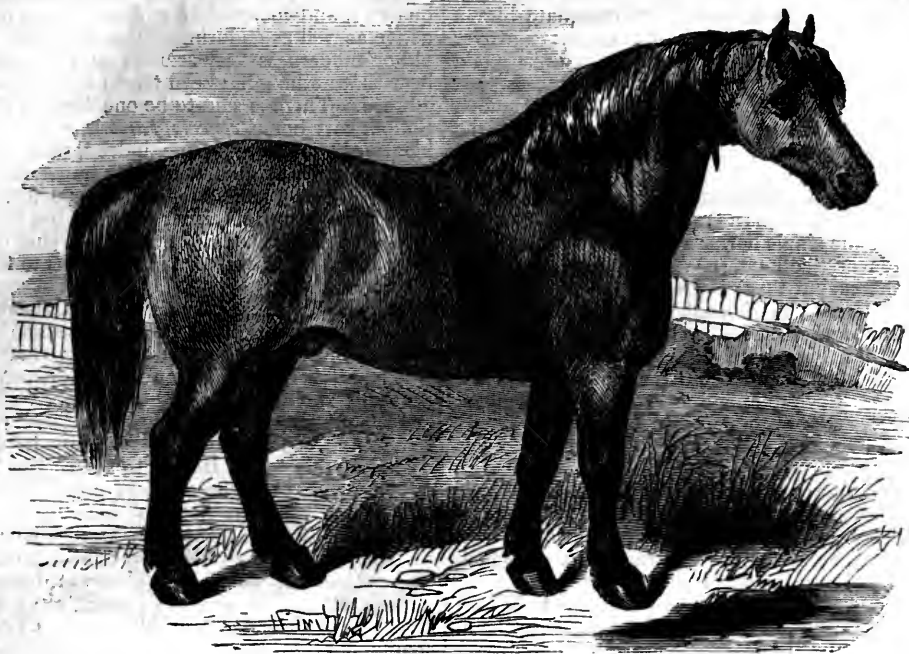

THE SUFFOLK PUNCH.

worth £35, £40, or even £50 or £60. He is far less liable to injury, from his quiet passive nature and indisposition to gallop and plunge, than the higher-bred horse, which is par-

case of the Clevelands, a fine coaching or quick draught horse, we mentioned the scarcity of pure-bred horses; and the same may be said for the Clydesdales and Suffolks,

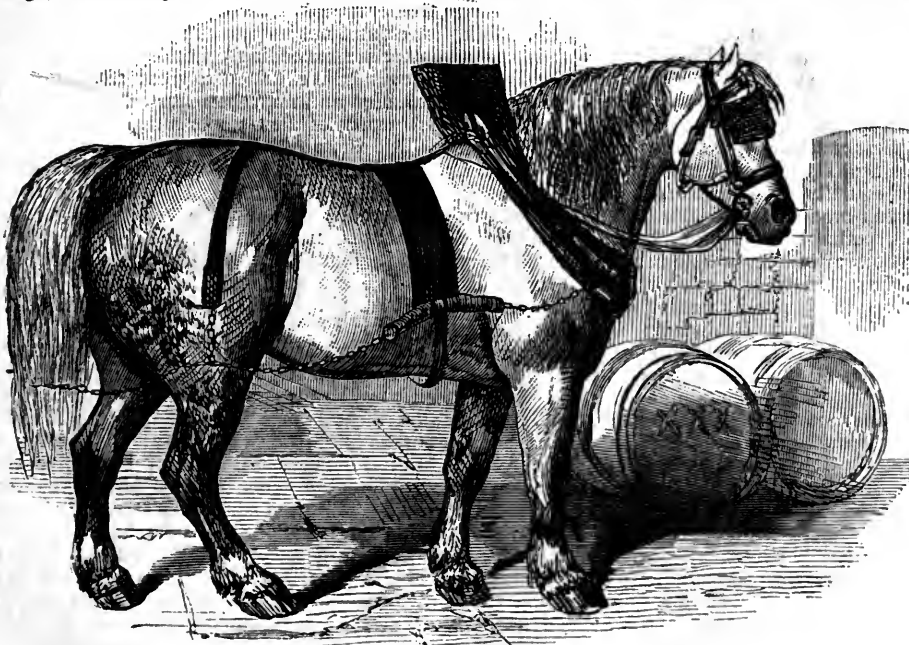

DRAY HORSE.

ticularly prone to accidents; and as he is not so delicate in his nature, he is less subject to colds or coughs and such diseases of wind as arise from them, and is usually free from what we call constitutional unsoundness. The cart horse

though not quite to so great an extent. The fact is that, breeding for size and weight, blood has been introduced of a foreign nature wherever and however it may have appeared to effect that object.

Particular Breeds, however, exist which have their characteristics, as they have their patrons—the North, the South, and the Midlands; and in proportion as the agricultural horse possesses the greater share of the one strain than of the other, it has been customary to designate him a Clydesdale or a Suffolk. It would be superfluous to go over again the principles of breeding, as those rules already laid down are sufficient, by modification, for all purposes. It is enough to notice especially the Clydesdale, the Suffolk, the Midland Counties or English Cart horse, and the dray horse, as having peculiarities at once attractive and valuable.

The *Clydesdale* is so called from his supposed country on the banks of the Clyde. He is a fine handsome horse, active and suitable for the single harness and two-wheeled carts of the lowlands of Scotland. We believe him to be a Flemish-bred horse, but there is great diversity of opinion on this score. The North of England farmers have every confidence in him, and we have seen one as much as sixteen hands two inches high, with the appearance of a cob, having a small neat head and a short tail. They have one great advantage—they are long and low, and fast walkers in consequence. Our draught horse has sprung chiefly from the Flemish stock, though much Norman blood has at times been mixed up with it. With due deference to some supposed authorities, we think the Clydesdales larger than the Suffolks, and we are borne out in that opinion by the book published by the Society for the Diffusion of Useful Knowledge. The writer also says that the cross which produced the present breed of Clydesdales was from Flanders stallions brought over by one of the Dukes of Hamilton, who crossed the best Lanark mares with them. Occasionally the Clydesdale mares are put to well-bred horses, and the produce is used for harness.

The *Suffolk*, better known as the Suffolk Punch, from the peculiar roundness of his appearance, is said to have been crossed originally with the Norman stallion. This is the general opinion of the *cognoscenti*. But it would be useless to deny that they have not unfrequently been mixed with the Flanders breed. It belongs especially to Suffolk, Norfolk, Essex, and the South-East Coast, and is to the full as great a favourite with the Southerners as the Clydesdales are in the North. There are two breeds of the Suffolk, one known as the old, which was exceedingly valuable, and of the highest quality as a cart horse; the other known as the modern Suffolk, much handsomer in our opinion, but of doubtful equality to its ancestors. The cross for this later or improved breed was the North Country horse, or Yorkshireman, perhaps three parts bred, by which the Punch lost something of his roundness, and acquired more quality. The characteristic of the original breed was, independently of everything else, its unconquerable determination to move whatever was behind it; and if Mahomet had had a team of the old Suffolk Punches, it seems very doubtful, according to the Essex farmers, whether he would ever have had to go to the mountain at all. Now the contention is that the modern Suffolk has somewhat lost this characteristic; that, though a very valuable cart horse, he will not literally "lie down" to his work and struggle till he dies. This may be the case; but he is a most beautiful horse, of great power for his size, with well laid and fine shoulders—a very valuable point, though not utterly indispensable in a draught horse, and, when crossed with hunters or thoroughbred horses making very fashionable carriage horses for country work. We give a sketch of the modern Suffolk, which is a good specimen of the class. The ordinary average height of the Suffolk Punch is from fifteen hands to fifteen hands two inches, which is a couple of inches higher than the old breed. The prices paid for them in those days were very high—as much as 100 or 150 guineas; and for an entire horse as much as 400 guineas has been known to have been given. Many men will even in cart horses gratify the eye, and in

point of good looks the two could bear no comparison. To say truth, the old sort was not handsome, and had low, powerful shoulders, a rather long head, and short round legs and pasterns, but he was strong and muscular in the quarters, and looked like pulling down a house; he was active as well as enduring. The pure-bred Suffolk, either old or modern, is very scarce; and we shall be sorry to hear that nothing has been done to resuscitate so valuable a breed. There is said to be one thing that is against the Suffolk cart horse, *ceteris paribus*, viz., that they require plenty of good keep—more, indeed, than some others—to do their work upon. It is quite impossible to draw up a just difference in this respect between them all; and no man but a practical farmer can give the information with respect to each separate breed after trying them fairly and separately. It is only due to the reader to state the fact as we have heard it.

The *English Cart Horse* is not as handsome as the breeds we have just mentioned; but, if handsome is as handsome does, we must class him among their equals. He is bred chiefly in the Midland Counties, Northamptonshire and Staffordshire supplying a great number. He is gigantic in size, of immense power, hardy and enduring, and at the same time of most exemplary energy in draught. The colour of this breed is said to be usually black, but the mixture with other breeds has produced cart horses of all colours. He has not unfrequently a neat head when divested of its growth of hair, and we have seen some of these horses used for railway work with beautiful shoulders. The notion that slanting shoulders in draught horses are either useless or positively detrimental is a mistake, and gives rise to carelessness of breeding. Of course, a finely-shaped horse is more valuable, of whatever class, than the reverse, only one point is less essential than another for some sorts of work. These horses are universally useful. The very large and well-shaped ones, after early and gentle work on the farm lands, are put by for the London market, where they meet with ready sale for the best class of railway traffic, the remnant of the old road wagon and carrier's work, and not unfrequently for the brewer's service. These latter are exceedingly handsome, and some of the large houses had obtained a great reputation for the careful selection and management of their studs. We may say a few words of them under a separate heading.

The *Dray Horse* is said by all authors on the horse to have been bred in Yorkshire or the Midland Counties of Stafford and Lincoln. Unfortunately, nearly every treatise on horses has been compiled from its predecessor, without discrimination; and the consequence is that nothing but personal experience can settle such questions. Now, upon application to one of the largest and oldest breweries in London, where one hundred and fifty horses are kept, we ascertained that the greater number are bred in Berkshire, Wiltshire, and the Western Counties; that the average height was from sixteen hands two inches to eighteen hands; and the average price from £60 to £70; that these horses came, at the ages of five and six years, not, as might be supposed, and as is often asserted, direct from the breeder, but from London dealers; and that their great excellence consisted in the rapidity of their walk. This, indeed, seems a *sine quâ non*, or indispensable qualification.

It is well to add, before we quit this section of our subject, that the above have increased in value, as have all other breeds of horses; and as they travel into the country to a distance sometimes of twelve miles, and have to return with a lightened wagon, they are probably bought for such purpose with more quickness than those which are confined to the London delivery. There are modifications in dray horses as well as in carriage horses or hunters, and we have endeavoured to represent in our illustration the marks which distinguish him from the smaller breed.

DOMESTIC MEDICINE.

A COMMON COLD (*continued*).

Causes.—The causes of a common cold are, generally speaking, cold, or sudden changes and alternations of temperature. Though they are more common in winter and cold weather, it may often be noticed that the cold is more troublesome in the house than in the open air. The fact is that it comes rather from draughts of cold air blowing on a particular part of the body, or coming in at the doors and windows, than from being out actively in cold weather. It is disheartening to think of the bad and imperfect construction of even good houses, so that in sitting at dinner, or at your desk, or even at your fire-side, you feel that there is a small gale of air playing upon your loins, or your feet, or some other part. This small gale, or draught as it is called, does this—it drives the blood of the skin into the deeper parts of the body. Fortunately it generally drives it to the mucous membrane that lines the nose and throat, and we get only a common cold. But for this, we might get something worse. Two or three evils tend to make us more susceptible of cold in cold weather. First, scanty clothing. Children are ridiculously naked in cold weather. Their arms and legs ought to be well and warmly covered, instead of which they go bare and exposed. This is a positively cruel fashion, for they are less able to resist the cold than grown-up people, and require to be more clothed instead of less. Hence they get lots of colds and coughs in cold weather. Grown-up people too, both ladies and gentlemen, often go out in cold nights with a very insufficient amount of clothing on; "full dress," in both cases, being only about half dress, and leaving the shoulders and chest exposed. It is impossible to meet all the sudden changes of our fickle climate, but we might dress more considerably and sensibly than we do; and if we like to starve ourselves for fashion's sake, we, at any rate, should not let our children go about unfairly exposed to the cold.

Another often unsuspected serious evil which favours our catching cold is loss of sleep, and going too long without food. In the winter time, many people put themselves out by late hours at fashionable parties. The heat of the body gets down, and does not get up again until a cold has been caught. Another evil still tending to make us liable to colds, is over-heated rooms with gas in them, which makes us unduly sensitive to cold air.

Treatment.—As we have hinted, this is a matter of common sense rather than of medical science. A person with a cold should keep out of draughts. If it is not very bad, men at least need not stay in the house; but when they are in they should be in a room comfortable, but not too hot. They should have nice, warm, nourishing food, and take the ordinary domestic remedies. If it is confined to the head and needs medicine, the following mixture may be taken by grown-up people.

Solution of citrate of ammonia	...	2 drachms.
Water	...	1 ounce.
Mix.	To be taken three or four times a day.	

One of the best remedies for a state of cold is ample sleep. Not only the sleep, but the warmth of the bed conduces greatly to recovery.

We must say a few words under this head about

INFLUENZA,

which from time to time rages as an epidemic, spreading quickly through the country, and affecting great numbers of people.

The symptoms are those of a severe cold, with this difference, that there is a great weakness and depression of strength. Sometimes this weakness is out of all proportion to the symptoms of cold. There may be little sneezing or cough, and yet the prostration may be great.

Influenza sometimes occurs in most extensive epidemics, and affects large numbers of the people. It seems to be borne on the wind, or at any rate due to some peculiarity or contamination of the atmosphere. There was such an epidemic in 1837. In the current winter, 1869—70, there has been an extensive prevalence of colds which may be called influenza; but this is scarcely the proper use of the word, which implies a sudden epidemic prevalence of colds not to be exactly explained by the ordinary weather of the season. In 1837 there was a great mortality, chiefly affecting the old and those whose chests were not very sound.

Causes.—Something in the atmosphere which has yet to be made out or discovered, just as the "something" that causes all other epidemic diseases, whether scarlet fever, or small-pox, or typhus, has to be discovered. But the cause of influenza is something more diffusible than these. In influenza the cause seems carried in the air; in the other diseases it is carried on the person, or on clothes, or in the secretions and matters passed from the patient.

Treatment.—Influenza requires the same treatment as a common cold, only it is more likely to require a doctor. The great point of treatment is to keep up the strength, and resist the exhaustion and prostration. To this end lots of warm comfortable food, and some stimulant, should be allowed. If the complaint continues and does not soon yield to domestic treatment, time and health, and perhaps life, will be saved by taking skilled advice. This is especially necessary in the case of delicate persons.

COSTIVENESS.

For this complaint every old lady thinks she knows a certain remedy. Too much attention is paid by many people to the state of their bowels. The number of persons who are always taking opening medicine is something wonderful. They seem to live chiefly for the purpose of taking pills. We have heard lately of a lady who had taken pills every day for the last fifty years. It is by such cases that the sellers of quack pills thrive, and are enabled to drive their carriages. The habit originates often in false notions of health, and of what health consists in. People would bind their bodies down to too rigid a regularity. No doubt it is desirable, for more reasons than one, that people should be regular in such matters as that under consideration. But all people are not alike, and to expect everybody to perform such functions at the same time and with the same frequency, is almost as absurd as it would be to expect all people to blow their noses at the same time, and use the same number of pocket handkerchiefs. The fact is, health is a variable thing; what is health to one person would be discomfort to another, and disease to a third. This is what people are slow to understand, and they lay down fanciful rules, which they think their body should obey. And if it does not, they proceed to punish their body with pills and other stuff, which are often a far greater evil than the disease, if disease it be. People should think less about this function than they do, so long as they feel well and comfortable. They should leave it to itself and live sensibly, and all would be right. However, we do not mean to deny that there is such a thing as costiveness or constipation. On the contrary, we shall try to point out the nature and the causes of it. But we advise people to be less nervous and thoughtful about it, and they will get on quite as well.

Two kinds of constipation are recognised by medical men: first, that which arises from want of material in the bowels to be discharged; and secondly, want of power or tone in the bowels themselves to contract upon and to expel the material that is in them. This distinction is very important, and will be easily understood. The first is called "costiveness," and the latter "constipation." They will be treated of in our next paper on this subject.

COTTAGE FARMING.

ARTIFICIAL AND OTHER MANURES (*continued*).

THE night-soil of the cottage deodorised on the earth closet system is worth about 10s. per head of the family, and therefore a properly managed "cottage commode," or earth closet, is one of the chief manurial resources of a cottage farm. All the washings from the bedrooms, kitchen, &c., and water from the roof-runs should be conveyed in glazed pipes to the liquid manure tank; but, as stated at page 210, vol. i., the most economical plan of utilising night-soil, solid and liquid, is by means of the earth closet, and every drop of urine from bedrooms and urinals, and solid fæces (if any) should go to the commode, allowing so many discharges of earth according to the contents of the bedroom pail. (The cottage urinal should be attached to the commode.) The annexed engraving represents Moule's "Cottage Commode."

The first thing is to lay in a sufficient stock of dry sifted earth during the summer time for the yearly requirements of the family—about two and a half tons will be needed for six persons. The weekly consumption would thus be one hundredweight of earth. The wet earth from the commode may be dried and used several times, but the practice should not be had recourse to when a suitable supply of earth from the field, garden, &c., can be obtained, as it generally can, for the earth from the commode, when spread over the manure in the manure pit, absorbs its maximum from the cow droppings. The dry ashes from the cottage stoves may be mixed with the dry earth in the proportion of two of earth to one of ashes; but earth alone is the best deodoriser; and it must be borne in mind that good dry earth properly sifted is essential to the efficient working of the earth-closet—in other words, moist earth will not flow regularly when released by the pulling up of the handle, or by the "self-acting" apparatus of the seat, and that bad earth is a bad deodoriser. The back of the commode forms an earth reservoir, which has to be supplied with dry earth as occasion requires. Below the seat is a movable pail. The discharging apparatus for releasing the earth from the hopper acts either by pulling up a handle, as in a water-closet, or it is self-acting on rising from the seat. The earth reservoir, as shown in the engraving, is calculated to hold about eighteen discharges; but, of course, it can be enlarged as the requirements of the family demand. The wet earth in the pail should be removed daily and spread over the manure in the covered pit, as formerly directed, or it may be kept in a store by itself for top dressing to certain grass land, as subsequently directed.

On a cottage farm of a few acres of arable land a supply of dry earth can be got from the land intended for root crops before seed time, and as the wet earth from the commode would be returned to the land, the land would thus receive remunerating interest for the loan of the earth, as it were. In the generality of seasons a sufficiency of surface soil could be collected dry enough for breaking down for sifting. If spread over the barn floor it could be broken fine by a garden roller or wooden mallet made for the purpose. For breaking fine three tons of dry clods the back of the spade is the readiest implement, as it fills the wire sieve, so that the breaking and sifting can be done in less room. A small wire sieve, "four meshes to the inch," is recommended, but we should prefer sifting much finer (eight to the inch). And we should also advise sifting the earth a second time when taken from the dry earth bin to fill the reservoir of the commode, for although stored perfectly dry, comparatively speaking, and kept

shut up in a large box or bin, where the commode is kept, it will in our moist climate absorb moisture sufficient to make it adhere together, consequently sifting at the time of use makes sure work by the discharging apparatus, upon which with the minute subdivision of the earth success greatly depends. No doubt coarser earth will eventually deodorise, but not so rapidly as fine earth; and the more rapidly and better the deodorising process is performed the richer the manure. It has justly been observed that, "the cottage commode will no more act properly without *fine dry earth* than will a water-closet without water."

It is only when the cottage farm is wholly under grass that any difficulty can be experienced in getting dry earth. In practice there are only two ways of getting it, for if it cannot be got inside, a plentiful supply can generally be had outside, for a little money, if the cottager looks sharply about him. In laying out new buildings, roads, walks, and in levelling, a large quantity of earth may be collected, sufficient to last for a number of years. This may be cropped with cabbages, which are very partial to such—we have grown Drumheads sixty pounds each on such hills—or they may be planted with shrubby, &c. The yearly supply may be dried in the summer time by spreading it over some open ground. In other cases earth may



be got for the carting of those who are building or making improvements. In the majority of park farms much earth can be collected inside, and the better the grounds are kept the greater the quantity, as all the sweepings, clippings, prunings, when charred as to make black ashes, increase the supply. If there is a large garden or a border along a boundary wall for growing vegetables, the whole supply of earth may be taken from such, and the cottage earth annually returned to balance the account. If the cottager has a horse, the mixing of the stable dung with the wet earth from the commode would greatly improve the manure for the growth of vegetables, whether for the cottager himself or for his milch cows in winter. The manure thus made, although improved, would never-

theless require the addition of artificial manures to supply the individual wants of the different kinds of crops thus grown, as subsequently directed; indeed, so important is the earth closet system to the manurial economy of grass farms laid out in the form of a small park, that a sufficient area of ground should be thus cropped in borders so as to supply the dry earth for utilising the night-soil; and as a cubic yard would fully supply a ton, it is easy to calculate, from tables already given, the area required to supply the earth and consume the manure. All the solid manure of the park farm might thus be used, leaving the grass land to be manured exclusively with artificial fertilisers. To this general rule there are no doubt a few exceptions where a top dressing of earth is needed to keep the grass land in order. In such cases the wet earth from the commode, or a portion of it, as the case may be, would be stored by itself, turned two or three times, and when sufficiently dry for mixing with artificial manures, from four to eight cwts., as a general rule, per acre, may then be applied annually along with five cwts. of common salt, three cwts. of superphosphate, and two cwts. of muriate of potash for top dressing permanent meadow and pasture.

Manures must be considered in their application as the food of plants; it therefore follows that general rules for manuring require to be conditionally applied. When we come to notice the different cultivated plants, as wheat, barley, oats, beans, potatoes, mangolds, &c., we shall discuss their respective manurial requirements with the climates best suited to their normal growth. In the meantime the

following outline will show the propriety of this course under the limited space at our command, and at the same time serve as a conclusion to this section of our subject:—

Large farmers apply from 20 to 30 tons of farm-yard manure to potatoes, mangolds, and swedes; about 20 tons to common turnips, and from 15 to 20 tons to carrots, peas, and beans. But when we mention that a ton of potatoes only yields about 6 ounces of common salt, 137 potash, 84 soda, and that a ton of mangolds yields 2,148 ounces of salt, 528 potash, 1,139 soda, and that for 10 tons of potatoes grown per acre we grow 30 tons of mangolds, it will readily be perceived how imperfect the old plan of manuring was, and how different the manurial requirements of these two plants are per ton and per acre. Again, the requirements of carrots, swedes, and common turnips are all different. More generally speaking, wheat, barley, and oats, from the large percentage of silica in their composition, are termed consumers of silica.

A suitable supply of silica must be in the land or manure, and in an available form, before the straw will stand up to carry corn (the silica is the clear flinty matter chiefly on the outside of the straw and corn). Beans, peas, lucerne, sainfoin, and clover are termed lime consumers,

from the large percentage of lime in their composition; carrots, mangold-wurzel, swedes, and turnips are termed potash consumers, from the large percentage of potash they contain. The potato is also termed a potash consumer. The consumption of the grasses, when they are allowed to ripen their seeds, is different from what it is when they are pastured. In the next place we may add that, as to climate, oats and turnips grow better in Scotland than in England; mangold-wurzel and clover in England than in Scotland, and so on. Here, then, we have another element of consideration which must not be neglected.

ODDS AND ENDS.

Ornamental Spills.—To make ornamental spills, bright coloured papers, and also gold and silver paper are needed. The thick paper is used, and it is best of the same colour on both sides. Take gold, silver, blue, scarlet, and rich green to fill one vase, violet, mauve, crimson, yellow, light

green, and gold and silver for another. Cut a strip of paper an inch wide, and the length of the sheet. Cut a piece off the top as in Fig. 1, and roll it between the fingers into a spiral stem, pointed at the top, and a little broader at the base where the end is pinched, and sewa down neatly so as not to show, see Fig. 2. Then take a strip of the whole length of the paper, and two inches wide. Three inches wide makes the top still handsomer.

Cut it in narrow strips to within a quarter of an inch of the top, like Fig. 3, making them very regular and even. The actual roll is to be like that of Fig. 4. Then curl these strips by twisting each separately and closely round a knitting pin, not letting one twist overlap the other, but exactly meet. It is wrapped tightly the whole length of the strip, and pressed on the needle by the fingers, the needle is then slipped out. Fold the top, A to A, in Fig. 3, backwards and forwards in little pleats and sew it to the broad top of the spill. If the curls are not enough to hang all round the spill, add another bunch for the centre ones. The spills that surround this need curls on one side only. An extremely pretty variation can be made by cutting strips of gold paper the width of the curls, and gumming them spirally round the stems.

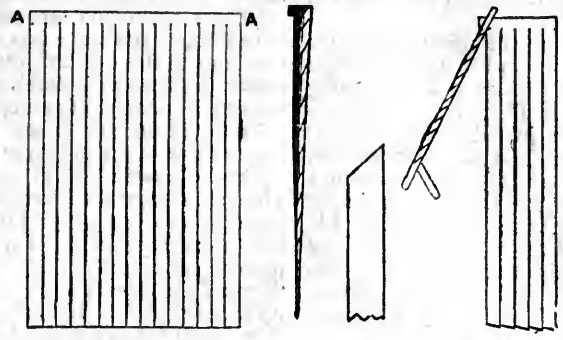

Fig. 3. Fig. 2. Fig. 1. Fig. 4.
ORNAMENTAL SPILLS.

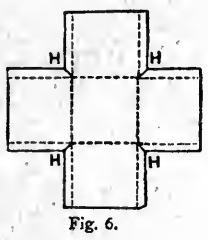

Fig. 6.

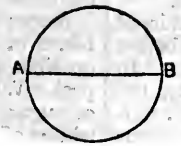

Fig. 2.

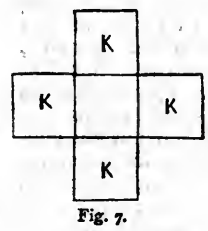

Fig. 7.

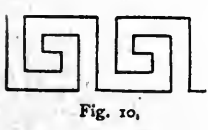

Fig. 10.

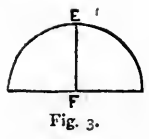

Fig. 3.

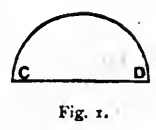

Fig. 1.

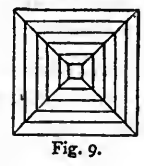

Fig. 9.



Fig. 5.

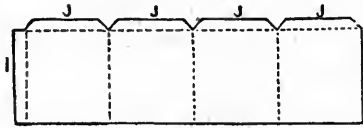

Fig. 8.



Fig. 4.

WAFER BOXES, ETC.

Wafer Boxes.—Get a quarter of a pound of red wafers, such as used to be required to fasten letters. Lay a wafer before you. Cut a second wafer in half, touch the cut end with the tip of your tongue, and wet it from C to D (see Fig. 1); place it then on the first wafer, upright from A to B, exactly dividing the first wafer in half (see Fig. 2). Cut the other half again from E to F, Fig. 3, and place it each side of the first half at right angles, as in Fig. 4. Cut another wafer in four, and place the four pieces between the others in the spaces, three of which only are seen at G G G, in Fig. 4. Fig. 5 shows the star complete. By moistening the base of the wafers, they can be attached all over the box.

To make a Box.—Cut out card as shown at Fig. 6, half cutting through the dotted lines. The corners must be cut through at H down to the dotted line. The half-cuts come on the outside. Fold the card inwards on the wrong side from these cuts, join the sides with paste or stitch them, and the box is made. Or a box may be cut like Fig. 7, the corners joined by strips of pasted paper the whole length of the side, and wide enough to lap over

each and brace them together. Fig. 8 is another way to make a box. Half cut through the dotted lines, and join it round by the narrow piece marked I, which lies inside. J J J J turns down, and a square to form the bottom is pasted to it. A lid is made like Fig. 7, but shallower in the sides, K K K K, and a little larger in the square than the box, to fit over it; or the lid may merely be a flat piece, fastened to the box by a strip of muslin or canvas the length of the box and lid, and pasted half the wide way inside the side of the box, and half on the inside of the edge of the lid, to form a hinge.

Pith Boxes and Beehives.—Many beautiful ornaments may be made of pith. Cover a box with ruby or bright blue satin paper; then lay the pith on it by gumming it lightly in layers close together, like Fig. 9; the pith for every row cut in four pieces, joined at the corners; and, of course, every row longer than the previous one. There may be two or three squares of pith, and then a space to show the coloured paper, and then pith again; or the Greek key pattern (Fig. 10) may be formed of the pith. To make the pith beehive, boil an egg very hard; cut it in half; take out the meat; dip it in strong glue outside, and bind pith closely round and round it. Attach it to a piece of card covered with red velvet, with moss at the base. It makes a pretty little ornament.

Seed Boxes.—It is possible to make from ordinary seeds glove-boxes, card-boxes, bézique-boxes, and boxes for charitable contributions, that are very ornamental. Commence with the sides. Draw the pattern first in ink. Cover one side of the box with thick glue. Drop on the seeds so as to form patterns. The pattern may be black, and the ground yellow, or two or three colours and shades may be introduced. The common seeds that we give our birds—canary, rape, and maw seed—look very well. Any gardener will help the amateur to a number of pretty seeds for the purpose. They must all be very small.

Faded Muslins.—Muslin dresses are frequently rendered unwearable by their colours not being "fast," long before they are sufficiently worn to justify their abandonment. In such a case it is well to discharge the colour entirely, and convert the faded dress into a white one. For this purpose, having well washed it in hot suds until the colour appears to be gone, wash it out of the boil, rinse it and dry it in the sun. If it is not quite white after such treatment, bleach it in the hot sun or repeat the boiling.

COOKING.

CUSTARDS (*continued*), PIES, PUDDINGS, AND CAKES.

Currant Custard.—When you have plenty of red currants (any other juicy, sharp-flavoured fruit will do), squeeze out the juice by pressing them in a cloth; to each pint of juice add a pint of water; sweeten to taste, and flavour with rose or orange-flower water. Set this on the fire, and, as it warms, stir in gradually and continuously half a pound of ground rice, and let it cook gently, still stirring, for a quarter of an hour or so, till it is quite smooth and well thickened; then pour it into cups or glasses to be eaten as boiled custard. Grate a little nutmeg, and put one ratafia on the surface of each custard. They are the better for standing a night to stiffen. If set in some very cold place—for instance, in a tin pail plunged in a tub of cold water fresh drawn from the pump—they will be as pleasant to the palate in sultry weather as iced custards, without their disadvantages. Arrowroot may be used instead of ground rice. By increasing the quantity of either ingredient, the custard may be made stiff enough to be set in a mould, and turned out before serving.

Custard and Syrup.—Have a large, wide, shallow, glass dish; white porcelain will serve as a substitute. Take small cups of various sizes and dimensions, butter their insides, and in them make baked custards rather stiff in

consistence, composed of egg (retaining *all* the whites) and a little cream or milk sweetened and flavoured according to taste. When cold and firm, turn these out upon your glass dish, bottom upwards, putting the tallest and biggest in the middle, and the smaller ones round them. Melt together, in equal quantities, red wine and currant, raspberry, gooseberry, or other red jelly; or you may mix the wine with syrups from those fruits. When nearly cold, pour this over and amongst the custards. Lay round the inside of the dish a necklace of ratafias reposing on the outer edge of the syrup. You have thus, at moderate expense, a decorative dish, attractive both to the eye and the palate. Serve each young person (we have a children's party in our eye) with a *whole* custard, a spoonful of syrup, and a couple of ratafias. Our coloured illustration (Plate III.) will supply ideas for a tasteful way of serving these things.

Curd Custards.—It is not generally known that the white skins from the inner surface of the gizzards of fowls have the same property as the stomach of a calf, namely, that of curdling milk. They may be employed for that purpose either fresh or dry. All that is required is to peel them off the gizzards, rinse them carefully, and hang them up in a dry place. If fresh, all that is needed is to chop them small before putting them into the milk; if dry, they may be bruised in a mortar. It takes the skins of five or six gizzards to curdle a quart of milk. Boil the milk, sweeten it to taste, and let it get nearly cold. Then throw in the gizzard skins; stir them in the milk a minute or so, and then strain them away by passing it through a sieve or strainer. Pour the milk in custard-cups, or little pots made for the purpose, with covers; set the milk, by putting them into a *bain-marie*, hot bath, or shallow stewpan, containing hot water. Let them cool six hours before serving. You thus obtain curd custards without employing either flour, arrowroot, gelatine, or eggs.

Baron Brisse's Rice Pudding, Baked in a Saucepan.—Rinse in water half a pound of rice; boil it in the least possible quantity of milk, together with a piece of lemon-peel. When cool add a little salt, a quarter of a pound of sugar, four eggs, and the yolks of four others, the whites of which you have set aside. Grease the inside of a saucepan with butter; sprinkle it with crumbs of bread. Whip the whites of egg to a froth, and gradually stir them into the rice, &c. Pour the whole into the saucepan, and bake in a gentle oven for a good half-hour. When done, turn it out of the saucepan, and serve it on a dish as if it were a cake.

Ground Rice Pudding, Baked.—Boil a teacupful of ground rice in a sufficient quantity of milk to swell it to the utmost. Let it get nearly cold; then stir in three eggs, a quarter of a pound of finely-chopped beef-suet, two table-spoonfuls of good moist sugar, two ditto of rum, and a little grated nutmeg. Pour it into a well-buttered pie-dish, and bake in a moderate oven. By baking this pudding in a mould or basin, and then turning it out on a dish, you may serve it masked with

Syrup and Wine Sauce.—Make good smooth melted butter, equal to half the quantity of sauce you want. Into this stir, to make up the other half, equal quantities of red wine and red-currant syrup. When on the point of boiling up, pour it over and round your pudding. This forms so elegant and well-flavoured an accompaniment to any light and delicate pudding, that it is worth while keeping the syrup in store for the purpose; or you may use

Currant Syrup (Sirop de Groseilles).—Take six pounds of currants (either white or red, or the two mixed together) stripped from the stalks. To these may be added either a pound of cherries with the stones removed, or a pound of raspberries; the addition is optional, often depending upon opportunity and season, but either one or the other will improve the richness of the syrup. If currants alone be used, let them hang on the bushes as late as may be—

say till the middle of September—and have them gathered only in the afternoon of a fine sunshiny day. Squeeze the juice out of the fruit either by hand through a napkin, or by means of a press. The former method will not obtain so much, but it will be purer and clearer; the latter is apt to express too much, causing the whole to be thick and turbid. A little practice in either case will hit upon the happy mean. Let the juice drawn pass the night in the cellar, or other *very cool* place, free from dust, to avoid fermentation, and to settle. If it is *very clear*, you may then pour it off, leaving the sediment at the bottom of the vessel; if there is the least cloudiness, it is best to pass it through a jelly-bag. Weigh the juice; put it into a *very clean* and bright stewpan, and add to it an equal weight of the best lump sugar broken up. Set it over a slow fire, stirring to prevent the sugar sticking to the bottom, and removing the scum as it rises. *Never let it boil*, although some recipes will tell you, to boil it for several minutes. When no more scum rises, set it aside to cool; when nearly cold, pour it off into an earthen jar or jug to pass the night. Next day, bottle it off in half-pint or other small-sized bottles; cork well, seal the corks, and store in a dry but not too warm place. This syrup, mixed with water, makes a refreshing summer drink; it is a nice addition to sauce for sweet puddings; and, poured over or round them, forms an elegant relief to the insipidity of rice jellies, stewed apples, creams in moulds, &c. &c.

Little Ladies' Tart.—Take half a pound of flour, a quarter of a pound of fresh butter, three ounces of pounded sugar, and three beat-up eggs. Work the whole into a paste, kneading it as if for puff-paste. After working it for twenty minutes, spread it out with the rolling-pin into a circular form, leaving it scarcely a quarter of an inch thick. Trim the outside edge, and crimp it with a fork or spoon. Slip an iron plate under it, and bake in a sharp oven. When done, take it out and let it cool. Just before serving, spread it lightly with fruit jelly, or apricot, raspberry, or strawberry jam. It will be prettier, if different coloured jellies and jams are laid in stripes from the centre, like the spokes of a wheel. Arranged in this way and cut up, it makes a tempting dish at a children's party.

Lemon Cheesecakes.—Every year a certain number of letters are put into the post without any address. Amongst our recipes we find one, from a fair correspondent, which is clear enough in itself, but has no title. It is a nameless preparation, and perhaps some of our readers, more acute than ourselves, will discover its proper title:—"Take one pound of sugar, broken into lumps; six eggs, leaving out two whites; three sponge biscuits, grated; the juice of three lemons and the rind of two, grated; and a quarter of a pound of butter. Put these ingredients into a pan over the fire, stirring them gently until the mixture looks like honey. Put it in a jar. When kept in a dry place, it will keep for two or three years." This is doubtless something good, but *what is it?* We will attempt a rough guess, and although it is very probable our guess may not hit the mark, we presume to call the above composition "Lemon Cheesecakes." You have only to light your oven, line a few patty-pans with thin puff paste, fill them with the above mixture, bake, and, presto! you have Lemon Cheesecakes.

Sly Bread: Bread Fritters.—Beat well, without frothing, five or six eggs in a salad bowl. Sweeten liberally; flavour with rose or orange-flower water, some thin-cut lemon-peel minced very small, and a glass of the very best brandy or rum. Stir all well together. Cut slices of bread a quarter of an inch thick. To make the dish more showy, and to hide what it is from those who taste it, you may stamp them into circles, ovals, lozenges, stars, half-moons, and any other fanciful shape. Throw this bread into the mixture in your bowl, and let it soak. Have ready a deep frying-pan, containing sufficient fat at the right temperature. With your frying-slice put the soaked bread into this, and

fry it exactly as you would pancakes or fritters. Pile them on a dish, and serve as hot as possible, dusted with sugar. It is a good plan to send up a few at a time, hot and hot. This excellent sweet dish is both economical, tasty to look at, and easy to execute. Few, at first sight, would suspect its composition. It may be varied by taking, instead of bread, slices of common cake containing currants and raisins. With the beat-up egg remaining you can make a small custard.

Green Gooseberry Pie.—A more sentimental, yet perfectly accurate, name for this would be Forget-me-not Pie. Make a bouquet of the true Forget-me-not (*Myosotis palustris*)—before presenting it to the favoured person, inhale its odour, and say whether it does not smell exactly like gooseberry pie. This favourite dish has three distinct phases: when the gooseberries first come, are dear, taste of the wood, and call for sugar; when they are full-grown, cheap, sharply acid, and must have more sugar; when they begin to change colour, to soften their hearts, to combine ripe flavour with unripe sourness, and require most sugar. This last state of gooseberries, for pies, is not the worst. In either case you pick off the heads and tails, *i.e.*, the withered flowers and the stalks. You put the fruit in a pie-dish, with an inverted cup to retain the juice; you sweeten, add a little water, put on the crust, and bake. This process is as simple, during the season, as the result is good. But there are people who like green gooseberry tart out of season. To be able to gratify them, you must know how

To Preserve Green Gooseberries, as well flavoured as if just taken off the bushes. Gather the gooseberries before they are quite full-grown; pick off their heads and tails without wounding the skin; put them into wide-mouthed bottles, shake them down, and fill them up to the corks. When tightly corked, dip the corks and the upper part of the necks of the bottles into a sealing mixture. In the next place you must tie wet bladder over them. Line the bottom and sides of a copper or large boiler with hay or straw, to prevent the bottles from sticking or slipping. Arrange the bottles in this, with their necks downwards, and cover them completely with cold water; after which, heat the water until it begins to boil; as soon as this happens, immediately rake out the fire. Let the bottles remain in the water until quite cold, when they may be taken out and must be *always* kept with the necks downwards. It is understood that the bottles must be quite dry before putting the gooseberries in, and that all fruit in any way injured or defective must be rejected. In opening a bottle, care must be taken not to let any of the sealing mixture fall inside.

Rice Soufflé.—Boil ground rice in milk to a thick gruel; add pounded macaroons; sweeten highly; flavour with vanilla, orange-flower water, rose water, coffee, or chocolate. Mix in the yolks of five or six eggs; beat the whites to a froth, and mix them in also, thoroughly and evenly; turn the whole into a large bread tin, well buttered inside (which it must not more than half fill), or into a broad open tin or silver dish, oval or circular. Set it into a rather brisk oven. As soon as well swollen and nicely browned, dust sugar over the top and serve. When it turns out well, this soufflé is a great success—and not difficult to achieve. It depends on the ingredients being well beaten, frothed, and mixed; on their being put into the dish *immediately* afterwards; on the sufficient temperature of the oven; and on the rapid transfer of the soufflé from the oven to the dining-room.

Buttered Apples.—Peel apples; remove the cores with a scoop, but leave the fruit whole; butter liberally the bottom of a tin or silver dish, arrange the apples in it in a single layer; fill the holes in the apples with powdered sugar; dust over them a little powdered cinnamon; pour oiled butter over them, and set them in a gentle oven. In a quarter of an hour or twenty minutes they will be done.

On taking out, put a spoonful of currant jelly, or better, of gooseberry jam, into the hole in the middle of each apple.

Apples and Rice.—Prepare the apples and the dish as for the previous recipe. Boil some steeped rice in milk, with a little lemon-peel; sweeten moderately. When the rice is cooked (not too much), spread a thick layer of it over the bottom of the dish; on this place the apples; fill the holes in the apples with rice; pour over them any milk remaining; put a little bit of butter on the top of each apple, and dust them well with sugar. Set into a gentle oven, and watch, to prevent burning. After cooking, put a spoonful of gooseberry or strawberry jam on the top of each apple. This dish is even better than the preceding.

Charlotte of Apples, without a Mould.—Take a sufficient number of apples to fill, when cooked, the dish required, with a few over, to allow for wasting; peel and quarter them, take out the cores, and slice them; put a large lump of butter into a stewpan; when it is melted, add the apples, and keep stirring them until they are tender enough to mash; then sweeten to taste. Cut slices of crumb of bread about a quarter of an inch thick—cut them into any regular shape, triangles, squares, &c.; fry them in butter to a light brown, and spread one side thinly with apricot jam. Then arrange them round your dish, lapping one over the other; fill the middle with your apple marmalade, over which spread a very thin layer of apricot jam. Reserve three or four smaller slices of fried bread to stick in the centre of the marmalade. If your dish will stand the fire, you may set it into the oven for a minute before serving.

Potato Cake, Sweet.—Cook mealy potatoes by baking, roasting, or steaming, if you can, in preference to boiling them. While still hot, peel and mash them to a paste. With a pound of mashed potatoes mix six raw egg-yolks, a quarter of a pound of sugar, and a little lemon-peel cut very small; when well incorporated, add the whites of the eggs beaten to a froth. Mix well again. Butter the inside of a pudding-dish or baking-tin; fill it with the mashed potato, &c.; pile the top, and make it shapely with a spoon; dust sugar over the surface; set it into a rather brisk oven, so as to form a thin brown crust. Serve hot in the dish or tin in which it was baked. You may further glaze the top by dusting more sugar over it, and setting it under a hot salamander.

Pilgrim's Potatoes, Sweet (a Trappist Recipe).—Slice onions, and brown them in batter in a frying-pan; then mix with them boiled potatoes cut in slices; then add a little milk, taking care not to make them too moist. Sprinkle sugar over them; let them stew five or six minutes, and serve.

Small Sponge Cakes.—Beat well together a couple of eggs; stir into them a teacupful of powdered loaf sugar; beat again; add gradually a teacupful of flour, beating all the while. Put the paste into a tin or into several small patty-pans as soon as it is completely made, and set into a smart oven immediately.

Tea Cakes.—Braid well together a quarter of a pound of butter and a quarter of a pound of powdered lump sugar; then mix in a full half-pound of flour. Beat up an egg in a tablespoonful of cold water, and mix it with the above ingredients. If two sorts of cakes be desired, divide the paste into two equal portions. To one add two ounces of well-washed currants and a very small quantity of ground ginger, with eight drops of essence of lemon; to the other put ground ginger as before, and one teaspoonful of caraway seeds, slightly bruised. Drop the paste in lumps on buttered tins, and bake a quarter of an hour in a brisk oven.

Tipsy Cake.—Procure a mould the shape of a hedgehog or porcupine; in this make a sponge cake; when cold, set it in a hollow glass dish. Blanch almonds by throwing them into boiling water; when the skins are removed, split them, and cut the halves, lengthwise, in two. Pour

over the back of the porcupine, to soften it, a glass of Marsala, Cetto Madeira, or other wholesome white wine. Then stick the back full of the almonds, to represent quills, and make the eyes with currants or raisins. When wanted, pour round it, in the hollow of the dish, as much of the same white wine as it will soak without melting or falling to pieces. Some add brandy to the wine, but that is apt to make it a little too tipsy. If you wish, on the contrary, to render it milder, when you judge that a sufficient quantity of wine has been absorbed by the cake, fill up the hollow of the dish with whipped cream or some kind of custard. (See our coloured illustration, Plate III.)

Light Gaufres (very tempting and nice).—Break the yolks of eighteen eggs into three pounds of flour; mix well, and stir in four pints of good milk, three-quarters of a pound of butter, a little salt, and a dessertspoonful of yeast; leave it three-quarters of an hour to rise; then add a wineglass of brandy and the whites of the eggs beaten to a froth. It is better to add these from time to time in several portions, as the cooking of your gaufres proceeds, in order to keep them all the lighter. Your gaufreing irons are heated over or in a clear fire, charcoal being by far the best. Try their heat with a little of the paste; if it answers well, smear the inside of your iron with a little fine oil, or butter, or sweet pork lard, to prevent the paste from sticking. This must be repeated with every separate gaufre. When a few are ready, serve hot at once, dusting each with powdered lump sugar. Those left warm up again well before the fire or in the oven. Try to see gaufres made once.

Gaufres: Wafers (another way).—With a couple of eggs, half a pound of flour, a quarter of a pound of grated lump sugar, a good lump of butter melted in milk, and a teaspoonful of orange-flower water, make a smooth batter which will hang together in a string when poured out of a spoon; then heat your gaufreing-irons, grease the inside with butter, pour in a spoonful of paste, close the irons, and put them over the fire, and turn them, so as to cook the gaufre on both sides. When you see that it is done of a nice colour, take it out, and proceed with the others. Keep them dry, and dust them with finely-powdered sugar before serving.

Cocoa-nuts are so cheap, and their flavour in sweet dishes is so distinct, that we give one or two American recipes for using them:—

Cocoa-nut Cake.—One pound of grated cocoa-nut, one pound of sugar, half a pound of butter, six well-beaten eggs, and half a pound of flour. Add the cocoa-nut to the cake just before it goes into the oven.

Cocoa-nut Cakes.—Mix one pound of pulverised loaf-sugar with one pound of the white part, grated, of cocoa-nut. Beat six eggs stiff, and mix them with the above. If there is more than enough egg than just to wet the mixture, do not use the whole; there should merely be sufficient to damp the cakes thoroughly. Bake on paper, without browning, in a moderate oven, and leave them on the paper until quite cold.

Orange Marmalade.—For one dozen Seville oranges take an equal weight of lump sugar; grate the outer rind of eight of these; peel the remaining four, and cut the peel into strips with a pair of scissors. Separate the insides of the oranges into their natural divisions, removing all stringy film and pips. Then boil them with the peels in a little water until quite tender. Then break them up with a spoon, and mash them together; add the sugar, and boil for twenty minutes, or longer if not thick enough. When the required consistency is attained, set aside, and distribute your marmalade into jars.

These sweets are extremely useful to eat with a morsel of bread at the close of any repast. A Scotch breakfast is not complete without them; and you know the saying, "Breakfast in Scotland, dine in England, and sup in France."

HOUSEHOLD DECORATIVE ART.

INDIAN PAINTING IN IMITATION OF EBONY AND IVORY.

THIS artistic fancy work, of which we give three illustrations, is easily accomplished by any one possessed of a very little skill, with a moderate amount of taste. Patient care is the chief requirement, and the result is highly ornamental.

Plain articles of box-wood, pear-wood, or white chestnut, and all close-grained, very white woods may be transformed into rich-looking objects. Fig. 2 is a design for a chess-board. The easiest plan is to take a sheet of cartridge-paper, cut the exact size of the table. Enlarge the design of Fig. 1 to the size of the paper, by squares which must be measured with a pair of compasses to get them exact. Draw the lines across at right angles both ways. When a correct drawing is completed on the paper, if there are many erasures, go over the right outlines with pen and ink. When dry, trace this on clear oil-paper, and transfer to the wood by means of blue, not black, tracing-paper (the article is kept by most stationers, or may be ordered). With a clean white rag rub the blue paper well, and remove much of the colour before tracing with it. Next, with a camel's-hair brush, dipped in Indian ink rubbed up in a saucer with water, draw over the outline of the tracing on the table. Shade the flowers or figures with Indian ink, and finish up with stippling them. The ground is entirely black,



Fig. 1.

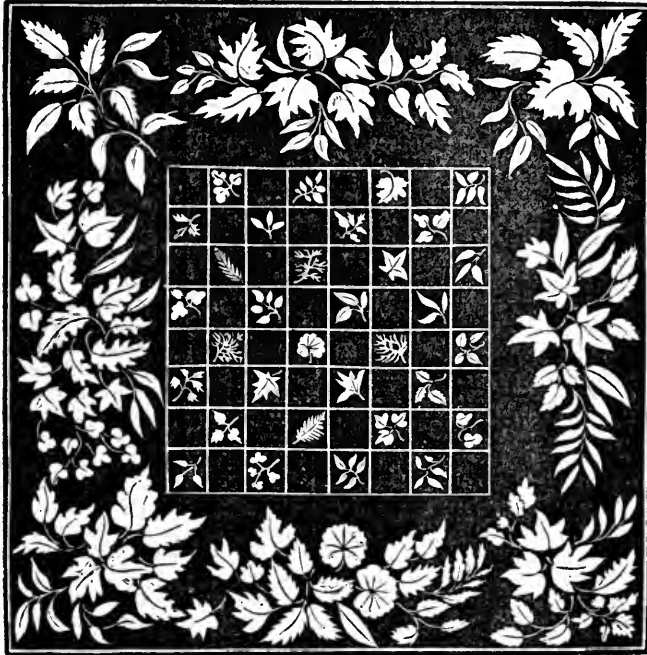

Fig. 2.

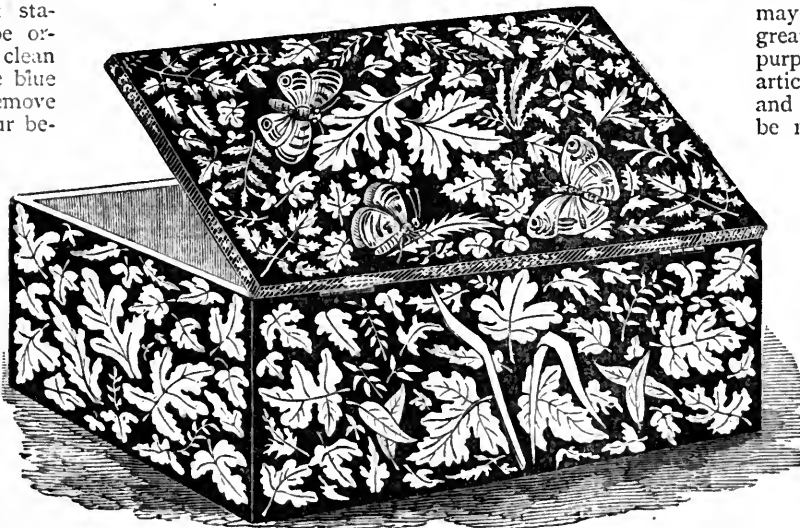

Fig. 3.

put on with a camel's-hair brush, charged with lamp-black and a very little indigo mixed in it, to intensify the black. The colour is rubbed up in a saucer with water, and used moderately wet. It must not be put on very black at once, but by degrees, never going over the same place

a second time till a day has elapsed. Care must be taken not to lose the outline of the design. The ground must be jet-black when finished, and perfectly even in tone. The design requires more shading as the work proceeds; or the shading may be left altogether till the ground is completed. Lastly, varnish it with pure copal, which should be procured colourless and genuine. It is better, perhaps, to send the chess-board to an artists' colourman to be varnished. A stand and legs to the chess-table may be made and painted black; a cabinet-maker will provide them. Fig. 3 is a box to be ornamented in the same way; it is suited to hold chessmen, draughtsmen, and a pack or two of cards, and may stand on the table. Fig. 1 is a design for a decorative border which may be used for a variety of subjects.

Both Fig. 2 and Fig. 3 must be varnished. A cover of wool, or fine, not coarse, cotton, in crochet or knitting, should usually cover the top of the table, to preserve the varnish from scratches.

The mode of decoration we have described may be applied to a great variety of useful purposes, and many articles of the simplest and cheapest kind may be made to assume a

very ornamental appearance by its aid. Leaves and grasses may be selected from the garden, and when flattened out and arranged, be made to supply a large number of highly interesting decorative designs.

Fig. 1 is a design of this kind. The edges of deal bookshelves look very pretty when

decorated in this way, and a pattern of the required kind may be made by first tracing a waved line, and placing on this line, apparently springing from it, tracings from a series of small leaves flattened out for the purpose. Such borders may be adopted from other decorative work

to be found in a variety of illustrated books. For hints as to good taste in selecting and arranging such objects, and the kind of decorative treatment which is most artistic, we refer our readers to the papers now appearing in these pages under the head of *The Principles of Good Taste in Household Furniture and Decoration*.

COOKING.

CHEESE, MACARONI, CALF'S-HEAD, SWEETBREADS, VOL-AU-VENTS.

Cheese Patties.—Beat up some yolks of eggs with mustard, cheese, wine, and butter. Fill the baked patties and put them in the oven. Serve hot.

Cheese Fritters.—Cut slices of apple, and add to these half as many slices of cheese, which must be the same in quantity. Let the cheese be put in a mixture of egg, butter, salt, and mustard, and put each slice between two slices of apple. Dip these into egg, fry, and serve hot.

Cheese Paste.—This is made with cream cheese and flour, with a little butter and three or four eggs, mixed with some good cream sufficient to give it the requisite consistence.

Cheese Marmalade.—Take any marmalade and boil a few teaspoonfuls of it with a pint of cream, adding a little preserved lemon-peel, dried and chopped fine. When slightly warmed, cover it with some rennet and pound a little white sugar over it.

Potted Cheese.—Grate one pound of Cheshire cheese, and add to it three ounces of fresh butter, a little sifted mace, and about a teaspoonful of mustard. Pound and mix well with the pestle and mortar, put it into small pots, and cover with clarified butter. It should be kept in a cold dry place.

Cheesecakes.—Put a quart of milk on the fire, and when it boils put into it about eight eggs, beaten well, and stir until the curd comes. Then put it aside, and when it is cold add a little salt, two spoonfuls of rose water, and three-quarters of a pound of carefully washed currants. Put it into a puff-paste and bake in tin patty-pans. Cheesecakes should be baked directly they are made, or they will be oily and also less pleasing to the eye.

Under the name of *Fondue* and *Ramequins*, French cooks mix eggs and cheese together in a variety of ways.

Fondue of Cheese.—When there is no handsome Stilton or Cottenham to present, or it is wished to avoid the break in a dinner caused by the "cheese course" (of which few may care to partake, and which those who do care for may decline, to avoid being singular), some preparation of cheese in a cooked or melted form makes a very agreeable substitute. Weigh in their shells the eggs you mean to use. Take the third of their weight of grated white cheese (Gruyère is the best, but good English kinds will do), and the sixth of that weight of butter. Break the eggs into a saucepan, and mix with them the butter and the cheese, seasoning rather highly with pepper and slightly with salt. Set the saucepan on the fire, and stir the whole together till the eggs are set, keeping it light. Then turn it out on a hot dish, and serve instantaneously, sending round with it the mustard-pot.

Ramequins.—Set a saucepan on the fire containing the third of a pint of milk and two ounces of butter. As it warms up, stir in gradually a couple of teaspoonfuls of flour, and keep stirring till it is hot. Then mix in four eggs and two ounces of grated cheese; Gruyère and Parmesan, or other white cheeses, are preferred; but good mild Cheshire answers perfectly. Make, with white writing paper, little cases about an inch deep and three inches square; fill them with the mixture, and bake a quarter of an hour in a gentle oven. By beating up the whites of the eggs separately to a froth before adding them to the mixture, you get *Ramequins Soufflés*. A cheese omelette (already given) will take the place of either of the above.

Welsh Rarebits.—Small Welsh rarebits will tempt many a guest; and at a supper, in spite of their heaviness on the stomach, the dish containing them will rarely be removed without suffering considerable loss. A fondue is lighter and more artistic; although a genuine Welsh rarebit, done in a Dutch oven on bread toasted and buttered before the cheese is laid on it, and delicately seasoned with mustard, has undeniable and considerable merit. But in whatever form cheese is cooked, it is rigorously requisite that it be served hot. A mellow Gloucester cheese is best for making a Welsh rarebit. We add another way:—Put the cheese into a saucepan with about one ounce of butter and a little ale—a very little will do. Put it on the fire and stir until it is quite melted, remove it and add an egg well beaten. It may be placed on the dish and browned before the fire.

Macaroni, au gratin; Ovened, with Cheese.—Good macaroni can be properly made only with the very finest wheat; it is, therefore, highly nutritious in any digestible form, and greatly to be recommended to invalids. A simple way of serving it is this: if you have the time, steep the macaroni, broken into pieces as long as your finger, a couple of hours in tepid broth (if not wanted for a meagre dish), or milk, or water. Then boil it in the same till tender. Tastes differ as to the degree to which macaroni should be cooked. Some like it melting, so that it can be pulled out in strings like toasted cheese; others prefer it to retain a certain firmness. Keep the macaroni warm in its saucepan. Butter the inside of a shallow metal or other dish that will stand the fire; transfer the macaroni to this; grate over its surface any delicate cheese you prefer (Stilton answers admirably); over that grate a thin layer of crumbs of bread, interspersed with bits of butter the size of hazel-nuts; set it into a brisk oven, or under a salamander. When the butter and cheese are quite melted, and the surface nicely browned, it is done enough. For those who fear the *toasted cheese*, as hard to digest, when the macaroni is boiled tender, pour off all the liquor except just enough to keep the bottom of the saucepan moist. Season slightly with pepper and salt; add butter and grated cheese; keep stirring till they are melted and well mixed with the macaroni, then serve on a hot dish. The macaroni in this case is not browned; there is *no* crackly, brittle crust on its surface—*i.e.*, it is not *au gratin*. It is not so pretty to look at, but is very acceptable and wholesome, nevertheless. A more elaborate way: boil the macaroni as before; drain it, and keep it warm in the saucepan. Stir a dust of flour into some milk—or better, cream—in a saucepan; add butter, finely-chopped parsley, and shallots, salt, pepper, and grated nutmeg. Set it on the fire, keep stirring in one direction till the sauce boils up; when thick and creamy, pass it through a strainer. Butter the inside of a dish that stands the oven; in it put the macaroni, mixing it with the above sauce and grated cheese. Level the surface with a spoon. Grate cheese, and put little bits of butter all over it; set it into an oven, or under a salamander, and serve immediately it is nicely browned.

Stewed Cheese.—One egg well beaten and strained is to be mixed, with a teaspoonful of cream, to about two ounces of cheese. To this may be added butter, in proportions of about half an ounce or more, according to the richness or poorness of the cheese. The butter is first put into the saucepan, and the other ingredients are added when it is melted. Stir and boil until it is well mixed, and serve it hot, either browned or plain.

Macaroni Pudding (sweet dish).—Break the macaroni into inch lengths; boil it in milk till tender. Line the inside of a buttered pie-dish with good thin pie-crust; set it into the oven till nearly baked enough. Take as many eggs as (with the macaroni and the milk in which it was boiled) will all but fill the dish; beat up the eggs, not frothing them; sweeten liberally; flavour with rose or

orange-flower water, and a wineglass of good cognac or rum. Add the macaroni and milk; stir all well together; pour it into the pie-dish lined with crust, and set it into a very gentle oven. Watch the preparation carefully while it is baking, for if it boils it spoils. As soon as the custard is nicely set, you must take it out, and sprinkle the surface with grated lump-sugar.

Calf's-head Cheese.—Cold calf's head is mostly too much done to hash nicely, and there is often not enough left to make a dish. It may be made very presentable, as follows:—When the calf's head, removed from table, is cold, cut off *all* the meat from the bones—lean, fat, skin, and tongue—into pieces not bigger than marrow-fat peas. Put these into a stewpan with the juice of half a lemon, the rind of the same peeled, then pepper, salt, grated nutmeg, a bit of sugar as big as a hazel-nut, and any brain sauce that may be left. Pour over them just as much of the calf's head boilings as will cover them. You will note that, by rejecting the first water, containing whatever impurities may have come away from the head, the *second boilings*, which contain *good* extracts only, are perfectly fit for use as stock-broth, &c. Set the stew-pan on a gentle fire, and let it simmer for twenty minutes, stirring occasionally. Then take out the lemon-peel, and pour all the rest of the ragout into a pudding-basin or other simple mould, in which you will let it cool and stiffen all night. When wanted, turn it out of the basin or mould, and serve at breakfast or luncheon, garnished with a few green sprigs of parsley.

Hashed Calf's Head (Calf's Head Ragout).—For this boil a calf's head expressly, as previously directed; but take it up while the flesh is still firm, and before it is quite done enough. Take out the tongue and peel off the skin. Then set the whole aside to cool. Make the brains into little cakes. When wanted, slice the flesh of the head lengthwise—removing the skin of the palate—into handsome slices, about half an inch thick, as large as you can cut them. Some, of course, must be comparatively small. Also cut the tongue into slices. Fry these slices in butter to a nice brown, after dusting them on both sides with flour, salt, and grated nutmeg. You may, if you please, dip them before frying in frying batter. As the slices of head and tongue are fried, put them into a stewpan, standing ready by the side of the stove. When the frying is done, brown a little flour in the butter left in the pan; stir in gradually a little of the calf's head boilings, and half a tumbler of Madeira or Marsala wine; season with the juice of half a lemon, a dust of sugar, and a very little cayenne. When this sauce is quite smooth, pour it over the slices of head in the stewpan; let them simmer in it over the fire ten minutes or so. Place the slices on a hot dish in orderly arrangement; taste if the sauce does not want a little more seasoning or a drop more wine. Give it a boil, and pour it over the meat in the dish. Serve, garnished with brain-cakes, fried or toasted bread, or little tiny cakelets, made of puff paste. If any of this ragout is left it may be combined with the remnants of the cold calf's head, and made into a small calf's head cheese, which in this case will turn out of the mould marbled with brown.

Sweetbreads are quite as frequently employed as ingredients in sundry made dishes (such as vol-au-vents, white meat pies, and ragouts) as served alone. Immediately you receive the sweetbreads, throw them into cold water, and let them lie there an hour or two. Then throw them in boiling salt and water, and boil them twenty or five-and-twenty minutes. Put them by; when wanted, they are ready to be dressed in the way required.

Sweetbreads, White.—Warm up the sweetbreads in a saucepan no larger than will hold them conveniently, in good white veal broth or calf's head boilings, seasoned with a blade of mace, the rind of half a lemon, a small pinch

of horse-radish, pepper and salt. When they have stewed long enough to be quite hot through and completely cooked, pour off the liquor into a smaller saucepan, straining away the lemon-peel, &c., and keeping the sweetbreads hot in the other. For sauce, stir into this liquor a little flour, a good lump of butter, and a dessert-spoonful of lemon-juice or vinegar. Keep stirring in one direction, letting it boil awhile, to reduce it a little. Then taste if the flavour is sufficiently high-seasoned. White dishes should not be insipid; while remaining delicate, they should still be piquant. You may further thicken with a couple of raw egg-yolks gradually stirred in. When the sauce is smooth and of the right consistency, dish the sweetbreads and pour the sauce over them.

Sweetbreads, Brown.—For this, a stewpan, whether of metal or earthenware, with a rounded bottom (fitting into one of the circular openings of your cooking-stove) is preferable. Prepare the sweetbreads by boiling as before. Put a good lump of butter into your stewpan; when it begins to brown, put in your sweetbreads. Keep turning them over and from side to side till they are gradually but completely browned nicely all over and thoroughly done inside. In this way, their outsides are coloured without being hardened; whereas, if they were roasted inside an oven or before the fire, they would, probably, be covered with an uneatable *crust* on one side, while the other side remained soft and colourless. Keep your sweetbreads hot by the side of the stove, while you make a sauce (unless you have prepared it beforehand) like that usually given for hashed calf's head or for veal cutlets without bone. Then dish the sweetbreads, pour this brown sauce over them, and serve garnished with fried or toasted bread, brain-cakes, forcemeat-balls, or any other little what-nots that you have handy and suitable.

Vol-au-vent of Sweetbreads.—In large towns the crust for vol-au-vents may generally be obtained from the pastry-cook's, by ordering it, which is the surest and perhaps the cheapest way. To make it well requires a considerable amount of skill and practice, and when made, much depends upon the oven. Nevertheless, for those who live in the country, we give plain directions from "Wholesome Fare," advising the amateur to try her hand first on an experimental essay for private consumption; which, in case of failure or half-success, will be no worse than matter for mirth. Indeed, making the crust of a vol-au-vent is one of the things which require to be *seen* done. The grand puzzle to the laity is how the hollow in the middle is made. Many fancy it is done by baking a lump of bread inside the crust, and then taking it out to make room for the ragout. The feat, however, is thus performed:—Roll out the lightest possible puff-paste to three-quarters or one inch in thickness. Lay it on an iron oven-plate. A clean saucepan-lid serves to cut out the required circle. Trim away the rest of the paste, which will serve for patties or garnishing. Trace (with a knife heated in hot water, to prevent the paste from sticking to it) a smaller inner circle within it, to form the lid of the vol-au-vent, leaving an edge about an inch broad, and making your knife penetrate to nearly half the thickness of the paste. The surface of the whole may be glazed with egg, or otherwise decorated. Put it into a brisk oven, when, if the puff-paste has been well made, the whole ought to rise to the height of three or four inches. When well-risen, and of a nice light brown, take it out, lift the cover immediately, and *with your knife remove the underdone paste or crumb within*, leaving the hollow which is to receive your ragout, and taking care not to make any leaks in it. But to accomplish this well is one of the nicest operations in pastry-cooking. To make the ragout to fill your crust, take the cold sweetbread, prepared as above directed; cut it into dice, which you next salt, pepper, and dredge with flour. Have, ready-opened in a basin, two dozen middle-sized oysters, with

their beards trimmed off, but with the liquor from both oysters and beards; also a small teacupful of button-mushrooms and the substance of two dozen olives, pared as you would pare an orange, all in one piece, but as thick as possible, and close to the kernel; which kernels you throw away. Into your stewpan put a quarter of a pound of butter, melt it, add a table-spoonful of flour, stirring well, and pouring in stock gradually, until your sauce attains a creamy consistency. Season slightly with salt and a very small dust of cayenne and grated nutmeg. Put in your sweetbreads, stirring continually, for fear of their burning or browning. When thoroughly heated and done enough, add, one after the other, your oysters, mushrooms, and olives, a glass of Madeira, Marsala, or Bronté, and a table-spoonful of tarragon or other aromatised vinegar. Stir and heat up again, taking great care not to let it boil. Taste if sufficiently seasoned, and serve in the vol-au-vent crust, after gently warming it. N.B.—A dust of sugar, so slight as not to be suspected, is often a great improvement in any savoury vol-au-vent.

Many people like vol-au-vents quite as well cold as hot, or even better, as being less cloying to the appetite. Cold vol-au-vent makes a nice supper-dish, and is just as producible as cold oyster-patties or cold veal-pie. Moreover, as a vol-au-vent may be made of anything, and must contain a variety of ingredients, most of which require previous preparation, it is an economical way of reproducing, in an elegant form, many little remnants which would otherwise be wasted. The housekeeper, on looking over the contents of her larder, can often out of them compose an original vol-au-vent. There is scope for her inventive genius. Bits of cold fowl, pigeon, meat, game, and forcemeat, unused oyster, caper, shrimp, or anchovy sauce, &c., will, with judicious additions, costing little, and a well-made, tastefully-flavoured sauce, constitute a dish pleasing to the eye as well as to the palate. You may thus turn to account delicate joints of poultry, brains, bits of veal, the livers of chickens, ducks, or geese, cocks-combs and kidneys, morsels of rabbit, small birds, as larks; portions of sausage, stuffing, nouilles, macaroni, and balls of fried mince-meat; anything, in short, which you have at hand. Meat vol-au-vents may have their character varied by a slight predominance of mushroom or walnut catchup; of Harvey's, Worcestershire, Reading, truffles, lemon-peel, or curry-powder. Again, vol-au-vents of fish are excellent, and, moreover, serviceable for meagre days. That of shrimps is one of the best and most celebrated; but cold cod, cods' sounds and tongues, flakes of turbot or salmon, fillets of soles, pieces of eel, cockles, mussels, lobster, crab, &c., will come in usefully. Meagre vol-au-vents may differ from each other by being flavoured with parsley, mustard and vinegar, oysters or anchovy; the sauce in all cases retaining its richness and smoothness. To almost any vol-au-vent you may add either oysters or mushrooms, or both; the same also of sweetbreads. A few olives, or a little tomato sauce, improve the more highly-flavoured ragoûts for vol-au-vents.

DOMESTIC MEDICINE.

COSTIVENESS (*continued*).

MANY people fancy that the matters discharged as waste from the body—the fæces—are made up for the most part of the remains of food that has not been digested and absorbed into the system. This is a great mistake. The bulk of such matters come from the mucous membrane of the bowels. It is well known that persons with diarrhœa often take very little food. The bile makes some contribution to the fæces, but not a very large one—not nearly so large as used to be thought; for most of the bile that is poured out into the bowels is mixed with the food, and absorbed again into the system. The fæces are formed

in the lower and larger part of the intestines, and they are meant to be got rid of. They are composed of materials that are bad for the system. Just as the urine is meant to be discharged, so are the fæces. Now costiveness often consists in the fact that these secretions of the intestines are deficient in quantity; there is a dryness in the mucous membrane, so that it does not secrete the materials it should secrete. The bowels do not act often, and when they do act, the motions are hard, dry, and scanty. The consequence of a want of secretion in the intestine is in the first place, as we have said, that the bowels do not act often, and when they do act it is with difficulty. But more than this. We have said that the secretions of the intestine are meant to remove something impure from the system. When this is not removed, the blood is not purified sufficiently; the patient feels sluggish; the complexion is sallow and dirty, not clear; the skin gets greasy and opaque; both mind and body are depressed; the appetite is not good, and what food is taken is not well digested. Such is *costiveness*.

Causes.—Costiveness is produced in many weak states of the system, and especially in cases in which the circulation through the bowels is languid or weak. It is favoured by tea, by beer, by the common wines, by indolence, by the scanty use of water, either for drinking or washing purposes, by want of exercise in the open air, by too much sitting, and too much use of the brain.

Treatment.—Now most people have very short and rough ways of curing costiveness. They go into the first chemist's shop, and buy some opening pills, or a dose of Epsom salts. Very often they get quite their money's worth of relief. But the bowels are only temporarily relieved, and very soon they are in the same plight as before; or rather worse, for this is a case in which mere purging does harm, and unless the whole nature of the ailment is taken into consideration temporary relief is gained at the expense of greater difficulty afterwards. To be constantly irritating the bowels with pills is very much like constantly taking the cane to a naughty boy. It is a rough temporary remedy, not a real one that is likely to do lasting good. The proper way is to ascertain first if the desired object cannot be brought about by suitable diet and increased exercise. Brown bread instead of white; milk and water, or cocoa, or coffee, instead of tea; stewed fruits and wholesome mixtures of vegetable with animal food; a good drink of cold water on rising, and at other times in the course of the day; whey or beef-tea substituted for solid suppers; exercise in the open air; and the use of sponge-baths, are domestic measures that all may take, and which will often succeed. It is by the plenteous use of cold water outside and inside, and the general regulation of diet in hydropathic institutions, that they succeed in curing this condition. Water favours all the processes of the body, and makes them active. This activity clears the blood, and causes the fæces to be properly formed in the intestine. If these measures do not succeed, or if the discomfort is very great, then other measures must be resorted to. Amongst these, an injection of warm water every morning should first be tried. If this does not succeed, opening medicines may have to be taken. It should not be strong, but simple. Mercury, blue pill, and strong doses of Epsom salts should be avoided. One or two mild rhubarb pills, or, if these are not sufficient, colocynth pills may be taken at bedtime, for temporary relief; but let our readers remember that they will only give temporary relief, they will not cure the bad habit of dryness or costiveness. For the cure of this, reliance must be placed on the diet recommended above, on exercise, and on such medicines as the following:—The aloes and myrrh pill of the Pharmacopœia, five grains. This pill, at first, should be taken every night, and may gradually be taken less frequently. If piles are troublesome, it is not suitable; and we do not recommend it in all cases, but in most persons it may be tried.

CONSTIPATION.

Here the fault is a want of contractile power in the bowels to expel their contents; not a want of contents. Such may be expected to be the case of weakly persons, who look pale, who think or write much; also of elderly persons, in whom the bowel loses its tone, and does not contract well. If there is much pain or discomfort, an injection or a dose of opening medicine may have to be given, with a temporary use of fomentations if there is any local pain. But if there is no pain, but just a want of action, then the following pill may be taken twice or thrice a day, associated with exercise and such measures as are generally calculated to strengthen the body:—

Watery extract of aloes...	...	$\frac{1}{2}$ to $1\frac{1}{2}$ grains.
Sulphate of iron	1 to $1\frac{1}{2}$ grains.
Extract of gentian	2 grains.
Mix.		

This pill will not act all at once or severely, but will gradually dispose the bowel to act of its own accord. It should be gradually discontinued. It is not suited to cases of piles. If gentle measures do not succeed, let a medical man be consulted; but on no account let people get into the habit of always taking opening medicine.

CONSUMPTION.

There are few diseases of more importance to the public than consumption; indeed, there is no single disease of so much importance. We have before us the Registrar-General's Report for 1855. In that year there were in all 425,703 deaths, and 52,290 of these were caused by consumption. Of these deaths 24,602 were of males, and 27,688 were of females. There is no reason, however, to think that the disease is more fatal in our climate than in others. As the disease is so common; as there are, unfortunately, few families which are not more or less directly concerned in it; and as, fortunately, we can speak of it in more hopeful terms than our forefathers could—we shall attempt to state those facts concerning the disease which it is important should be known. This is, in our opinion, eminently a subject for domestic medicine—we do not mean to the exclusion of scientific medicine—but the case of consumption is one upon which there are many erroneous views abroad, and in regard to the recovery from which much depends upon domestic wisdom and general domestic circumstances.

Nature of the Disease.—The disease, as far as it is local, has its principal seat in the lung, and the favourite part of the lung, where it almost invariably occurs, is the upper part of the lung, under the collar-bones. The disease consists essentially in a deposit of a certain substance in the fine texture of the lung. The name of this substance is *tubercle*. It may occur in small grain-like masses, or in larger quantities. In the former case the tubercle exists in the form of minute, firm, semi-transparent granules, of a blueish-grey colour. These may be very sparsely, or very thickly scattered through the lung. The more common form in which tubercle is deposited is in masses, quite opaque, varying in colour from a dirty white to a drab, or a bright buff, and in consistence from that of firm tough cheese to that of soft cream cheese. The masses vary in size and shape; the size varying from that of a millet-seed to that of a walnut, or even a small egg. Ordinary consumption, we say, consists essentially in the deposit of this substance in the upper part of the lung. Now, let the reader notice this fact: that the deposit may occur in other parts of the body, such as the bowels or the brain, but that—in grown-up people, at any rate—wherever else in the body it occurs, it is almost sure to be found also in the upper part of one or both lungs. This rule is so invariable, that it is called one of the *laws* of tubercular disease. For the discovery and the statement of this law, we are indebted principally to

Louis, a great French physician. Now, it may be asked, Why should the deposit of a small quantity of tubercle in the lung produce such serious effects on the body? For one thing, it takes up a certain amount of lung-tissue. The lung is a light and porous organ, meant to hold air. When tubercle is deposited in it, it becomes solid, or half-solid—so much air is excluded from the lung; so that, if you tap with the finger over it, it sounds more dull than it should do. So much air being excluded, the patient feels short in the breath; but this is only so when the deposit is in considerable quantity. We have yet to give the principal explanation of the serious effects that result from the deposit of a little tubercle in the lung. We should rather say that we have to state what we know, than that we have to *explain*, for there is yet a good deal that is mysterious in the disease. In the first place, this deposit generally coincides with, or follows, a general weakness of the constitution; without any obvious reason, the patient feels weaker than he or she should feel. Next, when this deposit occurs in the lung, it is slow to disappear or be removed, unlike healthier deposits in other parts. Not only does it tend to remain, but to increase, and, worse still, to break up the texture of the lung itself. The tissue of the lung is not merely pushed aside, but it *ulcerates—it is destroyed*, so as to leave holes, or, as they are called, cavities. This ulceration and destruction of the substance of the lung often affects also the blood-vessels of the lung. They become perforated, or ulcerated, and bleeding happens. Then the patient “spits blood.” Now, when this deposit of tubercle is going on, accompanied, as it generally is, with more or less destruction of the tissue or substance of the lung, there is more or less of *feverishness* in the system—the skin is hot, and there is a loss of appetite. And, in the great majority of cases, the patient undergoes emaciation; he gets visibly thinner, and loses weight. Why such a small deposit, in a comparatively limited piece of the lung, should cause such serious symptoms, may still be a difficult matter to understand. We shall state the facts in a future paper.

HOUSEHOLD AMUSEMENTS.

THE GAME OF BÉZIQUE.

It is rarely that a new game achieves so great a popularity as that which has been gained by *Bézique* in the course of little more than a few months from its first introduction into this country. The fact that it has soon become so popular is sufficient evidence that it must possess considerable merit as a pastime, and we will follow our account of whist, the best of all card games, with a description of *bézique*, its new rival.

The precise origin of the game is unknown, but it appears to have been gradually compounded of elements selected from several games previously in existence, and commonly practised in France and Italy. The name *bézique* appears to come from the Italian *bazzica*, which is one of these old card games, the word also meaning “correspondence” or “association.” The association or union of the cards in certain combinations is the great characteristic of *bézique*.

The advantages the game possesses over others, and which account for its success, are, first, the ease with which it is learnt, a very little attention sufficing to enable any one to understand it; next, its variety, and the continued element of chance which it contains, enabling a novice often to contend successfully against the best player; and, lastly, its adaptation to any small number of players—either two, three, or four. For two, however, it is especially suited, and admittedly superior to double dummy at whist, which it bids fair to supplant entirely. We shall confine our remarks at first to the game as played by two persons, as this is its best and most common

form, and the same rules govern it when played by a larger number.

Mode of Playing the Game.—Bézique is played with two packs of cards, from which all numbers from the two to the six inclusive are thrown out. Bézique packs are commonly sold, but they are only ordinary packs without the small cards, and it is much better to buy the ordinary packs at once, as these may be used for other purposes also. The backs of the two packs should be alike, but even this is not necessary.

The two packs are shuffled together, and laid face downwards on the table. The players then cut for deal,* which goes to the highest. The dealer gives eight cards to his opponent, and takes the same number, the most convenient way of dealing them being two at a time alternately, although some players deal three to each, then two, and then three again. In this, as in other points of the game, practice varies, and there is no settled rule. When the sixteen cards are dealt, the seventeenth is turned up, and placed at the bottom of the pack, but partly exposed, so that it may be seen by the players. The suit to which the turned-up card belongs becomes the "trump" suit for that hand. The remainder of the pack—or, as it is called, the *talon*, or *stock*—is placed with the faces downward between the players, at such a distance that they may each readily draw cards from it as the game progresses.

The non-dealer commences the play with any card in his hand, and the dealer follows, the two cards so played constituting a *trick*. Any card may be played, and the best card takes the trick. The usual value of the cards is somewhat altered, as the ten is next in importance to the ace, and thus the values run—ace, ten, king, queen, knave, nine, eight, seven. There is no gain in taking a trick, unless either an ace or a ten is included in it. For each ace or ten among his tricks the player counts ten towards game. If the same card is played when one has been led—the ace of diamonds, for instance, upon another ace of diamonds, or an eight upon an eight—the trick belongs to the first player.

The person who has taken the trick then draws the top card from the talon, and his opponent draws the next, and so on until the stock is exhausted, the rule being that each player holds eight cards in his hand before playing. When the whole of the cards in the talon have been drawn, the sixteen which remain between the players are played as at whist, with the exceptions that each person is bound to take the trick if he can, either by following suit or by trumping, and that the ten retains its bézique value.

The object of the game is to secure certain combinations in the hand, by which the player may count as high a number as possible. What these combinations are we shall explain presently. The player who first scores 1,000 wins. The scoring takes place after a trick is won, the player who wins it being entitled to *declare* what he holds, and score for it. A declaration can only be made after winning a trick. It is the practice among some players to allow only one declaration after a trick, and if the player holds what would enable him to make another declaration and a further score, he has to wait until he has taken another trick before announcing it. But others allow whatever may be held in the hand to be declared on taking a trick. As no laws are yet universally received, it is an open point as to which rule is to be followed. We give the preference ourselves to the practice of declaring everything that is held, when the opportunity arises. Obviously, the advantage is the same to the one side as to the other; and the reasons for the preference are that the play is less obstructed by waiting for the opportunity of repeated declarations, and that the game is conse-

quently shortened. This is in our opinion desirable, as considerable time is often taken up in reaching 1,000 points, four hands, or more than an hour's play, being commonly required for the purpose.

The Score.—The following are the combinations which entitle the players to count :—

	Points.
Four aces held together in the hand, and declared, count	100
Four kings held together, and declared, count	80
Four queens " " " "	60
Four knaves " " " "	40
Simple marriage (king and " queen of the same suit declared)	20
Royal marriage (king and queen of the trump suit)	40
Bézique (queen of spades and knave of diamonds)	40
Double bézique (the two queens of spades and the two knaves of diamonds) ...	500
Sequence (ace, ten, king, queen, and knave of the trump suit)	250
First seven of trumps declared*	10
Second seven of trumps declared	10

In addition to these points, which are all scored upon declarations, the following also count :—

Seven of trumps turned up... ..	10
Last trick	10
Every ace in the tricks taken	10
Every ten " "	10

The various cards composing a declaration must be exposed on the table when the score is taken, but they may still be used for tricks, as if they were in the player's hand. No second declaration may be made from exposed cards, unless something is added to them from the hand, to produce a fresh combination. Thus, a player who has declared a sequence, and has all the cards exposed, is not afterwards allowed to declare the royal marriage which forms a part of that sequence. He must declare the royal marriage first, and then add the other cards which form the remainder of the series.

The absence of an authoritative code of laws has caused some differences to exist in the practice of scoring, to which we must now refer. First as to the score for double bézique, which it will be seen is very high. Some players insist that the whole of the four cards composing the declaration must be shown together, and that a player who has declared single bézique is thereby debarred from declaring double bézique later in the game. Others do not like this restriction, and some of the best of the published codes of rules set it aside. In practice, having played the game according to both methods, we believe it is immaterial which rule is adopted. To retain the chance of scoring for double bézique, the hand is equally cramped in the one case as in the other, for when the first queen of spades and knave of diamonds have been shown, they must still be held until the desired opportunity arises, and the opposite player has all the time the advantage of knowing what are two, at least, of the cards in the adversary's hand. Double bézique is not very often made, as the chance of the four cards falling to one player is comparatively small; but we have, as an exceptional case, seen it made by opposing players in two successive rounds of the same game. Players sometimes agree to reduce the score for double bézique to 300, considering the ordinary score out of proportion to the rest.

As to the scoring for the "last trick" the practice is also different, some holding this to mean the last of the entire hand, while others reckon it the last bézique trick taken

* The mode of "shuffling" and "cutting" has already been explained in our article on Whist, page 262, vol. i.

* The player holding this has the privilege of exchanging it for the original trump card, and counting ten also.

before the final cards are withdrawn from the table to be played in whist fashion. We give the preference to the latter rule, for the reason that the proper *bélique* play comes to an end by the exhaustion of the talon, and that, in general, more skill is required to secure the trick before the talon is exhausted than that at the end of the game.

One other difference remains to be mentioned. The various aces and tens taken in the course of the tricks always, as we have said, count ten; but some players wait until the end of the hand to count them, while others score each ten as the card is taken. The last-named rule is the best, especially when the game draws towards the close, as then it is often entirely a question of making small numbers to win.

We shall follow—in a future article—this description of the game with a list of the rules, according to the principles here explained, and instructions for the benefit of young players.

THE HOUSEHOLD MECHANIC.

GARDEN FURNITURE AND DECORATIONS (*continued*).

Summer-houses.—Before constructing a summer-house, a suitable site must be determined upon; and this requires some little consideration. It should be secluded, as a general rule, and dry; while, if sheltered by trees and shrubs, the wind, which in our capricious climate is often cold even in summer, will be to some extent excluded or moderated. It sometimes happens that an otherwise picturesque garden is marred in effect by the presence of an ugly piece of wall, or an out-building. In this case a summer-house, erected so as to shut out a view of the offensive object, will not only be useful, but conduce to the pleasant effect which a garden ought to produce upon the mind. Nothing of this sort, however, is effected by the erection of such ungainly structures as we frequently meet with even in our parks, which ought to be models in this respect. A Chinese pagoda is most certainly as much out of place in an English landscape as anything can well be; yet, in two, at least, of our metropolitan parks these monstrosities are to be met with. No less out of keeping are the square boxes, fitted with taproom tables, of which the Londoners seem so fond, and which look like a compromise between the cuddy-houses, usually found upon the decks of sea-going ships, and gigantic hen-roosts. We will endeavour to show how summer-houses may be constructed so as to avoid these common defects, and be made to add to the rustic effect and beauty of the gardens in which they are erected.

Having selected a suitable situation in which to build, the first thing will be to provide for raising the floor above the level of the surrounding ground. This precaution is important; for, if it be neglected, the bottom of the building will be always damp and unpleasant, will speedily decay, and become rotten. If the house is intended to be a permanent construction, it will be best to build piers of brickwork to support the plates carrying the joists and floor; if intended to be of a more temporary character, strong posts or supports of wood will be sufficient for the purpose. But whether of wood or brickwork, they should be long enough to raise the floor at least ten or twelve inches above the ground, to allow a free current of air to circulate between them. The expense involved will be amply repaid, both in comfort and in the durability of the structure. These supports should not be more than five feet apart, and if of brickwork the plates should be bedded in mortar. Square timber, about four inches by three, will be best for this purpose, and it should be laid on the centre of the brickwork, as shown at A in Fig. 1. The angles should be halved together by cutting out a portion from each, as we have shown in the same diagram at B, and nailed, or fastened with wooden pins. This plate should be carried through all the sides

of the structure, so as to tie it together, and form the base or foundation upon which the rest is erected.

Upon this the joists should be placed which are intended to carry the floor, and these should be also of square timber of such dimensions as may be deemed necessary according to their length, and about fourteen inches apart. If not above six or eight feet in length, timber of the size we have suggested for the plates will be ample; each joist should be halved over the plate, as shown at C, Fig. 1, and strongly nailed. Over these lay the floor, for which three-quarter inch yellow deal battens may be used. Before laying either joists or floor, however, it will be well to prepare the plates for receiving the uprights which are intended to support the roof; and, as the design must be a matter for the taste and consideration of the constructor, we shall only furnish such details as are required in the erection of a summer-house whatever may be the form chosen.

In order to erect these supports, it will be necessary, having determined upon their position, to bore holes in the plate, to receive tenons cut in the ends of each post; which may be done as we have described in the previous article on garden chairs. If a similar square piece of wood be used for the lintel to support the roof, it will be more convenient than if round timber is employed, and this will require mortising in precisely the same manner as the lower plate. As a general rule, it will be found sufficient to mortise the corner posts, and cut the centre ones tightly under the lintel; but if all are tenoned the work will be much stronger. The best material for these uprights will be nearly straight branches, or trunks of trees of a diameter suitable to their length: for a building about ten feet high, four or five inches will lock very light and pretty. The number of uprights may be varied according to taste; but care should be taken to avoid anything like square openings—they should be longer than they are wide in the proportion of at least two to one. When the frame is made and set up, it should be well nailed together, care being taken that it is perfectly upright, as nothing looks worse than a building the lines of which are not perpendicular.

The frame being secured, the next thing will be to provide for the roof; and here we may observe that a sure and certain method of making a building ugly, is to make the roof flat. The best and most effective method is to make the roof "hipped"—that is, so that it slopes from the centre point down to all the sides. The inclination should be bold and well marked, both for the purpose of throwing the water off quickly and for the sake of effective appearance.

For the frame of the roof square timber will be most convenient. The first thing will be to erect the ridges, as shown at Fig 2, which is a plan of the roof, from corner to corner. The foot of each piece will require cutting over the top of the lintels, as shown at A in Fig. 3, and the upper end at the angle required to fit both parts together, as at B, Fig. 3. When one part is ready, the other two pieces may be fitted to it in the same manner, and the whole nailed both to the lintel and together in the centre. If the span of the roof be not more than ten or twelve feet, wood of about one and a half inches thick and four inches deep will be ample; but the timber must be stronger if the span exceed this to any great extent. The ridge pieces being properly placed and secured, the rafters may be cut in, as shown at A, Fig. 2. Each of these will also require cutting at the foot, in the same manner as we have already recommended for the ridges; and they should be nailed both to the lintel and to the central supports. Unless the covering is intended to be of very heavy material—as, for instance, tiles—these rafters need not be more than two inches square. The whole of the roof should now be boarded with planed wood of about five-eighths of an inch in thickness; of course, placing the planed surface downwards. It will be as well to

plane the timber used for the construction of the roof, as it will be easier to paint, unless indeed the building is to be ceiled, which is quite unnecessary in most cases.

It is somewhat difficult to determine what is the best material for covering the roof. Both zinc and felt are flat, and very ugly. The ornamental tiles now made, look very pretty, especially when they become discoloured and

under the boards supporting the felt. This is a plan we can recommend, as cheap, durable, and very effective. It is well to let the reeds run over the edges of the building, as they will carry the rain-water well out of the way, besides improving the appearance of the summer-house. The apex of the roof may be ornamented according to taste; and the only thing which need here be said, may

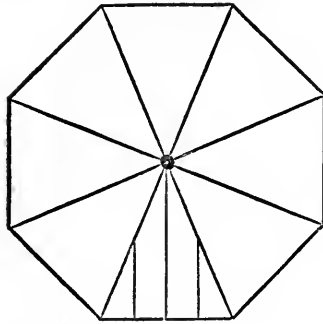

Fig. 6.

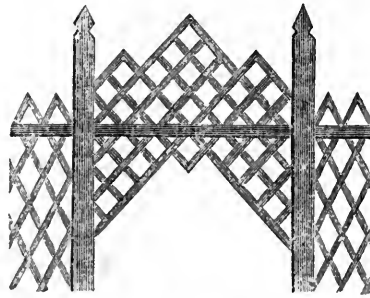

Fig. 13.

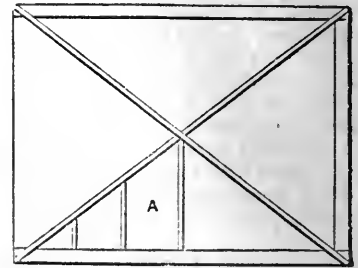

Fig. 2.



Fig. 9.

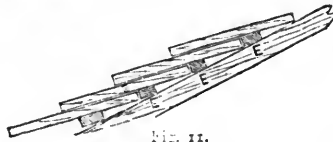

Fig. 11.

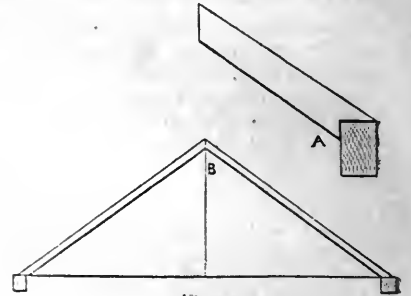

Fig. 3.

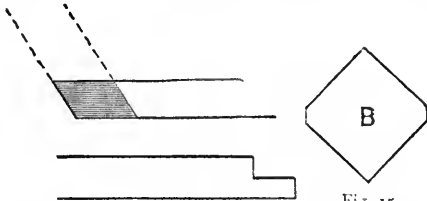

Fig. 15.

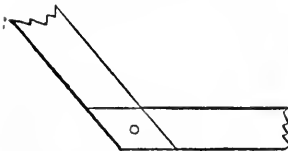

Fig. 5.



Fig. 1.

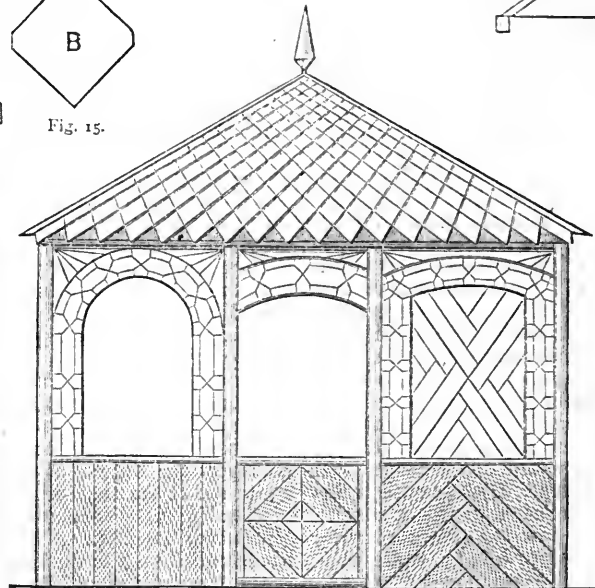
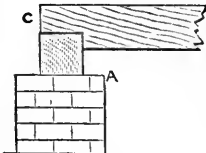

Fig. 12.

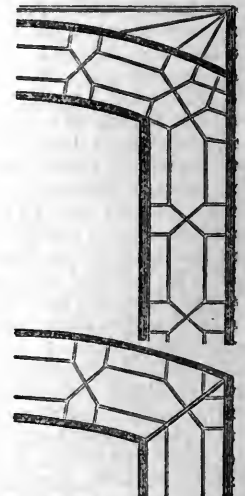

Fig. 14.

mossy, but they are very heavy and rather expensive. We have seen a very pretty effect produced by the following means. The roof was first covered with felt, so as to keep out the water. Over this was placed a layer of reeds, some three inches in thickness, and sloping down in the direction of the fall of the roof, that is to say, the same as that of the rafters in Fig. 2. In this case, the ridge pieces were allowed to stand up about three inches above the felt, and a batten or strip of wood was nailed to it so as to cover the upper end of the thatch, and keep it in its place; the lower end being secured by means of loops of copper wire, passing over the reeds, and secured

be in the shape of a caution, to avoid the ordinary conventional weathercock, which is most certainly out of place on the top of such a structure.

Having described the method and details of construction of what may be termed the frame of the building, we may now proceed to the more decorative portion of the work. It is rarely required that the whole of the space between the roof and the floor will need to be left open, except in that portion used as the entrance. The remaining spaces will therefore require filling up. This should be done to the height of about three feet above the level of the floor. A very good plan of doing this, will be to cut a

piece of round timber to fit between the uprights at the required distance above the floor, as shown in Fig. 4. This will form a sort of sill. The remaining space may then be filled in with branches, either squarely, as at A, Fig. 4, or diagonally as at B, as may be preferred. Some care will be required in fitting, in order not to

the openings, of course selecting for use only such pieces as have graceful curves, and are of picturesque outline.

It now only remains to show how the lower portion of the erection is to be treated, in order to disguise the space between the floor and the ground. This space must not be altogether filled up; but it is necessary to cover the

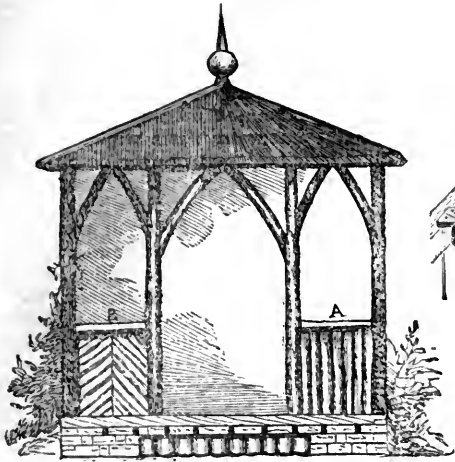

Fig. 4.

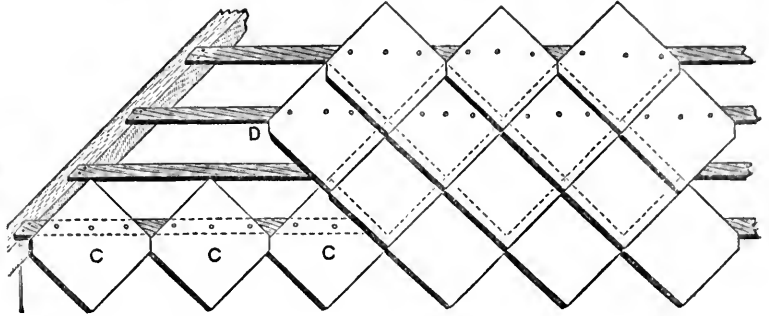

Fig. 10.



Fig. 5.

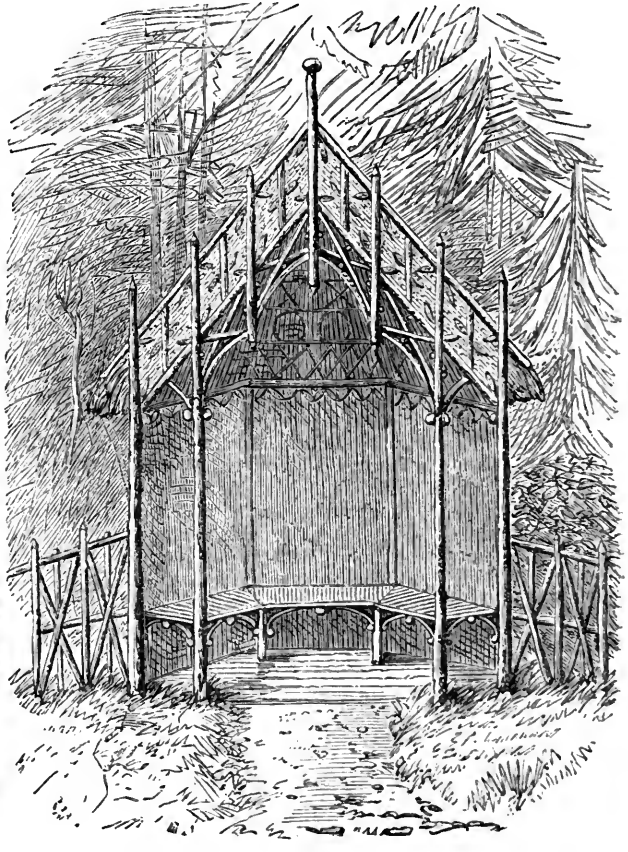

Fig. 7.

injure the bark of the wood, which should be preserved as far as possible. This will form a solid panel and keep out the wind well; but if a lighter effect be desired, an arrangement of interlaced, or simply crossed branches may be made, which will look very pretty, especially if flowers be trained and allowed to grow through and over the woodwork. Fig. 8 shows a design for open work.

The square junction of the uprights and the lintel supporting the roof, should be broken up by means of crooked or curved branches cut to fit both parts, and nailed to them, so as to form a sort of rustic arch over all

pieces which support the floor. For this purpose either the rough roots of uprooted trees, or artificial rock-work may be used; always taking care to leave spaces through which the air may freely circulate to keep the floor dry. The steps leading to the entrances may be formed by cutting the trunk of a tree into sections, equal in length to the required height of the step, and placing them side by side for the requisite distance. These will need very little fastening; but they should all be nailed firmly to the board upon which they stand. Should any portion of the lintel appear below the thatch, it may be covered with

strips of wood in much the same manner as we have described in a previous paper on garden furniture.

The directions we have given are for the construction of a square building; but the same mode of proceeding is equally applicable to one of octagonal form, or one with any number of sides; except, that the plates and lintels will require halving together at the required angle, somewhat as shown in Fig. 5. The ridge pieces of the roof will also require to be cut one from each angle to the centre of the building. Fig. 6 is a plan of this form of roof, and as the other details are precisely similar to those given above, they need no further consideration here.

To the amateur builder the square form of summer-house will be found the easiest of construction; and this is our reason for describing it in detail. But it should be always remembered, that more varied forms are far more elegant and ornamental; and that the extra trouble involved will be amply repaid when the work is completed.

In the two summer-houses which we next give, the upright and other main timbers are formed of young fir or larch trees. Preference is generally given to the latter, as being by far the most enduring; but we have known common Scotch fir last for more than twenty years when thus used, and that in a damp clay soil. In many instances proper trees can be thinned out of shrubberies and plantations, and will cost nothing; or they are to be bought for a trifle in most parts of the country. For the uprights, poles of six to eight inches diameter at the base, and ten feet long, are most suitable; the lower three feet are sunk into the ground to give a firm support. The chief roof timbers are smaller poles of the same kind, and the roofs are covered with a good coating of ordinary thatch, not less than a foot in thickness. In the open tracery of the fronts all the larger straight pieces are of the same material; other woods are used for the curved. This open work looks complicated, but as it is for the most part simply nailed together, it may be made very quickly. Where round dots appear in the woodcuts, filling the places of cusps in gothic work, they are formed of sections of sticks, each held in place by a single nail. The backs of both summer-houses are formed by nailing boards without the uprights. Those in Fig. 8 are covered within with the split branch-work described at page 373, vol. i., arranged in patterns as indicated in the cut. In both examples the seats are made in the same manner. In Fig. 7 the boarding is supposed to be lined with elm bark, which may be peeled in large sheets from the trees immediately after they are felled, provided they are cut down in the spring. Such bark is valueless for any other purpose, and may be had for asking. Along the upper margin of the bark we have shown a cornice of pine cones nailed in a zig-zag; the barge board which protects the thatch in the front of this house is treated with bark and cones in the same way. In both our designs, the laths which support the thatch are of the same kind of ornamental rustic work as the open tracery in front. As bare thatch is unsightly, the spaces between the rafters may be filled with heather, if it can be obtained, if not, with moss; but the use of the latter has this attendant evil—in spring-time it forms a source of overpowering temptation to the birds, who look upon it as specially adapted to their own architectural requirements, and appropriate it in the most unscrupulous manner, much to the disadvantage of the human nest to which it properly belongs. In bright summer weather Fig. 7, being very light and airy, forms a pleasant resting-place, but against bad weather it offers less protection than Fig. 8; but if creepers are trained along the open tracery it will be much sheltered. Many people will prefer the more shady and sheltered nook which is shown in Fig. 8.

In case our amateur should wish to thatch a summer-house himself, we give the method of procedure. The

straw to be used is first straightened with the hands, so that the stalks may all lie in the same direction. For convenience in working, thatch is usually put on in strips of about three feet wide, running from eaves to ridge. In these summer-houses the strips would all taper to a point at the latter. The straw is first laid on at the eaves in such bundles as can be conveniently grasped in the two hands, which are fixed in their places by tying them through their upper ends to the laths and rafters with stout string soaked in tar; a large needle, some nine inches long, is used for this purpose. Another layer of bundles is then placed overlapping the first, and so on, till the whole strip is completed, the binding on with tar-cording being repeated at intervals. The whole is then smoothed down with a large wooden or iron comb—the head of a rake will answer the purpose. The thatch has now to be further secured at top and bottom with buckles (as shown in Fig. 8), which are made of slips of willow or osier about two feet long, pointed at the ends and cut thin in the middle, so that they may be bent double without breaking. Another thin piece of the same material, called a runner, is laid on the thatch; the buckle is bent double and thrust in with a point on either side. It thus grasps the runner and holds it firmly in its place; the points of the buckle must slant upwards, otherwise it will let wet through the roof. In ornamental thatching, pretty effects are to be obtained by the judicious arrangement of buckles and runners. In Fig. 8 we have shown them placed in double lines, with shorter pieces of runner crossing diagonally between. One strip being secured, another must be added and well blended with it at the line of juncture. When the whole is finished, the eaves must be made level by paring with a sharp knife. In places where timber with the bark on is not easily obtainable, and tiles are expensive, a very neat summer-house may be made with laths and matched boards, and having wood tiles; but as the ordinary split laths, though strong, are not straight enough for the neater kinds of work, it is better to employ sawn laths, which may be obtained at most of the timber yards or saw-mills under the name of outside Venetian laths. They are generally sold for three or four pence the dozen, and are about two-and-a-half inches wide, little over one-eighth thick, and from three to five feet long, these can be easily split into two or three by means of the cutting-gauge described on page 24, vol. i. These laths may be employed to make a porch of the kind shown in Fig. 12.

Matched boards having a groove on one edge with a tongue and bead on the other can be had of various thicknesses and widths; they are planed on one side. For the roof, prepared floor-boards, which are planed on one side, may be used; those of seven inches wide are the best, as being nearest to the size of ordinary square tiles; of course, wider ones may be employed, and do not require quite so much labour to cover a given space, but, as a set-off, they do not look quite so well. Cut the board into squares, as shown at A (Fig. 9), then carefully take off about half an inch equally at opposite corners, and you have pieces like B, in Fig. 15. These pieces are to be nailed on to the battens, as at C C C (Fig. 10), so that the batten comes just above the cut corner, as at D (Fig. 10). The battens of one course will then come just above the upper points of the tiles of the next course below it, and is shown in section at E (Fig. 11). This kind of roof should have a good pitch. The lower corner can then be nailed to the batten of its next lower course, which will bind the whole into one solid mass. As the tiles are rather short in the grain-length, it would be well to take the precaution of boring with a brad-awl for each nail, and, failing anything superior, a common flat-iron serves well to hold beneath the thin wood to drive and clench the nails, as nothing is more difficult than to drive a nail through a piece of wood which vibrates. The ridges must be covered with a thin narrow

board, as shown in the summer-house, Fig. 12. We have given different designs on each side. Of course, the builder can use either, or vary it according to his individual taste. Fig. 14 is an enlarged diagram of the sides of Fig. 12.

There are many details of decoration which might be described here; but in a matter like this we think it better to leave all these to the taste of the constructor. The only caution we need offer would be, that the greatest care should be taken to have all parts in keeping with the rustic character of the work. We have frequently seen iron brackets and tables in rustic summer-houses such as we have been describing. These are decidedly out of keeping, and look very ugly in such situations. The furniture may be of the kind of which we detailed the construction in the former paper, which will at once satisfy the eye and answer all requirements.

In conclusion, we may observe that the tools required for the construction of garden furniture, and detailed in our last paper, will mostly be found sufficient for the construction of summer-houses; and that although at first sight the work may seem somewhat complicated and difficult of execution, it will be found easy enough when once commenced. There is no better plan of working than that described, and if carried out strictly in accordance with the suggestions here offered, the result will doubtless be satisfactory to all concerned in building or occupying such delightful retreats as summer-houses should be.

CLEANING CLOTHING AND UPHOLSTERY.

To clean Coloured Fabrics.—Nearly all coloured fabrics stain the lather used to clean them, and that without losing their own brightness in any way. No article of a different colour must be plunged into a wash or rinse so stained, but must have fresh ones; and no coloured article must be rinsed in a blued lather. Scarlet is particularly prone to colour a wash.

Different colours are improved by different substances being used in the wash or rinse; sugar of lead has the credit of fixing all colours when first cleaned, and may be used to those likely to run. To brighten colours, mix some ox-gall, say two-pennyworth; but of course the quantity must be regulated by the quantity of suds in the wash and rinse. For buff and cream-coloured alpaca or cashmere, mix in the wash and rinse two-pennyworth of friar's balsam for one skirt. For black materials, for one dress, two-pennyworth of ammonia in the wash and rinse. For violet, ammonia or a small quantity of soda in the rinsing water. There are some violets and mauves that fade in soda. For green, vinegar in the rinse, in the proportion of two table-spoonfuls of vinegar to a quart of rinse. For blue, to one dress, a good handful of common salt in the rinse. For brown and grey, ox-gall. For white, blue the water with laundry blue.

Dresses, mantles, shawls, opera-cloaks, under-skirts, Garibaldi's, and Zouaves (the latter and such small articles need not be touched if the trimming is removed), articles embroidered with silk, self-coloured or chintz-coloured, damask curtaining, moreen and other woollen curtaining, may all be cleansed as specified so far.

Blankets should be cleaned in the same way. Pull them out well, whilst wet, at both sides and both ends, between two persons. When half dry, it is a good plan to take them off the line, and pull them again; when quite dry, just give them a little more pulling out. This keeps them open and soft. Blankets are not blued so much as flannels, presently described. Never use soda to them, and never rinse them in plain water, or rub on soap.

The dyers and cleaners have a mode of pressing articles which gives to many of them, such as damask and moreen curtaining and Paisley shawls, a superior appearance to anything that can be achieved at home; but some

of them will press articles at a fixed price for persons cleaning them at home.

Worsted braids and fancy trimmings can be cleaned the same way.

Muslin Dresses, even of the most delicate colours, can be cleaned in ten minutes or a quarter of an hour, without losing their colour. Melt half a pound of soap in a gallon of water, empty it in a washing tub; place near two other large tubs of clean water, and stir into one a quart of bran. Put the muslin in the soap, turn it over and knead it for a few minutes; squeeze it out well, but do not wring it, lest it get torn; rinse it about quickly in the bran for a couple of minutes. Rinse again well for a couple of minutes in clean water. Squeeze out dry and hang it between two lines, see Fig. 1, p. 16. A clear dry day should be chosen to wash muslin dresses; half a dozen may be done this way in half an hour. The last rinse may be prepared the same way as the rinses for woollen fabrics. A coloured pattern on a white ground must not be blued. The bran may here be dispensed with.

When the dress is dry make the starch; for a coloured muslin white starch, and unboiled, but made with boiling water, is best for muslin dresses. Stir the starch with the end of a wax candle. Dip the dress. Hang it again to dry. When dry, rinse it quickly and thoroughly in clear water. Hang it to dry again. Sprinkle and roll it up; afterwards iron it with very hot irons. Hot irons keep the starch stiff. This rinsing after starching is called clear-starching; none of the stiffness, but much of the unsightliness of the starch is removed in this way.

All kinds of white muslins, lace curtains, cravats, &c., may be washed in a thick ley of soap as described, well rinsed, blued, and starched, like the muslin dresses above-named. Use blue starch to white. White muslin Garibaldi's should be very slightly blued, and the same may be observed of book-muslin dresses and cravats, as blue-looking muslin is very unbecoming to the complexion; a slight creamy tinge is preferable.

Morning cambric dresses may be washed the same way as muslin dresses; but they do not generally clean quite so readily, and perhaps may need rubbing a little in places that are soiled.

The advantage of thus cleansing dresses instead of washing them is, first, if coloured, the process is so rapid that there is not time for the colours to run. Secondly, the fabric is not rubbed, and therefore not strained and worn out. Thirdly, the process saves nearly all labour, and is so quickly done, that any lady may manage it for herself in the absence of a laundry-maid or a lady's maid.

Many ladies make a strong solution of sugar of lead—some put two pennyworth in enough cold water for one dress; stir it well when dissolved, and let the dress, muslin or cotton, soak a couple of hours to set the colours before washing it the first time. It does not need to be repeated. Those using sugar of lead should be careful not to do so if they have any scratches, abrasions, or wounds about their hands.

Chintz may be cleaned in the same way as muslin and print dresses.

Laces.—Laces of all kinds can with a little care be rendered equal to new. Make a strong solution of soap, as described for woollen materials. The laces may all be put in at once. Squeeze them in and out. They generally become free from dirt by once passing through. They may then be thoroughly rinsed, blued, and starched; but if at all discoloured and bad looking, must first be boiled. Soap each article thoroughly all over. Fill a basin or jar with water as blue as possible, and lumps of soda and soap. Put the lace in the pipkin. Put the pipkin in a saucepan of water just large enough to hold above by the rim (like a glue-pot), and put the saucepan-lid on the pipkin. Boil two or three hours, taking care the water does not boil out of the saucepan and let it burn; if need

be, replenish it. Turn out the lace in a basin; rinse it well. Blue it with the finest blue that can be procured, but not much. Get a bottle of the best drawing gum in solution from an artists' colourman (common liquid gum will not do); put a teaspoonful of this to a pint of water. Stir it well; stiffen the laces in it; squeeze them dry; lay them out on a clean dry towel; fold them up till the worst wet is absorbed. While still dry, pin out each piece of lace by every point, stretching it equal to new, but not straining any part, on a cushion (sofa-cushion or pillow) which has been first covered with a clean cloth. The right side of the lace should be up. Leave it till quite dry, which will probably not be till the next day. If it is Cluny lace with raised spots, take a pin and raise all the spots carefully as it lies on the cushion. Remove all the pins, and pick out every part and corner of the lace with the fingers. If raised, raise it by drawing it over the thumb-nail. Brussels lace and Honiton lace look better ironed whilst still a little damp, instead of being pinned out in this way. Arrange these also with the fingers, both before and after ironing. Crochet may be pinned out, or left to dry, pulled out with the fingers only, or pulled out whilst still damp and ironed. It is also a matter of fancy whether it is starched or not.

To bleach Lingerie, Lace, and Embroidery.—After washing and boiling, let it lie all day in excessively strong blue-water. Lay it out all night on the grass to dry. Boil again with soap, without soda or blue. Rinse well. It must not, however, be forgotten that too much soda turns linen, &c., yellow.

To stiffen Linen, such as cuffs that require to be very firm, boil the starch after mixing it cold. Into a pint of starch drop a bit of white wax half the size of a small hazel-nut, and a teaspoonful of brandy. The spirit is to retain the stiffness and increase it, the wax to save the starch from sticking to the iron. When an iron sticks to starch, soap the bottom of the iron. This is the plan usually adopted by London laundresses.

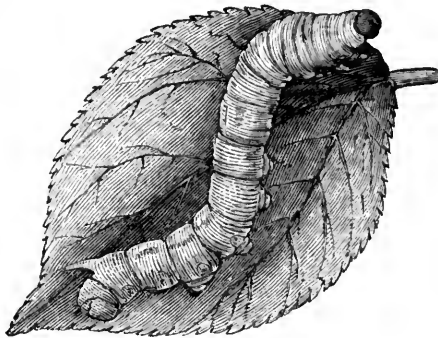

THE SILKWORM.

ANIMALS KEPT FOR PLEASURE.

THE SILKWORM.

MOST young people are fond of having some living pet, which they can have with them constantly at home, and comparatively few have an opportunity of indulging this harmless and kindly taste, owing to the difficulty of finding suitable accommodation for animals. Nothing can be more deleterious than the keeping of rabbits, mice, and such common favourites in a place where human beings are to live, however clean their owners may try to keep them. But the culture of silkworms will be found to fulfil the desired object of affording pleasant occupation and pastime combined, without any of the evils being experienced which inevitably attend the keeping of pets generally. The only objection which can be raised to these little creatures, is the bad smell which is commonly supposed to attend them; but this may be prevented by care and scrupulous attention to the cleanliness of their habitation. Nothing can be more desirable than the inculcation in the youthful mind of such habits of punctuality and thoughtfulness as this care necessarily involves; and thus pleasure may be made a means of profit, and very many most valuable lessons insensibly instilled.

But the keeping of silkworms should be considered not

merely as an amusement for the young, nor even in its more valuable aspect as a means of their instruction. It is our desire that serious consideration should be given, in the perusal of these remarks, to the enormous benefit to society which might be derived from their culture. This branch of manufacture would be eminently suitable for the profitable employment of women and children, especially as one of the chief desiderata is a light and delicate touch, and since it is capable of being profitably exercised in any well-regulated and cleanly household, it might easily be made to form a means of gain to poorer households, unattended with the almost inseparable evils of the great factory system. Not that we wish for a moment to depreciate those great centres of national industry; but it will be apparent that an employment which can be pursued at home, must possess many and incalculable advantages over one which demands the temporary dissolution of family influences and ties. If every household would devote a portion of the year and day to the cultivation of silkworms, with a view to the practical and commercial benefits to be derived from such a pursuit, it is impossible to overrate the benefit which would accrue to the general community, as well as to each individual pecuniarily. There are two special branches of industry which might be practised with success:—1st, the rearing

of the mere worm; 2ndly, the rearing of the worm until it becomes capable of producing silk. It may not be generally known to our readers, that the finer descriptions of what is usually termed cat-gut, are manufactured from the intestine of the silkworm; this manufacture is at present restricted almost entirely to Spain, but there is no reason why each family in this country should not contribute its quota towards a species of labour which might benefit individuals and ultimately enrich the commonwealth. Others, again, might devote their energies to the producing of silk; and thus each might contribute somewhat, while

enriching themselves, either to the establishment of a new trade, or to the revival of one which has unhappily fallen into decay. We allude to the silk-weaving community, chiefly associated with Coventry.

Perhaps, however, some of our readers may urge that it is too much to expect that these considerations should at first impress the minds of our readers; let us therefore turn to the subject of silkworm keeping chiefly as a pastime.

When the reader has determined upon attempting the rearing of silkworms, the first step will be to provide for their reception. This is soon done, and with the outlay of a few pence. Some stout cardboard, or, better still, Bristol board, should be procured, and separated with a sharp penknife into oblong pieces, five inches long by four in breadth. Then with the knife cut a small triangular piece out of each corner, so as to leave four projecting sides, about an inch deep, which being carefully folded up will make the sides of a neat tray; the corners may be secured by sewing them together with strong thread.

It will also be found advisable to make some larger trays in the same manner, each of a proper size to contain four of the smaller ones: the reason for this arrangement we will explain presently. The trays being finished, a piece of coarse muslin or tarlatan should be stretched over each, in such a manner that it may easily be removed, and a place chosen in which to deposit them. A high shelf, in a room of moderate temperature, is the best place.

As we are supposing that this is the first experiment, we must next procure some eggs; these may be had, for a

trifling expenditure, from some of the many dealers in such things, in Covent Garden Market and elsewhere. They are, at first, very much like mustard seeds in size and appearance, changing afterwards to a light grey. When they again change colour, and become whitish, it is a sign that the worm is about to break out, and the care of our little charges now begins. In each tray should be placed some mulberry leaves, or, if these cannot be procured, some lettuce leaves, which it is best to chop into small pieces, as a great saving is thus effected. As soon as the silkworm leaves the egg, in the form of a small dark-coloured maggot, about a quarter of an inch in length, it will attach itself to the food prepared for it and feed greedily (see engraving). The muslin covering must now be stretched over all, to prevent annoyance from dust or insects, and the whole carefully watched. At least once a day the trays should be cleansed, and fresh leaves provided; but it is much better to do this night and morning. The worms may be lifted, without danger, on the point of a fine camel's-hair brush, and should be sorted, so that those nearest to each other in size may be kept together.

At the end of about a week from the time of hatching, the head of the larva becomes large, and its first sickness, previous to casting its skin, commences. This sickness lasts three days, during the whole of which time it refuses food, and appears to be in a state of almost entire torpor. At the end of that period, the skin is cast, after much and evidently very painful exertion; so completely does the worm rid itself of its outer integument, that the covering, not only of its body and head, but even of its feet, jaws, and teeth, may clearly be discerned with the aid of a microscope. The worm now becomes increasingly voracious during about another week, when it passes a second time through a similar transformation. On two other occasions, and at intervals of about corresponding duration, the process is repeated, after which the appetite increases still more, and the larva grows rapidly for nine or ten days. It may now be considered to have attained its full growth, and is about three inches in length. After the second change, the large trays become useful; the smaller ones should be laid aside for future use, and the worms allowed a greater space in which to feed and live. They may now be observed to grow restless, and the muslin covering becomes very necessary to hinder them from crawling out of their dwelling-place, and making their escape. Sometimes slender filaments of silk will appear to issue from the thin greenish body, but gradually this appearance passes away, and the body assumes a semi-transparent, satin-like look. Practical entomologists tell us, that during this period the silk is in process of digestion, and that, on dissection, it appears to be wound in two separate bar-like substances within the stomach, presenting the likeness of the finest imaginable gummy thread.

The worm has now arrived at that stage of its existence at which its life-work begins. It has passed, as is above described, through five intermediate stages:—first, the egg; secondly, the scarcely discernible black maggot of which we have spoken; and afterwards, in a beautifully ordered succession, through three conditions of larger growth, in each of which it becomes more elegant in appearance, and, what is better, more fitted to accomplish the end for which it was created. During the whole of these changes, the greatest care and attention is necessary on the part of whoever intends to cultivate the silkworm. The strictest cleanliness must be maintained, as the larvæ are delicate, and will sicken and pine if neglected: the first evidence of their being in an unhealthy state being a most faint and disagreeable odour from the trays. Scrupulous attention must also be given to the changing of their food at the proper time; to its being plentiful; and, above all things, to its being *fresh*. Where mulberry

leaves are to be had, the thinnest should be selected, and care taken that they are not too old; as the mulberry tree frequently bears two crops of leaves in the same year, there can, in such cases, be no difficulty in furnishing suitable nourishment. If, however, it becomes requisite to fall back upon lettuce, the leaves should be chosen which lie nearest the heart of that vegetable, but by no means let the cultivator select the hard distasteful outer covering. The trays must be well brushed, and will thus be easily cleaned; and, with these precautions, there is no reason, humanly speaking, why the culture of the silkworm should not be made a source of considerable profit, as we have already suggested, apart from the pleasure which an intelligent mind may derive from observing the habits and characteristics of these interesting little creatures.

THE HOUSEHOLD CARE OF BOOKS.—II.

WHEN the covers of books become loose or badly worn, they should generally, if the expense be not an obstacle, be re-bound. It will be convenient for the reader to know what the probable cost of re-binding will be, and we append a list of prices for the more usual sizes and the simplest styles. It is given by a good London house, and may be supposed to supply a fair approximate estimate; no exact scale can be laid down, as the charge must always vary, to some degree, with the quality of the work and the amount of ornament. Our estimate is for mere plain binding, with decorative gilding or other ornament:—

	Demy 12mo.		12mo.		8vo.		4to.	
	s. d.	s. d.	s. d.	s. d.	s. d.	s. d.	s. d.	s. d.
Cloth ...	0 8	0 10	1 0	2 6	1 0	2 6	1 0	2 6
Half-roan ...	0 9	0 11	1 3	2 6	1 3	2 6	1 3	2 6
Half-calf ...	1 4	1 10	2 0	3 6	2 0	3 6	2 0	3 6
Half-morocco ...	1 10	2 2	2 0	3 6	2 0	3 6	2 0	3 6
Calf ...	2 3	3 0	4 0	7 6	4 0	7 6	4 0	7 6

To some it will probably be necessary to explain the method of indicating the sizes of books; they are named from the number of leaves formed by folding the sheets of paper on which they are printed. Thus a folio, which is doubled once, has two leaves to the sheet; a quarto (4to), doubled twice, has four; an octavo (8vo), doubled four times, has eight; a duodecimo (12mo), doubled six times, has twelve, and so on. This would be tolerably simple, were all sheets of the same dimensions; but so many different ones are employed, as frequently to puzzle the uninitiated how to describe any particular book. The dimensions of the usual sheets of printing papers are, in inches:—Demy, 22½ by 17½; royal, 25 by 20; super royal, 28 by 20; imperial, 30 by 22; double foolscap, 27 by 17; and double crown, 30 by 20. The sizes for which our prices for bookbinding are given are all "demy."

Cloth bindings, in which new books are usually published, have only been in use during the last fifty years; they are almost confined to England and America, books on the Continent being still issued in covers of thin paper. Previous to 1825, the common practice in England was to publish in boards with paper backs, but upon this the cloth case is a great improvement. Many cloth covers are so good in taste, as to leave no further binding to be desired; but some binders disfigure and vulgarise them with cheap and unnecessary gilding, which is always objectionable; a fact which should be borne in mind when re-binding in cloth is contemplated. It is also well to bear in mind, that, as this is a modern invention, it cannot with propriety be used on old books.

Properly, the term "bound" is applied to those books only which are covered with vellum or leather. Vellum is little used at present, though, formerly, most small books were bound in it. The leather most commonly used is

calf-skin, dyed various colours; sheep-skin also is used, but only for law and school books; except when prepared in a superior way to imitate the more costly morocco, and called roan. Morocco leather is made from goat-skin, and was formerly brought from Northern Africa, but is now manufactured in England. Its peculiar "grain" is given by the workman in pressing it, whilst it is being dressed with an engraved boxwood ball. Russia leather is certainly rather expensive; but otherwise, is one of the best coverings for books, as its peculiar odour, derived from the empyreumatic oil of the birch-bark with which it is tanned, keeps it perfectly free from insects; it is also considered good as preventing that enemy of book-bindings, mildew.

Half-bound (as half-calf, half-morocco, &c.) implies that the back and corners only are leather, and that the sides are covered with some cheaper material, generally marbled paper. Half-binding can only be recommended on the score of economy. It is a sham, and like all shams is in bad taste.

THE TOILETTE.

DISORDERS OF THE HAIR AND THEIR TREATMENT (continued).

Thinning of the Hair is a great trouble frequently with ladies, and is very conspicuous oftentimes at the partings. It is generally seen as a natural occurrence once in the year, more or less marked, oftentimes in the autumn. This answers to the moulting of birds, and is succeeded by a vigorous growth of the hair subsequently. Now it is very important to be aware of this physiological change, because we may otherwise do much harm by the application of stimulant washes and the like to the scalp, which irritate the hair-forming apparatus or the hair follicles, and thereby derange the formation of the new hair. When, then, the hair thins out in the autumn time, and young hairs are seen to be springing up over the scalp, it will be best to use only some such wash as the following, and to avoid ordinary hair lotions:—

Tincture of nux vomica	4 drachms.
Distilled vinegar	1 ounce.
Glycerine	1½ drachms.
Rose water	6 ounces.

To be sponged on to the head night and morning, the scalp being fairly brushed afterwards.

Thinning of the hair may be the result of family peculiarity. In a certain number of instances, the son follows the example of the father, in getting bald at an earlier age than is the case with the majority of people; in these instances, little real amendment can be effected by remedies. In the mass of cases, thinning of the hair arises from distinct disturbance of the general health. It may be slight when the indisposition is unimportant, it may be very marked when the bodily powers have been much reduced by severe illness, as in fevers and the like. The first matter to be attended to in all these cases, is the state of the scalp. If it be at all dry, scurfy, and red, a cooling lotion should be used for awhile. Here is the recipe for one:—

Solution of acetate of ammonia	1 ounce.
Dilute acetic acid	½ ounce.
Eau de Cologne	1 ounce.
Tincture of aconite	30 drops.
Distilled water	½ pint.

To be sponged on to the head night and morning.

When the scalp has become less irritable, we may then proceed to use some pomade calculated to promote the re-growth of the hair. Mention will be made of several pomades by-and-by. But if the scalp be dry and scurfy, and not red but itchy, or if the scalp remain very scaly or

scurfy, after the use of the cooling lotion, then the following pomade may be employed for ten days or so:—

The nitric oxide of mercury	very	5 grains.
finely powdered	1 grain.
Carbolic acid	1 drachm.
Olive oil	1 drop.
Attar of roses.	1½ ounce.
Fresh lard	

To be smeared over the scalp night and morning. The head to be washed with soap twice a week.

Amongst the more general conditions under which thinning of the hair occurs, is convalescence from acute diseases, such as fevers and other long illnesses; in these cases, the hair comes off in handfuls, and the thinnest covering of the scalp remains, but these cases get well. It is important to give internal remedies for some time in order to restore tone to the body generally, and indirectly to the scalp, and there is nothing better than quinine, in the form of quinine wine, with steel in addition, if the person affected be very pale. We continue this for a little time before using lotions or other remedies locally, to encourage the growth of the hair, for this reason: the scalp is weakened by the illness that led to the falling-off of hair, and the use of stimulating applications only increases the inability of the weakened hair-bulbs to form hair. Get the health up first, and then we may rouse the hair-forming apparatus to its work. The following is a capital lotion for remedying the loss of hair which follows severe disturbance of the health by febrile disease:—

Tincture of lytta	1 ounce.
Distilled vinegar	1½ ounce.
Spirits of rosemary	1½ ounce.
Glycerine	2 drachms.
Rose water	3 ounces.

Mix.

The scalp to be well sponged night and morning with this lotion, and to be subsequently brushed with a moderately hard brush till a sense of heat or warmth is set up. For children, a weaker lotion should be employed.

Thinning out of the hair, in a less marked form, ensues upon debility, over fatigue, prolonged indigestion, mental anxieties, worry in business matters, grief, excesses of all kinds, disease consequent upon the violation of moral laws. It also occurs after confinements, and it is one of the most common consequences of eruptions of the scalp, such as a scald-head and ringworm, which latter will be discussed in a separate section. With regard to eruptions, it is only necessary to say that they must be cured by the doctor in an appropriate manner, and that it is impossible here to give any directions with that view, but we may say this much: That after the eruptive affection has quite disappeared, it may be advisable to encourage the growth of the hair by the use of the following pomade:—

Prepared beef marrow	6 drachms.
Oil of sweet almonds	2 drachms.
Red bark	1 drachm.

But the general run of the cases just referred to require local stimulation, and perhaps nothing better can be recommended than the following wash:—

Tincture of nux vomica	4 drachms.
Distilled vinegar	1 ounce.
Tincture of cantharides	6 drachms.
Glycerine	2 drachms.
Rose water	3½ ounces.

To be well sponged into the roots of the hair night and morning, the scalp being subsequently brushed till a glow in the skin is felt.

But it must be evident to the reader that some kind of tonic is needed to assist Nature in the formation of hair, and that such things as indigestion,

nervous debility, and the like, must be remedied. Indeed, to treat loss of hair successfully, it is quite necessary in many cases that the general health should be attended to by the physician. As a general rule, the taking of a course of quinine will do good; but at other times, a course of arsenic is required, and this must be taken under the supervision of a medical man, most decidedly. In all cases where the hair is thinning, there is a tendency in the scalp to become dry and irritable, and for the hairs to split up at their ends. Under these circumstances, both the scalp and the hair itself are too dry, and it is best, if using the washes, to apply some simple pomade to the scalp each day, or to use, as a means of restoring a proper growth of hair, pomades rather than lotions or washes. The following are two very excellent recipes for stimulating pomades:—

Prepared lard 2 ounces.

White wax ½ ounce.

These are to be melted over a slow fire, and then are to be added:—

Peruvian balsam 2 drachms.

Oil of lavender 12 drops.

To be well mixed.

Prepared beef marrow ½ ounce.

Acetate of lead ½ drachm.

Peruvian balsam 3 drachms.

Alcohol 1 ounce.

Tincture of cantharides, cloves, and
canella, of each 15 drops.

Mix, and use as a pomade.

To prevent splitting of the hair increasing to an injurious extent, in addition to the use of pomade, it will be advisable to have the ends or the points taken off every fortnight, and this will also help to stimulate the hair to renewed growth.

So far, then, we have spoken of general thinning of the hair of remediable character, depending upon debility from various causes and requiring tonic medicine to be taken internally, and local stimulants externally, in order that it may be remedied. We shall next speak at some length on the varieties of baldness produced in the several forms of ringworms—an exceedingly important matter to heads of families, and others who have the care of children.

PRESERVED COLONIAL MEATS.

APART from temporary grounds for scarcity in the supply of cattle, such as disease, want of water, &c., there are others of a permanent character, which will prevent home-fed flesh from ever being cheap and abundant. With the rapid growth of our population in numbers and material prosperity, the demand for the best article of food constantly increases, while the tendency of improved cultivation is every year to convert more and more land from pasture to tillage, and, consequently, to lessen the number of animals kept. At the same time, the possible supply of live stock from the Continent cannot be equal to our wants, either in quality or amount. Hence the question of preserved meats from distant sources, which has recently been so much agitated, becomes one of much interest to every household.

Now, the world at large has no want of ample grazing grounds abundantly stocked, only they unfortunately happen to lie at too great a distance from the centres of consumption. The prairies of North and the Pampas of South America, and the Australian bush, swarm with cattle, far too numerous to find employment as food in those countries; the problem, therefore, which many practical and scientific minds have endeavoured to solve, has been—How may this supply of meat be best brought to the English market?

The transportation of the living animals from distant countries is hardly to be advocated, either on the grounds of humanity or economy. They suffer much on the voyage and arrive out of condition. This trade can scarcely be expected to develop itself to such an extent as will meet the requirements of the case. If we are to receive meat from these sources on a large scale, it must be in a preserved state of some form or other.

Among the old methods of curing meat salting has been, as is well known, most in favour; but it possessed great disadvantages, except when applied to fat meat, such as bacon. When salted the lean parts of meat not only become tough and indigestible, but they also lose the best part of their nourishing properties. A numerous class of diseases would follow the exclusive use of a salt-meat diet. From this cause the scurvy was formerly the curse of the English navy, and is computed to have cost us more seamen than all our wars.

The necessity for some better method of preserving was strongly felt at the beginning of the present century, and the French Government offered a reward of 1,200 francs for the discovery of an efficient process. This premium was awarded in 1810 to Mr. Appert. Various improvements have from time to time been made upon his plan, but it is in principle the same still practised with the tinned Australian meats now imported.

The article to be preserved is placed, in a raw state, in a tin canister, and the lid soldered down, but a small aperture or pin-hole is left in the centre. The tins are then placed in an open bath and boiled. In order that a higher temperature may be gained than is possible with water alone, a chemical bath is used, generally of muriate of lime, but sometimes sulphate of potash or ammonia; by this means 300° Fahr. can be reached. When the meat is nearly cooked the pin-hole is hermetically sealed; the tins are then cooled, and the condensation of the steam inside causes a vacuum. They are afterwards again subjected to heat, and the cooking completed. The tins are then painted, and thus rendered perfectly air-tight. If the curing is sufficiently done, the tins collapse at the ends; if not, the fact is known by their swelling outwards. The principle on which articles are preserved by tinning is of course the exclusion of air.

A second and more recently-invented method, also founded on the principle of exclusion of air, is that of incrusting with fat. The bones are first taken from the beef or mutton, and it is pickled in a bath of salt brine, and afterwards in one of sugar and spice. It is next rolled up, placed in large tins or casks, and boiling fat is poured over it. It is said that failures are more common in this than the former process, and that the meat is not thoroughly secured unless it be smoked as well as pickled. The fat also imparts a disagreeable flavour to the meat, which has the additional disadvantages of being hard and indigestible; and it requires elaborate cooking to make it at all eatable. The penny and twopenny dinners for the poor in Norton Folgate, about which so much has recently been said, are made from meats cured in this manner.

A third method is by the infusion of some chemical substance into the meat, which prevents putrefaction. Various ways of doing this have been tried with greater or less success—generally the latter. Meats prepared in this way do not appear, as a rule, to stand long voyages well; and the chemical flavouring is not found, when brought in contact with unscientific palates, to give an additional relish. Sulphurous acid has been the agent most commonly used. Ice, or a low temperature attained by chemical or mechanical means, as a preservative, has also recently attracted much attention.

Whilst we are considering methods of preserving meat, we must not omit the only form in which preserved colonial meat has as yet become popular—that of Liebig's Extract. Although this can never become a substitute

for fresh butcher's meat with the masses, it has great importance for many reasons, more particularly because so easily portable, and from its value to invalids. The method of so preparing meat that its most nutritious properties may be preserved in a condensed form was first given to the world by Baron Liebig in 1847, and its value was at once recognised. In 1860 the manufacture of the extract was commenced on a large scale by his friend and pupil, Dr. Pettenkofer, at Munich; but it was soon seen that this branch of industry could best be carried on in countries where cattle were more abundant and cheap than in Europe; and in 1862 a Mr. Giebert established the manufacture in South America. This was the origin of the "Liebig's Extract of Meat Company (Limited)," to which Mr. Giebert's enterprise was afterwards transferred. The works of this company are situated at Fray Bentos, on the Uruguay, and are on such a scale as to allow of the cutting up of 200 bullocks an hour. This preparation is made under the sanction and nominal direction of Baron Liebig himself.

A sufficient reason for this apparent superiority of the Australian over the South American extract will probably be found in the better quality of the meat from which it is manufactured. Such of our readers as visited the Cattle Show at Islington last Christmas, may perhaps remember the South American bull exhibited there. It was enclosed in a kind of cage, and marked "Dangerous," and looked as though it would have felt more at home in a menagerie than among respectable, well-conducted English cattle. Its appearance was highly picturesque; but it needed no expert in such matters to see that, as food, it could bear no comparison with its neighbours. Such animals, when slaughtered, are found to have no interlarding fat among the fibres of the lean, which is hard and juiceless. This bull was a specimen of the almost wild herds of the Pampas, which were originally derived from Spanish stock; the Australian cattle, on the other hand, are of English breed, and their flesh has the characteristics of English beef.

For household use, as ordinary food, it must at present be in the "tinned" form that colonial meats will be of importance to our readers. In this shape, many are probably already acquainted with them. Although the trade in tinned Australian meats has been in existence for a short period only, it has already developed to a considerable extent; one company alone having recently exported at the rate of 100,000 lbs. a week. The cooked meat in tins, without bone, is to be bought at 7d. or 7½d. per pound; and, as it contains most of the nutritive properties of fresh meat, its greater cheapness is obvious; for it must be remembered that meat loses something like thirty per cent. in cooking, whilst ten per cent. must be allowed for bone in meat bought at the butcher's. The objections against it are, first and chiefly, prejudice, as a new article of diet; its unappetising appearance to some persons when turned from the tins; its being stringy in fibre; and its having a flat, "washed-out" taste, as from over-cooking. In due time, we may trust the putting down of the two first objections to common sense; we believe that the two last may be overcome by skilful cookery.

In the first number of the *Food Journal* (Feb., 1870) Mrs. Larkins gives her experiences in relation to a tin of Australian cooked beef. She scraped off all the surrounding fat and gravy, tied the solid meat tightly together, and, having floured, hung it to roast before a brisk fire, basting with the fat and gravy which she had placed in the dripping-pan. In half-an-hour it was well browned, and she poured off the dripping, and made a rich gravy with what remained in the pan in the usual way. The result was a tender and well-flavoured joint, such as any person would enjoy a dinner from, and equal, if not superior, to second-rate English beef.

While we know the tinned meat to be wholesome and

nourishing, it does not appear to us any serious drawback that a little trouble should be needed to make it thoroughly palatable. In the hands of French cooks, the difficulty would at once be removed, and it may be in those of English. But, we imagine, it must first become popular among those middle-class families in which the mistress is herself chief cook, and where some intelligence can be brought to bear upon it. For our own parts, we must say that, after the few first trials, during which, from its novelty, it was tasted with suspicion, we have eaten the meat, as turned from the tin, with as much relish as is possible with any cold meat, and can pronounce it good, cheap, and wholesome food; and, as such, think it ought to be known to every family, and especially to those to whom the present price of butcher's meat renders it an almost unattainable luxury. It is but just to add that our own experience has been in connection with the tins imported by Messrs. Coleman and Co.

It may be urged that in the tins we run some risk of having inferior or diseased meat palmed off upon us: in this form, it must be admitted, that such a fraud might easily be practised; but a common-sense view of the matter will show that the danger is not great. Articles are not adulterated without sufficient inducement. Dr. Hassall tells us, in his introduction to the "Report of the *Lancet* Commission," that it is in high-priced goods that adulterations are most frequent—in low-priced they would not pay. In England, where prices are high, there is every motive for passing off bad meat for good; in Australia, where sound meat is worth less than a penny a pound, there is no motive; moreover, the exporters know that they have prejudices to fight against before the trade can be fully established; and their interest is, to send the best possible articles. On the whole, our chances of getting wholesome meat are no worse as regards the Australian tinned meat than the butcher's shop.

ODDS AND ENDS.

To clean Cloth.—A contemporary recommends the following plan:—"Moisten a sponge with pure water, press it in a very clean towel till it becomes nearly dry; then sponge, one place after the other, the cloth; all the dust will enter into the sponge; wash the sponge afterwards with water. This method of cleaning wears the clothes out less than brushing. Many spots also disappear with pure water."

To make Glue (a material which should always be at hand).—We will describe the best way of making it, which is important, when its full strength is required. The glue, as bought, should be broken up small, just covered with cold water, and allowed to soak for a few hours. It should then be placed near the fire, and allowed to simmer. The addition of a few drops of linseed oil will improve it; and, when made, it should be kept in a dry place, as damp will totally destroy its tenacity and render it useless.

To clean Wine and Beer Barrels.—Bisulphite of lime is now extensively used in one of our largest breweries, for rinsing casks and arresting fermentation. When used for rinsing casks, the sulphate of lime formed by oxidation fills the pores of the wood and renders it airtight, the solution thus serving a double purpose. Wine barrels are often purified by burning sulphur in them, so as to produce sulphurous acid.

The Vine Disease can, it is said, be cured by blowing sulphur upon the diseased plant; but it has been found that irrigating the diseased plant with dilute bisulphite of lime is a simpler and more complete remedy. Had this been known some years ago, what an enormous amount of destruction might have been saved to the vines of Madeira and elsewhere.

ANIMALS KEPT FOR PLEASURE AND PROFIT.—THE HORSE.

HACK AND HARNESS HORSES (*continued*).

The Clevelands.—In speaking of the Clevelands as coach or van horses, we omitted to mention a cross between the large English cart mare and the thoroughbred Cleveland horse; a cross which gives great activity, and which, crossed again with a thoroughbred hunter, produces a high-class carriage horse. The Cleveland horse with the thoroughbred mare was tried at Neasdon many years ago by Mr. Hall, but we believe without eminent success. Our own view is that the highest blood should always be with the sire, where there is a difference of class. We append a sketch also of the Cleveland short-legs, the horse in question, which was the best specimen of that blood we

and plenty of food. However, the farm stabling should not be luxurious; it should be open, unless closed intentionally, and cracks and crannies will not be of very material consequence. During the winter months, after work, the horse's long coat having become saturated with perspiration, would present an obstacle to his being turned out into the cold wind, on the one hand, or put into a hot ill-ventilated stable, on the other. He would also require a great deal more hard food than when kept in a stable and regularly fed. During the summer months it is better, after the day's work, that he should be turned out, having only a shed to protect him from violent storms or exceptionally cold rain. There are questions of economy as to the manure made in the stable or in the field, which are purely for each farmer's consideration as to the situation of his pasture and his stables, and the carting of the food,

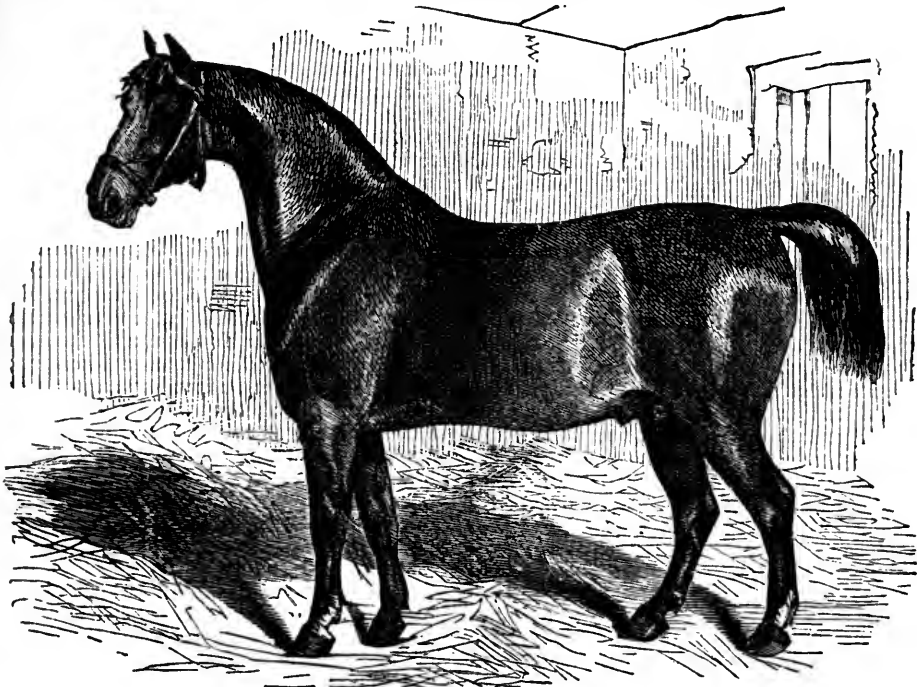

THE CLEVELAND SHORT-LEGS.

ever saw. He was sixteen hands two inches high, and looked like a pony.

Other Varieties.—There are many other varieties of the cart horse, which belong very remotely to some of these. We say *very* remotely, because it is impossible to class the numbers of wretched animals in and about London, which can be but cart horses, and which are entirely free from any marks or indications of strength or beauty; and which have nothing in common with the farm horse of our country but his patience and good temper. These are bought for very little money at Smithfield, and other places of a like kind; and their inutility is not always their only disadvantage. They bear the relation to the agricultural horse that the cab horse does to the gentleman's hack, and are often affected with some of the worst of contagious diseases—glanders or farcy. Of these we need say nothing; they are many of them fit for nothing but the knacker's yard. We shall in the next place turn from the horse himself to take into consideration the general method of management and keep.

Stabling.—It was once the fashion to allow a shed in a field, both summer and winter, to do duty for all purposes of shelter; but we have grown wiser, and now know that horses work none the worse for a fair amount of protection

and the cutting it, if he is to be fed under cover. These questions, which would be out of place in this short treatise, receive attention in another section of our work.

The *Food* of the agricultural horse is again different from the hack or harness horse. During the summer he is almost entirely fed upon grass, tares, clover, and *crushed* oats. It is not generally thought desirable to return to hard food when he has once begun upon his summer keep. When the labourer takes his mid-day meal, the horse should be taken out of harness, and allowed to graze. In the winter the agricultural horse has less work, and will, therefore, require less food; but at no season of the year must he be starved, as it is false economy. Oats, when cheap, mixed with chopped straw, is the best food you can give the cart horse in those months in which he has least to do, adding to them occasionally carrots or swede turnips; these act slightly upon the bowels and the skin. Clover is a valuable substitute for straw as the season advances, and the horse works more. Bran and roots are excellent adjuncts when the food is somewhat heating, as in the case of beans and barley. If the barley be placed in water of just sufficient quantity to sodden it, and it be then boiled, the barley will be found to have taken up the water, and to be in a state for bursting or sprouting. This is an

excellent restorative, and for cart horses, which require bulky food, very valuable for putting on flesh. As food varies so much in price, we have thought it useless to give an estimate of each separate article of keep per week. It varies from eight shillings, upwards; and the quantities are given as below.

During thirty-two weeks, the horse will require two bushels of oats per week; during a part of the time, when not working, Swedes or carrots from forty to forty-five pounds; and when in hard work, a substitute for roots of beans one and a half pecks, and some clover. During the remaining twenty weeks, give pasture, which should give a good bite, with occasional bran-mash or handful of bruised oats. The expense can be calculated, according to the price of corn, by any one. One rule should be observed with farm horses: that they should be a little above their work, remembering that good food means warmth and health. There are other systems of feeding, but this is one of the most strongly recommended, which is pursued in counties where the horse is well understood.

PONIES AND PLEASURE HACKS.

Ponies.—It must not be imagined because we have headed this section with "pleasure hacks" that we have therefore entirely left the regions of utility. Ponies and horses that are intended expressly for the pleasure of their riders have also a certain utility, as in the case of invalids; and many a gentleman who can scarcely be said to derive pecuniary profit, obtains much benefit of another kind from his horses. But we cannot omit from the most useful class of horses the ponies of this country. We have already mentioned them as forming an important item in the subject before us; and although we do not class them with the hack and harness horse, which is so widely useful, still, as a means of carrying on some businesses, and as capable of doing a great amount of work, the tradesman's pony is second to none. He has great advantages over the horse to the poor man—he costs less to buy, less to keep, he requires less care, and is capable of greater endurance. As a rule, being small, he does not get over the ground quite so fast, but occasionally he does even this; and as to distance, we should be inclined to back the pony. If he is to carry weight, or rather length, he will be placed at a disadvantage; but if the transaction of business be the first object, a light cart suited to his powers will rival any means of locomotion. They are seldom or ever lame or amiss; they seem acclimatised to any weather, and as long as they have enough to eat and drink are not particular about the quality. In a word, it is not too much to say that we have seen as many good ponies as we have seen bad horses, and there are plenty of these all over the world.

But we go higher in the scale, and the pony will be found to be equally useful. How many clergymen are there whose means will barely allow them to keep themselves and their families, yet to whom some mode of locomotion in these days of universal communication is almost a necessity? If we have such among our readers, let them go to the ponies. Not only will the family pony carry and fetch the letters, roll the croquet ground, mow the lawn, summon the doctor, live in the field, and be a picturesque pet and companion, but he will carry the vicar to distant parishioners, visitations, confirmations, and extraneous duties, by which he may assist others, if not himself; he will do the farm operations of a few acres of grass land, and when the ladies of the family want to pay visits in the summer months, a pony carriage is the only mode of conveyance which saves the attendance of a servant. Ponies do for such purposes as well in a field as in a stable, and require only the addition of corn on working days. In the winter they are scarcely required much for ladies' work, or the length of their coats would prove a hindrance to cleanliness; but in the summer such

an inconvenience is not much felt, as their coats become short and the herbage dry. The occasional oats, beans, or hay which they consume on hard work, with a paddock to run to, will be a very small item compared to their utility; a very few pounds will do it all.

Not only in the field of the vicar or curate is such an animal serviceable, but there are very few gentlemen's establishments in which there is not "the pony," who does the work of two horses. He is expected to be ready at all hours to carry lazy grooms a mile with a note, to give Master Tom at least two days a week in the holidays, to go with the luncheon to picnics and shootings, and to stand saddled all day or all night, when the work is too hard for the highly-priced horses. Masters have no conception what good things they have in the shape of ponies. On one occasion of unexpected lameness, we were mounted on the family pony with the Hambleton Hounds, and begged ever afterwards that we might be allowed the same privilege, when the day was expected to be exceptionally severe.

Now, these ponies are Welsh, or Scotch, or Exmoor, and some are from the New Forest. The Welsh are very good, and have been so crossed as to attain the size of fourteen or even fifteen hands, when they become valuable for anything. The Scotch are smaller, and the real Shetland only children's ponies. The Exmoor and Dartmoor are in themselves no great beauties, but they are very hardy and very clever. Some of them are wonderful jumpers, and on one occasion we saw one driven into a corner of a field in order to be caught, when he jumped a very high five-barred gate, over which he certainly could not have got his head, and thus escaped. Those that we recommend for use are, however, crosses with these. They are to be found at various fairs and markets, broken and unbroken, at any price from £3 to £30. It is a curious sight to see the drover, having singled out your pony, rush into him, and cling round his neck, the pony striving to disembarass himself all the while. A halter is brought, and then comes another fight, until with the assistance of his fellows and the mob, the pony begins to move, when you have an opportunity of seeing the action of your selection. If you like him, it is as well to arrange with the vendor that he shall be delivered at your house. He is more surely yours when you have him in the field or the stable. We have spoken of cobs and galloways before. They are quite distinct from the useful pony we have been recommending to poor men, which is an animal not exceeding thirteen hands two inches in height, at most fourteen hands, and without the pretensions to fashion which belong to the small horses and cobs kept in London stables, and groomed and fed with the care of a racehorse.

COOKING.

MUTTON.

THE domestication of flocks and herds—the possession of a never-failing standing dish of meat—is an indispensable condition of civilised life. The hunter, whose precarious meals depend on the chase, has no time to cultivate the arts of civilisation. When a people, as the American Red Indians, *will* hunt, out of ineradicable instinct, and *will not* rear domestic animals, nor grow the crops required to feed them, their existence becomes incompatible with ours. They must retreat before the advancing whites, and finally become extinct.

On reflection, we can understand the honours once paid to the ox, and the touching emblems with which the lamb is associated. Those humble and docile animals, in the early ages of the world, were the living barriers which effectually protected man from gross barbarism and savage life.

Good mutton is to be had in other countries; but there

is no better mutton than British mutton. The famous four-year-old wethers of the Norfolk breed are now very rare, in consequence of the difficulty of keeping them within bounds, as well as of the farmer's desire for quick returns; but as long as the Welsh hills stand there will be Welsh mutton, which the railways disperse over the breadth of the land. Another valuable mountain breed of sheep is the Cheviot, which possesses very considerable fattening properties, and can endure much hardship from starvation and cold. Many parts of their sheep-walks consist of nothing but peat-bogs and deep morasses. The Cheviots' fine close fleece keeps them warm in bad weather and prevents either rain or snow from incommoding them. They are excellent winter travellers, and will procure their food by scraping the snow off the ground with their feet, even when the top is hardened by frost. In point of flavour, their meat is equal to any that the Highlands can produce. It is natural they should have their partisans. Indeed, the annual extraction from mountain plants of scores of thousands of carcasses of mutton, and hundreds of thousands of fleeces of wool, is something wonderful.

The Southdowns are great favourites for their meat, their middle-lengthed wool, and their quiet habits; the New Leicesters for the same disposition, their long wool, and their readiness to acquire fat; and the first cross between the two for the rapidity with which they are fit for market. It will be seen that *mere mutton* (though it is indispensable that it should be good in its way) is far from being the sheep-farmer's only object. Thus the Dorsets are kept to give early lambs, others for their speedy growth, enabling their owner to turn his money frequently; others, as the merinos, &c., for their wool, which wool differs in quality, each quality being applied to special purposes.

Good mutton, of whatever breed, is known at a glance: the lean, dark bright crimson red; the fat, white and firm, and never too deficient in quantity according to the joint. Bad mutton is of an unsightly brownish colour, and has a bad smell, with little fat, and that flabby and yellowish. Often, but not always, the carcass looks as if the beast had been devoured by consumptive leanness. If you can get a sight of the liver, its state will sometimes tell you tales of the creature's healthiness or the reverse.

The rot is a disease to which sheep are subject under certain influences, which is really inflammation of the liver, and is not contagious or infectious. It is evidently connected with the soil and the state of the pasture.

It is curious that one of the effects of the rot should be to hasten, and that to a strange degree, the accumulation of flesh and fat. At the moment when the animal is smitten it appears to be improving for the butcher's uses. If in good marketable condition, of course it is sent to him at once. The farmer who suspects his flock to be ailing from that cause, is obliged to inspect every sheep daily, and dispose of those who cease to make progress or who appear to be beginning to retrograde. Now, the meat of the rotted sheep, in the early stage of the disease, is not exactly like that of the sound one. It is pale and not so firm, but is not unwholesome, and is even coveted by certain epicures, who perhaps are not aware of the real state of the animal. The only certain way of not partaking of such questionable fare, is to deal with a butcher in whom you can put perfect confidence, and who has a character and a good list of customers to lose.

Roast Mutton.—The joints mostly roasted are—the leg, for high days and holidays; the shoulder, for family dinners, for which it is better suited than the leg, in consequence of its containing a larger proportion of fat, so wholesome and beneficial to children and growing youths of either sex, if they will but eat it; the loin, chined, for the carver's convenience, and with the kidney-fat removed, an excellent and convenient dish for a small

party of diners; the saddle, or double-loin, showy for state occasions, but rather wasteful, being difficult to do much with as cold meat, in consequence of being carved in slices along the loin, and not having been chined or jointed at the junction of the vertebrae. The loin can be carved in the same way, when there are only a few guests to help. The best end of the neck may also be roasted, though it is more frequently reserved for boiling, or for cutlets. By the way, in etymological strictness, chops from the loin are real chops, while those from the neck are cutlets. *Côte*, is a rib; *côtelettes*, or cutlets, are little ribs. The French also roast (brown, in a stew-pan, often with vegetables), and highly esteem, the breast of mutton, under the name of the *carre*.

According to our ideas and experience, all joints of mutton are best roasted without any stuffing or other introduction of foreign flavour. French cooks are fond of sticking a clove or two of garlic into the leg before roasting; which, we think, spoils it, and also renders the old English (or rather Northern) accompaniment of red currant jelly—to which we adhere—impossible. The proverb, "There is no disputing about tastes or colours," is to be respected, as a maxim of toleration; but it does not make incongruous things congruous. The colours of a dress may be inharmonious and ill-assorted, and so may the flavours employed in dressing a dish. With roast mutton, the members of the onion family, in their stronger kinds, as garlic, or in their more pungent shape, as fried onions, appear unsuitable, and so to speak, discordant. The best sauce is its own gravy, with an accompaniment of currant jelly, cold. The vegetables sent up (with the leg especially) should be mild in flavour, as mealy potatoes, whole or mashed, salsify, sea-kale, &c.

We say nothing about the haunch of mutton, it being merely an overgrown leg, increased in size by leaving the loin still connected with it.

Mutton, for roasting, should be hung as long as the weather will permit without acquiring a taint; never less than five or six days, when possible. If frozen, it may be kept in that state indefinitely; but beware of the change immediately consequent upon a thaw. Before cooking (whether by roasting or boiling), a frozen joint must be thawed completely, by steeping it in milk-warm water at least twelve hours previously. Otherwise, while the outside is done, perhaps to rags, the inside will be bloody, raw, and quite uneatable. This we note in passing merely by way of warning.

The same principle prescribes the slow roasting of large joints when first put down to the fire, in order to let the heat penetrate to their interior, before exposing the outside to brisker roasting. A good cook will never hurry her roasts at the outset. A leg weighing seven or eight pounds will be better roasted in four hours than in two and a half, provided at the commencement she has been slow and sure. Constant basting is essential to success. An occasional dredging with flour is permitted. As the leg does not give out much gravy at first, she may use any good sweet dripping, even beef or veal, which she has in store. If absolutely obliged to use broth for basting, let her pour it in small quantity, into the catch-pan boiling hot. All roast mutton calls for extra hot dishes and plates. The spoon to serve the gravy should be kept hot, till the last minute, in a jug of boiling water.

In some parts of England, slices of cold ham are eaten with roast mutton, as they are more generally with roast fowl and turkey. They give by no means an unpleasant relish, but are scarcely compatible with currant jelly.

The shoulder, being thinner, takes less time to roast, and, giving out more fat, may be dredged and basted almost from the beginning. Currant jelly is its due. "Shoulder of mutton and kidney beans" form a Company (Limited) which has never yet brought anybody to beggary. Before kidney beans come, their place may be supplied by

asparagus, green peas, and early York cabbage; after they are gone, by Brussels sprouts, or any other delicate "greens."

Minced Mutton.—A tender leg of mutton, roasted to a turn, when it passes from the spit or bottle-jack to table, possesses irresistible charms. Still, healthy appetites have their limits; and something will be left to be welcomed, cold, at to-morrow's breakfast. After that, it will require a little help from the cook, to vary (not improve) it, for fastidious eaters. Cut off all the meat, and mince it; break up the bones, and boil them in as little water as will cover them, to extract their goodness. In the broth, after removing the bones, stew gently a little minced ham; thicken with a dust of flour, and season with pepper. When smooth and of the proper consistence, add the minced mutton, and let it warm thoroughly without coming to a boil. You may further flavour with Reading, Worcestershire, or Soho sauce, or a little catchup. Serve on a dish garnished around with toasted bread.

Hashed Mutton.—Our private opinion is that cold mutton, like cold beef, has been run down more pitilessly than it deserves. We would willingly lend a hand to raise it, and even welcome it to our sideboard, flanked by a jar of pickled walnuts. But it is useless resisting popular clamour. People call for hashed mutton; be it our business to supply them with the best article we can. Cut the mutton into slices not much more than a quarter of an inch thick, and of the length and breadth of the bowl of a gravy-spoon. Trim off the black and burnt parts, but leave the brown. Dust them on each side moderately with flour, pepper, and salt, and set them aside. Chop up the bones; stew them with the best of the trimmings in broth or water, with vegetables, adding a bunch of sweet herbs towards the close. You do not require much stock, but you do want it little and good; and you will have plenty of time to make it in the course of the day, as you will know perhaps over night, or at least in the morning, that there will be hashed mutton for dinner. When made, pass it through a strainer, to clear it of the bones and vegetables. For your hash: Brown flour in butter in a stewpan; stir in some of the cold roast mutton gravy you have left, after making sure there are no cinders in it, and that it has not got a burnt taste. Stir in as much (no more) of your bone broth as will fairly cover your sliced cold mutton. Then set it on the side of your stove, and flavour with the quarter or half of a pickled walnut braided smooth, a dessert-spoonful of the vinegar, some mushroom catchup, and, if you like, a little Harvey's or Worcestershire sauce. When they are well mixed, put in your sliced mutton, and stir it about. Let it stand awhile, to get warm through; then let it simmer gently over the fire, to get still warmer; but remember that, *if you let it boil*, you will have, as Mrs. Glasse is said to say, not a hash, but a harsh. While simmering, stir gently but continually. Then, with a spoon, arrange the pieces of sliced mutton on a dish; taste if the sauce meets your approval; let it boil up once; pour it over the meat, and serve garnished with toasted bread and whatever else (forcemeat balls, olives, nouilles, &c.) your judicious fancy may dictate. N.B.—Hashed mutton is open to receive a variety of flavours. For pickled walnut you may substitute a very little essence of anchovy, cayenne, catchup, and lemon-juice, after boiling the lemon-peel in the bone broth. Or again, you may flavour advantageously, venison-wise, with red wine, currant jelly, and a nice bouquet of thyme and knotted marjoram.

Stuffed Leg of Mutton.—The process of stuffing a leg of mutton with good red herring has been strongly recommended to our notice. The fish is first boned, then cut up fine. It is next peppered, and stuffed under the skin of the joint in the thickest part. It is said that this dish is a favourite with nearly all who have tasted it.

HOUSEHOLD DECORATIVE ART.

FRET-WORK AND CARVING IN WOOD.

THESE pleasing arts we propose to treat together, for, in the hands of the amateur, it is with the two in combination that the best effects are to be produced; still, as it is quite possible to gain good results by taking either separately, and as some persons may prefer the more simple and mechanical fret-work, while others may care only for the more artistic pursuit of carving, we shall endeavour so to frame our directions that such persons may be able to separate without difficulty the particular information they require.

Of the value of these pursuits, as Household Decorative Art, it would seem scarcely necessary for us to speak. Carved and perforated woodwork has now, for several years, been in general favour for numerous minor articles of decorative furniture; and, more recently, the arts of perforation and carving have themselves become fashionable amusements, both for ladies and gentlemen. So pretty and interesting are they, and so numerous are the purposes to which they may be applied, that they are not likely soon to be discarded. It is proposed to devote a few remarks to the necessary tools, and then to give such plain and brief directions for practice, as will enable the beginner to acquire the art without a master. Afterwards, will follow a series of practical designs, with sufficient explanations, which may be worked out by the reader, or which will furnish him with hints for arranging his own original compositions.

Complete sets of tools, for both arts, are to be procured at any good tool-maker's, and some fancy shops. Ladies' sets are sold at many of the above shops, containing the following articles at the prices marked.

For Fret-work.

	£	s.	d.
1 Buhl Frame	0	9	0
3 Dozen Saws	0	1	6
1 Cramp	0	2	0
1 Back Saw	0	2	6
2 Gimlets	0	0	9
2 Brad-awls	0	0	4
3 Files	0	1	9
1 Pair Pliers	0	1	0
Glass-paper	0	0	2
Wood prepared	0	3	0
Patterns	0	1	0
Box for Tools... ..	0	2	0
	£1	5	0

For Carving.

1½ Dozen Carving Tools, at 9d. ...	0	13	6
1 Rasp	0	0	9
1 File	0	0	9
1 Bent File	0	0	6
1 Cramp	0	1	6
1 Grounding Punch	0	0	6
1 Sharpening Slip	0	1	6
Box for Tools... ..	0	2	0
	£1	1	0

Gentlemen's sets contain more tools, of stronger make, and are more expensive.

For those to whom the expense incurred is no object, a complete set of tools in a neat box is of course extremely desirable; but, as many would wish to begin on a much more economical scale, we give the following list of articles, which are indispensable, and may be bought separately.

A cheaper saw frame than that given in the set, such a one as is shown at Fig. 26, page 49, in vol. i., will do, and will cost, with three or four extra saws, 4s.; half-

dozen chisels, ranging in size from one-eighth to three-quarter inches, at 9d.; half-dozen gouges, from one-sixth to three-quarter inches, at 9d.; mallet, 8d.; file, 6d.; V-chisel, 9d.; grounding punch, 6d.; oil-stone slip for sharpening, 1s. 6d.; cramp, 1s. 6d.; the total cost being 18s. 5d.

With a less number of tools it would scarcely be possible to do satisfactory work; but with these any one could well make a beginning. Afterwards, as the amateur felt his way in the work, he might buy others whenever he felt special occasion for them; and this, in our opinion, would be the best as well as the cheapest way. Only necessary tools would then be bought, and unnecessary ones are merely an encumbrance.

Two different forms of the frame or buhl saw, have already been described at page 49, vol. i. We need, therefore, only say of it, at this place, that it is a fine saw, set in a frame of steel or wood, by which it is supported and kept tight, as the string is supported and kept tight in a bow. By this arrangement, the saw can be made so minute as to allow of cutting round almost any curve or angle; were it not for this invention, fret-cutting would be impossible. It is necessary to keep extra saws in stock, as, whatever care is exercised, they are always liable to snap. Ordinary chisels and gouges have also been described in an early article of the Household Mechanic (see page 16, vol. i.), and from these, carving chisels in no way vary, except that sometimes they are bent, to facilitate under-cutting. It is, however, advised that the

two smallest, and one of the largest, gouges should be so ground as to take off the corners, and bring the ends to a semi-circular form, which will be found convenient in practice. The V-chisel is well described by its name: a cross section of its blade would form the letter V. Sometimes it is called a "dividing tool;" it is employed wherever it is necessary to cut out a clear line, as in indicating veins on leaves. The grounding punch is a small steel tool with some device cut on its end, as, for instance, a cross, a star, or a cluster of dots, and which, when struck with the mallet, leaves an impression on the wood as a seal does on sealing-wax; they may be bought in great variety; a pretty, rough effect is gained by using them on backgrounds, which conceals any inequality of surface. The cramp is a piece of iron, so bent as to form three sides of a quadrangle, through one extremity of which a screw works, in such a manner as to form a portion of a fourth side; this is used to embrace the edge of the work-bench and the article to be sawn or carved, and the latter is thus kept immovable when the screw is tightened. The oil-stone should have its edges rounded and tapering, to fit the insides of the gouges; and its sides flat, to sharpen their exteriors, as well as the other tools. As regards tools generally, it is advised that they should be bought of the best quality, and always kept sharp; good work cannot be made with bad or blunt tools. At frequent intervals, whilst the work is going forward, they

will require rubbing on the oil-stone (a very few attempts will show how this may be done most effectually), and then drawn two or three times along a razor-strop to give a fine edge. After they have been thus sharpened many times, they will require grinding; and, as an amateur cannot always have a grindstone at hand, should be sent for that purpose to a tool-maker. The ordinary charge for grinding is $\frac{1}{2}$ d. per tool. They should never be allowed to become rusty; a good edge cannot be given to a rusty tool. Whenever they are laid by for any length of time they should be oiled; the best for the purpose is neat's foot oil; all vegetable oils contain water, and do not effectually

prevent rust. If it can be done conveniently, keep them in a box or drawer lined with cloth or baize.

Beyond the tools we have mentioned, several odd matters, which will cost but a few pence, will be necessary. A screw-driver, gimlet, and screws, for fastening down the work whilst in hand, which will sometimes be found better than the cramp, or as adjuncts to it; a little sweet oil, for the stone; a razor-

strop, for giving a finishing edge; a soft black-lead pencil, and pair of compasses, for marking and measuring; and, for ladies, a pair of leathern gloves in which to work.

If a firm common deal table can be appropriated as a work-bench, so much the better; but, as it will often be necessary to screw the work down, it must be one into which screws can be driven with impunity, and a drawer beneath such a table, for the tools, would be convenient. But if none such is to be had, the following plan

may be resorted to: get a piece of deal board, two feet long, one broad, and an inch thick, and secure this on an ordinary table, as shown in the diagram (Fig. 1). This is found in practice a very good substitute for a bench; but, if it is resorted to, an additional pair of cramps will be necessary.

And here it should be impressed upon the novice, that, for both carving and fret-work, absolute firmness in the article under

hand is an essential. For fret-work this immobility can only be attained by the cramp, because frequent changes of position will be needed; but, for carving, nothing is generally better than screws driven into the table or work-board, close to the edges of the work. It is not often necessary to alter the position of carving, and when it is required, they can without difficulty be withdrawn and re-adjusted.

For sawing fret-work, some further contrivance will be required; the thin wood used needs support, or it will be liable to break while under operation; to afford this, nothing is better than what is called a "horse," which is thus made: out of one end of a piece of similar dimensions to the carving-board mentioned above, a triangle is cut, about eight inches long, and five broad at its base. This horse is laid on the work-bench or board (as shown in Fig. 2) with the half in which the incision is made projecting beyond it towards the operator; the other, or square half, is screwed firmly down. On the projecting half, the

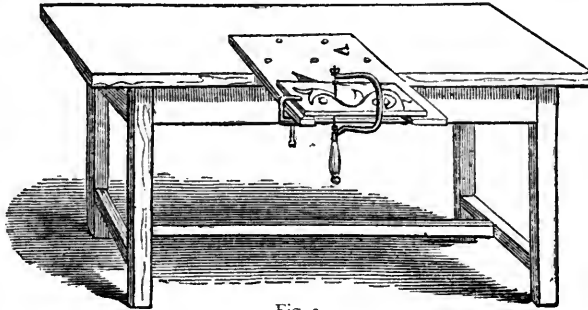

Fig. 1.

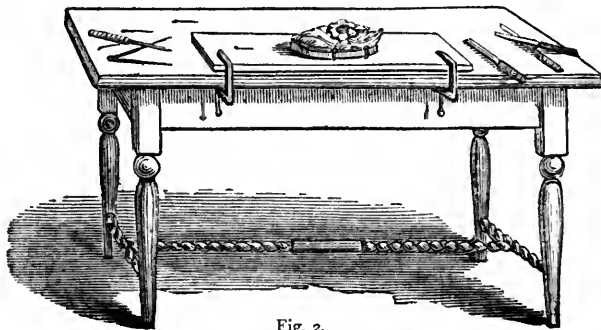

Fig. 2.

wood to be perforated is fixed with the cramp, in such a manner that the part to be operated on is brought over the incision. Firm support and convenience in working are thus gained at the same time.

THE HOUSEHOLD MECHANIC.

GARDEN FURNITURE AND DECORATIONS (*continued*).

Rock-work.—The proper and artistic arrangement of artificial rock-work, is a matter which demands some care on the part of the operator; nothing is more easy than to pile a few large blocks of some rough material one upon the other and call the resulting heap "rock-work," which it certainly is not. But if properly constructed, artificial work of this description is very picturesque.

The most suitable material for this kind of work is, of course, natural rock. A few large, rough blocks of stone properly arranged, will produce a far more pleasing effect than the most elaborate construction of artificial materials, and should always be used in preference; but as these are not always obtainable, the roughest and most suitable lumps of a material which most nearly resembles stone in its outline and texture should be selected. One of the most readily obtainable substances which is adapted for this purpose, is the large rock-like mass often found in the centre of large stacks of bricks after burning, and which is formed by the partial fusing of the clay. These masses are known in the trade as "burrs," and may be procured at a cheap rate in almost any brickfield. In selecting them for this purpose, only those pieces in which all the shape of the brick is destroyed, should be used, as nothing is more destructive of natural effect, than to see part of a moulded brick projecting from a group of ferns or flowers. By way of variety, a small quantity of broken fire-clay obtained from gas or glass-works, and consisting of the fragments of retorts, and the pots in which the glass is boiled, may be used; while the addition of a quantity of chalk will be a further improvement. As we before remarked, all formal shapes must be destroyed; and only the accidentally fractured portions exposed to view. A large heavy hammer should be used, and the material broken up so as to make it irregular.

For erecting rock-work, some mortar or cement should be used, and it is better to build it so as to be independent of the earth enclosed; as, if this settles, as it will do after heavy rain, the rock-work will become displaced. For ordinary purposes, good mortar made of one part of lime, to three of sand, will be sufficient; but if it be intended for the decoration of fountains, or any place where there is a flow of water, Portland cement will be required, which should be mixed with the same proportion of sand, and used as soon as possible.

With these materials at hand, the erection of the rock may be proceeded with. If the work is to be of an extensive character, it will be advisable to lay a foundation of concrete, as advised for the construction of fountains; but for all ordinary purposes a few inches of rough gravel placed in a trench, and rammed down very closely, will be sufficient. Upon this foundation some of the largest blocks should be laid, and bedded firmly in the mortar. The work should be made as irregular as possible, and care taken to avoid any appearance of design in its construction. At intervals, openings should be left, in which flowers or ferns can be planted, and these should be also at irregular intervals, and quite open into the bank of earth beneath the rock-work, to allow for the striking out of the roots. If the first course or layer of stones be not high enough, a second or third may be placed upon it until the required thickness is obtained, each fragment being secured by means of mortar as above described. The upper line should not be straight or of regular form, but varied by placing some large masses here and there,

as the task may suggest. When the body of the work is thus erected, it may be finished by placing upon it in places, pieces of stone or other material, different in colour and texture from the main portion; but plaster casts, and, in most instances shells, should be excluded, as producing an artificial and incongruous effect. Ferns, ivy, and creeping plants, should be planted in abundance; and if some moss can be procured it will greatly enhance the beauty of appearance. For the decoration of fountains, perhaps artificial rock-work is more satisfactory than anything else. In this case it should be remembered that the material employed in construction will be seen wet, and therefore, in order to judge beforehand of what effect will be produced, it will be necessary to soak the stone in water in order to see what colour it appears when in that condition. The constructor can then select to suit his taste, with the certainty of being able to reproduce it when he pleases. A fine tall jet of water, issuing from out of well-arranged rock-work, produces one of the most natural and beautiful of fountains, and is always satisfactory to the eye. But, of course, all art should be disguised; even the jet-pipe itself should be a little below the stone, and all fancy jets should be, as a matter of good taste, reserved for more artificial constructions. In constructing rock-work for this purpose, the same precautions should be taken, and the same method adopted as we have recommended for garden work; but the stone should be well and carefully fixed in Portland cement to resist the action of the water. It is, of course, impossible to offer any design for the construction of rock-work, as that must altogether depend upon the situation in which it is to be placed, and the purpose which it is intended to serve. It need only, therefore, be remarked that attention to, and careful carrying out of the principles above given, guided by good taste, will be attended with success.

Tree-beds.—A very pretty addition to the garden may be made by cutting the trunk of a hollow tree into sections of about twelve to eighteen inches in length, and placing rare or beautiful flowers in the centre. The hollow part may either be filled in with earth, or left open, and the flowers placed therein in pots. If the plants be very delicate, perhaps the latter will be the safest mode of procedure, as they can easily be removed during unsuitable weather. The pots may be concealed with moss, and the plants should be arranged in a rough pyramidal form. These tree beds look very well if placed on a grass lawn, and their appearance is much improved if the ground and grass is raised a foot or more to receive them. The lower part may be inserted below the turf, or disguised by placing fragments of broken rock-work, or the crooked roots of trees round it. The inner part of the tree may be cut away with a chisel, so as to leave a circle of about four inches in thickness, which will be quite sufficient to support either the earth or the pots. If the lower portion be boarded over so as to form a kind of tray, these beds may be easily removed from place to place, if required.

Borders.—Borders may be made to garden beds in various ways, the simplest form being that of plain wooden boards, secured to stakes driven into the earth. In their ordinary form, however, these are very unsatisfactory in appearance, although answering the purpose very well for which they are intended. A very neat method of decorating these boards is now available by reason of the manufacture, at a cheap rate, of perforated zinc edging, such as is used for placing upon the edges of rain gutters. If this be used, a good stout sample should be selected, bearing a large open pattern, and it should be secured to the existing border by first tacking it to the wood, and then nailing another strip of wood over it, so as to enclose the zinc between the two pieces. One reason why wooden borders present so unsatisfactory an appearance is, because they are mostly placed in straight lines. For this there is no reason whatever, as the material can easily be

bent to any required curve. If, for instance, a circle is required, the stakes supporting the border should be first driven, not more than twelve inches apart; to these a strip of wood of the required depth, and about a quarter of an inch in thickness should then be bent and nailed. The second thickness may then be secured in like manner, and so on until the required substance is made up, taking care to break the joint in every layer. Another plan consists in sawing the wood about half way through its thickness, when it will easily take any curve not too violent. Of course these curves can easily be decorated with the zinc edging described above. A very excellent border, which is both elegant and durable, may be formed by the use of tiles of terra-cotta made for the purpose. These are manufactured in a great variety of patterns by

the Messrs. F. and G. Rosher, of Upper Ground Street, Blackfriars, whose work may always be depended upon both for elegance of design and superior workmanship. These gentlemen have recently introduced some very beautiful patterns for the purpose; some of which are shown in Figs. 2 to 9. The ball pattern, Fig. 2, and the Exhibition pattern, Fig. 5, are specially to be commended. These border tiles, which may now be procured at a cheap rate, may be recommended in preference to either the wood or box edgings, because they afford no harbour for slugs or other insects, they occupy less space, are very neat, give great

finish to a garden, and effect a considerable saving of time in the matter of trimming and repairing. When once fixed, they are done with, and need no further attention. They may be obtained of various colours, and the number of patterns is so varied that there can be no difficulty in satisfying the most fastidious and critical taste. The Messrs. Rosher have met one of the great obstacles to the use of these borders—the difficulty of making other than square beds—by manufacturing artificial stone edgings of a variety of pleasing designs, which may be used in the construction of beds of any shape. A variety of curves are made of each pattern, by a combination of which almost any possible figures may be obtained. But perhaps the prettiest border of all, is one of artificial rock-work, which possesses many advantages. Thus it can be constructed of any required shape, is exceedingly durable, and the older and more moss-covered it becomes, the more picturesque it is in appearance. In constructing a border of this description, cement should be used; and especial care

taken to secure each piece of stone firmly, that it may not be disturbed in digging the beds enclosed. The instructions given in the early part of this paper may be strictly followed in constructing rock-work enclosures of this kind.

Garden Brackets.—Very pretty brackets, such as are used in gardens for the support of flowers in pots, may be made as follows:—A piece of wood of about an inch in thickness, and of the required size, may be cut somewhat to the shape indicated in Fig. 10. This will be the top of the bracket. A second piece may be like A, Fig. 11, and this should be well secured to the shelf. Both of these may then be decorated with split branches as described for garden chairs, and one or more struts of natural branches placed across the

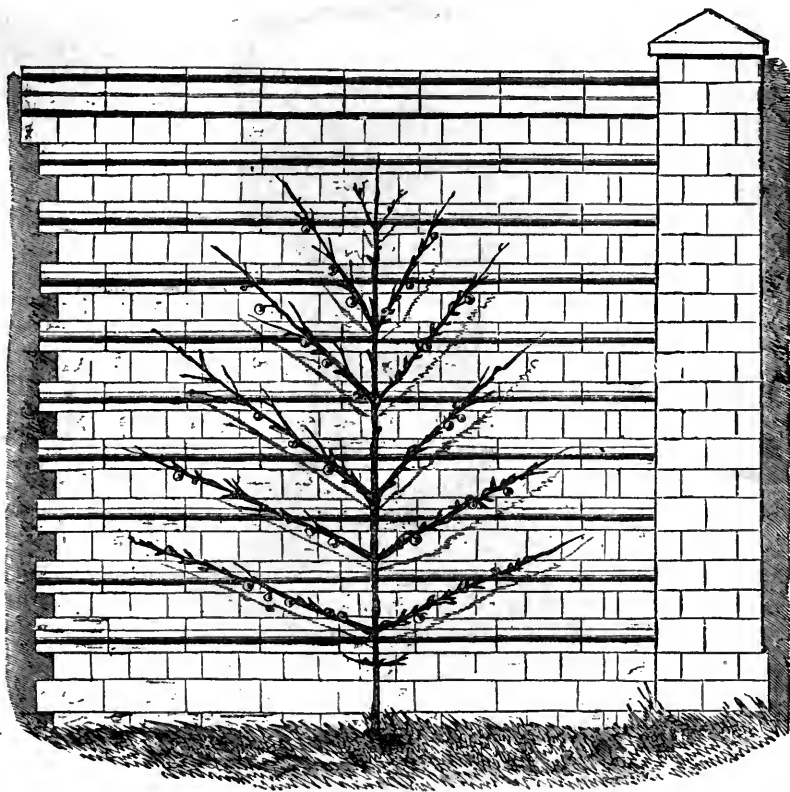

Fig. 2.

angle to support the shelf, see B, Fig. 12. There are many ways which the tyro will soon discover, of varying the design of such little matters as these, which add much to the beauty and finished appearance of the garden or conservatory. A very elegant novelty has recently been introduced, which partakes somewhat of the character of a bracket, and is used for the support of ferns, mosses, and plants of various sorts. This is called the Watsonian Patent Fern Brick, and is the invention of Dr. G. C. Watson, of Chester. These bricks are intended for building into, or insertion in the walls of conservatories, or other places where they may be required,

and for the purposes of wall decoration they are very useful. When a new wall has to be erected the bricks may be built in; but for the decoration of an old one all that is needed is to remove the brickwork by means of a proper chisel until a space is obtained large enough to admit the brick, which should then be wedged firmly into its place, and the joint neatly pointed again with cement. These bricks are so formed as to represent a sort of alcove, of elegant design, with a balcony which projects in the form of a beautifully modelled shell, to hold the ferns or flowers. These shells are easily removable, and can be purchased separately in case of accident. The whole of the fern brick is made of terra-cotta, and is of course very durable. These bricks are made of various sizes, and can be purchased at prices varying according to size, at from ten and sixpence per dozen. Fig. 13 shows how these shells may be arranged for wall decoration; Fig. 14, how they may be set up in the form of a column for use under a glass shade, from which our readers will see how elegant an ornament may be constructed by such means. This,

the latest novelty in garden decoration, may be obtained of the same firm as we have mentioned as making terracotta garden border, the Messrs. Rosher, of Blackfriars.

While on the subject of wall decoration, we may mention another novelty which has been introduced by the firm we have mentioned, and which bids fair to supersede all the old-fashioned trellis-work of iron or wood, which has hitherto been used for the support of wall trees and plants. "Foxley's Beaded Bricks" are in shape and size similar to ordinary bricks, except that upon one side a bead or fillet is moulded. This bead is perforated with holes at intervals of about two inches, which serve by means of bass, string, or wire, to tie in the branches and keep them from the wall. If a new wall has to be erected, these

which it is to be placed; rather wider than the diameter of the flower-pots, and two or three inches deeper. This should be made of inch board. About two inches above the bottom of this box, a ledge should be placed, as shown in Fig. 16, and nailed or screwed firmly on. Upon this, a frame made of open woodwork, consisting of bars about an inch square should be placed, and under this, upon the bottom of the box, a shallow zinc tray reaching up to the frame which is to support the flower-pots. Into one corner of this tray a short pipe of lead may be soldered, and a tap placed on the lower end, or a cork inserted. This arrangement will allow of the plants being watered without removal from the room in which they are placed; as the water which drains out of the pots will fall into the

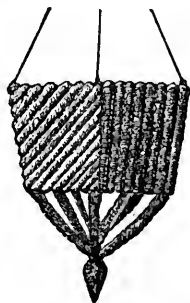

Fig. 17.

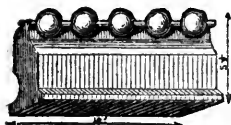

Fig. 2.

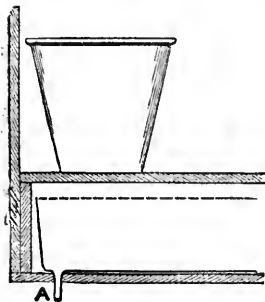

Fig. 16.



Fig. 19.

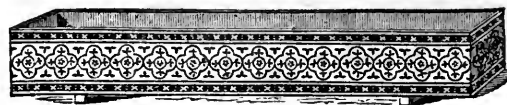

Fig. 20.

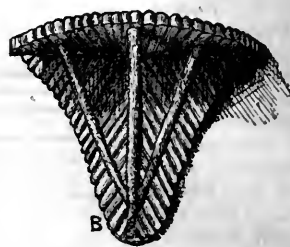

Fig. 12.



Fig. 3.



Fig. 4.

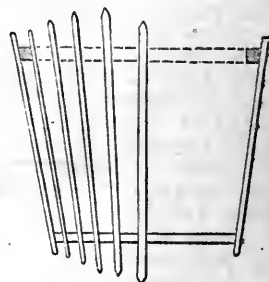

Fig. 24.

bricks may be built in with the ordinary brickwork as may be required; while, if it be desired to make use of them upon an old wall the original brickwork may be removed in such spaces as may be determined upon, and the beaded bricks inserted in its place. Walls erected with these bricks have an ornamental appearance, and do not become defaced by nail holes, while the trees secured to them may be easily kept clean and free from insects. Fig. 1 shows a wall constructed on the principle laid down by the inventor, and which seems to have met with the approval of most authorities. Fig. 15 shows the brick.

Window Boxes.—It is often convenient where window gardens are cultivated, to place the potted flowers in boxes, to facilitate their easy removal when required. The ordinary window-boxes are common affairs enough, but in order to be thoroughly useful, they should be carefully constructed. The simplest form will consist of a box or trough, of the length required to fill the window in

tray, when it may be drawn off into a pail by means of the small pipe A. The interior of the box should be well painted, and the exterior may be decorated with split branches or in any other way suitable to the situation in which it is placed, according to taste. A little moss to pack over the tops of the flower-pots will greatly improve the appearance of the window-box. Ornamental tiles are often used, with an effect shown in Fig. 20. They may be secured with a rabbeted fillet of wood at the top and bottom.

Flower-baskets.—There are many kinds of flower-baskets, made of various materials, such as wood, wire, terracotta, &c. But as the two latter can be obtained at a cheap rate of the manufacturers, we need only describe the construction of the former. For large out-of-door baskets suitable for summer-houses, the best we have seen were made of sections of small butter-firkins, cut and decorated as we shall describe. A good sound barrel

being selected having all the hoops in good condition, it should be cut through with a saw, about eight inches from the bottom. This forms the ground-work of the basket. In order to decorate this, split branches may be used, in some cases placed at right angles with the top, in others obliquely, as in Fig. 17. The bottom of the basket may be ornamented by placing a group of crooked branches, as shown in the same figure, and the effect is very rustic and pretty. Holes must be bored in the upper part for the wires which support the basket, and a number of small holes should also be bored in the bottom of the firkin, to allow of the escape of water. Baskets of this sort are well adapted for out-door situations; but for conservatories, or rooms, a lighter style will be more suitable. Very pretty decorated baskets, either of circular or octagonal

two in the way above described, and placed upon a pedestal formed with the trunk of an old tree, having the bark unremoved. The bottom was fastened to a heavy block of wood. The decorations were pine cones, used in the way we have already described in our article on summer-houses, with moss pushed into the spaces between them, so as to conceal the cask. Standing in the midst of a circular flower-bed, with some small-leaved trailing climber twining about it, the effect would be picturesque. If not used for a flower-bed, the base should be more massive than it is in our diagram. To enlarge the base, rough pieces of wood, in blocks, with pieces of bark and pine cones arranged over them, would be suitable. The plan of decorating with split branches, which we have already described, will be found very useful for this kind



Fig. 15.



Fig. 13.



Fig. 21.



Fig. 5.



Fig. 6.

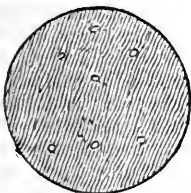

Fig. 18.



Fig. 7.

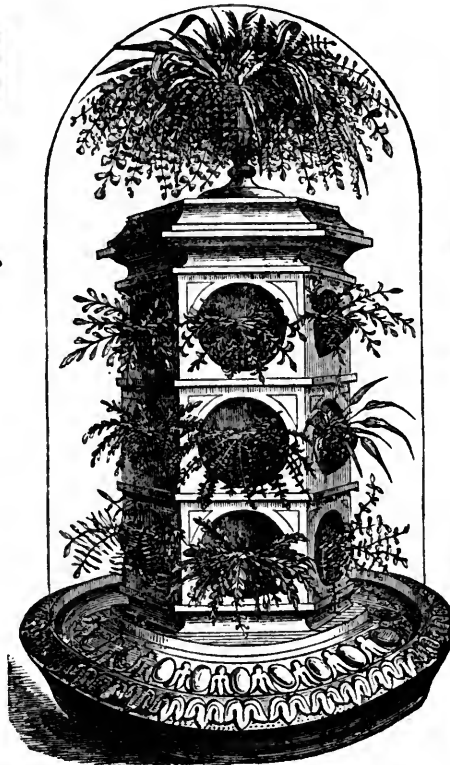

Fig. 14.

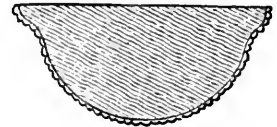

Fig. 10.



Fig. 22.

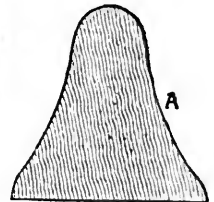

Fig. 11.



Fig. 8.

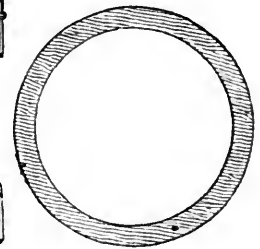

Fig. 23.



Fig. 9.

form, may be made as follows:—Take a piece of board of three-quarters of an inch or an inch in thickness, according to the size of the basket, and cut it to the shape and size the interior of the basket is intended to be at the bottom, as at Fig. 18. Now cut a second piece rather larger than this, the centre of which must be cut away, as at Fig. 23. To form the basket, these two must be secured together with strips of wood, to form the sides. These may be plain and painted (Fig. 24), or of rustic pattern, and of the natural branches of trees; but if they be of small diameter and intended for the room, perhaps the former will be best. The bottom may be covered either in the way recommended for garden baskets, or disguised by letting the lower ends of the wood forming the sides project below it, as shown in the figure. It will be advisable to secure the slips to the upper ring with small screws, as the jar of nailing would be very likely to split the wood. Fig. 19 is a sketch of a rustic basket or vase, for which we are indebted to the kindness of a correspondent. It was formed of an old cask sawn in

of flower-stand, especially if any difficulty is experienced in obtaining the pillar with the bark upon it. An excellent picturesque effect would be obtained by using sections of a hollow tree, having rugged, fantastic outlines ranged about the base of such a stand, with flowers growing in the eccentric holes and hollows. The appearance of a garden or conservatory is greatly improved by the introduction of a few vases of flowers judiciously arranged, taking care, of course, that they be of suitable designs, such as we have shown in Figs. 21 and 22.

In concluding this section of the Household Mechanic, we would observe that, although we have described only some of the more simple constructions used in garden decoration, the principles are the same in the most complicated work, and we have selected these because they can easily be executed by the tyro as soon as he has acquired a slight command over the tools and materials; and also, because our directions will be much more easily understood than if illustrated by complicated diagrams, or set forth in elaborate descriptions.

ODDS AND ENDS.

Acorns as Chimney Ornaments.—Half fill two white hyacinth-glasses with clean water; procure two thoroughly-ripe acorns; take the cups from the fruit, and put a needle and thread through that end of the acorn which fitted the cup; pass the needle through a bung, or cork, which must exactly fit the neck of the glass; fasten the thread on the top of the bung, long enough to suspend the acorn close to, but not to touch, the water; drop a little piece of sealing-wax on the thread where the needle has perforated the cork, so as to make it thoroughly air-tight.

To clean Gold and Silver Lace.—In an earthen pipkin put some finely-sifted alabaster; put it on the fire to boil, stirring it often with a stick. When sufficiently boiled and well stirred, it becomes very light. Lay the article on a piece of flannel, and strew the powder over the lace, beating it with a hard brush. When the lace is sufficiently bright, dust the powder off with a soft brush. Silver lace may be cleaned with calcined hartshorn; and warm spirits of wine, applied to tarnished gold of any kind with a soft brush or flannel, will restore it to its proper colour.

Hints for the Laundry.—A great deal of soap is often needlessly wasted, for want of a simple provision, of the cheapest kind. The washerwoman finds she loses much time, and is often annoyed, by her soap slipping from the sloppy bench, and so keeps it in the water, where it of course is wasted. A little wooden bowl is very inexpensive, and should always be provided. The saving effected will very soon pay the cost of several such bowls. A black bottle of ox-gall, procured from the butcher at a very small cost, should be kept in the laundry, as, in washing coloured things, it will preserve the colours clear and bright. You may scent the gall, if you object to the smell, with a little musk.

To scour Boards.—One part of slacked lime to three parts common sand; scour the boards with a hard brush. It will destroy vermin and whiten the boards.

Coffee Starch.—This is excellent for starching dark clothing—much better than that ordinarily used, as it does not lessen the richness or depth of the colour in the black. Take a cup of strong coffee, made in the usual way, and add to it two tablespoonfuls of the best starch, mixed with enough cold water to make it a smooth, soft paste. While the coffee is boiling fast, add the starch, stirring all the time. Let it boil for about a quarter of an hour, and give it a stir round with a spermaceti candle. Turn it into a pan, and, when nearly cold, pass your dark-coloured or black clothes through it.

To revive Gilt Frames.—One ounce of soda beaten up with the whites of three ounces of eggs. Blow off the dust with a pair of bellows from the frames, then wash them over with a brush dipped in the mixture, and this will render them fresh and bright.

To wash new Black Worsted or Lambs'-wool Stockings.—Let them be soaked all night, and then washed in hot suds, with a tablespoonful of ox-gall to half a pint of water. Rinse till no colour comes out. Iron on the wrong side.

DOMESTIC MEDICINE.

CONSUMPTION (*continued*).

Symptoms.—The symptoms of consumption should be distinguished from the physical signs of the disease. As most people know, doctors can, by certain sounds of the chest, produced by tapping upon it with the fingers, and other sounds, to be heard by the ear applied to the chest, directly, or through the stethoscope, judge pretty easily and decidedly of the existence of this disease. It can easily be understood that when a piece of the lung, instead of being filled with air, is filled with a cheesy or

semi-solid body, it alters the sounds of breathing, and gives a duller note when tapped by the fingers than when in health. Still, the details of these physical signs can only be understood by doctors. The symptoms are more intelligible. We have already incidentally enumerated several of them, in the course of our description of the nature of the disease. We ought to be a little more specific in our description of them. The principal symptoms are cough and spitting, associated with wasting of the body. But all these are not proof of consumption, and may often be found in mere bronchitis. Spitting of blood, if added to the above symptoms, and if the patient be a youngish person, is a serious symptom. But it has, perhaps, been too much feared. Certainly, many people have, at one time or other of their lives, spat a little blood without any particular harm seeming to come of it, or without their drifting into consumption. And it is very rare for people to die of spitting of blood in consumption. It is generally not serious in amount. Of late years, much attention has been given to the temperature of the body, as proof of a deposit of tubercle going on. Of course, there are many other diseases besides tubercle which produce fever and a high temperature, such as rheumatic fever, inflammation of the lungs, typhus fever, scarlet fever; but these are all to be recognised by their respective groups of symptoms; and, if these be absent, the high temperature may be significant of tubercle being insidiously deposited. The digestion in some cases is good, but in many others it is very indifferent. There is generally a want of appetite for food, and when there is an appetite, there may be more or less feeling of sickness, flatulence, &c. Then the urine may be thick. The bowels at first may be confined, but the tendency of the disease is to diarrhoea and looseness. In the early stages of the disease, it is not always easy to be detected, at any rate, by non-medical persons. The cough may be very slight, and so may the wasting and loss of strength, and all the other symptoms; but when the disease is more advanced, the character of it is only too obvious. The expectoration becomes very great, and comes up in distinct masses, often flat and circular in form, like a piece of money. The emaciation proceeds; the burning heat of the skin recurs every evening, terminates in night sweats, and the patient is visibly in a consumption.

The Causes of Consumption.—Most people think that this disease is hereditary, and cannot be produced, excepting in such people as inherit it. There is, undoubtedly, a proportion of cases in which it occurs hereditarily—that is to say, a tendency to the disease, not the disease itself, is transmitted from one or other parent or grand-parent. But very great authorities have thrown doubt on the extent to which we can blame hereditary influence for this disease. The great Louis, who has worked most laboriously at this subject, says, "*I have observed nothing decisive in favour of the hereditary character of consumption.*" Still, it is impossible to deny that in some families, not unfavourably situated in life, there is a strong disposition to consumption; but there is every reason to believe that this point of hereditary influence has been overrated, and that, even where there is undoubtedly an hereditary tendency to the disease, this may be either encouraged or opposed. As modern investigation has tended rather to show that hereditary tendencies have not so much to do with the occurrence of this disease as was thought, so it has tended unquestionably to show that other things, far more controllable, have to do with the production of it. None of us can control our descent. We must take our inheritance as it is, and make the best of it. We may be able to determine, in some degree, the constitution which we shall transmit to our children, by a wise or a happy choice of the partner of our lives; and it is right, in the matter of marriage, to take health into consideration; but we cannot choose in parents. What

we can do is, to know the weaknesses which we inherit, and to do everything to overcome and oppose them, and convert them into advantages. Now, what we wish above all things to point out, in connexion with this disease, is, that *it can be manufactured*, and that it is actually manufactured on a large scale—and in such a way as to show that we may be able, by avoiding the influences which seem to produce it, and by substituting opposite influences, to escape the disease. What, then, are the influences which produce consumption?

Climate has been thought to do it; but it is very doubtful whether it really does so or not. Our climate is changeable and fickle, but we do not know that there is more consumption in our climate than in other European ones; mere cold and wet do not produce consumption. The Faroe Islanders are exposed to cold, wet winds, and live for the most part on fish and wind-dried mutton; and they scarcely know what consumption is. They have plenty of bronchitis and rheumatism; but Dr. Panum, who was specially commissioned by the Danish Government to examine into the health of the islanders, could scarcely find any cases of genuine consumption. Our climate, then, fickle as it is, is not unfavourable in this respect. It may be too trying for people when they have got consumption, but it does not—judging from ascertained facts—tend specially to produce it.

THE REARING AND MANAGEMENT OF CHILDREN.

CLOTHING FOR A GIRL EIGHT YEARS OF AGE.

Under Clothes.—The under-clothing of a girl of eight requires more taste and shape than the clothing of younger children. There are different methods of making various garments, and we shall lay before our readers several of the best patterns for the purpose. Our recommendation with regard to material is:—Where economy must be closely studied, no doubt the patterns entailing least labour will be used. For such, buy the long-cloth in the best available shop—for a much better article can be purchased at some shops than at others, for a given price—and let eightpence, eightpence-halfpenny, or ninepence be the cost. Where the more elaborate patterns are used, the labour of making deserves material finer, and likely to last longer, and as much as a shilling or eightpence may be given for the long-cloth wanted. Always use the best sewing cotton. This will cost as much as twopence-halfpenny a reel, but is worth its price. Common cotton is loose and fluffy, and makes untidy work. It is also given to knot, and to break, and to wear out. Thus, work executed with such a ligament will frequently drop in holes. The best cotton (many shops call inferior articles "the best," and most reels have printed labels so designating them—beware of this)—Clarke's or Taylor's, or sewing-machine cotton, which is generally well prepared, strong, delicate, and even, can be used rather fine, and so produces neat, pretty needle-work. Do not draw the stitches over-tight in working, because if you do so they are liable to crack. Many persons soak long-cloth before making it up; it should afterwards be ironed. Our objection to soaking is that it puckers the stuff and makes it less easy to form regular seams. It is better to buy long-cloth perfectly free from dress. The seams before sewing may be well rubbed with *dry* soap. There is no objection to waxing cotton which is inclined to knot. The glazed cotton is not at all desirable for plain work. As soon as it gets worn a little by frequent passing through the material, it will be found loose in twist, inferior in quality, rough, and easily broken, producing common coarse stitches. Always have at least two good pairs of scissors—a large cutting-out pair, and a fine pair for cutting the threads and paring away irregular

edges. The fine pair should be quite small, with large handles for the fingers, and very long slender points—they will cost about one shilling and sixpence; cutting-out scissors from three shillings and sixpence to five shillings—according to their size. Cutting-out scissors do well with both points sharp; but are preferable with one point sharp and the other rounded. In use, the rounded point is kept underneath. The little scissors must have both points sharp. A pair of button-hole scissors, in addition, are most desirable for every one doing much work at home. When embroidery work is attempted, it is necessary to have a pair of scissors on purpose, to do it well. Those used even for cutting threads, are not sharp enough to clip away the muslin well, and prevent its being ragged. We also advise our readers to have about—not locked up—two pairs of scissors—large and small, or one moderate-sized pair, old ones, accessible generally—to keep persons from being tempted to use their good scissors for inferior purposes, such as cutting paper, whalebone, string, &c. These can be ground occasionally. It may seem to the uninitiated very extravagant to have so many pairs of scissors. But, we ask, can a person labour without fitting tools? And which is most extravagant, to use each tool for its right purpose, or to use tools for wrong uses, and thereby render them unfit for the purposes they were purchased for? Proper, tidy work cannot be done without the necessary implements. In closing, blunted scissors jag the work to pieces. Neither are very large ones suited for finer trimming and thread cutting. In making dresses or children's frocks it is utterly impossible to succeed unless furnished with good scissors. Where there is much cutting out, it is a good plan to wrap and re-wrap the handles of the scissors with a strip of soft rag or kid, cut narrow, so as completely to pad them, and prevent their hurting the fingers, as they will do if constantly used to cut through several folds of long-cloth or any substance not very easy to cut. Scissors are sold now with ornamental leather-covered handles, fitted in leather shields. They are commendable for the comfort in using given by handles thus protected, and for their pretty appearance. It is also a good plan to keep scissors in sheaths, as it helps to protect them from rust and damage, and from breaking if accidentally thrown down upon the points.

Fig. 1 is a simple pattern for the chemise of a girl eight years old. It measures in length from A to B twenty inches. The width at the base from C to D is twenty-four and a half inches, double, allowing for turnings in. Under the arms, E to F, it measures eighteen inches. The side seams are run and felled. The bottom is hemmed half an inch wide. The sleeve is cut like Fig. 2. A and D are stitched together. The side has a hem turned on the right side, the angles rounded, and is stitched. Without allowing for turnings, the sleeve measures ten and a half inches long, and two and a half wide. It is run into the armhole; a straight piece, about two inches wide, and equally as long, is run to it, turned over, and hemmed down at the opposite edge as a false piece, to give strength to it. The false piece is put on at the back, and is indicated by the dotted lines G to E and H to F in Fig. 1. In front, at I, a slit is cut three and a half inches long, after a hollow has been cut out of the stuff at the neck, which is done by first doubling it together, and then doubling the front alone, and cutting that an inch lower in the hollow than the back. At the slit E put a narrow false piece, like a hem, on the right side, run it to the edge and turn it down, and stitch it all round on the left side, make a narrow hem on the wrong side, fold the right over the left, and stitch it across. Cut an inch and a half wide strip of long-cloth sufficient to encircle the neck—the half-inch is to turn in at the two edges; it makes a half-inch band when completed.

Gather the neck of the chemise; run it neatly to the right side of the band. Double the band, turn in the edge, and hem it down on the wrong side. Make a button and button-hole where it meets. Of course the edges here have previously been turned in and sewn. The length of the band for the neck is thirty inches.

Fig. 3 is a simpler pattern, with less work in it. It is all cut in one. It is twenty inches long and eighteen

or twenty wide (each side) at the bottom, where it is hemmed. The sides are run and felled, the sleeves are hemmed at the edges and at the shoulders, the points have loops, and fasten to buttons at A and B. The flaps are hemmed round, and have strings at C and D. The corners at E and F have loops of cotton placed across, and afterwards button-stitched over to prevent their tearing down.

Fig. 4 gives another pattern for a chemise. It is cut in two breadths, back and front, each eighteen inches wide. It is sloped for the neck, the front is an inch and a half lower than the back is, and the armholes are rounded out.

Gores are put both sides. Each gore is in two pieces, four inches wide at the bottom, and commencing immediately below the armhole. The gores are sewn to the sides of the chemise, and felled. The sides of the gores are run and felled together. The sleeves are of a very pretty shape, stitched together underneath, and with the edges turned over and stitched on the right side; they are run into the armholes, and a band an inch wide (not allowing for turnings) run on the wrong side over them and hemmed down, as a false piece. The neck is set into a wide band, measuring an inch double. It is gathered at the neck into the band, which is the size round of the neck, probably thirty inches.

Fig. 5 is another style of pattern. A neck piece is cut,

the chemise sloped at the side, run and felled, leaving enough open for the lower part of the sleeves, A to B, which is afterwards slightly sloped; the top of the chemise is sloped from A to C like the yoke or neck piece. It is then gathered, and run to the yoke on the wrong side. On the wrong side the yoke is carried straight across the back, from A to A (see Fig. 5), and needs no sloping. A second yoke piece is cut like the first, and tacked to it on

the wrong side. Round the top, E to F, Fig. 6, the raw edges meet. At the bottom, G to H, Fig. 6, and A to C, Fig. 5, the raw edge of the lining piece allows for a turning in. This is turned in a little above the turning of the outer one, and neatly hemmed down to the gathers of the chemise. The sleeves are beautifully shaped, coming almost to a point on the shoulders, which prevents their slipping out and showing under short sleeves, as ill-cut sleeves do. They are run into the armhole, and a false piece put on the wrong side, as described (Fig. 4), and the hems turned down and stitched on the right side. The neck of the yoke is set in

a very narrow band, double stitched, and so is the piece which buttons from D to C, Fig. 5. Add the two buttons. Another way of setting in a yoke is thus:—Cut two yokes of the long-cloth. When the skirt of the chemise is ready, gather it, and run it under the first yoke, leaving a raw edge to the yoke. Run in the sleeve the same way. Cut a narrow band of long-cloth, turn in both edges, tack it over the raw edge of the yoke. Finely stitch it down at both edges. This band forms a square all round the edge of the yoke, and is extremely narrow, perhaps a quarter of an inch. Put a false piece round the join of the sleeve behind. Then add the second yoke as a lining, tacking it to the first width, both raw edges meeting at the top, or neck. Turn in the lower edge, and finally hem it to the gathers

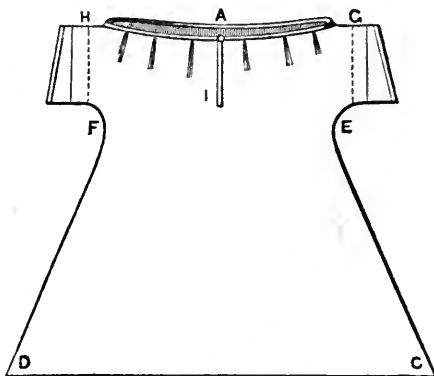

Fig. 1.

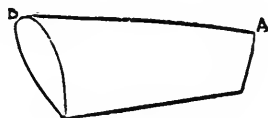

Fig. 2.

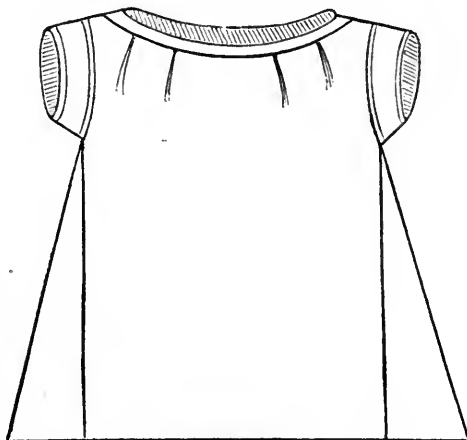

Fig. 4.

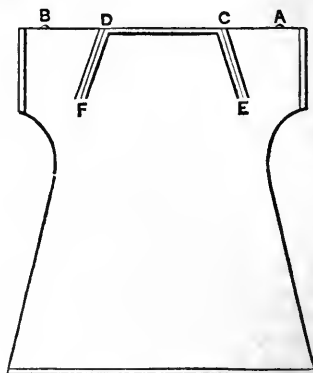

Fig. 3.

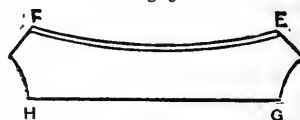

Fig. 6.

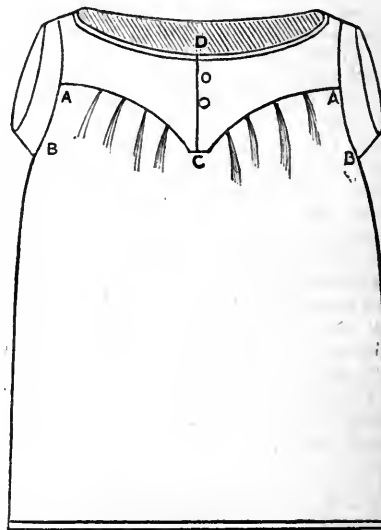

Fig. 5.

between the two rows of stitching of the band in front. Be very careful not to let the hemming stitches come through to the front. Set the neck in a band, and otherwise complete the chemise in the manner before stated.

THE TOILETTE.

RINGWORM.

Ringworms, and the Loss and Diseased State of the Hair consequent thereon.—Perhaps there is no topic of more importance than this, for careful consideration in a HOUSEHOLD GUIDE. For this reason, although we have already touched upon this disease, we now deal with it in a more fully detailed paper. Ringworms are very common indeed, very contagious, sometimes difficult, and always tedious, to cure; and on these accounts, and from attacking especially the young, who are congregated together in schools, or in a large family, create an amount of annoyance and trouble that it is impossible to describe. Hence, we shall be doing a real service, in giving as complete and lucid a description as we can of the appearances by which ringworms may be recognised, the mode in which the simplest kinds can be most readily cured—for those instances in which the disease is severe, we most earnestly counsel should be placed under the care of a medical practitioner—and the means to be adopted to prevent the spread of ringworm from one person to others living together under the same roof. The term “ringworm,” is oftentimes used to any eruption which occurs in the form of a ring, or circle. There are many skin eruptions of a circular character, however, which are not ringworms. Perhaps we need only say, here, that any eruption which is much raised or thickened, and is covered over with white scales in abundance, or which consists of little solid elevations, the size of a split pea, or somewhat less, is not ringworm. But those eruptions on the body which itch, and consist of simple red circles, without there being any thickening, varying in size from a threepenny-piece to half-a-crown, and growing paler in the centre as they enlarge, often somewhat pimply, with pimples not larger than pins' heads at the circumference, will most probably turn out to be ringworms. On the head, ringworms are always associated with alteration of the structure of the hair. We often hear people talk of scald-head and ringworm, as though they were the same thing. The truth is—and it is just as well to point this out here—that the term “scald-head” has been used to signify both ringworms and other diseases of the scalp accompanied by crusting, indiscriminately. Ringworms, as has been proved by modern research, are dependent upon the presence and growth in the skin of vegetable fungi, which produce a certain amount of irritation, and hence give rise to redness, itching, and scaliness, and which, moreover, attack the hair, and render it dry, brittle, and loosened, so that it either falls out, or breaks off close to the scalp. Ringworm is not a discharging disease. Little blisters, or tetter, may form in severe cases, but not as the rule, and these are only of temporary duration. No crusts, the result of the drying of discharge, are formed in ringworm, though the formation of the cuticle is disturbed, and hence scaliness results. What we wish to point out is, that ringworm is a different thing from the discharging affections—“the humours”—of the scalp. In a rare form of ringworm, called “Favus,” yellow, sulphur-coloured crusts form; but these simply grow up as such, and are not the consequence of discharge. When, therefore, mothers of families and others have a child affected by a “discharging” disease of the scalp, they may be satisfied that it is not true “ringworm.” And now, what are the different forms of ringworms, or, as they are called in scientific language, *tinea*? Dr. Tilbury Fox describes nine species: 1, *Favus*; 2, *Tinea tonsurans*,

or ordinary ringworm of the scalp; 3, *Kerion*, the same as the last disease, but with this addition, that the follicles of the hair are inflamed; 4, *Tinea circinata*, the common circular ringworm seen on the body; 5, *Sycosis*, or ringworm of the beard; 6, *Tinea decalvans*, or, as the ancient called it, *Area*, in which simple, round, bald patches are produced; 7, *Tinea versicolor*, or the light brown and itchy stains, or circular patches, seen generally about the chest; 8, *Tinea tarsi*, or ringworm of the eyelids; and 9, *Onychomycosis*, from two Greek words signifying fungus of the nails, or, in other words, ringworm of the nails. Now to describe, in brief language, the features of these different kinds of ringworm.

Favus is rare in England, and occurs in the children of the poorest and most ill-fed of the population. It is known by the development of little straw or sulphur-coloured crusts, that are what is termed “cupped,” like a lupine seed. In the early stage, these little cups appear as yellow specks, but get to about the size of split peas, or less; they are at first separate, but by-and-by they join, and form a mass in appearance resembling a honeycomb. These crusts are made up of “a mould,” or vegetable fungus, which destroys the hairs, producing baldness. This disease must be treated by a medical practitioner. We make this reference to it here, for the purpose of stating that it is sometimes caught from cats, so that parents and others may guard against this source of mischief to children. Many cases of the kind are on record. Cats, themselves, get the disease from mice. When a cat is affected by this favus, little yellow crusts are seen about its ears, its back, its nose, and other parts, whilst, at the same time, the animal is weakly. When, therefore, anything of the kind is observed in cats or kittens, care should be taken that they are not permitted to be fondled by children, lest the disease be transmitted to them. “Mangy” cats had better be got rid of.

Ordinary Ringworm of the Scalp.—This is the variety of ringworm which most interests our readers. It is caused by the growth of a microscopic fungus, and bears the scientific name of *Tinea tonsurans*. It is often associated with the circular ringworm of the body, and the latter may often precede the disease of the scalp. Sometimes the first thing that attracts attention, are two or three (perhaps one) small, red, scurfy, itchy circles about the forehead. The head is then discovered to be itchy, and, on close and attentive examination, little scurfy circles, similar to those on the forehead, are discovered in one or several parts of the scalp, and these patches, which vary in size from a threepenny-piece to a shilling or more, may be bounded by a red blush. This is the earliest stage. By-and-by, the patches alter their appearance; they are covered over by abundant fine white scales, and the hairs get altered, being dry, withered, and presently twisted and broken off a line or so from the scalp. Then we get the characteristic appearance of the common ringworm of the scalp, “consisting,” as Dr. Fox describes it, “of little circular patches, varying in size from one half to several inches in diameter, the hairs of which look dry, withered, and as if nibbled off at a distance of a line and a half from the scalp.” It is the broken-off hairs that is the characteristic of the complaint. These hairs occur in no other disease but ringworms. If the scalp be carefully examined, spots, in various stages between the well-marked disease and the smallest scurfy specks, will be noticed, in severe cases of ringworm, in different parts of the head. As the disease progresses, nearly the whole of the hairs may become dry, brittle, and broken off. This form of ringworm usually occurs in pale and lymphatic children. Now, what is to be done when this form of ringworm occurs? We have before said that the treatment of any serious case should be at once committed to medical hands. We would impress this strongly on the mind, for the simple and sufficient reason

that early treatment is above all things needed, if we would cut short the duration of the disease. The cause of the ringworm is the fungus, or parasite, that finds its way down into the hair follicle deeply; and when it has reached the deeper parts of the follicle, it gets into the young parts of the growing hair, and is carried up with the hair, which is disorganised by it, and is, of course, all the more difficult to be got at by remedies. If, therefore, ringworm is suspected, it should be at once attended to. We will indicate what steps may be taken with regard to the simpler cases of the disease. In the first place, the fungi which cause ringworms grow more luxuriantly on some than other persons, and especially on those who are of the lymphatic temperament. "Persons," says Dr. Tilbury Fox, "attacked by ringworm, assimilate very tardily, and are deficient in fatty matter. What I particularly wish to emphasise is, the fact that in very many instances children attacked by ringworm will be found to have been in the habit of taking very little fatty food, or, if taking it, to have assimilated imperfectly. Mothers and nurses," he continues, "will, in reply to questions, state that this or that child 'never touches a bit of fat.' But, supposing children do eat fat, we can often readily explain why it is not assimilated; for these are symptoms of disordered bowels, inactive liver, and scanty secretion of bile, with which deficient absorption of fat must be associated."

HOUSEHOLD CHEMISTRY.

FOOD—(continued.)

Butchers' Meat.—A joint of meat consists, then, of muscle, almost always surrounded or interspersed with a certain quantity of solid fat. The proportions of fat and lean are, as we have already seen, subject to enormous variations. And it must be remembered that the leaner meat is, the more water it contains, and this water has to be paid for at the same rate as the rest. The composition of the meat is, of course, pretty much that of the muscle, but it sometimes differs from it in one particular. In ordinary beef and mutton a portion of blood remains in the capillary vessels, and imparts to the meat its fine red colour. The composition is then that of the muscle. But when the blood has been drained away after, or as is the horrible practice with the calf, before the death of the animal, the flesh is white and slightly different in composition. The treatment of the calf is as absurd as it is barbarous, for the small quantity of blood which would otherwise be retained improves the meat in flavour and digestibility. Ordinary white veal is the most watery, and one of the least digestible of common meats.

In the selection of meat several circumstances have to be taken into account, and it would be too much to pretend that our scientific knowledge is yet sufficiently accurate to enable us to set aside entirely the results of experience gleaned through centuries. Individuals differ so much, that what is suitable food for one man will often be injurious to another, and few persons have any real difficulty in deciding what suits themselves. Every one knows that pork is difficult of digestion; the nightmare that so often haunts us when we eat it for supper is as good an indication as any scientific experiments which have yet been collected. On the other hand, venison and turkey (but not fowls) are to be reckoned as light and easily digestible forms of meat. Unless a very large proportion of fat is eaten, there is little danger of our not getting a sufficient proportion of flesh-formers in our animal food. It more often happens that we eat them in very large excess.

It is highly important to be able to judge for oneself of the good or bad quality of butcher's meat. A vast amount of meat is sold in England, which from putrescence or loathsome disease in the animal, is dangerous and disgusting for food. Dr. Letheby, whose experience upon

this subject is very great, tells us that about two tons a week are seized and condemned in London alone, and this no doubt is far less than the real quantity offered for sale. It is absolutely sickening to read Dr. Letheby's description of some of the meat destroyed by the active inspectors in London. Pork covered with pustules of small-pox, swarming with the little worms called *trichinae*, crimson from scarlet fever, &c. In the country the inspection of meat is very irregularly carried on, and it cannot be doubted that large quantities of diseased meat are regularly sold, either as joints or still more frequently as sausages.

The following are the simple and intelligible directions given by Dr. Letheby for judging of the quality of meat, which every housewife should learn by heart.

"Good meat has the following characteristics:—

"1st. It is neither of a pale pink colour, nor of a deep purple tint, for the former is a sign of disease, and the latter indicates that the animal has not been slaughtered, but has died with the blood in it, or has suffered from acute fever.

"2nd. It has a marbled appearance, from the ramification of little veins of fat among the muscles.

"3rd. It should be firm and elastic to the touch, and scarcely moisten the fingers—bad meat being wet and sodden and flabby, with the fat looking like jelly or wet parchment.

"4th. It should have little or no odour, and the odour should not be disagreeable, for diseased meat has a sickly cadaverous smell, and sometimes a smell of physic. This is discoverable when the meat is chopped up and drenched with warm water.

"5th. It should not shrink or waste much in cooking.

"6th. It should not run to water, or become very wet on standing for a day or two, but should, on the contrary, dry upon the surface.

"7th. When dried at a temperature of 212°, or thereabouts, it should not lose more than 70 to 74 per cent. of its weight, whereas bad meat will often lose as much as 80 per cent.">*

Roasting of Meat.—The chemical changes which take place during the roasting of meat are very imperfectly understood. The outside dries and becomes brown and hard, just as bread does when toasted. To prevent the hardening from becoming excessive, it should be basted from time to time with the melted fat which runs from it, and which serves not only to keep it moist, but also to prevent the temperature from rising too high. In the interior of the meat the temperature is, of course, much lower, and seldom rises above 150° to 170° Fahr., whereas water boils at 212°.

The effects of the heat upon the inner portions of the meat are, to render the muscular fibres more tender and easy of mastication, to coagulate or solidify a portion of the albumen and blood which exists in the liquid of the muscle, and to develop the peculiar flavour and odour which are so well known in roast meat, and which depend on chemical substances, the nature of which is not known. Thorough cooking is also an important safeguard against injury from the horrible parasitic animals which sometimes infest butchers' meat. There can be no doubt that they are all destroyed by a temperature of 212°; so that, if the meat can be raised to that temperature during the cooking, it may be eaten with safety, even if it has come from a diseased animal. Few persons, however, would, it may be supposed, care to try the experiment voluntarily.

The changes which occur when meat is *baked* need not be considered here, as the process is very similar to roasting.

Boiling of Meat.—It is usual, in boiling meat, to immerse it in cold or lukewarm water, and raise it gradually to a little below the boiling point, where it is maintained until the cooking is completed. Now, it has already been mentioned that flesh contains a great quantity (nearly three-

* "Lectures on Food," p. 235.

quarters of its weight) of *juice*. This juice consists chiefly of water, but contains in solution some highly nutritious and easily digestible articles of food. When meat is boiled in the manner above described, a great portion of these constituents are washed out of it, and the meat becomes to that extent less sapid and nutritious. But, on the other hand, the *broth*—the water in which the meat was boiled—becomes a solution of food which, in all well-regulated households, is flavoured, and, if necessary, boiled down into good and useful soup.

Baron Liebig suggested, many years ago, that the meat might easily be saved, to a great extent, from this weakening action of the water. He recommended that the meat should be plunged, first of all, into boiling water, boiled in it for a few minutes, and the pot then removed to a cooler place, where it could be kept for the necessary time at a temperature not higher than 165° Fahr. The effect of this treatment would be, to coagulate and harden the outer surface of the meat, which would then, to a great extent, prevent the juice from escaping while the process of cooking was going on. It must, of course, be remembered that this mode of boiling meat could only improve its quality at the expense of the broth. It is only a question of whether the juice shall be allowed to escape into the water, or shall be kept in the meat. You cannot have it in both.

It is obvious that *stewing* is but a modified kind of boiling, in which the meat and gravy are served together, generally with the addition of some flavouring substance. In the same way *broiling* is a kind of roasting, in which the melted fat is either collected as dripping, or is allowed to fall into the fire.

Beef-tea Broth.—When the object is to obtain in the liquid state as much of the nutritive matter of flesh as possible, it is evident that cold water should be employed. The meat should be minced as fine as possible; then mixed with a very little water (for the strongest beef-tea, not more water than beef) and a little salt, and heated gradually till it boils, when it may be strained for use through a piece of muslin, which may afterwards be squeezed to remove the last of the liquid. The residue will then consist of almost tasteless fibres.

Such an extract as this, when evaporated to dryness, constitutes the solid extract of meat which is now so largely sold. There is no doubt that these preparations, when properly made, give beef-tea quite equal in quality to the best that can be prepared from fresh meat. One particular kind which we have tried is sold in small round cakes like chocolate. The beef-tea made from it cannot be distinguished from the best home-made.

Beef-tea prepared by the ordinary method, or from the solid extract, does not, unfortunately, contain the albumen of the flesh-juice. This valuable article of food is rendered insoluble (coagulated) by a temperature of about 133° Fahr. Hence, during the boiling of the beef-tea, it separates out, rises as a scum to the surface, and is removed during the straining. The same change can be seen in the egg, of which the white consists almost entirely of albumen. Every one knows that when the egg is boiled, the white becomes solid and insoluble in water.

Liebig suggested that when it was necessary to prepare beef-tea of the greatest possible strength and nutritive value, the minced beef should be stirred for an hour or two with a very little *lukewarm* rain water, to which a little salt, and a few drops (say twelve to one pound of beef) of hydrochloric acid (spirits of salt) had been added. After straining and pressing, a beef-tea would be obtained which would contain albumen in solution, in addition to the other constituents of the flesh-juice. When required for use, it should be warmed slightly, but it must not be made hotter than the hand can easily bear (100° Fahr. or so), or the albumen will coagulate. The object of keeping the albumen in the liquid state is to ensure its

more easy and rapid digestion in the stomach; in *nutritive value* it is as good solid as liquid. The beef-tea so prepared is, of course, a mere medicine. It has the somewhat unpleasant taste of raw meat, and would probably be rejected by most invalids.

Bones: *Gelatine*.—Bones contain a certain proportion of a firm, tendon-like solid, quite insoluble in water. If a bone is suspended in weak hydrochloric acid for a few days, all the mineral matter of it—about two-thirds—is dissolved away, and an elastic mass remains, having the form of the bone, and very similar in composition to the flesh-formers of food. This substance is called *osseine*. If, instead of soaking the bone in acid, it is boiled for a long time in water, or, which is still better, if it is boiled for a much shorter time at high pressure in a "Papin's digester," the mineral matter remains unaltered, but the osseine gradually changes its nature, and becomes converted into *gelatine*, which is easily dissolved by the water. If the water is now allowed to cool, the gelatine will solidify as a firm jelly. The hides of animals, their tendons and some other parts, will yield gelatine when similarly treated. *Calves' feet*, when long boiled with water, yield very fine gelatine. The jellies which are so often obtained in cooking operations are always formed in this way. The flesh-forming power of gelatine is, as we have before remarked, more than doubtful, and the value of bones in cooking is therefore not so great as some people suppose it to be; but still, whether it act as flesh-former or heat-giver, it cannot be doubted that gelatine possesses some, perhaps a very considerable, value as food.

Fish.—The number of kinds of fish which are used in different countries as food is very great, and they exhibit remarkable diversities in composition and flavour. An eminent French chemist, M. Payen, has made some careful experiments with regard to them, and has increased our stock of knowledge very materially, for he has not only determined the chemical composition of the most important of them, but has also ascertained the proportion that the useless bear to the edible parts of each fish. This latter calculation is of great importance in fixing the relative value of different fish as articles of food. The heads, tails, fins, bones, &c., were reckoned as useless, and it will be readily understood that their weight bears a very different proportion, in different fishes, to the weight of the whole animal. In the salmon, for example, this waste amounts, on an average, to about 9 parts in 100; in the sole to 14 parts, in the mackerel 22, the eel 24, the pike 32, the carp 37, the whiting 40, and in the barbel to no less than 47 parts in every 100.

Equally remarkable differences are observed in the composition of the edible parts of different fishes. Some contain a great deal of fat, some very little, and in some it appears to be almost entirely absent. Thus, the flesh of fresh-water eels contains 24 parts in 100, of roach 13, bleak 8, fresh herrings 10, mackerel 7, salmon 5, and carp 1; while that of the sole and barbel contains less than one-third of a part in 100. The quantity of water varies according to the quantity of fat, just as it does in butchers' meat, in which, as we have already seen, fat takes the place of water; the greater the proportion of fat, the smaller being in all cases the proportion of water. The fishes last named contained, in 100 parts of flesh, the following quantities of water:—Eel 62, roach 67, fresh herring 70, bleak 73, mackerel 68, salmon 75, carp 77, sole 86, and barbel 89. It is therefore evident that the leaner fishes are much more watery than even lean butchers' meat, which seldom contains more than 72 parts of water in 100. This fact will be remembered by the careful housekeeper.

The flesh-formers in fish are similar in composition and properties to those of butchers' meat, and they are probably of equal value. Their proportion varies from 10 to 22 parts, or even more, in 100.

Preservation of Meat.—The great importance of animal

food to man has naturally suggested many attempts to preserve it from putrefaction, and we may conveniently consider, in this place, a few of the most important results which have been obtained.

In the first place it must be remarked, that it is the flesh-formers of food only that are liable to undergo the curious chemical process that we call putrefaction. Neither the mineral substance nor the fat of meat will putrefy, although the latter will decompose to a certain extent, and become what is called "rancid," if putrefying flesh-formers are in contact with it. Lard and tallow are merely fat purified as much as possible from the flesh-forming constituents of the body, and every one knows how well they keep as compared with flesh. The putrefaction of albumen, fibrine, and the other flesh-formers, is a complex chemical change, which can only take place when several conditions are present. These are :—

1. *Certain Limits of Temperature.*—At the freezing point of water all putrefaction ceases, and also at the boiling point. It is most active at a temperature of from 70° to 80° Fahrenheit.

2. *Water.*—Perfectly dry substances never putrefy.

3. *Air.*—If air be entirely absent, no putrefaction can take place; but it appears that this is because air always contains the germs, or seeds, as it were, of low forms of organic life. It has been proved that substances cannot putrefy or ferment (and the two processes are very similar) unless minute fungi or infusoria—tiny vegetables or animals—are present. The process of putrefaction is, in fact, carried on entirely by these living things, which are themselves carrying on their own vital functions during its continuance. When a substance like albumen putrefies, it is changed by the action of these organisms into new and simpler compounds, some of which are poisonous, and possess a most offensive odour. Illustrations of the production of animal life during putrefaction are afforded by the maggots which accumulate in meat, and the mites which multiply in myriads in cheese, during their decay.

4. The absence of substances which would destroy the life of the organic germs, or prevent the animal matter from being affected by them. Common salt, saltpetre, sugar, and many other compounds, possess this power. They are known as *antiseptics*.

All processes for the preservation of food are designed to prevent putrefaction, by destroying one or more of these conditions. Some of them have been known for ages, but the greater number owe their origin to the remarkable scientific activity of the present century. They admit of a very simple classification.

1. *Processes which depend on Cold* are familiar to every one. The fishmonger stores ice in his cellar to keep his fish from putrefying. Fish and game come to us from America, and are sent to India, in ice ships, and can in this way be kept fresh for a period of time which would have sufficed to render them rotten, if exposed to the temperature of the air. Every housekeeper knows how soon meat goes bad in warm weather, and knows also that the colder the weather the longer the provisions will keep. At the freezing point, no putrefaction can take place, and the bodies of animals, when frozen, can be kept for any length of time. In cold climates, food is often preserved through the long winters by the simple process of allowing it to become frozen; and, to show that there is no limit to the preserving action of cold, we may mention that the bodies of animals which have been extinct for ages have been found in Siberia with the flesh and organs in a state of perfect preservation.

2. *Processes which depend on the removal of Water* are numerous, and many of them well known. Vegetable substances, in particular, are often preserved by drying, as is the case with tea, hops, and pot-herbs. Potatoes have been preserved very successfully by the same method; and, during the Crimean war, cabbages, carrots,

and other vegetables, were supplied to our troops in a dry state, compressed into flat cakes. When soaked in water, they were restored to their ordinary condition, and almost to their original flavour.

Meat, also, can be preserved for any length of time in the dry state, but it is always injured by the process. Two preparations of the kind, called *charqui* and *penmican*, are used by hunters and others in America. They are, however, very inferior to fresh meat in flavour and digestibility. The extracts of meat which are now sold in the dry or pasty state are good examples of this mode of preservation, and many others might be cited.

3. *Processes which involve the use of some Chemical Agent.*—The most important of these are the familiar operations which have from time immemorial been known under the names of salting, smoking, pickling, and preservation with sugar. The precise mode in which these substances act is still very obscure, but we have already indicated the kind of action which they appear to exert. When a piece of meat is immersed in a solution of salt (to which saltpetre, sugar, and spices are often added) a gradual *diffusion*, or mixture of the liquids, takes place; a great portion of the flesh-juice passes out from the meat into the brine, and its place is supplied with the salt and other constituents of the pickle. The meat will then keep for a length of time, but it will easily be understood that its quality is permanently injured by the treatment which it has undergone; for, not only will the fibres have become harder and more difficult of digestion, but the valuable juice, to which so much of the flavour of meat is due, will, to a great extent, have been removed from it. It has been found possible, by an interesting process, to separate a great portion of this juice from the brine, and to boil it down for soup; but we have not heard that the process has been made use of on a large scale.

The *smoking* of salt meat or fish removes a good deal of their water, and introduces instead a small quantity of tarry oils, produced by the burning of the wood or peat. These oils contain *creasote*, a most powerful antiseptic, and this contributes remarkably to the preservation of the meat.

The action of vinegar, sugar, and spirits of wine, in preserving, is probably similar to that of salt.

4. *Processes which depend on the exclusion of Air*, or, more strictly, of the organic germs which are always present in air, are very numerous, and are, for the most part, the fruits of modern science. All kinds of methods have been tried, although very few have come into common use. Many of them propose to effect the exclusion of air by coating the substance over with gelatine, meat-gravy, fat, paraffin, or some other impervious substance. The preservation of sardines in oil is a good example of this method.

But the most remarkable process for the preservation of food is that which was first employed by Appert in 1810, and which, with slight improvements, is now carried on upon a gigantic scale. In this process, meat, soup, vegetables, &c., are enclosed in tins with a narrow orifice. They are then boiled fiercely for some time. The steam drives out the air, and, while it is still rushing out, the hole is closed with solder. As the tin cools, the steam condenses and leaves a vacuum, and, if this vacuum be perfect, the food will keep for an indefinite time. We have ourselves seen tins of meat, which were supplied in 1824 to one of the Arctic expeditions, were left there for a quarter of a century, and then brought back to England. Even now, whenever a tin is opened, it is found to contain perfectly fresh and good meat.

Meat prepared by this process is always overcooked, but even this difficulty has been got over, by introducing a small quantity of sulphite of soda, or (better) bisulphite of lime, into each tin. Any small quantity of oxygen remaining in the tin is absorbed by these salts, and the necessity for prolonged boiling is therefore removed.

THE HOUSEHOLD MECHANIC.

GARDEN FURNITURE AND DECORATIONS (continued).

Fountains.—In a garden nothing is more pleasing than a fountain. It matters very little whether it be of large or small dimensions; the graceful curves assumed by the falling water, the glittering spray, and the grateful sound produced, combine both to soothe the ear and gratify the eye. It is very surprising that fountains are not more generally introduced in this country, considering how well we are supplied with water—at any rate, in all our larger towns. Perhaps, however, this may be partially accounted for, if we remember the idea, which unfortunately seems so prevalent, that fountains are difficult of construction, and exceedingly liable to get out of order. Both these notions are erroneous, and we hope to show in this article

basin to receive the falling water, or to modify the height or shape of the jet, being merely subordinate matters, which may be arranged according to individual taste.

In the first place, some leaden piping must be procured; if the jet is not intended to be very large, that known as half-inch will be both strong and large enough. There is a cheaper piping, known in the trade as "compo," and much used for gas-fitting; but lead will be found more serviceable and cheaper in the end. As the tube will have to be soldered both into the cistern and to the jets and taps, the proper soldering materials will have to be provided. These are as follows: first, a small soldering iron, commonly known as a copper bit, which consists of a piece of copper, with one end tapered off, somewhat in the shape of a blunt chisel, except that it is bevelled from all its four sides, so as to be almost pointed, and riveted into

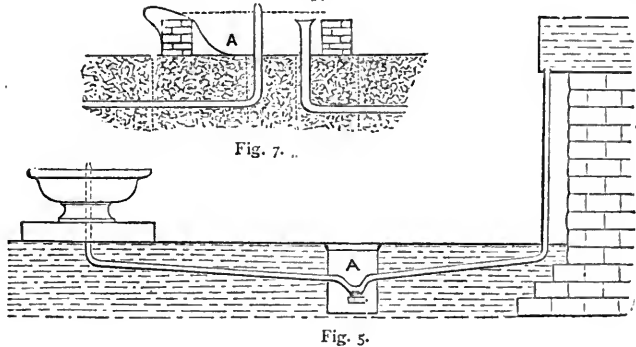
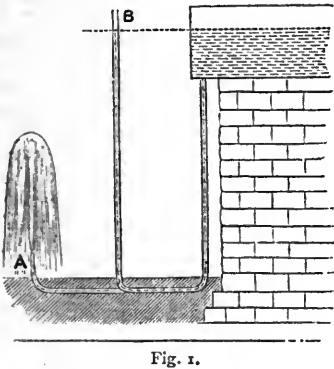
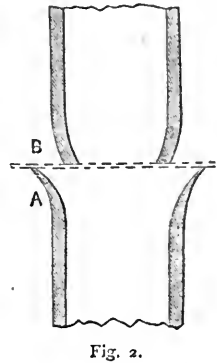
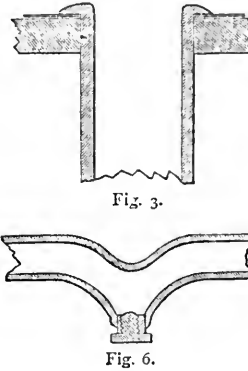
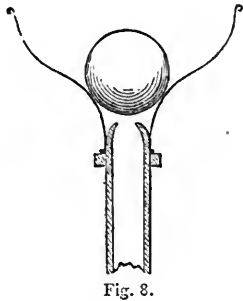
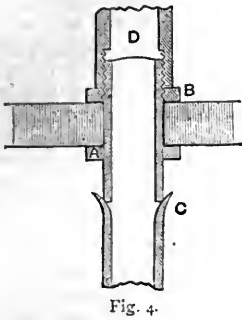

how fountains may be properly constructed by the amateur mechanic, and how such precautions may be taken as will effectually prevent any derangement of them when finished. The first matter for consideration is the supply of water. If a very large jet is required, it will be well to have a separate service pipe laid on into the garden, and this should be connected with a main in which the supply is constant; but if only a reasonably small jet is to be used, the ordinary pressure obtained from the tank which is arranged to supply the household will be sufficient; especially if the flow of water into it be constant, as it mostly is under the present system. The principle upon which fountains are constructed is so well known that we need only mention it. If a pipe be carried from a cistern, or vessel of water, as shown in Fig. 1, the fluid will rise in the pipe to exactly the same level as that contained in the reservoir, as at B. But if we were to cut the pipe at A, the water would issue in a jet, upwards, in endeavouring to reach this level: this would be an example of a fountain in its rudest form.

Thus it will be seen that all that is required is the construction of a pipe to convey the water from a higher to a lower level; all the arrangements as to the form of the

a piece of iron, which forms the handle. This can be obtained of almost any ironmonger, at the cost of about one shilling; a flat file will also be required, similar to that used by brass finishers; a hammer, a plug of some hard wood, of a conical shape, and a good strong pocket knife, will complete the list of tools required for soldering; but if the tank be of wood lined with metal, as is mostly the case, the brace and bits mentioned in our first article will be found very handy for boring the necessary holes in the wood.

The materials required for soldering will consist of—first, some soft solder, similar to that used for gas-fitting, a piece of common resin, and a piece of sal-ammoniac. Besides this, it will be well to provide a small quantity of whitelead, the use of which we shall presently describe. Before attempting the actual construction of the fountain, the operator should make some experiments in the art of soldering, by joining some short pieces of piping together, so that he may be sure of making a water-tight joint, wherever it may be required: this he may do as follows:—a piece of pipe being cut to the required length, one part should be opened, till it becomes somewhat similar in

shape to the mouth of a trumpet, as shown at A, in Fig. 2. This will be effected by gently tapping the cone of wood into it with the hammer; the other part of the pipe should then be dressed round with the hammer until it assumes the shape shown at B, in the same diagram. Both parts should then be scraped with the knife, until a perfectly clean and bright surface of metal is obtained, when the two tubes may be inserted one in the other, so as to leave a ledge of about a quarter of an inch between the lower and upper portions. Upon this should be placed a little powdered resin, when the joint will be ready for soldering. The soldering-iron should now be placed in a clear coke fire, until it becomes hot enough to melt the solder freely. This will be considerably below a red heat, and the iron should not be made too hot, or it will burn the lead or melt it into holes. When the proper heat has been obtained, the iron should be cleaned, and "tinned," by first lightly filing it with the flat file, and then placing it upon the piece of sal-ammoniac, so as to bring the point in contact with the salt. Now if the solder be applied it will readily melt, and the soldering-iron will take up a portion of the molten metal, and exhibit a bright surface similar in appearance to a plate of tin. It is now ready for making the joint. The pipe having been so arranged as to ensure its remaining steady, a bar of the solder should be taken in the left hand, the soldering-iron in the right, and a drop or two of the molten solder allowed to fall upon the intended joint. With the point of the soldering-iron, this should then be drawn completely round the pipe, adding as much solder as may be required to fill the shoulder formed by the opened pipe completely up. The pipes will now be found firmly united, and when cold any little irregularity in the soldering may be trimmed off with the file.

As in the construction of fountains it will often be necessary to join taps and jets to the pipe, we will describe that process here. When the tap is bought it will mostly be "tinned" up a portion of its length; but, as this has been in contact with grease and dirt, it is not sufficiently clean to take the solder easily. It will, therefore, be safer to repeat the process. The brass should be lightly filed or rubbed with glass-paper until quite bright, and sprinkled with powdered resin. The soldering-iron should then be heated as described for making the joint in the pipe, and a little solder applied. As soon as the metal becomes warm, the solder will flow readily over it, leaving a bright surface, which should not afterwards be touched with the hands. The joint may then be made as above described.

The only other matter of this description we need mention is the method of joining the leaden pipe to the metal forming the bottom of the tank from which the supply of water is to be taken. To effect this, a hole of the same size as the pipe to be inserted should be bored with a centre-bit and the pipe passed through to the interior of the cistern. The upper portion of the pipe should be opened with the cone of wood, as for a joint, except that it should be spread much more. The edges should then be dressed round with a hammer, until they form a kind of flange, as shown in Fig. 3. If the lining be of lead, both the pipe and the surrounding portion of the cistern must be thoroughly scraped and cleaned. This being done, the parts to be joined may be sprinkled with resin, and the soldering effected in the usual manner. Should the cistern be lined with zinc, however, the mode of cleaning it is somewhat different. The lead pipe should be prepared as usual, but the zinc should be brushed round with a little muriatic acid (spirits of salt), and the solder applied while this is wet. When the joint is made, the superfluous acid should be wiped off with a piece of rag.

Should the cistern be of stone or slate, it will be better

to call in a slate-worker to attach the pipe, as it is difficult to bore this without proper tools; and there is great danger of fracturing the slabs of which it is composed. In this case an appliance similar to that shown in Fig. 4 will be required. This consists of a brass tube with a solid flange, A, attached, which is passed through the bottom of the tank, and secured in its place by means of a nut, B. The lower end of this tube, C, is soldered into the leaden supply-pipe. The flange and nut should both be furnished with a ring of thick soft leather, to ensure perfect contact between the metal and the slate, and prevent leakage; and the joint at C should be made before the tube is inserted in its place; a little whitelead should also be inserted between the leather and the slate.

This concludes the more technical portion of the work, and we may now proceed to the actual construction of the fountain.

The selection of the site upon which this is to be erected is a matter for individual taste, but we may remark that unless the pressure of water is great, and the jet of considerable strength and size, it will be well to choose a tolerably well-sheltered situation, or the beauty and effect will be considerably marred by the wind blowing the water from the perpendicular and out of its due form. This is particularly the case with fancy jets, which are usually very fine and easily disturbed; but if a very bold large jet be used, with a heavy pressure, the clouds of drifting spray and deflection caused by the wind are rather an additional source of beauty than a defect. When this matter has been disposed of, and a suitable site fixed upon, the pipes may be laid, and connected with the tank or other source of supply. In doing this, however, it is necessary to take precautions against accident through the pipes bursting during frost. A trench should be dug of not less than eighteen inches in depth, and sloping gradually towards one point, as shown in Fig. 5. If a narrow strip of wood can be obtained, it should be laid at the bottom of this, and the pipe dressed down evenly to fit it; while, if it passes under flower-beds, or places where it is likely to be injured by digging, it should be completely boxed in. At the point marked A in Fig. 5, a small box or well should be placed; and at this part the pipe should be bent, as shown in Fig. 6; the well being covered with a stone or slab of wood. At the lowest part of the pipe a tap or screwed plug should be inserted, for the purpose of drawing off all water from the pipes during frosty weather.

This will complete the hydraulic arrangements, so far as the supply of water is concerned, and we may now proceed to the external arrangement of the fountain.

The first thing will be to excavate a portion of the ground upon which the fountain is to stand, to the depth of twelve or fourteen inches, and somewhat larger than the diameter it is intended to be. This space should be filled in with concrete made of gravel-stones or broken bricks, mixed with a little lime, and should be rammed very closely down, so as to form a firm basis for the upper work. It is important to attend to this, as, if a good foundation be not laid, the water will soak away the earth unequally; and the fountain will speedily settle out of its place, and become deranged. A space of about four inches square should be left in the centre for the passage of the pipes. It will now rest with the constructor to determine what shape the fountain shall be. If it is to be a large basin nearly level with the ground, the best way will be to build a circle of brickwork, as shown in section at Fig. 7. This should be of hard "stock" bricks, and should be laid in Portland cement. The moulding forming the basin should then be "run" by means of a mould made of zinc or iron; but as this is a matter which requires considerable skill and practice, it will be better for the amateur to get this done by a workman, as he would stand but little chance of performing it successfully.

If, however, the basin is simply to hold water, and is to be partially decorated with artificial rock-work, the inner portion of it may be filled in with cement, as shown at A, Fig. 7. The outer part may then be covered with rock-work, which should be bedded in Portland cement also; and for this a plasterer's trowel should be used. Of course, if the fountain is to be of complicated design, and comprise figures, &c., both basin and figures must be purchased; as they have to be cast, or moulded, and are altogether beyond the powers of construction common among amateurs. If the fountain be thus purchased, it will only be necessary to set it upon the foundation of concrete.

If only a small fountain be required, the basin may be formed out of the ordinary pans of red clay used for washing purposes. Two holes should be bored in the bottom of one of these—one for the supply and one for the waste, or overflow pipe, which should be considerably larger than the supply. When the pipes are put in their places they should be fixed by pouring Portland cement into the pan to the depth of about an inch. This will render the basin perfectly water-tight. The outer part may then be surrounded by artificial rock-work, as described above, or disguised as the taste may suggest.

The waste or overflow pipe, which we mentioned in our last paragraph, should be at least three times as large as the largest jet; or if there be more than one set, of all of them together, and should be carried into the nearest drain. Should there be no drain near, a tolerably deep hole should be dug down into the gravel, and loosely bricked or boarded round. If the quantity of water used be not very large and the fountain be only occasionally used, the waste will soak away from this, and it will last for years. Of course this well should be securely boarded over to prevent accidents.

The whole of the fountain being thus constructed, it only remains to determine upon the shape and variety of the jets to be employed. Whatever forms of jet are employed, the amateur will do best by purchasing in preference, to constructing them for himself. They require to be made with great accuracy, and should be bored and turned in the lathe, so as to be perfectly true. For a few shillings a small variety may be obtained, and they should all fit upon one screw to allow of their being easily changed. For a fountain with a central pipe only, three or four jets will form a nice selection. Of these, one should be a plain central one for forming a strong, high column of water of the full power available. The second may be one pierced with a number of small holes, and similar in shape to the rose of a watering-pot. This will form a series of jets somewhat resembling a plume of feathers. The third may be the one consisting of two discs of metal, placed nearly in contact; this produces a uniform film or sheet of water, which looks like a globe, or shade of glass, and is very beautiful in its constant change of form and colour. The fourth is one which is a constant source of fun and amusement to children, and consists of a simple jet of rather small dimensions, upon which a wire basket is placed. A ball of painted cork should be placed in this, and the water turned on, when the jet of water will lift the ball and keep it suspended in mid-air. Should it fall, it will be caught by the basket and immediately raised again. The neck of the basket should be so contracted that the ball, when it falls, will return to the centre of the stream of water, as shown in Fig. 8. If the fountain be only of small size—say a jet of one-eighth of an inch in diameter—the basket may be constructed and fitted by the amateur; or a wire-worker will make one for a few pence. The ball should be made very truly, or it will fall too frequently. There are many jets and arrangements of a more complicated character which may be added if required, but these must be left to the selection of the constructor, to accord with his taste or fancy. Those we

have named may be depended upon as easy of working, and not liable to get out of order.

Of course these jets must be screwed on to the supply-pipe above the level of the water in the basin; and the top of this pipe will have to be surmounted with a short brass tube, with a screw tapped upon its upper end to receive them. As they are usually made to fit one pipe, there will be no difficulty in fixing them when this is done. A brass tap will also be required to turn the supply of water on or off, and this may be placed at any part of the pipe which can be conveniently reached for the purpose. In order to prevent the pipes bursting during the winter, a pipe of sufficient length to reach above the top of the water in the cistern should be obtained, with a screw attached at the lower end, to fit on or into the mouth of the supply-pipe, as shown at D, Fig. 4. This will exclude the water and admit the air. The plug or tap at A, Fig. 5, being now withdrawn, all the water will flow out of the pipe and leave it dry, under which circumstances injury from frost will be impossible. One other matter only requires a word of caution. The whole area of the jets, when measured up, must not exceed the size of the supply-pipe at its smallest part. Thus, it will be of no use to put a half-inch jet on if any part of the pipe be contracted to a diameter of, say, three-eighths of an inch. The smallest aperture in the entire length is its working diameter, and if this be exceeded in the jets, they will be weak and ineffective. Of the artistic principles involved little need be said here. It should be borne in mind, however, that if a number of jets are employed one should be predominant, the others subordinate, both in strength and height of projection. It is better to aim at a bold simplicity of effect, than to fritter away the water in a number of small jets. The introduction of figures of men or animals is a doubtful matter, but if they are used, care should be exercised in order to avoid some of the most supremely ridiculous specimens of their application, which unfortunately are not at all uncommon in this country.

We have reserved some further remarks on the arrangement of rock-work for our next paper, in which we shall give illustrations of rock-work suitable for fountains and other purposes of garden-decoration.

The whole of these garden structures and articles of furniture are well adapted for the amateur craftsman. To make them strongly is in the power of anyone, and in such things rough workmanship does not spoil the effect, but is often in better keeping than the neat finish of the skilled artisan.

THE REARING AND MANAGEMENT OF CHILDREN.

CLOTHING FOR A GIRL EIGHT YEARS OF AGE (*continued*).

Drawers for a Girl Eight Years of Age.—There is a difference in the cut of drawers for girls and boys. The girl's are shorter than a boy's, by an inch at least, from A to B (Fig. 1), and about two inches wider from C to B, across the seat. Otherwise, up to this age they are made the same. To cut the drawers, double the long-cloth the way of the selvage, from E to F (Fig. 2), and cut out the two sides of one leg together. From A to B measures twenty inches long. From G to E is eleven and a half inches. From C to B measures fourteen inches and a half. From F to H, the leg, measures eight inches. These measurements are made as the stuff lies, double. Slope a piece of the upper side from E to G about two inches for an ordinary child. For a high-stomached child, only take off one inch at G, sloping away to E. Cut a second leg like the first. Run and fell the first leg from B to H. Make a half-inch wide hem, setting on an embroidered edge, from F to H, all round. Make above this four quarter-inch wide tucks, and one half-inch wide tuck

above those, to match the hem. Make up the second leg the same way, reversing the slope cut from E to G (Fig. 2), so as to have a right leg and a left leg. Run and fell the two legs together, back and front, from A to B (Fig. 2). Cut a slit in each leg, where the fold of the long-cloth came from E to C. Cut an inch square of long-cloth, fold it in half shawl shape, and sew and fell it in as a gusset at C, the end of the side slit. One of these gussets must be put to each slit. Hem each side of the slit narrowly. Cut two bands three and a half inches wide, one is fourteen and a half long, the other thirteen and a half. The longest

another at D in the drawers, to let down as the child grows.

Fig. 3 is another pattern for a child's drawers. The legs are cut as described above, but they have only one tuck, and a hem made deep. Each leg is made separately, and hemmed narrowly from A to B (Fig. 2). Then, unjoined, they are set into a single band, buttoned behind; a perpendicular button-hole in the centre of the front fastens the band to the stay-bodice. The only difference in the cut of these drawers from Fig. 2 is that they are allowed quite two inches deeper from A to B (Fig. 2), which

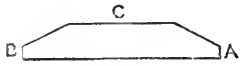

Fig. 18.

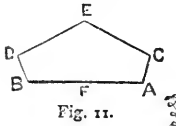

Fig. 11.



Fig. 17.



Fig. 3.

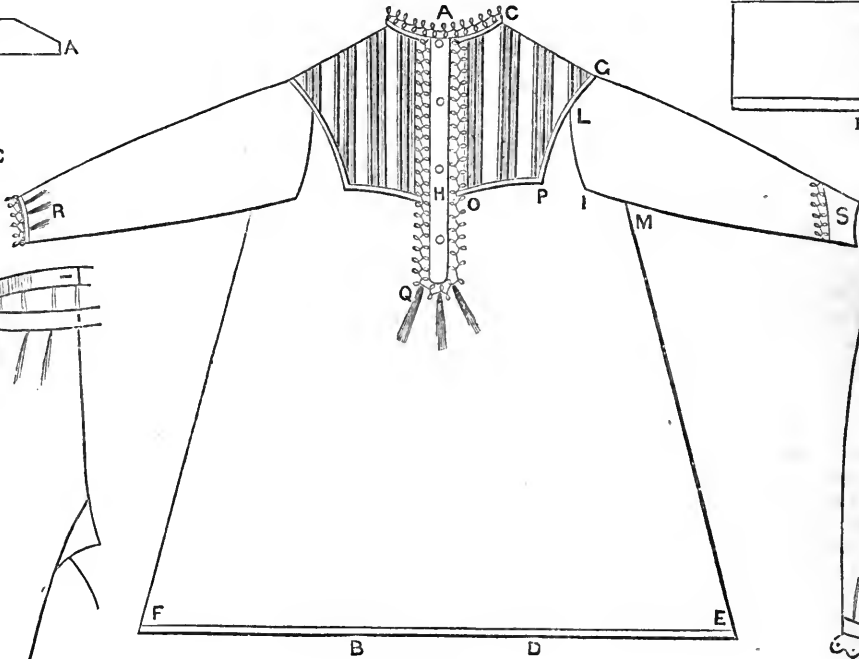

Fig. 12.



Fig. 4.

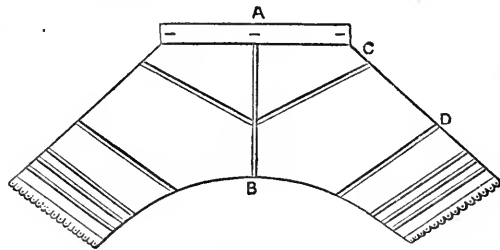

Fig. 1.

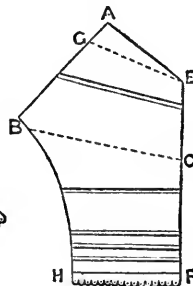

Fig. 2.

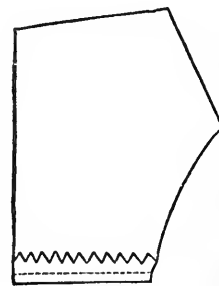

Fig. 5.

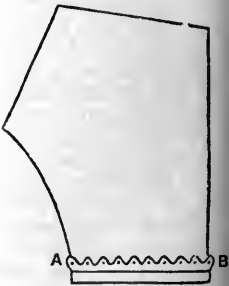

Fig. 6.

band is for the back of the drawers. Gather the front of the drawers, run it to the shortest band; double the band, turn in a quarter of an inch, and hem it down on the wrong side. Turn in a quarter of an inch at both ends and sew it. Set the back band on the same way. Make button-holes at the four ends of the band, and in the centre of the front band. The button-holes are horizontal, the way of the band. There are buttons on the stay bodice to fix them to. Fig. 3 shows the drawers complete and stretched out to display the shape. Young girls of this age need a little trimming on the drawers, as they show much. If low bodies are worn, the chemises should also be trimmed at the neck and sleeves. Embroidery, crochet, or tatting, or crochet and mignardise braid edges are suitable; a tuck is made at C, Fig. 1, and

is sloped gradually away from B to H. This is because they are intended to hang easily instead of fitting tight.

Fig. 4 is another pattern for drawers for a girl from eight to ten years old. It does not differ from Fig. 3 in the cut, but, instead of a hem and tucks, the legs are gathered and set into a knee-band an inch wide (double); this may be of long-cloth, both sides, or faced with embroidered insertion; it should be edged with a muslin work set in like a frill; the muslin work should be as wide as the leg of the drawers before it is gathered, and then drawn into the size of the band; the band must be in two pieces, each one inch wide (turnings extra). The embroidered edge is run on the front band, and the back one is turned down over it and hemmed. The stitches must not come through to the front, or it may be whipped on to the edge.

To set an embroidered edge on drawers shaped like Fig. 3, before making the hem, run the embroidery to the edge of the leg, the right side of the embroidery to the right side of the leg, and the edge of the embroidery the

thus turned back; hem it neatly down all round the leg at the line from A to B, taking the stitches right through the muslin and the long-cloth. When finished, turn up the embroidered edge again, and turn the right side of the

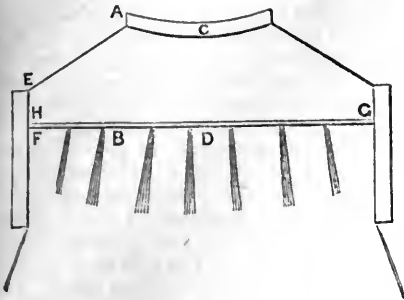

Fig. 8.

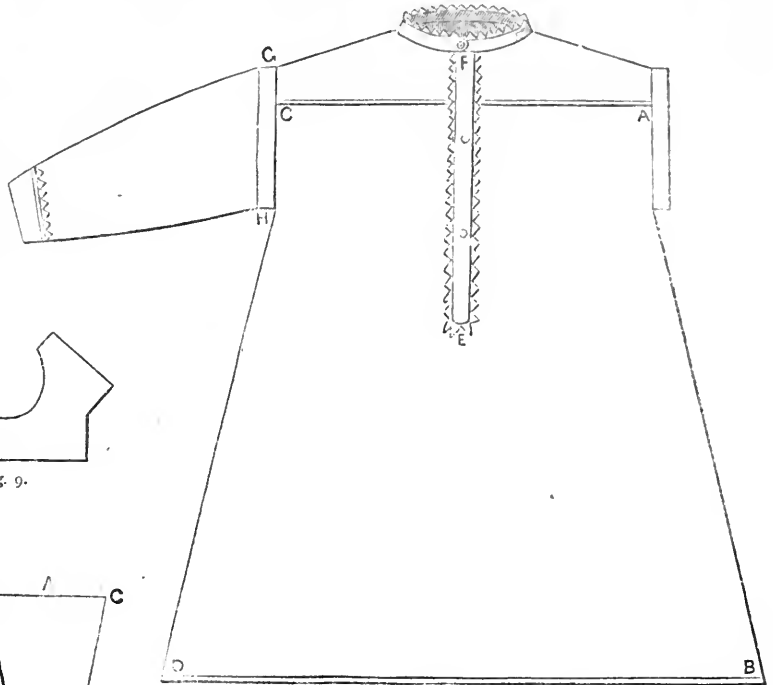

Fig. 7.

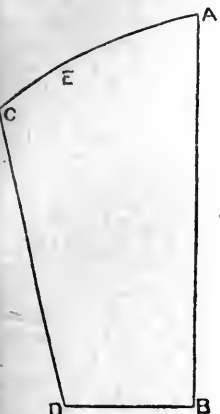

Fig. 10.

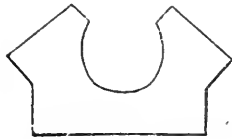

Fig. 9.

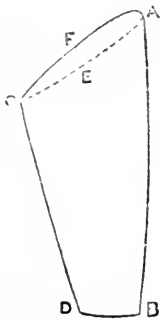

Fig. 14.

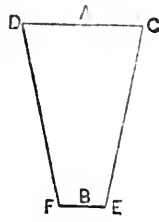

Fig. 15.

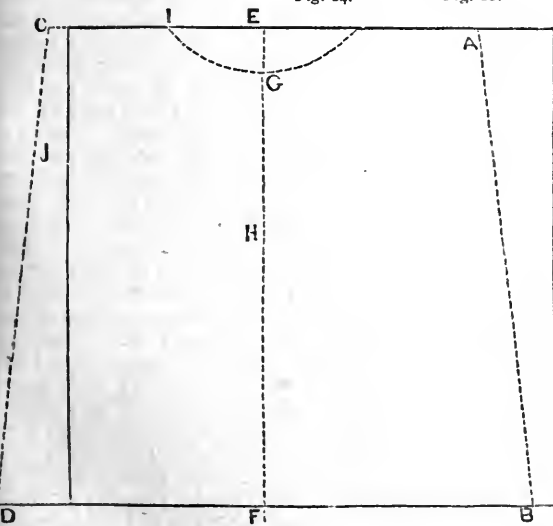

Fig. 15.

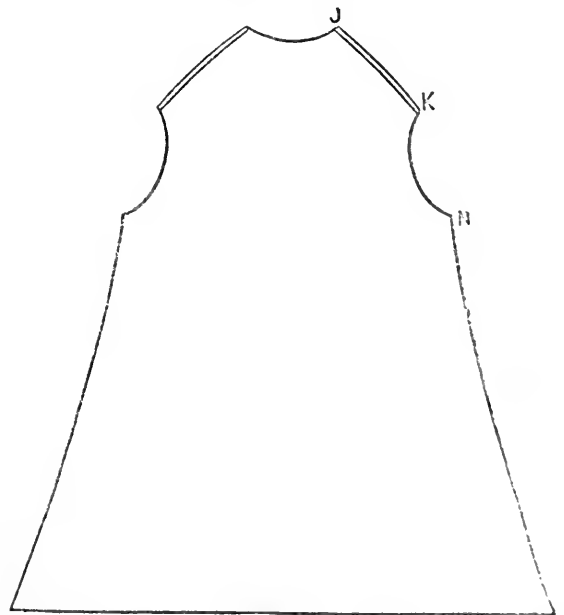

Fig. 13.

reverse way, as shown in Fig. 5. The dotted line is where the stitches run. Then turn down the hem in the usual way, turning it in beyond where the embroidery is run on. The leg must be turned inside out to do this. The embroidery must then be turned back, up the leg, as shown in Fig. 6. But you will now have the leg inside out, and the right side of the embroidery will be seen when it is

leg out; it will now be properly fixed. Of course, the two ends of the embroidery are neatly hemmed and felled together before putting it on the leg, to make a circle of it. It is better to have no trimmings to drawers than to use *crochet* or *tatting*, which does very well for chemises and nightgowns.

Night-dresses.—Fig. 12 is the design for a plain night-

dress for a little girl eight years of age. Fig. 8 shows the upper part of the back. Two pieces are cut alike for the night-gown, from the yoke to the hem; these are twenty inches long. At the hem, B to D (Fig. 7), the gown is thirty-one inches wide; slope this away to A and C, two and a half inches each side, so that it measures twenty-six inches across from A to C for the back, and slope it away four inches each side for the front breadth; also in the front cut an opening F to E (Fig. 7) eight inches down; on the right side, cut off an inch all down; turn back on the right side another inch; tack it down, turn half an inch down on the wrong side of the left side, and tack it; gather the piece at E, and draw it up close. Cut a yoke back and front, like Fig. 8. Cut the yoke piece by the pattern (Fig. 9). It is sloped out more in the neck in front than behind, which makes the yoke narrower in front than behind. This is seen in Fig. 7. The yoke piece is seventeen inches long from G to H (Fig. 8), seven inches deep at the widest part, A to B, five and a half inches deep at the hollow of the neck, C to D, and three inches deep on the shoulder, E to F. Draw this first on paper. Cut it out at every line except the shoulder lines, from A to E. Double the paper over, giving the right slope to the shoulders, and cut the front by the back, hollowing out the neck last of all. From E to A, on the shoulders (Fig. 8), is four inches long; the neck measures six and a half inches round; the yoke in front at the centre of the neck measures four inches deep. Pipe the yoke piece all round the outer edge; join the two sides of the gown by running and felling, leaving three inches open at the top for half the armholes; hem the bottom half an inch wide; gather the back and stitch it to the piping of the yoke; gather the two fronts, and also join them to the fronts of the yoke; cut a second yoke, turn in a narrow edge at the outer side of it, tack it to the first yoke as a lining; hem it on the wrong side to the gathers of the yoke back and front. Cut the slit in front twelve inches deep, including the yoke in the measure of the lengths; cut a strip of long-cloth seven inches long and two and a half wide; this allows half an inch each way for turnings, a quarter of an inch for each turning; run it to the neck on the right side, so as to turn it over, double and hem it down on the wrong side, not letting the stitches show; cut a band twelve and a half inches long and two inches wide; make a false hem down the front of the gown on the right side an inch and a half wide; first pipe round the edge of the false piece, and then stitch it to the gown with stitches not seen in between the piece and the piping; run a half-inch wide false piece on the other side; fold the broad edge over the narrow one, and stitch it across at E (Fig. 7); cut the sleeves with the stuff double, the fold on the cross, A to B, like Fig. 10, fourteen and a half inches long; from C to D twelve and a half inches long; from A to C nine inches wide, the cuff four inches wide; allow a quarter of an inch more on each measurement for turnings for the sleeve; run and fell the sleeve together the length-way; gather the wrist till it measures four inches round, and set it in a cuff.

To make the cuff, cut a pattern by Fig. 11, four and a quarter inches long from A to B, six inches from C to D; two inches wide from C to A, and four inches from E to F; run and fell this together, and pipe both edges, turn down, and hem the upper edge; join the cuff to the wrist of the sleeve, and put a narrow false piece over the gathers on the wrong side. To set the sleeve with the night-gown, gather the top half round, from A to E, both sides (Fig. 10); draw this till the top of the sleeve measures six and a quarter inches round; run the sleeve in. Cut two bands twelve and a quarter inches long, and two and a quarter inches wide; join each round by hemming and felling; run one to the top of the sleeve, and turn it over; run the other edge of it to the night-

gown. This band is shown from G to H (Fig. 7). Turn in both edges of the second band; turn the night-gown inside out, tack the second band as a lining to the first, and neatly hem down both edges. A coarse tatted trimming, or a moderately fine crochet one, may be put plainly round the neck, front piece, and cuffs; to do this, hold the straight edge of the trimming wrong side up, to the right side of the gown against the edge; sew it neatly all along without any fulness, but easily, not straining the trimming. When finished, turn it up the proper way, as shown in Fig. 7.

A very handsome night-dress for a little girl of eight years can be made like Fig. 12. From A to B it measures thirty-seven inches long, from C to D thirty-nine inches; from E to F it is thirty-three and a half inches wide. The yoke is only in front. The shoulders are six inches from C to G, eight inches from A to H; from H to I is ten inches. The opening in front is twelve inches long. To make this gown, the yoke is cut first by the measures given; then strips of long-cloth half an inch wide are cut; these are folded up as narrow as possible, and tacked on to the yoke in strips of three together in the way shown in Fig. 12. After being tacked, they are finely stitched on at both edges. The back is cut plain and narrow, like Fig. 13. Join the front of the gown to the yoke; it is sloped away and shaped so as to be set on without any gathers, quite plain. Lay the edge of the gown under the yoke. Tack it. Turn in a little at the top, and hem it to the yoke on the wrong side. Run and fell the back and sides of the gown together by the side seams, leaving the armholes, which are cut out well rounded, like a dress-sleeve. Turn down a narrow bit on the right side of the shoulder of the back of the gown from J to K (Fig. 13), lay the yoke of the front shoulder over it. Tack it. Hem it on the wrong side. Run the sleeve (which shall presently be described) now made, into the armhole from L to M (Fig. 12) and all round the back, N to K, Fig. 13, with the sleeve *wrong side out*, inside the gown *right side out*, so that, when finished, and the sleeve is turned, the part run can be felled down on the wrong side of the gown in the usual way. Also fell down the rest of the sleeve and the yoke, leaving the raw edge of the yoke outside. A better way is to run in the sleeve, by laying it over the armhole and tacking it, leaving both with raw edges, not putting the edges together as usual, but like one sheet of paper laid on another. Cut a strip on the cross, an inch wide, not allowing for turnings. Stretch it so as to lie flat, and tack it over the armhole; it will come a little over the yoke. Stitch it both sides. Take a similar piece a little narrower, and place the same way, on the wrong side. Hem the edges instead of stitching them. Carry the band which edges the yoke over this. Now take a long half-inch wide strip of long-cloth, turn in both edges, and make a very narrow band. Lay it over the raw edge of the yoke on the right side of the gown, and tack it from O to P, passing L and G, and up the shoulder to C, in Fig. 12. Then stitch this both sides. Set the neck in a band about an inch wide, double, and stitch it on the right side at both edges. Down the front there is a piece two inches wide, and twelve and a half long; turn in a little all round. Curve the edge at Q; tack it on, and afterwards stitch it all round. To make the sleeves, cut the pattern (Fig. 14) eighteen and a half inches long from A to B, sixteen and a half from C to D; nine inches across from A to C. Slope the back of the sleeve from A to C. The wrist, B to D, four and a half inches wide. Run and fell the sleeve together; gather the sleeve from A to E both sides, till it fits the armhole. The rounded part, A to F, is placed inside in front at L, in Fig. 12, F to L and A to G. The sleeves, of course, are reversed for the two sides. The wrists may merely be put in a band to slip over the hands, as at R in Fig. 12, or have a gauntlet cuff, as at S. There are no

gathers at the wrist to this sleeve. The gauntlet can be cut by Fig. 11. The bands must all be cut the selvage way of the long-cloth, that is, down the stuff, not across it.

Another Night-gown.—A very quickly-made gown is a pattern like Fig. 15. It can be cut from twenty-eight or thirty-inch long-cloth. Take a piece sixty-six inches long. Double it in half on a large table without a cloth, or on the floor. It now forms a square, like the lines in Fig. 15. Fold a slanting piece off one side, like the dotted line from A to B, eight inches wide at A, and two inches at B. Cut off the folded piece; then reverse them and first pin, and afterwards sew, these two pieces on the other side, like the dotted line C to D. Then run and fell the gown together at the sides, within five inches of the top, which is the narrow end. Hem the bottom all round half an inch deep. Then fold the gown in half at the dotted line from E to F, measure seven inches from I to C. Put a pin there. From I to E hollow out the neck about an inch deep from E to G. Then fold the front alone, and hollow it an inch deeper, to G. Cut an opening, eleven inches long, to H. Make an inch wide hem on the right side, and a very narrow one on the left. Fold the broad hem completely over the other. Fix it so with a pin, whilst on the wrong side you run the spare fulness at H, and sew it securely down; stitch across this hem at H. Next cut the shoulder straight open from C to I, both sides. The piece from I to C measures seven inches. For shoulder pieces cut four pieces of long-cloth, like Fig. 16—seven inches long from A to B, four inches wide from C to D, two inches wide from E to F. Take one of them. Pipe the two long sides, C to E and D to F. Run the night-gown to this from C to I (Fig. 15), and the other side of the gown to the other side of the same piece. The broad part of Fig. 16 comes at C, or the armhole of Fig. 15. The narrow part of Fig. 16 at the neck of Fig. 15—that is, at I. Take another piece the shape of Fig. 16, not piped. Turn in the edges of the long sides, and line the piece already let into the shoulder, by hemming it down on the wrong side. Form the other shoulder the same way. Cut two pieces of long-cloth, fifteen inches long, and seven inches wide. Run and fell them together like Fig. 17. Run and fell the sleeve from A B (Fig. 17) into the armhole, C to J (Fig. 15). Take a strip two inches wide and four and a half long, and set the wrist into it, by gathering it. Run on the band on the right side, and turn it over, and fell it on the wrong side. Take a band seven inches long, and two wide, and set the neck into it, gathering it as much as is required. A couple of buttons in front, and a frill round the neck, whipped on, and the same to the cuffs, finish the gown. It may be made somewhat stronger at the armholes by the addition of a square piece of four inches made into a gusset. Fig. 18 is the pattern for a chemise sleeve.

ODDS AND ENDS.

Paint for Garden Palings, &c.—Take any quantity of tar, and grind it with as much Spanish brown as it will bear without being too thick to lay on. It should be used while fresh, as it hardens with keeping. This colour should be laid on with a large brush. If the wood is smooth, it will be somewhat bright and glossy. The brown colour may be modified by introducing a little whitelead, or whiting and ivory-black. This mixture is a good preserver of the wood, is durable, and cheaper than ordinary paint. Of course it is not adapted for indoor work.

How to make Black Paper for Tracing Patterns.—Rub smooth a little lampblack and mix it with sweet oil. Paint over the paper with this, and dab it dry with a fine piece of linen. Pull this under the pattern, and upon the material to which you wish the pattern transferred, and go

over the lines with a hard point of wood or metal. If you require it, the transferred lines may be fixed, by using a pen with a kind of ink composed of a little stone-blue well mixed with water in a teacup, with a small piece of sugar added to it.

To make Eau de Cologne.—(Light and delicate. Those who prefer a fuller perfume may add five drachms of essence of lavender.)

Essence of bergamot	5	drachms.
Essence of citron or cédrat	5	drachms.
Essence of lemon	4	drachms.
Essence of rosemary	2½	drachms.
Essence of orange flowers	3	drops.
Alcohol, or ordinary spirits of wine,				
of the strength usually sold in				
shops	1	quart.
Mix together.				

Take especial care to buy the several ingredients at a good druggist's.

American Whitewash.—The first of the two following receipts was adopted for the President's house at Washington, and is said to be very durable, although more expensive than common whitewash. The second is cheaper, but also has the recommendation of durability. 1. Take half a bushel of unslaked lime, and slake it with boiling water, keeping it covered during the process. After straining the mixture through coarse canvas, add one peck of salt dissolved in warm water, three pounds of ground rice, boiled to a thin paste and stirred in boiling hot, half a pound of powdered Spanish white, and one pound of fine glue dissolved in warm water; stir all well together, and leave standing for a few days. When wanted for use, it must be heated in a kettle, and must be applied hot, in the ordinary way, with a brush. 2. Make whitewash in the usual manner, only with hot water, containing a strong infusion of salt; into this, stir a little fine sand; let the mixture be about the thickness of cream. If desired, it can be tinted with green, blue, black, yellow, &c., by mixing with it the proper colours, which may be obtained, at a small additional cost, of any oil and colourman.

To kill Worms, and prevent them from damaging Books.—There is a little insect called *Aglossa pinguinialis*, which deposits its larvæ in books in the autumn, mostly in leaves nearest the cover. These slowly produce a kind of mites, doing very much mischief. The small wood-boring beetles are the most destructive, as they mostly get into the binding of the book. The best preventative for this is the use of mineral salts, to which most insects have the greatest dislike. Alum and vitriol should be mixed with the paste used in covering the books for binding. It is a common practice with bookbinders to use starch instead of flour; also to powder the covers and the book-shelves with powdered alum and pepper; and two or three times a year to rub the covers with a piece of cloth that has been steeped in a solution of powdered alum and dried.

HOUSEHOLD DECORATIVE ART.

FRET-WORK AND CARVING IN WOOD (*continued*).

A GREAT variety of woods may be made use of; for the beginner, one of smooth, close grain, and medium hardness, is preferable, such as pear-tree, sycamore, or lime. For large and bold carving, nothing looks so well as oak or walnut; but oak should not be attempted till some skill has been acquired, as its irregular grain makes it difficult to manage. For minute work, box and ebony may be used, as will be shown hereafter when we come to some of our more delicate designs. The woods we have mentioned are those most commonly accepted, but many others will be found useful in practice. Those

woods are unfit which are very soft and loose in grain, which split easily, or are full of knots.

In fret-work thin panels only are used, varying in thickness from one-eighth to half an inch. For all the kinds we have mentioned—box and ebony excepted, which are more expensive—the cost should not greatly exceed 1s. per superficial foot. They may be bought ready prepared of

draughtsmen:—Rule parallel lines upon the design at equal distances from top to bottom, and from side to side; this will divide it into a number of regular squares, which may be further subdivided by diagonal lines crossing from corner to corner. Then take a piece of paper, of the size of the work, and draw upon it the same number of lines in a similar manner; this will give squares like

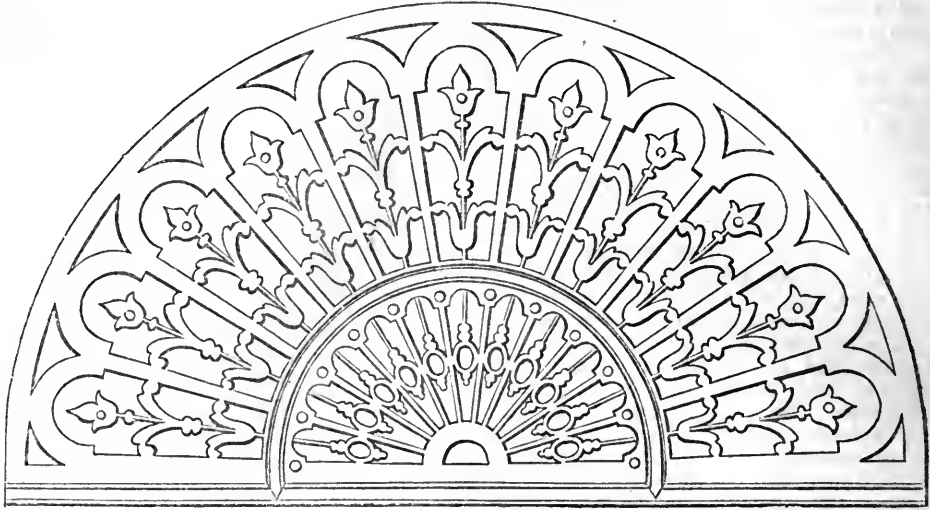

Fig. 1.

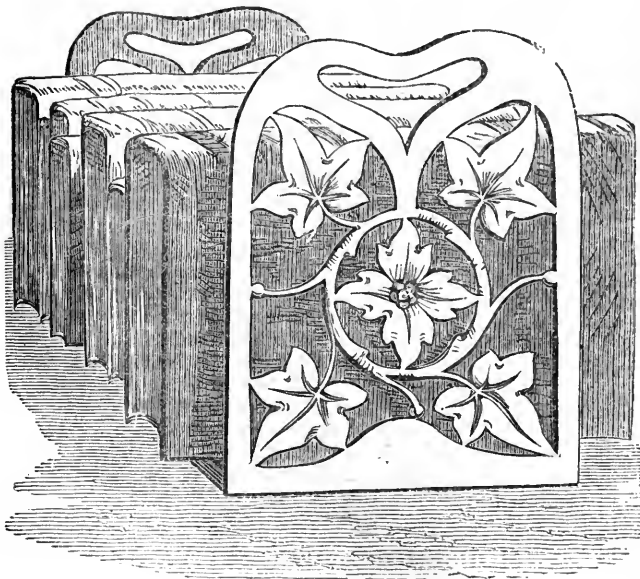

Fig. 2.

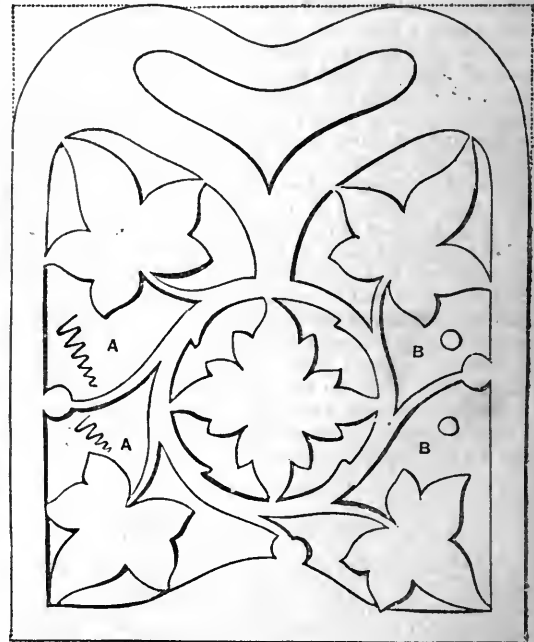

Fig. 3.

those on the design, only larger in scale. Thus our first design (Fig. 3) is the end of a book-slide drawn to half the working size; if lines are drawn across it at intervals of half an inch, the corresponding lines must be drawn on the paper patterns at intervals of an inch. With these as guides, the design can easily be enlarged, and will give a pattern seven by five and a half inches. If drawing lines on the book be considered objectionable, a piece of tracing paper can be laid over the design and the lines marked upon it: the figure will show through. After the pattern

tool-makers, and at some fancy shops, or, more cheaply, at timber yards. If at the latter, they will require well planing on both sides, which can be done for a trifle extra at the yards. It is usual to draw the pattern of the fret on paper and paste it over the panel. Had space allowed, we should have given designs at full size, which could at once have been traced off as patterns, but we have been compelled to adopt a smaller scale. We therefore recommend such of our readers as are not skilled in drawing, to enlarge them in the following manner, which is well known to

has been drawn, it will be well to make a few random strokes of the pencil on all those parts which are to be cut out, as at A A, Fig. 3, by which any mistake in the sawing will be avoided. In cases where more than one pattern is required (the book-slide, for instance, will need two), take a piece of thin paper, and, when the first panel has been perforated, lay it thereon, and rub over with a piece of heel-ball; this will give the pattern in black, whilst the parts cut out will remain white. Heel-ball is a composition of lampblack, wax, and grease, and may be bought at 1d. per cake of the oil and colourman, or the shoemaker.

In carving, when the design is in relief (that is, has a background), or is to any extent a *flat* composition, a paper pattern pasted on the wood is also used; but as in the process of carving, the pattern is in many places cut away and destroyed at an early stage; and as some further guide is necessary for the chisel, a soft black-lead pencil is required to retrace the forms of the design upon the wood.

As a first attempt, we propose that the book-slide end (Fig. 3) should be perforated. It is given half size, the real dimensions being seven by five and a half inches. We will select a piece of pear-tree panel, three-eighths of an inch in thickness. It must first be cut to a rectangular form, as shown by the dotted line, with an ordinary saw, and the pattern fastened on it; paste is better for this purpose than gum or glue. Through each of the portions to be cut out, a hole must then be bored, as indicated by small circles in the wood-cut at B B; for this many persons use a gimlet, but the practice is open to objection as being liable to fracture the wood; some use an Archimedian drill, which answers better, but costs 7s.; it is the custom of the writer to employ the smallest size gouge, which pierces freely and cuts a clean hole. The panel should now be cramped to the horse (Fig. 2, p. 85), and the outer portion forming the curves at top sawn away.

The saw will next have to be put through one of the holes, and worked to the nearest outline of the design, which must be followed till an acute angle is reached; it should then be worked backwards to the starting-hole, and the opposite line cut till the same point is arrived at;

the piece cut round may then be taken out, and the operation repeated till the whole space is cleared. The saw will then have to be removed to the next, and so on till the whole design is pierced; of course, the panel will sometimes require removing, to bring the part to be operated on over the opening in the horse. The operator should be so seated as to be rather below his work, and care must be taken to keep the saw perpendicular. A spot of oil applied now and then to the saw will make it work more freely.

When the whole is pierced, the edges must be made even with the file and glass paper, and the pattern removed by slightly damping; and nothing more remains to be done beyond staining (if desired), polishing, and making up, of which we shall treat hereafter. Fret cutting is very simple, and, after a few attempts, may be done neatly by any one.

This book-slide may be much improved, if it be afterwards finished by carving, as in Fig. 2; at present, however, we do not recommend the beginner to attempt it. In our next article we shall give a bolder and better defined example of carving, with full directions for the method of working, and on this we should advise the first trial to be made. Small work, like the carving on this book-slide, will be best deferred till some little skill has been acquired.

Our second design (Fig. 4) is for a table-casel to hold a print, drawing, or photograph, drawn to a scale of a quarter of an inch; the ledge A has to be fixed on at the cross-bar B. Half-inch walnut panel is recommended for this design, which is intended for fret-work only.

Fig. 5 should also be made in walnut wood, but in thinner panel than the last. It is intended as a frame for a photograph, and is drawn to half the real size. Full effect cannot be given to it without carving, but of this, like the book-slide, we advise that the sawing-in only should at present be done.

The semicircular drawing, Fig. 1, is a design for one of a series of uprights for a standing card-rack or envelope-holder. This is purely for fret-work, and should be cut from quarter-inch pear-wood. To form the rack, four or more of these uprights will have to be fixed on a piece of flat wood, forming the bottom, at intervals of about an inch.

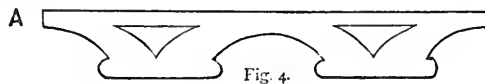
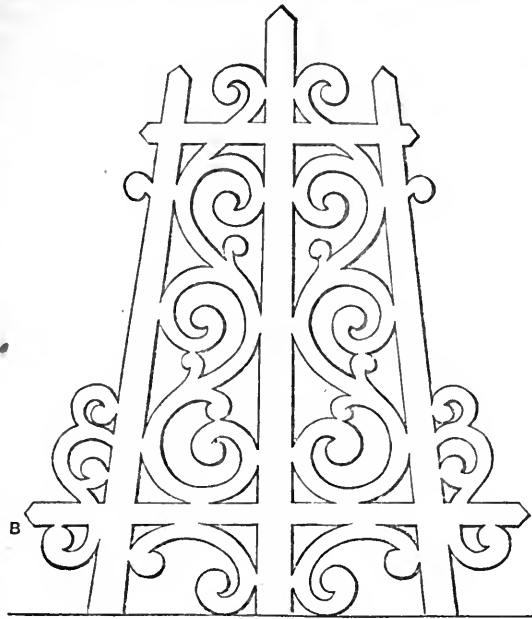

Fig. 4.

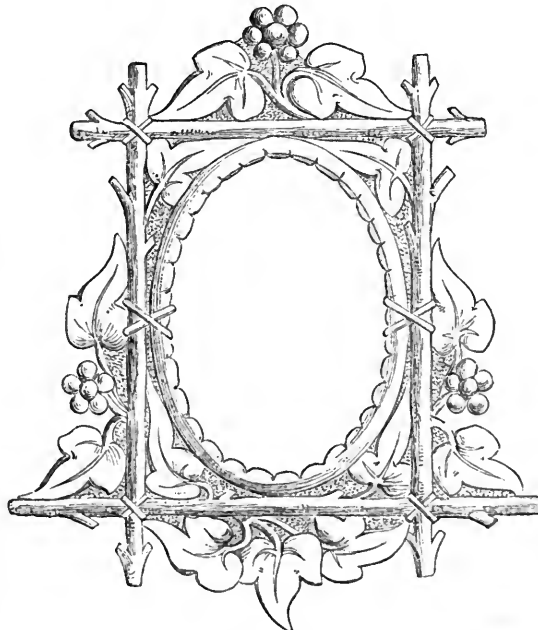

Fig. 5.

DOMESTIC MEDICINE.

CONSUMPTION (*continued*).

Impurity and Closeness of the Atmosphere.—By far the worst influence that we know of in the production of cases of consumption is the absence of fresh air and want of exercise in the fresh air. Hence when a number of people congregate together to breathe upon one another in a limited space, you have the great manufactory for consumption; or if people live in little close bedrooms, you get a similar result. Dr. Guy's researches on this subject are interesting. Taking spitting of blood as a criterion of either actual consumption or a tendency to it, Dr. Guy interrogated 104 compositors who worked in apartments having less than 500 cubic feet for each person. Of this number thus situated 12·50 per cent. had spitting of blood. He then interrogated 115 compositors who worked in apartments with more than 600 cubic feet; and of this number 4·35 had had spitting of blood. Of 101 compositors working in apartments with more than 600 feet, only 1·98 had had spitting of blood. In accordance with this investigation, women are more liable to consumption than men, and domestic animals than wild ones. "The stabled cow, the penned sheep, the tame rabbit, the monkey, the caged lion, tiger, or elephant, are almost invariably cut off by tuberculous affections" (Aitken). And those who lead an out-door life, such as sailors and agricultural labourers, are far less liable to the disease than clerks, tailors, compositors, &c.

Other trades seem to have a tendency to produce a form of consumption, by irritating the bronchial tubes, such as the knife-grinders, certain forms of stone-masonry, &c. All depressing influences, as well as close foul air, tend to produce consumption, such as grief, misfortune, anxiety, scanty food, want of sleep, defective clothing, &c. &c. It will be seen how differently we view the production of consumption, from the way in which it is ordinarily or popularly considered. Generally, it is thought a mere affair of "catching cold." On the contrary, it is brought on in those who live in warm, close rooms, far oftener than in those who brave the cold, and the wet, and the stormy weather, who live in the open air. Of course, it is not desirable that people who have a tendency to consumption should catch cold, or live carelessly in cold weather; but the vitally important thing is, that they should live active, happy lives, as much as possible in the open air; that they should preserve their bodies in the best possible condition by plenty of sleep and suitable food; avoiding all foolish fashions of dress, late hours, &c., and, in the estate of poverty, spending any means which they have thriftily, temperately, &c. &c. It is difficult for compositors, tailors, &c., to command good airy rooms to work in, but they have a right to ask for sufficient air to breathe; and to ask, or to see, that rooms are not over heated, so as to be unhealthy, and to make those who live in them over-sensitive. Few people can afford to seek another climate, but all can make the best of the one they live in.

Treatment.—We have done our principal duty, in trying to convey to our readers some idea of the way in which consumption is produced. Prevention here is certainly better than cure, and it is easier. But one of the blessed discoveries, made of late years, is that of the fact that consumption is not an incurable disease; that it is often quite cured; and that, even when it is not quite cured, life is often prolonged for many years in great comfort and usefulness. Dr. Williams has lately shown, in the *Lancet*, how much longer, on an average, patients with consumption live now than they formerly used to live; the chief difference being the discovery of the value of cod-liver oil and the advantages of open air.—Dr. Edward Smith, in his work on "The Construction and Management of Workhouses," says Dr. De Jongh's is "the purest and best kind of cod-liver oil;

and as it is very rich in biliary products, a small dose suffices, and it is thus economical in use."—Dr. Williams' patients are chiefly amongst the wealthier classes of society, who can go to a different climate, or take a sea voyage and a long holiday; but most practitioners will agree with Dr. Williams that consumption is far less fatal than it used to be, even among those who are poor. It will be gathered from what we have said, that the principal duty of treatment is to *improve the constitution*. This is to be done by *good food*, especially milk and butcher's meat, with beer, or wine, or spirits, as far as they agree. But this diet must be associated with *fresh air*. If the patient can go out, he should do so, as far as his strength will allow. A sea voyage, or a change of climate, may be tried, if this is possible, and if the disease is not too far advanced. If not, some of our own places should be resorted to, to escape the severities of winter and the cold winds of spring, such as Bournemouth, Torquay, Ventnor, or Hastings. The advantage of such places is, that delicate people can get out more freely and get the fresh air. Next in importance is cod-liver oil. It should be taken as food rather than as medicine. Begin with a teaspoonful night and morning, and go on to as much as the stomach will bear. It is best taken in orange wine, but different people prefer different ways of taking it. It is a wonderful remedy, and seems to increase the patient's strength, to add to his weight, and to favour the healing of the lung. If cod-liver oil cannot be taken, then there is the more need to take milk, in pints or quarts a day; not taking too much at a time. Sometimes the addition of a teaspoonful of rum or brandy to a cupful of milk makes it more digestible. The cough is a mere symptom, and may be treated with anything likely to relieve it a little. Amongst other things, the following drops may be given to an adult:—

Syrup of poppies	6 drachms.
Syrup of squills	6 drachms.
Mix.				

A teaspoonful to be taken three or four times a day, when the cough is most troublesome.

Sometimes the feverishness is very great; then some cooling medicine will be of service, than which nothing is better than an effervescing draught, such as—

The effervescing citro-tartrate of soda	2 scruples.
-----------------------------------------	-----	-----	-----	-------------

To be taken in water, while effervescing, once every four hours.

These are the simple principles of treatment, the great aim being to keep up the system, so that the lung may heal, and that no fresh tubercle may be deposited. If care is taken, if food can be taken well, if fresh air can be inhaled freely, then there is good reason to hope that the disease will be arrested.

DEAFNESS.

This is a very common and troublesome complaint, only too familiar to our readers. It has various causes, of which we can only enumerate the principal. Some of them are remediable, and others are only partially so or not at all so. Perhaps the most common, and certainly the most remediable, cause of deafness is *wax in the ear*. Some wax in the ear is natural, and necessary to the proper hearing. And if it is not present, the ear is dry, and does not hear so well as it otherwise would. This, indeed, may be the cause of bad hearing; but it is much more common to have too much wax in the ear, and it is curious, but true, that this accumulation of wax happens in certain people more than in others. The wax goes on accumulating, until it more or less fills up or plugs the passage of the ear, causing sounding noises and a want of proper hearing. The wax in this case can generally be

seen, by getting a strong light thrown into the ear. But sometimes it is placed so deeply, as to be out of sight, until the ear is explored by the help of the *speculum* of the surgeon. Sometimes only a little piece of wax will very much spoil the hearing.

Treatment.—An accumulation of wax has to be removed by warm water injected with a syringe. The water used should be comfortably warm, and the syringe used should contain from an ounce to two ounces. The syringe used by surgeons is much more effective than those to be procured at a chemist's; and unless the wax is close at hand and easily dislodged, a surgeon should be applied to. All picking and poking of the ear with pins should be carefully avoided. It often happens where there is wax, that it does not come away at once. The syringing has to be repeated in a day or two; a little oil dropped into the ear helps to soften and detach the wax.

HOME GARDENING.

CABBAGES (*continued*).—COLEWORTS.—CORIANDER.

The Cabbage.—To resume the directions for the cultivation of the cabbage (see page 43): the cabbage plant requires to be frequently watered, at least until it has made good root, or more properly speaking got good hold of the ground. Final planting may be safely deferred till the spring, but not later; for if the plants have begun to grow, and afterwards receive a check by removal, they are almost sure to run to seed before they attain anything like the cabbage state; and this has invariably been found to be one of the many reasons for there being so many runners, as they are called, as there frequently are. The later and larger kinds should be treated exactly the same as already described, only that they must be planted at a greater distance, say from two to three feet asunder, according to the size of the sort employed or cultivated. They should be frequently looked over, and if any have failed or are running to seed, they should be pulled up, and the deficiencies made good with fresh plants. As soon as the plants are four or five inches high, they must have the soil drawn up about the stems, as by this means their growth will be very materially assisted, and when performing this operation—or, we should rather say, previous to doing so—all weeds should be removed from the ground. Dead or sickly leaves are more or less to be found at the base of almost every plant; these should be left untouched for a time, as the slugs will feed upon them in preference to that part of the plant in health, and therefore by leaving them unmolested, the plants themselves frequently escape their depredations.

They may be taken up with their roots entire, and with as much soil as will adhere thereto, and placed in a dry room or shed, where they will keep several weeks without injury.

Seed Saving.—The raising of seed of the different sorts is a somewhat difficult point, as it is well known to every person, acquainted with gardening, that no plant is more liable to be spoiled by cross breeds than the cabbage tribe. Not more than one sort should be saved the same year in the same garden; and, as the seed will keep good for several years, a sufficient quantity should be raised, of each kind, at different times; but, as we have already stated, not two varieties in one and the same season. Early in autumn, some of the handsomest cabbages should be dug up, and deposited in the ground up to the head, and in the spring following they will throw up flower-stems, which will produce abundance of seed. A few of the soundest and healthiest of the stalks from which the cabbages have been cut, and that have good sprouts, will do equally well. To have spring cabbages earlier than usual, of any particular kind, select the middle flower-stem from

amongst the rest, and keep the seed by itself, which will produce cabbages a fortnight earlier than seed from the lateral branches, although sown at the same time, or even later.

The Red Cabbage.—This differs from the common cabbage in nothing save colour, which is a purplish or brownish red. This cabbage is used chiefly for pickling, and, in my opinion, the dwarf red sort makes one of the most beautiful pickles that can be introduced on the table. There are three varieties of this cabbage grown to a large extent, for market as well as for private use, and these three are the large red, the dwarf red, and the Aberdeen red.

So far as the propagation, sowing, and subsequent culture is concerned, we may say they are, in all respects, precisely the same as recommended for the white cabbage, with the exception that the heads are not used in an open form, like coleworts, but are permitted to stand till they have formed close, firm hearts. The seed should be sown in August for a crop to stand the winter, and come in at the end of the following summer, and remain in perfection until the autumn.

Coleworts are in great request during several of the autumn, winter, and spring months, and to have a regular supply of them, three sowings should be made; the first about the middle of June, the second the first week in July, and the third the first week in August. The process of sowing should be conducted, so to speak, upon the same principles as for the others, and when they are three or four inches high, they must be transplanted where they are finally to stand—in rows one foot apart and the plants the same distance asunder in the row. Water must be given immediately after planting, and be continued at intervals until they become well established, after which they must cater for themselves in finding moisture from the soil, and as a rule they will at this period of their existence find little or no difficulty in doing so. When of a moderate size every other one may be cut for the table as wanted, and the intervening ones left will thus have sufficient room to grow into cabbages. As regards gathering, we have only to say that in taking the crop, as soon as the head is cut, the stems should be immediately pulled up, and taken to the refuse heap, in order to clear the ground, so as to relieve it of a slovenly appearance and an incumbrance at the same time. It must be understood, by-the-by, that it is only the stumps of the coleworts we desire to have removed, as those of the main spring crop, if left in the ground and cleared of decayed leaves, will afford an ample supply of useful sprouts for many weeks to come when greens are very frequently scarce. After the whole crop is gathered, whenever that may be, all decayed leaves, weeds, &c., must be cleared off, and the ground between the rows forked over, throwing the earth well up to the stems of whatever stumps, so to speak, may occupy the spot, and if a little manure were dug in at the same time, it would prove of great advantage. By this means the stems will push out in the autumn, and produce very fine sprouts, but little inferior to young cabbages produced during the months of January, February, and March. It is sometimes considered necessary to preserve cabbages all the winter; and those who are that way of thinking may do so, by taking up the plants and laying them down on their sides with their heads towards the north, and as low in the soil as possible; thus they will soon be covered by the snow, which will preserve them in severe frost.

Coriander.—This is a hardy annual plant, rising a foot high, or thereabouts, with doubly pinnate leaves. It produces its flowers in June, which are white and umbellate. It is cultivated in private gardens chiefly for its under-leaves, which are used in soups and salads. It is cultivated on a large scale for its seed, which is used by distillers, druggists, and confectioners, in large quantities.

Culture.—A sandy loam seems to suit this plant the best. It is propagated by seed, which may be sown any time during the month of February, provided the weather is open and dry, and the quantity of seed sufficient for a bed six feet long by four feet wide, and sown in drills nine inches apart, will be half an ounce. When the seed is sown, the drills must be filled in regularly, covering the grain, so to speak, not more than half an inch deep. When a succession is required, small monthly sowings should be made during spring and summer, as the plants, at this season, will soon run up to seed. A pinch or two of seed should be sown in a frame, in August and September, in order to be protected through the winter; for, as these plants do not bear transplanting well, they must remain where sown.

ANIMALS KEPT FOR PLEASURE.

THE SILKWORM (*continued*)

IN our last paper on this subject (see pages 76 and 77), we traced the interesting but perhaps less important period of the silkworm's existence, during which it is preparing for the work for which it has been created—its childhood, as it were. We have now to consider the manner in which it fulfils its appointed task, and to describe the stages through which it passes in the later and more useful part of its life.

When the worm has attained its full development, instinct teaches it to search for a suitable place in which to commence the labour of spinning for itself the cocoon, the covering of which is the staple of what we in commerce denominate silk. At this time some stout cones of paper should be made, securely fastened with gum, and arranged in a convenient row for the reception of the spinners—one for each. If some such provision be not made, each will choose a corner for itself, and considerable difficulty will arise in detaching the cocoon without injury to its outer integument. The silkworm should, when it is seen to be ready, be placed in one of these cones, and it will then begin its toil. After three or four days all will, on inspection, be found complete, and a small oval ball will have been manufactured, about the size and shape of a blackbird's egg, and of a yellowish colour; the shade of colour differs, however, varying from a deep brilliant yellow to a pale lemon-white. Now, take five or six of these, place them carefully in a saucer of tepid water, taking care that the temperature is only high enough to dissolve the glutinous matter which unites the filaments, without injuring the chrysalis which lies hidden within; select the end of the thread in each ball, and, joining five or six together, wind them off in such a manner that the silk may afterwards be conveniently tied up in hanks. Considerable exercise of patience and great delicacy of touch are necessary in this operation, as the ends are not easy to discover on a first inspection, and the exceedingly attenuated nature of the threads renders them very liable to snap asunder if not gently handled. It is also needful to exercise a judicious caution in selecting cocoons of a similar shade, otherwise the hank, when completed, will present an incongruous appearance, owing to the different hues of its component threads. When all the silk has been wound off (the last wound being the first spun, will be found to be far inferior in texture to the outer covering), the inner shell of the cocoon will be laid bare. This should be carefully slit open with a sharp penknife, and the chrysalis will then be discovered, which must be deposited in a tin box, or some similar receptacle, to wait until the moth is ready to emerge; a layer of bran

may be placed underneath the chrysalids, to prevent them from being bruised, as they are very tender. If it should be thought desirable specially to obtain the eggs of the moth which may be developed from any one particular caterpillar, it is better to leave the entire cocoon undisturbed, but in that case the silk will be sacrificed, as the moth when perfect will work its way out through the entire covering. Such a selection is quite unnecessary, and is to be deprecated for its wastefulness.

After a period of three weeks, the last development takes place, and the moth issues from its covering. The silkworm moth (*Bombyx mori*) is of an exceedingly elegant and fairy-like appearance, although small and plump. It is of a greyish white colour, with four wings, has black and rather prominent eyes, and black feathery *antennae* or feelers. In this condition its existence is but shortlived, and it appears to derive little enjoyment from its life, but remains usually almost motionless in the place where it was originally placed. Of its wings it apparently does not realise the use, as it never attempts to fly; occasionally a slight awkward fluttering conveys the moth a short distance in search of its mate, but for the most part it is in a state of almost perfect quiescence during the few days—seldom exceeding three—for which it survives.

A layer of stout white paper should be placed at the bottom of each tray, upon which the moths should be deposited; here they will lay their eggs, which will adhere securely; and when the eggs are all laid, and the moths have died, the papers may be removed and laid by in a place sufficiently protected from artificial heat during the six winter months. Each moth will produce about 400 eggs, and it thus becomes evident that with a moderate amount of precaution the supply of eggs, and consequently of silkworms and of silk, may be multiplied almost indefinitely, and the rearing of these little insects may be elevated from a source of mere pastime and idle amusement into a source of actual profit.

It is quite uncertain at what time the culture of silkworms was first transported from its native country of China to more western climates. However, the most generally accepted tradition is, that in the year A.D. 552 two Christian missionaries, who are said to have been Persians, having penetrated to the Celestial empire, brought back with them, on their return, a supply of the silkworm's eggs secreted in the hollow of a cane. These they brought to Constantinople, then at the height of its splendour and luxury, and from these, as it is believed, came originally the insects which have since been a source of so much pleasure and profit to so many thousands in our continent of Europe.

It is much to be regretted that more attention has not been devoted to the subject of sericulture as a profitable and suitable branch of employment for women and children. In the present time, when, owing to the advance of science, it has become a matter of absolute child's play to construct houses of glass, the mulberry tree might be reared in large quantities by the erection of suitable conservatories, and made the groundwork of factories especially devoted to this description of industry. It is unnecessary to point out in how great a measure such a proceeding would tend, not only to enrich the resources of our already so highly favoured country, but to provide what has been long felt to be the most imperative necessity of the present day, a fitting employment for the weaker members of society, and to enable them, without any undue labour, to assist in the general progress of the age, and contribute their mite to the prosperity of the country of which we are all so proud to proclaim ourselves inhabitants.



THE COCOON OF THE SILKWORM.

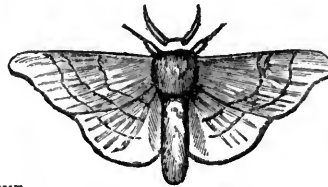

THE SILKWORM MOTH.

CLEANING CLOTHING AND UPHOLSTERY.

Washing made Easy, Quick, and Unlaborious.—Many gently-reared women, through inisfortune, are obliged to attend to the homely duties of washing linen, often actually to labour at the wash-tub themselves. Their physical training has unfitted them for such fatiguing work, and their soft hands are wounded in rubbing at soiled garments. To all such, a recipe for washing with scarcely any labour will be welcome, and we give ours as the result of personal experience. It came about in this way: We found our flannel vests and expensive coloured stockings were shrunk and discoloured so much by the best laundresses we could secure, that we resolved to try to do them ourselves. We succeeded without any trouble. Flannels we have had now for a considerable period, could not be told from new unwashed flannel; stockings that used to shrink, fade, and run in holes, now do duty their full time.

In the article on Children's Clothing, a promise was given elsewhere to give directions for washing, or rather cleaning, children's flannels. The promise is now redeemed, and we are sure no mother who once tries our recipe will ever discard it again.

To Clean Flannels and Woollen Hose.—If the flannels are only slightly soiled, one lather of soap is sufficient for them; if much soiled, there must be two—a wash and a rinse—in that case blue the rinse. If only one lather is used, blue that.

If many flannels are washed together, two lathers, or even three, are needed; in that case do not blue the wash—that is, the first lather. Do not put two articles at once in a lather; complete each, and hang it on a line immediately. Do not put coloured articles in a blued lather, or articles of different colours in the same lather. Coloured things can be washed after white ones in unblued lathers, but never in blued lathers. The thick-ribbed woollen hose so much worn now, take a great deal of soap. As examples of all kinds cannot be given, the following must suffice. To wash two flannel chemises, about a yard long, white; and two pairs ribbed scarlet woollen hose. Cut a half pound of the best yellow soap into three equal pieces. Cut one of these pieces in half. The half piece is to be used. Shave it fine, put it in a quart saucepan, fill it with warm water, and set it to melt. When melted, pour half into a foot-bath or small tub; reserve the other half warm. Add two quarts of water to the bath; when cool enough to bear the hand, blue it excessively. It is not possible to blue it too much, for new flannel, it will be observed, is very blue; and it is the liberal bluing of flannel which keeps it a good colour. If you wash it white, you will soon find it turn yellow. Mix the blue well, or your flannel will be streaky. Put in the flannel (one only), knead it well about, squeeze it in and out; in five minutes it is clean, if the hems are of flannel. If made with binding, it will probably be needful to rub the binding a little to get it clean. It may be slightly rubbed for a minute about the arm-pits. Squeeze it out of the suds slightly by the arms, like Fig. 1, and drawing it through one hand. If squeezed at all tight, or

wrung, or twisted on one side, it marks and spoils the flannel. It is no matter if it is covered with suds, and looks perfectly dyed blue. Shake it out; take it between the hands by the hem, holding it at A and A, Fig. 2; grasp it well, let it go easy, and pull it twice; grasp it again about B and B, and do the same; and repeat the pulling out at C and D. It will sound like a drum. Of course you do not pull it hard enough to tear it, but lightly and smartly. You must pull each sleeve separately, at E E and F F, and at G G and H H. This stretches it nicely, and removes any creases. Peg it to the line by the sleeves. If not dry by night, hang it on a horse at a fire, or in an empty room, but do not fold up the flannels together damp, to shrink them. When dry, you will find the soap and all overabundance of blue evaporated. As soon as the first



Fig. 1.

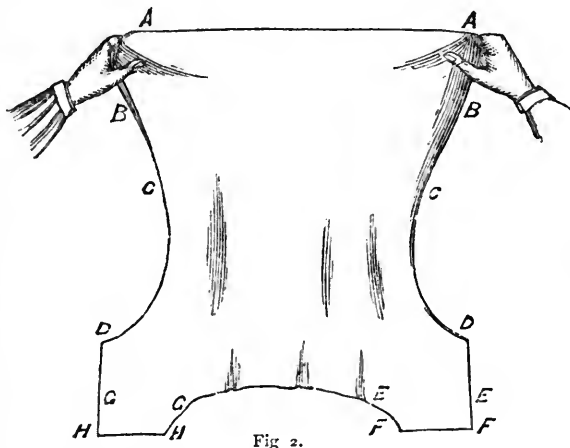

Fig 2.

flannel is wrung out, clean the next. You will have enough lather left for one or two more. If you have no more white flannels, use it for handkerchiefs, towels, or cuffs. Next take the other half of the lather, pour it in a basin, and add as much water as there is lather, or enough to make a quart in all. Take one stocking at a time and clean it. When the two pairs are finished, they will have used the most of the soap. Time to complete the whole (after the soap is melted), ten minutes. In five more, the handkerchiefs or towels that are using up the rest of the lather may be cleaned, put in a saucepan with the blue lather and left to boil with some soda. The lather from the stockings

is deep red and useless; also the soap is exhausted from it, on account of the thickness of the articles cleaned in it. The stockings require a very little gentle rubbing at toe and heel, and, if laced boots are worn, at the instep. Use no soda to the flannels or hosiery.

The causes of laundresses and others shrinking flannels and discolouring them are various. Putting them in lathers too hot or too cold, or rinsing in plain water, or letting them lie in the tub, shrinks flannel. Too hot lathers, the use of soda, and washing them with flannels over-soiled, or their being over-soiled, discolours and

turns them yellow. Rubbing soap on flannel shrinks and mats or felts it, causing it to lose much of its useful effect. Flannels should never be worn too long, or much soiled, for then they become troublesome to clean. Coloured flannels must be cleaned apart from white ones.

General Washing made Easy.—All articles of white linen and cotton hose to be washed should be laid to soak in cold water, overnight, if possible. In case of emergency, soak them not less than half an hour. Soap all soiled parts, as the wristbands and neckbands of garments, and soles of stockings. Soak pocket-handkerchiefs apart in cold water, to which is added a handful of salt.

Melt soap as for cleaning, using the best yellow, in the proportion of half a pound to two gallons of water. When melted, turn this into a tub. For convenience, the soap will melt in a much smaller quantity of water, and the rest can be added in the tub. So far this is the ordinary method, the difference lies in using the soap so little diluted, instead of mixing it with a very much larger quantity of water into ordinary suds. Squeeze the articles

thoroughly out of the cold water, and put them into a tub. Many of them will come clean by merely being in the strong ley. Knead them about as you would bread, and squeeze them in and out. The worst articles will require a little rubbing where they are most soiled, but not much. Dip in the suds and rub. Rub the linen on the linen, do not rub your own hands and skin them. Ascertain that everything is clean by holding it up (squeezed out), and returning those not free from all spots and stains. If the suds are still strong, no more soap is needed to boil them. If not, squeeze out each article and soap it well; put it in the saucepan (with a china plate or dish at the bottom), lumps of soap (not if the suds are strong), and lumps of soda. Blue the suds well and pour them on the linen. Boil not less than two hours; if much discoloured they may boil all the afternoon. If the suds are weak, or very dirty, they should not be used. Then add lumps of fresh soap. Many persons object altogether to boiling the linen in what it has been washed in, as making it a bad colour; but in using a very strong ley of soap, we have not found it so. If the boiling is not concluded till night, the linen may be laid in a tub for the night, and rinsed next day and hung on a line to dry. When clothes do not dry out of doors, they must not be left damp in a basket, but hung on horses or lines indoors at night, and will, most likely, be dry by day. They will then only need starching and rolling up. The unstarched articles must be sprinkled with water and rolled up, if quite dry, to be damp for ironing. They will keep damp rolled up till next day. If mangled first they look best. Some persons consider mangling without ironing sufficient.

It may be observed that it is optional to make the ley of soap twice as strong as the quantity here named, and so effect the cleansing process even more rapidly.

It may be objected that this use of soap is extravagant; but how can it be when all the soap can be extracted out of the water, and, therefore, no more used than is needful to clean soiled clothing? By having a reserve of a few handkerchiefs and towels, in case of need, not a particle of soap need be wasted. We have found the cost of soap, soda, blue, and starch, about twopence for washing that cost eighteenpence put out! a penny of this, only, was for soap.

INMATES OF THE HOUSE.—LEGAL.

BIRTHS.

UNTIL the twenty-eighth year of Henry VIII., there were not any means of knowing the number of births, deaths, and marriages in the course of a year. In the year 1536, Thomas Cromwell, Earl of Essex, was Vicar-General of England, and caused registers to be kept in every parish in the kingdom. At that time the aid of the Church was necessarily invoked for the rite of christening, to which all sought to be admitted, and for the rites of marriage and Christian burial. If, therefore, a note were made of every occasion on which any of these rites were celebrated, there would be, it was conceived, a complete list of all births, deaths, and marriages that had taken place. The parish register system was obviously an improvement on the total absence of registers, affording, as it did, the means of tracing descent—of proving all the important personal events of a family—as well as a source of information to the government upon the question of the number of its subjects. But, as time went on, it was found that parish registers were not to be implicitly relied on: there were many—Roman Catholics and Protestant Dissenters—who did not bring their children to be baptised in the State church, and though they had to come thither for marriages, they did not seek its aid on the occasion of a funeral. Then the clergy were lax in keeping their books, and the government was lax in calling for them; so that, from a variety of causes, the system devised by Thomas

Cromwell failed to secure the registration of more than a large section of the people professing the State religion. So inefficient, indeed, had the parish register scheme become, by the beginning of the present reign, that it was found necessary to legislate afresh, and with regard to the many new exigencies of the public need. By an Act of Parliament, passed in the present reign, the registration of births, deaths, and marriages is now regulated. The registration of births is not compulsory, unless the government, by its agents, demands it; but within six weeks after the birth of a child, it is competent to either parent to have the birth registered at the office of the local registrar, free of charge. If six weeks have elapsed, the registration must be at the office of the superintendent of the district; the local registrar must attend with the parent, and a charge of 7s. 6d. must be paid. After the lapse of six months from the birth of the child, the registration is attended with some difficulty, and must be at the office of the Registrar-General, at Somerset House. It is the duty of the local registrar to take notice of births in his district, and to call on the parents for particulars as to date of birth, sex of the infant, and names and calling of the parents. If he should so call, either the father or mother—or, in their unavoidable absence, some one equally well informed—is bound to furnish the details mentioned. In this way, the children of all religions are included, and those who, going to the church for baptism, are entered on the church-books, get the benefit of double registration. Considering the benefit it is to be able readily to certify as to the precise day of one's birth, it is a pity registration was not made compulsory. It is, however, permissive only, except on demand of the local agent of the government. Formerly, there was a tax payable to the government on the birth of a child; a duke's son was assessed at £30, a commoner's son at 2s.; but this tax—originated in 1695, and renewed in 1783—was abolished long since, and there have been hardy people who have so far advanced on a line of political economy diametrically opposite to this, as to require that, in consideration of the physical assistance they have yielded to the State, they should be free from taxation. It is, perhaps, needless to say that statesmen have not as yet approved the claim.

The law relating to the vaccination of infants is imperative in its tone, and commands the parent (or other person having the care, nurture, or custody) of every child born in England or Wales, to procure, within three months after the birth, the vaccination of the child by the medical officer or practitioner appointed for the purpose—the names and addresses of these are duly advertised—in the union or parish where the child is resident, except only in the case where the child has been previously vaccinated by some duly-qualified medical practitioner, who shall, if required, certify to the success of the vaccination made by him. Every parent (or other person) neglecting this duty, after receiving notice to perform it from the registrar of births and deaths of the sub-district to which the case belongs, shall forfeit a sum not exceeding 20s., which shall be recoverable before any two justices of the peace for the county or borough where the offence is committed. Of course, if at the time of being presented for vaccination the child should not be in a proper state of health, the medical man is not justified in proceeding to vaccinate, merely in order to avoid the penalty of the law. He must be ready to certify the cause of delay, and must vaccinate the child on the first fitting opportunity afterwards. Properly speaking, a certificate of successful vaccination should be sent to the registrar of births by any private practitioner who may perform the operation, though this is not *de rigueur*. The books of the parish vaccinator are made up from time to time, and a summary of their contents is returned to the registrar of births.

COOKING.

MUTTON (*continued*).—SOME SWEETS AND SAVOURIES.

Shoulder of Mutton, Boned and Stewed.—Take out the blade-bone of a shoulder of mutton, leaving the knuckle-bone, to serve as a handle. The butcher will do it for you the first time; having seen it done once, you will afterwards easily be able to do it yourself. Strew its under-surface with pepper, salt, chopped parsley, and mint, or other seasoning approved of. A French cook would probably put garlic, to which we venture to demur (although it is quite correct and *en règle*), believing that garlic is the ruin of mutton. Roll it into a pear-shaped form; tie it tightly with string, to keep it in shape; put it into a stewpan with a tight-fitting lid; a *daubière*, or one that will hold fire on the top, is the best. Moisten with a glass of white wine and a pint of broth. Season slightly with salt and peppercorns; lay round it two turnips halved, two carrots ditto, and four whole onions, besides a bunch of sweet herbs. Stew gently for three hours. If you turn it, avoid doing so with a fork. On serving, pour the gravy over it, and surround it with the vegetables whole, and little mounds of mashed potatoes.

Mutton Kidneys, Broiled or Roasted (convenient, relishing, quickly done, nutritious, and digestible, if properly, *i.e.*, lightly, cooked).—Split the kidneys in two, without separating the halves; peel off the thin outer skin. Pepper and salt them slightly. Broil them, laying the flat sides first on the gridiron, to keep the gravy in; or fry them, *idem*. Or keep the halves flat, side by side, by running a small tinned-iron skewer through them, and roast them in a Dutch oven before the fire. Or place them, with the flat side upwards, in a metal or earthenware dish, and oven them in your cooking-stove. If ovened, they must be served in the same dish; if roasted, with the skewers still sticking in them. In any case, unless very moderately done, rosy and tender inside, in short, *saignant*, or bleeding (as the French say, kissing their fingers), mutton kidneys shrivel into something resembling imitations of Windsor beans punched out of shoe leather. Between putting them to the fire and taking them from it, the cook has hardly time for an out-door gossip. Immediately before serving, put on each half-kidney a bit of fresh butter as big as a hazel-nut, and as much finely-chopped parsley as you can pinch between your finger and thumb.

Mutton Kidneys, Stewed or Sautéd.—Split the kidneys, and peel off the outer skin, as before. Slice them as thin as possible on a plate, so as not to lose the juice that oozes from them. Dust them with flour, pepper, and salt. Brown flour in butter in a stewpan; dilute with wine, or in default thereof, with cider or perry, adding a tablespoonful of catchup. When smooth, take it off the fire, and in it cook the sliced kidneys. A very few minutes will do them; they may simmer, but must never boil. When nearly done enough, take them off the fire, to finish on the side of the stove. Toast a round or slice of bread, large enough to hold the kidneys on its surface. Butter it, and toast the buttered side again. (This convenient substitute for *fried* bread is often easier to do, and less greasy when done.) Lay it on a hot dish, buttered side uppermost. On this pour your stewed kidney, gravy and all. Veal kidney, unintentionally underdone, may be very nicely re-dressed in this way.

Sheep's Brains, Roasted (a nice breakfast dish, or side-dish at dinner).—Take four or six fresh brains; soak them an hour in salt and water; remove their outer skin; throw them into boiling water, with a dessert-spoonful of salt, and a tablespoonful of vinegar mixed with it when cold. Let them boil galloping for ten minutes; take them out, and set aside to cool. At the bottom of a Dutch oven (or of a dish that will stand the oven of

your stove) put as many thin slices of unsmoked bacon as there are brains. Smear each brain with oiled butter; roll it in bread crumbs mixed with chopped parsley or other sweet herbs, pepper and salt. Roast before the fire, or bake until nicely brown, turning them so that they are done all round equally. You may serve each bacon-slice and brain laid with a fish-slice on thin toast. They may be accompanied by tomato sauce or melted butter, made piquant by a little pepper, salt, and vinegar or lemon-juice.

Scalloped Sheep's Brains.—Scalloped oysters and other shell-fish are general favourites. The same way of cooking may be applied to cold meat, vegetables, mushrooms, fish, &c. Throw the brains into cold salt and water, to cleanse. Set a stewpan, containing water in which salt and vinegar have been mixed, on the fire. When it boils, throw in the brains; let them boil galloping eight or ten minutes. Take them out, and let them drain and cool. If you want them immediately, you must throw them into cold water, and then drain them on a napkin. Cut the brains into dice about half an inch square; mix with them an onion or shalot, and some parsley chopped very fine; season with salt, pepper, vinegar, and a little essence of anchovy. Put a good lump of butter in a saucepan, and when it is melted toss the brains, &c., in it, till they are all thoroughly cooked, without letting them brown. Butter the inside of scallop-shells, or tins made of the same form and size; strew their bottoms with a layer of bread crumbs; distribute amongst them with a spoon the stewed brains and their share of the sauce; cover all with another layer of bread crumbs level with the surface of the shells, and a little heaped in the middle. Brown them nicely in a briskish oven, or before the fire.

Haggis.—Hearne, the North American traveller, recommends a haggis made with blood, a good quantity of fat shred small, some of the tenderest of the flesh, together with the heart and lungs torn or cut into small shivers; all of which is put into the stomach and roasted by being suspended before the fire with a string. Care must be taken that it does not get too much heat at first, or it will burst. It is a most delicious morsel, even without pepper, salt, or any seasoning.

Sheep's Head has so little meat belonging to it, either inside or out, that we doubt whether it is worth the trouble it gives, especially if the cost price be not very moderate. Nevertheless, having eaten it with great satisfaction in "the North Country," we borrow a genuine Scotch recipe from that high authority, Mistress Margaret Dods. Choose a large, fat young head. When carefully singed by the blacksmith (if it cannot be done at home, which is better), soak it and the singed trotters for a night, if you please, in lukewarm water. Take out only the glassy part of the eyes, scrape the head and trotters, and brush till perfectly clean and white; then split the head with a cleaver, and lay aside the brains; clean and cut out the nostrils and gristly parts and split the trotters. Wash the head and feet once more, and let them blanch till wanted for the pot. Take a large cupful of pot barley, and about twice that quantity of soaked white dried, or fresh green peas, with rather more than a gallon of water. Put to this the head tied up with string (the brains and tongue remaining in their place), two or three pounds of scrag or trimmings of mutton, perfectly sweet, and some salt. Take off the scum very carefully as it rises, and the broth will be as limpid and white as any broth made of beef or mutton. When the head has boiled rather more than two hours, add sliced carrot and turnip, afterwards some onions, and lastly parsley, shred. A head or two of celery sliced is admired by some modern gourmands, though we rather approve of the native flavour of this really excellent soup. The more slowly the head is boiled the better will both the meat and soup be. From three to four or

five hours' boiling, according to the size of the head and the age of the animal, and an hour's simmering by the side of the fire will finish the soup. Many prefer the head of a ram to that of a wether; but it requires much longer boiling. Serve with the trotters, and large-sliced carrots round the head. The pound or two of scrag is a great improvement to the broth. The sauces ordered for boiled mutton or cow-heel are well adapted to this dish, if sauce need be had where it is so little required. Sheep's head, not too much boiled, makes a good pie if nicely cut down with the peeled tongue; or an excellent ragoût or hash of higher flavour than calf's-head ragoût. For the ragoût a very suitable sauce may be made of the broth seasoned and thickened with butter, flour, and chopped parsley.

Boiled Mutton.—Put the leg into hot water containing a dessert-spoonful of salt; skim while boiling up, and keep it to a boil, without galloping, for about two hours, according to the size of the leg. It should not be overdone, but should blush about the centre of the thickest part, all round about the "pope's eye." An hour before it is done, throw in carrots halved lengthwise, and parsnips also, if liked. Half an hour afterwards add turnips sliced. When the latter are tender, mash them with butter, milk, and a little pepper, to be served separately in a vegetable-dish. Serve the carrots and parsnips round the leg. For caper-sauce to go with it, make melted butter with some of the boilings; throw into it two dessert-spoonfuls of capers, or nasturtium seeds or buds, or chopped gherkins, and one spoonful of their vinegar. Stir together, boil up again, and pour the sauce into a hot boat. Boiled neck of mutton, taking less time, is served in exactly the same way. Boiled shoulder should be accompanied by onion-sauce (boiled with it, and mashed with pepper, butter, and milk). The addition of mashed turnips and caper or other piquant sauce is optional. A smoked ox-tongue is sometimes sent up as a companion dish to boiled mutton, as a relish analogous to ham with roast. In hot weather, mutton for boiling may be rubbed with salt, as a precaution, twelve hours previously. But mutton regularly salted, like beef and pork, does not meet with general approval. In fact, mutton does not graciously lend itself to the process of salting.

To keep up the requisite variety of subjects, we append a few approved recipes for

SOME SWEETS AND SAVOURIES.

Rock Cake.—Beat a quarter of a pound of butter to the consistency of cream; then mix well with it a quarter of a pound of sugar and two eggs, whites and yolks together; then add a pound of flour and a few well-washed currants. Stir them into a paste together, and set into the oven at once. You can make it into one or several cakes.

Soda Cake.—Mix well a quarter of a pound of butter, a pound of flour, half a pound of sugar, three eggs, and a quarter of a pound of stoned raisins. Dissolve a teaspoonful of carbonate of soda in a breakfast-cupful of milk. Add it to the above, and knead well together. Put it immediately into your cake-tin, and set in a steady oven. It will take an hour's baking.

Sponge Cake.—Take four eggs and their equal weight of pounded lump sugar, and three eggs and their equal weight of flour. Beat the seven eggs and the sugar together for a quarter of an hour; then add the flour, and beat the whole five minutes longer. Put this paste into a buttered mould, and set immediately into a smart oven.

Sweet Jelly, for Twenty Guests.—Put into a saucepan a pound of lump sugar broken up, a quart of clear spring water, and an ounce of best prepared gelatine. Set the saucepan on a slow fire. When the gelatine is dissolved, and the liquid begins to boil, take the saucepan off the fire, but leave it on a corner of the stove.

Beat six whites of egg to a froth, add them to the liquid, beating the whole up together. Pass it through a horsehair sieve. Stir in a tumbler of rum, kirschwasser, or any other approved liqueur. Put it into one or more moulds. When cold, turn it out of the mould by wrapping it for a moment in a towel dipped in warm water. The jelly takes at least six hours to stiffen, but is better made overnight.

Coffee Jelly.—Roast gently a couple of ounces of coffee to a golden chestnut, instead of a dark brown colour. Grind it, put it into a coffee-biggin, and pour over it, instead of water, a dozen tablespoonfuls of boiling milk. In a quantity of boiling milk, more or less considerable, according to the number of guests, dissolve some best prepared gelatine. Half an ounce for every ten persons is a fair allowance. Strain this milk through a horsehair sieve, and convert it into a boiled custard by means of sugar, vanilla, and beat-up eggs. When it is ready to take off the fire, stir into it the coffee made with milk. Pour it into your mould, and leave it to stiffen in a cold cellar for four-and-twenty hours. Turn it out of the mould just before serving.

Whipped Cream.—Although this may be made to *look* nearly as well with inferior cream, it is not really good, unless with *good* cream, which is sometimes difficult to procure. For the best cream, the whites of two eggs will be sufficient to mix with a quart; the poorer the cream, the more whites you must put. After mixing them, stir in well half a pound of pulverised sugar. Then whip the mixture to a froth with an osier whisk that is scrupulously clean. As the froth rises, take it up by large tablespoonfuls, and pile it in a deep glass or porcelain dish. Surround the pile, inside the dish, with slices of sponge cake, sugar biscuits, or macarons. Then pile more whipped cream, if there is room for it. A nice plan is to have a sponge cake made in the shape of a hollow cylinder. The cake being placed in the middle of the dish, the hollow is then filled with as much whipped cream as it will hold without running over. Or you may line the inside of a mould with thin slices of sponge cake. Then fill up entirely with whipped cream. Set it aside a few hours, to settle and stiffen, in the coolest place you have. Fill up with more whipped cream if there is any vacancy, and turn it out of the mould on a dish.

Syllabubs.—Flavour a pint of Marsala or Cete Madeira with whatever suits your taste, as rose or orange-flower water; or you may steep in it overnight the rind of a lemon cut very thin. Put it into a large bowl. Sweeten liberally; stir in three tablespoonfuls of brandy, the juice of a lemon, and a pint and a half of the richest cream. If you want the froth of your syllabubs very stiff, add the white of an egg. Then beat all to a froth with your osier whisk. As the froth rises, skim it off with a spoon, and with it fill your syllabub glasses, heaping it as high as it will hold together; and so on, till your cream is all whipped up. Set the syllabubs in a cool place, where they will get firm and settle into a high-flavoured liquor, capped by a crown of snowy froth. Syllabubs are better made the day before they are wanted. When half your glasses are filled with white syllabub, you may vary the colour of the rest, and make them pink by mixing with the remainder of the cream a little red currant or raspberry jelly melted. Black currant jelly will give a still deeper tinge.

Blanc-mange.—Dissolve in a saucepan, over a very gentle fire, two ounces of the best isinglass in two pints of new milk. Add the rind of a lemon and a pint of cream; boil a quarter of an hour and take out the peel. Sweeten, and flavour either with cinnamon, rose or orange-flower water, or vanilla. While cooling, stir in a little white wine and brandy, and pour your blanc-mange into moulds, to stiffen.

HOUSEHOLD DECORATIVE ART.

FRET-WORK AND CARVING IN WOOD (continued).

CARVING is not only more difficult of execution, but is more difficult of explanation than fret-work. The process

upon paper; such will be the case with the bread-platter, Fig. 5. But when, as in the inkstand, Fig. 1, the ornament projects boldly, not only must a plan be drawn on the upper surface, but also a series of elevations, so to speak, on the sides. The first will show where to cut



Fig. 5.



Fig. 4.

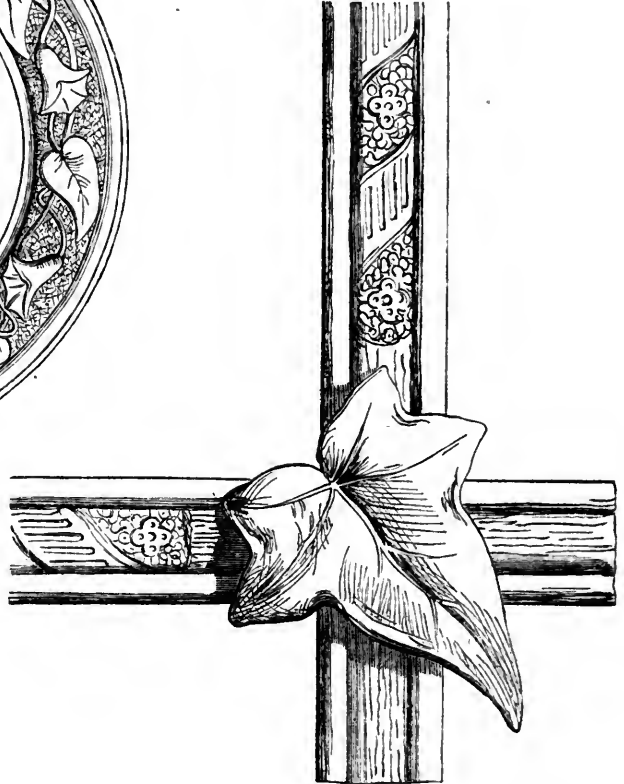

Fig. 6.

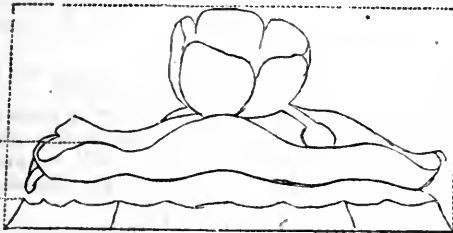

Fig. 3.



Fig. 1.

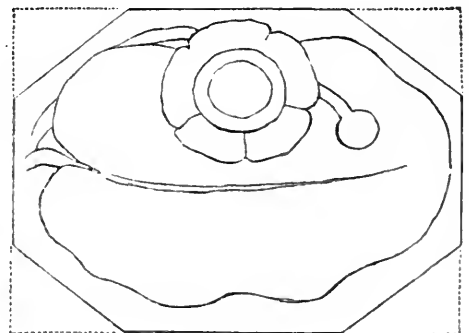

Fig. 2.

may be divided into three stages: drawing the design, blocking out, and finishing. When the ornament is in low relief, that is, when it only slightly projects from the background, the drawing need be scarcely more elaborate than for fret-work, and can be wholly made in a similar manner

down vertically, the others where to cut along horizontally. This inkstand has been specially designed of broad and simple forms as a first lesson in the art, and a means of illustrating the method of working. It represents the flower, bud, and leaf of the common yellow water-lily; the

first is hollowed out to receive a glass for ink, while the last forms a tray for seals, sealing-wax, and similar articles, and across which pens may be laid and held from falling off by the upturned edge in front. Walnut will be the best wood from which to carve it; a piece 7 inches long, 5 wide, and $3\frac{1}{2}$ thick, will be required. The corners must be sawn off, the plan, Fig. 2, pasted on, and the elevation of the ground or slab on which the leaf rests, B, Fig. 3, measured and drawn on the sides of the wood. In order to secure the work firmly, place it on the table or carving board and make round it a number of gimlet holes, close to the edges, and drive in screws; these will hold it as firmly and more conveniently than a vice. The design has first to be blocked out, which is done with the mallet in the right hand, and a large tool grasped by the left—an excellent tool for this purpose is a somewhat flattened and round-ended gouge, like that shown at full size in Fig. 4. Slightly outside the line which marks the boundary of the leaf on the plan, cut down to slightly above the line which marks the boundary of the ground or slab in the elevation, removing all the useless wood which lies between vertical and horizontal lines drawn from those points; the clearing away is only done to a little outside the lines, that some wood may be left to allow for errors—it will be cut off in the after process of finishing. The elevation of the leaf, line A, Fig. 3, has then to be measured and drawn on the wood, and the clearing away process repeated from round the flower. This will constitute the “blocking out,” which may be done boldly and rapidly, since if attention be paid to the guiding lines there will be no danger of cutting too deeply, but the novice will do well to cut to some extent across the grain or he may accidentally split off portions of wood which ought to remain.

Finishing will require greater care. The use of the mallet may be in a great measure dispensed with, and the tool held firmly in the right hand, with the handle pressed against its palm, while the fingers of the left should be placed on the blade to give greater steadiness. For the different parts different tools must be used, each where it is most appropriate. In shaping the large hollow within the leaf nothing can be better than the gouge before mentioned, but the vein up its centre must be made with the V-chisel by cutting two lines which gradually approach each other towards the end; while the ribs, which run from the vein to the edges, will require a gouge of about three-eighths of an inch wide. The V-chisel will also be found most useful for the undercutting between the ground and leaf, as also between the leaf and flower. A very little practice will teach the novice which tools are best fitted for special purposes. As a rule he will find the gouge more safe and useful than the chisel, wherever it can be used, which will be in most cases, except for giving the last touches on flat and convex surfaces. In finishing, especial caution against cutting exactly with the grain should be observed, it is always dangerous; the proper direction is one crossing the grain at a very slight angle. As a final operation the file and sandpaper will be required here and there to give smoothness, but they should be used sparingly. In this inksand, as in all *bold* carving, richness of effect must be procured by giving a variety of surfaces on which the light may play; much smoothing would tend to destroy this variety and to lessen the effect. Carving is always most effective if the tool-marks can be left to show, and it should be an object with the beginner so to learn to master his tools that they may leave strokes fit to be seen. Sharpness and clearness are beauties in wood carving, and much use of sandpaper leaves it with dull surfaces and blunt edges, as lifeless and uninteresting as those of cast iron.

When the object to be carved is in “the round” (that is, when it has no background whatever, and is intended to be seen from every side), the method of drawing the

design given above will be insufficient, and it will be well to make a rough model in clay of the proposed work. How this can be done may be learnt from our previous articles, entitled *Modelling in Clay for Amateurs*. From the model every part may be measured with the compasses, and every dimension transferred to the wood as the work progresses. By doing this, time will be saved and errors will be avoided. We do not, however, advise the amateur to carve in the round till he has had considerable practice in the art, as he will find it incomparably more difficult than carving in relief.

In Fig. 5 is given a design for a bread-platter, of thirteen inches diameter, with leaves and flowers of the corn convolvulus. Bread-platters are commonly made of sycamore wood, and may be bought, turned and ready for carving, at about three shillings each. The carving on this is very simple; the ground is first sunk with a medium-sized gouge, and levelled with a small chisel, the edges being cleared out with a V-chisel. The slight undulations of the leaves have then to be made with a larger gouge, the veins marked with the V-chisel, and the stems rounded, and in this some use of sandpaper is recommended, as the article is for use as well as ornament, and very sharp edges would be destroyed in the scouring required to clean it. The ground is lastly roughened with a grounding punch. It is often desirable to have a greater variety of grounding punches than can be bought at the tool-maker's, and it is easy for an ingenious person to fabricate them for himself from stout iron wire, with a hand-saw file.

The picture-frame of which a corner is shown in Fig. 6, should be made in oak. The construction is that of the ordinary Oxford frame, the leaf being cut out with the frame-saw, carved, and glued on afterwards.

COOKING.

MUTTON (*continued*).—LAMB.—PORK.

Chops and Cutlets.—Everybody can fry a chop; not everybody has the means of broiling one nicely, which is by far the best way of cooking it plain. All we propose here is to give a few hints respecting the dressing of chops and cutlets with taste and variety.

Chops, Plain Fried.—Trim the superfluous fat off chops from the loin; round them into shape. If fresh, let them receive a blow on each side with the flat side of the butcher's cleaver; if sufficiently kept, they are as well without it. Fry them in butter, turning them with a slice or a pair of chop-tongs, *i.e.*, without pricking them. Do them nicely brown on the outside, and tender, rosy-red within. Lay them on a hot dish. Dust a little flour into the butter in which they have been fried, brown it, dilute with a tablespoonful of catchup, and about the same quantity of good mutton broth; season with a little pepper and salt. When this sauce is worked smooth, pour it over the chops, and serve. It is evident that the chops can be served truly plain, bare, as they are, without the sauce; but this addition does not give much trouble, and *does* give considerable style and relish to the dish.

Cutlets, Plain Fried.—Take cutlets from the neck, chop off the heel formed by the bit of back-bone, scrape off the flesh adhering to the upper part of the rib, so as to allow of its being handled with the fingers; trim the fleshy part into a nicely-rounded shape. Fry the cutlets as before; round the tip of each bone-twist a piece of white writing paper, tastily frizzled. Arrange your cutlets on the dish in a circle or oval, lapping over each other with the rib-ends uppermost. Between each cutlet you may lay a thin slice of fried or toasted bread, and either pour gravy, made as before, into the bottom of the dish, or serve it separately in a sauce-boat. In the middle of the circle of cutlets you may also put a mound of mashed

turnips, or mashed potatoes, or stewed roots, or other ragoût of vegetables that suits your taste and convenience. Cutlets so arranged are helped, not by a fork or a spoon, but by each person taking one with the fingers.

Cutlets, Broiled and Bread-crumbed.—We hold to our distinction between chops and cutlets, the latter belonging to the same class of Norman French words, as “mutton,” “beef,” and the names of our other *meats*. The like etymology was formerly applicable to butchers, who were called feshers in Scotland. Trim your cutlets, and garnish their ends with paper as before; season slightly on each side with pepper and salt. Dip the fleshy end into oiled butter or beat-up egg, and then make as many bread-crumbs stick to it as you can. Lay them on a dish strewed with bread-crumbs, and strew bread-crumbs over them while they await their broiling, which should not be done till just before they are wanted. When the fire is clear and the gridiron hot, broil them briskly, taking care that the meat is not too much done, nor the bread-crumbs burnt. Arrange them in a circle on their dish as before, and send up with them a sauce-boat of brown savoury gravy.

Chops à la Jardinière (gardener's way).—Prepare your chops as for frying plain, seasoning them slightly with pepper and salt. Take any delicate vegetables that happen to be in season; young carrots, green peas, green asparagus shoots, French beans, young broad beans, salsify, turnips, celery, &c. Cut these into pieces and lengths, not much larger than hazel-nuts; for quantity, allow enough to serve a good tablespoonful with each mutton chop. Stew these in no more good mutton broth than will cover them, till all but done enough. Vegetables which discolour or badly flavour the water, as beans, salsify, &c., should be stewed separately, and then added to the rest. Then fry your chops in butter until they are three-quarters done; set them aside; then, in the butter left in the pan, brown a little flour and small-chopped onions, and add it to the ragoût of vegetables. The convenience of this receipt is, that the ingredients being brought to a forward state of preparation, the dish can be served at twenty minutes' notice. When wanted, put the chops into a stew-pan, pour the ragoût of vegetables over them, and then stew and toss them together till all are done enough; arrange your chops on a heated dish, and pour the ragoût amidst and over them. You may garnish with fried or toasted bread, but the dish requires no further ornament, and is generally approved.

LAMB

is in season from Christmas till the end of May, when, unless it has been dropped very late, it begins to make a near approach to mutton. Nevertheless, as accidents will happen in the best-regulated flocks, ewes now and then present their owners with lambs at moments when they least expect them. Such exceptional lambs, if only for the sake of uniformity, mostly find their way to market, or are consumed at home.

Very early lambs are troublesome to rear, and consequently fetch high prices. Where there is a demand for house lamb, or the farmer makes their rearing his business, the period of yearning should commence as early as September or November, in order that the lambs may be ready for market in December; but in any case the lamb season is necessarily limited. In a general course of breeding, it is desirable that the lambs should not fall until the severity of winter is past, and the pastures afford some food for the little ones. This is particularly important in exposed situations. Thousands of lambs die every year from the cold to which they are exposed as soon as yeaned. On the other hand, there may be inconvenience and danger if the lambing is deferred too late: hot weather is as fatal to the mother as cold is to the offspring. It frequently induces dangerous fever; and at

that season both the mother and her lamb may be injured by the luxuriance of the grass.

Early lambs are in great part obtained from the Dorset breed of sheep, whose principal distinction and value consists in the forwardness of the ewes. With proper management, the lambs will drop in September, and, brought up as house lambs, be ready for market at Christmas. By many farmers, the practice of house-sucking lambs is carried out on a large scale. By all of them, however, a building is usually set apart for this purpose, divided into a certain number of coops for the sorting of the lambs according to their ages. Every evening the ewes are turned into the respective divisions of the lamb house, and each mother soon recognises her offspring. They remain together until the following morning, when they are separated, and the ewes driven back to the pasture.

About a couple of hours after this, the ewes that have lost their lambs, or whose lambs have been sold, are driven in and held until their udders are emptied by the lambs, when they are returned to their separate inclosure. At twelve o'clock the real mothers are again brought, and remain for an hour or two. At four o'clock the foster-mothers are compelled to pay another visit of an hour's length, and at eight o'clock the true mothers return for the night. The greatest attention is paid to the cleanliness of the building, and the lambs are supplied with good wheat-straw for them to nibble, and pieces of chalk to lick. We note these things to show how impossible it therefore is that these delicacies can ever be sold cheap.

Bad lamb is rarely sent to market; indeed, we do not remember to have ever recognised any offered for sale. In the first place, it could hardly fail to be detected by the most inexperienced eye; and, secondly, the young is liable to fewer complaints than the adult animal. Often, as soon as a lamb is seen to be ailing, it is killed immediately, “to save its life,” and consumed at home. We have seen such lamb served at table, perfectly wholesome and presentable; whereas, had it been allowed to live twenty-four hours longer, it would have been completely unfit to slaughter, and, if spared, have remained, perhaps for months, a pot-bellied and unprofitable weakling.

Early lamb is sold by the quarter; later in the season, it may mostly be had in joints, by the pound. Which quarter—the fore or the hind—is preferable, is a matter of taste and economical consideration. The fore-quarter is the state dish; it contains more fat mixed up with the lean than the hind-quarter. Although roasted whole, it can be divided, on family occasions, by the carver removing the shoulder, and sending it away untouched, to be eaten cold next day. With guests present, it is a common practice, after simply raising the shoulder, to put between it and the breast a lump of butter, the juice of a lemon, and a good dose of cayenne, and to mingle these, as they trickle out, with the gravy in the dish; the only objection to which is, that, not everybody's palate, nor everybody's stomach, can stand meat so highly devilled. One inconvenience of taking too much capsicum is, that you can taste nothing for a couple of days afterwards.

To the fore-quarter, more than to the hind, is applicable the fault found by the French with lamb—that it is a *viande pas encore faite*, an incomplete, unfinished meat, which has not yet attained its growth. This seems to us an unreasonable prejudice in a nation so excessively fond of veal—not to mention squab pigeons taken from the nest. Still, the fore-quarter is the fashion. We ourselves confess to a weakness for the hind-quarter. If the party is large, there is more of it, and more readily carved; for those who object to fat, there is unmixed lean. And, we would ask, if not only the haunch of venison, but the haunch of mutton, are so highly esteemed, why should haunch of lamb be under-valued? With roast quarter of

lamb, whether hind or fore, one thing is indispensable, namely—

Mint Sauce.—Spear-mint (the true species, both for this and to boil with green peas) is a plant which becomes a weed in any but the driest and sandiest soils. In ordinary garden ground, it soon shows its encroaching disposition. It may be obtained early, by covering it with a *cloche*, bell-glass, or hand-light; by putting a tuft into a frame or hot-bed; or by growing it in-doors, in a pot, or mignonnette-box. Wash the sprigs of mint, to clear them from dust or rain-splashes; let them dry on a napkin; strip off the leaves, and chop them fine on your chopping-board. Fill your sauce-boat one quarter full of chopped mint; pour over the mint, vinegar equal to half the contents of the sauce-boat. Drop in a few lumps of sugar, and let it stand at least an hour before serving, to extract the flavour of the herb. Before sending it to table, stir up all together. Mint sauce will keep for a time, bottled, and be just as good, if not better than it was the first day.

Another accompaniment to roast lamb, hot or cold, is salad.

An additional advantage of the hind-quarter is, that it divides handsomely; it makes two nice little roasts; the leg, and the loin with the kidney in it. Or, for still further variety, you may boil the leg, and serve it, like boiled mutton, with caper-sauce, and attended by sea-kale—turnips will, at that time, be scarce, or non-existent. Suitable vegetables to go with it, will be new potatoes, spinach, or asparagus. The loin you may convert into—

Lamb Chops, with Cucumber Sauce.—Fry the chops exactly like mutton chops, plain; or, having the means, you may bread-crumbs and broil them; arrange them on the dish, lapping over each other, in a circle, with a plain place in their centre. Have ready your sauce, hot, prepared in either of the following ways:—Select young cucumbers that are not seedy; peel them; taste the flower (not the stalk) ends of each, to ascertain if they are bitter; in which case they must be rejected, as one bitter cucumber would spoil all the sauce. Cut the peeled cucumbers into dice; put them into a saucepan, with a little water, and boil them, taking care not to burn, till they are tender enough to squeeze, as a purée, through a cullender. Return the squeezed purée to the saucepan, with butter, pepper, and a dash of vinegar. Mix thoroughly; heat up; and serve in the middle of the broiled or fried chops. Another way: Peel the cucumbers, as before, and test the freedom of each from bitterness. Slice them, as for eating raw, and dress them in like manner, but very moderately, with pepper, salt, and vinegar. Put a good lump of butter into a saucepan; as soon as it begins to melt, add the dressed cucumber. Cover close with the lid. Keep shaking and tossing the contents over a very gentle fire, till they are done quite tender, but not broken to a mash. That result obtained, they are fit for serving in the middle of the chops. The flavour of cucumber sauce may be heightened by boiling the peelings in water or broth, straining it off, and using it to cook the cucumber in; but this method, though excellent when judiciously executed, requires great caution and frequent tasting, to prevent the slightest twang of bitterness from spoiling the peculiar perfume of the vegetable.

PORK.

Mutton, as we have just seen, has, so to speak, two ages; pork, more versatile, passes through four. First, the sucking-pig, roasted, or more conveniently baked, whole, then the quarter porker, firmer in the lean, less buttery in the fat, with delicious crackling, to be artistically scored and protected from the fire's fierce rays with buttered paper; handsome in its entirety, whether fore or aft, whether leg and loin, or shoulder and sparerib. "Quarter pork," it is somewhere written,

"combines the tenderness of infancy with the pleasing elasticity of youth." The hind-quarter, crackled, makes a delicious roast, from six to eight pounds in weight. The fore-quarter, salted for a week, may be divided into two most delicate boils; the very thing to accompany rabbit, boiled fowl, or other white meat that requires to be assisted by the smoothness of fat and the savouriness of salt." By dividing the hind-quarter, roasting the loin, salting and afterwards boiling the leg, you have two dishes so unlike and yet so excellent, that it is impossible to say which is the better of the two. Then the porker proper, invaluable on account of the multitudinous uses to which he may be put; the favourite pupil of the German Schwein-general, to whom, when he blows his noisy cow-horn, from every door in every street there issues a pig. On the coast of Tuscany, some ill-advised pirates carried off a number of swine to their boats. The swine-herd, missing some of his charges, sounded his horn. At the sound, up started all the grunters. Crowding to one side of the boat, they upset it, and forthwith swam to shore, leaving the thieves floundering in the sea. Porkers were the wealth of the Anglo-Saxons. Amongst their live stock they had "great abundance of swine." Then the bacon hog, mature, complete, incapable of laying on another pound of fat; good for all purposes, fresh or salted, roast or boiled, entire in chins, spareribs, and hams, or subdivided into chops, and comminuted into sausages. The bacon hog is serviceable, not merely to-day and to-morrow, but next year and the year after; a fact which we will illustrate by giving the late William Youatt's receipt for—

Pickled Pork.—For pickling pork, the sides should be rubbed over with sugar and salt, and then laid in a brine-tub, in which a layer of salt has already been strewn, and a slighter one of sugar. The pork must be cut into such pieces as will admit of its lying quite flat in the tub. The rind must be placed downwards, and between each layer of pork a layer of salt and sugar. When the tub is quite full, a layer of salt sufficiently thick to exclude the air must be spread over the whole, and the tub covered closely up and left for a week or ten days. If by this time the brine has not begun to rise, warm water must be sprinkled over the top layer. Pork, pickled in this way, will be ready for use in about three months, and with proper care will be as good at the end of two years as it was when first begun. The sugar is considered to impart a finer and richer flavour than saltpetre, although the latter is most commonly used. There is no reason why both sugar and saltpetre may not be advantageously combined with the salt in pickling pork as well as in salting beef, for in this latter process there can be no question that a pickle composed of three parts salt, one part saltpetre, and one sugar, is the very best that can be used, making the meat tender, juicy, well-flavoured, and fine-coloured.

The flesh of the pig—of the bacon hog especially—desires more than half its utility from its combination with that household treasure, common salt. Without salt we should eat little pork in summer, and lose many a rich dish.

Stewed Pork and Vegetables (an economical, easy, and wholesome German dish).—Put into an iron pot the heart of a large savoy cabbage cut in quarters, six carrots halved lengthwise, three turnips halved, eight middle-sized potatoes whole, and a couple of pounds of fresh pork, fat and lean together, the latter predominating. Season with pepper and salt, and throw in a tumbler of broth or water. Close down the lid of the pot as tight as possible, and set it over a very gentle fire to stew from two and a half to three hours. When the time for serving arrives, put the pork in the middle of the dish, arrange the vegetables round it, and pour the gravy over all. You may further heighten the flavour of the stew by seasoning the sauce in any way you know likely to be approved.

HOUSEHOLD CHEMISTRY.

FOOD (*continued*).

Milk.—Milk is the most remarkable and the most perfect of all foods. Produced by a wonderful provision of Nature, just at the time when the young animal requires it, and just in the proper quantity, it contains in itself all the most important constituents of food, in proportions balanced with the utmost exactness to the wants of the animal. It may be taken as a type of a well-arranged dietary scale.

Yet it must not be supposed that all milk has exactly the same composition. Slight differences are observed not only in the milk of animals of different kinds, but also in that of animals of the same kind, or even of the same animal under different circumstances. Every one knows how much better the milk of some cows is than of others, and also how much the quality of the milk is affected by the health of the animal, the nature and quality of its food, and so on. And every mother knows how quickly her baby's health is affected through the milk, by any slight imprudence of her own in the matter of diet. A very curious instance may be quoted to show the subtle way in which foreign substances may be communicated to young animals in their daily nourishment. It has been observed that when cows eat red madder roots, no alteration of colour can be observed in their milk, but after a time the bones of the calves which drink it are found to be *died red*.

These variations of composition introduce considerable difficulty into the scientific study of milk. It is not possible to set up an exact standard of composition for milk, and to condemn, as diluted or adulterated, all that does not exactly conform to it. In judging of the quality of milk, we are compelled to allow somewhat wide limits, and to content ourselves with saying that good milk ought not to contain less than such and such a quantity of each separate ingredient. To show how necessary such an allowance is, it may be mentioned that in milking a cow, the last portions drawn off are found to be richer in cream than the first, probably because the cream rises to the surface, even in the cow's udder.

Before studying the composition of milk, it will be as well to consider, by the light of the knowledge gained in previous articles, the general nature of the elements that ought to be present in the food of infants. We must remember that the food has additional work to do in the case of an infant, inasmuch as the organs of the infant have to *grow*, whereas those of the adult are, for the most part, stationary.

The food, then, must contain, firstly, *flesh-formers*, to repair the waste of the muscles, and to provide for their increase; secondly, *heat-givers*, and, thirdly, *mineral food*, such as water, salt, &c. The heat-givers are divided into two chief classes: the fats and oils, and the sugars and starches. Every satisfactory dietary should contain at least one member of each. The mineral food is particularly important in the case of infants, not only because salt, or some similar chloride, is necessary for the purposes of digestion, but to provide for the rapid formation of bone which goes on in early life.

Composition of Milk.—If a drop of milk be examined under a microscope it is seen to consist of very minute transparent globules of oil, floating on a transparent liquid. The globules are so small, that ten thousand of them, placed side by side, would only measure an inch; and although they are themselves perfectly transparent, they are the sole cause of the opacity of the milk, for the rays of light in passing through them are bent about and scattered in all directions, instead of going on in a straight line through the liquid. This curious effect of small transparent globules or fragments is not confined to milk. When oil is shaken up with water the mixture is opaque;

and for the same reason powdered glass is opaque, although every separate fragment is transparent.

If the milk be allowed to remain at rest for a few hours, the greater number of the oil globules rise to the surface, and constitute what is called *cream*. The liquid below, generally known as *skim milk*, is semi-transparent, and would be perfectly transparent if it were not for the oil globules that still remain in it.

Cream.—*Butter*.—Each of the oil globules of which cream consists, is enclosed in a very thin membranous envelope or bag. When the cream is exposed to violent agitation or *churning*, these envelopes are burst, and the semi-solid oil is pressed into one uniform mass. This is *butter*. It will readily be understood that although freshly prepared butter consists mainly of oil, it must always contain small quantities of the other constituents of the milk. This is the reason why fresh butter will not keep. The curd of milk is, as we shall afterward see, very apt to putrefy, and during its putrefaction it not only communicates a bad flavour to the butter, but causes a portion of the butter itself to decompose. In Europe the putrefaction of the foreign matters of the butter is usually prevented by mixing it with salt, which acts precisely as it does in preserving meat; but in other countries the butter itself is often purified, and the foreign matters removed, by melting it over a vessel filled with boiling water, and keeping it in the fluid state until the impurities have either sunk to the bottom, or risen to the surface, and been removed as scum. This last process is very effectual, but unfortunately it destroys, to a great extent, the peculiar and delicate flavour of fresh butter.

The celebrated *clotted cream* of Devonshire and Cornwall is prepared by heating cream nearly to the boiling point, until the envelopes of the oil globules are burst, and then, after some hours' standing, skimming it off from the thin and very poor milk which remains below. It only differs from butter in that it retains a great deal more of the curd and sugar of the milk. Very excellent butter may indeed be prepared from it by merely beating it with the hands in a shallow vessel. It is of course much more difficult to keep than even the freshest butter.

The natural colour of butter varies very much with the nature of the pasturage, the time of year, and other conditions, but it is often heightened by the use of saffron or some other harmless vegetable substance.

Skim Milk.—About one-half of the oil of the milk can be removed in the form of cream. The bluish looking liquid which is left after skimming, contains, in addition to the remainder of the cream, almost the whole of two very important constituents of the milk, the curd and the sugar. These may be separated from one another by very simple means.

Curd.—Milk contains a variable quantity—from $1\frac{1}{2}$ to 8 per cent.—of a complex chemical compound called *caseine*. The same substance, or one very similar to it, is found in beans, peas, and some other vegetables, and is then known as *legumine*, or *vegetable caseine*. We pointed out in a previous article that this substance was one of the most important of the so-called flesh-formers, the substances which are similar in composition to the flesh of animals and which are, therefore, believed to be intended by Nature mainly for the building up of the muscles and other organs of the body. Flesh-formers—caseine among the number—are distinguished from mere heat-producers by containing the element nitrogen to the extent of about 15 per cent. All the flesh-formers, moreover, possess to a greater or less extent the power of existing in two different states, in one of which they are soluble in water and in the other insoluble. White of egg (albumen) affords the best example of this. Every one knows how easily it becomes insoluble by heat.

Curdling of Milk by Acids.—In the natural condition of milk the caseine is in the soluble state, and is perfectly

liquid, and it retains this condition when the cream has been skimmed off. It is believed that it is held in solution in the milk by a little alkali, which is known to have the power of dissolving caseine, even when present in water in very small quantity. Now acids are substances which are opposite in their nature to alkalies, for they combine with, or, in chemical language, *neutralise* them. Potash, soda, and ammonia are examples of alkalies; and vinegar, lemon-juice, and vitriol (sulphuric acid), of acids. When any acid is added to milk, the caseine becomes insoluble and separates out in the form of curd, and there is but little doubt that this is because the acid neutralises the alkali which held the caseine in solution. The fact itself is familiar to every one. It is indeed taken advantage of in some culinary operations for clarifying turbid liquid, as for instance in the manufacture of milk punch, in which, after the punch has been made in the usual way with rum, sugar, lemons, and spices, a quantity of milk is thrown suddenly. The acid of the lemons (citric acid) immediately throws down the caseine and the curd thus formed entangles in it not only the cream, but also the pulpy parts of the lemons, and after standing for a few hours the punch may be strained off through a jelly bag as clear as sherry. Milk punch, therefore, contains scarcely anything of the milk except its sugar.

The action of *rennet* (the mucous membrane of the fourth stomach of the calf) in curdling milk is not well understood. It cannot depend on the formation of acid, as was at one time supposed, because it will produce the same effect when alkali has previously been added to the milk.

When milk is taken into the stomach, the caseine is immediately rendered solid by the acid of the gastric juice. Solids are always more difficult to digest than liquids, and this is probably the reason why milk takes rather longer to digest than most liquid articles of food.

The curdling of milk, which has become sour by keeping, is easily accounted for. Acid is produced in the milk by a process which will be noticed further on, and this renders the caseine insoluble, just as all other acids do.

INMATES OF THE HOUSE.—LEGAL.

BILLS AND NOTES.

ONE of the most important features in our mercantile system is that of the law relating to bills of exchange and promissory notes, and considering that a very large proportion of the mercantile property in the kingdom lies in them, it will not be out of place to explain shortly what are their requisites, and what is their form; who may make them; how they may be transferred, and how accepted.

The writer of this paper gives as his authorities Mr. Justice Byles' voluminous work on Bills of Exchange, and Mr. Smith's "Compendium of Mercantile Law."

A *Bill of Exchange* is a written order from one person to another for the payment of a certain sum of money to a third party. He who makes this order is called the *drawer*; he to whom it is addressed, the *drawee*, and if he accepts it, the *acceptor*; he to whom the money is to be paid, the *payee*.

The following is a simple form of a bill of exchange:—

£20 : 0 : 0. London, March 14th, 1870.

[Stamp.] On demand, pay to Thomas Smith, or bearer, the sum of Twenty Pounds, for value received.

Henry Grant.

To Frederic Waters, Merchant,
Sheffield.

Here Henry Grant is the *drawer*, Thomas Smith the *payee*, and Frederic Waters the *drawee*; and the purport

of the bill amounts to an undertaking from Henry Grant to Thomas Smith, or any one else into whose hands it may in the course of business pass, that Frederic Waters is a person competent to accept the bill, and that on request he will accept and pay it.

In the foregoing form the bill was made payable *on demand*; in many cases they are made payable *at sight*, that is to say, as soon as they have been presented for acceptance and have been accepted; *a certain time after sight*, that is, a certain time after acceptance; *a certain time after date*, that is, a certain time after the date of drawing the bill.

They may also be made payable to the *payee*, as "to Thomas Smith" simply, or to Thomas Smith, or order; or, more simply still, "to bearer" alone, without mention of any name.

Bills of exchange are of two kinds, inland and foreign.

An *Inland Bill* is one drawn in any part of the United Kingdom of Great Britain and Ireland, the Islands of Man, Guernsey, Jersey, Alderney, and Sark, and the Islands adjacent to any of them (being parts of the dominion of Her Majesty), and made payable in, or drawn upon any person resident in any part of, the said United Kingdom or Islands.

A *Foreign Bill* is one drawn by, or made payable to, a person residing in none of the above localities, that is to say, by some one abroad. The following is the form of a *Foreign Bill of Exchange*, but, as the law relating to such bills differs from *Inland Bills*, we will refrain from further comment on them:—

London, March 14th, 1870.

Exchange for 10,000 livres.

[Stamp.] At two usances [or at sight, or — after date] pay this, my first bill of exchange, second and third of the same tenor and date not paid, to Messrs. —, or order. [or bearer], Ten Thousand Livres, value received of them, and place the same to account, as per advice from

James Hood.

To Mr. —, at Paris.

Payable at —.

A *Promissory Note* or, as it is frequently called, a note of hand, is an absolute promise in writing, signed but not sealed, to pay a specified sum at a time therein limited, or *on demand*, or *at sight*, to a person therein named or designated, or to his *order*, or to the *bearer*.

He who promises is called the *maker*, and he to whom the promise is made, the *payee*.

Thus, a bank-note is a promissory note made by a banker, payable to bearer on demand, and intended to circulate as money; just as a cheque is a bill of exchange drawn by some person upon a banker, directing him to pay a third person, or bearer, or order, a certain sum of money.

The following is a simple form of a promissory note:—

£100 : 0 : 0. London, March 14th, 1870.

[Stamp.] On demand, I promise to pay to Mr. John Scott, or order, One Hundred Pounds for value received.

Charles Jones.

The various ways of payment, which can be adopted in the case of a bill of exchange, apply equally well to a promissory note; and although it is not absolutely necessary for the validity of a bill or note that these precise forms should be retained, it will for business purposes be better that they should be adhered to, as an unpractised hand might very easily make an error which would involve many legal questions, and be the subject of much litigation.

Property in bills and notes can be passed from one to another just like property in money, and the holder is entitled to have payment made to him at maturity, that is to say, when the time specified on the bill or note for payment has arrived, or to bring an action against the person who cannot, or refuses to, pay. For this reason, bills and notes come under the general category of negotiable instruments, as they may be taken instead of money, considering that they bear with them the right to sue for the amount stated on them. How and to whom they can be transferred, we will consider further on.

The principal parts of these instruments are, the *amount, stamp, date, time for payment, place of payment, designation of payee, name of drawer, and name of drawee*. These we will consider in turn, remembering, however, that (excepting drafts or cheques on a banker) all negotiable instruments made in England, if for less than twenty shillings, are void; and if for more than twenty shillings and less than five pounds, are also void, unless they specify the name and abode of the person to whom the money is to be paid; are attested by one witness, who shall sign his name; bear date at or before the time of issue; and are made payable within twenty-one days after date, but not to bearer on demand; nor will such instruments be negotiable after the time therein limited for payment.

Amount.—It is usual to specify this in figures on the left-hand upper corner of the paper, as well as in writing in the body of the bill or note. When there is a difference between the words and figures, the words in writing will be attended to, to the exclusion of the figures.

Stamp.—The stamp is necessary for every inland bill or note; if unstamped, it cannot be admitted as evidence in a court of law, and will not be recognised even as the admission of a debt from one person to another. The paper, on which a bill or note is to be written, must have the stamp previously impressed upon it; for if that be neglected, it cannot afterwards be stamped, unless it has been impressed with one of equal or higher value, but of a wrong kind.

Date.—The date, though a usual part of every bill and note, is not strictly necessary; for, if it bear no date, the time of making will be proved by circumstances, from which day the instrument is supposed to date. A bill or note dated on a Sunday is perfectly valid.

Time for Payment is generally expressed specially, but the actual payment takes place three days after the time specified in the instrument; these days are called the "days of grace." When, however, a note or bill is made payable *on demand*, the days of grace are not allowed. When no time is expressed, the instrument is payable on demand.

Place of Payment.—Although it is not usual to specify a certain place where payment will be made, still, if he thinks fit, the drawer may appoint one, and if he does, payment may be made conditional on presentment at the place named; but, in the case of a promissory note, it is otherwise, if it be only named in a memorandum at the foot of the note.

Designation of Payee.—The person to whom the bill or note is made payable, must be named or described in such a manner, as to avoid all possibility of doubt. If the instrument be made payable to a person without further words, it is not negotiable. If it be made payable to a person or his order, he may transfer the instrument to any one by indorsing it, that is, by writing his name upon it. If it is made payable to bearer alone, or to some specified person or bearer, it may be transferred by simple delivery. If a blank be left for the payee's name, any holder may insert his own, by which he will become payee, and will convert the instrument into a regular bill of exchange.

Name of Maker or Drawer must be specified beyond a doubt; and it must be remembered, that any one who

inscribes his name on a piece of blank stamped paper will be held liable on any bill or note with which the blank may be subsequently filled up. A person who is unable to write may sign by his mark. The *drawee* must also necessarily be specified or described. If it is intended by the parties to the bill or note that interest shall run from the time of making, it must be so provided for in the body of the instrument. The law presumes interest to run from the maturity of the bill or note, provided that payment is not made at the appointed time.

ANIMALS KEPT FOR PROFIT.—PIGS.

CHARACTERISTICS OF THE CHIEF ENGLISH BREEDS.

"If you are desirous of having a good breed of some kind of animal, and cannot afford to keep thorough-breeds or shorthorns, invest your money in pigs." Such was the counsel offered by an eminent agriculturist many years ago to a friend, who was about to establish himself as a farmer; and better advice could not easily be given to a man who, possessed of only limited means, is yet laudably desirous of achieving a reputation in some branch of the business which he has undertaken. In pigs, above all other animals, will he find the greatest combination of those qualities which he should look for if he would farm with profit. The original cost, even of the best, is not very great; full-grown animals, from a prize stock, being obtainable at prices ranging from 15 to 30 guineas, and younger ones, of course, are proportionately cheaper, while pigs which are not, perhaps, quite up to the standard required for prize-taking, but are yet well-bred and useful, may always be bought by weight in open market; in constitution they are exceedingly hardy, thriving well with far less care and attention than most of the other denizens of the farm-yard; the food necessary to preserve them in good condition is of the cheapest description, and they will consume, and actually fatten upon, refuse which would often be wasted were there none to eat it. Moreover, their extraordinary fecundity renders a good sow as valuable as a small annuity to her possessor. After death there is no portion of the carcase but what has its peculiar value; the flesh becomes pork, bacon, ham, Bath chops, sausages, &c.; and the bristles are valuable for certain kinds of brushes. In fact, to the farmer for pleasure, the farmer for profit, or the cottager, the pig presents characteristics well worthy of his careful attention; and, if only sufficient care is taken in their selection and management, they cannot fail to be a source of profit to their owners.

The excellence to which the various modern breeds of swine have been brought in England is, undoubtedly, principally due to the influence of the several agricultural societies which now exist in every corner of the land, and chiefly is praise due to the Royal Agricultural Society of England, who, by holding their annual meetings in different towns, and by offering substantial prizes for competition, have enabled breeders to compare notes with each other as to the result of their experiments, and have stimulated that spirit of rivalry amongst them, which is essential to success. The vast improvement of the cottager's pig of the present day, when compared with the cottager's pig of only thirty years ago, and the fact that there is not a county where there is not, at least, one first-rate herd to be seen, and from which a good strain of blood may not be procured, are sufficient indications of the successful results which follow from this system.

The object which the pig-breeder should constantly keep in view, is the production of an animal which will yield the largest amount of consumable food at the cheapest rate and in the shortest possible time: experience has shown that, both in the case of cattle and of swine, the more highly-bred they are, the more they possess these qualifications. A pig out of a prize herd will fatten far

more readily than its less aristocratic neighbour, though on the same food; it will also yield more meat, since the bone is finer and the flesh more equally distributed, and it will be ready for the butcher at an earlier age. The deduction to be drawn from these facts is, that it is much better economy to select a moderately well-bred pig, at a slightly increased price, than to purchase an inferior animal, and so apparently save a few shillings on the bargain.

An intending purchaser will, of course, be guided in his selection by the purpose for which he proposes to keep his pigs. If, on the one hand, he simply requires them to consume his superfluous garden stuff, and hopes by fattening two or three in the course of the year, to be assisted in paying his rent, buying them lean to sell again

into his stud at the commencement may blemish his stock for generations.

But in the first place, our intending breeder must determine what kind of pig he may prefer to keep, and in the solution of this question he will probably be determined by the locality in which he lives, and the breed which is most popular in his own neighbourhood, or for which he himself has the greatest predilection. It is not intended in this paper, nor, indeed, would our limits permit us, to enter into any elaborate discussion of the origin of the modern pig, or to dilate on the different foreign breeds, which are as numerous, and vary in appearance almost as much, as the several kinds of horses, but simply to mention the commonest English breeds, and offer such remarks on their chief characteristics and

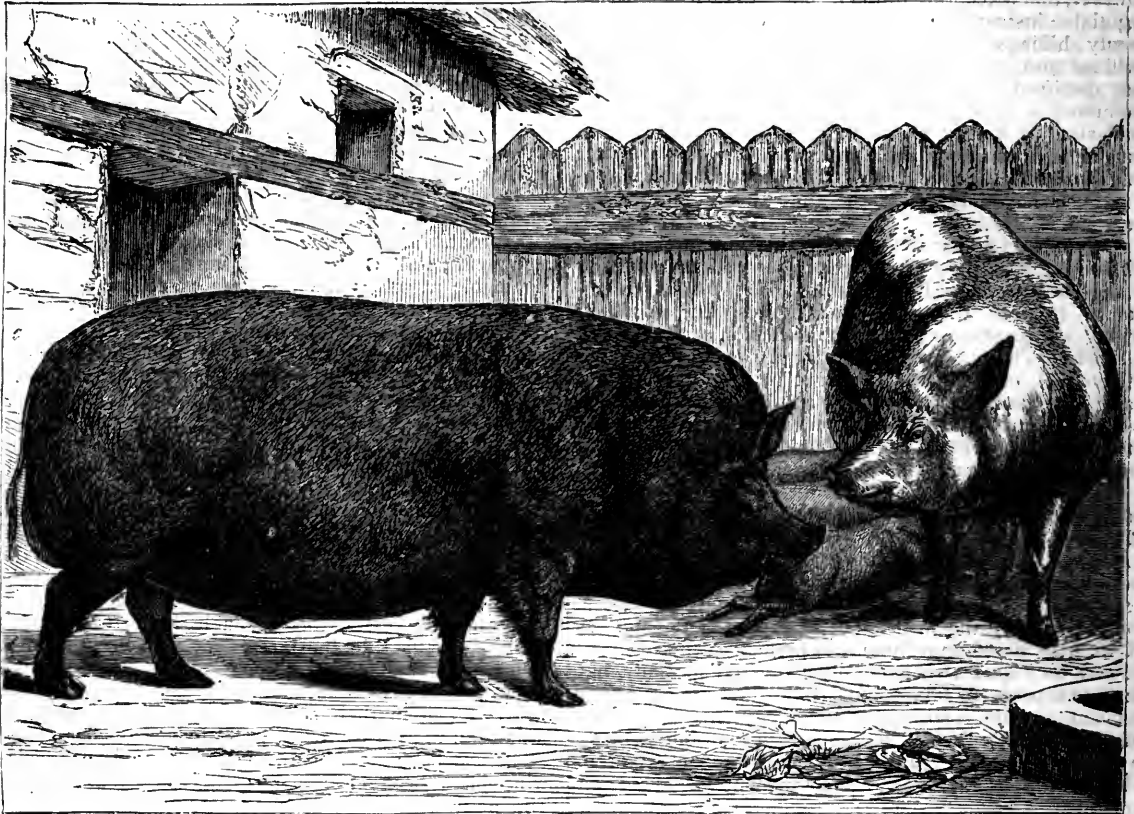

IMPROVED ESSEX BOAR AND SOW.

when fat, two courses are open to him. He can either purchase them at about eight or ten weeks old, and sell them fit for pork at the age of about five months; or, secondly, he should procure them when full grown, and fatten them for bacon pigs. Of these two plans, the former is most to be recommended for the poor man to pursue, both because the process requires less time and he can consequently turn his money over oftener, and, also, because the necessary food is less in quantity and cheaper; little or no barley-meal and other expensive ingredients being required.

But if, on the other hand, the purchaser intends to set up a breeding establishment, and hopes to be able to produce such animals as shall be worthy to compete for prizes at shows, let him betake himself to one of the most celebrated breeds in the kingdom and not hesitate to pay a long price for the best pigs, since it is only from thoroughly good parents that thoroughly good offspring can be expected; and the introduction of one inferior pig

relative merits as may appear to be practically useful in solving the difficulty of selection.

The improved Berkshire and the improved Essex are the only two black breeds which call for any special description, inasmuch as, though there are several others known by different names, their origin may generally be traced to one or other of these two. First, then, of the improved Berkshire breed, which are distinguished above all others for their handsome appearance and symmetrical proportions. These are the largest of the black species; the usual weight of a full-grown bacon pig of this kind being about 700 lbs. The hair should be black and silky, and there should be plenty of it interspersed with but few bristles; the ears erect and small; the snout very short, and the feet and legs from the knee-joint downwards as fine and delicate as possible; the only white hair admissible in a well-bred Berkshire pig is on the feet, the snout, and at the tip of the tail, and also, in many cases, a blaze or star in the centre of the forehead; these marks

are indispensable, but more white would greatly lessen his saleable value.

The improved Essex breed, which are now held by many persons in high esteem, owe their origin and reputation principally to the zeal and exertions of the late Lord Western, who made their cultivation the subject of his special attention. They are a small ornamental breed of pigs, showing at the same time more quality and neatness, if the expression may be allowed, than perhaps any other kind. In colour they should be wholly black, and, except in size, they possess most of the characteristics before detailed with reference to their Berkshire cousins. But in constitution they are somewhat delicate; and this, combined with an excessive aptitude to fatten, causes the sows to be less prolific and the young more difficult to rear: they are, however, very valuable for crossing with coarser species.

To turn to the white breeds, first in order, as in size, stands those of Yorkshire and Cumberland. From these breeds come those magnificent specimens of the porcine

course, for purposes of exhibition. In the next place they should be healthy in appearance, having their skins free from scurf or roughness, and the hair crisp and short; the head should be small and well put on to the shoulders; the ears short and nearly erect, and the snout abruptly protruding direct from between the eyes, not, as is so often seen, straight down from between the ears; the forelegs should be wide apart or they will be unable to support the weight of a fat pig, and the hind legs also, though in a less degree, should stand well out from under the body. The back should be level and broad throughout its entire length, rising very slightly at the shoulders and between the hip-bones. The sides, especially of a sow, should be well filled out and not flat, to allow of plenty of room for the action of the internal organs; indeed, a pig cannot be too broad over the loins; and as this is the most difficult point to get in perfection, it is one to which particular attention should be paid. The hams should fall square down from the tail and lap well over the hocks, and the belly should not be more than six or

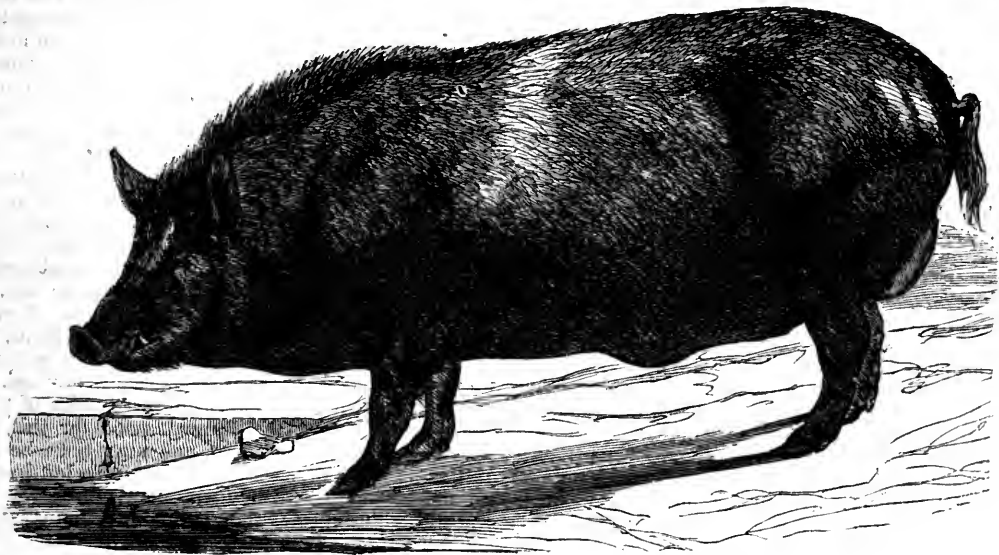

IMPROVED BERKSHIRE BOAR.

fancy which are to be seen annually at Islington, nearly filling the pens provided for them, and exciting alternately feelings of wonder and pity in the minds of astonished visitors. They attain enormous weights, often scaling as much as 11 cwt., and are therefore the most preferred for bacon pigs. The skin is fair and pinkish, often however with a few pale blue or black spots upon it, which tell of a cross with a darker coloured breed at some possibly remote period; and it should be thickly covered with white hair of a fine quality; the snout should be very short indeed, and almost hidden in the cheeks; the ears slightly pointing forwards over the eyes; the chest should be deep, the back broad, and the legs as short as possible.

The Windsor or Prince Albert's breed are the only other white pigs which merit a separate notice. They bear the same relation to those last described, that the Essex do to the Berkshire breed, being Yorkshire pigs in miniature, and they are, in fact, probably descended from the latter.

But whatever breed of pigs a man may ultimately decide upon purchasing, his animals should, if he would breed them for profit, possess the qualifications mentioned in the following remarks, which will apply to all pigs alike. As before insisted on, his pigs should be pure bred, for a cross will continually crop up in a most persistent manner, and will often show itself in the progeny even after many intervening generations, spoiling them, of

eight inches from the ground in a store pig, and three or four inches in a fat one. The tail also should be well set on and have a slight tendency to curl in it.

It is hoped that the above hints, though necessarily imperfect, may enable our readers to recognise a good animal when it is brought under their attention, and assist them, to a certain degree, in forming a judgment for themselves as to the relative merits of pigs of various breeds; but in this, as in all other sciences, a long practical experience is required before the subject can be thoroughly mastered.

We propose, in a future number, to direct our attention to the housing, feeding, rearing, and general management of this most useful animal.

ODDS AND ENDS.

To clean Coloured or Doeskin Gloves.—Have ready on a table a cloth folded three or four times, a saucer of new milk, and another with a piece of brown soap in it. Take a glove and spread it on the cloth. Then dip a piece of flannel in the milk, rub it on the soap till you get off a sufficient quantity, then commence rubbing the glove with it; commence at the wrist and rub lengthways towards the tips of the fingers, holding the glove firmly

with the left hand. When done, spread them out and put on a line to dry slowly. Pull them out cross-ways as they dry. When quite dry, put them on the hands to stretch.

To clean a Swans'-down Cape or Tippet.—Make a lather of the best yellow soap and lukewarm water. Hot water causes the skin to shrink. Work the swans'-down about in the water, but do not rub it; pass it again through lukewarm suds, repeating this till you see the article is quite clean. After which rinse it through lukewarm water, then through cold, and squeeze it carefully. Shake it well and dry it in the sun, holding and shaking it, to prevent it drying in tufts or looking matted together.

To renovate a Black Silk Dress.—To make it appear like new silk, dissolve in boiling water some glue or gum-arabic. Mix with it sufficient cold water, and sponge the dress all over with it. Do this on the wrong side. Dry it, sprinkle it slightly, roll it up tightly in a towel, let it lie for a few hours, and iron it with an iron, not too hot, as silk easily scorches.

Glue Stiffening.—For stiffening dark chintzes or calicoes, take a piece of glue as large as the palm of the hand, break it in pieces, and put in a saucepan, with three quarts or a gallon of rain-water. Set it over a fire and let it boil until the glue is melted. Take it off and put it into a large pan, and when lukewarm it is fit for use. Put the material into it, and work it about until it has taken the glue-water. Squeeze it well, open it out, and dry as quickly as possible. After which, sprinkle it, and dry it quickly.

False Pearls are much lighter than real ones, and are more brittle, but they are oftentimes imitations of extraordinary exactness.

To clean Plate.—Let it be washed clean in boiling water immediately after use, and dried with a soft linen cloth—be sure that it is perfectly dry—then lay on some whitening (which is sold in balls) till quite dry. Brush off the whitening and polish with a soft leather. Another plan which has been approved of is the use of a piece of flannel dipped in salad oil and applied, then afterwards rubbed with the bare hand till it is perfectly bright. All leathers, brushes, &c., should be kept perfectly clean, and used for the plate only, for if used for any other metal it is likely to scratch the silver. It is an excellent plan once or twice a year to clean the plate in hartshorn liquor, as under:—Three pints of water and one ounce of calcined hartshorn; boil together, and then boil the plate in the mixture, after which drain them over the vessel, put some old rags into the liquor, and let them absorb it, dry them, then polish the plate with it, finishing it off with a wash-leather. The rags are afterwards useful for cleaning brass taps, finger-plates, &c. We give this receipt, as it is one in common use, to be found in many works on the subject, and we seize the opportunity to warn the reader to be very careful, for, used carelessly, it has a tendency to make the silver brittle, and also to unfix the soldered joints.

HOME GARDENING.

CAPSICUM.—CORN SALAD.—THE CARROT.—THE CHARDON.

Capsicum.—There are three species of this genus in cultivation; the *Capsicum annuum*, or annual capsicum, which, although a native of India, is so far naturalised to this country as to endure the open air of our summer. It has a branching stem, about two feet high, producing long, linear, dark-green leaves. It produces its flowers, which are white, in June and July, and these are succeeded by pods of various forms, as long-podded, short-podded, round short-podded, and heart-podded, all of which are red and yellow.

The Capsicum cerasiforme, or Cherry Pepper.—This is

an annual plant, and will stand our summers, although a native of the West Indies. It has the same general character of foliage as the former, and produces its flowers from June to September. The pods are small, generally cherry-shaped, sometimes heart-shaped, bell-shaped, or angular, and in colour red or yellow.

Capsicum grossum, or Bell Pepper.—This is also a native of the Indies, is a perennial plant, and will bear the open air in summer, but requires stove-heat during the winter and spring months. The green pods of all the varieties are used for pickling, for which purpose the last-mentioned species is generally considered far superior to the other two, on account of its skin being thick, pulpy, and tender, three qualifications very desirable, so far as pickling is concerned.

Culture.—All the species of capsicum are propagated by seed. Sow the annual sorts between the months of March and April, in a moderate hotbed, covering the seeds with a quarter of an inch of finely-sifted soil, draw the glasses over the frame, and there let them remain until the plants are big enough to hold between the finger and thumb, or, in other words, until they are sufficiently strong to handle with safety. You may then transplant them into a new but very moderate hotbed, to forward them for final transplanting, in June or July, into the open ground, in beds of light, rich earth, at from fifteen to eighteen inches apart, taking care to water them liberally, until such time as they become well established in their new quarters. When so treated, they invariably bloom about July or August, and produce pods liberally during the months of August and September. Should there not be the convenience of a hotbed or stove, the sowing must be deferred till May, when warm weather can be calculated upon. Sow on a bed of light earth, under hand-glasses; and, as soon as the plants are well up, give them plenty of air during the day, but cover them down close at night, until all danger from frost is over; and at the end of June plant them into a bed, or beds, as already advised. Those desirous of saving seed, must preserve a few of the handsomest and largest first-formed pods for this purpose, which will ripen in autumn, and must then be gathered and hung up to dry. The seed must be left in the pods till the spring, when they will be required for sowing; and then—but not till then—trash them out.

Corn Salad.—This is a small annual plant, with long narrow leaves, of a pale colour, the lower ones rather succulent. The flowers are produced in April, are collected in little close corymbe, and are very small, and of a pale-bluish colour. This plant is frequently used as a substitute for lettuce, when that plant is scarce, and also as an ingredient for increasing the variety of small salads, for which purpose it is now grown in most gardens.

Culture.—It is raised from seed; and, for a bed of twenty square feet, a quarter of an ounce will be ample. The time for sowing must be regulated by the demand, to answer which purpose, as a rule, two or three sowings, at most, during the spring and summer, will suffice. The first sowing may be made towards the close of March, or beginning of April, and the plants will soon be up; and when they are big enough, they must be cut, for they will then be young and tender. A second sowing should be made the first or second week in August, and the third in September, to furnish the table during the autumn and spring months. Sow the seed in a bed of rich mellow earth, broadcast, and rake it in evenly. When the plants are up, thin them out to two or three inches apart, in order to give them sufficient room to grow strong for gathering. Should seed be required, leave a few plants in spring, and they will produce seed in July and August.

The Carrot.—This is a hardy biennial plant, too well known to require any description in this article. It is used in soups and stews, and also as a vegetable

accompaniment to various joints. There are several varieties; but the best for general purposes, are the long and short horn, Altringham, long orange, and early red. The carrot delights most in a deep, light, mellow soil, of a sandy nature, which should be well and deeply dug, in order to break the lumpy parts, and particularly for the orange and red sorts, which are longer-rooted, and consequently require a deeper soil than the horn variety.

Culture.—The carrot is raised from seed; and, to have early summer crops, sow about the beginning of February, on a warm border; but for a main crop, towards the end of the month or beginning of April, according as the weather may prove favourable. The proper sort for these sowings is the long orange. Successive sowings should be made of the various kinds, up to the end of April, for main crops. A little seed should be sown at two different times in May for carrots to draw young late in the summer. Another sowing may be made the first week in July, for a later crop to draw in the autumn. Lastly, another sowing may be made the first week in August, for a young crop to stand the winter, for drawing off in the spring. The seeds of the carrot have long, forked hairs, by which they adhere close together, and, in order to sow them regular, it is essential that they be mixed with sand and well rubbed together, so as to separate them previous to sowing. A calm day should be chosen for sowing this seed, as it is very light, and consequently could not otherwise be sown with any degree of certainty. Carrot seed should be well proved previous to sowing, by placing a little in a flower-pot, and setting it, either in a hotbed or hothouse, as, for the want of this precaution, crops frequently fail—this seed being more subject to being bad than many other sorts. One ounce of seed will be required for sowing a bed thirty feet long by four and a half wide. It may either be sown broadcast, or in drills eight inches apart. As soon as the plants are two or three inches high, they should be thinned out, and cleared of weeds at the same time, setting the plants five or six inches asunder in every direction, for the early crop, to draw off while young; but for later or main crops, intended to grow to their full size, the plants should be left seven or eight inches apart. The whole must be kept perfectly clear of weeds at all times. Some of the carrots will be fit to draw by the end of June, and will be a very good size in July, and of full growth by the end of October, when they may be taken up and stored for winter use. After they are taken up, the tops must be cut off, but not too close; these must be neatly stacked up, laying them heads and tails alternately, and the whole well packed with sand, as the operation progresses. Should you desire to save seed of any particular variety, plant some of the largest and best roots, somewhat early in spring, eighteen inches or two feet apart every way, inserting the crowns about two inches below the surface; they will soon be up, and produce ripe seed in autumn, when it should be gathered, taking only three or four of the main umbels, as it is from the seed of these that the most vigorous plants are produced.

The Chardoon.—This is a hardy biennial plant, very similar to the artichoke, but rises to a greater height, namely, from four to five feet. It produces its flowers—which likewise very much resemble the above-mentioned vegetable—in August and September. The tender stalks of the inner leaves are the parts to be used, which should be earthed up, in order to render them white and delicate for stewing, and for soups and salads in autumn and winter. The best soil for the chardoon is one that is light and deep, but not rich, and the time for sowing, for a small early crop, is about the latter end of March; for a later or main crop, the first week in April; and, for a still later crop, the end of June.

TEA.

IN an article on page 380, vol. i., we gave a few remarks on How to make Tea; we shall now deal more exhaustively with the subject as a commodity.

Of the plant which produces tea (the *Thea Sinensis* of botanists) there are two principal varieties: the *Thea Bohea*, and the *Thea viridis*. The first is cultivated in what is known as the black tea country of China, which is the district adjacent to Canton; the second in the northern or green tea district. It was formerly supposed that all black teas were produced by the former, and all green by the latter shrub, but such is proved not to be the case. It is now known that both kinds of tea can be and are prepared from either plant, and that they owe their differences in colour and flavour to the manner of drying. Green tea, being dried rapidly, retains to a fuller extent its natural colour and active properties; while black tea, being dried more slowly, and undergoing some degree of fermentation, is wholly deprived of the first, and in some measure of the second. For green tea also the younger leaves only are used, or mature ones from which the woody central vein has been separated; whilst in the common kinds of black this vein is present, and, as it yields little extractive matter, there is considerably more strength in a pound of green than of ordinary black tea.

Setting aside the niceties of chemical analysis, we may say that, practically, the constituents of tea are its woody fibre, which is generally present to the extent of one half of its weight, and sometimes in the common black sorts to the extent of sixty-five or seventy per cent.; tannin, which is bitter and astringent, and which gives to the infusion most of its colour, and what is known as its "strength;" theine, the peculiar principle of tea; and a fragrant volatile oil to which tea owes its flavour. These two, and especially the last, are present in very small quantities, but to them all the refreshing and exciting qualities of the infusion are due; they alone act upon the nervous system. They are easily soluble, and are generally wholly extracted in the first five minutes after boiling water has been poured on the leaves. The tannin is extracted more slowly, and cannot be wholly drawn out unless the leaves stand in the tea-pot for a long while in a hot place, or unless they are boiled. The woody fibre is almost wholly insoluble and useless, and is thrown away as "tea-leaves." Treated with alkali, however, exhausted tea-leaves yield about four per cent. of nitrogen, the ordinary nourishing property of vegetables; and are therefore not unfit for food; but practically this is scarcely worth taking into account.

For a long time it was doubted whether, beyond its temporary effects in stimulating and refreshing the system, tea possessed any value, or contained any real nourishment whatever. This question must be considered as having been satisfactorily settled by Baron Liebig. He shows that theine, the peculiar principle of tea, is the substance most easily converted to the formation of bile, and that by means of it the supply of that necessary fluid can be kept up in those who live on a low diet, and can take but little exercise. This accounts for the popularity of tea with poor people, and those who lead sedentary lives.

The facts we have stated will lead us to form some rational views on the subject of making tea. Different persons require to drink it from different motives, and we must know what these motives are before we can say dogmatically what method of making is the best. All the really valuable qualities, those which refresh and nourish, are, as we have seen, to be drawn in the first five minutes after infusion (if the water be *boiling*, which is essential). It is no real economy to extract the whole of the colouring matter and tannin from the leaves; but some, and especially poor persons, who have few luxuries, rather

than drink pure water, choose that which is thus coloured and flavoured. The question is simply one of taste. Tannin, which is the same principle as that drawn from oak bark for tanning leather, is not positively injurious, unless taken in large quantities, or there is a tendency to constipation; but as nourishment it is almost worthless, and there can be little waste in throwing away tea leaves not fully spent.

The Chinese make tea by placing the leaves under a piece of silver perforated or filagree work to keep them from rising, in a porcelain cup which has a cover, and pouring on the boiling water. The Japanese grind the leaves to powder, and stir them in. The Tartars boil the tea leaves in their soup. So much do the methods of using vary according to national taste or custom. The addition of sugar, though not of milk, appears to be wholly a European custom, and we may at this place mention that an excellent and refreshing drink may be composed of weak green tea to which lemon-juice is added instead of milk. It may be drunk either warm or cold, according to taste or season.

Descriptions and Qualities of Tea.—The choicest and most costly samples of tea never leave China. The Chinese are so much a nation of tea drinkers and tea fanciers, that the wealthier classes pay prices to which no European would consent. Some of the Mandarin teas sell in China for upwards of 50s. per pound. Even if such sums were to be obtained in the English market, similar teas could not be sold here, for their flavour is so delicate that it would be spoiled by the long voyage. Among European nations the Russians are the chief tea fanciers, and pay the highest prices. Their most costly teas are brought over-land through Asia by caravans. A common, but not the most delicate form of the over-land article is "brick tea," which is made by moistening the dust of the tea leaves by steam, and compressing it in moulds. These tea "bricks" sometimes circulate as coin in parts of Central and Northern Asia, and are made into a kind of soup by the Tartar tribes with milk, butter, meal, and salt. Some high priced teas for the Russian market have hitherto been brought by sea to London, and thence sent on; but the opening of the Suez Canal has now diverted this trade by way of Galatz and the Black Sea. The English market is supplied with the cheaper kinds only; the more usual are—

Of Black Teas.—*Bohea*, which is a coarse, common leaf, and contains a large amount of woody fibre. As it is much roasted, it keeps a long time without becoming musty, and makes a dark infusion. Its name is derived from the Bohea hills, in the black tea district.

Congou, which formed the bulk of the East India Company's importations during their monopoly, is a better and more carefully prepared tea; but, since the trade was thrown open in 1834, it has sunk in repute.

Souchong is the finest of the strong black teas, and is made from younger leaves than the preceding. *Padre Souchong* is Souchong of the finest quality. Some kinds of Souchong, as the *Caper*, are scented by roasting with various flowers.

Pekoe is the finest of black teas. It is made from young buds, picked in April. Very young buds, clothed with down, make *Flowery Pekoe*. Pekoe does not keep well; since, in order to preserve its delicate flavour, it can only be slightly roasted.

Of Green Teas.—*Twankay* is a coarse and common description, corresponding to Bohea in black.

Hyson Skin is the lighter and inferior leaves of Hyson, blown from it with a winnowing-fan.

Hyson is, or should be, good green tea, gathered in spring, and carefully dried and rolled.

Young Hyson is an earlier, and therefore more delicate gathering.

Gunpowder, so called from its granulated appearance,

is the finest and most carefully rolled leaves picked from the Hyson.

Adulterations.—The conclusions drawn by Dr. Hassall, from the investigation of many samples of tea by the "*Lancet Commission*," were that Congou and Souchong alone reached the English consumer in a pure state. The scented black teas and all the green teas examined, with the exception of a few from Assam, were more or less adulterated. No such thing as green tea of a natural colour, at that time, found its way to the English tea-pot. All the leaves were faced with brilliant colour by artificial means, and frequently with highly poisonous substances. This was partially the work of the Chinese manufacturer, for at that time no professedly green tea was shipped without being first painted, to meet the taste, or supposed taste, of the English customer; but partially also of the English dealers, who coloured inferior black teas, that they might palm them off as the more highly-priced green kinds. When Dr. Hassall's statements were published, much public indignation was expressed, and some slight change for the better took place, for since that period it has been possible to purchase uncoloured green tea. But the reformation was not to the required extent, and a flourishing trade is still carried on in the manufacture of green from black tea, and in numerous other methods of adulteration, as has been shown by the disclosures of Dr. Letheby, and the discussions to which they have given rise in the public press.

The colouring of green tea by the Chinese is effected by putting a mixture of plaster of Paris and Prussian blue into the pans during the last drying, and sometimes turmeric. Prussian blue is not absolutely poisonous, but it must be considered an injurious substance. An artificial brilliancy is also sometimes given to the tea by blacklead or China clay. They also adulterate by the admixture of worthless leaves, gathered from the ash, plum, and other trees, and sometimes with more offensive matters. At the present time there is said to be a large quantity of cheap tea in Mincing Lane, of which the chief ingredient is silk-worm dung; and seizures have been made of an article composed of exhausted leaves, rendered pungent by the dung of pigs and dogs.

But far worse than these are many of the substances used for adulteration at home; among them are mineral green, verdigris, arsenite of copper, chromate and bichromate of potash, and chrome yellow (a form of lead)—all deadly poisons—beside a number of other mineral substances, such as chalk, gypsum, carbonate of magnesium, sulphate of iron, and blacklead, some of which, if not poisonous, are at least injurious. A large number of English leaves are mixed with and sold as tea; of these, from its astringency, those of the sloe, or black-thorn, are most in favour. These leaves are dried, broken into small pieces, and mixed up with a paste formed with gum and catechu.

The re-making up of exhausted leaves is another fraud sometimes practised in London. The leaves are bought from hotels and coffee-houses, mixed with gum, re-dried, and faced with rose-pink and blacklead, to make black, or with some form of copper, to make green tea. The catechu, or Japan earth, which has been mentioned, and which is freely used in the adulteration of tea, consists chiefly of tannin, and imparts astringency and colour; it is also to give colour that rose-pink and other extracts of logwood are used.

China has always been the great tea-producing country, but the plant is also indigenous to Japan. It is also grown in Java, and has been cultivated with success in British India. But as the cultivation of tea demands an enormous amount of labour; and as labourers are nowhere more cheap and abundant than in China, it does not seem probable that any other nation can here enter into successful competition with the Chinese.

CHOOSING A TRADE.

GOLDSMITH'S WORK: ENGRAVING.

ALTHOUGH most of the metal-work used in machinery, as well as much of that which is intended for ornament, is produced by the process of casting, a very large proportion of it is produced by means of stamping. Some of the smaller pieces of clock and watch work, for instance, are made by cutting the shapes from the sheet-metal with sharp dies, and turning them on a lathe; and most of the larger and lighter portions of chandeliers and decorations, formed of metal, are obtained by pressing the thin sheet-metal into a mould with repeated blows of a hammer. This process is called "stamping out;" and as in deep patterns there would be great danger of splitting the metal, the mould is first partially filled with a leaden shape, resting on a bed or layer of clay, so that the metal is not struck down so far as to bend it violently at once. At each blow of the hammer, the thickness of the clay is diminished, and at last it is removed altogether, till only the leaden lining remains; then that is removed, the metal is struck completely home, and the full pattern is obtained.

It is of the work of the goldsmith and the silversmith that we wish now to speak; and this work so closely resembles that of the ordinary metal-worker, that the processes differ only in the greater delicacy and the more exact method of operation, because of the smaller size and increased value of the material.

Indeed, gold is so costly, that it is seldom used for forming articles of great size, standard gold being worth £3 17s. 10½d. per ounce, and consisting of twenty-two parts pure gold and two parts of alloy. Of course, standard gold is seldom used, even for fine jewellery; and to use pure gold would be almost impossible, since it is so soft a metal, that it would too quickly bend and wear out, unless it were hardened with an alloy of copper or silver. The name given to the pure metal by goldsmiths is "carat" gold, from *karatrium*, which was the twenty-fourth part of the old *marc*, or half pound. Thus "carat" gold is "24." A mixture of twenty-three parts of gold and one part of alloy is "23 carat," and so on—the most usual material in the best goldsmith's or jeweller's work being "18 carat," or eighteen parts of gold to six parts of alloy, which is both hard and malleable, and capable of being wrought into enduring patterns. This malleability, or capacity for being beaten thin or moulded easily, is one of the peculiar properties of gold—the others being its yellow colour (for gold is the only yellow metal), and its great weight, for it is the heaviest substance known, except platinum.

The extreme malleability of gold is evident enough from the manufacture of gold leaf, which may be reduced to the 300,000th part of an inch. In order to make gold-leaf, the metal is first cast in small bars; these are afterwards rolled into thin ribbons about an inch wide, and then cut up into pieces of about an inch square. One hundred and fifty of these pieces are piled up together with thin pieces of vellum between them, and the whole of them are beaten with a convex-faced hammer, fifteen pounds in weight. This extends the size of the plates, which are then divided each into four pieces, and placed between layers of the membrane from the entrails of the ox; they are then beaten again with a lighter hammer, are again divided into four pieces each, and beaten a third time. This process extends them to leaves or sheets only the 280,000th part of an inch in thickness; so that a hundred square feet of the leaf weighs no more than about an ounce troy. It may be seen, then, how minutely gold may be divided; but this is by no means the utmost degree of its divisibility, for the silver-gilt wire used for embroidery is covered with such minute portions of gold, that after the leaf has been placed on

the silver and so drawn out with the wire, the thickness of the gilding is not more than one-twelfth that of the gold leaf.

Of course, real gold and silver "plate"—by which we generally mean vases and articles for table service—is formed of the true metal, with more or less of alloy; but the larger quantity of "plate" used is no more than an inferior metal covered with a coating of gold or silver. Cheap articles of jewellery are also formed in the same way. The ordinary process by which a very thin coating is deposited, is that called "electro-plating," by which a solution of gold or silver is made to cover the surface of the article exposed to it by means of the action of an electric or galvanic battery. The thick plating is effected by mechanical means—that is to say, by pressure between steel rollers, which will cause a thin layer of gold or silver to adhere to a thicker plate of another metal.

That part of the business of the goldsmith which consists in manufacturing the larger articles from this kind of plate, is almost entirely a handicraft—that is to say, such articles as tureens, flagons, large vases, and many others are formed by hand, by a process not unlike that employed by the tinman or the coppersmith; the tools employed being light hammers, some of them formed of wood; and a kind of crutch-shaped anvil called a horse, on the end of which a hollow utensil will hang while its sides are shaped. Of course, the more ornamental portion of the work is accomplished by the use of the mould, the stamping-press, the graver, and the die.

Now the use of the stamping-press has of late years caused a considerable change in the business of the jeweller who manufactures that small kind of goldsmith's work worn for personal adornment. The stamps and dies have been brought to such perfection that comparatively little jewellery is now made by hand—or, rather, only certain parts of it—and the fitting together of the separate portions is effected by hand labour. In former days, the workman received the quantity of gold required in a piece about a quarter of an inch thick. The first thing that he had to do was to hammer it out thin; then to cut it into the proper slips with the shears, and afterwards patiently to form it into the desired shapes with various small tools, fastening the parts together with a fine solder made of gold, silver, and copper. Now, however, either steam machinery is employed, or the workman uses what is called a "drop-down" or "monkey press," which is, in fact, a hammer falling on a die, into which it stamps the gold; so that it at once assumes the required pattern. In this way various parts of bracelets, brooches, &c., are made, and are afterwards put together to form the complete ornament; while the dies and machinery are so perfect and precise in action that, though of course jewellery and other articles require finishing by hand, there is much saving of time and superseding of manual labour. Even for hand-made jewellery, the gold is now prepared by a rolling-machine, and is made into strips by a cutting-machine; but dies so formed as to stamp out both the various parts of the body of the ornament, as well as the more decorative portions, are in constant use.

Just as in the casting trade the mould-maker and pattern-designer are the most important among the operatives, the designer, engraver, and modeller are foremost in the goldsmith's and jeweller's art. A working goldsmith or jeweller earns only very moderate wages; but the artist who can design a magnificent piece of plate or construct an elegant pattern for jewellery or other ornaments, is often able to command a handsome salary. In electro-plating, for instance, the design is everything, and some of the salvers, shields, urns, goblets, and tazzas produced by this process are exquisite in modelling, and deserve to be placed side by side with those famous ancient productions which were the work of Benvenuto Cellini and others, who both modelled and engraved in metals.

The art of engraving, both on metals and on gems or precious stones, is, in fact, so ancient that there is no historic period when it was not practised. In the British Museum, and other collections of antique art, there are numerous examples of the engraving of ancient Egypt, in porphyry and jasper, which our modern tools would not cut, except by a great exercise of patience; and to show that signets or stamps—now called seals—were used as official signatures in the very earliest times, we need only turn to the first books of the sacred Scriptures. Engraving is an art depending entirely on the skill of the operator, who, for the most part, uses only the usual *burin*, or lozenge-shaped graver, with small gouges and needles for scooping out hollows or making fine tracery. The wages to be earned, therefore, vary according to the degree of skill attained; and not only a natural taste for design, but a firm, accurate, and delicate touch, a correct eye, and great patience are required to ensure success.

As so much in gold and silver work depends on the stamping of patterns, however, the business of the "die-sinker" is of great importance, and die-sinking is but another sort of engraving. A die is, in fact, no more than a punch struck with a hammer, so that it impresses the shape with which it is engraved upon the metal which is forced into it. The art of "die-sinking," then, is at least as old as the oldest existing coin, which is said to be about 4,000 years. Before machinery was used the process of stamping was of a very primitive description. The die, or mould, for one side of the medal or coin, was fixed in a wooden block; the piece of metal was placed on it, and the other die, for the reverse side of the coin, was held in the hand and struck down upon the metal with a hammer, thus forcing it into the matrix beneath, and at the same time giving it the impression of the punch. The application of the mill and screw, and of various levers and hammers, has altered all that, while the dies are produced with greater ease and certainty. The piece of steel from which the die is made is first heated until it becomes softened, so that the engraver, by the use of small tools of hardened steel, can cut away the metal with comparative facility, and form what is, in fact, a metal seal. This steel seal is then hardened, becomes what is called a "matrix," or mould, and is used as a stamp, by the application of which, under great force, another block of softened steel will take the impression like wax. This second piece of steel, which, of course, has the design reversed—that is to say, the depressed portions projecting, and *vice versa*—is called the "puncheon," and, after being sharpened with the graver and thoroughly hardened, is used for striking fresh dies, all of which resemble the original, and save the cost of fresh cutting.

DOMESTIC MEDICINE.

DEAFNESS (*continued*).

WE will now enumerate a few other causes that may cause more or less deafness. Amongst these a common cold is one. There is a tube (the Eustachian tube) between the throat and the ear. In the course of a common cold, this tube may be congested and thickened, and the congestion and swelling may extend to the cavity of the tympanum. Generally, there will be more or less redness and swelling of the membrane of the throat, and perhaps sore throat. In deafness from this cause, there are various singing and cracking noises heard. When this condition is part of a common cold in a perfectly healthy person, it disappears as the cold disappears, but in certain delicate children it is often more or less tedious.

Treatment.—The treatment of deafness connected with a cold is very much the treatment proper to the cold

itself. Warmth, gruel at night, putting the feet in hot water, &c. The following mixture, too, will be helpful:—

Chlorate of potash	1 drachm.
Sesquicarbonate of ammonia	16 grains.
Simple syrup	1 drachm.

Water, to eight ounces. Mix. An eighth part to be taken three times a day.

In the case of children or young persons, if there remains a certain amount of deafness after a cold, with large tonsils and relaxed throat, then a little cod-liver oil is likely to be useful, say a teaspoonful or two, night and morning, and the following mixture may be given:—

Chlorate of potash	1 drachm.
Tincture of iron	36 minims.
Simple syrup	4 drachms.

Water to six ounces. Mix. One tablespoonful to be taken three times a day.

If there is not quick improvement, then a medical man should be consulted. Indeed, if this can be done conveniently, it should be done even before giving the above medicines, as the nature of cases varies so much. There are two other diseases which are apt to impair the ears, which we must say a word or two about. The first is scarlet fever, and the second is gout. And we must not close the subject, without saying a word or two about discharges from the ear.

Deafness from Scarlet Fever.—Nearly everybody knows that scarlet fever has the power, in addition to all its other powers for doing harm, of spoiling or impairing the hearing function. It does this, by more or less destroying the fine structure of the ear. We have already remarked on the connection between the throat and the ear. The brunt of scarlet fever falls upon the throat, and the diseased state of the throat extends up the Eustachian tube to the ear. This is the cause of a great deal of the permanent deafness that we see. The treatment of it is quite beyond the reach of domestic medicine, and, indeed, forms part of the treatment of scarlet fever. The only suggestion we would make, is to keep the mouth and throat sweet and clean in scarlet fever, by rinsing or mopping them with warm water. Where the patient is old enough, and the throat is not too much swollen for it, plentiful gargling with warm water is valuable.

Deafness from Gout.—Gout is a recognised cause of deafness. Whether deafness in any given case depends upon gout or not, will have to be ascertained by the presence or absence of other symptoms of gout. If there are swollen knuckles, and gouty toes, and some indigestion and acidity of stomach coincident with the gout, the probability is that there is some gout in the ear; for aurists have actually found deposits of gouty stones in the fine structures of the ear, and often find that many cases of deafness are the better for medicines that cure the gout. In such cases of deafness, with gouty joints, dyspepsia, acidity, &c., the following medicine may be tried:—

Bicarbonate of potash	1 drachm.
Sesquicarbonate of ammonia	16 grains.
Water	8 ounces.

An eighth part to be taken three times a day. Beer and porter should not be taken.

It only remains for us to notice the subject of *Discharges from the Ear*. They are for the most part met with in children and young persons. Children, during the teething period or after eruptive fevers, are very apt to have discharges from the ears. This is especially true of delicate children with fine skins and fair hair. It is often the explanation of children being in pain and off their food, who are too young to say where they are bad. It will often be noticed that a child shrieks, as if in pain, or is restless and feverish, without any apparent reason. A few

days afterwards there is a discharge of matter from the ear which explains the pain. The pain is occasionally very acute and throbbing, at other times it is a dull, aching pain. When this ear-ache has once happened in children, it may be suspected again, in cases where there is pain and crying and loss of appetite, and no very definite reason for it. There is generally more or less impairment of the power of hearing in these cases. In such cases, the discharge generally ceases after a few days; but it may become chronic, that is, it may persist for weeks or even months. In such cases, the best medical advice should be sought.

Treatment.—The treatment of such cases depends very much upon the stage. If there is severe pain or aching in the ear, warm fomentations and a potato or onion poultice are the best remedies, taking care to change them as soon as they lose their heat. If this does not relieve the pain, an opiate is the likeliest thing to give relief; but for this medical advice should be taken. If the pain is relieved and the discharge has set in—and the discharge generally does relieve the pain—the ear should be bathed twice a day, and even gently syringed once a day, and good, simple, wholesome, nourishing food should be given. Cod-liver oil will, in most cases, be a valuable help towards the cure. It should not be given till fever has subsided and the appetite begins to return; but then it is a powerful remedy. For children liable to discharges from the ear having a certain delicacy of constitution, cod-liver oil is the best medicine, or rather kind of food. Where this does not agree, steel wine, in doses proportionate to the age of the patient, should be given. It now only remains for us to notice the case of

Discharge from the Ear following Scarlet Fever and other Eruptive Fevers, but especially Scarlet Fever, and we do little more than mention it, for it is part of one of the gravest diseases, for which the patient is sure to be under the care of a medical man. For the mere sake of the ear, the best skill available should be obtained, especially if there is deafness associated with the discharge. Generally speaking, the great medicines needed are simple, nourishing food, fresh air, and cod-liver oil, and a change of air, especially a change to the sea-side, as soon as convalescence and other circumstances will permit.

We dismiss the subject of deafness with these remarks. The ear is a most delicate organ, and should not be rudely treated. The very fact that it is so difficult to see its interior, or understand what is going on in it, is a reason for not allowing any quackish liberties to be taken with it. All picking and irritation of it should be avoided.

DEBILITY.

Few diseases are more often talked about than debility. It is, indeed, the favourite medical idea just now, that all diseases are only different forms of weakness. There has been a beautifully simple theory fashionable of late years, to the effect that all diseases were weakness, and all the best medicines were *strengthening* things, of which wine, spirits, and beer have been the favourites. No matter what the apparent complaint has been, weakness has been the real one, and the main thing the physician has had to do, has been to support the system. Whether the patient has laboured under small-pox, or inflammation of the lungs, or consumption, his great danger has been weakness, and his great remedy has been alcohol, in some shape or other. The effects of this doctrine have been very bad—bad in many ways. For, in the first place, it is a false and absurd doctrine, and could not do much good in itself, simply because it was false. But, in the second place, it is essentially a mischievous doctrine, because it encourages the use of certain articles which we are already too apt to use too freely. It gives a medical character and sanction to a bad habit. It gives men and women medical

authority for taking frequently and freely that which had better be taken seldom and sparingly.

We have said that this twofold doctrine—that all disease is weakness, and that the great remedy for all disease is something strengthening—is absurd. Now it is pretty obviously absurd, but we must try to point out in a few respects how very absurd it is. For, really, we are here dealing with a question of great importance, in which common sense and medical science should go together.

Now we all know what simple weakness is; such as that we see in a child, or a slender woman, or a man recovering from a fever, in the course of which his muscles have shrunk or become fatty. This is simply the absence of muscle. But when we are told that acute disease, or chronic disease, is mere weakness, we neither understand nor believe the statement. A man of rheumatic nature, who has been cold and wet, may feel weak and aching, and good for very little work—there is not much pain about him—he has no energy or strength. But to say that his complaint is mere weakness is a mistake, an actual error. He has got cold and is rheumatic. If you want to restore his strength, you will not do it by giving him excessive quantities of food and wine. These would make him worse; but let his rheumatic disorder be rectified, and his face will regain its brightness, and his step its firmness. A child may be pale and off its food, and have swellings in its neck. No doubt it is weak, but it is a weakness connected with paleness and swelled glands. Give the remedies that cure these, and the weakness will give place to strength. Again, a person may have a cold “hanging about him”—never so bad at any particular moment as to complain very loudly; but he feels he is not up to the mark. Now, cure his cold, and his weakness will pass away. But to hear some people, and even some doctors, you would think there was such a thing as actual simple weakness that you might take hold of, and that wine and such things did take bodily hold of this evil and cast it out. Whereas the scientific truth is, that weakness depends on some error of health, which must be rectified; and that, when this is rectified, strength naturally returns. The illustrations we have given above will enable intelligent readers to understand our meaning, and to understand that all weakness, excepting that which is natural to infants, and young and old and slender people, has a cause, which cause may be removed before proper natural strength can be restored. You could not, by any amount of beef or beer, make a child, or a slender woman, or an old man, strong. Neither will such things make one strong whose weakness depends upon disease, or disordered health, unless this is first rectified. Of course food is necessary, and wine and spirits even may be necessary, but only in connection with means which will remove the original disorder.

SEASONABLE FOOD.

JUNE.

Meat.—Beef, veal, mutton, lamb, buck-venison.

Poultry, Game, &c.—Fowls, chickens, pullets, ducks, green geese, turkey-poults, pigeons, leverets, rabbits, plovers.

Fish.—Salmon, turbot, soles, mackerel, smelts, trout, pike, carp, eels, tench, lobsters, prawns, shrimps, mullet, haddocks, skate, sturgeon.

Vegetables.—Cauliflowers, spinach, potatoes, beans, peas, artichokes, asparagus, carrots, parsnips, turnips, lettuces, cucumbers, onions, radishes, cresses, and all kinds of salads and garden herbs, sorrel, white beet, horse-radish, rhubarb.

Fruit.—Gooseberries, currants, cherries, strawberries, apricots, peaches, and various kinds of apples, pears, and nectarines, grapes, pine-apples, melons.

HOUSEHOLD CARE OF PICTURES.—II.

IN the glazing of pictures it is necessary that they should not be hung opposite a light, which increases the difficulty of seeing them. Any one visiting the corridors of the House of Commons may see the effect of glazing the mural paintings. Owing to the steady light there, the effect is greatly in favour of the process. Where the surface of a picture is of a peculiarly delicate nature, and in instances where the paint has a tendency to chip off, the protection of glass is very necessary. There arises, however, a few practical difficulties in glazing a picture successfully, which only persons professionally conversant with paintings can overcome. In the first place, the picture should never touch or rest on the glass; if it does so, in all probability it will sooner or later adhere in parts to the glass, and when it comes to be taken out of the frame at any time, pieces of paint will be torn from the picture. It is therefore advisable always to keep a certain space between the picture and the glass. This is usually accomplished by fitting the picture in what the gilders call a "flat"—which is a plain flat encasement. This keeps the picture from touching the glass. Another important reason for keeping the picture away from the glass, and also a reason for procuring a good piece of glass, is that there is often a decomposition of the salts used in the manufacture of glass which is destructive to colours when the glass touches them. On this account it is therefore a very excellent plan to place the picture and frame bodily in a small glazed box, as is the way adopted in the case of the picture before referred to in the National Portrait Gallery. By this means the glass is kept a considerable distance from the surface of the paint.

It must not be supposed that this enclosure of a picture in even what may be supposed to be an air-tight box, will obviate any attention being given to the picture. It is found, even under the most successful circumstances, that pictures need occasionally taking out of their frames, if only to change the little atmosphere that is between the glass and picture. The effect of the enclosed atmosphere can, in ordinary instances, after a time, be seen by a certain bloomy appearance of the picture. It is, therefore, the custom to have the front of the box to open or take out, fastening it with a lock and key. This movableness of the front—or back, whichever it may be—necessitates care being taken to make it air-proof; for if not so, the dust and damp will creep in all round the edges to a considerable distance, as is so often seen. Of course, all these operations require to be well understood, or it would be impossible to take any intelligent care of pictures, either by the householder or the traveller; but if the pictures have any value in the eyes of the owners, it will generally be economy to place them in the hands, or to take the advice of those who have a professional knowledge of the subject.

If disbelievers in the art of picture-cleaning could occasionally see the obscuration of some pictures, occasioned in a few months by the dust and smoke of English cities, their adverse views would soon be somewhat modified. The discoloration being so great in many cases in a few months, the state of pictures neglected for years can well be imagined. The reason, to a great extent, that this obscuration of pictures is not noticed in households, is owing to a want of knowledge of what the tints of a picture should be. Only an educated eye can at once perceive the loss of truth in colour, and in light and shade, by a film of dirt. An ordinary observer, even in contemplating a bad painting and a fine one, does not recognise the force of the distinction between them. He does not see that the one lacks all the careful modelling which gives the proper roundness and form to the objects; and that there are no gradations of degree in the brightness of the colour of objects near the eye, and those sup-

posed to be afar off. In a fine painting these important distinctions exist as in nature, and constitute its superiority to the bad one. An artist would discern the difference between a bad painting and a good one, and the want of some such knowledge on the part of householders, is shown in the state in which they suffer pictures under their care to remain, and grow worse. Sometimes it may be a question when a picture has been neglected for a very long period, and is consequently in a very dilapidated state, how far it is safe and advisable to clean it; but it is very obvious that if householders would only give their pictures some attentions in their earlier stages of discoloration and decay, there would be fewer pictures in this state.

Another disadvantage occurs on occasions when the family are away in the country, that of having all the blinds down and shutters closed, thus shutting out the pictures from all light, which is their very life. If any doubt has previously existed in the minds of our readers, of the real necessity of attending to pictures, it must surely be dispelled on reflecting upon these few facts. If pictures only passed through these few vicissitudes, they would amply justify occasional attentions.

The attentions to pictures, with which householders are concerned, are those of dusting, polishing, and ordinary cleaning. Although the operation of dusting a picture would seem to the general mind simple enough, yet it is an operation requiring a great amount of care. In dusting a picture, an accidental projecting wire in the feather-brush may make a scratch across it. In polishing, if a silk handkerchief is used without care, the surface is made to look greasy and smeary. When a pad of cotton-wool is employed (and cotton-wool will be found to polish better than the handkerchief, inasmuch as it can be oftener changed), the presence of little hard pieces of matter may cause mischief. In both cases, if not guarded against, the button on the cuff or sleeve of the polisher may occasion scratches. Again, the operator must be exceedingly precautionous not to press with any force on the canvas, or the marks of the strainer underneath will be forced into distinctness on the picture, giving a very insightly appearance to it, and eventually producing thousands of thin hairy cracks of a serious nature. To keep pictures in proper order, they should be dusted at least every other day. They should be carefully polished about every month, and this should be done in the same manner that a piece of fragile glass would be polished—that is to say, lightly rubbing it, and occasionally breathing on the surface. The best way to polish a picture will be found, as a rule, to be with a slanting movement—but the operator must be a good deal guided by the situation from which the picture is lighted. Thus, if the light is derived from a skylight, the friction should be upwards and downwards. The mode of removing spots should be as follows:—The picture (if possible) should be taken down and laid flat, face uppermost, of course, on a table. It should then be lightly dusted, and with a little roll of cotton-wool, dipped in lukewarm water and squeezed as dry as possible, delicately wiped over, drying the picture immediately with a nice soft piece of linen. A piece of sponge will do instead of the cotton wool, if not used too wet, for it hardly requires to more than damp the surface. This operation will be found to successfully remove all ordinary discolorations. It will be borne in mind, however, that it is always better to return to spots—fly-marks for instance—that are a little obstinate of removal, a second time, in the same manner, than keep the place wetted too long. Injudicious use of water will cause the varnish to perish and turn opaque, and if soap is attempted to be used, beyond the dangers before referred to, the consequence will probably be that a film will spread over the colours which possibly cannot be removed. After this operation of cleaning, the picture must be properly polished, and it will then be in a good condition.

THE HOUSEHOLD MECHANIC.

HOUSEHOLD BOILERS.

WHEN the winter is marked by any considerable degree of severity, one of the most unpleasant results to be looked for as possible is, the exploding of kitchen boilers. It would hardly seem probable that such an element of danger as a steam boiler liable to explosion, could be found in a domestic establishment. We are accustomed only to associate such things with large factories and locomotive engines. But it is nevertheless a fact that the household is subject to the sad catastrophes steam boilers produce, and we have fresh in our memory several of these lamentable occurrences. The most prominent in our mind at the present moment, is that which took place in the kitchen of Longlane Vicarage, Derbyshire, by which two women were killed, and a third severely injured. This explosion was preceded by several others, in various parts, both in London and the country, of a like dangerous and fatal character. Previous winters, too, have contributed their quota of deaths from this cause, so that we think it but a duty to direct the attention of our readers to this subject, and to point out the means of preventing these dire occurrences in such boilers as are liable thereto. And here, lest any unnecessary apprehension should arise, we will explain that it is not every boiler that is subject to explosion. The ordinary kitchen boiler, supplied from a small cistern with a ball-cock attached, is perfectly safe. It is the boiler arranged on what is known as the circulating system that is dangerous, and it is only boilers constructed on this principle that have exploded. In general, these boilers are connected to an overhead cistern (placed perhaps on the second or third floor) by means of two pipes, so that when the fire is lighted, the steam and heated water rise through one of these pipes, and the colder water, from its superior gravity, descends through the other. A thorough circulation is thus set up, which is maintained as long as the pipes are free, the water supply kept up, and the fire burning.

This arrangement is perfectly safe so long as these conditions are complied with, for the surplus steam finds a free escape from the overhead cistern, while the two open columns of water form two natural safety-valves to the boiler. But what is the consequence if the thoroughfare through the two connecting pipes is at any time closed? Why, the steam having no outlet, accumulates within the boiler and pipes, and at last, without any warning, makes its escape by rupturing the boiler, and spreading death and destruction around. Now a frost is exactly the thing to produce these disasters, which we find only occurring in frosty weather. The circulating pipes become choked with ice, and the boiler, unable to withstand the accumulated pressure of the steam within, as a natural consequence bursts. It seems strange in these times, when scientific knowledge is so widespread, and so cheaply and easily attained, that such gross blunders should continue to be perpetrated. But it is so, and it is exceedingly reprehensible, as there are chances of the tubes becoming

choked from other causes than frost. Such being the fact, and there being many circulating boilers extant, the first step with our readers should be, to ascertain the principles upon which their boilers are constructed. If they are upon the circulating system, they should next find out whether they are fitted with a safety-valve, and if not, by all means let them get one attached without delay. They are in danger of an explosion from the circulating pipes choking in the summer, and that danger is imminent in the winter, especially if the pipes are at all exposed to the influence of the altered temperature.

But the valve required is of a special character; and it is not every plumber or ironmonger who could devise one off-hand which would meet the case.

We therefore subjoin a vertical section of a valve of known efficiency, which was designed by Mr. L. E. Fletcher, of Manchester, to prevent the explosion of circulating boilers. It is technically known as of external dead-weight construction, the seat of the valve being spherical, and without either guide fangs or spindle, so that there is nothing to interfere with its free action, or impede the thoroughfare. The central hollow pedestal, A, on which the valve B is seated, is of brass, as is also the external cylindrical shell, C, which drops over it and contains the valve itself, while the weight is simply a ring of lead, D. The area of the opening at the valve seat is a quarter of a square inch, so that every pound weight on the valve gives a pressure of 4 lbs. on the boiler, whilst 45 feet is the total head of water which this valve will balance. One point of importance is, that these valves should not have a greater lead on them than that due to the head of water; therefore, they will require different loads for different positions. The proportions of the shell and dead weight are therefore arranged for easy calculation; the shell being adapted for a constant head of 10 feet of water, and the lead weight for a head of 35 feet, which is equal to 10 feet for each inch measured upon it vertically, since it is 3 1/2 inches high. Thus with the lead

weight as shown, we have a valve adapted for a column of 45 feet; with a weight 3 inches high, for a column of 40 feet; with one of 2 inches,

for a column of 30 feet; and of 1 inch for a column of 20 feet. Should the valve be required to balance a column of greater height than 45 feet, which is scarcely probable, the lead weight can easily be increased, either in height or thickness.

A plumber or brassfounder will be perfectly able, from the foregoing particulars, and our engraving, together with the following dimensions, to make and fit one of these valves for about £1:—that is, 10s. for the valve, and 10s. for labour and material in making the necessary connection. The dimensions are as follows:—total height, 6 1/4 inches; outer diameter of lead weight, 2 1/2 inches; inner diameter of weight, 1 1/8 inches; outer diameter of shell carrying the weight, 1 1/2 inches; internal diameter of hollow pedestal, 3/8ths of an inch at bottom, and 1/8ths of an inch at top. It may prove of further convenience if we state, that for the above proportions, with a diameter of 1/8ths of an inch at the bore of the valve-seating, the

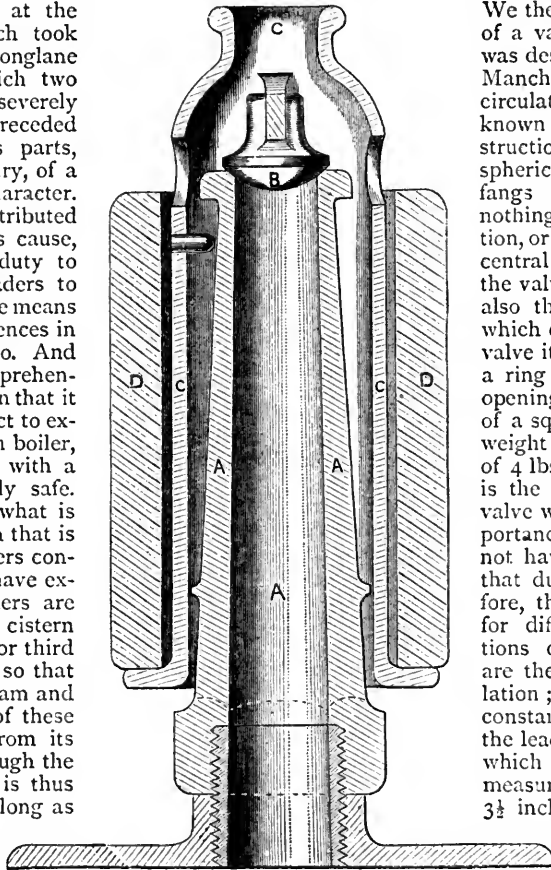

Fig. 1.

weight of the external brass shell should be 1 lb. 1 oz. as nearly as possible; and that of the lead weight, 1 lb. 1 oz. for each inch of its height. With regard to the position of the valve and the mode of fixing it to the boiler, we can only leave this to the discretion of the fitter, it being a matter of convenience. Whenever possible, it should be fixed in front of the kitchen range, being brought out, if necessary, by means of a connecting pipe, so as to be always in sight and accessible. These valves should be kept clean and bright—in fact, they should be treated as ornaments, and then they can always be depended upon. If fixed away in a dark corner they are never looked at, much less examined, and being thus left to themselves year after year, are generally useless when their services are required. The valve shown in our engraving has a wrought-iron flange attached to it with a screwed nipple, which can be secured to the boiler by bolts tapped into the plate. This may be found convenient in some cases where the valve can be placed directly on the top of the boiler, but we recommend the arrangement previously described wherever practicable. Here, then, is a very simple preventive measure against one of the most dire calamities that can possibly befall a household. We most sincerely trust that all those who may require it will avail themselves of its benefits without delay.

ARTIFICIAL TEETH.

MOST of us are accustomed to regard artificial teeth as wholly a thing of the present day, but such is not the case. Of the wisdom of the ancient Egyptians a knowledge of dentistry formed a part, and mummies have been found with wooden and ivory teeth; some of them even fixed, in modern fashion, on gold plates; and with hollow teeth stopped with gold—so true is it that there is nothing new under the sun. The classic writers also speak of artificial teeth as being well known both in ancient Greece and Rome. A century and a half ago, as appears from advertisements in old newspapers, goldsmiths did the work of dentists in making and cleaning artificial teeth. A few months since, while some excavations were being made on the site of the Inquisition, at Murcia, in Spain, the workmen came upon the bones of the victims of that terrible institution in former times; in one of the jaws was a silver tooth—this fact was observed by a friend of the writer's, who happened to be on the spot.

But since dentistry has been recognised as a separate branch of surgery in modern times, the precious metals have not been used for the actual teeth. Ivory was one of the earliest substances employed; it was easily shaped, and when first put in, matched tolerably for colour with the natural teeth; but from its porous nature it was soon saturated with the fluids of the mouth, and underwent chemical changes, which rendered the breath offensive; its appearance became dark and disgusting, and it rapidly decayed. The tooth of the hippopotamus, being harder and covered with a fine enamel, promised better, and was regarded with favour for a time; but it was found to have the same disadvantages as ivory. The teeth of domestic animals, cows and sheep, have been used, but these would not do in many cases, and only for front and canine teeth. Among the old materials, nothing was better than the crowns of human teeth, mounted on artificial bases. These in a healthy mouth would often wear for from eight to twelve years; but there was much difficulty in procuring a supply, which rendered them costly, and many persons had a horror of wearing dead men's teeth in their mouths. A great stride was made in the art when mineral teeth were introduced. Porcelain teeth are a French invention; they were first made at Paris, about 1820, and have now superseded all others.

Unlike those we have mentioned, they are cleanly, since as they are not porous they do not absorb secretions; they are not acted on by the chemical agents in the mouth; they never change colour; and as they can be more nicely fitted, they can be worn with greater ease and convenience.

Artificial teeth are sometimes fixed upon the natural roots, when they are free from disease, but only in the case of front teeth of the upper jaw. A better way is by attaching them to a plate of gold or platina, which is secured to the adjoining teeth; this admits of readily taking out for the purpose of cleaning, a point of great importance. When there are no teeth to which they can be attached, spiral springs are sometimes introduced, which press against the cheeks, and thus hold the plate in place; but these are very uncomfortable to the wearer, and continually liable to get out of order. Messrs. Lewin Mosely and Sons, of 30, Berners Street, and 448, Strand, some years since invented and patented a method of securing the plate by atmospheric pressure, which does away with the necessity of springs and their attendant disadvantages. This plate is so accurately fitted to the irregularities of the palate that no air intervenes, consequently it remains firmly attached on the same principle that a leather sucker adheres to a stone. To obtain an exact *fac-simile* of the mouth, the dentist presses a soft and plastic composition against the gums and palate which gives an exact impression in reverse of the form of the mouth; from this a model in plaster is taken, which is again cast in metal, and dies made, between which a thin gold plate is hammered and fitted, until it takes the exact form of the mouth and accurately fits the gums, palate, and the remaining natural teeth. The most delicate manipulation is required in taking a perfect impression of the mouth in the first place, and the most careful workmanship in the mechanical fitting of the plate is absolutely necessary, in order to ensure a perfect fit, upon which depend comfort and correct articulation. This plate is now tried in the mouth, with wax placed upon it to receive the impression of the teeth of the opposite jaw; and the depth to which their marks penetrate indicates the length required for the artificial teeth, that they may exactly meet them. The plate, with the wax upon it, is then taken from the mouth, and brushed over with oil; wires curved like the jaws, and hinged together behind, are placed above and below it, and these are separately embedded in plaster; the plate and wax are then removed, which the oil permits to be done readily. The contrivance thus made, which represents the two jaws, is called the "articulator;" in it the artificial teeth are temporarily placed, and arranged to their correct positions; they are afterwards transferred in the same order to the metal plate, to which they are soldered by the little platina pins which project from them; the space between the plate and teeth is sometimes filled up with vulcanised india-rubber, and sometimes with mineral pastes variously made. The best material for the plate is gold, but alloys are used, and sometimes other bases are substituted. Platina is also considered well adapted. For cheap sets of teeth, cheaper materials are employed, generally, under different names, vulcanised india-rubber (that is, india-rubber with which sulphur is mixed). Gutta-percha has also been used, but it does not resist the acids of the mouth well. Artificial teeth, exactly corresponding in colour and shape to the remaining natural teeth, are now carefully fitted to the plate; and so well is the imitation carried out by Messrs. Mosely and Sons and other first-rate dentists, that it is almost impossible to distinguish the one from the other—the real from the false.

There is another method of fixing called the continuous gum; it consists of an artificial gum, in which the teeth are embedded, and which is made of a somewhat similar

composition to that of the teeth, but more flexible; this fits over the real gum, and is coloured to resemble it.

Many people who are desirous of having artificial teeth are deterred from visiting the dentist, by the fear of pain and the natural dread of an operation. To all such we can confidently recommend "the Alexodyne," a *specialité* of Messrs. Lewin Mosely and Sons, which has entirely superseded chloroform, ether, and such anæsthetics, for dental purposes. This agent, which is administered by inhalation, is capable of annulling physical pain or of preventing it from being felt. Its action is far more rapid, in producing an insensibility to pain, than any other anæsthetic; its transient hold upon the senses causes no ill effects or reaction—no headache, sickness, or prostration; and the recovery to consciousness is speedy and without any unpleasant sensations. The unfailling efficacy of its pain-deadening qualities is all that can be desired, and severe operations can be performed without the patient being conscious of suffering.

For stopping hollow teeth, the only unobjectionable substance is sponge gold, which is a chemical preparation of fine gold. Tin-foil, from its malleability, is easily inserted, but it soon oxidises and destroys the colour of the tooth. A mineral amalgam is commonly used, which is made of mercury, silver, and tin.

To those who have lost their teeth, the advantages of replacing them by good and well-fitted artificial ones cannot be doubted; of these mere appearance is the least, though neither that nor their power for restoring distinct enunciation is to be despised; but without complete mastication good digestion is impossible, and they are therefore an important means of preserving health. The cause why so many artificial teeth prove failures lies in the desire for cheapness, which too often renders good materials and good workmanship impossible.

The fact of a dentist being an advertising dentist, by no means implies that his work is necessarily cheap or bad. He is compelled to make himself known to his patients, and if they insist on cheap teeth, to furnish them with such. There are, of course, exceptions to the rule; but most of the advertising dentists are gentlemen who understand their profession, and can supply good teeth for fair prices.

In the management of artificial teeth the great point of importance is to keep them clean, as it is, indeed, in that of natural teeth. To all who have sound teeth, and would avoid the necessity for artificial ones, the practice of some of the high caste Brahmans of India is commended for consideration, though scarcely, perhaps, for imitation. They spend an hour each morning cleaning the teeth with a twig, and recite certain prayers at intervals.

ODDS AND ENDS.

To clean Black Silk, with very little Trouble and Expense.—Take entirely to pieces the dress, jacket, &c., and well shake each piece; then spread over a deal table a newspaper, or sheet of clean paper, and on it lay a breadth of the silk. Brush it well both sides with a fine soft brush—a hat-brush would very well answer the purpose. Shake it again; fold together in half, and place it on one side of the table. In the same manner shake, brush, and shake again each piece of the silk. Remove the paper, and place on the table a clean newspaper, or sheet of paper. Newspapers answer best; they are large and smooth, and probably at hand. On the paper again place a breadth of the silk, and into a clean quart pudding-basin pour a half-pint of cold water, adding half-a-pint of good *sweetened* gin, which is better for the purpose than *unsweetened*, as the sugar stiffens the silk. These are the proportions for any quantity required. Have ready a piece of black crape, or black merino, about half a yard

square; dip it well into the liquid, and thoroughly wash over the *best* side of the silk. Be careful that it is well cleaned, and, if possible, wash it from edge to edge, and wet it well all over. Then fold over the silk in half; then again, till the folds are the width of those of new silk. Place it in a clean towel, and clean each piece of the silk in the same manner, laying one piece on the other; and remembering by a mark which is the last piece done, as that must be the last ironed. Let the silk lie folded in the towel until a large iron is well heated; but be careful that it is not *too hot*; try it first on paper, or a piece of old damped silk. Use two irons. Open the towel when the iron is ready, and place the piece of silk that was *first* cleaned on an old table-cloth or sheet folded thick; iron the *wrong side* quickly, from edge to edge, until dry. Fold the silk over lightly to the width of new silk, and place it on one end of the table until all is done. This simple process stiffens, cleans, and makes the silk look new.

Directions for cleaning Black Merino, or any Woollen Stuff, Black Cloth Jackets, Cloaks, or Gentlemen's Clothes, &c.—Purchase, at a chemist's, one pennyworth of carbonate of ammonia. Place it in a clean quart pudding-basin, and pour upon it a pint of boiling water; cover it over with a clean plate, and let it stand to get cold. Having taken entirely to pieces the dress, jacket, or cloak, shake each piece well; then spread a large newspaper over a deal table, place one breadth of the material upon it, and brush it well on both sides with a *fine hard* brush; shake it again, and place it on one side of the table, folded in half. Brush and shake in the same manner each piece, folding and placing one piece on the other at the end of the table. When all are brushed, remove the paper and replace it with a fresh one, upon which place another, if thin. Lay upon the paper one breadth of the stuff, quite smooth and flat, the wrong side next the paper; then take a piece of black merino, about half a yard square; dip it in the carbonate of ammonia and water (cold), well wet it, and wash over the stuff or cloth. If cloth, care must be taken to wash it the *right way*, so as to keep it *smooth*; when well washed over, fold the material in half, and place it in a clean towel, laying one piece over the other, until all are done. Mark the last, as that will be the last to be ironed. Let the merino, or cloth, rest in the towel for about an hour; then iron the *wrong side*, after placing it on a thickly-folded blanket, or sheet, with a thin sheet of paper, old glazed lining out of the dress, or piece of linen, over the blanket or sheet. Iron each piece on the wrong side until quite dry, and have two heavy irons, one heating while the other is in use. Fold over the pieces, the width of new merino, but be careful not to fold it so as to mark it sharply, especially cloth. Gentlemen's clothes can be thus cleaned without taking to pieces, or ironing, unless quite convenient. Vests and coat collars are thus easily renovated, the colour is revived, grease spots and white seams removed.

To renovate Crape.—Brush the crape well with a soft brush, and over a *wide-mouthed* jug of *boiling* water hold tightly the crape, gradually stretching it over the jug of boiling water. If a strip of crape, it is very easily held tightly over the water, letting the piece done fall over the jug until all is completed. The crape will become firm and fit for use, every mark and fold being removed. White or coloured crape may be washed and pinned over a newspaper, or towel, on the outside of a bed, until dry. Crape that has been exposed to rain or damp—veils especially—may be saved from spoiling by being stretched tightly on the outside of the bed with pins, until dry; and no crape should be left to dry without having been pulled into proper form. If black crape, lace, or net is faded or turned brown, it may be dipped into water, coloured with the blue-bag, adding a lump of loaf sugar to stiffen, and pinned on to a newspaper on a bed.

ANIMALS KEPT FOR PLEASURE AND PROFIT.—THE HORSE.

PONIES AND PLEASURE HACKS (*continued*).

THE price of these ponies, which are of all colours, and are intended for roughing it, should vary from £10 to £15 or £20. The latter is a long price, though we have advanced upon that for a good one. The better sort may be found in the yards of dealers, who buy them when they think they can turn something by them, and, not unfrequently, as a matter of fancy. There are some peculiarities also to be noted. A large horse should look smaller than he really is; a pony should look larger, when his symmetry is perfect. No greater compliment can be paid him than to say that he "is a horse in miniature." In buying from a drove, when young, pick those that appear to have most quality, as ponies usually grow coarser as they grow older. If bought too thick

lucrative than that of middling horses, and there is always a ready sale for a very good one.

Of saddle horses for pleasure, the first of which we shall treat is *the Hack*. He is essentially a saddle horse, and is supposed to resent harness by kicking the trap to pieces. If you wish to insult a very particular *petit maître* who has called your attention to his hack, ask him whether he goes in harness. Some are used chiefly for the roads, either exclusively in the country, or in the suburbs of London. They do a great amount of road work in this latter capacity; for where men are fond of horse-exercise, and are yet confined to business for several hours of the day, the riding backwards and forwards is almost the only way of getting it during eight months of the year. In the country they carry the squire, especially if he be not a sportsman, on non-hunting days into the market town, or on magisterial or county business, and with the former of the two, they go to see a fox found occasionally, though

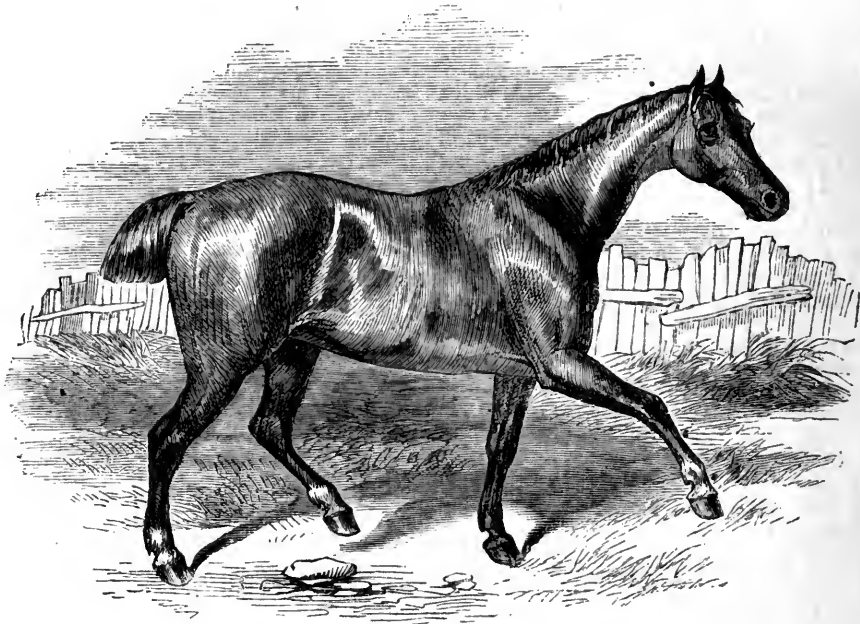

HARMATTAN, THE PROPERTY OF MRS. GEORGE PAINE.

when young, they become clumsy and cob-like. In buying for children, select the narrowest you can find. When not over-weighted, their powers of endurance are beyond belief.

The really valuable cobs and ponies that come into the London market are many of them very well bred. They are by thoroughbred horses, out of small mares, and when well broken fetch high prices. There are two or three studs of ponies which come yearly to the hammer, and the most successful breeder of them is a gentleman of our acquaintance, who has been known to sell ponies of 14 hands, or a little more, for almost fabulous prices; and we annex an illustration of a chestnut cob, called Harmattan (African Whirlwind), under 14 hands, which made 130 guineas last year. It is the property of Mrs. George Paine, of Norfolk Crescent, by whose permission the sketch was made. She uses it entirely for harness, and it is one of the finest goers in London. Lord Stamford was a great buyer of good ponies, and he is always to be seen on something quite unique on Newmarket Heath—a popular exhibition-ground for this class of horse. They are most of them quite as good as they look. The breeding of first-class ponies is more

this is out of their line. Then the question is, What are the most desirable points for such services?

The hack should be good-looking and well-bred. His legs and feet should be especially sound, as our English roads are hard, and if ridden from the suburbs to town and back, some portion of his journey will be notoriously so. He should have a light head and neck, and his mouth should be good, though when used exclusively for country work that is a secondary consideration; near London and large towns it is a *sine quâ non*. He should have a good constitution, as he is expected to do regular work, though he will be as well fed and cared for as gentlemen's horses usually are. A horse of this kind should have no vices, such as shying or kicking; and he should be perfectly safe, that you may thoroughly trust him with a loose rein at a foot pace. All his paces should be good, but the two with which you are most concerned are the walk and the trot. Cantering, excepting by ladies, and in places where the sides of the road are grass, as in Cambridgeshire, Leicestershire, Northamptonshire, is not often indulged in; it is apt to knock horses' feet to pieces sooner than the trot. Great attention should be paid, not only to the way in which a hack picks up his feet, but to that in

which he puts them down. He should lift them well, bending his knee, and throwing his feet out before him; and the *heel of the foot should come first to the ground*. A good hack will walk from four to five miles an hour, sometimes more towards home; and it is far better that he should trot nine miles in fine form, than twelve or fourteen in a slovenly manner. The after-dinner stories of gentlemen who have favourite hacks or hunters are not to be believed. Racing men seldom err by making theirs too good, except when they want to sell.

As a hack has to go along the road as his primary calling, less attention may be given to great strength, unless it be combined with quality. Hacks should be small, about fifteen hands, or at most fifteen hands one inch, handy to get on and off, quiet enough for a stranger to hold, and certainly not clumsy, as so many weight-carriers are. It should be remembered that *action carries weight*, but then it is not the gaudy fore-leg action which has so many

horse will be pace as well as endurance. His journey is usually through lanes and fields, soft from winter's rains, and therefore the first consideration in the former case is of less importance in the present one. Instead of the walk and trot, as the groom does most of these, the first desideratum is an easy swinging gallop at three-quarters' speed, which carries you at about thirteen miles an hour, including stoppages, by which we mean gates to be unhasped, dirty lanes to be walked through, and small fences or gaps to be occasionally jumped. These, then, are two accomplishments of the covert hack; and although both may be acquired in a very few lessons, it is desirable that they should not have to be given when the master is in a hurry to get to his hunter. Good wind is in this case quite indispensable, and good action too, but it is more the action of the hunter than the roadster. Indeed, a good covert hack should be a small hunter of about fourteen hands three inches, not less, as, excepting on very wet days, or

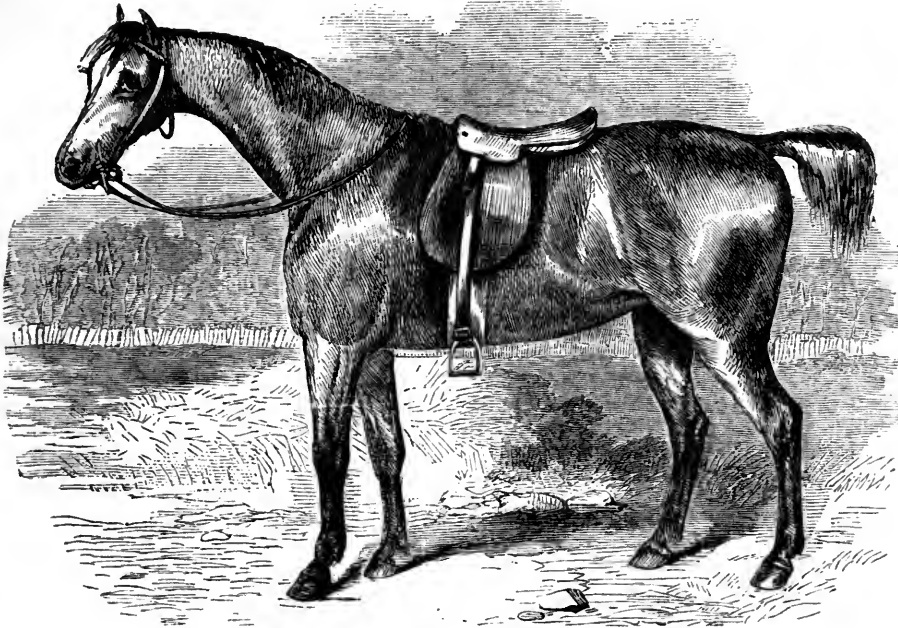

COVERT HACK.

admirers, but good action and true, both *behind* and before. The best market for buying a good hack is from a good trustworthy dealer. Gentlemen know their value, and though many a first-class hunter finds his way from one gentleman's stable to another's, it is not often that they will be tempted to sell a favourite hack, excepting for a very long price. There are plenty of honest dealers to be met with in London and the provinces, and such a hack, sound and good-looking, as we have endeavoured to describe, is worth from 80 to 130 guineas. A great deal more has frequently been given, but anything beyond 120 guineas may be considered a fancy price. The perfect hack need not be so fast as the covert hack, nor so handsome as the park hack, but he must have some of the qualities of both. Newmarket was at one time a great mart for these horses; and, being found slow for racing, when they had action they were bought at two or three years old for small sums and turned into hacks; but racehorses nowadays are very unsound, and it is no longer so fashionable a mart for them as formerly.

The *Covert Hack* is a hack for a special purpose, *i.e.*, to carry his master from the breakfast table to the meet; and as the object is to gain time, the requisites of this sort of

in very muddy countries, the best men do not adopt overalls, and in that case anything lower will subject the rider to being covered with mud. Gentlemen who indulge in book-making, and who have been looking at pictures by Alken and descriptions by Nimrod, should remember that those gentlemen wrote and drew forty years ago, and some of their customs as well as costumes are obsolete. These hacks are kept in the same condition as hunters, and come out upon an average three days a week, according to circumstances; those with large studs frequently have two, and sometimes go to the meet on wheels when practicable. A covert hack sometimes has an infirmity or two, which goes off by the time he has got on to the grass; he is also allowed to kick or to shy if he is fresh enough and meets with anything to shy at. But a good, sound, smooth galloper, about the size we have described, and nearly thoroughbred, is worth as much money as the other, though his qualifications are not the same. Of course, all these circumstances vary with weight. We write for ordinary mortals, and append a portrait of a very good one, which carried thirteen stone for many years.

The *Park Hack* is, again, in some respects different from the other two. He is called "flatcatcher," for he frequently

combines with the most showy externals half the infirmities to which horseflesh is heir. And if, indeed, he be confined to his especial work, he will be no more the worse for a certain amount of unsoundness than will the honest merchant's clerk or linendraper's apprentice for his mosaic chains or sham jewellery. It is only when either the one or the other comes out of his place that he will be detected or despised. A handsome, high-stepping, round-barrelled, small-headed, gaudy-looking park hack is just as capable of walking up and down Rotten Row, with a bog spavin, thick wind, curby hocks, and unsound feet, as the honest clerk is of doing his work with his moustaches or imperial. No one would, perhaps, be more surprised than the people who are on them to know how many defects they have. They are ornamental and useful for the one purpose for which they were bought, and two hours' walking exercise is just about what many of them are fit for. But this is not the case with all. There are horses to be seen in Rotten Row of inestimable value, whose goodness is alone known to their owner, and whose value is incalculable. They are of all sizes, from fourteen hands two inches to fifteen hands three inches high; highly bred, many of them of the best blood in England, beautifully shaped, of the richest colours, with courage and docility so combined that it is a positive treat to ride them; well broken, of splendid action, without a blemish or a spot which can take from their value. The fashion of giving enormous prices for park hacks perhaps went out with Count D'Orsay and the late Lord Chesterfield; but we know that noblemen and gentlemen still alive allow no price to stop them when they get exactly what they want. To the great size and beauty to which these horses may be brought there is no limit, and as this and good manners are indispensable requisites of the park hack, we need scarcely add that in a dealer's hands they are very valuable. The same may be said of a lady's horse, which should combine high courage with perfect obedience, and be in other respects very much what we have endeavoured here to describe. He should be able to canter with either leg, for his own sake and his rider's, and if high enough to keep her habit from the mud, so much the better.

COOKING.

PIE-CRUST, PIES, PATTIES, AND PÂTÉS.

Pie-crust.—What is a pie? A complete answer would contain considerably more antiquarian lore than we have room to make a show of here. There being no respectable Latin for "pie," we may suppose that the Romans, not having the word, did not know the thing; and that pies, not being older than the Christian era, cannot put B.C. after their names. There is no Latin word even for paste, *i.e.*, dough. The Greek derivative, "artocreas," bread-flesh, bread mixed with meat, is just as likely to have been a sandwich, or mincemeat-stuffing, or a sausage-roll, as a pie. *Pastete* (German), *pasticcio* (Italian), *pâté*, and (in old French) *pasté*, and patty, all spring from the root which gives us pastry. Nevertheless, the paste, or crust, is not *essential* to a pie, although it is mostly a very pleasant, and often a very convenient addition. An English dictionary before us defines "Pie, *s.* a crust baked with something in it." It would have been nearer the truth, had it said, "something baked with something (four-and-twenty blackbirds, for instance) in it." Several world-famous pies, or pâtés, have no crust—as hare pâté, or *pâté de lièvre*. Others, as goose-liver pies, may either have a crust or not. Others, as certain goose pies and pork pies, may have a crust of stiff, unrolled, unfatted paste, to hold the contents, as a wall, which no one is expected to eat. We question whether the patty made of "lightfoot," which the miller of Mansfield set before the king, had any other crust, if even that. The French have only one word, *pâté*, both

for crusted and crustless pies; their *petits pâtés* are our "patties." Many pies and pâtés are meant to keep some time, as well as to travel long distances—that is, to the other four quarters of the globe, Australia being admitted as the fifth. The French export trade in pâtés is very considerable, the internal trade large; and the prices being high, the annual amounts received by pâté-makers are something handsome. There are many localities, each of which is celebrated for its own particular kind of pâté, as Amiens of ducks, Pithiviers of larks, and Strasbourg of goose-livers. A snipe pâté, with half-a-dozen birds, costs fifteen francs at Montreuil-sur-Mer (Sterne's); one with a dozen snipe double that sum. Very nearly the same in preparation were the "pots" of game and wild-fowl, so highly esteemed a couple of centuries ago. On the 3rd of December, 1680, Sir Thomas Browne wrote:—

"Deare Sonne,

"I am glad you received the pot of teale. I hope they will prove good, for they were the fattest, this late open season, that I have seen for some yeares. I must also tell you, that this Friday Mrs. Skoltowe sends you a pot of teale by the waggons; shee desired my wife to give you notice thereof, shee being somewhat ashamed to write concerning such a meane present, being so highly obliged unto you. Comming so late unto you, you may well keepe them till Christmasse, or the middle thereof."

There are in reality only two kinds of pie-crust:—Puff-crust, varying in lightness and flakiness with the quantity of butter used, the number of times it is rolled out, the knack of the pastry-cook, and the way in which it is baked. For vol-au-vents, patties, tartlets, &c., puff-crust must be made to perfection, or they will turn out failures. A vol-au-vent particularly is the touchstone of a pastry-cook's ability. Secondly, standing crust, solid though sufficiently brittle, substantial and granulated rather than flaky. This is used for meat and fish pies made in moulds, to be turned out when cold, and also for open tarts and tartlets containing fruit with a good deal of juice and syrup. In the latter case, the paste should contain a little pounded sugar and a larger proportion of egg. The pastes for buns, biscuits, sponge and other cakes, as well as batter for dipping things in for frying, for pancakes, puddings, &c., are quite distinct from pastes for pie-crust.

Puff-crust.—Suppose we begin with a simple puff-cake. Just moisten a pound of flour with water, add a spoonful of salt. Work it into a soft paste, and leave it for half-an-hour. Then roll it out about half an inch thick. With your knife spot its surface with little dabs of butter; fold it in two; roll it out again; dab it with more butter; roll out again; and so on, repeating the operation four or five times. All this should be done expeditiously, and immediately before setting into the oven. The more butter is used (within certain bounds), and the more frequently it is folded and rolled, the lighter will be the crust. Meat, and other substantial pies, should evidently have a more solid crust than apple, cherry, and other fruit pies. With this puff-crust, you may either make plain puff-cakes, cutting them out with a wine-glass or tumbler (in default of more ornamental cutters made of tin); or by putting a spoonful of marmalade or jam into each before baking, you convert them into tartlets. By laying a tin circle, like half-a-crown, in the middle of each, before baking, you make a hollow for the reception of custard, cream, or jelly, after baking. For puff-crust of a far superior quality, take a pound of flour, heap it in the middle of your pastry-board (which may have three of its sides guarded with a wooden edge), put into it a tumbler of water, a saltspoonful of salt, a lump of butter as big as a walnut, and two egg-yolks; the whites will serve to glaze your crust. The water will be gradually added with the right hand, while the ingredients are mixed together with the left. That done, make it up into a lump, and let it rest for half an

hour. Then dust your board with flour and spread out the paste with your rolling-pin. Take three-quarters of a pound of butter and spread it on the paste, but only in the middle, so that about half of its surface is covered with the butter. Fold the paste so as to enclose the butter; roll it out with the pin, making it twice as long as it is broad. Then fold it in four as you would a napkin, namely:—put 1 upon 2, 4 upon 3, and then 2 upon 3. Then roll out again. That is called giving it “a turn,” or “a roll.” Give six turns or rolls in all. Not longer than five minutes after the last roll, employ your paste for the purpose required, otherwise it may turn out heavy.

The temperature, *i.e.*, the consistence, of the butter is of considerable importance. Too hard, it will not easily mix with the flour; in a running state, it will leak out at the edges at every roll. In winter, butter is easily warmed; in summer it may be plunged in cold pump water. Some cooks use ice.

Standing Crust.—In the central hollow of your pound of flour put a saltspoonful of salt, two eggs (both yolks and whites), and a quarter of a pound of butter. Work these together with the hands, and gradually add a glass of water and (if for sweet things) a little pounded sugar. If too hard, soften with water; if too soft, stiffen with flour. The paste should be sufficiently firm and adhesive for you to model it with ease into the lid and inside of your pâté mould. Make up your paste into a ball, dust it with flour, cover it with a damp napkin, and let it lie an hour before using it. Your crust being ready, you can now make a

Mackerel Pie or Pâté.—Have an oval baking-tin, a little longer than a mackerel, and a little narrower at the bottom than at the top, so as to enable you to turn out easily the pie with its standing crust. Take two or three mackerel, cut off the heads and tails, split them open at the belly, remove the backbone and the ribs, leaving the flesh entire. If there are roes and milts, save them. Dry the mackerel with a cloth, dust them inside and out with flour, sprinkle slightly with pepper and salt. Take two-thirds lean veal, and one-third fresh pork, fat and lean together; chop these to a mincemeat, with the roes and milts of the fish. Season with pepper, salt, and mace. You may add a little fine-chopped lemon-peel pared very thin, and sweet herbs, if liked. Mix all well together. Line the bottom and sides of your baking-tin (previously smeared with butter) with pie-crust firm and thick enough to bear turning out. Fill the insides of your mackerel (two will make a good-sized pie) with the stuffing; lay them in their places, and fill up the spaces between them and the crust with the same. Cover them with the remaining mincemeat; pour over them a wineglass of water, and cover the whole with the top-crust ornament, and glaze with white of egg. Set in an oven that is not too quick, and bake. This pie, which is eaten cold, is best left in the tin until wanted, in order to allow its contents to solidify and stiffen. It is a delicate preparation, very commodious for a pic-nic, or as a standing dish for breakfast or luncheon. It is also producible with perfect propriety at the close of a dinner. In the same way, you may make fish pâtés of herring, salmon, trout, and other rich fish. Dry-fleshed fish, as conger, haddock, sole, ling, and the like, require to have their pâté “nourished” with butter or cream, and some flavouring, as oysters, or a “suspicion” of anchovy.

Veal Pie.—Take a sweetbread. If fine, one of its portions will suffice. Steep it an hour in salt and water; throw it into boiling salt water, and boil, if small, a quarter of an hour; if large, twenty minutes. Set it aside to cool. In this state, it is ready to appear under any of the disguises which sweetbreads assume. Take a piece of veal, the flesh of which will fill your pie-dish three-quarters full. Cut it into pieces somewhat smaller than walnuts.

Dust them with pepper, salt, and flour, and set them aside. Prepare two or three hard-boiled eggs. Set the veal bones on the fire in cold water, and boil them down till the broth will jelly. When nearly done, add the rind of half a lemon and a bunch of sweet herbs. Boil a quarter of an hour or twenty minutes longer. Pour off the broth; add to it half a glass of white wine and (unless the inside is wanted white) a tablespoonful of mushroom catchup. This is the gravy for your pie. Now fill up your pie-dish (distributing them equally) with the pieces of veal, the sweetbread cut into dice, and the hard eggs in quarters. Grate a little nutmeg amongst them. You may slip into the interstices a few oysters or forcemeat balls. That done, warm the veal-bone jelly and pour it into your pie. Cover with a moderately thick and solid crust, and bake in an oven that is not too fierce. If the pie is to be eaten cold, you can put an undercrust as a lining to the dish. After standing a night, the pie can be taken out of it, and appear alone.

Small Mutton Pies may be made with cold, under-done, roast mutton, as the meat must be previously cooked. Put your cold roast gravy in a stew-pan, thicken it brown with flour, season with a little red wine, catchup, pepper, and salt. Keep your sauce thick. In it just warm the mutton, cut into small dice after trimming off the skin and most of the fat. Line patty-pans with rather light crust; fill them with the hashed mutton and its sauce; cover with a top crust; set into a brisk oven, and serve scalding hot.

Lark Pâté.—For a dozen larks, take half a pound of lean veal, half a pound of sausage-meat, and a quarter of a pound of unsmoked bacon. Empty the larks, cut off their heads, necks, and legs, which set aside. Take the livers, chop them up fine with the veal and the bacon; add the sausage-meat, a little minced parsley and thyme, and, if approved, a chopped shallot. Mix these and season with pepper and salt, adding two dessert spoonfuls of good white wine. With this stuffing fill the inside of each of your larks. Make a good stiff paste for a standing crust, and with it line throughout, bottom and sides, a mould or pie-dish. Put a layer of mincemeat at the bottom, then a few larks, and so on, filling up the empty spaces with mincemeat. When all is put in, lay a few thin slices of bacon on the surface; then put on the top crust, closing it well at the sides, and making a small hole in the centre. Bake for an hour and a half in a moderate oven. While the pâté is baking, put into a saucepan all the *giblets* of the larks with a bit of knuckle of veal, a sliced carrot, some sprigs of parsley and thyme, and sufficient water. Boil these down till the liquor will form a jelly; strain off, and when the pâté is baked, pour it into the hole at the top, which you close with some little pie-crust ornament previously made. This pâté is to be eaten cold, and is better for keeping two or three days. Partridge, snipe, and woodcock pâtés are made in the same way, only that for the two last the *whole* insides or entrails of the birds—unless especially forbidden—are minced up with the rest of the stuffing. In that case, it is understood, as a matter of course, that the birds must be fresh, or at least not high.

Eel Patties.—Skin and empty middle-sized eels, cut them into inch lengths, throw them into salt and water for an hour. Put them into a stew-pan with salt, pepper, mace, a sprig of parsley, and lemon-peel; pour over them no more hot water than will cover them. As soon as the bone can be removed (from five to ten minutes), take them out and do so, thus splitting each piece of eel into two. Set them aside. Remove the lemon-peel, &c., from the broth; thicken it with butter rolled in flour; flavour with lemon-juice or a teaspoonful of vinegar, and to this sauce return your pieces of eel. Then make patties in patty-pans, as directed for small mutton pies. Eel patties are served either hot or cold.

HOUSEHOLD DECORATIVE ART.

SKELETON LEAVES.

THE subject of this paper is but one of many means of household decoration, but it certainly deserves a high rank among the adornments of the home of taste. Though

skeletons of animals, by allowing insects to eat away the flesh until the skeleton was clean, he tried his method upon leaves, but failed. Not to be beaten, he persevered, trying other methods, until rewarded by success. The beautiful specimens he produced, caused so many others to attempt the discovery of the means he used, that, after



GROUP OF SKELETON LEAVES AND SEED VESSELS.

so little known, it is not a new art, for the figure of a skeleton fig-leaf was published at Naples by an anatomist as far back as 1645, and created great curiosity at the time. Many attempts were made to discover the secret, but it does not appear to have become known; and on the death of the artist the method for a time was lost. About 70 years afterwards, a Dutch anatomist turned his attention to the subject. Having been in the habit of procuring

some years, finding he could no longer keep his secret, in 1727 he published it. This method, with very little difference, is that by which most of the leaf skeletons now seen are produced; and it is the method we here introduce to the reader, convinced that an art at once beautiful, extremely simple, and inexpensive, cannot fail to find a host of admirers.

Firstly, then, as to the choice of leaves. And here, to

the non-botanical reader we would say, that there are two great divisions in the vegetable world, called exogens and endogens. In an exogenous leaf, the veins branch at angles from a large central vein or mid-rib (see Fig. 11, page 138). In an endogenous leaf, the veins start from the base of the leaf, and curve upwards to the point

intact the veins, which form the skeleton, and the secret of this is by maceration. Other methods have been tried with partial success ; but the simplest, and we believe by far the best and most certain process, is to lay the leaves in water until they partially decay, allowing the skin and fleshy matter to become decomposed, and stopping the

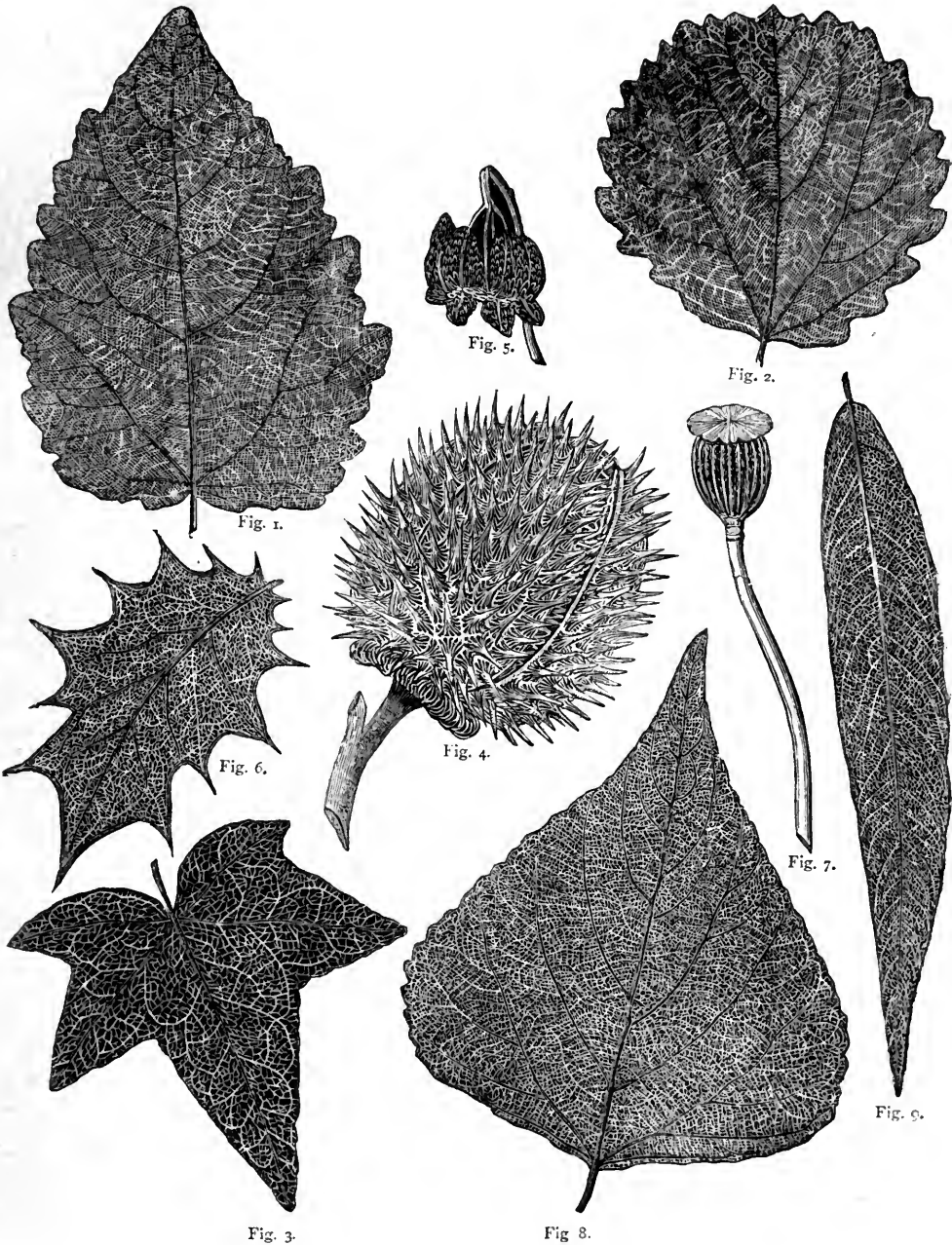

(see Fig. 10, page 138), and it will be found that very few leaves like Fig. 10 will be of any use for this purpose, while there are very few like Fig. 11 that cannot be made use of. Also that a leaf may be roughly divided into three parts :—the veins, to convey the sap ; the fleshy matter, filling up the spaces between the veins ; and the outer skin.

Now the object in view is to separate all three, retaining

process before it attacks the fibres. It is quite plain that unless perfect leaves are gathered, the result will not be perfect skeletons; and, indeed, great care must be exercised in the choice, for a very slight scratch or blotch in the leaf will render the skeleton imperfect. The leaves should be well matured ; young leaves, with few exceptions, are useless ; consequently, they must not be picked at the end of a branch, but lower down where they are older. They

should not have suffered much from the sun and wind; or the edges will probably be imperfect, and they must not be gathered too late in the season, or they will be getting brown and leathery. For most leaves, July is usually the best month, but the nature of the season makes a great difference. A good plan is to hold the leaf up to the light, when a defect is generally very readily seen. Evergreens are good late in the autumn, but they may be picked at almost any time, having due regard to the age of the leaf.

A large number of leaves should be gathered in preference to a few, they are then to be placed in an open vessel—a small tub or pan, or anything available—and covered with water (rain water is to be preferred) and placed in the open air, exposed to the sun; the loss of water by evaporation being made up as required. After two weeks they may be examined at intervals according to discretion, say twice a week, but oftener, if the weather is warm; and any leaves that are found to be soft and pulpy may be removed to a basin of clean water.

The maceration is the most unpleasant part of the whole business, for when the vessel is disturbed for the



Fig. 10.

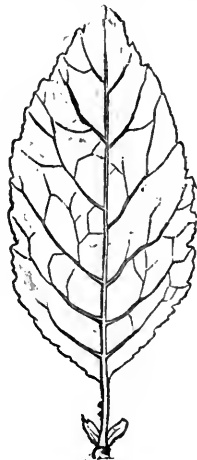

Fig. 11.

purpose of taking out the decayed, pulpy leaves, the stench is often unbearable, and the leaves look so filthy, that it does not seem possible that such beautiful results can be arrived at by these means.

A word as to removing the leaves. Until practice has taught expertness, do not attempt to remove a pulpy leaf, at any stage of the process, by means of the fingers; but have ready some old cards of various sizes—anything of the sort will do—gently cause the leaves to float, then slip a card underneath, and lift it from the water for examination. When immersed again, it will float off uninjured. Without this precaution, the novice is almost sure to destroy the decayed leaves; for, if carelessly lifted out, they will often break by their own weight.

When the decayed leaves are collected in the basin of clean water, the operation of cleaning commences. It will be necessary to have at least two brushes, one a soft camel's hair, as thick as an ordinary lead pencil, and a stiffer one, something like those used by grainers; or an old tooth-brush will do very well. A leaf should be floated on to a card, lifted out of the water, and gently brushed with the soft brush until the skin is cleaned off; then reverse the card and leaf in the water, and again slip the card under the leaf; the other side will then be uppermost; this, again, must be gently brushed to clean off the skin, when usually the fleshy parts will wash out as loose green coloured matter, leaving the clean skeleton on the card. Sometimes small portions of green matter will

adhere to the skeleton, when the soft brush must be again applied; if that does not move it, use the hard brush, but always with the greatest possible care; and it must never be used with a sweeping motion, but always with a downward, tapping motion, or the skeleton will inevitably be destroyed. Another basin of clean water should be ready at hand, and the card with the cleaned skeleton should be immersed, and the skeleton left in the water while other leaves are cleaned, or until a convenient opportunity occurs for bleaching them. It is always better to bleach the skeletons immediately they are cleaned, for if they lie very long in the water, they will sometimes take a brownish tint, which is not easily got rid of.

The skeletons may be bleached in various ways; but the simplest, and perhaps the best, method is to get some chloride of lime and well mix with water, allow it to settle, and pour off the clear liquid for use. If this is done before commencing the cleaning operation, the clear liquid will be ready to receive the skeletons when washed free from impurities. Of course, the card should be immersed in the solution, allowing the skeleton to float off. The time occupied in bleaching varies—a strong solution bleaches quicker than a weak one; but experience will show when a strong solution may not be used. Some skeletons take longer to bleach than others; indeed, they will sometimes be destroyed by the length of time they have lain in the solution, and yet not be bleached perfectly white. A delicate leaf, such as the ivy, will often be beautifully white in a couple of hours; while an obstinate sawtooth leaf has been in the solution until it has fallen to pieces, of a whitey-brown colour. When the leaves are sufficiently bleached, they must be lifted out again on the card, and immersed several times in clean water, and then finally left for, say half an hour, in a fresh basin of clean water. After that, again float them on to a clean card, taking care that they are as flat and as near their natural shape as it is possible to get them; the assistance of the camel's-hair brush will be of great service here. When nicely arranged on the card, lift them out and let them drain; then dry them off as quickly as possible, to prevent any dust settling upon them. They may be dried in front of a fire, or may be put into a warm oven for a short time; only see that they do not get baked brown, as they cannot be bleached again in that case. When dry they usually adhere to the card, but if the card be bent it mostly causes the skeleton to leave it, if not, the point of a pin will raise it at once.

They are now sufficiently strong to bear handling with ordinary care, but not until now; for it must not be forgotten, that there is great danger in handling them while they are pulpy, unless a card be used.

Most leaves and seed-vessels may be put to decay in the same vessel, but the holly, Fig. 6, must always have a vessel to itself, or its spines will injure and destroy the remainder. It gives some trouble in cleaning, from the twisted shape of the leaf, otherwise it is tolerably easy, and if the skin be nicely cleaned off the horny margin and the spines, and then well bleached, it fully repays the trouble. Of course the holly, from its shape, cannot be laid upon a card; moreover, the margin is so strong that, when the rest of the leaf is quite soft, it may be handled with impunity.

No rule can be laid down as to the time taken in decaying, except that old leaves take longer than young ones. A properly matured ivy or aspen leaf will generally be ready to clean in a fortnight of warm summer weather, while an old magnolia leaf has often lain eighteen months and then wholly decayed, without in any degree separating the skeleton. Leaves containing tan cannot be done by this process, for the tan resists decomposition. A method sometimes successfully adopted with oak leaves is to put them into a vessel with large numbers of caddis-worms, which eat away the soft parts and leave the skeleton, which is then bleached in the ordinary way.

The list of subjects available for this purpose is so large, that we can only mention a few, to give the learner a start. After that, the woods and fields, the gardens and green-houses, will be continually offering fresh subjects for experiment; and the wonderful diversity of form and structure laid bare will as continually incite to fresh efforts. All poplar leaves, Fig. 8, may be said to be easy; the silver poplar, or abele, Fig. 1, is especially easy and beautiful; so is the aspen, Fig. 2. The apple and pear of the orchard, the crab-apple of the wood, and the various ivies, Fig. 3, are also easy. The willow, Fig. 9, requires some care, as it is very delicate; gathered early it decays quickly. The maple—another beautiful leaf—must be gathered young, and cleaned with the hard brush and a tapping motion. The seed-vessel of the thorn-apple, Fig. 4, of henbane (represented to the left of the group, page 136, having six cup-like vessels), of the wild poppy, Fig. 7, of the Canterbury bell, Fig. 5, and of the columbine, all offer easy subjects.

After being bleached, they may be mounted in various ways, according to taste; but being beautifully white if well bleached, their appearance is much improved by a dark background; so that, if arranged as a bouquet under a shade, the bottom should be covered with black velvet, and some delicate leaves displayed about it. If forming a group to hang against a wall, the back should be covered with black velvet.

MARKETING.

POULTRY, ETC.

Turkeys.—A young cock-turkey is the best, and may be known by its smooth, black legs and short spurs. The spurs must be closely looked into, because it is an old trick of the dealers to cut and scrape them in order to get rid of old birds as young ones. If in good condition, the eyes will be bright and full, and the feet soft and pliable; whereas, when stale, the eyes will be dim and sunken, and the feet stiff and dry. The beak of a young turkey is somewhat soft, but hard and rigid in an old one. The legs of an old hen-turkey are red and rough, and the vent is close and firm. In other respects a hen-turkey may be judged of as a cock-turkey, spurs excepted.

Fowls.—A young cock will have short spurs, which will require the same inspection as those of turkeys. A fine bird will have a pale, smooth comb, a full, fat breast, and a large rump. The skin should be delicate and transparent. Pullets are best when about to lay, at which time they have partially-formed eggs inside. Fowls with black legs are best roasted. Game birds should also be roasted. Young Dorking, Spanish, and Cochin should be provided for boiling. For broth, an old hen will do, if well cooked. When fowls become stale, the vents become loose, which purchasers should observe.

Geese.—A young goose will have its beak and feet yellow, with a very few bristles about them; but an old bird will have the feet and bill red and bristly. When fresh, the feet are pliable, but stiff and dry when stale. The fat of a young bird is whiter and softer than that of an old bird, and the breast is plump, as is the case with all poultry in good condition; knowing which, the dealers have a trick of breaking the breast-bones, to deceive their customers, and foist upon them old birds for young ones.

Ducks.—The feet and legs of a fresh-killed duck are pliable and soft, but those of a stale one are stiff and dry. Freshness of the eye is an indication of a fresh bird. A wild duck has rather small, reddish feet, while those of a tame duck are of a dusky yellow, and somewhat large. An old duck should be kept hanging a few days before it is cooked; it will generally be lean and thin, as compared with a plump young bird.

Teal and Widgeon.—These should be chosen in a

similar manner. If young, they will be plump and fat in the belly, and if fresh they will have pliable feet. If old, they will be hard and lean in the belly, and have stiff and dry feet; if fresh, the eyes will be tolerably clear, and the inside of the mouth not rank in smell. Many stale, old, and worthless wild ducks, widgeon, and teal, are sold by street hawkers, in London, who seldom or never buy good ones.

Pheasants.—A young cock-pheasant will have short and blunt spurs, while an old one will have them long and sharp. The hen-pheasant is known by its plumage, and its flavour is preferred by many, though not by all, except when almost ready to lay.

Grouse and Blackcocks.—These are judged of as in the case of pheasants.

Partridges.—The legs of young birds incline to yellow, and the beak is dark. The red-legged French partridges are not nearly so good as the English, though much handsomer birds in the feathers. The plumage of a cock-partridge is tinged with red on the breast, while that of a hen is plain and light. In old partridges the beak is whitish and the legs are blue.

Woodcocks.—When these are fat, which is seldom in less time than a fortnight after they land on our shores, they will feel thick and firm, and a streak of fat will appear on the side of the breast. Fresh birds will have supple feet, and the head and throat clear; whereas, when stale, the feet are stiff, and the head and throat are nasty.

Snipes.—These must be judged of by the same rules as woodcocks.

Pigeons.—Tame pigeons, when fresh and in good order, are plump, and have their feet pliable and of a dusky white. If they are stale, the vent is discoloured. Wild pigeons are not reckoned so good as tame, but they improve with keeping. Wood-pigeons run larger and not so fat; they are to be chosen by the same rules as the others.

Larks and other small birds should be fat or plump, not too "high," and with pliable feet.

Hares.—An old hare does very well for soup, but for ordinary purposes it is by no means desirable. It will be distinguished by its dry, tough ears, its blunted claws, and its widely-parted lip. A young hare has soft and tender ears, sharpish claws, and the parting of the lip close. When in good condition, a hare is thick in the loin; if fresh, the body is stiff, and the flesh not very dark, but when kept it becomes softer and blacker. For present use, it is well not to purchase too fresh. In choosing a hare, one that is long in the body will often turn out the most economical. A leveret, or young hare, generally has a small knob or bone on the fore-leg, near the foot, which disappears when the animal reaches full maturity. The leveret should be bought and cooked before it becomes *high*, as it is best eaten comparatively fresh.

Rabbits.—An old wild rabbit has long rough claws, and fur often inclining to grey. When fresh, the body will be rather stiff and the flesh dry and pale; but if stale, it will be limper, and the flesh dark-coloured. Some choose both hares and rabbits by feeling the first joint of the fore-leg, but it requires practice to acquire this skill; and it is doubtful whether the supposed differences at that joint, in animals of various ages, really exist. It is said that in a young rabbit the bones of what is called the knee-joint of the fore-leg are not so closely united as in an old one. Ostend and tame rabbits, sold ready skinned, should be chosen fresh, and not too fat, and with the meat rather plump and pale. These make good pies, and are better stewed or boiled than roasted. For roasting, wild rabbits are usually selected, and, with brown onion-sauce and good stuffing, form an agreeable addition to a dinner rather than a dinner in itself.

THE REARING AND MANAGEMENT OF CHILDREN.

MORAL INFLUENCE: LOVE AND FEAR.

THE affection which a mother feels for her offspring, being one of the strongest instincts of our nature, is sometimes supposed to need no culture. Yet nothing is more opposed to true maternal love than the excessive fondness apt to be displayed in caresses, with which, upon all occasions, a mother is tempted to humour the caprices of a little child. Thinking that one so young is incapable of knowing right from wrong, a tender parent hesitates to impose restrictions on her infant's wishes. At the same time such restrictions are needful, and tend, in the end, to establish a more lasting affection than would result from over-indulgence. When the age of reason arrives, and children weigh the actions of their parents as in a balance, the difference between the love which imposed self-sacrifice for the sake of the future, and the thoughtless folly of present gratification, are strikingly apparent. Childish hardships if not then forgotten, merge into grateful recollections, whilst over-indulgence is regarded as the stumbling-block of life.

The highest test of maternal love is the judicious blending of approval or reproof, according as it is right or wrong to gratify a child's fancies. That description of love which consists in anticipating every wish, and humouring every whim, is but the shadow of affection. The time comes when baby-passions are no longer to be quelled by bribes of sweetmeats and toys; and a bond of love which has been formed mainly on so insecure a foundation is ready to be broken at the first sign of opposition.

It is hardly possible to specify the means by which the growth of true maternal love may be secured. The first requisite is, that a mother should be convinced of the necessity of checking herself whenever she feels that she is deviating from the path of duty. If she knows that it is wrong to give way to her babe's will, she may rest assured that by so doing she is losing her hold on its affection. Trivial as the occasion may apparently be, any act which excites a child to an outburst of passion, and prompts to rebellion, is to be regarded in the light of a serious matter. It may seem a small thing to dispute whether a child shall lie down, for instance, before he is tired with play or not; but if the appointed time for taking repose has arrived, there should be no hesitation in causing the games to be ended. Again, if a child wishes to remain with his parent when it is not convenient that he should do so, a fit of crying should not be heeded, proceeding, as such appeals do, from disappointment, not pain.

Sympathy with unavoidable infantile sorrows may be most freely indulged in. But the sympathy should be of a kind which indicates that the grief of the child, although shared by the parent, must be borne patiently. Where very young children are concerned, gentle firmness of manner is the most convincing argument on these occasions. Wayward children should be suffered to perceive that their waywardness is a cause of real sorrow to their parents. And it is surprising how keenly affectionate reproaches are felt by sensitive little hearts.

Children like to feel themselves of sufficient importance to produce an effect on their elders, and, being naturally tender-hearted, they lend their efforts to dispel any cloud they may perceive upon the parent's brow. The knowledge that they are doing something against their will for a purpose, often induces them to overcome a repugnance to perform a required duty.

The sense of justice is strong in very little folks. In order not to do violence to this feeling great care is needed on the part of parents in making the reason of their actions plain whenever misrepresentation is liable to take place. Children of delicate health are especially exposed to trials

of temper in this respect. They see their playmates partaking of certain pleasures which are denied to themselves, for no sufficient reason, as far as they can perceive; from not realising the motives which prompt their parents to make them exceptions to the general treatment, they only feel the result. An intelligent mother will be careful not to make these privations more painful than they must inevitably be. Whenever any pleasure is interdicted to a single member of a family circle, she should endeavour to find some adequate compensation for the disappointment of the sufferer. By so doing, a brooding spirit of discontent is prevented, and a feeling of grateful confidence becomes established between parent and child.

Without perfect trust in the guidance of a parent, no affection can be very lasting. Therefore, whether it be in giving pleasure, or in causing unavoidable pain, the child's ultimate good should ever instigate a mother's actions. The folly of telling an untruth to gloss over a disagreeable task is productive of endless trouble. If suffering has to be borne, or a dose of nauseous physic has to be taken, what is so likely to produce a rebellious spirit on the recurrence of the trial, as for a child to have been led to believe that a painful operation does not hurt, or that a repulsive dose is not nasty? It is far better to say at once, "What is going to be done will perhaps hurt you for a minute, but it will take away your pain afterwards;" or, "The medicine is certainly not nice, but it will make you well." The promise of a reward in either case is fair enough—ay, and it is better to make the reward excessive in the child's mind, than that it should fall short of the expectations raised. If once it can be proved that the mother's predictions are verified, a great step will have been made towards securing perfect reliance on her judgment; in fact, there is no surer method of implanting true filial affection than by telling the truth to one's child on all occasions where alike pleasure or sorrow are concerned. No one is so apt to prescribe the antidote to distress of mind as a mother. She is equally fitted to temper exuberant mirth with discretion.

Second only to the power of love in the management of children is the rule of fear. Mothers usually intimidate very sparingly—some threatened correction is the ordinary mode by which they exercise fear. The indifferent and uneducated persons generally, find terrifying young children a most effectual mode of ensuring submission. Hence the nervous dread of darkness, mysterious sounds, and unaccustomed appearances. The agonies which many little folks endure from these cruel tyrannies are enough to make a strong mind quail when, later in life, the sufferings are remembered. Dark closets, bogies, and ghosts, are the horrors by which ignorant servants are liable to get their end accomplished, whenever they have to do with a refractory child. Happily, public opinion is becoming so universally opposed to this system of terror, that young children of the present day suffer less from fear than in past times. Still, the practice undoubtedly exists largely in nurseries where the supervision of the mother is not very active. And what makes the vicious habit particularly difficult of detection is the secrecy which is imposed on the infant mind relative to the infliction. Few little boys and girls will betray their nurse's malpractices, without they are unwittingly led to an avowal. There are sure signs, however, by which such treatment may be discovered. These will be found in anxious looks and shrinking movements when places of terror are approached. If asked on the spot, the children will probably deny the existence of any terrors of the kind, for the dread of being "found out in telling tales" overrules all other nursery fears, but observation and tact will always bring about an open confession, provided a parent be desirous of learning the truth.

The first indication of fear is found in shunning dark-

ness. A well-managed child knows no dread of night ; taught by a wise mother that darkness is a sign that little folks should go to sleep, they look upon night as the curtains which are drawn across the sky, to shut out the light for the express purpose of securing peaceful slumber. No other interpretation of night should a little being be suffered to know from the commencement. But if, unfortunately, darkness is made a period of terror, a reign of ghosts and evil spirits, it is impossible but that children should succumb to the dread of night, making the extinguishing of a candle a fearful calamity. With beating heart does many a little victim to childish fears bury its head beneath the bed-clothes, striving in vain to sleep.

The best remedy for evils of the kind is boldly to assail them. By learning all about the terrible dread, a mother is enabled to prove the utter falsehood of the assertion that such things as ghosts have any existence. She should lead her child hand in hand to the dreaded places, and, knowing no fear herself, dispel its presence from her child's mind. If, however, the nervousness has become confirmed, it will be necessary to leave no scope for its influence. Lamps and night-lights should be placed wherever the little sufferer is likely to be exposed to fright ; a bell should be within reach, and every precaution should be taken to supply supposed means of safety.

HOUSEHOLD AMUSEMENTS.

THE GAME OF BÉZIQUE (*continued*).

HAVING explained the principles of the game (pages 69 to 71), we will proceed to give some advice to the learner.

When the cards have been dealt, sort those in your hand into their respective suits before playing. Look over them carefully at the outset, to see what combinations they give promise that you may obtain ; keep the most likely cards in reserve, and hold the worthless or unpromising ones in readiness to play to tricks. If, for instance, you have two kings or two queens dealt to you among the eight, there is a probability that you may soon obtain two more, or the opportunity to declare one or more marriages. If at first you have one or two of the five trump cards which compose a sequence, do not part with them, as you may obtain the rest. A sequence is always a good thing to aim at, when there is reasonable prospect of success, as the number scored for it, 250, goes far towards the game.

If you are the non-dealer, and have to lead a card, do not play a small trump, if you can help it. Reserve such cards as long as you can conveniently, as they will enable you to take tens of other suits, or to secure tricks when you wish to make your declarations. If you have a ten of a suit not trumps, lead it, for tens are good leads early in the game. In order to take the ten, your opponent might have to play an ace, and thus spoil a chance of four aces. If he has a small trump he may take it, but it is probable that he may be without one, and thus your ten will pass safely.

Tens are of more importance in the game than young players are apt to believe. Winning or losing a ten makes in reality a difference of twenty to the score, as the one side is kept back as much as the other advances.

After a few tricks have been taken, the character of your hand may probably be changed by the fresh cards drawn from the talon. A hand that is very unpromising at the outset often assumes a different complexion by the drawing of two or three new cards, which make it a strong one. You must therefore be prepared to relinquish any particular design you may have formed, if you can substitute for it something still more promising.

When you hold several promising cards, and are embarrassed as to your choice of those which shall be kept, the following rules may be found of service :—

It is rarely advisable to retain knaves for the chance of four, as the score is only forty ; therefore, part with your knaves in preference to your queens or kings, even if you hold a greater number of the former. Play, also, with aces, if you have the opportunity of making them in your tricks, for you may cramp your hand for a long time for the opportunity of obtaining four, and when they are declared one or two of them may be won from you by your opponent. Keep kings or queens early in the game, as you may gain both the combination of four, and two or three marriages. Relinquish queens in preference to kings, when the chances of both seem about equal, as the latter score the higher number.

If you have declared four kings or four queens, use some of them immediately in playing to tricks, as this will enable you to hold new cards for a fresh combination ; but be careful to reserve those which will count in a sequence or *bézique* ; or in a marriage, if you have drawn the corresponding card.

As a general rule, play as soon as possible with declared cards. By doing so, you can not only retain the new ones for fresh chances, but you keep your opponent in the dark as to what you may hold, and this is important. When your cards are revealed, he knows at once what it is still possible that he may get, and this often alters the whole character of his play.

The same rule of course holds good in your own case. Notice carefully your adversary's declared cards, and be guided in your own play accordingly. Thus, if he declares four aces, kings, or queens, do not, as a rule, seek to gain that particular combination yourself, for he is very likely to draw a fifth or sixth, and thus to make your success impossible. So if he declares four queens, and two of them are queens of spades, you know at once that you cannot gain *bézique* or double *bézique* during that hand, and can therefore part with the knave, or knaves, of diamonds, which you may have been keeping in reserve.

Be also on the watch for a similar display of sequence cards, as an incautious adversary, by the exhibition of two kings, &c., of the trump suit in his declarations, may show you at once that you cannot gain a sequence, and release your hand for other combinations. Not only so, but if you see a sequence card played to a trick early in the game, you may generally conclude that the corresponding card is in the player's hand, or he would not relinquish the chance of the sequence by playing it.

To watch the game in this way, and to remember at all points what cards have been played, is thus of as much importance in *bézique* as in whist ; and, all other chances being equal, the game will be with the player who exercises the best memory.

We will add here a few remarks as to the advisability of holding cards for the higher combinations. Do not part with *bézique* cards in the early stages of the game, and, as long as you can, avoid making a declaration, which will show that you hold them. If you get two *bézique* cards, and draw a third, retain them all for the chance of a double *bézique*, until the talon is almost exhausted, or until your adversary shows that he has the fourth in his hand. You may, however, declare the single *bézique* as the game advances, retaining the cards for the double *bézique* as long as it seems likely to arise.

With regard to the next highest score—*i.e.*, that for the sequence—the remarks we have already made will guide you in most stages of the game, but we may add that when the talon is getting low, and you hold but three of the sequence cards, it is often advisable to relinquish the chance, to secure some less important combination. Be careful to declare your royal marriage *before* you show the sequence, as the declaration of the latter prevents that of the marriage afterwards.

Look after the seven of trumps, if it comes into your

hand, that you may not inadvertently play it away before declaring and scoring for it. Sometimes, however, you may be compelled to play it without scoring for it, as when all the other cards in your hand are certain, or almost certain, to score. If you take an ace or a ten with it, the loss of the score for it is counterbalanced by the gain of the ten from the adversary. But if a sequence card has been turned up, secure it by exchanging your seven for it, even if you have to spoil four aces by playing one to the trick. If you hold the same card yourself, you will still, by taking it, prevent your adversary from gaining his sequence in that hand.

If you find, in the play, that a particular card, or a particular suit, embarrasses your opponent—as you may perceive by his hesitation to play, or perhaps by his sacrifice of a ten in the trick—play another of the same kind, if you can, immediately afterwards. And so, if you, being leader, have risked a ten, and your adversary is compelled to pass it, play any other ten you may hold, as this may possibly be the best opportunity that will arise to make it.

Your play must be regulated in great measure by the state of the score towards game. When it approaches the conclusion, you must “play to the score,” as the phrase is—that is, you must keep in view at every trick the influence it will have on the score, rather than the loss of cards which you might wish to hold under ordinary circumstances. Thus you will secure as many aces and tens as possible; and you will take as many tricks as you can, won by using sequence or other valuable cards, so as to keep your opponent from declaring, if he should hold the necessary cards. The game is often won in this manner.

Secure the last trick if you possibly can, not only because it counts ten, but still more because it gives you the last opportunity of declaring, and debars your opponent from a declaration for which he may have been waiting. Therefore, if you have the lead, play the ace of trumps, which you should always reserve for this use when you hold it. We have repeatedly seen the declaration of a sequence, or other good score, prevented by bold play in this fashion, during the last trick or two before the cards are all drawn.

In the play of the last eight cards, your only aim is to secure as many as possible of the remaining aces and tens, which count ten each towards game. In order to do this, you must first remember the cards the adversary has declared, and has had exposed upon the table, and play out an ace when you know that he can follow the suit, or a ten when you have reason to think that he has not the ace, but holds some other card of that suit in his hand. Lead your trump cards when you think the opponent can use his to take your aces and tens from you. Reserve as many trump cards as you can, towards the end of the hand, for the same purpose.

A few observations on three-handed and four-handed b3zique will be given in another paper.

DOMESTIC MEDICINE.

DIABETES.

THIS disease is not very uncommon; and though far beyond the bounds of domestic medicine, its nature and general treatment may properly be explained here. There are two kinds of diabetes, very different from each other. The one symptom which they have in common is, that persons affected with them pass an unusually large quantity of water. In the one case, diabetes insipidus, the water is thin, light, and watery; in the other, diabetes mellitus, it is heavy and high coloured, and contains a large quantity of sugar. We shall describe first, and very shortly—

DIABETES INSIPIDUS.

In this complaint a great quantity of water is passed in the course of twenty-four hours. The calls, moreover, are very frequent, even in the night. The thirst is very great. It is not easy to say where all the water comes from; for even when water is not drunk, it accumulates in the bladder, and has to be frequently passed. Five and six, and even nine and ten pints of water are passed in twenty-four hours. Excessive thirst is very frequently the first symptom noticed. The causes of this complaint are obscure, and the treatment of it should be left entirely to a medical man.

DIABETES PROPER, OR DIABETES MELLITUS, is a very different disease.

Symptoms.—Like the former complaint it is characterised by great thirst, and by the passing of a large amount of water. The appetite is generally good, even large. There is more or less ailment and disturbance of the general health. There is loss of muscular strength, and other effects; often there is pain in the loins. The skin is dry and hot, with sense of burning in the hands and feet. The body shrinks in bulk, and loses weight; and there is often great mental depression and irritability. There is an unusual liability to boils, and also to cataract. In young persons affected with diabetes there is a liability to consumption. But the most remarkable features of this disease are in the urine; the quantity of this passed is very large. The natural or average quantity passed in twenty-four hours is about two pints; in diabetes patients sometimes pass forty pints; and respectable writers have recorded cases in which seventy pints have been passed in twenty-four hours. But it is not the quantity of urine, but a certain quality of it, which is characteristic of the disease of diabetes. This quality is its containing sugar in large quantities, which raises the specific gravity of the urine. Supposing the specific gravity of water to be 1,000, that of urine, containing sugar, may rise to 1,040 or 1,050. The specific gravity of natural urine varies from 1,015 to 1,025. Diabetic urine contains not only sugar, but urea and other solids in excess, which result from the loss of weight in the body.

Such, in general, is the nature of diabetes. Much has been done lately in the way of elucidating it; but it yet remains a considerable mystery, even to medical men. The great question is, Where does the sugar come from? Much of it, no doubt, is taken in the shape of food. Not only is sugar taken directly in food, but a great deal of starch is taken, in the form of bread, potatoes, sago, &c.; and starch in the diabetic system is converted into sugar. In healthy people, however much sugar is taken, it will not appear in the urine as sugar. It was lately thought that the true explanation of this disease had been discovered. A French physiologist, M. Bernard, thought that he had made out that sugar is formed in the human body, in a state of health, *in the liver*, but that in health it does not long remain as sugar, in the blood, but on being taken at once from the liver to the lungs, is there converted into water and carbonic acid. In the diabetic patient it was thought there were two faults: first, that an unduly large quantity of sugar was formed in the liver; and, secondly, that it was not converted in the lungs, but passed on into the general current of the blood, and carried out of the body by the kidneys. This theory of Bernard has, in the opinion of most physiologists, been falsified by the researches of Dr. Pavy, who seems to have shown that this formation of sugar in the liver does not happen in live animals, but only after death, and that Bernard was misled by testing the blood and the liver of dead animals. Another important discovery has been lately made—that diabetes (*i.e.*, sugar in the urine) can be produced temporarily in

animals by irritating with a sharp instrument a certain spot at the top of the spinal marrow; by giving chloroform, &c. &c. It is important also to associate this artificial production of diabetes—by irritating the top of the spinal cord—with the fact that in actual cases of diabetes in the human subject there have been found faults in the nervous matter along the arteries of the brain and spinal cord. Such discoveries as these may lead us to hope that we shall one day understand, and perhaps be able to control, the formation of sugar in the human system. Meantime we can only mention a few of the

Causes that tend to produce diabetes, or to make it worse:—Worry and anxiety are among the causes of diabetes or the things that aggravate it. Diabetes occurs sometimes in more than one member of a family, and so seems to be occasionally hereditary. Cold east winds, and fatigue, and all causes of disease or exhaustion, are to be avoided; for cold and diseases that would not hurt others are very dangerous to diabetic patients. Great bread-eating is unfavourable in diabetes; so also is the habit of drinking sweet wines, starchy sorts of food, and other things that may be converted into sugar.

Treatment.—One great point in the treatment is to give food having two qualities. First, that it be *nutritious* (for the body is thin and wasted); and, secondly, that it does not contain much sugar or starch. Common bread is not to be taken in great quantity, because it contains starch, which is convertible into sugar. Various substitutes have been provided for it, of which Camplin's biscuits and almond rusks and biscuits are the best. Amongst other forbidden things are, not only sugar, but pastry, fruit, confectionery, potatoes, carrots, parsnips, beet-root, turnips, radishes, macaroni, rice, sago, tapioca, arrowroot, liver, oysters, lobsters, carp, mussels, beer, port wine, liqueurs, coffee. But it is doubtful whether too sudden and too absolute a change of diet is good. Meat, poultry, game, ham or bacon, white fish, eggs, milk, or, better still, cream; Neufchatel, Stilton, or cream cheese; butter; greens, such as lettuce-leaves, spinach, and water-cresses; beef-tea, good fresh water, tea, soda-water, Vichy water, sherry, claret, Burgundy, or weak brandy and water, are the articles with which the body must be supported and refreshed.

It is very important to prevent cold being taken, and warm clothing should be worn. It is also highly necessary to secure a proper amount of sleep, to avoid fatigue, worry, and anything that depresses and exhausts the body or the mind.

Remedies.—We cannot enter into much detail here, for the case of diabetes is much too serious for domestic medicines. We will only indicate the kind of medicines that have been found useful—steel medicines, alkalies, opium, cod-liver oil, and bromide of potassium.

We will only add that, with proper care concerning food and clothing, rest of mind and body, and proper treatment, diabetes may be either cured or controlled to a great extent. The older the patient, the better the prospect of keeping the disease in check. When recovered, diabetic patients should still live carefully. There is, perhaps, no disease in which care is so well repaid. It is wonderful how, with proper care and suitable remedies, the specific gravity of the water will fall, the thirst will diminish, and the patient feel altogether stronger.

DIARRHŒA.

Diarrhœa (from *διαρρέω*, to flow through) is a complaint that most people have occasionally, and think they understand. It certainly is a complaint for which domestic medicine is naturally resorted to. Sometimes, indeed, this seems rather to aggravate matters than to help them; but if a little explanation of the different causes of the disease is given, more good and less harm will be done. We have already alluded to the complaint as a very

common and serious one in infancy. It is very fatal to children, especially in large towns, and to children who are being brought up on artificial food. All this we have set forth in a former article. We are to consider, now, the diarrhœa of grown-up people. This is a far less serious and fatal disease than that of children, but, nevertheless, incommodes and disables a great number of people in the course of the year.

Symptoms.—The symptoms do not need much description; the chief one is the frequent action of the bowels, and the passage of loose motions. The motions may consist of little more than watery fluid; or they may be yellow, and contain much bile, or, at any rate, the colouring matter of bile. There may, or there may not, be sickness. Sometimes there is a mere feeling of sickness, and at other times the patient vomits everything taken, and quantities of watery fluid besides. In very hot summers, the amount of fluid discharged, by sickness and purging, from the bowels is sometimes enormous. It makes the patient very weak and cold, gives a sunken appearance to the eyes, and a very shaky feeling to the knees. The attack may be accompanied by sharp, griping pain, or it may be nearly painless. The tongue is generally furred, but it may be clean. This condition may last only for a short time, or it may go on for days together, or even weeks.

Causes.—Diarrhœa is caused by many things, but there are one or two which are particularly to blame. One of the most powerful causes of the disease is season. Summer and autumn are particularly active in producing diarrhœa. The hotter the summer, as a rule, the more diarrhœa there is. In the very hot summer of 1868, it was very prevalent, and very fatal to young children. The heat is the principal cause of the complaint, and it seems to act in two ways. It acts, *first*, on the patient's system directly. It relaxes the system, and it probably increases the amount of bile secreted by the liver; and this, thrown into the intestine, causes diarrhœa, or *cholera*, which means simply a flow of bile. The heat acts, *secondly*, on the earth, and on all the things upon the earth, especially upon the things that are allowed about dirty, ill-kept houses; on animal and vegetable matters that are allowed to accumulate, and undergo change and decay, instead of being at once removed. The heat decomposes these things, and causes exhalations from them which poison the system and produce diarrhœa. It is for this reason that it is so important to have the water-closets of houses all in order in summer-time, and to allow no collection of organic matter about them. In large towns, diarrhœa is known to be worst in the dirtiest houses and streets.

Though heat is the principal cause of diarrhœa, it is often helped in its action by errors of diet, by taking things which irritate the stomach and bowels, such as unripe or unsound fruit, sour drinks, especially sour beer, unwholesome food, too much cheese, &c. But it is not at all uncommon to meet with cases of diarrhœa in which no irregularity of diet can be traced.

INMATES OF THE HOUSE.—DOMESTIC.

THE LAUNDRY-MAID (*continued*).

WHITE cotton stockings should be washed on the right side, and turned inside out before putting into the copper. If very much soiled, they may be safely cleansed by using a stocking-brush, made of fine fibre for the purpose. Woollen stockings should not be boiled, but must be turned before putting out to dry, otherwise the colours will run. Neither stockings nor socks should be wrung lengthwise, but across, by the laundress placing her thumbs at the tops and gathering up the whole length in creases, when one twist of the hands will be sufficient to wring out the water.

All the white things being washed, the coloured articles should undergo the process of two rubbings and one rinsing in clean cold water; but not boiling, unless the clothes be servants', and very greasy. Coloured muslins should be left in the rinsing water till the moment of hanging them out, to prevent running. A handful of salt in the rinsing water will often prevent running. When half dry, it is a good plan to take both coloured woollens and cotton things off the lines and shake them well out, before re-hanging them to finish.

Babies' diapers should never be washed in water containing any soda. The effect of doing so is to produce irritation of the skin, which is rarely attributed to the right cause, and often occasions unnecessary physicking. On this account, infants' under-linen should be washed in the rinsing-suds of flannels, and should be boiled before soda is added to the copper water.

Kitchen cloths and coarse things require much the same treatment as other articles. If very greasy, a little lime may be added to the copper when they are put in to boil. Some people consider powdered pipe-clay an excellent mode of cleansing coarse cloths. Messrs. Robertson Cook, and Co.'s washing preparation is also recommended for the purpose, but, with careful use, ordinary soap and soda ought to be sufficient to preserve the whiteness of kitchen cloths. No kitchen cloths should be put aside dirty after use.

When a wash is finished, all the utensils should be scrubbed and put aside in their appointed places. The lines should be wiped dry, and twisted across the hand and elbow of the laundry-maid into a neat coil before being placed in a bag. The pegs also should be collected into a separate bag, and all things left in readiness for the "getting-up," which must form the subject of a subsequent chapter.

When the things are brought in from the wash, the laundry-maid should sort each kind into separate heaps—flannels, muslins, table and body linen, and coloured things requiring a different treatment to get up. Folding and starching follows. Begin with starching.

To make Starch.—About two ounces of maize starch should be allowed to every quart of water. The starch should be mixed in a clean earthenware bowl, by gradually pouring on a sufficient quantity of cold water to reduce it to a thick paste. Then add the hot water from a kettle, *whilst boiling on the fire*, stirring all the time, to mix the starch evenly. Generally, no boiling afterwards is necessary. If, however, the starch should appear at all "lumpy," it will have to be boiled and strained through a fine sieve.

It is a good plan to melt about two inches of composite, wax, or tallow candle, to a bowl of starch, in order to prevent sticking to the irons. Also, if the starch be intended for coloured things likely to "run," a little salt should be added. This applies particularly to black and white mixtures and braid. "Glenfield Patent Starch," so strongly recommended as the only starch used in the Royal Laundry, is best for fine muslins and lace, to which may be added, if preferred, a small quantity of white wax. "Australian Satin Glaze Starch" is well adapted for articles that require extra stiffness, such as gentlemen's collars and cuffs. Ordinary rice starch is good for wearing apparel generally, and plain flour starch for servants' kitchen gowns.

Begin with starching the muslin and net materials. These should be dipped into hot starch of moderate thickness, and should be afterwards slightly squeezed in cold water. They should then be tightly rolled in a clean coarse wrapper, for several hours before ironing. Hanging lace and muslin in the open air after starching is liable to make them limp, unless the weather be very sunny. If dried in the open air, they require damping afterwards, like all other dried starched things.

The usual plan is to sprinkle all starched materials after they have been dried, and to leave them for some time in the wrappers, as described; but in families where washing at home is practised, and saving of time and trouble is a consideration, the following plan will be found more expeditious and quite as effectual:—Having starched all the articles in the usual manner, take a clean coarse wrapper, made of old sheetings, towels, or the like, and lay the starched things as smoothly as possible on the surface, covering them with a cloth of corresponding size. Then fold the wrappers over to the size of the rollers of the mangle or wringing-machine, and pass the rollers over them once. This will have the effect of squeezing out all superfluous water, and reducing any lumps of starch to evenness. In fact, the articles are half-ironed by the process, and are ready for immediate finishing. Shirt collars and linen cuffs are better done by the above plan.

The starching process being completed, folding for the mangle is the next work. In doing this, the object should be—to fold the things in as few folds as possible, and to keep the materials as straight as the shape admits of. Garments, such as night-dresses and under-linen, should be commenced folding at the bottom, shaking them well, to prevent unnecessary creases. Gentlemen's shirts should *not* be mangled. After the wristbands and collar have been starched, the shirt should be laid flat on the dresser, and the fulness of the back smoothed open; then lay in the starched places on the bosom, fold the sides of the shirt over and over, and roll the shirt up as tightly as possible into a small bundle for several hours.

Some care is required, in folding sheets and table-cloths for the mangle, to keep the folds even. The best plan is to begin by folding the article in half (two persons are required for large things), then take up the corners at each end, and bring them to the middle fold, pull the article straight, and flap it up and down a few times, fold across, and lay it on the dresser, where any rucks should be smoothed out by hand. By the above plan, it is easy to pass an iron along the seams, without unfolding the whole article. Table linen and sheets require to be passed through the mangle twice or three times, body linen (afterwards to be ironed) only once. Cotton stockings should be mangled on the right side, and ironed on the wrong.

Ironing.—Cover the table or dresser with a coarse ironing flannel, doubled, or a piece of old blanket. Stretch over it some clean old sheeting, fastened to the table at the corners with flat-headed brass nails. Have at hand a basin of clean cold water, to damp out any folds that may have been badly ironed. Rubbers and iron-holders should be scrupulously clean. A knife-board, sprinkled with Bath brick, is the cleanliest mode of polishing flat-irons.

The heat and size of the irons should be regulated according to the articles to be ironed. Flannels require a heavy, cool iron, and calico scorches with less heat than linen.

The plain linen articles should be ironed first, and hung to air, whilst the lighter materials are in hand. Muslins and net require ironing twice, being gently pulled every way of the thread between each ironing. Embroidered muslins should be ironed over several thicknesses of flannel. As a general rule, all fine muslin work is better first ironed through a piece of old thin cambric: this prevents scorching, and also clears the muslin from the starch. Gentlemen's linen fronts and cuffs should always have the iron first passed over them in this manner.

In ironing pocket-handkerchiefs, the iron should be passed along each side before the middle is touched, the ironer slightly pulling the corner in the left hand, whilst she irons with the right. To form pleats neatly, the frill should be laid straight in front of the ironer whilst she makes the creases of the desired width with the nail of the right hand, the left holding the point of the hem in place till the iron is passed over it. All pleats must be laid even to the thread.

ANIMALS KEPT FOR PLEASURE AND PROFIT.—THE HORSE.

THE HARNESS HORSE.

High-class Carriage Horse.—Instead of pursuing the subject of saddle horses, which would have led us to the hunting-field, we turn aside to notice the remaining classes of harness horses. We gave a succinct account of the useful hack and harness horse early in this series. The present class is not less useful, but it is a more limited class, and ornamental at the same time. Indeed, this latter quality is a necessity, for most of them are bred and sold for the London market, and are seldom much used off the stones. There are other kinds, smaller, better, more numerous, of which we shall speak when we come to talk of light broughams, mail phaetons, and dog-

The late Mr. Ramsay, then of Bushey in Hertfordshire, sold "Coventry" to Lord Ongley, for seven hundred guineas, having once refused a still larger sum; and this is, perhaps, the longest price given for a single harness horse. These would now be called the "prime old-fashioned sort," because their tails were docked in a fashion somewhat after the modern sporting publican's form. We should like to see more of them, docked or undocked; and we subjoin a sketch, inferior indeed, but illustrative of what we mean.

Now the carriage horses we so much covet should be something like this, but in pairs. Their attainment is very difficult, and when found there is, notwithstanding the great prices, a great demand. Their carriage horses are the pride of certain families, for whom the dealers are on the look-out at all times; and they can only thus

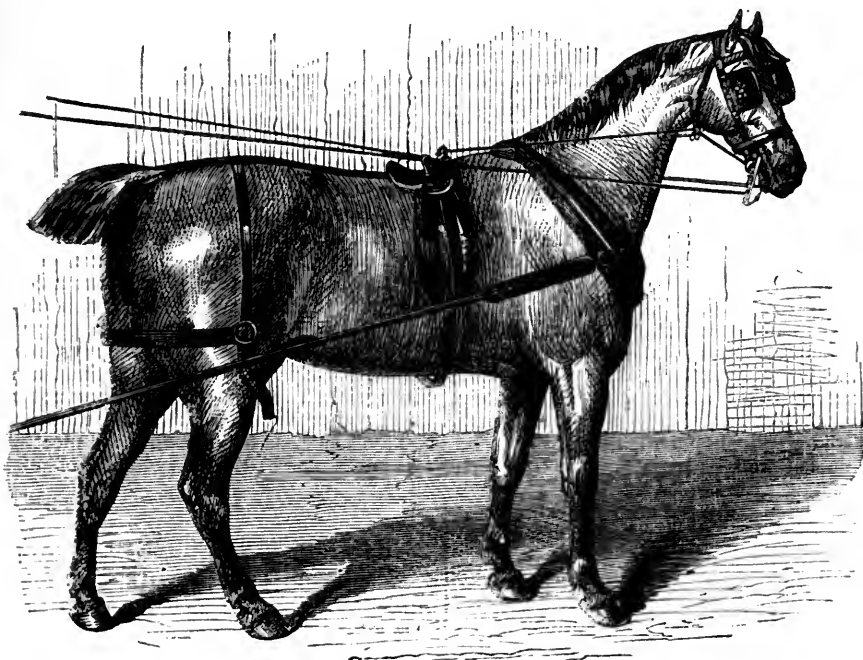

OLD-FASHIONED HIGH-CLASS CARRIAGE HORSE.

carts. At present the writer has before him one of those magnificent animals, great in great capitals, and of inestimable value in the Row, the Bois, and the Prater.

The handsomest horses we have ever seen of this kind were the horses of private cabs. The carriage is very heavy, on C-springs, with a quantity of iron-work, and a small tiger (groom) hanging on behind; but with such horses as Lord Chesterfield, Counts D'Orsay and Batthyany, Mr. Line Stephens, Lords Gardner and Pembroke, drove, it was exceedingly handsome. The prices they sold for were enormous; and only a few years ago a baronet, remarkable now for his hacks, was tempted to give five hundred guineas for a dark chestnut. We should perhaps describe the best we ever saw, if we were able to do justice to a hog-maned bay horse of Lord Chesterfield. He was a good bay, sixteen hands, looking quite thoroughbred, round as an apple, with a light head and neck, and magnificent shoulders; and he had this great peculiarity, that he could move as grandly at five or six miles an hour between the Marble Arch and Apsley House, as he could at the rate of sixteen between Apsley House and the Barracks, not at that time the popular drive that it is now.

be served. What would be considered almost a fabulous sum, is sometimes asked and obtained, if the horses are sound and of very unusual excellence. Their heads must be small, their necks beautifully arched, if not by nature, brought into place by education; their shoulders oblique and high in the withers, for the saddle will never gall them; their backs short, barrels round, quarters long, and their legs and feet as sound as legs and feet can be. This is absolutely essential, as their action is to be high and true; and though they, many of them, tread upon the old stones as if they were new-laid eggs, they should go into hospital as soon as the London season is over, if there is a hope of keeping them for any length of time; an inclination common to all who have them.

The reader has been made familiar of late years with many of these sorts of horses, at various horse-shows, which can only belong to the aristocracy or the very wealthy commoner, who, if he may indulge a social vanity without ridicule, had as well indulge it in horses as in anything else. The worst of it is, he is apt just to overdo it. The Duchess of Beaufort has exhibited some beautiful brown carriage horses at Islington; some of the

respectable dealers who supply the London market, or who job them by the season, usually have some very handsome pairs. The dealer should be an excellent judge of action, and always drive good steppers.

These horses, of course, are too valuable to be "picked up," as it is called, here, there, or anywhere. They are made to order. The counties which have been remarkable for them have been Lincolnshire, Northamptonshire, and Shropshire; and successive crosses with the Cleveland bays, always by a thoroughbred horse, supply the best of them. The carriages in which they are seen to best advantage are the large, roomy, C-spring carriages; as they are somewhat too large for the mail phaeton or the brougham, unless it be exceptionally heavy.

We have here only taken into consideration the very best of our carriage horses. Those who desire to approach the fashion without paying for it, are compelled to put up with some faults, which, in a cursory inspection as they pass along the street, escape detection. Thus, unfortunately, from the habit of sending unsound sires into the provinces, many of our handsomest London carriage horses, double or single, are roarers or whistlers. The noise of the wheels serves to drown all other sound, and it is not till pulled up with a jerk that the admiring passenger looks with pity upon so fine a model. They may have also curbs, a thoroughpin, bad windgalls, or defective vision in double harness, and yet pass muster on a drawing-room day. This is the *videri quam esse* principle so common to our times. We mention it, without recommending it, for the information of our readers.

Light Phaeton and Brougham Horses.—We are not aware that any writer mentions a fact, usually known and acted upon by good amateur coachmen—to use small and moderate-sized horses for all light work. There is nothing to be gained by putting two large carriage-horses into a phaeton or brougham. The low, short-legged horse, with plenty of activity and good shoulders, if he have good action and carry himself well, is large enough at fifteen hands. A pair of smart little horses, handsome enough for London, and good enough for the country, would cost in a dealer's yard, or at the hammer, as much as from £100 to £200. When sound they are far less liable to injure their legs and feet than the larger and heavier horses, who are always kept round and fat; and they do not look amiss when in good working condition, which your tall thoroughbred horse is sure to do. They are also quicker on their legs, and capable of doing a journey into the country. No person in the country would ever keep the larger sort, as they are out of place. If a horse-owner has leisure to do so, he may buy horses of this class separately, at moderate prices; he will have only the inconvenience of matching them. But a buyer of horses ought to be prepared to buy at all times, if he expects to be suited. There is nothing so difficult as meeting with what you want in horseflesh at the moment you want it. Perhaps within a week of having purchased the nearest approach to your requirement, you will meet with the very thing you wanted at less money than you have already given. A match horse is a valuable animal, and there is no means of fixing a price for a really very good pair of any sort: the value of either is doubled, and sometimes trebled. They want not only form, height, and action, but even colour. Greys, chestnuts, and blacks match handsomely in any form; but in other colours there should be uniformity.

Of Single Harness.—To what we have already said in our article on the generally useful hack and harness horse, there remains but little to add. We have explained what a really first-class cabriolet or tilbury horse (now out of date) used to be. The young man's fashionable carriage now is a light, single-horse phaeton. It is light, neat-looking, and economical;

in fact, it gives as much show for the money as a man can expect. It requires a very neat, active, well-bred horse, carrying what a dealer calls "his two ends" well; and, when not overdone with too much plated harness, gives great effect to the turn-out. He should have as few defects as possible, as he has no companion to hide blemishes. He should be good and useful, for he may be wanted for town or country; and the sort of carriage to which he is attached is equally adapted for both. There was a heavier class of carriage in vogue a season or two back, which belonged rather to an older school. This was a single-horse phaeton, of large size and weight, with a hood to it. It had a very substantial look, and the horse driven in it was usually a fine powerful animal, with good action and large sound limbs, adapted either for this or a single brougham. Requiring great strength, it was customary to dispense with so much quality or breeding, the two being almost incompatible. The two qualities combined give the perfection of the horse for all purposes. We need not say anything about dog-carts and such carriages, because, being used mainly in the country, horses will be found in all stables fitted for them.

The old post-horse was a character in the coaching days, down the Great North Road and along the western turnpikes. Out of London he sometimes answered the generally received opinion of what he was—a thoroughbred bag of bones, with scarcely a leg to stand upon, but full of old beans, and capable of doing his share of ten miles an hour with the best of them—and in electioneering times full fourteen. But, lest men should imagine that such was the normal condition of our post-horses out of London, our illustration, page 145, represents one of Mr. Robert Newman's greys, standing ready for a start for Epsom. It is taken from a photograph by a distinguished amateur, and it does not need our pen to show our readers that it is one of the very best sort of common harness horses one could meet with for strength and pace—one of the fine old sort of posters.

INMATES OF THE HOUSE.—LEGAL.

BILLS AND NOTES (*continued*).

Parties to a Bill or Note.—The parties to a bill or note must be such as would be capable of entering into any other contract. So, an infant (a person under the age of twenty-one) cannot bind himself by one, though he can take the benefit of it; but if, after he has come of age, he ratifies the bill or note which he has drawn or made whilst he was an infant, such instrument will be binding on him. As an agent for some other person, an infant can enter into any contract; so any instrument which he may draw in such capacity is valid as against the principal.

Any bill or note may be drawn, made, accepted, or indorsed by an agent so as to bind his principal, but must be done by what is technically called "procurator." The agent either merely writes the name of his principal, or signs himself thus:—

Thos. Williams, per proc., A. B.

Here A. B. stands for the name of the principal.

A *partner* is, in law, an agent to the firm to which he belongs, so he may draw, make, accept, or indorse bills and notes in all matters in which the business of his firm is concerned, whether he sign his own name or that of his firm; and in the same way is liable for all bills or notes drawn or made by his other partners. The same law holds good with respect to sleeping partners, whose names do not appear, but who take a share in the profits of the firm.

A married woman cannot be a party to a bill or note,

unless she is acting as agent for her husband, or unless she is judicially separated from him; if a single woman be a party to one, and marry, the property or liability in the instrument falls to the husband.

Transfer.—We have already said that bills and notes may be transferred by the holder to any one else, just as coin or other valuable articles, but the mode of transfer depends upon the wording of the instrument itself. A bill or note, made payable to "A. B. or bearer," or "bearer" simply, may be transferred by simply delivering it into another person's hands; but a bill or note, payable to "A. B. or order," cannot be transferred to any one until A. B. has "indorsed" it, that is to say, has written his name on it.

Now indorsements are of two kinds, *blank* indorsements and *special* indorsements.

A *blank* indorsement is made by the mere signature of the indorser usually and properly, though not necessarily, on the back of the bill; its effect is to make the instrument thereafter payable to bearer.

A *special* indorsement, besides the signature of the indorser, expresses in whose favour the indorsement is made. Thus a special indorsement made by Charles Smith is in this form:—

Pay Mr. Frederic Jones, or order.
Charles Smith.

The effect of this is to make the instrument payable to Frederic Jones or his order only, and accordingly Jones cannot transfer it to any one else otherwise than by indorsement.

There is no legal limit to the number of indorsements, and if there be not room to write them all distinctly at the back of the bill, the supernumerary indorsements may be written on a slip of paper annexed to the bill, which is called the "allonge."

Thus it will be seen that every indorser of a bill is in the nature of a new drawer, and if the drawee does not accept or pay it, is liable to any one into whose hands the instrument may subsequently come. The legal effect of indorsement is a contract by the indorser that, if the drawee does not pay the bill, he (the indorser) will—on receiving due notice of the dishonour—*i.e.*, intelligence that the bill has been presented for payment, but that it has not been paid—pay the holder the sum which the drawee ought to have paid, together with such damages as the law allows as an indemnity.

There are three ways, however, by which a man may indorse a bill without incurring personal liability.

a. By adding "without recourse to me," or any equivalent expression, to his indorsement.

b. By an agreement in writing, or simply verbal, between the indorser and his immediate indorsee, that the latter will not sue the former, but the acceptor of the bill only.

c. By converting an existing *blank* indorsement into a *special* one in favour of the person to whom he transfers it.

The following specimen of a bill of exchange will illustrate the meaning of the above remarks on indorsement:—

London, March 16th, 1870.

£500 : 0 : 0.

Two months after date, pay Thomas Jones, or order, the sum of Five Hundred Pounds.

Henry Thomson.

To Mr. Edward Giles, Merchant,
Manchester.

Frederic Green.

Accepted, Edward Giles.

Here we have a bill for £500 indorsed by Frederic

Green. If Edward Giles does not pay the £500 on the 19th of May, 1870, which is the time, together with the three days of grace always allowed, specified on the face of the bill, the holder can sue Frederic Green for the amount. In the same way the indorser of a note is surety for the maker, and is held liable if the maker does not pay the amount of the note.

It will be seen in the above example that Edward Giles is the drawee, that is to say, the person whom Henry Thomson (the drawer of the bill) certifies to be competent to pay the £500. When, however, he (Giles) signs his name with the word "accepted" before it, he becomes the acceptor of the bill, which amounts to an unconditional engagement on his part to pay the bill. The request made to the drawee for acceptance is called *presentment for acceptance*, and such presentment should be made to the drawee himself or his agent, at his house or place of business, during regular business hours, and the bill itself should be left with him for twenty-four hours, unless in the mean time he accepts the bill, or refuses to do so.

When the drawee of a bill for any reason refuses to accept it, it frequently happens that a third person, whose name does not appear on the instrument at all, and who wishes to save the drawer's credit—for the latter is liable for the amount on the bill, if the drawee does not accept—accepts the bill in the place of the drawee, and such acceptance is called "acceptance for honour;" and the acceptor for honour places himself in the position of the party for whose sake he accepts the bill, incurs all his liabilities, and is entitled to all his remedies.

The holder of a bill or note which has been dishonoured—*i.e.*, presented for payment and not paid, or presented for acceptance and not accepted—should give notice to all parties to the instrument who are prior to himself. Supposing a note or bill has been indorsed by the original payee to A., and A. has again indorsed it to B., and B. to C.; the latter presents it at maturity, and, if it is dishonoured, must give notice to that effect to the drawer and the two indorsers A. and B., and sue all or any of them for the amount.

The following is a form of notice of dishonour, which has been given by one of the greatest legal authorities on such matters in our time:—

Sir,—I hereby give you notice that the bill of exchange, dated 22nd ult., drawn by A. B., of —, on C. D., of —, for £100, payable one month after date to A. B. or his order, and indorsed by you, has been duly presented for payment, but was dishonoured, and is unpaid. I request you to pay me the amount thereof.

I am, &c.

Table of stamp duties payable on a promissory note for the payment to the bearer *on demand*:—

	£	s.	d.	s.	d.
Not exceeding	1	1	0	0	5
Exceeding £1	2	2	0	0	10
" 2 2 0	5	5	0	0	13
" 5 5 0	10	0	0	0	9
" 10 0 0	20	0	0	0	20
" 20 0 0	30	0	0	0	30
" 30 0 0	50	0	0	0	50
" 50 0 0	100	0	0	0	86

Promissory note for the payment, *in any other manner than to the bearer on demand*, of any sum of money:—

	£	s.	d.	s.	d.
Not exceeding	5	0	0	0	1
Exceeding £5	10	0	0	0	2
" 10 0 0	25	0	0	0	3
" 25 0 0	50	0	0	0	6
" 50 0 0	75	0	0	0	9
" 75 0 0	100	0	0	0	10

Promissory note for the payment of any sum of money,

either to the bearer on demand, or in any other manner than to the bearer on demand:—

Exceeding	£100 and not exceeding	£200	£	s.	d.
"	200	300	0	2	0
"	300	400	0	3	0
"	400	500	0	4	0
"	500	750	0	5	0
"	750	1,000	0	7	6
"	1,000	1,500	0	10	0
"	1,500	2,000	0	15	0
"	2,000	3,000	1	0	0
"	3,000	4,000	1	10	0
"	3,000	4,000	2	0	0

And where the same shall exceed £4,000, then for every £1,000 or part of £1,000 of the money thereby made payable, 10s.

The stamp duties now payable on bills and notes for the payment of money to the bearer or order, or at any time otherwise than on demand, are as follow:—

Not exceeding	£5	£	s.	d.
Exceeding	£5 and not exceeding	10	0	1
"	10	25	0	2
"	25	50	0	3
"	50	75	0	6
"	75	100	0	9
"	100	200	0	1
"	200	300	0	2
"	300	400	0	3
"	400	500	0	4
"	500	750	0	5
"	750	1,000	0	6
"	1,000	1,500	0	7
"	1,500	2,000	0	8
"	2,000	3,000	1	0
"	3,000	4,000	1	10
"	3,000	4,000	2	0

When exceeding £4,000, for every £1,000 or part of £1,000 of the money thereby made payable, 10s.

Such are the most important heads of the law on this subject. In another paper we will discuss what remedy there is on dishonoured bills and notes, and also add a few words on cheques and I O U's.

TO REMOVE VARIOUS KINDS OF STAINS.

WE shall commence by dealing with the most common stains, namely:—

Ink-stains in Woollen Table-covers and Carpets may be removed by washing the spots with a mixture of a teaspoonful of oxalic acid in a teacupful of warm water; after which, the places must be rinsed with clean cold water, to take out the acid.

Another Method.—Pour milk upon the ink directly, and rub it with a damp flannel; repeat until the ink disappears. Then wash with flannel and water, and rub dry. When milk is at hand, place a plate under the ink spot, and pour milk on the ink. Allow it to lie in the milk, and when removed from the table, if not free from ink, dip it in a cup or basin of milk, and rinse in cold water.

To remove Ink-stains from Floors or Mahogany.—Rub on with a cork a little spirits of wine, and wash it off with water.

To remove Stains of Port Wine.—Wet the stain with sherry or bleaching liquid.

To remove Mildew.—Wash in bleaching liquid.

Stains in Silk.—Stains in coloured silk dresses can often be removed by pure water.

Acid, Tea, Wine, and other Stains.—Stains caused by acids, tea, or fruits, can often be removed by spirits of hartshorn, diluted with an equal quantity of water. To remove tar, pitch, or turpentine, the spot may be saturated with sweet oil, or a little tallow may be spread upon it, after which it must remain for twenty-four hours. If the article is of linen or cotton, it must be washed in the usual way; but, if silk or worsted, it is to be rubbed with ether or spirits of wine. Pure spirits of turpentine will remove

recent spots of oil-paint by rubbing. Wax and spermaceti should be scraped off, and the places where they have been should be rubbed with spirits of wine, spirits of turpentine, or mephuric ether. Grease spots can commonly be taken out of silk by means of French chalk, as follows:—Scrape a little chalk upon the spot, and place underneath a warm iron or a water-plate filled with boiling water. The heat melts the grease, which is absorbed by the chalk, and it can be removed by rubbing or brushing. It may be needful to repeat the process. A very good stain mixture is made with half an ounce of salts of tartar, half an ounce of sal-ammoniac, and half a pint of soft water. Places to which this is applied should be washed afterwards in clean water. The mixture of oxalic acid and water, above described, will remove ink-stains and iron-mould from linen and calico; the article must be wetted with it, and held over the steam of hot water, after which it must be washed with pure water. If necessary, the process may be repeated; but it must be noted that the preparation is highly poisonous.

Stains caused by Scorching.—For whitening scorched linen, it is often sufficient to wet it with soapsuds and lay it in the hot sun. Another method is, where milk is plentiful, to put one pound of white soap into a gallon of milk, and boil the scorched article in it. Another plan is, to squeeze out the juice of two middle-sized onions, which is boiled in half a pint of vinegar, with one ounce of white soap and two ounces of fuller's earth; the mixture is applied cool to the scorched part, and when dry washed off with clean water.

Stains caused by Mildew.—Mildew is removed in several ways from linen; some dip the article in sour buttermilk, lay it in the sun to whiten, and then wash in clean water. Others apply soap and chalk, or soap and starch, adding half as much salt as there is starch, and the juice of a lemon.

Linen.—Stains in linen can often be removed by rubbing them with soft soap, after which a starch paste is put on, and the articles are dried in the sun. This process may need to be repeated several times. The soap and starch are to be washed off with pure cold water.

How to restore Stained and Discoloured Muslins.—Discoloured muslins may be whitened, if they are laid in a flat dish with suds made of white soap, and set out in the sun. This takes time, and the suds have to be renewed daily. In the country, away from the smoke of towns, white linen may be bleached by being wetted with soapsuds, and spread out upon the grass in the sun.

Oil Stains.—Oil stains in floors and carpets may be treated with a paste made of fuller's earth and water, which will have to be applied several times. If this paste is applied to coloured textures, the addition of a little ox-gall will preserve the colours from injury. The paste, when dry, can be removed with a brush.

Stains on Mahogany, &c.—The marks made by cups of hot water on varnished tables may be taken out with a little oil, which must be rubbed on, after which a little spirits of wine must be also rubbed in. A teaspoonful of oil of vitriol in a tablespoonful of water, or the mixture of oxalic acid and water, above described, will take ink-stains out of mahogany. The application is to be made quickly with a brush, or morsel of flannel, and then washed off with milk.

Silver and Electro-plate Stains.—The obstinate dark stains upon silver and electro-plate may almost always be removed by means of a little dilute sulphuric acid. Pour the acid into a saucer, and with a linen rag, wetted in it, rub the silver stain till it is gone. The article should afterwards be treated to a coat of fine whitening and spirits of wine. Let this remain on for half an hour, then wipe it off with a silk handkerchief, and polish with soft wash-leather or a plate-brush.

HOUSEHOLD AMUSEMENTS.

KITE-MAKING.

KITES hold a very prominent place among the toys and playthings of the young, and to know how to make them is a desirable accomplishment, for they are somewhat expensive articles to buy. Moreover, a boy will always prize more highly and take more care of, an article which is the product of his own ingenuity, than of one which has been purchased in a shop, and the fellow to which may be procured with no farther trouble than an application to an indulgent parent. So the boys of a household should be encouraged to manufacture their own kites, which they may readily do by attention to the directions we are about to furnish.

Before proceeding with our instructions, we may say a preliminary word about kite-flying as an amusement. Some people object to the more active out-door games for youths of tender years, deeming them likely to receive injury through the recklessness of older and more vigorous companions. Those who have such fears will do well to encourage their boys as much as possible in kite-flying, which will take them to the fields and open recreation-grounds at their disposal, and keep them safely amused for hours while they are in the enjoyment of fresh air.

Most boys, however, require no such inducement or direction, but take to kite-flying as naturally as they take to hoops and tops. An intelligent youth should be taught to give his kite novel and interesting forms. He may have his attention drawn to the accounts of Chinese travellers, who describe the people, old and young, as holding annual kite festivals, in which figures of the strangest shapes—dragons, dogs, fishes, and monsters of extraordinary form—are seen floating in the air, and the efforts of the juvenile kite-flier are outvied by his grandfather, who enters into the pastime with equal zest and ambition to distinguish himself. Nor must it be forgotten to explain to him how Benjamin Franklin with his kite brought electricity from the clouds, and thus made the plaything of a boy the instrument of an important scientific discovery.

The uninstructed efforts of a boy to make a kite are usually productive of failure. Either the thing, when tried, falls to the ground like a stone, or it pitches and tumbles about in the air in an extraordinary manner, but will not rise, notwithstanding all his efforts; but to make a good kite, like many other things, is simple enough, when you know the right way to set about it. The mistakes usually made are, that the framework is too heavy, or that the various parts do not bear the proper proportions to each other. Both these faults may be easily avoided with a little care.

In making an ordinary kite, of the shape shown in Fig. 1, the first thing required is a lath, which is to form the backbone, and must be just the length you desire for the kite when made. For this you must go to a lath-render's, and select one of the straightest and smoothest laths you can find among his stock. Then you want a stout cane, which must be split through the middle, one piece serving for the bow, or top of the kite. At the stationer's you may procure some large and strong tissue paper, of any colour you may fancy, to form the covering for the framework; and with these articles, and some good strong string, your materials are complete.

Having made your lath the required length, you trim off the corners at the top and bottom, and then tie the exact centre of the split cane to the lath at the point marked A in Fig. 2. The cane must be firmly affixed, by passing the string over and round the junction of the two pieces of material. This being done, notch the two ends of the cane, and insert a long piece of string in one of the notches; then bend down the cane so that it forms a bow, and pass the string from C to D, twisting it into the second notch. Now bring the string to B, the bottom of the lath, which must be also notched for its reception; pass it up to C, then down to E, where a hole may be drilled for it, and finally up to D, where the string is to be tied and cut off. If you are making a very large kite, you should pass the string again from D to A, and thence again to C, so forming a diamond with its upper portion. The framework of your kite is now complete, and you must try its balance. Stand it on the ground, and steady the top with your finger; then withdraw your touch, and if the skeleton remains steady for a moment, and then falls either backward or forward, it is all right; if it leans to either side, the balance is out, for you have got more of the cane on one side of the lath than on the other. You must then shave off a part of the cane on the heavier side; but if this is not found sufficient, you must untie the string and begin the framework anew.

Supposing it to prove correctly balanced, you lay the framework upon your paper which is to cover it, and cut the latter to the shape of the kite, leaving a good margin all round, which is to be pasted down. Then remove the framework, and paste it well over, string and all, on the side which is to be covered; lay it down carefully on the paper again, and press the pasted portions, so as to make them adhere closely. This being done, paste the margin of the paper all round, and fold it over the edges of your frame, which will then be completely covered. When all is dry, you may lay the kite on its face, and paste down strips of the paper over the string and lath at the back, so as to give it a finished appearance. If you like, you may adorn the face with various devices, as seen in Fig. 1.

At each side of the kite a tassel formed of paper is

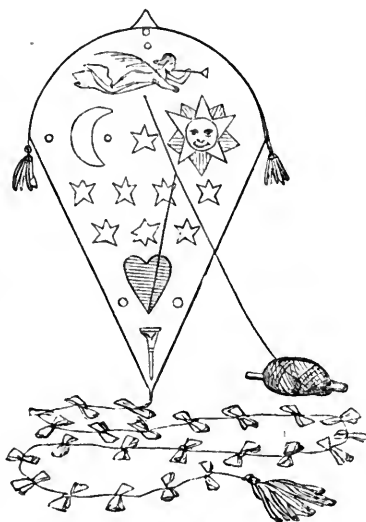

Fig. 1.

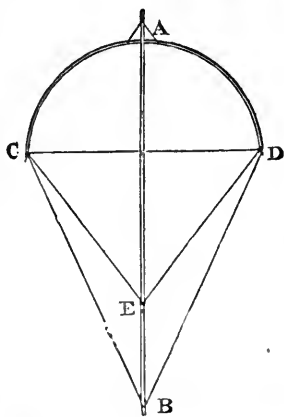

Fig. 2.

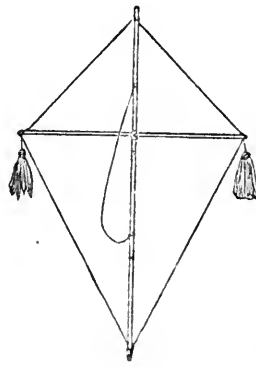

Fig. 3.



Fig. 4.

fastened, by tying it to the cane which forms the bow; and these tassels are termed the kite's wings.

When the kite is made, you must drill two holes through the lath for the belly-band, or loop to which the string is affixed. One of these holes must be above the line marked CD in Fig. 2, and the other at a distance below, which must be regulated by the height and weight of the kite. The loop when made must hang rather loosely down, allowing space for the arm to be passed through to carry the kite. Many a failure in kite-making is caused simply by the imperfect adjustment of the belly-band, and you must try if the kite appears well balanced by the band, before you attach the string by which it is to be flown. This you affix to the band at such a point as the proper poise of the kite may seem to require. If you find the kite "pitch" slightly in flying, a little alteration either of the band, or of the position of the string upon it, will sometimes suffice to correct the imperfection.

The tail of the kite is made of slips of paper lightly twisted, and tied at intervals along a string, which is attached to the bottom of the lath. The length of the tail must be proportioned to the size of the kite, as it has an important function to perform in steadying its course. The end of the tail is usually ornamented by a paper tassel similar to that used for the wings, but rather larger.

Cloth or calico is sometimes used instead of paper as a covering for kites. The simplest form of cloth kite is shown in Fig. 3, two laths, fixed transversely and united by a string, constituting the framework. This kite, being heavier, requires a different kind of tail to that used for the paper kite. It should be made of small semicircular bags of cotton, which become filled with air as the kite rises from the ground. Their shape, and the way they are attached to the string, are shown in Fig. 4.

We shall have something to say respecting bird and other fancy kites in another paper.

DOMESTIC MEDICINE.

DIARRHŒA (*continued*).

Distinction between Cholera and Common Diarrhœa.

—Diarrhœa is often called English cholera. It is important, here, to state the difference between English cholera and that fatal disease, which comes occasionally to us from the East, and for which, specially, the name of cholera should be reserved. Cholera has many of the symptoms of a bad case of common diarrhœa. But it has other features of its own. For one thing, it is generally known to be in the country, and to have travelled steadily to us from the East. Secondly, the persons getting it have generally had some connection with other persons having it. Either they have lived with them, or nursed them, or washed for them. Then, in cholera proper, the motions and vomiting are like thin rice water; the surface of the body gets cold and blue; the breath gets cold; and there is no urine, or very little, passed; cramps are more violent than in the common summer diarrhœa. If cholera is not in the country, diarrhœa, though sometimes a severe and inconvenient complaint, is generally not very serious.

Treatment.—Supposing the diarrhœa not to be very bad, the proper thing is not to interfere with it immediately—to let it have its course for a short time; but if it persists, and makes the patient faint or weak, then it is proper to interfere. If anything unwholesome or indigestible has been taken, it may be tight to take a mild dose of opening medicine, such as a teaspoonful or two of castor-oil; or the following powder:—

Rhubarb	10 grains.
Magnesia	10 grains.
Ginger	3 or 4 grains.

Carefully mixed with a little water.

But if the purging has continued for some time, and it is not clear that anything irritating or unwholesome has been taken, then it is wrong to take opening medicine. It is astonishing how many people try to cure a purging by taking opening medicine, and how seldom they succeed—or rather, if homœopathy were true, would be less astonishing. The following mixture is one that will relieve summer diarrhœa in most cases:—

Dilute sulphuric acid	60 minims.
Spirits of chloroform	1½ drachms.
Tincture of opium	20 minims.
Tincture of cardamoms	3 drachms.
Simple syrup	2 drachms.
Peppermint water	...	to	8 ounces.
		Mix.	

A sixth part of this to be taken every three, four, or six hours, according to the frequency and severity of the diarrhœa.

This acid mixture has come largely to supersede the old chalk mixture, which has been the general diarrhœa mixture of chemists. We may give the prescription of the chalk mixture, for those with whom acids do not agree; only saying that the first mixture will suit many people who would not expect it to suit them. It is especially preferable in cases where there is much sickness; as well as purging.

The following is the chalk mixture, which may be tried if the acid mixture does not succeed:—

Chalk mixture	8 ounces.
Aromatic confection	1 drachm.
Tincture of opium	20 minims.
		Mix.	

An eighth part to be taken every three or six hours.

The diet, in all cases of diarrhœa, should be simple. If animal food is taken, it should be of the simplest kind, as well-done butcher's meat. But milk, rice, arrow-root, sago, &c., will constitute a fitter diet. The patient should avoid taking milk and the first of the above two mixtures together. Moreover, the two mixtures should not be taken within a short time of each other. Rest, and a cool, fresh atmosphere, are proper.

If the complaint does not quickly yield to such treatment, there is something special in the case, for which medical advice should be taken.

DIPHTHERIA.

Diphtheria (from *Διφθερα*, a skin or membrane) is a disease, the name of which has become familiar to people of late years. The case is one, however, in which familiarity breeds, not contempt, but fear. The disease has been long (more or less) known in the world; but it occurs in different forms. The part principally affected is the throat; but the nature of the throat affection, and the degree to which the disease takes hold of the system, vary in different epidemics. According to Dr. Copland, this disease was remarkably prevalent in the latter part of the sixteenth and beginning of the seventeenth centuries in Spain, Italy, and other parts of Europe; while in the middle of the last century it prevailed very generally, not only in our own country, but also on the Continent, and extended to various parts of North America. The disease seems to have been first distinguished in this country by Dr. Fothergill, who described it as "a peculiar sort of sore throat, attended with ulcers." We owe the clearest accounts of the disease to the French physician, Bretonneau, who saw several epidemics of it.

Symptoms.—The disease consists essentially in a peculiar form of sore throat—or rather, bad throat, for it may not be felt by the patient. There may be an absence of either soreness or pain. The tonsils of the throat—oval-shaped bodies at the side of the throat—are

covered, more or less perfectly, with a white covering of very different degrees of consistence. It may be as tough almost as leather, or as soft as cream or soft cheese. All above this the throat is seen to be red. Swallowing is generally a little painful, and it may be very much so. Swallowing, at a later stage of the disease, is often difficult, from a sort of palsy of the muscles. The back and front of the nostrils may become affected in the same way as the throat, and yield a great discharge, which produces irritation of the upper lip. In bad cases the tube connecting the throat and the ear may be affected. So also may the inside of the cheeks, and the tongue itself, be covered over with the white covering which we have described. There may be a swelled state of the glands of the neck. In bad cases it is common for the windpipe itself to become affected. The white matter is thrown out on the inside of the windpipe, and gives rise to the sound and other symptoms of croup. This is more apt to happen in the case of children. When it does happen, there is more or less coughing, which sometimes brings away the white covering in larger or smaller pieces. Such are the local effects of this disease; but it produces general symptoms. Sometimes these are very severe, sometimes they are quite slight. In bad cases the illness may set in with shiverings, feelings of soreness and weakness, headache, general aching and stiffness of the neck. Soon there is great prostration and restlessness; the breath becomes foetid and the tongue furred. The nose or the mouth may bleed freely. There is some feverishness, and the pulse is quick and feeble. Vomiting is a frequent symptom in bad cases. The prostration in bad cases is intense, and will generally be accompanied by some delirium. There are two sources of danger in this disease: first, there is the danger of the patient being choked by the white skin or matter filling up the chink of the windpipe. This is the way in which the disease oftenest proves fatal to children. Secondly, the disease produces death by exhaustion by prostration. Even in cases in which the breathing is not interfered with, there may be such complete prostration of strength as to bring life into danger; this is the principal risk of the disease in grown-up people, who are not so subject to this disease as children. The disease may either terminate quickly and cause death, or it may end in recovery. This recovery is likely to be slow and to be hindered. The disease is apt to produce several consequences, which take a long time to disappear. It may disarrange the kidneys and put the urine all wrong, causing it to contain blood or some of the constituents of the blood, especially *albumen*. It often produces palsy of the muscles of the throat, or of some other parts of the body, as the limbs. This palsy may come on shortly after the attack, or it may not follow for weeks after. Without actual paralysis (palsy) the patient may be completely prostrated for a long time by this disease—the pulse may be greatly depressed, and the nerves shaken, for weeks after the attack. It is, perhaps, a more lowering disease than any other. The disease prevails at times in an epidemic form. Sometimes scarlet fever prevails at the same time. This fact has led some to think that the diphtheria is only a form of scarlet fever; but the diseases are quite distinct. It is undoubtedly contagious—apt to be communicated.

DIPHTHERIC SORE THROAT.

We have described diphtheria in its true and severe form. There is a very common kind of sore throat which is sometimes described as *diphtheria*, but it is in reality a very much slighter and less serious disease. This is a form of sore throat in which there is not a continuous covering over the tonsils, but the tonsils are covered with little white or yellowish-white spots, quite distinct from each other. The throat may or may not be painful. There is slight chilliness or actual shivering. The tongue

is coated. This is a very common case of sore throat—the most common case; and it generally soon gets well, with frequent gargling with warm water, and proper medicine, like the following mixture:—

Chlorate of potash	1 drachm.
Spirits of nitre	2 drachms.
Simple syrup	4 drachms.
Water	8 ounces.
Mix.	An eighth part every three or four hours.			

Treatment of Diphtheria.—We need not say that such a serious disease requires a doctor; but there are a few points which may be properly explained to friends. The great thing in the treatment of diphtheria is to support the patient. As we have said, the disease is a most lowering one; accordingly, the vital thing is to give plenty of support, especially beef-tea and milk. Wine, or even brandy, in bad cases, will also be required; but particulars here must be left to the doctor in attendance. Gargling the throat with warm water is most pleasant and soothing. When, by any chance, a doctor cannot be had, the following mixture represents the kind of medicine to give:—

Chlorate of potash	1 drachm
				or 4 scruples.
Tincture of perchloride of iron	1 drachm.
Simple syrup	$\frac{1}{2}$ ounce.
Distilled water	8 ounces.
	An eighth part to be taken every three or four hours.			

There are two points of great importance for preventing the spread of this disease. One is, to receive all the discharges from the throat—after gargling, or at other times—into a basin containing Condy's disinfecting fluid. Some of the same fluid should be mixed with all the discharges from the patient—the motions, urine, &c. Also, as far as possible, the patient should not be seen unnecessarily by other people. By way of comfort, we may say that only a few cases of diphtheria are very bad ones, and that recovery happens often in very bad cases. The name is given to many cases that are slight, and do not need all the stimulants they get, and all the fuss that is made about them.

The case of diphtheria is one in which the fashion of giving stimulants has gone to its extremest lengths. It must here be repeated that diphtheria is a very depressing disease, and bears stimulants well. It not only bears them well, but it is the better for them; but the accounts one hears of the way in which champagne and turtle-soup are given to the patients are suggestive of excess, especially if the case is one only of diphtheric sore-throat, and not of true diphtheria. We can only repeat here a short description of the signs whereby we may know whether stimulants are doing good or harm. If they do good, they do not heat the patient; they do not dry the tongue, nor cause headache; nor do they increase lightheadedness and delirium, but diminish both, and they make the patient feel stronger. If the effects produced are the reverse of these; if the patient is made hotter, and more uncomfortable, and the tongue drier, then the chances are that stimulants are not doing good. In any case, beef-tea and milk are the best food.

Another point we ought to impress on our readers: that where cases of diphtheria or diphtheric sore-throat occur in a house—especially if one case occurs—the house should be looked after, to see if it is airy and healthy, and that the drainage is all in order. The rooms may be disinfected either by Condy's fluid or chloride of lime. Condy's fluid is a most valuable agent, which should be kept in every household, for the purpose of cleansing and purifying anything of a foul, unwholesome, or poisonous character. Its uses are numerous, and there is not the slightest danger in any of its applications.

HOUSEHOLD DECORATIVE ART.

FRET-WORK AND CARVING IN WOOD (*continued*).

WITH the present article we give three designs, for all of which the frame-saw will be the principal tool; but some after-carving will be requisite. Fig. 5 is intended for the cover of a large photographic album, or blotting-book, for a drawing-room table. For such minute work, thin panel, of about $\frac{1}{8}$ th of an inch thick, should be used, and of some hard wood. It may either be dark as ebony, and mounted on a light panel, or, what will look better, white wood, as box, and mounted on panel covered with crimson velvet. This will throw up the wood-work, and produce a very rich effect. It will not be possible to obtain box, of the required size, in one piece; so that, if used, different pieces must be neatly joined together. Very little carving will be needed on it, beyond delicately marking the veins of the leaves with a V-chisel. The raised shield in the centre, for arms or monogram, must be sawn out, and carved separately, and glued on afterwards.



Fig. 1.

Fig. 2) is supported by a piece of perforated and carved work, identical with one-half of the lower part of the back, which will adjoin it when completed. The opening in the top of the upright piece in the centre is to admit the head of a nail, or hook, by which it may be hung up. The wood should be $\frac{3}{8}$ -inch oak or walnut. This bracket is adapted for carrying a small vase for one or two flowers or a light plaster bust.



Fig. 2.

The hanging card-rack (Fig. 4) should be made, as regards its principal part, the back, of similar wood. The projecting slips in front must be thinner panel of the same. Fig. 1 shows the method by which it is fastened together.

As regards the fitting together (the making-up) of carving and fret-work, we believe that, in most cases, the amateur will find it to his advantage to employ a professed cabinet-maker. Nothing but the accuracy acquired by long practice will ensure neat and strong joints in small fancy articles; and, if this mere joinery-work be clumsily done, the due effect of good carving will be lost. If, however, our amateur determines on doing

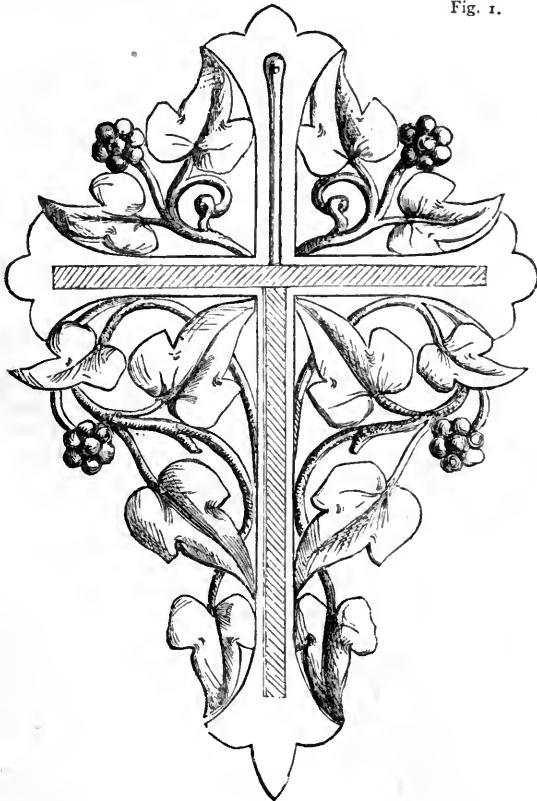

Fig. 3.

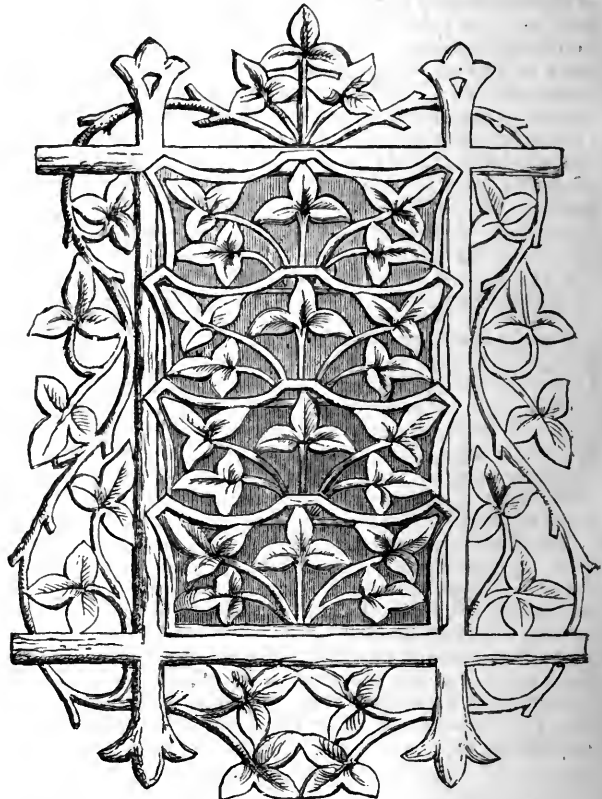

Fig. 4.

At this place, it may be observed that, when such thin panel is used, it is easy to saw through two, or sometimes three, pieces at once, if they are fastened together by a piece of soft paper glued between them; they can be separated afterwards, without difficulty, with a thin knife.

Fig. 3 is a small bracket, the shelf of which (shown in

every part of the work with his own hands, we advise him to gain some little experience, by practising on valueless wood, before he tries his skill on that upon which labour and art have been expended. The examples we have hitherto given are of simple construction, and may readily be put together by the amateur, if he desires it. For instance, each end of the book-slide (Fig. 2, page 104)

would be held in its place by two pairs of small brass hinges (cost, 2d. per pair). The table-easel (Fig. 4, page 105) would have a back-leg fixed on, behind the centre of the cross bar, near the top, by a similar pair of hinges; while the ledge on its front would be glued in its place, and further strengthened by small screws driven in from behind. When glue is used, as little as possible should be applied, and the two pieces of wood rubbed backwards and forwards on each other, till nearly the

whole of the glue is forced out. The great point to be attained in gluing is, that no air should be left between the two pieces; this alone will give a good, sound joint. The corners of the picture-frame (Fig. 6, page 113) are united by the simple joint, shown at Fig. 41, page 77, vol. i., the under-half of one piece being sawn out to admit the other, from which the upper half has been sawn; the two are glued together, a hole bored from front to back with a gimlet, and a peg driven in; the leaf is then glued over the joint, which it strengthens and conceals. The bracket (Fig. 3) may either be joined with glue and screws, like the table-easel, or, better, with small brass hinges; the shelf will then fold back on the upper part, and

the support, to right or left, on the lower, and thus make the whole bracket flat, to pack for removal. In the card-rack, a thin strip of wood runs down each side of the slips (Fig. 1), and is fastened to each slip by two small screws, being itself fastened to the back by glue and screws from behind. In the design we have given for the cover of a photographic album, a broad border of velvet might be adopted with excellent effect. It might be cut in some light wood, such as box, with a fret-work border of some darker wood. In short, the amateur carver could vary the effect by many easily-contrived modifications.

If the amateur makes up his own work, he will also require to know how to stain and polish it. This is generally better done before fitting together; and we shall give various methods in another article.

GLOVES AND GLOVE CLEANING.

FOR wear and real service, no glove can compare with one of genuine kid, which has a softness and elasticity unequalled by other materials. The best kid gloves are made from the skin of the sucking kid only, and as a single pair alone can be cut from a skin, they are necessarily expensive. Cheap "kid" gloves are made from lamb-skin, which has not the wearing qualities of genuine

kid; and generally it will be found truer economy to buy the former, at from 3s. 6d. to 5s. per pair, than the latter at much lower prices, not to mention the gain in appearance, which is, perhaps, a matter of more importance in gloves, than in any other article of dress.

The leather for such kid gloves as are made in England, is imported from France; it undergoes the preliminary operations of tanning in that country, and after it arrives here, is soaked in a bath of yolk of egg to give it additional softness, dyed, and made up. The colour of the glove is, to some extent, dependent on the natural colour of the animal from which it is made. The skins of dark or spotted kids are found to be so completely

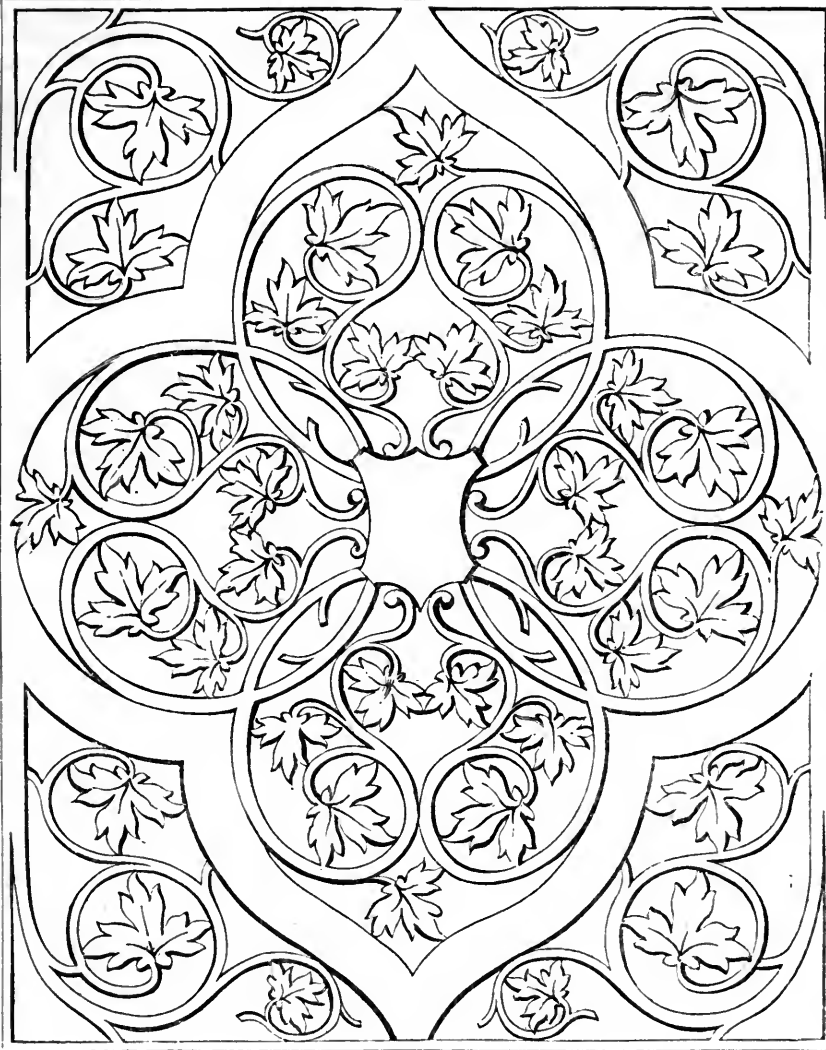

Fig. 5.

tinged throughout their thickness with colouring matter, that they are unsuited for the manufacture of white gloves, and are, therefore, dyed to make dark ones. The report that the French use rat-skins for making "kid," is without foundation.

Next to kid in softness and elasticity is cheveril, which is made from the skin of the young goat, after it has ceased to be a kid, but before it has reached maturity; two pairs can usually be cut from one of these skins, and they make admirable gloves for riding and similar purposes. What are known as "dog-skin" gloves are not made from the hides of our canine friends, but from those of the Cape sheep; animals which in some respects more nearly resemble goats, as they are covered with hair instead of wool. Less of this material finds its way to

market now than formerly, as the South African farmers find it more advantageous to keep wool-producing sheep, and the original breed is becoming scarce; consequently inferior leather, made from ordinary sheep-skin, is used to supply its place. The more expensive kinds of dog-skin only wear well, and the ordinary colour of this material is one which soon suffers from dirt and stains. Tan or brown calf will generally look better for a length of time.

The insecure manner in which fastenings are attached to the glove is often a cause of annoyance; the ordinary sewn-on button makes a point, as a rule, of coming off at a critical moment, and few of the improved fastenings are quite satisfactory. A useful one has, however, been patented by Messrs. Wheeler and Co., of Poultry, and Regent Street, London. It consists of a button shaped somewhat like an ordinary shirt-stud, with a shank ending in a small flattened head; this is passed through the leather, and a little disc of metal with a hole in its centre, and slit for the purpose, is slipped over it on the inner side of the glove: this is very neat and secure.

For cleaning kid gloves, oil of turpentine or camphene was formerly in use; benzole or benzine, prepared from rectified coal-naphtha, is now preferred, as the disagreeable smell goes off more quickly. For cleaning gloves it is necessary to have a stock or wooden hand: on this the glove is stretched, and sponged with the benzine, two or three times over; clean fluid being used each time. The benzine will clear itself, and become fit for use again, if time is allowed for the dirt to sink to the bottom.

An inodorous composition for glove-cleaning, may be made in the following manner:—Put one part of soap shavings in two parts of rain or distilled water, and set in a hot place to dissolve; it will be made more efficacious if a small quantity of liquid ammonia is added, and may be scented to taste with any ordinary perfume. The glove must be stretched on the stock, and the composition applied with a piece of flannel; care being taken to rub in one direction only.

Buck-skin, doe-skin, or chamois-leather gloves, may be cleaned when they are not very dirty, by rubbing them with a dry powder, composed of fullers' earth and alum; which must be swept off with a brush, and the gloves afterwards powdered with whitening and bran. But this will not be sufficient if the gloves are very dirty; they must then be washed with the soap solution, and afterwards rubbed with a paste made of pipe-clay, coloured to the required tint with yellow ochre, and diluted with beer; when they have been dried, the superfluous powder must be removed by dusting.

Good glove-powder, for ordinary use, may be made by drying Castile soap, and pounding it in a mortar, or with pipe-clay, coloured, as may be required, with ochre or Irish slate; or with a mixture of powdered soap and pipe-clay.

HATS, AND HOW TO TREAT THEM.

ALTHOUGH little is to be said in favour of our stiff, ugly, and uncomfortable "chimney-pot" hats, they are a necessary evil, and we must be contented to make the best of them. If, when our present ones were once worn out, the fashion could be done with for ever, we might be justified in taking as little care of them as possible; but, as they will inevitably have to be replaced by others of the same pattern, it will be wiser to attend to all those points which may tend to their preservation.

No article of dress becomes shabby so quickly, for want of a little care, as a hat; light, air, and dust, all tend to turn it brown, if it is exposed to their influences; it ought, therefore, to be kept in a hat-box whenever it is not in use. On ordinary occasions a soft brush should be used. When the hat is wet, it should never be wiped with a

pocket-handkerchief (unless a clean one is specially used for the purpose), but the superfluous moisture should be taken off with a dry soft cloth. If it has only received a partial sprinkling, and a rough, mottled appearance is left, dip a hat-brush lightly in cold water, and pass it gently round in the same direction as the nap. When all parts are uniformly damp, take a hard brush, and with that bring the nap to its former state of evenness; then lay the hat on its side, on a clean cloth, for the night, to dry. After it has been brushed with the ordinary hat-brush, next morning, it will look little the worse for the wetting it has undergone; and the better the quality of the hat the more times may this be repeated without injuring it.

Bulges, or indentations, may be removed by warming the hat (by steam is preferable), and taking them out with a hot iron. Any attempts to restore the shape by other means will probably result in cracking the hat.

Gloss may be renewed when, after some wear, the nap becomes dull and grey-looking, by brushing with a hot brush, or, better, by gently pressing a flat iron, ordinarily heated, two or three times round in the direction of the nap.

To scour a hat, for the removal of salt water, or when the nap has become clotted, take a basin of boiling water, some yellow soap, and a hard brush. Rub a little soap on the brush, dip it in the hot water, and rub round in the direction of the nap. Do this until the nap is smooth and the soap is thoroughly worked out; then scrape round with the edge of an ivory paper-cutter, which will bring out the dirt. Afterwards use a soft brush and a little clean cold water, and dry as above.

To remove grease, soak a piece of flannel with benzine collas, rub gently over the part, and afterwards expose to a good current of air.

The method of manufacturing hats has undergone a complete change within recent times. Formerly, the soft fluff of the beaver, or the cheaper fur of some other animal substituted for it, was worked into a felt foundation, and formed the nap. This material, in various shapes, had served as the head-dress of the upper classes of Europe for three centuries: it had been known much longer, for Froissart, whose *Chronicle* was written in the fourteenth century, mentions "biever hats;" but it only became common when the development of the American trade furnished a plentiful supply of beaver. But so perseveringly were these animals hunted, that at the beginning of the present century the fur became scarce; and about 1810, attempts were made to provide a substitute, by means of silk plush drawn over pasteboard frames. These, at first, were not very successful, and the old kind of hat remained common till 1840, when the growing scarcity of beaver led to great improvements in the making of silk hats, and they have since become general.

To form the foundation, or "shape" of the best silk hats, calico, saturated with a solution of shellac, is joined together (on a wooden block to give the requisite form) by the application of heat, and afterwards lined with delicate sheets of cork: a light and elastic body is thus made. The rims are formed of stouter calico, without cork. Round the lower part of the crown, to the inner side, india-rubber cloth is attached, to prevent the transmission of grease: the shape now receives a coating of shellac varnish, and is ready for the finishing processes. The plush used for covering consists of a pile of the finest silk woven to a foundation of cotton, and is imported from Lyons—English makers not having as yet learned to equal the French in quality, and more particularly, in brilliancy of dye. From this a case for the crown is cut out, sewn together, and attached to the shape by means of heat, the shellac varnish acting as a cement; the plush covering the brim is not sewn on, but is attached by heat only.

Linings and trimmings are now sewn on by women, and the hat has only to be "shaped." As yet the brims are perfectly flat; they are made to receive such shape as the fashion of the day may demand by softening in a stove, and moulding with the hands and a hot iron. Much skill is required in some of these processes, more particularly in fixing the plush to the brims and shaping. The London hatters form a highly independent body of men, dictating their own hours of work and wages to the masters, and allowing none to engage in the business who have not been regularly apprenticed, or who do not belong to their trade society.

When buying a new hat, it should be remembered, that the more stoutly it is made the more durable it will prove, but that for comfort a light and elastic one is best—the purchaser has to decide which of these points is most important in his particular case. The nap, to be of good quality, should be short and full; and especially, it should be seen that ventilation is properly cared for.

For both the health and comfort of the head it is necessary that between it and the hat there should be a supply of cool air. For hot climates, such as India, "helmets" are made composed of two distinct hats, one within the other, the space between being for the circulation of air alone. Such an arrangement as this is unnecessary for ordinary English weather; but arrangements should be made for both the ingress and egress of air. The best method of doing this that we have seen, is that adopted in the Aletheon Hat, patented by Messrs. Cooper, Box, and Co., of Laurence Pountney Lane, London; in this a kind of cork rack pierced with holes is fitted in that part which presses on the forehead, through it a constant supply of fresh air flows over that portion of the head which needs it most, and then escapes through an aperture, left for the purpose, in the top. We find these hats approach more nearly to comfort than any others. As has already been seen, the best hats are provided with a grease-proof lining in that part which touches the head; various methods have been suggested for the preservation from grease when this precaution has not been taken, but nothing will be found better than the insertion of a strip of gutta-percha tissue between the lining and hat.

ODDS AND ENDS.

Washing Clothes.—If pipeclay is dissolved in the water, the linen is thoroughly cleansed with half the labour and fully a saving of one-fourth of soap; and the clothes will be improved in colour equally as if bleached. The pipeclay softens the hardest water. A halfpennyworth to four gallons of water.

To keep Moths from Fur and Woollen Clothes.—In May brush fur and woollen clothes, wrap them *tightly* up in linen, and put them away in drawers. Pepper or red cedar chips are good preservatives from moths, but camphor is the best.

Washing Chintzes.—These should always be washed in dry weather, but if it is very cold it is better to dry them by the fire than risk spoiling the colours from freezing in the open air. It is better, if possible, to defer their washing till the weather is suitable.

To clean Paint.—Simmer together in a pipkin one pound of soft soap, two ounces of pearlsh, one pint of sand, and one pint of table-beer; to be used as soap.

Another Way.—Grate to a fine pulp four potatoes to every quart of water; stir it; then let it settle, and pour off the liquor. To be used with a sponge.

Coffee as in France.—Coffee should be roasted of a cinnamon colour, and coarsely ground when cool. For one pint of boiling water take two ounces and a half of coffee. Put the coffee into the boiling water; close the coffee-pot, and leave it for two hours on a trivet over the

fire, so as to keep up the heat without making it boil. Stir now and then, and after two hours remove it from over the fire, and allow it a quarter of an hour to stand near the fire, to settle. Then pour it off to serve. Loaf sugar should be used for coffee.

Wash-leather Gloves.—The grease spots should be first removed by rubbing them with magnesia, cream of tartar, or Wilmington clay scraped to powder. Make a lather of soap and water, put the gloves into the water lukewarm, as hot water will shrink them; wash and squeeze them through this, then squeeze them through a second sud. Rinse in lukewarm water, then in cold, and dry them in a hot sun or before the fire, well stretching them, to prevent them from shrinking.

Another Way.—Place the gloves on the hands, and rub them with a soft sponge in lukewarm soap-suds. Wash off the soap-suds in clear water. Pull and stretch them, and put them in the sun, or before the fire, to prevent them from shrinking. When nearly dry, put them again on your hands, and keep them on till quite dry.

To mend China.—A very fine cement may be made by boiling down a little isinglass, and afterwards adding to it about half the quantity of spirits of wine, which should be applied while warm. This cement is especially valuable in mending glass, as it is free from any opaque appearance. A very strong cement may be made in the following manner, and kept for application at any time:—Heat a piece of white flint stone to a white heat, and cast it, while at this heat, into a vessel of cold water, which will reduce it to a fine powder. Carefully preserve this flint powder, and mix it with rosin to the consistency of thick paste. The rosin should be heated in an earthenware pipkin. To apply this cement, heat the edges of the pieces of the article to be mended, rub upon them this cement, and place them neatly and well together. When dry, scrape off all excrescence of the cement, when the article will be perfect.

Damp Walls.—Boil two quarts of tar with two ounces of kitchen grease in an iron saucepan for a quarter of an hour; to this mixture add some slaked lime and very finely-pounded glass, which has previously been through a hair-sieve. The proportions should be two parts lime to one of glass, worked to the thickness of a thin plaster. This cement must be used as soon as made, or else it will become too hard. One coat, about an inch thick, has generally answered the purpose, but if the wall is very damp, it may receive two coats. Paint over the cement or plaster, and paper may be used to cover it.

A Pleasant Strengthening Drink.—Boil very gently in a saucepan the following ingredients:—The rind of a lemon, a small piece of cinnamon, and a teaspoonful of pearl barley, in about one pint of cold water. When the barley is tender, strain through a fine sieve, and sweeten with a spoonful of treacle, honey, or sugar, according to taste.

To restore Plated Cruet-stands, Candlesticks, &c., when the Silver is worn off.—Purchase at the chemist's two pennyworth of mercury, and a pennyworth of prepared chalk, mixed as a powder. Half the chalk may be used. Make it into a paste with a little water, in a saucer, and with a small piece of leather rub the article until the tarnish quite disappears. Polish with a leather. If this powder is used about once a week to plated articles, when worn, they will be kept as white as silver.

The Simplest Method of cooling Wine.—Fold *entirely* round the decanter a wet cloth, and place it in a current of air. If the cloth is not placed *perfectly* over the decanter, the effect will be lost, and the wine spoiled.

Sirof de Poires, or Syrup of Pears.—Heat any juicy pears in a saucepan over the fire until the pulp, peel, &c., have separated from the juice, which should then be strained, and gently boiled to the consistence of treacle

(not golden syrup, but real old-fashioned *treacle*), which in appearance it will resemble, but with a more agreeable flavour of sweet and acid. On the Continent this syrup is made in considerable quantities, and forms a very delicious jam.

To prevent Drawn Beer becoming Flat, and to remove Tartness.—Put into it a piece of toasted bread, and cover closely with a clean cloth, firmly pressed into the mouth of the jug. A small piece of carbonate of soda removes the tartness of stale beer. Egg-shells will also restore sour beer, and give it a new, bitter taste.

Shoes for Infants.—Get at your shoemaker's a pair of very thin leather or kid soles, the size required, and borrow the pattern of the upper part to suit the sole—with straps, if approved. Purchase about a quarter of a yard of coloured silk, velvet, or French merino; also a small piece of white union, or silk, and a skein of sewing silk, to match the material. Cut the material and the union to the pattern of the upper part of the shoes; tack them together round the edge, and bind them with narrow sarcenet ribbon, of the same colour as the outside material. Stitch the ribbon firmly. Bind the soles in the same manner. Sew up the back, and sew on the upper part of the shoes to the soles. Finish with small buttons to the straps, and rosettes in front.

To stuff Sofa Cushions.—Cut up or tear into small pieces any waste paper, and fill the case. It is a nice employment for invalids or very aged ladies, and really makes a cool, soft cushion.

To mount Prints or Maps.—First strain your calico or other material lightly over the prepared wooden frame. To do this, tack it smoothly and evenly alone one side of the frame; then turn the frame, and pulling the calico tight with one hand, press in and drive the tacks with the other, and so proceed also to fasten at the top and bottom.

To clean Decanters or Water Bottles.—Tear up soft paper into small pieces; put them into the decanter or water bottle; pour on to them cold water, and shake until clean; then turn them out and rinse.

Pamphlet Case.—Purchase at a fancy stationer's two white or coloured embossed cards, the size according to taste and requirement. Ornament the top of one with a coloured engraving or drawing. Make a hole in each of the corners of both cards. Get two yards of coloured sarcenet ribbon, about an inch wide; cut it in two, and with a bodkin draw one piece through the hole in one corner, then through the corresponding hole of the other card. Pass the ribbon under the card, and draw it through the lower hole, then through the upper hole; do the other side the same way. Fasten the ends of the ribbon with a bow; leave them long to allow for expansion.

HOUSEHOLD CHEMISTRY.

FOOD (continued).

Cheese.—The action of rennet in rendering caseine insoluble has already been noticed. When the caseine curdles, it entangles, and carries down with it whatever cream may have been present in the milk, and a clear liquid called *whey* remains, which contains little besides the sugar of the milk. In the well-known Devonshire *junket*, the whey is allowed to remain mixed with the curd, while in the ordinary *curds* and *whey* the two are separated from one another, though served in the same dish. The curd is salted to keep it from putrefaction, and in many cases is coloured. It is then strongly pressed, when the greater part of the whey is removed from it, and *cheese* is produced. The cheese is preserved for a time in a cool place, and the obscure process called *ripening* then takes place. This appears to be a kind of fermentation, and certain peculiar acids possessing a

strong and characteristic flavour are produced during its continuance. The well-known mites and maggots, as well as microscopic fungi, very frequently make their appearance at this time, their germs having been obtained from the air. It will be seen that cheese consists essentially of caseine and butter. The *richness* of the cheese depends on the quantity of cream that the milk contained. The poor salt cheese of Holland, and some other places, is made from skim milk, and contains little besides caseine. The richer cheeses are made from unskimmed milk; and in the dairies where the finest cheeses, such as *Stilton*, are made, cream is added to the milk before the introduction of the rennet. Cream cheese, and other similar kinds are made from cream alone, which retains enough caseine to curdle with rennet. It is very slightly pressed, and must be eaten fresh.

Whey—Sugar of Milk.—When the butter and the caseine have both been removed, there remains only the sugar, which, with the greater part of the salt and the small remaining traces of oil and flesh-formers (the latter similar in nature to albumen), remain in solution in the whey. If the whey be evaporated down, beautiful crystals of sugar are obtained. They are generally collected, like sugar candy, upon strings suspended in the liquid. Sugar is actually prepared on a considerable scale in Switzerland from the whey which remains from the cheese-making. But it must not be supposed that this sugar is identical with that of the sugar-cane. It is much harder, less soluble in water, and less sweet in taste than the sugar with which we are all familiar, and it is different in many of its chemical properties; and yet, curiously enough, it is identical, or almost identical, with common sugar in composition. When milk sugar has been dried at a temperature a little above that of boiling water (about 270° Fahr.), it has, indeed, exactly the same composition as common sugar. Both consist of the elements carbon, hydrogen, and oxygen, and both contain in 100 parts 42 of carbon, 6½ of hydrogen, and 57½ of oxygen. Instances of this kind are very common in chemistry, and it is often possible to afford a satisfactory explanation of them, but the chemistry of the sugar is still in a very imperfect state, and the cause of the difference between cane and milk sugar is still unknown to us.

All the sugars, and many are known, are prone to undergo a peculiar change which is called *fermentation*. It is a change, if such an expression may be allowed, which is not of their own seeking. They do not change of themselves. Common sugar, for instance, when dissolved in pure water will remain for an indefinite time without fermenting; but if the solution contain organic compounds of the kind which is liable to putrefaction, if certain low forms of organic life be present, and if, lastly, the mixture is kept at a suitable temperature (about 80° Fahr.), the sugar very soon begins to change into alcohol and the gas called carbonic anhydride (or carbonic acid). The changing organic matter with its living population is called a *ferment*. Ordinary beer yeast is a good example of a ferment. During its operation it takes nothing from and adds nothing to the sugar, which decomposes as though by the force of example. Now when caseine begins to undergo the first incipient stage of putrefaction, it acts as a very powerful ferment upon milk sugar; but the milk sugar in its fermentation does not change, as ordinary sugar does into alcohol and carbonic anhydride. It is entirely converted into a fixed and somewhat powerful acid called *lactic acid*. This is the cause of the sour taste of milk which has been kept too long, and this is, as was before mentioned, the cause of the clotting of sour milk. Sour milk should be avoided by persons whose stomachs are easily upset, and should never be given to children, not because either lactic acid or clotted caseine is injurious, but because the change shows that the process of putrefaction has commenced. Milk which has

been curdled by an acid or by rennet is not in the least injurious.

Average Composition of good Cow's Milk.—The following may be taken as exhibiting the average composition of one quart of good cow's milk. The great variations of composition to which it is subject have been already noticed. Milk is slightly heavier than water. One quart weighs forty-one ounces, whereas a quart of water only weighs forty ounces. In the following table, as throughout this article, we only allude to the more important constituents, although others have been detected in milk by different chemists:—

	Parts in 100.	Ounces in one quart.
Water	87	35½
Sugar	5	2
Butter	3½	1½
Caseine	4	1¾
Mineral Salts	½	¾
	100	41

The milk of other animals differs sometimes to a considerable extent from the above. That of ewes and goats is the richest, as much as nine per cent. of caseine and ten per cent. of butter having sometimes been formed.

The milk of the ass and mare is poorest in caseine and butter, but it contains rather more sugar. The milk of the carnivora contains next to no sugar, but a proportionately larger quantity of butter. Human milk is very similar in composition to that of the cow, which explains why children so often thrive well upon the latter.

Adulterations of Milk—The Lactometer.—The most common frauds in regard to milk are the addition of water and the removal of cream. Both these processes give a bluish tint to the milk, and the "sky blue" of London milk has become proverbial. For the detection of these frauds the instrument called the lactometer is useful. It is simply a glass tube closed at one end, and marked with fine divisions on the outside. The milk to be examined is allowed to remain for twenty-four hours in the tube, and the depth of the layer of cream is then observed by means of the graduations. A few good samples may be examined first by way of trial.

Chalk, starch, and some other substances are occasionally used to give an appearance of cream to milk which has been skimmed or diluted. Some of them can only be detected by the microscope, but chalk soon settles to the bottom instead of rising to the top, and can be tested for in the following simple manner:—Allow the milk to stand in a tumbler for several hours; then pour it carefully out, leaving only the sediment at the bottom. Fill the glass with water, and again allow it to stand until the sediment has subsided. Repeat the washing with water a second time, and if there be any chalk in the milk it will now be seen as a white powder at the bottom of the glass. Pour off all the water you can, and add a few drops of vinegar to the sediment. If it consists of chalk it will *effervesce* distinctly, just as carbonate of soda does when treated with an acid.

COOKING.

PIES, PATTIES, ETC.—PORK.—POULTRY.

Eel Pie.—For this, choose eels rather larger than for eel patties; cut them into two-inch lengths, and cleanse in cold salt and water an hour. Take out, and dry in a napkin. Roll them in pepper and salt mixed with grated nutmeg, and then in flour. Lay them in your pie-dish, interspersed with small bits of lemon-peel and mace, hard eggs in quarters, and, if you like, forcemeat-balls. Pour over them some veal stock flavoured with sweet herbs, and relieved by a dash of vinegar or lemon-peel.

Cover with a crust like that for veal pie, and bake the same. It may be eaten either hot or cold. If the latter, or for travelling, or at a pic-nic, like the veal pie it may have an under-crust. In that case the bones should be removed, as for eel patties, which will make it more convenient for a meal to be made in a railway carriage.

Oyster Patties.—Save the liquor from the oysters, extract that from the beards, and in the two together warm the oysters, halved or quartered, with a little butter and flour, seasoning with pepper, mace, nutmeg, and lemon-juice. Keep this ragout very smooth, thick, and delicate-flavoured. You may then with this make patties like eel patties. Serve hot or cold. Or for more "distinguished" patties, called *bouchées*, or "mouthfuls," make the lightest possible puff-paste (six "rolls"); with a stamp or wine-glass, cut it into rounds about two inches in diameter; in the middle of these, with a smaller stamp or glass, mark a smaller circle, cutting through the paste to about one-third of its thickness. This inner circle is to form the lid of the *bouchée*. Glaze their tops with beat-up eggs, set into a quick oven; as soon as well risen and baked, lift up the lid with a knife, scoop out the greater part of the inner crumb, fill up with the oyster ragout, put on the lids, and serve hot. Puff patties, or *bouchées*, may be made with lobster, minced fowl, sweetbread, or anything, in short, which is light and delicate.

Hare Pâté, Pâté de Lièvre (French receipt, from a good authority).—For this, an earthen pâté-dish with a lid is indispensable. Skin your hare, empty it, saving all the blood in a cup, cut it up into joints or half-joints, of convenient size for serving to a guest. Take a pound of sausage-meat and a pound of well-chopped veal; mix them together. Then mix separately two or three minced shalots, minced thyme and parsley, pepper and salt. Chop the veal-bones into moderate-sized pieces. At the bottom of the dish put a layer of hare, then a layer of the mixed sausage and veal. Sprinkle that with the mixture of herbs and spice, and then cover them over with a few very thin slices of fresh bacon. Proceed in the same way until the dish is all but full. Pour in the blood, and half a pint of white wine. Cover the whole with thin-sliced bacon and three or four bay-leaves. The veal-bones should have been inserted here and there in the substance of the pâté. Put on the lid, and seal it down hermetically round the edge with a thick paste made of flour and water. Bake, by letting it pass the night in a baker's oven after the bread is drawn. Wild-fowl pâtés, and especially wild-geese pâté, are made in the same way, and are excellent.

Hare Cheese.—This is also a true hare pâté, answering all its purposes, and still more convenient on some accounts. Have an earthen glazed pâté dish, either round or oval, with a well-fitting earthen cover. Take a full-grown hare; skin and empty it; save the blood. Cut it into joints; take the flesh of the best portions—the back, thighs, and shoulders—leaving the bones; set it aside. With the inferior portions—the legs, ribs, the head split in two, the liver, heart, and bones—you can make a civet or stew, or soup. Take a pound of the neck or loin of veal; remove all the flesh from the bones. Take half a pound of fresh lean spare-rib of pork; serve it the same. Take a quarter of a pound of sweet white or unsmoked bacon—the fat only. Chop up together, on a block, *very* fine, the bacon, pork, veal, and hare's flesh. Season to your liking with pepper and salt. You may either mix the hare's blood with these chopped meats, or add it to your stew. Another addition, depending on taste, is two or three shalots, or a middle-sized onion, minced very fine. When these ingredients are thoroughly combined, line the bottom and sides of your pâté dish with slices of white bacon cut excessively thin, to prevent the meat burning

and sticking to it. Then put in a layer of chopped meats; level it with the back of a spoon, and on it place very thin slices of bacon; then another layer of meats, and so on, till it is all used up. On the uppermost layer, put slices of thin bacon, and cover the whole with the skin of the bacon and pork, to keep in the juices. Pour over it a breakfast-cup of water, or of light white wine. In the middle make a star with four or five sweet bay leaves, on one side of which lay a small bunch of parsley, on the other of thyme. If there is still room between the meat and the cover of the dish, you may put in the veal and pork bones, chopped to a convenient size, to help to make jelly; but the most economical use you can make of them is to add them to your stew or soup. Put the cover on your dish, and fasten it down with a stiff paste made of flour and water, to prevent evaporation as much as possible. The more nearly you can close it hermetically the better. Set it in a *slow* oven, and let it remain there three or four hours, according to the degree of heat. A quick oven would make the meat hard, and dry the *pâté* up. When cold, the hare cheese is fit for use; but it will keep at least a week in a cool dry place, and be all the better for keeping. In this short but comprehensive section, our readers are furnished with examples of pies with top-crusts, with crusts top and bottom, with standing crusts; of patties and *bouchées*, of *pâtés* without crust, containing the bones of the meats, and of those without them. Our space, unable to comprise the minor details, has still included the grand outlines of pie-making. A few more choice receipts may be given hereafter.

Roly-poly Pudding (superior).—Take three-quarters of a pound of butter; set it beside you on a plate. Then take a pound of flour, and knead it into a paste with a little milk, which should be tepid in winter, cold in summer. Roll it out with your rolling-pin on your marble slab or dresser, sticking into it, from time to time, little bits of butter; roll out again, and do the same, until all the butter is used up. In this way you will have a nice light paste. When finished, roll it out long and thin, as broad as your saucepan will boil it conveniently. Then spread over it a layer of any kind of fruit preserve—apricot jam, strawberry, raspberry, &c.—which is approved of, and which you have at hand. Roll the paste on itself, beginning at one end. It will then have the shape of an overgrown sausage. Work the paste together at the ends, so as to close the preserve well inside. Flour the outside; tie it up in a cloth, fastening the ends and middle with string. Put it into a saucepan of boiling water, at the bottom of which you have placed a plate, to prevent the pudding sticking to the bottom. Boil it for three hours, taking care to keep the saucepan filled with hot water. Turn it out of the cloth immediately before serving.

PORK.

Sucking Pig.—There is no time of the year at which sucking pig is not good; it is preferable and better during the cold months of the year, and is at its best and cheapest from the middle of November to the end of December. The sows have had the benefit of the autumnal fruits, and their owners often prefer thinning, or even entirely slaughtering their litters to running the risk of rearing them through what *may* turn out several weeks of hard frost. That time of year, too, allows a longer interval to elapse between the killing and the roasting, which is important when they have to travel far to market. But in any case, we advise the roasting to take place at as early a date as convenient. Sucking pigs may be killed at from a fortnight to three weeks old; or they may be allowed to enjoy their brief term of life as long as a month or even five weeks. It is a matter of expediency with the rearer, and of taste with the purchaser; and also a question of the size of the dinner-party. A

five weeks' pig will be too much for a small family, but not too much for a large assemblage of hungry appetites. And you have to decide which *quality* of flesh you prefer. At a fortnight, your pig is more marrowy; at a month, more meaty. The Chinese breed furnishes the most delicate porklings—delicious little things, that you may wrap in a white handkerchief, and carry off under your arm or even in your pocket. They should be stuck: all the blood suffered to drain out; scalded and scraped gently; the bowels taken out, and the inside sponged dry and clean. In towns, the cook is relieved of all these preliminary preparations by professional slayers of the innocents. The precise mode of trussing or dressing varies according to locality. In some districts, the feet are cut off and sold with the heart and liver, to stew as "pettitoes." A little dish is gained, with no loss to the joint, as they would only be dried up and wasted. The kidneys are always left as they grow. Sucking pig is mostly stuffed; the stuffing may be either sweet or savoury. For the first, take bread-crumbs, raisins split and stoned, and prunes partly stewed and with the kernels removed, equal parts of each. Season slightly with pepper and salt, and bind together with raw egg and a little of the prune juice. Savoury stuffing may be more varied, being composed of bread-crumbs, beef-suet, the cooked liver chopped, sweet herbs, lemon, egg, and spice, with any high-flavoured additions you like (in moderation), such as sage and onions, mushrooms, anchovy, capers, sausage-meat, &c. When the belly is filled with either kind of stuffing, sew it up with needle and thread; lay the pig in a natural position in a baking dish; brush it all over with oiled butter, set it into a steady oven, and baste frequently with good butter. If the oven is brisk, it may be prudent to cover the pig with buttered paper till it is well heated through. It is often customary to carve sucking-pig, at least partially, before sending it to table, by decapitating and quartering it, and splitting the head. At table it is then easy to distribute it according to the choice of the guests. If stuffed savoury, it may be accompanied by any good, well-seasoned brown gravy; if sweet, by—

Plum Sauce.—Take as many raisins as will fill your sauce-boat something less than one quarter full; stone, and chop them into four or five pieces each. Into your sauce-boat put an equal quantity of bread-crumbs; mix with them a little grated nutmeg and a pinch of salt. Put the chopped raisins into a saucepan with as much half-wine and half-water as will half-fill the sauce-boat. When they boil, pour them over the bread-crumbs, stir all together, and serve.

Pork Chops and Cutlets.—The remarks made respecting mutton chops and cutlets are also applicable here; *only*, with pork, there must be no rose-pink inside. Every particle of the meat should be raised to, and kept for a few minutes at, a temperature at least a trifle above that of boiling water. This cannot be effected by the sudden application of severe heat, but rather by the continued action of what cooks would consider a moderate heat. Pork chops, therefore, are best fried over a gentle fire, and may be put into the pan as soon as the fat melts. If a joint is roasting before the fire, they may be laid in the latchpan to get well warmed through before frying. Thorough cooking, without drying up, is the first essential of a good pork chop. After that, few viands are more grateful than pork chops for tastiness in serving, and any other pleasant adjuncts bestowed upon them. It raises them from the bachelor's solitary and commonplace, not to say vulgar, morsel, to the dignity of a *dish* presentable at any dinner of moderate pretensions. The gravy may be browned and thickened, and made piquant by chopped gherkin and Worcestershire sauce. A *very little* mustard might be mixed with it; but it is a dangerous ingredient in sauces with any but the lightest-handed of cooks. But

that we are accustomed to associate horse-radish with roast beef almost exclusively, a teaspoonful of horse-radish vinegar might be used with advantage to give a zest. Pork chops may also be bread-crumbed and broiled slowly, taking care to trim off superfluous fat, lest it drop into the fire and smoke them. The style of pork chops is greatly heightened by combining them with some sauce or vegetable, however simple, if elegant in its way. For instance, pork chops surrounding mashed potatoes, turned out of a mould after browning in the oven; pork chops on a *purée* of sorrel or a layer of spinach; pork chops encircling a mound of Brussels sprouts, with brown matrimony or other well-devised sauce poured over the sprouts; pork chops on stewed red cabbage or chopped savoy; pork chops alternating with slices of hot peas-pudding, with brown gravy poured over all; pork chops in a pool of tomato sauce; pork chops having in their centre apple sauce (flavoured with cloves, lemon-peel, and juice) or cucumber sauce. The above are more than a word to the wise.

Roast Pork requires the same thorough penetration by heat, accomplished by the same means—namely, its *gradual* transmission through the mass. Hence it is scarcely possible to roast properly pork that has once been frozen. All joints of pork are the better done for basking in the latchpan before actual roasting. Although it is not advisable to roast really salt pork, even after steeping, many persons like it rubbed with salt two or three days previously. The leg (when scalded, mostly roasted with the skin on, scored into crackling) may be stuffed with sage and onions in the way directed for stuffing boiled leg with parsley. When the loin and the sparerib are so large that the fat must be raised, so that they cannot be cracked, their flavour and appearance will be improved by dusting their upper surface, just before they are done enough, with powdered sage and chopped parsley. Of course, either of these joints will have been chined at the junction of the ribs with the back-bone. Frequent basting with *hot* dripping will help the heat to penetrate their substance. Nothing cold (broth, cider, wine, or water), should ever be put in the latchpan, to help out the gravy. Like pork chops, roast pork gains greatly by the style of its accompaniments.

Pork and Apple Fritters.—Prepare a light batter as for pancakes. Take cold pork, boiled or roast, the latter being preferable, mince it rather fine. Take apples peeled and cored, chop them small, and mix them and the minced pork with the batter. Then fry them as you would apple fritters, stirring up the batter every time you take any. Fritters can be made in like manner with cold minced pork, and any approved chopped vegetable (previously cooked), as potato, parsnip, salsify, &c., instead of apple; but unless used in moderate quantity, the fritters will not hold well together.

Pork à la Mode.—An excellent *mode* for very large pork, such as portions of the shoulder, loin, or sparerib, of the very largest bacon hogs. Put the joint, rubbed with pepper and salt, into a *daubière* or pot having a close-fitting lid, with whole onions, celery, carrots, sage, parsley, and knotted marjoram, or thyme, a glass or two of wine, and enough water or broth to keep all from burning. Stew gently for three or four hours. Place the pork in the centre of a dish; arrange the vegetables round it. Strain the gravy, skim off the fat; thicken, season, and dilute it, according to your judgment, and pour it boiling hot over the pork. When removed from table, trim it into a handsome lump; put it on a smaller dish; warm up the remaining gravy (without the vegetables), and pour it over the pork. You will thus have a handsome dish to present cold. This is one approved way of dressing wild-boar (with the skin and fat on). If we indulge mutton with the honours of venison, there is no reason why pork should not be treated as wild pig—a

kind of game well worth securing, when it falls in your way.

Scrambled Pork (American).—Freshen, by steeping, some nice salt pork; cut it into mouthfuls, and partly fry it. Just before it is done, break into the pan with the pork from six to twelve eggs; break and mix the yolks with the whites, and stir them quickly with the pork. If the pork, while frying, has given out much fat, drain it off, before serving, into a basin, and save it for shortening crust, &c. Mealy potatoes (baked, boiled, or roasted) are usually served with scrambled pork.

Pork Pancakes.—Make a light batter with milk, flour, and eggs; add a little yeast, and give it time to rise. If the pork is salt, freshen it by steeping; cut it as thin as possible, and fry it until done enough. Then dip it in the batter and fry it again, pouring over it a spoonful of batter. When fried on one side, turn it as you would a pancake. Cold boiled or roast pork, sliced thin, will not require any previous frying, but may be fried at once with a due allowance of batter.

POULTRY.

The Common or Domestic Fowl.—The word “poultry” ought to include no more than common cocks and hens; but it is popularly made to comprise all the domesticated species of birds—turkeys, ducks, geese, &c.—and as such we understand it here. Which breed of fowls is the best for table, is a question of prejudice, habit, and locality. Every county has a “strain” which is superior to that of the other fifty-one counties; every neighbourhood has some crack breed which is unrivalled elsewhere. The poultry-consuming world is divided into parties. One side complains that few persons have any idea of the extent to which we are tyrannised over by our cooks and the poultrymen. The former say, “White-legged fowls look so much better on the table than those with dark legs;” the latter, of course, meet the views of their patrons by offering for sale only those with white legs, to the exclusion of the far more numerous dark-legged fowls which are almost banished from the shops of English poulterers. In France, the favourite breeds are La Flèche and Crèveœur, the legs of which are as dark as can be, and the Houdan, whose legs are not quite so dark. All these are now conspicuous in our poultry shows, and might be imported advantageously; but the poulterer knows that the English cook only looks to what she considers appearances, and will not buy them in consequence of her prejudices. The Spanish fowl thrives well in town or country, and is an excellent table-fowl; but its legs being black, it is put upon the cook’s black list. “New English cookery books,” continues the complainant, “pander (not all of them) to this well-known and absurd prejudice; but all the old books, under the heading ‘To choose Poultry,’ say, ‘Dark-legged fowls are the most juicy and best-flavoured.’ Evidently the French are of that opinion. My family, as well as myself, prefer dark-legged poultry, as sweeter and more nourishing. But my object is not to disparage one breed of fowls at the expense of another, but rather to remove disabilities which prejudice has thrown over the appearance in the kitchen of one highly-deserving class—viz., the dark-legged. In rearing, I have found the dark-legged hardier than the white, in the proportion of four to three. Consult a knowing person in the country on what fowls to keep, and the first question asked will be, ‘For your own consumption, or for market?’ And then the secret comes out. ‘White legs for market; their appearance fetches top price; but give me dark legs for a nice fowl at home.’” Decidedly, common sense would tell us that a good fowl’s legs can never be of a bad colour, especially as we do not eat the legs. Poultry exhibitions, it must be confessed, have not much helped the epicure. In the English shows, made up of live birds, beauty of feather, high condition, courage,

and purity of breed, are the grand points aimed at. As far as eating is concerned (except in respect of weight), they might as well be canary shows; while the French exhibitions of dead fat poultry make size and weight their principal object, without sufficient regard to quality. A combination of the two systems might produce more satisfactory gastronomic results. And there is no reason why poultry should not be *tasted* by the judges, as fruit is at every horticultural meeting. Fatted fowl is good, but not too fat nor kept too long confined in coops. We specially recommend young birds, from nine to twelve months old, taken in good plight from their usual run, and shut up for four or five days, on a diet of barley-meal and water with a little broken bread and milk, giving them a hearted cabbage or lettuce to peck by way of pastime. This short course of regimen is prescribed principally for the sake of *cleansing* them; because cocks and hens are *very* fowl feeders. Poultry should be made to fast (with plenty of water within their reach) at least twelve hours before killing them; they should never be killed with anything in their crop. It is best to pluck them while still warm, and then hang them up in an airy safe, to keep till tender; the time of which will depend upon the weather and their age. If required to be sent to a distance, they should not be packed till completely cold. This rule is equally applicable to game. Large quantities of game and poultry are annually greatly injured or spoiled by being packed warm, or so close together as to heat spontaneously. After their first rough plucking, fowls require a second looking over, to clear them of any stumps or sprouting feathers that remain; then, before emptying, they should be singed with the flame of burning paper, to clear them of hairs and down still left on the skin. When emptied, the heart, liver, and gizzard (cleaned) are to be set aside; the inside of the fowl wiped out with a rough cloth, and in warm weather slightly rubbed with pepper and salt, to help to keep it. As a rule, domestic poultry should not be kept too long; turkeys are allowed the longest period, and may be hung up a day or two *after* their stuffing and preparation for the spit, especially when truffles or high-seasoned ingredients are used. Young fowls do not require any long delay (twenty-four hours will suffice) before cooking, to make them tender; old ones will need to be softened and compelled to yield by long-continued boiling or stewing.

Roast Fowl.—The subject in this case *must* be young; never more than a twelvemonth old. Truss it according to the custom of the country; without the leg-shanks, or with them and the toes with the claws chopped off, pheasant-fashion. Some fasten the liver to one wing, and the heart and gizzard to the other; by which both are apt to be dried up, unless the wings are protected for a time by buttered paper. Foreign cooks mostly roast the liver *inside* the fowl, which keeps it plump and tender, and reject the heart and gizzard, or use them in stews. Baste the fowl at first with good butter, then with its own gravy; keep the latchpan at a certain distance from the fire, for fear of ashes or cinders falling in, which would spoil the gravy utterly. Roast fowl is served in various ways. The simplest is to lay it on a hot dish, and send up its own gravy in a sauce-boat. With mushroom sauce (very prepossessing), pass the roast gravy through a strainer into a saucepan, thicken and brown it with a dust of flour, and stir in a large tablespoonful of pickled mushrooms with the vinegar belonging to them; or you may make mushroom sauce with melted butter, as you would caper sauce, and send it and the gravy separately with the roast fowl. With water-cresses (once the highest fashion, and still a dish for good society); take the choicest water-cresses, dispose a layer of them on a dish, so that, besides a bed for the fowl to lie on, there shall be an outer circle to form a fringe round it. Immediately

the fowl is taken from the fire, lay it on the cresses. It is indispensable that it should be served hissing hot. The gravy is sent up in a sauce-boat, and the carver gives cress with every portion of fowl. At many of the best tables, a rigorous accompaniment of hot roast fowl is salad, hints respecting which will be given in a future article. Cold roast fowl may be hashed, by cutting it up into joints, warming it in its own gravy thickened and seasoned, with the addition of any mushroom sauce that may be left. Cold roast fowl makes an elegant dish converted into a Mayonnaise, already described. If you have *plenty* of cold fowl, you may cut the flesh off the bones in as handsome pieces as you can; but if short of meat, you need only divide it into presentable joints, and then arrange it in the Mayonnaise construction, with salad, sauce, &c.

Fowl roasted on a String, not a Jack. (Alexandre Dumas, Sen.)—On one occasion M. Dumas thought fit to prove his culinary acquirements by cooking a very complicated dinner, one dish of which was a pair of fowls roasted on a string. His vice, or assistant cook, had hitherto been obedient; but at this she rebelled, standing up for the jack, until he threatened to get her paid off and turned out of the house forthwith. She yielded, and five minutes afterwards the fowls, each on its string, were spinning like a couple of spindles, side by side, before the fire. M. Dumas' plan is based on physiological facts. Every animal has two orifices, an upper one and a lower one. To roast a fowl in first rate style, the upper orifice must be stopped, after the Belgian fashion, by thrusting its head into its crop and sewing the skin over it with needle and thread. By the lower orifice, the fowl will have been emptied. Its liver, chopped small with parsley and other sweet herbs, and mixed with butter, will be returned to the place of the absent intestines. And now, what ought to be the cook's grand object? Decidedly to retain in the creature she is about to roast the greatest quantity of gravy possible. But if she thrusts a big spit through it from end to end, and a small one across it to keep it in place, she makes four holes, instead of two, for the gravy to escape from. But if, on the contrary, you tie its feet together with a string, and suspend it vertically by that string, with its lower orifice upwards and its upper orifice closely plugged; if you dust it slightly with salt and pepper, and baste it with the very best fresh butter, pouring a spoonful now and then in at the fowl's inferior orifice, you then fulfil all the logical conditions for having an excellent roast chicken. You have only to watch it while it roasts, to cut the string which holds it when the skin is covered with little blisters out of which issue jets of sweet-smelling steam. You then deposit it on its dish, and pour over it the contents of the latchpan, with which not a drop of *broth* must have been mixed during the whole process of basting.

To cook Old Fowls.—The oldest and toughest fowls may be made into a savoury and nutritious dish by the following method, which is given as a tried and warranted receipt, because such birds are so often pronounced uneatable, thrown away, and wasted. When the fowl is plucked and drawn, joint it as for a pie. Do not skin it. Stew it five hours in a close saucepan, with salt, mace, onions, or any other flavouring ingredient that may be approved; a clove of garlic may be added when not disliked. When tender, turn it out into a deep dish, so that the meat may be entirely covered with the liquor. Let it stand thus in its own jelly for a day or two (this is the grand secret); it may then be served in the shape of a hash, a curry, or a pie, and will be found little inferior to pheasant under similar circumstances of age. The addition of stock, made from game bones and trimmings, will improve the flavour. Italian poulterers kill fowls by bleeding, receiving the blood in cups; which blood is sold for enriching stews of a like description to that just given.

SEA-WEEDS: HOW TO OBSERVE, USE, AND PRESERVE THEM.

AT the pleasant time when heads of families are cheerfully making their arrangements for the periodical visit to the sea-side, which has of late years become an institution forming a portion of the yearly life of most respectable households—and, from annual custom, considered indispensable—it will not be amiss if we endeavour to assist the labours of those who have to make provision for the amusement, as well as for the maintenance, of their party. Too often, for want of suitable employment, time is found to hang heavily both upon seniors and juniors. The ordinary routine of home being laid aside during the holiday, and the different means of amusement having been exhausted, all feel that weariness which is the

these “blooms of ocean.” Does not the term “weed” suggest to us something obnoxious and useless; something to be got rid of, in fact, as worthless lumber? Whereas those among us who have cultivated the most intimate acquaintance with sea-weeds, or (to give them the proper names by which science has divided them into groups) with the *Fuci*, *Algæ*, and *Confervæ*, discover increasingly their value and beauty, as, with the aid of the microscope, an insight is obtained into their delicate and elaborate organisation.

But it is not only as a source of scientific recreation that sea-weeds deserve regard. As an inexpensive and fructifying manure, some species occupy a most important place in agriculture. Those who have tried such a dressing for asparagus and strawberry beds in the autumn, will testify to its fertilising qualities and to the increased



Fig. 1.

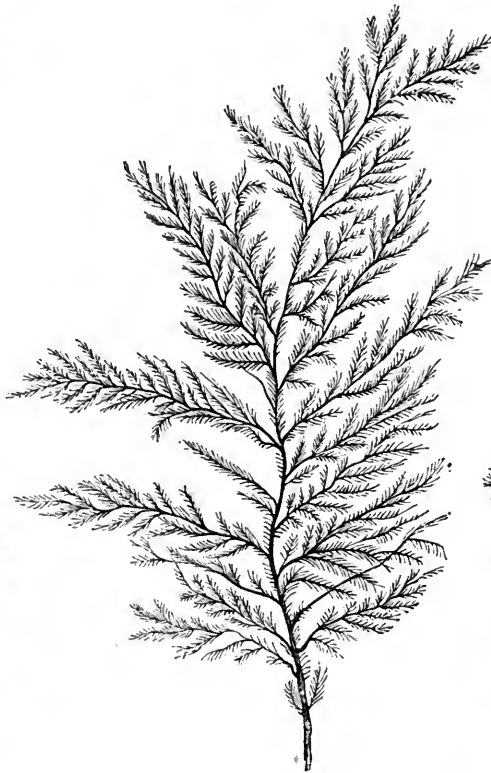

Fig. 4.

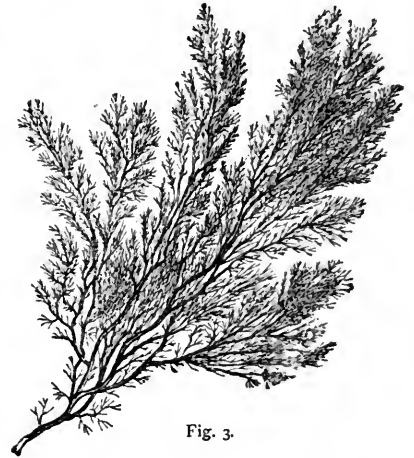

Fig. 3.

inevitable result of idleness; and the trip which was projected as a source of health and pleasure becomes, instead, a period of dissatisfaction and disappointment. All who have experienced the truth of these remarks will, we are convinced, be pleased to be introduced to an employment combining amusement with the most useful instruction, and especially adapted to wile away the hours passed on the sea-beach or amongst the rocks—we allude to the collection and preservation of sea-weeds.



Fig. 2.

It may here be remarked how much it is to be regretted that such a misnomer as the title of “sea-weed” should have been handed down to us. Like most popular fallacies which have only antiquity to recommend them, the epithet has been retained even by those who admit its use to be erroneous; and it would probably now be in vain, were any bold reformer of nomenclature to attempt the substitution of the title “sea-flower” for the opprobrious name now in common use. Yet such a substitution would be justified by fact, and would much more truly describe

size of the produce. Then again, our northern neighbours find in the “Dulse” a palatable esculent, which, in the sad famine seasons, has even been proved to be capable of sustaining life. The “Carragheen,” or “Irish moss,” Figs. 1 and 2, carefully picked, washed, and bleached in the sun, is boiled as a cheap substitute for isinglass, and produces a gelatine, equal in its nutritive qualities to more expensive vegetable jellies, if, indeed, it is not superior to most. Careful housewives of Scotland collect this “Irish moss” largely during their summer visit to the sea-coast,

and preserve it for winter use in the composition of blanc-mange, &c. The green laver, now a common article in the London shops, is nothing but a sea-weed, growing plentifully on the coast of Devon; it is picked from the rocks in autumn, washed, salted, and boiled in vinegar to prepare it for sale, and then becomes, as most people are aware, a most valuable adjunct to roast mutton, not only on account of its excellence as a relish, but also because of the health-giving properties of the iodine which it so plentifully contains. The manufacturer and the

chemist know full well the chemical wealth which lies scattered on the sea-shore after a night of storm. The practical surgeon, amongst all the resources of pharmacy, knows of no more successful remedy for scrofulous glandular enlargements than poultices made of the sea-weed commonly called "tang," perseveringly applied. One other well-known instance of the usefulness of the same last-mentioned "tang" will at once rise to the remembrance of all who have at any time undertaken the care of a party of young people at one of our numerous watering-places—viz., the extemporised barometer, consisting only of a long specimen of the dark-brown sort, which, by its moisture or dryness, foretells the coming weather with such marvellous accuracy.

Unfortunately for the progress of this particular branch of natural history, the desire implanted in the hearts of the young for a more intimate knowledge of the marvels of that wonderful creation which everywhere surrounds them, is too frequently checked and damped by a want of sympathy in their elders, who wage war against the hoarding of these natural treasures, which they scornfully reject as "mess and rubbish." How much better and wiser would it be, while regulating the indiscriminate collection of such objects, to assume a leadership in the pursuit, and to encourage an intelligent accumulation and classification of specimens, so as to form an assortment of the different species of each weed for more minute investigation at a future time! Even should the personal tastes of the juvenile collector never lead him to a more practical application of the collection to purposes of science, from such a hoard valuable additions may be made to the boxes of some laborious botanist, less favoured in the opportunity for pursuing his researches in various parts of the coast; for there is, in fact, as great a variety in the local distribution of ocean's flowers as there is in those of earth. Many, it is true, are common to all parts of the sea-beach, but others are strictly confined to particular localities—witness the Gulf-weed, so called from its being found only in that tract of ocean known as the Gulf-stream; it is on record that a disabled vessel, driven out of her course, and deprived for days of such help as might have been obtained from the sun or the stars, has found in this weed a friendly guide, indicating her position in the trackless deep. In our own country, the exquisitely minute specimens of distinct but wonderful variety of delicate red fibres, so much prized by the extensive collector, are almost indigenous to the Devonshire and Cornish coasts. The beautifully shaded "sea poppy," the brilliant *Delesseria sanguinea*, the curiously-berried *Sargassum bacciferum*, are seldom found except in particular spots; these may be readily sought out in one of the numerous handbooks on the subject, now so admirably got up at a price within the means of all, and in the guise of a royal road to marine botany for the weary or the idle.

To induce a more careful investigation into, and preservation of, the marine flora, we shall now proceed to give a few trustworthy directions for the guidance of the amateur collector, premising that such hints are the result of many years' experience, and tested by the possession of one of the largest of private collections.

The first thing to be considered in commencing a collection of sea-weeds is, when and how a good supply may best be provided, from which to select the finest specimens.

The best season for collection is during the months of September and October, as what may be called their harvest is then at its height; they are, for the most part, in full bloom, and in the greatest perfection, owing to their having been but newly dislodged, by the action of autumnal gales, from the rocks in deep water, upon which they flourish most luxuriantly. From this cause, they have a fresher appearance than those specimens which are found at other seasons; although, in our variable climate, such favourable circumstances lead to their

discovery, in most months, from the ordinary action of the tides. Where it is possible to do so, it is very desirable to gather largely, and even indiscriminately; by this means, an opportunity is afforded for the selection of the most perfect plants, the preference being, of course, given to such as have been cast up entire, and retain the fully-developed fibrous root. In addition to this, some are of so exceedingly delicate and minute a structure, that they are apt to escape the eye when lying by themselves; whereas they cannot be overlooked in the course of a systematic examination, conducted with ordinary care and perseverance.

At the end of every day, the sea-weeds which may have been thus obtained should first be thoroughly washed in a large, shallow pan of cold fresh water. While they are being thus cleansed, care should be taken to remove any parasites, or foreign matters, which may have attached themselves to any of the filaments; for this purpose, each branch should be gently agitated every now and then; a bone knitting-needle is a good thing to use in doing this, as it is less likely to injure some of the more delicate descriptions of weed.

If it is inconvenient to spread the specimens out at once, they may now be shaken out on to a folded linen cloth. To absorb the moisture, and placed in a shady spot, where there is a current of air, so as to dry thoroughly. This, it may here be premised, they will never do, unless the washing has been carefully performed, and all traces of salt removed. When quite dry, they may be set aside, until an opportunity can be found for the more elaborate portion of the preservative process, which, being a tedious operation, requiring the use of much patience, is admirably adapted as an amusement for winter evenings or wet days.

Provide some common foolscap paper and some blotting-paper, or, which is preferable, Bentley's botanical paper. Spread some grease thickly over a sheet of the foolscap, which, when thus prepared, is to be laid on the bottom of a shallow dish, large enough to hold the sheet without its becoming bent or wrinkled; over this pour cold water until the dish is nearly full. Now select the specimen which is first to be laid out, and float it upon the surface of the water, separating each filament from its neighbour with a camel's-hair brush, until the entire plant lies spread out in the form in which it is to be finally preserved. In doing this, it will be found necessary to exercise a certain amount of precaution, as to the side of the plant which is placed uppermost, and the direction in which it is spread out; any knobby excrescences, or redundant branches, should be on the upper surface, and the longest branches should have plenty of room allowed them to lie straight. Next, place a small weight upon the centre of the floating specimen, and from this point begin to pick out the fronds separately, so as to exhibit their mode of growth. Here, again, the bone knitting-needle will be found useful, and may be supplemented by a lady's pointed stiletto, for places where a finer instrument is required. This part of the process demands much patience, and cannot be executed hastily, as the plants are often brittle, or entangled. Where the growth is unusually redundant, the less important fronds must be cut away with a pair of sharp scissors, and as each portion is disentangled, its place must be preserved by putting a small weight upon it; a few smooth pebbles will answer admirably for weights, or some square chippings of stone may be used, such as can be obtained in any stonemason's yard. If the specimen is a very large one, and not of a minute description of sea-weed, only a small portion at one side need be accurately picked out to show the distinctive character; and, in doing this, the assistance of a good magnifying-glass will be found useful; the remainder of the plant may be pressed in a rough condition. Figs. 3 and 4 show the *Cellaria toricata*, or squirrel's tail, in the two conditions.

Each branch being arranged. suck up all the water

in the dish with a small sponge, and slide out gently the greased paper bearing the object upon which you have been operating, laying it first upon some blotting-paper, to absorb the moisture; remove the little weights, and place over all a sheet of oiled foolscap. Re-arrange upon this any branches that may have slipped out of their places; and, finally, put the whole underneath something weighty to dry. In travelling, a flat leather portmanteau answers this purpose very well; but we should recommend a determined collector to procure two pieces of oak board, about fifteen inches by ten, and about three-quarters of an inch thick, the edges bevelled, and a leather strap attached to one of them, to go round both and fasten them together, when the plants will be more flattened out.

When quite dry, the displayed plant may be removed from the greased paper (which can be used again), and placed—at first indiscriminately—in a book, made with guards between the leaves, slightly fixed with narrow strips of gummed paper at the principal branches; against each should then be written its name, both popular and botanical, the locality in which it was obtained, and the date. When the collector has made some progress in the study, these specimens can be removed, the nomenclature verified, and each plant disposed upon a separate half-sheet of demy paper. By this separation, any deficiencies can readily be supplied at future opportunities; and the whole may now be enclosed in one of those large wooden cases, made and lettered in imitation of a book, which is commonly used for an herbarium.

Such a collection as has here been described will, if formed with discrimination, prove valuable, not only as a reminiscence of pleasant hours and rambles, but as a means by which the earnest student may obtain a fuller insight into those marvels of creation which everywhere surround us with their incontrovertible evidence of the existence of an over-ruling and beneficent Power. A little experience in the use of a small botanical microscope will enable the student to discriminate between the ordinary *Fuci* and the *Conferva*.

COOKING.

BEEF AND TRIPE.

Salt Beef.—In ordinary weather, a round of beef, weighing seven or eight pounds, will be sufficiently salted for domestic use in five or six days; but meat absorbs salt much quicker in hot weather than in cold. During the former, it must be protected from flies (whose maggots are not afraid of brine), by throwing net or muslin over it, or keeping it under a wire-work cover, or in a meat-safe. Rub the meat all over with half an ounce of crushed saltpetre, to give it colour. Let it so remain for two or three hours. Then you may pile over the meat half a pound or so of good brown sugar; this is not essential, but is a great improvement; those who taste the beef will find the flavour good, without guessing the reason why. Then cover it completely with common salt, piled over it till every part of it is hidden. To be sparing of this useful article is very poor economy; it is hardly prudent to spoil five-shillings' worth of beef for the sake of twopenny-worth of salt. Turn the beef in the salting-pan every day, and ladle it with the brine which comes away from it. Before boiling it, rinse it rapidly in cold spring water. You may stuff it in one or two places with chopped parsley, thrust into holes made through it with a knife. Lean joints of beef should always have a portion of fat salted with them, to be boiled and served at the same time. Set salt beef on the fire with the water cold, and remove the scum as fast as it rises. When it boils, throw in turnips, carrots, onions, and parsnips, if approved. Afterwards allow it only just to bubble up, without ever coming to a gallop. Beef that has long been salted in

brine, before it can be cooked, must have some of the salt drawn out by steeping in fresh water.

Hashed Beef.—Without unfairness, it may be said that beef is less inclined to lend itself to hashing than any other meat. We are also tempted to believe that many popular writers have, perhaps out of sheer frolic and fun, abused their privilege of abusing cold beef, for the sake of teasing their better halves. Possibly, the time and trouble of hashing beef might be more satisfactorily bestowed on something else, leaving it to appear as it is. Thus, for a family dinner, giblet soup, boiled cod and oyster sauce, with whole potatoes; cold beef and pickle, with mashed potatoes; hashed calf's-head and apple pie, might be tolerated, now and then. Nevertheless, you may hash beef thus: Cut the cold meat into small shapely slices; dust them on both sides with flour, pepper, and salt. If you have cold roast-beef gravy, put it into a stewpan; if not, use butter instead. In this, brown a teaspoonful of flour; dilute with good broth, not making more than will cover the beef. Stir in a tablespoonful of catchup, the quarter of a pickled walnut, bruised small in its own vinegar, and a very small pinch of scraped horseradish. Let the sliced beef simmer in this half an hour, without ever coming to a boil. Arrange the beef on a hot dish; pass the gravy through a strainer; give it a good boil up, and pour it over the hashed meat.

Beef Griskins (of Cold Meat, Roast or Boiled).—The best for these are the thin part of the ribs, the breast, or other portions of the bullock in which the fat and lean are nearly equally mixed. Chop fine one or two onions or shallots, some parsley, and mix them with pepper, salt, grated nutmeg, and oiled butter, which last must be kept sufficiently warm to remain liquid. Cut the beef into slices a good inch thick; steep them in the above, turning them over from time to time. When they are well soaked, press them on both sides in breadcrumbs mixed with a little grated cheese. Then grill them over a gentle fire, till they are thoroughly heated, and nicely browned on both sides. While they are broiling, put the butter, onions, &c., in which they were steeped, into a saucepan, with a couple of tablespoonfuls of broth. Let it boil a few minutes, shaking it about; add a teaspoonful of vinegar and a tablespoonful of catchup, and serve it in a sauceboat with the broiled beef griskins. A good way of disposing of a cold roast-beef bone is to put it into a toad-in-a-hole pudding; when you get all the goodness out of it, and still have some picking left.

Beef Tongue, with Piquant Sauce.—Many cooks forget that tongue can be served in other ways besides cold boiled, after salting and smoking. The following makes a handsome dish, which, moreover, is as good at the second or third heating-up as at first:—Trim the tongue into handsome shape, removing the cartilage, the small bones, and other superfluities that may be left at the root. Wash it well, rubbing it with the hands; leave it to cleanse an hour in cold pump-water. Then throw it into a large soup-kettle of boiling water; let it boil half an hour; then take it out; reject that water; rinse, and wipe out the soup-kettle clean; then return the tongue to it, well covered with cold water. One result of this operation is, that, the tongue being thoroughly cleansed, the second boilings are perfectly available for soup—pea or other. As it boils up, skim. After two hours' gentle boiling, add onions, carrots, turnips, celery, a bunch of sweet herbs, &c. These are for the benefit both of the tongue and the broth remaining. After three hours' boiling, take the tongue up, avoiding pricking it with a fork. Peel off the skin, if it will come away easily, and trim loose odds and ends at the root. Now put the tongue into a deep stewpan, whose bottom is covered with thin slices of veal and unsmoked bacon. Surround it with very small onions, two bay leaves, a few cloves and pepper-corns, a sprig of thyme or knotted marjoram, a slice or two of ham, and a

carrot chopped small. Then cover the whole with the boilings, close down the lid, and let it stew gently a couple of hours longer. Take up the tongue; peel off the skin, if not done before; split it in two from above, without separating it at the lower part. Lay it, thus open, but still connected, on a large, hot dish. Take as much of the second liquor as will suffice to cover it; season this, in a saucepan, to taste, with salt, vinegar, mustard, and scraped horseradish. The two last ingredients must be used with great discretion. Boil up, remove the horseradish, pour it over the tongue, and serve. The carver will take care to exhaust one half of the tongue before he begins the other. What is left will then be presentable, warmed up, in a handsome shape. If, after peeling off the skin, it is wished to reserve either the whole tongue, or half of it, to be sent to table *cold*, it should be covered with a *glaze*, laid in a large dish, and surrounded with the second boilings reduced to a jelly, cooled in cups or little moulds, and then turned out on the dish.

Meat Glaze, in a Hurry, (for the above or other Meats, to be served cold).—Cut a quarter of a pound of beef or veal into very thin slices; fry them in butter over a gentle fire; take the fryingpan off the fire; add a wine-glass of water, pepper, and salt. Set the pan on the fire again; scrape the inside with a spoon; let it boil up and thicken; pass it through a strainer into a cup, and it is fit for application to the meat to be glazed.

Hodge-podge.—Take the bottom part of a breast of beef; cut it into pieces about two inches square; rinse them in cold water; let them remain there awhile; then scald them for two or three minutes in a saucepan of boiling water. At the bottom of a large stewpan, with a hollow lid, put a few scraps of fat beef or veal; on them a layer of carrots sliced; then the breast of beef; then a slice of ham and a sausage for each guest. Over these meats place salsifies and scorzoneras cut in short lengths (if you can get them), kidney potatoes, two sticks of celery halved, and a taste of onions, parsnips, and turnips. Season with pepper and salt, fill up with good broth, cover the lid down closely, and cook slowly with fire below and hot charcoal above. When cooked, brown butter and flour in a saucepan; dilute with liquor from the hodge-podge; season with catchup or other approved sauce. Arrange the hodge-podge in a large hollow dish, the vegetables beneath and the meat on the top; add the liquor according to your judgment; pour the sauce over all, and serve hot.

Minced Beef (fresh) and Boiled Potatoes.—Broiled or fried meat is often served, because it is a *speedy* mode of cooking. Now, a broil is either very good or very bad; and it is possible for a beefsteak to be uneatable, solely on account of its toughness, especially in large towns, where butchers will cut up a whole bullock into steaks, irrespective of joints or their quality. If fortune favours you with one of those steaks of which you have a presentiment that it will turn out leathery, chop it small, toss it in butter in a stewpan with parsley, green onions, chopped shallot or onions, pepper, and salt. In ten minutes it will be done enough. Take the mincemeat out of the stewpan, and set it aside. Put a bit more butter into your stewpan; add flour; brown it; moisten gradually with a little good broth, or, in default thereof, with water. Let it boil a moment to take the rawness away from the flour. Return the mincemeat to the gravy; let it stew a minute or two; add a teaspoonful of vinegar and a tablespoonful of mushroom catchup. Send up this *hachis*, or hash of *fresh* meat, accompanied by mealy boiled potatoes; or you may make a dyke of mashed potatoes round the inside of a large dish, and pour your *hachis* in the middle. During the mushroom season, when you restore the fried meat to the gravy, put in a few nice fresh mushrooms (both buttons and expanded ones, with the upper skin peeled off and cut in quarters), and

omit the catchup. This mince must not be confounded with hashed cold beef, to which it is evidently preferable, not having lost its gravy. Although hashes are pretty and pleasant when *well* done, cold meat, we venture to suspect, is sometimes written off with *too* hard a pen. A hash is either very good, or very so-so. We far prefer a slice of tender, fresh, juicy cold meat, with pickle and potatoes, to a horny, briny, bedevilled hash.

Beef Cheese.—Take three parts beefsteak from any fleshy part of the animal, and one part equally composed of lean veal and uncooked ham; chop them together as finely as possible; cut a lump of white bacon into small dice, and mix it with the minced meat; season with salt, pepper, allspice, chopped parsley, and chives or green onions, half a clove of garlic, bay-leaf, sprig of thyme, and half a wine glass of brandy. Line the bottom of an earthen pâté-dish with thin slices of bacon; on this place the seasoned mincemeat; cover with more thin slices of bacon. Put the cover on the dish; lute it down with paste made of flour and vinegar, and send it to pass the night in a *very* slow baker's oven. Let your beef cheese cool and stiffen in the cellar for four-and-twenty hours before opening or cutting it up. This makes a useful, nutritious, and economical dish to help out a cold dinner, where there are many children or guests to serve in a hurry, and where *bones* are inconvenient, as in travelling, and on many occasions of an active and busy life.

Tripes à la Mode de Caen (the most popular French way of dressing Tripe).—Take three pounds of uncooked tripe, consisting of the thick, the thin, and the honey-comb, half a neat's foot or a whole calf's foot prepared. Scrape and wash the tripe in tepid water, until it is perfectly sweet and clean. They will do this for you at the tripe-shop; then let it lie an hour or two in the coldest pump-water you can get; then cut it up into pieces two or three inches square; also cut your neat's foot in pieces. Put the pieces of foot at the bottom of a deep earthen pot; on them pack closely half your tripe, and on the tripe lay eight or ten middle-sized onions; then the rest of the tripe, and then another layer of eight or ten onions, which you will finally cover, to cap up the whole, with half a pound of white bacon cut into thin slices. Brown slightly a quarter of a pound of butter in a stewpan with a tablespoonful of flour; dilute it considerably with water, and as soon as it boils up pour it over the tripe in the pot. [This addition to the contents of the pot, though good, is by no means indispensable.] Pour water into the pot till all is well covered; season with pepper, salt, parsley-sprigs, and other approved aromatic herbs. Some put in twelve or fifteen juniper berries, to give a peculiar flavour, which has many admirers. That, however, is optional. Cover the pot with a lid, if it has one, but do not lute down the lid with paste. A wooden lid, or even stout brown-paper doubled or trebled and tied down with string, answers very well. Then confide the pot to a baker, the fire of whose oven is spent. Success now depends on him, and you will beg him to prove himself a gentle baker. Set in at seven or eight in the evening, and it may remain there till he lights the fire in the morning. But the prime way of eating it is to contrive that the pot shall leave the oven at dinner-time, and to set it unopened in the middle of the table. It is very good, nevertheless, warmed up again.

N.B.—The juniper flavour has numerous partisans, of which gin is a notable instance. Juniper thrushes are much sought after. The poor birds, in their passage over Mont Cenis, feed by the way on juniper berries. They are ruthlessly and unsparingly snared or shot, and sell well, particularly in innkeepers' bills. Foolish Savoyards, to kill the thrushes who would spend their winter in killing the slugs and snails that ravage your vines! The genuine wild flavour is imitated by stewing juniper berries with ordinary thrushes.

FIRE PAPERS, STOVE BOARDS, ETC.

A Simple Fire Paper, Green and White.—For a foundation procure a sheet of common white cartridge paper, sold at stationers' at a penny, and cut it oval by rounding off the corners. Take a sheet of green tissue paper already doubled, fold it in half lengthway, and in half across width-way. Fold this once more in half, the lengthway. Then cut it in narrow strips, not quite to the top of the fold, in the manner shown by Fig. 1. There will be eight of these pieces in the sheet; cut them separately. A fold will be observed in the centre of the strips of every piece. Reverse each separately, so that the strips stand out like loops in the cut part, and bring the uncut margins together, Fig. 2. Tack four green ones, side by side, to the lowest extremity of the oval of cartridge paper. Fold a sheet of white tissue paper, and cut it in the same way. Then sew four white pieces by the side of the four green; and

papers further apart towards the bow of the oval foundation, and press them closer at the ends. The pieces of tissue paper are fastened to the cartridge foundation by tacking them on with a needle and thread. Sew a few horizontally round the bottom.

This pattern may be varied by continuing the colours all down the fire-apron in stripes, instead of in a chess-board pattern as shown in the illustration, Fig. 3. The tissue paper need not then be divided in short pieces, but only in strips.

A third variety of fire paper which can be made from this pattern, is to cut the paper in the way described, parting it in long strips, and tack it to the foundation horizontally, following the shape of the foundation with a bow or bend. The top is garnished with a few roses and leaves, the manufacture of which will be presently described. Fig. 3 shows the shape of the foundation of cartridge paper, which is somewhat of an oval. If one sheet is not large enough, sew two together; fold them at the dotted line down the

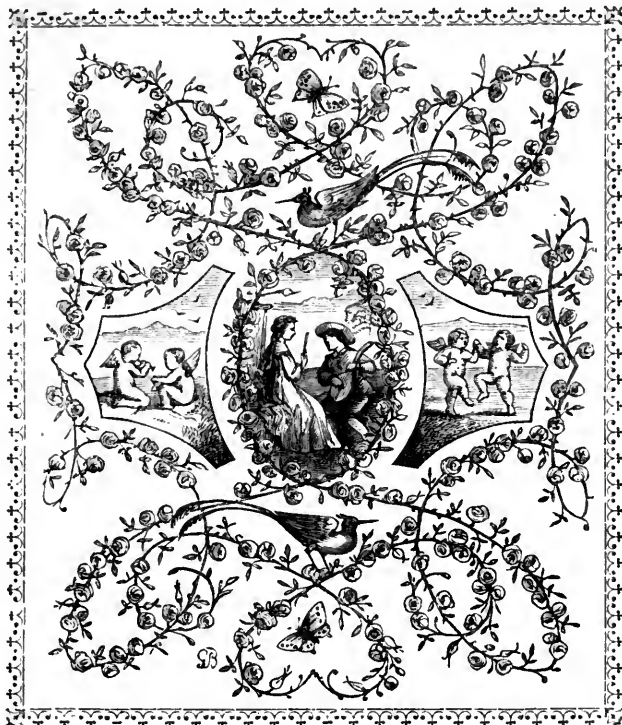

Fig. 23.

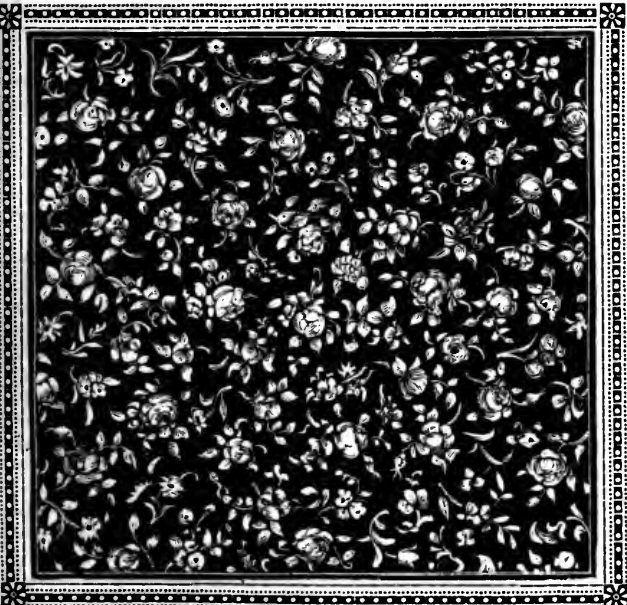

Fig. 24.

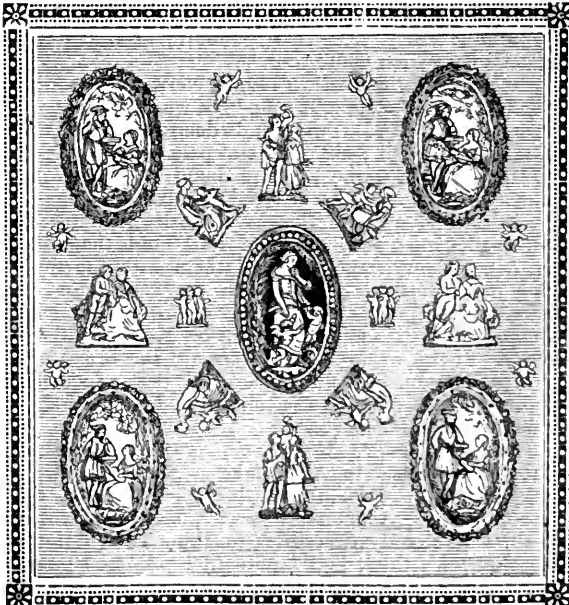

Fig. 25.

again, next to those four white, till the width of the paper is covered. Continue cutting more sheets of tissue as they are required. Commence a second row of the cut papers, by reversing the colours, placing four white over the four green, and four green over the four white. Spread the

centre, and cut both sides of the cartridge together, to make them alike. A fringe can be added round any fire paper, by folding the tissue paper in half lengthway, and cutting it all along, like Fig. 1, only not doubled at the edge, see Fig. 5. The length may be folded again in

short pieces, for facility of cutting, as several folds can be cut through at once, see Fig. 6. This fringe can be added all round the fire paper, single or double. With green the roses must be white, the leaves green. There is a slight garland of dark green leaves carried across.

Green is the best colour for brightening up a room; two shades of green, instead of green and white, are the most durable. However, the colour of the furniture must be considered in choosing the colour of the fire paper. The pattern above given can be made in any colour desired.

Yellow-shaded, goffered Fire Apron (Fig. 7).—To make this apron, three shades of yellow tissue paper, two sheets of each, are required, and one white. The paper is folded in strips the entire length, and the width of the crimping-board. When crimped, cut it in narrow strips half an inch wide the centre length, to within an inch of the top. Take care not to damage the crimping in doing this. Where the paper is folded, cut it narrower, or separate it when unfolded. Arrange two papers of each colour together; place the white in the centre, the lightest tint each side of it, the middle tint beyond that, and the darkest tint at the two extremities. Box-pleat the tops, or gather them to the foundation. Arrange a bouquet of yellow roses and green or dead leaves at the top.

To make Roses and Leaves for Fire Stoves.—Cut a strip of paper, the length of the sheet of tissue, three inches wide. Fold it into small squares, and fold these in four, from which cut by Fig. 8. Fig. 9 resembles a quarter of the rose when open. The dotted line shows the fold. Each rose has twelve of these circles, sewn together as a penwiper is sewn, in the centre.

Take the first round, and crush it up between the fingers quite close; crush the next to it, and so on. The first ones are crushed very close; squeeze all twelve tightly, and then partly open the outer ones and turn them back.

For a Yellow Rose, three Shades.—Three rounds of the lightest; five rounds of the middle tint; four rounds of the darkest tint.

For a White Rose.—Two rounds for a heart, of pale lemon colour; ten white rounds.

For a Blush Rose.—Two rounds very pale pink; two rounds darker pink; light rounds of white.

For a Pink Rose.—Two rounds deep rose; four rounds middle tint of pink; six rounds of pale pink.

Damask Rose.—One smaller round of yellow in the heart. All the rest deep red and pale red.

The Leaves.—Cut the leaves of dark green tissue, or two shades of green, like Fig. 10. Fold them in the centre, and mark the veins in them with the scissors. They are prettier, if folded in the centre and then crimped slanting; opened and dipped in hot wax or composite candle melted, and left on a slightly wet plate to dry. If not waxed, make a pleat at the broad end in sewing them on. Muslin leaves look best, especially for slight garlands, such as that shown in Fig. 3. Fig. 11 is another design for leaves.

To make Flowers to place in Shavings.—Instead of placing the roses together, take a piece of wire and crook the top. Make a hole through the centre of the rose petals, slip them on the wire, and pinch them up in the way already described, touching each point near the wire with thick liquid gum (not prepared gum, for that is too moist, but gum melted down with water in an egg-cup). Cover the wire with green paper. Cut the leaves like Fig. 11. Run a fine green-covered wire, such as is sold for making wax-flowers, through the leaf in the way indicated, and join it to the main stalk of the rose, and wrap the paper at the base of the leaf round it. The stems of these roses and leaves are roughly made, and not intended to show. A group of blush roses, pink roses, and damask roses, with one or two of a

deep claret (almost black), are very pretty in a fire-stove placed at the top of white shavings, which should also fill the fender, in which a few roses may be sprinkled. The leaves can be used without wire.

Water-lily Fire Apron.—A pretty apron may be made of rows of so-called water-lilies tacked on between green leaves. Fold a couple of squares of white tissue paper in four, and then in half, across the centre; cut this like the dotted piece in Fig. 18; open these up, and place one within the other, reversing the places of the points; take a thread of gold-coloured worsted in a rug needle; knot both ends; place it through the flower; pinch up the flower at the back with the fingers slightly, and sew it together with the wool; the ends of the wool are left hanging out in front to represent the stamens, one longer than the other, like Fig. 12. To make the leaves; fold the paper twice, once each way, and cut the leaves, in the manner shown in Fig. 10. Two leaves are cut together. Have an equal number light and dark. Take an inch-wide strip of green paper, and sew on to each strip alternately one flower, a pair of light, and a pair of dark, leaves. Cut a piece of paper large enough for the top of the fire-paper. Sew the strip covered with flowers and leaves to the lower part of this, till there are sufficient of them. Then form a group of lilies at the top, surrounded by leaves. Fig. 13 displays the apron complete. Flowers and leaves, made half the size of these, are even prettier.

Shaded Oval Fringes.—A new pattern for fire papers made in shaded tissue paper, is very pretty, and in good taste. The best way to make one of these is, first to cut a tongue of card, oval at one end and square at the other, an inch and a half wide and two and a half or three inches long (the shape of Fig. 4). Fold a strip of the tissue paper several times, and cut out the shape of the card from it. Crimp the rounded end, and then cut it in fine strips about an inch deep. The fire paper should be made entirely of one colour, and in as many shades of that colour as possible. Arrange the tongues one over another, with the fringes close, every one of a different shade, from light to dark and from dark back again to light. When the means of crimping the paper are not at hand, cut the tongues much deeper, say six inches deep, and notch the edges as before, but make the fringe four and a half inches deep. Roll up this between the hands till it is finely and carelessly curled, like moss. In shaded green this is very pretty, but requires some patience to make. The first directions may be followed without crimping by cutting the fringe extremely fine. The design is also pretty in white, relieved by a slight wreath of coloured flowers and roses placed from the top half way down, slanting.

For handsome steel grates fire papers are not generally used. Purchase a yard and a half of tarlatan, and pull it entirely to pieces, thread by thread. Fill the grate and fender entirely, as full and lightly as possible. The fire-irons are removed, greased with mutton fat, rolled in paper, and put away in a dry closet for the season. Arrange a slight wreath of myrtle on the top of the shavings, or carelessly throw a few well-made muslin roses about the tarlatan in the manner shown in Fig. 14. It is very tasteful to use pale-coloured tarlatan, the shade of the furniture, for this purpose, but the tint should be extremely light. A little gold, sold for the purpose, looks well on the coloured cloud thus arranged in the stove. Nothing can be prettier than the palest shade of pink tarlatan, unravelled, in the grate, with a few moss roses carelessly arranged about it, and the lace window curtains lined with pink tarlatan throughout, a couple of shades deeper in tone. Very pale green contrasts better with gold than with flowers.

Another elegant way of fitting up a handsome stove for the summer is to order a piece of looking-glass in a plain gilt frame, to fit in as a chimney board. Displace the steel fender, and use a rustic one gilt, with a green tin inside, charged with flower-pots containing plants in bloom.

In place of the mantel-shelf valance of fringe, hang point lace in deep vandykes mounted on silk, edged with a narrow silk fringe, the colour of the furniture. Curtains of fine lace, lined with coloured tarlatan or thin silk, may be looped each side with good effect in some apartments. Fig. 15 shows the disposition of these adornments.

Curtains to chimney-pieces are much used in France, and are seen in England in many good old-fashioned houses: where the chimney boards are of cloth or velvet, they are also of cloth or velvet. Many sleeping apartments have such draughty chimneys, that curtains of this kind would be no undesirable addition. Where there is no more air than is needed for health, these curtains might be drawn in the day as a finish to a room, and undrawn and looped back at night when the apartment is in use. They should

arrange a piece of furniture gimp. Line the chintz curtains, and either hem over the edge with lining or bind it all round. Sew the curtains to the rings. Put hook nails in the wall each side and a loop of chintz, to hold back the curtains when not in use.

A bedroom, where there is a white muslin toilette frock over pink glaze, and a looking-glass draped with white muslin and pink, would be very prettily completed by a mantel-shelf draped with white muslin over pink also; and if there is a glass over it with a shabby frame, a little muslin and pink ribbon, dressed over it, would be an excellent addition. Fig. 17 is an illustration of this. Or the curtains may be looped back from the grate, and a pretty fire-apron or shavings placed in it.

Some sitting-rooms during summer emit so much

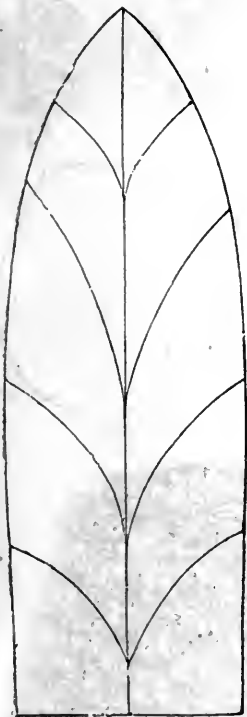

Fig. 10.

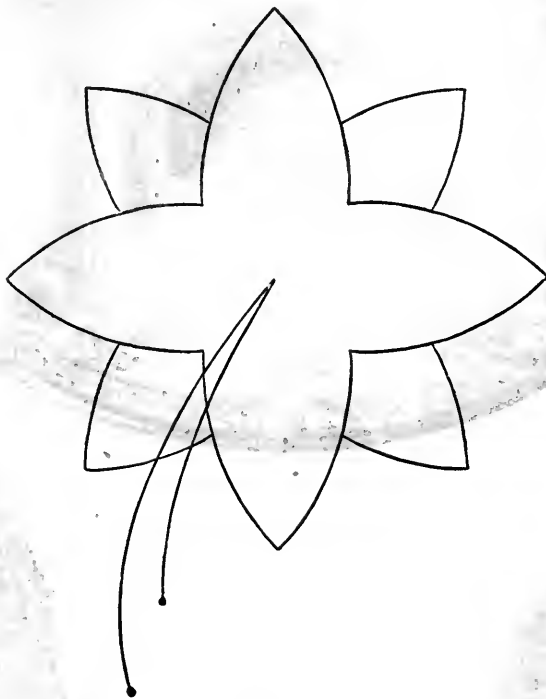

Fig. 12.

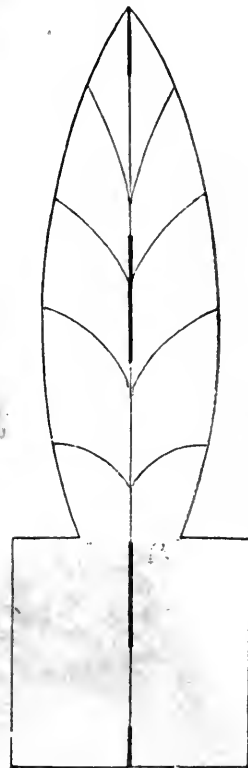

Fig. 11.

be removed if fires are lit, because drapery round a grate in use is unsafe. Many bedrooms furnished with mean grates and mantel-shelves would be much improved by such hangings, even of chintz. A mantel-shelf board should be procured: any board a foot longer than the shelf and half as wide again or twice as wide will do. Nail on at the back a couple of brass eyes to hold it subsequently to the wall; below, it should be furnished with an iron rod all round. If this is not to be procured, very thick wire twisted together might serve the purpose. Put hook nails at the ends to hold the wire; bend it square like the shelf-board, keeping it just with the margin. Put a hook nail in the centre, at C (Fig. 16), to support it. Place the rings on the wire before securing it. In Fig. 16, A A are the brass eyes, B B the rod, and C the hook in the centre. Cover the board with chintz. Make a valance of chintz, lined with glaze of a plain colour, to match the furniture, which we will suppose is green. Make a broad hem of the green over the chintz, about four inches deep. The valance should be about eight or ten inches deep. Box-pleat, and nail it round the board. Over the nails

draught, damp, earthy smell, and falls of soot into a room, as to render curtaining the grate a very useful process; as much air as is desired can be admitted by the windows or doors.

There is another mode of ornamenting fire-stoves, by which a pretty effect may be secured. Fill the stove with very white fine shavings, and thickly scatter them in the fender, entirely filling up every space. Purchase at a wholesale artificial florist's a packet of ivy-leaves, in three different sizes. Then buy six yards of black ribbon wire. Cut off, with an old pair of scissors, half a yard, three-quarters of a yard, and a yard of the ribbon wire. Cut the pieces down the centre, and take out the wire from the thread. Take one of the half-yard lengths of wire, open a packet of the smallest-sized ivy-leaves, and with dark green cotton bind the stalk firmly on to the end of the wire, as naturally as possible; then take another leaf and fix it in the same way, the length of the leaf from the other. Place alternately a leaf of each size, repeating them until the wire is completely covered; or making each wreath distinctively of one sized leaf, and then

blending the wreaths alternately. Use three of each size. Make up the nine wreaths in the same way, placing the leaves as *naturally* as possible, avoiding stiffness, and mixing the different sized leaves as shown in Fig. 22. Tie the tops of the wreaths together to a stick, and fix

The wreaths may be merely twined about the shavings, or fixed at top, according to taste. Figs. 19, 21, and 22 show how the leaves should be attached.

A few ivy-berries—red, brown, and green—add to the appearance of the decoration; they may be bought at

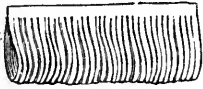

Fig. 2.



Fig. 6.



Fig. 1.

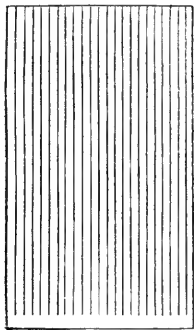

Fig. 5.

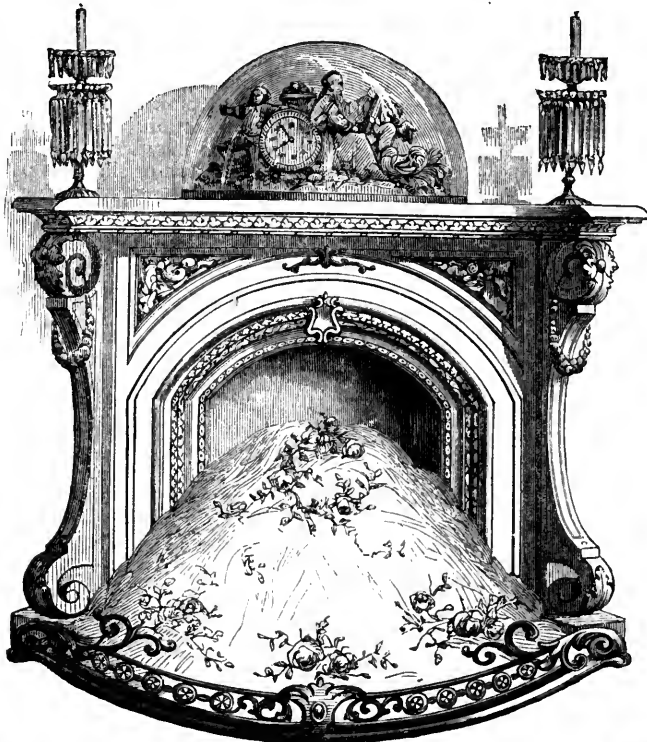

Fig. 14.



Fig. 21.



Fig. 22.

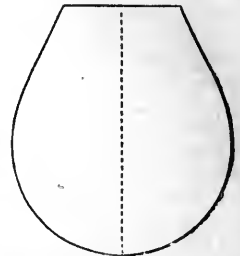

Fig. 4.

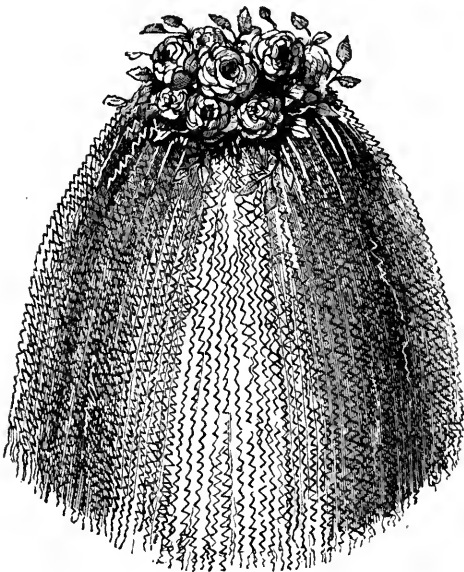

Fig. 7.

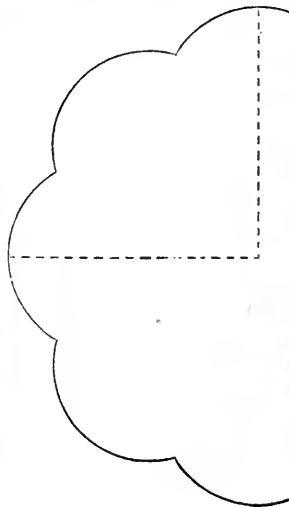

Fig. 8.



Fig. 13.

it at the back of the grate behind the shavings, allowing the wreaths to fall carelessly and gracefully into the fender. Fix separate leaves on to wire and place them among the shavings in the fender, to give the appearance of loose leaves from the ivy, and make as many more wreaths as may be required to trail about the fender.

the same place, and can be easily attached in little branches between the leaves. Passion-flower leaves with berries; rose-leaves and buds (the leaves mounted in threes), or any *naturally trailing* plants, look well; but it is most important to avoid the vulgarity of gaudy wreaths of any flowers that do not creep. A bunch of

ferns at the top of the wreaths has a good effect, and fern-leaf decorations *alone* are very nice; the fresh leaves frequently fixed among the shavings, or arranged in pots, hidden among the shavings (see Fig. 20).

made in the following way:—Get a quire of pure white tissue paper, fold each sheet lengthwise (opened) into narrow folds about an inch wide, and cut each fold, forming strips; leaving about two inches of the paper uncut, to keep the strips together. When each sheet but one is



Fig. 20.

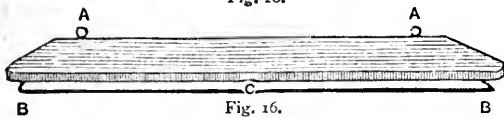

Fig. 16.



Fig. 19.

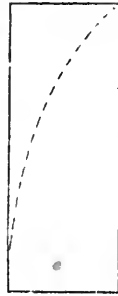

Fig. 18.

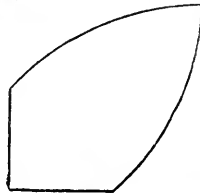

Fig. 9.

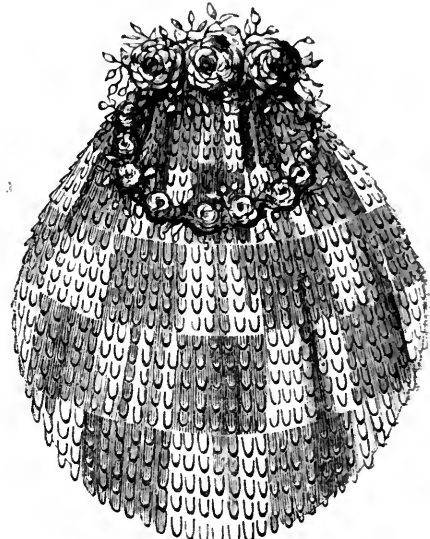

Fig. 3.

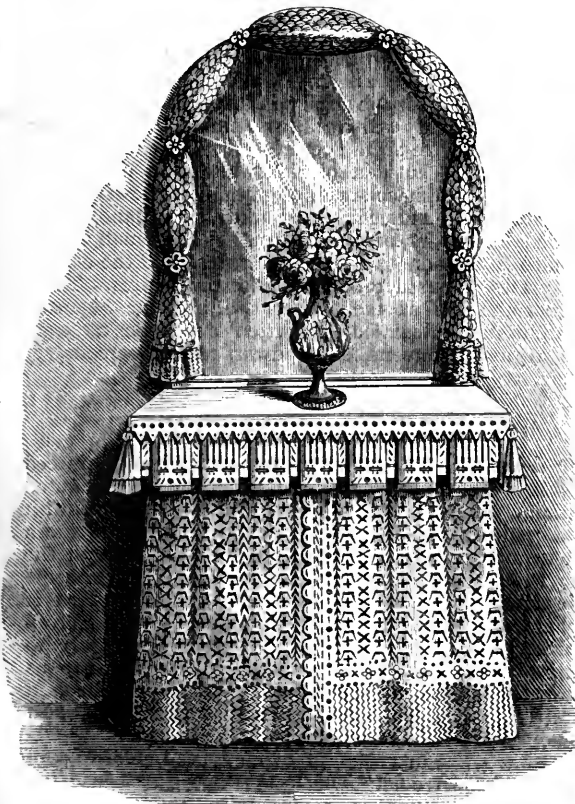

Fig. 17.

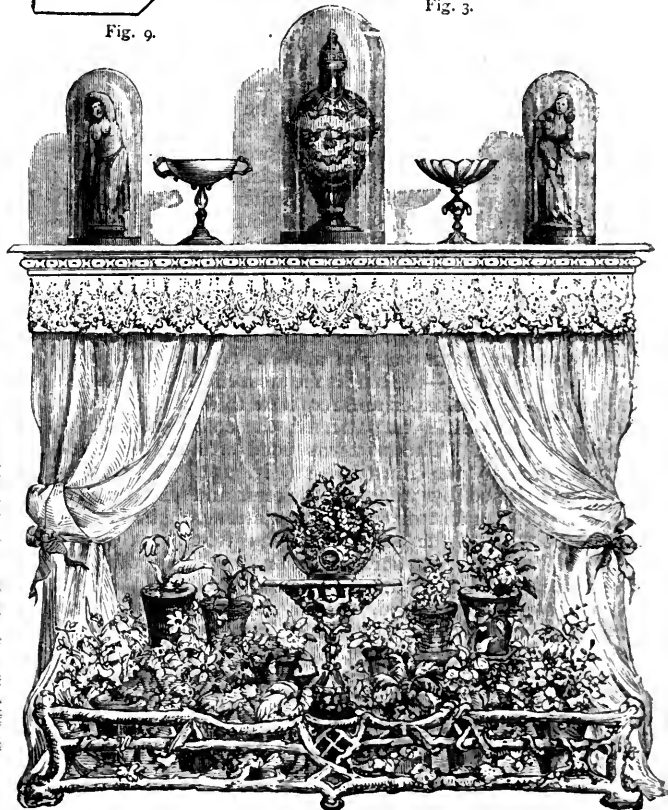

Fig. 15.

which are very expensive, look very well at top, and grasses may be mixed with the ivy in the fender.

To give the leaves a natural hue, pass them quickly over the flame of a candle, through the smoke.

A very pretty, simple, but elegant, stove paper may be

cut into strips, take hold of the uncut parts of each, and gently shake the paper straight; then sew the uncut parts of each sheet firmly together, and fix them to a stick. Fill the grate and fender with white shavings; fix the stick down at the back of the grate, and let the strips of

paper fall over into the fender. Cut the sheet of the paper that is left into strips about half a quarter of a yard wide, and tie it into a bow and ends. Pin this bow on to the top of the fire paper, where it is fixed to the stick.

This style of paper is far more elegant than the coloured papers with the tasteless designs sold at bazaars. Simple elegance is preferable to vulgar display.

ORNAMENTAL CHIMNEY BOARDS.

Indian Board.—Procure, or put together, a deal frame that will exactly fit into the chimney of the grate intended for decoration, from side to side of the marble or wooden posts, and from the bar under the shelf to the ground. With tacks strain tightly over this a piece of common long-cloth, over which paste plain black paper, entirely covering it. It is next needful to purchase a number of the German embossed scraps, such as are sold for Christmas and birthday cards. They can generally be procured at the valentine makers', and they are often kept by fancy stationers and others. The greater the variety the better. Cut them apart in small sprigs, and gum them carelessly all over the black screen. A bouquet may be placed in the centre or not, according to taste. When the decoration is finished, varnish the screen; let it dry, and varnish again. Two or three coats of varnish are enough. It is best to keep it whilst being varnished in an unused room, or a cupboard. Lay it on two or three large, wide-spread sheets of newspaper whilst putting on the varnish, to prevent damaging the apartment, and keep the screen locked up till completed, to secure it against dust, &c. When quite dry and hard, it is fit for use. Another way is to make a narrow wooden frame, and stretch black or white turlatan across it. Mount the sprigs of flowers on the net. Dress the grate with shavings, which will be seen through the transparent screen, unless it is lined. See Fig. 24.

Wedgwood Board.—These Wedgwood boards can be rendered very elegant with a little patience and good taste. They are designed, by the present writer, expressly for the HOUSEHOLD GUIDE, as well as the Sèvres screens, which will be presently described. This pretty invention will also be applied to some other articles of household decoration that will shortly be given. Procure a frame for a mantel-piece board, as already described. Cover it with long-cloth, and over that paste, very evenly and without damaging the delicate surface, satin paper of a Wedgwood blue-grey, or a Palissy grey-green—the blue is the most effective. Thirteen sheets of lace note-paper are required to decorate it, and they are of five different patterns; the cost is about two pence per sheet. The patterns used will be perceived by reference to the illustration (Fig. 25). The paper is the kind used by valentine-makers, and can be procured retail at most of the fancy stationers' shops, and also probably at the same place as that from which you get the German scraps. Portions only of each sheet of paper are used, and are nicely cut out with a sharp penknife on a board, or with small scissors. Great care must be taken to keep the work very clean—apply the decorations with gum. For the centre, there is the figure of a maiden, led onward by two Cupids. Some roses grow at the feet, and an acacia spray almost embowers, but is very subordinate to, the principal figure. An oval border of daisies converts the design into a medallion. It is separated from the sheet of paper at this border. The design represents "Innocence."

The four corners are next filled with four similar medallions, for which purpose as many sheets of the paper containing them are needed. The design represents a young prince, in mediæval costume, standing beside a high-born maiden, who is seated beneath a tree playing upon a lute. A lace border encircles this, and again a border of roses, beyond which is a border of forget-me-nots. The medallion is cut out between the rose border

and the forget-me-not border, the latter not being used. This represents "Love."

Above and below the centre medallion are two small groups of classical figures. A hunter and a maiden bear on their shoulders an infant Hymen, who waves his lighted torch above his head. The subject idealised is "Marriage." Two sheets of this paper must be purchased. Cut out two groups of the figures alone, and place as shown in the engraving. At the lower corners of the paper are, each side, groups of three Cupids. Remove the Cupids from the four sheets of paper, and place them each side of the centre medallion of "Innocence" as shown. At the upper corners are, each side, a single flying Cupid. Cut out all four of them, and place where indicated.

Another group is a Watteau design. A lady and gentleman seated on a fauteuil, the lady's tunic suspended with roses. The subject is "Courtship." Two sheets of this paper are wanted. Remove the figures from both sheets, and place them on the board where shown. At the upper part of the paper are two Cupids, cross-legged. Remove them all, and fix them in their places. There are on this sheet of paper two doves, and a garland of roses, which could be cut out for decoration. Remove the centre from the roses.

Lastly select a sheet of paper containing at the foot of groups of palm trees, a classical figure of a maiden with a lyre, seated, an Ascalon or Cupid whispering to her some message he has brought. The subject is "The First Whisper of Love." Four of these sheets are needed. Remove the figures and place them as shown. All round the edge of the screen arrange a border of lace paper. The remains of the lace paper will cut up for the decoration of jardiniers.

Sèvres China Fire-screens.—Make a frame as before named. Cover it for the Sévigné with turquoise blue satin paper; for Du Barry with a pale rose pink. The illustration (Fig. 23) must have all the centres of the medallions, both round and oval, cut out of rich white satin paper, and laid on first. Purchase scraps of garlands of flowers, birds of Paradise, and butterflies, and form the garlands round the medallions and between them. A few small Cupids may also be introduced among the roses. Fill the centres with pretty coloured groups of Watteau figures. These designs—the Indian, the Wedgwood, and the Sèvres—are admirably calculated, if carried out upon a larger scale, to make screens, either dwarf dinner-screens, or folding.

ODDS AND ENDS.

To bronze Images.—Prepare a soap, by boiling linseed oil with caustic ley of soda, to which add a saturated solution of common salt; boil the whole together until it has a granular surface, pour it upon a linen cloth, strain with a good pressure. Dilute what passes through the cloth with boiling water, and strain this again. At the same time have ready two solutions, viz. :—four parts of sulphate of copper, one part of sulphate of iron, dissolved separately in boiling water. These two solutions are to be mixed and slowly poured into the solution of soap, as long as they cause any precipitate. This precipitate is a mixture of the oxides of copper and iron, combined with the inorganic acid of the soap, and that causes the bronzing matter. The copper soap is green, the iron soap is of a reddish brown colour, whilst together they cause the green rusty appearance common to antique bronze. When the precipitate above described is entirely separated, a fresh portion of the combined solutions of sulphates of copper and iron must be poured upon it in a copper pan, and then made to boil. It is then left to settle for an hour, and the liquid part decanted off. The sediment, or bronzing matter, must then be well washed with warm water. Lastly, it must be washed with cold water, pressed in a

linen bag, well drained, and dried by degrees. The bronzing matter is used in the following way:—Boil twelve ounces of pure linseed oil with twelve ounces of litharge reduced to a very fine powder. Strain it in a coarse canvas bag, and let it stand in a warm place till it becomes clear. Mix fifteen ounces of this varnish with twelve ounces of the bronzing matter, and five ounces of the best whitewash. Melt these altogether in a porcelain vessel, to a gentle heat, by placing the vessel in hot water. This mixture, when melted, must remain some time exposed to the heat of the water, to expel any moisture it might contain. The article to be bronzed must be heated to 200° Fahr., and while thus heated must receive the melted mixture, which must be put on with a painter's brush. By skilful management in keeping up the heat, the bronzing may be done so as to keep the minutest lineament of the figure, and appear smooth also. Small things may be dipped in the bronzing mixture, and exposed to the heat of the fire until nicely coated with it. The articles bronzed, by being exposed to a free circulation of fresh air for a few days, lose the unpleasant smell of the mixture; they must then be rubbed with soft linen or cotton wool, and touched with shell gold or metal.

To stain Marble artificially.—A solution of nitrate of silver penetrates the marble, and gives it a dark red colour; a solution of nitrate of gold penetrates it less deeply, and imparts to it a beautiful purple violet colour. Verdigris sinks to the depth of a line into the marble, and leaves it a fine green colour. A solution of dragon's blood imparts a red colour, and gamboge a yellow tint. To give the two colours it is necessary to polish the marble with pumice stone, to dissolve the gum resins in hot alcohol, and put them on with a camel-hair brush. The tinctures got from woods, such as Brazil wood, logwood, &c., penetrate deeply into marble. Tincture of cochineal, with a little alum added, imparts to marble a fine scarlet colour, similar to African marble. Artificial ornament, dissolved in ammonia, gives a fine yellow colour. If verdigris be boiled with white wax, and applied to the marble, and removed when cold, it will have penetrated five lines, and have left a fine emerald green. When it is intended to give several colours in succession, great caution is necessary. Those tinctures prepared with spirits of wine, or oil of turpentine, must be put on while hot; but the dragon's blood and gamboge are to be used when the marble is cold. For this reason it is necessary to melt them in alcohol, and use the gamboge solution first. This, which is transparent, soon becomes disturbed, and precipitates a yellow colour. Those parts of the marble which have received the tinctures are to be heated by passing a charcoal chaffer, or a red hot iron plate, over them; it is then allowed to cool, and the iron again passed over the parts where the colour has not been absorbed. When the yellow colour has been used, a solution of dragon's blood is to be applied in the same way, and while the marble is heated, the other vegetable colours may be applied similarly. The last colours to be used are those mixed with wax. These require the greatest caution, because, if too hot it causes them to penetrate too deeply, which renders them less suitable for delicate work. During the operation, cold water should be thrown occasionally upon them.

Fancy Method of tarring Fences.—Having added to the tar some whitening, with colouring powder in accordance to the colour required, heat the whole together in a cauldron after the usual manner, and apply it with a large paint-brush. It looks very well for outhouses and yard fences, and is a great preservative to the wood. Venetian red and French yellow are very good for the purpose of colouring. For roofs no colour is required, as the white is preferable, reflecting the heat of the sun. For this purpose it is well to sprinkle the roof over with whitening before the tar is cold.

DOMESTIC MEDICINE.

DROPSIES.

DROPSY means a collection of water in some particular part of the body, or in the body generally. The dropsy has different names, according to the situation it occupies. If it exists nearly all over, it is called *anasarca* (*ana*, through; *sarkos*, the flesh). If the water accumulates in the belly, it is called *ascites*. If it fills one or both sides of the chest, it is called *hydrothorax*, or water in the chest. There are other strictly local and much less serious collections of water, such as *hydrocele*; but these are not properly dropsies in the serious sense of the word. Dropsy is not a disease in itself, but is the symptom, or the consequence, of other diseases. The older writers used to look upon dropsy as a disease by itself. Now, we look upon it rather as a mere proof of something else—something deeper than itself. Before describing the particular diseases of which dropsy is a symptom, we shall try to explain in a few general words how it occurs. It occurs often from some impediment to the circulation of the blood. If a garter is put too tightly round the leg, the foot and all the leg below the garter will swell, because the garter hinders the blood coursing back from the foot to the hand; it accumulates in the blood-vessels, that is, in the veins, and the watery portion of it passes, or oozes, through the walls of the vessel, and escapes into the general flesh, causing it to swell. This is dropsy, produced by a simple cause that can be easily removed—a mechanical obstruction to the circulation. Mechanical obstruction is a very common cause of dropsy, as we shall presently explain. Another cause of dropsy is *thinness of the blood*. The blood, when thin, is more disposed to ooze through the wall of the blood-vessel, and less disposed to pass along the proper channel than usual. This is a common cause of another large class of dropsies. The reader will now understand that dropsy is a mere sign of something else. If the disease of which it is a sign can be cured or removed, then it can be cured, or will cure itself, very quickly. In the Registrar-General's returns, dropsy is still to be seen reported as a cause of death; but it is only so in a secondary way. A certificate that dropsy is the cause of death is an imperfect one, which a doctor should not give. He should state in it what is the cause of the dropsy. This leads us to consider briefly the principal kinds of dropsy, and the reader will follow us most intelligently who remembers that dropsy may either arise from a fault of the blood itself, or from some fault, or obstruction, in the channels through which it flows. As a matter of simple fact, dropsy is generally connected with disease of one of three or four great organs, as, 1, the heart; 2, the liver; 3, the kidney; 4, the ovary. When a medical man sees dropsy, or signs of water, either in the limbs or any of the different parts of the body, he immediately considers within himself what the organ at fault is. Accordingly, we shall describe briefly the several principal dropsies:—1, dropsy connected with disease of the heart; 2, dropsy connected with disease of the liver; 3, dropsy connected with Bright's disease, or disease of the kidney; 4, ovarian dropsy, or dropsy connected with disease of the ovary.

1. *Dropsy connected with Disease of the Heart.*—Heart diseases, though not so common as is generally thought, are certainly not uncommon. They are amongst the most common causes of dropsy. The great use of the heart is to force the blood both through the lungs, that it may get charged with fresh air, and through the body, that the body may be everywhere supplied with fresh blood. Now the heart may fail to do this. In several ways it may be injured. Rheumatic fever is one of the diseases which often affect the heart. Drinking freely is another cause of heart disease; or mere age

may produce its chief effects on the heart and weaken it, or make its valves thick and not so supple as usual. The valves often become thick and unpliant, allowing blood to escape backwards that should be sent forwards; or the muscle of the heart may be too weak to drive the blood vigorously on. In either case the blood does not circulate well, either through the lungs or through the body. It accumulates or passes slowly through its blood-vessels; and the thin watery part of it oozes through the walls of the vessels, and makes the patient's body swell. This happens first and most in the parts that are farthest off from the heart, such as the feet and ankles. The blood is more apt to stagnate here, especially if the patient stands much. So it comes to pass that in the evening, after a day's standing, the swelling is greater than in the morning. When the patient lies down in bed, the heart is rested and gets stronger; and the weight of the column of blood does not fall so much on the veins of the feet. This swelling may be very slight, and quite confined to the feet and ankles, or it may be very great, causing the legs to be twice their usual size, and not confined to the legs, but affecting the whole body and arms. The flesh pits wherever you press it with the finger. When it is so great, the breathing is generally very bad, and the patient is not able to lie down. This arises from the fact that there is water in the internal parts as well—in the chest, and in the meshes of the lungs, and everywhere. Generally, in this state, there is less water passed from the body than usual, and what is passed is thick and high-coloured.

Treatment.—We need not say that such a case as this requires the wisest medical treatment. Though it is very serious in its nature, great relief is often obtained from sensible medical treatment, and the patient is often restored to comparative health. Relief is generally obtained by the judicious use of means for ridding the body of the water. Sometimes this is best done by purgatives that produce copious watery evacuations, such as two scruples, or a drachm, of compound jalap powder, in the early morning, two or three times a week, or by medicines which increase the amount of urine, such as cream of tartar, which may be taken (a teaspoonful) two or three times a day in water or barley-water. While these means are taken, it is necessary to keep up the strength of the body by proper nourishing food. But the particular medicines to be used must be determined by a medical man. All causes of cold should be avoided by such patients. Intemperance in drinking is most injurious, and, if continued, will be fatal.

2. *Dropsy connected with Disease of the Liver.*—In this case the water accumulates principally in the belly. The liver may have become enlarged simply in consequence of disease of the heart; for when the heart is weak, or when its valves act so badly as to allow the blood to go backward as well as forward, the liver becomes engorged and enlarged, and it presses heavily upon the veins of the belly, just as the tight garter does on the veins of the leg, and the watery part of the blood oozes out of them and the belly fills with water, until it becomes a great size. Often the legs swell at the same time. The urine will be small in amount, and probably have a thick and red sediment. The appetite is likely to be very slight. There may be jaundice occasionally.

Causes.—As we have said, this disease of the liver may be a consequence of heart disease; or it may be a direct result of intemperance, especially in the use of spirits or beer. Nutmeg liver is a liver frequently met with in persons who have drunk heavily, and in whom the liver gets hard, and its blood-vessels get engorged and congested. Hot climates, too, produce congested state of the liver, especially if people live as if they were living in a cold climate, and drink beer, spirits, or wine in excess. And the liver may become diseased slowly and

insidiously in a way that interferes with the proper circulation of blood in its blood-vessels, and so causes dropsy of the belly. Depressing influences may produce disease of the liver.

Treatment.—This dropsy is even less intelligible to non-medical persons than the previous kind. Only one thing they can know better than their doctor can—that is, their own habits; and if there is any error in these, they can put it right. If they are depressed, they must try to look up “to the hills from whence cometh their help,” and to relieve themselves as much as possible of all causes of care and worry. If they are intemperate, their physician, however wise, cannot cure them of that vice. Their own efforts, and their own sense, must help them here. They must treat themselves religiously, and use every means to overcome this evil. We have known men addicted to intemperance get jaundice and dropsy, and have every appearance of a general break-up, and then a great change come over them. They became temperate; and all the bad symptoms went away, and they recovered.

We must not be understood to say that intemperance is always the cause of disease of the liver that causes dropsy. In many cases it is not so.

3. *Dropsy connected with Disease of the Kidneys, or Bright's Disease.*—The kidney is the organ which separates the urine from the blood. If the urine is not separated from the blood, it accumulates there, and the watery part of it escapes from the blood-vessels into the flesh, especially into the loose parts of the skin, such as that under the eyelids, which become puffy. The hands and feet also swell, and other parts of the body. This is a peculiar form of dropsy in another respect. The urine, on being boiled, is found to become cloudy, or half solid, in consequence of its containing what chemists call albumen, which comes from the serum of the blood. The patient is generally pale in the face. He is weak. Perhaps he is sick in the morning, and has more or less dull, aching pain about his back. It was the late Dr. Bright who first showed the connection between these symptoms and the disease of the kidney of which they are the result. Hence the disease is called Bright's disease. Before Dr. Bright's time, physicians saw the dropsy, and the paleness, and other symptoms; but it was reserved for Dr. Bright to show the connection between these and the disease of the kidneys. The exact state of the kidneys varies in different cases; and a popular description of these various cases would be difficult to give. Suffice it to say, that in some cases the kidney is larger than usual, and flabby; in others, smaller and firm. But in both the fine tubes of which the kidney is made up are affected, so as to do their work badly, and not remove water from the blood so well as they should. In a few cases the disease comes on sharply; in most it comes on insidiously and slowly.

Causes.—Sometimes Bright's disease comes on without any obvious cause. In many cases it is caused by intemperance. Sometimes it is caused by a chill, and in this case it is often acute. The more acute, on the whole, the more favourable the prospect of the case. There is a form of dropsy which comes on in connection with disease of the kidney that occurs also with scarlet fever. (See “Scarlet Fever.”) Of all such forms of dropsy, it the most frequently gets well.

Treatment.—We need not say that such cases as Bright's disease require a doctor; and the wiser the doctor the better. The disease is too deep, and the organ affected is too serious and too much out of sight, to be meddled with by those who do not understand the nature of the case. In the way of domestic medicine, it is very important to avoid chills, to wear flannels, to keep up strength by proper food, &c. We may say one thing for the comfort of the patient, that with much care he

may partially or entirely recover, although the case is one requiring great care.

4. *Ovarian Dropsy*.—There is a little body called the ovary, about the size of a large almond or two almonds. It is appended to the womb. Sometimes this body becomes diseased, and begins to enlarge and fill with water, until it attains an enormous size. It may contain many pints or quarts. Such is ovarian dropsy. We do not know much concerning the causes of it.

Treatment.—There are two ways of treating it. One is to tap the ovary, just to let the water out. This is easy enough, but it soon fills again. The other way is to open the belly, and take the whole tumour out; and this operation is now frequently done. It cures the disease. Mr. Spencer Wells in London, and Mr. Thomas Keith in Edinburgh, have justly acquired a great reputation for the skilful and successful performance of this operation.

ANIMALS KEPT FOR PROFIT.—CATTLE.

THE HOUSING, FEEDING, AND MANAGEMENT OF DAIRY COWS (*continued from p. 310, vol. i.*)

THE feeding will vary with the breed, the season, and the locality; the same system will not answer for all. It has already been hinted that the excellent Ayrshire cow often fails more southward, and in particular, it scarcely ever answers in the West of England; and a rich feeding which will give return from high-bred animals, often causes a loss on cattle not in themselves capable of yielding such increased production as is necessary to pay for the better food. As a rule, a hardy race used to rough fare does not do well when richly fed; and on the whole there will be, in most circumstances, the greatest satisfaction from more or less pure shorthorns, or crosses with that breed.

Again, the food available may differ greatly. Where brewers' grains are obtainable they are of great value when used in moderation, and are used in all town dairies, but cause poor watery milk if given in excess. The prices of oil-cake, another valuable adjunct, will vary greatly at different times, and so will the quality of the roots grown in different districts. Thus, it is singular that the Scottish turnips can rarely be equalled in England, which is the reason Scotch dairies, as a rule, are more profitable. But on an ordinary occupation the system of management will be somewhat as follows, leaving out, of course, the details and order of cropping, which it is not our present business to describe:—

During the summer, if the pasture be tolerably good, the cows will be grazed. It is a great mistake to overstock pastures, as is often done, and at least two acres should be allowed for every ordinary cow. It is well to change from one field to another every fortnight or so, as the animals seem more contented, even if the grass be no better. Shade must also be provided for them, or they will be tormented with flies to such an extent as to be always in motion, which both checks the milk and renders it sour; indeed, in very hot weather it is well to keep them in the stalls or sheds. While the grass is rich and sweet the best cows may be milked advantageously three times daily, the others twice; and after the evening milking they should be let out to graze again till nearly dark, when they are again housed for the night. The careful farmer will try to have a crop of rye-grass, clover, or lucerne, in order that in case of a deficiency in pasturage he may supplement it by cut food in the stall; and some cut fodder must, of course, be provided in this way if the pastures are mown for hay. Besides these green crops, cabbages produce a great weight of food, and, if planted in rows a yard apart, mangolds may be placed between them, and will come on after the cabbages are consumed; but to go into details on this part of the subject is foreign to our purpose in this series of papers.

The aftermath following the hay crop is, in favourable seasons, excellent pasturage for the cows, and usually increases the milk very considerably; but it is necessary only to allow them upon it a very short time daily at first, or they become affected with "hoove," from the sudden change to so succulent a food.

About September the pasturage often begins to fail—often before; but this altogether depends upon the season. Frosts also usually begin to occur, and if the cows are let out while the frost is on the grass, it suffers so much from their tread as rarely to spring well again. In either of these cases a small quantity of hay should be given morning and evening, which will both save the herbage much longer and keep up the milk, at a time when it becomes more valuable. In case of frost or heavy dews, the cows should be kept until it is nearly off the grass.

Towards the end of October the cows should be taken in altogether, save for an occasional walk to drink on fine days, at all other times watering them in their stalls, and a gradual change will be made to the winter feeding. The most perishable and greenest crops will be used first. There will be the green tops of the mangolds, the cabbages, and a part of the green crops of the farm, the remainder having been converted into hay. With these should be mingled chaff cut from sweet straw, with a small portion of hay mixed, taking care to change the diet gradually, and to give green food especially in small quantities at a time, and free from moisture. The earlier turnips will next come available, then the swedes, and mangolds last. All roots go further and agree best with the cattle if pulped and mixed with the chaff, and then allowed to stand a day to ferment and get warm. In this state it is much liked by the cows, keeps up the milk well, and is very wholesome. Such, in fact, should, as speedily as is safe, be settled down to as the staple food of the winter, keeping most of the hay as a delicacy, and for the cows when calving, and feeding the remainder chiefly on straw-chaff, with only a little hay mixed in it, and pulped roots. The quantity will vary from a half cwt. to one cwt. daily, according to the size of the cow. If the animals are of a good breed, it will pay to add two or three lbs. of bean or Indian meal, and three or four lbs. of rape cake to the daily feed; but in breeds used to plain fare this will be money thrown away. It is impossible to give any rule; the innate capacity of the animals must be learnt and studied. Some dairy keepers, by such liberal feeding, will keep a cow in milk through the winter, laying on flesh all the while, and then sell her fit for the butcher. Such management is remunerative; but in many good breeds no feeding, however liberal, would produce such a result. As a rule, it may be said that about 70 lbs. of chaff and pulped roots, in the proportion of about 20 lbs. of chaff to one cwt. of turnips or mangolds, with about six lbs. of hay both morning and evening as a *bonne bouche*, make good stock rations for an ordinary cow. The addition of two lbs. meal and two to four lbs. oil-cake daily, will generally make her improve in condition, and with shorthorn crosses increase the milk greatly. If grains can be had, about 14 lbs. daily, with a little less other food, this will be a great advantage.

On such feeding the cows should yield well, and the butter will, when they are used to it, be of good flavour. If any disagreeable taste be found when the cows are first brought in, a teaspoonful and a half of saltpetre should be put to every gallon of cream, and the whole placed in warm water, stirred for a quarter of an hour, and then allowed to cool very slowly. Adding a little hot water to the cream before churning will often remove such defects, which will, however, soon disappear if the roots are of good quality and not given in excess. Should the roots run short, chaff alone may be substituted for half the quantity, pouring over it some thin linseed tea or mucilage.

Whatever be the food, two ounces of salt daily should be allowed to each cow. This quantity has been proved by many experiments to be the best for the cow and for the production of milk. Water should be always within the animal's reach, and be kept fresh and pure.

Every morning the cows should be curry-combed and well rubbed down, the dung removed, and a small quantity of fresh litter supplied, but as little as possible. Care must also be taken that the liquid manure drain does not get choked up or obstructed; and every spring and autumn the walls should be white-limed over. In fact, the shed should always be, and appear, clean and sweet, which will tend greatly to the health of the cows.

It is very essential to keeping up the quantity of milk that the udder be drained to the *last drop*. If this be neglected the quantity rapidly diminishes, and the last portion is, moreover, far the richest and most valuable.

From six weeks to two months before calving the cows must run dry, or their next milk will fall off. They should then be restricted to half the quantity of roots, adding more chaff instead. Some feed them on straw alone, but the result is so much flesh is lost that after calving the cows do not get again into full milk for some time. The treatment and diet after calving will be given in another paper. These, and all other changes in diet, should be made gradually during several days.

Thus the winter will pass, coming by degrees to the longer-keeping roots, the mangolds being last of all. The aged cows will get some oil-cake and meal till they are fattened sufficiently and are sold off, the others, about May in average seasons, will be able to be turned into the most forward grazing fields. Here particular caution must be observed only to let them out for a short time at once till they get accustomed to the change; and as, after tasting they will refuse hay, some cut green food must be provided for them at morning and night till they can be grazed the whole day. And so we complete our year.

If the simple plan of grazing to the utmost possible extent be followed, it will be sufficient to provide good shelter at night, and a small supply of roots and other food to meet the deficiencies of the winter. The practice of more or less entire stall-feeding during the summer is, however, gaining ground in the better-farmed districts, and on a large scale is very economical. As many as two hundred head can be fed from the cutting of one scythe, and the saving of pasture is, of course, considerable, while the manure is of great value. The subject has, however, already been under consideration when we spoke of fattening cattle. Another paper will, we think, bring this subject fairly to an end, when we shall take up, and give our best attention to, the subject of sheep.

ACCIDENTAL FIRES.

WE use this term as a common and convenient form of expression, and not that we believe many of the so-called accidental fires to be really such. Accidents from fire, as from other causes, are, in reality, of very rare occurrence; they are generally the result of carelessness, and might, by the observance of proper precaution, be prevented. The subject of fire insurance has already been treated in vol. i.

Ordinary Precautions.—The most fruitful sources of fires are the mismanagement of lucifer matches, of candles, lamps, or gas; and of fires in grates.

Lucifer Matches.—Numerous fires arise from matches falling into the hands of children; unfortunately these dangerous articles cannot be kept under lock and key, as they are so often required in the dark; but they may, and should always, be kept on a high shelf, out of the reach

of children. Young children should be given to understand that they are dangerous and improper as playthings, and should be punished if found in possession of them. "Safety matches," those which strike on the box only, should alone be allowed to enter the house. The greater number of accidents occur from loose matches, and by the use of the "safety matches," all these might be avoided. Even mice sometimes cause fires; they are attracted by the phosphorus, and carry away the matches to nibble. Lucifer matches are a great convenience, but their cheapness causes them to be used in a lavish manner, which often endangers property, and the manufacture of them is destructive to health and life; a heavy duty upon them would be a boon to the community—we should then see them used more sparingly, and kept with greater care.

Candles.—When candles are lighted with pieces of paper, the latter are often thrown down and trampled on, but only partially extinguished. A paper-light may always be easily and effectually put out by a steady puff from the mouth, if the person will only take the trouble of learning how to do it; but better than paper, are the small wax tapers sold for the purpose, which are blown out with greater ease. Candles are more dangerous than gas-burners in being movable; and than lamps in being unprotected by glass. Gas-burners in bedrooms, when protected by globes, and placed at safe distances from curtains, are preferable to candles, which are always in danger of being placed so near to drapery, that a chance puff of wind may bring the two in contact. The practice of reading in bed cannot be too strongly reprobated; to place a light sufficiently near to show type well, and yet to be at a safe distance from the bed, is next to impossible, while, at any moment, the reader is liable to fall asleep. This habit ought to be strictly forbidden among members of the family; and lodgers who persist in it ought not to be allowed to remain. A common candle ought never to be left burning. Floating and night-lights, which are surrounded by water are safe, and should be used for this purpose.

Gas.—Notwithstanding the fearful accidents which sometimes happen with gas, it is, as a rule, safer than movable lights. To lessen the chances of escape, gas should always be turned off at the main when not in use. In case an escape be strongly and offensively smelt, turn off at once from the main, and set open the doors and windows, but by no means take a lighted candle into the room till the smell has passed off.

Fires.—A large fire ought not to be left burning at bedtime, and even a small one ought, at that time, to be protected by a wire fire-guard. Paper, linen, or other light and combustible articles should never be left near the grate. Cinders and ashes, apparently dead, should not be put in a bucket and set in a closet, for the purpose of being thrown away afterwards; neither should they be thrown against a wooden building. Wood-ashes require more care in this respect than those from coal, as they retain heat for a greater length of time, and are more liable to re-ignite.

To check Fire when first discovered.—Every house of large or medium size ought to be provided with a chemical fire extinguisher, by means of which a fire can be arrested in its earlier stages, by the inmates, without external help. The "Extincteur," or chemical fire-engine, made by Messrs. Dick and Co., costs from four pounds to six guineas, and can be managed by any one, male or female. It consists of an iron cylinder, charged with water, carbonate of soda, and tartaric acid. The machine has loops through which to pass the arms, so that it can, in an instant, be slung at the back, and at the bottom is a stop-cock, with a short hose and nozzle. When the stop-cock is turned, the carbonic acid gas formed by the combination of the chemicals, ejects the fluid with such force,

as to propel it in the same manner that water is discharged from an ordinary fire-engine for a distance of from thirty to forty feet. Fire cannot burn in the presence of carbonic acid gas, and the quantity liberated by one of these engines extinguishes it instantly over a large surface, and the contents are not in any way injurious to life or property. Failing one of these instruments, it should be remembered that wet blankets and rugs economise water, and are more effectual in extinguishing and preventing the spread of fire than water when thrown on; and at the same time do less damage to furniture. In the hurry and confusion of a fire, doors and windows are too apt to be thrown open; they should be kept shut as much as possible. Fire can only spread rapidly when it is plentifully supplied with air.

Precautions against Loss of Life by Fire.—To the practice of building houses with wooden stairs, the greater number of deaths by fire are to be attributed; in Edinburgh the houses are higher than in most other British towns, but deaths from fire are almost unknown there, from the fact of the stairs being of stone. In the better class of houses in London stone stairs are now, to a great extent, being introduced, and it is the duty of the public to give such decided preference to houses so built, as to force the general adoption of the practice on the builders. It is essential that the inmates of houses with wooden stairs should see that a means of egress from the top of the building is provided; such as a sky-light, through which the adjacent roofs may be reached. Captain Manby recommends that in all lofty houses, from which there are no such means of escape, a rope ladder, with cross pieces of wood to serve as steps, should be kept in the upper rooms. In any case a knotted rope, which would serve the purpose in extremity, might be provided at no great expense.

How to proceed in case of an Alarm of Fire.—When an alarm of fire breaks out, remember that much depends on your remaining calm and collected. Take time for consideration, and do not act precipitately. Call to mind what modes of exit there are from the house, before going upwards or downwards. If you are in bed, and have not time to dress, roll yourself in a blanket, rather than a sheet or counterpane, as the former will be some temporary protection against the fire. Shut, and keep shut, all doors and windows. If the smoke is so suffocating that you cannot breathe standing, go on your hands and knees—within a foot of the floor there will always be air that can be breathed; a wetted silk handkerchief, or piece of flannel over the face will permit breathing, and keep out smoke. If you can neither make your way upwards nor downwards, get into a front room, and if there is a family, see that they are collected there. Do not throw yourself from the windows, or permit others to throw themselves, unless there is a "jumping-sheet" held below; but, if you have no rope, tie sheets and blankets together by the corners and make one; fasten one end to a beam-piece of furniture, and let down the women and children by tying the other end round the waist; lastly, you can slide down it yourself.

Clothes on Fire.—When you discover your clothes to be on fire, endeavour to be calm, and to retain your presence of mind, and on no account rush about wildly. If you are alone, seize any loose rug or woollen article, if such be near, and wrap it tightly about you; this will extinguish the flames at once. If nothing of the sort is at hand, and there is no one near to help you, keep your clothes as tightly about you as possible, and try to put out the flames by rolling on the floor. If a man is present when a woman's clothes catch fire, he should at once throw her down, and, if no better woollen article presents itself, take off his coat and wrap it round her. A woman's shawl will answer the same purpose. Whenever it is possible, textile fabrics should be rendered fire-

proof. Saline solutions, more especially one of alum, are most commonly employed, but these have the disadvantage of weakening the fibre of the fabric. Better applications are sulphate and phosphate of ammonia and borax.

Chimneys on Fire.—When a chimney is discovered to be on fire, throw into the grate a few handfuls of common salt, or scatter flowers of sulphur over the dullest of the coals; the mephitic vapours thrown off will check the combustion. Shut the damper if there is one, and cut off all current of air up the chimney, by fixing a wet carpet or blanket tightly across the fireplace. Closing the top of the chimney should not be resorted to, as it forces the suffocating smoke downwards into the rooms, neither should water be thrown from above, which damages the carpet and furniture. Chimneys never ought to be set on fire to clean them; even if there were no danger in the practice, the intense heat generated, rends and weakens the walls; but those in regular use should be swept at least once in every three months.

THE HOUSEHOLD MECHANIC.

PAINTING.

To enable an amateur to accomplish any ordinary mechanical task likely to be required in a moderate household is the purpose of our papers in *The Household Mechanic*. We shall here endeavour to instruct our reader in house-painting, which is probably in no way less useful than the kindred art of construction, as it serves to preserve the wood, and keep it from warping, while it is also pleasing to the sight.

It will be necessary, in the first place, to give the reader a general insight into this art. There are two branches of painting—the painting of wood and the painting of plaster. In this article we purpose to give directions for the painting of wood, and in the next we shall treat of the painting of plaster. As we are not speaking to professed painters, we need only allude to the great difference in the qualities of painters' goods and the consequent variation of prices for different kinds and qualities, for the sake of putting buyers on their guard in purchasing these goods. This, we may remark, accounts for the great discrepancy of price charged by the professors of this art for apparently identical work. In the first place, it is necessary to remember that whitening is, to a great extent, mixed up in common white-lead; in the second, inferior oil is used in the mixing of paint, and very little turpentine; in the third, colours vary widely in value, and common colours are mixed to assimilate costly ones; in the fourth, varnishes greatly vary in value and quality, as we shall have occasion to remark when speaking of the imitation of woods. It is desirable, as far as possible, to mix your own paints, and to pay the best price for colours, purchasing them at a warrantable warehouse. It is impossible to prescribe the exact number of coats to be given, as much depends on the kind of wood, its newness and hardness, the kind and quality of the paint, and the perfection of the workmanship desired. Three coats (although many painters only give two) and the flattening or finishing coat may be taken as an average sufficiency for plain painting of new wood. Two coats and the flattening would do for wood which has been before painted. Four coats (according to some five) are necessary for the ground-work when the imitation of woods is intended. Five coats are necessary for new plaster, although four may do for that which has been before painted.

Directions for painting in White.—Having applied to the knots, with a brush, a preparation of lead-powder (red is most general) ground in water, and mixed with strong glue size, while quite warm, which should be heated in an iron vessel, stop with putty the indents of the nail heads

and any cracks or blemishes which sometimes occur in the wood, generally at the knots. This being done, the next thing will be to apply the priming or first coat of paint, which should consist of white and red-lead, mixed or ground with linseed oil, using as driers patent driers, or litharge and a little burnt white vitriol, well ground in turpentine, thinned to the consistency of rather *thin* paint with boiled oil. It is a judicious practice to strain the paint before using, through a coarse canvas, in order to keep out any small pieces of the driers which may have escaped grinding, or any extraneous matter that may accidentally have found its way into the paint. It must be borne in mind that to effect good painting considerable time, as well as exertion, is requisite. The paint should be so well beaten into the wood before smoothing that the arm of the novice at such work will at first ache; but if the paint is simply laid on without this exertion, it will not properly adhere to the wood; and, while drying, will run in small patches, and appear like a greasy surface. Panels or large surfaces should be painted first, and when the paint has been well beaten in, the whole should be carefully smoothed down (quite straightly) with a flat or broad brush, using a small brush to smooth the beginnings and the endings, which must be in a cross direction, but afterwards blended in with a light touch, so done, as to leave the cross-grain of the painting scarcely perceptible, which, under such circumstances, will disappear in drying. It is impossible to state the exact time that should be allowed for painting to dry sufficiently to receive the next coat, as that depends on the state of the atmosphere, the quantity of driers employed, and the temperature of the air kept up in the apartment or room. Under any circumstances, however, the first coat ought to stand a few days before the application of the second. While speaking on this subject, it will be as well to observe that the second coat should stand a little longer than the first before application of the third, and so forth for any number of coats, excepting the one immediately preceding the flattening or finishing coat, which ought not to stand above two days, as much of the beauty and solidity of the work will depend on the latter drying into and blending with the former. The priming being quite hard and dry, it should be well dusted, and the surface rubbed smooth with glass-paper. This being done, you may proceed with the second coat. Having mixed the white-lead in raw linseed oil, thin with equal quantities of oil and turpentine, but to a consistency considerably thicker than the priming, using as driers litharge or patent driers, but only half as much as used for the priming. Be particular in straining, that no dirt or bits of the driers remain in the paint, as that will render the surface rough, and spoil the appearance and gloss of the work. If the work is intended for a third coat before the flattening, the colour will be sufficiently good; but if not, the addition of a little lamp-black or Prussian blue will much improve the appearance of the paint, as it will free it from the yellow cast of the oil. The third coat, if the work is intended for a flattening, will be precisely the same as the second, but adding the lamp-black or Prussian blue. Too great care cannot be taken to prevent dust from settling upon the paint while wet, as this will not only spoil the colour and appearance of the work, but render it rough and coarse. If the work is out-doors, calm weather, free from rain, should be selected; but if in-doors, a sufficient current of air may be created for drying the paint and clearing the smell by leaving the blinds drawn down before an open window.

We now proceed to give directions for the flattening or finishing coat of paint. The white-lead should be mixed to a *stiff* consistency with linseed oil, and rendered *quite thin* by the addition of spirits of turpentine, using no driers, as the turpentine will dry quite fast enough, and requires dexterity of the workman in laying on the paint to

prevent it drying before the surface is nicely levelled. It is desirable, too, that the doors be kept closed for a short time to prevent the uneven and too rapid action of such drying. The addition of a little lamp-black or Prussian blue should not be omitted, as it greatly tends to increase the perfection of the colour. Great care must be taken to ensure the lamp-black or Prussian-blue being exceedingly fine, as bits passing through the canvas strainer (although very small) melt and suffice to stain the paint with the pressure of the brush. If a slight gloss, which is preferable for upstairs work, is required, the paint should be mixed in a similar way, only using more linseed oil in the mixing of the white-lead. Should it be required to re-paint, the work should be well rubbed with glass-paper, and, if necessary, with fine pumice-stone, afterwards clearing it off with canvas. If, however, the work be dirty, it must be first scrubbed with soap and water, and when quite dry prepared as usual. In some cases, where bad oil paint has been used, it is necessary to scrape it with the painter's knife before adopting the usual process, but this never occurs excepting in common work. In the cases of blistered work, or where the surface of the old coats of paint is rough and uneven, the best means is to clean off the old paint, to effect which mechanical scraping is very generally resorted to, or the method of washing over the work with oil of turpentine, and burning off the old painted surface. This is a dangerous operation, and may be well replaced by a safe and much more easy plan, namely, spreading a thick paste of fresh slaked quick-lime, mixed with soda, over the whole surface of the work, which will displace all the paint and dirt, and when the work is washed the following day, it will be left quite bare, and may be treated as fresh work.

Green Paint for Garden Purposes.—Nothing is of greater importance to the setting off of a country or suburban residence than the appearance of the verandahs, the trellis-work, and the garden-stands. To keep them in perfect condition, they should be painted every spring, and they fully repay both the trouble and expense of doing them in the way which we will prescribe. Having washed them quite clean from all dust and dirt, choose a clear day, when they are perfectly dry, and use for the first coat the following mixture:—White-lead and mineral green ground in turpentine, with the addition of a small quantity of turpentine varnish. When the first coat is quite dry, use the following for a second coat:—The same mixture as before, but using as much turpentine varnish as will give a good gloss; and if a brighter colour be desired, adding a small quantity of Prussian blue, which, in our opinion, greatly improves the beauty of the colour. With regard to the making of the varnish, it may be done in the following manner:—viz., by adding a little more than a pound weight of rosin, which should be pounded, to every quart of turpentine, and letting it boil for about half an hour on a hot stove, or in an oven with the door open. But we must warn our readers of the danger of making most varnishes, as unless done in a perfectly scientific manner, according to the rules we prescribe, they are likely to take fire, and for this reason it is customary to make varnishes in a fireproof building or apartment, and therefore we would suggest purchasing the varnish as the safest and best plan for small consumers.

Painting to imitate Fancy Woods.—The imitation of woods and marbles has now been brought to such perfection, that in some cases—as, for instance, the imitation of oak—where the real and the imitation are placed side by side, it is scarcely possible to distinguish the imitation from the reality, and, indeed, even after examination. Imitations of marble have, in some instances, been brought to almost equally great perfection, although the art of imitating oak has received the greatest attention. We shall treat of these in another paper.

SOUVENIRS.

ALBUMS.

EXCEEDINGLY pretty souvenirs may be made from a couple of embossed cards, by ornamenting them with water-colours and converting them into an album or a plaster-case. Fig. 1 illustrates a very pretty pattern for this fancy-work. The first design has a border of rustic - work and ivy, but may consist of garlands of roses and leaves carried all round the border, in the way shown in Fig. 2, on the next page. This pattern can be procured in embossed card.

Choose white cards. Let the rose be alternately white, damask, yellow, and pink. Tint the pink roses with crimson lake made very pale with water; tint the yellow rose with King's yellow, or pale gamboge, or lemon yellow. For the damask rose use carmine, but not too deep. Each must be gradually worked up. The colours must be applied moderately wet, that they may not run; and very great care must be taken not to go beyond the embossed part, nor to leave any of it uncoloured, especially in finishing. Whilst wet, do not retouch any part of the card. Gradually finish up the pink roses with lake, touching lastly the hearts with carmine. Work up the damask rose with carmine only. The yellow rose is first improved with the same yellow, if lemon yellow with gamboge, and lastly with burnt sienna sparingly applied. The white roses are shaded delicately with Indian ink, and the hearts tinted very slightly with crimson lake. Every mark of the petals in the embossing should be nicely worked up with the sable pencil (brush). Colouring the leaves must proceed along with the flowers, or the effect will be found hard and vulgar. But the early tints of green must not be washed on whilst the first tints of the roses are wet, or the colours will run together. Tint the leaves pale with sap green and

Hooker's green, No. 1 and No. 2; also paint a very few as dead leaves, with raw sienna first worked up, some with burnt sienna, some with madder brown or dragon's blood, and a touch or spot of green about them. The green leaves can be quite finished up with the colours used for them at first. But every shade of green necessary can be made on the palette by mixing Prussian blue and gamboge in various proportions. The more varied the

colour of the leaves the better. Observe the same care in colouring them exactly down to the level of the card, but not beyond, as was observed with the roses. Use the colour very dry, well finish the leaves, and mark the veins. Fig. 2 has a line round inside and out forming an embossed ridge. This is very delicate to treat, to cover it exactly with deep gamboge and not in the least trespass beyond. When the card is otherwise quite complete, this line is covered with gold obtained from gold shell or saucer. If there are butterflies in the corner, take very great pains and illuminate them exactly like real ones, two of one kind and two of another, reversing the corners. Two covered with brown sienna, well shaded, and the spots, marks, and lines picked out in gold, look well; the other two made to represent "the Chalk Farm butterfly," with cobalt blue, marked with a little white. "Peacock" butterflies, and "nettle tortoiseshells," or



Fig. 1.

"brimstone" butterflies would make a good ornament. If possible, they should be copied from real insects. When the gold has lain by for a day, burnish it with an agate burnisher, or the rounded end of a glass phial, rubbing it very lightly and quickly till the gold shines; if done with a heavy hand, the gilding will be rubbed off, and the fancy-work damaged. If there are crowns or coronets in the corner, colour the strawberry leaves or fleur-de-lis, and the frame of the crown, with gamboge or yellow ochre. When dry, put in the jewels with vermilion and emerald green. Put the black tails to the ermine and shade it

with Indian ink. Shade the gold with burnt sienna. Let two of the crowns be filled with crimson, and two with blue velvet. Use carmine for the crimson, and cobalt or Prussian blue for the blue one. The latter is rather the best in effect. The more elaborated (but not too minute) the device upon the card the better; the corners especially should be rich in colour and finished up carefully.

Another device is gem pattern (shown in Fig. 1, also). We will suppose the diamond in the centre to be coloured with smalt and shaded with French ultramarine. The lilies with orange vermilion shaded with vermilion, and afterwards with carmine or lake. The leaves emerald green, shaded with Hooker's green, No. 2. The dots scarlet. If there are as many as five devices, lozenges or flowers, use scarlet for the centre and two ends, and blue for the two intermediate ones. Intersperse green and a little yellow if possible. Put the colour on these very intense, very vivid, and as much all at once as possible. It must look very even, and like illumination when finished. Put the gold line round the centre as already described.

The centres are blank, and the design must be drawn on this. It can be traced from the illustrations furnished. That of Fig. 1 is a Cupid swinging on a garland of roses, heartsease, forget-me-nots, and their leaves, suspended by a few tendrils between two spiders' lines. The spiders' lines must be kept most delicate. The spiders are tinted in raw umber and shaded with Indian ink. The roses are coloured in the way before described. For the heartsease mix carmine and Prussian blue, and use lemon yellow for the three under-petals. The eyes are of orange vermilion. For the forget-me-nots, mix cobalt and permanent white, and drop on the little petals in fine distinct dots with the point of the brush. When dry, dot a centre of lemon yellow. Shade the petals with cobalt and white deeper than that first used. Shade the yellow centre by a line half round under it of burnt sienna, and a very black speck in the centre. Let the leaves be of two shades of bright green. The motto underneath must be written in gold. The Cupid is the most difficult. If there are any hard edges of outline remove them. Tint the flesh entirely with raw sienna, very pale. When dry tint again with orange vermilion, very pale indeed. Let that dry. Draw a thin outline on every part of the flesh with orange vermilion, not pale. Shade with Venetian red, very pale and rather wet. Tint the knees, toes, elbows, stomach, and face with a little pink madder. Tint the cheeks with rose madder. Touch on the lips with dry carmine; also draw the outline of the eyelids, nostrils, and ears with the deep, dry carmine. Dot in the eyes with cobalt. Colour the hair with Spanish liquorice. Draw little rings over it with raw umber and burnt sienna, keeping it light and golden, and shading it well. Touch the eyebrows with burnt sienna. The scarf is of cobalt pale, shaded with cobalt deep. The wings are only to be slightly indicated with outlines, and a stroke or two of emerald green. Colour the branch work of the border with burnt umber, light in tint, and shade with

madder brown. For the leaves use Hooker's green, No. 1, and shade with No. 1. Touch on the high lights with indigo and white.

We shall return to this subject in another short paper, explain the constructive details, and give other designs.

ON FLOUR USED FOR BREAD-MAKING.

If it be true that bread is the staff of life, no one can be insensible to the statement which has been made by authors on the matter, so many times of late—that we make a very great mistake, from a dietic point of view, in the kind of flour which we select for making bread. The most nutritious bread is not the whitest, but rather the reverse, since the branny portion of the wheat grain, which is systematically rejected, contains very valuable substances and salts, that taken into the body go to form

bone, flesh, and nerve, as well as to assist in the digestion of starchy matters. The central portion of the wheat grain, or that portion which forms the ordinary flour of the shops, consists solely of starch, which is not a flesh-forming substance but a heat-giving principle of food. The bran contains phosphates, of which bones and nerves are so largely made up; gluten, or flesh-forming substance; and cerealin, a peculiar body which has the character of a ferment, changing starchy matters in such a way as to be more readily absorbed and utilised by the system in the act of digestion.

It stands to reason, therefore, that flour made from the entire wheat grain contains the very substances which are needed to make it nutritious, and that the removal of the bran in the making of flour, as ordinarily practised, entails the loss of very important items of diet. Further, it is clear that the

physiologist is right in recommending the use of whole grain flour, provided that there are no special drawbacks on account of its physical character. But this is just what has been the case hitherto. When the bran is mixed with the ordinary flour and taken, it is found to be difficult of digestion, and, in some cases, to irritate, the latter result being due to the mechanical action of the bran scales upon the intestines, and hence there has been a real difficulty in extending the consumption of brown bread. It was also affirmed that in the heating of the flour made from the entire wheat grain, the cerealin and salts of the bran were so altered as to be inactive when taken into the stomach. These two matters have recently been shown to be susceptible of complete amendment, and the *Lancet* has specially called attention to the subject, and recommended the public to use the entire wheat flour of Messrs. Chapman and Co., both for young and old, inasmuch as this firm has by proper machinery been enabled to produce a flour in which the bran is pulverised in the most complete manner, and in which the cerealin and the salts remain unchanged, in consequence of the mode in which the flour is roasted ready for immediate use. Professor Atfield finds that three-fourths of



Fig. 2.

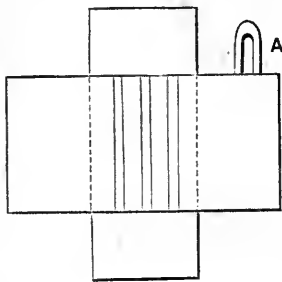

Fig. 5.

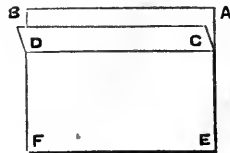

Fig. 3.

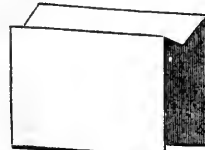

Fig. 4.

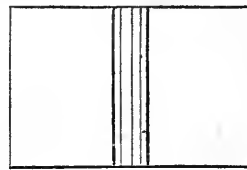

Fig. 6.

the cerealin remains in the prepared flour in an active condition.

Here we have an important problem solved, and a perfect flour at length given us. The use of entire wheat flour is to be commended; particularly, too, in an age when the quality of the nerve, muscle, and bone of the young and old is by no means improving; when the staff of life, upon which these depend, is deficient in the very principles which go to improve it, and which principles are thrown away with the bran; and when by general consent amongst medical men the exhibition of phosphates is so largely demanded, for the rectification of deficient tone in the organisation of the nervous system of the people.

It is not our intention in the present short article to go thoroughly into the subject of bread-making, as we have other papers thereon in preparation; nor shall we dwell upon the component parts of wheaten flour, with a view to a more complete explanation of their chemical nature: this will be done under the head of Household Chemistry. Our sole intention in writing this article has been to call attention to a principle involved commonly overlooked, and to which it is impossible to give too serious attention.

We also pass over for future notice the various kinds of flour in ordinary use, such as Indian meal, &c.

DOMESTIC MEDICINE.

DRUNKENNESS.

OUR readers will perhaps be surprised that we should treat of drunkenness among diseases. But it is really a disease, and it is eminently a disease about which we should try to say a few words in a work on domestic medicine. We do not mean to say that drunkenness is always a disease from the beginning. Men, and women too, drift gradually and insensibly into drunkenness without knowing it. Sometimes the habit is formed carelessly, from the mere love of company and jovial society. Sometimes it begins by taking small sips of brandy or gin to relieve pain of different kinds. This is a way of relieving pain which some people cannot too suspiciously guard against. Women especially, both young and old, are tempted by pains they experience, to take a little spirit of some kind. But it is often a dangerous thing to do, and it must be understood that something else, such as a cup of warm tea or coffee, and a warm external application will often afford relief. We are obliged, for the mere sake of fairness, to admit that drunkenness does sometimes originate in the too carelessly given advice of medical men to their patients to take wine, beer, or spirits in considerable quantities. There has been a habit, or a fashion, common of late among doctors, of recommending liberal diet, and especially the free use of wine or brandy, and some form of beer. This medical fashion has made many a drunkard. Fortunately, medical men are now seeing this, and are acting with much greater care and sense of responsibility in ordering stimulants. We say fortunately, for not only was the fashion bad, and often frightful in its consequences, but the remedy, as prescribed, was bad and injurious. Passing over those cases in which drunkenness seems to originate in a way that can be understood and followed, we come to the genuine disease of drunkenness, or as the doctors call it, *dipsomania* (from the Greek words, *dipsa*, thirst, and *mania*, madness). Everybody is familiar with cases of this kind, in which the love of drink seems a madness or mania: there is an intense craving for intoxicating liquors, accompanied with general depression of the system, and especially of the nervous system, and restlessness. Accompanying this state, there is often also a certain slyness, or untruthfulness, or deceitfulness, which is characteristic. Such people will often deny that they

drink much if they are questioned on the subject; and yet the love of drink is the passion which dominates over all their life and all their other feelings. They will admit all the arguments against drinking, but they will drink again; and the habit acquires strength with indulgence. As it gets stronger the power of self-control gets weaker, self-respect grows less and less, and after a time, the power of resistance is completely gone. Dr. Austin Flint, a wise American physician, says truly, "Before this stage is reached, reason and persuasion may have some effect, but in the advanced stages, it is useless to attempt to reason the drunkard into temperance; he lacks moral strength enough to govern an acquired appetite, which represents a morbid condition as much as the delusions of insanity." Sometimes, more than one such case occurs in members of the same family.

Treatment.—Now, it seems at once the kindest and the truest view of this awful state, to look upon it as a disease, and to treat it accordingly. A person so affected will pursue drink at every cost—at the cost of losing his respectability, his reputation for truthfulness, his work, his property, and destroying the comfort and welfare of his family. It is a grave question, how far such a person should be treated as other insane persons are treated, and forcibly put under a course of treatment; often such a forcible treatment would be the greatest blessing to all concerned. We have not a law that empowers this. The United States passed an Act in 1865, of which the following is an extract:—

"Any justice of the supreme court, or the county judges of the county in which any inebriate may reside, shall have power to commit such inebriate to the New York State Inebriate Asylum, upon the production and filing of an affidavit, or affidavits, by two respectable practising physicians and two respectable citizens, freeholders of such county, to the effect that such inebriate has lost self-control, or is unable from such inclination to attend to business, or is thereby dangerous to remain at large. But such commitment shall be only until the examination, now provided by law, shall have been held; and in no case for a longer period than one year."

We have no legal power of this kind in our country. But we need it very much. At the same time, it is a power that should not be frequently exercised. In the United States there are four asylums for the inebriate:—the Washingtonian Home at Boston; the Sanatorium in Media, near Philadelphia; a Retreat at Chicago; and one at Binghamton, called the New York Inebriate Asylum. The great majority of patients come to these homes voluntarily; and these cases give most satisfaction, and are also treated with the greatest success. Dr. Albert Day, the distinguished superintendent of the first of these homes, lays down three cardinal points for the inebriate:—1, No hope for an inebriate until he thoroughly distrusts the strength of his own resolution; 2, no hope for an inebriate except in total abstinence as long as he lives, both in sickness and health; and 3, little hope for an inebriate unless he avoids, on system and on principle, the occasion of temptation, the places where liquor is sold, and the persons who will urge it on him. The general experience at these homes is, that the sudden and complete discontinuance of the stimulants is less inconvenient, less painful, and less difficult to the patient than the "tapering-off" system. At the homes, the patients live in pure atmosphere, and in a rational manner amuse themselves with all sorts of games. A good table is kept. Once a week, after prayers, a kind of temperance meeting is held. Further particulars of these important institutions may be seen in the *Medical Times and Gazette* of April 9th and 16th. Bromide of potassium, and other medicines, may allay the painful sensations of the first days of teetotalism; but if this is firmly and strictly carried out, these sensations soon subside. Let us hope soon to see homes established in this country. Meantime, let us urge inebriates to recognise the real nature of their case, and to cure themselves.

THE REARING AND MANAGEMENT OF CHILDREN.

CHILDREN'S CLOTHING (continued).

Pinafores.—Children's pinafores may be made in a variety of ways. The simplest mode of forming a girl's pinafore, for any age, is like Fig. 1. It is cut out of a width of fine linen diaper, the shoulders shaped by folding it in half, letting it meet down the centre of the back, and lap over a little for a hem; then folding it again in the centre from G to H, and cutting off the slopes from the doubled material, marked at A to B. When opened again it appears as in the diagram. Run and fell it neatly on the shoulders, A to A and B to B. Cut a straight slit from A to J and B to J, on the two sides, and hem it round for the armhole. Hem the top and run a tape in. Sew it at K in the centre, to prevent its being pulled out. Sew on strings at L and L to tie behind. The bottom of the pinafore has a half-inch hem. The length should be rather less than the frock, and the width sufficient nearly to encircle it. At the full part of the skirt perhaps a third is

latter case, the sleeves are tied up with bows of similar ribbon. These pinafores may also be made of brown holland or of Hoyle's prints. Fig. 2, made of Hoyle's print, light or dark, suffices for frock and pinafore in one, during summer. Where nicety is studied it may be made in checked white muslin, and worn over a clean tucked white petticoat. To make it, take two breadths of the print, and cut the two alike for back and front, try the pinafore pattern, Fig. 1—the dotted lines marking the front, and two gores inserted between it and the back. The neck at the back should be hollowed, but not be hollowed out to fall quite as low, by an inch, in the centre as the front. Slope the shoulders and leave open places for the arms. Run and fell the breadths together at the sides and on the shoulders. It will be needful to cut a placket hole, half the length behind. Hem one side narrow and the other broad. Stitch the broad hem over the narrow where they meet. Set the top in a band, the size of the child's neck. Add epaulettes or little sleeves. If epaulettes only, the under sleeves must be trimmed. Sleeves are best, as children's clothes sit better for being

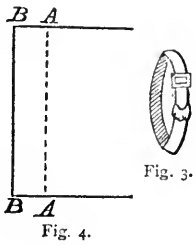

Fig. 4.

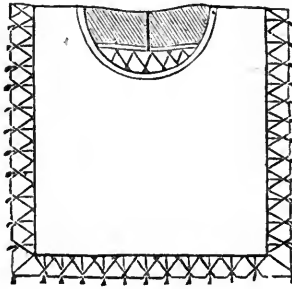

Fig. 6.

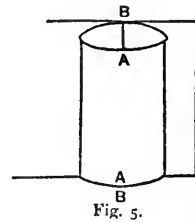

Fig. 5.

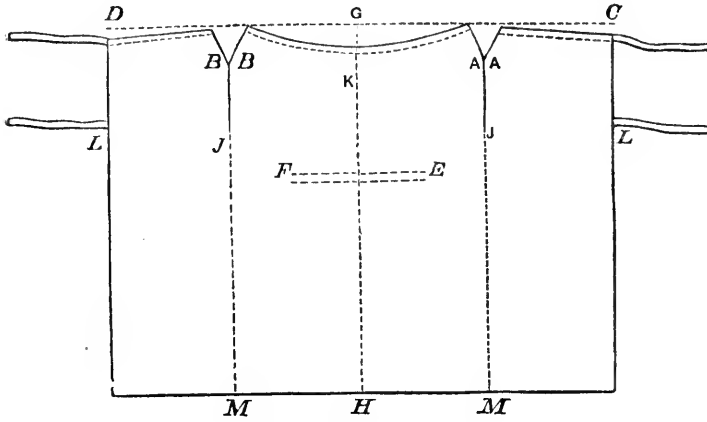

Fig. 1.

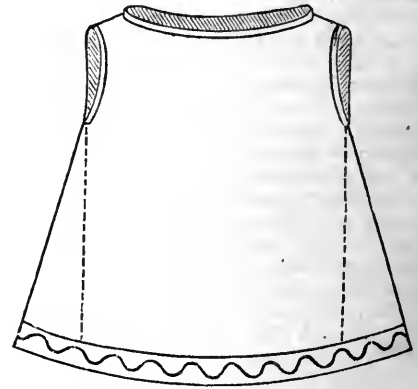

Fig. 2.

left open behind. Some mothers like to make pinafores, for such young children, large enough to cover the frock, and run and fell them together behind. They leave the rest entirely loose, but add little epaulettes, like those in Fig. 10, page 20, edged with muslin embroidery, and a similar trimming is also added round the neck. These pinafores, instead of being drawn by a string to the neck, are often set in a band there, like Fig. 2. For dress occasions, over silk frocks, these pinafores may be made of fine book-muslin or Swiss muslin, edged with embroidery or lace; but a little shorter than the frocks. For children of four years old they are extremely pretty—at six and eight years they also look well. Either of the pinafores, Fig. 1 or Fig. 2, may be made with a band, by double-gathering the material from E to F, Fig. 1, drawing it to the waist, piping a diaper band, and stitching it on with long ends of double-piped diaper to tie behind. In muslin, the band may be of muslin, with lace round the muslin ends, or they may be of insertion, run with a plaid or coloured ribbon which ties. In the

fastened on the arms by ribbons; or, for economy, straps buttoned. A band of black velvet, lined with sarcenet ribbon (to which it is run by both edges), buttoned over, edged with black lace at the end folding over, and fastened by a steel slide and unseen hook, or a pretty button, fastens sleeves well, and lasts long. Lace or crochet, lined with coloured ribbon, can be used the same way. (See Fig. 3.)

Pinafores for boys of four and five may be like those of girls, but at six they ought to differ. Fig. 10, page 20, gives a good pattern for a boy's pinafore, at any age past two years old, and may be also used for girls. It can be made in two ways of brown holland. The first way is to join two widths and cut them like Fig. 1; the piece between the arms in front forming one width, and the two backs, which in Fig. 1 are separate, are united and take the other width. Slope the shoulders, hollow the neck; join the sides and shoulders, leaving open a space for the arms. Hollow this out and pipe it. Before piping, put in the epaulettes, which must be braided and trimmed first.

Make three pleats for the front, and pin and afterwards tack them. These pleats must reduce the width of the material sufficiently to make the body the size for the child. These box-pleats, as they are called, are made by running an ordinary tuck, Fig. 4, and opening and spreading it each way afterwards, Fig. 5, bringing the seam, B B, flat to A A. Tack the fold down the centre to keep it in place till the pinafore is complete.

The back of the pinafore is managed the same way; but the placket hole must be cut so as to come under the centre pleat, and show no join when the pinafore is on. The box-pleats must be stitched down across the waist. Braid the pleats next, if they are to be ornamented. Then braid a neck-band. Set the neck into a band; it can be edged with embroidery or not. Make a deep hem, an inch wide, to the skirt, and if the body is braided, that should be trimmed to correspond. Make a two-inch wide waist-band. Cut two lengths, pipe the first and line with the second. Round the ends. Let them wrap over a little behind, and fasten with a button and button-hole. Braid the band. Such pinafores as these of brown holland may be made perfectly plain, only edging the neck and epaulettes with tatting or other trimming; or they can be braided with narrow white, black, or scarlet braids, stitched on in patterns. White piqué dresses made this way, and braided, serve as summer frocks; it is also an easy and not an ugly way of making frocks for children. The other method of producing this pattern—and if a frock is wanted, the best way—is to make the body first and separate in the way already described, and sew it to a two-inch band; the lower edge is best piped. Then make the skirt separately, and much fuller than for the pinafore—that is, three or four yards full. For a boy, pleat it all round in large pleats one way, inch and a half deep, and overlaying one another quite half an inch. For a girl, cut a front width, with a gore each side. Fig. 6 is a design for an ornamental bib pinafore for a young child to wear at meal times. Pinafores for boys of eight and girls' princess pinafores will appear in a future number. If a skirt is gored, set the front plain to the waist. The rest of the skirt pleat—over the hips in single pleats, each side turning to the front, and behind in box-pleats. About two box-pleats each side behind can be made, or one each side, and one at the centre behind covering the placket hole. The latter is certainly the best, as it agrees with the pleated body.

INMATES OF THE HOUSE.—DOMESTIC.

THE LAUNDRY-MAID (*concluded*).

Goffering is very much in use at present, and machines are made expressly for the purpose. For laces and other light frills the ordinary goffering-irons answer very well. These are used by the ironer putting her thumb and second finger through the handle, as in using scissors, then she turns the thumb under, taking up the frill between the irons from underneath. In the action of bringing the thumb uppermost again, the goffer is formed. All goffered frills require to be ironed first. Goffering is done from the left hand to the right. Care is necessary not to scorch with goffering-irons. Very little heat is necessary to form the goffers.

All *piqué* materials should be ironed on the wrong side, over several thicknesses of flannel, if ironed at all. *Piqué* looks better if well shaken only whilst drying, only ironing the hems and bands. *Piqué* waistcoats should be ironed through muslin or soft cambric, as described.

Bed furniture, made of dimity, should not be ironed. After it has been starched, and pressed through the rollers of the wringing-machine, it should be shaken out and laid upon clean grass to dry. When nearly dry, the

laundry-maid should pull the dimity the way of the ribs in the material. Two persons will be wanted to pull the curtains, back, and tester pieces.

Lace and muslin window-curtains should not be ironed. After washing, they require to be put into rather thick starch, and afterwards cleared in a small quantity of cold water. To prevent the necessity of wringing, they should previously be lightly tacked together in folds of a convenient length, and the laundry-maid should only squeeze the muslin, and turn it over and over in the tub till all the dirt is removed. Having rinsed and starched them in the usual manner, they should be carried to some spare room, where they may be pinned out on the floor to dry. A clean sheet should be laid over the carpet or boards, and the curtains pinned to it at full width, and very straight.

White cashmere and merino articles are better mangled and not ironed, as the heat of the iron is apt to make woollen materials fade in colour. White alpaca should be ironed between muslin, and finished on the wrong side.

Black silk stockings look better if washed without soap. They require washing in two waters (hot), using some of the best washing powder instead of soap. In rinsing them, a good deal of blue should be put into the water. White silk stockings are washed, in the usual way, in soap lather, and the rinsing-water should contain a little cud-bear or pink saucer, to give the flesh-coloured tint. If ironed, they should be turned inside out for the process, but it is better to dry them between two mattresses.

Getting up lace requires a separate notice. Few ladies trust their fine laces to a laundress. They either do it themselves or send it to a lace-cleaner. The latter is an expensive plan, and by taking a little trouble the work can be done very well at home. Large pieces of lace, such as shawls, scarfs, &c., should be folded into a convenient length, and washed in lather made of the soap-jelly described in a previous article. The lace should not be twisted or wrung, but simply patted and squeezed with the flat palm of the hands, till no more soiled water oozes out. Before bluing, the lace should be put into a pan, and set under a tap of flowing water (when the water is coming in from the main is a good opportunity), and after several gallons have run through the lace, it may be passed through blue water, if desired. For our own part, we consider the blue contained in the starch sufficient, without any further addition. The lace should then be unsewn, and stretched out to dry over a clean mattress. The edges should be previously worked out between the finger and ball of the thumb. The *nails* should never be used to open the edges of lace. Each scallop round the lace should, if possible, have a pin placed through it to the mattress, beginning at the corners.

Border lace is best washed on a wine bottle, previously covered with fine flannel, stitched flat and smooth on the bottle. A bottle thus covered should always be kept for the purpose in a clean linen-closet. Take one end of the lace, and begin by lightly tacking each scallop to the flannel all round the bottle, then tack the other edge, drawing the lace to its full width, and so on, until all the lace is sewn in layers on the bottle. Then plunge the bottle in some warm suds made of soap jelly, and squeeze the lace with the hands till the suds have well penetrated. Repeat the process in second suds, and afterwards rinse, as described, under flowing water. Set the bottle in the sun, for the lace to dry, turning it round as often as necessary. When tolerably dry, put the bottle into some Glenfield starch, working the starch through with the fingers. Afterwards, wash off the superfluous starch on the outside, by plunging the bottle for an instant in cold water. Set the bottle in the sun to dry again. Unless the weather be very favourable, this may require two days to accomplish. In the meantime, cover the lace with some thin material, to keep off the dust. When dry, the lace will only require unsewing from

the bottle. If it has been well tacked on, it will come off looking even and raised in the meshes, like new lace. The above is the best way of cleaning old point lace, Honiton, and every kind of *guipure*. The pearl edges may require a little working out with the ball of the thumbs.

If lace be very much soiled, a little sweet oil may be laid on each fold as it is being put on the bottle. New lace also is rendered less liable to crack in the meshes, if moistened with oil before washing.

Clear-starching is an art, of which the process is kept a secret in the trade, but ladies may get up their fine muslin embroidery almost as well by the following means:—Wash and rinse, as described for fine materials, then pin out the article over several folds of flannel, and iron as usual. This is necessary to emboss the raised work. If the design be in lace, "raise" the pattern, by passing an ivory stipple into the scrolls, rubbing gently until each thread looks clear and glazed. The end of an ivory handle of a crochet needle answers very well for this purpose. When finished, the article should be left till perfectly dry. Only the plain parts of the muslin or net should be touched with the iron. Isinglass is sometimes used for stiffening fine lace.

Blonde is seldom successfully washed at home. If attempted, the above plan will be found to answer as well as any.

NURSE AND NURSERY-MAID.

Where the care of young children is concerned, the duties of the above domestics are precisely the same, the chief distinction being, that in families where more than one domestic is kept in the nursery, the upper servant is usually styled "nurse," and the under servant "nursery-maid." Also, in households where much responsibility is vested in one nursery domestic, she is often called "nurse." If the female head of the household superintends the management of the children, a "nursery-maid" only is generally kept to do the rougher portions of the work, such as scrubbing floors, emptying slops, &c. It is advisable that employers should understand the nature of these distinctions, because, in making engagements, disappointment is unavoidable if the precise position of the servant is not clearly defined.

Next to the engagement of a governess, that of a nurse requires the greatest consideration. If the mother of the children spends a great deal of time in the nursery, she is naturally the individual to whom the little ones look for advice and assistance. But if from pressure of business, ill health, or any other cause, she is compelled to confide the care of her offspring to a stranger, too much care cannot be taken to secure the services of a well-informed, kind-hearted deputy. The most essential qualities to seek in a nursery attendant are truthfulness, intelligence, cheerfulness, and cleanliness. As a general rule, these qualities are not very commonly to be found in the class of domestic servants from whence inferior situations in a household are filled. Nurses, as representatives of mothers, should be drawn from the more highly educated circles of society than usually constitute the domestic servant class. Daughters of small tradesmen, ill-paid civil service employes, and clerks, that have enjoyed the training which a well-regulated home above the reach of actual want affords, are excellent, generally speaking, as upper nurses; and the assistance of such, when once secured, should be rewarded in a generous spirit. Having enjoyed the blessings of a settled home, they usually impart an air of comfort to the nursery apartment, and take pains to instil into the minds of their infant charges high principles and a love of home. These qualities are seldom acquired by the domestic who has filled every kind of situation in ever-varying households. Experienced the latter may be, but the experience is apt to be of a kind which is mingled with bitterness and

dissatisfaction at the numberless changes to which their path in life has been subjected.

In choosing a nursery-maid, early rising, good temper, and strength of constitution are necessary qualifications. Truthfulness is obviously of so much importance, that any shortcoming in this particular should not be overlooked. If a nursery-maid has time to spare from more active duties, it is advisable that she should be a fair needle-woman; not only that she may assist in mending the children's clothes, but because a young person who has a taste for sewing is generally more companionable to the little folks in the nursery than one who has no inducement to sit down when her more active duties are finished.

In addition to the ordinary duties of the nursery, an under-nurse is generally required to assist in washing infants' linen, flannels, socks, frills, tuckers, &c. Time should be allowed for this work on a certain day of the week, the children, in the meanwhile, being placed entirely under the care of the nurse or mother.

In preceding articles on the rearing of young children, in the *HOUSEHOLD GUIDE*, the question of food and clothing has been minutely entered into. It therefore only remains to indicate some points of nursery management not included under those heads.

Whenever the plan of the day's work rests with the nurse, the primary consideration should be to secure plenty of time for out-door exercise and recreation. With this view, nursery cleansing, and other arrangements should be made subservient to the state of the weather, in order that exercise in the open air may be taken in the finest part of the day. As young children generally wake early, the morning walk should, in summer time, take place before the sun's heat is oppressive. The most healthy time for walking out in the summer months is between eight and ten o'clock in the morning, and from half-past five till seven o'clock in the evening. In the spring and fall of the year, from ten to twelve o'clock in the morning, and from three till five o'clock in the afternoon, will be found equally suitable. Young children should never be exposed to the burning heat of the sun, neither should they be allowed to sit down in the parks and squares of towns. As far as it is possible, little children residing in the country should spend the greater part of their time out of doors; the nurse, if necessary, doing any light needlework in the meantime. Any kind of game which exercises the limbs of children whilst in the open air, is conducive to health; only when passing through the streets should they be required to walk hand in hand.

In the absence of the children from the nursery, the windows should be open from the top and bottom sashes, and the bedding exposed to air. If the nursery boards are scrubbed, a fire should be lighted in the room, to quicken the drying and take off the damp chill.

All children under four years of age (and as much later as the habit can be enforced) should be persuaded to rest on returning home from a walk—the little ones to sleep, and the older ones to read books or look at pictures, whilst in a recumbent position.

In the meanwhile, the nurse should wash and dress herself thoroughly in another room, if she has been prevented from doing so in the earlier part of the morning. Whilst the children are taking their morning nap is the best time for the nurse to do any little work not suitable to the nursery. Before leaving the room, however, she should take every precaution to prevent accidents, by the children falling out of bed, playing with fire, or what not.

In order to leave no inducement to the children to lie awake in their beds, the nursery blinds should be drawn down during the morning hour of slumber. All toys should be put out of sight, and the apartment made to appear as little suggestive of play as possible. In the

waking hours of children the reverse should be the case. The more the floor is bestrewn with toys, and the more nursery litter is about, the more happy the place is to its infant denizens. A skilful nurse will know when to enforce habits of order, and when to give way to a natural inclination on the part of children to create confusion.

The seeming love of disturbance and destruction shown by all healthy children should not be too seriously regarded. The impulse springs from a desire to test bodily strength and to acquire knowledge. It needs guiding, not checking. If improper things for these purposes are placed within the reach of children, the fault is not theirs. The sole good of an article to a child's comprehension is the use it can be put to. They know nothing of the value of the presents well-intentioned friends make. All that children think of is the amount of pleasure a toy can be made to yield; and, for all practical purposes, a fine horse, stripped of saddle, mane, and tail, reduced, in fact, to a mere block of wood—or a beautiful doll, denuded of fashionable attire, and converted into a bundle of rags, answers the purpose, in their degraded state, more effectually than in the original condition. At the same time, little children should not be permitted to commit ruthless destruction on works of art, for of such a nature toys, now-a-days, are. On the contrary, gifts of the kind should be treated with respect by those in charge of the children, and should not be sent into the nursery to share the fate of common toys. There should be toys too good for every-day use, just as there are Sunday clothes. Some restraint should be imposed in the use of such pleasures; and when the gratification of handling them is at an end, the precious treasures should be put carefully aside. Expensive toys may thus be made to serve a double purpose—pleasure in their use, and admiration of their structure.

ODDS AND ENDS.

To clean Furniture.—The cleaning of furniture should depend on the mode in which the furniture was originally polished. The method at present most generally adopted is French polishing, and in such case a little spirits of turpentine should be employed, which will clear off grease and dirt without softening the varnish; it should, however, be rapidly done. If the furniture was originally polished with furniture-paste—composed of bees'-wax dissolved in spirits of turpentine by means of heat, and a little copal varnish, or resin (finely powdered), with a little Indian red added—it should be renovated by the same composition. In the case of furniture polished with oil, renovating (commonly termed cleaning) should be effected by means of linseed oil, slightly coloured by a little alkanet root, which dissolves in oil aided by slight heat.

To clean Dirty or Stained Furniture.—If the furniture is in a bad state, but not stained, it will be sufficient to cleanse it by well washing with spirits of turpentine, and afterwards polishing with linseed oil coloured with alkanet root. When, however, the furniture is stained or inky, it should be washed with sour beer or vinegar, warm; afterwards rubbing the stains with spirit of salts, rubbed on with a piece of rag, which will remove all the stains. The wood may then be polished, either with linseed oil coloured with alkanet root, or with bees'-wax, dissolved in turpentine, with a little copal varnish or resin added.

To render New Mahogany like Old.—This is of service in the cases of furniture repaired, or when lacquered handles have been changed for mahogany ones. Soap and water will darken to some extent; but if darker is required, use oil; or for very dark, lime-water.

To clean Lacquered Brass-work of Furniture.—Wash in warm water, using a soft rag. If the work will not clean by this means, it must be re-lacquered.

To make Coloured Drawings or Prints resemble Oil-paintings.—This is a favourite plan of treating pictures, as it gives them a showy appearance, and prevents their requiring glasses. Wash over the drawing or print with a solution of isinglass, and when dry, apply with a very fine soft brush a varnish, composed of two parts of spirit of turpentine and one of Canada balsam, mixed together.

Asphalte for Garden-walks, Fowl-houses, Sheds, &c.—Having laid the walk quite even, and beaten it firm, pour upon it a coat of hot tar; while hot, sift thickly all over it road-dust or cinder-ashes. When cold, repeat the same process several times, and a good, hard, durable, and wholesome flooring will be effected. It is particularly recommended for the purpose of fowl-houses, as being very healthy to the stock.

To sharpen and temper Saws and Edged Tools.—Many good saws have been spoiled by persons attempting to sharpen them without sufficient knowledge of how to do it. A file should be run along the edge of the teeth until they range evenly, after which the blade should be laid on a smooth leaden surface, and a moderate rap given on every alternate tooth by means of a square steel punch and a hammer, turning the blade then on the other side, and repeating the process, taking care to see that the teeth are equally set. This done, the teeth may be sharpened by the file, beginning at the handle-end of the saw-blade. The file should form, with the saw-blade, about two-thirds of a mitre angle, and be held at an opposite inclination for every alternate tooth, each tooth being brought to a good sharp point. In good tools the quality of the steel is alike throughout. It is desirable to observe, in purchasing tools, that they be rather too hard than soft, as the temper will become reduced by wearing. To temper a tool:—Having brightened its surface, melt sufficient lead to immerse the cutting part of the tool, into which place it for a few minutes, until it becomes hot enough to melt tallow, with which rub it, and then replace it in the melting lead until it becomes of a straw colour. Should you chance to let it remain until it turns blue, rub it with tallow and let it cool: then repeat the process. Should you, after this operation, find the tool too soft, repeat the process without using tallow; and when at the temperature above directed, plunge it into very cold water, or vinegar and water. A saw may be tempered in the same way, but it requires to let it remain a little longer in the metal, until beginning to become blue; as, in this condition, steel is more elastic and sufficiently hard.

To repair Broken Walls.—Mix with water equal parts of plaster of Paris and white house-sand, with which stop the broken place in the wall.

To clean Looking-glasses.—Having dusted the glass with a soft duster quite free from grit, in order not to scratch the glass, sponge it with diluted spirits of wine or gin, and dust over it a little very fine powder through a muslin bag; rub the glass, with a light hand, with the soft duster, and finish off with a soft piece of silk, or old handkerchief.

To clean Stone Steps and Stairs.—Where there are large flights of stone steps and flagged pathways, the process of cleaning is a long and tedious one. The common method of cleaning with hearthstone, or caked whitening, not only gives a smeary appearance, but washes off with a shower of rain. The preparation which we here give not only has a great preference in appearance, but in the long run saves labour; as with it twice a week is sufficient for whitening, and the remaining days washing will be found sufficient:—Take a gallon of water, and colour to the intensity of deep-coloured blue water with stone-blue. Boil in it a pound of white size, and dissolve in it a quarter of a pound of whitening and three cakes of pipe-clay, stirring it well about. Wash over the steps with this solution in a slight, quick manner, and afterwards finish with clean water in the usual way.

HOUSEHOLD DECORATIVE ART.

FRET-WORK AND CARVING IN WOOD (*continued*).

Staining.—It is sometimes necessary that carved wood should be stained, but it should never be resorted to without sufficient reason; generally, the work looks better when the natural grain is shown, and the attempt to make one kind of wood look like another is commonly bad and false taste. There are, however, exceptional cases, and it is always allowable to heighten the effect of the natural grain by giving it a deeper tone. A good stain in ordinary use with amateurs, for the latter purpose, is made by grinding burnt umber with beer, adding lampblack to produce dark shades. Enough should be mixed at one time for the whole article or set of articles to be stained, as it is not easy exactly to match the shade afterwards. The mixture should be applied with a brush, and the bottle frequently shaken. The wood should be brushed while still wet, in the direction of the grain, to equalise the tint and to keep the wood smooth, as all stains have a tendency to loosen and raise the fibres. Bichromate of potash, weakened with water to the desired tint, will answer the same purpose; but, as it stains the fingers, care must be taken to put it on with a brush.

New oak may be made to resemble old by exposure to the fumes of ammonia, or by brushing over with vinegar, in which pieces of rusty iron, such as old nails, &c., have been placed for a few hours. Care must be taken to dilute this solution sufficiently, since, if it is applied too strong, it will turn the wood black.

If it is desired to make wood *perfectly* black, in imita-

tion of ebony, a strong decoction of logwood chips should be brushed over it two or three times, and, when it is dry, vinegar with iron rust as above. This will give a most complete black.

Various prepared stains for wood are advertised and sold, and the receipts which might be given for making stains are endless; the above are, however, those which are likely to prove most useful.

Polishing and Varnishing.—Whenever it is intended that the work should be polished, it must be done before making up, as afterwards it would be impossible to rub all parts equally. Varnishing is better done after making up. Fret-work, when not carved, generally looks best polished, and delicate fret-work should often be mounted on polished panel; but carving should be varnished, since its irregular surfaces will not admit of the rubbing necessary to produce a good polish. As polishing can only be done on the

face of the work, there will be many parts in fret-work which cannot be reached for rubbing, and which must therefore be varnished.

For applying French polish, a ball of wool should be made, and covered with linen; this should be moistened occasionally with a single drop of olive oil, to

make it slide freely, and the polish rubbed with it, in a circular manner, over the wood till it shines. After leaving for a day, it should be polished a second time, and finished by rubbing with a little spirits of wine. For varnishing, use the best oak varnish, and apply it lightly and evenly with a soft brush.

The ebony stain will require to be polished with bees'-wax and turpentine. Dissolve bees'-wax in turpentine by setting it in a hot place, and apply while warm with a

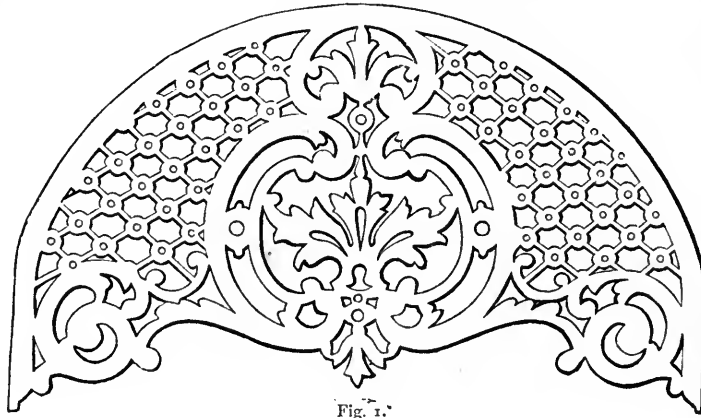

Fig. 1.

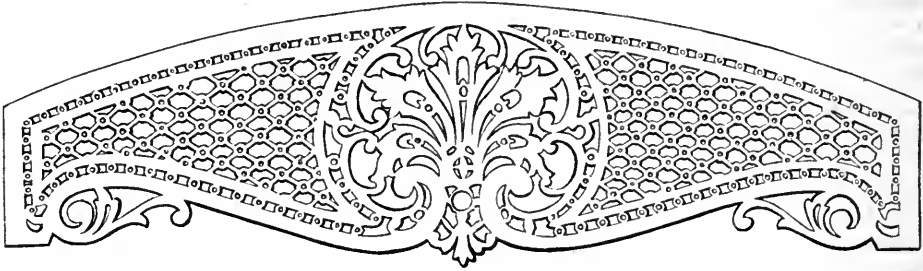

Fig. 2.

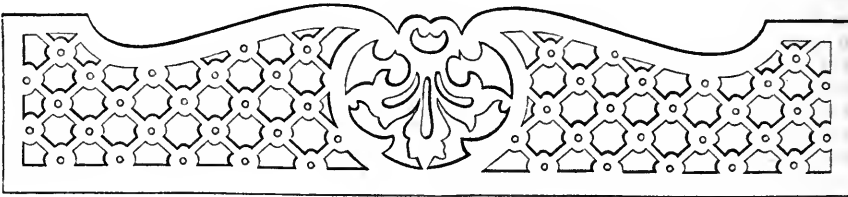

Fig. 3.

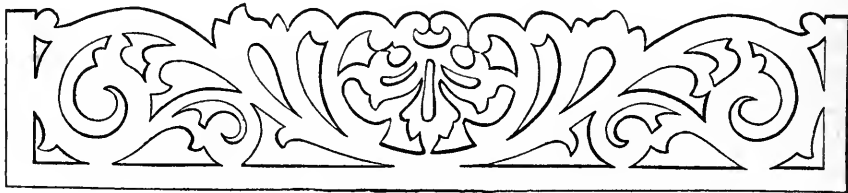

Fig. 4.

brush ; it must be rubbed till it shines, which will cost some little time and exertion.

With the present and succeeding articles will be given a number of designs for ornamental fret-work borderings. They will be found simple and interesting things to cut, and can be applied to various uses. In Fig. 5 we show a what-not, and in our next number will be represented a set of hanging book-shelves decorated with some of them. Any of the series may be used on these or similar articles varied to taste. Worked on a larger scale, cornices might be formed of them to go over window-curtains, and in fact they are applicable to a variety of uses.

In the what-not and book-shelves we have introduced twisted shafts, which have always a rich effect in combination with fret-work or carving. They are most frequently made by turning in a lathe ; but if the amateur does not possess a lathe, and wishes to make them, he may do so in the following manner :—From a square piece of wood (for these articles it should be from one and a-half to two inches square) cut off the corners of that part which is to be twisted with the chisel, and plane so as to bring it to a regular octagonal shape, and repeat this operation so as to make it sixteen-sided ; this, when the edges are smoothed a little with rasp and file, will be near enough to circular for the purpose. Then take two strips of paper, each of half the diameter of the wood ; thus, supposing the latter to be two inches thick, each strip of paper should be one inch wide ; twist them spirally round the wood, side by side, and secure them at every turn with drawing-pins. Having done this, paste *one* of them securely to the wood ; the other may then be removed. The wood left exposed must now be cut away with a gouge of suitable size, to a depth of one-half in the centre, and one-quarter its width at the outsides. The edges of the portion covered with paper must be rounded off with a chisel, and when the whole has been smoothed with the rasp, file, and sandpaper, a twist will be formed, if the work is done neatly, not inferior in appearance to one turned in a lathe, and with little more outlay of time or trouble. Any remains of angles left by the original shaping of the wood will be effectually cleared away by the amount of filing and sandpapering the twist will have to undergo in finishing. Twists look much better in oak than in other woods.

In the above fret-work bordering, as in all fret-work cut in thin panel, it is probable that the amateur may find himself inconvenienced by a tendency in the wood to warp. If it does so, the panel should be exposed with its *convex* side to the sun, or to the fire at a moderate distance, till it resumes its original plane surface ; or the *concave* side may be slightly damped and the wood pressed for a day or two.

All the examples we have given are simple, and suited

to those who have not acquired great skill in the art ; and as these lessons are intended for beginners, we do not propose to give difficult and elaborate designs. We should rather advise the amateur who finds that he can execute an ornamental design from a given pattern in a satisfactory manner, to exercise the skill he has acquired in working out his own ideas, and in the imitation of nature ; thus he will find far more interesting than copying from any examples, however excellent. If he goes to nature, he will find no want of admirable subjects for his chisel ; leaves, fruit, and flowers he will find the most easily represented of natural objects, and the most readily converted to the purposes of decoration ; next to these still life (dead game,

birds, &c.), which can be formed into admirable groups for panels (as for sideboard-doors) and other purposes. Birds look especially well in wood-carving, the loose texture of feathers being well adapted to be shown in this material. After these come living animals ; while the most difficult of all is the human figure.

In dealing with the human figure in wood-carving, the amateur will do well not to trouble himself with those niceties of anatomical accuracy which are needed in the higher branches of sculpture. In this material they may be discarded for the sake of picturesque effect, and play of light and shade. Rustic figures and grotesques, which are scarcely admissible in marble, are generally the most attractive subjects in wood.

To facilitate his labours in the higher branches of carving, the amateur is earnestly recommended to avail himself of our lessons in clay modelling, and to acquire some little knowledge of that art. He will find it of far more practical use than drawing, in the arrangement of his compositions, as it will show the actual forms he intends to carve. Whatever is done in carving must be done at once and for ever ; no experiments can be tried, and no errors in composition rectified. It is, therefore, of great importance that he should be able to judge of the effect of the work by making a clay sketch before-

hand ; in this material the shape can be quickly moulded, and alterations and additions readily made.

HOW TO GET RID OF SMOKE, AND MANAGE FIRES.

A "SMOKY house" is a proverbial evil too common to need description ; but the abatement of the nuisance depends upon so many circumstances as to render it a matter of difficulty in most cases. The remedies are sufficiently numerous, but the success results from the means being adapted to the particular object in view.

Smoke, we need hardly explain, arises from the imperfect combustion of coal, so that we lose great part of the

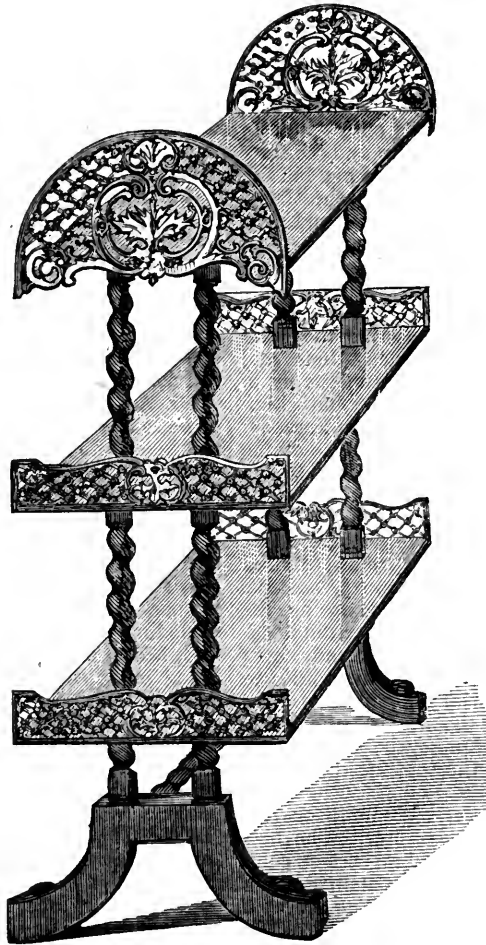

Fig. 5.

heat from the unconsumed coal being sent up by the draught of air in the form of soot and smoke, or what are familiarly called "blacks." Thus, not only is smoke a nuisance, but a sad waste; and the question naturally arises, Can we avoid the smoke of the domestic hearth?

Evidences of the above evils are common within and without doors. If we look at any fracture through which a draught penetrates, a cracked window, or a shrunk skirting-board, we shall find that the edges are ragged, with a fine fringe of soot pointing towards the fire-place. This fact alone is sufficient to prove that the air is charged, both inside and outside our houses, with a vast amount of infinitely divided carbon. The effect upon plants is still more striking. The palm, which best throws off its covering of soot, is the only tree which flourishes in London. Blooming geraniums and rose-trees in the balcony will, in a month's time, consist of smutty stalks and melancholy flower-pots. If vegetation grows black, what shall we say of fabrics of all kinds, furniture, &c., which have not any capacity to throw off this sooty sprinkling? Families, who have a town and country experience, have only to compare their washing bills to perceive how enormously a residence in the latter decreases the cost of washing. The loss to Londoners from this source alone must be very large.

Chimneys are powerful ventilators, if properly constructed, as may be shown in a few words. Suppose the fire to be lighted, a warm current of air soon rises in the chimney, the draught of air generally entering the room by the open door, or the crevices when door and window are shut. If the chimney smoke, the supply of air is defective, or the flue may be too small; but chimneys are almost invariably too wide. Professor Faraday, in his lucid manner, thus explained the advantages of the open coal fire and the chimney in comparison with the stove and flue. Thus, a parlour grate will consume in twelve hours forty pounds of coal, the combustion of which renders 42,000 gallons of air unfit to support life. Not only is that large amount of deleterious product carried away and rendered innocuous by the chimney, but five times that quantity of air is also carried up by the draught, and ventilation is thus effectually maintained. Since the ascent of smoke up a chimney depends upon the comparative lightness of the column of air within to that of an equal column without, the longer the chimney the stronger will be the draught, if the fire be sufficiently great to heat the air; but if the chimney be so long that the air is cooled as it approaches the top, the draught is diminished.

Many attempts have been made, with more or less success, to consume the smoke from coal fires. The best grate for the purpose, as also for the more perfect combustion of the coal, was the Cutler Stove, patented about 1813. It was constructed with a thin plate bottom, instead of a grating, and which, being made to rise and fall by means of a spindle and two chains, when lowered, it formed a box capable of containing a supply of coals for twenty-four hours. The fire being lighted on the top of the coal, the heat caused it to emit the gas, and supply the fire above it, *as an oil-lamp would do*. Thus, the gas having to pass the fire previous to its ascending the chimney, the greater part of it was consumed, and very little smoke could pass up the chimney. The same improvement has been applied to the common stove, by having it filled with small damp coal, and the fire made at the top, which was economical, and required little attention, it being only requisite to raise the coals slightly to increase the fire.

Here are the instructions to make this smokeless fire, as given in the *Builder*:—"Clean out your grate; cover the bottom with a sheet of paper, cut out or folded to fit; place the coals in the grate to the level of the top bar, keeping the larger ones to the front, to prevent waste.

Light your fire on the top, and allow it to burn downwards, undisturbed. An ordinary fire, prepared and lighted in this way, will, according to the size and form of the grate, burn six, eight, or ten hours without any removal of coal, burning brighter and warmer than if lighted from below, as fires are ordinarily made. The coal should be tolerably equal in size, something like Macadam stone; place the large to the front, the small to the back. The paper is put in the grate to prevent any air rising through the bottom bars. The fire is lighted on the top, and made to burn downwards, to prevent rapid combustion, and to keep the heat on the surface of the coals, cinders, or coke; and, if undisturbed, the combustion will be so complete that there will be no waste ashes. The grate must be cleaned each morning, and the paper must be renewed on the bottom of the grate when the fire reaches the lower layer of coal. The writer and his friends have made their fires as described for some weeks, and can vouch for 'the saving of coal,' the cheerfulness, and warmth, and freedom from smoke. The grates in which this fire was made were not so dirty nor so difficult to clean as formerly."

Dr. Arnott's patent grate is constructed on this plan. It is estimated that in a common fire, with a large open fire-place, five-sixths of the heat passes up the chimney. By contracting the throat of the chimney, the draught becomes so as to permit of making an opening into the chimney from the upper part of a room without the risk of it smoking; and by this arrangement of Dr. Arnott, a more perfect ventilation is obtained than by any other means.

Dr. Arnott maintains the advantages of this new fire-place to be—1. Chimney-sweeping can scarcely be wanted, for there is no soot. 2. Chimney-flues without soot cannot catch fire; and if fire were in any way produced, shutting the hood-valve would extinguish it. 3. The huge evil of smoky chimneys would cease. 4. The occasional sudden rush of air towards a hot wide chimney when the door is opened, and which carries readily the light muslin of a lady's dress towards the grate, and inflames it, cannot happen with this grate. 5. The danger of sparks from exploding pieces of coal thrown on the carpet does not exist here. 6. The chimney-valve, by its powerful ventilating effect, obviates all objections to the use of gas-lights in houses, thus leaving their beauty, cleanliness, cheapness, and many conveniences unmarred. Explosion from accidental escape of gas in a room or house cannot happen where there is the ventilating chimney-valve, for cold gas entering a chimney-flue produces a more powerful draught than hot air does. 7. The change of any existing grate of an old fashion into this is easy, and little expensive. 8. Any kind of coal or coke may be used in this grate, even the small coal or coal-dust, which is very cheap. In this stove, there are in the piston-rod notches to admit the point of the bent poker, and the ratchet-catch supports the piston at any desired height, when the lever is withdrawn.

It is not our purpose here to enter into any account of the different smoke-consuming furnaces which have been patented, and it will be sufficient to state that the principle of all those in general use is the same. By the action of movable furnace-bars, a thin layer of coal is continually pushed under the fire, and of course all the smoke has to ascend through the incandescent mass, and is consumed in its passage.

The heating of the hall is sometimes economically effected by the dining-room fire, which fire-place, at the sides and back, consists of fire-bricks or slabs of three inches thick, which, when red-hot, contain a great heat; and at the back of which, in the wall (next the hall) is a kind of hot-air closet about a yard square, and five or six inches deep, as the wall will admit; and at the bottom of this closet is an air-brick to let in the cold air, and at the

top is another to allow the hot air to escape into the hall. In the present instance, the library is also similarly heated by the kitchen fire, and the plan would admirably suit a green-house, where it could be applied. The above was so constructed when the house was built.

What is often called fog, which darkens London in winter, is in reality the smoke of countless coal-fires, which are much increased in very cold weather. To prevent this has been adopted this simple plan: before you throw on coals, put all the fire to the front of the grate towards the bars, fill up the cavity at the back with the cinders or ashes which will be found under the grate, and then throw on the coals. The gas given out in the process of roasting the coals will then be absorbed by the cinders, and render them, in an increased degree, combustible. The smoke will thus be burnt, and a fine, glowing, smokeless fire will be the result. This rule should be enforced from the kitchen upwards.

Coke is often substituted for coal for the avoidance of smoke, and it makes a fine clear fire; but coke is not so economical as is generally supposed. It is true that a pound of coke produces nearly as much heat as a pound of coal; but it is equally true that a pound of coal gives only three-quarters of a pound of coke, notwithstanding the latter is more bulky than the former. The fumes of burning coke are, however, very pernicious, and have been known nearly to cause suffocation, as the noxious vapour could find no egress.

Coals require much circumspection in their purchase. Many years ago five-sixths of the London public were supplied by middle-men, or "brass-plate coal-merchants," whereby the prices were increased by the amount of their commissions, which was just so much loss to the consumer. The weight should be watched. Dr. Kitchener, whose father was a coal-merchant, tells us that in weighing different kinds of coal, there was the surprising difference of thirty pounds in the weight of two sacks, which were equally well filled.

HOME GARDENING.

THE CHARDON (*continued*).—THE CAULIFLOWER.

The *Chardon* is propagated by seed, which should be sown in a bed of light earth, moderately thin, and raked in evenly; and as soon as the plants are well up, they should be thinned out to five or six inches apart in every direction, in order to allow them room to strengthen for transplanting. In about eight weeks' time after sowing, prepare a piece of ground in an open situation, by manuring and digging it well; then, taking advantage of a rainy day, lift the plants, trim their roots and any long straggling tops of leaves, and insert them, either in drills or on the level ground, in rows at least five feet apart, and four feet and a half asunder in the rows. They must be watered immediately after planting, and the operation repeated occasionally, until such time as they have made fresh root. Hoeing about the plants will be likewise necessary, in order both to loosen the soil about the roots and to cut down weeds. In August, September, and October, the plants will have advanced in growth considerably, that is to say, they will have attained the height of three or four feet, and then it will be necessary to earth them up. In performing this operation, we adopt the plan of tying up the leaves of each plant with bass, and afterwards to dig and break the surrounding soil well, and place it close round each plant a foot or more up the stem. As the plants advance in growth, continue to tie and earth them up accordingly, giving them their final earthing-up in October. If the weather be dry in August and September, they must be regularly watered—a precaution that will prevent their going to seed. Provided you have paid proper attention to them by blanching them from a foot

and a half to two feet or more in height, they will be ready for use, and may be dug up as wanted, any time in autumn as well as throughout the winter till spring. It will be necessary to protect these plants, in the event of severe frosts occurring, either by taking them entirely up and turning them down on one side, or covering them with a good thick layer of dry litter as they stand. Those desirous of saving seed, should leave a few full-grown plants in the spring, which will soon shoot up and produce seed in the autumn.

The Cauliflower.—This is not only the most delicate, but the most esteemed of the cabbage tribe. The flower-bud forms a firm, close, white head, which, when boiled, is, as regards flavour, second to no other vegetable. Of this much-admired edible there are several varieties and sub-varieties; but the principal sorts cultivated are the early white for the first early crops, the large or later for chief early and main crops, and the *Walcheren*, which, in our opinion, is the very best in cultivation. The various sorts are raised from seed, which should be sown on a light but not over-rich soil; and for a bed ten feet long by four wide, half an ounce of seed will be required. Sow at three different times; namely, for the first, or early and general summer crop, make a considerable sowing about the last week in August, and do not transplant them until the middle or end of November, or just before hard frost is apprehended. The situation best suited to them is one under a wall with a southern aspect, and the ground, as we have said before, not over-rich; and if they take hold before frost comes, they will stand the winter without any other additional shelter than the wall. Plants thus treated always make much the largest and best cauliflowers during the summer, though they certainly do not come to perfection quite so soon. Cauliflower plants are frequently killed with kindness, or too much attention, and, when thus treated, seldom or ever do any good. Those desirous of having them in a little earlier than usual may adopt two methods: namely, to plant a few in small pots and place them under a frame, or in some convenient part of a vinery or other glazed house, until the middle of March, when they may be taken out of the pots, and planted, with their balls of earth entire, into the open ground, and covered for a short time at nights with hand or bell glasses. The distance at which the plants should stand is two and a half feet every way. The second method is to select the seed when ripe, taking that produced by the flower-stem, and sowing it by itself, and the plants from this seed will come into flower a fortnight sooner than those produced from seed of the laterals. This, however absurd it may appear, is absolutely the case, which we have proved by repeated trials, and this may be considered the case with the whole of the *Brassica* tribe. This crop will commence flowering in the end of May, and be in full perfection in June. For a late crop, to succeed the early or main summer crops, sow some of the large or later sort about the latter end of February or beginning of March, under frames, or hand-glasses, or a border of light and rich earth; and as soon as the plants are large enough to handle with safety—that is to say, when they have leaves an inch broad—prick them out into other beds of the same description, and at the distance of three inches asunder in every direction. Here they must stand until the end of April or beginning of May, at which time they will be strong enough to remove into their final situation in the open garden. If the weather should prove unfavourable at the time of sowing, as may be expected at this early season, a moderate hotbed should be prepared; and after setting on the frame, the bed should be covered, four or five inches thick, with light and rich soil, and the seed sown pretty thick, and as soon as the plants are well up—that is to say, sufficiently large for transplanting—they may be pricked out under another frame, but without heat, to gain strength for the open air.

HOUSEHOLD AMUSEMENTS.

KITE-MAKING AND KITE-FLYING (continued).

Fancy Kites.—The most appropriate form for a fancy kite is, of course, that of a bird, but it is far less easy to

The natural form of a kite is often taken as a model for the artificial structure which bears its name, and kites made of coloured cotton are sometimes used by sportsmen, to keep partridges and other birds of which they may be in pursuit from flying beyond range of gunshot.

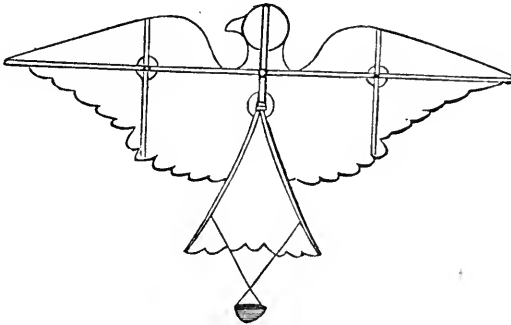

Fig. 1.

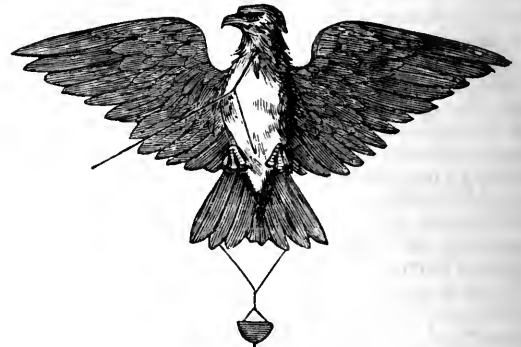

Fig. 2.

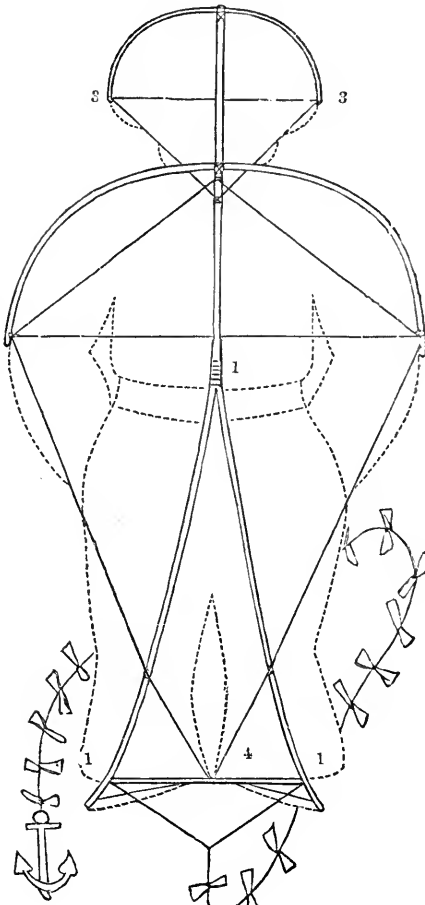

Fig. 3.



Fig. 4.

make a good bird kite than either of the plain forms previously described. Still, with care and patience, no great difficulty will be found in the matter. The chief thing to bear in mind is that the framework must be light, and at the same time present a sufficient expanse of surface to offer full resistance to the wind, and be readily borne up.

With boys, however, the eagle is a more popular form, and this is therefore chosen for illustration. The method of making is much the same in any case, and our description will serve as a guide, whatever may be the exact shape required.

The best plan of procedure is first to take some calico or coloured cotton, and draw an outline of the bird, being

careful to extend the wings to a sufficient width to support the framework in the air. The illustrations, Figs. 1 and 2, will be a guide to the general proportions. Leave an ample margin for turning over the lath and wire of which the framework must be made, before you cut the calico to the figure you have drawn upon it, and do not be particular as to details of the feathers, &c., until you proceed a little further. Having formed this general outline of the bird, stretch it upon a table, and adapt your framework to it. Commence by making the backbone, for which you must take a cane of the necessary length, and split it about half way up, the split portion being spread out to form the tail. At the point where the cane is divided, bind it securely to prevent the split extending farther. Then take a bit of wire, bending it so as to represent the ends of feathers, and extend the severed portions of the cane to the width required for the tail. The mode of proceeding in all these details is indicated in our first illustration.

You now require a strong, but not heavy lath, as long as the entire width of your kite; this is to form the cross-piece, and is bound to the cane at its junction with it, a little above the point of division for the tail. Two pieces of split cane are then attached to the lath transversely, about the middle of each wing. Finally, you have to form the upper and lower edges of the kite with bent wire, which must be securely fastened at each point where it comes in contact with the rest of the framework. The head and beak are formed in a similar way.

The framework being adjusted, one side is pasted all over and laid upon the calico, the edges of which are then pasted down carefully upon the wire. The kite must now be laid aside to dry, and when it has become so, the surface is painted to represent the colours of the body, feathers, &c. This need not be done with very great nicety, as the general effect at a distance is all you have to study; the details are of course lost when the kite is flying in the air. The kite should now look something like the figure in our second illustration. The tail, with which it is flown, should be made of the little calico cups described in our last paper, and attached in the manner shown in the figure.

Many other forms besides those of birds are occasionally adopted for boys' kites. The *sailor kite* is not more difficult to make than the one last described; but, unless it be formed of light material, well balanced, and steadied by a tail of good length and proportionate weight, it will not be very easy to get it to soar upward in the air. We give here back and front views of a sailor kite, the mode of making which will be easily understood from the diagrams, Figs. 3 and 4, and the instructions already afforded.

A kite which will mount well with a gentle wind may become unsteady in a rougher breeze, and hence, a first unsuccessful trial in ascent must not be taken as conclusive evidence of failure. Defective balance, as we have previously explained, will cause a kite to pitch. If this cannot be rectified by scraping the lath or cane on one or other of the sides, the fault may be adjusted in a little more weight being added where required, by additional pastings of paper. The length of the tail is important, and must be fixed by repeated trials, if the first hit is not successful. Usually it is necessary to have the tail from eight to twelve times the length of the kite, according to its character and the intervals between the twisted paper or little cotton bags with which the tail is formed.

A good stout string is required if the kite is large and intended to be flown to any considerable elevation. If the string is too weak, the force of the wind will cause it to snap when the kite begins, as boys say, to "pull," which, in a rather strong breeze, it may do so heavily that a boy can scarcely hold a kite that stands as high as himself. When a kite is in the air, much amusement may be afforded by sending "messengers" up to it. These are formed of circles of paper passed over one end

of the stick on which the string is wound; and the wind takes them gradually up the string until they reach the kite's face. The stick should be dropped from the hand and the string allowed to slip freely through the fingers as the kite ascends. In bringing it down again, the stick should be held firmly in one hand, while the other winds the string steadily upon it.

COOKING.

VEAL.

CALF'S-FLESH, as the Germans call it, has a double merit—it affords excellent dishes in its pure and simple state, and is also the canvas on which cooks can embroider almost any culinary design they please. Different countries vary much in the age at which they customarily kill their calves. For ourselves, veal slaughtered too soon—the "staggering Bob" of some English counties—is simply detestable. Rather than eat it, we should prefer to abstain from meat. The poor creature has not had the time to acquire either its palatable or its nutritive qualities. While heartily joining in the triumphal strain of "Oh, the Roast Beef of Old England!" we would add to it the rider, "Oh, the Veal of France!" Certainly, we have good veal in England—it would be a wonder if we had not—but, in our humble opinion, they have better in France, because they let it live a little longer; it is fine, fat, and, at the same time, delicate.

For roast veal, the parts preferred are the fillet (thigh), the loin (with the kidney), the shoulder, and sometimes the neck.

Have the bones of the loin chined at their junction with the backbone, to save the carver trouble. Before actual roasting, you may lay it on its back in the latchpan, to let the kidney get *well* warmed through; otherwise, when the *meat* is done enough, the kidney may still remain underdone. On putting it to roast, baste first with butter; the kidney fat afterwards will give some help. When done, lay the loin of veal, dry, on a hot dish; serve the gravy in a sauce-boat, and send up lemon to squeeze over the portions helped by those who like it.

The kidney may be served in its place in the loin, or, if large, and suspected to be a little underdone, it may be sent up *immediately after* the roast, thus:—Have ready slices of toasted bread, a very little larger than the kidney is thick. Cut the kidney, fat and all, into slices three-quarters of an inch thick. Lay each slice of kidney on a slice of toast; pour over each half a dessert-spoonful of gravy and a squeeze of lemon-juice; dust moderately with pepper and salt. Set them for a few minutes in your cooking-stove oven, or else under a hot salamander, and serve.

Roast neck of veal is simply chined at the joints, and roasted as above, with *plenty* of butter to baste it at the outset.

Roast shoulder of veal makes a handsome dish stuffed. Pass the blade of a sharp-pointed knife between the upper surface of the blade-bone and the meat, so as to form a pocket. Fill this with the stuffing given below. If the joint is put to roast with this opening *upwards*, there is no need to close it artificially.

For veal dressed in any way—roast, boiled, fried, or stewed—there are few more acceptable accompaniments than

Fillet of Veal, English Way.—By "fillet," with veal, is generally understood a handsome cut from, and across, the best and thickest part of the thigh. Take out the marrow bone in the middle—it will help to make soup or stock for gravy—fill the vacant place with as much as you can make it hold of

Veal Stuffing.—Into a bowl grate crumb of bread; add thereto the rind of half a lemon, some beef or veal suet,

some parsley and thyme, all chopped very fine. Season with pepper, salt, and the juice of the half lemon. Break into the mixture one or more eggs, so as to make the whole into a stiff paste. You may vary the stuffing by the addition of sausage-meat and chopped mushrooms when handy. Your fillet being stuffed with this, bind it with string into a shapely lump, and set it before the fire to roast. Put a lump of butter into the latchpan; when melted, baste the veal with that; dredge it with flour and baste again. Continue basting till it is done enough. Remove the string; lay the veal on a hot dish; serve the gravy separately in a sauceboat, and send up a lemon with it for those who like to make use of the juice.

Fillet of Veal, French Way.—Trim the fillet into handsome shape; lard the upper surface and sides all over with thick strips of bacon. [If you have no larding-pin, or do not know how to use it, cover the veal with thin slices of bacon instead.] Sprinkle it with pepper and salt and a little chopped parsley. Cover the bottom of a stewpan with two thin slices, one of bacon, the other of ham. On these place the fillet of veal; surround it with a fair quantity of carrots and onions, and a bunch of sweet herbs; moisten with a pint of broth or stock; lay another slice of bacon on the top of the veal; put on the lid of the stewpan, and stew it by a gentle fire, with burning charcoal on the lid, if convenient. When the veal is cooked, in another stewpan brown some flour in butter; dilute with broth and a little white wine; add to it the gravy from the veal, after passing it through a strainer. Taste if this sauce is seasoned to taste. Serve the veal and the vegetables on separate dishes, each covered with a portion of the sauce.

N.B.—English fillet is carved by slicing it *horizontally*, giving each person a portion of stuffing; French fillet, by cutting it across downwards, and sending round the vegetables and sauce.

Stewed Brisket of Veal.—The breast of veal consists of two portions: first, the long bones, which may be either roasted, with the sweetbread fastened to it, the whole covered with buttered paper to prevent drying-up and burning, and served with melted butter or mushroom sauce; or, it and the sweetbread may be boiled, and served with white sauce or oyster sauce. Secondly, the thick end, or brisket, which makes a very delicious dish thus prepared:—Cut the brisket across into small squares or pieces; put them into a stewpan, with three or four lumps of butter as big as walnuts, sliced onions, bay-leaf, thyme, pepper, salt, and (if permitted) a clove of garlic, cut small. Cover close with the lid and cook gently for a couple of hours (with fire above as well as beneath, if you have the means), stirring or shaking frequently. Ten minutes before serving, throw in a dessert-spoonful of chopped parsley; add a little *consommé*, if needed; let it have one good boil-up. Arrange the bits of brisket on the dish, and pour the sauce over them. You may garnish with slices of lemon and fried or toasted bread.

Brisket of Veal and Rice.—Set on the fire a quart of washed rice, in two quarts and a half of broth, including the cold fat which floats on its surface; season with pepper and salt. As soon as it boils, set the saucepan on the corner of the stove, and let the rice cook gradually. When done, butter the inside of a tall stewpan, or plain-shaped mould; line it with rice an inch and a half thick; fill the middle with brisket of veal, stewed as above, and a little of the thickened sauce, reserving the rest; cover the stew with rice, till the stewpan or mould is full. Cover it with the lid, and set it in a gentle oven, or set it on the hot hearth, and heap burning charcoal on the lid. Leave it there, watching that it does not burn, for half or three-quarters of an hour, to stiffen and consolidate. Then turn it out of the mould on a hot dish, and serve, accompanied by the rest of the sauce, heated up, in a sauceboat. It is less trouble to surround the dish with a wall of rice,

and to pour the stewed brisket of veal into the middle. In this case, the addition of curry powder to a portion of the stew will give you two distinct dishes—one, plain stewed veal; the other, veal curry.

Breast of Veal à la Marengo. (This is an imitation of the famous fricassee fowl *à la Marengo*, which fowl, however, should be previously fried *in oil*.)—Cut up your breast of veal into handsome pieces about two inches square; throw them into cold water for half an hour; take them out, drain them, and dry them in a napkin. Put a lump of butter into a shallow stewpan. When it is melted, put in the pieces of veal, some thin slices of onion, a little minced ham, some broth, pepper, and salt. Toss up these together over the fire. When the veal is cooked and nicely browned, add a dash of vinegar (or a few pickled mushrooms, if you have them), and serve. Done in this way, there will hardly be enough sauce to constitute a handsome-made dish, according to many people's tastes. If you wish for more, just before the pieces of veal are done enough, dust them with a little flour, add more broth and a table-spoonful of catchup; keep stirring till the cooking is completed. Arrange the pieces of veal on a dish; taste if the sauce is to your liking; give it a boil, and pour it over the veal. You may garnish with small bits of toasted bread.

Hashed Veal en Blanquette, as a White Fricassee.—Cut away from the bone the flesh of any cold roast veal, in shapely pieces; flatten them with the blade of your knife, and remove any brown or burnt bits hanging to them. Season them slightly with pepper, salt, and grated nutmeg. Put a lump of butter into a stewpan; stir in a little flour, without letting it brown; dilute with any good white broth or stock. You may add a little chopped parsley and onion, a slice of lemon-peel, and the juice of half a lemon. Mix these well together, and let them come to a boil. Take the stewpan off the fire; put in the pieces of cold veal, and let them warm through *without ever boiling*. When hot, you may pile them in the middle of a dish. You may then, if you think fit, thicken and improve the sauce by egg-yolks, butter, and a dash of vinegar. Make the sauce quite hot, pour it over the veal, and serve garnished with toasted bread.

Veal Liver Pâté (without Crust; to be eaten Cold).—Take as much veal liver as you are likely to want, and white bacon equal to two-thirds of the weight of the liver. Chop them together, and put them into a bowl. Season with pepper, salt, allspice, and parsley chopped small. Add chopped onion that has been browned in the frying-pan in butter, a slice of ham minced small, and three or four egg-yolks; mix all well together with a wooden spoon. Beat the whites of the eggs to a froth, and incorporate them with the rest. Line the sides and bottom of a stewpan, or metal mould, with very thin slices of bacon; then put in the minced liver, &c. Cover all with thin-sliced bacon, and put on the lid. Set it into a gentle oven, and let it cook gradually, but thoroughly. When done, take it out and let it cool; when cold, turn the pâté out of the stewpan, or mould, on to the dish on which it is to remain as a standing resource as long as it lasts.

White Puddings.—[These, the counterpart, and the contrast to black-puddings, are made with the white part of a calf's pluck, known as the "frill" (not the leaf fat), and by French cooks, as the *fraise*. In Paris there is an immense consumption of cocks'-combs and the so-called cocks'-kidneys. To meet the supply, artificial combs and kidneys are stamped out of this same *fraise*, and so cleverly executed as to deceive any but experienced observers. White puddings will not keep, but should be eaten as soon as made; they are good when you know the person who makes them, better if you make them yourself.] As soon as the calf is killed, the frill should be thrown into cold water, and kept there (changing it from time to time), till

wanted. The quarter of a frill will make a fair quantity of puddings. Boil it in salt and water; when cooked, set it aside to cool. Then chop small and separately the boiled frill, a large onion, and a bit of white bacon. Soak some crumb of bread in milk, and let it simmer on the fire. Set the onion and bacon in a saucepan over a gentle fire; when the onion is tender, mix with it the calf's frill, the soaked bread, a little sausage-meat, two or three egg-yolks, salt, pepper, and allspice. Stir well together, and taste if the flavour is agreeable. Put this into sausage-skins, so as to make small sausages; or wrap portions, equal to two tablespoonfuls, in veal or pork leaf-fat, so as to form flat cakes. Smear these with oiled butter or leaf-fat; dust them with bread-crumbs; broil them over a clear fire, or oven them (American or cooking-stove), and serve immediately, piping hot.

N.B.—White puddings, equally agreeable, can be made, by substituting for the veal frill some pig's frill, or even chitterlings (boiled, after *thorough and perfect cleaning*), and mixing with it any cold white meat, chopped fine—fowl, turkey, rabbit, or veal—which you happen to have. The preparation gives a little trouble; but it makes a nice variety, and is not seen on every table. Calf's frill is also prepared in a form called *andouillettes*, which will not only keep, but travel, and for which several French towns, as Tours and Troyes amongst others, have a reputation. These are best purchased ready-made.

Nouilles.—[Some cooks think these very grand, to give a finish to ragôuts and stews, to throw into soup, and to serve purposes for which vermicelli and macaroni are employed. We, therefore, indicate the way to make them. The trouble they give does not prevent their concoction, if they are worth it, which we are inclined to question.] On your pastry-board heap a pound of flour; make a hole in the top, and into it break half-a-dozen eggs; add a couple of ounces of oiled butter and a little salt; knead all well together. Divide the paste into six equal portions; spread each of them out with the rolling-pin till they are not more than an eighth of an inch thick; dust them on each side with flour, and lay them one above the other by threes; roll them together into two thick rolls. Cut these up into strips or strings, varying both in breadth and thickness. Have on the fire a pot containing five or six pints of boiling water. Pass the fingers of your left hand under the strips of paste, shaking them, to prevent their sticking together; drop them gradually into the boiling water, stirring it gently with the right hand with a wooden spoon, that they may not adhere to the boiler or to one another. After poaching in this way for seven or eight minutes, take them up with a strainer; throw them into cold water for a minute or two; take them out; put them to drain on a coarse cloth or sieve, placing them so that they do not touch each other. When dry, they are fit for use. Besides thread-like, and ribbon-shaped *nouilles*, make a few about the size and shape of scarlet-runner beans or small birds' eggs.

Nouilles, with Ham (A counterpart of Macaroni with Cheese).—Cut some ham into small dice, fat and lean together. Toss it, with some butter, in a stewpan, over a very gentle fire. Dilute with good broth. When mixed, put the *nouilles* into the stewpan; add another bit of butter, and a little grated cheese which is not strong in flavour. Mix altogether with a wooden spoon, taking care not to break the *nouilles*; serve hot, accompanied, if you like, by hot buttered toast and a little good mustard.

Maintenon Cutlets.—[These were invented by Madame de Maintenon, Louis XIV.'s "left-hand" wife, to please the king's failing appetite when he was advanced in age.] Take cutlets of the neck or loin of veal, not too small. Trim them neatly from skin, gristle, and the heel of the bone, and leaving the tip of the rib-bone fleshless, in order that it may be taken in the fingers. Put the cutlets and their

trimmings at the bottom of a stewpan, with lemon-peel, parsley, minced shalot or onion, any other sweet herbs (as thyme or marjoram) that please the taste, and a few bits of sweet bacon cut into dice. Pour over them just enough veal or beef broth to cover them; season with pepper and salt; close the lid well down, and stew them slowly (about an hour) till tender. Take them out, and set them aside to cool; they will then be ready for use; strain the liquor in which they were stewed, and set that aside. When the cutlets are wanted, oil or butter sheets of white writing-paper, as little glazed as may be; wrap each cutlet neatly and separately, and broil them over a very slow fire, otherwise the paper will burn. They take some time to get thoroughly hot throughout. Serve them, so wrapped in paper, arranged on a dish, garnished with parsley. For sauce, to be served separately, warm the liquor in which they were stewed; stir in with it a couple of egg-yolks and two tablespoonfuls of cream, never allowing it to come to a boil. Taste if salt enough. A little cayenne pepper may be added, if liked. Serve at the same time a lemon, cut in halves, to squeeze over the cutlets, when taken out of their paper, on each guest's plate. This is one of the dishes which has the advantage of being brought to a convenient degree of forwardness the previous day.

Fricandeau of Veal.—[For this preparation—a segment of veal, larded, stewed with bacon, carrots, onions, parsley, sweet herbs, and seasonings—we are indebted to the age of Leo X. Its inventor was Jean de Carême (John of Lent), who received that nickname in consequence of a celebrated *soupe maigre* which he composed for the Pope, his master. He was the direct ancestor of the famous Carême, who was cook first to George IV., and afterwards to Baron Rothschild. Leo X., luxurious and magnificent in his tastes, was far from narrow-minded in his patronage of merit. He fostered the genius of Raphael the painter, and encouraged the genius which could discover a fricandeau. We give an easy receipt from a sound authority.] Take a handsome piece of the leg, about four inches thick. Trim into it an oblong or oval shape; prick its upper surface with thin strips of bacon. Put it in a stewpan, together with the bits of meat trimmed away from it, a little lean bacon or ham, carrots, onions, bouquet of sweet herbs, whole pepper, and cloves. Moisten all with just enough stock to keep them from burning and sticking to the bottom; baste the meat frequently with its gravy. Have ready a purée of sorrel or some cooked spinach; spread a bed of this over the bottom of the dish in which the fricandeau is to be served. When the veal is thoroughly done, take it out of the stewpan and lay it in the middle of the sorrel or spinach, with the larded surface uppermost. Strain the gravy left in the stewpan (as the vegetables, &c., are *not* to be served with it, being used merely to give flavour), return it to the stewpan, and reduce it by boiling as nearly to a glaze as time will allow; then pour or spread it with a spoon over the veal.

Veal Cutlets, without Bone (an Elegant and Delicate Dish).—Take the best end of the neck of veal, cut out all the thick fleshy part entire, so as to have a sausage-shaped roll of meat; cut this across into slices a quarter of an inch thick; dust them slightly on both sides with flour, pepper, and salt. Fry them in butter to a nice light brown, taking care not to dry them up too much. When done, arrange them neatly and regularly on a hot dish. Dust a little flour in the butter remaining in the frying-pan, brown it, grate a little nutmeg, and add the juice of half a lemon; dilute with a tablespoonful of catchup, a glass of white wine, and, if required, a very little stock broth. Stir these well together, pour the sauce over the cutlets, and serve garnished with toasted bread. The bones and other remains of the neck of veal will stew down to broth or stock. If you do not think fit to take the neck for the purpose, you can slice the cutlets off a piece of the thigh.

SUMMER AND OTHER DRINKS.

Wholesome Water.—Spring, well, rain, river, pond, and ice or snow water are the ordinary conditions in which that liquid is presented to us. They are not always wholesome or fit for drinking. Many springs are too laden with either carbonate or sulphate of lime; many pools with decomposing vegetable or animal matter; many wells are impregnated by the soil in which they are dug, the strata through which they pass, the materials of which they are built, or by unhealthy infiltrations which escape from sewerage. Water for drinking should contain a certain quantity of air in dissolution. Ice and snow-water have none, and are therefore unfit both for drinking and as a medium for fish to live in. The air, however, may be restored by agitation. Thus, trout are found in streams that spring from glaciers, at no great distance from their source, because the water has been aerated by falling and being broken while leaping from rock to rock. It is curious that the air contained in water should hold more oxygen than atmospheric air; it explains why so small a quantity should serve for the respiration of fishes. Water, indeed, appears to have the power of changing the composition of the atmosphere. The air which enters into water at its conversion into ice, and which is separated from it by distillation, contains even a greater proportion of oxygen.

Easy tests of good drinking water are, that it readily dissolves soap without curdling, and that it cooks vegetables well, especially dry vegetables, as peas. Drinking water should be running, limpid, scentless, insipid (not flat or vapid), giving no sensation of weight when taken on the stomach, yielding but a slight precipitate to the nitrate of silver, the nitrate of barytes, and the oxalate of ammonia. Its temperature should not greatly differ from that of the atmosphere. The best is water which flows over a flinty or a granite bed, and whose source is *not* in calcareous ground.

Raspberry Vinegar added to water, in the proportions of a dessert-spoonful of the first to a tumbler of the latter, makes a most refreshing drink. It must not be kept in a metal vessel, as the acid would act upon the surface.

Artificial Chalybeate Water, for Weakly Constitutions that require Iron.—There is a constitutional weakness, called by medical men "anæmia"—that is, bloodlessness, from which young women are the principal sufferers. Tonics (especially iron), generous living, and pure, rather bracing air, are the usual remedies employed. When ferruginous waters are at hand, they are used, either alone or tempered with wine, as a daily beverage with great advantage. There are ferruginous springs, as the Spa waters, which enjoy a European reputation. Those who cannot travel in search of such springs may fabricate a supply at home. Take bits of old iron, such as a worn-out horse-shoe, broken up into four or five bits; or half a pound of new iron nails. Wash them clean from all dirt and dust; if you can expose them to the air during a dewy night, in a place where they will take a little rust without being defiled by blacks, your chalybeate water will be ready all the sooner. Put the iron, rusty or not, into a stone or earthen pot holding three or four pints. Then fill the pot with rain or river water, which contains the greatest quantity of air. You may aerate water which is poor in air by pouring it repeatedly from one vessel to another. After standing twenty-four or thirty-six hours, the water is fit for use. When consumed, add more well-aerated water, and let it stand. The air in the water (containing, remember, more oxygen than atmospheric air) will oxydise the iron sufficiently to extract from it a constant supply of chalybeate elements.

Fruit Essences added to water, in the proportion of a tablespoonful of the essence to a tumbler of water, form pleasant, cooling beverages.

Ginger Beer.—Mrs. Rundell's celebrated receipt for ginger beer runs thus:—Slice four lemons and crush two ounces of ginger; add to them one pound and a half of lump sugar, and two ounces of cream of tartar, or the same amount of lemon-juice. Pour on the mixture two gallons of boiling water, and when nearly cold add a tablespoonful of barm. Bottle it the next morning and tie down the corks. In two days it will be fit for use.

Apple Water.—Two large apples cut into slices and steeped in about a quart of boiling water, when cooled, strained, and sweetened, is a very pleasant drink for hot weather.

Lemonade.—Pare two dozen lemons of the ordinary size as thin as possible. Put eight of the rinds into six quarts of hot (not boiling) water. Cover and leave it for about four hours. Rub some fine sugar on the lemons, which afterwards remove and put into a china bowl, into which the juice of the lemons is next squeezed. Add about a pound and a half more of the sugar, and allow the mixture to cool, when it is fit for drinking.

Tisane for Gout (excellent, though simple).—Divide half an ounce of pounded nitrate of potash into four packets—one packet to serve for a day. Put the contents of a packet into a jug, and pour over it a pint of boiling water; let it stand to cool and allow the sediment to settle. This pint of tisane is to be drunk between meals, in two, three, or four times during the course of the day. When the symptoms begin to be relieved, the tisane may be continued at the rate of two or three wine-glasses a day. The nature of this draught is based upon the *alkaline* treatment of gout. The Vichy waters, held in such esteem by gouty patients, are eminently alkaline. The same thing, in another form, is as much nitre as will cover a sixpence, taken at bed-time, in a glass of barley-water. A London physician, advanced in years and knowledge, long subject to attacks of gout, always takes, as a preventative, magnesia and milk of sulphur in equal quantities; one or two doses of this, he says, always ward off an attack. Our readers may have quite as much faith in what a doctor administers to himself as in what he prescribes to others.

Prune Tisane, for Irritation in the Throat.—Boil half a pound of prunes (dried French plums) three-quarters of an hour in a quart of water, keeping the water to that quantity; then pour off the liquor and let it stand to cool. Sipped in the night, or at intervals during the day, it greatly relieves irritation of the vocal organs. If the patient finds it too sweet or syrupy, it may be diluted to taste with boiled water, and even sharpened with a little lemon-juice. Few children will refuse to eat the prunes after their boiling.

Tea made over-night.—To prepare tea for a very early breakfast, make it over-night, and pour it away from the tea-leaves into another vessel. It will keep perfectly well, for it is by long standing with the tea-leaves that it becomes bitter. In the morning simply warm it up. Tea is drunk at a temperature of 140° Fahr., or 90° above an average night temperature of 50°. It is more than twice as easy to raise the temperature up to 140° than to 212° (the boiling-point needful for *making* tea), letting alone the trouble of tea-making.

Orangeade.—Squeeze out the juice of a dozen oranges. Put the peel from four of these in boiling water, and cover up closely. Put sugar in water and boil to a thin syrup. Skim the last, and when cold mix the juice, syrup, and the liquid from the peel; add as much water as you please, and strain through a jelly-bag. Drink it when cold.

Currant Water.—A couple of teaspoonfuls of currant jelly in a tumbler of water, with about ten grains of tartaric acid.

In hot weather it is well to bear in mind that excessive drinking loads and oppresses the stomach, by distending it too much.

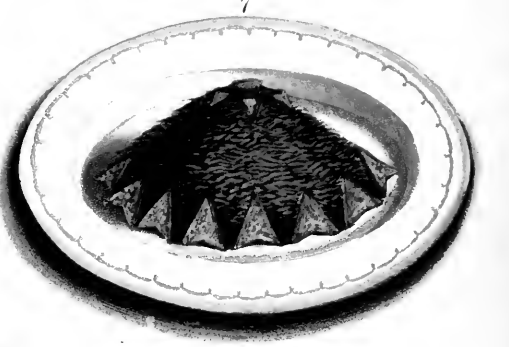
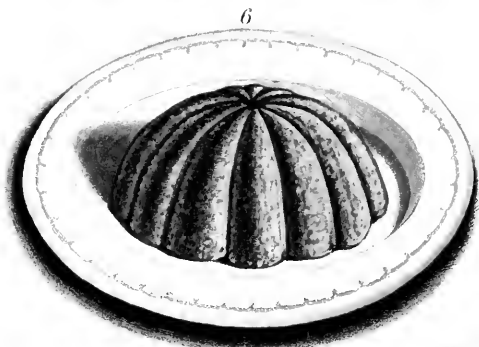
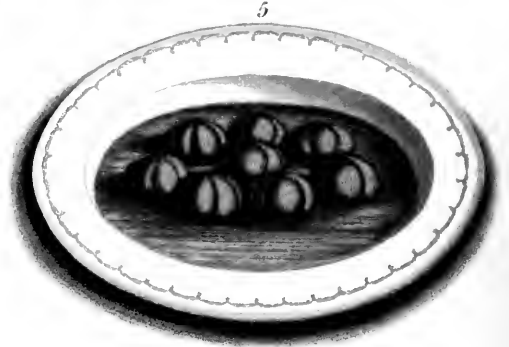
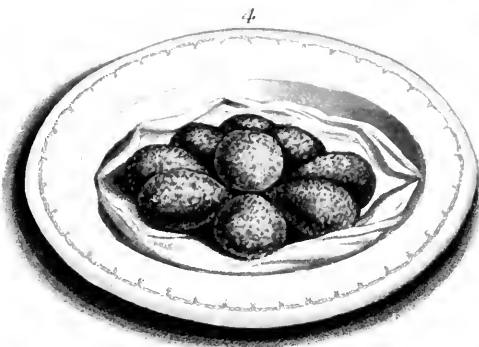
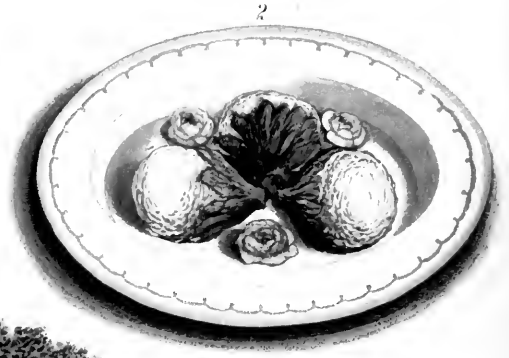
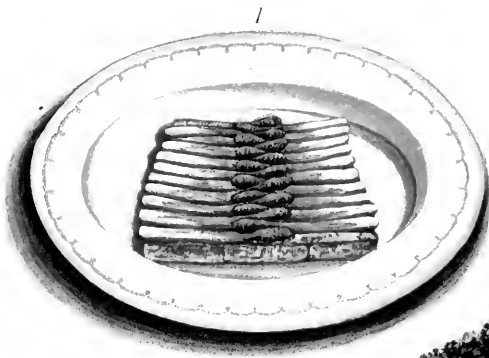

Cook's and Confectioner's Plate IV

1. *Asparagus on Toast.*

4. *Potato Rissoles.*

6. *Mashed Potatoes.*

3. *Salad.*

2. *Cauliflowers.*

5. *Baked Tomatoes.*

7. *French Beans.*

ANIMALS KEPT FOR PROFIT.—PIGS.

HOUSING, BREEDING, AND REARING.

THE profit to be derived from a herd of pigs will of course be in a ratio corresponding to the amount of care and attention which may be bestowed upon them. Warmth, light, air, wholesome food, and moderate exercise are absolutely essential for the well-being of any animals; and the pigs which enjoy these advantages will amply repay their owner for his outlay and trouble, by breeding readily, by fattening quickly, and by their freedom from disease: the bacon will fetch a higher price in the market, and the effluvium, which is to a certain extent unavoidable in piggeries, will be by these means reduced to a minimum.

Nothing can be more ob-



Fig. 1.

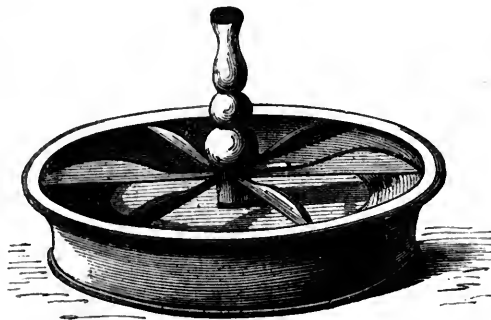

Fig. 3.



Fig. 2.

jectionable, or ill-adapted for the purposes for which they are intended, than the usual kind of sty, which is considered, by many people, to be good enough for a pig, and which is commonly found in the country. A lean-to roof, covering in a house barely large enough for its inmate to turn round in, with an entrance so low that a man must stoop to enter it, and a little unevenly-paved yard outside, scarcely bigger than the house itself; such is the prevalent idea of what a pig-sty should be like, and this forms the model upon which most are built. Some wealthy fanciers, on the other hand, have gone too far towards the other extreme, and have erected their pig-

geries on such a scale, that the profits of the herd are likely to be swallowed up for a long time to pay for them. It is in a happy medium between these two extremes that the best description of pig-sties is to be found. A row of good-sized loose boxes, with a folder or yard in front of them, will be found to be as useful as any kind, inasmuch as the houses can then be used, on an emergency, for any other kinds of stock as well as pigs, and will answer the farmer's purpose when he is, as he often is, at a loss to know where to put a cow and calf, or a sick horse, if his accommodation be limited. The partition-walls of these loose boxes should not reach to the roof, but an open space should be left under the rafters, to admit of a free circulation of air along the entire length of the building, which will greatly conduce to keeping it sweet and fresh. The doors should be constructed in two parts, so as to allow of the upper division being left open in warm weather, or when circumstances may render it desirable. The floors should be paved with brick or stone, or, better still, covered with a thick layer of clean gravel laid on a substratum of ashes and cinders, and it should be on a slight incline,

with a drain at one end to carry off all wet and moisture; and, finally, light may be supplied, either by small windows in the back wall, or by panes of glass let into the roof itself at intervals; this latter plan is probably the best.

The full-grown boars should be kept apart from, and, if possible, out of hearing of, the rest of the herd. Being naturally of an excitable and somewhat savage disposition, it is of the greatest importance to keep them quiet and undisturbed, as, otherwise, they will fret themselves to such an extent as soon to become gaunt and thin in appearance. Their house should be of a good size, and so built as to be easily divided into two parts, into one of which the boar may be turned while the other is being cleaned out, and while his food is being prepared; and care should be taken that the par-

tion-walls and doors are of sufficient strength effectually to prevent his breaking out. Boars are exceedingly dangerous animals to deal with, being possessed of astonishing strength and cunning, so that the greatest caution must always be exercised even by those who regularly feed them, while strangers should never venture within their reach, if it can be avoided. When the tusks begin to attain a formidable length, they are usually sawn off as a precaution against accidents, but even without them pigs are able to inflict very awkward wounds. Their bite resembles that of a greyhound, inasmuch as they make their teeth meet, and then tear

through the flesh without unclenching them. After they have attained maturity two boars should never be permitted to be near each other, but up to the age of about seven or eight months boars of the same litter may be kept

together without harm. The following remarks on the feeding of sows will be found generally to apply to boars as well, except that, as a rule, the latter do not require to be so well fed, nor should they be kept in such high condition, and it will be found advantageous occasionally to administer gentle opiates with their food, as may seem meet.

The breeding sows without litters by their sides, and other store pigs, may with advantage be allowed during the summer months to be at large in a common folder, with the opportunity of occasionally finding their way into a neighbouring paddock or orchard to graze. The free use of their limbs, and the constant exercise thus gained, is exceedingly useful in keeping them in good health, and will be found to be a certain preventive against that cramp or paralysis of the hind-quarters, to which pigs that are always confined in small sties are so frequently subject. It is very necessary, of course, that they should have good

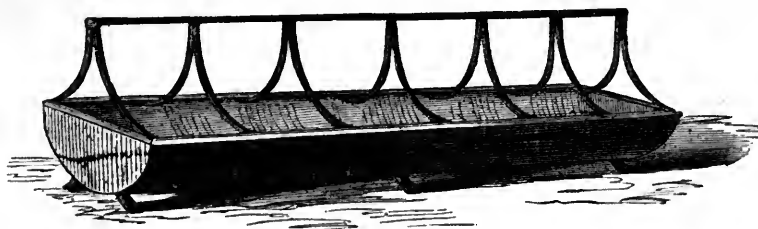

Fig. 4.

strong rings in their noses before this liberty is given them, as, otherwise, they will do great damage to the turf, turning it up in every direction in their search for roots, and causing it to present a most unsightly appearance. The best kind of ring that can be used is the common swivel ring, which turns loosely on a stout wire, one end of which is passed through each nostril, and the two ends then twisted into a knot on the top of the snout (see Figs. 1 and 2). It is difficult for the pig to get this ring loose, and if he attempts to "moot," as the habit is called, the knot presses painfully on the tender part of his nose, and soon causes him to desist from his mischievous practices. They are not so likely to break, nor do they wear out so speedily, as more fancy kinds of rings are apt to do, and this is in itself a great consideration, as, if we may judge from the screams which it elicits from the patient, the operation is a very painful one. But when they have by any means been displaced by the pig, they must be immediately renewed.

As to the feeding of store pigs, it is difficult to say what they will not eat. Wash from the house containing the trimmings of vegetables and other refuse, thickened with sharps, barley, or oatmeal will afford a capital meal; Indian corn, well ground, is cheaper, and will do almost, if not quite, as well. Brewers' grains, too, mixed with the wash, form a very wholesome and nutritious food, and can readily be obtained for fourpence per bushel at most public houses. A little whey, skim-milk, or buttermilk, if it is to be got, is a pleasant addition to their food. Pigs are very fond of all kinds of roots, such as refuse potatoes, parsnips and carrots, and especially of swedes and mangel-wurzel; but, before the latter are given to them, they should be sliced or pulped, in order to lessen the chance of choking, an accident to which pigs are very liable. Cut vetches and fresh bean-straw are good for them to pick over as an occasional change. After harvest they should be sent to feed on the stubble, and especially on the bean stubbles, where they will manage to pick up a vast quantity of grain, which from over ripeness and other causes is inevitably shed on the land and would otherwise be wasted.

The sows ought to have two litters every year, of not less than six or eight on each occasion; any one that has less than this number by the time she is two years old should be fattened forthwith for the butcher, but, as few hilt (as young sows are called) bring more than four or five, and even less, in the first farrow, a valuable sow should not be discarded without being permitted two or three trials. In one case which came within our own experience a sow produced two young ones only in her first litter; four in her second and third litters; eight in the fourth; twelve in the fifth and sixth, and sixteen on the two following occasions, and so this sow, which began so badly, afterwards gave birth to the wonderful number of fifty-six pigs in four consecutive litters.

The sows should visit the boar about Christmas and again about the beginning of July, and as the period of gestation is between fifteen and sixteen weeks, or, according to popular belief, three months, three weeks, and three days, the litters will then be farrowed in the middle of April and the middle of October, so that they will have attained some age and strength before the very cold season commences; otherwise, it is difficult to give them the amount of warmth which they require when very young.

Three or four days before the sow farrows she should be placed by herself in a roomy sty, and have plenty of clean short straw given to her, which she will herself arrange in the manner she thinks best. At this period her food should be carefully attended to, and roots must be forbidden unless they have been previously well steamed or boiled; as much milk as can be spared, with whey and a little oatmeal, will be found beneficial. If after the birth she appears weak and exhausted, a little brandy may be given her; but, if, on the contrary, fever supervenes, lighten her food and let

it be thin gruel only, or something of that nature. Up to the last, she should be permitted to graze in an open meadow for an hour or two each day, as the fresh air and exercise cannot fail to do her much good. When the actual time of birth arrives, she should be left to manage it by herself as much as possible, and strangers must be rigorously excluded from her presence. Her regular attendant may often be present with advantage, as in certain cases his assistance may be useful, but, as a general rule, he should not meddle with her, unless interference is absolutely necessary.

The young pigs are, for the first three weeks of their lives, subject to several maladies and accidents which it is difficult to guard against or prevent, and during this period they require somewhat careful attention. If they show signs of *scouring*, change the mother's food and give her more barley-meal in her wash, as well as some dry corn or beans, which will generally have the desired effect. They sometimes also suffer, at this age, from an affection of the brain, which soon makes itself evident, and those so affected should be killed for "sucking-pig" at once. A third and very common misfortune to which they are liable is the loss of their tails—a loss which is of course very detrimental to their personal appearance, and one for which no effectual remedy, so far as we are aware, has yet been devised. Again, however careful the sow may be, she very often cannot avoid lying on and suffocating some of her young, especially when they run close by her side in their eagerness, as she is preparing to suckle them. When this happens, the dead pigs should be instantly taken away, lest the sight should awaken her cannibal propensities, as it is by no means improbable it would, and from eating dead pigs she should come to devour them alive. To obviate the chance of this misfortune, it is a capital plan to fix a strong beam, eight or nine inches broad, projecting along the whole length of the walls of the breeding-shed, at a height of six or eight inches from the ground. The sow is thus prevented from lying close up against the wall, and the young can get underneath the beam if they are in danger of being overlaid.

A breeding sow should be kept in good condition, but not over fat, and, while suckling her young, she should be fed at regular and frequent intervals; by which means her milk will be rendered more abundant and richer in quality, and her young will thrive better accordingly. In most cases the litter will require no assistance but that which their mother can herself afford them until they are a fortnight old, at which time they will be able to feed themselves to a certain extent, and they should be encouraged to do so, in order to relieve the mother and save her from being too much reduced in flesh.

Sows have, as a general rule, twelve dugs, and by some unexplained, but natural rule of selection, each little pig in the litter chooses one for his own private use as soon as he is born, and keeps to that one exclusively until he is weaned. The consequence is that, if there are more young than dugs for them to feed from, the surplus must be brought up by hand from the first, unless by good fortune there should happen to be another sow in the herd, ready and willing to act as foster-mother to them. But in any case, as soon as they are a fortnight old, a hurdle or railing should be so placed as to cut off a portion of the breeding-sty, into which the young ones can get and feed away from their mother. At first their food should consist of nothing but milk, slightly warmed, which should be placed in a dish, shallow enough to enable them easily to get at it; and if the attendant dabbles his fingers about in it, the little pigs will soon begin to suck them, until, at last, finding that they do not get enough in that way, they will discover how to drink by themselves. Little pigs which are brought up by hand from birth are generally fed at first out of an ordinary child's bottle. Very soon the milk may be thickened by the addition of some barley or oatmeal, and

afterwards, as they grow and are able to take it, the ordinary pig-food, as mentioned above, may be given them by degrees. The trough for their use at this early age may be either long or round, and should be divided by cross-bars into at least as many parts as there are pigs, or even more, each being only large enough for one pig to feed from at a time, or the stronger ones will be apt to drive away their weaker brethren and deprive them of their fair share of food. (See Figs. 3 and 4.)

At three weeks old, the boars of the litter which it is not intended to keep for breeding purposes should be castrated, and by the time they are about eight weeks old they ought to be fit to leave their mother; if, however, they appear hardly strong enough to do so, another week or ten days may be allowed them. They should be weaned gradually, being permitted to visit the sow at first only three or four times in the day, and this number should be gently reduced until they leave her altogether. At this time as much attention must be paid to the sow as to the young; she should be turned out to graze oftener, and her food must be lessened by degrees both in quantity and quality, until at length her milk has entirely dried up, and she can begin to consider the desirability of having another litter.

DOMESTIC MEDICINE.

DYSENTERY.

DYSENTERY used to be a very serious disease, even in this country. The second Dr. Heberden, in his essay on the "Increase and Decrease of Different Diseases," shows that, in the seventeenth century, the number of deaths set down in the weekly Bills of Mortality, under the title of *Bloody Flux and Gripping in the Guts* (a very vivid summary of the symptoms of dysentery), was never less than 1,000 annually, and in some years exceeded 4,000. For five-and-twenty years together—namely, from 1667 to 1692—they every year amounted to above 2,000. Now, although dysentery is a common disease at certain seasons, it is very seldom a fatal one in this country. In tropical countries, however—and in armies and fleets, in hot or autumnal seasons—when there is any want of fresh, good food, or of proper protection from the damp air of the cold nights that follow hot days, and of good clothing—there is apt to be dysentery. Especially are these causes likely to produce dysentery, when supplemented by disaster, or depression, or intemperance. In two years and a half, our army in Spain lost no less than 4,717 men.

It is curious that a disease once so fatal in this country should be scarcely ever fatal now. The change is doubtless due to a number of great sanitary improvements, dating from the Great Fire of London in 1666, which consumed everything from Temple Bar to the Tower. We have had no plague since then. Agues, too, have almost disappeared. The streets and houses destroyed by the fire were very filthy, very close, and densely crowded. Doubtless, this fire was regarded as a great calamity at the time; but it really was one of the hugest blessings. Better drainage, better living, greater general cleanliness, and more perfect medical knowledge, are amongst the other improvements to which the better health is due.

Symptoms.—Dysentery is easily known by its symptoms. There is a twisting, griping, severe pain in the belly, accompanied with a desire to have a motion, which consists not of a proper motion, but of mucus or mucus and blood. This desire is very frequent, and is not much relieved by going to stool. Sometimes there is a good deal of feverishness, and the pulse may be quick. There is a tendency to sickness, and the pain is of a sickening kind. It is also very weakening. Few kinds of pain take the strength out of one more effectually than the pain of dysentery. The disease consists of *inflammation* of the mucous

membrane of the gut, chiefly in its lowest and largest part. In bad cases it goes on to *ulceration*.

Causes.—Autumn is the season for dysentery, with its hot days and cold nights. Perhaps unripe fruits, sour beer, and other wrong kinds of food have something to do in producing it. The worst cases we see here are those which come from hot countries, in which the disease is apt to become established or chronic. As we have said, the dysentery of this country generally gets well with a little wise treatment. It is not uncommon at the autumnal season of the year in teething children.

Treatment.—Dysentery, though not a fatal disease in this country, is a very painful and weakening one, and should not be played with by domestic remedies. There is another reason for having it treated by a doctor, in the fact that it is one of those diseases which it is easy to treat wrongly, and to make very much worse. Our instructions to the patient who is at sea or out of reach of a doctor would be: "Do not take much opening medicine. If you take one dose of it, let it be a mild dose of castor-oil." The principal remedy for the patient to rely on is opium. If the patient be a grown-up person, and the pain be very great, and the passage of blood and slime frequent, half a grain of opium, or five grains of Dover's powder, three times a day, or even oftener, is the remedy that will most frequently answer best. Hot fomentations to the bowels, and a warm poultice of linseed or bran, will also give relief. It is also very important that only suitable food should be taken; such as sago, arrow-root, milk, rice, &c. The opium should be taken in the form of a pill, thus—

Powdered opium $\frac{1}{4}$ to $\frac{1}{2}$ grain.
Conserve of roses, enough to make a small pill.
To be taken three times a day.

TO PREPARE FEATHERS.

MAKE two bags of coarse cloth or calico, one to hold the goose feathers, the other for those of chickens and other birds. When plucking poultry, cut off the wings and pick them carefully; then the larger feathers should be stripped from the quill and added to them, and be careful that no skin or flesh adheres to any of the feathers. The bags are then to be placed in a brick oven used for baking bread, and kept there always, except when in use for baking. The bags should be occasionally hung out in the wind, and beaten with a stick. As soon as you have sufficient for a pillow, buy some ticking and stitch the case round on the wrong side with strongly waxed thread; lay it on a table, and rub it over on the wrong side with white wax—or common yellow soap will do as well. If wax is used, it must be warmed first, and then applied. Soap is preferable in case of the ticking being washed at any time, as it washes easier than the wax would do. If neither pillows nor bolsters are required, the feathers can be put into beds that have become a little empty. The goose and duck feathers should be used for best beds, and the mixed feathers for those that are inferior, as they have not the curl that the goose feathers have, and therefore do not shake up so well, but lie heavier and in masses. It happens sometimes that feathers done in this way have a putrid unpleasant taint, caused by having some of the skin adhering to the quill, this may be, perhaps, thought an insurmountable difficulty to overcome; but if, after a family wash, the bag, tied closely at the neck, is dipped into the copper of soapsuds while boiling, and moved about with a stick for a short time, then lifted up and squeezed with a stick against the sides, then taken out and hung out in the air and shaken several times in the course of a few days, when the feathers feel dry and light, and are free from smell, they may be again put in the oven and kept aired for use.

THE REARING AND MANAGEMENT OF CHILDREN.

CLOTHING FOR A GIRL EIGHT YEARS OF AGE (*continued*).

To make a Plain Skirt.—Cut it long enough for a twenty-four-inch skirt; allow about two inches for the hem, and half an inch to turn in at the top. The number of breadths used in a skirt depend on the width. It should measure ninety-four inches all round at the widest part of the hem. Make the front width sloped away with a gore on each side. If the width of the material brings a joint at the back of the skirt, make the two back breadths plain; but if there is only one breadth behind, let that only be plain; gore the side widths for a child. Fig. 1 shows the way the skirt is joined. There are, of course, one, two, or three breadths each side (those marked B B),

pipied, and the piping hemmed on the wrong side. To put it in a band, cut a strip of the material about two inches wide. Turn in two inches, pin to the body, and stitch it to it on the right side. Cut a similar strip of lining, and, after the bone cases are put on, pin it on the wrong side and hem it to the body. Turn in the lower edge of the band and of the lining of the band, and sew them together. To join the skirts, pin the breadths first, and then run them neatly, taking a back stitch every time the needle is inserted afresh. Keep the gored side uppermost. Overcast the edges afterwards. In working with a machine, tack the breadths when one is gored, and keep that one uppermost. Lay the skirt on a table to turn up the hem, and make a little pleat in it wherever it is required. Pin it, and then run it neatly, taking a frequent back stitch. Pleat the skirt at the waist, turning

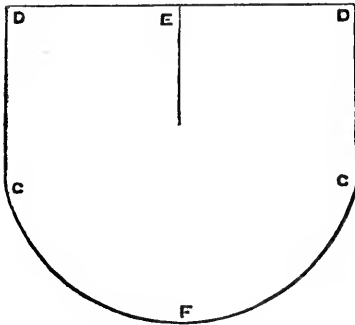

Fig. 14.

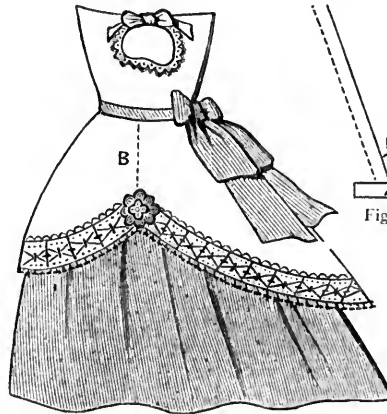

Fig. 12.

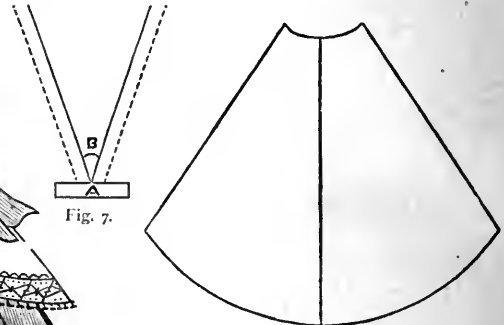

Fig. 6.

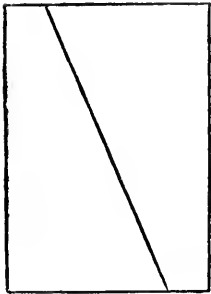

Fig. 2.

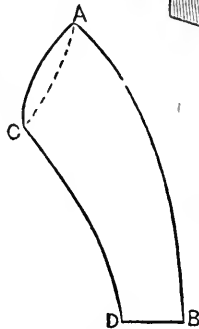

Fig. 11.

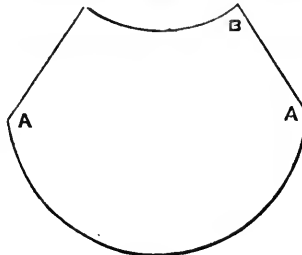

Fig. 13.

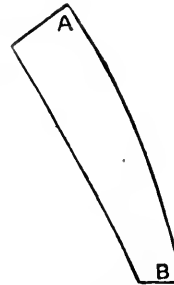

Fig. 10.



Fig. 3.

according to the width of the material. A is the front breadth, the dotted lines showing where it is gored; B B are the side breadths, and C half of the back breadth. To cut gores, the breadth must be folded on the slant, allowing enough at what is the broad end of the piece, after they are cut apart, to make the narrow end or top of the other. Fold it on a table, press down the fold with the hand and cut it. The gores for the two sides must be folded different ways, as illustrated by Figs. 2 and 3. Breadths gored together can only be used for opposite sides, when the material has no reverse. Such materials as long-cloth, alpaca, &c., are the same both sides, and can be reversed. The size of the body can be ascertained by measure by the directions for measurement recently given, or can be taken from the pattern of a body for a velveteen tunic, which will follow, as it is useless to reiterate directions. The body should be lined with union, or, if coloured, a black and white speckled gingham or linen, such as is sold for dresses, makes a nice lining. The body is stitched together under the arms, and on the shoulders. The backs require an inch-wide hem; the stitches should only be taken through the lining. At the waist it must either be put into a band or

down half an inch first on the wrong side. Pin the pleats and afterwards sew them together. Then sew them to the band of the body. A good pattern for a sleeve will be given with the velveteen tunic. An easy way of trimming children's frocks is with braid or ribbon velvet. Black always looks well on any colour, and any colour on black. Lay the braid on the skirt or body, which should be spread on a table; steady it by a pin or two. Tack it along slightly. Then take the work in the hands, or to the machine, and sew on the trimming.

Dress and Tunic.—It is very usual now for little girls to wear frocks of two colours, or black and a colour, and consisting of body, tunic, and petticoat. These skirts are entirely gored, and have no pleats at the waist. Fig. 4 is an illustration of one made of black velveteen and blue cashmere. The petticoat has four entirely gored widths, cut like Figs. 2 and 3, and a front width gored away each side till it is as narrow at the top as at the side gores (see Fig. 5). The side gores are joined on to the front as shown in Fig. 1, and the slopes meet at the back as shown in Fig. 6. When completed, it must not measure more than twenty-six inches round the waist. The back can be left partly open as a placket-hole, and here it must

have false hems of the material, cut on the straight, of ribbon. A false hem is a piece run on the right side, turned over, and hemmed down on the wrong side like a real hem. To strengthen placket and pocket-holes in children's dresses, put a transverse piece of ribbon or tape, as shown at A in Fig. 7, on the wrong side, and hem it down neatly and strongly. Also make a loop and overcast it at B. Cut a lining for the gored breadths of the petticoat in grey twilled calico. Tack each breadth of cashmere to a corresponding breadth of lining; then stitch them together, and overcast the wrong side—it is lined to allow it to bear the weight of the flounce; hem the bottom. Cut a number of pieces on the cross of the cashmere, nine inches wide, for the flounces, and join the breadths.

flounce should measure seventeen and a half inches, when complete.

The tunic is either cut in the same way in gored breadths, or, if the velvet is wide enough, is cut out in one like a cape. The gored skirt of the petticoat should be folded in half, the fold coming at the back seam and down the front. Lay it on paper, and cut out the pattern. Newspapers may be joined with pins when not large enough, and afterwards tacked together with needle and thread. Cut the pattern double in newspaper, make it eight inches shorter than the petticoat, by cutting off the lower part. It then serves to spread on the velvet as a pattern. The tunic looks best if cut wide enough at the waist behind to allow all that part to be gathered which joins to the

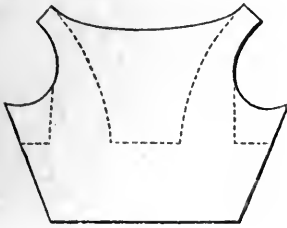

Fig. 15.



Fig. 4.

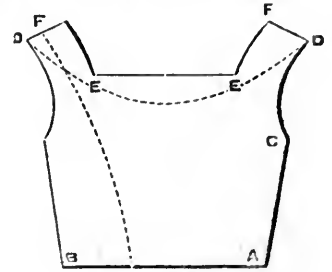

Fig. 8.

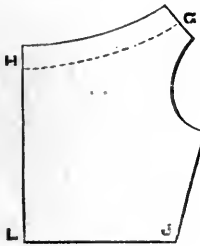

Fig. 9.

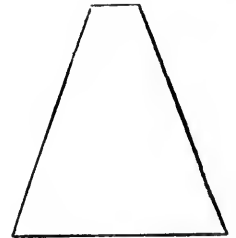

Fig. 5.

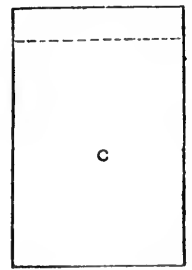
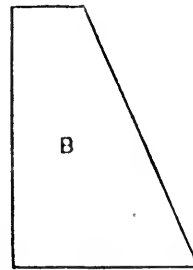
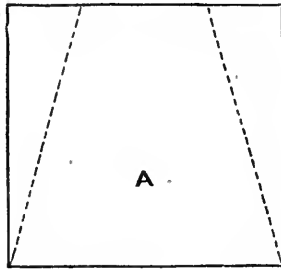
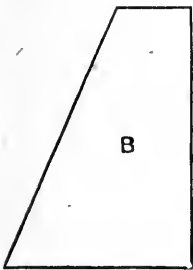

Fig. 1.

It may be hemmed or bound with black velvet at the lower edge. Finely pleat all the length at the top, and afterwards arrange it on the skirt with pins, and finally neatly stitch it all round, or run it merely at the top. Before pleating it, tack down about half an inch all round the top. Put the waist of the petticoat into a two-inch wide band, or sew it to a body made of grey Derry. The latter is very preferable, because skirts on bands drag round the waists of children, and spoil their figures. Put no sleeves to the Derry body, and merely hem the neck and arm-holes narrowly. The length of each breadth of the skirt is twenty-six inches; half an inch of this is allowed to turn in at the waist and one inch for the hem. When finished, it should measure ninety-four inches all round the hem of the skirt and twenty-six round the waist. If it is a little fuller in the waist, make a few pleats at the back. The flounce, when completed, is seven inches wide. From the waist of the skirt to the top of the

back of the body; but it may be plain all round. The tunic measures sixteen inches long. Down the centre of the front it must be exactly on the straight of the material. Cut out the turrets as shown in Fig. 4. They are each three inches long and three wide, making three-inch-wide tabs. See that one comes exactly in the centre of the front, and that they meet well behind. If the skirt is in breadths, the breadths must be joined before these tabs are cut. There is also a space of exactly three inches between each tab. Run a half-inch-wide strip of black muslin lining, cut on the cross, on the right side all round the edge of these tabs, very easily; turn it over on the wrong side, and hem it down. If it will not stretch enough to be flat, it must be snipped at the corners. A better way is to tack a four-inch wide strip of soft black Victoria lawn all along the right side of the tabs or turrets. Run the tabs all round to this. Then cut out the lining between the tabs. Untack it; turn it on the wrong side; tack it

down again, and finally hem it. The tabs are handsomely trimmed all round with narrow braid and jet beads.

Fig. 8 shows the front of the body of black velvet. From A to B the waist is twelve inches; from C to A, the side, it is fourteen inches; D to D, the dotted line of the neck, is seventeen inches; E to E, the square of the neck, is eight inches; F to F, the dotted line which shows the length of the brace, is twelve inches. The brace comes to the top of the shoulder seam; it is not carried behind. The back, Fig. 9, measures from G to H, the dotted line at the neck, nine inches; from H to L, the length of the back, nineteen inches; from J to L, the waist, seven inches. This does not allow for turnings. It will be noticed that, although the back of the neck is cut square in shape, it is very much higher than the front. Fig. 10 is the shape for the brace, twelve inches long from A to B. When the pattern of the body is cut out, the braces are lined (the shape must be reversed for the two sides) with Victoria lawn. Trim them by a pattern with narrow braid and jet beads. The braces are then to be joined to the body by the dotted line, shown in Fig. 8, taking corresponding slopes both sides. The wrong side of the brace is first tacked and then stitched to the right side of the body, and turned over. This is accomplished by rounding both conveniently over the hand. Tack the brace at the shoulder to the front of the body and also at the waist. Then join the backs and fronts of the body, stitching the sides and shoulders, and hemming the back full an inch broad. No allowance was made for this hem in the size. Next pipe the waist, using black silk or satin; then pipe the neck. It is better not to hem down the piping, but leave it raw and narrow, and run a ribbon or a tape over it. Children's dresses are better without bones at eight years of age; otherwise bone cases are run on before the pipings. Pipe the armhole.

Next cut the sleeve by Fig. 11. From A to B this measures eighteen inches long, and from C to D eleven and a half. It may be cut in two pieces, and joined together. One piece is hollowed by the dotted line from A to C. The rounded side is put to the top in stitching it in, and the seam an inch behind the shoulder seam. Pipe the cuff, and line it a few inches up with black silk or satin. Braid and bead it to correspond with the tunic. Round the neck of the dress a deep lace is tacked inside, and drawn round the throat by a narrow ribbon. The braces cover the tops of the sleeves like epaulettes. A handsome blue saracenet sash completes this pretty costume. The shoes should be blue or trimmed with blue bows.

A charming summer dress can be made like Fig. 12. The measurements and pattern may easily be taken from the previous costume. The under-skirt and low body is of silk; any colour, or even black, may be used. A light greyish sage-green is pretty. The skirt is quite plain, and gored like Fig. 1, with plain back breadths. Over this is a fine sprigged book muslin tunic. It is gored first like the front breadth in Fig. 1 (A), but wide enough at the top of the waist to go from one side-seam of the body to the other; the slope in the skirt, of course, proportionate. It is hollowed out at the waist to sit well, and scooped at the hem. Fig. 13 is an illustration of it. Cut the pattern first in tissue paper, try it on the child over the silk skirt, and make any necessary alteration. It is to cover the front like an apron, A and A forming a seam straight from the side-seam of the body down the skirt as shown at B in Fig. 12. The back is a single straight breadth, rounded at the lower part from C to C, see Fig. 14. From D to C, each side, it must be the same length as from B to A, in Fig. 13; but it hangs much longer in the centre, from E to F. Join these two breadths at the side by a mantua-maker's seam; hem all round the lower edge very narrowly indeed, and neatly sew on an inch-wide insertion and a narrower edge, both Valenciennes lace. Gather

the back breadth, without turning down the edge, from D to D, having first made a placket-hole at E. Set the waist into a very narrow band, hemmed over it both sides. Cut the bodice, by the help of a low body pattern, in the way shown in Fig. 15; the dotted lines represent the corslet, now to be cut from the muslin. The body of the tunic is a good guide for this one, and can be cut away in the manner shown in Fig. 15. Make a very narrow hem round the top, after joining the sides and shoulders, and run the insertion over the muslin, not beyond it, as in the skirt. Hem the waist, and fasten it to the skirt-band. A handsome wash of a corresponding colour to the dress is worn over this, and bows on the shoulders and on the skirt, as in Fig. 12. As an out-door dress in summer, a short loose jacket, cut up in the centre of the back a few inches, completes the costume. Place a ribbon bow at the neck. The hat should be white, of a colour like the dress. We shall shortly give directions for making a mantle.

The articles on dress-making, which will be published in future papers, will be a great assistance in the making of the clothing of children over four years of age, because the principles are generally the same in regard to the rules and methods of cutting and placing.

THE HOUSEHOLD MECHANIC

PAINTING (continued):—IMITATING FANCY WOODS AND MARBLES.

THE imitation of the veins or variegations of marbles, and of the grains and knots of various woods, has been a general form of decoration in all ages, and continues to be more practised and is made a more special study than ever. The number of coats for paint-work intended to be grained is from three to five, the last being the same colour as the ground or basis of the wood to be imitated. It is well, too, that the preceding coat should be likewise of the same colour, but a trifle darker if anything, as this prevents any irregularity in the intensity of colour. In laying on the paint, great care should be taken that it is laid evenly, to effect which the brush should be passed upwards, tightly from the bottom about a hand high, when, being removed, it should be passed downwards, tightly from the top of the panel, so as to meet where it terminated in passing up. Each panel or piece of work, being completed, should be smoothed over with a very soft brush and equally light hand.

As the best mode of laying on the graining colour somewhat varies in accordance with the wood to be imitated, it will be necessary to give special directions under the head of each wood.

Walnut Wood.—The grain of this wood is very superb. In the centre of the tree it is of the finest texture, often forming a kind of fine knot of somewhat kidney appearance, around which centre beautiful kaleidoscope patterns, which form the half of a beautiful kaleidoscope figure, to effect the perfection of which it is customary to lay the adjoining planks open, side by side, in order to form a figure for the centre of a small table or other piece of furniture. From this kaleidoscope figure emanate, as it were, the mouths of rivers, with sundry ramifications quickly but gradually tapering to a close, expressed by the rich chestnut-coloured ground of the wood. The spaces between these apparent rivers are taken up by what may be described as picturesque stems of ruined trees, interspersed with groups of little knots and marks, bearing a resemblance to groups of islands. In other parts the grain is of a wavy appearance, resembling the trickling of a shallow stream, passing, in a winding course, over beds of pebbles, describing occasionally some figure such as a shield, which a skilful cabinet-maker will apply as a natural embellishment for a keyhole or other similar

purpose. In other places the grain and knots give the idea of imperfectly-described faces or heads, like as the cocoa-nut lends the idea of the face of a monkey. The wood, unpolished, is of a dirty greyish colour, that of one tree little differing from that of another beyond being a trifle lighter or darker; when polished, however, there is very great difference; the most beautiful is that which is well covered with dark umber grainings, sometimes nearly approaching to black, with a ground somewhat richer and deeper in colour than dark rich chestnut. The inferior woods are, when new, of lighter colour, with dark grainings passing across in a somewhat straight direction, and of a dead brown colour, or they are almost entirely of a deader greyish brown, without beauty attaching to the grain.

Skill, to great extent, can be displayed in the imitation of this wood; but, for general purposes, the amateur will do well not to elaborate the work too much, but to leave sufficient appearance of the ground, with well-defined marbly delineations of deep hue. The colours generally used for imitating walnut-wood are—red ochre, in half proportion to the weight of white-lead, shaded or brightened by umber or yellow ochre. The veining is executed by aid of ochre, umber, and black, mixed with a little water and diluted with small beer. A large paint-brush, half worn out or jagged with a pair of scissors, is a good tool to lay on the graining colour. In an irregular position, somewhere towards the centre of the panels, a grand knot should be formed by the twisting of the brush round and round, and from this should emanate, in an almost imperceptible manner, veins of deeper hue, representing an appearance of stems of ruined trees; and immediately, while quite moist, each portion should be touched up and veined by a small fine brush, clearing the ground colour of patches and perfecting the shading or veining. The interstices where no particular design has been executed should be filled up by graining of a wavy appearance, and relieved in parts by smaller and larger groups of little knots resembling islets. A piece of soft wash-leather twisted up or bound round the thumb is used by many in the formation of the knots and veins. The imitation of this wood looks very pretty, as the colour is bright and lively, even when not done in so perfect a style as we have described, but simply with a wavy appearance, interspersed with dark grainings and a few knots; the graining colour having for the most part been laid on unevenly, in a wavy manner, and varying in shade as it has been left thicker or thinner. After a few days, when the graining colour has become thoroughly hard and set, the work will be fit for varnishing; we will, therefore, give directions for the making of a varnish peculiarly well adapted for imitations of all fancy woods, as it gives a better gloss than spirit varnishes. It possesses, likewise, a great additional advantage, being free from danger in making, as it is made without the application of heat. Directions:—Each piece of the copal for this purpose must be tested by means of the essential oil of rosemary to ascertain whether it will soften at its touch, and such pieces as will not soften must be rejected. Having selected the copal, grind it to very fine powder, and lay it in a vessel (glass is best for this purpose) to the depth of about a quarter of an inch, and pour upon it about the same extent of the essence of rosemary, stirring with a white stick until the copal is dissolved. After awhile add a very little pure alcohol, letting it run over the surface, and so continue to do till the varnish has become nicely fluid. In a day or two it will become beautifully clear and fit for use. Great care must be taken to keep it free from dust or bits, and it is advisable to avoid the use of the last drop remaining in the vessel. Varnish should be laid on very evenly and firmly, with a perfectly clean brush, and the work executed in a similar manner to that directed for painting. In laying on varnish, it is to be observed that the brush

should be passed over the same hand's length of work four or five times repeatedly, each time gradually progressing a little, so as by degrees to reach the foot of the work.

Gilded beadings or other gilded decoration lends an excellent finish to imitation walnut-wood. Gold varnish (which we shall hereafter give directions for making) may be employed with advantage, and is to be preferred for this purpose to the ordinary method of gilding, as it is less liable to wear off by cleaning or dusting.

Sienna Marble.—The ground-work must be prepared as described for the imitation of fancy woods, letting the last two coats be of stone yellow. When the ground is quite dry, add broad patches of raw Sienna and white paint, the patches of white being less in size and of less decided forms; while freshly done, these should be blended with a piece of soft wash-leather. When partially dry, describe with a hair pencil, between the patches, broad veins of a mixture of dark blue and Venetian red; with a feather, passing over these veins, a broader, irregular tracing of a fainter, more plum-coloured hue, which may be formed of the remnants of the last-named colours, thinned, and a little lake added, with some additional fine veins in this colour. If desired, the richness of the marbling may be increased by the addition of fine veinings and small patches of burnt terra de Sienna and deep plum-colour (formed of lake and Prussian-blue). The graining colours may be mixed as directed for the imitation of walnut-wood, or, which is probably preferable, with turpentine and a little gold-size. When quite dry, the work may be varnished with very fine colourless varnish, such as we have described under walnut-wood.

Graining to Imitate Oak.—There are so many different ways of imitating this wood, that we shall here give a selection of approved methods. It is a generally well-known fact that the art of imitating oak has been brought to very great perfection; so great, indeed, that, in some cases, it has been found difficult, even after examination, to distinguish between the reality and the imitation.

Three or four coats of paint are requisite for the ground-work of imitation oak, the two last being tinted to the colour of the wood. If you require the work darker, use to colour the ground-work raw terra de Sienna and a little red-lead; if lighter, chrome yellow and Venetian red. When the ground-work is quite dry, the graining colour may be applied, which, for oak, requires to be thick. It should be composed of whitening, coloured by Vandyke brown or umber, enriched by a little burnt or raw terra de Sienna, mixed in beer or in turpentine, with a little gold size. The graining colour should be laid on unevenly, and for this purpose it is well to employ a worn brush or one jagged with a pair of scissors. When laid on, it should be combed down with a large-toothed comb of gutta-percha or ivory, then passed over in a wavy manner with a fine soft comb; and, finally, the middle of the panels, or where the fine grain of the centre of the tree is intended to be produced, should be passed down with a soft comb. Knots and veins are sometimes formed by the brush, and sometimes by means of the use of a piece of soft wash-leather, either twisted up to a point or bound around the thumb. The graining being perfectly dry, the work should be washed over with ale. A little burnt umber mixed in the ale is thought to improve the appearance of the fine grain of the work. The work is then ready for varnishing. Graining colour for imitation of this wood may be well mixed in the following manner:—Mix whitening, Vandyke brown and raw terra de Sienna in boiled oil and turpentine, using a large amount of sugar of lead in order to set the colour; but, should it set too quickly for the working of the combs, thin with boiled linseed oil. The graining colour may also be made with Vandyke brown, gold size, and a little soft soap, mixed in turpentine, with the addition of boiled oil.

PRINCIPLES OF GOOD TASTE IN HOUSEHOLD FURNITURE AND DECORATION.

CARPETS AND OTHER FLOOR COVERINGS.

HAVING considered the decoration of the walls, we have, in the next place, to speak of floor enrichments, in order to complete the background of our room, before we turn our attention to the articles of furniture, to which the wall paper and carpet are to be subservient.

It must ever be borne in mind that no part of the furniture of a room should be determined upon without reference to the whole scheme of decoration. Whatever, therefore, is decided upon as the first feature must be accepted as the key-note with which all the remaining features must be arranged in perfect harmony. The wall-paper is a part of the decoration which is generally found to be already provided when a tenant takes possession of a house; and as landlords' tastes in art matters are by no means to be implicitly relied upon, it is not improbable that this gratuitous decorative feature will be one which it would be unwise to regard as the key-note, and set our furniture to

to wall-papers, carpets, and hearth-rugs; and, for the most part, what has been said respecting the treatment of the former is true also of the latter.

There are, however, a few special observations which it is necessary to make in reference to floor decorations generally. According to the rule laid down in our first article, we have to adapt our ornament to the position which it is to occupy, and the purpose which it is to serve; therefore, the design of a carpet should, in the first place, be quite suitable for being placed in a horizontal position; and, in the second place, perfectly adapted to be trodden upon, and for furniture to stand upon it. Obvious as

this appears, it is strange that these essential qualities are so often found to have been entirely disregarded in the design of carpets and hearth-rugs and other floor enrichments.

The carpet being intended to be placed on the floor, where we have to look down upon it, and not view it laterally as we do a wall-paper, it is necessary that the ornament should be designed specially to be viewed from above, and in various directions. The bi-symmetrical arrangement, which is suitable for a wall, is not adapted

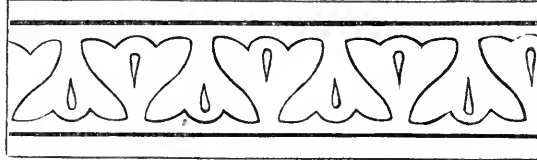

Fig. 6.



Fig. 5.

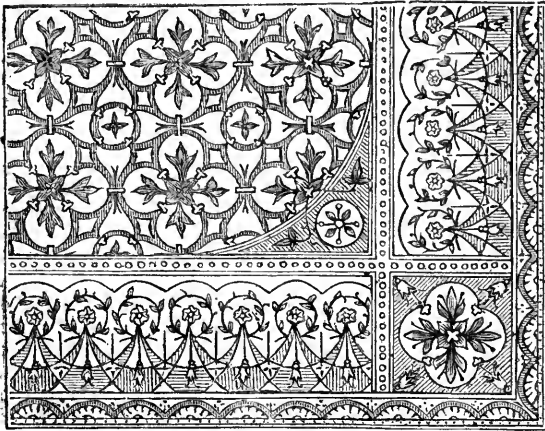

Fig. 1.

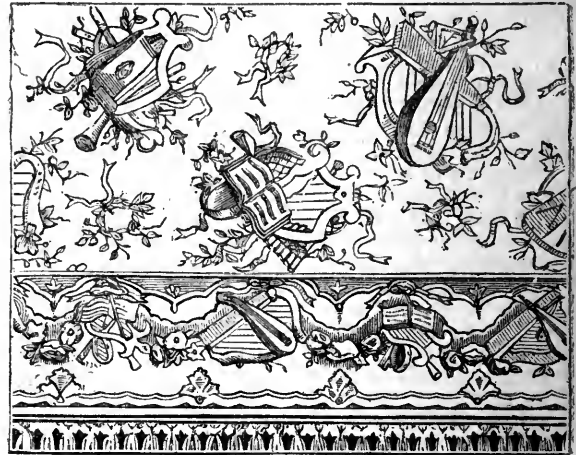

Fig. 2.

it accordingly. By far the wiser plan, therefore, if the paper be of an unsatisfactory design, either in colour, light and dark, or form, is to have it immediately replaced with one which is, in every respect, agreeable, and based on the sound principles already explained. Should such tenant be already possessed of the articles of furniture for the room, the colour and character of these should be kept in view, and the choice of the wall-paper entirely regulated thereby; while, on the other hand, if the wall-paper be first decided upon, everything subsequently added should have reference to it.

The importance of thus adapting the colours which occur in the furniture to the general colour of the wall-paper and of the carpet, or of adapting the wall-paper and carpet to the colour of the furniture, cannot be too strongly insisted upon.

The general remarks we have previously made respecting the harmonious relations of colour, are applicable alike

for the floor, which requires a pattern which shall look equally well from every side of the room, and not appear the right way up from one point of view, while from another it is inverted.

The arrangement, therefore, which is most suitable for floor decoration is the *radiating*, in which the forms spring from a common centre, star-like, as in Figs. 1 and 3.

This principle seems to be in accordance with the natural law observable in the conformation of plants, which rest upon the ground, or raise their heads but little above it. These are generally found to have their parts disposed in a radiate manner, thereby presenting a more beautiful appearance as viewed from above. If border ornaments be introduced in the design of a carpet, which are intended to be against the walls of the room, the bi-symmetrical arrangement (as in the border of Fig. 1) is, in such a position, not objectionable, because then it comes under the same condition as the wall-paper. But if bands

of ornament occur nearer the centre of the room, they should be designed so as to look the same both ways (as Fig. 6), or, at least, to look right both ways (as Fig. 5), and not appear to have a right way and a wrong way.

Being intended to be trodden upon, all designs for floor decorations should invariably be perfectly flat in treatment, as in the carpet, Fig. 1, and the floor-cloth, Fig. 3. By this rule we must condemn a very large number of the

rather than adapt the forms. This we pointed out to be a mistake in the treatment of wall-paperings, and it is even less pardonable in floor decorations, because still more inconsistent. Sometimes objects, such as musical instruments, are introduced, forgetful of the impropriety of walking on fiddles, and harps, and trumpets, and the like, as in Fig. 2. Or again, landscapes are depicted under your feet, and you walk on birds, and trees, and houses

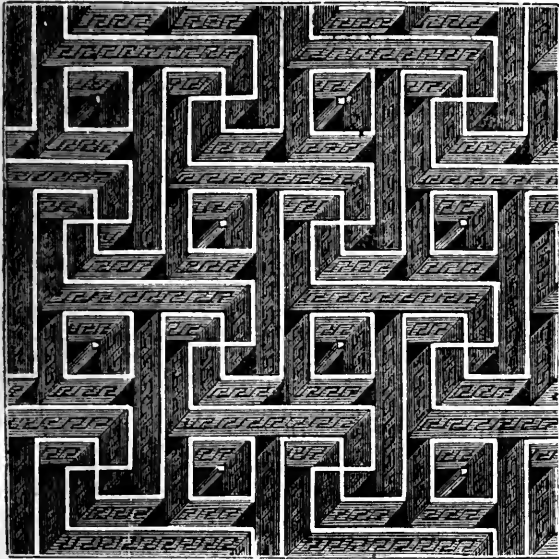

Fig. 8.



Fig. 4.



Fig. 7.

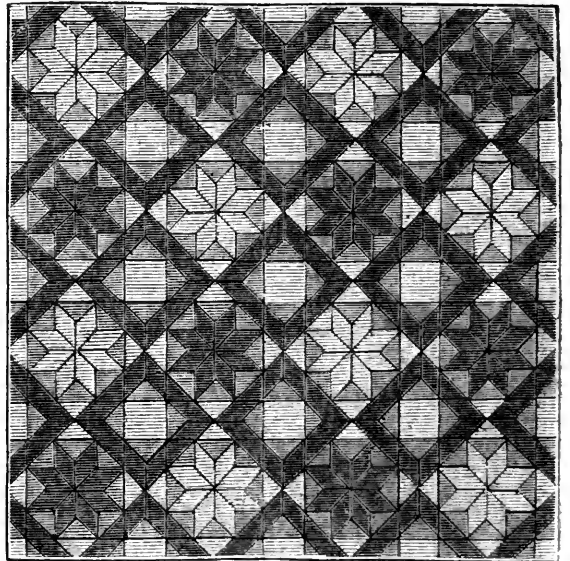

Fig. 3.

designs, both for carpets, hearth-rugs, floor-cloths, tile-pavements, and the like, in which the ingenuity of the designer seems to have been exercised in devising every variety of means of disturbing the flatness which it should have been his aim to preserve.

We sometimes find floral designs with foreshortened flowers and leaves, and with the light and shade represented, without any attempt whatever to adapt them for ornamental purposes, as in Fig. 4.

Indeed here, as in many wall-paper patterns—such as Figs. 1 and 3, page 40—the attempt has been to *imitate*,

and lakes, and see the sky beneath you, as though you were looking down into the antipodes. Such flagrant instances of bad taste and impropriety are, fortunately, not nearly so prevalent as they were some few years ago, although they are still by no means uncommon. Indeed, even in the most noted establishments, where the best designs and manufactures are to be found, specimens of bad taste, so far as design is concerned, are also to be found, simply because there is still a demand for bad taste as well as good. If, for instance, we go to Messrs. Woollams and Co's, of High Street, Marylebone, and

examine their specimens of wall-papers—or to Messrs. Jackson and Graham's, and look at their patterns of carpets—while we find some of the very best examples, we observe also those which are designed on false principles, but for which, alas! there is still too great a demand. It is to be hoped, however, that by the sale of the most tasteful designs by such firms as these, and the spread of an art education through the agency of schools of art, the demand on the part of the public for decorative works designed on false principles, or on no principles, will continue to become gradually less and less, until there will be no occasion, on the part of the producer, to provide any but tasteful designs, since the purchaser no longer requires any other.

We often find that, in one material, the ornamental forms are treated in a manner suitable only to some other material. Thus the mouldings, strapwork, cartouches, shells, and other architectural relief ornaments, are often laboriously imitated, with all their light and shadow, in carpets; while, in truth, the more perfect the imitation, the more unsuitable it becomes for the purpose of floor decoration. In Fig. 7 the treatment is such as would be much more suitable for carved wood-work than for floor decoration. Another error, which is sometimes observable in the design of carpets, and, indeed, of all surface decoration, is the absence of an uniform scale by which the relative sizes of the forms introduced are regulated. It is very inconsistent, and shows want of taste, to introduce forms which have known relative sizes on two different scales, by which some appear of huge dimensions, and others unnaturally diminutive.

Fig. 8 is an illustration of a false treatment, which is by no means uncommon in floor-cloth patterns and designs for tile-pavements. The light and shade is so arranged as to cause the forms to appear in perspective; and the pattern seems to be constructed of bands, or pieces of wood placed with their edges upwards. The effect of all such patterns is to produce a feeling of insecurity to all who walk upon them; while, on the other hand, it is pleasant to tread upon such a design as Fig. 3, where the treatment is perfectly flat. The same difference is observable between the carpet design, Fig. 1, and those shown in Figs. 2, 4, and 7.

ODDS AND ENDS.

A Substitute for Cream.—Stir a dessert-spoonful of flour into a pint of new milk; simmer it, to take off the rawness of the flour; stir in the yolk of an egg, well beaten, and strain it through a fine sieve.

Tea.—If tea should chance to come to the boil by being placed too near the fire while infusing, the bitter taste may be removed by pouring a small quantity of cold water into the pot.

To clean Bottles.—Tea-leaves, well shaken up with cold water, clean carafes and decanters most effectually.

To remove a Speck or an Eyelash from the Eye.—This, we all know, requires the aid of a looking-glass, or the kindly hand of a friend, whether in or out of the house; but there are times when neither of these helps are near; so Nature has provided that, if we will use her appliances, she will assist us; and, with a little practice, it will be found the best and quickest in the end. The upper and lower eyelashes are given as a protection to the eyes; but they also serve as little brushes when an accident happens. By taking the upper eyelashes between the thumb and finger, and drawing the lid completely over the under-eyelashes, and gently moving it backwards and forwards; any specks in the eye fasten on to the lower fringe, and remain there after having let go the upper. This is a sure plan, and can be adopted anywhere; but it requires some perseverance to acquire it, and should not be given up if

the first attempts are unsuccessful. Any disagreeable feeling about it is not half so painful or dangerous as is occasioned by the smallest speck.

To cleanse Cloth or Silk from Spots of Wax.—Place a piece of soft soap upon each spot and warm it slightly before the fire, or the sun (if hot) will serve the purpose. Wash the spot afterwards with soft water, and it will disappear.

Another Receipt.—Cover the spot with spirits of wine or turpentine, and rub the place gently with a soft rag. Continue the same process until the spot disappears.

An admirable genuine Receipt for cleaning Silks, however Light in Colour.—Boil down a pair of old, but not much soiled, white kid gloves, with a pint of water, until it is reduced to one-third of a pint, and nothing remains of the white kid gloves but the silk with which they have been sewn; then, with a large soft brush, or flannel, wipe over both sides of the silk with the preparation, and twelve hours afterwards iron the silk on the wrong side; it will then appear quite new, and wear admirably, without deteriorating in appearance, until it is entirely worn out.

To clean Carpets.—When the carpet is well beaten and free from dust, lay it tightly down, and scrub it with soap, dissolved in soft water mixed with bullock's gall—about four gallons of water to a pint of gall. This will restore the colours of the carpet to their original brightness, and make it look almost like new. The brush employed should be of soft character, with long bristles. By applying to your butcher, he will tell you when he intends slaughtering a bullock, and will save the gall for you, charging you only a few pence.

To cut Pencils.—This is not quite so trifling a matter to some as at first appears. Where much delicate drawing is done, which requires a constantly fine point, and at the same time very clean fingers, a great deal of the incessant scraping of the knife can be avoided, by cutting away the wood from several before commencing, and having a sheet of fine sand-paper on which to rub the lead to a point. It will be found a sure and quick method, and does not necessitate touching the lead. The pencil should revolve in the fingers while being rubbed.

Paste.—How many little things are left unattended for the want of some ready-made paste in the house! Liquid gum is often not strong enough to hold thick material together; but dextrine answers all purposes. It is very cheap, is mixed with cold water, and keeps better than paste till next wanted. Keeping some of the powder in the house, and a special pot or jar for mixing, will be found most convenient. It can be made thick or thin, to suit what it is required for.

Sick Cats.—Cats, being one species of flesh, are subject to some of its ills; and when this shows itself by their moping and refusing their food, or by an eruption on their skin, a simple remedy will often cure them. It is to mix some butter and sulphur well up, and smear their coats with it. Their love of cleanliness will soon cause them to lick it off, and they will have had quite enough of a dose for one day. The same to be repeated until quite well.

HOUSEHOLD LAMPS.

PETROLEUM LAMPS.

ALTHOUGH the introduction of lamps for burning the mineral oils is of comparatively recent date, they have become so universally adopted, as to be now considered almost absolutely necessary in the house. This is not to be wondered at, if we consider how well adapted they are for household use, as furnishing, at a cheap rate, a brilliant and constant light. In the minds of many, however, there still lingers some doubt as to their safety; and the fear of a dangerous explosion is sufficient to prevent

many a careful housewife from adopting them in the place of candles or the old-fashioned oil lamps. That these lamps are somewhat dangerous, if improperly used, there is no doubt; but if only ordinary care be used, there need be no more danger than in the use of sperm oil or common candles. In this paper we shall show how the ordinary petroleum lamps in common use may be safely worked; and also give some account of the mineral oils used in them, and show how they may be tested, in order to find out whether or not they are explosive or dangerous. Although commonly accounted as a recent discovery, the mineral oils were well known to the ancients; and Pliny mentions the petroleum of Agrigentum, in Sicily, which was used in lamps under the name of "Sicilian oil." It was not, however, until the year 1859 that the commencement of the present trade took place. In that year a spring of oil was struck at Oil Creek in Pennsylvania, by sinking a well to the depth of seventy feet, which yielded, for many weeks, nearly one thousand gallons per day.

Having once discovered such a source of supply, many more wells were sunk, and the trade at once assumed great importance. The lamps for burning mineral oils were soon after this introduced, and are much the same, in point of construction, now as at that period.

As there are some important points of difference between these lamps and those used for the burning of other oils, and as it is important that those who use them should understand their peculiarities of construction, we will here explain them, taking, as an example, a simple table-lamp of the ordinary form, the arrangement of which will be easily understood by means of the accompanying diagram, which represents one of them in section.

A is the upper portion of the reservoir, which holds the supply of oil. B is a cylinder of metal, having a flange or screw, by which the upper part of the lamp is attached to the reservoir. This tube is perforated, to allow of the free passage of air to the flame. C is a disc of metal placed across the tube, so as to prevent the escape of the oil from the reservoir. D is a flat tube of metal of the width and thickness of the wick, and it is perforated at E, to allow the cogged wheel, F, to press against the wick, and by means of which wheel the cotton is raised or lowered to the required position. G is a partition of perforated metal, which serves the double purpose of steadying the current of air admitted into the cylinder at H, and catching any fragments of burnt wick which may fall. I is a dome of metal, through the top of which is cut an aperture rather larger than the tube, D, over which it is placed: its purpose is to increase the draught, and ensure the supply of a constant current of air to the wick during combustion. K is the lower part of the glass tube or chimney, used to increase the draught still more, and protect the flame from wind, which would render it flickering and unsteady.

The action of this apparatus is as follows:—The oil is drawn up the wick from the reservoir, and ignited at the top of the tube, D; a current of air passing in at H, in the direction of the arrows, proceeds through the perforated disc, G, above which it meets and feeds the flame, carrying it out through the aperture in the dome, where the light is produced.

In order to set this lamp burning, a wick of cotton should be inserted in the tube, D, and turned up by means of the toothed wheel to just above the level of the dome. It should then be cut off quite square by means of a pair of sharp scissors, taking care that none of the fibres of the cotton are left loose, or they will cause an irregular flame,

and the lamp will smoke. The outer corners of the wick should then be cut off for about a quarter of an inch, more or less, according to the width of the wick. The reservoir having been filled with oil, the lower part of the wick may be immersed, and when it has become saturated with the fluid it may be lighted. It should then be turned down while the glass is placed in position, after which it may be again-raised until a brilliant flame is produced. When the lamp is first lighted the flame should be kept small, as it will increase in size and intensity as the heat increases; and if fully turned up on its first ignition, it will speedily become too large, and will probably break the glass, or give off volumes of dense black smoke and a great quantity of soot. Besides this, the glass chimney should be allowed to become gradually heated, or it is very likely to break.

It frequently happens that those who are inexperienced in the use of these lamps, make the mistake of turning the wick up until it stands just above the dome. The lamp will burn even when thus arranged; but the light is feeble, and a most offensive smell is produced, because the combustion of the oil is not complete.

This arises from a deficiency in the supply of air. Hence it is of the utmost importance to keep the per-

forated plate clean, and free from pieces of burnt wick, which are liable to choke up the apertures and impede its progress towards the flame. When the lamp is in good order, there will be no smell whatever; and if any offensive vapour is given off, it may be regarded as sure evidence of imperfect combustion, which may mostly be traced to a deficiency of air, through the partial stopping of some of the apertures through which it is intended to pass. In order to remedy this defect, the upper portion of the lamp should be removed and the wick taken out, when a little boiling water, poured over the partition, G, will remove the obstruction, and the lamp will again burn freely. In order to ensure perfect safety in the use of these lamps, the following precautions should be taken:—First, the

wick should completely fill the tube, D, in order to preclude any possibility of direct communication between the flame and the oil in the reservoir; secondly, the lamp should always be extinguished before the reservoir is refilled; and lastly, on no account should the lamp be placed in any situation where the oil can be raised to above its vaporising point, or an explosion is well-nigh certain to be the result. Servants will sometimes place a lamp on a range, in order to observe some cooking operation, ignorant of the great danger to which they are exposing themselves and the entire household in case of the ignition of the vapour. In default of an apparatus for extinguishing the lamp (which is much to be desired), the best plan is to turn the wick well down, and then blow a little upward and across the top of the glass tube, by which means the flame may be easily and safely extinguished.

There are so many erroneous opinions prevalent with regard to the explosive properties of petroleum, that it may be well if we here state what the common burning oil really is, and how it is prepared for household use.

The mineral oil burned in lamps is petroleum oil, and not "paraffine," as it is usually termed. The crude oil, as obtained from the wells, is mostly explosive, and unfit for burning in lamps. It is therefore submitted to a process of distillation, by means of which the more inflammable portions are removed. The two first products of this distillation are kerosene and a spirit known as benzine, both of a highly inflammable and dangerous character. The next product is the ordinary burning oil. This, if

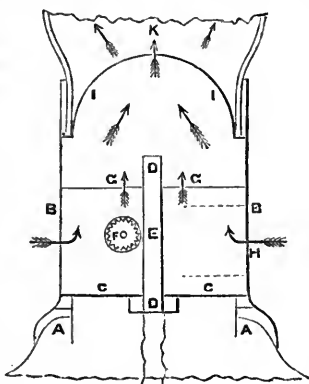

Fig. 1

properly prepared, does not either explode or give off inflammable vapour at ordinary temperatures, and is, consequently, perfectly safe. A very simple plan of testing petroleum oil is to pour a little into a saucer, and apply a lighted match to the surface. If the oil is fit for use it will not ignite, and on immersing the match the flame will be extinguished; while, if it is capable of giving off inflammable vapour at ordinary temperature, it will at once take fire, and should be rejected. It is purely a fallacy to suppose that even crude petroleum is explosive of itself; it is inflammable and burns furiously, but in its fluid state it cannot explode. The only chance of explosion is when petroleum vapour becomes mixed with atmospheric air, when an explosive mixture is formed; but even this will not ignite unless brought into actual contact with a flame. From this it will be seen that there is little or no danger incurred in the use of petroleum oils, if only ordinary care be exercised. Still, it should be remembered that the oil is highly inflammable, and it should be stored, if possible, out of the house, in case a fire should occur. As in many other instances, the rage for cheapness has led some tradesmen to purchase and sell inferior oil, the use of which is attended with some risk; but, happily, the great bulk now sold is perfectly free from even a suspicion of danger. The following table shows the comparative cost of light obtained from various materials for a period of ten hours, the quantity of light being of course equal:—

	s.	d.
Wax	7	2
Tallow	2	8
Sperm Oil	1	10
Coal Gas	0	4½
Paraffine Candles	3	10
Petroleum Oil	0	6

From this it would appear that, with the exception of coal gas, petroleum oil is the cheapest source of artificial light with which we are yet acquainted; and we may reasonably expect that, now we can be well assured of its safety in use, it will become much more extensively adopted even than it is at present.

HOUSEHOLD DECORATIVE ART.

GLASS PAINTING.

THERE are two methods by which coloured glass windows may be made. In the first, a number of pieces of glass, which have been stained with colour in making, are fitted together with thin leads, in such a manner as to form figures and ornamental patterns. On these *some* painting is employed, but the main effect depends upon the original colour of the pieces. This is called stained glass work; windows of the Gothic period, and those placed in churches within the last thirty years, are thus formed.

The second method consists of painting in colours on plain glass—forming, in fact, a transparent picture, as the other may be said to form a transparent mosaic. This is called enamel painting on glass; it was used for the church windows of last century, and is now chiefly employed for house decoration.

Of the two, stained glass is by far the most brilliant and beautiful, but it cannot well be fitted into ordinary sashes, and in the windows of dwelling-rooms the necessary lead lines are often objectionable; it may, however, be well employed in the upper parts of the windows of houses in the Elizabethan style, and frames fitted with it, hung against common plain glass windows, have often a good effect. Enamel painting, on the other hand, is specially suited to the large squares in the windows of modern houses.

As both methods are successfully practised by amateurs, and especially by ladies, we shall give the mode of pro-

cedure in both. Those who attempt enamel painting or figure-subjects in stained glass, should have some previous knowledge of drawing, and the use of the brush; great artistic skill is not required, as the effect depends more on the beauty of the material than accurate drawing or fine art qualities. Decorative work, calculated to add greatly to the appearance of rooms, in geometrical patterns and the like, may be done by any ingenious person. Of this we shall speak in the latter part of these articles but we shall first describe the more elaborate processes.

Materials.—First in place among the materials will be the glass itself. The best plain glass for enamel painting, and employment as white in stained work, is common sheet glass—plate glass does not take colour so well. It should be about one-tenth of an inch thick, and should show a green tinge at the edges: its cost will be about sixpence per square foot. The stained glass is of two kinds—pot-metal, in which the colour is equally diffused through the whole thickness, and flash glass, which has only a film of colour on one side. The most brilliant and expensive colour is “ruby,” the best of which costs 2s. per foot; all other colours may be bought at about 1s. 6d. All kinds of stained glass are commonly kept at glass warehouses. Two *applied* colours only are used for stained glass work—China pink, and a solution made by dissolving silver in nitric acid, which gives a fine yellow. The enamel colours are composed of mineral pigments, fused with a soft kind of glass, and afterwards ground. All these must be procured from a professional glass painter; the prices vary greatly, and cannot be stated. A sovereign will, however, buy a sufficient stock to last the amateur many months.

Tools.—Of these the most important are, a transparent easel, which can be made by a carpenter for 5s. The annexed cut shows a good form for the amateur. It is composed of a wooden frame, covered at the back with thin semi-transparent paper, and in front of this with a sheet of glass. Over the top is a mill-board shade to exclude unnecessary light. It must have *two* back-legs, instead of one like the ordinary easel, that no shadow may be thrown across the work. It should be raised a few inches above the table on which it stands, that the light may pass beneath to the palette. On this the glass is placed to be painted.

Brushes.—A flat badger-hair brush four inches wide for “matting,” camel-hair brushes long and fine for tracing, and short (some flat and some round) for painting, and stiff, short, hog-hair brushes for scrubbing out. The whole will cost about 10s. A ground-glass slab, muller, and palette-knife will also be required, to grind the colours, and will cost 6s. A few small palettes of common ground glass, six inches square, at 3d. each, will also be convenient.

Stained Glass.—Before beginning a work in stained glass, it is usual to make a small sketch, in which the arrangement of colour can be decided. This being done, what is called a cartoon is drawn, which gives the design the full size of the work; this is sometimes coloured, but not generally. In this, the leads are indicated by broad black lines, and much care is necessary in arranging them, that they may all fall in parts where they will not spoil, but rather add to the effect of the work. It is also necessary to take care that the shapes of the different pieces of glass are such as it is possible to cut without breaking. The lead lines are traced off on a piece of paper, which is laid on a board; over this the sheets of coloured glass are laid, and the pieces required cut out with a glazier’s diamond, the black line below showing through the glass, and serving as a pattern. Between the different pieces of glass, intervals of one-eighth of an inch are left, to allow for the insertion of the lead. Most amateurs will prefer that this, as well as the final operation of soldering the leads together, should be done by a

glazier. As, however, some may wish to do the whole work themselves, and the description of the process will be interesting to all, we shall give sections on them hereafter. The sheet of plain glass which forms the front of the easel is next laid over the cartoon, and on this the lead lines are also, as well as all the other *lines* of the design, traced with a camel-hair pencil and rather stiff Indian ink. The pieces of coloured glass are then taken one by one from the glazing-board, well cleansed with quicklime and water, and "matted," which is done as follows:—The glass is first brushed over with tracing colour ground finely, with water in which a *little* gum Arabic has been dissolved; only a little gum must be used, or the surface will be liable to crack. The tracing colour may be bought ready prepared from a glass painter; it consists of oxide of iron, powdered glass, and some substance such as brickdust, to give a "body;" black or brown may be used, according to the nature of the work. The "mat" is worked quite flat and equal with the large flat badger-hair brush till it begins to dry; the pieces are then fastened in their respective places on the easel-glass with wax—that used is composed of equal portions of bees-wax, pitch, and resin melted together in an earthen pipkin; this is dropped in small spots, while hot, in the spaces left between the pieces of glass for lead work. Care is required in melting the wax, as the substances are highly inflammable. The easel is placed with its back to a window, so that the light may pass through the work to the painter, and the cartoon set beside it for convenience of reference. The painting is now begun. All lines in the design are first traced on the coloured glass over those already indicated on the glass of the easel. To be effective, these lines should be broad and bold, as they look much fainter in the finished work. Wherever strong shadows are required, they are also now put in by cross hatching. The colour used is the same as for matting, and with no more gum than is just sufficient to attach it to the glass. Lights are made by scrubbing off a portion of the mat with a stiff hog-hair brush. The whole is then washed over, to fix the colour, with a clean brush and spirits of tar. Afterwards the work is again gone over, and the lines and shadows strengthened where required with the same colour, but ground this time with spirits of tar instead of gum water. Finally, the high lights are made by removing the whole mat where required, and clearing the glass with a point of hard wood.

After this has become dry, applied colours, if any are used, are put on. In figures, it is usual to make the faces and hands of plain glass, and these are now tinted with China pink. The colour is ground with spirits of tar, and brushed on quickly, or there is danger of washing up the mat. The bright yellow, technically known as "gold stain," is also applied at this stage, if required; it is often used for veins of leaves, letters in inscriptions, borders of draperies, and similar purposes; and frequently proves a valuable resource. It is made by dissolving silver in nitric acid,

in the proportion of a half-crown piece to a gill of acid, to which a handful of common salt is added; afterwards to give body, and make it more easily seen while applied, it is thickened with finely-ground red ochre. This solution is applied on the *back* of the glass, which for that purpose has to be taken from the easel and laid flat, with its face downwards, on a table. An outline in the solution is drawn with a camel-hair pencil round the part to be stained, and the colour allowed to flow equally over the enclosed space.

The next process is *firing*, by which the colours are so fused with the glass as to become a part of it. This is usually done in kilns, which are iron ovens fitted with sliding shelves of the same material. The shelves are covered with a bed of powdered whitening, which must be thoroughly dry and perfectly smooth. On this the pieces

of glass to be fired are laid, and the kiln heated to as high a temperature as can be reached without melting the glass, which, however, becomes perfectly soft, and would lose its even surface, were it not prevented from so doing by the level bed of whitening. When the proper heat has been reached, the kiln is allowed to cool gradually; if this should take place too rapidly, there is danger of the glass breaking. In towns, where the work can be conveniently sent to the kiln of a regular glass painter to be fired, it is better for the amateur to adopt that course; the ordinary charge for firing is 6d. per foot; some amateurs, however, use a "muffle," which is a miniature movable kiln, made of iron, and, like it, fitted with slides; the pieces of glass are laid upon whitening within it, in the same manner as the kiln. It is then placed in a strong fire, with coals heaped over it; but this contrivance can only be used for small pieces.

After firing, the glass is well washed, and examined against a strong light. Blisters will sometimes have arisen in the kiln; if so, they are rubbed down with pumice-stone and water, and the defect repaired with new colour. The lines and shadows will also have grown fainter in firing, and will probably want re-touching in parts. Where "gold" stain has been applied, an opaque coat of ochre will remain on the glass. This is scraped, or, better, washed off with spirits of turpentine; and, if the yellow appears too faint, new solution is floated on. A second firing is now necessary, but should no re-touching of any kind have been needed, one firing is of course sufficient. If a second re-touching is resorted to, a third firing follows.

Enamel Painting.—For this, the preliminary sketch and cartoon are made in the same manner as for stained glass; but as the whole design can be formed on one piece, the painter has much more freedom in the treatment of his subject; for there are no difficulties in the shape of cutting out glass or lead lines to be attended to. The cartoon, however, is not coloured, as it sometimes is for stained glass; for if it be simply in black and white, it can at once be placed on the easel behind the glass to be painted, and lines and shadows traced from it. All the



TRANSPARENT EASEL AND SHADE.

earlier processes in enamel painting are precisely the same as those in staining. It is not till after the first firing that the actual enamel painting begins. The colours are, as has already been stated, vitrified into a kind of glass. They are, in the first place, ground fine with gum water, in the same manner as the tracing colour, and applied like it, and flattened down with the badger-hair brush. These colours are laid on as flat washes merely, all lines and light and shadow having been formed in the previous treatment with tracing colour. When dry, they also are washed over with spirits of tar; and a second coating of colour, to render the lines more intense, ground with turpentine, is applied. This, too, has to be rendered perfectly flat with the badger tool. The glass is now fired a second time, and the colour re-touched and strengthened where necessary, and, of course, fired afterwards. If deep colours are required, it is well not to lay on a thick wash at once, or it may blister in burning, but to gain strength by putting on successive thin washes and firing between, repeating the process till sufficient depth has been gained. The enamel colours are weak and ineffective as compared with stains, and no applied colour, corresponding to the beautiful "ruby" stain, exists; the best red is a purple-pink, which may be converted into an imitation of ruby by applying silver solution at the back.

COOKING.

VEGETABLES.

Vegetable Soup.—Pick, wash, and drain a good quantity of green vegetables, such as lettuces, sorrel, orach, purslain, chervil, celery, &c.; shred them with a knife. Roots—as carrots and turnips—are to be chopped small; bulbs—as leeks and onions—to be sliced very thin. Put them over a gentle fire, in a large stewpan, with a good lump of butter; keep turning them about with a wooden spoon, so as neither to let them brown nor burn. When they begin to soften, dust in a little flour, which will give the soup a certain smoothness and consistency, pleasant to the palate as well as to the eye. Then stir in enough water to dilute it and make the requisite quantity of soup; on meat days broth may be substituted for water. Let all boil together till every kind of vegetable is perfectly tender. Take the soup off the fire; stir a few spoonfuls of it into two or three egg-yolks broken into a basin. Combine the mixture with the soup to thicken it. Put a few very thin slices of bread at the bottom of your soup-tureen, and pour the soup over them.

Potatoes au Maître d'Hôtel (Steward's Way).—Slice cold potatoes; put them into a stewpan, with just enough butter to oil their surface completely; dust them with a little finely-chopped parsley, pepper, and salt. Stir the potatoes about in this, heating them thoroughly, but not actually frying them.

Mashed Potatoes.—It must be understood that potatoes for mashing must be mealy, well cooked, and yet not sloppy, but thoroughly dry. Heat the bowl before you put them in (to help to drive off moisture), and mash them to a pulp, or rather, to a pasty powder, with a wooden spoon. You may add a dust of salt, and perhaps pepper, if desired. But some cooks mix in butter and milk, or cream, which are all very well if you want a *purée of potatoes*, which is a thing by itself, quite different from genuine mashed potatoes. The *purée* you may make with any inferior quality of potato; the latter, in its perfection, is to be obtained only from the most floury, and is one of the nicest ways of dressing that vegetable. Mashed potatoes may be served simply heaped on the dish; or, when so dished, they may be set under a salamander to have their surface browned, which will help to drive off superfluous moisture; or they may be put into a pudding-basin or mould (buttered inside), and set into the oven just long enough to gild the

surface in contact with the mould. They are thus not only heated and dried, but their cooking is thoroughly consummated.

Souffled Potatoes.—This elegant preparation is not very difficult to execute. Peel potatoes; cut them, in the direction of their length, into slices a quarter of an inch thick; fry them, till they are three parts done, in *moderately* hot fat. Take them out, drain, and let get nearly cold. Then throw them into *very hot fat*, and plenty of it; keep them moving with a slice till they are well *souffled* or swollen, and of a nice light brown, which takes place almost immediately. Take them out, dust with a little very fine salt, and serve at once.

Carthusian Potatoes.—Wash mealy potatoes, cook them in their jackets, either in the ashes, or in a saucepan with just enough water to cover them. In the latter case, when cooked enough, pour off the water and let them dry in the saucepan. Peel and mash them; then mince an equal quantity of any underdone cold meat you have—mutton, veal, fowl, or game. Mix this with the mashed potatoes, seasoning with butter, pepper, salt, chopped parsley, and chives or young green onions. Incorporate with the whole two or three raw eggs, according to the quantity. Make these into balls a little less than a hen's egg. Dip them first into beat-up egg, then roll them in flour or bread-crumbs, and fry them *nicely*, so as to be light-brown outside and *not* greasy within. Pile them on the dish in a pyramid, and serve garnished with fried parsley. They themselves are an appropriate and substantial accompaniment for any kind of hash or stew.

Stewed Carrots.—Cut the green tops off short-horn carrots immediately they are drawn from the bed. Scrape them slightly, cut off the filaments, and throw them into cold water. Brown in butter a very small quantity of chopped onion and flour; if onion be objected to, some other browning, as caramel or burnt sugar, may be substituted; but so little will suffice that it will hardly be suspected. Then stir in as much good stock as will cover the carrots; when it boils throw them in; season *very* slightly with pepper and salt. As the stock reduces keep stirring them, to prevent sticking and burning. By the time they are done, the gravy should be reduced almost to a glaze. Transfer them to a hot vegetable-dish, and pour the gravy over them.

Long-horn or Altringham Carrots as Carrot Soup.—To keep this as *red* as possible, some cooks reject the hearts of the carrots. After proper cleansing, cut up into slices as many carrots as you want, with a turnip, a leek, and an onion, and boil them in no more than sufficient water till they are soft enough to squeeze through a cullender. Return this *purée* to the boiler, and dilute with good veal or beef stock; season lightly with sugar, salt, and pepper; keep stirring while it boils up. Put into your soup-tureen either dice of toasted or fried bread, or a little rice boiled separately, and after one more stir-up pour the soup over them. Parsnips are generally halved or quartered before cooking, and so served as a sort of garnishing; but they may be mashed or chopped fine, reheated in a saucepan with butter and pepper, and served separately in a vegetable-dish.

Boiled Salsify.—The root of this plant resembles a stick of horse-radish, only covered with a rind as black as soot. Scrape off the rind till you come to the flesh, which resembles that of the parsnip in substance and colour. Cut the roots as scraped into three-inch lengths, and throw them for a couple of hours into a pail of cold water, which they will discolour with a tinge of reddish-brown. Throw them into boiling salt and water, and keep it boiling incessantly. They will take at least an hour to cook, which is the only inconvenience attending their dressing. When quite tender, drain them; arrange them on a hot dish as you would asparagus, and pour over them either good melted butter, white sauce made with cream, or—

Dutch Sauce.—Put into a saucepan (an earthen pipkin is better) a quarter of a pound of the best butter, three or four raw egg-yolks, a teaspoonful of flour, a little salt, and a dessertspoonful each of cold water and lemon-juice or vinegar (tarragon or plain). Set this on a very gentle fire, or, if you can, in a large stewpan half-filled with boiling water. As the butter melts, keep stirring incessantly in one direction, till the sauce is perfectly smooth and even. Should it threaten to oil, throw in a dessertspoonful of cold water and stir again. You may season further with a little pepper. Taste if the sauce is to your liking, and just before serving add a few drops more vinegar. Instead of putting in all the butter at once, you may incorporate it with the other ingredients piecemeal—say in three separate portions, one after the other. But then the stirring must never stop, which, in fact, is the grand secret of making this sauce good. Dutch sauce is served not only with vegetables (asparagus, cauliflower, sea-kale, Jerusalem artichokes, salsify, &c.), but with boiled fish, meats, and poultry—with anything, in short, requiring a delicate white sauce.

Fried Salsify has this convenience, that when preparing a dish of boiled salsify you can cook double the quantity you want, and reserve half of it for frying next day. Before frying, you may steep your cold salsify in pepper, salt, and vinegar, but it is not necessary. If you do so, drain them well, then dip them one by one in frying batter (see below), and throw them into a pan of hot fat, according to the directions previously insisted upon. When done of a nice light brown, take them out; let them drain a moment on the slice, or on a hot coarse towel; pile them in a pyramid on the dish, and serve garnished with fried parsley. No sauce is required with them. We give other receipts for fried vegetables, which the intelligent cook can easily extend.

Salsify and Cream.—Another way of warming-up cold boiled salsify is to put it in a stewpan with a lump of butter; as that melts, add a little flour; dilute with cream or milk; season with salt and grated nutmeg; let all boil together, well stirred, and serve. Salsify roots, left in the ground, will send up in spring stout green shoots, which are excellent, boiled and eaten like asparagus.

Fried Celery.—Select solid, moderate-sized heads of celery; cut off the tops so as to leave them six or eight inches long, including the sweet and nutty portion of the root. Split the heads in halves, and wash them thoroughly to cleanse them from every particle of grit or sand, without detaching the leaf-stalks. Then boil them, but not to a mash, in good, well-seasoned broth. Take them out; let them cool and drain as dry as may be. Thus prepared, they are ready for frying. When wanted, roll the half-heads of celery in flour, dip them in frying-batter, and fry them with your utmost skill. Pile them in the same way as sugar biscuits on the dish, and serve as hot as possible. They need no sauce; nevertheless, you may send up with them a little savoury brown-gravy sauce, made with the broth in which they were boiled. To complete this receipt, we give—

Batter for Frying Vegetables, &c.—Make a thickish batter with water or milk and a quarter of a pound of flour. Add a little salt, and half a wine-glass of brandy; stir all well together. Beat an egg, white and yolk, to a froth, and incorporate it with the batter. After standing an hour in a warm place, it is fit for use.

Fried Chardoons.—Many English cooks, if chardoons were put into their hands, would not know what to do with them. The best ways of dressing them are frying and stewing. The chardoon resembles a head of celery in shape, but is much larger. After trimming the outer leaves and roots, it may be cut into two lengths, and the lower half split in two, or quartered according to size. Boil these in salt and water till tender; then take them out to cool and drain. For stewing, they

have only to be put into as much rich savoury gravy as will cover them, and, when thoroughly done, to be served with the same poured over them. For frying (to be performed exactly as with celery), the upper portions of the leaf-stalks will probably be the most convenient; nevertheless, the quartered hearts, if sufficiently reduced in size, fry perfectly.

The Jerusalem Artichoke.—The only secret in cooking it is, first to peel it, throwing each root immediately afterwards into cold water, to avoid the contact of the air, which would brown its surface as it does that of a cut apple. Put them next into boiling salt-and-water, and boil them till tender (from twenty to five-and-thirty minutes), which a fork will test; then pile them on a dish, and pour over them melted butter, white sauce, or Dutch sauce. They may also be mashed, and served in the same way as mashed parsnips. The famous Soyer peeled a dozen into the shape of a pear, and boiled them in three pints of water, with one ounce of salt, one of butter, and a few sliced onions. When tender, he made a border of mashed potatoes on a dish, fixed them on it point upwards, sauced them over with either cream sauce, white sauce, melted butter, or maître d'hôtel, and placed a fine Brussels sprout between each; a contrast which is exceedingly simple, pretty, and inviting. They are also good fried, the small ones whole, the larger ones divided, after a dipping in batter, or in egg and bread-crumbs. Cooked in this way well, they require no sauce but a little salt.

Leeks are at their very best in February and March. They may be served as a vegetable, like asparagus, with melted butter; but are better used in combination with other things in pottages, to which their mucilage is a valuable addition.

Cabbage Plants when cooked and laid in their dish, merely require squeezing with a plate, holding the dish sidewise, to express the water. Early York and other summer cabbages may be done the same way; but as they will be more substantial, after squeezing in their dish, they may be cut across with a knife into squares of a size for helping, and have a little butter spread upon their surface, and also be slightly peppered. The same may be said of *savoys*, more substantial still, as well as of other *large-hearted* cabbages, of which the drum-head, though often grown for sheep and cattle, is an exceedingly sweet and delicate table cabbage. Brussels sprouts, after a slight squeezing, may be served plain; or, for meat days, with good gravy, and for meagre days, Belgian fashion, with matrimony sauce.

Cabbage Cake.—Boil any large-hearted cabbage (slit at the stalk-end to let the water penetrate) quite tender. Squeeze the water from it, and chop it small. Butter well the inside of a cold stewpan; dust it with grated biscuit. At the bottom put a layer of chopped cabbage three-quarters of an inch thick; then a thin layer of sausage-meat, nearly cooked in the least possible quantity of water; then another layer of cabbage; and so on, till the stewpan is nearly full, letting cabbage be the upper layer. On this spread a few thin slices of bacon, and set it into a very gentle oven. When you judge the chopped meat done enough, turn out the whole on to a dish, as from a mould, and serve either plain or surrounded with rich brown sauce. Minced cold meat may be used instead of sausage-meat.

Chopped Cabbage, without taking the trouble to mould it, makes an appropriate bed for boiled or fried sausages, fried or poached eggs, pork chops, broiled kidneys, brown-stewed sweetbreads, and many other small things.

Stewed Red Cabbage.—This is valuable, because the cabbages may be planted so as to be ready in Lent, when few other vegetables are available. Shred the cabbage, as for pickling; rinse it in cold pump-water. If you have any sweet fat salt meat boilings, you may use them to cook it in; but if you have the slightest doubt, use salted

water instead. Throw the cabbage into boiling water, and let it boil galloping till tender. Then drain it in a cullender, squeezing it slightly. Lay the cabbage on a chopping-board, and chop it. Put a lump of butter in a stewpan, and upon this throw the chopped cabbage. It will then be of a dull purple, not tempting to look at. Pour over it a dessertspoonful of vinegar, and mix well; the colour will immediately change to that of pickled red cabbage. More vinegar may be added, if a sharper flavour is liked. Season with pepper, stir in more butter, and, when quite heated through, serve. It makes a handsome substratum for boiled sausages or poached eggs. Good beef or veal dripping may be used instead of butter. Stewed red cabbage heats up again perfectly. One large cabbage will furnish several dishes.

Cauliflower, with Stuffing.—Cut your cauliflowers into sprigs or branches; throw them into boiling salt-and-water; let them boil two minutes; then take them out and drain them. Cover the bottom of a stewpan with thin slices of white bacon. On them put your cauliflower sprigs, upright, heels upwards, as tight as you can pack them. Fill up the interstices with a stuffing made of fine minced veal or pork (cold meat will do), beef suet, breadcrumbs, pepper, salt, and a little chopped parsley or other sweet herb. Beat up three eggs, and pour them over these. When they have soaked in, add enough broth to cover the whole well. Then stew over a gentle fire. When the cauliflowers are tender, and the sauce all but evaporated, clap a hot dish on the stewpan; turn the latter topsy-turvy, and the cauliflower will be left standing in a handsome mass. This, which might be called cauliflower pudding, makes a showy dish, and does not really give much trouble, nor take a long time to do.

Couve Tronchuda, or Portugal Cabbage (in French, Chou à grosse côte, large-ribbed Cabbage).—An excellent cabbage when taken at the right time, but hard and tough when cut in certain states. It (or rather the seasons which influence it) is somewhat capricious; hence, different people look upon it with different degrees of favour. Portugal kale is best after a continuance of mild, cloudy, showery weather—for instance, in spring after a mild winter. This cabbage does not form a heart; but, in recompense, the veins and footstalks of the leaves are of extraordinary thickness, being swollen more than is seen in any other variety of the tribe. This general succulence of habit, added to its delicate glaucous-green colour, which often becomes yellow in the centre of the plant, as if it were blanched, gives it a very prepossessing appearance. The directions for cooking usually given are, to strip off the green part of the leaves, and to eat the ribs and footstalks, boiling and serving them like sea-kale; but when they are sufficiently full grown to be so treated, they are mostly tough and hard. *Couve tronchuda* has thus been brought into disfavour. The middle part of the plant, which ought to be the heart, is excellent for table use; it is fleshy, delicate, sweet, tempting to the eye as well as agreeable to the palate, tasting something between cauliflower and sea-kale, and, therefore, possesses all the good qualities of cabbage, without the strong flavour and smell with which that vegetable is sometimes chargeable. In cooking, take care to throw the heads into a large vessel of boiling water. Sow from the end of May to the end of June. We add these instructions, because the plant is more adapted for private gardens than for sale at market. A single sowing will suffice, as from the same seed-bed three or four transplantations may be made during the summer, some of which will turn out better than others, according to the chances of the season; but very frequently the latest the best. The plant is not particularly tender in ordinary winters; but if a small space on a

south border can be spared for a late setting of Portugal kale, with a few handlights to cover them, the gardener will find himself repaid in spring by some excellent dishes of delicate greens.

Sea-kale (Crambe maritima).—It is curious that a vegetable now so highly esteemed should have been introduced into the London markets with difficulty. Its cultivation—and that very restricted and local—dates from little more than a hundred years back, although on many parts of the south coast the inhabitants, from time immemorial, have been in the habit of searching for it when blanched by the drifted sand, and cutting off the white shoots close to the crown of the plant. It is the blanching which makes sea-kale so delicate; unblanched, it is uneatable; and we have known French people, who had come into possession of gardens where it had been planted by English occupiers, root it up and throw it away; because, not being aware of the mode of earthing it up or covering it with pots, they had tried its full-grown leaves, and found them detestable. It is the action of light which gives sea-kale its strong and bitter taste, as well as its glaucous-green and reddish-purple colouring. Consequently sea-kale, as soon as cut, should be kept in a dark place until wanted. By exposure for several days on a greengrocer's stall it will acquire a decided tinge, which injures both its appearance and its flavour. Select, therefore, sea-kale as white as ivory, brittle, and with every other appearance of freshness.

Sea-kale.—After careful washing and brushing to remove all sand and grit, throw the sea-kale into boiling salt-and-water. If young and fresh, it will be cooked in from twenty to thirty minutes; if stale and discoloured, it will take much longer, and also discolour the water in which it is boiled. In this case it is desirable to change the water when the kale is half done; in short, the best sea-kale is the easiest cooked. Try with a fork if it is tender; take it up and drain it; lay the heads in one direction, like asparagus, on a toast or sippet, and mask it with melted butter, white sauce, or Dutch sauce. If the water in which it was cooked remains colourless, the toast may be soaked with a little of it; otherwise not, as it is sure to be bitter. Though usually served white, sea-kale may be stewed brown, by transferring it when three parts done, to rich brown gravy, and finishing it off in that.

Asparagus officinalis is another hardy, native, maritime plant, still found wild on some parts of the coast. Its seaside origin is proved by its tolerance of, if not its fondness for, salt. An approved mode of weeding asparagus-beds is to sow them with salt, which kills the weeds and worms, but does not touch the asparagus. It is so old a vegetable as to have been a favourite with Cato. But although so long under cultivation, and always propagated by seed, the varieties into which it has run are not numerous nor marked. Choose bunches of asparagus which have the cut fresh and the heads straight. If the cut end is brown and dry, and the heads bent on one side as if stretching in that way in search of light, the asparagus is stale. Scrape off the white skin at the lower end and shorten it a little, so as to make the heads of equal lengths; throw them, as done, into cold water, and let them remain there till cooking-time. Then tie them into small manageable bunches, and throw them into boiling salt-and-water. They will take from twenty to five-and-thirty minutes. Fresh asparagus cooks more quickly than stale. On untying the bunches, lay them with their heads all one way, either by themselves in the dish, or on a toast moistened with the water in which they were boiled. Sauce for asparagus is oiled butter (excellent, and much used abroad), melted butter, or white sauce. As it is permitted to eat asparagus with the fingers, it is best to send up the sauce separately, instead of pouring it over the vegetable.

ANIMALS KEPT FOR PLEASURE.—BIRDS.

THE CANARY.

UNDER the above title we propose to devote a series of papers to the proper treatment of this class of domestic pets. We shall also speak of the management of English song birds; but, while we do so, we wish it clearly to be understood that we are no advocates for keeping such birds in cages. Among all living creatures, none are more formed by nature than these to find their happiness in freedom; and those who condemn them to a life of captivity and consequent misery, may rest assured that the pleasure which any human being can derive from constituting himself the gaoler of one of these innocent creatures is an unhealthy and vitiated one. That birds should sometimes be destroyed as food, or for the protection of property from their ravages, is necessary; and the delight which uncultivated minds find in the destruction of animal

of nightingales. We should be glad to meet the Berlin police on such an errand of mercy in the Seven Dials. This, be it understood, applies to British song birds only. To keep a canary is as legitimate as to keep a cat or a dog; like them, it has lived in a domestic state for generations; it has become, so to speak, purely an artificial animal, ignorant of, and unfitted for, the sweets of liberty; and the limited amount of happiness it is capable of enjoying can only be attained in the cage. It is a grateful task to us to show how that happiness can most fully be imparted. Our directions for the treatment of British song birds are given in the hope of ameliorating the condition of those kept. If people will persist in keeping them, they should at least know how to reduce their sufferings to the minimum. But let no person buy an English bird from motives of compassion; for, were there no comparatively speaking tender-hearted purchasers, the brutal bird-catchers would find their occupation gone.

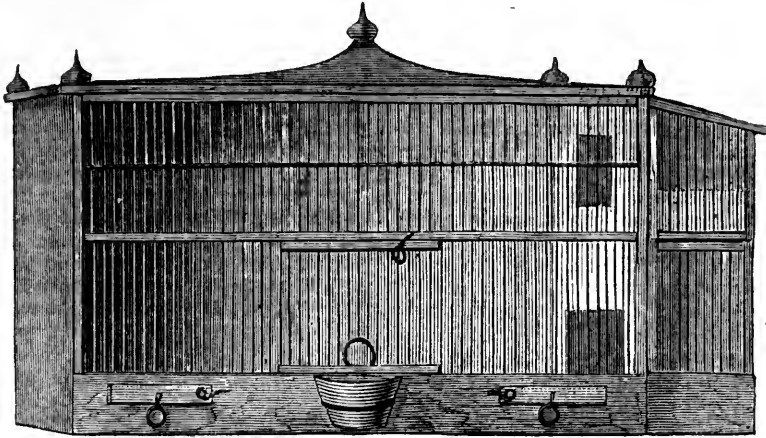

Fig. 2.

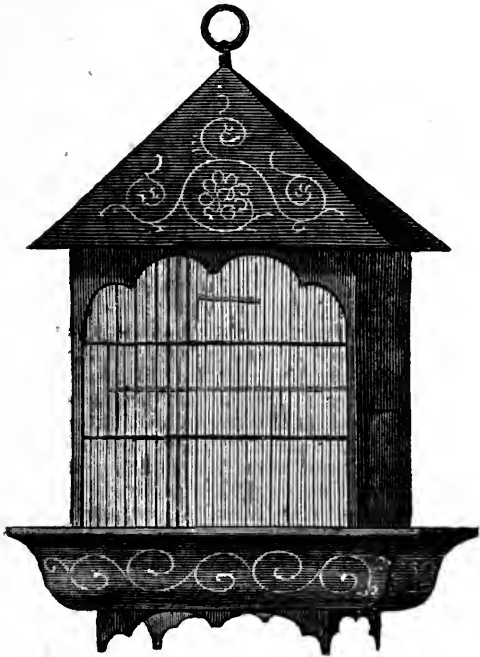

Fig. 3.

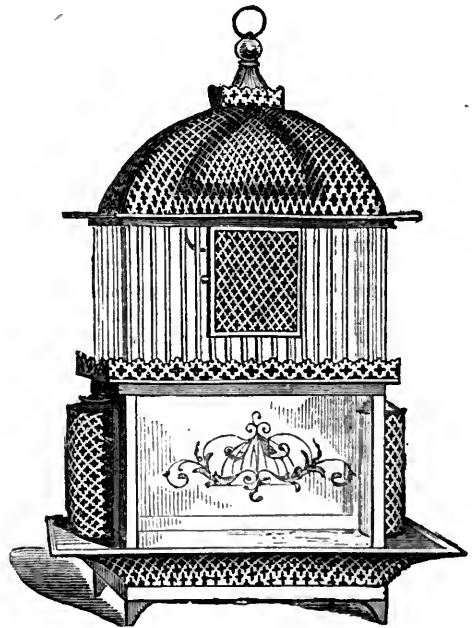

Fig. 4.

life may be, to some extent, excused as a natural instinct implanted in man for his own preservation; but no such plea can be used for those who wantonly deprive them of liberty. The bird-catcher and bird-keeper hold that relation to the honest sportsman that the slave-dealer holds to the soldier. In Berlin, the authorities occasionally make a descent on the captors and dealers in birds, liberate their victims, and fine heavily all who are found in possession

Cages.—Of first importance to those who propose to keep birds is the selection of proper cages. Some excellent hints on this subject are given in that charmingly original, and on this and kindred matters exceedingly well-informed work, "Kidd's Own Journal," from which we quote the following: "The cages in general use are altogether ill adapted to comfort, being open to the air at every point, and admitting a succession of draughts from

morning till night. Above all things, avoid the circular, open-barred brass cages, with sliding doors, now so much in vogue. They are frightful instruments of destruction. The brass, when water lodges on it, presents gangrene, and, when this is tasted, produces sometimes a lingering, sometimes a sudden death. All manner of cheap cages, too, must be regarded as inadmissible; they are made of dry deal and invariably harbour vermin. The proper description of tenement for a canary is a mahogany cage thirteen inches long, eleven inches high, and eight inches deep. The top, back, and one of the sides should be of wood; the other side, as also the front, should be of tinned wirework, so as to admit the air, and at the same time exclude a thorough draught. Just above this wirework, at the side, should be a wooden slide, running in a groove; it might then be used or not, as occasion might require. The cage inside should be painted white. A long, square, but narrow perch should run from end to end, about the centre of the cage; and a second, of a similar kind, directly behind the two tin pans inserted at the front of the cage, one on either side, to hold the seed. In the middle of the wirework, at the front, let there be a hole sufficiently large to admit the bird's head while drinking. Never use glasses or fountains for holding water, but receptacles of tin, suspended by bent wires. Glasses and fountains are apt to get displaced, and many a prisoner dies for want of water, thus unthinkingly removed beyond his reach. By having these two perches only, the bird's feet will be kept clean, and he will have plenty of room for exercise, without injuring his plumage. In addition to the water supplied in the tin, it is always expedient to have a square earthenware bath, fitted in a mahogany frame, ready for use. These are so made as to be easily suspended on the doors of the cages, when the latter are opened. They are over-arched with wire, to prevent the bird escaping, and are obtainable of any dealer." A cage answering to this description is shown in our illustration (Fig. 1).

Breeding cages for canaries are required of larger proportions; the following are given as suitable:—Length, 2 feet 4 inches; depth, 12 inches; height, 20 inches. The top and sides should be of wood, the front of strong tin wire. Three or four perches should run across the cage, and a little chamber, or rather one large chamber divided into two, should be made immediately under the top of the cage to hold the nest-boxes; in front of these should be circular holes, to give ingress and egress to the birds; and behind, in the side of the cage, doors by which you can yourself get access to them. Beneath the nest-boxes should be a small cage separated by wires from the larger one: this is for the young birds after they have left the nest. A distinct apartment of this kind is rendered necessary by a habit which the old birds have of plucking off the feathers of their young to line the nest for their next brood. This arrangement will prevent their being thus disfigured, and their wants will be provided for by the cock, who will feed them through the wires. The arrangements for food and drinking water should be the same as in the inner cage; but breeding birds will not

require the bath. Fig. 2 shows a breeding cage of the most approved form.

For most descriptions of small song birds the ordinary cage described above will be suited; but those which are of larger size than the canary will demand cages on a larger scale. The blackcap's cage should be 16 in. long, 13 in. high, and 10 in. deep; the nightingale's should be 17 in. long, 14 in. high, and 11 in. deep; and as the latter bird is of shy habits and loves seclusion, both sides of the cage should be formed of wood; it is well also to provide a green curtain, behind which he may shelter himself, if so disposed. His food must not be given him in tins.

In all cases it is most desirable that the woodwork of cages should be of mahogany, French-polished without, and painted within with two or three coats of white oil-paint, as a safeguard against those pests of cage birds, parasitical insects. Care must, however, be taken that nightingales are not placed in newly-painted cages, or, indeed, near white paint generally; for, so delicate are their lungs, that the white-lead will prove fatal to them.

When cages have become infested with vermin, rectified vegetable naphtha, applied to every part, has been found a complete remedy.

The wires of cages should not be painted; the paint is liable to be pecked off, and, being eaten by the birds, to prove injurious to them. The best material for this purpose is tinned iron wire, which can always be kept clean, and does not rust.

A description of cage, composed wholly of zinc and wire, has been recommended on the ground of its greater cleanliness. It is of German origin, and differs in several respects from those in general use. We show such an one in our illustration, Fig. 3. The bottom is movable, and the ordinary drawer or tray is thus dispensed with. When

it requires cleaning, the small catches which fasten the upper and lower parts together are undone; and the former, with the bird in it, can be set on the table, while the latter is thoroughly washed. The bottom extends some two or three inches beyond the upper part, and forms a tray in which the dirt and seed thrown out by the bird are caught, instead of being scattered in the usual objectionable manner over the carpet. If necessary, such a cage as this might be plunged bodily in hot water, without suffering damage, and the most perfect cleanliness insured. The zinc, when japanned, may be made highly decorative, and the cost ought not to be much greater than that of wood, while it would last much longer.

A good wire cage which protects the bird from cold and draughts, is shown in Fig. 4. It shields the bird, without concealing it, by being surrounded to a certain height by sheets of ornamental glass, and is certainly one of the best obtainable, as it secures all the advantages we have described as desirable or necessary, and it is at the same time ornamental in its general effect and details. Any bird exposed to the air is not so well sheltered as in a cage resembling a nightingale's. Many lose their birds from keeping them in open cages, and exposing them to colds or draughts, as in our next paper we shall proceed to show more fully.

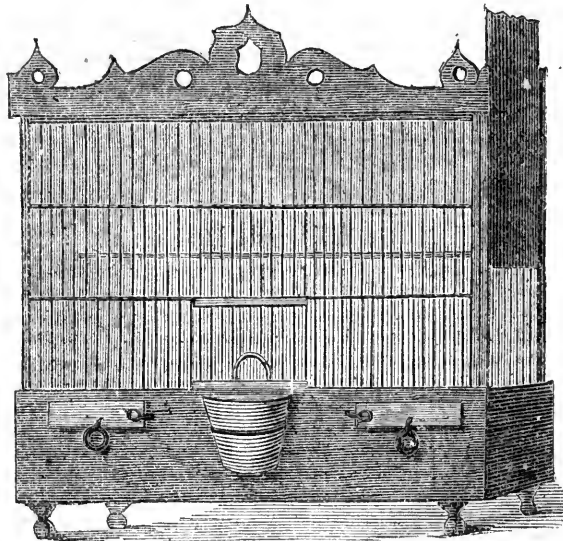

Fig. 1.

SEA BATHING.

THE fashion of "a change to the sea-side" every autumn has of late years prevailed to so great an extent throughout Europe, but especially England, that it has almost amounted to a mania. This custom, however, which is on the whole a most salutary and beneficial one, has not been introduced by the dictates of the physician; as the public themselves have, in the majority of instances, selected the sea-coast as their healthful retreat, quite apart from any advice of the medical faculty. On this account it is that almost as many lives have been lost as saved by sea bathing, by its reckless unadvised use in comparative health, and by carelessness and misuse in the treatment of the invalided. The absurd notion which has taken hold of the mind of the public—that sea water can do no harm—is totally unfounded, and without substantiation. Beneficial effects from sea water, as well in health as in disease, depend upon the same principles as those of fresh water. Although its prejudicial effects are less easily incurred, and by slower degrees, yet they are no less certain.

We purpose in this article to set forth the great advantages that may be derived from sea bathing, and to do our part, as the HOUSEHOLD GUIDE, by pointing out to our readers how they may avoid the evils to which we have referred to above.

The distinction between sea-water and fresh-water bathing is very considerable, the former having a decided preference. The object of cold bathing is in almost all cases the bracing and strengthening of the system. True it is that the most important results of baths are effected by the temperature of the water; nevertheless, its chemical composition is to be considered as a matter of great importance. The sea bath, or mineral bath containing salt and iron in solution, is necessarily far more tonic and stimulating than fresh water can possibly be. The composition of sea water is:—Muriate of soda, muriate of magnesia, sulphate of soda, and other salts in small proportion, besides iodine, bromine, and animal and vegetable substances. The qualities of sea water vary very greatly in different seas, and under different degrees of latitude. In deep water the saline components are in proportion much greater than on the surface and along the shore. The water around the shores of Great Britain contains somewhat more than an ounce of salts to every quart of water; while in the Mediterranean, along the southern coast of Europe, the proportion is much greater, and gradually increases in a southerly direction, until about the Line it amounts to above a quarter of a pound. Northwards, however, it decreases by equal degrees; so that on the shores of Northern Europe the water is comparatively fresh, and at the Pole is but very slightly salt. This seemingly strange fact is accounted for by the great flow of water towards the Pole, and appears to be amongst the wise arrangements of the great God of Nature, for the purpose of preserving the equal freshness and purity of the water, leaving it the saltiest in those parts where salt is required to preserve it from the corrupting influence of the heat. The beneficial effects derived from sea bathing vary in different places, and upon different constitutions, dependent on the composition of the sea as well as on the climate, and temperature of the atmosphere. The advantages, which have thus been derived from bathing in water impregnated with certain substances, have led to the introduction of medicated baths, of which we intend to speak in a subsequent article. These substances, mixed with the water, are in some degree absorbed by the skin, and carried into the system.

There are circumstances necessarily connected with a visit to the sea-side, which greatly tend to increase its beneficial effects. In almost all instances the used-up man of business or of pleasure; the man suffering from

general debility, occasioned by his mental or physical powers having been overtaxed, or from continued residence in close, unhealthy towns; and persons suffering from general languor and lassitude, or undergoing difficult and tedious convalescence from the effects of severe illness or accident are benefited. To these people it is not the sea air alone, nor yet change of air; but it is change of scene and habit, with freedom from the anxieties and cares of study or business, the giddy rounds of pleasure, the monotony of every day life, or of the sick-room and convalescent chamber, which produce such extraordinary beneficial effects—a seemingly perfect renovation of wasted energies and renewal of the powers of life—effects not to be obtained by means of any purely medical treatment.

We shall not here go into details of the action and effects of cold bathing, as it will be treated of specially in a future article; but it is necessary for us to speak of it so far as it specially regards sea bathing. With bathing in the open sea, there is to be considered, first, the shock experienced on entering water at its natural temperature, when shivering, convulsive respiration and oppression of the chest are always experienced, although but for a moment, and pass away on immersion and free action in the water; secondly, the stimulating effect of the saline substances; thirdly, the mechanical action and pressure of the large moving mass of water and the motion of the waves acting as douches, which, combined, are not in all cases well borne by delicate persons and children. The direct effect of cold bathing is sedative and benumbing, causing the blood to recede from the surface of the body into the grand arterial trunks, congesting the brain and internal organs, depressing the vital powers, and as it were bringing on death. It is this direct effect we have to guard against, and this we can only do by encouraging sufficient and healthy reaction, indicated by the genial glow, feeling of general vigour, and increased appearance of blood to the surface of the body, sometimes simply wearing the aspect of a healthy skin; but at others exhibited by small red patches like measles, diffused redness as in scarlatina; or spots like flea-bites. It is, therefore, how to avoid the direct evil effect, and how to encourage sufficient and healthy reaction that we have to consider.

First, the duration of a cold bath should not be too prolonged, and it is to be laid down as an unexceptional rule, that a certain degree of vigour and power of reaction are essential in all by whom cold sea-bathing should be attempted. Thus it is not advisable that old people, the weak and delicate, including children, or such as are disposed to internal congestion or hæmorrhage, should take a cold sea-bath. General lassitude, with tendency to sleep, headache, or toothache, sensitiveness of the breast, increase of appetite, and constipation are frequent results of a cold bath at the commencement of a course of sea bathing.

For bathing, therefore, in the open sea, it is desirable to prepare the delicate and unaccustomed by giving them a few preliminary tepid baths, which produce a gently stimulating action on the skin, acting at the same time as a sedative to the nervous system; and by gradually lowering the temperature of these baths, the patient becomes strengthened to undergo the shock of a cold bath without risk, the severity of which very rapidly becomes diminished by the force of habit in bathing. But the mischief caused to persons of certain age and of certain conditions of body, from sudden, injudicious application of cold, to so extensive a surface as the whole body, by means of a course of cold sea bathing, can be as well imagined as described. We should here remark that tepid sea bathing may be continued for a long time, without producing the relaxing effects caused by frequently bathing in common warm water.

In the second place we have to consider the effects of sea bathing as regards the time of year, as also the time of day when it is undertaken. The temperature of the

sea by the end of June reaches a comfortable degree of warmth for the strong and healthy, and those inured by habit to cold sea bathing. During the month of July it is constantly on the increase, and reaches its highest temperature in the month of August, continuing the same with slight variation into the month of September, when it gradually becomes lower. The *early* part of the month of August, therefore, is the most suitable time to commence a course of cold sea bathing; the delicate or invalided having been previously inured by tepid baths.

More importance should be attached to the time of day best suited for bathing than is generally thought necessary. The early morning is usually supposed to be the proper time, and so it is for the strong and healthy. The early rising, the bracing morning air, the lively run and frolic of the going to the bathing-place, with mirth and laughter, tend to enliven the spirits and invigorate the system. But, alas! for the weak and delicate, too frequently thought by their parents or guardians to be only dull and lazy, who are turned out to go along with the healthy and thoughtless, what a picture do they present! Chilled in body and depressed in spirits, they reluctantly undress, put on a clammy bathing garment, and with cold dabbled feet as white as marble, stand shrinking and quaking on the steps, till dragged into the water by the guide. On emersion from the water the picture is still worse. Standing on the cold, wet floor, the shivering object endeavours to find sufficient energy and strength to regain the cast-off clothes; but this exertion seems more than the enfeebled frame can support; and then, colder and more dispirited than ever, able neither to run nor walk, with the utmost difficulty the victim to ignorance reaches home. The consequence and after picture, however, we leave to be imagined.

In the morning before ten o'clock the temperature of the sea is at its lowest, and it is, therefore, at this time unsuited to the uninured and delicate, while it is most bracing and invigorating to the strong, and such as can aid reaction of the circulation by the exercise of swimming. The sea reaches its maximum temperature at twelve o'clock, and continues the same until five; it is therefore during this time the delicate should bathe, the earlier the better, but in this, of course, persons must be guided by the tide. It is here necessary to remark, that, for delicate persons and children, it is desirable they should bathe two hours after breakfast, and therefore, should the tide not admit of this, it is desirable to arrange the dinner-time to be after the bath, and to refresh the stomach, if necessary, by some bread and bitter ale, or a sandwich of cold meat, with a cup of cocoa, and by not bathing until sufficient time for this light luncheon to have digested has elapsed.

In the third place, we have to consider the frequency of the bath, and the treatment which should be adopted in taking it. A few days' residence on the coast should always be allowed to elapse before commencing a course of sea bathing, which should never be done in a state of fatigue when coming off a journey, nor yet on the day succeeding the taking of medicine, however simple. Moderately delicate persons, too, who do not class themselves amongst the invalided, should be careful to observe moderation, and bathe on alternate days, as daily bathing is frequently found productive of lassitude, accompanied by a manifest wasting of the body. During a course of sea bathing, and even when the warm sea water bath is used, friction with a flesh brush, or coarse hair gloves should not be omitted. This may enable a person to continue the course, when otherwise he must give it up. It is to be observed, moreover, that on coming out of the water, the body should be quickly rubbed with a coarse towel, but as the influence of salt water acts beneficially upon the muscular fibre it is totally unnecessary and superfluous to expend time in carefully wiping the skin, while the speedy

resumption of the dress is of the utmost importance. In cases, however, of the skin being especially delicate and morbidly sensitive, it is necessary to wipe off the salt water, as it acts as an irritant to the skin; but in these cases extensive use of the flesh brush should not be omitted, as by that means a more hardy condition of the skin, and a consequent diminution in the sensibility of its natural delicate organisation is secured. The use of the brushes, also, should not be overlooked in all instances in which sea bathing is resorted to for the purpose of restoring an enfeebled system to the vigour of health. There is no case in which moderate exercise after bathing is not to be recommended. It must not, however, be violent nor too long continued.

On entering the sea the head should be instantaneously immersed, the eyes being kept closed, as, without this practice be strictly adhered to, no fair trial of the effects of sea bathing can be made. The blood-vessels of the brain are not so speedily influenced by the different degrees of temperature as the superficial or capillary blood-vessels, the collapse of which causes those of the brain to congest, as also those of the lungs and the grand arterial trunks, bringing on the fatal consequences so often occasioned by the immersion of the body into water of lower temperature than itself. These consequences are not rare, and occur every bathing season. The use of a cap, too, is strongly objected to by physicians, as cases of headache and a tendency to apoplexy have been known to occur to persons through keeping their head and ears from contact with the water. We have yet to speak of the injudicious practice very generally adopted, of a number of young people crowding together in a bathing machine, with the sun's rays pouring down upon it. By this means they incur an amount of exhaustion occasioned by the inhalation of a vitiated atmosphere and the depressing influence of an excessive temperature, similar to the languor and torpor occasioned by remaining in overcrowded, ill-ventilated rooms. The ill consequences of passing into the water in this state are most dangerous. We are aware that it is not in all cases done by choice, although we believe it most frequently to be so, as on a fine day it may take hours to gain admission to a bathing-machine. The grievous imperfections of the bathing arrangements of our coasts are generally known, and on this subject we think it advisable to print the following extract from a letter of Dr. Robert Barnes to the editor of the *Lancet*, August, 1868:—

"But my immediate object in addressing you is to call attention to the very defective arrangements for sea bathing provided at our English watering-places. A machine, more likely to be wet and dirty than clean, and a towel or two, appear to constitute all that is necessary to the minds of our 'proprietors.' On sandy beaches the machine is commonly run out just far enough to enable the bather to walk into water that will cover his knees, rarely far enough to enable him to plunge. The consequence is, that ladies, children, and all who cannot swim, dabble about with their bodies out of the water, and get out chilled, shivering, with teeth chattering, blue lips, and general horripilation; and there is no sort of provision to aid in counteracting the species of collapse by restoring the circulation to the surface. Such bathing as this is positively injurious—even dangerous to delicate persons. The thing most wanted is a bucket of warm fresh water, say at 90 degrees Fahrenheit, to stand in, and wash away the salt and sand whilst rubbing and drying the body. This is not only a luxury, but a safeguard, especially to ladies and children. With it, bathing, even in comparatively cold weather, becomes useful and agreeable. On sandy shores, the water is often charged with organic matter, and this, added to the hygroscopic property of the saline ingredients, keeps the feet sticky, clammy, and uncomfortable for the rest of the day. It is an immense comfort to get rid of this. Is there any reason why this warm water should not be provided? It is an essential element at all the 'Établissements des Bains' in France. Of course a small change would be expected; but I venture to say that a good bathing-place, properly equipped with this and other conveniences, would soon prove remunerative. At present, medical men are obliged to forbid many of their patients from bathing. If they knew of a place answering to medical requirements, that place would not lack encouragement or support."

Those who have been indulging in the gaities of our fashionable sea-side resorts should not take a bath until an hour or two after luncheon. We mention this, as we are aware of the anxiety often felt to take an early bath, for the purpose of overcoming the exhaustion and feverishness occasioned by the overnight's dissipation.

We must not omit specially recommending sea bathing for young ladies, provided there be no disarrangement of the natural functions at the period of life when childhood is developing itself into maturity, as it then builds up the constitution, giving it tone and regularity not easily parted with. But youths who suffer from functional disarrangement may be much benefited by bathing in tepid sea water, which greatly assists other means in raising the system to health and cheerfulness, in place of lethargy and dissatisfaction; but until a degree of tone has been gained by the system, and a consequent establishment of some degree of functional regularity, a course of sea bathing should not be indulged in.

It is unnecessary to remark that rules are needless for perfectly-seasoned bathers of strong constitutions, as such may remain in the water for a very long period with little danger, provided there be no undue inclemency of the weather. There are those who indulge by bathing in the open sea daily throughout the year, although of course these are few; with them, as with daily bathers at their own homes, the consequences are doubtful, and such a course can in no way be recommended, as dyspepsia, chronic congestion of the liver, and such like complaints, are insidiously contracted thereby. Those who have acquired the healthful practice of swimming should under no circumstances fail to make use of it, as by swimming the body is not only kept in constant immersion, but the muscular exertion aids greatly in maintaining the balance of temperature. No swimmer should bathe either in the sea or river without having some other swimmer or a boat at hand. Swimming is a very fatiguing and exhausting exercise, and many who have remained too long in the water have become so much enfeebled by it as to be scarcely able to stand on emerging from it; and should this weakness, or cramp, come on at sea, the bather would probably be lost.

We now come to speak of children, and much may be said with great advantage on their behalf. The constitution, as also the particular state of their health, should be considered, so as to ensure beneficial results; for how can it be expected that what is suitable for the strong and healthy should be beneficial to the weak and delicate? It is a most salutary plan to habituate delicate children with a tepid sea water bath given every morning at home, the temperature of which should be gradually lowered, before commencing a course of sea bathing. A maxim is prevalent that as bathing in cold water is strengthening and invigorating, a compulsory plunging of a child into cold water must be equally so. With this view, therefore, and for the purpose of hardening them, a rule is established in some families that all the children shall be cold bathed every morning. This arrangement is carried out irrespective of constitution or particular temperament, thus fostering chronic and acute congestion of the organs of their bodies, and paving the way for the inroads of consumption, bronchitis, and such like diseases. The shock of a cold bath upon the over-sensitive nervous system of a child naturally creates a dread of being plunged into the sea, together with the empty horror and childish apprehension of danger in approaching the great and roaring ocean. The systematic and inconsiderate manner in which children are ducked by the guides is in itself sufficient to bring on an attack of convulsions or other illness. The ducking of children is conducted like the plucking of geese—so much by the dozen—and we believe in the case of ducking children the charge is really less—it is nothing. Who can wonder, then, that casualties occur

in sea bathing, and parents secure sickness, and not health in exchange for their hard-earned gold? Let us then endeavour to establish quite an opposite system, which we shall now proceed with zest to describe. Let kindness and persuasion be for the future the means to induce our children not only to submit to, but delight in, their sea bath. Let us—as well father as mother—take our children with ourselves into the bathing-machine. Let them see us swim and take our bath, and, however young, they will soon learn to imitate us. It is the terror at first instilled into children by “you naughty boy” of the nurse, and the unfeeling and disinterested treatment of hirelings, which causes this terror. The supposed unwillingness, however, of some children when ordered to take a sea bath is oftentimes a natural instinct of the unsuitableness of a cold bath to their constitution; therefore, in such cases—as also in the case of infants—it is advised to wash them in a tub of sea water at home, the change of water for which twice a week is amply sufficient. Moreover, if the child's constitution is too delicate to bear the effects of a plunge, let it be washed with a large flannel well filled with the water. Let children run about during the months of July, August, and September, when the tide is low and the sands warm, barefoot. The action of the sand will serve as a stimulating power to their feet, and a degree of hardiness will be thus established, not to be secured by other means. Young children, under such circumstances, will soon venture into the water. Let a woollen dressing-gown be exchanged for their ordinary garments, and in the trusty hand of father, with trousers tucked up, the little ones will march into the sea as readily and bravely as they could find their way into a cake shop. This is the way to lead the ducklings to the water. Be careful to avoid bathing too late in the evening, which is likely to create perspiration during the night, and prevent the intended invigorating effects of the bathing. Bathing during flood-tide should be selected for children, whenever possible, as then the water is warmed by flowing over the sands exposed to the sun's rays during the low tide of the sea. Should a child chance to evince shivering fits after a bath, let it be immediately put to bed between blankets, and bottles of hot water or bags of hot bran placed to the feet and armpits. The advantages of sea air and bathing are great to children suffering from enervation of the vital powers, and with a tendency to consumption, if practised judiciously, but produce most mischievous effects, if practised imperfectly and in a negligent manner.

There remains yet to consider sea bathing in respect to certain diseases for which it may be beneficially applied. Sea air and sea bathing exercise great power in regulating the action of the bowels. Sometimes constipation is temporarily caused, but more frequently, upon arrival at the sea-side, a relaxed state of the bowels sets in; this is more especially the case with children, sometimes extending even to diarrhoea. Torpor of the bowels has not unfrequently been rectified by a course of sea bathing, and a regular system become established, when all other methods have failed. In the case of dislocations and sprains, the astringent and tonic effect of the cold sea bath, brought to bear locally, forms an invaluable auxiliary to other remedies, as it braces the surrounding muscle and tissues, and thus strengthens the natural supports. The respiratory passages and air-tubes are often greatly benefited by residence at the sea-side, which may be attributed to the greater purity and consequent salubrity of its atmosphere. Sea air and bathing are most efficacious in the rectifying of chronic and constitutional diseases, and indeed serve as a remedy when all other remedies have failed. Scrofula in particular is beneficially affected by sea residence and judicious sea bathing. At first the sores often enlarge and the discharge increases, but this is only by way of purifying and clearing off the disease, and after a short time the

sores become entirely healed. Of head-aches there are many kinds : those occasioned through nervous depression are almost without exception benefited by sea bathing and sponging the head with cold water every morning. The body should be repeatedly immersed, but the continuance in the water should be of short duration. Neuralgia and other nervous affections should be treated in the same manner, but it must be borne in mind that unless both the head be profusely bathed with sea water and the body immersed the pain will be rather increased, and probably brought on ; but if the sea bath be judiciously applied, it will be found, almost universally, to avail in arresting neuralgia and all complaints of the nerves requiring tonic treatment. Those, again, who very generally suffer from head-ache after bathing are persons of full habit and good digestive organs ; these head-aches are of the congestive order, and may be checked, if not entirely prevented, by being moderate in diet, taking plentiful exercise, keeping the bowels free by aid of mild aperient medicine, and remaining a limited time only in the water. Sea bathing is beneficial in cases of head-ache arising from anæmia, frequently exhibited by hysteria, especially with young ladies of delicate constitutions, as also for constitutional, general, or local debility of parts of the body. In all the last-named cases a course of tonic medicine, with sea baths, taken at suitable times and weather only, and careful attention to diet, are required. In cases of paralysis the use of sea water sometimes proves beneficial, but it must not be used without due knowledge and great care. The object to be aimed at in paralysis is to strengthen the nervous system and to induce the superficial or capillary circulation to increased activity ; tepid sea water bathing, therefore, is sometimes advised ; but generally in cases of some long standing, sea air and drinking a little clean sea water, procured at a good distance from the shore, as an aperient in the morning, have been proved beneficial. The water acts as an aperient, improves the digestion, while increasing the appetite, and has no tendency to constipate the bowels. In cases of phthisis, residence at the sea-side is very pernicious, but as a tonic a short visit may be attended with much advantage ; but such visit should only be for a week or two, at most ; for, however much good may seem to be produced, risk would be run by continued residence, although short visits may be repeated.

Cases in which sea air is undesirable are pretty numerous, and we name some of them to put our readers on their guard. All persons suffering from any affection of the heart, or organs connected with the arterial trunks, and those whose heart's action is painfully impulsive, should be very cautious how they engage in bathing, as fatal results would follow should speedy reaction fail to ensue. Cases connected with over-secretion of bile, hepatic congestion, and febrile disarrangement, are not likely to be benefited by residence at the sea-side, but more probably considerably aggravated. Those whose constitutional powers have been strained and enfeebled by a course of severe study, and who exhibit symptoms of natural delicate and relaxed organisation should be careful in indulging in cold sea bathing, as the shock is likely to prove too severe for such constitutions to endure.

Now that our beautiful and convenient railway system takes thousands down to our coasts for a day's healthy recreation, it may be as well to warn those of the reckless class of bathers who indulge in a sea bath within a few hours after arrival, that a plunge in the sea after a night's debauch, followed by nervous prostration and attendant head-ache, would not be unlikely to be attended with serious results, more especially in the case of high livers, and such as are of non-plethoric habit. There are constitutions upon which bathing, however judiciously managed, persistently produces ill effects, although in the majority of cases such ill effects are produced through ignorance or

non-observance of proper and salutary rules and guidance. Sea air oftentimes exercises most beneficial effects, where sea bathing would be equally injurious.

That a residence at the sea-side is generally healthy cannot be doubted, from the fact that, even during the most sultry heat of summer, the air is constantly in motion ; it is, moreover, free from fogs and vapour, and the particles of salt with which the air is strongly impregnated greatly tend to lend tone to the system. It is particularly beneficial in cases of disposition to consumption or scrofula, intense nervous susceptibility, evinced by hysteria, and such like nervous affections, disarrangement of the bronchial organs, dyspepsia, and like complaints, which are much more rare on the sea-coast than in the inland parts of the country. The exhilarating influence of the sea air is proved by the fact that those who indulge in extra quantities of wine and spirits for the purpose of maintaining a comfortable condition of constitutional force for the discharge of business, are able to dispense with the same when at the sea-side, the excitement produced by the use of fermented liquors being compensated by increased appetite, induced by the extra amount of air and exercise taken, without exception, by visitors on the sea-coast. The rosy, healthy appearance of the face after a sea sojourn is greatly attributable to particles of salt adhering to the skin and exciting to action the capillary blood-vessels and cutaneous nerves. In a word, feebleness of constitution and an impaired state of health are generally indicated by pallor and flabbiness, upon which condition the action of salt water exercises more influence than even change of temperature, as it acts powerfully upon the muscular fibre ; and thus it is that a course of sea bathing is so beneficial, invigorating, as it does, the ailing patient, giving him in exchange for flabbiness, firmness and vigour of muscle.

The special application of water by means of douches, shower, and other baths which are used for sea as well as fresh water, will be treated of in the next article on this subject.

DOMESTIC MEDICINE.

DYSPEPSIA.

THERE is a great deal of talk about dyspepsia, which means difficult digestion ($\Delta\upsilon\varsigma$, difficulty ; $\pi\epsilon\pi\tau\omega$, to digest). The best way for us to treat the subject is to describe briefly and clearly a few of the principal forms of dyspepsia, or indigestion, avoiding details and refinements. Moreover, we shall, at the very outset, caution people who occasionally suffer from indigestion not to read much about it. Reading about the stomach and its difficulties often leads the imaginative to conceive disorders and difficulties where they do not exist. People should not know that they have a stomach, and therefore should not be constantly speculating about its sensations. At the same time, there are a few really uncomfortable sensations which show indigestion ; and concerning these we shall make a few simple remarks.

Preliminary to our description of dyspepsia, we shall say a few words on the process of healthy digestion.

When proper, natural, simple food is taken into the healthy stomach, no more is felt of it. If it be of the nature of soup or beef-tea, it is absorbed, as it were, by the coats and veins of the stomach. If it be meat, it is, by the movements of the stomach, carried round and round its cavity, and mixed up with the gastric juice, which oozes into the stomach whenever food is put into it. This gastric juice is a clear, colourless, acid fluid, which flows freely into the stomach, as we have said, whenever food is taken into it. The free acid present in the gastric juice (of the dog) is lactic acid. The gastric juice has very slight tendency to putrefaction, and may be kept for an

indefinite length of time in a common glass bottle without developing any putrescent odour. The peculiar property of this fluid is that it dissolves meat, boiled white of egg, and such like substances. It does so even outside the body, but it does so best inside the body, assisted by the high temperature of the stomach and by its peculiar movements. Gastric juice does not dissolve all kinds of food; it does not dissolve fat, nor starch, nor oil. Its proper duty is to dissolve meat, gluten (the most nutritious part of bread), casein (the most nutritious part of milk), albumen (white of egg), &c. It is supposed that about fourteen pounds of gastric juice are poured daily into the stomach. Of course it is not secreted all at once; the stomach would not hold so much. What happens is this, when animal or albuminous food is taken, gastric juice flows out into the stomach and dissolves a portion of food. Having dissolved the food, it is absorbed—sucked up, as it were—at once into the blood, with the food it has dissolved; then another portion is poured out, to dissolve more of the food and to be absorbed; and so on, until all that kind of food which it dissolves is taken up from the stomach into the system. This will be the work of some hours. That portion of food which the gastric juice is not able to dissolve—such as fat, starch, &c.—passes on into the intestine, and is there digested by other juices and secretions. The chief of these are the pancreatic juice, the bile, and the intestinal secretion, all contributing in one way or other to the solution of the food, and towards making it into a sort of emulsion which is favourable to its being absorbed into the system. Now in health, we repeat, all these processes go on without causing any pain, or discomfort, or distension. The patient is not aware of them.

It will be readily understood that, in order to the due digestion of the food, the stomach must be strong and well. It must have its chief work to do when it is strong enough to do it. It must have good blood in all its veins and arteries; and its nervous power should be good and healthy. If men weaken their stomachs with excessive work—that is, with superabundant meals—when they are tired and exhausted, digestion will not go on well. If they take very little air and exercise, their blood will not be good red blood; and if they worry themselves, their nerves will be weak and powerless; the nerves of their stomach will be weak too, and neither appetite nor digestion will be right. It may be difficult to classify dyspepsias, but it is easy to state the general conditions on which good digestion depends. Who are the people that are always talking about their digestion and their dyspepsia? Not sailors, nor agricultural labourers, nor mechanics, nor boys and girls, nor, for the most part, men; in other words, not those who live much in the open air, and use their limbs and muscles. But who are the people that are half afraid of their meals, and have miserably to consider what shall we *not* eat, and what shall we *not* drink? They are indoor sort of people, tailors and shoemakers, milliners, clergymen, literary men, and nervous, fidgety people, who are always worrying themselves. Then there are people that weaken their stomachs by things which they take—not only by too much beer and spirituous drinks, but by living too much on tea, and taking too much tobacco.

Our readers will see that we are trying to indicate the nature of dyspepsia or indigestion by, in a general way, indicating its causes. Let us now be a little more particular concerning

The Symptoms of Dyspepsia.—Digestion is difficult when it is *painful*. Sometimes there is very severe pain in the stomach as soon as food is taken—so severe that the patient is fain to bring the food up, and tries to make himself sick. The kind of pain varies, being sometimes very sharp; sometimes of a burning kind such as is vulgarly called heart-burn; sometimes the pain is of a more dull description, and of the nature of weight

and discomfort. It is a very common feeling for the food to lie heavily in the stomach as if it did not move. *Sickness* is another symptom of indigestion; it may be the mere feeling of sickness or nausea, or it may be actual *vomiting*; and this vomiting may happen either immediately after a meal, almost before it has been well taken, or not for two or three hours after. A more common symptom still is a *feeling of distension* of the stomach after taking food. There may be a feeling of distension without much actual distension, but generally the distension is real, and often very considerable. This distension, which is more common in women than men, may arise from the generation of gas in the stomach or intestines; putrefactive changes in the food itself, which changes are prevented in healthy digestion; or the intestines themselves may secrete gas, in a way which it is not very easy to understand, but which certainly does happen. Often the distension in this way is enormous, and gives rise to belching and pain and great discomfort. We have yet to mention another common symptom of dyspepsia—*regurgitation*, or the rising of fluid into the mouth from the stomach or some part of the digestive track. The fluid which so rises may be very small in quantity, or it may be in great quantity. It generally has an acid taste, and may be intensely acid. At other times it is acrid, and seems to burn or scald the throat; or it may be greasy and nauseous, having the smell of rotten eggs, and denoting putrefactive changes in the food. Or it may be like simple water. In this last case it is called *waterbrash* or *pyrosis*. Such are the local symptoms of dyspepsia. They will not all occur in each case, but one of them will be predominant, and generally there will be more than one. Then there are general symptoms. It will easily be understood that when a process so pleasant and agreeable as digestion generally is, is so hampered and uncomfortable, the whole system is more or less put out by it. There is depression, sometimes amounting to melancholy; languor and want of energy and interest in one's work; the appetite is variable and capricious; the bowels act irregularly, sometimes being loose, and at other times constipated. Such is the general character of dyspepsia. It is not an acute disease, but a troublesome discomfort. We are so created, that all essential functions are not only not painful, but positively pleasant. It is a pleasure to eat, and we feel the better after eating; but in this disordered state eating is not a pleasure, and the consequences of it are positively uncomfortable.

THE FRUIT ROOM.

FILBERTS may be kept upwards of two years by packing them, when quite ripe and dry, with their husks on, in earthen jars. Spread a layer of salt over the fruit, tie the jars over with brown paper, and keep them in a dry, cool cellar. Among the best kind of apples for keeping are the golden Reinette, the old Nonpareil, and the Foreman Screw; they may be laid on straw, and frequently turned. Pears should be wrapped separately in paper, and kept in glazed jars, closely covered; or each pear should have its stalk tipped with sealing-wax. If walnuts become shrivelled, soak them for eight hours in milk and water, before sending to table; it will make them plump, and cause them to peel easily. To restore the freshness of grapes, cut the stalk of each bunch, and put it into wine, as flowers are set in water. Fruit should be gathered on a dry day, and is better stored in cellars than in dry presses and closets higher in the house. Each sort of apple and pear should be kept by itself, and apples will keep longer in heaps, covered up, than if lying exposed. When apples are frozen, no artificial means must be used to thaw them; if they thaw in the light they rot, but if in darkness they keep sound.

LADIES' BATHING DRESSES.

GREAT reforms have been made within the last few years in the bathing dresses worn by ladies. Great reform was needed—for the preservation of modesty as well as of health and comfort. The long, loose gown, formerly worn, was apt to dab wet and flabby against the bather as she left the water, and cause a chill. Swimming in such a garment was very nearly something miraculous. Even in dipping in and out of the water, it would cling round the legs and impede freedom of motion. The very greatest objection of all was, that occasionally the air filled it, or the wind caught it, as the bather rose above the surface of the waves, and bore it up above the crest of the water like a balloon. The dress now in vogue amongst ladies of the highest rank, becoming more general every season, and which we hope will soon be universal, is of French origin.

At many of the French watering-places, machines are not known. A row of buildings on the shore serves bathers to undress and dress. From these they run across the sands to the water. Perhaps it is to this circumstance that the pretty and modest dresses now in vogue owed

from which it is sloped straight away; the armholes afterwards are hollowed out. It should be long enough to reach the knees, when finished, in front, and two, or even three inches longer behind. The sleeves are from two to three inches deep. The waist-band is made of the material doubled, and hooks over the blouse, reducing all the figure. Down the front there is a two-inch wide hem on one side only; the other is simply bound with braid. Large buttons fasten it down the front. Before cutting the front out, pin a fold down the centre of four inches wide. This allows sufficient for the two-inch hem to be made, and to lap over under side. The trousers can be cut from any pattern of white ones that fit (see Fig. 2). They are joined behind, turning in an inch at one side and a little way up in front. An inch-wide false hem is put on the rest of the front and sloped away to the join. This will be observed in Fig. 3. It buttons an inch over the inner side, which is the one that has an inch turned in. Stitch this across a little below the join, and cut off the superfluous turning at the back. Pleat the trousers into an easy waistband two inches wide, double. Do not make them fuller than is absolutely necessary, for the less material used the better; the more there is em-

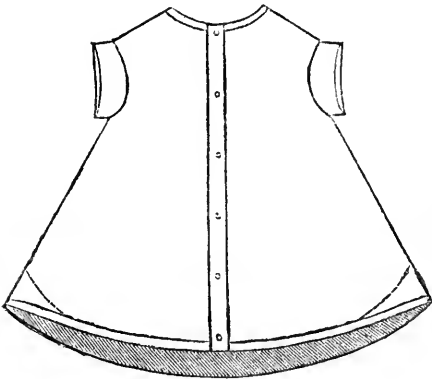

Fig. 1.



Fig. 4.

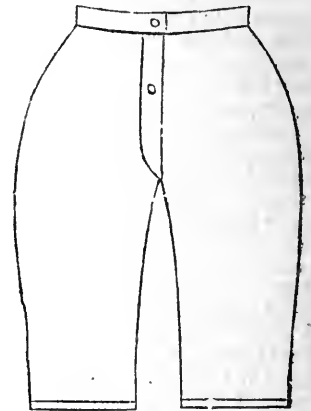

Fig. 3.

their origin. To swimmers such clothing is indispensable. The bathing garments consist of a pair of trousers and a blouse belted at the waist, with or without sleeves. There are a good many different ways and fashions for making these. Some are very plain, some piquant. A lady, not young, or ill-shaped, should choose a plain garment; as also will those of retiring disposition and delicate sentiment. A very stout woman, on the wrong side of forty, attired as a jaunty young sailor, would be ludicrous. Equally absurd would a tall, angular, very thin lady seem in like adornments. But young and pretty girls may be allowed to give some scope to the lightness of their hearts, which will express itself in fanciful costume. There is no reason why bathing garments should not be made with taste and some ornament; but by ladies of good character, what is remarkable and "loud" will be decidedly avoided. They will not desire to call any particular attention to themselves in the water by conspicuousness, though they may naturally and properly desire not to look unsightly objects, but rather pleasing ones, to their companions, or to any one who inadvertently sees them, in addition to securing their own comfort and protection.

The French bathing dress is cut like a boy's tunic or larger. The pattern of a boy's brown holland pinafore enlarged will prove a good guide. Fig. 1 shows the shape. It is cut open at the throat, sits plain on the shoulders,

employed, the heavier the gown will be when saturated with water. The serge used should be of a very light fine make. The French have an excellent serge for the purpose, and are partial to black suits. Many of these are trimmed with cross-cut bands of tartan, wide on the skirt, and narrow on the body, sleeves, and trousers. A pretty variety of patterns is made by rounding off the corners of the skirt of the blouse at the dotted lines in Fig. 1, making the round come to a marked point where the side-seams meet.

Serge costs about half-a-crown a yard, and is very wide. A costume will take about five yards. A width is required to cut each leg, and a width each for the front and back of the blouse. The sleeves, bands, &c., can be cut out of the pieces. Bathing caps are made of oil-silk, covered with coloured chenille nets.

Join the skirt to the band of the body. The sleeves may be mere epaulettes, deep under the arm, and scalloped quite away to the top; or square, short sleeves, or long ones. Long sleeves are of the coat shape, with very open cuffs. The band is made of the material, and hooks on. It should be quite loose, to allow perfect freedom of action to the bather or swimmer. The natural movements of the body in the water are far more graceful than the wholly imaginary excellence of a braced-in waist, the artificial smallness of which is as strikingly marked and ugly, as rouge cheeks compared to the real bloom of health.

and beauty. The trousers should be cut from the pattern of a boy's knickers, if the lady making them has got a suitable pattern. Of course, they must be considerably larger than a boy's, and half as wide again at the upper part. Pleat them into a band. They are entirely joined. Put them on first; then the blouse; and, lastly, the band.

Coloured flannel is a good material for bathing gowns, but serge is better, and also dearer—perhaps not dearer in the end, because wider. It can now be purchased in every colour. Messrs. Howell and James, of Regent Street, have a great variety of serges for the purpose, such as grey, lavender, light blue, magenta, green, white, &c. Nothing is more suitable than a dark blue. This may be trimmed with scarlet military braid, without being re-

trimmed each side with half-inch wide white military braid. There are two plain rows also on each side of this. Round the neck are points piped with white and rising from a band of white braid. There are short square leaves, waved at the edge and bound with white braid. The edge of the blouse is also waved and bound. The trousers are cut open outside at the ankle, waved and bound round. A rosette fastens the waistband.

Fig. 6 is a dress for a child. A couple of plain breadths are joined, the shoulders sloped, the top hollowed at the neck a little, and pleated in a band, which is afterwards covered by a ruche. A waistband of the material is hooked over it, to keep it to the figure. The sleeves are little puffs, edged with a ruche. The trousers may be



Fig. 2.

Fig. 8.

Fig. 7.

Fig. 5.

Fig. 6.

markedly conspicuous. A date brown is not a bad colour for bathing dresses, and may be trimmed with white braid. White, trimmed with blue, is pretty, but a little conspicuous, unless at a bathing-place where such gay articles are commonly worn.

Fig. 7 is a dress of dark blue serge, trimmed with a broad scarlet military braid between two narrow ones. It opens on the cross down the front, and fastens with long hooks and eyes. There is a rosette of braid on the shoulder. The trimming is carried round the skirt. The waistband of serge has a row of wide braid in the centre and a rosette. There are no sleeves; the arms are trimmed round with a ruche of scarlet braid. The neck is cut square just round the throat, and ruched. The trousers open above the ankle with a curve, and braided. The hair is brushed off the face and tied back with a ribbon.

A brown serge costume may be made with a two-inch wide outside hem all down the dress, very neatly

cut by any drawers the child wears, and left untrimmed. Children should be supplied with gowns, and many who now refuse to go in the water, would then gladly do so. The child's gown may be filled up with a plain piece to the throat, if desired.

Fig. 8 is a purple gown. It is nearly close round the throat, and is trimmed down the front and skirt with four or five inches of a woollen material, striped purple and white, and cut on the cross, to make a slanting ornament. This looks well with short or with long sleeves and cuffs ornamented. The lower part of the trousers is also bound with trimming.

A plain costume with one row of broad braid all round looks neat. The neck is square, edged with a ruche of scarlet braid round it.

Fig. 5 is a very stylish costume in the sailor-fashion, fit for a swimming dress. It is of blue, trimmed with white.

Materials of mixed wool and cotton are unfit for the sea, because they pucker in water. The serge or flannel used

should be shrunk before cutting it out. Linen and brown holland, which some persons recommend for bathing costumes, are not desirable; they are much too chilly.

Sandals are greatly worn by bathers, especially on stony coasts. There is also another useful invention for bathers by Mr. Norman, bootmaker, Westminster Bridge Road, London. It is a loose boot, of coloured felted flannel, of a mediæval cut, like Fig. 4, with a double sole of the same, and easily slipped on or off. It can be had in any colour, and is very inexpensive.

Long hair may be left floating, tied back by a ribbon, as it looks prettiest, but is inconvenient (see Fig. 5). Or it may be twisted into a coil on the crown of the head, and secured by a hair-pin each way; or placed in an oilskin cap, edged with scarlet.

On re-entering the machine, after a sea bath, the dress worn in the water should be immediately thrown aside, and the bather should wrap round her a flannel gown, large enough to envelop her person entirely; this is necessary to avoid a chill. Over the gown she should rub herself well in every limb till the skin glows and becomes dry. A loose, coarse flannel is the best for this; and the Welsh make will be found decidedly preferable to Lancashire or any other English kind. However, still better by far is a gown made of *house-flannel*, sold at the oil-shops. Its powers of friction, and thereby exciting a healthy and agreeable glow, are greater than those of any better-looking sort. The flannel used in India by the fakirs has the merit of excelling any other for powers of friction, warmth, and almost endless durability; but it is not every one who would be able to procure this.

Such a flannel gown may readily be cut from shrunk flannel by the pattern of a lady's waterproof. It may be made the same size, or a little less full in the skirt and towards the lower part, because a waterproof is worn over the dress, and the flannel gown has no dress to take up its fulness. Very loose coat-sleeves may be put in, and down the front it should wrap over considerably, and be fastened by several large buttons. Keep these buttons up the skirt and slip the gown over the head. A couple of buttons will then in a second close the throat and body. If the arms are in the sleeves, rub the limbs and body vigorously. Those who are not capable of much active exertion may leave the gown unbuttoned, and not use the sleeves, but cast it round them like a cloak, and drag it round and round, and see-saw it from side to side, to dry and warm every part of the skin. The sandals or bathing-boots should have been cast off directly after the flannel gown was slipped on. The boots come off most quickly. A square of coarse flannel, folded two or three times, should be placed in a dry part of the machine for the bather to stand upon whilst rubbing and drying.

COOKING.

VEGETABLES (*continued*).

Salmaquindi.—Select your ingredients for their contrast of hue as well as of flavour—green parsley, brown herring or anchovy, yellow yolks, white of egg, pink veal, scarlet hung beef, &c., all minced to different degrees of fineness. Take a large, flat, circular dish—oval will do, but not so well. In the centre place a striking tuft of blanched chicory or endive, to mark the place where the Sun will be. Define its circumference with strips of herring or anchovy; round it spread a band of minced chicken breast. Next strew a circular zone of egg-yolk; next, a green ring of parsley with hung beef or tongue. And so on; as long as your cosmic materials last, you continue to lay "cycle on epicycle, orb on orb." The outlying regions to be a garland of water-cress in sprigs. The tasty eye will see the place to insert small turnip-radishes, capers, olives, and other gems, effectively into this vegetable mosaic.

Spinach.—After careful washing and picking, throw the leaves into a stewpan with a bit of butter, and no water but the moisture clinging to them. Cover down close with the lid, and set it on a gentle fire, shaking now and then. The spinach is to be stewed, not fried. When tender, chop it small, and heat it up again in the stewpan with salt, pepper, and more butter. When transferred to the dish, smooth its surface with the back of a spoon, and sprinkle it with dice of fried or toasted buttered bread. Poached eggs laid on spinach make a favourite and pretty-looking dish, soon prepared, if the spinach is cooked beforehand. And spinach is all the better for being heated up once or twice, because it gets each time an additional dose of butter.

Artichokes.—When cut, throw them into cold water, to expel earwigs and other insects. Throw them into plenty of boiling salt-and-water; the time to cook them will depend upon their size and age. Serve melted butter with them, for those who like to dip the leaves in. They are good cold, with pepper, oil, and vinegar. Young artichokes may be quartered and fried, but require a skilful practitioner. Artichoke-bottoms, divested of the so-called leaves, make a nice dish served in rich brown gravy. Artichokes are also eaten *raw*, as a *hors d'œuvre* or relish.

Salads.—A good salad is a very nice thing; a poor salad is a very bad thing: in any question of the table, the difference is enormous, and ought not to be allowed to exist, especially when the removal of the defect is so easy. A plain cook is apt to think that so simple a thing as a salad may be safely left to take care of itself; in fact, as it is not *cooked*, it is no business of hers. In which case, the master or mistress of the house, instead of resisting the fool in her folly, had better attend to the salad themselves. In the first place, the vegetable which forms the basis of the salad—whether lettuce (cabbage or cos), endive (plain or curled), corn-salad, watercress, &c.—must be fresh, clean-picked, crisp, and at the same time free from all superfluous moisture. A plain cook's intellect will often carry her as far as that. Sometimes even she will provide a few ordinary garnishings, as bits of celery-hearts, spring or seedling onions, to chop very fine, slices of cold baked beetroot, nasturtium, borage, or mullein flowers, &c. An important item, to relieve a salad from insipidity, is, when it is placed in the bowl, to sprinkle over it a *small quantity* of aromatic herb chopped *very fine*; either tarragon, chervil, balm (in a very young state), garden cress, or mustard, or a very little indeed of each of those that are to be had. In winter, tarragon may be replaced by a *small quantity* of tarragon vinegar, added *after* the salad is made.

It would be absurd to shrink from the stubborn fact that you cannot make a first-rate salad without *oil*—of course the best procurable. Poppy-seed oil is by no means to be despised. We ourselves prefer first-rate poppy-oil to second-rate olive-oil; and it is possibly often sold under the name of the latter. Certainly, there are passable substitutes for oil; but they are not the real thing. Alexandre Dumas, the father, gives a receipt for a salad of lettuce hearts, *à l'Espagnole*, without oil or vinegar, a souvenir of his travels in Spain, where vinegar has no taste at all, while oil in general has a great deal too much. People there feast on slices of bread, spread with oil which we should think fit only to burn in lamps. What Spaniards would swallow, M. Dumas could not; so for oil he substituted raw yolks of egg, and for vinegar the juice of lemons—to be had there in plenty. This, with a sprinkling of pepper and salt, is the whole secret of his *Salade à l'Espagnole*.

The salad in the bowl, sprinkled with the chopped aromatics, and garnished and trimmed with the pretty little et cæteras, awaits the moment of dressing (the close of the repast), either on the sideboard, or (better) as an ornament

to the dinner table. It should accompany the final roast turkey, fowls, leg of mutton or lamb; or lobster or crab; in which latter case, the proper dressing is Mayonnaise sauce, made with oil too, please remember.

The bowl is placed before the person honoured with the task of dressing it. To ask a servant or a waiter to do it, would imply that all the party were without proper taste, incapable of telling chalk from cheese. The golden rule being "prodigal of oil, prudent with salt, and avaricious with vinegar," the salad-dresser will first measure over the salad four bumping salad-spoonfuls of oil, mixing with the first the quantity of pepper, and in the second, of salt, he knows to be approved. He then mixes the salad with the spoon and fork until every particle of it has come in contact with the oil. This insures the vinegar draining to the bottom of the bowl, if, unfortunately, it is applied in excess; but for four spoonfuls of oil, one spoonful of good vinegar (in which a *little* made mustard has been mixed) will suffice. Salad too strongly acidulated may be set down, like Beau Brummel's wisped cravat, as "one of our failures." Too much vinegar destroys the crispness of salad, and utterly overpowers its flavour. Nothing short of horseradish can stand it. After another tossing and mixing, with one toss more, the salad is ready to be handed round.

The student will thank us for some finishing touches which raise salad quite above the common level.

To salad to be eaten with hot roast fowls, mutton, or lamb, add a large gravy-spoonful of the gravy from them, and then a claret-glass of claret, after the dressing is complete. Mix once more and serve.

With a salad of watercresses, to be eaten with roast pork, goose, or duck, mix slices of apple, peeled and cored; then dress with oil and vinegar as usual. If the meats are *cold*, mix a little of the stuffing with the salad.

With a salad of cold boiled dried haricots mix, besides chopped parsley and onion, an appreciable proportion of chopped London pippin, or other sharp, good, "firm-fleshed" apple.

Lettuces sown thickly, like mustard and cress, in a frame or under a handlight, and cut, like them, only after they have grown about three inches high, make a very delicate spring salad. Dressing: plenty of good oil or cream and a dash of vinegar.

Cos lettuce, which bears travelling well, and is therefore adapted for town consumption, is a refreshing summer salad, with a slight dressing of vinegar and powdered sugar.

Winter salads may be composed of various proportions of garden red beet, baked in a slow oven and sliced cold; celery; cold boiled salsify; watercress; forced mustard and cress; and blanched dandelion or chicory, grown in a warm dark cellar.

Nautese Salad.—Take six hard eggs, six large roasted onions cold (Tripoli or Madeira, if in season), six sardines preserved in oil (or a Yarmouth bloater), and some parsley chopped fine, with a little tarragon or chervil the same. Peel and slice the onions, and put them at the bottom of the salad-bowl. Scrape the scales off the sardines, take the flesh off the bones, and lay it in pieces upon the onion. Over those lay the hard eggs cut in slices, sprinkle the chopped herbs over all, and send the salad to table so arranged. At table, when the moment for eating it arrives, one of the party will give the usual dressing of oil, vinegar, salt, pepper, and mustard, will patiently mix the contents, and pass the bowl round. If it be convenient to substitute the bloater for the sardines, dip it into boiling water, and let it remain there two or three minutes. Strip off the skin, open it at the belly, draw out the backbone and the small bones attached to it, and then cut up the best parts of the flesh into the pieces you want.

Winter Salad.—Cover the bottom of the bowl with small boiled onions cold; lay round them a few gherkins

of the true, small shoot variety: spread over them fillets of anchovy (or herring); add a liberal allowance of pickled tunny or salmon; sprinkle with a variety of aromatic herbs chopped fine; decorate with a few whole hard egg-yolks, the whites of the same, two or three teaspoonfuls of capers, and some olives with the kernels removed. Send to table to be dealt with as above. Every season in Paris, some new salad of this class has a run, with a high-sounding name and a slight change of the ingredients.

ODDS AND ENDS.

To make French Polish for Boots and Shoes.—Boil in a quart of liquid—being two parts vinegar, and one water—a quarter of a pound of glue, and the same quantity of logwood chips, with about the sixth part of an ounce of each of the following ingredients:—soft soap, isinglass, and finely-pounded indigo. When boiled for a quarter of an hour it should be strained off, and when cold be fit for use. It should be applied with a piece of soft rag or sponge, the shoes being quite dry, and free from dirt.

Herbs.—When hung up to dry in loose bundles, herbs soon lose their odour; they should be thinly spread out, shaded from the sun, and when dried pressed together, and put into paper bags. It is an excellent plan to strip off the leaves, rub them fine, put them separately into wide-mouthed bottles, and label. Thyme, when broad-leaved and common, is preferable, but the lemon-thyme is used in certain dishes. Mint should be gathered when about six inches high.

Herb Mixture.—Equal proportions of knotted marjoram and winter savory, with half the quantity of basil, thyme, and tarragon, dried and rubbed to powder and mixed together; keep in a wide-mouthed bottle, closely corked; very useful, and ready for forcemeats.

Cure for Burns.—The following cure was successfully tried by a lady upon one of her own children, who was severely burnt by a little companion. She wrapped it up completely in cotton wool or wadding, so that not a breath of air could touch the body, and night and day kept it saturated with vinegar, which caused the pain to cease immediately. She persevered until the fresh young skin had formed a sufficient covering of its own underneath. Her husband, who did not enter quite so readily into her system, lifted a little of the wadding from the cheek one day when she was out, and was charmed to see the new skin growing so well; but the spot on the cheek was the only scar the child had when quite recovered. A quill leading to the mouth served it to breathe and be fed by.

Steel Ornaments.—The best way to preserve steel ornaments of any kind—brooches, earrings, bracelets, combs, &c., from rust:—Pound some starch in a pestle and mortar, and sift it through a piece of fine net; half fill a cardboard box, the size required, with the pounded starch; place the ornaments in it, and cover up with more starch. When the ornaments are wanted for use, brush off the starch with a fine brush; but they should be kept in the starch when not in use.

Orangeade at any Time of Year.—Take a glass jar which will hold something more than a quart. In it put a quart of spirits of wine, or white brandy of the ordinary strength. Peel three fine oranges rather thick; throw this peel, divided, into the spirit; squeeze the oranges, and add the juice to the spirit and the peel. Tie the jar down closely with moistened bladder, and let it stand for six weeks in a warm apartment, where you can shake it once or twice a day. At the end of six weeks strain the spirit through muslin, and cork it down close in pint or other small bottles. For use, dissolve a lump of sugar in a glass of cold water; stir in a dessert-spoonful of the orange-flavoured spirit, and you have a wholesome glass of refreshing orangeade at short notice.

ANIMALS KEPT FOR PLEASURE AND PROFIT.—THE HORSE.

COACH HORSES.—HUNTERS.

AMONG the horses which the railroads have driven entirely from our roads is a class which had attained, at the time of expulsion, almost perfection. We mean the best stage-coach horse. When the great coaches, which found their way from London to the north and west, were at their height, they drove out of town four horses that were in some instances good enough to go into any gentleman's drag. The pace, including stoppages, for a journey of one hundred or one hundred and fifty miles, averaged nine miles an hour—in some cases ten or eleven. The change was effected in one minute, sometimes in less; and between Shrewsbury and London it was seldom that

rule the half-bred ones were found out in a week, and were obliged to be cashiered from the fast coaches, to save their lives and the proprietors' credit for punctuality. The size of the horses in these coaches did not exceed fifteen hands three inches for the wheelers, and fifteen hands one inch for the leaders. They got one day's rest in the seven, and the average length of time they lasted in the "Quicksilver" Mail or the "Hirondelle" was two years. This will give some notion of the effect of pace, and will teach a lesson to those persons who are always doing twelve or fourteen miles an hour in and out again at least three days a week. It is true that of these horses some had seen their best days, but the majority were in the prime of life and condition, and retained everything that was valuable of their strength and activity, excepting a few blemishes, which had unfitted them for private life any longer. We have ourselves seen teams sent out of

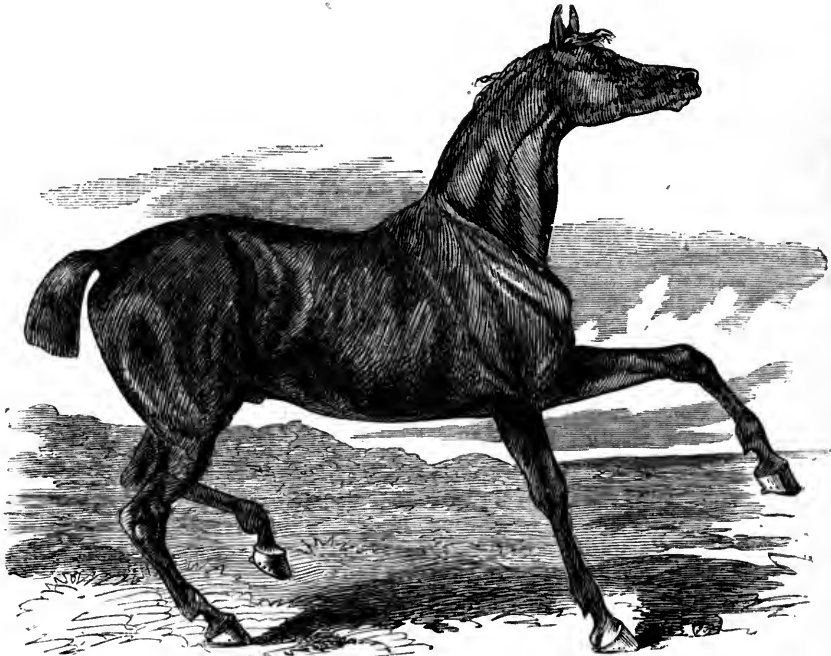

OLD-FASHIONED STEEPLCHASER.

a deficiency of five minutes occurred in the "Wonder," which was as often a minute before as after its time. The whole appointments were admirable, and would be a source of admiration to the lover of coaching, could he see such a thing now. But our business is with the cattle. The wheelers were strong, short-legged, good-actioned trotters, at all events one of them, who steadied the coach; the leaders were not unfrequently thoroughbred horses, that galloped the whole of the ten miles, requiring no whip, but tossing their manes, on a bright summer's morning, as gaily at the end as the beginning of their journey; and as the coachman threw down the reins at the end of his stage, they hardly seemed to have done more than an exercise gallop on Newmarket Heath. One of the most beautiful sights of London was the start of the mails from the General Post Office on the 1st of May, or on some great gala day, when every coachman took as much pride in his team as his wife did in her children. The secret of the work that was got out of these horses was their breeding and condition. The work was too fast for anything but blood; and although it was found on slow and hilly roads that weight was indispensable, as a general

London on the Brighton road, driven sometimes by the proprietor himself, of which the Four-in-Hand Club would have been proud; and have seen leaders with a blemish, or a vice, whose shape and action would have commanded a hundred guineas in any market. This class of horse is not now required, and the natural but rather unfortunate result is a shortness of supply. We have been guilty, to a certain extent, of a digression; but we could hardly find a better place for a short description of a thoroughly and exclusively British institution, the stage-coach of Old England.

HUNTERS.

Whenever one begins to speak of hunters, or indeed anything connected with the sports of the field, all profit seems at once to disappear. The pleasure, moreover, seems to belong so very exclusively to a class. So it once did. Twenty-five or thirty years ago there were fewer railways, and then the hunting men were the great landed proprietors, the country gentlemen, and the farmers, with such a happy sprinkling of jovial souls as accident had placed in the country, instead

of the large towns and cities. But the railroad broke the barriers of this exclusiveness; and although they certainly did not increase the number of sportsmen, they increased the number of horse-taming vulpecides; and to such an extent, that the supply has since then never equalled the demand. The ordinary impressions about hunting, in these fast days are so wrong, that it seems worth while to go through this class of horse (if for no other reason) to correct them.

A Poor Man's Hunter.—Hunting as a sport has recently been provocative of considerable controversy, with which, however, we in these pages have nothing whatever to do. It certainly tests a man's pluck, endurance, and intelligence to no mean extent. It is said to be difficult to get 20,000 men safely and steadily out of Hyde Park, under certain conditions. Probably it is. Change them to twenty couples of high-bred foxhounds, a little over-ridden by a too ardent field, not well under command, and we for our part would rather take the

horses are sent to the public auctions, without any warranty beyond that of being a "hunter," it is always considered to extend to these two points. No horse can be a hunter which is defective in the wind or eyesight.

But why should it be necessary to go to a first-rate horse-dealer? If your hack or harness horse is well bred enough, and can gallop and jump, you will be well enough provided for your occasional holiday. That word "hunter" is a sort of bugbear. Your horse is now as much a hunter as he is anything else, only it will sound somewhat pretentious to call him so. The truth is, that there are plenty of poor men's hunters all over the world, if they will but forego the pleasure of a name. We can give our readers a little anecdote, which will illustrate our position. A farmer, possessed of a curious three-cornered, unsaleable sort of horse, pointed him out to a friend as "a hunter." "What in the world makes you call such a brute as that a hunter?" "He's not a

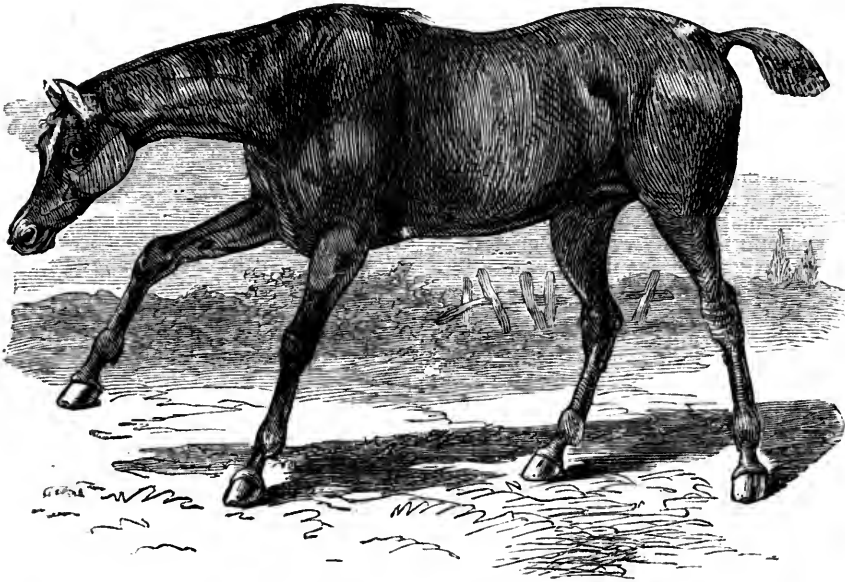

HIGH-CLASS NORTHAMPTONSHIRE HUNTER.

soldiers. But it is not a poor man's sport! No; but it may be made so. Like everything else, there are many ways of doing it. Supposing that a man can get one holiday a week, and can afford to keep one horse, he can have the best and the cheapest day's enjoyment in the world, *if he be a sportsman*. Even in these days of railroads, the necessity of living in a large city need not debar him of his pleasure. Then of what sort must the horse be? Expensive? On no sort of consideration. A poor man's hunter does not require the qualifications even of a poor man's hack. The first thing to be regarded is the weight to be carried. Beauty is not an essential, but strength is. He need not be a great trotter, but he should walk and gallop well. He should also be a safe and reliable fencer; an accomplishment so easy of acquirement, that every broken-down racehorse is taken out of a racing stable, and so taught to jump, that the odds are about two to one against his tumbling down once in four miles, in eleven minutes. Legs and feet in a hunter are of much less importance than in any other kind of horse. If you keep him in his right place—that is, in the fields—he is not likely to suffer from hard ground. The great soundness of a hunter consists in his wind and in his eyes; and when

hack, is he?" said the farmer. "'Deed, he's not," replied his friend, "he's lame." "Well, he won't go in harness," was the rejoinder, "and as he must ha' been sent into the world to get his living somehow, he's only fit for a hunter." To sum up all in a few words, if a poor man has a horse, of a tolerable class, such as we have previously advised him to buy, and has taken a fancy occasionally to go to look at the hounds, he cannot do better than turn his slavey, for the day, into a hunter. Their character in the field has more to do with the horseman they have on their back than most people think; and in hunters this is especially the case.

The Hunter Proper is quite another matter. He may be one of four, or ten, or twenty. He may cost £150, or £500; but, being a hunter, and in a gentleman's stable, he is there only for one purpose—to ride to hounds—and he is never used for any other. Pace and endurance are two of the qualities essential for the true hunter. He is required sometimes to go at his best pace, from twenty to thirty or thirty-five minutes, with no opportunity of catching his wind, but such as he may get in opening a gate, or in pulling up to take a fence more slowly. He has to do this over grass or fallow land, as the case may be. A hunter, therefore, if

not quite thoroughbred, should be nearly so; and we shall repeat our caution, that there should, at all events, be no doubt about the pedigree of the sire. But it sometimes happens that he has to remain out with a heavy weight upon his back for ten or twelve hours together, wherefore this blood should be famous for stoutness as well as speed. Many sires sent into the provinces are selected for this quality; as the modern system of racing, we regret to observe, manages to do without it. In conformation, we have told our readers already what a hunter should be. His wind and eyesight must be unquestionable; his shoulders as oblique as possible, as the necessity for recovering himself in the case of a fall is manifest. He should have great depth of girth, and consequently short fore-legs, which must be strong, and capable of sustaining him in galloping or jumping down hill. His back should be strong, and he should be well ribbed up, but not so closely as to interfere with his pace. His thighs must be muscular, and his hocks clean and well-shaped, such as we have formerly described them; and there should be no imperfection here, if it can be avoided. A hunter's feet should not be too small. Again, nothing is more essential than a good temper. An irritable horse in a crowd is a nuisance, not only to his rider, but to the rest of the field, as it is impossible always to steer clear of collisions. Hounds are also liable to be sufferers; and, paradoxical as it may appear, it is more easy to replace a good horse than a first-class hound.

Size.—The height of a good hunter must vary according to requirements. The minimum should be fifteen hands two inches; and, excepting for a very big man, sixteen hands should be the maximum. The theory of having a horse considerably above your weight should be limited by circumstances. If a powerful horse be very easy indeed to ride, of course it will be an advantage to have two, three, or four stone in hand; but it is very seldom that this is the case. They are usually rough and very tiring gallopers, and when the rider becomes fatigued, and is unable longer to hold his horse together, he loses all the advantages of the extra power. A man riding eleven or twelve stone should buy hunters to carry at least a stone over his weight, and he can always find thoroughbred ones to do it. Riding weight includes saddle and bridle, as opposed to walking weight. A man riding fifteen or sixteen stone in the Midland Counties, as is not unfrequently the case, requires the very best class of hunter to carry him. It is at these weights that the vast sums of money given to dealers and in private sales begin. Two, three, and four hundred pounds are frequently given for these horses, and as much as six hundred and a thousand have been known to have been offered without tempting the vender. The places of sale for such horses are the fashionable country-dealers' yards immediately preceding and during the season: the best of the London dealers are constantly looking for them in every direction, and hard-riding men will tell you, not with the success which the demand ought to encourage. When a really good stud comes by any accident up to London, there is no difficulty in realising a very fair price by them, and it is one of these cases in which we recommend the purchaser to be very careful that he does not get the black sheep of the flock.

Age in the hunter is usually considered of less consequence than in hacks or carriage horses. It takes a certain length of time—or was considered to do so before these days of four-year-old steeplechasers—to make a hunter. He has a trade to learn—a variety of fences to study—before he is quite accomplished. We trust the foolish old notion of taking a young horse out, “to give him a fall,” is nearly obsolete. Young hunters want encouragement, and the fewer falls they get, the better for them. They must tumble some day, but it should be

postponed as long as possible, and then a horse becomes a natural jumper and fond of the amusement. A horse should be taken out at four, and ridden behind others, so as to have nothing but gaps and easy fences to negotiate. At five he may be ridden more boldly, with a good man on his back; but he should never be ridden to a standstill, as he is nearly sure to become cunning, and to lose his courage afterwards. At six he is a good hunter, but he is not to be called perfect—or, in other words, a perfect old gentleman's horse—until at least three or four years later. The perfection of age in a hunter, if he retain his boldness and love of the sport, is ten years old; whether he does so or not depends entirely upon the schooling of his last four years.

It was impossible to omit the hunter from our articles on the horse, though the general reader will be more satisfied to deal with the useful. What we have said, however, can scarcely be considered out of place even to the novice, or to the proprietor of a single horse.

INMATES OF THE HOUSE.—LEGAL.

BILLS AND NOTES (*continued*).

IN a preceding paper we mentioned the properties of Inland Bills of Exchange and Promissory Notes; in the present article we propose to discuss in a few words the nature of a Foreign Bill of Exchange, of a Cheque, and of an I O U.

As we have before remarked, foreign bills are those which are drawn and payable abroad, that is, not within any part of Great Britain and Ireland. They differ from inland bills in the following respects:—They are drawn in three parts, each part being a facsimile of the others, whilst the whole of the three papers form what is called *a set*. Each part of this set contains a condition that it shall continue payable only so long as the others remain unpaid. Only one part is accepted, and whichever part contains the acceptance is called the *first* part. Only one part is negotiable for value, and he who gives value is entitled to all three. These precautions are taken for the sake of safety, for one part may be sent to a distance, and if it is lost in transit, the loss does not invalidate the two remaining parts which are still in existence.

Stamp.—A *bonâ fide* foreign bill does not require a stamp; but if a bill is drawn in Great Britain and made payable abroad, or drawn abroad, negotiated, presented for payment, or paid in Great Britain, a stamp is required. A bill is, for legal purposes, considered to be drawn in the country in which it is to be paid; so a bill drawn in France, and divided into sets, but payable in England, is really an inland bill.

Usance.—A foreign bill is often drawn payable at one *usance*, or at two or more *usances*, that is to say, payable after the period has elapsed which is customary between the places where the bills are drawn and made payable; so that the English law of three days of grace is not applicable to foreign bills. If, however, the bill is payable in England, the English rule about the three days of grace holds good.

Protest.—A protest is a solemn declaration made by a notary public when a foreign bill is refused acceptance or payment, in other words, dishonoured. The protest must be written under a copy of the bill and must declare that acceptance or payment (as the case may be) has been demanded and refused; the reason, if there be one, must be assigned, and it is then declared that the bill is protested. Protest is necessary in the case of a dishonoured Bill, and the holder must send a copy of the protest to the drawer, with this exception, *viz.*—if the drawer had no reasonable expectation that the Bill would be accepted or paid, or if he has admitted his liability to pay, by a promise to do so.

The following is an example of a foreign bill of exchange:—

London, Jan. 1st, 1820.

Exchange for 10,000 livres.

At two usances [or at sight, or — after date] pay this my first bill of exchange, second and third of the same tenor and date not paid, to Messrs. Cliquot and Co., or order [or bearer], Ten Thousand Livres, value received of them, and place the same to account, as per advice from

James Grundy.

To Messieurs Sillery and Co., Paris.

Payable at —.

Table of Stamp Duties on Foreign Bills of Exchange.

	£	s.	d.
When the sum payable shall not exceed	£25	...	0 0 1
When it exceeds £25 and does not exceed	£50	...	0 0 2
"	50	" "	0 0 3
"	75	" "	0 0 4
"	100	" "	0 0 8
"	200	" "	0 1 0
"	300	" "	0 1 4
"	400	" "	0 1 8
"	500	" "	0 2 6
"	750	" "	0 3 4
"	1,000	" "	0 5 0
"	1,500	" "	0 6 8
"	2,000	" "	0 10 0
"	3,000	" "	0 13 4
And when it exceeds £4,000, then for every £1,000 and part of £1,000 of the money thereby make payable			0 3 4

A Cheque on a Banker is in legal effect, as we have before mentioned, an inland bill of exchange, drawn on a banker, payable to bearer or order on demand, consequently is subject to the liabilities and rules which regulate other bills. With their almost universal use, however, as payment for money, certain customs have arisen respecting them, which are now a part of the mercantile law of England. A cheque must be directed to a banker, and signed by the drawer, who has money deposited with the banker, out of which the cheque is to be paid on presentment. The following is a form of a cheque:—

London, March 20th, 1870.

No. —.

Messrs. Coutts and Co., Strand, London.

Pay Mr. Alfred Bennett, or bearer [or order], [Stamp.]

Twenty Pounds.

£20 : 0 : 0.

Frederic Waters.

The chief distinctions between a bill of exchange and a banker's cheque are briefly these:—

A bill of exchange is drawn upon a person who is expected, and who in the ordinary course does accept it, whilst a cheque, though drawn upon a banker, is not accepted by him; it is understood to be a request or order to pay money instantly when the order is presented, and accordingly does not need to be accepted. The three days of grace usual on bills of exchange are not allowed on cheques.

A cheque passes from hand to hand upon the faith reposed in the maker of it, and a confidence that there are sums belonging to him at his banker's which will be sufficient for the payment.

As a cheque is not accepted, it is not always, like a bill of exchange, indorsed; it may be indorsed, however, and then the holder may bring an action against the indorser in default of payment.

A cheque may be what is technically called "crossed," which is a characteristic unknown to a bill of exchange.

A cheque may be drawn or negotiated for any sum of money, large or small.

All cheques or drafts must be stamped with a stamp of 1d.; but by a recent Act of Parliament, all bankers, into whose hands a banker's draft shall come unstamped,

are allowed to affix the necessary adhesive stamp, cancel it, and charge the drawer with the stamp; nevertheless, the drawer is not relieved from the penalty.

It was considered some time ago that if a cheque were *post-dated*, that is to say, if it were to bear date on a day subsequent to that on which it was really drawn, it would be void; two recent decisions, however, have settled that a cheque now-a-days may be post-dated, if payable to the drawer, or some one on his behalf. It need not specify the place in which it was drawn.

As a rule, the drawee of a bill is not liable until he accepts it; but a banker, in whose hands money has been lodged, is an exception to this rule. He is bound to pay his customers' cheques after a reasonable time; and if he does not do so, he is liable to have an action brought against him by his customer. Mr. Justice Byles gives a case in support of this:—

John Matthews kept a banking account with Williams and Co., bankers. One morning the balance in their hands to Matthews' credit was £69 16s. 6d. About one o'clock on the same day a £40 Bank of England note was paid in to Matthews' account; and a little after three a cheque, drawn by Matthews for £87 7s. 6d., was presented. The clerk, after referring to the books, said that there were not sufficient assets, but that the cheque might probably go through the clearing-house. On the following day the cheque was paid.

Matthews, however, brought an action against the bankers. No actual damage to Matthews' credit was proved, but the jury gave a verdict for him, but with no damages. Upon which he applied for a new trial. Lord Tenterden, the judge, remarked that it was a discredit to a person, and therefore injurious, in fact, to have a draft refused payment for so small a sum, for it showed that the banker had no confidence in the customer; it was an act, moreover, calculated to be particularly injurious to a person in trade; that his judgment, however, proceeded on the ground that the action was founded on a contract between the plaintiff and the bankers; that the bankers, whenever they should have money in their hands belonging to the plaintiff, or within a reasonable time after they should have received such money, would pay his cheques; and that there having been a breach of such contract, the plaintiff was entitled to recover damages.

Therefore, as the law stands, although the customer cannot prove that he has sustained any special damage by the non-payment of his cheque, the jury are directed to give such damages as they may judge to be a reasonable compensation due to the customer's credit, taking into consideration, of course, his standing and position as a business man.

If the sum which the customer marks on his check be altered and increased by any subsequent holder, the alteration is forgery; and if the banker pay the larger sum, he cannot charge his customer with the excess, but must bear the loss himself. But if the drawer of the cheque give any facility or occasion for the forgery, he will then have to bear the loss. For an example, we will refer to a case quoted by Mr. Justice Byles:—

A customer of a banker, on leaving home, entrusted to his wife several blank forms of cheques signed by himself, and desired her to fill them up according to the exigencies of his business. She filled up one in the following manner, and delivered it to her husband's clerk to get it cashed:—

No. —.

No. 1, St. James's Square,

London, March 1st, 1869.

London and Westminster Bank,

Westminster Branch.

[Stamp.]

Pay to John Smith or bearer

Fifty-two Pounds Two Shillings.

£ 52 : 2 : 0.

James Robinson.

The clerk, however, before presenting it, inserted the words "*Three hundred*" before the word *fifty*, and the figure 3 between the printed £ and the figures 52 : 2 : 0 ; so that when he presented the cheque, it appeared to be drawn for the sum of £352 2s. od. The banker paid it. An action was afterwards brought by James Robinson, the drawer, against the banker ; but it was held that the improper mode of filling up the cheque had invited the forgery, and therefore that it was just that the loss should fall on the drawer, and not on the banker.

The above example illustrates fully the consequences that may ensue on a carelessly-drawn cheque. The greatest possible precautions should always be taken, not only to guard the drawer against loss to himself, but to avoid throwing temptation in the way of his servants.

It is now a very common occurrence for the purposes of business for a cheque to be *crossed*, that is to say, marked with two parallel lines across the face of it, between which is written the name of some banker, or simply the words "and Company." The effect of this is that the cheque, in the first case, can only be presented for payment through the banker *specified*, whilst the effect, in the second place, is that it can be paid through *any* bank. An Act was passed relative to this subject, by which it was declared felony for any one to fraudulently obliterate or alter the crossing of any cheque, but which recognised the right of a lawful holder to cross a cheque, and on a cheque crossed with the words "and Co." to prefix the name of any banker.

If the drawer of a cheque dies before presentation, his death is a countermand of the banker's authority to pay it ; but if the banker pays the cheque before notice of the death, the payment is good.

An I O U is simply an acknowledgment of a debt, and does not in itself amount to a promise to pay. An acknowledgment of this nature is often made in the following way :—

Mr. Adolphus Ellis.

London, March 1st, 1870.

I O U £20 : 0 : 0.

Harry King.

An acknowledgment of a debt in this form is called an I O U ; and, as has been remarked by a learned judge, it is evidence of an account stated, but not of money lent. As it is not a promise to pay, it does not require a stamp.

In some cases, however, an I O U will contain an agreement that the money is to be paid on a certain day, then the instrument is a promissory note, and accordingly must be stamped. If the contracting words be such as to make it not a promissory note, but an agreement, it must be stamped accordingly, unless the instrument be under the value of £5.

We have now shortly discussed the properties of Bills of Exchange, Promissory Notes, Cheques, and I O U's ; but before we bid adieu to this branch of the law for good, we will mention what steps should be taken by the loser of an instrument of this kind, and also how a holder can bring an action for the payment of his bill.

Immediately on the loss of a bill or note, the loser should give notice to that effect to all the parties liable on it, for they will thus be prevented from taking it up without due inquiry ; the loss should also be publicly advertised, for the fact of any person discounting it after notice of the loss has been given will be strong evidence of fraud.

If a lost bill or note be in the hands of the finder, or of any one to whom he (the finder) has transferred it, and the transferee has taken it under circumstances which would amount to fraud, the true owner of the instrument may bring an action for the recovery of it ; and if it has been paid by the acceptor or the maker to such wrongful holder, the true owner may bring an action for the recovery of the amount stated on the instrument.

If a debtor remits his creditor a bill or note, by a conveyance which the creditor directs, or by post, if that be the ordinary vehicle of transmission between them, and the bill or note be lost or stolen, the loss will fall on the party to whom the bill was intended to be remitted.

As we have before remarked, an action may be brought for the recovery of a bill itself, or for the amount stated on it. The holder of the bill, that is, the person who is entitled to receive the value of it, is the only person who can sue on it. If, however, there are several persons liable on the face of the bill, the holder is not bound to single out one and to bring an action against him, but may sue any or all of the parties named. A substantial satisfaction of the debt, however, by any one will clear all the others.

It must also be borne in mind, that although the holder of a dishonoured bill may bring an action against all the persons liable, and may obtain judgment against *all*, he can only levy the amount of the debt on the goods of *one* party. Were he to attempt to levy on a second party's goods, the Court would restrain him.

Finally, as regards interest, unless it be mentioned on the face of the instrument, it is in the discretion of the jury at the trial to give or withhold it, or to reduce it below 5 per cent., which is the usual rate given. So when the interest on a foreign bill is governed by the law of a foreign country, in which the rate of interest is high, the jury may give a higher rate.

BERLIN WOOL MATS.

THERE is a pretty kind of moss used now for making borders to mats and covers to tea-caddies, in conjunction with a few flowers made in Berlin wool, disposed about in a picturesque way.

The old way of making moss is with varieties of shades of green, yellow green, blue green, and plenty of dead-leaf green. Cast on a steel needle twenty-four stitches, and knit up all the wool in the plain stitch as tightly as possible. Take the colours at hazard and without method, using a skein of each. It is dipped in water when finished, baked in the oven, and then unravelled. The new moss is scarcely any trouble to make. It is used all of one colour—a bright grass green.

The following method is that commonly adopted :—A skein is spread out and held in any way, such as over a couple of winders, or it may be cut open at one end and tied to a leaden pincushion by the extremity. It is then tied all along at distances of an inch apart with yellow sewing silk, and the silk is carried from the left to the right. The silk is generally wound on a netting needle to do this. When the centre skein is so tied from end to end, cut the wool right through in the centre of every space between the tying, leaving it hanging like a number of little tufts to the silken string.

The silk, in the next place, is sewn to the foundation of the fancy work, which may be a dark thin card, or a piece of dark green calico.

Flower-pot covers can be made of this moss, and paper or muslin roses, heart's-ease, daisies, geraniums, &c., arranged about it.

A moss flower-pot cover can be easily made on thin card, covered with dark calico ; and with lilies of the valley alone, placed at intervals upright will form a pretty design. The flowers can be purchased by the dozen, and are not very expensive. By judicious selection and arrangement of colour, very charming effects may be thus obtained. Either rich warm masses of brilliant colours, contrasting and deriving increased beauty from the green of the moss, may be secured, or more delicate effects, by associating it with the quieter and lighter colours.

D'OYLEYS, ANTI-MACASSARS, ETC., FROM NATURAL FOLIAGE.

To young ladies desirous of making presents to friends, by whom the work of their own hands is more likely to be appreciated than the most expensive article merely bought in a shop, or to those at a loss what to contribute to bazaars or fancy fairs, we would suggest the beautiful and ingenious method of arranging ferns, or other gracefully-shaped leaves, as centres of a set of d'oyleys, where each can have a varied design, according to fancy or skill. The material should be of the finest jean, cut into circles, either with a cheese-plate or in any other simple way. The ferns or leaves selected should be flattened, by leaving them several days under pressure. The kinds which will be found most suitable, and have the best effect, are those of an open character, that is, very much pierced or perforated, such as the fern, wild geranium, oak, very young sprigs of vine, jessamine, or rose-leaves; also the airy stems of grasses and harebells; these can easily be had in the country, and sea-side visitors can attain the same results with sea-weed. Many will find it most convenient to begin their work upon a drawing-board, as it gives greater facilities for being safely laid aside in the intervals of the process. Having arranged the leaves tastefully in one of

even a photograph. Continue the process until it is of the required shade; never hurrying over it, or taking too much ink on the brush, for fear of blots; nor even allowing the dots to be coarser at one time than another.

Fig. 1 is simple, but appropriate in design, consisting merely of a few young vine leaves, *apparently* laid over grasses, but in reality the grasses are laid over the vine; for the darkest leaves in the d'oyley are the first removed, the pure white always remaining till the ground is finished, which has generally the best effect when graduated or vignettted from the centre outwards. When satisfactorily concluded, it must be left a short time to dry; care also should be taken to allow it to be sufficiently dry between the removal of each layer of leaves. Then proceed with a pen, dipped in the same ink, to draw in the veins, &c., taken from the originals; the whole to be finished by a rose-coloured silk fringeround the edge; or, by way of greater variety, each might have a different-coloured fringe.

Fig. 2 is a design which is capable of extensive adaptation to a great variety of tastes and requirements, inasmuch as, instead of the monogram here introduced, anyone may substitute their crest, armorial bearings, or a scroll with motto or name. This monogram was traced on paper, afterwards cut out with the scissors, and placed on *first*, the leaves arranged as in Fig. 1. The

whole effect of this d'oyley could be reversed, by keeping it darker towards the outer edge, leaving the monogram upon a light ground in white, which could be tinted with colour or gold at pleasure.

Having completed the d'oyleys,



Fig. 3.

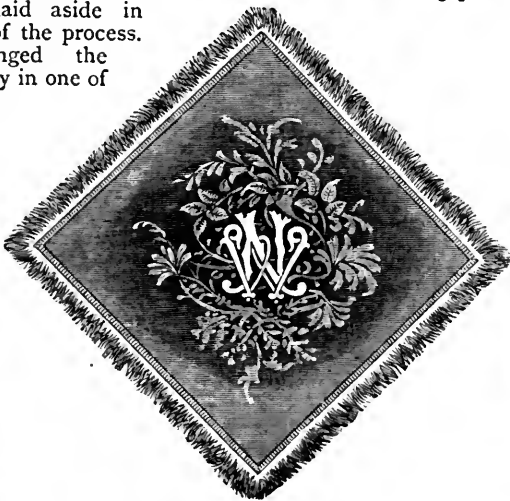

Fig. 2.

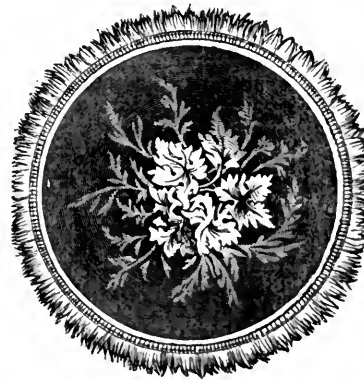

Fig. 1.

we give directions for the anti-macassar in Fig. 3. Its average size is about one yard in length by three-quarters wide. As this involves more labour and material (though nothing in comparison to the time demanded by crochet, knitting, or tatting), we would advise that it should be done with marking ink, as it then admits of being washed. A larger

thin. Then by dipping an old tooth-brush into it, and drawing it constantly backwards and forwards across the teeth of a small tooth comb, or a small steel instrument sold for this purpose, the d'oyley is covered all over with the finest spray, which produces the effect of a delicate granular ground, as fine as a highly-finished lithograph, or

kind of leaf may be selected to suit the proportion. The group of Cupids chosen for the centre of Fig. 3 was traced, cut out, and placed in the same way as the monogram, and the details finished afterwards with the pen from the original. If the drawing should prove too difficult for the artistic powers of the operator, and the engraving selected be not too valuable, an easier method is to cut it out, and paste it on, after the dark ground is finished; it has only to be carefully steeped in cold water to be taken off before the anti-macassar is washed, and can then be replaced as before. The corners should be composed of leaves a size less than those used for the centre, and the four connected by a trailing border of convolvulus, vetch, speedwell, ragged robin, or ivy. Another application of this process is the decoration of lamp-shades and fire-screens, where the green ground, generally preferred, suits admirably as the natural colour of the foliage, and it may also be used for the decoration of bedroom and other furniture, made of light coloured woods, and afterwards varnished.

We will only add that this fascinating combination of nature and art affords great scope for the display of good taste and decorative arrangement.

COOKING.

SEA FISH.

Turbot, Boiled.—The turbot is the fish for the feasts of the wealthy; but it would be a mistake to suppose that they only profit by it. On the contrary, it is so highly esteemed, and steam and the railway have so equalised the prices, that it is rarely, if ever, to be bought cheap, and the fishermen profit by the increased drain upon epicures' purses. Even in fishing-towns, where turbot could be occasionally indulged in by people of moderate means, every fish is often secured by the dealers before it is caught, and, immediately it is landed, sent off to the metropolis or nearest large town; so that people residing on the coast, who want a superior dish of fish, may frequently have to send inland to fetch it back again. Turbot, like soles, is scarcely ever out of season, and is particularly good during the summer and autumnal months. It is a fish, too, which may be eaten more frequently than salmon, not palling on the palate, nor overtaxing the digestive powers. The freshness of the turbot is known by the appearance of the gills, eyes, and skin; the condition by its plumpness, the creamy whiteness of the under side, and the clear brown tints of the upper side. This latter varies much in colour and mottling, but in good fresh fish is always distinguished by a certain healthy clearness. Lean fish are sometimes taken, apparently pining away, as if they were going into a consumption; these may not be unwholesome, at the same time they are not inviting. We have also seen fish dotted over with spots, either owing to the attacks of some parasite, or the breaking out of boils; instead of testing their quality, we have left them for the consideration of market inspectors. The degree of freshness at which turbot is eaten is a matter of taste. Immediately transferred from the sea to the kettle, they are delicate, creamy, soft-fleshed, and comparatively flavourless. Many prefer them after two days' keeping, and twelve hours' salting. We have even known turbot condemned as stale, which, by careful washings with vinegar, salt, and water, and immediately boiling in plenty of water, eat excellently well. But the biggest turbots are not the best—one of from five to seven pounds being preferable to larger.

Your turbot being emptied, rub it on both sides with salt the evening before you cook it. Immediately before boiling, rinse off the salt, and wash the fish well, both inside and out. Then lay it on the movable bottom of your fish-kettle, with the white side upwards. Set the

kettle on the fire, three-quarters full of water. If the fish is quite fresh, plenty of water will do no harm; if it is in the least "forward," plenty of water will do good. In the latter case, add a wineglass of vinegar (and stir it up in the water), besides the usual handful of salt. When the water is milk-warm, put in your turbot, in order that some degree of heat may have penetrated its substance by the time it boils. Let it come gradually to the boiling point, skimming carefully all the while. A six pound turbot will take five-and-twenty minutes' boiling; larger ones longer in proportion; and note that large fish require more boiling, not only in consequence of their size, but of the greater solidity of their flesh. As soon as boiled enough, take the turbot out of the water, whether wanted to be served immediately or not. You can keep it hot by setting it crosswise on the top of the fish-kettle, covered with a napkin dipped in the boiling water, so as to confine the steam. To serve, slip the fish from off the strainer on to a large hot dish covered with a napkin. Garnish with scraped horseradish, or parsley, or small fried fish, as smelts and soles. Whatever sauce is sent up with turbot should be delicate and subdued in flavour, and not too highly charged with spice or vinegar, whether it be caper sauce, lobster sauce, shrimp sauce, or anchovy sauce. A boatful of good melted butter is a very presentable accompaniment. In helping turbot, the skin is always left on the flesh from the white side, and a bit of the outside fin given with each portion.

When turbot is removed from table, if any is left, the cook should take the flesh off the bones while it is still warm, neatly scraping off the brown skin, and dividing it into handsome portions. This can be warmed up in a saucepan next day with any sauce remaining, eked out, if need be, with a little fresh-made melted butter, and will so make an acceptable addition to next day's dinner. Also with cold turbot, smeared with a little essence of anchovy or essence of shrimps (the latter perhaps preferable for the purpose), you may make an excellent mock lobster salad. A mayonnaise of cold turbot is likewise an agreeable summer dish.

The Brill lends itself in every way to exactly the same treatment as the turbot; only, being much less thick in substance, and somewhat less firm in flesh, it takes proportionately less time to boil. When turbot is not to be had, brill may be accepted as not too despicable a substitute; but sometimes, in a scarcity of the former, the latter will fetch nearly turbot prices, which it certainly is not worth, being decidedly not only inferior in flavour, but poorer in gelatine and other nutritive elements. Small turbot and brill, of a size for frying, are excellent dressed that way, exactly like fried soles, of which more anon. After emptying them, scraping off the scales and spines from their brown side, and washing, they should be dried in a napkin, dusted and rubbed with flour, and then committed to the frying-pan.

The Sole.—Like lobsters, soles are always in season in the London markets. In fishing towns they may often be bought *alive*, killed, and fried immediately; they are first-rate then. At the same time, soles have the advantage of bearing well, in cool weather, to be kept till the second day. They vary much in size, from the little things called "tongues" to specimens weighing a couple of pounds and upwards. These latter are best treated as—

Boiled Sole.—Scale your fish thoroughly on both sides, and do not strip off the brown skin, but leave it as intact as you would on a turbot or brill. Empty the fish, and do not reject the roe, if there is one, but return it to its place immediately before boiling, an hour or two previous to which you will rub the sole on both sides with salt. Its thickness being comparatively trifling, you may plunge it into boiling salt and water. In about ten minutes it will be done enough. Serve on a napkin, with the white side upwards, accompanied by shrimp, anchovy, or essence of

shrimp sauce. A small sole boiled in this way is one of the most suitable dishes to offer to a convalescent.

Baked Soles, Norman Fashion.—Fine soles are most suitable for this; a couple will make a handsome dish for half-a-dozen persons, supposing there is something good to follow. For each sole, taken a dozen fine, bright, yellow-fleshed mussels; cook, take out of the shells, and pick them in the usual way. The soles are to be well scaled, but not skinned on either side. Butter liberally the bottom of a dish that will stand the fire, and cover it with slices of onion cut very thin. On these lay the soles with their white side uppermost; distribute the mussels round and amongst them. Season with pepper and salt. Pour over enough cider or perry to moisten all well. Sprinkle a little chopped parsley on the surface, and set into a gentle oven. Watch, and baste frequently during the cooking. Serve in the dish in which they are cooked. The gravy in it is sufficient sauce.

N.B.—Parisian and other grand cooks might ask for champagne, sauterne, or other expensive white wine, to pour over the fish. The Normans use the best sparkling cider, "Sillerie de Normandie." In ragoûts generally, perry and cider replace French wine so well that it is needless to employ the latter, unless you have more money than you know what to do with.

Fried Soles.—There are several fanciful ways of dressing soles, as filets of sole, *i.e.*, the meat stripped from the bone, and then stewed, stuffed, pickled, rolled up, spitted on skewers, roasted, &c. These make very pretty dishes to look at, and some cooks like to do them as samples of their skill. A good sole, well fried, is a dish, say, for a cardinal; but how often do you get it ill-fried!

And now let us try whether we can fry a sole. The fishmonger, besides emptying the fish and cutting off the head, has flayed off the brown skin; we wish he had not. But he has left the white skin, and scraped off *all* the scales. We wash it once more, drain it, and dry it thoroughly between the folds of a napkin; for this reason: any moisture left adhering to its outside, when it is plunged into the boiling fat, would be suddenly converted into steam, and explode, scattering the fat in inconvenient directions, and perhaps burning your face and hands. We then rub the sole in flour, causing as much as we can to stick to it. This not only gives a pleasing brown colour, but helps to form the outer crust which retains the fish's juices. The fat in the pan (sweet pork lard), tested by the strip of bread, is hot enough. In with the sole then, by the help of the fish-slice. We leave it a minute, to receive its surprise, just raising it, to prevent its sticking to the bottom. The under side being nicely browned, we turn it. In another minute or so, we promptly lift it out of the fat with the fish-slice; a few drops fall from it, and it remains suspended in air, dry and golden-brown outside, and savourily succulent within. We lay it daintily on the napkin with which the dish is covered; and, though a well-fried sole needs no sauce, we send up with it nevertheless a little delicate shrimp or anchovy sauce, and two or three smoking mealy potatoes. The practice of flaying off the brown skin of soles deserves reconsideration by cooks. The custom is by no means universal, and we are ourselves more inclined to honour it in the breach than in the observance. At Dunkirk, for instance, where they know what good fish is, we have eaten soles served by an accomplished cook with the skin left on *both* sides. In fact, *why* remove the skin from either side? Thorough scaling is sufficient for cleanliness; and for appearance, soles can always be served like turbot and brill, with white side uppermost. Even if the brown skin be not liked to eat, it helps to retain the natural juice of the fish, and in boiling it keeps the water out; if it is liked, by all means let it be eaten, being not only wholesome but very nutritious. Sole skins contain so much gelatine, that in some towns the

fishmongers realise a handsome profit by drying them, stuck flat against a board, and selling them to brewers to "fine" their beer.

The Lemon Sole is a Channel fish, often caught in tolerable abundance, which derives its name not from any connection with lemons, but from the French *limon*, "mud." It is, in fact, the *limaude*, or mud sole. Its flesh, whiter but less firm than that of the sole, is probably also less nutritious. It hardly does to boil, but may be so cooked, after salting; as fried fresh, it is liked by many, on account of its delicacy and clear milky hue. The same may be said of

Flounders and Dabs, which ascend the courses of rivers so high as often to be taken in quite fresh water. They also may be boiled or stewed; but we hold they never do themselves so much credit as when making their appearance really well fried. As a *friture*, they are held in great esteem in Paris; as otherwise than fried, at Blackwall and Greenwich.

Water Souchy.—Take well-cleaned flounders and dabs, with which may be mixed soles, lemon soles, and plaice. Cut them across into moderate-sized pieces, rejecting the heads and tails. Into a stewpan put as much water as will cover them, with chopped parsley and sorrel, peppercorns, salt, and a tiny lump of sugar. A glass of white wine is a great improvement, but it then ceases to be *water souchy*, and becomes a matelote. When the liquor boils throw in the fish, and let it stew until it is tender. Then arrange the pieces of fish on a dish; give the liquor a good boil up, and pour over it. Send up with the souchy a lemon and a plate of brown bread and butter.

The Halibut.—Of all flat fish, the halibut is the largest, measuring sometimes about seven feet in length, and weighing from three to four hundred pounds. In its proportions, the halibut is rather longer than other flat fish. The moderate-sized specimens, which most frequently find their way to English markets, are usually sold by the pound in cuts or slices. The flesh has not much flavour, but is light and wholesome. A dear relative of the writer was fond of halibut, because it is so delicate and white. No fish, in fact, can be more pleasing to the eye in any form of white preparation. To boil halibut plain, after scaling the skin on both side, salt it for six hours, and (unless the piece is very large) plunge it into boiling water. The time of boiling, of course, will depend on the size. Serve, accompanied by white sauce, made with milk instead of water, liberally dosed with butter, and slightly seasoned with salt, and a small pinch of scraped horse-radish. Shrimp or anchovy sauce go well with it. Where there are the means and skill of frying *well*, halibut, cut into steaks of the proper thickness, and so prepared, is both sightly and palatable, garnished with fried parsley. Some well-buttered sauce is desirable, to obviate its natural dryness. Slices from the middle of a halibut may be divided and trussed into convenient-sized cutlets, by cutting them into equal halves directly through the vertebræ. The same plan may be adopted with slices from the thick parts of other large fish (cod, over-sized pike, and salmon), which it is customary to dress as steaks. We have never heard or read of halibut being in any way served *whole*, like turbot or brill.

Halibut Souchy.—Made with the fish cutlets, prepared as above, it is excellent treated as souchy of flounders, allowing plenty of butter, and using white wine, cider, or perry, for at least half the liquor they are to be stewed in. Halibut cutlets will take a little longer stewing than smaller fish. If you put no acid in the stew, serve, accompanied by lemon, and brown bread and butter.

Much art is not usually required for preparing most varieties of our English fish; but skate, halibut, ling, plaice, flounders, and many other kinds, may be greatly improved by the art of the cook, and by the mode of dressing adopted.

THE HOUSEHOLD MECHANIC.

CONSTRUCTION OF GLASS HOUSES AND CONSERVATORIES.

THE construction of a conservatory will at first sight appear a rather formidable undertaking to the household mechanic ; but when he has acquired some little skill in the use of the tools, it will not be found nearly so difficult as might be supposed. Like most other things, a conservatory is complex considered as a whole, but when reduced into detail, it is simply an arrangement of sashes and doors, with their respective frames, modified of course, so as to be suitable to the purposes for which they are employed, but easy of construction, and quite within the reach of the tyro. In these papers we shall first describe

ing may be erected in the corner, although we think it better to have both the ends of glass, and simply use the wall for the back of the structure. If the building is intended to be a permanent one, some care should be taken to obtain a firm foundation. This will be most readily effected by digging out the earth in the line of the intended building, to the depth of eighteen inches or two feet. In this trench, concrete, made as we described for the construction of fountains, should be placed, to the thickness of eight or ten inches, and perfectly level. The latter point may be determined by means of a spirit level, placed on the edge of a board some feet in length. Upon this concrete, brickwork, constructed of hard, stock-bricks, may be placed, until a level of eight inches or more above the surrounding earth is obtained, and this should extend com-

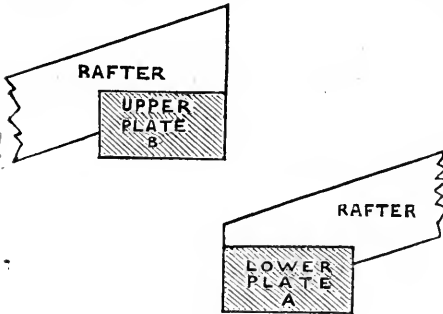

Fig. 2.

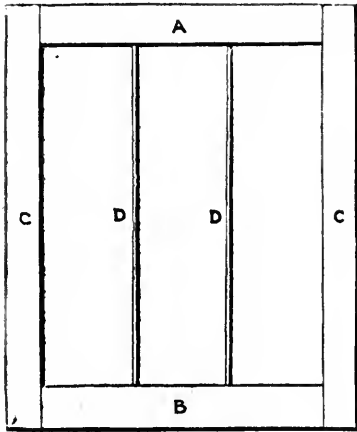

Fig. 3.

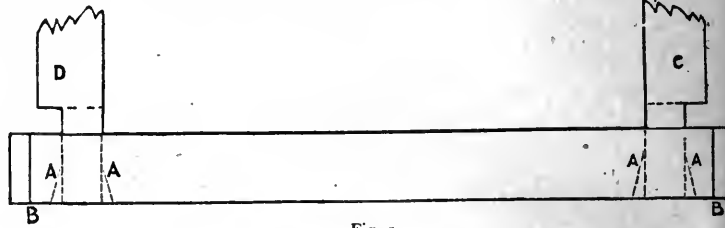

Fig. 5.

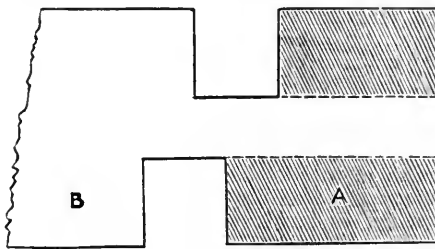

Fig. 6.

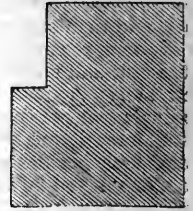

Fig. 4.

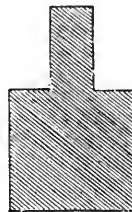

Fig. 7.

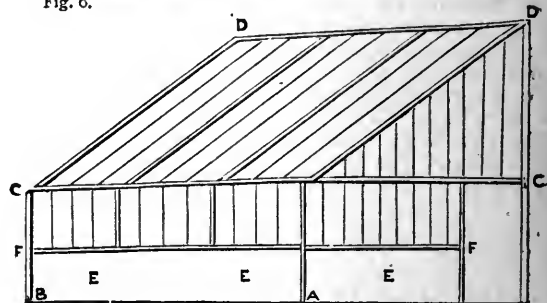

Fig. 1.

each part of the building in detail, and afterwards show how these portions should be erected and fitted, so as to form a whole. As it will be out of our province here to allude to what are more properly matters for the consideration of the gardener, such as heating apparatus, &c., we shall confine ourselves strictly to the details of construction required for the erection of the building, and, for facility of description, to the more simple forms of glass houses in common use—merely observing in passing that, however the design may be varied, the principles of construction are the same in all cases.

The most common form of glass house, and the one most likely to be constructed by the amateur, is that shown in Fig. 1, and which will chiefly be used for the purpose of cultivating and raising plants. As this is the simplest of construction, we will treat of it first.

As will be seen from the sketch, this form of building is well adapted for erection against a wall which will enclose one side ; or, if two walls stand at right angles, the build-

ing may be erected in the corner, although we think it better to have both the ends of glass, and simply use the wall for the back of the structure. This foundation will then be ready to receive the wooden plate upon which the frame of the building will rest. This plate should be of yellow deal (as, in fact, should the whole of the wood-work), about four and a half inches in width, by three inches in thickness, and it should be firmly halved together at each angle, as we have described in the articles on summer houses. If the building is to be erected against a wall, a small portion of the brickwork should be cut out, so as to admit the ends of the plate, which may then be wedged firmly into its place, having, however, been first bedded in mortar upon the brick foundation. Before fixing the plate, the situation of the door, and the general shape of the building, must be determined upon ; and the places where the uprights are to be, marked, and mortices made to receive them. In the end, according to the sketch, Fig. 1, one mortice will be required next the wall to receive one of the door posts ; a second, at the distance required to allow for the width of the door—say about two feet six

inches; a third for the corner post A; a similar one for the opposite corner post B; and one for the back corner against the wall. The two posts which stand against the wall will require to be longer than A and B, by the height allowed for the pitch of the roof, and these should be tenoned upon the top end to receive a plate, which will have to carry the rafters and roof. At the proposed height of the door—say six feet six inches—a mortice will have to be made to receive the lower plate marked C, which should run entirely round the building, and be halved precisely as the lower one at each corner, and be morticed to receive the two corner posts and the door post. The whole of these posts and plates should be planed on all the sides which will be seen, in order that they may be properly painted. If the building be not a very large one, wood of the following dimensions will be sufficient:—For the upper plate, four inches by three; for the corner posts, and other parts, three inches square. In all cases the tenons should pass quite through, and a hole be bored through plate and tenon, in which should be inserted a pin of wood, driven tightly, to fix the whole framework together. When the whole of this framework is prepared, it will be best for the tyro to erect it, taking care to fix all the parts perfectly upright and level. The two uprights next the wall may be secured by means of iron “holdfasts,” which may be obtained at any ironmonger’s shop. The next thing will be to fix the upper plate which is to support the top end of the roof. This will have to be morticed to receive the tenons of the uprights next the wall, to which it should be secured by pins in the usual way. If not sufficiently strong, it may be supported by iron holdfasts, driven into the wall directly under it: in fact, it is as well to adopt this precaution in all cases, as it will confer much additional strength and rigidity upon the structure.

The two end rafters may now be cut, as shown at D, Fig. 1, and fixed in their places, even with the outside of the plates and uprights, so as to form a perfectly fair and even frame over the whole structure. Wood of about three and a half inches deep, by two inches and a half in thickness, will do well for the rafters, of course placing it edgewise. The other intermediate rafters must then be fixed parallel to the outer ones, in number according to the requisite length of the building; but, as a rule, not more than three feet six inches apart. These rafters should be planed quite true upon their upper surface, as upon them the sashes will have to slide. The feet, or lower end, should not be cut to a point, but so as to allow a thickness of not less than an inch at the thinnest part, as shown in the diagram at A, Fig. 2, and the upper end, as shown at B, in the same diagram. When the work has proceeded thus far, the lower portion marked E, in Fig. 1, may be bricked up to the required level, and the sill of the windows, marked F, bedded in mortar, as described for the plates. The uprights may now be cut in, so as to fit between the sill and the upper plate, and these should be placed so as to correspond with the rafters, that the front and roof may be divided into an equal number of parts. The opposite end to that in which the door is placed need have no uprights, but may be formed of one sash up to the level plate.

This will complete the framework of the building, which will now only need the insertion of the sashes and door, the construction of which we will now proceed to describe.

In an ordinary sash, such as is used for house-work, the bars which support the glass are usually worked with a moulding upon the inner side; but as both the working of this, and the fitting together of a moulded sash, is almost too complicated an affair for the tyro, we shall, in this instance, consider only the ordinary square-barred sash, such as is commonly employed for greenhouses. As in the construction of sashes the mortice and tenon joint is in frequent use, we should advise the tyro to practise the construction of this form of joint well, before commencing

to make the sashes required, and to this end he cannot do better than consult the earlier papers, under the heading of the Household Mechanic, in this work.

A sash consists of four parts; the top and bottom rails (A and B, Fig. 3); the styles, C C, which form the sides; and the bars, D D, which are simply inserted in order to reduce the dimensions of the glass. The whole of these are rabbeted to receive the glass; the top and bottom rails and styles on one side, the bars on both sides, as shown at Figs. 4 and 7, which give a sectional view of these parts. As will be seen from these sections, a portion of the wood has to be planed away to receive the glass; it is, therefore, important that it should be clean and free from knots, or it will be liable to fracture during the progress of the work; this is especially the case with the bars, which should always be of wood of the best quality. For a sash, suitable for a greenhouse such as we are describing, an inch and a half will be a suitable thickness; and for the ordinary-sized sash, say five feet by three, the following will be about the right dimensions of the wood, always supposing the thickness we have named:—the top rail, three and a half inches wide; the bottom one, four and a half; the two styles, two and a half inches each; and the bars, one inch. The best plan will be to cut out all the wood required first. Thus, for a structure such as that shown at Fig. 1, five sashes will be required of equal height—three for the front, and one for each end—consequently, ten styles will be wanted—then the top and bottom rails of the requisite length, and lastly the bars, which need not be quite so long as the styles. The styles should be cut some two inches longer than the length of the sash when finished, for reasons which we shall presently see. When the whole of the wood is cut out, it should be planed straight with the trying plane, square at the edges, and to an equal thickness, which latter should be measured by means of a gauge. The work may now be “set out,” that is, the places where the mortices and tenons will be required will have to be marked with a pencil, and the thickness of each by means of a mortice-gauge. The first thing will be to arrange all the styles *in pairs* upon the bench, and, if convenient, secure them temporarily together with a pair of hand-screws. The extreme length of the sash should then be marked upon them with a pencil, as at B, Fig. 5. Next, the width of the rails should be measured and allowed for, *inside these lines*, of course. Then the size of the mortice may be fixed upon. For the top rail, the mortice should not be less than two inches from A to A, and the bottom may be three inches. These mortices should not be cut squarely through, but slightly longer on the back part, to allow of the insertion of wedges. For a sash of one and a half inches in thickness, the mortice should be about three-eighths of an inch in width. The morticing may now be proceeded with, cutting away an equal portion of the wood from each side. As the ordinary mortice chisel is too thick, a finer one than this should be used, such as is made on purpose for this kind of work, and sold under the name of a *sash chisel*. The styles, being now done with for a time, may be set aside, and another portion of the work taken in hand.

The next thing will be to prepare the rails. The setting out of these will require some little consideration. The first thing will be to mark the extreme width of the sash with a pencil, taking care, as with the styles, that the rails are arranged in pairs. The thickness of the styles should then be set off, and a mark made to indicate their position when the sash is completed. One side of the rail should then be squared over to this mark, which will be where the cut will have to be made, to form the shoulder of the tenon. The other side will have to be allowed longer by the depth of the rabbets, which will be about a quarter of an inch: because that part of the style will be cut away, to allow of the insertion of the glass. This will be at once

understood upon reference to the diagram, Fig. 6, which shows a section of the style, with the tenon and shoulders cut to fit it. The mortices for the bars may now be made. Unless the sash be very long, these need not be made quite through the rails, but only cut in about an inch and a half. The preparation of the bars may next be proceeded with. These will have to be set out from the styles, and may be marked in precisely the same manner as the rails; taking care to allow the back shoulder so much longer than the front one, as that it may fill up the rabbet in the top and bottom rails. The position of the tenons must be indicated on each part by lining it with the mortice gauge. To produce the necessary rabbets, a "sash fillister" should be used. This is a plane made expressly for the purpose. Should this, however, not be included in the tool-chest of the Household Mechanic, that plane, known as a "side fillister," may be made to answer the purpose, and it should be made to cut away the wood exactly up to the side both of mortice and tenon, as shown in Fig. 6. The rabbeting being completed, the work may be fitted together—the tenons having been cut, as has been described in previous papers. It will be seen that a portion of the tenons of the rails will have to be cut away, because the mortice is less than the entire width of the rail: this should be carefully done, so as not to injure or break off any portion. The bars should be first inserted into their respective mortices, and when this has been effected, the styles may be put on, and the sash will be ready for wedging up.

ANIMALS KEPT FOR PLEASURE.—BIRDS.

THE CANARY (*continued*).

THE Canary (*Fringilla Canaria*) derives its name from the Canary Isles, where it was first seen in a wild state; it has since been found at Cape Verd, St. Helena, in various parts of Africa, and at Madeira. The first two naturalist writers who named these birds were Aldrovandus (who published a work on birds in 1599) and Gesner, who lived in the sixteenth century.

Canaries are supposed to have been introduced into Europe about the fourteenth century. They were first taken to Italy, and afterwards to different parts of Germany and France. Mr. Adens said he brought to France some canaries from Teneriffe, which were as brown as linnets, but became white after being kept some years. This he attributed to the climate being colder. Vast numbers of these birds were bred in Germany and the Tyrol, and great numbers were imported to England annually, some of those who brought them having to walk hundreds of miles, with the birds on their backs, before they embarked for England. The grey, the yellow, the white, the blackish, and the chestnut are the principal kinds, and it is from their combination and tints that we derive the numerous varieties that we now possess.

Mr. Smith enumerates twenty-nine sorts, commencing with the wild bird found in the Canary Isles; two grey canaries; five flaxen canaries, one with red eyes; three yellow kinds; three kinds called the agate; four kinds of dun-coloured; six variegated kinds, one kind spangled with black and yellow, one kind entirely a fine yellow; and also grey, yellow, and black-crested.

To select Canaries.—Birds are known to be old that have blackish, rough scales to their feet, and strong, long claws. A fine rich, clear, healthy, mealy hen, paired with a healthy, clear, yellow cock, if both are bred from clear yellow stocks, will produce handsome jonque birds. There are two classes of clear canaries, of a darker or lighter shade of colour, designated by the synonymous terms, yellow and white, jonque and mealy, orange and white, and gold and silver.

Birds for Breeding.—To match birds of the same nest for breeding is considered unadvisable, as it will in every

respect weaken them. To breed crested birds, if one has a fine crest, match it to an opposite. Good pied birds may also be obtained by having one parent handsomely pied, and the other clear yellow or mealy. Cinnamon-coloured birds are to be obtained by matching a green male and clear yellow or mealy female; or the reverse. Some persons pair their birds the latter end of February; others a month later. As soon as the birds are paired, keep feeding them high, and add a little moist sugar to the bread and egg until the hen has commenced laying, as it will prevent her becoming egg-bound.

General Treatment.—In winter canaries should not be allowed to remain in a cold room; in summer it is proper to allow them fresh air, which they enjoy. In the light and heat of the sun, they sing gaily and freely. Wholesome air and a lively situation will keep your birds in spirits and health; but beware of placing them in draughts, as many birds contract colds and asthmas, and other incurable diseases from that cause. Cleanliness being a great preservative against most of their disorders, at the bottom of the cage a false bottom should be made to draw out, that it may the easier be cleaned and covered with sifted gravel or sand; some persons recommend sea-sand, the saline properties of which are considered good; some place between the wires a piece of cuttle-bone, or a lump of bay-salt. The cages require to be kept clean, and the perches should be of a size which a bird's claws can grasp; they must be firm and well fixed. Keep the birds' feet clean, and let them have fresh water every day. The cages and birds must be kept free from vermin; examine the crevices and cracks of your cages, and if you find vermin, remove the bird, and wash the cage with a mixture of tobacco and sulphur placed in boiling soap and water; should the bird have any parasites, syringe him daily with this mixture when cool, and while the bird is damp sprinkle over him Scotch snuff; or take him in hand and apply it to the root of the feathers of the breast, back of the neck, and across the back to the loins. In the course of a week he will be free from insects. Some persons wash the cages in hot water, in which a piece of copperas has been infused; others touch the cracks or crevices of the cages with benzine. If a piece of old mortar and plenty of gravel are kept at the bottom of the cage, it will aid in keeping the birds healthy.

Disorders of Canaries.—As birds are attacked with various diseases, we enumerate the following symptoms, which may attract attention:—Placing their heads under their wings; lowering their wings; their feathers becoming bristled, uncompact, or loose; a cough, whine, or moan, as if in pain; panting in their breathing; severe purging, dirtying their vent and tail-feathers after excretion, and repeatedly bobbing down. Great negligence is displayed in not, immediately they appear unwell, administering in their food or water such medicines as are essential to their cure. In all cases where milk is administered in warm weather, remove it before it becomes acid. On seeing the bird unwell, if you blow up the feathers on the belly, you will perceive whether the belly is swollen, full of red veins, transparent, sinking to its extremity. Magnesia, castor oil, &c., are sometimes recommended when this is the case, but the disorder is seldom cured. The simplest plan of administering medicine to birds is by mixing it with their food and water.

Obstruction of the Rump Gland (by many called the "pip," which is a severe cold).—This gland contains the oil necessary for anointing the feathers. Wild birds, during wet weather, exude this oil among their feathers to repel the rain. The birds in confinement, not having proper baths, the gland becomes inflamed and ulcerated. If the bird appears to be continually pecking its feathers, and the feathers are ruffled at the top of the tail, it is a clear indication of the disease. The ulcer first assumes

a yellow, and then a brown appearance. If not severely ulcerated, apply sweet, olive, or castor oil, with a brush; if it afterwards gets worse, prick the ulcer with a needle, and gently discharge its contents, afterwards bathing the part affected with warm water. A few grains of magnesia, or a small quantity of camphor, may be given in the drink.

Diarrhœa, or Dysentery.—If diarrhœa is not cured before it becomes confirmed dysentery, it is seldom cured after. Rhubarb, powdered chalk, and ground ginger, mixed with the seed in small quantities, and given on alternate days, will sometimes remove the disorder in its first stage. Its symptom is a voiding of a white matter, which adheres to the feathers round the vent. When this becomes watery, with white globules in the centre, it is an indication of extreme danger; the birds then refuse all food, and pine until death ensues.

Costiveness.—The simplest remedy for this disease is a teaspoonful of castor oil, placed in fresh milk, sweetened.

Asthma.—This disease arises from neglected colds, exposure to draughts, or from the birds being kept in very hot rooms. The symptom is a gasping as if for breath. Pure mild air and salutary food may in this case benefit, but it is seldom cured. Chickweed, groundsel, or water-cress, will sometimes ease the bird; lettuce and endive leaves are also recommended. Castor oil, with fresh milk and bread, sulphur in the seed, and a small quantity of camphor in the water, are given to birds suffering from this complaint.

Consumption, or Decline.—Atrophy is the form this disorder sometimes assumes in its earlier stages, produced from impure air or improper food. In addition to their ordinary food, give millet-seed, a little fresh milk and bread, water-cress, groundsel, or chickweed; place in the water a small piece of camphor, and in the seed a small quantity of sulphur, occasionally; these attentions will give the birds ease, if it does not cure.

Epilepsy.—This disease exhibits itself in sudden fits. The readiest method you can adopt is to take a little water in your mouth, and spurt it in a slight shower over the bird, or syringe it. Some persons have recourse to cutting the bird's toe-nail until it bleeds.

Ulcers.—If soft ulcers arise on the head or other parts, anoint them with sweet or olive oil. Tumours require opening and drawing.

Giddiness.—Some birds, that have been in cages open at the top, acquire the habit of twirling and twisting their heads and necks so far back, as to overbalance themselves. When this is the case, remove them to covered cages, or place a dark covering over the top of the cage.

Moulting.—At this period it is requisite to attend birds with great care, as they sometimes suffer severely. They require to be kept warm and free from draughts the whole of the time. A few grains of sulphur placed with their seed causes them to moult freely.

SEA-SIDE AMUSEMENTS.

SHELLS AND SHELL-WORK.

THE numerous marine watering-places which are thronged in the summer and autumn months with visitors should serve as so many schools for the naturalist. There zoology, geology, botany, and conchology afford never-ending occupation, of the most useful and instructive kind, for the mind of man, the little child, and the hoary sage. The sheltered bay, the open strand, the bold, rocky barrier, against which the breakers swell and roll, all have their own peculiar animal and vegetable inhabitants; and the several varieties of shore are fully represented by one or other of our marine watering-places, which circumstance enables us, by visiting different parts successively, to investigate the produce of the sea with the utmost advantage. The various classes of marine

animals and their innumerable species are so full of interest, that the minds even of the most careless, when drawn to them, cannot fail to be interested and instructed.

Shells are a secretion of carbonate of lime formed by their inmates for the preservation of their bodies. Shell-fish are termed *mollusca*, or *mollusks*, by reason of the softness of their flesh. Their species are very numerous, and have varied habitats. Many are found between tide-marks, resting under loose stones, burrowing in the sands, or deposited upon sea-weeds. The several species of mollusks live at different depths of the sea, and for this purpose the sea has been divided by conchologists into four separate zones: the *littoral zone*, or tract between tide-marks; the *laminarian zone*, or tract from low-water mark to fifteen fathoms; the *coralline zone*, or tract from fifteen to fifty fathoms; and the *deep-sea coral zone*, or tract from fifty to one hundred fathoms and more. Dead shells, however, of almost all species are found at depths far greater than those in which the several species live; but this is owing to the fact that littoral shells fall from precipitous coasts into deep water, and are mingled with the inhabitants of other zones. They are, moreover, carried by currents over the bed of the sea, and probably are more especially scattered by reason of being devoured by mollusk-eating fish. Thus it is that even littoral shells are found broken and decayed in the deep bed of the sea, or washed ashore in a like state. We believe it is a well-known fact that the cod and most other fish are voracious devourers of the mollusca, and searching the stomachs of fish is a source with the naturalist in collecting shells.

The *littoral zone* depends for its depth on the rise and fall of the tide, and for its extent on the form of the shore. The shells of the shore are more circumscribed in their range than those which inhabit greater depths of the sea, owing to the variations of climate and other vicissitudes to which they are necessarily exposed. The district comprising the lower part of this, and the higher part of the laminarian zone, affords nourishment and shelter to the *rissoæ*, and other kinds of shell-fish. The *laminarian zone*, extending from low-water mark, is the abode of the vegetable-eating mollusca, which resort hither to the groves of *laminaria* or tangle, and other sea-weeds. Here bivalves abound on soft beds of the sea; and the cuttle-fish, calamary, and numerous shell-fish, take refuge amongst the vast beds of grass-wrack (*zostera*) existing little beyond low-water mark on sandy and muddy shores. The richest-coloured shells belong to this zone, as also do the oyster-beds of our seas and the pearl-fisheries of the south. In the tropical seas reef-building coral beds are often substituted for sea-weeds. The *coralline zone*, extending from fifteen fathoms, abounds, in northern seas, with horny zoophytes, succeeding the beds of sea-weed by which the coast is begirt; and here both rocks and shells are covered with the incrustations of the *nullipore*, which constitutes the chief vegetable growth. Bivalves and the beds of scallops pertain to the shallower parts of this zone. The *deep-sea coral zone*, which extends from fifty fathoms, abounds in shells, which, however, are for the most part small and poor in colour: their range is much greater than those of the other zones, which is attributable to the uniformity of temperature in the deep sea. Here still exist the *nullipore* and small branching corals (to which the *terebratula* adhere), and the largest corals of the northern seas. With reference to these zones, it is to be observed that the greatest depth of the British Channel is seldom above twenty to forty fathoms. The univalve, or snail-like species of mollusca, generally inhabit rocky districts; their organisation adapting them for crawling over rocky and sea plants, which afford them their appropriate food. The conchifera, or testaceous acephala, are the species of mollusca which uniformly, and in the greatest numbers, inhabit the sandy shores, as they are capable of living buried to a considerable depth in the sand; their shells



Fig. 1.



Fig. 2.



Fig. 3.

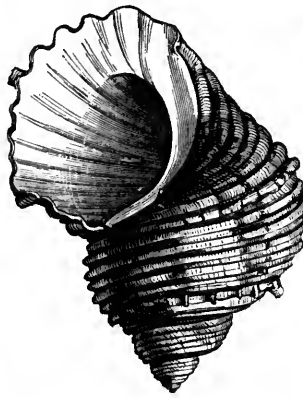

Fig. 4.

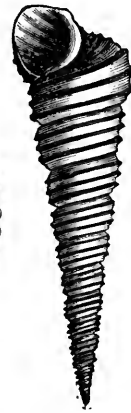

Fig. 5.



Fig. 6.

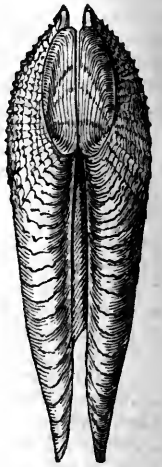

Fig. 7.

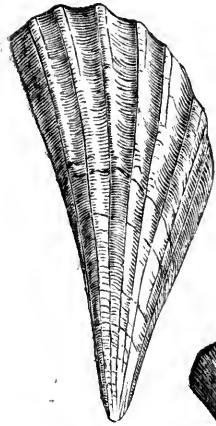

Fig. 8.



Fig. 9.

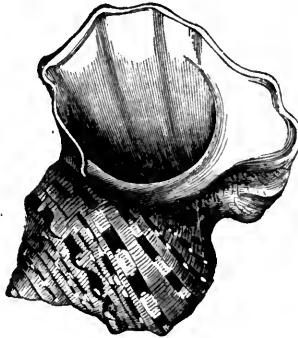

Fig. 10.

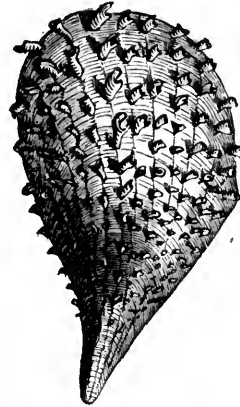

Fig. 11.

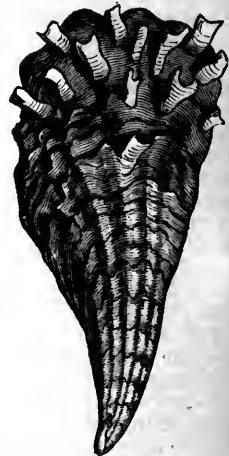

Fig. 12.

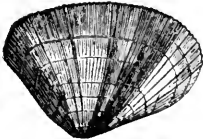

Fig. 13.



Fig. 14.



Fig. 15.



Fig. 16.

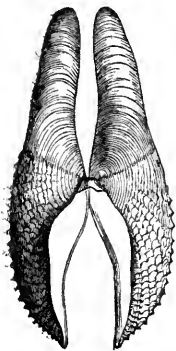

Fig. 17.

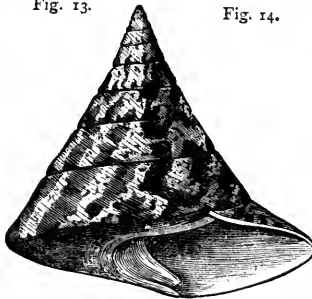

Fig. 18.

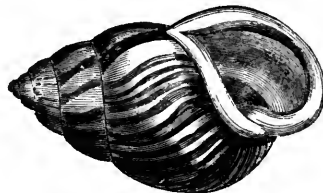

Fig. 19.

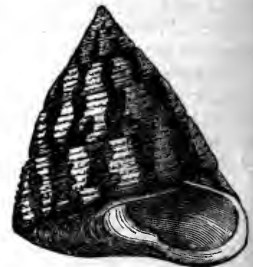

Fig. 20.

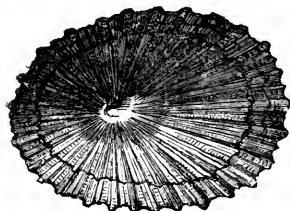

Fig. 21.

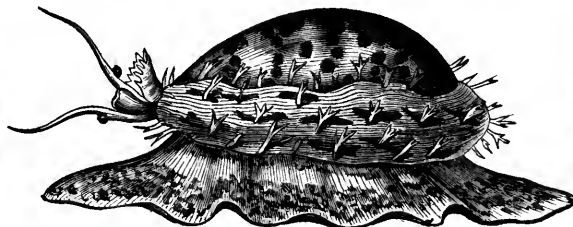

Fig. 22.



Fig. 23.



Fig. 24.

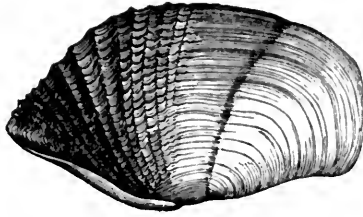

Fig. 25.

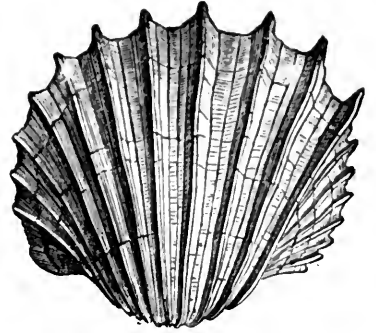

Fig. 26.



Fig. 30.

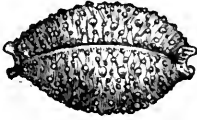

Fig. 27.

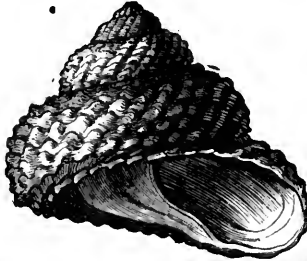

Fig. 28.



Fig. 29.

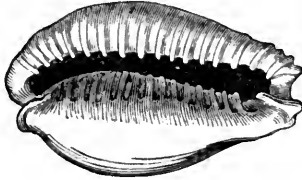

Fig. 31.

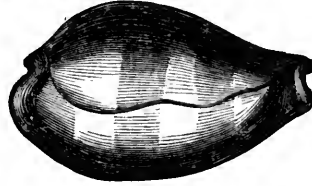

Fig. 32.



Fig. 33.



Fig. 35.

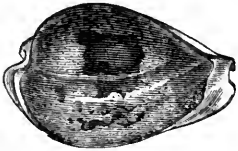

Fig. 34.



Fig. 38.

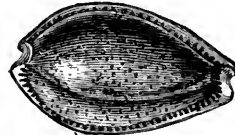

Fig. 35.



Fig. 37.

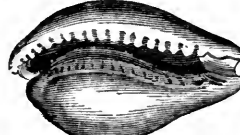

Fig. 39.



Fig. 40.

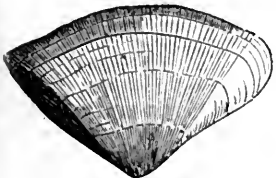

Fig. 41.

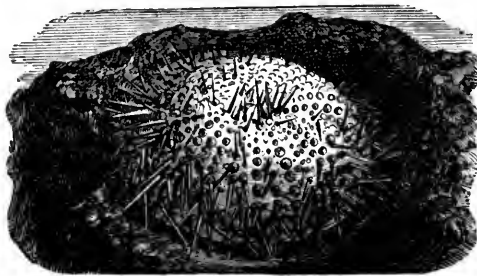

Fig. 42.

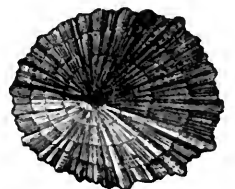

Fig. 43.

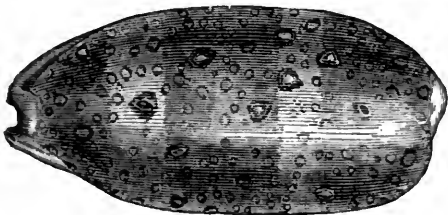

Fig. 44.

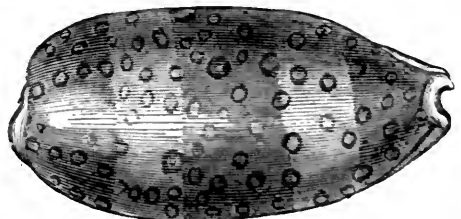

Fig. 45.

are continually met with on these shores, and they themselves may be found buried along the margin of the retreated tide. The shells of this species consist of two principal saucer-shaped pieces, more or less perfectly covering the body of the animal; these shells are annexed by a more or less complex hinge, working on a highly-elastic ligament. The scallop and common cockle are specimens of these. The former remarkable for the simplicity of its structure, both as regards the animal itself and the hinge of its shell; the latter for its wonderful powers of burying itself in the sand. We append a list of such shells as are commonly to be met with on the shore, and of some which are as commonly sold at our ordinary watering-places.

The subjoined specimens of shells are for the most part to be found in some species upon our own shores. Figs. 24 and 26, although not intrinsically British, are met with in simpler forms along our coasts, and are represented on account of their elegance and service in the formation of feet for boxes, pincushions, and stands; for the last of which the British species is admirably adapted. The following is a list of the figures:—

- | | |
|----------------------------------------------------------------------------------|----------------------------------------------------------------|
| Fig. 1. <i>Turritella terebellata.</i>
(Lamarck.) | Fig. 24. <i>Tridacna squamosa.</i>
(Lamarck.) |
| Fig. 2. <i>Turritella sanguinea.</i>
(Reeve.) | Fig. 25. <i>Pholas crispata.</i>
(Linnaeus.) |
| Fig. 3. <i>Turritella goniostoma.</i> | Fig. 26. <i>Cardium costatum.</i>
(Linnaeus.) |
| Fig. 4. <i>Turbo argyrostomus.</i>
(Linnaeus.) | Fig. 27. <i>Cypræa nucleus.</i>
(Linnaeus.) |
| Fig. 5. <i>Turritella angulata.</i>
(Sowerby.) | Fig. 28. <i>Trochus Cookii.</i>
(Chemnitz.) |
| Fig. 6. <i>Turritella replicata.</i>
(Linnaeus.) | Fig. 29. <i>Cypræa gangrenosa.</i>
(Dilwin.) |
| Fig. 7. <i>Pholas dactylus.</i>
(Linnaeus.) | Fig. 30. <i>Buccinum undatum.</i>
(Linnaeus.) |
| Fig. 8. <i>Pinna bullata.</i>
(Swainson.) | Fig. 31. <i>Cypræa eburnea.</i>
(Barnes.) |
| Fig. 9. <i>Buccinum senticosum</i> (<i>a species of whelk</i>).
(Linnaeus.) | Fig. 32. <i>Cypræa onyx.</i>
(Linnaeus.) |
| Fig. 10. <i>Turbo marmoratus.</i>
(Linnaeus.) | Fig. 33. <i>Bulimus sultanus.</i>
(Lamarck.) |
| Fig. 11. <i>Pinna nigrina.</i>
(Lamarck.) | Fig. 34. <i>Cypræa subviridis.</i>
(Reeve.) |
| Fig. 12. <i>Pinna rudis.</i>
(Linnaeus.) | Fig. 35. <i>Cypræa spurca.</i>
(Linnaeus.) |
| Fig. 13. <i>Donax denticulatus.</i> | Fig. 36. <i>Aplysia inca.</i>
(D'Orbigny.) |
| Fig. 14. <i>Cypræa nucleus.</i>
(Linnaeus.) | Fig. 37. <i>Cypræa Capensis.</i>
(Gray.) |
| Fig. 15. <i>Trochus imbricatus.</i>
(Gmel.) | Fig. 38. <i>Planorbis corneus.</i>
(Linnaeus.) |
| Fig. 16. <i>Succinea putris.</i>
(Linnaeus.) | Fig. 39. <i>Cypræa subviridis.</i>
(Reeve.) |
| Fig. 17. <i>Pholas crispata.</i>
(Linnaeus.) | Fig. 40. <i>Turbo margaritaceus.</i>
(Linnaeus.) |
| Fig. 18. <i>Trochus Niloticus.</i>
(Linnaeus.) | Fig. 41. <i>Donax rugosus.</i>
(Linnaeus.) |
| Fig. 19. <i>Bulimus sultanus.</i>
(Lamarck.) | Fig. 42. <i>Echinus</i> , commonly
known as the Sea-urchin. |
| Fig. 20. <i>Trochus virgatus.</i>
(Gmel.) | Fig. 43. <i>Patella cæralia.</i>
(Lamarck.) |
| Fig. 21. <i>Patella umbella.</i>
(Gmel.) | Fig. 44. <i>Cypræa argus.</i>
(Linnaeus.) |
| Fig. 22. <i>Cypræa tigris</i> (<i>Cowrie</i>).
(Linnaeus.) | Fig. 45. <i>Cypræa argus.</i>
(Linnaeus.) |
| Fig. 23. <i>Chiton magnificus.</i>
(Deshayes.) | |

Collecting Shells.—There are many ways and means of collecting shells, extending from gathering the dead shells washed ashore by the sea to dredging the deep waters. When the tide is at its lowest, the collector should wade amongst the rocks and pools near the shore, and search the crevices and ledges of overhanging rocks, using the arm, whenever of sufficient length, and when not, an iron rake, with close-set teeth, which will be found a very useful instrument. He should turn over all loose stones, and examine the leaves of all growing sea-weeds. Chitons and limpets, which are to be found on rocky coasts, may be detached by using a pocket-knife. It has been recommended by those who have paid particular attention to these shells, that the chitons should be left to die, being secured between two boards; the dead bodies being extracted, the shells may be purified by means of employing a little chloride of lime placed in the interior. The use of warm water will sometimes be found serviceable

in the detaching of ormers (*halitides*) from the piece of rock to which they adhere, afterwards giving them a sudden shove sideways with the foot. Mere violence should not be employed in detaching them, as in most cases the shell would be damaged thereby. Cowries and other shell-fish are frequently to be found beneath madrepores and loose fragments of rock, and therefore the collector should never omit turning these over. Coral reefs, which are not likely to be explored except by the professed naturalist, are well known to harbour great quantities of the most beautiful shell-fish. In collecting from the rocks, great pains should be taken to look very closely into the crevices and under the loose fragments, as all species of mollusca hide very closely. In wanderings over the rocks beneath the sea, the collector should bear in mind to preserve his feet against the pricks of the *echini* (see Fig. 42), the back-fins of sting fishes, and the stings of the medusæ. Very minute shells, most serviceable in the manufacture of ornaments, as they form a beautiful groundwork, are to be obtained by washing sea-weed, generally of the smaller and finer order, in a bowl of fresh-water, when the fish will immediately fall to the bottom. But should they be required alive—as for the aquarium—the weed should be immersed for some time in a bowl of sea-water, when the little mollusks will generally for the most part creep out. At very low water bivalves may be taken on sandy shores by digging with a hoe, spade, or fork; while in rocky places others may be found, which having bored their way into piles and rocks, require the aid of chisel and hammer to take them. The hoe used for gathering cockles is similar to the garden or turnip hoe. The neck, however, is somewhat longer and lighter. The mark in the sand always determines where to dig, and by expert use of the hoe a bushel of cockles may be gathered in the course of a few hours. An easy and simple method of obtaining minute and small shells is to select them from the *spolia marina* and drifted shell-sand, which are found washed up after storms on sandy shores, and which fringe the line of high water. This may be well managed by washing the sand in water, when the shells can be more readily seen and extracted. With the very minute ones, more pains are necessarily required. Beautiful and rare specimens of shells are frequently obtained from the stomachs both of fish and star-fish. Another good plan is to search the refuse of trawling-nets, when such can be discovered, thrown away by fishing-vessels.

Towing-nets for collecting Shells.—Oceanic or floating mollusks may be procured by means of a towing-net, consisting of a bag made of flag-bunting, somewhat resembling a jelly-bag, being about two feet deep and one foot in diameter, the mouth sewn round a wooden or wire hoop. To this hoop should be attached three pieces of cord or whipcord, each about fourteen inches in length, at equal distances, tied together at their ends, and fastened to a strong line or cord. To complete the net, a small oval bottle should be attached at the bottom, for the purpose of steadying the net and receiving some of the fish. This net should be towed astern. It may be either held in the hand, or fastened to one of the boats at the side of the vessel, clear of the ship's wake. The length of the line required will depend on the speed of the vessel and the strain occasioned by the partially-submerged net.

Dredging as a Means of Collecting Shells.—The dredge excels all other methods of investigating the fauna of the ocean. It has been employed for scientific purposes since 1788. The dredge of the zoologist differs somewhat from that used for taking oysters, scallops, and whelks, as the oyster dredge, as well as being rudely made, would admit of the escape of all minute fish and shells. A dredge, sufficient for the purposes of the private collector, may be made so neatly with movable joints as to fold up and carry in the hand. A dredge is made of iron, and shaped like a

scraper. To it is attached, by means of eyelet-holes in the frame, and copper-wire, a fine net bag made of spun yarn, which, on account of its softness, is not apt to cut, as one of harder cord would be; or there may be a double bag, the finer one inside, so as to protect it. The outer one may be made of two pieces of hide, bottomed with a piece of stout net (sometimes made with iron rings), so as to permit the water to escape. The aperture is made narrow, so as to prevent the admission of large stones. The zoologist's net, moreover, has a blade or scraper on each side, so that it uniformly falls to the bottom in the right position. When the dredge is required for use, it is fastened securely by the ring to a strong rope; but should the bottom of the sea be rough (to prevent damage, or the dredge being lost in case of catching on an oyster-shell or piece of rock) it may be secured to the centre ring simply by a piece of yarn which will easily break, and *made fast* to the rope by a side ring. Thus, in the case of accident, instead of the dredge being lost, it will hang on one side and may be hauled in. In order to obtain sufficient warning of the dredge being caught, and to ascertain the degree of tension, it is a good plan to have the upper end of the rope fastened to the bulwarks by india-rubber springs, termed "accumulators." The strength of the rope or line may be regulated according to the size and force of the vessel. It should be sufficiently strong to anchor her, supposing she be moving in smooth water at a moderate pace, so that, should the dredge catch, the strain may be relieved by the letting out of line until the vessel is brought round, and the dredge, which will usually capsize, becomes released. The length of line required is about double the depth of the water; should the line be too short, the dredge will only skim, and if too long will be in danger of getting caught. In case of the bottom being sandy or muddy, the line must be shortened or the dredge will get buried. Many hours' amusement may be obtained in using this instrument, and good oysters and scallops secured in addition to sea-shells. All blacksmiths along the coast can make it, and a fisherman will fasten on the net, should any difficulty be found in doing it. Dredging should never be carried on against the tide, but with or across it. Near the shore, in bays and sheltered parts of the sea, and in smooth water, where the depth is not great, a rowing-boat, with two persons, will serve for the purpose, one rowing, the other holding the rope of the dredge, which is lowered over the boat's stern, with the edge of the scraper downwards, until it reaches the bottom, when, a good length of rope having been hauled out, the boat may be rowed away, until a sufficient space of ground has been covered, say for half an hour to two hours (the time being regulated by the depth of water and nature of the bottom), when the dredge should be hauled in, and the contents emptied on a piece of tarpaulin, to save dirt from the boat. In larger sailing boats the rope is passed through a movable block fixed to the shrouds, and hauled in by means of a double winch or drum. The contents of the dredge are washed in a tub of sea-water, and sifted by means of from two to five sieves, made of copper wire, which should fit into each other, the coarsest being at the top, and so on in gradation. The meshes should be $\frac{1}{2}$, $\frac{1}{3}$, $\frac{1}{4}$, $\frac{1}{5}$, $\frac{1}{8}$, $\frac{1}{16}$ of an inch, and in the case of two, the one should be $\frac{1}{4}$ of an inch mesh, and the other a fine sieve. The objects out of the larger-meshed sieves should be selected, and the rubbish thrown away, but the contents of the finest should be put to dry, and examined at leisure for minute shells. The sand, when dry, may with advantage be put away in bags, until opportunity serves for re-sifting and searching, as it often yields abundant gleanings of value and interest to a careful searcher.

Cleansing and Preserving Shells.—All shells obtained by dredging, or otherwise captured with the fish alive, may be at once immersed in scalding water, that means being preferable to boiling, for the sake of the

shell. From univalves the fish can be extracted by means of a fine crochet-needle or curved piece of wire; the operculum (if any) being preserved with the shell. From bivalves the fish may be readily extracted by means of a penknife or scalpel. The valves should be at once tied together with thread, while the shells are fresh and moist, as they invariably gape. A few, however, may be left open, so as to exhibit the interior and the hinge. It is necessary that all marine shells should be soaked for some hours in fresh water, to prevent the chemical action of the sea-salt upon the carbonate of lime, of which they are composed, eroding their surface. A soft brush should be used in cleaning shells, and that gently, or the epidermis will be damaged and rubbed off, which will interfere with the perfection and beauty of the shell. Chloride of lime may be used with care and moderation, when necessary, to deodorise the shells.

Shell Ornaments.—Several classes of choice ornaments may be manufactured of shells. Success in this work mainly depends on taste in the arrangement. For different purposes the arrangement will necessarily vary; but, as a general rule, it is advisable to assort the shells into the several species and colours. The same rules serve for the arrangement of shells as for the laying-out of flower-beds. Take, for example, Kew Gardens and the parks. There the beauty of the flowers is greatly enhanced by the taste with which the colours are contrasted, as well as the elegance and variation in the form or shape of the beds. As with flowers, those of pale lavender colour are invaluable in contrasting with deep-coloured flowers and leaves; so with shells, the glittering, silvery, pale lavender coloured ones, of opal hue, have an equally superior value. The sides of boxes and all plain surfaces may be well adorned with oval, oblong, or other figures, moulded or bordered with shells of suitable size and appropriate colour. The cement with which the shells are fastened on may be tinted to *one* colour, as pale lavender, by the addition of a little blue; violet, by the addition of red and blue; salmon colour, by the addition of Venetian red; or it may be of various colours to suit the individual colours of the shells. There are some shells which form elegant feet for boxes or tea-caddies. Boxes and pin-cushions are the usual articles into which shells are manufactured, but they are well suited for many other purposes.

Bedroom Ornaments.—The manufacture of shell toilette boxes and pin-cushions might afford great amusement to visitors at the sea-side. The boxes may be constructed of millboard or cardboard, depending on their size and the purpose for which they are designed. Fig. 46, page 236, shows a box with pin-cushion when constructed; Fig. 47 shows the mode of cutting out the frame. Pretty pin-baskets for the toilette-table may likewise be formed by covering close-worked, common-plaited baskets with shells. Chipped or damaged glass or china toilette-bottles or baskets may be restored by rubbing them over with glass-paper, to take off the smoothness of surface, and decking them with shells. To save trouble in making the boxes, glove or other boxes may be employed.

Fastening on the Shells.—On first reading this article, many of our readers will doubtless be of opinion that shell ornaments are very fragile and may readily be blemished. Such supposition is correct with regard to most of those offered for sale, as the cement with which the shells are fastened on will not bear a blow. Boxes or ornaments, however, with the shells cemented on with a paste of white-lead, plaster of Paris, or a composition of plaster and isinglass, will be as strong as though they were stone-china. The plaster must be sufficiently thick to support the shells, but if *too* thick will have a clumsy appearance, and not bear a good gloss when dry. We have already spoken of the tinting of the cement. The

paste should be laid on, for the reception of shells not exceeding the size of a common nut, about the thickness of a shilling, and for larger ones deeper in proportion to their size. The shells may be arranged sometimes so as to show all the upper surfaces, and sometimes part of the upper and part of the under. Very minute shells form an excellent groundwork to fill in the interstices between the larger ones. Should the gloss of the ornament not appear sufficient, it may be varnished, when dry, with very fine, colourless, copal varnish, such as we have described under the head *Painting, in the Household Mechanic*.

To make Card or Mill-board Boxes.—Having cut out the parts, make some good paste by boiling flour and water mixed together, keeping it well stirred; cut some slips of cotton cambric three-quarters of an inch wide; paste them half-breadth on one side of all the parts to be joined, and leave till quite dry; then complete the junction by pasting on the other side. The lid may be fixed on in the same manner, the cambric serving in the place of hinges. The interior should be papered with some fancy paper, and the pincushion on top of the lid should be set on with the velvet before fixing on the shells, as in Fig. 46.

Tools and Apparatus for the Naturalist.—In addition to the scalpel or penknife and the crochet-needle mentioned, the naturalist may be advantageously supplied with a delicate pair of pliers or forceps, made of horn or soft metal; a plain black japanned tray, and some small trays, lined with fine black cloth or velvet, made of wood or cardboard; several camel-hair or sable pencil-brushes, and one or two magnifying-glasses of different powers.

We are indebted to the valuable work by M. Louis Figuier (revised and enlarged by Charles O. Groom Napier, Esq., F.G.S.), entitled, "The Ocean World," for the representation of many of our shells; and we would direct the attention of such of our readers as are desirous further to study the wonders of the ocean to this work.

We would also remind our readers of former articles in the HOUSEHOLD GUIDE on the Marine Aquarium, and on Collecting and Preserving Sea-weeds.

In our next article on this subject we shall introduce other interesting amusements for the family at the seaside.

COTTAGE FARMING.

ARTIFICIAL AND OTHER MANURES (*concluded*).

Native Guano is a natural rather than an artificial manure, being the sewage of towns dried and deodorised by the now well-known patent process. It contains all the valuable properties of cesspool matter, notably ammonia (fixed), phosphates, and alkalies, in a portable and

concentrated form. It has been proved, both by chemical and practical tests, to resemble Peruvian guano in composition, and nearly to approach it in agricultural value. It is a cheap manure, being delivered at five shillings per cwt.

As an agent in promoting growth in root and grain crops, vegetables and flowers, native guano is of considerable value, being readily absorbed by the soil; it has no offensive smell; and as a manure for use in dry or warm weather surpasses Peruvian guano. For cottage gardens

about three ounces to the square yard, and about two ounces to a gallon of water, if applied in a liquid form; for root and grain crops, about four to five cwt. per acre at the time of sowing, produces beneficial results. For strawberries, raspberries, fruit trees, &c., sprinkle round the roots in the spring. The utilisation of sewage is a national necessity, not only for its value as a manure, but because of its sanitary value in preventing the pollution of our rivers; for, as Dr. Letheby, the eminent analytical chemist, stated in his evidence before the Committee of the House of Commons, on the 25th of March, 1870, the sewage water is "practically defæcated" by this process, and rendered "innocuous."

SPADE HUSBANDRY

Spade-culture is more profitable than horse-culture, both on large farms and on small farms, provided the land is adapted for digging at all seasons of the year. But on heavy clay soils, that bake in the summer time when

under corn and grass, and which become so hard that they cannot be dug in dry weather at the close of hay and corn harvest, save at a greatly increased expense of labour—soils, too, whose affinity for water is so great during the winter months, that they cannot be dug without more or less injury, small farmers and large farmers have both been obliged to lay aside the digging fork and spade and yoke the plough, as such soils can only be profitably "worked between the wet and the dry." Steam-culture is more profitable than either horse-

culture or spade-culture, and steam-culture for the heavy, rough work, and spade-culture for the light work, is the most promising system of tillage for cottage-farming generally, as was formerly stated. The working details of this system will be given in a separate paper. But there are a great many examples where the arable land cannot be laid out for steam, and as horse-culture on such is infinitely more expensive and objectionable than on large fields, owing to the greater trampling of the horses' feet at the headlands, from the fact that the headlands of the small field must be as broad as the headlands of the large field, it follows that in such cases the balance is in a greater degree in favour of the spade, even on heavy clay land. And this, too, is not all; for it is a well authenticated

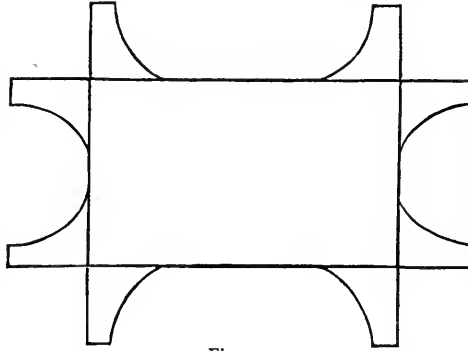

Fig. 47.

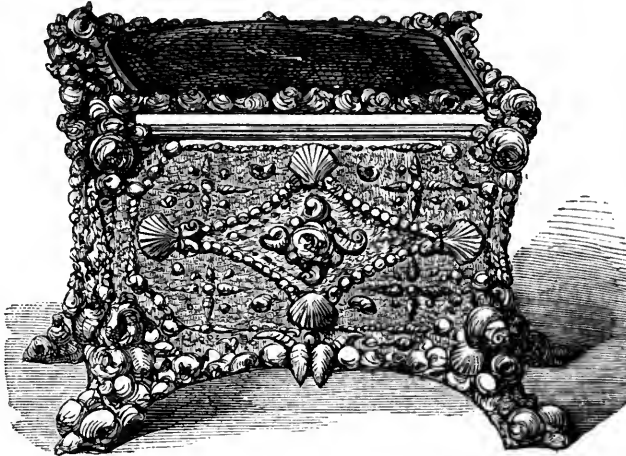

Fig. 46.

fact, in practice, that small farmers, who have to hire, seldom get their clay lands ploughed between the wet and the dry. There are other examples which, perhaps, more immediately concern us—*viz.*, cottage farms which consist of two, three, or four acres of land, the one half permanent meadow, and the other half arable land, the latter surrounding the former ornamentally, in the form of a belt. Or the grass may adjoin the cottage, and the arable lands be laid out at the farther end of the farm.

Thus, in the annexed two diagrams, Fig. 1 represents an example with the arable land in eight fields, 1 to 8, surrounding the grass land A, inclosed by a strained wire fence or iron hurdle fence. A gravel walk, *a a a*, and shrubbery, *b b b*, run round three sides of the fence. The dotted lines indicate the subdivisions between the fields, and the cottage may be at C. Fig. 2 is a plan showing the grass land, A, adjoining the cottage, C, with the eight fields, 1 to 8, at the farthest side of the farm. The gravel-walk, *a a a*, runs round the grass, and *b b* may be shrubbery.

In some examples the gravel-walk and shrubbery run round the arable land, thus giving access to the fields at both ends. In other cases the gravel walk and shrubbery are dispensed with, the fields being accessible from a road outside. In the diagrams the lines are straight and the farms square acres, the object being to illustrate the principle on which land is thus laid out for cottage farming. But in practice it is

Field operations in the cultivation of the land, and in the harvesting of most of the crops grown, very closely resemble those of gardening, and so do the permanent improvements of draining, trenching, &c., in getting the land into a state for profitably digging with the spade.

Drainage.—If the land is naturally dry, draining will not be necessary; but in most cases, deep thorough drainage—as already directed—is the initiatory work of the cottager. If he is a labouring man, he may do the work of drainage himself; but on small farms, as on large ones, it is now generally done by contract, at various prices per acre (£4 to £10), according to the depth of the drains, the distance between them, the nature and the price of draining-tiles, and wages in the district. If he does the work himself, he will require a set of draining tools, which will cost him from 30s. to 40s., according to quality.

Trenching two spit deep for deepening the soil, is the next work, without which spade husbandry will not prove successful. By way of illustration, it has been said that an acre of land cultivated two feet deep is equal to two acres cultivated only one foot deep—because the former affords as much feeding-ground to the roots of plants as the latter. In trenching the land, all the small stones, flints, and obstructions to the spade in digging, are removed. In trenching stony ground we have gathered as many stones.



Fig. 4.

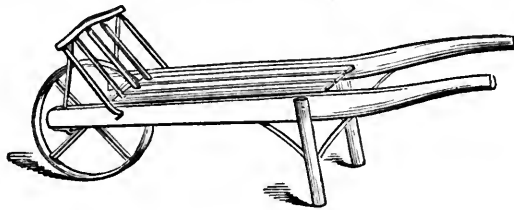

Fig. 3.

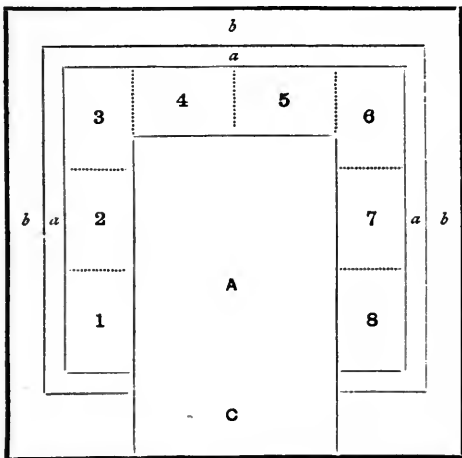

Fig. 1.

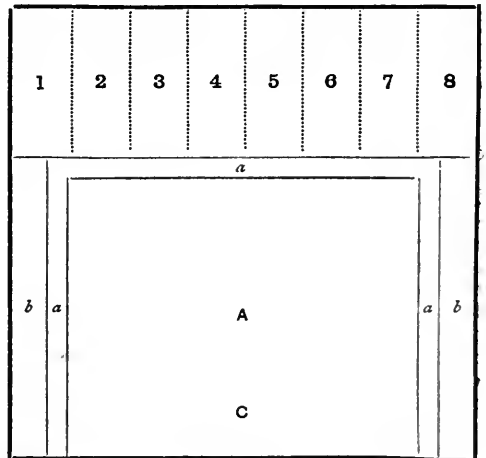

Fig. 2.

seldom that the cottage farm is ever rectangular, or in one field, while the walks and lines inside the boundary fence are for the most part curved in various ways, with the exception of the subdivision lines between the different crops. There are, however, examples of straight walks and fences as shown. And with regard to the course of cropping, the eight fields illustrate the principle of a four-course shift extended to eight, as formerly explained, and this mode of cropping may be further extended to twelve or sixteen fields, or the arable land may be laid out on the principle of a five-course shift, extended to ten or fifteen, Italian rye-grass, clover, sainfoin, and lucerne being grown as forage crops several years in succession.

as did the work of drainage. Thus, let the dotted lines, Fig 2, represent the drains. Open the first drain between 1 and 2. Fill it with stones gathered off the surface. Then open the second drain between 2 and 3, throwing the earth towards 3. Next trench plot 1, and with the stones, collected therefrom in a basket, fill the second drain; open the third drain, and, with the stones in trenching plot 2, fill it, and so on across the field to 8. The trenching is done thus:—At the bottom of plot 1 open a trench right across, two spits deep, twelve inches each—*i.e.*, twenty-four inches deep, and twenty-four inches broad—and wheel the earth across, to fill the last open trench at the lower end of plot 8. Rake on, and then trench twenty-four inches wide; turn the top spit

into the bottom of the open trench, and then throw the bottom spit over it, and so on, up one plot and down the other, until you finish trenching at plot 8. The work may be done at from sixpence to eightpence per perch, the workman making 2s. 6d. per day.

Bastard-trenching.—When the sub-soil is of an inferior quality, and unfit for being thrown to the surface, the bottom spit is then turned over, and the top spit of the next trench thrown over it. The work is technically termed *bastard-trenching*, and is performed thus:—Wheel the top spit of the first trench of plot 1 across to fill the last open trench in finishing plot 8. Then dig the bottom of the trench, breaking up the earth and removing stones. Next, turn the top spit of the second trench over the bottom spit of the first, dig the bottom spit of the second trench, and so on. Afterwards, by deep digging, and ultimately close trenching, the bottom spit may be gradually brought to the surface and incorporated with the surface spit, so as to form a working soil twenty-four inches in depth.

The tools required by the cottager for trenching, digging, manuring, &c., are a digging spade and fork with open-head handles, two shovels and bastard digging fork with cross-head handles, a four-pronged dung-fork for filling and turning farm-yard manure, a light three-pronged dung-fork for spreading farm-yard manure, and a two-pronged pitch-fork for various purposes; also a box wheel-barrow which may either be of wood or galvanised iron. In each there is a top for increasing the size of the barrow when wheeling light materials—at home, carrots, cabbages, turnips, and potatoes—and out, manure to the field.

A harvest and forage barrow (Fig. 3) will also be required for wheeling home forage-crops daily to the milch cows, and the hay and sheaves of corn in hay and corn harvest. With one of these long barrows, we have seen a cottager wheel home, at one load, as much green clover, tares, &c., as served his two cows a whole day; and if the plots (Figs. 1 and 2) are each a quarter of an acre, he will carry home the produce of each at twenty times or loads, or forty loads, if half an acre, and so on. The sheaves are laid heads and tails across, and tied down with two ropes, from the front one to each handle. And, as a rule, there should be the length of one field of planks for wheeling upon.

The management of the grass land is similar in every respect to that of small farms wholly in grass, which we propose treating under Park Farming; and, to avoid repetition, the yearly management of both will be noticed under this heading in our next paper, when illustrations of the implements required for such will be given. A hand-dibble, and Josiah Le Butt's *hand drill* (Fig. 4), which, by turning a screw, is adapted for sowing wheat, barley, oats, vetches, carrots, mangel-wurzel, and the various small seeds, as fast as the cottager can walk, and with which he can drill his quarter of an acre at a morning-yoking. But for wheat, barley, oats, beans, and peas, the dibble is generally preferred. A potato-dibble is sometimes made with two short blunt dibles on the bottom of the foot-bar; but a single one with a cross-handle, which the cottager drives in with the force of his arms is generally preferred. The mode of working them will be described under Potato Culture.

All the above implements will be required under the mixed system of steam or horse culture, and spade culture, which will be treated in a different paper, but a few more hand machines will be illustrated, which are better adapted for it; and, to avoid repetition, as the different crops are suitable for both systems, they will be treated separately.

In the remainder of this paper we shall notice the manual labours of the cottager, peculiar to spade husbandry, during a whole season, commencing at the close of corn harvest.

We refer our reader to Fig. 2, where he will find the cottage farm divided into eight fields, say a quarter of an acre each, and to the succession of crops in a previous paper, which showed the cottager's crops for the first year. But with the exception of clover, which is sown the previous year, he has to cultivate and seed his land before he reaps his harvest. We shall therefore show his labours in each field separately, with the previous crop which it yielded.

Field 1 is in wheat stubble, and has to be manured and dug at least fourteen inches deep with the digging fork for mangel-wurzel and potatoes next year. In Flanders the small farmers have long spades, with which they dig their land eighteen and twenty inches deep. Where mangels cannot be grown, Belgian carrots or cabbages may. No more manure should be wheeled than the cottager can dig in a day, and as he goes home to breakfast and dinner he can take a barrowful with him each time. It is seldom that more than a half manuring with cottage manure can be given, the other half being artificial manures, applied in the spring time; and the manure should not be put into the bottom of the open trench when digging so deep, but be spread along the face of the last dug spit, as in mixing compost, and the deeper you dig the narrower the spit will be. The manuring and digging will form a good week's work for the cottager, rather more on stiff soils in dry weather. Leave the surface rough, but not in stitches. The winter frost will break the clods. In the spring time the land requires to be dug with the fork to the full depth of the winter spit, *i.e.*, well loosened, but not turned over so as to retain the winter made mould on the surface. The seeding, application of artificial manures, hoeing, and harvesting, will subsequently be noticed under Potatoes, &c.

Field 2 is under potatoes and mangels, and when these crops are removed the land has to be forked twelve inches deep for wheat or barley. This is lighter work. If part of the land is under cabbages they will not be off before winter, so that winter wheat will be dibbled in after the potatoes and mangels, but either spring wheat or barley after the cabbages, when the whole field is sown out with clover seeds in spring.

Field 3 is wheat or barley stubble sown out with clover, or rye-grass and clover. This will require very little labour from the cottager until spring, when artificial manure may be needed, and in summer the daily cuttings for the cows.

Field 4 is clover stubble, and has to be dug twelve inches deep for winter wheat. This is generally heavy work, as the land requires to be dug close, generally in dry weather, with a level surface sufficiently fine for the dibble, and if the work can be finished a month before seed time so much the better, as wheat prefers a stale to a fresh seed bed.

Field 5 is oat and wheat stubble, and has to be dug and manured as Field 1 for winter vetches, spring cabbages, and turnips, after the tares. Very likely there will not be a sufficiency of summer made manure for the whole, so that the cabbage will have to be dug deeply just now and manured during March or April. The whole of this field will have to be dug twice for vetches and cabbages in the autumn; the cabbage plot a second time in the spring, and the plot under vetches as the crop is cut for the cows, for sowing with turnips, the land being then manured with artificial turnip manure.

Field 6 is in cabbage and turnips, and has to be dug for spring wheat or oats, as such crops are removed. This is light work, and the wheat or oats may be dibbled in with Field 8.

Field 7 is wheat and oat stubble, and has to be manured and dug deeply in the autumn for peas and beans. The work is similar to that described under Field 1. Some seed the ground in autumn, others as early in the spring

as the weather will permit; but of this hereafter. For both crops, the land should be thoroughly dry and manured in the autumn. In our northern counties this cannot always be done, but manuring in the spring is attended with a twofold loss—injury to the land and unsuitableness of fresh manure to the crop.

Field 8.—This is bean and pea stubble, and has to be dug close for winter wheat. The work closely resembles that of Field 5, under clover stubble, but is seldom so heavy.

Next year Field 8 takes the place of Field 1, Field 1 takes the place of Field 2, Field 2 that of Field 3, and so on. The year following Field 7 takes the lead in the rotation, and thus the succession of crops and the labours of the cottager run year after year, until he gets over his whole farm, as formerly stated when treating of a succession of crops. One question remains for solution—viz., how to time his labours so as to do the whole work in season, for unless done in season success will not be the result. With only two acres there is no difficulty, but with four to six acres it would be otherwise in adverse seasons. The subdivision into a number of small plots helps greatly in our fickle climate, not only at seed time, but also in hoeing and harvest. As a rule, it is better to hire an extra labourer for a few days than work with a bad season; and on no account allow the work to fall behind the season.

The general routine may be greatly diversified, and the appearance of the small field ornamented by the introduction of a greater variety of crops, such as sainfoin, lupine, and lucerne, on soils adapted for them. Two or three hills of hops may also be grown, and we have seen iron hurdles placed along the dotted lines, and fruit trees trained, on the French, or rather, old English plan.

DOMESTIC MEDICINE.

DYSPEPSIA (*continued*).

Causes.—We have already, in a general way, indicated the causes of dyspepsia; and we need do little more than amplify what we have said. There are a few principal causes which we will briefly enumerate.

1. *Kinds of Food.*—Veal and pork are notoriously more apt to cause indigestion than beef and mutton, so with lobsters, crabs, &c. The common sense and general experience of every body will soon teach him, in a general way, what agrees with him, and what does not. Spirit-drinking is a common cause of a kind of dyspepsia, and so is excessive tea-drinking. This is most seen in women who live a good deal on tea, which revives them temporarily, but does not feed them. It is important also to observe that people cause dyspepsia often by taking too much food—that is, more food than they work for. This is really the point. People should take food according to the work they do. And both apostles and physicians declare that they who do not work should not eat. People eat often because dainty food is provided in great quantities for them, not because they have appetite. Hence comes dyspepsia and all its uncomfortable train of sensations.

2. *Want of Exercise and Fresh Air* are causes of dyspepsia.—How can men, or even women, be healthy who never use their greatest muscles; who might as well almost have no limbs; who never walk or even ride if they can get horses to drag them along, and who do not revel in the luxury of fresh air; who prefer heated rooms to the natural atmosphere; whose notion of muscular exercise is the use of a pen, or the playing of a piano? How can such people have appetite, or have good digestion to wait on appetite? Dyspepsia is a natural state, or rather a natural punishment, for people who live so unnaturally.

3. *Mental Causes* of dyspepsia are very common—*anxiety, worry, depression, or ennui.*—We all know how anxiety, or any bad news will take away our appetite, and with the appetite goes the power of digesting food. *Ennui* and dissatisfaction, moods which some people seem to think worthy of cultivation—a determination not to betray delight or satisfaction with anything—are not only miserable states in themselves, but they predispose to dyspepsia.

4. *Bad Habits.*—We have specified spirit drinking in excess. We must here denounce more than a very moderate use of tobacco. We are not prepared to say that a tolerably moderate use of tobacco is positively injurious. It may often do good to some irritable and sensitive people in great moderation; but, speaking generally and for healthy people, it is a thing of the wrong sort—of the nature of a poison. And to everybody in much quantity this is its character. It deprives the system of saliva, and it hurts the nerves which supply the stomach and the heart.

5. *Personal Peculiarities.*—Some people are disordered by particular things. It is no use reasoning about it—there is the fact. In some the particular thing is a tiny piece of egg; in others it is pork; in a third, it is veal; in a fourth, lobster. One case is recorded, even by so great an authority as Dr. Prout, of a person who could not eat mutton. He was thought to be whimsical, and mutton was served up to him under some other guise, without his knowing it; but it invariably caused violent vomiting and diarrhoea. Now, when people have a peculiarity of this kind, they should just accept the fact, and act upon it. Instead of this, they are apt to set up for being dyspeptics. If they would quietly regard their peculiarity, and say nothing more about it, they would do quite well.

Treatment.—Domestic medicine will often be of considerable importance in dyspepsia. For, although there are occasionally subtle causes of indigestion which require a physician for their detection and removal, in other cases the cause is palpable, and nothing more than common sense is requisite for indicating the remedy. If there is anything obviously wrong in the habits of the patient calculated to produce dyspepsia, he must discontinue it. For example, if there has been an excessive use of strong tea, that must be discontinued. Still more, the excessive use of tobacco, or of alcoholic drinks, must be abandoned. Any articles of food that are found from experience to disagree, must be discontinued. Pastries, rich puddings, and sweetmeats, are generally to be discarded or used very sparingly. Animal food, well cooked, will generally agree as well with dyspeptics as any other kind of food, or even better, especially good sound mutton or beef. Milk, in moderate quantities, is likely to suit very well, taken by itself, and not in addition to a meal. One very remarkable case is recorded by Dr. W. Hunter, in which a father brought his child to him with great pain in the stomach, frequent and violent vomitings, great weakness, and wasting of the flesh. All remedies had been tried, and failed, and the case seemed desperate, even to Dr. Hunter. But Dr. Hunter recommended two things—rubbing the stomach with warm oil, and, secondly and most particularly, to avoid offending a weak stomach—and with this view to give nothing but milk, and to begin this in a spoonful—if necessary, a teaspoonful. The success was complete. This, of course, was a very extreme case. In cases less serious, while taking proper care, it is also well not to become too particular and nice about one's food. Variety is not only good for the body; but it is well, on moral grounds, to cultivate the power of being pleased with as many things as possible. We have known some delicate persons fancy that they could not take more than one kind of food, and even believe that something dreadful would happen to them, if they took anything else; but a

little experiment, made in a trustful spirit, has undeceived them, and they have found that they could eat very much like other people.

It is of moment to find out whether tea or coffee suits best at breakfast. Tea will suit most sensitive stomachs best. But it is more constipating than coffee, so that the latter may be in some cases more suitable. The question of malt liquors is one upon which no dogmatic rule can be laid down. In the majority of cases, claret, or *vin ordinaire* will suit better than any form of beer, especially if the tongue is at all apt to be furred, and there is any tendency to stoutness. This is especially true for people who live much indoors, and whose skin is hot.

It is of almost more moment than the kind of food to consider the fit times for taking it, and to observe some kind of regularity in the matter. While some people live as if they lived only to gratify their stomachs, others live with an absurd disregard of their natural wants. If they are hungry, they put off their meals and wait till a more convenient time. When this comes, the chances are that the stomach is tired, and the appetite is gone. While a man's stomach should not be treated as his god, it should be treated as a very respectable servant. Its hints should be considered, and it should be well remembered, that work can no more be done without food than the steam of an engine can be kept up without coal. It is impossible to lay down an universal rule; but, as a general rule, people with weak digestion should never go long without a little food. They should not take great meals, but small ones frequently.

It is of great consequence that proper time should be given to meals. And meal-taking should be a pleasure, to be enjoyed within proper limits. People should not swallow their food as fast as they can, but chew it well first.

HOME GARDENING.

THE CAULIFLOWER (*continued*).

The Cauliflower.—For a third and last crop, sow some of the same seed as that recommended for the last crop (see page 187), about the last week in May, on a bed of light, rich earth, and in a warm situation; and when they are big enough to handle, prick them out as already advised. This is commonly called the Michaelmas crop, and will begin to produce their heads about the latter end of October, and continue in perfection till Christmas, provided open, mild weather follows. The ground on which the plants are intended to grow should be well prepared by manuring and digging several times over, in order that the manure and soil may become thoroughly incorporated; as the richer the ground is, the finer and larger will the cauliflowers be. Commence planting by beginning at one end of the bed, and dig over as much as will serve for one row; then stretch a line across, and draw a drill with a hoe about four inches deep, and at the bottom of the same insert the plants at two and a half feet distance from each other, and give them a good watering, to settle the soil to the roots; and then proceed for another row in the same way, until the whole be complete; after which they must have a liberal supply of water, until such time as they have good hold of the ground. The ground for early crops should be open and well exposed to the sun; but a shady border should be chosen for all crops planted after the first week in May.

After each of the respective crops is finally planted out, the ground about the same must be kept continually hoed, for the purpose of keeping weeds under, and earthing up the plants at the same time. When the soil has been drawn up to the stems of the plants some little time, fork the ground between the rows lightly over, which will be of considerable advantage to their growth. All crops must be liberally supplied with water in dry

weather; those out of flower twice a week, and those in, every other day, which will contribute to their producing very large heads. As the flower heads appear, the larger leaves should be broken down over them, for the purpose of defending them from the sun and rain, as well as to preserve them in white and close perfection. In respect to the *hand-glass division*, some gardeners, towards the end of October, transplant a quantity finally into rich ground, which has been well manured, under hand-glasses, in rows three feet and a half asunder, and three feet apart in the rows, placing two or three plants centrally under each glass three or four inches asunder, with the design of retaining only one or two of the best in the spring. A better method, according to our notion, is, to plant them in small pots filled with not very rich soil, and plunge the pots into the ground—two or three under the centre of each glass—and give a moderate watering. Allow the leaves of the plants to get dry, and then put on the glasses close until they have taken root, which may be seen in a week or ten days by their showing a renewed growth; after which, tilt up the glasses to admit fresh air on the warmest side, raising them two or three inches according as the weather is. Continue the glasses all the winter, but tilt up the south side of the same every day in mild weather, in order to strengthen and harden the plants; and in very fine weather take the glasses quite off for a few hours during the middle of the day, especially if the plants appear to draw, or get too forward in growth; but put them on early in the afternoon, and always keep them on at night in frosty weather, until the end of March or beginning of April, admitting air more freely as the fine weather advances; and when the weather is very mild and showery, the glasses should be taken quite off frequently, in order to afford them all the benefit of rain.

In the beginning of April, the gardener had better take up all the pots, and turning the plants carefully out, with the balls entire, place them in the holes where the pots came out, and close the soil about them, placing one plant under each glass; give them a little water, and when the leaves are partially dry, shut the glasses close down over them until they begin to grow, when they must have plenty of fresh air for a week; the glasses may then be taken quite away, and the earth drawn well about the stems, which will be found to greatly encourage them. On no account withhold water in dry weather; but, on the contrary, supply it liberally whenever necessary.

There are various methods of preserving cauliflowers through the winter; but the one most approved is, to take the plants up a day or two before they are full grown, and when they are perfectly dry take off all the large under-leaves, place them in rows in a dry shed, and cover the roots of each row with dry earth, laying them sideways, with the crown or head of the second row close to the under-leaves of the first, and so on till the whole is complete; thus they may be kept in a good state from the beginning of November to the end of January. It may be necessary to cover the whole with a mat in very rigorous frosts, but not generally so; and care must also be taken to clear away all decayed leaves as they appear. Those desirous of saving seed should mark out some of the prime plants of the early and main crop when the heads are in full perfection, as those of the early spring will not ripen very punctually. The seed should be sown in September, and then it must be well looked after, otherwise the birds will destroy a great part of it, and the branches must be gathered as the seed ripens, and laid, elevated from the ground, in an airy situation, to dry and harden to full perfection, after which it must be rubbed out and cleared from the husky parts, and spread on a cloth to dry equally, when it may be wrapped up and put by for use the following spring and summer.

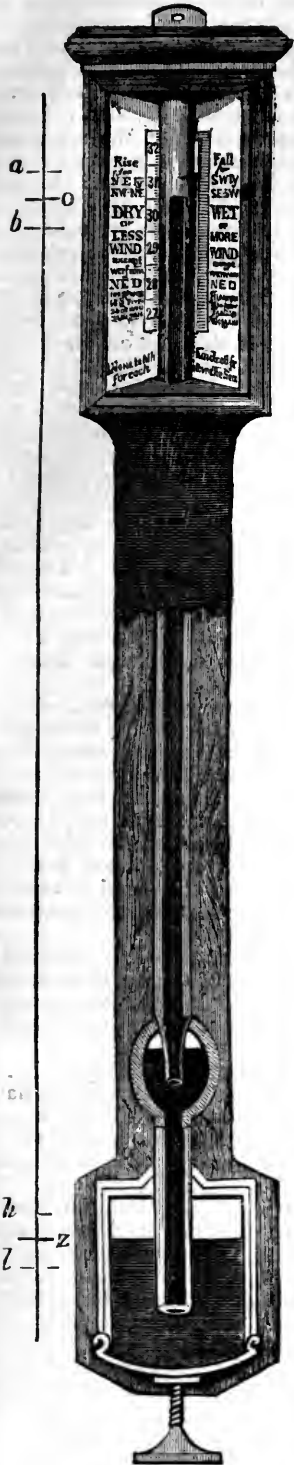

Fig. 4.

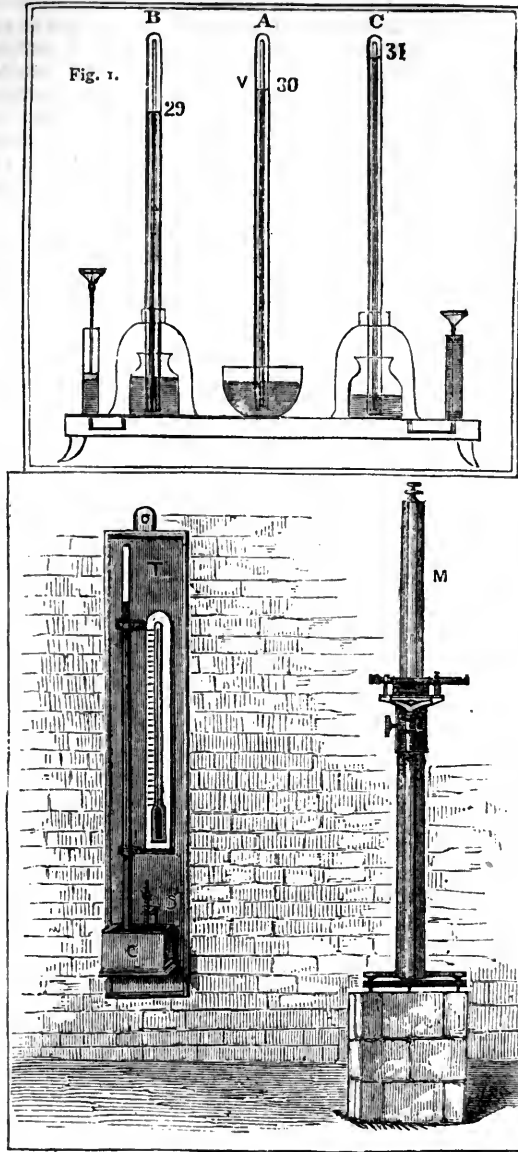

Fig. 2.

PHILOSOPHICAL INSTRUMENTS FOR DOMESTIC USE.

THE BAROMETER OR WEATHER-GLASS.

NEXT to the question, "What is the time?" is the morning household inquiry as to "What will the weather be?" A barometer, as well as a clock or watch, is usually to be found in every house, but the reason for its weather-

To arrive at simple but correct data for determining the present or forthcoming state of the weather, the Meteorological Office of the Board of Trade considers the following instruments indispensable, viz. :—a barometer, a thermometer, and an hydrometer, in connection with the observed direction of a weathercock.

The Barometer.—For two thousand years the phenomena on which the action of the weather-glass is dependent (now referred to the pressure of the air) were explained by the dogma of the ancient philosophers—that

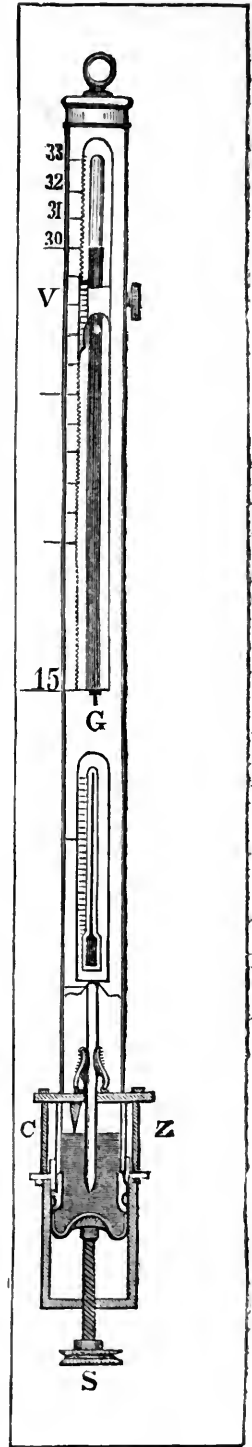

Fig. 3.

indicating oscillations is too frequently passed over as practically unimportant, or regarded (as Lord Dundreary would say) as "one of those things which no fellow can comprehend." The instrument itself is exceedingly simple in construction, and the principle upon which it acts is readily explained.

"*Nature abhors a vacuum.*" It was noticed that space was always filled with some material substance, and that the moment a solid body was removed, air or water always rushed in to fill the space thus deserted. Hence it was concluded that it was a universal law of Nature that space could not exist unoccupied by matter, and the above phrase was a figurative expression of this idea.

Thus, when the piston of a common pump was drawn up, the consequent rise of the water was explained by declaring that, as according to the nature of things a vacuum could not exist, the water of necessity rushed into the space the piston had previously occupied. In the middle of the seventeenth century philosophers discovered a limit to Nature's abhorrence of a vacuum. Some Florentine engineers, employed in sinking a pump to an unusual depth, found they could not raise water in the tube higher than ten mètres, or thirty-two feet. So remarkable appeared this limit to their skill, that they consulted the great philosopher Galileo; but though he had taught that air has weight, he failed to perceive the proper explanation why the water could not be raised higher than thirty-two feet, and is said to have replied, that "Nature did *not* abhor a vacuum *above ten mètres.*"

This engineering failure led to a most important physical discovery. Torricelli, a pupil of Galileo, pursued the inquiry, and reasoned that the force, whatever it might be, which would sustain a column of water ten mètres high, in a cylindrical tube, must be equivalent to the weight of the mass of water sustained; consequently, if another liquid, heavier than water, were employed, the same force could only sustain a column of proportionally less height.

The liquid metal, mercury, being $13\frac{1}{2}$ times heavier than water, Torricelli argued that the force that sustained a column of water ten mètres high could only sustain a column of mercury $13\frac{1}{2}$ times lower, or about 76 centimètres high. To prove this, he made the following experiment, one which has ever remained memorable in the history of science. Torricelli took a glass tube, about 32 inches long, open at one end and closed at the other; this he filled with pure mercury—having closed the open end with his thumb—and inverting the tube, plunged the open end into a basin of mercury. On removing his thumb, the mercury instead of remaining in the tube fell, as he expected, and after a few oscillations came to rest at a height of about 76 centimètres, or 30 inches above the level of the mercury in the basin (A, Fig. 1).

The correctness of his argument being thus verified, he further reasoned, that the weight of a column of air of the height of our atmosphere was just sufficient to counterbalance or support a column of water about 32 feet in height, or a column of mercury about 30 inches in height.

This experiment, and the resulting doctrine, caused a great sensation among European *savants*, and (as is usually the case when teachers have to be sent to school again to unlearn what they have taught) opposition. The celebrated Blaise Pascal, however, recognised the force of Torricelli's reasoning, and devised a crucial experiment. "If (said he) it be really the weight of the atmosphere, under which we live, that supports the column of mercury in Torricelli's tube, we shall find—by transporting this tube upwards in the atmosphere—that in proportion as it leaves below it more and more of the air, and has consequently less and less above it, there will be a less column sustained in the tube; inasmuch as the weight of the air above the tube, which is declared by Torricelli to be the force which sustains it, will be diminished by the increased elevation of the tube." This argument Pascal verified by first sending Torricelli's tube to the top of a church steeple, and afterwards to the top of the high mountain of Puy de Dôme. In the first instance, he found only a slight fall in the height of the mercury, but in the second, the difference between the height of the column on the plain and on the mountain-top amounted

to nearly eight centimètres, or three inches. This experiment put an end to further controversy on the subject, and the dogma of Nature's abhorrence of a vacuum had to give place to an established philosophical principle.

If we repeat Torricelli's experiment, we shall notice that on the mercury (which completely fills the tube) coming to rest, a vacant space is left in the upper part of the tube. This is a vacuum, the most perfect one it is possible to attain, and which is known under the term of the "Torricelli vacuum," V, Fig. 1. If we bring a Torricelli tube under the influence of an exhausting syringe, as shown at B, Fig. 1, on working the pump we shall find that with each upward stroke of the piston, as the pressure on the surface of the mercury in the cistern decreases, there is a corresponding fall in the column of mercury, and rise in the level of the mercury in the basin, as the rarefied air can no longer support 30 inches of that metal. If, on the other hand, we bring a Torricelli tube under the influence of a condensing syringe, as shown at C (Fig. 1), on increasing the external pressure on the surface of the mercury in the cistern, the column of mercury rises, and the mercury in the basin falls.

As a column of mercury, 30 inches high and 1 inch superficial in section, has experimentally been proved to weigh as nearly as possible 15 lbs., and as such a column is, as nearly as possible, that which the pressure of a column of air will support—it results, that the weight of a column of air of the height of our atmosphere, and of surface equal to 1 inch superficial, will also equal, as nearly as possible, 15 lbs.

But our atmosphere, besides being a heavy, is also an elastic fluid—therefore compressible—so the lower strata is condensed by the weight of its superincumbent mass. The density of our atmosphere, therefore, cannot be uniform, but must diminish and become rarer as we approach its upper limits; and this we can readily prove to be the case by taking a flask, closed air-tight at the foot of a mountain, to the summit; on opening it air will rush out of the vessel. On again closing it air-tight, removing it to the base of the mountain, and re-opening it, air will rush in.

We have thus far learnt that the mercury is sustained in Torricelli's tube by the pressure of the air on the surface of the mercury in the cistern, and that that pressure on a given surface of mercury is proportional to the height of the column.

The experimental tube of Torricelli is, in fact, the instrument now universally known as the barometer, its name being derived from two Greek words, signifying *weight-measurer*, though it is used as a measure of atmospheric pressure in the same manner as we use a weight as a measure of mass, or an arc as a measure of angle.

Experience teaches that the height of the column of mercury varies when kept at the same level in the same place. Such variations indicate corresponding changes in the density and elasticity of the surrounding air; when the air's density and elasticity are increased the mercury rises, when they are diminished, it falls. The column, therefore, measures the intensity of the atmospheric pressure, and it is only necessary to add a recognised scale, to accurately measure the *height of the barometer* and the variations in the instrument. In Germany the old Paris standard is generally adopted, in France the decimal scale, and in England the English yard-measure is employed for the barometric scale.

It is commonly supposed that a steady rise in the barometer indicates the approach of fine, and a steady fall that of rainy weather; a sudden and great fall the approach of a storm, and a sudden rise the clearing up of a storm; hence this instrument has popularly obtained the name of "the weather-glass." The common barometers are marked "Fair," "Change," "Rainy," &c., against certain

points of the scale; but the sooner these terms are disused, by public consent, the better, as they have no foundation on fact, and are useless and misleading. Though in general terms we may say that the rise and fall of the mercury indicates a change of weather, in reality the mere observation of either of these effects, taken alone, is not a sufficient guide. High winds, electrical tension, and other causes not yet thoroughly understood, exert their specific influences on the pressure of the atmosphere, either to densify or rarefy it. In England 30 inches is taken as the mean, or standard measure for the pressure of the atmosphere, and the variation ranges between 28 inches and 31 inches. Other causes that influence the height of the mercury are—1, The effect of temperature upon this metal which, like others, expands with heat and contracts with cold, so that on a hot day (other things being equal) the reading would be higher than on a cold day. 2, When the mercury is rising, its surface is slightly convex, when falling, concave, which may lead to a trifling source of error in taking the readings on the scale. 3, Should the tube of the barometer be small, the capillary attraction between the glass and the liquid metal would exert an action sufficiently great to create an error. When great correctness of observation is desired, corrections for temperature and capillary action must be made, for which purpose tables of corrections have been drawn up by meteorologists.

Should the smallest quantity of air creep into and up the barometer tube, it would create a serious deterioration to the efficiency of the instrument, for were but $\frac{1}{1000}$ inch of air let into the bottom of the tube, on reaching the top or Torricellian vacuum, V, Fig. 1, it would expand to 1 inch.

From these statements it will be obvious that great care is required in the manufacture of the barometer, and the following are the points of construction:—A clean glass tube, over 33 inches long, of a diameter that will render the column of mercury distinctly visible, and reduce the capillary action to a minimum; mercury chemically pure, and freed from air by boiling; an arrangement for preventing air-bubbles passing up the tube; an accurately graduated scale, with some provision for correctly expressing the real height of the column from the level of the metal in the cistern, and if for ordinary household use the usual indications of "Fair," "Change," "Rainy," &c. should be replaced by those adopted by the late Admiral Fitzroy, of the Government Meteorological Department, or combine the two sets of indications till the old-fashioned notions and prejudices in favour of the former terms have been eradicated, by a sounder comprehension on the part of the public at large as to the true value of the indications of the barometer. Besides its use as an indicator of present or coming weather, the barometer is employed for determining the height of mountains and other elevations above the level of the sea, and is of the greatest value to the experimentalist in determining certain physical properties of gases, vapours, &c.

Regnault's Barometer.—The simplest and most accurate form of this instrument is that represented in Fig. 2, but as it is only adapted for fixed stations, its use is confined to the laboratory for comparing the density of gases with that of the atmosphere, or in observatories as a standard barometer, that is to say, one of known accuracy, by which other barometers may be compared before they are sent out by the philosophical instrument-makers to their customers, or for any subsequent corrections, should they get out of order.

It consists of two parts:—An accurately-made Torricelli tube, T, Fig. 2, inverted in mercury, placed in an iron cistern, C, over which is fixed a double-pointed steel screw, S, that before every observation is screwed down so as just to touch the surface of the mercury in the cistern, which is determined by noticing where the point and its reflection

in the mercury exactly meet; and secondly, a cathetometer (or measurer of perpendicular height), M, accurately levelled in all its parts. A wire, intersecting the eyepiece of the small telescope, is first "sighted" with the upper point of the screw, S, and is then moved up the accurately graduated and adjustable standard that carries the telescope, till the wire "cuts" the level of the mercury in the upper part of the barometer tube; we then measure the distance between these two points; if to this we add the known length of the screw, we have the height of a column of mercury exactly balancing the atmospheric pressure. The barometer is fixed on a board that is immovably fastened to a brick wall, the cathetometer being placed on a firm block of stone.

Barometer of Fortin.—It is not often possible to fix a barometer permanently to a wall in the manner just described; moreover, it is frequently desirable that the instrument should be portable, and without materially diminishing its efficiency, it is important to simplify the method of measurement. The arrangement of Fortin or the mountain barometer completely satisfies these requirements, and is shown in Fig. 3.

The barometer tube, T, is, for protection, enclosed in a brass tube, G, and dips into a cistern, C, made of a glass cylinder closed at the upper end by a wooden cap, the bottom being formed by a leathern bag, which can be raised or lowered by the action of a screw, S. This reservoir is held in position by brass mountings clamped together by three long screws, and is screwed on to the long brass guard-tube, G. By this arrangement the mercury in the cistern is exposed to the eye, and its level is adjusted by means of the screw, S, raising or depressing the leathern bottom till the surface of the mercury just touches an ivory pin screwed into the roof of the reservoir, the point of which exactly corresponds with Z, the zero of the scale graduated on the brass protecting tube, so that the real height of the column from the level in the cistern may be correctly expressed. In some instruments the zero point in the transparent cistern is marked by two slits in the brass box which covers the reservoir, made horizontally, precisely similar and opposite to each other, the upper edge representing the beginning, or zero point of the scale, up to which the level of the mercury must be adjusted. If the cistern is not transparent, the adjustment of the zero point is, in some old-fashioned barometers, effected by means of a "float" (in the mercury) passing through a hole in the roof of the cistern, the mercury being screwed up till a mark on the float "cuts" the top of the cistern case. The upper level of the mercury is observed through two perpendicular slits in the brass tube made opposite to each other, and its height can be registered by a vernier, V, working up and down the scale by means of a rack and pinion, till its edge cuts the surface of the column, and as in the former case, the readings are direct. Both of these instruments should be provided with a good thermometer for registering the temperature at the time of observation. It is better that the bulb of this thermometer be of the same diameter as the tube of the barometer, and cased in brass or iron, so as to be as much as possible similarly circumstanced as the instrument to which it is attached.

A great advantage in the barometer of Fortin is the facility with which it may be transported from one place to the other, or up steep mountains; for by raising the screw, S, sufficiently, the whole of the mercury may be forced into the tube and upper part of the reservoir, and on the instrument being carefully reversed, and kept in this position, it may be carried about with perfect safety.

If made for a standard, the tube may be as large as 1 inch diameter in the bore,* if for a mountain barometer,

* It should be observed that the larger the bore of a barometer tube, the greater will be the error by temperature, the mass of mercury being more readily affected by heat.

the diameter may be reduced to 0.15 inches, the graduation on the scale then commencing at 15 inches, instead of 27 inches.

Daniells' Water Barometer.—The two previous arrangements having been given as illustrations of "instruments of precision," it is desirable to place before the reader an arrangement of excessive sensitiveness to atmospheric changes, though at present it is but a scientific curiosity. Professor Daniells constructed for the Royal Society a water barometer which was fixed in the hall at Somerset House. The tube was 1 inch in diameter and 40 feet long, the average height being 400 inches; its sensitiveness was excessive, every rise or fall in the mercurial barometer being represented by 14 inches of water. To prevent the admission of the outer air from the cistern, the water was covered with a layer of solution of caoutchouc in naphtha. The column appeared to be in a state of perpetual motion, similar to the slow act of respiration. By its means it seemed as if one could feel the pulse of the coming storm. In windy weather this barometer was constantly fluctuating, indicating numerous changes of pressure which had no sensible effect upon the most delicate mercurial barometer, the most important point being, that this instrument preceded by one hour the indication of the mercurial barometer of $\frac{1}{2}$ -inch bore, as this does the mountain barometer of 0.15-inch bore by the same interval of time. The drawbacks to such an instrument are, the necessity for a very long tube, as the pressure which will sustain 30 inches more or less of mercury, will sustain 30 feet more or less of water; and the fact that water freezes at 32° Fahr.—a temperature very often existing in temperate climates, or elevated stations; whereas mercury does not solidify till exposed to a temperature of 40° below zero or 72° below the freezing-point of water.

The sensitiveness of the water barometer being so great, it is a question whether it would not be desirable to erect such instruments in properly constructed observatories at certain points along our coast lines, under the management of the Board of Trade Meteorological Department, so as to enable it to send out still earlier telegraphic warnings of coming storms, to points of the greatest importance for the shipping and fishery interests.

POINT LACE WORK.—V.

THE border for a pocket-handkerchief forms the subject of our present illustration, and is one of the prettiest and most useful purposes to which modern point lace can be applied. The design must be worked four times, once for each corner of the handkerchief; they can be worked separately (each being perfect in itself), and joined at the narrow parts with bars. The braid used should be the finest and narrowest that can be procured, and the thread also of the finest. The braid should have an open edge, and we should advise the open overcast being worked into its outside edge throughout. A single row of braid forms the outside and inside border of the design, and in the former case the pearl-stitch should be used (as described in page 282, vol. i.) to form a light finish. The cambric, or fine French lawn, for the centre of the handkerchief, should be cut larger than is required, and being placed under the row of braid forming the inside edge of

the design, should be stitched closely to it with fine cotton so as not to show, and then cut away at the back, leaving the lace work quite clear. The lawn may also be turned in at the edge, after having been cut to the required shape; and being hemmed slightly, may be tacked neatly under the braid. Some prefer this plan, as it can be untacked and washed separately, which certainly saves the lace; for the latter will not, of necessity, require cleaning every time the centre of the handkerchief is washed, and thus a good deal of wear will be avoided.

If the corners have been worked separately, they must be tacked on a square of paper or coloured calico, and the braid, forming the edge on each side of the design, worked round them, as there must not be joins in this. The bars uniting the ends of the corners, as well as those connecting the whole border with the braid at each edge, can then be worked before the outside pearl is made.

The open stitches introduced to fill up the leaves should be as varied as possible; we have already described some in the second and third articles on this subject, in vol. i., and we now give three new ones to use with them. Fig. 1 is worked in the following way:—Commencing from the braid on the left side, four overcast stitches are made into the braid above, at a little distance from the side (between which and the stitches the plain thread forms a space); then comes another such space and four more overcast; and thus until the opposite braid is reached,

where a stitch is taken through to fasten it; putting the needle in a little lower down, a thread is taken across again and brought out opposite, and four overcast stitches are worked, commencing the first one between the first and second of the last row, and the others between the next two and so on, which brings

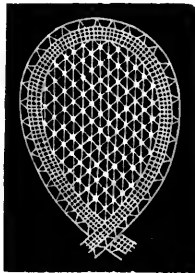

Fig. 2.

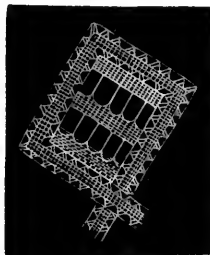

Fig. 3.

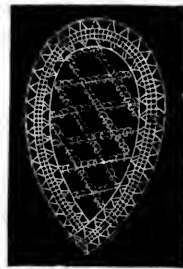

Fig. 4.

the fourth outside the last of the preceding row, the thread stretched across being taken in with the overcast stitches. A space, as before, follows this; and then four overcast again and a space, until the braid is reached, when the thread is stretched back, and the overcast and space continued to fill up the opening. The design will show how the rows of overcast and the spaces follow each other. In Fig. 2, a space is formed by the thread; then two overcast stitches are made in the braid at the top; and a space and two more overcast, alternately, to the opposite side of the opening; then the thread is stretched back, at a very little distance from the last row, and two overcast stitches made into each space, taking in the stretched thread with them, and not drawing the thread with which they are worked too tightly across the spaces. The thread being again stretched back at the end of the row, the same process is recommenced and continued throughout. To work Fig. 3, a row of overcast is made from left to right into the braid at the top, not *very* tightly; then stretching the thread back, another row is worked in the same way, each stitch being between those in the last row; after stretching the thread, this must be repeated, and at the end of it the thread is fastened off, instead of being again stretched back. The next row begins from the left again, and a long twisted overcast stitch is made in every third of the last row; it is twisted by passing the needle twice over the right hand part of the stitch, which must not be drawn up, but left long, as in the design given. Now the thread is stretched back, and two of the usual overcast stitches taken into each long one; then again stretching the thread back, two are worked into each space, and one between



LACE WORK. BORDER FOR HANDKERCHIEF.

each stitch of the preceding row; then a row of plain over-cast, and the thread fastened off, and the long stitches commenced again. The open work should be done, as we have said, with the finest thread, and so arranged as to make each corner of the pocket-handkerchief as different as possible. Sometimes the designs themselves are varied, so that the two opposite corners only are alike, and this might be easily done in working the designs we have given—the leaves, which in it are pointed, being made round in the braiding; the rounded ones pointed; and any other slight alteration of the same description which might suggest itself to the fancy and ingenuity of the worker.

From want of space, we have been compelled to give the end of our design separately; but it will be easily made to fit on quite correctly.

In our next chapter, we hope to give a design for a lamp or candle shade, in the form of a miniature banner-screen.

INMATES OF THE HOUSE.—DOMESTIC.

NURSE AND NURSERY-MAID (*concluded*).

INDISPENSABLE as watchfulness is at all times in the management of children, the need of vigilance is most urgent, to detect the first signs of disease. Any change in the natural habits of children should be reported by the nurse to the parent. Any accident, however slight, that a child may have sustained, should be spoken of to those most interested in its welfare. Matters that may appear of no moment at the time, frequently prove the forerunners of serious ailments. No one can prevent mishaps, but concealment is a grave error. The cause of many a spinal complaint has been traced to an unlucky fall, and numberless hidden diseases have arisen from children swallowing improper substances. Nothing is more fatal in these cases than the delusion that no harm can come of such accidents. Sooner or later the truth is liable to become known, and the nurse to suffer blame for an evil which candour would have dispelled.

Some nurses are tempted from over-anxiety to suggest, that upon any little derangement of health "a powder" should be given. They look upon certain medicines as the cure-all of every complaint, instead of a last resource, to be administered only under medical advice. Dieting is, however, generally, the only dose a young child, living in pure air, needs when a little out of health. By dieting is meant substituting one kind of food for another—as beef-tea instead of meat; bread and milk instead of bread and butter or cheese; light egg-puddings in place of those composed of fruit, jam, and suet; avoidance of tea, coffee, wine, and beer, if such articles of food, unsuitable to most young children, have been partaken of. If having tried change of food, combined with plentiful use of water for bathing, and ample exercise in the open air, a child still shows symptoms of failing health, medical aid should be sought.

The occasions which require instant remedy are those which, from their sudden appearance, the nurse is most likely to be the first to perceive. Amongst these are *croup*, one of the most alarming diseases of childhood. This terrible complaint is often unpreceded by any symptoms of a common cold. The first intimation of its approach is usually given in a loud, brazen-sounding cough, unlike any ordinary cough. Only one sound may be uttered at considerable intervals at the outset, but the first cough should call forth active measures. In the absence of immediate medical aid, an emetic may be safely given. When vomiting has set in, a warm bath, at a temperature of 98° Fahrenheit, should be prepared, and the child should remain in it from a quarter-of-an-hour to twenty minutes. An eminent physician, in an excellent work on maternal management of infants, recommends

as an emetic for croup, one grain of tartarised antimony dissolved in an ounce of boiling water. Some such remedy should be at hand in every family consisting of young children, for attacks of croup are prevalent even with robust children between the ages of two years and twelve; and the chances of recovery depend chiefly on promptness in applying a remedy. Attacks of the kind are most general in the spring and fall of the year, during the prevalence of north-east wind after rain.

The manner in which a child sleeps is a great indication of its healthful state. Perfect composure in sleep denotes perfect health. The flitting smile that plays across an infant's features when asleep—poetically called an "angel's whisper"—arises from flatulency, and is of frequent occurrence. The child's position should be slightly changed to dispel the wind. Rolling of the head upon the pillow is a more serious sign, especially if the eyes be fixed, and the child starts fitfully in its sleep. If the child be unusually costive, an aperient dose may remove the symptoms; if otherwise, a medical man should be consulted.

Another sign which should excite attention is the appearance of a child's limb drawn in an unusual manner. The thumb drawn tightly into the palm of the hand, for instance, may precede an attack of convulsions. The passing of a child's hands over the top of its head and forehead also, may denote some disturbance of the brain.

The cry, which to many nurses always means hunger, varies very much in infancy, according to the nature of its wants. The shedding of tears, which is the most pathetic appeal to our feelings, is in reality the least alarming of all kinds of crying. It is supposed that the flow of tears arises only from mental emotions, whilst the tearless cry denotes bodily pain. The cry of hunger is generally heard when an infant wakes from slumber, and may be known by alternate fretfulness and a catching sound of the breath, accompanied by an eager movement of the tongue and lips, and carrying of the hands to the mouth.

A continuous moaning cry proceeds from wearying pain, of which the seat may be generally ascertained by observing the movement of the hands and legs. If the legs be updrawn the pain will probably be in the stomach; if the hands be frequently put to the mouth, cutting a tooth may be suspected.

Any of the above indications of pain should be reported to the mother, and if medical aid be sought, the nurse has no responsibility in the treatment of the case. All her thoughts should be centred in carrying out the doctor's instructions, whether they coincide with her notions of propriety or not. In describing a child's symptoms she should avoid speaking from her own impressions or past experiences, confining herself strictly to present facts. The medicine should be administered with faithful exactness, the nurse carefully noting its effect. If anything strikingly unusual should follow on giving a dose, she should confer with the child's parents on the subject, and be advised by them whether to follow the doctor's directions or not.

The dress of a nurse needs some words of comment. Steel hoops ought never to be worn in the nursery, however much the foolish fashion may be adhered to out of doors. Neither should long skirts be worn, tripping little children up as they are liable to do. Gowns made of washable materials are most suitable. These are easily cleansed if soiled by nursery duties, and cost but little to renew. A waterproof apron worn under the ordinary white apron will be found a great comfort to a nurse, and might be supplied with advantage at the cost of the employer. Every nurse should also be furnished with a long, loose, warm wrapper, made like a dressing-gown, for night wear, when her duties require her to rise from her bed to take a baby to and from the

mother's room. This garment should be purchased by the mistress of the house, and kept for the use of any nurse who may succeed to the situation.

THE GOVERNESS.

There is no class of female labourers whose vocation is generally so little appreciated, and respecting whose position in a family so many differences of opinion exist, as that of the resident governess. Daily teachers do not suffer under similar disadvantages. They give their lessons at appointed times, and when the task is done they are free to exercise their leisure as they please. The chief responsibility of the latter is confined to imparting the particular branches of learning in which they are supposed to be well versed, leaving the general moral culture of their pupils to other hands. It does not need much argument to show that the daily governess's duties, both in point of work and moral responsibility, are infinitely lighter than those which attend her sister labourer in the field of education—the resident governess. Neither is the average payment of both classes of teachers fairly balanced. Many well-informed people—liberal in other respects—seek to secure the constant supervision of their children in intellectual knowledge, health, and moral guidance, at a salary which they know it would be folly to offer as wages to any good cook or upper domestic servant. The deplorable part of this state of things is that situations of the kind, on the terms named, still find many candidates.

Hitherto the sphere of female labour has been so limited, that the calling of "governess" has been almost the sole refuge for those compelled to earn their bread. False notions of propriety have, until recently, interfered to prevent women from engaging in any pursuit save that which bears the stamp of gentility; and needlework and teaching being considered the only employments to which the above designation might be unmistakably applied, both needlewomen and teachers have abounded in proportion to the pressure of circumstances which has driven unmarried women to become self-supporting. Any young woman who can read and write, and has been a certain number of years at school, feels herself qualified to turn governess for a living. Whether she has been specially educated for her vocation or not, matters little. Provided board and lodging, and a pittance for pocket-money and clothing are offered, applicants for vacant situations are numberless. Under such circumstances, it would be a marvel if the services of the class of teachers had not depreciated. It may be presumed that the time is not far distant when the profession of governess will assume a more elevated character than it has ever held in people's minds. When no longer regarded as a makeshift mode of eking out a living, we may expect to see a class of female teachers duly trained, and accredited competent to discharge their adopted profession, exercising an enlightened influence over the minds of young girls confided to their care.

In the meanwhile, both parents and teachers have their distinct responsibilities, which, in justice to all concerned, cannot be too seriously regarded.

Without pretending to decide whether the generality of young children are better taught at home by a governess, or at school, during morning hours, it is very certain that the teacher should possess certain indispensable qualifications. Any one exercising authority over the minds of little folks should be, in the most literal sense of the word, a superior person. A governess should not only be thoroughly conversant with the subjects she professes to teach, but she should be an example to the children under her charge—in conduct, deportment, and general personal habits. Many things in life tend to efface the book-learning we acquired in childhood; but the example of our elders and teachers is rarely forgotten. The

manner of viewing the ordinary affairs of life, the interpretation we give to inexplicable facts, the prejudices which influence our judgment in mature years, may all be prompted by the unwritten lessons we learnt from simple contact with a refined or vulgar mind—an uneducated, or intellectual person, as the case might be.

It is not reasonable to expect that a very desirable teacher can be found without considerable search. Superior abilities in followers of every calling of life are the exception, not the rule. If difficulty is experienced in selecting proficient in mechanical arts, how greatly is the task increased when the more subtle distinctions of mental qualifications are in question! Judging from external appearances, numberless eligible teachers may be found on every side. Style of dress and pleasing manners are very much the effect of the prevailing taste of the day, and are adopted accordingly; but a peculiar cast of mind is not so easily discerned. It is only by intimate acquaintance that one is enabled to discover the inner-self of those with whom we associate.

In engaging a governess, something more than the stereotyped list of questions which are addressed to a domestic servant, when applying for a situation, is needful. Some certainty of knowledge, that the candidate really possesses fitness for her post, is necessary. This certainty can hardly be expected to result from an interview of a few minutes' duration, such as it is customary to bestow at an agent's office, or on the introduction of a chance go-between.

The best mode of engaging a governess is through private recommendation. People, of whom the circumstances, family, and connections, are known on either side, are likely to be more congenial to each other than strangers. A feeling of semi-friendship is the usual result of such acquaintance, and is altogether the most happy auspice under which similar relations can be formed. The children themselves are no less benefited by the favourable circumstance than the employer and employed.

Having succeeded in finding a desirable instructress of approved principles and acquirements, the question of salary should be decided in a liberal spirit. A common sense of justice should prompt this course, added to a feeling of humanity, which dictates that we should enable those who serve us in their prime of life to make some provision for old age. People who are not prepared to make a pecuniary sacrifice on this account, can hardly expect entire devotedness on the part of those who serve them.

HOUSEHOLD DECORATIVE ART.

GLASS PAINTING (*continued*).

Biting-in.—It is often desirable to produce clear white or yellow spaces through deep red or blue stained glass; as in the letters forming an inscription, which could not well be leaded-in separately, this may be done by using flash glass, and removing from it the film of colour by a chemical agent. Fluorine is the only known substance which will dissolve glass, and fluoric acid must be used in the following manner:—The piece of glass to be acted on is coated on those parts which are not to be exposed to the action of the acid, with Brunswick black. This is of a bituminous nature, and is applied with a brush; the back and edges of the glass are also covered with a mixture of equal proportions of bees'-wax and tallow. The glass thus prepared is laid on a gutta-percha tray, and the acid diluted with an equal bulk of water poured on. In about ten minutes the film of colour on ordinary flash glass is eaten through, and the piece is at once removed from the bath with a pair of pliers, and washed. While the glass is in the bath it is necessary that it should be watched, and occasionally rubbed on the surface with

cotton wool on a stick, and not allowed to remain a moment longer than is necessary, or the edges will become rotten and ragged. This operation should be performed

kept in a gutta-percha bottle, as it will soon make its way through one of glass. After the biting-in process is completed, it is generally

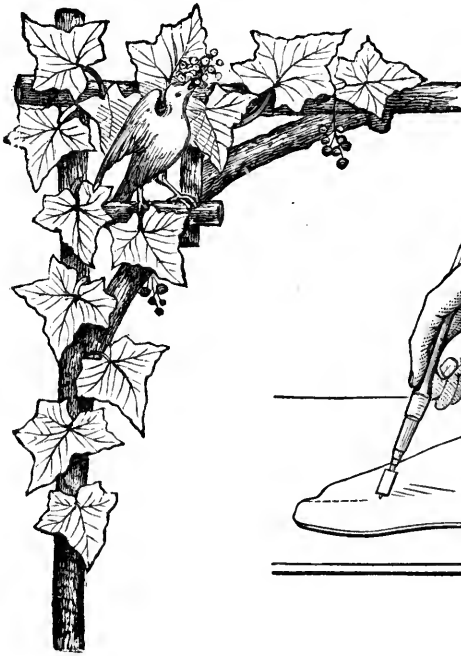

Fig. 9.

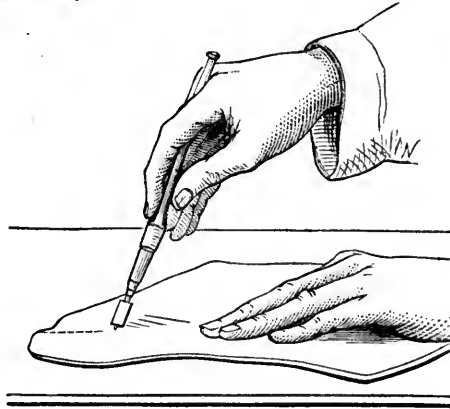

Fig. 2.

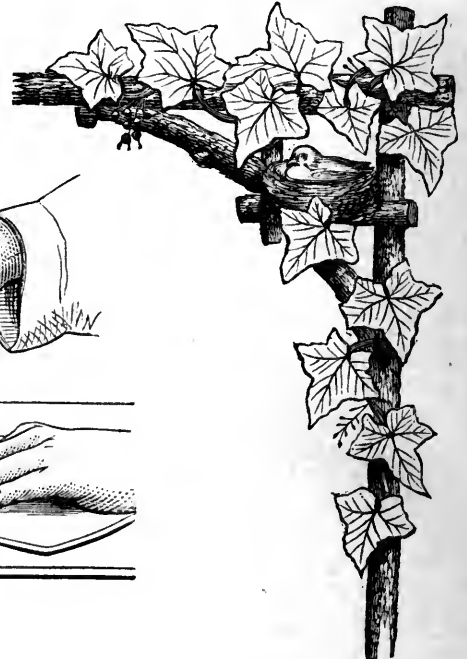

Fig. 4.

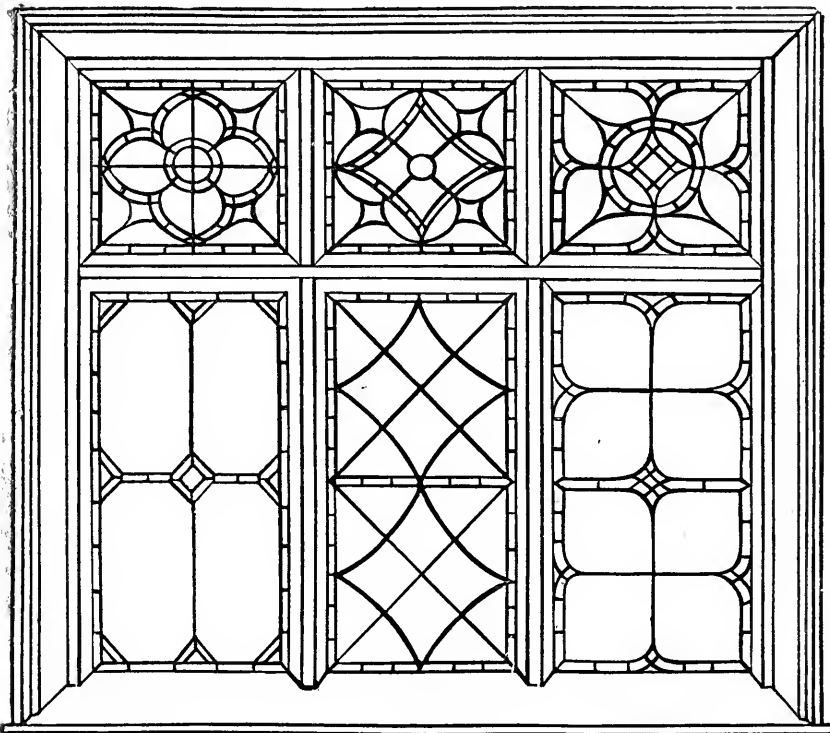

Fig. 1.

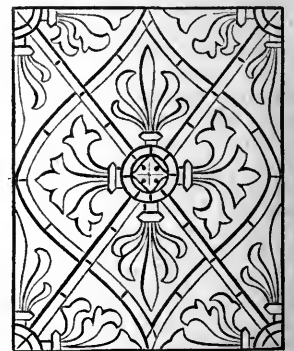

Fig. 5.

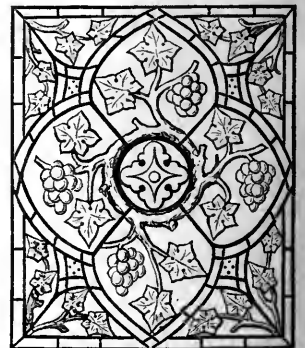

Fig. 3.

out of doors, as disagreeable fumes arise, and the acid should not be allowed to touch the hands, or it will produce sores. It is well to oil them before beginning, to protect them against chance spots. Fluoric acid must be

necessary to "mat" over the glass in order that any irregularities or defects in the outlines of the corroded parts may be repaired with tracing colour. It is then possible to make that portion which retains its colour

more ornamental, by scratching on it a slight pattern with a point of hard wood, and by completely scrubbing off the mat in some parts, to form leaves, flowers, &c.,

well informed on the subject; for few ordinary glaziers understand stained glass work, and the employer must be able to give instructions. A knowledge of what can and

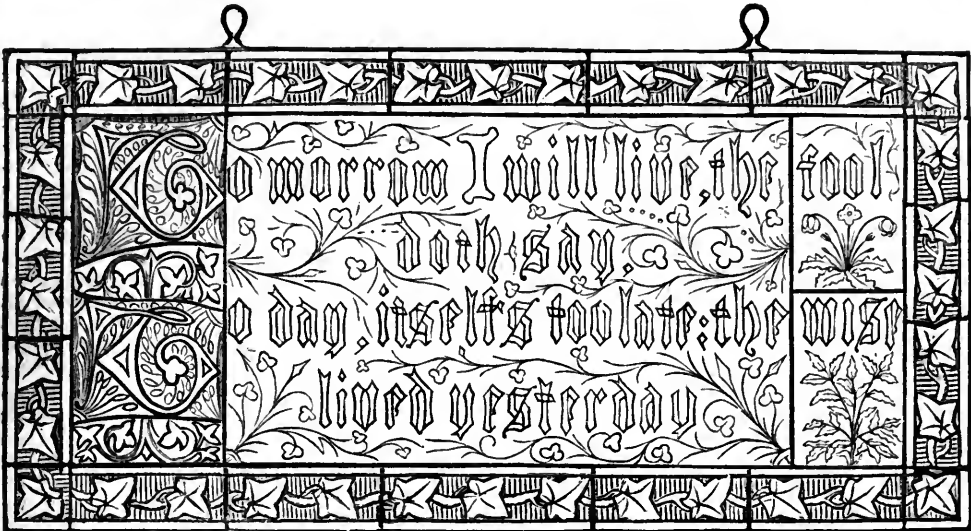

Fig. 6.



Fig. 7.



Fig. 8.

as in the example which we have given from a design of our own now in progress. (Fig. 6.)

Cutting-out.—Whether the amateur cuts out his own glass, or entrusts it to a practical glazier, he should be

what cannot be done with the glazier's diamond is, moreover, essential before forming the design, as the forms employed must only be such as it is possible to cut in glass. As a general rule, it may be said that all

straight lines, projecting angles, and convex curves are easily cut; concave curves are more difficult—and extremely so, if very sharp; while an angle running into a piece cannot possibly be cut, and the difficulty must be overcome, as at A, Fig. 7, by cutting the piece in two, and bringing a lead line, A B, to meet the angle. The flowing, and often complex lines in stained glass, can rarely be cut at a single operation, like the straight ones in ordinary windows. For instance, in cutting the ruby glass to form the red cloak in Fig. 7, the concave line, C D, will first require that a straight line, as there indicated, be cut; the diamond will then be drawn round the curve, and the glass carefully removed in small pieces by pliers. Had the curve been more deep and sharp, as shown by the finer curved line, two or three successive curved lines must have been drawn, and the nibbling-out process repeated as many times. The cutting will always demand care and patience, and even then the glass will frequently break, but the amateur must submit to the vexation as a necessary evil. The diamond must be held between the fore and middle fingers, and supported by the thumb, in the manner shown in the cut, Fig. 2; the exact slope at which it will best work will vary in different diamonds, and to ascertain it, a few first trials should be made on a piece of waste glass.

Leading.—The last operation in stained glass work is fitting the pieces together with thin flexible leads, and soldering the joints. This in no way differs from ordinary leaded window-glazing. The glass is fitted into the grooves of the lead with a blunt knife, and whenever a joint has to be made, one of the strips of lead is sharpened to a point, and inserted into the groove of the other. The surface is scraped bright with a knife, and a little powdered resin put on, to act as a flux. The heated iron is next rubbed bright on a piece of tin with solder and resin. The end of the strip of solder is then applied to the joint, and melted down with the iron. Fine solder, that which contains more tin than lead, should be used; it will cost 2s. per lb. The leads will cost 3½d. per lb. When the whole design is fixed together it is cemented, linseed oil is poured over the glass, and in this powdered whitening is spread, and well worked with a brush into all the crevices of the lead work, over which dry lampblack is lastly brushed. The cementing at the same time fills up and conceals defects in the lead work, binds the parts more firmly together, and thoroughly cleanses the glass. If the amateur performs these operations himself, special tools will be needed—a glazier's diamond, 15s.; stopping knife, 1s.; pliers, 1s.; and copper bit for soldering, 2s.

We believe that we have touched upon all technical facts of importance to the amateur, and it only remains for us to make some suggestions as to the manner in which he may most advantageously employ his knowledge.

There are in most houses some windows, as for instance, those on staircases, which are only needed to transmit light, and not to be looked through, and in which the insertion of painted glass would add greatly to the beauty of the house. Coloured glass *is*, it is true, used to some extent, in such situations, in many modern-built houses; and answers a good purpose so far as by its brightness it adds cheerfulness to their interiors; but, in themselves, the borders and corners of blue and yellow so used, are the reverse of pleasing. This state of things may be improved by the amateur glass-painter; there is no reason why the windows of our halls and staircases should not be filled with good and decorative coloured glass, as well as those of our churches. We have something to say on this subject; and also on the treatment of windows which are intended to be looked through, and the method of decorating without obscuring them.

In our first article we spoke of stained glass as being less adapted for house decoration than enamel painting:

this is partly because the lead lines, when constantly near the eye, as they must be in a dwelling-room, would, by many, be thought unsightly, and partly because a number of pieces of glass, when merely fixed together by leads, require more support than can be afforded by a sash frame alone. This would less apply to hall or staircase windows, which are only seen occasionally, and where saddle-bars (cross-pieces of thin iron) would not be objectionable. In Figs. 3 and 5, therefore, we give two designs for geometrical patterns in stained glass, to be substituted for ordinary sash panes in such situations; a single saddle-bar across the centre, or, if preferred, two diagonal ones, would render either of them secure. They are intended for windows in which the panes are not less than 18 inches high. In Fig. 5, the colours proposed are—centres, green; surrounding circles, ruby; straight strips, blue; curved, yellow; and the remainder white glass, with the anthemion ornament drawn upon it in tracing-colour, which gives, when finished, and against the light, a grey. In Fig. 3, the centre and border strips, blue; the curved strips, ruby; the four diamond-shaped spaces on diagonals, green; the remainder white glass, with the vine pattern in tracing-colour—that portion within the curved lines being gold-stained behind. These colours may, of course, be varied to taste, and many pleasing combinations formed: geometrical designs, such as these, always look well in practice, and demand only the most rudimentary skill in drawing for their production.

Figures may also be used in such positions, provided the necessary support can be given. That shown in Fig. 7 would be suitable, and have a good effect. Its colours should be—cap and mantle, ruby; doublet, orange; hose, green; shoes, purple; background, quarries of white glass, diapered with tracing-colour; and border, blue, with yellow flowers.

Enamel painting may be used in similar situations as well as in rooms: its great advantage is, that it can be applied to any window in the place of plain glass without mechanical difficulty, but the colours are far less vivid and beautiful than those of stained glass; still it admits of infinitely greater delicacy and freedom of treatment, which are important in works to be placed near the eye. Fig. 8 shows a design to be executed in this manner. The colours employed are—cap and doublet, ruby (that is, red with gold stain behind, the nearest approach which can be made to ruby in enamel), with gold border; hose, greyish yellow; shoes, buff; covering of chair, blue; lectern and floor, dark tracing-colour; background, diaper in light tracing-colour; border, ruby, with gold flowers.

We have now to speak of those modes of decoration, which can be practised without rendering the window obscure. For such windows of dwelling-rooms as overlook back premises which it is not desirable to see, enamel paintings which cover, or almost cover the place, like the last example, are admirable; but these would be out of place in front windows: to such, a border only of enamel painting might be applied. Portions of a design for this purpose, the remainder of which may easily be supplied by the imagination of the amateur, are shown in Figs. 4 and 9. These give the upper corners only, the rustic trellis-work, with leaves, would be continued round the other portions of the window. The stem would be in dark tracing-colour; the leaves, gold; the fruit, ruby; and the birds (redbreasts), in their natural colours, brown and red. Our reason for not giving the leaves in their proper colour, green, may be mentioned:—No good green exists in enamel; the best is formed by laying blue on the face and gold on the back of the glass; but for effect, in this case, the gold only will be better and more brilliant. A design of this kind might be applied to those sash windows of which the upper and lower parts are composed of single sheets of glass, but the expense and danger of firing would be considerable. In windows of smaller squares, the effect

of the design would not be materially interfered with by the intersecting sash-lines, and no such difficulties would have to be encountered.

Another method of decorating front windows, would be by hanging against them frames filled with stained or painted glass. These might either be figure subjects on a similar scale, coats-of-arms, mottoes, or texts, enclosed in ornamental borders; such as that shown in Fig. 6, page 249. We should recommend this description of decoration for the first essays of the amateur. In making such a tablet, there is no mechanical difficulty which he could not overcome by following our directions, unaided by the glazier; and in case the result were not satisfactory, the work could readily be removed and altered, which would not be so easy were it fixed in a window. In the example given, the whole centre is composed of three sheets of flash glass, the middle blue, the ends ruby. The letters are bitten-in with fluoric acid, and gold-stained at the back; the ornament between is etched on the mat. The border is of white glass, lined with tracing colour, and the leaves gold-stained at back. The lines are from Cowley.

We have already spoken of a department of stained glass decoration which might be practised by those possessed of no artistic skill. It consists in simply cutting out and leading together small pieces of coloured glass in such a manner as to form geometrical patterns. No painting or firing is required, and good effects may be obtained in it. In Fig. 1, we give designs for this kind of work. A window in the Elizabethan style is supposed to be filled with it. All the glass in three upper compartments is coloured, in the lower the smaller pieces only are of different colours, and the larger plain. Designs of this description, like those in Figs. 3 and 5, might be applied to sash windows.

It would be impossible, even in an elaborate treatise, to give anything like satisfactory rules for the proper arrangements and proportions of colours in plain work. As in painting, good colour can only result from instinctive good taste on the part of the operator; and rules, at the best, can only show how to avoid gross errors. Generally speaking, it will be found that grey—that is, plain glass with tracing-colour patterns—may be used most freely; next yellow, then red, blue, green, orange; and purple most sparingly; and in arrangement, most authorities consider the effect best if light or grey can be introduced between positive colours.

ODDS AND ENDS.

Contamination by Zinc Tanks.—M. Ziurek calls attention, in *Dingler's Polytechnic Journal*, to the fact that water, kept in small reservoirs made of zinc, or collected from roofs covered with zinc, is invariably contaminated with that metal; and that the use of such water for domestic purposes is highly injurious to health. The author recommends that where zinc vessels are used for purposes indicated, they should be painted over with asphaltic varnish or any iron pigment.

Anti-macassar.—Purchase, at a lace warehouse or good linedraper's, a yard of coarse white or black net, and work in a frame with coloured Berlin wool, either from a pattern for Berlin worsted work, or a pattern for crochet. It should have a border close to the edge, and wide fringe at each end, tied in by drawing through a double loop of wool, about a quarter of a yard long, with a large needle, and then taking the ends of the wool through the loop, and drawing it quite tight. This anti-macassar looks very handsome worked on black canvas.

Curtain Bands.—Nothing is prettier to hold back muslin curtains than bands of crochet roses. A row of the flowers are joined—the number must depend on the size—using Walter Evans and Co.'s Boar's Head cotton, No.

12; about nine roses would be enough. Each side of these work an edge; first, a straight line of chain stitches, and on these a pattern in chain or fancy, three or four rows deep. At each end make a large loop across the band, and cover it by working over it, first, as many double crochet as it will take, and on those long stitches. Make these loops at each end as the sides are worked, going round and round. These loops are to pass over a brass hook. The band is simply looped from the hook across the curtain horizontally, and holds it back, but does not lift it up. The bands may be lined with pink muslin, or used without.

Hortus Siccus—the best and easiest Mode of drying Plants.—Turn the contents of your tin collecting-case on to a newspaper, and carefully select and arrange the plants, removing dead and faded leaves. Having ascertained the class and order, spread each plant on to sheets of white paper: large glazed foolscap is the best; blotting paper absorbs the colours of leaves and flowers, glazed paper preserves them. Cover the plants with another sheet of paper, and lay more plants on that, one layer above the other; press with heavy books. Change the papers every day; have two sets of papers; and carefully dry the damp sheets before using them again. Be very careful to spread every leaf and petal as flat as possible. When quite dry, fix each specimen to a sheet of paper, either by strips of paper crossed over the stems, or sewn with needle and thread. The classes and orders, place where found, and date, should be neatly written.

To smooth Muslin Dresses when creased, but not sufficiently soiled to wash.—Lay the dress on an ironing-board, and with a clean sponge damp it thoroughly with starch. Fold smoothly together, and iron on an ironing-board for dresses. The dress may be ironed without folding together. Have the iron ready heated, and iron each breadth and portion as it is wetted with the starch. Do not fold it when ironed, but hang it lightly before the fire to get perfectly dry. Dresses and slips should never be folded. In Paris, Brussels, &c., the laundress carries home muslin articles fixed to a bar of wood.

To clean Looking-glasses and Mirrors.—Get half a pint of spirits of wine, put it in a basin, and with a clean sponge wash the looking-glass well over; then take another sponge, and wash it well over with clean water. Dry the glass with a fine, soft, linen duster, and polish with a silk handkerchief.

To clean Knives.—Scrape at one end of the knifeboard a little heap of Bath brick; rub on to a piece of wet flannel some yellow soap; lay the knife flat on the board; dip the soaped flannel in the brick-dust, and rub it on the knife. When clean, wash the knives in a jug of warm water, but be careful not to let it touch the handle. This method saves the knives, as well as the labour of cleaning in the usual way.

The Saxe Weimar Nettle Shawl.—Purchase a pound of double German fleecy wool: colours to taste. Get a bone netting-needle, and a bone mesh nearly an inch wide. Net twelve stitches on to a piece of fleecy; tie in a round. Increase, or net two stitches into the third, sixth, ninth, and twelfth stitches of the second row, netting round and round. Net two stitches always into the increased stitch. When the size desired, a border may be made in stripes of another colour on a larger mesh. For fringe, cut a skein of wool, the colour of the shawl, into pieces double the width of the fringe, which should be full one-eighth of a yard wide; draw two or three pieces of the wool together in a loop through the outer row of stitches, and pass the ends of the wool through the loop; draw it tight; and when you have gone all round the shawl, cut the fringe even. Then, on a sheet spread on the floor or a large kitchen-table, iron the shawl, with another sheet or large newspaper spread over it. This makes a very light, warm, elegant shawl.

POINT-LACE PAPER FLY CAGES.

POINT-LACE paper fly cages are really elegant little things in their way, and one can readily be made from a model, with a moderate amount of patience, in an evening. Cut eight pieces like Fig. 1 out of white tissue paper, and eight like Fig. 2. The best way is first to pencil the outline, and then cut the paper. With a little skill, enough may be cut at once by folding the paper. The design and border, be it observed, must all be kept in one, and in no place are the lines to be cut through, only the spaces between cut out with a very sharp knife, and the paper laid on stout card or millboard or the back of an old portfolio. The dotted lines are the pieces by which the lace is to be joined to make the cage. Take the full measure from A to B, Fig. 1, and cut a circle, the diameter of which is double that size. With a bow pencil this is very easy. Take the length from A to B with the pencil, and draw the circle at once—without that aid, a tumbler, or small basin may serve to draw the round. Cut it out of thin cardboard and cover

long enough below the round of card to hold the eight pieces of Fig. 2 and a tassel. Above, it must be as long as Fig. 1. Now, at the top of the round, fix the eight pieces of Fig. 1 upright from C to A to the wire. The dotted piece from A to B is gummed and fastened to the round. Fix the lower part of each piece of lace, one on each pencil line on the round. Gum both parts of the piece of lace before attaching it to the wire and round. Next attach the eight pieces of Fig. 2 below the round to the wire in the centre, and at the top to the eight sections previously pencilled on it. The piece which projects from Fig. 1 requires a bit of very fine flower wire run through it from B to E to keep it out in place beyond

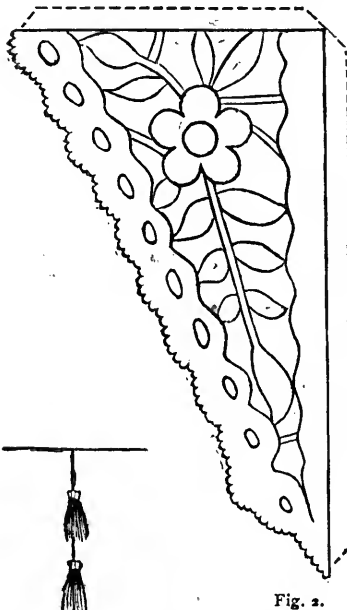

Fig. 2.



Fig. 5.



Fig. 6.

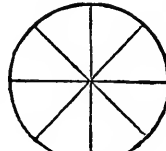

Fig. 3.



Fig. 4.

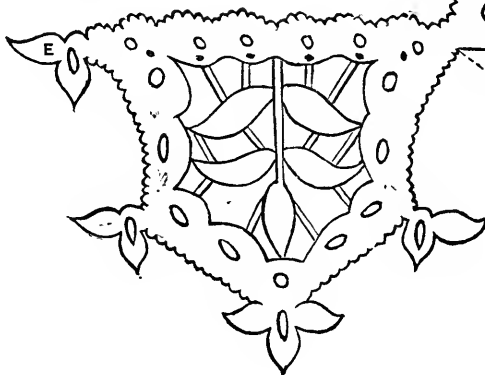

Fig. 1.

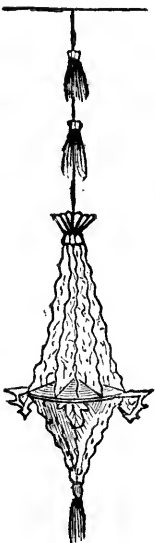

Fig. 7.

it both sides with green paper, or use green card. Divide it into eight equal sections with a pencil line, as Fig. 3, on each side. Let the colour be very bright. Make a hole exactly in the centre, just large enough to insert a wire. Make two loops in this to keep the round in its place, one above and one below the round. The wire must be left

paper; cut this like Fig. 4, leaving enough plain for a heading. Tie the top to the wire below close to the lace, wrong way up, like Fig. 5, then turn it down. Tie it a second time, above the fringed ends, like Fig. 6. It should be put on before the lace. The length is a matter of taste. The basket may be suspended entirely

the round of cardboard. The best way to do this is to cut four pieces of wire as long as the round of card is across, and as long as two of the projecting pieces of lace, leaving a little bit to turn down each side. Turn down one end, run it through the lace from end to end, and turn down the opposite end to prevent its slipping out. This wire should not show. There are some little holes from B to E for its insertion. At the bottom of the fly cage fix a long tassel of tissue

by wire. Ornament it with two shorter tassels tied round the wire.

Fig. 7 illustrates the appearance of the fly cage complete. Figs. 3, 4, 5 and 6, are given much smaller than the actual size, to economise space. Figs. 1 and 2 are of the correct proportions.

SEA-SIDE AMUSEMENTS.

SEA-FISHING.

SEA-FISHING forms a grand amusement for the man of active habits when at the sea-side. The sea being free

Lines.—Fishing by means of lines and hooks is practised all round the coast, and especially on those parts where the bottom of the sea is rocky and rugged, commonly termed "foul," or where the water is deep, with rapid and strong tides; such seas being unsuitable for the use of nets. Much of the best fish is caught by lines, especially cod, haddock, whiting, conger, pollack, hake, ling, coalfish, and the various kinds of flat fish, generally passing under the name "white fish."

In the purchase of fish, it is judicious to select such as are marked about the mouth with the hook. This shows that the fish was on his feed, and more likely to be in

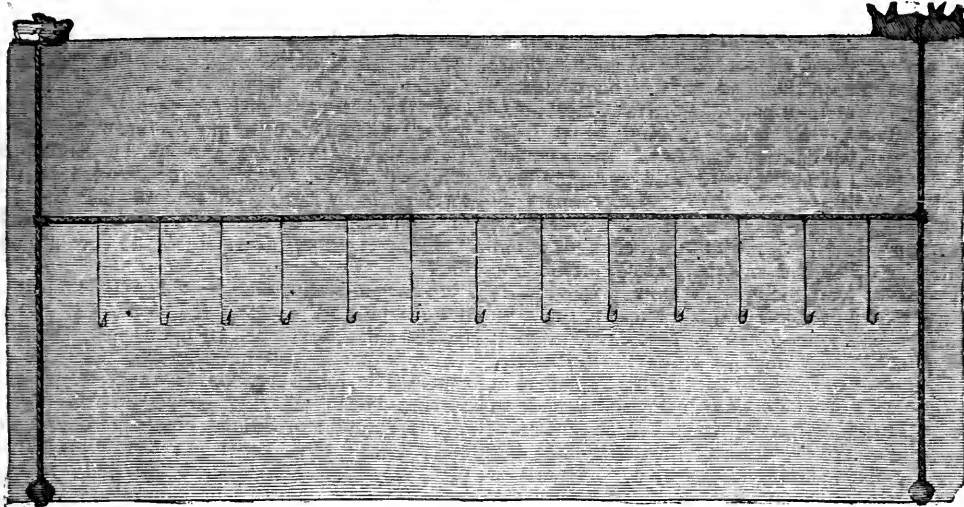

Fig. 4.

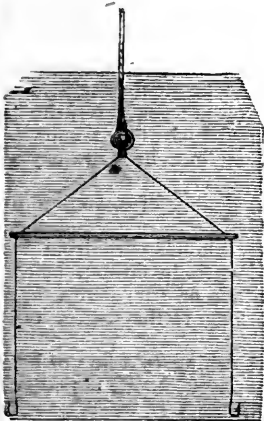

Fig. 1.

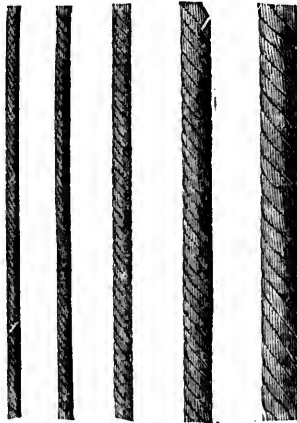

Fig. 3.

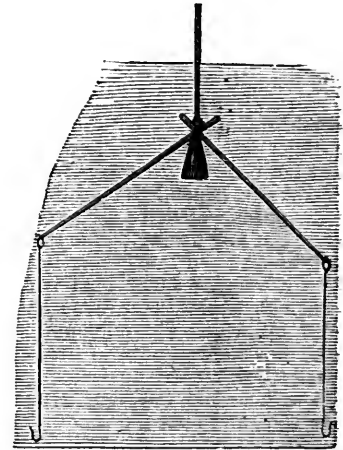

Fig. 2.

to every one to fish in, lends an additional charm to this kind of fishing. Much good fish may be caught by the amateur who is guided by sound practices; and it is therefore our purpose to supply such practical information as may increase his pleasure, and render fishing a profitable occupation. Fish caught by yourself not only tastes better as being the trophy of a grand sport, but is really so, as it escapes the bruising by packing, and also the deteriorating effects of sun and heat. Various kinds of fish, at the sea-side, are desirable for breakfast, dinner, tea, and supper, and therefore it is well to learn how to catch all sorts. We shall proceed to give directions for the making and use of lines and nets, with full particulars of all kinds of baits, as used for the capture of various kinds of fish in different seas and at different depths.

good condition than those caught in a net, by which the invalided as well as the healthy are captured. Fish with short body, thick shoulders, and small head, are most likely to be firm to the touch, which is the proper means of testing the quality of fish.

There are two great divisions of fishing with the line, the one being long-line, and the other hand-line fishing.

Hand-lines.—Fishing by means of hand-lines is termed "railing" (trailing); lines for which are made of many different materials, and in several ways. They should be fine, but strong; the finer they are, consistent with strength, the better. They are known in the trade under various names, dependent on their strength and the purpose for which they are designed. Silk, horse-hair, hemp, flax, Indian and other grasses, are used in their

construction. All lines should be waterproof. The eight-plait silk, which is expressly manufactured for trolling and heavy salmon-fishing, is also suited for coast-fishing in heavy water. There are, besides the patent hair-line, the line composed of silk and hair mixed, the entire horse-hair and gut lines, the silk line with gut or horsehair at the lower end, and the hemp or flax eight-plait, and other lines. Plaited lines are generally to be preferred to twisted for sea-fishing, being less liable to break. Twisted hair-lines, however, are considerably the cheapest. In choosing hair-lines it is desirable to see that there are no flaws or discolorations; and of silkworm gut, the smoothest, roundest, and most transparent is the best. Should you desire to tie or knot horsehair or gut lines, or render them pliable, coil them up and let them soak in warm water, or rub them with a piece of india-rubber, which will likewise smooth them, should they have become chafed or fretted. Any man can manage two lines, holding one in each hand. Each line should be at least forty yards in length, and armed with two or more hooks, kept apart by a piece of strong wire, or a spreader may be used. Fig. 2 represents the hooks as kept apart by means of two pieces of whalebone, about a foot long, the snoodings on which the hooks are fastened round one end, while the other end of each piece of whalebone is fixed on a piece of lead about one pound in weight. It need not, however, be attached to this; but care must be taken that the whalebone forms two separate angles. Fig. 1 represents the snooding (to which the hooks are fastened and attached to the line) kept apart by means of a piece of strong wire or whalebone, or it may be made to differ only from Fig. 2, by having a third piece of whalebone passing from one to the other of the angles, keeping the pieces firmly fixed; this, however, our experience has proved not to be so effective in its action as the more simple form represented in Fig. 2. For bottom-fishing, a heavy leaden weight should be attached to the lower end of the line, not far from the hooks, for the purpose of sinking the bait nearly to the bottom, where fish principally feed. In this way the hand-line is used by fishermen while fishing with a long line, making use of the intervals unemployed by shooting, hauling, or re-baiting that line. To every line is attached from half a fathom to two fathoms' length of snooding, which may be of silk, hemp, or flax, dependent on the degree of fineness required and the species of fish to be caught. Snooding may be procured at any fishing-tackle maker's, and at most shops on the coast.

It is a very excellent plan before using a line to rub it well with a piece of canvas or flannel moistened with linseed oil, which not only preserves it and renders it pliable, but likewise aids in straightening it. A line may be well straightened by fastening one end to a quart bottle well corked, lowering it astern, when the vessel is under way, and fastening one end on board. In making longer lines for deep-sea fishing, it is only necessary to have stronger lines and no gut.

To make a Mackerel Line.—Purchase a hank of "mackerel or whiting line," and be particular in examining that it is free from blemishes. Fasten to the line, by a water-knot, two fathoms' length of silk, or very fine hemp, snooding, and by the same means attach to the snooding a yard or more of stout gut, to which the hook must be fastened. The hank should be kept wound on a reel, and will be always ready for use. To effect the sinking of the line, a leaden weight should be employed, and attached at the point where the line and snooding are joined. The weight of lead required, however, will depend on the current and state of the water, as also on the depth desired to be reached. This line is suitable for the catching of most kinds of fish, but the strength both of line and gut must be regulated by whether it be employed in top or bottom fishing. In order to catch several fish at a time, two or

more hooks may be attached to the gut, dependent on the strength of the line; a spreader, too, may be used for bottom fishing. We must now proceed to inform the reader how—

To make a Twisted Hair-line.—Dark-grey horsehair is generally used for this purpose. The tail of a colt is amply sufficient to make two lines, and may be purchased for two or three shillings. The hairs are sorted according to lengths, and tied into bundles. About a dozen form a good thickness for a strong line, which may be twisted together by means of being fastened by one end to a hook in the sheaf of a block; the sheaf being made to revolve by blows with the right hand, the other end being held in the left, until the hairs have become sufficiently twisted. The process is completed by the twisted set of hairs being spun the reverse way in the same manner, until firmly twisted. A number of these lengths are then joined together by means of a double water-knot, sufficient to make a line of the length required. These lines are strong enough for the capture of large fish; which the roughness, occasioned by the knots, is serviceable in raising—a smooth line being apt to slip through the fingers. Snooding and gut, as directed under "Mackerel Line," are suitable to be attached to this line.

Preservation of Lines.—This is a subject which must not escape your notice. It is a good plan to have lines barked (that is, steeped in a tan-pit); the cost for doing which is small, and may be executed in a day or two's time. The following, too, is an excellent mode of preserving lines:—Having coiled up the line, plunge it into a solution of diluted glue, and boil it for a quarter of an hour; then lay it on the grass or other clean place to dry, the weather being fine; taking care that the several thicknesses or component parts of the line stand apart, which may be effected by pressing the line, by parts, lengthwise.

When you have ascertained that the line is dry, it should be again coiled up, and plunged into a boiling solution of catechu, boiling it for half an hour or more. The line should then be taken out and well washed in cold water, hanging it up to dry; after which it will be fit for use, and proof against the corrupting effects of the sea-water, the quick destruction of lines and nets by which is well known. It should always be observed that lines be quite dry when put away, and kept in a dry place.

Snooding.—The length and quality of snooding to be attached to a line is determined by the nature of the line and kind of fish to be caught. Snoods vary from half a fathom to two fathoms in length (a fathom being six feet). It is manufactured either of silk, hemp, or flax, and should be selected according to the degree of fineness required.

For the purpose of long-line fishing, to a line or back of fifty fathoms in length, one hundred snoods are attached, with hooks already baited with mussels, whelks, pieces of herring, cuttle, or whiting, and may be made after the following manner:—Cut from the ball or hank of twine a portion, double the length required for each snood, and attach it by one end to a hook in the sheaf of a block, and keep the sheaf spinning round with the right hand; the left being engaged in holding the other end of the twine. When sufficiently twisted, fix it by the middle to the hook, again repeating the spinning of the sheaf, until the twine becomes closely twisted.

In this way the sea-fisher may contrive to make a very strong snooding on which to fasten the hook. It is well that snoods should be formed of separate threads, loosely fastened together near the hooks, to prevent their being bitten through by the teeth of the fish. Moreover, it is necessary, when used for large fish, to cover the end of the snooding with copper wire, as directed under the heading "Hooks."

COOKING.

SEA FISH (*continued*).

WE hope our readers will not be alarmed by a second article headed "Sea Fish;" we give it, without any afterthought, simply in consequence of the importance of fish, as supply of food, to a nation of islanders.

The Plaice.—Although, to our taste, no more, at the very best, than a second-rate fish, the plaice, nevertheless, claims attention from its frequent plentifulness and cheapness, and from its wholesomeness. There are persons, too, who place it somewhat higher than the rank which we accord to it. Its flesh, like that of the halibut, is very white, but watery and deficient in firmness. As food, therefore, it is hardly substantial enough for working men, though well-suited to persons who take only moderate exercise. The plaice is a summer fish. The Kentish fishermen say it is not at its best until it has tasted May water; but it is eatable during the greater part of the year. When a plaice is fresh, plump, clear-skinned, with the orange spots on the back brightly coloured, it may be safely handed over to the cook. Where there are the proper appliances, and a knowledge of the theory of frying laid down in our last article, the best way of dressing plaice is to fry it; but it is useless attempting to fry a plaice in a pan with a scanty spoonful of fat at the bottom, not deep enough to drown a shilling. Unless the fish can take a hot bath in fat, it is best to give up all thoughts of frying it. The *size* of the plaice need be no impediment; it can be cut up into squares, by division along the backbone, and then transversed. The pieces, dried and floured, as directed for soles, can then be fried in quite a moderate-sized, *deep* frying pan, containing plenty of hot fat. *Well* fried, served on a napkin, and garnished with parsley, fried or green, they will make a dish not less inviting, and more convenient to help, than if the plaice had been served entire. They may be dusted with a very little finely-powdered salt. Fish for frying should not be salted. In all other cases, as soon as you get your plaice, after emptying, scaling, and drying, rub it well on both sides with salt, and hang it in a current of air, to carry off as much of its watery particles as may be. Next to frying, we recommend broiling plaice; for which, if the fish is inconveniently large, it may be divided, as in the former case, and the pieces broiled by twos or threes. When a clear steady fire for broiling cannot be insured, a nice way is to bake your plaice in the manner styled by French cooks, *au gratin*. For this, the bigger the plaice, the better. If there is room, you may leave the head on, for show. After salting and drying your fish, rinse it, and let it drain.

Take an oval dish, that will hold your plaice and stand the oven. Smear the bottom well with butter; then scatter over it a layer of grated bread-crumbs and chopped parsley, with several small lumps of butter (if for abstinence days; if not, a little chopped beef or veal suet). On this lay the plaice, white side uppermost; sprinkle it with more crumbs and parsley, and lay on the top lumps of butter, or dripping, or veal or beef suet. Set it in the oven of your cooking-stove, which should be brisk enough to brown the bread-crumbs. As soon as any juice comes away, baste the fish with it, and continue to do so until it is done enough. Serve in the dish in which it was baked; and immediately before serving, sprinkle over the fish a dessert-spoonful of vinegar or lemon-juice.

Boiled plaice is apt to prove insipid, unless well dried and salted previously. It should be plunged into boiling salt and water, and allowed to boil from five to eight minutes.

Plaice or Flounder, with Norman Sauce (Alexandre Dumas, Sen.).—Butter the inside of a silver dish; lay your fish in it; season with pepper, salt, and a glass of white wine; set it into the oven. Cook thirty mussels, and

ten or twelve mushrooms. Put a lump of butter into a saucepan, with a little flour; stir till it begins to brown; dilute with some of the liquor from the mussels; thicken with three or four whites of egg and a wine-glass of cream. To this add the gravy that comes from the fish. Let this sauce simmer and reduce for a minute. Arrange the mussels and the mushrooms round the fish; pour the sauce over all, and serve.

John Dory.—The name of this fish is probably derived, not from any supposed relationship with Ann Chovy, but from the French *Jaune Doré*, yellow gilded, in consequence of the under-tints seen on its surface, especially when first taken out of the water. It is a Channel fish, ranging further south rather than in a northerly or westward direction; but railways now distribute it freely over districts where it was never seen fifty years ago. "Give a fish a good name, and sell it," is applicable to the John Dory. Its reputation rivals that of the turbot, to which it is only fit to serve as a lackey. Quite small dories, not bigger than your hand, when cleaned and divested of their enormous fleshless heads, are excellent fried; beyond that size, they are best boiled. The peculiar oiliness of their skin unfits them, by the odour it gives out, for broiling. The flesh of the dory is white and very firm; in fish weighing more than seven or eight pounds it is apt to be strong and coarse. Such fish are all the better for being salted at least a couple of days; and vinegar should be added to the water in which they are boiled. On occasions where quantity is indispensable, *two* dories, weighing from four to six pounds each, will give greater satisfaction, as to flavour and quality, than *one* weighing from ten to twelve pounds. Few fish take so long time to boil. A five-pound fish may safely boil galloping for half an hour. As to putting them into tepid or boiling salt and water, the cook must be guided by their size—and in some measure by the strength of the fire. With a slow fire, boiling water is safest, to insure the fish being done enough. The cook need not be frightened by seeing the tail split and the flesh open along the whole line of the back; on the contrary, it is apt to deceive her into the belief that the fish is cooked enough, when it is scarcely half-done. After draining over the fish kettle, serve the fish on a napkin, garnished with scraped horseradish and green parsley, and accompanied by any sauce sent up with turbot, only considerably more highly flavoured.

If any is left, let the cook, after removing every particle of skin, take the flesh from the bones, divide it into sightly pieces, and set it aside. Warmed up again, it is apt to be strong, and is, therefore, best eaten cold with oil and vinegar, as a salad, or in a mayonnaise. It makes, however, not a bad fish curry, in the way to be given for lobster curry. This is a substantial and satisfying fish, well worth the working man's purchasing *when* its price falls within the range of his purse. It might be supplied in much greater abundance by more extensive fishings in the Channel. In French fishing towns, it is often absolutely cheap. The dory was introduced to public favour by Quin, a famous actor and epicure of the last century, a contemporary of Garrick, and Hogarth, the painter. Whenever he carried a dory inland, he had a keg of *sea-water* slung behind his postchaise, to boil it in.

The Cod.—The hen has been called the cottager's save-all; the cod is man's save-all of the seas. Not only does he devour and thrive on multitudes of creatures which we disdain to eat—starfish, small crabs, and sundry mollusks—but he feasts on prey which is completely out of our reach. Cunning naturalists search cods' stomachs for specimens which they have collected in the depths of ocean. On buying a whole cod, it is always amusing to see what a medley its stomach contains. The squeamish are recommended not to be present, lest they witness the finding of dead animals tossed overboard, sailors' case-

knives, and silver watches, and have to account for their presence there, as well as rare Brittle-stars and Echinodermata. The cod is a notable instance of Commandant Maury's rule, that the warmer the water, the more inferior the quality of the fish which inhabit it—and that, not merely speaking of fish in general, but in the case of the very same species of fish. Along the North American coast the temperature of the water is several degrees below that of the ocean; and from Maine to Florida tables are supplied with most excellent fish. The "sheep's-head" of this cold current, so much esteemed in Virginia and the Carolinas, loses its flavour, and is held in no esteem, when taken on the warm coral banks of the Bahamas. The same is the case with other fish: taken in the cold water off that coast, they are delicious; when caught in the warm water on the other edge of the Gulf-stream, though but a few miles distant, their flesh is soft and unfit for table.

In Europe, the temperature of the Mediterranean is four or five degrees above the ocean temperature of the same latitude, and the fish there are generally indifferent. The cod, though ranging as far south as Spain, does not enter the Mediterranean, whose waters are too salt and too warm to suit it; but immense quantities of salt cod are consumed throughout the Mediterranean basin, which furnishes employment to the fishermen of the north. As to cod itself, those who have not tasted it would hardly credit the difference between fish taken in deep, cool waters—the middle of the German Ocean, for instance—and those which, in pursuit of herring or other fry, have sojourned for a time in tepid shallows. The London market is supplied with both; to have the real thing, you must trust to your fishmonger. It is easy enough to know a fresh, healthy cod—bright eye, pink gills, plump body, clear skin, white flesh, the stiffness of recent death; but the grey-brown hue of healthy cod varies so considerably, that it is not easy to discriminate, by outward signs, between a *good* deep-water and a *good* shallow-water fish—and the latter, being perfectly wholesome and palatable, can only be reproached with its "shallow" deficiencies, namely, want of firmness and delicacy. The proof of the cod is in the eating. Under that test, there is as much difference between a first-rate deep-water and an ordinary shallow-water cod, as there is between a good turbot and a good plaice.

Besides supplying millions with food, the cod keeps thousands of families *in work*. The shiploads of salt cod distributed throughout the world to countries where cod *are not*, are not caught and prepared without manual labour, which finds employment for countless honest hands. Not to mention the British, Norwegian, and Newfoundland fisheries, a little fleet annually leaves Dunkirk, to try their fortune in the expanse of seas which lie between Denmark, Norway, and Iceland. During the greater portion of their lives these hardy mariners scarcely see a summer. They start at the beginning of April, stretch as far north as they can, and only return when driven back by the snow-storms and icy blasts of autumn.

Our fishermen, especially while deep-sea fishing, occasionally perform the cruel operation of "crimping" cod; that is, of slashing its flesh, while still alive, with deep cuts reaching down to the bone from head to tail. The object is to render the flesh firmer by the muscular contraction caused by the wound. The prevention of this cruelty lies with the purchaser; by protesting against it and refusing to buy, his palate will lose nothing, because the infiction is either unnecessary or useless. A deep-water cod needs no crimping; he will do honour to his origin without it, while the most barbarous crimping in the world will not convert a shallow into a deep-water fish. On codfish to be served whole or in unusually large pieces, crimping, at the fishmonger's, may be practised with advantage. It allows the salting of the flesh a few

hours previous to cooking; and by affording the water access to the interior of the fish's substance, allows it to be plunged into boiling water, which gives another chance of improving the quality of a second-rate fish.

It is desirable that codfish, as soon as caught, or as soon as they come into the fishmonger's possession, should be emptied (reserving the liver and roe) and well rinsed out inside. A slight lesion, or decomposition of the entrails, will give a taint, of which it is not easy to get rid. The gills should also be removed. The fisherman cannot do this, nor the wholesale dealer; but immediately a purchaser has obtained possession of a fish, he will be wise to perform the operation. Servants unaccustomed to cleaning fish should be warned *not to remove the sound*; otherwise the cat will often enjoy the tit-bit on which the master and mistress had reckoned. The liver will be cooked or not, according to its quality, being sometimes pale, flabby, and unpresentable, although the fish itself is excellent. Skate liver is very good to eat with cod, or may accompany it in the shape of liver-sauce. A good deal of cod-liver oil is made of the livers of dog-fish and other squalidæ, and is none the worse for the substitution. The advice, to empty codfish as soon as may be, is equally applicable to the other large species of the genus *Gadus*, such as coalfish, haddock, ling, hake, extra-sized whiting, &c. Cod is in season from the close of summer till its spawning-time, in March or April, according to the locality. Codlings, *i.e.*, juvenile fish, the youths and maidens of the great cod family, are delicate and acceptable all the year round, that is, whenever you can catch them. Along the coast cod may still occasionally be bought whole, in spite of those provoking snatch-aways, the railways. For a small family, a twelve or fourteen-pound cod will make four nice cuts or joints—the head and shoulders, two middles, and the tail-end; divided into three, it will supply as many dishes for a party of six or eight. We take for granted that the cod has been thoroughly scaled outside, well washed within, the eyes removed, and the sound left in its place. The tail-end will be kept *fresh*, the other pieces rubbed with salt.

Cod Steaks.—Cut the tail end into pieces of equal thickness, say one inch; their length and breadth will vary with the part of the fish from which they are taken, but *that* makes no difference in the time they require to fry. Leave the skin on. Dry the pieces separately between the folds of a coarse cloth; roll them in flour, so that the whole of their surfaces are evenly covered with it. Then fry them, after reading over again what was written *apropos* of frying soles. Serve on a napkin, garnished with parsley, and accompanied by anchovy sauce. You may also convert the thicker parts of the fish into steaks, if required; only *they* make handsome dishes dressed in other ways, whereas the boiled tail-end is only suited for private discussion by the members of a household.

Baked Middle of Cod.—If there is any sound, take it out, boil it twenty minutes, cut it into small pieces, and mix it with a stuffing made as directed for pike stuffing. Fill the inside of the cod with this; bind the fish with string, leaving loops on the back to lift the fish with. Lay the cod into a baking dish with the back part upwards; pour over it enough water, in which a dust of flour has been mixed, to fill the dish one-third full. Throw in a dozen or more oysters and their juice, a pinch of scraped horseradish, and a little grated nutmeg. Lay lumps of butter over the back of the fish; set it in the oven, and baste *frequently* until done enough. When done, place the fish on a hot dish by the help of the string, which then remove; with a spoon garnish the fish with the oysters. Pour the gravy into a saucepan; stir in a teaspoonful of anchovy sauce and another of vinegar; mix; boil up; pour it over the fish, and serve.

HOUSEHOLD DECORATIVE ART.

ORNAMENTAL JARDINIÈRES.

VERY pretty jardinières may be made in imitation of Sèvres china and of Wedgwood. Each jardinière is cut out of cardboard, square, wide enough to hold the flower-pot and saucer, and an inch higher than the top of the pot. Cut the sides in four square pieces, of stout cardboard, narrower at the base by an inch than at the top. Join the four pieces by strips of thin linen, pasted inside, down the corners; when these are dry, line the card with good white paper. Let this also dry. Then take two pieces of turquoise-blue satin paper, the size of one of the sides.

At the top and bottom this paper is not quite to reach the edge, but only to meet the border of flowers. At the two sides, where the jardinière is joined, it is to wrap over. Draw an oval in the centre; be sure it is correct, and then cut it out. Paste each of these pieces evenly on the two opposite sides of the jardinière, wrapping the ends over the sides. Cut two more like them, but not wide enough at the sides to wrap over; let them rather be slightly within the edge. Remove an oval in the centre of each, and paste them on the two remaining sides. Let this dry well. Next, with purchased German embossed garlands, &c., ornament the edges of the ovals, disguising the meeting of the pink with the white. One or two tiny Cupids

them with white paper, line each with a bluish-grey dead paper. Cover the outside in the same manner. Then cut out an embossed design from lace paper—figures are the best—in the manner recommended for the chimney boards, see page 165, and attach with gum to the centre of one side of the jardinière. Gum the level parts of the figure only, and not the raised ones, and be sure not to flatten it in pressing it on. Place a similar ornament on each side. Edge the jardinière, not with gold, like the Sèvres, but

with strips of white paper. A good way to keep embossed paper medallions well raised, is to gum them on the reverse with a strong solution in all the hollow parts; let this dry completely. Then gum the flat parts only, and

attach it to the article to be ornamented—merely lightly place it on and gently press the edges, to avoid breaking the dry gum on the reverse. Fig. 2 illustrates the Wedgwood jardinière, and a similar figure to that upon it can

be procured from lace-paper makers'. Instead of blue-grey, the Wedgwood may have a pale stone-green ground, to imitate Palissy ware. These square jardinières can be placed upon tables or stands in the corners of rooms. Larger square jardinières, made to fit the tops of little occasional tables, are very effective. The pots can be ranged within. Cut the card deeper than the largest pot, and nearly as long as the table is square at the base; towards the top it becomes a little wider. Make it up in the same

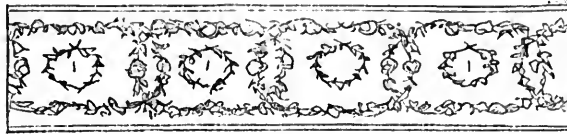

Fig. 3.

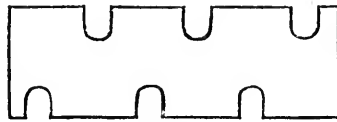

Fig. 5.

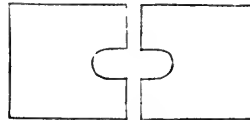

Fig. 4.



Fig. 2.

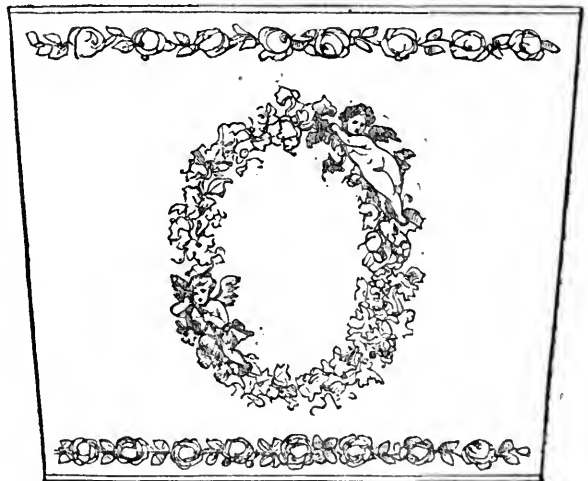

Fig. 1.

and butterflies, or little birds, may be introduced into these garlands. Then add to the borders wreaths of flowers, just covering the margin of the pink paper. The extreme edges are covered with gold paper, which is bought in the sheet, cut in narrow strips, gummed, and placed over the edges. The strips should be ruled on the back with a pencil before being cut, and each strip be folded in half down the centre, and opened again, before it is gummed. With blue paper the Sévigné Sèvres china is imitated; for the Du Barry substitute pink. Fig. 1 is an illustration of the jardinière. A jardinière in real Sèvres china, at the present time, is worth about £300.

The Wedgwood jardinières are made of cardboard, in a similar manner to those for the Sèvres. Instead of lining

way as the small ones; the Sèvres china, or the Wedgwood, or Palissy can be imitated. Fig. 3 presents a pretty design for a table jardinière, square, or for a long narrow window-box, to be used in a room or in a greenhouse.

When the pots and saucers also are arranged inside these jardinières, there is an unsightly space at the top. To conceal this, cut two pieces of card with a half-circle out of the centre of each, like Fig. 4. Place one of them on the top of the jardinière, inside, letting it rest on the pot, and the flower projecting out of the half-circle; place the other piece the other side of the flower in the same way; the two pieces of card thus overlap each other in the centre, and the sides of the half-circles meet. On the top of them spread enough moss, real or artificial, to

cover them. Before putting them over the flower-pots, stab them all over with large holes by the aid of a stiletto. For boxes containing rows of pots, cut the card like Fig. 5. If there is only one row of plants, only cut out the half-circles on one side, but, if there are more than one, on both sides. Measure the distances first, so as to make the excisions in the right places.

Jardinières from these designs may be made works of superior art, by drawing and colouring them by hand on white wood, which can be cut to order for the purpose, and should be thin. Water-colours—all the transparent ones rendered opaque by mixing them with permanent white and a little gum—or oil-colours, are both suitable. Oil-colours are the most permanent. Either must be varnished when completed. If glass, the shape and size of the wood can be procured, and placed over it, securing the edges to the wood, and the edges of the glass itself together at the corners; by bindings of gold paper, the effect is much enhanced. Such stands may be placed on brackets, or surmounting dwarf bookcases, or on greenhouse shelves. It is best to have a solid base of the wood, as well as sides, so as to make each jardinière like a box without a lid, especially if it is glazed. Then, when not charged with flower-pots, a heavy book, or some shot can be put inside it to prevent its being easily upset.

Such jardinières can also be made of poticomanic. It is necessary to have a glass shape first, procurable to order from a wholesale glass importer. Inside this place the devices, gumming them to the glass with a thin solution of isinglass, or very pure white gum. When quite dry and well fixed, paint on the wrong side of the glass the grounds of such medallions as are white. Let that dry. Then add the ground colour, painting still on the wrong side. If the ground is uniform, without white medallions, put it all on at once. When dry, repeat the ground colour, till it is perfectly even and smooth in appearance on the right side; each coat must dry before the next is added.

INMATES OF THE HOUSE.—LEGAL.

LANDLORD AND TENANT.

IN the present paper we shall discuss the following heads of this important subject, using as few legal phrases as possible, with the hope that a short exposition on this branch of the law may be of some benefit to our readers, who may be unwilling to seek professional assistance on matters of every-day occurrence: *Who may be Landlords and Tenants; Leases for Years; Leases from Year to Year; and Lodgings.*

All persons who are not under any legal disability may grant leases for such terms as are consistent with the nature and quantity of the estates which they have. A lease granted by the guardian (so appointed by will) of an infant is valid until the heir comes of age, when it may be repudiated or confirmed by him.

If an infant make a lease, he can repudiate it when he comes of age; but if by any act of his own—viz., by accepting any sum by way of rent or otherwise—he will be there-
after bound by it.

A married woman cannot grant a lease of any lands, except on those which have been settled on her alone.

Assignees may deal with the lands and property of a bankrupt in the same manner as he himself could have done, and may lease or sub-lease them at their pleasure.

A lease made in a lucid interval cannot afterwards be impeached by proof that the grantor of the lease had been insane before, or was insane after, it had been granted.

Anyone may become a tenant, subject to certain qualifications and exceptions.

An infant will be held liable for the rent of a house or lodgings suitable to his condition in life.

Leases for Years.—A lease is a contract by which the use and possession of a house and land are granted by the owner, who is called the *lessor*, to a second party (the hirer), who is called the *lessee*, for a certain time, at a certain rent, and subject to certain conditions and obligations.

No precise form of words is absolutely necessary for the construction of a lease, but as in the case of drawing bills, or making notes, it will be better that the usual well-known forms be adhered to. Our space will not allow us to print these forms *in extenso*, but in a future number, and when space is more at our command for a comprehensive treatise on this important subject, we may probably find room for them.

Leases for three years or less may be entered into by word of mouth, and do not absolutely need a written agreement; but although such parole agreement is perfectly valid, the desirability of it is by no means great, as it might be difficult to remember the precise words which passed at the time of making the contract, and so a number of legal difficulties would arise; it will be found expedient, therefore, that an agreement should be drawn up, specifying all the particular points of the contract.

All leases which are drawn for longer than three years must be by deed; but as the drawing of such documents entails considerable expense, it is often the practice to draw up simply an agreement for a future lease, and such a proceeding is the best and cheapest way of entering into the contract when the property is neither large nor of great value. It must be remembered that, in order to complete the lease, the premises must be entered and taken possession of, either by the lessee or by his agents or servants; for until he has done so, although all the stipulations contained in the agreement may have been carried out, the lessee cannot bring an action for trespass against any one who may enter or damage his house or grounds.

Another important precaution should always be taken. The intending tenant should always ascertain whether the proposed landlord is the freeholder of the premises, or simply the leaseholder. If he be the latter, the would-be tenant must be very careful in inspecting the lease, as he might find himself burdened by restrictions contained in the first lease which might unfit the premises for the objects which he had in view. Again, he must find out that all arrears of rates and taxes have been paid by the first lessee, for if they have not, he, as the under-lessee, becomes liable for them. It must be understood that an agreement for a lease must be in writing to compel the lessee to take possession. It is often difficult to determine whether an instrument of this nature is an actual lease or merely an agreement for one, but if words are used sufficient to show a present intention between the two parties, viz., that the one should cease to be in possession of the premises, and that the other should take possession of them for any specified time, then the document will amount to a lease. Great notice in such cases, however, is taken of the apparent intention of the parties at the time of entering into the contract, and so if it would create an inconvenience to construe an instrument as a lease, this fact is a strong argument that the parties only intended to draw up an agreement for a lease.

When it is not quite clear on the face of the document either when the term is to commence, or whether the term is to commence subject to the performance of some condition, or for how long the term is to continue, the instrument will not operate as an actual lease. The difference between the position of a tenant holding premises under an actual lease and an agreement, is this in the first case, the lessee is perfectly safe, and cannot be ejected from his premises during the period for which the lease runs; whilst in the second, supposing the lessor

were to sell or grant the lease to some third party, the latter would be able to eject the tenant who held the premises under the simple agreement. There is often a stipulation in an agreement that the tenant shall hold under the *usual covenants*. Now, these usual covenants are, principally, that the tenant will pay the rent and such taxes as the landlord is not compelled to pay by Act of Parliament; that he will keep the premises in repair and yield them up at the proper time; that he shall not be disturbed by the lessor, or any one claiming through the lessor, in the quiet enjoyment of the premises. Supposing the premises to be intended for a special purpose, such as a farm or a public-house, *customary covenants* are included.

The law implies that the lessee shall use the premises in a tenant-like manner; that is, do no actual or voluntary injury to them, but it does not imply that he shall keep them in repair. By the term *keep* in repair is implied putting them in repair, and then keeping them in repair. In the case of a farm the law implies that a tenant will occupy it and conduct the management of it in a husbandlike manner, according to the custom of the county in which it is situated; that he shall commit no waste, voluntary or permissive; and shall pay his rent. Voluntary waste is an act of commission, such as pulling down a wall; permissive waste is an act of omission, such as suffering a wall to fall down for want of necessary repair.

Tenancies from Year to Year.—If a house be let by word of mouth, or by writing, at a yearly rent, and for an indefinite time, a tenancy from year to year will be created, unless there be some proviso to the contrary. So, supposing an agreement of this nature to be made, and no further notice given by the landlord at the end of the first year, another year's tenancy is created. A period of six months is usually the requisite notice to quit, but of course an agreement may be made, which will allow three or even one month's notice. The landlord of an unfurnished house does not warrant it fit for habitation; so a tenant, after he has taken possession, cannot compel the landlord to repair it, unless there has been an agreement between them. The landlord, however, of a furnished house, will be held liable for breach of contract, if the furniture of his premises is unfit for use.

If a house, or a set of apartments in a house, are let for an indefinite time, at so much a quarter, month, or week, the hiring will be considered as quarterly, monthly, or weekly, as the case may be, in absence of any agreement to the contrary, and in such case a quarter's, month's, or week's notice to quit must be given before either the tenant can be turned out or go out of his own will. In the case of lodgings, it should be ascertained by the intending lodger that all arrears of rent and taxes have been paid by the landlord, as the lodger's goods or property are liable to be seized in distress. A landlord may break open his lodger's door and seize his goods for arrears of rent due from the lodger.

If a lodger's property is stolen on the premises through the negligence of the landlord in not taking proper precaution, or in allowing improper characters to assemble at late hours, or from any want of care in his selection of honest servants, the landlord will be held liable.

The keeper of a lodging-house cannot forcibly eject a lodger who insists on remaining in his rooms after the proper time has elapsed, or after a formal notice to quit has been given; but he may, in the absence of the lodger, shut up the door of his apartments, and so prevent the tenant from entering; he must take care, however, that all property left by the tenant be ready for delivery.

If a lodger desert his lodgings without paying his rent, the landlord, after giving the owner notice by advertisement, may sell any effects, and take the proceeds as discharge for the rent due.

WRITING INK.

THE chief substances used for black ink are Aleppo galls and sulphate of iron—three parts of the first to two of the other; the quantity of water and other ingredients added depending upon the price and the quality. Gum arabic is also invariably added. In addition to these, lump sugar, sugar candy, vinegar, sulphate of copper, corrosive sublimate, and creosote, are occasionally employed. Although the ink may be made by placing the crushed galls, sulphate of iron, and gum arabic into a jar, with a certain quantity of water, and, after allowing them to stand in a warm place for some months, straining off the ink for use, this method fails to extract all the active principles from the galls, and ink thus made soon turns mouldy.

Black ink, as a rule, may be regarded as water containing the gallate and tannate of iron, kept in suspension by the gum it may contain. The colour of the ink, when first used, depends upon whether the salts of iron are in the state of proto-tannate and proto-gallate, or in that of per-tannate and per-gallate. Ink newly prepared leaves a pale mark, in consequence of these salts being in a proto state, but darkens by attracting oxygen from the air, and being converted into a per-salt. The more gum is used, the more brilliant will be the gloss the writing will possess when the ink is dry; but if too much gum is added, the ink is not so suitable for fast writing. The gum serves the purpose of keeping the insoluble salts of iron, on which the colour of the ink depends, in suspension, and enables the writing to retain its colour longer, by preventing the decomposition of the ink.

Sugar is chiefly added when we wish to take copies. Creosote is used to prevent the formation of mildew; a minute quantity, three drops to a pint of ink, are sufficient. If too much is added, the paper does not take the ink so well.

The smell of the creosote is sometimes considered objectionable. Corrosive sublimate, in the quantity of one grain to a pint of ink, also answers, to preserve it from mildew, but is not suitable for ink used with steel pens, as it soon destroys them. Sulphate of copper preserves the ink, and increases its blackness. But it not only destroys steel pens very quickly, but when quill pens are used, it takes off the edge of the knife with which they are mended. Vinegar is now very rarely added to ink, as it rapidly corrodes steel pens. It should only be employed to make the ink more fluid when we use a quill pen, and wish to write fast on bad paper. Logwood and other vegetable astringents are sometimes used instead of the Aleppo galls; but they are only used in very cheap ink, which is sure to fade and turn brown—especially if used on inferior paper, where too much chlorine has been employed in bleaching the rags of which it is made.

In making ink, it is necessary to avoid using too much of the sulphate of iron, or the writing discolours. An excellent form for making black ink is given by Mr. Brande—viz., Aleppo galls, bruised, six ounces; crystals of sulphate of iron, four ounces; gum arabic, four ounces; water, six pints. It is best made by boiling, for some hours, the galls in the water, adding more water as it evaporates. Then strain it, when hot, into a pan through thin calico. Put the decoction into a clean vessel, and add the gum, and boil until it is dissolved. Then strain the hot liquid through calico into a stone bottle. To this add the sulphate, previously dissolved in water, and let the whole stand some months before use. It is necessary to add either the corrosive sublimate or the creosote at once, to prevent its turning mouldy. If the Aleppo galls appear to be of inferior quality, it is better to add a larger quantity. This is also advisable to be done when it is wished that the writing should not change colour for many years.

THE HOUSE.

WATER SUPPLY (*continued*).

IT may so happen that some of our readers, in the course of their travels about the world, either in the capacity of officers, missionaries, merchants, explorers, or seekers after information, may be placed in situations where it will be necessary for them to exercise their ingenuity, both in the discovery of sources from which water can be obtained, and in its purification after discovery; and to ignorance of the general principles of that which may be called water-finding, may be attributed the loss of a vast number of valuable lives. Shipwrecked on an uninhabited coast, destitute of rivers, the castaway is too apt to give way to wild despair; and, instead of taking measures calculated to prolong life, only shortens it by frantically and aimlessly wandering up and down on the margin of the salt tide, which only mocks instead of satisfying his craving thirst. Instead of doing this, let him search carefully along the bases of the cliffs, rocks, or banks bordering the sea, looking sharply out for such strips of verdure as may present an appearance of freshness and luxuriance beyond that presented by the surrounding herbage; under such spots will probably be found a continuation of some cleft, crack, or crevice, leading down from the high land behind, and in all probability water will be found by removing a few stones, and forming a cavity or basin for it to settle or collect in. Let him also search the rocks above high-water-mark for settlements of rain-water, which will not unfrequently be found in deep cavities between boulders, or in hollows under over-hanging ledges. Open stretches of sand are not unfrequently marked by a dark, moist, serpentine track, which remains after the sun has completely dried the general surface; on digging away the sand, and forming a well-hole or pit, fresh water will, in the majority of cases, be found to have been the cause of the moist streak. It is at all times well to bear in mind that by dipping heavy garments or blankets in the sea, and then putting them on wet as they are, a very large quantity of fresh water is absorbed through the pores of the skin into the system, which becomes much relieved by the supply of liquid thus afforded. When water is found in small quantities lodged between the hollows of stones, it can be conveniently collected for use by the aid of a piece of sponge, woollen cloth, a small bundle of rags, or

bunch of moss, fastened to the end of a stick. This, as moisture saturates the moss, can be pressed between the hands, and the water allowed to run into any convenient vessel. A passing rain-shower can be readily and easily made to yield an important supply, by stretching any large piece of cloth, such as a sail, sheet, blanket, or boat's awning by the four corners. For this purpose you place a stone in the centre, which causes a depression to be formed. The water which has fallen on the whole surface flows to this, and running through the substance of the fabric falls into a vessel placed below. The first runnings of such an arrangement as this, unless the material of which it is formed is quite free from contamination by perspiration, should be thrown away, as the water becomes poisoned by admixture with it. In dry regions removed from the sea, it will often happen that the channels of streams, which during the rainy season are filled with water, are found empty in the summer. In searching for water in these dried-up riverbeds, travel as far towards the source as practicable; then, after selecting some spot at which the greatest depression exists, lift out the stones, shingle, and gravel until a pit of fair depth is formed, and in many cases it will very soon fill with good water. It often happens that in districts where very little rain falls, the night-dews are very heavy and abundant; before sunrise in the morning every blade of grass and leaf will be found laden with crystal drops. These can be shaken or beaten off into a wide shallow vessel, and collected. A very considerable quantity of water can be obtained in this way. The pitcher-plant, which grows abundantly in some countries, often holds within its natural reservoirs an abundant store of fluid; but caution is required in partaking of water so stored up, as multitudes of insects, and even

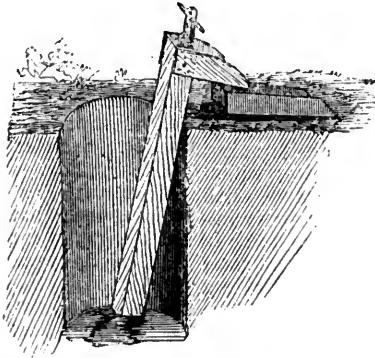

Fig. 3.



Fig. 7.

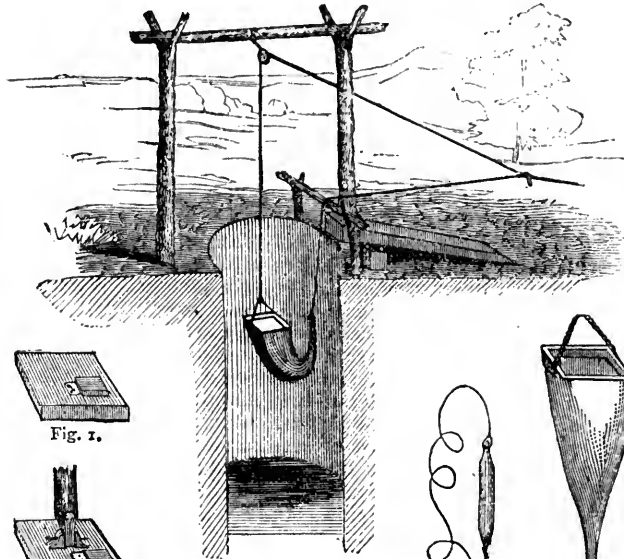

Fig. 5.



Fig. 1.

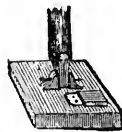

Fig. 2.



Fig. 6.



small animals and reptiles, are not unfrequently encased in these curious leaf-cups. At times, however, no such impurity exists, and then the water from Nature's own goblet can be freely made use of. The joints of large-growing bamboo-canes are often found to contain a noteworthy quantity of perfectly wholesome, clear, and cool water, which is discovered by the gurgling sound emitted on shaking the canes as they stand. When the store is found, a hole is made in the cane for the water to flow out through, into a hollow, cane-joint placed for its reception. The travellers' tree, of Madagascar, is another water-yielder of considerable importance, and might, we think, be cultivated with considerable advantage in very

arid countries. In growth it closely resembles the common plantain, and the water is obtained by puncturing the leaf-stalks at their attachment to the main stem of the plant. The thorn-covered porcupine-like plant, known as the "bachelor's pillow," will, on being denuded of its thorns and cut into slices, yield a considerable quantity of juice, which may be used as a substitute for water; and it is most remarkable that the sap of all the so-called drink-yielding trees and plants, amongst which may be placed the cocoa-nut palm, the water melon, the *Agave Americana*, &c., although surrounded by an atmosphere highly heated and extremely dry, pour forth juices delightfully cool and refreshing to the palate. In situations where water is scarce, and cattle, sheep, and horses are kept in any number, it is most wasteful and injudicious to allow them to crowd into the pond or pool which has been formed for the retention of their supply. A trench or groove should be dug near the margin of the pool, which should be surrounded with a fence made of poles or brushwood. The water-trench should have a sheet of canvas or waterproof sheeting pressed evenly down into it, so as to form a lining. The water intended for use may now be dipped by the lever arrangement described in our last paper into the trench, or it can be raised by the aid of a plank-pump, which is made as follows:—

Nail four planks together at their edges, so as to form a long square box or tube, about eight inches square; then fit a thick, strong piece of board to the orifice of the pipe thus formed. Nail a strip of soft leather or canvas round the edge of the board, so that it may fit the tube accurately. Then bore a hole about as large as a tea-cup through it, and hinge another bit of wood as a sort of cover to the hole, in such a manner that it will move freely up and down, as shown in Fig. 1. Now push one of these about six or eight inches up one end of the tube, seeing that it fits tightly, and fasten it by nailing, or rather screwing it through from the outside. Screws are best, in case it should be necessary to take it out to repair the valve. Then nail over the orifice three or four bars, about an inch square, so as to form a grating at the bottom of the tube. A long stout pole or bar of wood must now be secured to the centre of the board, as shown at Fig. 2 in the preceding page. An auger-hole bored through the other end of the pole serves to drive a wooden pin through to form a handle to work the board up and down with. When the arrangement has been put together, as shown at Fig. 3, it can be set at a slight inclination in the pool. A little water thrown down the tube makes the sucker-board draw. As the piston-pole with its cross-handle is forced up and down, the water will flow copiously out over the edge of the tube into a wooden conducting-trough, which carries it at once into the trench.

Such a pump as the above will, with a good supply, raise water enough for a large herd of cattle, say fifty, in about twenty minutes; it costs only a few shillings, and can be made by any one possessed of a moderate share of ingenuity and a few simple tools in a day. The settler in a new country will often be dependent for a supply of water on a well of his own sinking, which will not unfrequently be situated at some distance from his house; such a well or pond should be roofed over with tree-trunks, strong branches, and brushwood, in order to keep off stray animals, and prevent loss by evaporation. If the pit in which the water rests is not very deep, the plank-pump will be sufficiently powerful to raise it. If a deep sinking has been made, then the following description of drawing apparatus will be found simple to make, inexpensive, and efficient:—From iron (which is best for the purpose if it can be obtained) or from strong wood, make a frame, say from eighteen to twenty inches square. Then to this attach a long, funnel-shaped, tapering

bag, made of either stout canvas or leather. The narrow pointed end of the bag is left open like the sleeve of a coat, as shown at Fig. 4. Fasten a rope handle to the frame, which, if of iron, will be heavy enough to sink in water. If it is of wood, lash fast a weight to one side of the frame. A pair of forked upright poles are erected at the well sides, and a cross-bar adjusted across the top in the forks. A smooth wooden or bone ring is hung from the centre of the cross-bar, for the main draw-rope to work through: a pulley would, of course, be much better. At the front of the well a short pair of uprights and bar are fixed. Two ropes are used to lower and raise the bucket, viz., the main rope and flush rope. The main is slightly longer than the flush, and works, as before-stated, in the pulley or ring. The flush-rope is attached at one end to the point of the sleeve-like mouth of the bag, and at the other is connected with the main rope, care being taken that the relative lengths of the two are such that when the handle of the bucket is within a short distance of the head travelling ring, the tail of the sleeve must be in such a position as to hang directly out over the small front cross-bar. The apparatus is raised by being either walked away with by manual labour, or carried out by a bullock, donkey, or horse. After the bucket has been allowed to plunge and fill itself, it is drawn up as before described by raising the main-rope and mouth or large end of the bucket, until the two are level, as they will remain till the small end of the bucket reaches the rail, over which it will be drawn, inclining downwards, and so allow all the water in the bucket to run out into a lined trench made for its reception, the large end being still drawn up towards the pulley. Fig. 5 shows the arrangement in its complete form. No time is lost in raising water by this arrangement, as the instant the bucket has discharged its contents it is lowered again. In the conveyance of water from the place at which it is raised to the house of the consumer, every effort should be made to protect it from contamination.

In this country, earthenware, iron, or wooden tubes, are very easy of obtaining; but in countries where the bamboo grows, excellent water-pipes may be made from large canes, by first burning out the knots or internodes with a hot iron fastened to the end of a flexible wire, as shown at Fig. 6, and then jointing them one in the other, end to end. When united, a small wooden pin driven through both cases keeps them in place. Tubes of this kind can be carried very long distances, by supporting them on X-shaped supports, as shown at Fig. 7.

Water, whether pumped, dipped, or drawn, from make-shift wells is rarely clear or pure; it therefore requires, in many cases, treatment before use. In our next paper we shall treat on the purification of foul water, and the manufacture of make-shift filters.

SEASONABLE FOOD.

SEPTEMBER.

Meat.—Beef, veal, mutton, lamb, and venison.

Poultry and Game.—Fowls, pullets, chickens, geese, ducks, partridges, grouse, pigeons, hares, rabbits, turkey-poult.

Fish.—Cod, haddocks, flounders, plaice, mullet, salmon, soles, smelts, lobsters, oysters, prawns, carp, tench, pike, perch, herrings, brill, turbot, crabs, eels.

Fruit.—Apples, pears, plums, cherries, peaches, grapes, strawberries, melons, pines, walnuts, filberts, hazelnuts, quinces, medlars, currants, damsons, figs.

Vegetables.—Potatoes, cauliflowers, cabbages, turnips, peas, beans, artichokes, carrots, onions, mushrooms, lettuce, sorrel, celery, beet, scorzonera, salsify, leeks, thyme, sage, pennyroyal, marjoram, and all sorts of salads and sweet herbs.

COOKING.

SEA FISH (*continued*).—COOKED OYSTERS.—SEA URCHINS.—CRUSTACEANS.

Boiled Cod's Head and Shoulders.—We have already mentioned cods' heads as an economical dish; *this* may be presented on any occasion. After twenty-four hours' slight salting, if not done previously, crimp the shoulders of the fish, cutting down to the bone, all along the thick part only, on both sides, making the cuts at two or two-and-a-half inches' distance. This will cause the fish to cook equally throughout, as well as allow you to plunge it, resting on the fish bottom, into water at least scalding hot. If large, the thin parts may be kept in their place by passing string once or twice round the shoulders, to be removed on transferring the fish to the napkin-covered dish. The sound will remain in its place inside along the backbone. Remove all scum as fast as it rises. The time for allowing it to boil (from twenty to forty minutes) will depend on the size, quality, and age of the fish. A small, young head and shoulders will take less time than you are apt to fancy; perhaps will be cooked enough by a quarter of an hour's boiling; while an old, solid, substantial, firm-fleshed fish will take longer than you expect, sometimes three-quarters of an hour. As with John Dory, the thinner parts may show signs of parting (although they have no serious intention of doing so), while the mass of the fish is still underdone. Serve garnished with scraped horseradish and accompanied by

Oyster Sauce.—For each guest allow at least four oysters. In opening them, save all the liquor in a separate cup, to let it settle; remove the beards, and put them in a cup, which set on a warm part of the stove to extract the liquor. Put the oysters also into a cup by themselves. *Large* oysters may be halved or even quartered for sauce. Into a saucepan put as much half milk, half water, as you require sauce; throw in a *small* pinch of scraped horseradish and a dust of nutmeg. Add a good lump of butter, the liquor from the oysters and their beards, and dredge in as much flour as will make the sauce of quite moderate thickness. Keep stirring one way till all is smooth; then let the sauce just come to a boil; then throw in the oysters, and immediately set the saucepan aside to let them *warm* through, which they will do while you are dishing your fish. Oysters in sauce or ragôts should never *boil*; it makes them shrink and turn leathery. When your fish is dished, stir the sauce again, put it to the fire for a moment, and pour it into a sauce-boat previously heated. In default of oysters, essence of shrimp or anchovy sauce go well with cod.

In helping cod's head and shoulders, remember to distribute the sound, the cheek-pieces, the tongue and other tit-bits inside the head, of which the experienced carver is well aware. The middle cut of cod is boiled and served in the same way. If large, its equal cooking will be furthered by crimping on both sides in two or three places. Otherwise, the outside and the thin are apt to be overdone, while the middle of the thick is still pink and clings to the bone.

Cold Cod, next Day.—When the fish is removed from table, pick off all the flesh in handsome flakes; reject the skin, but divide the sound into small pieces, and secure the tongue and all other eatable parts of the head. If there is no sound left, take a dried sound; steep, and boil it twenty minutes; then cut it up into portions, and add it to the cold fish. Put the whole into a stewpan with any sauce that may be left, two or three bits of butter, a dozen or so of oysters and their liquor, or the same quantity of hustled mussels and some of *theirs*, if approved; or either may be replaced by an equal quantity of cockles. You may add pepper and salt to taste, and perhaps a teaspoonful of essence of anchovy or shrimps. When this is gently and equally heated through, pile it with a spoon in the

middle of a metal dish, or an earthenware one which will stand the fire. Let the liquor remaining in the stewpan boil an instant; then pour it over the fish in the dish. Strew grated bread-crumbs or rasped biscuit over the whole, and set into a brisk oven or under a red-hot salamander. When the surface is browned, the dish is ready to serve, and, if nicely managed, will be sure to find favour.

Salt Cod.—In many countries (Roman Catholic and tropical) salt cod is much more extensively used as an article of food than it is in Great Britain; in the north, too, though principally prepared for exportation, it forms a considerable item of popular consumption. With us, salt cod is usually accompanied by parsnips; probably because that wholesome root is at its best and sweetest during the course of Lent. The excess of salt must be extracted from the fish by a steeping in tepid fresh water proportioned to the time it has been in salt; for this season's salt fish, twenty-four hours will suffice; for over-year's, forty-eight hours will not be too much. In large towns, at certain epochs, as Ash Wednesday and Good Friday, salt fish may be bought ready steeped; but you will be surer of moderating the degree of saltiness by performing the operation yourself. So distinct do French cooks consider salt cod from fresh, that they employ different words, *morue*, to denote the former; *cabillaud* when they mean the latter. If you serve parsnips with your salt fish, cook them first in plenty of boiling water, until they are quite tender; then take them up. In this water, with cold added to it to make it tepid, very gently boil, or rather stew, your steeped salt fish for half an hour or forty minutes. While it is stewing, mash your parsnips, mixing with them pepper, butter, and a little milk; after which, keep them hot in a saucepan set on the side of your stove. When the salt fish is tender, serve it on a napkin, accompanied by the mashed parsnips and

Egg Sauce.—Boil one or two eggs quite hard. When cold (which you may hasten by throwing them into cold water), chop them quite fine, whites and yolks together. Taste the liquor in which your salt fish and parsnips have been boiled. If not too briny, take some of this, and, with the addition of a little water or milk, make good melted butter with flour and butter. When smooth, throw in your chopped-up eggs; give it one boil up, and transfer it to your sauce-boat.

Stock fish is prepared from other species of *Gadus* besides the common cod, as the ling and the hake. The Norwegians have a method of drying the former and rendering it semi-transparent, like light-tinted tortoise-shell, or gelatine, and of serving it in that state on grand occasions.

Cods' Soups and Tongues.—The dried sounds and the salted tongues (the latter from the North Sea fisheries) are convenient to have in store in country places; although, on account of the indispensable steeping, they are not articles which can be served in a hurry. Both, when sufficiently freshened and soaked, are eaten, alone, plain-boiled, with egg-sauce; but, from their glutinous nature, they make a better dish combined with codfish, either salt or fresh. Dr. Kitchener recommends cods'-sounds pie; this is good, but is much improved by the addition of at least an equal quantity (in all) of hard eggs, oysters, and fish-flesh, seasoned with pepper and mace, and enriched with good melted butter. Then, baked with a nice light crust, it is excellent, either hot or cold. Cods' tongues will furnish a dish, in an emergency, thus: steep, bail, and set them aside. When wanted, dip them in egg, cover with bread-crumbs, fry light brown, and serve with egg-sauce. So fried, they also make nice garnish for any sort of boiled fish.

The Haddock.—After the cod come two members of its family, the haddock and the whiting, both well-flavoured, wholesome, and nutritious, which dispute the

superiority between themselves. The one, however, does not supersede the other, their qualities being different. The haddock's merits are scarcely so fully admitted as they deserve. This may partly arise from the circumstance, that in some fishing-boats, when out for turbot and other grand fish, the haddock are the perquisites of the fishermen. Consequently, they may be had for moderate prices, when what is considered the cream of the catch is sent away to a better market. But a good thing is always good, and the wise man profits by what the ignoramus neglects. The haddock will keep, if opened and cleaned; and is the better (except for frying) for six or twelve hours' salting. Both it and the whiting are in season at the same time as cod, but with a more extended range, owing to their more speedy recovery from spawning. The haddock is the more northern fish of the two; witness its excellence and fineness in Scotland. It is also very good along the Irish coast. The flesh of the haddock, approached in that respect by the ling and the hake, is firmer and takes longer cooking than any other of the cod family. This must not be forgotten, especially when boiling is employed; a haddock will take nearly twice as long to boil as a codling or whiting of the same size. Boil your haddock with the tail thrust through the eye-holes or tied between the jaws; set it on the fire, if large, in tepid water. Serve accompanied by oyster, shrimp, anchovy, or lobster sauce, any or either, made *very good*.

Baked Haddock stuffed like pike, and treated in the way directed for baked cod (and well basted with plenty of good butter), is excellent. Small haddock cannot be fried at the same time with codling and whiting, because they take longer to do. If they are to appear together on the same dish as a fry, fry the haddock first separately, and then the whiting and the codlings.

Finnan Haddies are an esteemed preparation of haddocks split, slightly salted, and smoked. All they require is a few minutes' broiling or ovening. You may imitate the real thing at home, recalling, though not rivalling, the original, if you have a chimney, at the bottom of which wood only (and that not resinous) is burnt.

The Whiting, like the haddock, is occasionally cheap, though for a different reason. It will *not* keep, and consequently will not travel well. Its flesh, decidedly the most delicate of the whole cod family, is peculiarly welcome to invalids. The whiting extends its haunts more to the south than most of its other relations, and acquires there more considerable proportions. In the Channel, specimens are not unfrequently taken weighing several pounds; these, as well as all whittings for boiling, are the better for a few hours' salting. Small whiting are generally fried, and are delicious when the frying is *well* executed; but, however small, a well-boiled whiting is better than a badly-fried one. For frying, they are often *skinned*; for which we know no better reason than that they look pretty in that state *before they are cooked*. Their tails should be thrust through their eye-holes. For boiling, truss them in the same way; throw them into boiling salt-and-water, and let them remain there from four to eight minutes, according to size. Very large whiting, of five or six pounds, should be put into tepid water, and boiled at least a quarter of an hour. Serve with shrimp or anchovy sauce.

The Coal Fish, so called from its dingy, sooty-hued skin, not unfrequently appears in our markets during the cod season, at moderate prices, when it is well worth purchasing. Unpractised caterers condemn it for its dark complexion, which is only skin deep. The flesh of the coal fish is white, delicate, approaching that of the whiting, and, like it, is speedily cooked. It sometimes reaches respectable dimensions, and then may be boiled, whole or divided, and served with the same accompaniments as cod or haddock. Smaller coal fish, whose size

admits of it, may be fried to advantage. About the islands north of Scotland the coal fish is abundant, and affords a great resource to the inhabitants.

Ling and *Hake* are more summerly in their season than most of their brethren, which is convenient. Their forms are elongated, almost eel-like; their flesh, firm and good, though in no high estimation with English epicures, may be dressed in the ways indicated for haddock.

The Whiting Pout—bib, brassy, pout, bleus, or blinds, for, like the Spanish Don, it has plenty of names—is another wholesome fish, locally abundant, but despised because it is cheap and sometimes droll to look at. It has the singular power of inflating the membrane which covers the eyes and other parts about the head, which, when thus distended, have the appearance of bladders; whence, perhaps, its name of pout. Its resemblance to the whiting is worn "with a difference," being a much deeper and stouter fish. It is said to range northward as far as Greenland, is not common on the east coast of England, but is very abundant all along the Channel. Its flesh is firmer, drier, and less delicate than that of the whiting, and the bones are stouter. It is the better for twelve hours' salting, and still further improved by drying in a current of air. Broiled, or boiled, and eaten with a bit of butter, they furnish a dish which, if not absolutely luxurious, is often acceptable, and never ruinous. A slight smoking over a wood fire varies and improves their flavour as broils.

The Gurnards, red and grey, are solid-fleshed, summer and autumnal fish, which, although not first-rate, are good enough to induce the cook to do her best with them, and, when offered at low or even moderate prices, do not deserve to be left unnoticed. They are caught most abundantly, though far from exclusively, in the Channel. Their firm, white, substantial flesh separates well into flakes, but requires thorough cooking. They are deceptive as to the quantity of meat upon them, in consequence of the size of their enormous fleshless heads. For boiling, simply empty them and take out the gills, leaving the head and all the fins for show. They are best stuffed with pike stuffing, which will make them take a little longer to boil; but, in any case, the gurnards require quite as much boiling, size for size, as haddock or John Dory. Serve with shrimp or anchovy sauce, highly flavoured. By baking, a large gurnard is rendered anything but a vulgar dish. In this case, remove the fins, but leave the head and tail. Stuff it with pike stuffing, highly, but not over-charged with lemon-peel, sweet herbs, and spice. Sew up the belly with needle and thread. Put it in a baking dish with flour and water, a few oysters, mussels, or cockles, and some of their juice; cover the back of the fish with lumps of butter, and baste frequently while baking.

When done, transfer it to the dish; lay the shell-fish round it; heighten the gravy (thickening, if need be) with Reading, Worcestershire, or anchovy sauce, and half a glass of red wine; pass it through a strainer; heat it up again; pour it over the fish, and serve.

Get the fishmonger to prepare small gurnards for frying, by cutting off their heads, tails, and fins, running his knife along the bottom of the dorsal fin, so as to cut away the small bones which form its roots, and opening the belly to allow of its thorough cleansing, and leaving the skin on the other parts of the fish. Nicely fried, garnished with parsley, and accompanied by a well-supplied cruet-stand, they are very presentable either at breakfast or dinner.

There is little difference in the quality of red and grey gurnard—the former are the prettier to look at, especially boiled. The same of the sapphire gurnard, which occasionally finds its way to market. Its large pectoral fins, handsomely marked with blue and red, are sometimes made into chimney ornaments.

DIRECTIONS FOR DRESSING GLASS STANDS OR DISHES WITH FLOWERS.

THE ornamenting of the table has within the last few years received great attention, and been rendered not only more elegant, but less expensive. Formerly, massive designs in silver, branch candelabra, and silver-mounted épergnes gave due magnificence to the banquet. These, if costly, were heavy. The introduction of the Russian mode of spreading the table with flowers and fruit, and either only setting a few dishes on table, or handing them all, which is the true *mode à la Russe*, has

A glass table-ornament cannot be decorated with artificial in the same way as with natural flowers, as the stand cannot be moved without displacing the flowers.

The best way to dress a glass "Exhibition" flower-stand is as follows:—Get a sheet of brown millboard, not too thick, about fourpence in price; three dozen ivy leaves; a bundle of French dyed moss; a sheet of dark-brown tissue paper; a strong needle; and a reel of very coarse black or dark-green cotton or silk. Unscrew the stem of the glass flower-stand; lay on the cardboard, or millboard, the largest glass dish, and mark it round with a pencil to get the size. Cut out the round piece a quarter of an inch

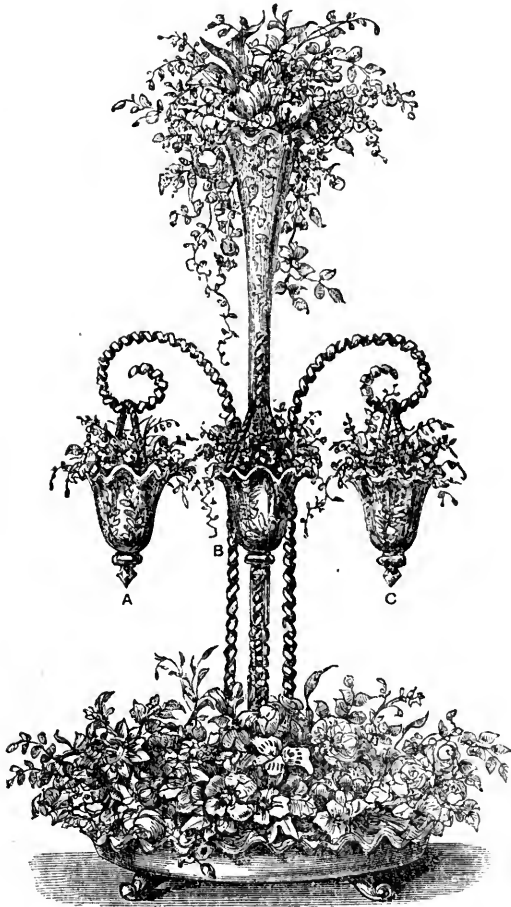

Fig. 6.—"ROSA FOUNTAIN," 18 INCHES HIGH.



Fig. 5.—"EXHIBITION," 18 AND 22 INCHES HIGH.

brought amongst us graceful ornaments of glass, pyramids of exquisitely chaste crystal—light, airy, sparkling, and fragrant with blossoms.

Glass stands are decorated with natural flowers by filling the dishes and cups with *damp* moss, firmly pressed down, then lightly covered with French dyed moss, nicely cleared of brown leaves, &c., and damped, and well pulled out. In the moss, flowers, ferns, and grass are fixed according to taste, and a wreath is twined, either from the upper or lower dish, round the glass stem. This wreath may be made of ivy, or any trailing plant.

The above sketches of glass dishes are made from the newest patterns, and the stands may be purchased of Messrs. Boucher, Guy, and Co., Glassmen to Her Majesty, 128, Leadenhall Street.

within the pencil mark, so that it will drop into the dish; cut a round piece out of the centre for the stem to pass through; then mark out, and cut in the same way, as many round pieces of card or millboard as there are glass dishes, and cut out, for the back of each, a round of the brown tissue paper, rather larger than the millboard.

Sew the ivy leaves round the edges of the circular pieces of millboard, thus (Fig. 1):—Make a large knot to the thread; place a leaf on the millboard, as at A, Fig. 1; put the needle in at the back, through the left-hand small division of the leaf at B; cross the thread over the leaf from B to C; put the needle downwards into the other small division of the leaf at C; then up again into the next leaf in the same way at D, until they are fixed all round the circle. Fix the leaves round all the pieces

of millboard in the same way, holding the board with the fingers below, while the thumb steadies the leaf.

Now open the bundle of moss; part it carefully, and remove, without disturbing it more than possible, the dry leaves, &c.; then place on the round millboard a small piece of moss, enough to cover about a finger's length, allowing the fullest and greenest part to rest half over the ivy leaves. Take the needle and thread; hold in the left hand the millboard, and put in the needle at the back so as to come out at the left side of the moss, as at A (Fig. 2). Hold the moss firmly with the thumb; draw the thread over the little bundle of moss, and put the needle in at top (B). Press the thumb firmly on the moss, having the fingers below: with the right hand lay another little bundle of moss close to the one fixed; put in the needle again at the back, and repeat until the millboard is covered with moss; then sew over the moss firmly above the last stitch; again above that, until the whole is well fixed up to the hole in the centre.

Cover, in the same manner, the other round pieces of millboard, and paste at the back the round piece of brown tissue paper.



Fig. 3.

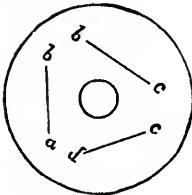

Fig. 4.

When they are all finished, lay on the table the flowers to be used—either the best paper or cambric flowers. The former are less expensive, and are more durable than cambric, as they will brush, if dusty; and the leaves will last a very long time, and will bear to be used to fresh flowers.

First select the roses; place three at equal distances on the moss-covered millboard, by running the stalks firmly under the moss and the thread that has fixed it; the first rose from a (Fig. 4) to b; the second rose from b to c; the third from c to d, as at Fig. 4. Then fill in the spaces with smaller flowers, ferns, grasses, &c.

The upper glass dish should be filled with smaller flowers than the large one below, made to droop over the edge; and the bell-shaped glass at top may have three roses and buds in sprays hanging down the side. Into the moss of the upper dish the stalk of the wreath should be inserted, and the leaves or flowers twined round the stem. Ivy, passion-flower leaves, rose leaves and buds, or any naturally trailing plants are effective.

When the flowers are all fixed in the moss, unscrew the glass stem, Fig. 5, and place in the lowest dish the flowers arranged for it; then screw in firmly the stem through the hole made in the cardboard. Unscrew the bell-shaped vase at top, and in the small glass dish place the flowers, with the wreath attached, twining it round the

stem. Then screw in the top vase, and place the roses or flowers prepared for it in the centre of the moss with which it is filled.

Flowers thus fixed on cardboard can be easily removed, and put away in a box.

The glass flower-stands, represented at Figs. 6 and 7, are not made to unscrew, as that drawn at Fig. 5. The three glass vases, A, B, C, Fig. 6, are to be filled with flowers as they hang.

We shall offer some further remarks on this subject in another paper, and give other varieties of glass flower and fruit-stands for the table, which would combine admirably with those that have been already described.

DOMESTIC MEDICINE.

DYSPEPSIA (concluded).

EXERCISE in the open air is indispensable. Those who can afford it should travel whenever convenient. The interest and the occupation of travelling are very curative of dyspepsia. Sir James Johnson used to say that no case of purely functional dyspepsia, that is, where there is no struc-



Fig. 7.—"FLORA," WITH FIGURE IN FROSTED GLASS, 18 AND 23 INCHES HIGH.

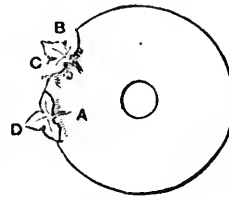

Fig. 1.

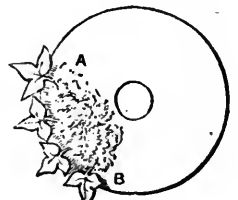

Fig. 2.

tural change in the stomach, could resist a pedestrian tour over the Alps. Few can enjoy such an expensive luxury as this; but the open air and the open country are free to all, and should be enjoyed by all. Those of sedentary and indoor habits should have an outdoor game or pursuit, which compels them to leave their close rooms and comfortable chairs daily. It is idle to think of having dyspepsia cured without attention to these points. Good digestion

and good appetite are the reward of those who work with their bodies; and all people that have bodies should use them and give them work to do, if they would have a healthy mind in a healthy body.

As regards medicines, what we have to say is of far less consequence than what we have said concerning habits, unless, indeed, it be one negative point, which we shall express thus—*abstain from taking opening medicines.* We do not go so far as to say they should never be taken; but we aver that to be constantly taking them is to ruin the stomach and bowels, and is bad for the system itself. People who are everlastingly taking medicine should be given something that is perfectly powerless to effect either good or harm. If they must always be taking something, let them take that which is most harmless. We have treated of the subject of constipation separately.

Are there no medicines, then, which cure dyspepsia? No medicines will cure it apart from proper care about one's

food and habits. It is not the duty of medicine to cure people who keep making themselves ill. Suppose a case: if a man keeps taking strong spirit, and irritating his stomach, and heating his system by it, is he to be cured by taking any kind of medicine? Certainly not. He is to be cured by not taking that which makes him ill.

But there are many medicines which greatly help to relieve the pains and discomfort incident to dyspepsia. We shall try to indicate in a few sentences the remedies which relieve the commonest dyspeptic sensations.

For *Water Brash*, or the rising of clear water into the mouth, accompanied generally by some pain at the stomach, medical men know well that there is no better medicine than bismuth. In some such form as two bismuth lozenges—up to five may be taken—two or three times a day: or the medicine may be taken in the following mixture:—

Subnitrate of bismuth	1 drachm.
Carbonate of magnesia	1 drachm.
Water	8 ounces.

An eighth part to be taken three times a day. Shake it well.

If there is any flatulence, substitute peppermint-water for water; and if there is much pain at the stomach, two or three minims of tincture of opium may be added to each dose of the mixture.

For *Weakness of the Stomach*, shown by want of appetite and slight feelings of weight, heaviness, and discomfort after eating, a light bitter should be taken, such as—

Infusion of camomile	1 ounce.
Peppermint-water	$\frac{1}{2}$ ounce.

To be taken three times a day.

The addition of two or three minims of tincture of nuxvomica will improve this mixture in many cases. If this does not seem to strengthen the stomach, the following mixture may be tried:—

Dilute nitro-muriatic acid	7 to 10 minims.
Tincture of cardamoms	$\frac{1}{2}$ drachm.
Tincture of gentian	$\frac{1}{2}$ drachm.
Simple syrup	$\frac{1}{2}$ drachm.
Water	1 $\frac{1}{2}$ ounces.

To be taken at eleven and four daily.

For *Acidity of the Stomach, and for Heartburn*, a few grains of magnesia, with or without a few grains of soda, occasionally, is a temporary and useful remedy. Rich pastry, rancid butter, and sour beer should be avoided. Claret, or weak sherry and water, or very weak brandy and water, or water, will generally agree better than beer.

For *Flatulence* one of the best medicines is a little vegetable charcoal in water, say a teaspoonful in water, when necessary. A little peppermint-water will give temporary relief. Windy kinds of food should be avoided—crude vegetables, fermented liquors, gassy beer, and such like.

The subject of biliousness, as well as costiveness, has been dealt with separately.

It will be understood, that what we have said is intended chiefly for those who are beyond the reach of good medical advice, and is meant to apply only to cases of simple dyspepsia. More or less indigestion occurs in all serious diseases; consequently the food has to be light and simple, and adapted to these. But dyspepsia proper is not so much a disease, as a mere disorder or a weakness of the stomach; and to this only our remarks apply.

EPILEPSY.

Epilepsy—from *επιλαμβάνω*, to attack unexpectedly, from the suddenness with which the attacks come on—is a disease which is not uncommon, and the appearance of which is only too familiar. It occurs *in fits*, which come

on either with some slight sensation that serves as a warning to the patient, or without any warning at all. The definition of epilepsy might be, “sudden loss of consciousness, with more or less convulsion, lasting for a short time, followed by heaviness or sleep.” There is another degree of epilepsy, called by the French the *petit mal*, called by ourselves epileptic vertigo or dizziness, in which there is a temporary loss of consciousness, and some peculiarity of gait or look, but no proper convulsion. The fully-developed fit of epilepsy is a very sad sight to witness. It is rare for patients to die in it, so that there is generally the comfort of knowing that it will not prove so fatal as it looks. We shall show before we have done that there is another bit of comfort for onlookers in the fact that the disease is not so uncontrollable as it was—in other words, that a remedy has been discovered which greatly controls, if it does not cure, the disease.

Symptoms.—When, then, a person suddenly falls down, with little or no warning, goes completely unconscious, breathes thickly, is *worked* or convulsed all over, foams at the mouth, gets very red or bluish-red in the face, he may be considered to have epilepsy. It differs from apoplexy in that the patient is violently convulsed, and in the fact that such attacks are apt to occur repeatedly in the same person, and to pass off quickly without leaving any bad effects. It very often happens that the patient bites his tongue in the course of an epileptic fit. The fit does not generally last longer than three minutes, and usually not so long, when it passes off gradually, the movements become less violent, the breathing becomes quieter, the *rigid* colour of the face is gradually restored, and the patient recovers consciousness. This may not happen, however, till after a sound sleep for more or less time. After a fit a patient often feels relieved. We have said that an epileptic attack is a very shocking thing to witness. The patient is either entirely unconscious, or would seem to have consciousness very different from that suggested by his contortions. At least so a very illustrious sufferer has reported. The late Dr. Alison, of Edinburgh, physician, philanthropist, and philosopher, in the latter part of his life was subject to epileptic attacks, and is said somewhat sharply to have corrected a friend who spoke in pitying terms of an epileptic. He described his sensations, in coming out of an attack, as like coming down from heaven to earth. There is every variety in the cases of epilepsy, as regards the severity of the fits and the frequency of their occurrence. At first they often appear only in the night, the patient not knowing of their occurrence, or waking only with a sense of head-ache and confusion, or with a sore, bitten tongue. In not a few cases an epileptic attack happens once, and does not recur. In some, especially in females, they happen with some regularity, and in others only at very long intervals, and with no regularity. The epileptic vertigo or dizziness is sudden and temporary. It may be so slight as scarcely to be noticed, or it may amount to a visible loss of speech and consciousness, accompanied by a pale, vacant face. The relation of such cases to epilepsy is shown by the occasional occurrence of *falling*, or *convulsions*, as occurs in ordinary epilepsy. In many cases of epilepsy, as we have indicated, prior to the attack a sensation of some kind is felt in some part of the body, called an *aura*. This sensation is very various in its nature, and not easily describable. Sometimes, when it occurs in a limb, it is said that if the thumb is pressed firmly over the nerve between it and the head, the fit is averted.

Causes.—Attacks similar to those of epilepsy occur in the course of certain diseases, such as diseases of the kidney, and of the brain; in the onset of some eruptive fevers, as small-pox, or scarlet fever; and in lying-in women. But we are speaking of epilepsy proper, and unconnected with other obvious diseases. It is certainly difficult to assign a cause for this wonderful disease. Doctors are still not

agreed as to the condition of the brain in epilepsy: some considering that it arises from a sudden pressure of blood on the brain; some from a contraction of the great blood-vessels suddenly cutting off the supply of blood. Nothing certain is yet made out. It is also difficult, as yet, to speak precisely concerning the *causes* of epilepsy. It is probable that there is a peculiar constitutional nervous element in the subjects of this disease. As to *age*, it occurs most frequently in patients from ten to twenty years of age; it is less frequent from two to ten years, and from twenty to thirty. Up to fourteen the sexes are pretty equally liable to this disease. After fourteen, the number of female cases predominates. *Intemperance* may give rise to it; sexual excesses and other bad habits are also probably not unfrequent causes; occasionally worms, especially tape-worms, seem to cause the attacks, for they have been known to cease on the worms being expelled.

Treatment.—It is satisfactory to know that the power of medicine over this disease is very much greater than it was a few years ago. It is very important to attend to the general health. If there is anything obviously wrong in this, it should be rectified; if the patient is weak, he should be strengthened. If worms exist, or are supposed to exist, the medicines which remove worms should be administered. Sometimes there will be some loss of flesh and great weakness accompanying attacks of epilepsy. In such cases, cod-liver oil is a most important part of the treatment. If there is intemperance, or any other sin in the habits of the patient, it is vain to expect a cure till this is remedied. The great improvement in the medical treatment of this disease consists in the discovery, made a few years ago by Sir Charles Locock, of the power that *bromide of potassium* has over the complaint. It is quite remarkable how it diminishes the frequency and severity of the attacks, and in many cases practically cures the disease. It requires, of course, to be taken for a long time, and often in large doses, and in connection with other medicines; and although not injurious, it ought only to be taken under medical observation and instruction. Consequently, we give no further directions for its use beyond mentioning that the dose for an adult varies from ten grains to twenty or thirty, three times a day, in water.

We will only say that epilepsy is not now the hopeless disease which it was in former times.

HERBS, THEIR DOMESTIC USES, PROPERTIES, AND CULTURE.

THE term "herbs," though formerly applied to all the "green herbs" provided "for the service of man," is now commonly restricted to those plants of home-growth which are used to give flavour to culinary preparations, or in domestic medicine. "Pot-herbs," and "sweet-herbs," are phrases of loose application, and it would be difficult to class the several kinds under them. The first is generally given to those used in cookery only, and many of those known as sweet-herbs are employed as pot-herbs. Apart from their value in improving flavour, aromatic herbs in cookery have a stimulating action on the system, and, in the quantities in which they are used, are beneficial; although many of them would be absolutely poisonous, if taken in large quantities. On the medicinal properties of the various plants, which are at the present day too much in danger of being lost sight of, we shall touch while treating of them in detail.

The cultivation of all the more valuable and better known herbs is extremely simple, and they may be grown by those who have gardens too small for the cultivation of vegetables. They are much better gathered fresh for use when required, than when partially faded, as will commonly be the case when purchased.

For winter use, whether home-grown or otherwise, they must be dried, and the proper time for gathering them for this purpose is when they are most in season, which is, as a rule, when the colour of the blossom first begins to appear. They should be gathered after sunshine, when they are perfectly free from moisture. Most people hang them in bunches, in a shady place, under cover, to be dried by the circulation of air alone; but a quicker method preserves the flavour and aroma more fully. They are better divided into small bunches, and cured in a Dutch oven before an ordinary fire; care must, of course, be taken not to burn them—this will not happen so long as they do not change colour. When dried, they should not, as is the general practice, be hung up in the bunches, or enclosed in paper bags, since either of these methods involves some loss of their properties; but the leaves should be picked off, reduced to powder, and passed through a hair-sieve. They should then be put in glass-stoppered bottles, and labelled; when stored in this manner, they are ready for immediate use, and will keep uninjured for a great length of time.

To save trouble when required, an excellent herb powder may be prepared by mixing the following—the leaves being dried and powdered, as directed above: parsley, winter-savory, sweet-marjoram, and lemon-thyme, of each two ounces; lemon-peel, cut very thinly and dried, and sweet-basil, one ounce each. Dry in a warm, but not hot oven, till they can be finely pounded in a mortar, and rub the powder through a hair-sieve. This, when put in a glass bottle as above, will retain its fragrance for many months, and form a delicious and cheap flavouring.

Thyme.—Of this two species grow wild in England, mostly on high and stony land. They are said to give a fine flavour to the flesh of the animals which feed on them; but these plants are inferior in fragrance to the cultivated varieties, which are natives of Southern Europe. Common or garden thyme is a shrubby evergreen, of about a foot high; the leaves and young shoots are much used for stuffings, and also for soups and sauces. Lemon-thyme has a strong perfume, like the rind of lemon. Thyme grows best on a dry and rather poor soil; it may be propagated from seed sown in early spring, but offsets or layers are the more usual methods. As borders, it may be grown to advantage: the variegated kind is exceedingly pretty.

Sage is a native of the south of Europe, but has long been naturalised in our gardens; its use in cookery is chiefly in stuffings, for correcting the too great lusciousness of certain kinds of meat, such as goose and duck; for this, the common red sage, and the green variety, are most employed. The other kinds—the small-leaved, and the broad-leaved balsamic sage—are more esteemed for medicinal purposes. As a medicinal herb, sage has lost much of its reputation in our own time, and that unjustly, for it possesses considerable aromatic and astringent properties; and sage tea is undoubtedly useful for debility of the stomach, and in nervous cases. For sore throats it makes a grateful and cooling gargle. The Chinese are said to prefer tea made from sage to that of their own country. The expressed juice of the leaves is still used in some parts of the country for making sage-cheese. This plant requires little or no care; it thrives best in a shady border, and may be propagated by slips merely dibbled into the ground in spring and autumn.

Marjoram is of several kinds. We have a wild native marjoram, which grows chiefly among copse wood, on chalk soils, and which has a somewhat similar but inferior flavour to the cultivated varieties, and may be employed in their stead when they are not at hand. Marjoram is used for soups, stuffings, &c., the sweet and winter-marjorams, which are natives of the south of Europe, being preferred. These plants grow readily on a light, dry soil, but require frequent change of situation. Winter-

marjoram is propagated by layers, but sweet-marjoram must be sown in April; the seeds rarely ripen in this country, and are imported from France. For seasonings, the leaves are best when dried. Marjoram is heating in its nature.

Savory, being highly acrid, is not much used in cookery, and is preferable when dried. There are two sorts, summer and winter savory, both of which are natives of Italy. Winter savory is used as a vermifuge.

Mint.—Several plants of the mint species grow wild in England. Spearmint, or garden-mint, is the kind most cultivated for cookery. Its use for boiling (to be afterwards withdrawn), with peas and some other dishes, is well known. Pea-soup should never be made without it, not only on account of the improved flavour given, but also because it corrects the flatulency to which that dish is apt to give rise; it is also used in spring salads. Few plants bear drying better without loss of properties. Medicinally it is stomachic and antispasmodic. The peculiar flavour and properties of peppermint are chiefly owing to the camphor which it contains, and of which one-fourth of its essential oil is composed. It is not used in cookery; we

pale or yellow, it indicates that a change of soil is required. They are propagated by dividing the roots in spring.

Parsley has been so long cultivated among us, that the time of its introduction is unknown. It is from Southern Europe, and was well known to the ancient Greeks, who awarded crowns of this plant to winners of their public games. The common, plain-leaved variety is now almost superseded by the curly, which equals it in flavour, and is far superior in beauty for garnishing purposes; and is, moreover, less liable to be confounded with fool's-parsley, a kind of hemlock and a poison; from this plant being used in mistake, some accidents have arisen. Parsley is a diuretic, and is useful to cleanse and purify the teeth and breath from strong smells. It should be remembered that to parrots it is poison. Naples, or celery-parsley, is a variety between parsley and celery, and is used as the latter. Hamburg-parsley is cultivated for its roots, which grow as large as small parsnips, and are wholesome, palatable, and tender when boiled; they are either eaten with meat or in soups. Parsley should be sown in drills on any spare border in March. A good supply of parsley may be en-



MARIGOLD.

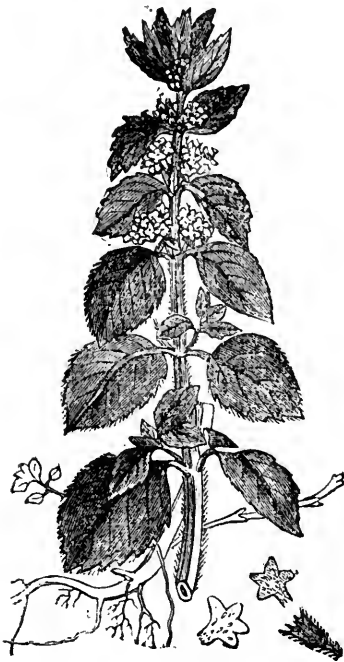

MINT.



LAUREL OR BAY.

have tasted it, substituted for spear-mint, with lamb, in mint-sauce, by an ignorant cook, and can by no means advise our readers to repeat the experiment. Pennyroyal is still used to flavour certain dishes, as hogs' puddings, but not so much as formerly. All plants of this family delight in low, moist situations. When the leaves become

sured through the winter by sheltering the rows with some light covering, as brushwood; or it may be dried. It may be remarked, that of celery (a member of this family), the outer stalks, which are usually thrown away, because acrid when green, lose that taste when dried, and become, for soups, equal in flavour with the centre.

Basil.—Sweet or large, and bush or least basil, are the two chief varieties of this herb. They are natives of the East Indies, and are said to be much used by the Chinese. They are more employed in French than in English cookery, and have a highly aromatic odour, resembling that of cloves.

Clary is a native of Italy; it is used in soups, and has a powerful odour, highly disagreeable to some persons. A medicinal wine is made from the flowers.

Tansy grows wild in England, chiefly on river banks where the soil is sandy; its leaves have a powerful aromatic bitter. There are three varieties: the plain, the curled leaved, and the variegated. The juice of the leaves, and sometimes the leaves themselves, chopped and bruised, are used to flavour puddings; its use in cookery is very ancient. It has value as a vermifuge, and is good in colic and gout.

Fennel is an English plant, and grows wild on chalky soils; it is particularly abundant in the neighbourhood of Faversham; but it has long been cultivated in gardens. It is used in fish-sauces, soups, and salads. From the elegance of the leaves it is much in favour for garnishing. In Italy, where it grows to a large size, it is cultivated in the same manner as celery among ourselves; thus treated and blanched,

Dill, which is a native of Spain, resembles fennel, but is smaller. It is used in pickles, more particularly with cucumber, and sometimes in soups and sauces; but its medicinal properties form its chief value—it relieves flatulency and indigestion.

Tarragon is said to come from Siberia; it has a powerful smell and aromatic taste, and is employed in France to correct the coldness of salad herbs. It is used in pickles and soups; and when infused in vinegar, makes a good fish-sauce.

Chervil, which is sometimes seen in our gardens, grows wild in various parts of the Continent; the curled is used for garnishing; a beautifully-frizzled variety is cultivated in the gardens of Paris. The tender leaves are employed in salads; the roots are poisonous.

Marigold.—This plant is a native of France and Spain; but has been cultivated in this country since 1573; it is now chiefly found in cottage-gardens. The flowers were formerly much employed in broths and soups; medicinally, they strengthen the circulation, promote perspiration, and are good in liver complaints. Both in cookery and medicine they are now almost disused, which is to be regretted, as the herb is a valuable one. In sage-cheese the layers of curds are often coloured alternately



CHERVIL.



HYSSOP.



RUE.

it loses its strong taste, and is eaten with oil, pepper, and vinegar. Medicinally, the leaves are considered diuretic, and the root aperient.

green (with sage) and yellow—the latter is derived from the juice of these flowers. Marigolds are grown from seed, and will flourish anywhere.

Rue, also called *Herb of Grace*, is a native of the south of Europe, but has been grown in this country time out of mind ; its medicinal virtues were formerly much in repute ; it is a stimulant and antispasmodic, excites the circulation, and increases the secretions. The leaves are taken either powdered or in infusion. This plant is a hardy evergreen shrub, and will grow in any situation ; it has a strong, ungrateful odour and hot, bitter taste.

Hyssop is also chiefly medicinal, though the leaves and young shoots are sometimes used as pot-herbs ; it comes from the south of Europe and the East. For medicinal purposes the leaves and flowering tops are dried ; they are a gently stimulant aromatic, and the infusion is good in chronic catarrhs and disorders of the chest and lungs, also applied externally to restore the natural colour in bruises and black eyes. The hyssop of Scripture is not this herb, but the caper plant.

Rosemary is a hardy under-shrub, which grows wild among rocks along the shores of the Mediterranean. As a medicine it is tonic and cordial, stimulates the circulation and nervous system, and is good in headaches. It is taken as an infusion, or sometimes in the form of snuff. Powdered, the leaves are used to flavour confectionery, and the dried sprigs are, from their fragrance, good to lay among linen. Formerly it was thought to strengthen the memory, and thence became the emblem of remembrance and fidelity, and was worn at weddings and funerals. It will grow anywhere, but is most fragrant on dry soils ; it may be propagated by side-slips merely dibbled into the ground in spring and September.

Lavender comes to us from the same localities as rosemary, which it resembles in habits and method of culture, as also in medicinal properties. Lavender is a corruption of the Latin name "lavandula," which it received because used by the ancients to scent baths and the water in which they washed. It has been cultivated in England since 1568. The dried flowers are much used to place among linen.

Balm is a native of the south of France : it has a faint, aromatic taste, and a pleasant smell somewhat resembling lemon. An infusion of the leaves makes a grateful and useful drink in fevers ; it should be dried for use.

Camomile grows wild in England, the double variety is that most cultivated. The flowers have a powerful aromatic bitter, and are a fine tonic. They are dried and usually taken as tea ; they are also used in brewing, in the same manner as hops. Camomile flourishes in most soils, and is propagated by dividing the roots in spring.

Carraway is an English plant ; the leaves and roots were formerly employed as pot-herbs ; the seeds only are now used, and chiefly in cakes and confectionery. This plant has stimulating properties, and will grow in any soil ; the method of propagation is by seed.

Laurel or *Bay Leaves* are employed to flavour custards, hasty-puddings, &c. They should be used sparingly, as their flavour is owing to the presence of prussic acid, a deadly poison. The laurel of antiquity and the poets is not the common laurel, but the sweet bay, of which we give an illustration. This in the south of Europe attains to the size of a tree. The leaves of both plants are used in cookery, but those of the latter are preferred ; medicinally they are narcotic.

Cosmary or *Alecost* is a native of Italy, and was formerly much used to put in negus or ale, hence its second name. It was introduced in 1568 ; a dry soil suits it best ; it is propagated by slips, and when once planted will last for years.

Herbs, as a rule, occupy but little space, and require less care. All who have gardens should grow them, and know their properties. The English climate is especially suited to the growth of aromatic plants, which are said to be more fragrant here than in the south of Europe.

BLACKING.—I.

A GOOD blacking for household use may be made by mixing up into a paste three ounces of ivory-black, two ounces of treacle, and half an ounce of sweet oil. On this, half an ounce of sulphuric acid (oil of vitriol) is to be poured. Afterwards, three-quarters of a pint of water, in which one-quarter of a pint of vinegar has been previously mixed, is to be gradually and thoroughly incorporated with it.

Another form for blacking consists of four ounces of ivory-black, half an ounce of Prussian blue, one ounce of sweet oil, two ounces of treacle, one ounce of sulphate of iron (green copperas), and a quart of vinegar. The brilliancy of this blacking will be much improved by adding half an ounce of strong sulphuric acid (oil of vitriol). The use of this substance is, however, attended with the drawback that it destroys the leather, and rots the stitches of the articles on which it is employed. In cases in which expense is an object, the olive oil may be replaced by oil of an inferior description, such as fish oil. All these kinds of blacking, however, require friction with a brush to give a polish to the surface on which they are applied.

Liquid composition blacking is, however, sold that does not require any rubbing. The leather is merely to be cleaned from dirt, and then this liquid is to be applied over it. When dry, it will be found to shine with a bright, glossy surface. Composition of this kind may be made by adding a strong solution of gum arabic to any ordinary blacking.

A superior blacking of this kind, for using on harness, is thus composed :—Four ounces of the best glue, or gelatine, and three ounces of gum arabic, are to be dissolved in three-quarters of a pint of water by heat. The liquid is then to be strained through coarse muslin, and placed in a pan over the fire, and six ounces of treacle added to it. Six ounces of very finely-powdered lampblack are then to be gradually sprinkled in, and the mixture evaporated until it acquires a proper consistence, the composition being kept continually stirred during all the time it is over the fire. When this blacking is perfectly cold, it is to be put into wide-mouthed bottles, and preserved from the action of the air.

All the above-mentioned compositions have the disadvantage of losing their polish on exposure to wet. Other preparations, however, are not only free from this defect, but, by rendering the leather and stitches waterproof, tend to preserve them from the influence of the weather. One of these compositions is formed by melting together two ounces of mutton fat and one ounce of bees'-wax. With this, whilst fluid, two ounces of soft soap should be mixed. Then two and a half ounces of lamp or ivory-black, half an ounce of indigo, and six ounces of sugar-candy are to be finely powdered and rubbed together in a mortar. These powders are then to be gradually added, and thoroughly mixed in with the others. At the last, half-a-pint of oil of turpentine should be poured in, and the several ingredients well stirred into a uniform mass.

A cheaper—though perhaps inferior—blackening, of the same nature, is prepared from :—Bees'-wax, one pound ; soft soap, six ounces ; ivory-black, four ounces ; Prussian blue, one ounce ; linseed oil, two ounces ; oil of turpentine, half-a-pint. In making this preparation, the wax is first melted and mixed with the soap ; then the colours, after being finely powdered, are ground on a slab with the linseed oil, and added to them. When this is done, the whole is thoroughly mixed up with the turpentine. In using the two last kinds of blackening, only a small quantity should be employed. It should be carefully spread over the surface of the leather, and then polished with a soft brush or rubber.

THE REARING AND MANAGEMENT OF CHILDREN.

CLOTHING FOR GIRLS EIGHT TO TEN YEARS OF AGE.

Dresses.—Fig. 1, p. 272, is a pretty design for a frock for a little girl from eight to ten years of age; it is made with a "princess" tunic. At the present moment it is the fashion to wear dresses composed of two or three shades of the same colour. We will suppose Fig. 1 to be a spring or summer frock, made of two shades of green llama—an inexpensive but ladylike material, light, and very suitable for children. This material used to be known by the name of *mousseline-de-laine*. It costs about one and sixpence per yard. The skirt and body are of very light, rich green, known to artists as emerald green. Make the skirt in the way already described in the account of clothing for a girl of eight years, making it long enough for the child, and wide in proportion. The width of a child's skirt does not increase equally with its length. A hem six or seven inches deep is made on the right side. This cannot be done with part of the skirt turned up; it must be a false hem, each piece cut to follow the slope of the gore of each breadth, in the way indicated by a dotted line in breadth B in Fig. 3, which illustrates the tunic. Join the breadths of the hem; run it on the wrong side to the bottom of the skirt; turn it over; turn in an inch at the top and tack it down; then run on a white *passementerie* trimming half an inch from the upper edge. To make a hem six inches wide, the false piece must be cut eight inches deep. For the body make a plain Garibaldi. Directions for forming this article of clothing for a girl have already been given. Trim it down the front each side of a fold in which the buttons are inserted, and lay a row of trimming on the neck-band. Make coat sleeves, with false cuffs, after the manner of the false hem; sew these on also with white *passementerie*, and place a row round each arm-hole. Next cut the tunic out of a rich deep green (the colour artists use under the name of Hooker's green, No. 2). Figs. 2, 3, and 4 illustrate the way this tunic is cut; A is the front breadth; B the one next it; the back breadth may be plain, and C the one next it. If the skirt is not full enough with these breadths and the two breadths on the other side corresponding with B and C, but of course reversed, let in one or more gores each side, cut to points without any body between B and C. The straight sides of all the gored breadths are to the front. Join A and B together, the whole length of the body and sides. Join C to B the same way. Cut the back breadth each side like B, Fig. 3, in the body; but instead of goring the skirt part, leave the material cut straight off each side of the waist, and pleat or gather it.

When the breadths are all joined, proceed to mitre the skirt, taking care a mitre comes in the centre of the front breadth, and mitres end exactly at each side of the front breadth, as shown in Fig. 1. The easiest way is to have a stiff card well cut out in very deep, exact mitres; place it on the material and draw the outline with a white chalk pencil, as far as possible at a time. Cut out the mitres, as shown in D, Fig. 4. Then draw straight lines up from them, favouring the slope of the skirt, as shown in A. When these are exact, cut them. Bind them all round the edge with a very narrow, but stout saracen ribbon, with a satin edge of the same colour as the tunic, or with braid. They will never sit well bound with a common ribbon. One side of the front is left open all down, bound with ribbon, and buttoned over with white buttons. In every mitre there are three buttons. The ordinary china buttons are used for this purpose, which may be bought for twopence-halfpenny the gross.

A loose out-door paletot, the shape and dimensions of which will shortly be given, should be made of the light

green llama. Cut a lining of white cambric muslin. Run the seams of the llama and the seams of the lining separately. Put the right sides together and tack them. With a blue chalk pencil mark the scallops on the lining at the lower edge, and lines up, as in the skirt. Run these all round a little way in, and then cut them as the tunic was cut. Undo the tacking and turn the jacket, pulling out all the points. Tack it together again on the right side, and bind the mitred tongues as the skirt was bound, carrying the ribbon up the fronts. Sew on white buttons as a trimming, and to fasten the jacket. Round the neck and sleeves put a row of white *passementerie*. The paletot is otherwise finished in the usual way. The hat worn with this should be rice-straw, trimmed with green, of the darkest shade. For warm summer days, make the skirt and Garibaldi of plain jacquet muslin, with a row or two of green ribbon over the hem, and wear the green tunic over it. Blue is even prettier than green with white. The walking paletot may be made of white muslin, trimmed with a row or two of coloured ribbon straight round.

Fig. 5 is pretty, in velvet, velveteen, plain silk, llama, cashmere, or muslin. It is a plain skirt and a plain square body, with puffed sleeves. In all but muslin, it is simply trimmed above the hem of the skirt, round the neck, the waist, and the sleeve bands, with real or imitation Cluny insertion, an inch or an inch and a half wide; in white muslin, Valenciennes insertion, or muslin embroidery, is first mounted on coloured muslin. The inch-wide striped muslin is useful for this. Cut it apart in lengths in the centre of the white stripes; turn in the white and use it as a ribbon. This is well run to the dress, and the insertion very neatly run down at both edges over it. If proper care is taken by the laundress, it will wash entire. The sash is short, and should be worn behind. It may be made of muslin edged with trimming, or of coloured ribbon. A ribbon bow on each shoulder is a pleasing addition to a young child's toilette.

Another design for a child's dress is intended to be made in white alpaca. The vandyked piece is of blue washing silk (foulard), piped along the vandykes and top with blue satin. It is lined with soft Victoria. A blue satin piping is placed just below the hem of the dress. The cuffs are trimmed like the skirt, but not so deep. A narrow row of points of blue enclose the throat. The sash is made of the foulard, piped with satin, and lined: There are four bows, a buckle, and two pointed ends. The band is lined with buckram, to stiffen it sufficiently. The out-door jacket is made to fit. This is also trimmed round with the blue vandyke, and up the front the vandyke turned outwards; a vandyked blue collar is added. There are no sleeves, but the arm-holes are piped and trimmed with narrow blue vandykes. The sash is worn over the jacket. This design, made in buff alpaca, trimmed with brown or violet, is very pretty.

Fig. 6 is another design. The tunic is separate from the corset, and joined at the waist. The under-body is white muslin, drawn round the throat, with small bishop sleeves. The petticoat is of light silk, small-pleated all one way. It is false, and joined to the skirt above the scallops, which are bound with satin. Or the petticoat may be of white muslin, handsomely embroidered. Another way of making this dress is with a llama or cashmere plaid false skirt, and a llama or cashmere body in place of a muslin one.

Fig. 7 is an illustration of two ways of making a child's frock. First, let it be of black and white small check. Trim the skirt above the hem with a plain row of black ribbon velvet, and above that a row put on instead of the flounce, and at the head of it two or three rows plain or the Greek pattern, here shown. Cut the body square, and trim round with the Greek pattern. Trim

the band also, and fasten it with a rosette. Make short puffed sleeves. Secondly, make it of plain camlet. Put a flounce, pleated one way at the base; then a row of black braid as a heading; run rows of braid on the belt and cuffs. Let the body be high and plain, and the sleeves coat-shaped. But, if preferred, the flounce and the Greek pattern may both be used. Buff llama or cashmere, trimmed with black velvet, is very effective. The rosette of the band should be at the back.

Fig. 8, a ball dress for a little girl. This is a very stylish toilette. First, a plain frock and low body are made of pale sky-

tulle. Measure it half as long again as the net foundation, and every drawing half as wide again as the sections on the net. Then run every drawing with a long thread. Pin the top and bottom of each to the net foundation, and pin them at intervals to the marks of the net. Then draw up the thread. Run the tulle to the net. This, all but a band, completes the skirt. The other way is to cut every section of the tulle separately, half as long again as the foundation and half as wide again. Run each side and put each on separately. A trimming, such as the ready-made satin pipings, must then be put down over each seam. White satin,

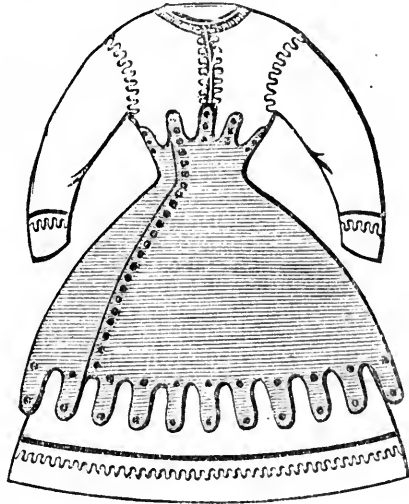

Fig. 1.

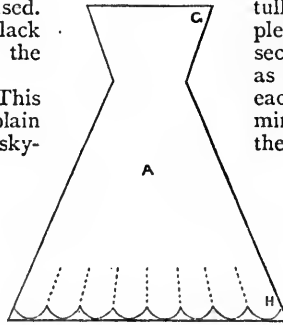

Fig. 2.



Fig. 7.

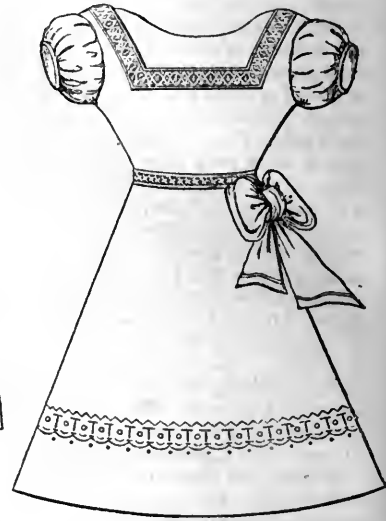

Fig. 5.

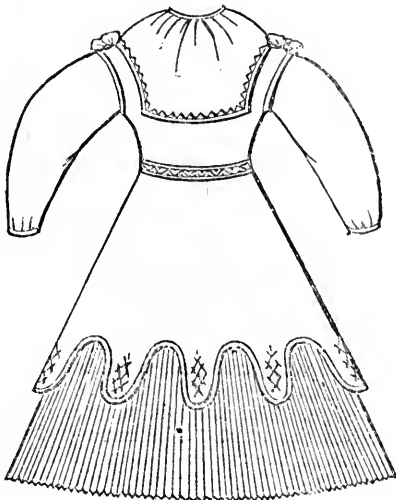

Fig. 6.

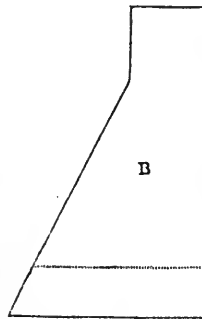

Fig. 3.

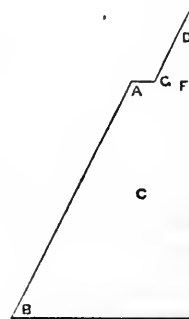

Fig. 4.

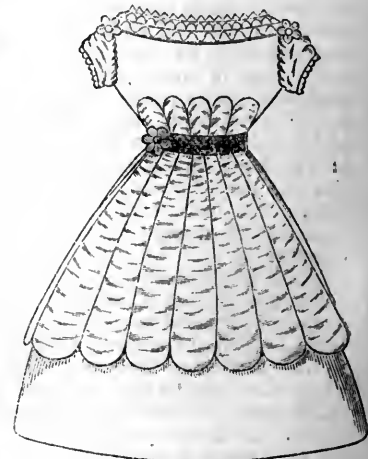

Fig. 8.

blue silk, and there are four rows of Valenciennes lace round the top. The tunic is of tulle. Cut a foundation in imitation Brussels net. To do this, cut a front breadth, like A, Fig. 2, and a breadth for each side, like B, Fig. 3; a second breadth each side, like C, Fig. 4; and a back breadth, like A, Fig. 2. Try these on, and make any needful alterations. Join these breadths. Fold in half, and fold again and again, to mark the sections for the puffs of tulle. A join must not come right in front. There are two ways of putting on the

or the colour of the slip, can be used. Cover the corset the same way, but separately. Make full sleeves of the tulle. There is a blue band and a short sash and cluster of bows behind, and bows at the backs of the shoulders. The shoes should be of blue kid, with heels, and large clusters of bows on them. This dress is also very pretty, and less expensive, made of blue Japanese silk and white tarlatan. A foulard skirt, made this way, and a white jacquet Garibaldi, form a pretty summer dress.

HOUSEHOLD DECORATIVE ART.

GILDING.

OUR readers can easily learn a method of gilding which

is painted over evenly with a coat of gold size, which is made by mixing well finely-powdered yellow ochre with parchment or isinglass size, till it is of a full yellow colour. The materials can be purchased at any

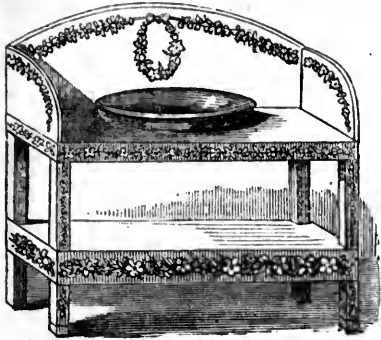

Fig. 1.



Fig. 2.

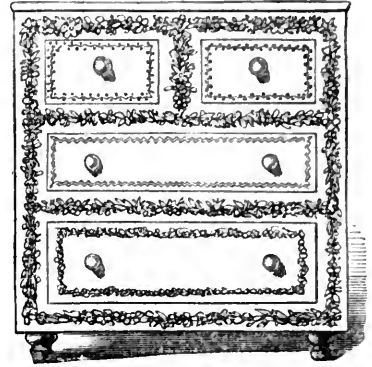

Fig. 3.

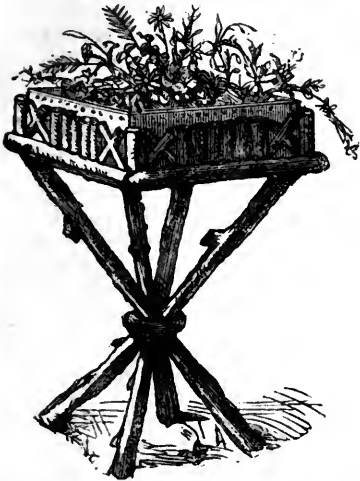

Fig. 4.

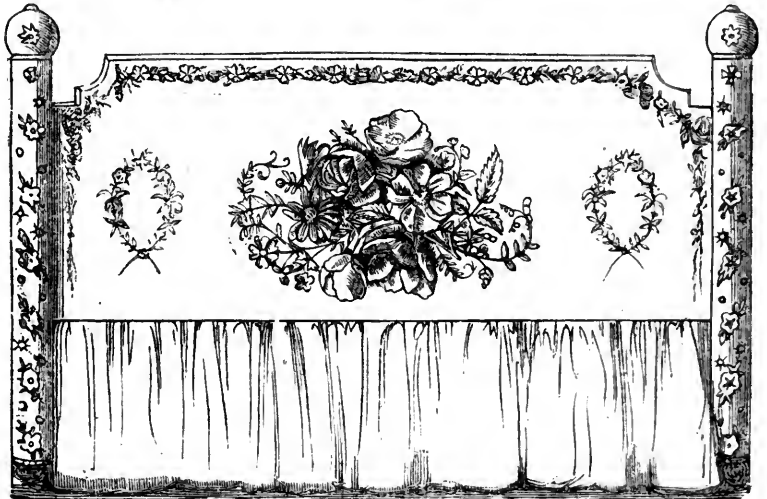

Fig. 5.



Fig. 6.

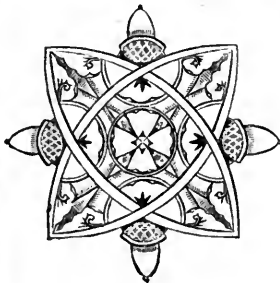

Fig. 7.

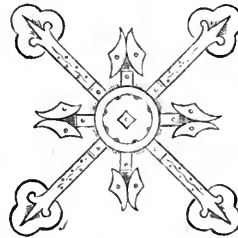

Fig. 8.



Fig. 10.

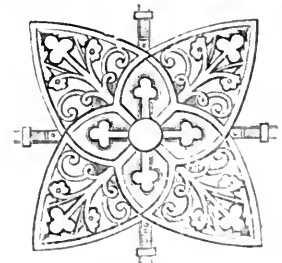

Fig. 9.

will enable them to make pretty fancy articles of decoration, or to renovate old looking-glass and picture frames and cornices. The process is very simple. The article to be decorated, such as a

general oil-shop where paint is sold, and a moderate-sized brush, to apply it to the articles to be gilded. Apply three coats of this size, letting the first and second thoroughly dry before touching them

wicker basket, a small plaster statuette, or a rustic stand, or the old frames alluded to already, must be

over. When the third is nearly dry, but still sticky, it is ready for receiving the gold leaf. Gold leaf is sold

ready for the purpose in books. Take up the leaf with a long-pointed flat camel's-hair brush, sold for the purpose (Fig. 11), raise the gold leaf, and with a light movement dexterously throw it on a cushion, made as described below, on which it is cut to the required shape with a knife sold for that purpose. If it does not fall flat, it may be got in that position by the brush, aided by blowing with the mouth. Apply it carefully, so that it rests flat, and with another camel's-hair brush (Fig. 12) press it well, but very gently, into all the crevices of the article being gilded. To allow for these crevices when the gold leaf is thrown on in the way described, it should be suffered to fall loosely, or puckered, looking so that the material may go into every crevice when spread. It adjusts itself readily to its position. Place on a second leaf before finishing off the first too much, so that they may amalgamate and not show the join where one is laid a little over the other. Burnishing is done by gently and briskly rubbing the gold with an agate burnisher, when it is quite dry. It is better, however, for ladies not to attempt this, but, when the gilding is finished, and has been left a few days to dry, to wash it all over with a thin clear size. This makes it what is termed dead gold. To give the gold a red colour mix red ochre in the gold size instead of yellow, or, instead of the size, use a mixture of four ounces of bees'-wax, one ounce red ochre, one ounce of verdigris, and one ounce of alum. If the gilt work is required for out-door ornament, the article to be decorated must first be painted yellow. When the paint is quite dry, it must be sized with an oil size, made of drying oil, or boiled oil, amply coloured with fine-ground yellow ochre. If too thick, reduce it with oil of turpentine. Gild it in the same way as before, choosing a day not windy, and then varnish it with copal.

To prepare casts for gilding with oil size, which is the best way, cover them liberally with oil. In two or three hours they will be dry. The process must be repeated over and over again till the cast has absorbed as much oil as possible. This will be about a day and a night drying. When completely dry, cover it with a coat of thick size. Let this dry. Add the oil gold size, giving a liberal coat, and as this dries, gild them in the way described. They may be either burnished or varnished. The gold size dries generally in less than a quarter of an hour. The gilding is less bright after varnishing.

Common plaster brackets—to be purchased at any cast-maker's—thus gilt, ornament a drawing-room prettily, and may be made to hold a Parian marble vase, or some other appropriate article. Small statuettes, gilt, look well anywhere in a drawing-room, on such brackets, or on a piano. If placed at a distance, arrange them as they are, but if where they will have close inspection, as on a dwarf piano or girandole, put them under glass shades. The gilding need not then be varnished or sized. Glass is so cheap now, that shades are not very expensive, and add wonderfully to the refinement and brightness of a room, and they soften very much any want of finish in an amateur's work of art. Figs. 7, 8, and 9 may be applied to various uses in connection with Household Decorative Art. Inside a gilt basket

put a jam pot, or a shallow earthenware basin. Fill them with sand, covered on the top with charcoal, if you have any. Make the sand very wet with water. Arrange a choice bouquet of real flowers in the basket, by placing them in the sand. If the basket is then placed under a glass shade, as wax flowers would be placed, the flowers will last for a fortnight. They require water added, and the ends of the stalks occasionally clipped. A little salt mixed in the sand brightens them, especially when they begin to look less fresh. Glass shades—and, of course, the stands under

them—should always be much larger than the objects they cover. It is bad and vulgar taste to allow the glass almost to touch the ornament it protects—it dwarfs it, and spoils its effect, just as an insufficient margin of white round a water-colour picture, or a bad frame to an oil painting spoils either in appearance. Rustic work of apple twigs, holding a shell, always will look well gilt, and makes a pretty ornament for a table, mantel-shelf, or bracket (Fig. 10). Rustic fenders, constructed of such twigs, and gilt—such as are described in our article on "Stove Ornaments" (page 169)—are pretty in summer. Boxes for the inside of windows may be made elegant decorations by constructing, first a plain box from an old packing-case or egg-

box, worth sixpence, painting it a lively green, or other colour, over a first coat of stone colour, letting each dry perfectly before re-touching, and finally varnishing it, then constructing an ornamental box of apple twig rustic work, large enough just to enclose the first box, and gilding it (Fig. 4). Rustic work-stands can be constructed to hold flower-boxes. They may be entirely gilt, or merely painted green and varnished. If the box is white-varnished, and the rustic work round the box gilt, the result is very delicate and pretty. All the pots on the white stand may be gilt. Long, narrow stands, flat, and not occupying very much space, are suited for windows, especially front windows. A square box, with table-like legs, may occupy the centre of a room, now that centre tables are out of fashion, or the space between two rooms, with the folding doors thrown open, or in a single back window through a suite of rooms. In a summer-house, during the fine weather, such a table and stand (gilded for out-door use) would look exceedingly pretty.

How Picture-frames are Gilt.—The first thing to be done is to lay on the work a priming of whitening mixed up in hot size, and afterwards to fill up any holes in the frame with a thick paste of the same materials. Then another coat of the wash is to be applied, but thicker than before, with a dabbing action of the brush, until the frame has received from three to four coats. The surface is then to be slightly moistened, and made perfectly smooth with pumicestone. This, when dry, is to be finished off with glass-paper, using first a coarse, and lastly a very fine, glass-paper. Then apply the gold size as before described. The frame is now ready for the application of the gold leaf. The gold leaf for gilding is to be purchased in books, containing twenty-five leaves in each book. The quality varies according to the price at which they are sold. To use it, a leaf is gently

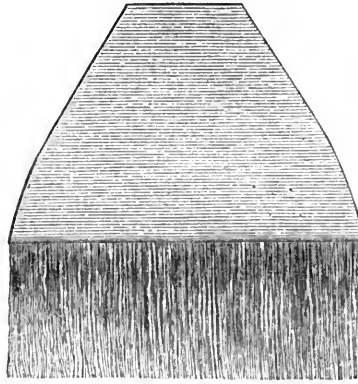

Fig. 11.—A "TIP."

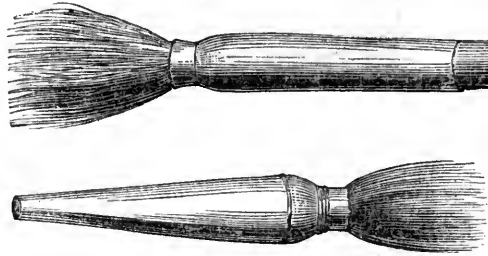

Fig. 12.

blown from between the pages of the book on to a cushion. This cushion consists of a small flat board, over which two or three layers of woollen cloth are laid. This is then covered with a piece of smooth leather, which is secured in its place by being nailed around the edges. The gold leaf is then divided, while on the cushion, into two, three, or four strips, wide or narrow, short or long, as required, the object being to prevent as much as possible any waste of the gold leaf. The knife employed must have a smooth edge, not too sharp, and should be quite straight. A camel's-hair brush is then to be well wetted in water, and passed carefully over a small portion of the surface, so as to moisten the gold size, if necessary. The slips of gold lying on the cushion are then to be taken up, one by one, by means of the brush we have described, called a "tip," and applied to the wetted part. This tip is made by gluing a row of camel's-hair between two pieces of cardboard. Sometimes the hairs of the tip fail to lift up the gold; in that case, the hairs are gently rubbed between the face and palm. This, probably, by inducing an electric action, immediately causes the gold leaf to adhere to the hairs. When the leaf gold is applied, it is blown on, to drive away as much of the moisture beneath it as possible, a dry and soft camel's-hair brush being very gently pressed against the surface, to cause the gold to adhere. Another part of the frame must then be wetted, and more gold leaf applied in the same manner, taking care, in doing this, that the slips overlap each other by the eighth of an inch. After the surface is entirely covered over with the gold leaf, the frame is left for a short time, until it becomes almost dry. It is then carefully burnished over with a piece of polished flint or agate, to render the surface of the gilding more brilliant, any part of the work that it may be desired should be dull being omitted, and being painted over, instead, with clear size. When the work is entirely dry, it may be varnished over with clear size to complete it. If an old frame requires to be re-gilt, the method adopted is to wash off the old gold, and some of the size, and paint the surface over with fresh gold size, and re-gild, as before directed. Where frames are gilt in oil, to enable them to bear washing, the oil process is adopted, the gold size employed being prepared from boiled linseed oil and ochre. This size is to be painted over the surface very smoothly with a fine soft brush. This is generally done at night, the surface of the size being in a proper condition for gilding by the morning. After being gilt, it may be smoothed off by means of cloth, sealskin, or Dutch rushes. When frames that have been gilt in this manner require to be re-gilt, the surface of the gold is to be washed very clean previously to re-gilding them.

Any lady with a little ability may re-gild old frames, as well as construct the variety of pretty articles we have named. The casts may also be done in water-gilding; but oil gilding is most effectual.

Drape a bedroom mantel-shelf with velvet; on the top place a rustic flower-box, gilt, the whole length and breadth. Fill it with a few honey-pots or common jars, concealed by moss, and having in them pretty artificial flowers. In a summer room, where there are no good mantel ornaments, this is a pretty arrangement. If there is a handsome chimney-glass, in a good frame, so much the better; charge the rustic box, then, with real flowers, in pots—which, by the way, are not healthy in a sleeping-room. If the grate is filled with plate-glass, a rustic fender, and flowers also, as in the article on "Rustic Ornaments," the effect is complete. Such boxes may be painted white, and only portions picked out with gold leaf, and then the whole varnished.

Plain wooden window boxes may be painted in oils—white, pink, blue, green, black, or any colour. Then draw on them a device (see Figs. 7, 8, 9) with yellow ochre. Let

it dry. Pass a coat of gold size (oil) over it; this dries in about ten minutes. Before it is quite dry, gild it in the manner already described. When the gold is quite dry, in a day or two, varnish it with copal. It can then be used in or outside the window. Figs. 7, 8, 9 are caustic tile patterns, which may be repeated the whole length of such boxes in gold.

Common red flower-pots, treated in this way, become ornamental enough to decorate sitting-rooms as *jardinières*. The round edge at the top of the pot should be covered with gold, the lower part of it waved. Round the base of the pot a plain line, narrower, is sufficient.

Many articles of domestic furniture which have become shabby might be renovated and rendered very pretty by painting them entirely of some effective colour, gilding in a pattern, and then varnishing; thus very old worn materials could be rendered apparently new and very pretty. A room could soon be thus furnished with a French bedstead with an ornamental foot-board; a wardrobe with a decorated door; a couple of chairs with fancy backs; an old chest of drawers enriched; and a washstand a little ornamented in the most conspicuous part. They should all be *en suite*, of course. Whilst on the subject of renovating old furniture, such articles as we have named—and added to them a folding screen, and three flower-pots, one larger than the other—must all be painted alike; say, for example, a pale old china green. When the paint is dry, decorate them with flowers and birds cut out of dimity, or coloured paper scraps; the one or the other must be exclusively used—the two must not be mixed. They may be arranged very prettily (see Figs. 1 to 6). When dry, varnish each article. Gilt pots may stand on the mantel-shelf as ornaments. Hang the shelf with pink glaze, covered with a muslin frill, and cover the toilette with muslin over pink. The draperies of the room must be white. A pale turquoise-blue, or a pale blush rose-pink, also make pretty grounds; so does white, or a cream buff. Make a cover for the top of the chest of drawers of coloured pink glaze, covered with white muslin just the size; make a hem, run in a string, and tie it tightly down just over the ridge at the top. The toilette-table is not painted, but covered with a muslin frock in the usual way. Cover the part of the washstand where the basin is placed with white marble oil-cloth. Paint and decorate the rest. With blue use pale pink glaze, or very pale buff, cream colour—not yellow—or dark claret-brown velvet—not red. With the buff, hang the mantel-piece with deep crimson velvet; cover the top of the drawers with it; match it in chintz for the toilette-table, and cover it with curtain lace; dark-coloured linings make muslin look dirty. Netted toilette frocks and covers for drawers are very pretty over coloured linings of a dark shade. Netted, or very open leno curtains, may be lined with dark crimson glaze for the windows and bed, with the buff furniture. The cover on the toilette-table should be of ordinary white marcella. The towel-horse needs no decoration: simply paint it the ground colour, and varnish it.

When such designs as flowers and wreaths are put on articles of furniture by gilding, they must be picked out and slightly shaded afterwards with burnt sienna, burnt umber or black, in fine lines, with a camel's-hair pencil, before varnishing (see Figs. 1, 3, 5, and 6).

Varnish for Gold.—Six ounces each of grain gum lac, dragon's blood, anatto, and gamboge; dissolve each in two and a half pints of alcohol; mix the lac and gamboge when dissolved, and add as much of the other two solutions as gives the desired colour.

We ought also to have stated, in reference to gilding designs—either of flowers or such ornaments as Figs. 7, 8, and 9—that the loose gold may be lightly rubbed away with a soft piece of wool after the size has become dry and hard.



DESIGN FOR LAMP OR CANDLE SHADE IN POINT LACE WORK.

POINT LACE WORK.—VI.

A LAMP or candle shade for the table—the design for which we give with our present article—is a very pretty mode of applying point lace work. It is, as will be seen, in the shape of a small banner-screen, and stands on the table, being mounted somewhat after the fashion of a miniature pole-screen. A brass upright rod is fixed to an ornamental stand or foot, weighted with lead to ensure its steadiness, and a horizontal brass rod is fixed within an inch or so of the top of the upright one, and to this the banner-screen is attached, the size of the latter being usually seven inches in breadth, and about eight in depth. A piece of rose-coloured satin (or, indeed, any other colour, if preferred) is used for the screen itself, and should be half an inch larger every way, when made, than the pattern given for the lace. It should be lined with white silk or sarcenet; and a piece of drawing-paper a quarter of an inch smaller being placed between them, the satin and silk must be turned in, and very neatly sewn together round the edge. This is afterwards trimmed with a rose-coloured and white silk cord, so as to hide the stitches, a second cord passing along the top, but being only sewn at the corners, and left loose, is taken up in the middle in a short festoon, the end on each side hanging to about half the depth of the screen, and terminating in a small rose and white tassel. A fringe of the same colours, about an inch and a half in depth, is sewn along the scalloped edge, and forms a pretty finish. The lace-work should be extremely fine, the braid with an open edge (being the narrowest that can be procured), and all the open stitches being executed in the finest lace-cotton made. The dotted bars must also be very delicate; in short, the whole must be as thin and clear as possible, so that the colour of the satin may show well, and give effect to the whole. A fine open overcast should be worked into the edge of the braid, to give lightness, and some of the spaces formed by the design may be filled in with the same stitch, as it will make a pretty variety when mixed in with the several others we have already given in our previous chapters. When the pattern is worked, a single row of braid forms the outside edge, and is attached by bars to the centre design. The mounting for these screens is sometimes made so that the upright rod may, with the work attached to it, be removed from the stand and used as a hand fire-screen. The two open stitches, which we illustrate, are simply and quickly done, and may be worked as follows:—In Fig. 1, a row of plain overcast is made into the braid, and the thread stretched back, and then another row of overcast taking each stitch between those of the preceding one, and working-in the stretched thread with them, fastening off at the end of the row. Putting in the needle again on the left side, about as much lower down as the space occupied by the overcasts (or even lower, if desired), three long twisted overcasts are now worked into every fourth stitch of the preceding row, and a space of thread, of course, will be left between each of these *sets*; then let the thread be stretched back, and the usual overcast again commenced, making three into the spaces and one between each long stitch.

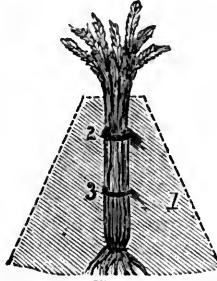

Fig. 1.



Fig. 2.



Fig. 3.

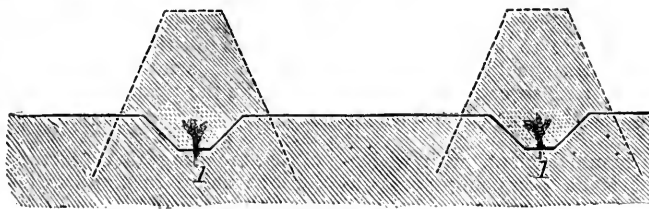

Fig. 4.

(This can be varied by four long stitches into the fourth, and only two into the spaces of the next row.) After the two rows of stretching back and overcast, the thread is fastened off again, and the long stitches recommenced from the other side, care being taken to let the set of long stitches be placed between those previously worked, as the illustration will show. For Fig. 2, three overcasts and a space are made into the braid; and without breaking off the thread, work back five overcasts into each space, and one between each of the three stitches of the former row, after which the overcast and spaces are repeated, and the same process begins again. In all this open work, not only should the thread be the finest procurable, but the stitches should not be tightly drawn, as the light and lacy effect of the whole greatly depends upon this. When the lace work is completed, it must be lightly tacked at the corners, and the centre of the sides, to the satin screen (which should be entirely finished and trimmed with the cord previously), leaving a margin of satin about half an inch in width round the lace, and the whole then fixed to the horizontal rod. The stands can be obtained at any Berlin-wool shop, and also at many ironmongers' where lacquered and brass work is sold.

In our next article on this subject the reader will find a pretty design for a small "Marie Stuart" head-dress, which answers admirably.

HOME GARDENING.

CELERIAC.—CHIVES.—CAMOMILE.—CELERY.

Celeriac is a variety of celery, commonly called turnip-rooted celery; the roots of which is the only part used, and the flavour of which is excellent in soups; it is also used as a salad; the roots and rind being cut or pared off, they are put into cold water, and set on the fire, and boiled till a fork will readily pass through them, after which they must be taken off, and when cold, they may be eaten with oil and vinegar, much in the same manner as you would do beetroot.

Culture.—Sow the seed at the same time as for celery, and treat the plants in the same way for the open ground, until the time of final transplanting; but for an early crop, sow on a moderate hotbed the first or second week in April, and when the plants are strong enough, plant them out on another hotbed, setting them an inch and a half apart, and giving them a good watering as soon as planted. Give abundance of air every day until the beginning of June, when transplant them into their final situation, on a bed of light rich earth, and at the distance of fifteen inches asunder every way, and not in trenches, as you would do celery. Give them abundance of water as soon as planted out, and repeat the operation daily in very dry weather, but every other day in moderately cool weather. Hoe them occasionally, to clear them of vermin, and loosen the soil at the same time. Many persons water to excess, thinking that without abundance of moisture the plants will not arrive at their full perfection; but we can assure our readers that such is not the case, but that the vigorous growth

of the plant depends much more upon the richness of the soil than on the watering.

Chives.—This is a hardy biennial plant, with small bulbous roots, connected in branches, from which the leaves—which are awl-shaped, thread-like, and are produced in tufts—rise. The flowers appear in June, on round stalks, are white, and tinged with a reddish purple. The foliage of this plant is frequently used as an ingredient in salads in spring, for which purpose they are more esteemed than onions, on account of their being much milder in flavour. They are likewise used in soups, stews, &c. The chive will grow in almost any soil or situation, and is propagated by slips, or divisions of the roots in the spring or autumn. Plant them in rows eight or ten inches apart, and the same distance from each other in the rows, and they will soon increase into large bunches. In cutting the leaves for use, they should be taken off close to the ground, and others will shoot up in succession. A bed thus planted will continue in perfection for three or four years, after which time the roots should be taken up, divided, and re-planted as already advised.

Camomile.—This is a hardy perennial plant, and grows wild in various parts of the kingdom, in gravelly pastures and by roadsides. The leaves are cut into threads and are prostrate. It produces its flowers in August and September, which are yellow in the disc, but white in the rim or outer portion, and the whole plant is bitter and highly aromatic. It is cultivated chiefly for the sake of its flowers, which are a safe bitter, and serviceable for many complaints, and is much used under the name of camomile tea. There are two varieties of this plant—the single and the double flowered. The double-flowered variety, though more beautiful than the single, is less efficacious, yet is more cultivated by growers for the market, on account of its greater bulk and weight.

The camomile delights most in a poor, sandy soil, and is propagated by parting the roots, or by offsets or runners. Detach the small tufty sets with roots any time during the months of March, April, and May, and plant them eight or ten inches asunder, giving them water when planted, repeating the operation from time to time as required. They will soon take root and overspread the ground, and will produce plenty of flowers the latter part of the same summer, and continue to bear for several years in succession. The flowers should be gathered just when they are full-blown, and spread in a shady place, and when they are quite dry they should be put up in bags for use.

Celery.—This is a hardy biennial plant, with wedge-shaped leaves and furrowed stalk, producing greenish-coloured flowers. The leaf-stalks, after being well blanched in the manner we shall presently advise, are used raw, as a salad, from August to April. They are also very frequently stewed and put into soups. There are many varieties, but those chiefly grown are Lion's Paw, Cole's Blood Red, Cole's Crystal White, &c. The above three sorts are best for general culture; but there are several coarser kinds, which, being more hardy to stand the winter, are better adapted for spring use, and suit well for soups and stews. All the sorts are propagated from seed, which should be sown on rich and rather moist soil; and for a bed four feet and a half wide by ten long, half an ounce of seed will be quite sufficient. For the main summer, autumn, and winter crops, make the principal sowing from the middle of March to the 1st of April. Sow in soil as above, and in dry weather water moderately both before and after the plants are up. As soon as the plants are big enough to hold between the finger and thumb, prick them out into nursery-beds, three inches apart in every direction. Always make these beds very rich, by manuring with good rotten dung. Supply

the plants well with water, and when they are from six to twelve inches high, plant them into trenches for blanching. For this purpose, and a month previous to planting, allot an open compartment, and form it into trenches eighteen inches wide and six inches deep, at five feet distance from each other, measuring from the centre of each trench, as at 1, Fig. 4. Fill the said trenches with good, well-rotted stable-manure, and that from an old hot-bed will be found as good as any. Dig the dung into the bottom of these trenches, working this and the soil well together during the process. This digging repeat two or three times, in order to incorporate the dung and soil the better. At the time of planting, apply a little more dung of the same sort, and dig it in, and give it a good watering afterwards; but do not plant till the evening.

In performing the operation of planting, first take up the plants from the nursery or seed-bed, and trim, stripping off all straggling leaves and side-shoots close to the root, but never cut the tops, the leaves being very essential to the growth and well-doing of the plants. Trim the roots, cut off the tap-root, which will cause them to form a brush of fibres, and thus, preventing them from striking deep into the ground, the plant will never run to seed before the following spring. As soon as the plants are thus dressed, immerse the roots in water while out of ground. Plant a single row at the bottom of each (Fig. 2), setting the plants five or six inches apart, and give them a good watering immediately, and repeat it in dry weather until the plants show a renewed growth, and occasionally continue until the plants are ready to be earthed up, as represented by the dotted lines (Fig. 3), but not afterwards. Continue planting out a monthly succession, from June to September, and thus provide for a supply from July to the following spring.

As the plants advance from eight or ten to twenty inches or two feet, earth or land them up, as it is termed, as at 3, Fig. 1. The two first mouldings must be done very carefully and sparingly, being careful not to load the plants with too much earth at first, only drawing a little mould on a ridge on each side of the row, leaving the plants, as it were, still in a drill, as represented by the dotted lines in Fig. 3, and thus they will receive the full benefit of the rain and waterings; and when the plants are strong enough to bear six inches of mould, earth or land them up to that height, being careful that no earth falls into the heart of the plant, and to prevent which tie the plants loosely with bass, as shown at 2 and 3, Fig. 1.

Some persons very strongly recommend long strands of bass-matting tied together till of sufficient length for one entire row, and fasten one end of this bass to a small stake put down at the end of the row for the purpose (see Fig. 2); and then, beginning with the first plant, give it one twist round the top of the leaves, and then pass it to the next, and so on to the end of the row (Fig. 2), where it must again be fastened; and then proceed to mould it up with a spade, being careful to leave basses enough to hold the mass of earth which will be used in the ridge, still keeping the plants in a hollow, as before directed. The process being thus ended, the bass must be unravelled, beginning at the end where left off.

The autumn and winter crops having attained their full growth, give them a final earthing or landing up, nearly to their tops, which will materially increase the length of the blanched part, and be a means of protecting them more effectually from severe frost during winter. Always choose a dry day for this work, and also when the plants are perfectly dry; for if water should be lodged in the bottoms of the leaves, it cannot easily escape after being landed up, consequently the plants would be in imminent danger of becoming rotten, and the crop lost.

DOMESTIC MEDICINE.

ERYSIPELAS.

Erysipelas is, like too many of the terms in medicine, an English word, made up of Greek words—*Ἐρυσίπυλος*, *to draw*; *πέπλος*, *near*—expressive of the tendency of the disease to spread from one part to another. The more English names for it are “St. Anthony’s fire,” “The rose,” &c.

Symptoms.—The disease consists in a more or less extensive spreading blush of the skin, with a tendency to the formation in it of blisters, or, as doctors say, of vesicles. The skin is red and swollen, and feels burning hot. There is generally some degree of constitutional disorder—such as sickness, loss of appetite, headache, shivering followed by fever, &c. The tongue is likely to be furred a good deal. The disease may attack various parts of the body; perhaps its most common site is the face and head. It rarely confines itself exactly to the spot where it begins, but spreads more or less. The seriousness or otherwise of the attack depends for the most part on the extent of the redness, and the severity of the general symptoms of the patient. If there is great prostration, dry tongue, or delirium, the case is serious. If there is but slight disturbance of the general health, it is not serious. There is a very fatal form of erysipelas peculiar to new-born children, especially in hospitals, beginning for the most part in some soreness of the skin, especially that connected with the separation of the navel-cord. We say there is such a form. We should almost have said there was such a form of the disease; for it has been greatly abolished, since the discovery of the importance of ventilation and fresh air in lying-in-hospitals. This form of erysipelas is occasionally seen in private houses, especially where cleanliness, sweetness, and fresh air, are not sought after. The disease spreads, and tends rapidly to the formation of matter, or of sloughs. The little infant is greatly affected and prostrated by it; and, in hospitals, generally dies.

Causes.—Ordinary erysipelas is generally caused by something wrong in the system. Certain people are more apt to have it than others, especially such as have any weakness about their kidneys. It often only needs for such people to get a cold, or to be a little intemperate, to get a slight attack of erysipelas. In new-born children, as we have said, the disease generally originates in some soreness of the skin, as in that soreness connected with the state of the navel. But this of itself is not sufficient to cause erysipelas. There must be some poorness of the system, or some foulness of the air, which poisons the blood of the infant, and makes it liable to erysipelas.

Treatment.—We need scarcely say that erysipelas is too serious a complaint for merely domestic treatment. Nevertheless, a good deal depends on domestic treatment, and we shall be particular on what may appear very simple matters, but which are really of very great moment; and we shall conclude with a little notice of useful medicines for such as cannot command a doctor’s advice. First of all, fresh air is of the greatest importance. Draughts should be avoided as far as possible, but fresh air is indispensable. Then the relief of the part affected will depend very much upon the domestic treatment it receives. The doctor will instruct; but he will not object to some liberty on the part of the patient, or his good nurse, in using one or other of those local applications, which are found in the particular case to give most relief. In one case, most relief will be obtained from dusting the part freely with flour; in another, from a warm poppy fomentation. As a general rule, all cold applications should be avoided. Local sorenesses of children should, as a rule, be soothed with poppy fomentations and poultices. Then the diet of the patient should be simple and nourishing. Milk and beef tea are always safe.

Occasionally stimulants will be necessary. If the tongue is furred, and the skin very hot, no harm will be done by a little opening medicine, and by a few doses of an effervescing medicine, such as—The effervescing citro-tartrate of soda, one drachm, three or four times a day, in water, effervescing. But the medicine which is pre-eminently useful in cases of erysipelas, and the giving of which should not be long delayed, is the tincture of the perchloride of iron, in some such form as the following:—

Tincture of perchloride of iron	...	1	drachm.
Simple syrup	...	3	drachms.
Water	...	6	ounces.

Mix. Two tablespoonfuls should be taken every four hours, in as much water.

As a general rule, erysipelas now-a-days, with our discoveries of the value of fresh air and sensible diet, is not a fatal disease, and need not occasion so much alarm as it used to do. It is worst in hospitals and unhealthy houses; and in very young children it is much more dangerous than in older subjects. We will not enter into the treatment of the disease in children, further than to say that fresh air and good milk, in cases where the child has not a mother or a wetnurse, are immensely important.

ERYTHEMA.

Erythema (*Ἐρυθμα*, *to redden* or *cause blushing*) may popularly be regarded as a sort of erysipelas. It is a redness of the skin in patches, and differs from erysipelas in not affecting such an extensive surface; in not tending to spread; and in not tending to the formation of blebs or vesicles. The patches of redness may occur on the limbs, chest, or face. We shall only notice two kinds of common occurrence.

Erythema nodosum is a common complaint, especially among young women. It consists of oval patches of inflamed skin, situated for the most part on the legs. They remain distinct, and do not run into each other. The patches are red, and swollen, and more or less painful. The health is mostly faulty, the patient being weakly. There is often some irregularity of the monthly functions.

Causes.—Debility, and irregularity of functions in young women.

Treatment.—The case is one for good advice. Any irregularity must be rectified. As a rule, weakness must be treated by tonics, of which quinine and iron are eminently useful and generally soon make a satisfactory impression on the disease.

Erythema intertrigo is a form of redness of the skin, which occurs in the folds of the skin of infants in the neck, thigh, and other parts, but which will be more properly noticed elsewhere. It often coincides with thrush and diarrhoea, and can only be cured by curing these.

FRUIT AND FLOWER STANDS FOR TABLE DECORATION.

A TABLE VASE manufactured in this country that became very popular, was one called “the Josephine.” It was awarded a prize at the Horticultural Exhibition. “The Excelsior” vase, distinctly different in style, obtained the first prize some few seasons subsequently. Of all crystal table decorations, it is best fitted for a centre-piece. It consists of a very large, flat, circular dish of glass, from the centre of which rises a slender shaft of the same bright material, surmounted by a cornucopia. Round the side of the dish three other cornucopias are arranged, these, as well as the dish, are dressed with flowers, fern fronds, grasses, roses, stephanotis, geranium, passion flowers, fuchsias, &c. The dressing of these ornaments should not be heavy—the happy medium is just to avoid scantiness. Fill scantily and lightly, in

the way described on page 264, till the desired effect is produced. "The Excelsior" is made in five sizes. One of the smaller of these sizes is enough for a small table. On a larger table three may be arranged, or if very large, three together, the largest in the centre, in the way shown in the illustration, and two smaller ones at the extremities of the table. A single "Excelsior" may be very well supported by a piece of plate on either side, at some distance, or scent fountains. Small baskets of flowers and of fruit are constantly placed tastefully amongst the dishes, or at the corners of a table. The "Denmark" basket is a great favourite for this purpose, and is used by the Princess of Wales. It is made in all sizes, from the size of an egg to one about nine inches across. It is the shape of Fig. 7, entirely of clear glass, and stands on three legs of an ornamental description. It is filled with moss and flowers. Fig. 2 is filled with fruit, oranges,

pears, grapes, and strawberries, laid upon leaves. The basket is cut in a honeycomb, and the handle corrugated. Fig. 3 is a simple basket for fruit or flowers. Fig. 4 is from a classic model, and fit for flowers only. The vase is of pure glass, the ornament round it like a cable festooned, and a cable handle. Fig. 5 is a tazza from a mediæval model, fit for flowers or fruit, made of pure glass, in shape of a shallow saucer; a circle, finely corrugated, is attached to the centre of the saucer by way of handle. On this, and round the tazza's edge, are a few knobs, which are

gemmed. The dish is of a vast size, and round it are three cornucopias. It is, in fact, the same as the "Excelsior," without the centre shaft. Tall, narrow glasses are sometimes placed beside each guest, holding a single flower. A pretty table decoration in the strawberry season is a single shaft of this kind fixed in a glass saucer. The saucer is piled with strawberries, and a flower crowns the shaft. For a strawberry party a small stand of such a kind is placed to every guest, a tiny glass bowl of sifted sugar, and a little jug of cream.

Finger glasses can be charged with rose water for formal parties, and a little sprig of some small kind of flower, or a moss-rosebud, placed in each.

Table fountains with perfumed jets are elegant additions to the dinner table. We will imagine a dinner table with either a "Josephine" or an "Excelsior" in the centre. Other ornaments should serve as what may be termed the half-centres. Between the centre and each side



Fig. 2.



Fig. 5.

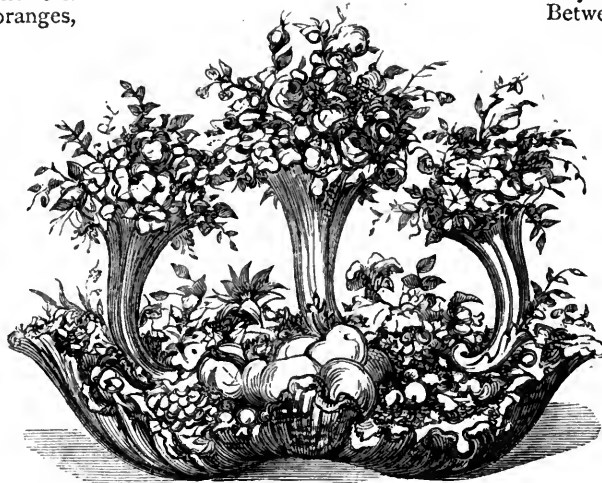

Fig. 6.



Fig. 3.



Fig. 1.



Fig. 7.



Fig. 4.

pears, grapes, and strawberries, laid upon leaves. The basket is cut in a honeycomb, and the handle corrugated. Fig. 3 is a simple basket for fruit or flowers. Fig. 4 is from a classic model, and fit for flowers only. The vase is of pure glass, the ornament round it like a cable festooned, and a cable handle. Fig. 5 is a tazza from a mediæval model, fit for flowers or fruit, made of pure glass, in shape of a shallow saucer; a circle, finely corrugated, is attached to the centre of the saucer by way of handle. On this, and round the tazza's edge, are a few knobs, which are

gemmed. Fig. 6 is a large and beautiful ornament. The glass

is a handsome ornament of silver. Right and left of each silver ornament a scent fountain might well be placed. Beyond, lengthways, place four "Alexandra" baskets.

Plates and dishes of fruit, garnished with flowers, must be placed between the ornaments,

sufficiently to save the table from looking meagre without making it crowded. Place to every guest finger-bowls, single flower vases holding one flower, and coloured salt for one. The finger-bowls should be charged with rose-water, and a tuft of flowers dropped inside. Ornamental cards are used to enhance the luxury. The napkin may be elegantly folded, and charged with flowers. We shall give separate articles on napkin folding.

HOUSEHOLD. AMUSEMENTS.

THE GAME OF BÉZIQUE (*concluded*).

Three-handed Bézique.—This is played with three packs of cards, and is governed by the same rules as the ordinary two-handed game; but the score is larger, usually consisting of 1,500 points. The double bézique counts 500, and a triple bézique 500 more, but all the cards must be shown together. The single or double bézique may, however, have been previously declared, the cards being left on the table. Sometimes the game is fixed at 2,000, and triple bézique is then allowed to score for 1,500.

In three-handed bézique the 25th is the turn-up or trump card. The player to the left of the dealer leads, and the deal passes to the left in rotation, the play to each trick following in the same order. In the play of the last eight cards each player must take the card before him if he can, either by following suit, if he has it, or by playing a trump; but if he can do neither, he may play any card from his hand.

In the three-handed game, each player strives to keep back the score of his opponents as well as to make his own; and when one is in advance, and the other some distance behind, the play of the person whose score stands between the two will therefore occasionally favour the latter, so as to keep back the more dangerous adversary.

Four-handed Bézique.—There are two ways of playing this game, as to the respective merits of which opinions vary. Some prefer that each should play on his own account, and others that the four should be divided into two sides and play partners, as at whist. If the parties play individually, four packs of cards must be used. The game should not be set at more than 1,500, as otherwise it is apt to last too long. Triple bézique, which very rarely occurs, would count 1,000. Supposing all the eight bézique cards to fall into the hand of one player, he could not count beyond this, from the necessity of parting with one of his eight cards to play to each trick.

This form of four-handed bézique is interesting from the variety it affords, and the scope there is for play in fighting against the hands of the three opponents, and keeping each back, as occasion may require. Its chief defect is its length, inasmuch as it often takes quite as long to score as in two-handed bézique; and the game is necessarily made to consist of a greater number of points, from the chance that an extraordinary hand might otherwise deprive it of its interest.

Four-handed bézique played with partners is a preferable form of the game. Either three or four packs may be used, and the game is generally fixed at 2,000. One player on each side scores for himself and his partner. After a trick is taken, either partner, or both, on the side taking it, may declare and score. Marriages, sequence, &c., can only proceed from the hand of each individually; but bézique having been declared by one of the partners, the other, having the same cards, may declare double bézique, provided the first are still on the table. The same rule holds good with regard to triple bézique, which scores 1,000. The score of 1,500 for a triple bézique, although it is allowed by some players, is much too high, as it allows 1,000 for the production of two additional bézique cards after the double bézique has been declared; and therefore, in our own opinion, gives too high a premium to the element of chance in the game.

We may remark here that there is a mode of playing bézique, in either the two-handed or four-handed form, which differs from the general practice. A trump card is not turned up at the end of the deal, but the first marriage declared determines the trump suit, and is scored for as a royal marriage. The sevens do not score under this method. In other respects the scoring, &c.,

proceed as in the ordinary game. The variation is not to be recommended, as it tends to introduce greater uncertainty and confusion into a game which already suffers from the want of uniformity in its laws and practice.

The following is a brief list of recognised rules of the game of bézique, according to the principles already laid down. Where they differ with laws given elsewhere, the variation has the authority of some of the most experienced players:—

RULES OF THE GAME.

1. The deal is determined by cutting, and falls to the highest card, ten reckoning next the ace, as in the game.
 2. The players deal in turn until the end of the play. A player dealing out of turn may be stopped before the turning up of the trump card, but not after.
 3. Should the dealer expose a card, or give a wrong number to either himself or the adversary, the latter may elect whether the deal shall be forfeited.
 4. Should the misdeal not be discovered until the players have looked at their cards, it must stand; a player short of his number may complete it from the talon; one having too many cards must not draw until they are reduced to the right number.
 5. A player is not compelled to follow suit, but may play any card he pleases, before the last eight tricks.
 6. After taking a trick the player may make any declaration, the declared card being exposed on the table.
 7. The score for either seven of trumps ranks as a declaration, and can therefore only be taken after a trick is made.
 8. The player exchanging his seven of trumps for the turn-up card, cannot use the latter in a declaration until he has taken another trick.
 9. A second declaration can only be made by an addition from the hand to exposed cards already on the table.
 10. No declaration can be made after the player has drawn his eighth card from the talon.
 11. Should the player omit to score for any declaration when it is made, he may rectify the error at any time when it can be clearly proved. If the matter is disputed, he cannot claim the privilege.
 12. If a player, in drawing from the talon, lifts two cards instead of one, his opponent may claim to see both cards, and take his choice between them. If the player who is second in turn to draw does the same thing, the adversary may see the cards, and elect which shall be retained.
 13. A player who plays to a trick with only seven cards in his hand loses twenty points, which may be either deducted from his score or added to his opponent's. If both omit to draw, and play with seven cards, there is no penalty, but each takes two cards from the talon.
 14. A player being in possession of nine cards forfeits 100 points, to be taken from his score or added to his adversary's, as the latter may elect.
 15. There is no penalty for playing out of turn, and if the second player plays to a card wrongly led, the trick holds good.
 16. The tricks already taken may not be looked over during the play of the hand, but either player may see the last trick at any time.
 17. In the play of the last eight tricks, the second player is bound to take the trick if he can, either by playing a superior card of the suit led, or a trump.
 18. A player revoking during the last eight tricks cannot claim any of the aces or tens included in them, but his adversary may score them all.
- In our next paper we shall turn to that popular and pretty out-door game, croquet, a favourite in most households, and deservedly so.

THE TOILETTE.

RINGWORM (*continued*).

Ordinary Ringworm of the Scalp (continued from page 94).—We now come to the local treatment of the simpler cases of this variety of disease. Whenever a ringworm appears, the mother or nurse should set to work to closely search every portion of the scalp for different spots of disease, and must remember that they are very readily missed, especially in light-haired children. The hair should be cut away from all diseased or suspicious places, for half an inch at least beyond the actual edge of the disease, so that a clear view may be obtained of the effects. If there are very many places over the head where the hairs are dry and broken off, it is much best to cut the hair of the crown off altogether. Every morning a search should be made for fresh spots, because it is an easy matter to destroy these. If the disease is extensive and severe, a doctor should be at once consulted, as we have said; but if there are only two or three places, and they are discovered early, an attempt may be made to destroy the disease by the use of the strongest acetic acid. Each spot is to be freely touched with this acid, which is to be applied with a piece of sponge tied to the end of a stick, and gently rubbed on. If it cause much smarting, a little poultice may be applied, to ease the discomfort. Sometimes the fluid blisters. In the course of a few hours, the part will blister or become more or less red and irritable. In twenty-four hours or so more, the scales may be removed, by bathing and lifting them off with a card; and we should then use some other application—tincture of iodine, or white precipitate ointment, ten grains to an ounce of lard. Dr. Fox, in a recent paper on the treatment of ringworms in the *Practitioner* for March, recommends that an application composed of two grains of bichloride of mercury to an ounce of lard—as weak as this—be used, with considerable friction. Some persons advise blistering ringworms as a *first* step. The acetic acid mentioned above answers all the purpose. If, after ten days or so, there is not a decided improvement, but the patches enlarge, and the hairs become much diseased and broken off, domestic medicine had better not be trusted to. When remedies, such as ointments or tincture of iodine, produce, after being used for some time, little yellow pustules, it is a sign that they irritate too much; and, if they be persisted in, harm instead of good will be done.

During the time that the above steps are being taken, it is desirable to keep the head very clean, by washing daily with soap and water, and to oil or pomade the hair, because this prevents the scattering of the seeds of disease. Whenever the short, dry hairs are seen over any patch, an attempt should be made to pull them out. It is said they are brittle and break off, but a great many do come out as desired. Diseased hairs are always loose, so that the pulling them out gives no pain. The pulling out of the hairs is called "depilation." About an inch or so of area can be cleared at a sitting. The ointment mentioned a moment ago may be used after each pulling out. The use of some remedy to kill the parasite must be continued as long as there are any signs of broken-off and dry, brittle hairs. We have said that if little yellow heads appear after the free use of the ointment named, there is too much irritation. Under these circumstances, it will be advisable to desist from the use of any active measures, and then the following ointment may be used:—

White precipitate	5 grains.
Carbolic acid	2 grains.
Fresh lard	1 ounce.

To be gently rubbed on, night and morning.

All diseased hairs should still be extracted. We stop

the application of remedies, when we notice the hairs to be growing out in a *straight*, and not a crooked manner, and to be of natural shining aspect, and firm in the follicle, instead of loose, dull, and brittle. It must be remembered that ringworm leaves behind a good deal of scurfiness at times, which must not be confounded with the actual disease. We shall know the difference by the fact that there are no loose and brittle hairs. When this scalliness occurs, the best treatment is the application of the following pomade twice a day:—

Balsam of Peru	10 drops.
Dilute nitric acid	10 drops.
Olive oil	1 drachm.
Fresh lard (scented)	1½ ounces.

To be applied to the scurfy part with the finger twice a day.

When the whole scalp is dry and irritable, the following embrocation may be used in the place of pomade:—Equal parts of olive oil and lime water, well shaken together, so as to form an emulsion. This compound should be freshly prepared every week or so. It may be scented as may be most convenient or desirable.

What is to be done to stop the spread of ringworm to other children in families and schools? When this unfortunate disease breaks out, it is the safest plan to wash thoroughly the heads of the unaffected with the following lotion, night and morning:—

Sulphurous acid	1 part.
Distilled water	6 parts.

This solution should be obtained fresh every few days, and from a good chemist. After its application, the head should be pomaded in the usual way, and the scalp thoroughly washed once or twice a week.

Again, inasmuch as the disease ringworm is spread by little vegetable seeds, which get into the hair, and are entangled by caps and brushes, it is of the utmost importance that those attacked by ringworm should have separate toilette articles, and that their caps or brushes should not be used by others.

Kerion is the same disease as the last, only that the hair-follicles are specially inflamed, and pour out a sticky secretion like the juice of the mistletoe-berry. The appearance, in the early stage, is much like a nutmeg-grater, with hairs coming through each aperture, these hairs being loose. When in an advanced stage, the disease looks like an abscess under the skin. The treatment is the same as for the last variety.

Ringworm of the non-hairy Parts of the Body, or *Tinea circinata*, occurs in little red, scurfy, itchy, circular patches or actual circles, which extend their circumferences from day to day. At first, there may be only a small, scurfy, red spot, but the ringed character of the eruption is characteristic. There is no discharge, and, as a rule, no crusting. These circles occur about the neck, the face (especially the forehead), the arm, and the body, and often in connection with ringworm of the scalp, as before described. Mothers and nurses are generally able to tell when this disease is present. The popular remedy, ink, is by no means to be despised, and does very well for the minor instances of the affection. If this do not seem to succeed, the following may be tried:—Hyposulphite of soda, ½ ounce; water, 6 ounces. To be used night and morning. The part to be well washed with soap and water first of all, and then to be wetted for some time with the solution.

Simple tincture of iodine, put on night and morning, acts very well. If the disease be very well marked, and evidently there be a great disposition to the rapid spread of the disease, acetic acid may be brushed over the spots as they appear, and the lotion above used subsequently.

COOKING.

SEA FISH.—SHRIMPS.—CRUSTACEANS.

The Red Mullet, or Surmullet, is sometimes called the woodcock of the sea, because it is cooked without being emptied. The liver, so dressed, is a delicious morsel; the mass of the rest of the "inwards" is trifling. The flesh is firm, flaky, white, highly esteemed; but scarcely to be recommended to weakly stomachs. The red mullet, which always fetches good prices, is a spring and summer fish, coming in with the mackerel, which it attends and follows, and returning with them, after their recovery from spawning, in the autumn. In fishing for mackerel, it has been found that, by going deeper, you hit upon red mullet, which swim *under* the shoals of mackerel, and are believed by fishermen to feed upon their droppings. Although perhaps not universally, there is little doubt this is generally the case. The smallness of the red mullet's intestines may be accounted for by its living "by suction," whether parasitically, or, like snipes, on minute worms and animalcules.

Red mullet may be boiled, which is not doing them justice; they may be fried, which is better, but they require some care to prevent their breaking. The best way is to oven them; and they may be perfectly done before a good fire in an American oven. In any case they should be scaled, the fins and gills removed, but the belly left untouched.

For baking, butter a metal dish, lay the fish in it, pour over them a wine-glass or so of flour-and-water or good broth, lay pieces of butter on them, and baste all the while they are cooking. The gravy which comes from them is *red*; it may be heightened by a teaspoonful of essence of shrimps or anchovy, but should not be discoloured by catchup, Reading, or other black-brown sauce. Serve the fish in the dish in which they were baked.

Oysters (cooked) appear more frequently as components of other dishes than by themselves. They afford great help to vol-au-vents, and give the finishing touch to fish pies, no matter what. Scalloped, in the way to be directed for crab, they are excellent. The simplest and best way of stewing them has been already given. For oyster patties, you have only to warm and season the oysters in the same way, and put them into the ready-baked crusts. Besides these, we recommend a delicate and easily-made

Oyster Pie.—Cover a well-buttered, deep plate or tin—a soup-plate answers perfectly—with puff-paste; lay an extra layer round the edge of the plate, and bake it very nearly enough. That done, fill the pie with oysters, seasoning with nutmeg, pepper, salt, and butter; dust in a little flour amongst them, and cover all with thin puff-paste. Bake quickly; when the top crust is done, the oysters will be done also. If to be eaten hot, serve as soon as baked, as the crust quickly absorbs the gravy. If to be eaten cold, let it cool, untouched, in the plate or pan. It is quite as good in this way as hot, and is excellent for picnics or for travelling.

Sea-urchins (Ourasins).—These pretty little orsons, of which our seas would furnish a supply, are considered great delicacies in countries where they are sent to table; but they are nowhere taken in sufficient quantity to furnish a staple article of food. In the primeval seas they must have been most abundant; every flint bed contains fossil urchins with their curious and beautiful warts and tubercles. Their flesh is pinkish, sweet, and when uncooked resembling that of the oyster in flavour. M. Figuiet says that only certain species of urchins are comestible; which we may be permitted to doubt. One, especially, named *Echinus esculentus*, resembles a sweet chestnut enclosed in its spiny shell. The shell itself is symmetrical, elegant, highly ornamented, and wonderfully contrived to suit the

creature's needs. The spines are organs of locomotion as well as weapons of defence. This species might strengthen invalids, if they could only be persuaded to try it; we ourselves have seen it eaten with great enjoyment. M. Figuiet says, "For my own part, I have only once partaken of sea-urchin (supported by the savoury bouillabaisse), and they appeared to me food fit for the gods."

Sea-urchins are found in every sea; they dwell in sandy bottoms, and sometimes upon rocky ground. When boiled, they turn red like the crab, and also resemble it in taste. In Corsica and Algeria the melon-shaped urchin, *Echinus melo*, is much esteemed. In Naples and the French Channel ports *Echinus lividus* is eaten. In Provence the common sea-urchins, *Echinus esculentus* and *E. granulosus*, are the favourites.

Sea-urchins are mostly eaten raw, like oysters. They are cut in four parts, and the flesh scooped out with a spoon. They are sometimes, but more rarely, dressed by boiling, and eaten from the shell like an egg, using long sippets of bread. Hence the name of sea-eggs, which they bear in many countries.

The Fresh-water Crayfish.—Although, undoubtedly, more abundant on the Continent than in Great Britain, we believe, nevertheless, that this curious little crustacean occurs in many streams, especially in the midland and southern counties, where, on account of its retiring habits, its existence is not even suspected. One means of discovering its presence is to twist some entrails or other animal offal in loose straw and rough sticks, so as to form a coarse network around it; to sink this near a steep river's bank, at nightfall; and pull it out suddenly *very early* in the morning, by a jerk which does not give the creatures time to disentangle themselves.

A miller once gave us a day's crayfishing, conducted on a different plan, of which we availed ourselves by deputy. He let off the water from the stream above the mill, till its level was reduced two or three feet. Some individuals without shoes and stockings, and *not* in their Sunday clothes, then waded along each river's bank. Wherever there was a hole, above or under water, they thrust in their fingers, and mostly pulled out a crayfish, which was immediately consigned to a bag hung round their neck. They were in no fear of bites, which, indeed, would be insignificant, and in a short space of time made a handsome catch.

On another occasion we procured crayfish to keep in an aquarium; but they pined at the bottom, hating the light, disgusted at being stared at, refusing to eat, and cursing in their heart of hearts the villanous temptation of the dead dog in a faggot, which had brought them into this pale captivity from their dear, dark holes on the river's bank. Be pleasant they would not, unless at night, when we were all up-stairs and fast asleep. Their hearts were more obdurate than ours; they stood out so well, and refused to be comforted so completely, that we turned them into a brook, to take their chance. And yet they might have been amusing, if they had not proved so nocturnal and shy. They are the very miniature of the esculent lobster, only of stronger build and much greater tenacity of life, with a further claim to close relationship by turning bright red when they are boiled.

It is this quality which causes them to be sought after by grand cooks, as garnish for many of their elaborate dishes. They are also used to make an old-fashioned and expensive soup—the *bisque d'écrevisses*. They may be served as you would a plate of shrimps, at breakfast, luncheon, or with salad at the close of a dinner. Most French cooks boil crayfish in *court-bouillon*, which, in our opinion, spoils them, as well as lobsters, crabs, and sea crayfish. The liquor is made by throwing into a kettle, three-quarters-full of water, bay leaves, thyme, parsley,

marjoram, pepper, cloves, mace, and any other aromatics and herbs you please, that will disguise the natural flavour of the fish, besides sliced onions and carrots, salt, wine, and vinegar. Boil these together three-quarters of an hour, pass the liquor through a strainer, and use it as a court-bouillon to boil your fish in. For those who like it for the above kinds of shell-fish (and it is also employed for shrimps and prawns), the same court-bouillon will serve several times, keeping longer, of course, in winter than in summer.

We strongly recommend, in preference, to cook crayfish (and all other crustaceans) English fashion: Wash them thoroughly in several waters, brushing them with a soft brush; for they are foul feeders, and often have mud adhering to them. Put them into a stewpan; sprinkle over them a good handful of salt; cover them with boiling water, and let them boil twenty minutes. Shell-fish, cooked in court-bouillon, are generally allowed to cool in it; when boiled in salt-and-water, they may be taken out as soon as done.

The shells of crayfish are so thick, in proportion to their size, that they need the accompaniment of a pair of nutcrackers.

Shrimps.—Three kinds of shrimps are caught along the British coasts—the brown shrimp, the red shrimp, and the prawn. The brown shrimp keeps close to the shore, and even affects brackish waters; it is mostly caught by fishermen or women, wading in the sea, and pushing a shrimp-net before them. It is the most highly-flavoured of the three. The red shrimp, of a clear pale pink, rarely attains the size of the preceding, is slimmer in its proportions, and much more delicate in flavour. It never enters brackish waters, but keeps well out to sea. It is sometimes called the Yarmouth shrimp, from having been accidentally discovered in Great Yarmouth Roads by some boats employed in recovering lost anchors by a process called "sweeping." Two boats, at a certain distance from each other, proceed up and down the roads, having a loose rope suspended between them, at the middle of which is fastened a large fish-basket or "swill," partly laden with stones to sink it. By these means the place of the anchor at the bottom of the sea is ascertained, and it is then raised and brought to land; but, in particular states of the tide, it was found that the swill, when brought to the surface, was filled with an unusual species of shrimp. The hint was taken immediately, and the red shrimp fishery established.

The prawn, considerably the largest of the three, is much less abundant. It resembles the red shrimp in colour and form, but is caught in traps and baited nets along rocky coasts, and at the mouths of rivers. Eaten fresh-boiled on the spot where it is taken, it is delicate and excellent; but when cooked for travelling is often spoiled by oversalting. When shrimps can be bought alive and boiled at home, you insure their freshness and follow your own taste. Boiled shrimps, clammy to the touch, and exhaling a pungent smell, are not fresh. To cook them, after careful washing, picking out all weeds and foreign matters, throw them into boiling salt-and-water and boil ten minutes, or until, upon trial, you find them done to your taste.

It may seem trifling, to those who know how to do it, to say anything about shelling shrimps; but when there is a right way and a wrong way, it is surely worth while to practise the former. When shrimps are boiled alive, the muscle contracts, and folds the tail beneath the body; when the tail remains extended after boiling, the shrimp was dead, and will be found soft and worthless. Now there is a difference in the shape of the different species of shrimps. The tail of the brown shrimp is *quite rounded* at the bend, like that of the lobster, whereas the tail of the red shrimp and the prawn presents a sort of knee or angle. To shell a brown shrimp, take the head between

your right finger and thumb; with your left finger and thumb-nail raise on each side the shell of the tail nearest the head; pinch the tail, and the shell will come away entire. At Honfleur, and other parts of the Norman coast, the finest brown shrimps are picked out to be sent to table as plates of *hors d'œuvres*, while the small ones are shelled, to make patties and *vol-au-vents*; by women who perform their task with incredible rapidity. Comfortably seated on a low, rush-bottomed chair, with their feet kept warm in a small tub or keeler, the shelled shrimps fly from their fingers to the basin which receives them, almost as if they were discharged in a stream by machinery. To peel red shrimps and prawns, take the head between the thumb and second finger of your right hand; take the tip of the tail between your left finger and thumb; with the nail of your right forefinger raise the section of the shell which forms the knee or bend; pinch the tail, and the naked flesh will be left attached to the head.

Shrimp Salad.—Shrimps serve for other purposes besides whiling away the time with bread and butter. For a salad, pile a teacupful or more of shelled shrimps in the middle of a small dish. Surround them with a circle of chopped hard whites of egg, as you would for a salmagundi; round this put a single row of capers, then a circle of chopped hard yolks; outside the whole lay a narrow border of water-cresses and quartered lettuce-hearts. The salad may be further embellished with a few gherkins and bits of pickled red cabbage. Send up with it, in a sauceboat, any salad mixture approved by the guests.

Shrimp Patties, or Vol-au-vent.—Shell the quantity of shrimps required; with the heads and shells make a broth as directed for shrimp sauce. Take a small quantity of this, scarcely more than will serve to moisten the shrimps, as the ragoût must be kept thick and creamy. Bring this to the right consistency with flour, arrowroot, or raw egg yolks, stirring in butter, and seasoning with pepper and grated nutmeg, or a *small* pinch of scraped horseradish. Salt, probably, will not be needed. A slight dash of lemon-juice or vinegar may be added. Spice should be used quite in moderation, as the natural flavour of the shrimps requires little to relieve it. Have ready, warmed, the crusts of your patties or your *vol-au-vent*. When the shrimps are thoroughly heated, without boiling, in the above sauce, distribute the ragoût amongst your patties, or with it fill your *vol-au-vent*, the crusts for which may either be made at home or procured from the pastrycook's.

ANIMALS KEPT FOR PLEASURE AND PROFIT.—THE HORSE.

HUNTERS (*concluded*).—STABLE MANAGEMENT AND FEEDING.

Irish Hunters.—Ireland has been for generations remarkable for its horses and horsemen. The latter certainly excel ourselves, nationally, in that accomplishment. Fine horsemanship has been almost universally considered one of the characteristics of the Irish gentleman. We refer our readers to the performances of the rough-riders of Ballinasloe, if they have any doubt about the people's participation in the science. The horses known as "hobbies," from which our proverbial expression is taken, are indigenous to Ireland. They are small, but well-shaped and of good constitution. The soil and climate of Ireland appear to suit the constitution of the horse; as the circumstances of the breeders are not so flourishing as those of England, and the horses themselves more so. They are usually capable of great endurance, and patient of weather and accommodation. But for many years their great excellence has been in the hunting-field. Fewer common-class hunters are to be met with now than formerly; but thirty years ago, when

sixty or eighty guineas was a fair price to give for a pretty good horse, it was usually understood that half the money would have purchased a better article in Ireland. Many of the horses ridden by the undergraduates at the Universities were Irish, as being more capable of standing the injudicious severities of a lordly beggar on horseback; and the possession of such a horse became so gratifying, that we were proud of his very uglinesses.

Their wonderful excellence consisted in their jumping powers. It was not the same as that of their English cousins, but was remarkable for its safety and its height. They were peculiarly safe among stone walls, over timber, and in banked countries. They always seemed to have a leg to spare, which they used in landing them over the highest walls and banks, often without displacing a stone. Cleverness was their great attribute. They were not handsome: strange to say, their shoulders were not faultless, and their hips square and ragged. They were not such good water-jumpers; but that is an accomplishment not common to many horses. They were also of great courage, seldom refusing anything at which they were properly ridden, and generally getting well over. So much virtue could not blush unseen, so that, eventually, they have become as dear or dearer than our own. We have some acquaintances who always buy four-year-olds in the Sister Isle, and they never get out of the dealers' hands under £200, though it is but justice to say that they do not take the worst out of the stable. It has been asserted that this undoubted talent for jumping safely, arises from the early habit of looking for pasture. We hardly think this is true, as the pasturage on which they are kept, as a rule, is as good as, or better than, our own. Besides this, Irishmen are quite aware of the value of good feeding for stock. They get plenty of early schooling in a head-stall and leading-rein, and they soon learn to take care of themselves. Their greatest fault is that they sometimes know more than their riders.

The *Steeplechaser* requires but little further notice, as he has become, to all intents and purposes, a cast-off race-horse. He was formerly selected from the very best class of thoroughbred hunters, and it was a splendid trial of nerve and skill on the part of a rider, and of magnificent fencing powers and endurance on the part of the horse, to get over four miles of good hunting country without an accident. The competition was manly, and the sport conducive to the propagation of good horses and fine horsemanship. Such is the class of horse which we have placed by the side of our high-class hunter. The *steeplechaser* shows a little more breeding of the two. But how all this is changed, any one may see by a visit to one of those obnoxious suburban meetings, where the competitors are announced for sale at 30 sovs., to carry 10st. or less, about two miles and a half; and where the only encouragement given to anything is to the publicans, the "welshers," the ring-men, and idle apprentices, who assemble upon these festive occasions. There are, happily, still some exceptions to this; but such descriptions are characteristic of the modern *steeplechaser*, who is only a means of low gambling and of gate-money. We must look elsewhere for the love of the horse, and his propagation for any good or useful purpose.

STABLE MANAGEMENT AND FEEDING.

General Principles.—Having got your horse, or horses, it will be desirable to know, first, some of the ordinary principles on which he is housed, clothed, and fed. This sounds very simple at first, but it is not so in reality, because horses are not all alike, and mischief is apt to occur from treating them as though they were. Some are good doers, others require much coaxing; some liable to cold, others very hardy; some are dissatisfied without a warm stable, others prefer more freshness of

atmosphere. It is not possible here to treat of each of these cases successively; but with a knowledge of general rules, your own experience will soon come to your rescue in particular cases.

Feeding.—A horse has, for his frame, a very small stomach; digestion goes on rapidly: therefore his food should be divided properly, and given regularly, if possible. This may always be done, excepting when out on a journey, and then a good horse-master usually makes his arrangements more for his horse than for himself. Of course, when the master pulls the phaeton, and the horse sits in it, the arrangement may be altered to suit the circumstances. However, it is not desirable that man should be the slave of his horse, as many men are; an hour or two longer on the road must be submitted to when necessary, and he is a bad constituted horse who cannot go through this. All hunters are compelled to do so on occasion, and the horse that cannot is not likely to find a comfortable place out of London. It is not a good plan to drag along at a slow pace returning home, or going to your destination, with a view to saving your horse; he will be the better for getting to his stable quickly. The only thing to be mindful of, is not to overdo it, as the taking him in leg-weary and feverish will cause him not to eat at all. Seven or eight miles an hour is fast enough for anything. A horse's food should also be made to accommodate itself to his size, and the amount of heavy work he is doing. The ordinary food on which a horse lives consists of hay, oats, beans, bran, and green-meat; and these elements varied answer nearly all purposes. They are given in different quantities, according to circumstances.

Quantity.—It is always bad economy to starve any living creature that is to do work for you; and in nothing is a deficiency so soon discoverable as in horseflesh. The same may be said of the quality of your hay and corn. If it be second-rate, it will find you out in the condition of your horses. We will not insult our reader by the supposition that he would voluntarily buy musty hay or damaged oats. Your horse will repay you for good, sweet, upland hay, even though a trifle dearer, and good, bright, heavy oats, weighing from forty to forty-six pounds to the bushel, when you can get them. Old split beans, when beans are wanted, have seen many a man through the tail-end of a run that he otherwise never could have enjoyed. But we are off our line. The number of feeds in the day should be four—we will say from six to seven, from ten to eleven, from four to five, and at eight p.m. The quantity of oats should be about three and a half quarters a day for a horse in regular work, of moderate size, and a good doer. The hay should be given after the last feed chiefly, to the extent of ten pounds during the twenty-four hours; but should be avoided when the hack is expected to have any sharp work. The other time is in the morning. With the quarters of corn is given a handful of chaff, which is made of cut wheat-straw and good hay, and is thus used to induce your horse to masticate his food, which greedy feeders are apt not to do.

Hay.—It is prudent to remind the reader that there are more sorts than one. New hay is not wholesome, because there is a certain fermentation necessary to take place before it can be good for horses. The lowland hay and pure clover are neither of them fit for quick horses, though the latter is cut into chaff. Upland hay has a fine scent and a greenish colour; should it be dark or brown, it will have lain out in the wet or have been too quickly got. Lowland hay has often dust in it from being washed by rain, or from the wet plants which grow among it. Musty hay has a very bad smell, and is very dark and dingy in colour; it is most deleterious to horses, and should never be given as chaff or in any other form.

Oats.—We have already said that they should be clean and bright and full, not too thick in the husk; and should weigh, if possible, from forty to forty-six pounds a bushel. Of course, the weight of the oats will make a difference in the value of each feed. Hacks and harness horses should be kept round and symmetrical, and should be fresh without being mischievous, which they become by over-feeding. Oats are often dried artificially, which is considered to be injurious to them. We do not know why, nor is it so when the oat was originally healthy. No kiln-drying will turn a bad oat into a good one. We remember a constant question years ago which always appeared in the newspapers, "Do you bruise your oats?" which no one had the courage to answer but Charles Dickens, who said very boldly, perhaps untruthfully, "No, we do not; for the best of all possible reasons, that we have no oats to bruise." Our reason is not his; but is simply this, we think it much better that horses should do it for themselves when they can. This, however, is a matter of opinion, and as we claim the right to express what we think of such matters, we willingly accord no less to those who, on such a subject, may differ from us. In good stables oat-crushers are not common, excepting under peculiar circumstances of constitution. Chaff is better for greedy feeding. Mastication is a law of Nature.

Beans are necessary to hard-worked horses of all kinds, more especially to old ones. Hunters require them, and they act upon them as stimulants. They must be given in moderation, lest they attack the eyes or the feet; and they are not good for the wind, though as forming a mere portion, and that a small one, of regular food, they will not be found injurious. A double handful at each meal is sufficient, and the oats should be diminished in proportion. We do not recommend them for horses in ordinary work. They sometimes keep muscle on delicate feeders, when no other sort of corn answers the purpose. They ought to be a year or two old when given, as new beans are very bad for the digestion, and cause flatulency and broken wind.

A mash of bran and oats should be given once a week, as on Saturday night, when the horse will lie still the next day; and linseed is also valuable. The Germans feed their horses much upon rye-bread, and it is a usual accompaniment to a day's journey. Gruel is another form of restorative with which the horse-owner should be conversant. It is made of a sufficiency of oatmeal and water to form a consistency of porridge when stirred up; it is placed in boiling water, and stirred over the fire till it assumes its proper thickness; it is allowed to become lukewarm, and is then given. It is one of the best cordials to a tired horse, and, if a horse be at all *thick-winded*, will be found an invaluable food for a long journey, giving oats only at the long bait, when there will be time to digest them.

Water.—Horses prefer water which has been for some time subjected to the action of the atmosphere. Buckets-full, however, left in the *stable*, as we frequently find them, do not answer that purpose. It was the fashion to give horses very little water at all, with a notion that it was bad for their coats and for their wind. This has been found to be a mistake, and, unless in the exceptional cases of sharp galloping soon after its administration, water does no harm whatever. In some stables it is left to the discretion of the horse, in others the groom gives a plentiful drink at each feed; and the horse soon learns to take as much as he wants and no more. This is the secret of success in the water allowance. A full allowance may be given at bedding-up time, and in the morning, excepting when going to meet hounds, when a diminution should take place. At ten o'clock, too, in case of the horse being wanted and galloped, some modification should be observed; but at four, when the horse has

done his work, and an interval has passed in dressing him over, he may have what he likes. Hunters will sometimes not feed without their water being given. Water should not be hard, as will be shown by the state of the coat; and so remarkable is the influence of water upon the health of the horse, that whole stables have become affected by a move of a few miles. Trainers know this well, and are very careful to do all in their power to neutralise the bad effects of the change. Neither does it matter in many cases whether it be from soft to hard, or hard to soft, the horse is equally affected. We speak, happily, of a few localities only; but it behoves men to be careful in estimating the character of a trainer or a jockey, when his success or failure may depend upon such a simple circumstance.

Green Meat may be made to combine those grasses which are given as temporary changes during the spring and summer months. They are slightly aperient, but tend at the same time to increase weight and size. The principal of them are tares; they should not be given fresh, but are better after lying exposed to the atmosphere. Clover is also very fattening, and grass mown beforehand answers the same purpose as tares. Carrots, in moderation, are very good indeed; they act upon the coat, and are said to be advantageously given to thick-winded horses in moderation. But whatever the food, it must always be regulated by the size, work, and constitution of the horse. Galloways, ponies, and small hacks should have a proportion of oats taken away, while a hack of full size and in hard work will not hurt on four quarters a day.

Turning Out.—This is a good opportunity to touch on a subject on which there has nearly ceased to be two opinions. How can a poor man turn out his horse? He always wants him, winter and summer. Why should a rich man turn him out? He cannot possibly care about the little saving it may be. We see no advantage to be derived from it. In winter it is cold, wet, miserable; and to be of any service to legs and feet, the horse must be thrown out of use for six or seven months. In summer it is hot, hard, and the flies are most irritating; excepting at midnight, it can be of service in no way at all, and then he is very likely to be stolen, if worth it. If rest be necessary for legs and feet, there is nothing so good as a large shed and a yard to run in and out laid with tan; the horse may thus get perfect rest, if he be not needlessly disturbed. It takes a horse months to get into condition, so that our theory and practice is never to allow him to get out of it.

The commonest litter in a stable, and the best, is wheat-straw. A bolting of straw is thirty-six pounds. In a fair-sized box or stall an economical groom need not use more than from two to three, perhaps only three, a week. In the country the manure is used as a set-off to the straw. Other straw we do not recommend, and all the other substitutes, as leaves, tan, &c., are fit for farm-horses. In our next paper on Horses we shall give attention to the subject of Stabling, &c.

ODDS AND ENDS.

To exclude the Air from Wine or Bottled Beer.—This applies to bottles that have been opened and have to be closed again, and prevents the liquor from becoming flat. Immediately upon corking it up again, turn the neck of the bottle downwards, always keeping it in that position, which can be securely done by having a board laid across like a shelf, perforated with holes large enough to admit of nearly half the bottle; it can be kept thus either in a cellar or a cupboard. The next best way is to lay the bottle on its side.

Iron Stand.—It is very important to retain as much heat in the smoothing iron as possible, which cannot be

done with an open iron-stand, for it not only extracts some heat itself, but admits the air from the bottom. This can be obviated by any non-conducting substance, but a clean white brick is perhaps the most convenient, as it keeps the heat so long, and retards radiation.

Blowing-out the Candle.—One could hardly expect there could be much variety in this slight operation; but, like many other things, there is a right and a wrong way of doing it. Hold the candle above you, and blow from beneath, and you will find that it does not smoulder away, but leaves the wick long enough to light easily next time. But by blowing down upon it, we all know the time and patience required to wait till it has melted and overflowed sufficiently to produce an agreeable light.

To stop ordinary Hiccough.—There are two simple methods of arresting this unpleasant affection—by a temporary check in either the respiration or the circulation. The first mode of doing so is by drawing in the breath just before the expected time, and holding it thus till the period is past. If it does not succeed with the first effort, it very likely will do so with the second. The other plan is to squeeze the right wrist with the finger and thumb of the other hand, at the place where the pulse is generally felt.

Garters for Children Superseded.—It is advisable never to begin putting garters on children, and then, as they grow up, they will never require them, but substitute loops to the stockings, and an elastic band, about an inch broad, from each side of the bodice or stays, with a large linen button at the end to slip the loop over. If the loop is too easy, it could go round the button twice, which will make it more secure. This plan is admirable for leaving the limbs in perfect freedom, and does not check the circulation, which, however imperceptible, is, in the course of years, one cause of the cold feet and red hands with which so many young girls are afflicted. This system is also largely adopted by the French, as it gives the straight leg so much thought of by dancers, and which is the first lesson beginners have to acquire.

ANIMALS KEPT FOR PROFIT.—PIGS.

FEEDING, KILLING, AND CURING.

HAVING in the two preceding articles given a short practical sketch of the methods which experience has pointed out as the most profitable for selecting, housing, breeding, and rearing swine, we propose in this paper, as briefly, yet in as useful a manner as possible, to follow out the subject by considering the most approved plans for fattening and killing pigs, and afterwards curing the flesh. In all probability, the poor man will find that it is more profitable for him to devote himself to this branch of pig-feeding rather than to that of pig-breeding; both because, in the latter case, the animals require, perhaps, more attention than the demands upon his time will permit him to give to them; and, also, because the food necessary to keep sows in a healthy and good condition, not only during the period of gestation, but also during the ten weeks or more that she is nursing her litter, must be of a good quality, and good food is decidedly expensive. Consequently, breeding will be found to be less remunerative than feeding, unless the pigs are of a very high class, and a ready market can be found for them. Breeding should be left to the farmer who has plenty of accommodation for a numerous herd, with fields for them to graze in, and a staff of men to look after them. The farmer has, also, the power of providing them with suitable food at a much cheaper rate than others, who have to purchase it; for he gives them the tailings of his own wheat, the whey or buttermilk from his own dairy, the roots grown on his own land, and the straw for their beds from his own ricks. All these things,

and many others needed for the proper management of a herd, the cottager has to purchase; and it is far better that he should fatten the pigs which the farmer has bred, than that he should attempt to breed them for himself. He will find it more to his advantage to buy one, two, or, if he can afford it, and has the accommodation, three pigs of proper age and character, to fatten them as speedily as possible, kill, and cure them. Half of the carcase of one fat pig will sell for enough money to buy another lean one, and the other half will serve for the consumption of himself and his family for a long time. If he should happen to live near a port, he has special advantages in the way of procuring damaged corn, or the sweepings of cargoes and warehouses, for an almost nominal sum, which will repay him cent. per cent.; if he has a patch of garden-ground, so much the better also, as he can then grow his own food to a large extent; if in a dairy country, skim-milk and whey, which are excellent foundations for food, can be had very cheaply; indeed, in almost all localities, there is some staple article of food, which can be bought on very moderate terms, and which will go a long way towards making excellent bacon.

It is exceedingly difficult to fatten a boar at all after he has attained maturity, and when it is done, the flesh is so rank and coarse as to be most unpalatable, and worth but little in the market. Consequently, before a male pig is put into the feeding-sty, it is absolutely necessary that he should be castrated. This should properly be done when the animal is very young, as before pointed out; but if from any cause it has been omitted, it is still necessary before he can be of any use for fattening. It is too much the practice to employ an unskilled hand for this operation, which causes the pig to undergo much more suffering than need be, and is, also, more likely to prove fatal to the patient. A professional man should *always* be called in, even in the case of sucking-pigs; but, as it becomes more dangerous as the pig grows older, an experienced person's advice is the more needful when they have arrived at full age. Sows intended for bacon are often submitted to a corresponding operation, known as spaying; but this custom is, happily, now falling into disrepute, as it causes the animal severe pain, and is as useless as it is dangerous. The flesh is none the better, nor does the pig feed any the more quickly by reason of it, and the arguments of its supporters are wholly untenable in the opinion of most of those who are best able to form a judgment.

The feeding-sties should be well littered down with clean, short straw, and should be wholly under cover. They may also with advantage be kept rather dark, as the pigs will be quieter and less restless than when exposed to the full light of day. Moreover, they will be more inclined to sleep, which should be encouraged; all outdoor exercise must be stopped, and all incentives to excitement carefully kept away; strangers should be, as far as possible, excluded; the atmosphere should be kept at a high, even temperature; the food must be good, and rich of its kind, and occasionally varied; in short, everything should be done which will be likely to induce the animal to eat when it is not asleep, and to sleep when it is not eating.

Plenty of barley, oat, or bean-meal forms in general the foundation of the food. This should be mixed with sufficient water, or milk, if it can be got, to render it palatable, and the mixture should be almost thick enough to admit of a stick standing upright in it; vegetables and pulped roots may then be added, and also sometimes a little sugar. Bran, Indian corn, linseed, and hemp-seed will also be found useful as a change; and cut vetches or tares, lucerne and clover, thrown into the sty, have a beneficial effect in keeping the animal in good health. The food should be given to the pigs at regular stated hours, three, or even four, times a day, and just as much

should be supplied each time as they will eat with avidity. They should never be in the least stinted in quantity, but, at the same time, it is almost as great a mistake to overfeed them as to give them too small an allowance. The feeding-troughs should be in the sty, under cover, that rain and dirt may not collect in them and spoil the food; and, further, before putting any fresh food into them, the attendant should always carefully clean them out, removing any relics of previous meals, lest they should have become sour and bad. Animal food should never be allowed, though it is not an uncommon practice to give it; but the soup in which flesh or bones have been boiled down may be used to mix with the meal.

As the pig becomes fatter he will require less and less food, consuming at last not much more than half the quantity which he devoured when first he was confined in the pen. If at any time he has difficulty in breathing, or shows other symptoms of surfeit, some purifying mixture should be placed within his reach. Cut green food, such as vetches or clover, as recommended above, are given in order to obviate this; but should they not be sufficient to prevent it, some salt or powdered sulphur may be administered in the food, and gravel or coal-ashes should be strewn about the sty, and this will generally have the desired effect.

Some feeders have adopted with pigs the plan which is very commonly employed in the case of cattle, namely, that of feeding them over a pit, into which all the manure falls, and which is never cleaned out until the animal has left the sty for the butcher; but this cannot, in our opinion, be recommended. We are inclined to believe that a pig thrives better if the sty is carefully cleaned out at frequent intervals, and fresh litter provided. In this way the sties will be kept almost free from the offensive smell which too often pervades them; and, secondly, more manure will be made and saved. The latter is an important consideration, inasmuch as the manure of a fat pig is the richest and most valuable for the farm or garden that can be obtained. Moreover, when a large quantity of it is allowed to accumulate, the pigs are apt to become covered with vermin, which is, of course, very detrimental to their health. If this is found to be the case, they should be well washed all over with soft soap, and thoroughly dried afterwards; but, as this proceeding annoys the animals exceedingly, it should not be resorted to unless absolutely necessary. It should be remembered, however, that all pigs are the better for being groomed and dog-brushed every day, and the occasional application of a little linseed oil on the brush is also efficacious in cleansing the skin.

In the work on this subject by the late eminent veterinary surgeon, Mr. Youatt, he tells us that, according to the chemistry of pig-feeding, it takes $3\frac{1}{2}$ lbs. of starch to make 1 lb. of fat, and $3\frac{3}{4}$ lbs. of barley to make 1 lb. of pork. So, if pork can be sold at 6d. per lb., and barley bought at 1d. per lb., it is profitable to make pork; but it is a poor speculation when the farmer only gets the manure for his pork. And, again, quoting from a report by Mr. Lawes as to some experiments in feeding, he writes:—"The average consumption of corn per pig per week was 60 lbs., or about 9 lbs. per day, which produced 10 lbs. to 12 lbs. of meat per week, or about $1\frac{1}{2}$ lbs. per day." A Yorkshire farmer gives his testimony in the same useful volume, as follows:—"I can put on 18 lbs. a week until a certain time, and then they begin to put on less and less every day, until at last you feed at a loss. The pig should be killed when the point of profit for daily food is turned. For this reason the pig should be weighed weekly. After trying nearly all the different kinds of cereals, and weighing my pigs once every fourteen days, I have come to the conclusion—if you want to gain weight fast, give plenty of barleymeal and milk; if you want to make the most of the food consumed, give

boiled vegetables and boiled meal, and finish off with raw meal. On the first plan, time is saved at the expense of food consumed; on the second plan, time is lost and the food saved."

Before any operation can be performed on large pigs, it will be necessary to secure them firmly, and, fortunately, this can be easily and safely effected. A slip-knot must be made in a strong cord of moderate thickness, and then, if the loop is dangled before the pig's face, he is sure to bite at it, and endeavour to get it into his mouth. If, however, he has become too wary, in consequence of having been caught before, some food should be offered him to induce him to open his jaws. In any way, with a little perseverance and quiet usage, the noose can be got just behind his front teeth on the upper jaw; the rope quickly pulled tight, and passed round a post, or fastened to a rail, and the pig is secured; he will be sure to pull at the rope as hard as he can, and the harder he pulls the tighter does the knot become.

When it is decided that the pig is fit to be killed, he must be kept without food for a few hours, in order that the intestines may be empty. He is then stuck by the butcher deeply in the side of the neck, in order that as much blood as possible may be drained off. As soon as he is quite dead, the next operation is to scrape off the hair and bristles, which may be effected either by scalding or burning. The course to be adopted will depend on the use for which the meat is intended. If it is to be eaten as fresh pork, the carcase should be plunged for a few moments into scalding water; then taken out again, and laid on a block or table, and scraped with a knife until every vestige of hair has disappeared. Bacon pigs, on the other hand, are usually singed with straw. In this case, the body is laid on a layer of straw, and is, also, thinly covered over with it; the straw is set on fire, and the bristles immediately scraped off, as in the former case; but it must be kept perfectly dry, and no water should be used in the process. It is by no means easy to do this successfully at one attempt, and, if all the hair has not been got rid of, the body should not be wholly burnt again, but a handful of lighted straw should be carefully passed over that part where the bristles still remain. In this manner the pig may be thoroughly cleaned, and the bacon is decidedly better than when the scalding process is made use of, inasmuch as the meat is firmer, and the sinews and veins more contracted. Having prepared the pig so far, the next steps are the opening it, cleaning, dressing, and finally cutting it up.

A few hints may, however, be found useful as to the curing of large pigs. For salting down the sides it is necessary to procure a large table or stone, so made as to allow all moisture to run off from the meat while it is being cured, and to this point special attention must be paid, as, if the bacon is permitted to lie in the brine, it will be inevitably spoiled. The table being placed in a cool, dry room, the flitches of bacon should be laid upon it, and thoroughly rubbed with salt; then placed one on the other and left for a few days. The rubbing with salt must be constantly repeated: so much of the old salt as has not sunk in being first carefully brushed off. The time required before it is thoroughly cured will depend on circumstances, and must be left to the discretion of the curer; but six or eight weeks may be named as usually sufficient to effect it.

By another plan often adopted bacon is hung up in a chimney, and smoked over a wood fire, but this is a dangerous process for an inexperienced hand to attempt. It is first sewn up in matting or thick cloths, and hung sufficiently high to avoid all risk of burning. The wood employed may be of any kind except pine or deal, which will give it a bad taste, and care must be taken not to continue the smoking longer than is necessary.

THE HOUSEHOLD MECHANIC.

CONSTRUCTION OF GLASS HOUSES AND CONSERVATORIES (continued).

THE sashes to form the roof are somewhat different in construction to those we have described, page 228. In this case, the bottom rail is thinner than the upper one and the styles, in order that the glass may be so placed as to run over it, and allow of the free passage of the rain-water. This difference in thickness will be equal to the depth of the rabbet which receives the glass. Thus, if the sash be one and a half inches in thickness, and the rabbet half an inch, the bottom rail will have to be one inch in thickness. The styles should be morticed precisely as we have described for the side sashes. The tenons upon the bottom rail will be what are called bare-faced—that is, the tenon will be cut all from one side, and will only have one shoulder, as shown at Fig. 1. This rail should not be less than six inches wide, while the same dimensions as we have given for the styles and top rails of the side sashes will be also suitable for these sashes. The upper ends of the sash bars will require cutting, in exactly the same way as we have already described for the other sashes; but the lower ends will have to be somewhat different. The best plan is to cut them as shown in Fig. 2. From this it will be seen that the rabbeted portion of the bar, A, is left much longer than the lower part—in fact, it should reach to the lower edge of the bottom rail. Beneath this, the tenon, B, which should be rather thinner than those used in other parts of the sash, should be formed, and, of course, fitted into a corresponding mortice in the rail. When these bars are fitted, the sash may be wedged up in the usual manner, and a brad or two driven through the projecting rabbeted portion, A, to keep it in its place.

The next thing will be to fit the sashes into their places; but before this is done, the stops which are to keep them in position will have to be fitted to the framework. For the side sashes, all that will be required will be to prepare a few slips of wood, about half an inch in thickness, and about one and a half inches wide, which must be cut in and nailed to the framework, at the requisite distance from the front of

the building, so as to form a rabbet of the thickness of the sash.

Into this rabbet the sash should be fitted, by fixing it firmly, so as not to rack it, and reducing its width by planing. If the sash is to move, there should be some little space left, to allow of its free working. Carpenters

say that there should be room on each side to admit of the insertion of a sovereign, but if the sashes are to be fixed, of course they should fit tightly into their places. For the kind of glass house which we are now describing, the best way will be to hang the sashes with hinges, either to the uprights, or to the upper plate, according as it may be wished to have them open. Either "butt" hinges, which are usually of cast iron, or "back-flaps," which are of wrought iron, may be used; the latter being, perhaps, the easier for the amateur to fit, as all that is required is to fix the sash into its place, and screw the hinges on to it and to the framework. It will be best for the tyro to hang all the sashes before they are glazed, for fear of breakage; and then, when the glass is in, he will only have to screw the hinges on to the frame, as they will not need removal from the sashes themselves. Any kind of fastening may be used to secure them when shut, but a common iron "neck bolt" will be most convenient.

The manner in which the sashes forming the roof are arranged, is a matter for the constructor to decide. In some cases these are fixed, in others they are made so as to open by sliding down from the top. Of course, the first-named plan is the easiest, and for a small conservatory, mostly all that is needed. For the convenience of the builder, we will here describe both plans, leaving the reader to choose that which he thinks most suitable to the work in hand.

In either case, the sashes must be constructed of sufficient width to allow of their resting on the rafter about an inch on each side. If they are to be fixed, the best plan will be to screw them to the rafter through the styles. The space between the two sashes should then be filled up, by means of a slip of wood of the same thickness, which may be nailed to the rafter. A second slip of wood, about an inch in thickness, and bevelled off on both edges, should then be screwed on, so as to cover the joints and keep out the water. This arrangement will

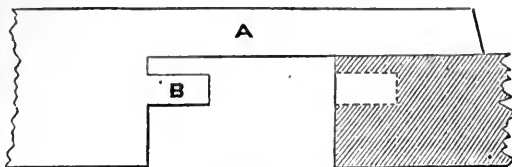

Fig. 2.

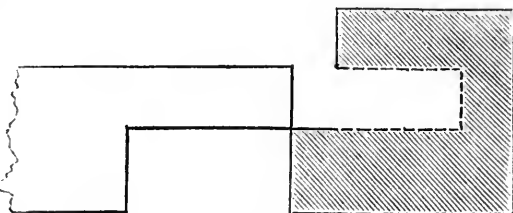

Fig. 1.

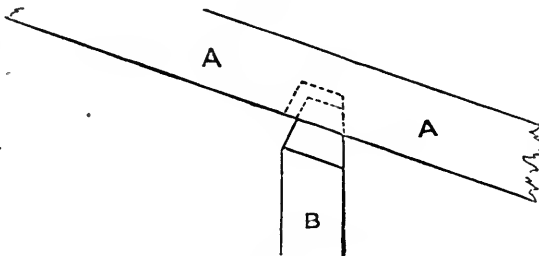

Fig. 6.

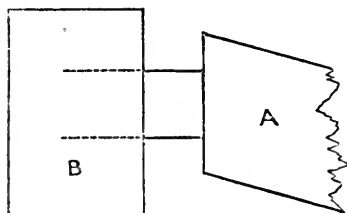

Fig. 4.

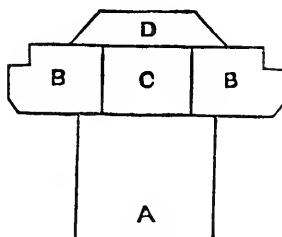

Fig. 3.

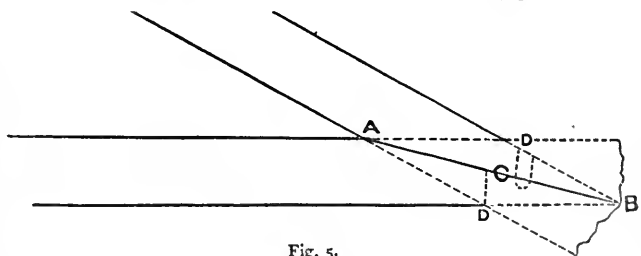

Fig. 5.

be readily understood on referring to Fig. 3, which shows a sectional view of it. In this diagram the letter A indicates the rafter; B B the sashes; C is the slip of wood which retains them in position; D is the ridge, or the stop, which is intended to close the joint, and which must, of course, reach along its entire length. When the sashes are to be fixed, it is a good plan to bed this slip well in thick white paint before screwing it on. The water may be excluded from the upper part of the building by means of either a slip of wood screwed to the top rail of the sash, and beveled on its lower edge, or by means of a strip of zinc; the latter is perhaps the best. If zinc be used, the joint of mortar in the course of brickwork nearest the sash should be taken out to the depth of about an inch, and the zinc bent so as to be fitted into it, and secured with small iron wall-hooks. The lower edge should then be dressed down to fit the top rail of the sash, and tacked to it; after which, the joint of the brickwork should be re-pointed with good mortar or cement.

If the sashes are intended to slide, some little difference will be needed in these arrangements. The slip, C, which separates the sashes, will require to be about an eighth of an inch thicker than the sashes themselves, to allow of their working easily. Care must also be taken to fix it perfectly parallel, or the sash will become fixed. It will be well to leave plenty of room between the sashes and the slips which divide them, to allow for the paint and for that expansion of the wood which is certain to occur in damp weather. To raise and lower the sashes, a cord or sash-line should be secured to the bottom rail, and passed through a strong pulley fixed to the upper plate. As the sashes will rarely require to be opened more than half way, it will be advisable to fix a stop, to prevent their slipping further. A block of wood should be screwed to the rafter about half way down, so as to nearly touch the styles of the sash; and a similar block upon the styles themselves, in such a position that, when the sash is half way down, these pieces may meet. This will prevent the sash from slipping entirely down in case of accident to the cords. The arrangements for keeping the water out of the upper part of the roof will be precisely similar to those at the sides of it; that is to say, the slip, C, must be carried round the top of the sash, and the ridge piece, D, screwed on so as to overlap the top rail about an inch. Unless for a special purpose, it will not be necessary to make more than one sliding-sash in the roof of an ordinary sized glass-house; and the fewer there are the better, as there is always some risk of breakage incurred in moving large and heavy sashes, such as those we are describing. As in the case of the side sashes, the whole of the fitting should be done before the glazing is attempted, that there may be no risk of breaking the glass.

The roof and the square side sashes being completed, the next thing will be to construct sashes with which to fill up the two triangular spaces between the upper plate and the rafters at the ends of the structure. This will, doubtless, seem rather an awkward job to the tyro, but if our instructions are carried out, he will find it much easier to accomplish than would be supposed. The first thing will be to prepare three pieces of wood, of the length required to form the top and bottom rails and the style next the wall, and these should be of the same dimensions as the styles of the other sashes. The style next the wall should then be fitted in between the rafter and the upper plate, close against the upright of the framework. Tenons should then be cut upon the top and bottom rails, the latter one being precisely similar to those used in the other sashes. The top rail will require cutting as shown in Fig. 4, in which A represents the rail, and B the style; and the easiest method for the tyro in fitting this joint will be to cut the tenon first, and then apply the rail to its place, and mark the place for the mortice upon

the style. The mortice may then be made, and the tenon fitted to it. At the lower angle, the junction of the top and bottom rails will require fitting, as shown in Fig. 5. In order to effect this, the rails should be laid across each other, as shown by the dotted lines. The point at which the inner sides intersect each other at A, should then be marked, as should also the end of the sash, B. The line, C, drawn from these two points, must then be cut through on each piece, and the two joined by means of screws placed through them at D D. When this frame is made and temporarily fixed together, it should be fitted into its place before the bars are inserted. When this is effected, the places in which the bars are to come should be set out on the bottom rail, and squared over to the top one with a drawing-square; of course, taking care that they are perfectly parallel, when the frame may be taken apart and the necessary mortices made. When this is done, the frame may once more be temporarily put together, while the bars are fitted to the upper part of the sash. This will require some care, as the tenons and shoulders will have to be cut at an angle, as shown in Fig. 6. A being the top rail, and B the bar, the length of each bar must be marked off at the bottom rail, and when all are fitted at the top, the tenons at the bottom may be cut and fitted into their places, and the sash wedged up and inserted into its place.

Stops should be cut round these sashes in the same manner as described for the others, and when glazed they may be nailed into their places. This will complete the whole of the outside work, with the exception of the door, which may be of the usual form, or what is known as a sash door, the latter being one in which a sash is substituted for the upper panels. The construction of doors has been described in former numbers; therefore, we need only remark that, for the sake of uniformity, the top of the middle rail should be kept level with the sill of the side sashes, and the space which is usually occupied by the top panel fitted in with a small sash, made exactly like those used for the side lights. Stops must, of course, be fitted round the door, and if the conservatory be small, it will be well to arrange the door so as to open outwards.

The building will now be ready for glazing, but before the glass is put in, the whole of the wood-work should receive at least one coat of paint; and as, in most cases, the construction of a conservatory will occupy the amateur for a considerable period, it will be advisable to paint each part as soon as finished, in order to protect it from the weather.

The arrangement of the internal fittings must be left to the constructor, as must also be the choice of material for the floor. If wood be used, joists must be laid on the lower plate, and supported in the centre by an extra plate laid on brick piers, as described for summer-houses. The flooring should not be laid close, but a space of about an inch left between each board. We should, however, advise that bricks, nicely laid in courses of alternate colours, be used in place of wood; or, better still, the fancy tiles made for the purpose, and supplied by Messrs. Roshier, of Blackfriars.

Although in this paper we have confined our descriptions to a very simple form of building, the intelligent amateur will find no difficulty in applying them to more elaborate work, the principles being in all cases the same. When the building is to be used for the display of rare plants, and is intended more for a place of recreation than for actual service in rearing plants, care should be taken to make it as elegant as possible. Thus, the sashes and doors, instead of being divided into equal spaces, should have narrow marginal lights, which may be filled with stained or embossed glass, which, with various other little matters, which we have fully described in another article (see page 248), will give an elegant and pleasing effect to the structure, at little extra cost.

We think the instructions we have now given will enable the household mechanic to construct either a greenhouse or conservatory with comparative ease. We would, however, advise that a drawing be made, to a scale, of the intended erection, and all the dimensions carefully marked upon it, before any part is commenced. At the present time, sash bars may be obtained at most timber yards already prepared for use, and quite as cheap as the amateur can make them. This saves much labour, and removes one of the chief difficulties, namely, the construction of sash-work.

Before attempting to construct an entire building, it will be advisable for the tyro to make a few small sashes, such as are used for garden frames. This will not only be useful work when finished, but it will so initiate him into the art of sash-making, as to enable him to execute larger works with ease and certainty.

ODDS AND ENDS.

Hanging Flower Baskets.—Elegant hanging baskets for windows or greenhouses can be made either at home or by order from the carpenter. First take a square of wood (Fig. 1), and fix to the four corners four long, stout, but very slender, iron wires, such as suspend the Paxton baskets. The best way to do this is to drill holes at the four corners, which may be done with a small red-hot skewer; pass a wire under the wood, and bring the two ends up through two opposite holes. Cross this with another wire in a similar way. Tie the two wires together where they cross by a piece of thinner wire, and then press the square of wood down close upon them. Branches of tree, about three inches wide, even, smooth, and equal, are wanted; and the silver bark looks especially well. Cut these in lengths, a little off the square—about an inch. There are four to every side, which should be as uniform as possible. Drill holes in all of them, an inch from the edge. Then string them on the wires in the way shown in Fig. 2. Unite the wires at the top by making a loop to each at the same distance from the basket, with the aid of a pair of pincers, slipping a larger wire ring through them—an S-hook will be stronger. Whatever is used must be very firm, because it will bear the weight of the pot. Fill the sides of the basket, between the logs, profusely with green artificial moss, and also the top when the flower-pot is inside. Any kind of plant not a creeper is suitable to fill the basket; or a vase of cut flowers, also embedded in the moss, makes a pretty centre-piece which can always be renewed.

To use Salt Sea-water for Washing.—As persons living close to the sea have sometimes a scarcity of fresh water, it is often useful to know how to make salt water available for washing. This may be done by adding soda to the sea-water. The water will become cloudy, and a white precipitate will fall down. When this has settled, the fluid may be poured off for use. The soda acts by decomposing the chlorides of calcium and magnesium, and, by supplying excess of free soda, prevents the chloride of sodium from injuring the soap.

To fix Crayon Drawings.—Make a strong solution of isinglass and water, and wash the drawing-paper all over with the mixture. This makes a good surface for drawing on; and when the drawing is completed, hold it horizontally over a basin of steam. This will cause the size to melt, and absorb the crayon. Allow it then to dry

thoroughly, and the drawing is fixed. It may be sized several times during the progress of the drawing, the effect being better after each absorption.

To join Tortoiseshell.—The ordinary method of joining tortoiseshell is by the combined effects of heat, moisture, and pressure. Bind the two parts together with a wet cloth or piece of linen; make the tongs hot, and with these press the joint together.

To prepare Crayons for Drawing on Glass.—Dissolve equal portions of asphaltum and yellow wax; add lamp-black; and pour the mixture into crayon moulds. The glass on which you are about to draw should be well cleaned with a leather, and must not be soiled afterwards. When trimming these crayons bevel from the edge, and the point can be made very fine.

To preserve Delicate Steel Articles from Rust.—Paint the articles over with white bees-wax dissolved in benzole. The benzole rapidly evaporates, leaving the steel covered with a thin coating of the wax, by which it is preserved from the action of the watery vapour in the atmosphere. As the solution is very volatile, it should be kept

in a glass bottle, furnished with an accurately fitting stopper.

Flexible Paint, useful for canvas coverings and blinds which are rolled up, to be made as follows:—Take one and a half pounds of yellow soap, cut into slices, and dissolve it in one gallon of hot water. When dissolved, and while hot, add a hundredweight and a quarter of oil-colour. Smaller quantities can of course be made by preserving the same proportions.

To remove a Scorch Stain from Linen.—We give an additional receipt for this purpose (see page 148).—Peel two onions, extract the juice, and mix it with half an ounce of soap, two ounces of fullers' earth, and half a pint of vinegar. Boil this mixture well together, and, when cool, put it on the scorched linen, allowing it to dry on; afterwards wash it in clean water, and rinse.

To gild Leather.—Leather used for bookshelves, or to exclude draughts from doors or windows, &c., may be decorated with gilding in the following way:—Apply white of egg with a brush; then lay on the gold leaf sold in books for gilding (see page 274); and, when dry, burnish with an agate burnisher, or with the tooth of some animal.

To take out Spots of Pitch, Tar, or Turpentine from Linen, Silks, or Woollens.—Scrape off as much as you possibly can; afterwards moisten the places with salad oil, and let it remain for a day. If cotton goods, they should then be thoroughly washed in strong warm soap-suds; or, if silk or woollen, apply some ether or spirits of wine to remove the grease. (See also page 148.)

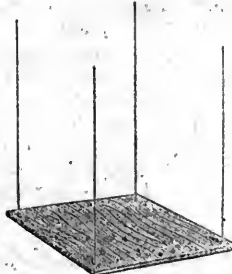

Fig. 1.

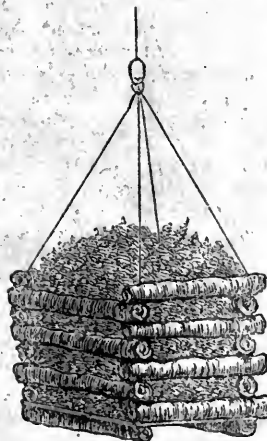
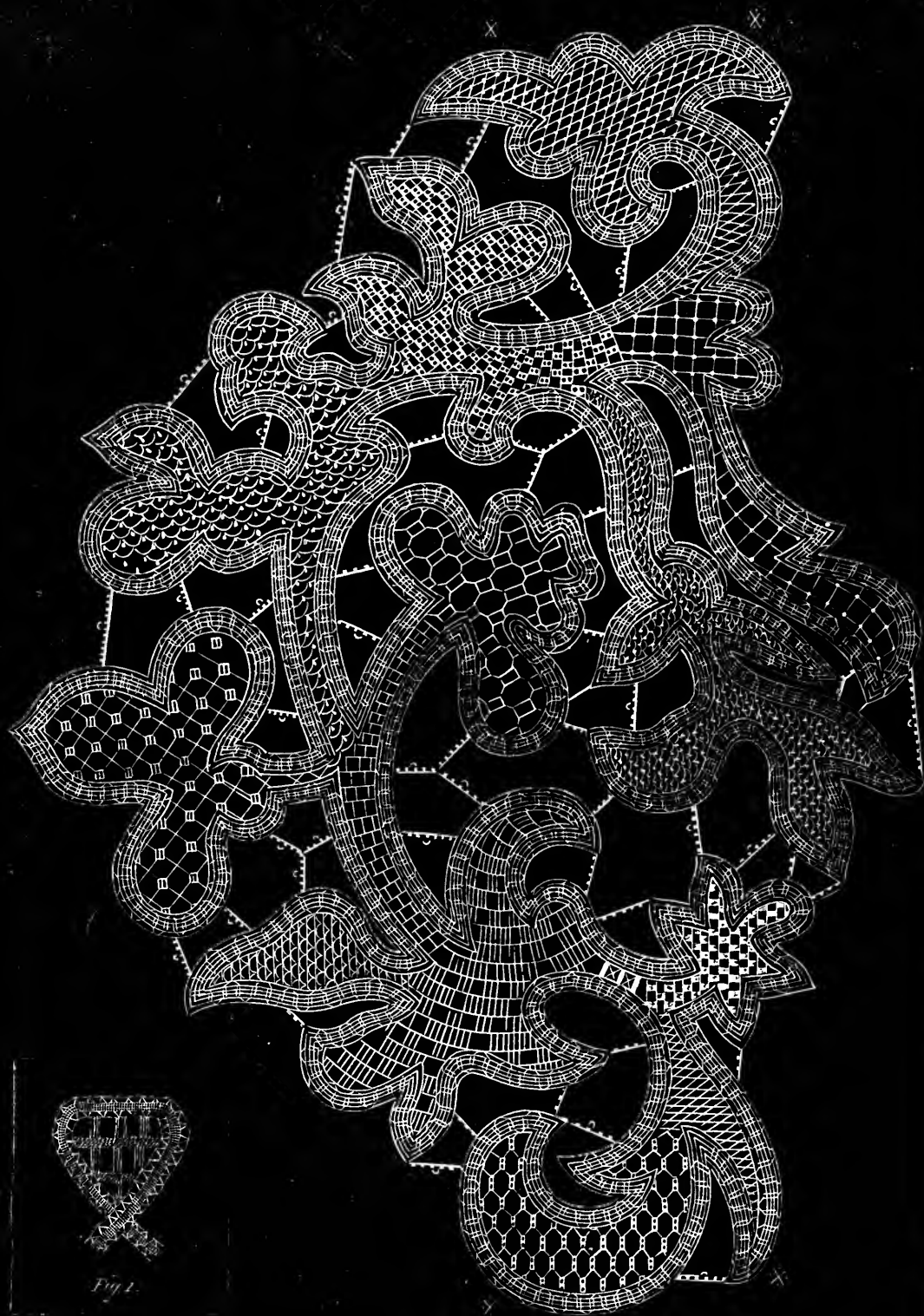

Fig. 2.

POINT LACE WORK.—VII.

THE Mary Stuart Cap, for which we give a design in our present number, is a very fashionable and favourite coiffure at this time, and seems peculiarly adapted for the point lace work, the delicacy and lightness of which is eminently suited for this becoming head-dress. It should be worked in very fine point braid, and with an edge into this edge, a row of open-overcast must be worked throughout on the outer side of the pattern. Great care should be taken in sewing on the braid, to keep well to the



MARY STUART CAP IN POINT LACE WORK.

design, and to retain the sharpness of the pointed leaves, so as to contrast well with the curves of the rounded ones. Our pattern affords an excellent opportunity for the display of open stitches in all varieties, and those which we have given in our former articles may all be made use of with much effect. We now add two which will be found useful. (Fig. 1.) For this a thread having been stretched from right to left, a row of plain overcast is worked and the thread cut; then, beginning on the left, three plain overcast are made into the last row, and then two very long ones, also overcast; then three plain, and again two long, and so on to the end of the row, and the thread being stretched back, three overcast are marked, and then one into each of the long stitches, taking up the second one first, and twisting each as the needle is passed into it; afterwards three overcast, and then the next long stitches taken up in the same manner as before, going on to the end of the row; after this, stretching back the thread, a plain row of overcast is done, and breaking off the thread, the row with the long stitches is commenced again, and the work proceeded with as before. When all this is done, a thread is taken across the long stitches, from right to left, and they are fastened in the centre, where they cross, by taking two overcast stitches round them, as it were with the thread, then carrying it on to the next, and doing the same thing in every row of long stitches.

There are other useful stitches which fill up well. In the first row, two overcasts, done loosely, are worked into the edge of the braid, then a space, and two overcasts, and thus alternately to the end of the row; without breaking the thread, return by working two into the space, leaving the space in this row under the stitches in the last. Going back again, work one between the two, and two into each space all along; then, in returning, a space is left, and one stitch is worked on each side of that which has been done, between the two of the preceding row and so on. Commence again with the space and two stitches, and proceed with the next as before, working the whole backwards and forwards. A lappet is to be joined to each end of this cap, for which we hope to give the design in our next article, as our space forbids our doing so in the present one. These lappets must be joined to the cap by worked bars, at the places indicated by crosses.

The Mary Stuart cap is much used by young married ladies, and it is worn rather forward upon the head, one point covering the front of the head, and the other falling just upon the chignon; the lappets forming a finish to it at each side, or are fastened across, or at the back of the chignon. A full cockade or bow of bright-coloured ribbon is placed on the left side of the head, just beyond the cap.

HOUSEHOLD AMUSEMENTS.

CROQUET.

No game ever worked its way more surely into general acceptance than croquet, and none bids fair to enjoy a wider share of popularity in time to come. It is little more than ten years since it was first introduced into England, but now there is scarcely to be found a lawn attached to the house of a private family where the game is not played, while at watering-places and other public localities provision is being made for strangers to enjoy the pleasures of the game in association with each other. And this great popularity is not to be attributed to novelty alone. The game stands by itself as one in which people of both sexes can participate in an out-of-door pastime, and find both exercise and amusement, while ample scope is given for the display of individual skill and ingenuity. For this reason we anticipate for croquet an enduring popularity in England, and believe it is destined to occupy a most useful place among the recreations which all must take at some time or other, if they wish to preserve health of body.

Croquet is a simple game in itself, although it requires much practice and attention to make a good player. It consists in striking balls with a mallet, so that they shall pass through hoops arranged in a certain order upon the ground. The first requisite for the game is the ground, which should be a level and well-rolled lawn, covered with fine grass, so that the play of the balls may not be obstructed by inequalities either of the soil or that caused by weeds, &c. Nevertheless, a perfect ground is by no means necessary for the game, which may be played on any level piece of turf, from twelve yards square upwards.

The arrangement of the hoops in the ground must depend upon the space at command, but the general character of their disposition will be seen in the example to which we shall presently allude. The usual number of the hoops is from eight to ten; they are made in the form of small arches, the legs or ends of which are inserted about two inches in the ground, leaving rather more than a foot above the soil. The span of these hoops or arches should not be less than five nor more than six inches. They are generally painted white, to make them more readily perceived by the players.

Our first illustration shows one common disposition of the hoops in a croquet-ground, the length of which is about twice its width. The extreme points at top and bottom represent the positions of two pegs, about the height of the hoops, which are known respectively as the starting and the turning-peg. At the outset the player places his ball between the starting-peg, marked A on

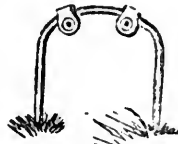

Fig. 3.

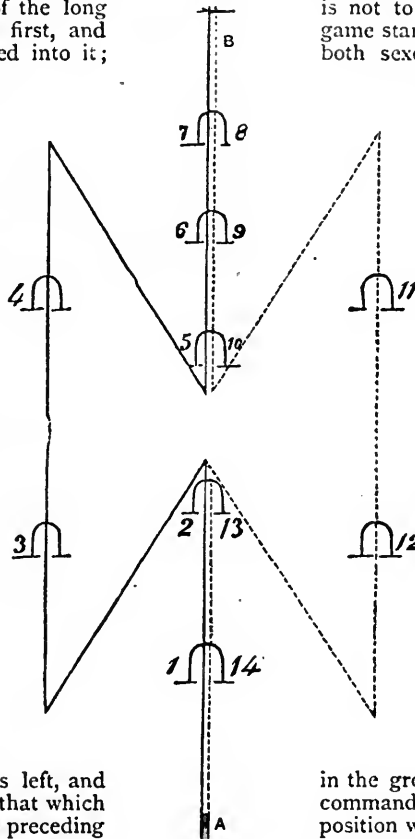

Fig. 1.

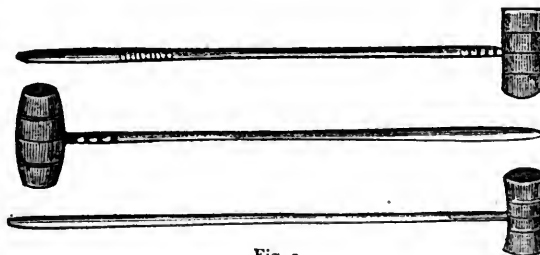

Fig. 2.

our diagram (Fig. 1), and the first hoop, to which the figure 1 is attached. He attempts to drive the ball through this hoop, and afterwards through the other hoops, in the order in which they are marked on the plan. The lines drawn from hoop to hoop show the direction in which the ball must be driven at each successive stroke, in order to make the circuit of the ground. After passing the seventh hoop, the player must drive his ball to the turning-peg, marked B, and, having struck it, he returns to the hoop he last passed, which thus becomes No. 8. Then he proceeds to each of the other hoops, as figured on the plan. All the central hoops are thus passed twice, and the outer hoops on each side once, before the round is completed. The conditions under which the player must make the circuit of the ground will be hereafter explained.

The balls used in croquet are made of boxwood, and are about the size of an ordinary cricket-ball, although varying slightly, according to the rule of the particular maker; but all the balls used in one game should be of the same dimensions. The best size is about ten inches in circumference. They must be painted of different colours, so that each player may identify his own, and that the play of each ball may follow in its proper order.

The mallets with which the balls are struck are of various shapes, the most common forms being illustrated in Fig. 2, page 293. There is no rule as to the shape or size of the mallets which shall be employed, and each player is therefore left to his own option. The usual length of the handles, which are made of ash, is about two feet nine inches; the heads are about four and a half inches long, and the material employed for these is box.

These are all the implements necessary for the game; but when several persons are playing it is found desirable to have some certain means of identifying the hoop through which each player has to pass next in order, and "croquet clips" have come to be employed for this purpose. They consist of small clips of metal, coloured or numbered to correspond to the balls, and attached to the tops of the hoops in the manner shown in Fig. 3, page 293—the rule being to fasten the clip of each player to the hoop through which he has next to drive his ball, so that it may not be forgotten in case his ball should be struck to another part of the ground.

The object which each player has in view is to send his ball through the various hoops, in their successive order, in a fewer number of strokes than his opponents, and so to complete the round as soon as possible; the first to do so wins the game. When only two persons are engaged they take two balls each, and play with each ball, each player thus having at least two successive strokes in rotation. A player must then make the circuit of the ground with both his balls before he has won the game. But when a party of four or more are engaged, each player takes a single ball.

The laws of the game, with some practical advice to the learner, will be given in another paper.

ANIMALS KEPT FOR PROFIT.—CATTLE.

REARING CALVES.

In former papers a general outline of the different breeds of cattle and of management, adapted both for large and small farms, was given. We now proceed to the details of the subject under the heads of rearing and fattening:—

Early maturity is a cardinal point, but although our improved breeds arrive at early maturity, breeding at too early an age is objectionable, whether for stock, beef, or milk. In other words, a heifer should not be considered a cow until three years, and many prefer four years old as

soon enough for breeds that arrive at their full maturity more slowly. The Alderney heifer has been quoted as one exception to this, but the practice of treating it as a cow at two years or fifteen months old, although common in the Channel Islands, is "penny wise and pound foolish," as it sacrifices functional development normally either for breeding or milking. A heifer calf should never be checked in her normal growth by any means. The practical rule is, avoid fattening, but keep her growing bone and muscle normally in the enjoyment of what farmers call "the best of rude health," which can easily be done under proper food and exercise. And what we have thus said of the heifer calf, applies with equal force to the young bull.

Old Age.—Experience must be left to decide when a cow is too old either for breeding or for the pail. It is seldom advisable to breed from a cow after she is ten years old, and at this age she is also considered "used up" in the dairy; but we have had useful cows older than this for both purposes. Some cows go early dry. Those that nurse each only her own calf—as the kyloe in some districts—are dry for three months and upwards, and in not a few cases for the whole of the winter season. They calve about the first of the grass, and go dry when the winter sets in. Some dairy cows which are great milkers are "milked through"—i.e., are not allowed to go dry; but this is not advisable, either for the cow, the quality of her milk at the time, or for her produce next season. Great milkers are generally great consumers, and when fully fed on succulent milk-producing food, it is often difficult to dry them. The proper plan is to put them gradually upon drier food some three months before calving, so as to have them dry six or eight weeks, and when dry, keep them fresh on cooling food, with plenty of light and exercise, to prevent fattening if disposed to obesity.

Breeding Herds are now timed to calve earlier in the season than was the rule prior to the growth of root-crops for the winter feeding. To calve before the grass, was then considered a misfortune both for cow and calf. It is now the reverse, for stock breeders prefer their herds to calve not later than January in the south and February in the north. There are two practical reasons for the change, viz.:—First, cows are enabled to bring up a greater number of calves, and, secondly, calves make more of the first year's grass. In commercial dairies, where the milk is sold, cows are timed to calve as required, so many coming into milk as others go dry, so as to keep up a constant supply for their customers, and the same may be said of family cows, required to keep the house in milk. Butter and cheese dairymen contrive to have their cows in the prime of milking by the time they are turned out to grass. But this rule is also being modified by the progress of indoor management, for as good butter and cheese are now being made from winter food as from the pastures of summer. But of milk, butter, and cheese we shall say more in another place. There are two ways of bringing up calves, the one by suckling, and the other by the pail.

When newly dropped, a calf should not be allowed to take much of its mother's milk; small quantities at a time until the bowels are opened, is the rule, and very great care requires to be taken to prevent the stomach being overloaded with an accumulation of undigested milk, which is liable to coagulate in the form of cheesy matter, and prove fatal. Cows difficult to calve should not be kept—more especially by private families—as their offspring, milking properties, and the quality of their milk are all more or less injured. Again, a milch cow should have a cooling diet at all times, and be in good keeping condition, for the sake of the quality of her milk, but it is more needful both before and after calving, for when her system is in an inflammatory state, sickly or feverish, or devoid of functional energy from poverty, the biestings and new

milk are consequently affected, and also the health of the newly-born calf. When newly-born, the calf is very susceptible of cold, and much more harm is often sustained from this cause than is generally credited. In a wild state cows not only lick their newly-born calves dry, but cover them over to keep them warm, and the instinctive lesson which Nature thus teaches should not be undervalued. Gently rubbing the skin once or twice a day greatly promotes circulation and animal heat. For a short time—some say ten, others fourteen days—the calf is allowed to remain with its dam in a loose-box; afterwards it should have a loose-box of its own, in which it can take sufficient exercise. Some tie it to a stake, but calves when tied never do so well as when loose, free exercise being absolutely necessary to the normal growth of bone and muscle. When tied to a stake or ring in the trevice, they are apt to lie more on one side than the other, and to move in an awkward confined way when on foot, and hence to grow unequally, often greatly deformed. The loose-box should be well littered with clean fresh straw, and have an occasional sprinkling of dry earth and salt, to deodorise the droppings, and thus prevent smell, on the earth-closet principle.

Some farmers allow their calves to suckle twice a day, others three times. We prefer the latter plan, and even suckling four times when cows are great milkers, or when they are suckling one calf for veal. When only turned to their dams twice a day—morning and evening—the calves get too much milk at a time, whilst the interval between meals is too long. This, however, is not the worst feature of the practice, for as the calf must be taught to eat other food, it is liable, if a good feeder, to take a full meal of such, so that when a full meal of milk is added, more or less surfeit is experienced; but when suckled three or four times daily, it takes no more of the other food than it can manage.

Some cows suckle two calves at a time for rearing, or one for fattening for veal—and two and even three sets in a season. The practice is very diversified. In the north some kyloes only suckle one calf, others two, and a few, first two, and then one, thus nursing three calves in a season. Some herds of this breed have been greatly improved, by greater attention to young calves and house-feeding, and in the long severe winters of the Highlands of Scotland, it is subject to further improvement, not only for breeding and the shambles, but also for dairy purposes. Thus, after suckling two calves for rearing or one for veal before the grass season, the cows may be milked as family cows or butter dairy cows during the whole of the grass season, and the milk and butter they yield is so rich and unequalled in quality, that we have been consulted by Highland families in London as to whether a couple of kyloe cows could be kept in the suburbs, and give as rich cream and butter as in their native places. To this we shall return. The Aberdeen, Angus, and Galloway polled breeds have been greatly improved, arriving at maturity of growth a year earlier than they once did, and when properly fed, are capital nurses, bringing up on an average three calves in a season, besides a month or two in the end of the season for butter and cheese, and the same may be said of our improved Suffolk and Norfolk polled breeds. Our improved Devons, shorthorns, and Herefords are like our improved polled and kyloe breeds, many of them not great milkers, but what they give is rich, and it is rich milk that makes good calves' milk, rich not only in butter, but in the caseine, saline, and aromatic properties that go to form bone and muscle, and they are generally good nurses, but no great things at the pail. The half-bred Devons, Herefords, and shorthorns and crosses, are now a very mixed and numerous race, more especially the latter, the shorthorns, some of which are great milkers, and fill the pail, but are poor nurses, and do not rear such good calves as the above improved breeds, which

yield a much less quantity of milk, but they yield milk longer, and sometimes bring up two pairs, and even three pairs, or six calves in a season. Such cows should suckle their calves four times daily.

When a cow suckles two calves, the second is generally bought of some cottager, or town dairyman, who does not rear bull calves, and only occasionally a heifer calf. It should be as near the age of the other as can be, and not removed from its own dam too soon, and, with few exceptions, cows become equally attached to both calves. The second pair are both brought in, and should not be removed from their own dams until they are a week or ten days old, owing to the change of milk; and town dairymen and cottagers ought not to sell their new milk sooner.

The length of time calves are suckled is very varied; some wean the first pair when eight or ten weeks old, the second pair when ten or twelve weeks old, and the third pair or single calf at twelve or fifteen. As the calves grow, the quantity of milk becomes less and less able to support them, consequently they require to be taught to eat something else. At the latter end of the season the quantity and quality of the milk both decrease, whilst proximity to winter is against late calves. But great improvements are now taking place in the growth of root crops and forage plants, and in household accommodation, and the old objections to late rearing are being greatly modified. As good calves are now being reared in autumn as in spring, and in the depth of winter as at midsummer. In point of fact, the old system of rearing and fattening cattle exclusively on the grass, and of starving cows and young stock during the winter half year, and ourselves on salted beef, butter, and cheese, is fast being reversed, for a greater weight of butcher's meat, young stock, and milk, are now produced in the winter season than in the summer time.

Cooked food—as subsequently spoken of under cattle cookery and cooking apparatus—is now preferred in the winter time, both for cows and calves, and also for milk for family use, and in the summer months a greater variety of green forage plants, seasoned with meal of some kind. Much depends upon what the farm produces, but generally more or less artificial feeding materials are now bought both by large and small farmers. Washy food is highly objectionable, and should not be given either to cow or calf. So long as the calf is sucking, very little drink otherwise is required, but towards weaning time the demand for water increases, but it should on no account be given in the form of sloppy food, as such is liable to derange rumination. It is seldom that sucking calves drink more water than is good for them, but to this there are many exceptions, which must be guarded against; and in the majority of cases water both for cows and calves should be filtered, for reasons subsequently shown.

Most of what has been said under suckling calves applies to rearing with the pail. There is seldom any difficulty experienced in getting the newly-dropped calf to take its milk. Some allow calves to remain with their dams a week or ten days, others give them the pail at once. The young calf readily sucks the fingers, and by placing the hand in the pail, the calf, in sucking, draws in the milk between the fingers. The greatest difficulty afterwards is to prevent calves drinking too fast. To obviate this, artificial teats have been used, but nothing very successful has yet been invented. In principle, the artificial teat is similar to the "baby's bottle," and better adapted for the single calf of the cottager than for the numerous herd of the large farmer.

Some give the pail twice a day, morning and evening—giving from one to two quarts of warm milk from the cow at each meal—according to the size of the calf; others milk and feed three times. The latter practice is to be preferred. We shall return to this subject in our next article.

PHILOSOPHICAL INSTRUMENTS FOR DOMESTIC USE.

THE BAROMETER OR WEATHER-GLASS (*continued*).

Gay-Lussac's Barometer.—One of the simplest, and at the same time most efficient, arrangements for accurate observation, is the "Syphon Barometer of Gay-Lussac" (Fig. 4). In this the glass tube is bent, so as to form two parallel legs, both being of the same diameter. The difference between the levels in the longer and shorter limbs is the barometric height. The measurement is effected by

divisions presume the level in the cistern to be constant and not fluctuating; there being, in fact, only one point at which the measured distance will exactly agree with the real distance of the top of the column from the surface of the mercury in the cistern. This is termed the *neutral point*, usually corresponding with 30° marked on the scale, and is ascertained experimentally by the maker during the progress of construction, and *should* be indicated on the instrument, together with the proportion between the area of a section of its tube and a section of its cistern. It is evident that the surface of the mercury in the cistern will

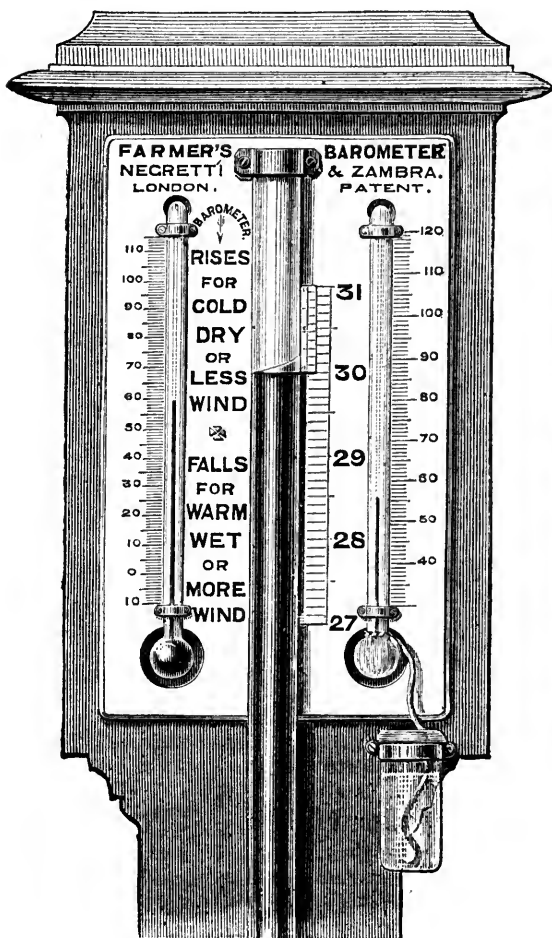

Fig. 6.

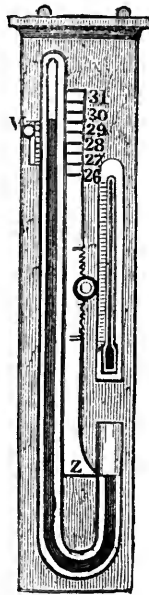

Fig. 4.

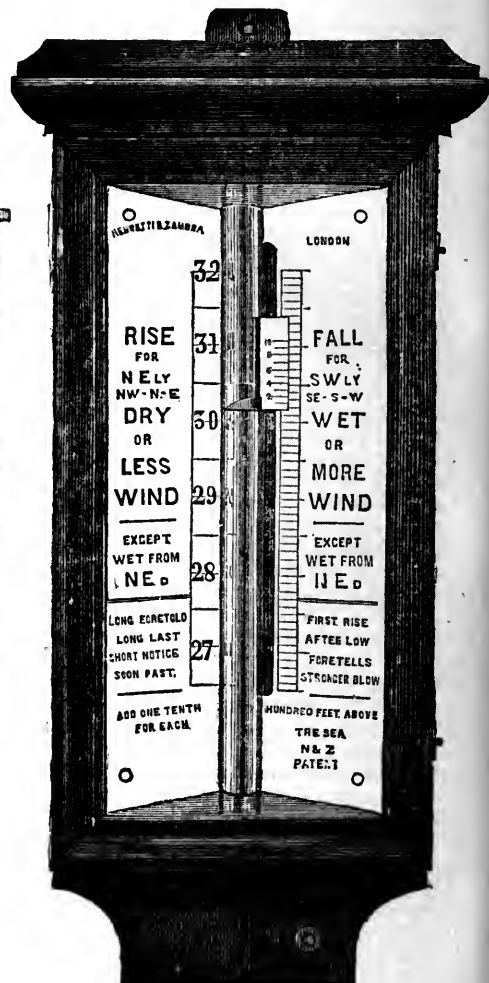

Fig. 7.

a scale, placed between the tubes, the zero point in which can, by a rack and pinion adjustment, be made to coincide with the level of the mercury in the shorter limb, or cistern, *z*; the vernier, *v*, having a separate motion on the opposite side of the longer tube.

The Common Barometer.—For the sake of cheapness of construction, as well as readiness of comprehension and management by unscientific purchasers, in the barometers usually supplied to the public the scales are fixed on the mountings, and no provision is made for adjusting the varying level of the mercury to the zero point of the scale. When the atmospheric pressure diminishes, the mercury sinks in the tube and rises in the cistern, and *vice versa*, but, the scale in this instrument being fixed, will not register the true height of the barometer, as its

below than the zero point *z*, as at *l* (Fig. 4, page 241), when the reading is above the neutral point as at *a*, from the abstraction of a portion of its contents to supply the rise in the tube, and higher as at *b*, when the reading is below the neutral point as at *b*. When the mercury in the tube is above the neutral point, the difference between it and the neutral point is to be divided by the *capacity*, and the quotient *added* to the *observed* height, to give the *correct* height. If the mercury is below the neutral point, the difference is to be divided by the *capacity*, and the quotient *subtracted* from the *observed* height, to give the *correct* height. Thus, if the capacities be as 1 to 42, one forty-second part of the difference between the neutral point and any particular reading must be added in the former case, and subtracted in the latter, to obtain a cor-

rected height. In the ordinary instruments supplied for household use, to avoid the necessity for making such corrections, the cistern is made very wide, as compared with the bore of the tube, to reduce the changes in the level of the mercury to a minimum, so as to be almost imperceptible under ordinary circumstances, so that for ordinary observations the variations in level may be disregarded.

The correction for capillarity being constant for the same instrument, it is generally allowed for by the maker in adjusting the scale. Corrections for temperature may be ascertained from tables that have been drawn up, which will show at a glance the amount to be subtracted from the height of the mercurial column on account of the expansion of the mercury through increase of temperature, the expansion being $\frac{1}{1000}$ of its bulk for each

not perceptible when the mercury strikes the top of the tube, it may be known that air has crept up into the Torricellian vacuum, and that the instrument is no longer in a condition to be depended upon.

The Wheel Barometer.—This instrument is a great favourite as a household barometer, not only on account of its showy aspect, which renders it well fitted as a handsome ornament for the hall, but because it is supposed to indicate so readily what the weather is going to be, and is usually most anxiously consulted before starting for a day's anticipated pleasure at a picnic party, or other rural excursion, and as a simple weather-glass it stands pre-eminent in the estimation of ladies and casual observers; but, if the truth must be told, it is not a very reliable form of barometer, as from its construction it admits of no scientific precision, and only shows

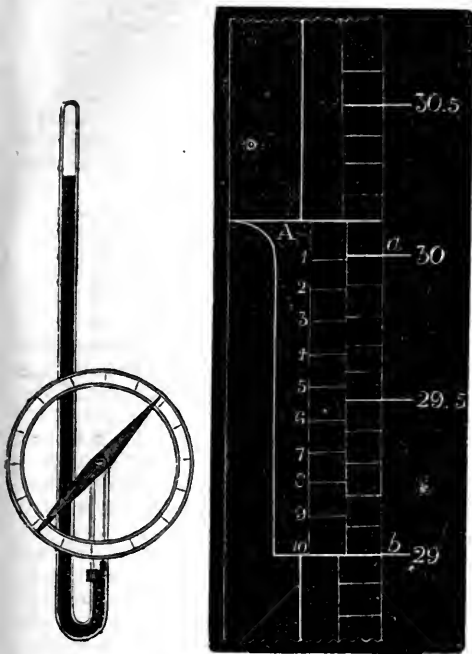

Fig. 2.

Fig. 5.



Fig. 8.

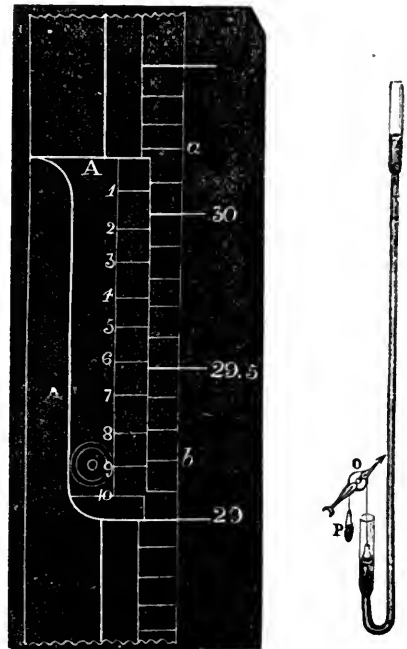

Fig. 3.

Fig. 1.

degree shown by the thermometer above freezing-point.

Fig. 6 is a representation of a modern form of Household Pediment Barometer, the old-fashioned indications being replaced by those suggested by Admiral Fitzroy, as shown in Figs. 6 and 7, which represent the faces of the barometers made by Messrs. Negretti and Zambra for Admiral Fitzroy.

The bore of the tube is about $\frac{1}{16}$ -inch diameter, and is provided with an air-trap, to prevent air gradually creeping up the inside of the tube and impairing its sensitiveness. This consists of a bulb of glass welded on a little above the open end of the barometer-tube, as shown in section in Fig. 5. As the air only creeps up between the glass and the mercury, it will be seen that it must collect in the upper part of the bulb, as the upper end of the tube, being immersed in mercury, is cut off from the sides of the lower portion of the tube that dips into the cistern. If air collects, it is only necessary gently to incline and then reverse the barometer (as for travelling), when all the air escapes from the trap, and the barometer is as perfect as when first made. If, on reversing the barometer, a sharp click is

whether the mercury is in a rising or falling state.

Fig. 8 shows the external appearance of this well-known form of barometer, and Fig. 1 its internal mechanism, by which the variations in the mercurial column are multiplied and so made more plainly evident to the observer; but the friction of the parts of this very mechanism and other causes tend to hamper precise action. It consists of a syphon-shaped tube, terminating at its closed end in a bulb of some size. Upon the exposed surface of the mercury in the cistern rests a small float supported by a fine silk cord that passes round a pulley attached to the axis of the index or pointer and is counterpoised by a small weight, P. As the mercury rises or falls, it imparts motion to the float, which in turn acts upon the index, so as to move it over the dial of the weather-glass, pointing in turn from Stormy—Much Rain—Rain—Change—Fair—Set Fair—Very Dry. The bulb is added to the top of the tube, so that by enlarging the upper surface of the mercury, the difference of level may be made to appear more predominant at the lower end of the tube.

HOME GARDENING.

CELERY (*continued*).—CHERVIL.—CLARY.—CORN SALAD.—CRESS.

Celery (continued from page 278).—Those desirous of gathering and preserving this plant for winter use should, on the approach of winter, and in order to "provide against the storm," take up a part of the crop, and, without cutting off the tops, lay them in a dry place, as in the back part of the hothouse, and cover the roots with dry sand or earth, leaving the tops out. In order to preserve those left in the ground, lay some long dry litter over the tops, but remove it when the weather is mild and fine.

As regards sowing for a late crop, you cannot do better than follow the hints we purpose giving, namely:—In order to have a late crop to stand till May in the following year, make a small sowing in the beginning of the preceding May; and when the plants are big enough—that is to say, five or six weeks old—prick them out into intermediate beds, four inches apart, till September, when they must be planted out into moderate trenches, as for the main crops, only not quite so deep; and as they advance in growth earth them up a little in winter, and finally in spring, in March and April. These will require protection during frosty weather, which is sure to make its appearance more or less in the winter.

In taking this crop you must dig down close to the roots, then, inserting the spade or fork (we prefer the latter implement for the work) under the roots, loosen them, and taking hold of the tops with the other hand, raise them up without breaking the stalks.

In order to save seed, either leave some of the established plants where growing, thinning them out to two feet distant in the rows; or, in the spring, take up a sufficient number of plants, cut off the tops and plant them in the ground, at the above distance apart in every direction.

Chervil.—This is an annual plant, rising from a foot to nearly two feet high; the leaves are of a very delicate texture, and three times divided. It produces its flowers in June, which are of a whitish colour. The tender leaves are the parts to be used in soups and salads, but have of late been in little demand. It is propagated by seed, and for a bed four feet square a quarter of an ounce will be sufficient. If successional crops are in demand all through the summer, you must begin to sow the seed the first week in February, and continue to sow a portion every three weeks, till August, and not longer between times, as the plants soon run up to seed, after which they are useless. Sow the seed in shallow drills, nine or ten inches apart, and rake it in lightly, and give a little water now and then. The leaves will be fit for gathering when the plants have grown three, four, or five inches high. They must be cut off close to the ground, and they will sprout again, and may be gathered in succession. For the purpose of saving seed, provided you require to do so, leave some plants standing where sown; they will soon run to stalk, and produce plenty of seed in August.

Clary.—This is a biennial plant, having large lower leaves, and a stem about two feet high, and of a clammy nature; the flowers, which appear in July and August, are in loose terminating spikes, composing whorls, and are of a pale-blue colour. This plant is in very little demand, although the leaves are used in soups. Most persons, however, dislike the scent, and therefore its principal use is in medicine. This plant is chiefly propagated by seed, and sometimes by cuttings and slips. A quarter of an ounce of seed will be sufficient to sow a bed large enough for most families. The seed may be sown any time from the middle of March to the end of April, in any bed or border, and raked in evenly, and, when the plants are advanced two or three inches high, a portion of the strongest may be transplanted, from twelve to eighteen

The barometer, whatever variety of construction, should stand or hang perfectly perpendicular during the readings, and should be kept in a room whose temperature is not liable to sudden variation. A northern aspect is preferable to southern. The height of the room above the sea-level should be ascertained. The observations should be made daily, and the rise or fall registered in some such form as that adopted by the National Lifeboat Institution (Fig. 9).

The top line of figures shows the days of the month, and the side columns the barometer scale, in inches and hundredths. The rise and fall of the barometrical column is registered, by drawing a line in the space opposite the barometer scale and underneath the particular day of the month. When the quicksilver in the barometer is rising, the line should incline upwards, and the contrary when falling; thus a continuous line will be produced, showing by the curves the barometrical variations for the month.

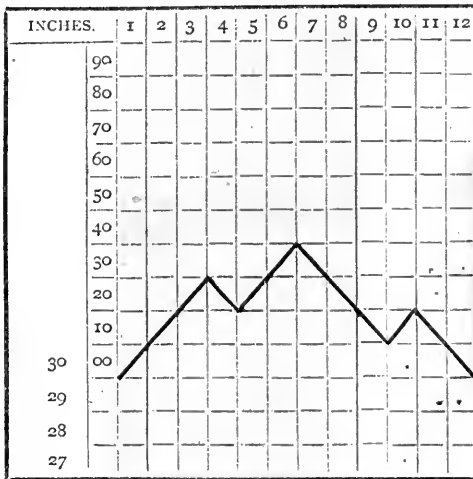

Fig. 9.

Before making an observation, the barometer should be gently tapped, to free the mercury from any adhesion with the glass tube. The index of the vernier should be brought level with the top of the mercury, the eye being kept exactly on a line with the top of the column.

How to read the Vernier.—Each inch on the barometer scale is divided into ten equal parts, these parts are divided into hundredths by the vernier. The vernier is an adjustable plate, one inch and one-tenth of an inch (together equal to $\frac{11}{10}$) in length, these eleven-tenths are divided into ten equal parts, each part being equal to one-tenth of an inch and one tenth of a tenth, and together equal to eleven hundredths. When the pointer of the vernier coincides with a division of the barometer scale, as in Fig. 5, each division of the vernier will exceed each division of the scale respectively, by 1, 2, 3, 4, 5, 6, 7, 8, 9, 10, parts whose denominators are the number of parts between *a* and *b*; the excess of each division being $\frac{1}{100}$ of a tenth, or $\frac{2}{1000}$ — $\frac{2}{100}$ of a tenth, or $\frac{2}{1000}$, and so on. The pointer in this position reads off to inches and tenths, viz.: thirty inches and one-tenth, expressed in figures, 30.10 inches. When the pointer does not coincide with a division of the scale, as in Fig. 3, observe each division of the vernier does not coincide, and the number placed against that division of the vernier will be the number of hundredths to be added to the inches and tenths. In Fig. 3, 7 coincides with a division of the scale, therefore $\frac{7}{100}$ are to be added to the inches and tenths, and the reading is thirty inches, one-tenth, and seven-hundredths, expressed in figures, 30.17 inches. In instruments of precision, such as the standard and mountain barometers, by an alteration in the divisions the readings may be taken to $\frac{1}{300}$ of an inch.

inches apart every way, to allow sufficient room for the plants and leaves to spread into full growth, when they will be fit for use the same year, and continue through the winter until the following spring and summer. Some of the old plants may be allowed to run up into stalks in spring, and they will yield ripe seed in the autumn.

Corn Salad.—This is a small annual plant, with long narrow leaves, of a pale colour, the lower ones rather succulent. The flowers are produced in April, are collected in little close corymbs, and are very small and of a pale-bluish colour. It is used as a substitute for lettuce when that plant is scarce, and also as an ingredient to increase the variety of small salads, for which purpose it is now grown in most gardens. It is raised from seed, a quarter of an ounce of which is sufficient for a bed of twenty square feet. The time for sowing must be regulated by the demand, to a certain extent, to answer which two or three sowings at most, during the spring and summer, will suffice. The first sowing may be made towards the close of March or beginning of April, and the plants will soon be up; and when they are big enough they must be cut, as it is only while young and tender that they are good for anything. A second sowing should be made early in August, and another in September, to furnish the table from autumn to spring. Sow the seed in a bed of rich melon earth, broadcast, and rake it in evenly. When the plants are up, thin them out to two or three inches apart, in order to give them sufficient room to grow strong for gathering.

Cress (American).—This is a biennial plant, the lower leaves of which are lyre-shaped, but those on the stalk are pinnatifid. It is generally esteemed as a winter cress and early spring salad, and is in demand in many places throughout the year. This plant likes a light, dry earth. It is raised from seed, a quarter of an ounce of which will sow a drill ten feet long. Sow in drills nine inches apart, in preference to broadcast, and rake the said drills in evenly after the seed is sown. For winter and spring use, sow about the end of August or beginning of September, on a warm border. If in demand throughout the summer, a sowing must be made every five or six weeks, from March to August. Water must be given liberally in hot weather, and on the approach of winter the plants must be sheltered a little by a light covering of dry litter or straw. Those desirous of saving seed should permit a few plants to run in the spring, and they will ripen seed the latter end of the summer.

Cress (Garden).—This is a hardy annual plant, rising with numerous small, long leaves, curled or plain, from which proceeds a flower-stem from fifteen to twenty inches high, and furnished with small white flowers, which appear in June and July. This is considered among gardeners as the principal amongst salad herbs, having a peculiarly grateful or pleasing taste. The varieties used in common are—the common plain-leaved, which, by-the-bye, is chiefly cultivated; the curled-leaved, equally good for salads, and in our estimation superior as a garnish; and the broad-leaved, which, though occasionally used in salads, is more often called in request for rearing young turkeys upon. All the varieties are raised from seed, which will grow on almost any soil, and if sown in beds one ounce of seed will be sufficient for sixteen square feet. When cress is in constant demand, as it mostly is in the summer, make a regular rule to sow a quantity every week, which will ensure crops, delicately young, in regular succession. Choose a warm situation, and for early spring crops commence sowing about the first week in March, and leave off, in the open air, about the middle of October; after which time it will be next to useless to sow in the open ground. After this season, and until frost sets in, sow under frames, and give air freely. For the demand through winter sow in pots filled with old tan in preference to soil, and place them in a

moderate hotbed prepared for the purpose, or in a stove. Protection will be necessary during the night, both in spring and autumn, and a covering of mats will be most suitable. Having allotted the ground, dig it and rake it very fine; then, without drawing drills—as is usual—sow the seed very thick in lines or drills, five or six inches asunder, and just cover them over with a little finely-sifted mould. Do not, under any consideration, stint them of moisture in dry weather. The crop should be gathered for use while moderately young, cutting it clean down to the root, after which it will shoot out again, but the leaves will be hot and not so fit for use as younger plants. Where seed is required, a portion of the first-sown crop should be left in the spring, which will soon run up and yield plenty of seed the latter end of the summer.

DOMESTIC MEDICINE.

FAINTNESS, OR SYNCOPE.

FAINTNESS is a most proper subject for treatment in a work on Domestic Medicine. It occurs more or less in most families—often from simple causes—and it requires immediate treatment.

It consists in a temporary failure of the activity of the heart; the blood, in consequence, is not properly circulated. It does not reach the head, and the patient loses clearness of vision and colour, and, if not prevented, falls on the floor, where, however, or even before reaching it, he recovers. There is no convulsion, and, though he can scarcely be said to be conscious, he is not profoundly unconscious, so as not to be able to be roused, as happens in epilepsy. There are all degrees of faintness, from merely feeling faint and looking slightly pale to the state we have described; and in some extreme cases, the state of fainting is hardly recovered from well before it recurs again and again, for hours or days together. We need hardly say that such cases as the latter are altogether beyond the reach of domestic medicine.

Causes.—What are the causes of faintness? It is not very difficult to describe these. Some people are so easily affected, that they faint if they cut their finger, or even if they only see the cut finger of another person. All one can say of such persons is that their muscular fibre is not strong, and that their nerves are sensitive. The heart, which goes on for years circulating the blood, is essentially a muscle. It is weak in some people, stronger in others. As a rule, it is weaker in women and stronger in men. Hence women faint more readily than men. Whatever weakens the heart and the muscles generally, acts as a cause of faintness. *Close, foul air* is a common cause of faintness or of languidness. *Purging* very often makes some people feel faint, especially if frequent and watery. Anything which greatly affects the nervous system, such as bad news or the sight of something horrible or disagreeable, will sometimes cause fainting. But of all causes of faintness, none is so serious as *loss of blood*. The muscles, in order to act well, must be supplied with blood; and if the blood of the body is lost—if it escapes, either from a vein opened purposely, or from piles, or from the source from which menstruation proceeds—in excessive quantity, then faintness will happen. The degree of it will depend on the constitution, and on the amount of blood lost. A loss of blood that would scarcely be felt by one person will be a serious cause of faintness to another. Sometimes frequent faintness arises from becoming very fat, the muscular system of the heart being impaired by fatty deposit.

Treatment.—People who are apt to faint should keep out of close places. It is very important to know what to do with a person fainting. The duty is very simple, but it is probable that life has sometimes been lost by

not doing it. When, then, a person grows white and faint, the proper thing to do is to lay him on his back as soon as possible. The thing wanted is to get the blood to the head, and by getting the head and shoulders on the same level, the work of the heart is helped. The mistake is often made of raising the head or keeping it up. Anything tight about the neck should be untied, and fresh air admitted. Smelling-salts should be applied to the nostrils, and a little cold water sprinkled sharply on the face to provoke a long breath, which draws the air into the blood, and so helps the heart. If the power of swallowing is intact, a spoonful of sal-volatile, in plenty of water, may be given. Such are the best methods by which a person fainting may be restored. But if there is some permanent cause of weakness and fainting, it must be remedied. Purging pills and medicines must be avoided. Diarrhœa, if it exist, must be cured by appropriate means. Losses of blood, either

HOUSEHOLD DECORATIVE ART.

FRET-WORK AND CARVING IN WOOD (*concluded*).

OUR next design is for a set of hanging book-shelves (Fig. 5). The series of fret-work patterns (Figs. 3, 4, 6, and 7) for decorating them are cut in the way which we have already fully described in a former number (see page 184), and the method of making the twisted shafts is also there described. For making these, oak or walnut-wood is recommended, and by

preference the former; for the perforated work, three-eighths or half inch panel should be used.

The two illustrations with which we now bring our series of examples in these arts to a close, give a design for a card-basket to be placed on the drawing-room table. It should be executed in panel of about a quarter of an inch in thickness, and will, if neatly executed, form a very light and elegant article. Six of the side pieces (Fig. 1) will be re-

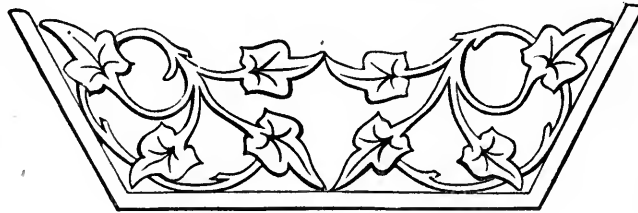

Fig. 1.



Fig. 2.

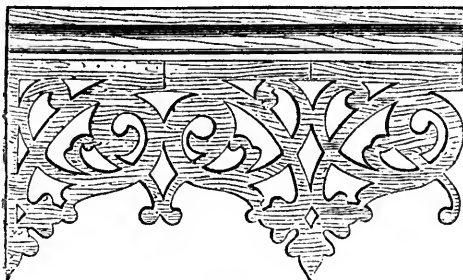

Fig. 3.

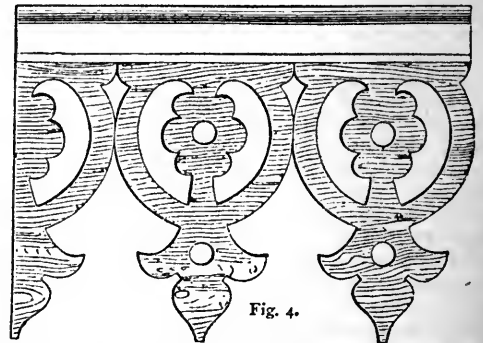

Fig. 4.

from excessive menstruation or from piles, must be stopped. A great tendency to grow fat must be corrected by suitable means, of which the principal are—proper exercise in the open air; good, plain, lean meat, with a little claret or weak sherry and water; no beer, and not too much bread. Any undue exercise should always be

required to surround the centre piece (Fig. 2), from which they will slope outwards; and in putting them together, great neatness will be necessary in mitring the corners. In Fig. 2, in consequence of one of those accidents which sometimes occur in wood-engraving, the points of the leaves in the design are made to appear somewhat too short, the result being they do not touch the

opposite portions of the pattern to which they should properly be attached. Unless they are connected at these points the work will be deficient in strength; the amateur must therefore remember to give the necessary attachments in working out the design.

Beyond the articles for which we have given designs, numerous other subjects on which the art may be satisfactorily employed, will suggest themselves to the mind of the amateur. Among minor ones we might indicate such things as paper-knives, stands for watches and jewellery, frames for small mirrors, forks and spoons for salad, decorative boxes, as for envelopes, gloves, &c., all which, with many others, are within the power of the beginner, and give an air of good taste to a home, or form graceful presents. The more advanced student will find that there is scarcely any article of household furniture on which good wood-carving may not be employed to advantage.

Among all the decorative arts this is, perhaps, the most

THE HOUSEHOLD CARE OF BOOKS.—III.

IN the re-binding of old books (those earlier than the present century), some deference should be paid to the style of the period to which they belong. On such, the modern innovations of cloth, or half-binding, should never

be used; but brown calf, as a rule, will never look out of place, nor will vellum be inappropriate for those under 8vo size and earlier than 1700. But even an appropriate new binding sometimes injures the appearance of a valuable old book, and those who have the good fortune to possess folios of the 17th century, will do well to consider if they cannot be preserved by repairing. Often the backs only of such books have suffered, and a skilful bookbinder can re-back them in the old manner, preserving the original sides. Books so repaired, sell for higher prices than if re-bound.

Damp is a great enemy to books, and should be guarded against by keeping them upon the shelves

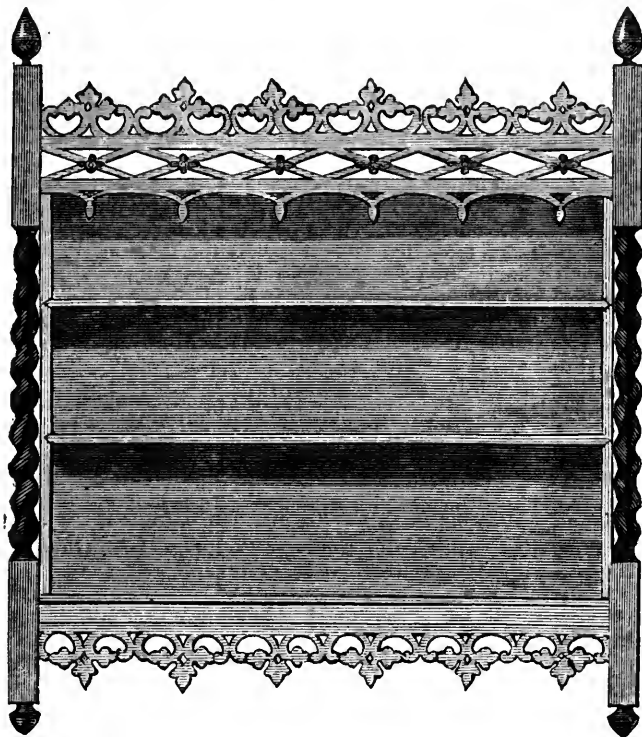

Fig. 5.

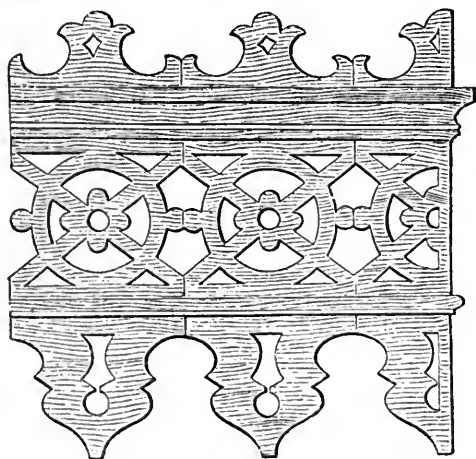

Fig. 6.

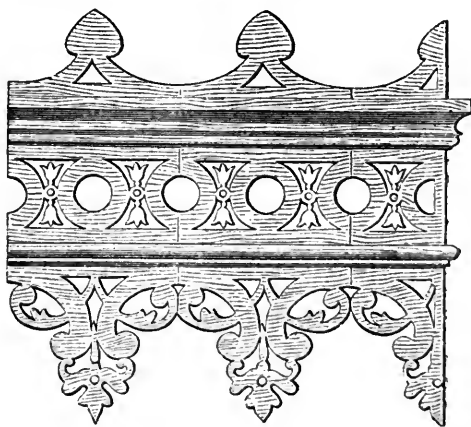

Fig. 7.

ancient, and it has always, in some form or other, been popular. There are few persons, even among those who care little for the more severe arts, who are not pleased with it; and we believe that those of our readers who will take the trouble to acquire it will be well rewarded, both by the interest they will feel in the work, and the results it will produce. That the art is neither too difficult nor laborious for even ladies, is proved by the many tasteful articles of ornament and utility executed by the ladies of many households.

at a sufficient distance from the walls to permit of a free current of air behind. In damp weather the room in which books are kept ought frequently to have a fire. Sometimes the larvæ of a little beetle, the *Aglossa pingualis*, make sad ravages (see also page 103). The best preventative is to have some books bound in Russia, or in what is called india-rubber binding. It is also necessary to their safety that they should often be moved, and they ought frequently to be rubbed with a flannel in which white birch bark is kept when not in use.

Some consideration should also be given to the character of the contents of the book to be bound, that the binding may be in proper keeping with them, as bindings which would be appropriate for the lighter works of poetry and fiction, would be out of place on those of devotion or philosophy. Attention should likewise be paid to the period of which the work treats, or at which it was written, and the ornament on the binding made to correspond with it; thus a history of Greece or a Homer should have Greek ornament, while Gothic devices alone can, with propriety, decorate a Chaucer. It will be necessary to remind binders of this, for most of them use their decorations promiscuously, with no regard to fitness. These things are in themselves of minor importance, but they all go to make up good taste, which is of great importance. A point worth insisting on is that of covering all new or well-bound books before reading; a paper cover may be made in five minutes, and tends much to preserve a binding. But as it often happens that paper is not at hand, and that inclination for the exertion of making a cover is also wanting, we recommend a plan found useful by ourselves, which is to keep by us half a dozen covers of moderately stout brown paper; it rarely happens but that one of them will fit the book sufficiently well for protection, if not for neatness, and the putting on does not occupy a minute.

Gold edges are happily far less common than they were a few years since; when used with some few exceptional bindings they have a good effect, as for instance with vellum; but in most cases they look like what they are—cheap and pretentious tinsel generally. The best that can be said of gilding when thus employed, is, that it protects the edges, and especially the top edge, efficiently from dust; but this purpose is answered almost equally well by colour. Marbled edges even are better in appearance than gold, but are rarely quite satisfactory; that which looks best is a quiet brown colour, more or less dark, as may be demanded by the tone of the covers.

The method by which books are fastened together is this:—A number of strings, known as “bands,” and generally of hemp, but sometimes of silk or parchment, are stretched across a frame; commonly five for an 8vo, and more for larger, and less for smaller books. Against these the backs of the sheets to form the volume are pressed, and sewn to them one by one, and afterwards glued. In bound books, the ends of these bands are attached to the millboards which form the foundation of the covers, and over which the leather is afterwards pasted. In cloth binding the process is somewhat different; the whole case being made separately, and afterwards fastened to the book by strips of muslin pasted in the beginning and end.

Some persons find a pleasure in re-binding their own books, but we cannot recommend amateur bookbinding to our readers. Neatness is the soul of good bookbinding, and cannot be gained without expensive presses and appliances, and much technical skill. We have never yet seen satisfactory amateur work. Much may, however, be done by way of mending. If leather covers or backs are torn, they may be repaired by damping the leather, fastening down with glue, and pressing with a hot iron; patches of leather may be put on in this way, if required. Should the back be gone, and the covers loose, a piece of soft leather may be cut, large enough to overlap the sides about an inch, damped, pared thin at the edges, and glued on. Strips of thin muslin should also be pasted to the book and cover inside; when a book thus mended has a neatly-written label added, it makes a sufficiently respectable appearance on the shelf. Cloth bound books may be mended in the same way with glazed coloured muslin.

Leather bound books, when scratched or worn dull, may be restored by varnishing; but common varnishes should

not be used, as they have a coarse appearance. A proper bookbinder's varnish may be made in the proportions of 3 pints spirits of wine, 8 ounces sandarac, 2 ounces mastic, in drops, 8 ounces shell-lac, and 2 ounces Venice turpentine. This must be applied with a camel-hair brush as lightly as possible, and when nearly dry rubbed with a soft ball of wool, covered with cotton, and moistened with a single drop of olive-oil to make it glide freely.

Many who possess old books would be glad to know whether they are common or rare, and, if the latter, what their value may be. The recognised authority on these matters is the “Bibliographer's Manual,” by W. T. Lowndes, which gives a short account of all rare, curious, and useful British books, from the first introduction of printing. By referring to this, the editions through which the book has passed may be learned, and the price for which copies have sold in the present century. Those who cannot otherwise obtain a sight of it, and can gain access to the Reading Room of the British Museum, may find it for themselves in Press 2048, Shelf C, in the Reference Library.

COOKING.

CRABS AND LOBSTERS.

The Crab.—Several kinds of crabs are eaten—as the small shore-crabs, and the spider-crab taken in the Channel, and which contain little meat, except that in the body—but the only species of any real importance is *the crab* which we see ready boiled (immense convenience), exposed for sale in the London fishmongers' shops. Lobsters and crabs, when they lose a limb, have the faculty of reproducing it. It is as if a soldier, after the loss of an arm in battle, were sure of another arm growing in its place. Thus we often see samples of both those crustaceans with one claw quite diminutive, or not more than half its natural size. Certain fishermen profit by this peculiarity. On the Spanish coast there is a species of crab known singularly enough by the name of Boccaccio; it is caught for its claws only, which are considered excellent eating. These are pulled off, and the mutilated animal is then thrown back into the sea, to be played the same trick at some future time, when the claws have reappeared. But besides this faculty, most, probably all, sea-crabs have a curious instinct; if one claw is wounded, they either shoot it off with a violent effort, or pluck it out with the available claw, promptly and resolutely as a dentist would ease a patient of a decayed tooth. It seems a cruel experiment to wound a crab's claw for the purpose of seeing it perform the operation; but the creature seems to think no more about it than if it were throwing away a worn-out glove. The same thing happens, if the crab is put into water warmer than suits its feelings, it immediately shoots off sometimes *all* its claws. Hence the great saving of risk and trouble, when crabs can be purchased ready boiled of respectable tradesmen who would not boil them *dead*. But in many places they must be bought *alive* or not at all, in which case, after washing and scrubbing with a brush, set them on a *gentle* fire in more cold water than will cover them, containing a liberal solution of salt. Take care that the water heats *very* gradually, in order that the crab may faint away under, rather than be suddenly killed by, the heat. It is a good precaution to put an inverted plate at the bottom of the boiler to prevent the crab coming into actual contact with it, and feeling the too close neighbourhood of fire; but even then, if the crab is strong alive, and the temperature is raised too suddenly, you will often hear “crack! crack!” in the water, and find that your specimen, by its own act and deed, has tumbled into hopeless ruin. It will be *eatable* (though injured by the water

getting into the claws), but cannot be presented *whole*. When several crabs are to be cooked at once, it is a good plan to put them, after washing, &c., into a small copper, such as is used for boiling linen or home-made beer; then to cover them with cold salt-and-water; and then to light a quite small fire under them, and keep it low till every member of the party is past claw-shooting. Crabs are such merciless eaters of everything living they can seize and mangle, that we need entertain no scruples about eating *them*. When they come to a boil, let them continue to do so, from a quarter to half an hour, according to size. Once dead, they require fast and thorough boiling to set the curd and semi-liquid portion of their contents. When wanted in a hurry, they may be cooled by plunging in a pail of cold spring-water; but they are better and firmer after passing the night on the stone floor of a cold cellar. The tests of a good, fresh-boiled crab are—its sweet smell, its weight, and the rigidity of the joints of the claws. Live crabs, with the shells too clear and semi-transparent, are apt to turn out watery. The sexes of crabs are easily distinguished by their external proportions—a matter to which epicures attach importance. The male has larger and stouter claws, stronger flavoured than in the female; the apron is narrower; the body, or carapace, smaller, and its contents more apt to be watery and worthless, even when the claws are good. The female has smaller claws containing delicate flesh, a much wider apron, and a larger carapace, which ought to be full of firm white and yellow curd, besides frequently containing coral. When the thorax starts from the carapace in boiling, it is a sign that all is right within. Finally, if lobster be the more highly esteemed, crab is reputed the more digestible crustacean. A pleasant way of eating crab is to have it served plain, cracked, with rolls, pats of butter, a lettuce, and a well-furnished cruet-stand. This, washed down by pale ale or stout, in pleasant company, and finished off with cheese and biscuits, makes an excellent repast by day or by night. But it is a friendly, confidential way of taking refreshment, inadequate to grand occasions. When show is wanted, as well as satisfaction, crab lends itself to something more ambitious.

Dressed Crab.—Works of art require time and patience, so does this; but do not be disheartened, it is worth the trouble. Crack *all* the claws of the crab, keeping the flesh from the joints as entire as possible. Set it aside. Save the four black tips of the shells of the large claws, which children call “soldiers,” for ornament. Take the breast or thorax from out the great shell. After clearing away the apron, the gills or “dead men,” &c., pick out all the white meat, and place it on a plate. On another plate put the *firm* contents of the carapace (white, yellow, and coral), dividing them into pieces the size of hazelnuts, and rejecting all film, water, &c. In the middle of the dish (not too large) in which you serve your crab, lay the contents of the carapace or “bottom,” over that put the pickings of the breast, and above and around all arrange neatly the pieces from the claws, garnishing with the soldiers at four opposite points. Surround the pile with a moderate quantity of mixed salad—quartered lettuce hearts, blanched endive, water-cresses, or other choice kinds that are in season. Over the crab only pour some approved salad mixture made nearly as thick as Mayonnaise sauce. When its turn comes, send the dish round, for each person to help himself with a spoon.

Scalloped Crab.—Pick out all the contents of the crab as before, only mix them all equally together. To them add about one-third their quantity of grated bread-crumbs, a good lump of butter divided into little bits, pepper (not much), salt (less), a dust of grated nutmeg, and a dessert-spoonful of vinegar or lemon-juice, sprinkled over the mass. Mix all equally together. Clean out the bottom shell of your crab, and fill it with the mixture; what is

left you may put into scallop-shells or tins. Set them into the oven of your cooking-stove, moderately hot, or in an American oven before a fire that is not too fierce. When hot through and slightly browned on the surface, they are fit to serve on a dish covered with a napkin, the crab-shell in the middle, and the scallop-shells round it, garnished with sprigs of parsley. Or, after gently warming the crab-meat, &c., in a stew-pan, you may distribute it between the crab-shell and the scallops, and brown their surface under a salamander.

The Lobster is boiled in the same way as the crab, only you may put *him* out of his misery at once, by plunging him into hot salt-and-water. This creature is so voracious and so prolific, that we may catch all we can without fear of exterminating that race of [sea-scavengers]; besides, it would be foolish self-denial to abstain from lobsters, and leave them to be cracked by conger-eels. Their development, too, is as strange as their increase is multitudinous. The form of the young larvæ differs so much from that of the adult, that it would be difficult, except on the clearest evidence, to determine the species from which they proceed. According to the observations of M. Coste, the young lobster casts its shell from eight to ten times in the first year, from five to seven in the second, three or four times in the third, and twice or thrice in the fourth year. Not till the fifth year do they attain their adult state. Whence it follows that the smallest lobsters served at our tables appear in something like their twenty-second change of clothing. Both adult crabs and lobsters shed their old shells annually, and immediately form new ones. The operation is not performed, as some suppose, by the animal shrinking and wasting away till the large claws, for instance, can be drawn through the narrow joint which connects them with the body. Such a diminution of the creature's substance would reduce it to a state of weakness not easily recovered from. What occurs is quite the contrary. Before being thrown off, the shell becomes soft and leathery, doubtless by the *absorption* of its calcareous matter, which is stored for future use in the creature's head. It is an economy of material, like that effected when the toad swallows its cast-off skin, and the stag browses on the horns that have fallen from his head. The shell then comes away in *large plates*, so that the flesh is not drawn through *any* aperture. We have seen crabs throw off the whole top of their carapace, like the sole discarded from a worn-out shoe. The old shell once gone, the new one is formed with remarkable rapidity, though it takes time to acquire its due degree of firmness. From the time of sickening to their complete recovery, about six weeks, lobsters are out of season; but this occurs at different times of the year in different localities, just as Loch Fine herrings come in at Midsummer, while Yarmouth herrings are not taken (in quantity) till Michaelmas. And as all paths on the sea lead to London, which is consequently supplied with lobsters from such diverse fishing-grounds as Norway, Ireland, the Channel coasts, and others, the practical result is that, in our metropolis, lobsters are never out of season. With boiled lobsters, the choice may be left to a respectable fishmonger—if you make it yourself, be guided by the delicate smell, the weight, and the stiffness of the muscle of the tail. Uncooked lobsters should be strong, alive, firm-shelled, heavy, and the blacker the better. Nevertheless, purple or “episcopal” lobsters are often as good as any, though they are only light pink when boiled. Barnacles on the shell indicate no defect in the flesh.

Lobsters make good use of their claws, inflict severe bites, and do not easily loose their hold. They may be handled, singly, with impunity, by grasping their head and keeping them at a distance. The latter condition is of some importance. An individual, in easy circumstances, but afflicted with kleptomania, or a propensity to thieving, was invited by some fishermen

to go lobster-catching. He accepted; and one of their earliest prizes found its way, head-foremost, into his trousers-pocket. The lobster protested in the only way it could. As long as possible he bore the sharp remonstrance with Spartan fortitude. [Do you remember the story, and the statue, of the Spartan boy with the wolf—or fox—concealed beneath his vest?] But when the pain became intolerable, he was obliged to beg the fishermen to rid him of his hidden enemy. They told him it could only be made to loose its hold by fire; and with lighted paper, shavings, matches, and tobacco-pipes, they inflicted on him worse retributive burns than he had already suffered bites. When lobsters are kept alive in quantity, their claws must be secured in some way, if only to prevent their injuring each other. At some fisheries this is done by driving a wooden peg between the nippers which terminate the great claw. This not only unnecessarily tortures the creature, but also often spoils the flesh of the claw by inflicting a wound which suppurates. The Norfolk fishermen, and others, adopt the more humane and more business-like plan of *tying* the terminal pincers together with string. The creature, without suffering, is prevented from doing harm, and can feed itself with its many minor fingers and thumbs.

Lobster, Plain, Split and Cracked.—Some London fish-houses have a sort of shears, by which they cut a lobster in two at a single stroke. This is neat and expeditious work. Without so powerful an instrument, you may cut a lobster into very passable halves. Pull off the great claws, of which you will crack the shells without removing them. Lay the lobster, on a board or dresser, flat on its belly, with the tail outspread. Hold it down with your left hand, and with a stiff, sharp-pointed knife in your right, beginning at the tip of the tail, split it through lengthwise up to the end of the snout. Open the halves, and lay them facing each other in the middle of a large dish; deposit the cracked claws beside them, garnish with parsley, and serve with the same accompaniments as for plain cracked crab. If the lobster is large, and the party not small and intimate, you had better separate the tail from the head, cut each half into several pieces, and lay them as near as may be in their natural position; divide also the great claws into halves or joints, contriving that there shall be a portion for each of the guests.

Lobster, with Piquant Sauce (a good excuse for an extra glass of wine at the close of a convivial dinner).—Split the tail as before, in order to remove the black thread, or gut. Divide it, and the great claws—taken out of the shell—into pieces of the size you would help with a spoon. Pick out the white meat of the body, the green and curd of the head, and lay them together in the middle of a small dish; over and round them neatly dispose your pieces of lobster. For sauce: Put three *hard-boiled* yolks of egg into a small basin; crush them to powder with a spoon; mix with them a teaspoonful of mustard in powder; add a saltspoonful of salt; nearly saturate the whole with tarragon vinegar; then add at least a dessert-spoonful of extra-hot vinegar, from some of Crosse and Blackwell's super-capsicomed pickles; when the sauce is smooth, with the flask in your left hand, add oil in drops, while, with your right hand, you patiently stir it. You only want just enough sauce to mask your lobster; you will bring it to the consistency of *good cream* by the addition of either oil or vinegar, as may be. Pour it over the lobster, serve, and take note of its exhilarating effects.

Lobster Mayonnaise is prepared exactly in the same way as directed for mayonnaise of eels.

Lobster Curry.—We hardly recommend you to devote a lobster to this—unless you like it—and it is really good, as well as easy to prepare; but Christmas and other festive occasions produce enormous lobsters, which cannot be consumed at one repast. Leave the remnants in their

shell till wanted; then pick out the flesh, the contents of the head, &c.; cut them into pieces, not larger than you would help with a spoon, and put them into a saucepan with a little bit of butter at the bottom. Incorporate smoothly a dessert-spoonful of curry powder with a teacupful of milk or broth. Chop two or three middle-sized onions; fry them in butter till quite tender, but as little browned as may be. Stir in a teaspoonful of flour; dilute with milk or broth; then stir in the mixed milk and curry powder. When smooth, pour it over the lobster in the saucepan. Let it warm through slowly, shaking now and then, and giving time both for the heat and the curry sauce to penetrate the fish. When you judge that this has been effected, arrange the lobster neatly on a dish, give the sauce a boil-up, pour it over, and serve accompanied by boiled rice in a separate dish, instead of placing the rice round it, which latter mode is contrary to Indian practice. N.B.—It is a mistake to make curries *too hot*; you thereby convert them into *devils*. At the same time that you taste the spices, you do not want to lose the flavour of the article curried.

Lobster Salad.—We almost hesitate to give a receipt for this, because everybody thinks he knows how to make it best; and, indeed, with good materials, it is not easy to go far wrong. Not a bad plan is this: Pick the shells clean; arrange them, empty, handsomely, on a dish, and garnish them with parsley, nasturtium flowers, &c. Put the contents of the shells, properly divided and mixed, into the bottom of a salad bowl; pour over them a liberal quantity of not too piquant sauce, or approved salad mixture. Then hide them under a coverlid of choicest salad hearts, picked leaf by leaf, and augmented with whatever suits your taste. When the soup is removed, announce the lobster salad as the bouquet of the feast; everybody will keep a corner for it. When its turn comes, and the salad-bowl and the dish of shells are placed on the table, you indignantly exclaim, "What a pity! what a shame! what an irremediable misfortune! The cats have eaten the lobster, and left us the shells! I could eat the cats, if caught, out of very spite. As it is, we must eat the salad, and smell of the shells, as canny folk do with their bread and cheese. Brown, will you have the goodness to mix the salad? The dressing, I suppose, is at the bottom. I haven't the heart to do it!" Whereupon, to the general comfort, Brown discovers that the lobster salad is *nearly* as good as if he had compounded it himself.

Gratin of Lobsters.—There are several ways of roasting lobsters; but almost all of them are troublesome, expensive, and uncertain, in inexperienced hands. The following mode, which we must premise is not our own but borrowed, will be found as savoury, and far more practicable.—Split the lobster (cold, boiled) down the whole of its length, without detaching, if possible, the shell of the head from that of the tail. Pick out all the white meat of the body (not of the tail) and the claws; mix it with the green curd and the coral (if any) minced fine. Put these in a saucepan with a bit of butter, a dust of flour, pepper, pounded mace, a glass of good red wine, and a teaspoonful of essence of anchovies. Slice the two halves of the tail, add them to the above, and warm all together over the fire, stirring carefully. With this ragout fill the two entire half-shells of your lobster. Dust bread-crumbs or biscuit-raspings over all, and brown in a tolerably brisk oven, or under a salamander. N.B.—Cookery-books, in general, make more of lobster spawn than it is worth. It is almost always full of sand or grit, which spoils every combination into which it enters; and to get rid of which it is obliged to be so thoroughly and repeatedly washed, that the little flavour it has is washed out of it too. It is then good only to please the eye, plague the teeth, and defy the digestion.



Fig. 3.
THE SOUTH
KENSINGTON PRIZE
FAN-MOUNT.

FANS, AND HOW TO MAKE THEM.

If we may judge from the general use of the Fan in all ages, it must be considered among the necessaries of life. There have been periods, even within our own recollection, when fans were scarcely common; but there has never been, in historical time, any epoch when they had wholly passed out of use. Among the ancient Egyptians the fan was something more than a toy; it

France, and it is said that they were brought thence into England, but were not common until about the time of the Restoration. Although *folding* fans were not in use in England before this time, it must not be supposed that English ladies were without some form of this elegant necessary. In the fourteenth century we are told that the severe English matron carried a fan with a handle a yard long,

be considered among the necessaries of life. There have been periods, even within our own recollection, when fans were scarcely common; but there has never been, in historical time, any epoch when they had wholly passed out of use. Among the ancient Egyptians the fan was something more than a toy; it



Fig. 2.

was an emblem of high religious and political significance, the king's fan-bearer in time of peace being his standard-bearer in time of war, and the fan his ensign. Fans were in common use among the civilised peoples of ancient Greece and Rome, as also in European nations generally, during the Middle Ages; but these, in form, had little in common with the fans of the present day.

The folding-fan is believed to be a Japanese invention. Adopted in China, it was brought thence to Portugal in the fifteenth century, and in the next century was in general use in Portugal, Spain, and Italy. Catherine de Medici introduced them into

with which she was accustomed to administer personal chastisement to her children and servants. These fans, like the shorter-handled ones which succeeded them, were usually made of feathers, and the general form may be gathered from the description of one given by Sir Francis Drake to Queen Elizabeth:—"Queen Elizabeth had a Ffanne of ffeathers white and redd, the handle of gold, enamelled with a half-moone of mother-of-perles, within that a half-moone of sparks of dyamonds, and a few seed-perles on the one side, having her majestie's picture within it, and on the backsyde thereof a device with a crowne over it." On the next page is an illustration (Fig. 1) of a fan belonging to that sovereign. We give

this, as it is interesting, and may be of practical use to our readers, more especially as we shall have something to say on the construction of feather-fans by-and-by.

When the modern and more convenient form of fan had once been introduced into France, that country appears to have assumed the dictatorship of taste in its manufacture and decoration, and almost all the fans that have been preserved to the present day are either of the French style called "Louis Quatorze," or are imitations of it. This may have been noticed on visiting the exhibition of fans, opened at South Kensington Museum in May, 1870, comprising the collections of their Majesties the Queen and Empress of the French, and other ladies of distinction and taste. This exhibition may fairly be considered as representing the fans of the two past centuries; and beautiful as many of them undoubtedly are, it is to be regretted that this series furnishes us with a warning of things to be avoided, rather than an example of taste to be followed. Unfortunately, the period at which the fan manufacture reached its zenith in France, and determined the style of these articles in other countries and other times, was one when the

lady readers who desire light, graceful, and remunerative work. As we have already seen, there is a wide field for improved taste in these articles. Most of the operations in fan-making have always been performed by female hands; and we shall have to speak of the materials used and the method of fabrication, as we propose to show that fan-making may not only be pursued by ladies as an occupation, but also as a pleasing and economical amusement, in the preparation of those required for their own use.

In speaking of the manufacture of the fan, we shall have to distinguish between its two parts—the fan-stick, and the mount—as these form two separate branches of industry. The materials for the sticks are ivory, pearl, bone, wood—

and more especially sandal-wood, from its fragrant smell—tortoise-shell, horn, and sometimes filigree work in the precious metals. The most elaborate sticks are in ivory, and of Chinese workmanship. The carving on some of these may be said to represent the labour of years. The manufacture of fans for the European market has formed an important branch of industry in China for nearly two centuries, and more especially in carving these richly-sculptured

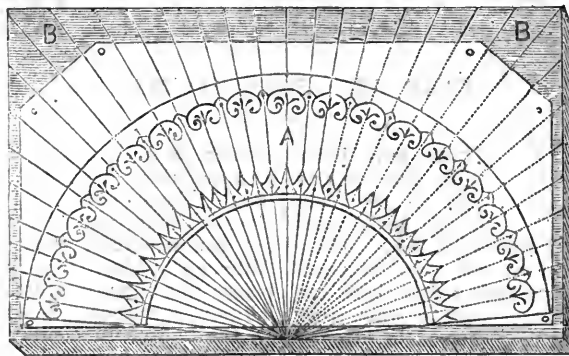

Fig. 4.



Fig. 1.

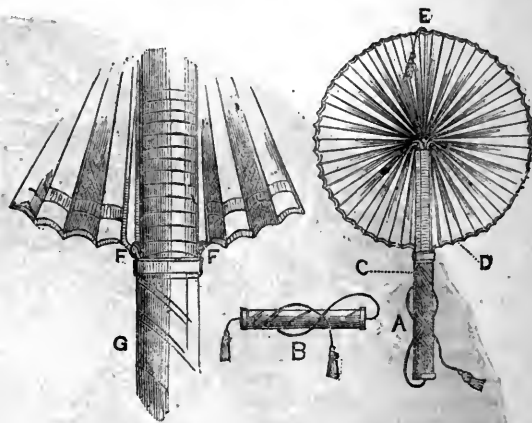

Fig. 5.

questionable taste of the Louis Quatorze style was degenerating into the *rococo*. Hence the decorations are for the most part artificial landscapes in the Watteau manner, maudlin pastorals, and vitiated pseudo-classical and mythological subjects. Fig. 2 is an example of a valuable fan in this accepted but doubtful taste.

A more suitable style of decoration, as it appears to us, is one in which paintings of natural flowers are employed—as a faithful copy of anything beautiful in Nature is always pleasing, and the work of delineation is also a healthy one for the painter. An example of this better taste is given in Fig. 3, from a prize fan-mount also exhibited at South Kensington Museum, designed and painted by Miss C. James, for which the premium offered by the Department of Science and Art to female students of Government Art Schools was awarded. The authorities at South Kensington very properly consider that the decoration of fans is capable of development in this country as a branch of female occupation, and as such we recommend it to the consideration of our

ivory sticks. Early in the seventeenth century Chinese workmen were even brought over to Paris, for the purpose of producing them in that capital. The Chinese themselves use fans, but of a less costly and elaborate description than those prepared for exportation. Next to the Chinese in this art are the French, who still produce, more especially at Dieppe, very beautiful examples of fan-sticks in ivory. The mother-of-pearl sticks are also elaborately carved, and, in addition, sometimes richly gilt. The commoner materials, such as wood and bone, are more frequently decorated with pierced work only. Metal sticks are comparatively rare; but among those contributed to the South Kensington collection a curious example may be remembered, in which they were formed of silver, and this fan is remarkable as having belonged to the unfortunate queen, Marie Antoinette.

The mounts are usually composed of paper, leather, or vellum, silk, taffeta, lace, or other light material; and these are generally adorned with painting, gilding, spangles, &c., according to the material and the maker's

taste. In preparing the mount, the first process is to stretch the material on a frame, and to mark out its semicircular form, as at A, in Fig. 4. On this the design is traced and painted; when sufficiently dry, it is taken off the stretching-frame. It is then laid upon a board, B, on which grooved lines radiate from a centre. On this the mount is fastened, as shown, and marked with a blunt instrument, resembling an ivory paper-knife, along the grooves. The lines thus formed indicate the future folds of the fan. In doing this, it is necessary to take care that the lines do not cross any important part of the design, such as the head or face of a figure. The mount is now folded at the creases, and cut level at top and bottom with a sharp knife. Two mounts are usually required for each fan, between which the thin continuations of the sticks, previously riveted together at the other end, are enclosed; the ends of the mount being attached to the two stronger and more highly-ornamented pieces known as the master-sticks, which are of the same width as one fold of the fan. The outer circumference of the mount has now to be bound with a binding, which is usually a narrow strip of gold or silver-paper pasted on it, and sometimes fringed, as with swans'-down.

The painting of paper fans differs from ordinary water-colour drawing, inasmuch as what is technically known as "texture" cannot in the former be attained by the use of thick rough paper—the lightness and neatness essential to the fan demand that a thinner and finer paper should be used; and this should be made from linen rag, to enable it to bear repeated folding. The fact of this smooth paper being used renders desirable the employment of stippling, rather than of washes, in the colouring. Where gold and silver are required, the painter may use the ordinary illuminating shell-gold or silver; or, if he prefers gold or silver-leaf, he may use, to fix it, a size composed of gum-arabic, sugar-candy, a small quantity of honey, melted in pure water, mixed with a little brandy, and applied with a camel-hair pencil. This preparation was long kept a profound secret by the fan-makers. When dry, burnishing may be accomplished by piling a number of mounts together, and pressing them.

When the decoration has to be painted on vellum, the same materials may be employed; but it is then desirable to take away the greasy nature of the skin, by rubbing over it a little powdered whitening, or by using ox-gall with the colours.

If the material for the mount be silk, three kinds of painting may be employed—water, oil, and varnish colours; but if either of the two last be used, the silk should be prepared by passing over the parts, intended to be painted or gilded, with a solution of isinglass. On this ground the ordinary oil colours may be used; but care must be taken that the painting be strictly confined to the sized parts, or the oil will spread, and wholly spoil the work. Should, however, by any accident a chance spot of colour fall on the silk, it must be taken out *at once* with a little clean turpentine.

As varnish colours, which have some advantages over oil, cannot be bought ready mixed, it will be necessary to give directions for preparing them. The colours should be first ground fine with a palette-knife in turpentine, on a glass slab, and then an equal quantity of clear copal varnish be added, and the whole carefully mixed. As these colours dry more rapidly than those mixed with oil, they will require occasionally thinning with turpentine when in use; and, when not wanted for a time, a little turpentine should be poured on the surface of the colours, to keep them moist. Nothing forms a better receptacle for these colours than a number of thimbles fixed in a wooden frame, with a cover to protect them from the dust. Camel-hair pencils used in these colours must be carefully washed in turpentine before being laid aside, or they will become hard and useless. For attach-

ing gold or silver, either in powder or leaf, to silk, the cement should be japanners' gold-size. This must be allowed to remain for some time, until it is only sticky in the least possible degree, before the gold or silver is applied. The leaf metal is then laid on, pressed down with a ball of cotton-wool wrapped up in soft wash-leather, and the loose gold rubbed lightly away with cotton-wool, or other equally soft material. If gold or silver powder be used, it is rubbed on lightly with a washleather ball, similar to the one described above.

The mode of painting last spoken of is best suited for being varnished, which at the same time gives an additional lustre to the work, and tends to preserve it. In the age of Louis XIV. a coach-painter, named Martin, attained to considerable celebrity by a varnish which he invented for finishing and heightening the colour of fans. The "Vernis Martin" forms one of the most valued excellencies of the highly-prized fans of that period; but the exact secret of his varnish died with him. A fine copal varnish will, however, answer the purpose sufficiently well; but this must be laid on with a camel-hair pencil, and confined to the painted part only, unless the whole surface of the silk be previously prepared with isinglass.

We have described these processes at some length, as we desire to render them intelligible and of practical utility to those who may wish to follow this elegant art as a home amusement. We believe our remarks on Painting to contain sufficient information for those who have previously some artistic knowledge.

Very pretty fans may, however, be made by those who do not possess such knowledge, the mounts being lace, coloured silk, or paper. In the two last materials plain green is a favourite colour. To this less ambitious style of fan, spangles are sometimes affixed with good effect. We have also seen fans of network studded with these brilliant ornaments; such fans are extremely simple and inexpensive, but their appearance by artificial light is extremely fairylike and pretty. As, however, a Spanish lady friend observed to us on a broiling day in Murcia, using them occasioned "*mucho trabajo y poco viento*" (much labour and little wind), the same remark might be made of lace fans, unless furnished, as they may be, with a back mount of paper or silk.

Of fans made wholly of hard materials, as ivory, wood, &c., we do not propose to speak at length, as the making of them demands highly-skilled labour, and cannot well be practised by the amateur. There is, however, no difficulty which will prevent any lady from making the sticks necessary for the mounted fan. The two outer or "master-sticks" will give most trouble; but they may be made by any lady of mechanical ingenuity. For the inner sticks, veneers of any hard wood, or ivory, may be bought, and be cut into strips of the required length, which will rarely exceed ten inches, with a fine saw. The breadth would be about half an inch. About eighteen or twenty of these strips would be required, and the master-sticks should be of the same kind of wood, and about three-sixteenths of an inch in thickness. The whole should be laid in the order in which they will occur in the fan when closed, and screwed tightly together with clamps. Two paper patterns, or gauges, of the proposed outline of their sides should be prepared, and be pasted on the outer sides of the master-sticks. Guided by these, the whole of the sticks can be reduced to the required outline, with a sharp file, at a single operation. A hole being drilled through all at the bottom for the rivet, the sticks may then be released from the clamps, and the master-sticks rounded on their outer edges with a file, and afterwards carefully smoothed with sand-paper. Their inner surfaces, as well as those of the other sticks, will require reducing to a state of perfect smoothness with sand-paper, coarse being first

used, and afterwards fine. If saw-piercing be employed to decorate them, it must be done before the final operation of sand-papering is performed. A very minute saw will be required, and full directions for performing this will be found in our articles on Fretwork and Carving in Wood. This, with the exception of the varnishing, will complete that part of the sticks which will remain visible; but the portions to which the mount will have to be attached, except in the case of the master-sticks, will have to be tapered by filing away the wood, not only from the sides, but also from the front and back. As the riveting together, though a simple operation, demands tools which involve some little outlay, and are useless for other purposes, it would be better to employ a white-smith to do it; there is also some little danger, if this is clumsily done, of splitting the wood. Suitable rivets, with plain or ornamental washers, may be bought at the gilt-toy makers'.

All the more valuable fans are made in the manner above described; but there are some cheap and elegant ones made to fold on different principles. The bouquet-fan, shown open at A, in Fig. 5, and closed at B, consists of two cardboard tubes, C and D, about five inches long, and the outer one rather more than half an inch in diameter, of which one is made to slide within the other. The mount, E, consists of a strip about twenty-six inches long and four broad, of fine varnished linen or calico, such as is used by architects for working tracings. Paper or other somewhat stiff material would do equally well. This is plaited into folds of about half an inch wide, and one end is cut with a sharp curved instrument, such as a gouge, which gives a scalloped appearance to the edge of the finished fan. Down each end of the mount a long, thin piece of tape, fourteen inches long, is glued, and a piece of string, about eighteen inches long, down the centre. Usually the mount is made in two pieces, and the string is concealed in the joining in the middle. Through the plain end of the mount a piece of thin wire is passed, to fasten the folds tightly together. Over the tapes two small rings are slipped, and the ends of the tapes, together with the string, are brought through the smaller tube, into which that part of the mount which is fastened together is inserted about half an inch, and fixed in its place by the ends of the tapes being brought through at the opposite end, and glued to it on the outer side. The end of the string is then passed through the larger tube, to the upper end of which loops of tape are glued, which pass through the rings on the tapes of the mount, as shown at F F, in the enlarged drawing, G (Fig. 5). Nothing more remains to be done beyond covering the outer tube with velvet, or other suitable ornamental material, and closing the lower end with a little gilt cap having a hole in the centre, through which the string is passed, and affixing tassels to the two ends of the string, by means of which the fan is opened and closed.

With the same form of mount another recently-introduced fan is made—a circular fan, of somewhat larger diameter. The mount being folded and fastened together as in the last, master-sticks are attached to the sides of the mount, as in the old folding-fan, from which this instrument differs in having the upper instead of the lower ends fastened together. When closed, the mount lies closely folded between them, and the sticks are secured by a hasp. To open it, they are released from this, each is made to perform a semicircular movement, and they meet on the opposite side of the centre back to back, and are again secured by the hasp; the fan being then spread, and assuming a circular form like the above. Landscape or figure decorations are not suited to fans of these kinds; a radiating or starlike pattern is more appropriate.

The telescope-fan, which is, when pulled out to its full length, like the old folding-fan, owes its name to the fact

that the sticks are made to slide up into the mount, and thus render it more portable. Each master-stick consists of two pieces. In the upper part, to which alone the end of the mount is attached, is a groove, in which the lower part slides. The other sticks are shorter than in the ordinary fan, and, instead of being pasted to the mount, sockets are left, into which they enter slightly when the fan is at full length; and when it is not in use, they are pushed up nearly to the top of the mount.

Some cheap, and in many respects beautiful, fans, Japanese and Chinese, are to be bought in our shops at low prices. The common Japanese fan consists of a piece of bamboo, of which the upper end is split into thin strips, bent in such a manner as to radiate like the ribs of the palm leaf. The ends of these strips are secured by another thin strip of bamboo, which passes round them and through a hole in the upright piece. On both sides of this framework coloured woodcuts on thin paper are pasted. The drawing on these woodcuts is always eccentric and mannered, but generally full of spirit and action, and, in beauty of colour, far surpassing anything of which the European art-workman is capable. The cheap Chinese fan is often much more simple, consisting of the bamboo handle and hoop-like portion of the frame described above, over which gauze or some similar texture is stretched. It often has the grotesque forms of decoration found on the Japanese fan; but merit in design and colour is less frequently met with. These fans do not possess the advantage of folding up, and are therefore of more use with us as hand-screens.

A beautiful feather-fan, which, like the above, cannot be folded, may be made in the following manner:—A segment of a circle, cut out in cardboard, should be taken, and feathers, such as the tail-feathers of the peacock, cut to the required length, and placed with the quill ends towards the angle, the other ends radiating outwards as they do in the spread tail of the living bird. These are secured in their places with a needle and thread, and by glue. Another and shorter row is then placed upon them, so as to conceal the quills, and secured as before; and afterwards similar rows—smaller feathers being used—as those of the "horseshoe" of the peacock. When the feathers have been thus brought down to the angle of the cardboard, that part will have to be inserted in a handle split to receive it. The back of the cardboard may be lined with silk, or some persons prefer to affix feathers on both sides. Useful hints on work of this kind will be found in our articles on Feather-screens, pages 289 and 321, vol. i.

Dress fans of the highest class frequently command high prices. The best fans still are, as they have long been, of Parisian make. One hundred pounds is sometimes paid for the most elaborate. The ordinary price of dress-fans in the last century was from £12 to £15. The manufacture of costly fans has altogether left England; but the production of the cheaper kinds is now upon the increase. Yet, in this direction, we can hardly compete with the French, who make common fans at 5d. per dozen. In our shops pretty circular and bouquet-fans can be bought at from 6d. to 1s. each, and telescope-fans at 2½d. Of the Japanese fans mentioned above, we have a sufficient supply at 6d. each—the Chinese cost about 1s. 6d.; but in cheap fans we are completely outdone by the Spaniards. Around the doors of the amphitheatres in which the bull-fights take place, stand numberless vendors of fans, shouting, "*Abanicos á uno quarto!*" ("Fans at a farthing!") and everybody buys them. They are made of strips of bamboo covered with paper, on which is a rude representation of a bull and a matador. When the questionable amusement of the day is over and twilight comes on, the more innocent sport of destroying these fans begins, and a temporary illumination is got up by each spectator setting fire to his fan.

ICE.

ICE, which was formerly a luxury, has now become a necessity of civilised life. We are so much accustomed to its use that we can no longer do without it, while new fields for its employment are constantly being discovered. But for ice, the present large trade in fish could scarcely be sustained, and game and other perishable provisions are by means of it brought to us from distant countries. Scientific men have even turned their attention to the bringing over of fresh meat from South America by means of packing in ice. This has not as yet been wholly successful, but fresh meat and fruits for consumption on ship-board are found to be well and easily preserved by it. It is also extremely useful in the household preservation of

food in hot weather, by the employment of ice-safes and refrigerators. In sickness, more especially in allaying fevers, and as an outward application in spinal and some other diseases, it is invaluable. In addition to its more ancient use for the cooling of drinks, which is derived from remote antiquity, and the manufacture of ices—an invention of the seventeenth century—these various employments for it have been brought into use and become common within our own time.

There are various methods by which ice, or artificial cold, may be produced, in addition to the original one by the employment of ice or snow stored in the winter. These are by evaporation, by the admixture and solution of saline substances, or by the use of ponderous machines, more remarkable for their ingenuity than their practical value to the household.

Consolidated snow, stored in pits and caverns, was in use among the classical nations, and is still employed in southern countries; but in the north, where it can be readily obtained, ice is more generally used; in fact, in those latitudes where ice is abundant, it is usual to scrape off any frozen snow that may be formed on its surface, before collecting it for storing.

Up to the beginning of the present century, the ice consumed in England was supplied from our own ice-houses; since that time, however, a large import trade in American ice has sprung up, and, more recently, Norwegian ice has come into the market, which, being brought from a shorter distance, and consequently at less cost, competes successfully with that of America. Our own ice, being frozen at

comparatively high temperatures, is less dense and cold than that obtained farther north. Much of the American and Norwegian ice that reaches us has been consolidated at 15°, or more, below the freezing-point. Foreign ice has also the advantage of being in larger blocks than can be obtained here, and hence offers less surface-area to atmospheric influence, and thaws less rapidly in consequence. Also, being obtained from large, clear, fresh-water lakes, it is much purer than that of our own ponds and rivers.

Foreign ice is now to be procured at moderate prices. American ice is sold by many ice dealers at about 7s. per 100 lbs.; 3s. 6d. per 50 lbs.; 2s. per 25 lbs.; and in any smaller quantity at 2d. per lb.; and is packed in mat or blanket, for the country, at a further charge of 2s. per 100 lbs.; and in larger quantities at some reduction upon this rate. The Norwegian ice, which does not enjoy so high a reputation, may be bought at the same prices in small quantities, and at slightly lower ones in large.

It was formerly believed, for the preservation of ice, that an underground structure of masonry was necessary, and many still incline to the same opinion, since, owing to the improvements in the mode of construction, such ice-houses may now be made at comparatively small cost; and as they also possess the advantage of being easily filled, we shall give practical directions for building them.

The proposed ice-house must be situated in a spot sufficiently elevated to allow of complete drainage. The side of a hill, sloping towards the north, is best, and, if possible, the drain should be made to open into the bottom of a stream, or pond, that water may flow out without admitting air. A funnel-shaped hole has first to be dug, according to the size of the proposed building, for which 18 feet wide, and the same deep, are good dimensions. These may, however, be varied to suit the taste, means, or requirements of the builder; but it must be remembered that ice keeps far better in large quantities than in small. From the bottom of this pit a drain, G (see Fig. 2), should be constructed, for which the best material is glazed earthen pipes. In this, for the perfect exclusion of air, two or three ordinary swan-necked bends, or a trap, as at H, should be inserted. The bottom of the pit should then be puddled with clay, to the thickness of about two feet, and a circular cistern, or well, F, formed, into which waste water may flow through a close grating, E, of wood, or

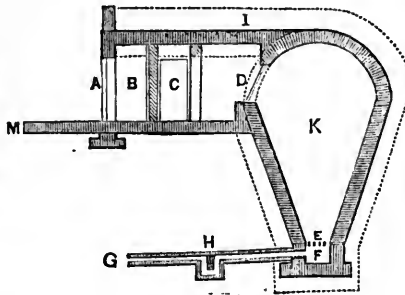

Fig. 2.

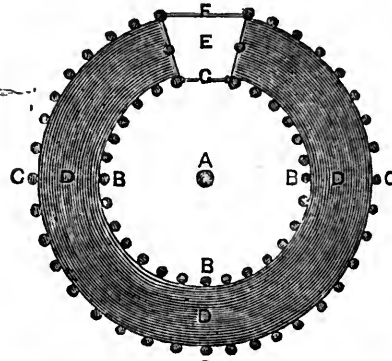

Fig. 3.

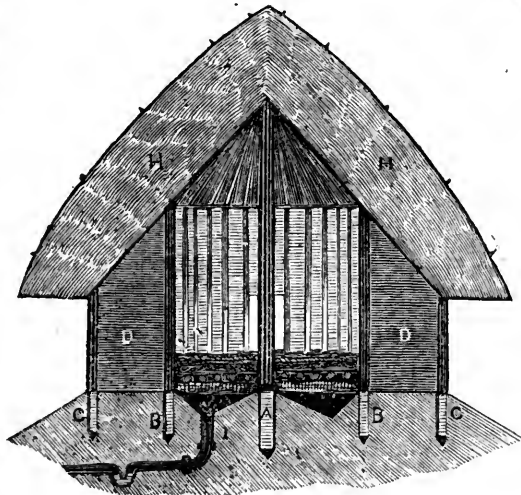

Fig. 4.

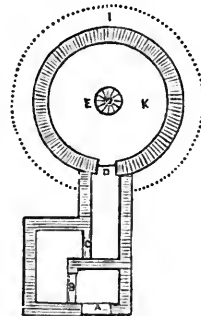

Fig. 1.

perforated tiles, on its top, and be thence carried away by the drain. This cistern will be of masonry, as will also be the walls of the ice-receptacle, K; if these are built of solid brick, about fourteen inches thick will suffice; but if of rubble-stone, they should be two feet in thickness. Instead of mortar, Portland cement should be used. As the walls are carried up, the outside space, which would be about two feet, should be filled up with puddling, I, separated from the masonry, for the sake of dryness, by coarse gravel. This work must be carried up a foot or so above ground, and then vaulted over. The vault, being exposed to rains, must be protected with three feet of puddling. Space for a small door, D, should be left on the north side, and this should be sheltered by a long, covered passage, which, for the better exclusion of air, should be winding, or have two or three angles in it, and should be crossed by three closely-fitting doors, A, B, C. The passage should be thickly thatched, and the ice-house itself might be covered with earth and planted over with ivy. A plan and section of such an ice-house are shown in Figs. 1 and 2. Whether it is good for an ice-house to be shaded by trees is a disputed point; so far as they keep off the rays of the sun, and render the earth cool below them, they are of course beneficial; but, as they have a tendency to produce dampness, which is a still greater enemy to ice than heat, their presence is objected to by many. We believe them to be useful, if thorough dryness can be secured in the construction of the ice-house. If the natural drainage of the spot will permit of the ice-house being sunk entirely below ground, some advantage may be gained in convenience of filling, by having a trap in the centre of the dome, which must, however, be carefully built up, or covered with a large stone, and puddled after the ice has been stored. In this case, the entrance must be by an underground passage with steps. It has been recommended that, instead of solid masonry in these houses, hollow walls should be used, packed between with some non-conducting substance, such as sawdust, fine coal-cinders, or charcoal. There will always be some waste through the melting of the ice, and the intention of the conical form is to allow that which remains to fall together into a close and compact mass. Some have recommended that, instead of a drain to the cistern at the bottom, that receptacle should be fitted with a pump. This arrangement presents the advantage of allowing the water, which is extremely cold, to be utilised. It is excellent for making up butter and for similar purposes.

The reason why the underground ice-house was formerly held to be indispensable, was the belief that the chief enemy to be guarded against was heat. It is now known that damp is far more prejudicial to the preservation of ice, and the chief real advantages of the underground building are that it is permanent and easily filled. An ice-house in a high and dry position is by most authorities now held to be safer.

From what we have said above, it will be evident that in London and other large towns, where foreign ice can readily be obtained, it is not desirable to incur the expense of building an ice-house; but there are many places where such a supply is not to be had, and where, if natural ice be desired, the home-storing will be necessary.

The cost of an ice-house, such as we have described, would be from £70 to £100; but we shall show hereafter that ice may be stored in a more economical manner.

The Chinese, who have perhaps the oldest experience in the subject, build their ice-houses on raised earthen platforms. They consist of a frame-work of bamboo, well and thickly thatched with straw, and the ice is packed within, between alternate layers of the same material. Similar views have been adopted by the Americans, who have perhaps entered more thoroughly than any other nation

into the question of the preservation of ice. The American ice-house is generally a wooden building, elevated on an earthen platform, and the ice is covered with sawdust, straw, charcoal, or similar non-conducting substances. In their ice-stack they also make use of a circular earthen platform, and on this the ice is, during frost, built into a cone, and united into a solid mass by water poured over it. It is afterwards thatched with a coat of wheat straw, one foot thick, then with a layer of faggots or brushwood, and finally with another coating of straw thatch.

An inexpensive ice-house, well adapted for small families in the country, and more especially to farmers, is the following, which is in all essentials the same as one recommended by William Cobbett, in his "Cottage Economy." This is also on the high-and-dry principle, and is not sunk in the ground. The materials recommended are wood and straw, and the form should be circular. A (see Fig 3) is the centre of a circle, ten feet in diameter, at which a post is to be erected, fifteen feet high, and nine inches thick at bottom, and not much less at top; BBB is a circle of about twenty-eight posts, nine feet high, and each one six inches thick at bottom; CCC is a circle of about thirty-eight posts, five feet high, and five inches thick at bottom. Between these two circles is a space, D, four feet wide. This has to be formed into a wall of wheat-straw by pressing that material compactly between the rows of posts; E is a passage through this wall, of which F is the outer and G the inner door. Round the tops of the posts a plate of wood must be carried to receive the rafters. It must be thatched over with wheat-straw to a thickness of four feet, as shown at H (section, Fig. 4), and ample eaves allowed, that the walls may be kept thoroughly dry. It will be necessary for the sake of drainage to dig a trench round the enclosed space, just within the wall from the central post to which the earth should be sloped, as shown in section. From this a drain, I, must be laid and trapped, for the exclusion of air, as directed above. A trench should also be dug round the outside of the building. The floor should be laid with logs of wood, eight inches in diameter, leaving a space of a foot between; these should be crossed at right angles, with a layer of pieces of smaller diameter and placed more closely together. These are again crossed in a similar way by still smaller poles, and finally by a layer of clean twigs or heather. On this the ice is to be put and well broken, and pommelled down in the usual manner; and, when filled, the space between the doors should be packed with straw. The cost of such an edifice as this would be trifling; but a yet more inexpensive contrivance for keeping a small quantity of ice will be found to be the following, which is within the reach of all working men who have cellars in their houses:—Take a butt, or puncheon; knock out its head, and bore in the bottom a small hole, about an inch in diameter. Place inside this a tub with a similar hole in the bottom, and let it rest on three pieces of wood, so that it may not touch the bottom of the larger tub. Through the two holes a pipe should be passed, to carry off any slight waste that may occur; then fill the space between the two tubs with powdered charcoal. Fit to the smaller one a lid with a convenient handle, and on this lid place a circular bag of pounded charcoal, about six inches thick, covering it entirely, and over this place another wooden cover. Bury it four-fifths of its height in a dry cellar, keeping it a few inches from the earth at the bottom by means of brick-ends. Fill the tub nearly with ice or snow beaten hard, leaving room enough to place within any substance to be iced. Always take care to keep it well closed.

In filling ice-houses the ice is generally thrown in loosely, and the smaller pieces made to run in among the larger as closely as possible. Some persons recommend beating and pommelling the whole down together, so as to form it into one mass; this has the advantage of more

completely excluding air, but the ice will be of a rough quality. The foreign ice has a great advantage over ours in this respect. Its great thickness—generally as much as twelve inches—enables it to be cut into rectangular blocks, which can be stacked close together. In filling ice-houses, it is recommended that no salt should be used.

Evaporation, as a means of producing ice, is scarcely practicable in this country; but, as we shall show hereafter, it may be used for cooling to a considerable degree. In India, ice is artificially made by this method to an important extent. On a large open plain pits are dug about thirty feet square and two feet deep; the bottoms are covered, to the depth of eight inches or a foot, with dried sugar-cane stems, over which are placed shallow pans of very porous earthenware; these are filled at evening with soft water, which has previously been boiled. The great evaporation—if the weather be clear, and the atmosphere still—so much reduces the temperature of the remaining water, that it is converted into ice. By this method, nearly the whole of the ice, which is indispensable in India, was formerly obtained; but a trade in ice has sprung up with America to such an extent, that one importer alone, Mr. Wyeth, has erected a large store-house, covering three-quarters of an acre of ground.

Of more practical value to us in Europe are the methods of obtaining a low temperature, though above freezing point, based on the same laws. In Spain, during the summer, water for drinking is kept in jars and bottles of an extremely porous nature—much more so than any earthenware known in England. These they expose to the air, frequently by hanging them on the branch of a tree near the doors; a great part of the water evaporates, and the remainder is rendered cool in consequence. The same principle has, within recent years, been introduced into England; and water-bottles and larger vessels may be bought at our earthenware shops, in which to cool wine and other beverages. Another simple method is that of wrapping a wet cloth round the bottle containing the drink to be cooled, and hanging it in an airy place. This is an expedient resorted to in some parts of the south of Europe. It is extremely simple, and within the reach of every one.

Freezing Mixtures produce cold by the rapid conversion of solids which they contain into fluids, thus rendering latent a portion of their sensible heat. They are composed of a mixture of various salts, which, to produce the desired effect, are dissolved in water. Numerous "freezing powders" are sold. One that is recommended is composed of:—One part by weight of crude powdered sal-ammoniac, intimately mixed with two parts of pulverised saltpetre; and to this, when required for use, add an equal bulk of carbonate of soda. Another valuable one is composed of:—Five parts of saltpetre and five of sal-ammoniac in sixteen parts of water. Prepared freezing powders are also sold at moderate prices. The salts being mixed with water, the vessel containing the liquid to be frozen is rapidly moved about in the solution. This method has long been known in the East. In the "Institutes of Ak-bar," a prince who reigned in India at the end of the sixteenth century, the process is thus described:—"One part of saltpetre must be thrown into two parts of water, and in this mixture a vessel of pewter, or silver, closely stopped; and containing the liquid to be frozen, is whirled rapidly for a quarter of an hour." Many improved contrivances, for bringing the surface of the vessel containing the liquid to be frozen into free and rapid contact with the freezing mixture, are sold as "freezing" and "ice-making machines;" but their principle is the same as that laid down in the "Institutes of Ak-bar." It must be remembered that, as salts cause cold only during their solution, if the temperature is not sufficiently lowered by the time they are dissolved, new salts must be added; and when

the water is so charged that it will dissolve no more, another vessel and fresh salts must be used.

Ice-making machines for domestic use, for freezing with these mixtures, are sold at prices ranging from 30s. upwards; but the cost of the freezing powders is too great to admit of their being used with economy, except in places where natural ice cannot readily be procured. Where rough ice can be had, it is cheaper to use that material and common salt, in machines adapted to this compound, which may be bought at about the same prices.

Ice-chests are wooden boxes with double walls, the space between which is filled with a non-conducting substance, such as charcoal, or a box lined with cork. Some ice merchants in London supply a chest of this kind for small quantities of ice at £2 10s., and they may be procured of larger sizes. These chests have tightly-fitting lids, and if kept closed, ice may be preserved in them for a considerable time. By having one of these, and filling it occasionally with foreign ice, a family may be as well and more economically supplied than they could be from an ice-house.

Ice-safes, or Refrigerators, combine with the above an arrangement of shelves and tanks within the chest for the reception of perishable viands, and wines to be cooled. One of these contrivances is an extremely convenient appendage to a household. In these the ice is kept separate and may be preserved for some time. They may be bought for £3 10s. and upwards.

Amongst other contrivances connected with ice may be mentioned the ice-water pitcher, which has double walls of metal, with a non-conductor between. In this iced drinks may be kept cool for hours.

MAKING SWEETMEATS.—II.

Acid Drops.—You must, in the first place, boil one pound of lump sugar with one cupful of water and one spoonful of vinegar, until the sugar becomes thick and glossy, and brittle to the touch. Then pour it upon a stone, and add to it a quarter of an ounce of tartaric acid, and two drops of essence of lemon. After well mixing, cut into the drop-like form, and round them with the thumb and finger.

Everton Toffee.—Get one pound of treacle, the same quantity of moist sugar, and half a pound of butter. Put them in a saucepan, large enough to allow of fast boiling over a clear fire. Put in the butter first, and rub it well over the bottom of the saucepan, and add the treacle and sugar, stirring together gently with a knife. After it has boiled for about ten minutes, ascertain if it is done, in the following way:—Have ready a basin of cold water, and drop a little of the mixture into it from the point of a knife. If it is sufficiently done, when you take it from the water it will be quite crisp. Now prepare a large shallow tin pan, or dish, rubbed all over with butter, to prevent its adhering, and into this pour the toffee from the saucepan to get cold, when it can be easily removed. To keep it good, it should be excluded from the air.

Elecampane or Candy Cake.—Take clarified loaf-sugar and boil to candy height; rub it a little about the sides of the pan, till it begins to grain or turn white; then throw it out upon a warm slab, and divide it into squares. The sugar may be coloured with cochineal by adding some to the syrup while boiling, sufficient to give it the desired tint. This used to be made from the decoction of the roots of elecampane, whence it derives its name.

Peppermint Drops.—Mix half a pound of sifted sugar into sufficient lemon-juice to make it a proper thickness. Dry it over a fire, gently stirring in, at the same time, one hundred and twenty drops of the oil of peppermint; after which, drop the mixture upon white paper well greased.

THE HOUSEHOLD MECHANIC.

CHEAP, SIMPLE, AND TASTEFUL HOME-MADE FURNITURE.

UNDER this title, it is proposed to give directions for the construction of a description of furniture which will, at the same time, possess the advantages of costing little, of being so simple that it can be made by any person of ordinary ingenuity without expensive tools or appliances, of being strong and serviceable, and of being at the same time so founded in its design on the canons of good taste as to be pleasing in appearance.

The materials required for it are inexpensive, the whole wood-work being composed of deal boards only; and beyond these, nothing is wanted except round-headed screws for fastening together, oil-cloth for covering tables and chairs, glass for book-case doors, a few hinges and locks, a little varnish, &c.

Furniture is easily made on this system, because in it all the more difficult operations in joinery are avoided: only the simplest joints are used, and in most instances the pieces are simply clamped together. As no attempt is made to conceal joints, and the whole construction is intended to be shown in the finished work, absolute precision and neatness in fitting may be dispensed with. In proof of the facility with which such articles can be executed, it may be mentioned that the whole of the examples given, as well as others, have been produced by the writer and a friend (by way of evening recreation), without the assistance of any carpenter's bench or vice, and with only a few of the most ordinary tools.

Articles thus made are stronger than common furniture, because the construction in every part is honest: strength is given wherever strength is required, and solidity is not sacrificed, as in most modern furniture, to the cabinet-maker's distorted ideas of beauty, as shown in what is

technically called "shaping." As all the parts are solid, and the whole construction shown, there can in these things be no plastering over of weak joints and defective workmanship with veneers or putty; and, as matter of fact, most of the articles given have stood the test of years of rough wear and tear.

This same point of honest construction may also be adduced as an argument for their being in good taste. Though fitness is not beauty, it is an essential part of beauty, and an article cannot be good in form unless that form explains its construction, and is suited to the uses for which it is intended.

The form becomes good when due proportions and appropriate ornaments are added to those qualities. A certain Gothic air has been preserved throughout these things, because, as it appears to the writer, it is in that style that the great principle of making construction itself decorative, can most easily be carried out.

Our first illustration is a table, the top 3 feet square, and the height 2 feet 5 inches. The whole of the framework is deal plank, 1 inch thick, and 4 wide. The legs, A A (Fig. 1), which cross diagonally, are made of pieces 3 feet long, and left at full width in the middle (where half the thickness of each is cut out to form the joint) to give the necessary strength; above and below some part is sawn away for the sake of lightness and decoration. They are screwed together at the centre, B, and the end of the cross-bar, C, is brought through by a mortice, and secured by a peg. The ledgers, D D, which support the top, are simply screwed to the outer side of the legs.

Fig. 1.

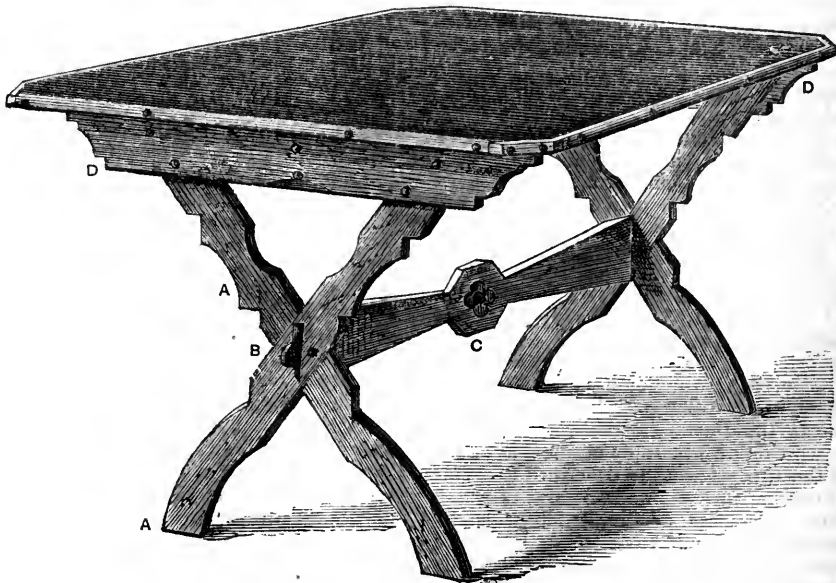

Fig. 2.

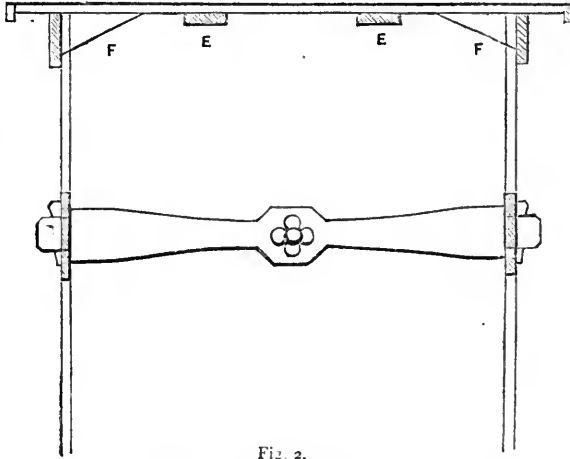
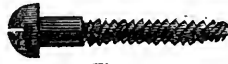

Fig. 3.



Fig. 4.



The top itself is formed of half-inch deal match-boards, 9 inches wide, each of which is secured to the ledgers by four flat-headed screws, and, after all are fixed in position, two supplementary ledgers are placed below (as shown in the section at E E, Fig. 2), to which they are also screwed.

Two triangular pieces, as at F F in the section, are also screwed in to prevent any lateral weakness. The groove and tenon edges of the match-boards (see Fig. 3) admit of the top being rapidly and strongly put together. The corners have to be cut off, and a good stout piece of black oil-cloth stretched over and secured with tacks on the under side. Some little care is required in straining this, in order to make it perfectly tight and without crease. Since there are many persons who object to oil-cloth, we may mention that green baize, or any similar material will, if preferred, answer the purpose equally well. Lastly, strips of half-inch board, an inch wide, have to be screwed round the edges; the longer strips on the sides should first be fixed in their places, and then the shorter pieces on the corners, overlapping the former, as shown in the illustration (see Fig. 1). The corner strips, being each fastened by two screws, will keep the others firmly in their places, and the whole of the edges can then be trimmed, and smoothed down with sand-paper. With the exception of staining or varnishing—of which we shall speak in a future article—the table will now be completed. If the upper edges of the strips are kept a trifle, say the twentieth part of an inch, above the level of the table, it will be well, as they will then prevent small articles, such as pencils or reels of cotton, from rolling off. It may be remarked that as these strips are merely screwed on, they can at any time be removed, and a new oil-cloth covering fixed to the table when the first becomes worn. All screws which are not concealed, used in this table, as in the other articles to be described, are "round-headed," like that shown in the cut (Fig. 4), and covered with black lacquer; they project above the wood-work, and assist in making it decorative. The whole of the materials for the table would cost some six or seven shillings, and the labour of three or four evenings would be amply sufficient to complete it.

ODDS AND ENDS.

To wash Summer Curtains.—The large white muslin or lace curtains, which are one of the ornaments and glory of summer, may be taken down one day, washed, and put up again the next, with no damage to themselves, and very little trouble to the owner. When taken down, tack strips of coarse muslin, about half a foot deep, all round; this is to come off again when finished. Let them steep well in cold water; they should not be rubbed, but gently squeezed and pressed with the hands from the cold into warm water, and then scalded instead of boiled. After being slightly blued and starched, they can be stretched on the parlour carpet, held tight with pins stuck into the muslin border a quarter of a yard apart, and remain there all night. They should be laid down the last thing in the evening, and the door locked to prevent unnecessary intrusion (beware of the cat). They will be found quite dry and stiff in the morning, and look as well as when bought. The border must then be taken off—which was only required to prevent the pins from tearing the edge, and to keep it from having a scalloped look. Lace veils, anti-macassars, and short curtains can all be done in the same way.

Netted Sponge Bag.—Net twelve stitches with coarse crochet cotton on a piece of the cotton, with mesh about three-eighths of an inch wide. Net twelve rows to form a square. Run a piece of cotton into the centre stitches, and continue netting round twenty-four rows. Run a piece of tape through the last row. Tie the ends in a knot.

A bright Tea-kettle.—A blackened kettle is not only unsightly but disadvantageous for keeping water hot, as its surface, when rough and black, is a powerful radiator of heat; whereas, if kept clean and polished, it will retain the heat of water boiled in it much more effectually. The

bright parlour kettle is, therefore, best adapted for this purpose.

When an Egg cracks.—Eggs sometimes crack upon being immersed in boiling water, or are found to be so when required for use. The plan to adopt, so as to prevent the contents from oozing out, is to gently rub the crack with moistened salt, allowing a little time for it to penetrate, and then it will boil as well as an uncracked one.

To remove Grease from a Wall-paper.—Mix some fullers' earth with some ox-gall and cold water, and plaster it over the grease spots. Pin a piece of blotting-paper over this, and allow it to remain for some two or three hours; after which brush it off carefully, and renew the application if necessary.

A method of Destroying Bugs and Fleas.—Buy an ounce of quicksilver at the chemist's, and beat it to a froth in a mortar, with the whites of two eggs; or, if desired to be thick, like ointment, use only one egg. Take the bedsteads to pieces, and apply the mixture to the crevices, joints, and screw-holes, and observe that it is thoroughly absorbed. If you have made an ointment, rub it on with your finger.

To kill Moths.—Furs or woollen garments should be well shaken before they are put away, and in the drawer with them should be placed pieces of camphor, cedar shavings, shreds of tobacco, or cuttings of Russian leather, or pine fruit from the pine trees which contain a certain amount of turpentine—any of these will generally prevent the moth from appearing.

An Easy Way to silver Glass.—This may be done by dissolving ten parts of crystallised nitrate of silver in fifty parts of pure distilled water; to this exactly six parts of the solution of ammonia is to be added; then one part of tartaric acid must be dissolved in four and half parts of water, and mixed with it; afterwards the whole must be diluted with five hundred parts of pure distilled water. Having thus prepared the silvering solution ready for use, it is now necessary to clean very carefully the glass we wish to silver, which is then placed into a vessel, and the solution poured in. The vessel is next put away in a quiet place, and kept at a temperature of 40° to 50° centigrade. When the glass is silvered, it may be carefully washed in a very gentle stream of water, and then dried at a moderate heat. As the silver would tarnish by exposure to the action of the atmosphere, it is advisable to varnish it over with some polishing varnish. For this purpose, amber dissolved in chloroform will be found an admirable preparation.

To whiten Linen which has discoloured.—Put a gallon of water into a saucepan, with one pound of finely cut up soap; and, when thoroughly melted, put the linen into it, and boil for about thirty-five minutes; then take it out, and rinse in two cold waters with very little blue in it.

To take fresh Paint out of a Coat.—Take the wrong side of a piece of cloth and rub the spot with it until it disappears. If this does not answer, apply a little spirits of turpentine or ether, with the top of the finger or a piece of sponge, and rub it as hard as you can. (See also page 148.)

Substitute for Milk or Cream.—Beat up the whole of a fresh egg in a basin, and add a small piece of butter, and mix with the tea or coffee gradually, to prevent curdling.

To keep Potatoes.—Potatoes should be kept from frost. If put into a cellar, the air and light should be entirely kept out by stopping the window with straw before the frost commences.

Oil for Watches and Delicate Machinery.—Put some of the finest olive oil into a thin bottle, and after surrounding the vessel with ice, freeze the oil it contains. The cold will cause the oil to separate into two portions—a solid part called margarine, and a thin liquid portion named oleine. This oleine is then to be carefully poured off, and preserved for use.

HOME GARDENING.

THE CUCUMBER.

Its propagation under Bell Glasses and in the Open Air.

—Towards the middle or end of April, sow the seed in a cucumber or melon bed, and when they have got their second pair of rough leaves, plant them out into small pots, two in each, and give them a little water to keep them moist, but not wet. About the second or third week in May, choose a compartment of ground lying warm, and where the soil is rich and light, and dig out a trench two feet deep, and three and a half feet wide, and the length according to the number of glasses that it is intended to contain, at four feet distance from each other. Then fill the trench in with good warm dung, broken well, and trodden down evenly, leaving the dung about three feet thick from the bottom of the trench—that will be allowing one foot for settling. As soon as the bed is thus made, cover it over either with the soil of the garden, or with sods of turf, preferring the latter if they can be procured. Do not allow any part of the dung to be exposed, and the fermentation will go on regularly. Insert trial sticks in different parts of the bed, and when the dung is come to its full heat, put on about six inches more soil (allowing the first covering to be two inches), and immediately put on the glasses four feet apart, and when the mould is warm under, turn the plants out of their pots, with the balls of earth entire, and insert them under the glasses—one ball containing two plants under each—and give them a little water directly, to settle the mould about them. Place the glasses over them immediately, and keep them close till they make fresh roots and begin to grow, when a little air must be given by raising the glasses a little on one side; and as the warmer weather comes on, give air more freely, in order to inure them to the out-door atmosphere.

When the plants begin to fill the glasses a second time, they must be trained from under them in a horizontal direction, laying sticks, similar to pea-sticks, upon the soil for the vine to run upon, as they always do better on these than on the ground itself. The plants will require but little more attention, further than watering sufficiently in dry weather, and continuing to lay sticks to catch the vines as they run. If the summer proves fine and favourable, they will commence bearing about the latter end of June, and continue producing fruit for two or three months at least. As soon as all danger from frost is over, the glasses may be taken off entirely.

Should dung be scarce—and in some localities it is at times—circular holes may be dug, eighteen inches deep, two feet across, and about five feet asunder, and filled in with hot dung trodden moderately firm, and immediately covered with about a six-inch layer of light rich mould, and the glasses immediately set on; and when the soil gets warm, either plants or seeds may be put under them; and although, in many parts of the country, the latter plan is adopted, we decidedly give preference to the former. If the plants or seeds, however, are managed as above, they will produce plenty of fruit from the latter end of June to the end of September, supposing the work to have been commenced the first week in May.

Sinking the bed into the soil is a circumstance that should be particularly attended to, for when the dung is made up in narrow strips, as it must necessarily be in trenches, the roots very soon strike into the sides, and, having no further scope to run, the plants receive a check they never afterwards recover from. On the other hand, when the bed is sunk in good rich soil, and the roots or fibres extend themselves out of the dung, they will work forward into the soil, and will continue to grow till autumn. Proper attention must be had to watering in dry, warm weather; two or three times a week will not be too often

up to the beginning of June, and after that time, a little every day will be required, giving this moisture in the evening from June to August, as the weather is warmer or cooler. At other seasons, morning is the best time. Soft or rain water should always be used in preference to well or spring water, which is injurious to the plants.

COOKING.

SEA FISH (*continued*). BACON, HAM, AND SALT PORK.

Broiled Mackerel and Tarragon Butter.—Chop a few tarragon leaves excessively fine (a little will go a long way, the flavour being very penetrating). Mix this thoroughly with fresh butter, pepper, salt, and a dash of vinegar, adding the vinegar to the chopped leaves *first*. This makes tarragon butter.

Empty your mackerel without opening the belly, *i.e.*, draw the small intestines at the opening of the gills, and the bowel at the vent a little enlarged. Wash and dry them carefully. Split the back down to the bone; cut off the snout and the tip of the tail; put them in a dish; pour over them a little olive oil; sprinkle them with pepper and salt, and let them soak for half an hour, turning them from time to time. Lay them on the gridiron; and when they are done, put some tarragon butter in the slit down their back, and serve on a hot dish, with some of the same butter spread in it.

Boiled Mackerel.—When the mackerel are done enough, open them, take out the back-bone, and sprinkle the inner surface of each half of the fish with a little very finely chopped parsley. Brown a little butter (just enough to serve for sauce to the fish) in a saucepan over the fire; throw in a dash of vinegar, and mix well together. Pour this over the opened mackerel; clap the two halves together, and serve. No other sauce is wanted, which is a great saving of time and trouble—in fact, this dressing *is* the sauce.

Stuffed Mackerel, Broiled.—Open the mackerel, wash the roes and milts, drain them well, and put them aside. Mince a few onions and a sprig of parsley *very* fine; then chop up with these the roes and milts, adding a little grated bread-crumb, and seasoning with pepper and salt. Fill the bellies of the fish with this stuffing, and sew them up with needle and thread. If you have any stuffing left, you can make it into little cakes; broil them in a Dutch oven before the fire, and use them for garnishing round the dish. Broil the mackerel slowly and thoroughly over a charcoal fire. When done, and laid on their dish, pour over them a little browned butter, with a dash of vinegar in it, as above.

Mackerel à la Poulette, stewed White.—Open the fish, save the roes and milts, and cut each mackerel into three pieces, rejecting the heads and tails. When all these are well washed, dust them, as well as the roes and milts, with a little flour, and put all in a saucepan with a lump of butter, seasoning with pepper and salt. Add a few onions and parsley chopped *very* fine, and just enough water to secure them from burning. Cover down close with the saucepan lid, and stew gently over a slow fire. There is no need to turn or stir the fish about. From twenty minutes to half-an-hour will do them, according to the size of the fish and the fierceness of the fire.

When done, arrange the pieces neatly on their dish. Let the liquor in the saucepan cease to boil. Stir in two or more yolks of egg, with a dessertspoonful of vinegar, continuing to stir until the sauce is smooth; then pour it over the fish and serve.

Plain Boiled Mackerel.—Draw the intestines, but leave the roes and milts inside. Throw them into boiling salt-and-water, and let boil from twenty to five-and-thirty minutes, according to size. There are people, indeed, who say that mackerel too much boiled is *poison*,

meaning that it cannot be too much boiled. Serve on a napkin strewed with fennel sprigs, and accompanied by shrimp sauce, fennel sauce, or mustard sauce.

BACON, HAM, AND SALT PORK.

Doctors differ as to the derivation of the pleasant word "bacon." Some fancy it to be a corruption of the Scotch *baken* (dried); others suggest that it comes from *beecheen*, the finest fitches being furnished by animals fed on beech mast. Moreover, in the old Lancashire dialect, bacon is both spelt and pronounced *beecheen*. Ingenious, but not conclusive. Pity the great Lord Chancellor Bacon did not record the origin of his family name. We get little help from the German *Speck*, the French *lard*, or the Italian *lardo* or *lardone*.

There are different ways of curing bacon. In Yorkshire, after the pig has been killed, it is allowed to hang twenty-four hours previous to being cut up. One pound of saltpetre is then rubbed into a twenty-stone pig, and one and a half or two stones of common salt; it is then put into a tub kept for the purpose. After having lain a fortnight, it is turned over and a little more salt applied—say half a stone; it then remains a fortnight longer in the pickling-tub, whence it is taken and hung up in the kitchen, where it remains to dry; but should the winter be far advanced, and dry weather set in, a shorter period might suffice. After being taken from the top of the kitchen, the inside is washed over with quicklime and water, to preserve it from fly-blows. It is then removed into a room not used by the family, away from heat, and where it will be kept perfectly dry, and is ready for use. The smoking system is rarely adopted. York hams are in great repute, not only in England, but on the Continent. The Westphalian plan is as follows:—Six pounds of rock-salt, two pounds of powdered loaf-sugar, three ounces of saltpetre, and three gallons of spring water, are boiled together. This should be skimmed while boiling, and when quite cold poured over the meat, every part of which should be covered by the brine. Small pork will be sufficiently cured in four or five days; hams, intended for drying, in four or five weeks, unless they are very large. This pickle (as well as most others of the same kind) may be used again and again, if it is boiled up afresh each time, with a small addition to the ingredients. Before, however, putting the meat into the brine, it must be washed in water, the blood pressed out, and the whole wiped clean.

Pickling-tubs should be larger at the bottom than at the top; by which means, when well packed, the pork will retain its place undisturbed until the last layer is exhausted. The bottom of the tub should be covered with rock or other coarse salt, and on it a layer of meat placed, and so on, till the tub is full. The salt should be used liberally, and the barrel filled with strong brine, boiled and skimmed, and then cooled. Hams and bacon may be smoked at home, hung up a chimney where wood only (and that not fir or deal) is burnt. But the operation is best—because more slowly and uniformly—performed in buildings specially constructed for the purpose. The Westphalian hams (principally cured at Hamburg) are smoked in extensive chambers in the upper stories of high buildings. The smoke is conveyed to these rooms through tubes from fires in the cellar. The vapour is thus condensed and the heat absorbed; so that the smoke, when it reaches the meat, is both dry and cool, and communicates a flavour far superior to that obtained by the common method.

Hams, after being smoked, may be kept any length of time by being packed in dry ashes, or powdered charcoal. Both bacon and hams, if exposed to the air, are liable to the attacks of flies and their offspring, maggots. An excellent plan is to put them in chests filled with bran, which will both keep them from turning rusty and protect them from insects. For hams, a most effectual preservative is, to sew them up in a coarse linen or cotton wrapper,

and to wash it over thickly with lime-wash. Hams, *well-kept*, are the better for keeping. Many epicures do not consider them *ripe* until they are two years old.

A good Pickle for Hams to be Smoked.—Take a deep stone-ware pan, just large enough to hold your ham. The same pan, and pickle made in the same way, will serve, at another time, to cure a couple of tongues. Into this put one pound of coarse brown sugar, one pound of grey salt, half-a-pound of bay-salt, and one ounce each of saltpetre and salt-prunella. Mix these well, and with them rub the ham; then pile them over it, and leave it a couple of days; after which turn the ham every day, piling the salt over it, and lading over it with a spoon any brine that may have formed at the bottom of the pan. Do this for a fortnight. If the ham is wanted for immediate use, you may then take it out, smoke it for three or four days, and boil it at once. If it is required to be kept, you had better pickle it three weeks or a month. A pound of treacle is a good substitute for, or addition to, the sugar. When it is used, a pint of beer may be added, to form a brine. The Americans employ treacle largely in curing meat, with great advantage both to flavour and keeping.

The French Country Way of Salting Pork.—Bacon, so cured, is almost the only meat ever tasted by millions of our neighbours. As soon as the pig is killed, it is invariably not scalded, but singed, in the way so well described by Cobbett, who shows his knowledge of boys, by saying that they love a bonfire. The carcase is laid on a truss of straw; fire is set to it to windward; then, after turning the pig, any bristles left are burnt off with torches of blazing straw. The burning complete, it is well broomed, washed with cold water, and well scraped with a knife as a final shave. At the killing, blood is taken for black-pudding. After opening, the "fry" is thrown into cold water for speedy use, and the chitterlings cleansed. Some leave the opened pig hanging all night to cool and stiffen; others, seizing time by the forelock, kill before daybreak, and cut up after sunset by candlelight. The pig is halved, and then cut up into convenient pieces of from three to five pounds each, reserving often the hams, head, feet, and tail, for special treats, and perhaps also a few roasting pieces. The head—*i.e.*, the chops (after removing the brains, ears, nostrils, and tongue, to stew with the tail)—may be salted with the rest; the hams also (left entire), as they are not often smoked or pickled with treacle. The feet are boiled tender, and broiled as tid-bits. For a pig weighing two hundred pounds, take thirty pounds of coarse common salt, two ounces of ground pepper, and four ounces of mixed spices, ground. Mix these well together, and with them rub well each piece of pork. At the bottom of the salting-tub (made of oak, with a cover) pack a layer of pork closely together, sprinkle it with the salt and spice; then another layer of pork, and so on, till it is all packed in the tub. Sprinkle the remaining salt on the top; pour in a pint of cold water, to draw the melting salt through the meat. Put on the cover, and see how it is going on every now and then. The pork may remain in pickle from four to six months; it is then best to take it out to dry on a wicker hurdle, in a dry and airy part of the house, where it will lie in a single layer ready for use.

Robinson, in his useful book, gives the following receipt for curing a Warwickshire ham:—Rub a leg of pork with two ounces of pounded saltpetre, and let it lie twenty-four hours. Then make a pickle of one gallon of river-water, one peck of pale-dried malt, one pound of sugar or treacle, one pound and a half of bay-salt, two pounds and a half of common salt, and three ounces of onions or shalots sliced. Boil together ten minutes, taking off all scum—pour it hot over the meat, straining off the malt. Keep the ham covered with the pickle, and let it be turned and rubbed daily for three weeks; then take it out, dry it with a cloth, and smoke it three weeks or a month. Keep it in malt-dust.

HOUSEHOLD AMUSEMENTS.

FANCY WORK IN CARDBOARD.

Raised Work with Perforated Card.—Beautiful fancy articles can be made simply of perforated cardboard, by raising any figure in layers, each layer smaller by a single row of holes than the previous one. The best effect is obtained by such figures as can be cut entirely in lines perpendicular and horizontal through the holes of the cardboard. For this reason it is that the crosses,

from the edge, as shown more particularly in the section, Fig. 2. Cut the last corner quite away to C, Fig. 1.

The card is to be folded to make the box at the dotted lines, A A A A, and joined. Afterwards the pieces between the B's are to be turned down at the dotted line C to D, to fix the bottom of the box to it.

But before forming the box, ornament the sides. Cut four squares of card, thirty-eight holes each way, and place them exactly in the centres of E E E E, taking care not to infringe upon the holes which are to be left to form

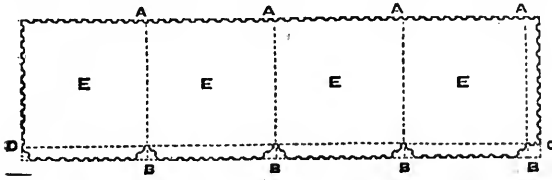

Fig. 1.

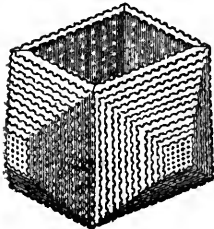

Fig. 3.

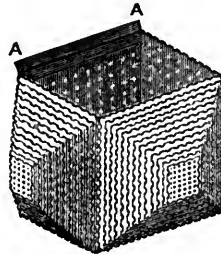

Fig. 4.

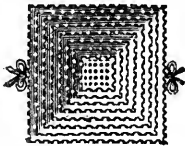

Fig. 9.



Fig. 2.

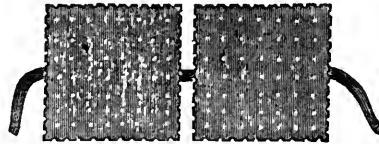

Fig. 8.

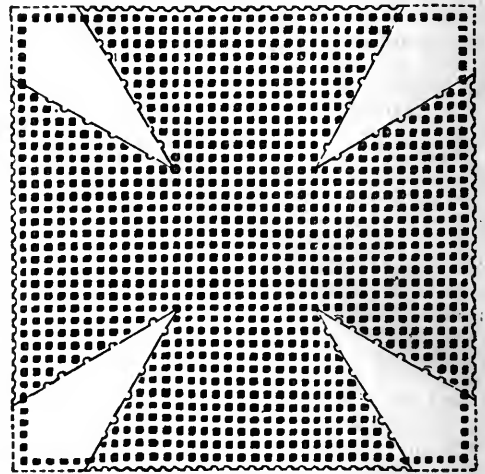

Fig. 10.

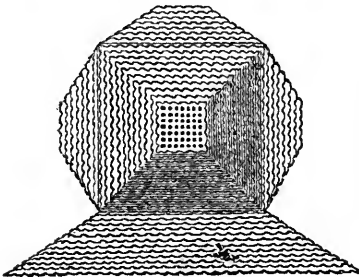

Fig. 6.

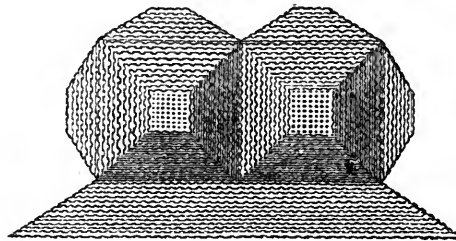

Fig. 7.

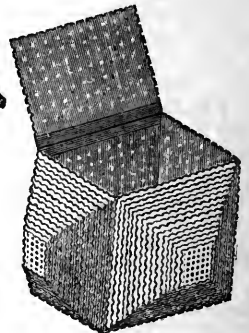

Fig. 5.

often made in such fancy work, look so beautiful. Cardboard with the finest holes is not used, but that sold as No. 2 is about the right size.

An exceedingly pretty gift-box may be made from a sheet of perforated card (price 1s.), in the following manner:—Cut a strip of card, forty-two holes wide (not counting the holes cut through), and thirty-nine holes long. The box is to consist of four sides, each thirty-nine holes square. One hole is allowed for the turning of every one of the four corners, and two holes over at the end to join it. Three holes are allowed all along at the lower edge, two to join on the bottom, and one to turn down.

Having cut off this strip of card, count thirty-nine along the length, and put a pencil-mark on the fortieth hole; repeat this three times more, and then you will have pencil marks at the four places marked A A A A in Fig. 1. You next cut out the little corner bits indicated at B B B B in the lower margin, cutting them up to the third row of holes

the edges. On these again place four squares, thirty-seven holes each way, and go on laying square over square, each one a single hole smaller every way than the last, until you arrive at a square of eight holes. When the ornamenting is completed, join the box round in the manner indicated, bending it into corners at the four spaces left for that purpose. Let this join, and dry well. Then turn down the pieces B B B B (Fig. 1), as shown in Fig. 3, and join on a square of thirty-nine holes for the bottom. Cut another similar square for a lid, and ornament it as the sides of the box are done.

To make the pedestal, cut a square of forty inches, another of forty-one inches, and so on, cutting each square a size larger than the last, until you have raised your pedestal as high as you wish it.

Join the lid to the box with a narrow strip of fine muslin, half an inch wide, and as long as the box. Paste this on one side only, join it lengthways, and half the width to the

top edge of the box on one side, inside, leaving the other half standing up above the box, Fig. 4, A to A. When this is dry, paste the half of the muslin standing up on the same side as before, and attach it to the inside of the lid, Fig. 5.

The box may now be fixed on the pedestal. The whole of the parts of the box should be joined together with a thick paste made of arrowroot and water. Gum is apt to discolour the work. This little box may be lined inside with cherry-coloured silk, cut of the exact size, run together on the wrong side, and attached at the upper edge by paste, a hole below the edge of the box. A strip of narrow embossed gold-paper must be neatly pasted over this, and the lid lined in the same way. The extreme edge of the gold-paper must not come quite to the edge of the box. The silk lining is made of a single strip, joined, and a square piece again joined to that to form the bottom of the box. As a ring or trinket casket, the box makes a charming birthday or bridal gift, or an object for a fancy fair. If the box is lined with silk, line the base of the pedestal in the same way, gold edge and all, for that will make it very complete. See Fig. 6.

A handsome casket may be made in the same way, the front and back twice as long as the width of the sides, and embellished with two raised squares or panels. See Fig. 7.

A varied and very handsome casket may be made in this way:—Get a page of Baxter's oil prints—of very small size, such as the "Allied Sovereigns," which are used for needle cases—or of minute photographs. They must all be of one size, the subjects should be pretty, and suitable to be placed together as parts of one whole. If the casket is to be double, six pictures will be needed for the box, and two more for the lid. Cut eight pieces of card the size of these, whether they are square or oblong; and if oval, cut out the margin of the oval, and let your square or oblong of card be just large enough to mount it. Do not, however, fix the photograph till you have completed your card panel. Continue adding piece after piece of the cardboard, every piece a hole larger each way than the last, till you have raised your panels as high and handsome as you wish them to be. Then construct your box in the way already named. Add the lid, and afterwards line it. Lastly, construct the pedestal, line the bottom with silk, edged with gold-paper, and then fix on the box. To conclude, put the pictures on the centres of every panel.

In making the box, each layer should be subjected to pressure, and allowed to dry before the next is added. A large book on the top is sufficient at first. When the panel becomes small, two or three pence will be weight enough. Always put a clean sheet of paper between the card and the presser. When the box is pasted on to the pedestal, fill the bottom inside to the corners with something heavy enough to keep it in place till it dries. Nothing could be better for this purpose than a quantity of small shot.

Needlebooks and pincushions may be made in the same way, raising one side only, and leaving the other plain. Put on the strings on the raised side between the first and second layers of card, the first layer having been previously covered on the inside with silk. The wrong side consists merely of two layers the same size, the inner one lined, the outer plain, and the string let in between. The two strings are made of one piece, which unites the sides of the needlebook at the back, where also the flannel for the needles is afterwards joined on with a coloured bow. Fig. 8 shows the book open, and how the ribbon is placed. Fig. 9 displays it closed, the strings tied on one side, and the bow that fastens in the flannel or cashmere for the needles, on the other.

A pincushion may be made with one or both sides raised. The pincushion of ribbon, between two sides of silk, is made separate, and the ornaments pasted on afterwards.

The cushion must not be stuffed full, but kept very flat, by taking a few stitches through, as they are done in a mattress, and tying the ends together in the manner shown in Fig. 9; the ribbon serves to form the border for the pins.

To form boxes, cut a strip of card, like Fig. 1, in the raised perforated work, and cut out the four sides as you wish. Then you can attach inside, coloured paper, foil, or silk by the corners only; and, lastly, form your box into shape and join it. Fretwork must always be lined with rich coloured paper, foil paper, silk, satin, or ribbon. In making the box, do not line the piece to turn up to secure the bottom, but after the bottom is pasted on and dry, line it from the inside.

In doing fretwork, you must not drag the knife along, but cut down right through with the point. A very sharp knife is indispensable.

In adapting patterns, always remember that wherever you make a cut to meet a cut, the piece between will come out bodily, and the designs must be humoured to prevent this where it is not wished.

No. 1, or the finest card, should be used for this purpose. We add a pattern for a star, Fig. 10, which may be attached to a broad ribbon for a book-marker, or to a square piece, covered with silk or satin, for a needlebook, the coloured fabric showing prettily through the sides of the star. Cut a square of thirty-six holes. In the centre, mark a square of twelve holes with pencil. With a pencil mark the arms of the cross, one from each dot of the centre square to the margin, where they count six each way. Make every layer one hole smaller every way, and in the centre also, till you have raised it as much as you wish. Then in the centre of the star place a square of seven holes, on this place a square of six, and diminish to a square of two. We shall return to this subject in another article.

ARTIFICIAL CHALYBEATE WATERS.

THESE waters are most strengthening and tonic in all cases of debility. They have long since obtained the highest celebrity for complaints peculiar to females, and too great attention cannot be paid to aid in increasing the use of them. It must be remembered, however, that they are not suited to all constitutions, as for instance, for persons of full habit of body, and those of plethoric or inflammatory conditions of system. To make an agreeable effervescent chalybeate draught:—Mix two drachms of crystallised sulphate of iron with three drachms of pulverised loaf sugar, and divide into twelve parts, which may be folded up in paper and termed "powders." Mix two drachms of pulverised bicarbonate of soda with three drachms of pulverised loaf sugar, and divide into twelve parts, which may be folded in papers as the former, but the papers should be of a different colour. Take one of each of these powders, and dissolve them separately, each in half a glass full of water; pour one glass into the other, and drink during effervescence.

Another Receipt.—Dissolve any amount of crystallised citric acid in four times the weight of hot water, charged with pure peroxide of iron in the washed state, precipitated by ammonia from the sulphate of iron. This solution sweetened, and charged with carbonic acid gas, forms a most agreeable draught and is salutary to the stomach.

Another Receipt.—Pour a pint of water, impregnated with fixed air, upon an ounce of iron filings. Let it remain four-and-twenty hours in a cool place, then pour off the liquid, which will be ready for use. Chalybeate water may be well taken two or three times a day, but should be used sparingly, especially at first—that is, should not be too strongly impregnated with iron, nor more than half a tumbler taken at a time.

PARASOLS AND UMBRELLAS.—I.

PARASOLS are articles of use which are constantly undergoing changes of fashion, but certain general rules may always prevail in their selection. First, avoid all extremes of shape and ornament, all eccentricity, for that will but be the caprice of an hour. Consider the purpose for which the parasol is required, the occasion, and the remainder of the toilette with which it is to be associated. The eccentric, square-shaped parasols, patched up of two colours, which came in a season or two back, have been an entire failure. They were so remarkable at first as invariably to attract attention to the wearer, and they were of very little use for the purpose they ought to have effected, namely, shading the sun from the face. Besides, they were stiff and ugly. An unfortunate tradesman, who had invested largely in these articles, intended to sell at 10s. 6d. a piece, has been glad to get rid of them at £2 2s. a gross.

Parasols for the sea-side and country, where the sun is very intense, or even in the parks early in the morning, are best of what are termed the parachute kind—that is, small umbrellas, with long, unbending handles, and made of white holland, buff gingham, or even of tussore silk. Tussore silk parasols, lined with white or pink, are admissible for general carriage use. In the streets of London the parasol should accord with the dress, and not be too ornamental. If the dress is dark, and economy closely studied, a dark brown parasol or parachute of silk can be carried. Twilled silk is excellent for use, from its softness; but, with a light toilette, a grey dress, or a muslin of pale colours, a dark parasol would be very ugly. In mourning, whilst the black is deep, only a black parasol can be used, and it is in good taste to have this very plain, or, at least, only trimmed with a whalebone fringe. In half-mourning, grey becomes admissible; but a light spot, in the shape of a parasol, over a figure robed entirely in black, would be even uglier than a dark spot hovering, like a Damoclesian blot, above the head of some fair girl in airy muslin. For walking, a parasol perfectly plain, or, if the wearer is well dressed, surmounted with a couple of frills of the same material, is in the best taste. A black lace covering may be used with perfect propriety. White lace covers are only fit for carriages or fêtes. Plain parasols may be used in carriages, but they should be white or very pale, and more ornamental ones can be used without objection. But at fêtes and flower-shows the most elaborate parasols may be displayed without criticism, except in regard to the good taste exercised in their adornment, and their consistency with the rest of the toilette. A very magnificent costume would render a plain parasol nearly as absurd, by contrast, as the assumption of something highly ornamental with an otherwise simple and unpretending *ensemble*.

Nothing is more ladylike and in better taste than a plain white silk parasol, unlined or lined with white. For the present fashion, the addition of a couple of frills of the silk, also white, is not highly censurable. Such a parasol is fit for any occasion—for the street, the carriage, a fête, or a flower-show. It should have a bending handle, because the straight one is too stiff for the graceful movements, and makes a disagreeable line, dividing the dress, in appearance, when closed. White has the advantage of not fading, of being suitable to wear with any dress and any bonnet, and it has the great advantage that it reflects the light, and thereby aids in keeping the wearer cool. For the same reason, as well as on principles of good taste, light colours are the next most suitable, as screens against the light and warmth of summer. Steel grey and dove grey can be worn with most colours, and are therefore next best to white, and perhaps a little less liable to soil. French grey or lavender looks well in a parasol, but there are many colours with

which it will not assort. Parasols should never be lined with anything but white or pink. Pink reflects an agreeable glow on a pale face, but should be avoided by ladies who are florid. But, then, pink will not look well with any other colour in the toilette. We saw recently a parasol lined with violet. Such a colour would reflect a corpse-like hue on nearly every face that ventured beneath it. Decided colours, such as bright blues, violets, and greens, are not pretty for parasols; but if they are worn, or are mixed with white, a lady will have occasion for two or three parasols, and should only wear them with costumes that introduce the same colours. Satin is used now for parasols.

The handle should be chosen neither too thick nor too thin. Handles that are very slender slip out of the fingers, and those that are too thick are clumsy to hold and ugly in appearance. Utility should always be considered before fashion. There are some remarkably ugly and *outré* sunshades to be seen in the shops this year, with walking-sticks for handles, like Irish shillelahs. Ladies of good taste will not, we think, carry them. They are very heavy in the hand also, which is a great objection. A parasol should be as light as possible.

Messrs. Jay, of Regent Street, have a parasol with a new kind of fastening for the joint in the centre of the stick. Instead of the rather unsightly waist of metal, an ivory ring unites the two pieces, by means of a small pin at one end and a groove at the other, as the lids of china teapots used to fit in. When bent, the two pieces are connected by a silver chain. Whilst noticing this invention, a pretty parasol for mourning caught our attention. It was simply made of black silk, with two fringes of white whalebone. Another parasol, elegant and costly, without being over-decorative, was made of white pigeons' feathers entirely, wreathed with the bright plumage of the peacock at the edge and at the top, and tasselled with the same jewel-like feathers.

Many persons of good social position and slender means are obliged to practice small economies in dress. A black lace parasol-cover is always a useful article, because it can be transferred from one parasol to another, and makes it possible to wear for some time a light parasol which is a little soiled, or which has been cleaned. Parasols can be cleaned or dyed for a shilling, and may serve for use in the country, or for children. If a parasol has been good at first, it will admit of re-covering. A very handsome one may be worth trusting to the hands of a tradesman, but ordinarily it would be more expensive than desirable. But a country, sea-side, or garden parasol may easily be made when the silk upon the frame is worn out. Pick it off, and cut the size exactly in brown holland or buff cotton. Stitch the seams together, and hem the edge. Open the frame. Slip the cover over it. Run round the top with strong thread, and secure it well to the frame. Then tack one of the corners of the cover strongly to the little holes at the point of one of the ribs. Tack the opposite corner. Tack them all round in the same way, always taking the most opposite ribs, so as to strain the cover equally. It is then sewn to every joint of the ribs in the same way, as neatly as possible.

Old umbrellas, when quite useless, may be covered with cotton or alpaca, by cutting from the old covers; but, if they are not very bad, these had better be done by a tradesman, when they will look equal to new. A silk umbrella which has slit in the centre of the breadths may be repaired in the following manner:—First open it. With silk the same colour draw the slits as close as possible. Then lay inch-wide strips of ribbon down every seam, running each side, first stretching them with a pin. Parasols may also be repaired this way, with a prettily contrasting colour, and a bow at the top.

As we have further information to give, of sufficient value to justify the appearance of another article, we shall shortly return to this subject.

INMATES OF THE HOUSE.—DOMESTIC.

THE GOVERNESS (*continued*).

AS in every other kind of engagement, the exact details of the governess's duties vary according to the peculiar wants and habits of the family. At the same time, the clearer the understanding arrived at as to where responsibility begins and ends, the more secure are the chances of comfort on the part of all concerned. As a general rule, governesses in middle-class families are expected not only to teach little children, but to be to some extent both nurse and needlewoman. What is called by some employers "filling up spare time by making one's-self generally useful," is a most unsatisfactory state of being for a governess. No sooner is the teaching at an end, than the sewing claims attention; and if special care for a sick child is necessary, the governess is required to be its attendant. In the general desire to do something of everything, the all-important work on hand is liable to be neglected. The teacher's mind becomes distracted, her temper is sorely tried, and disorder reigns where calmness of demeanour and unvarying regularity are vital necessities. No teaching can be successful under such circumstances. No good servant, in any branch of household labour, would endure such interruptions in her work as many governesses are daily subject to; and people commit an act of utter delusion, if they imagine that they are doing justice to their children by such supposed economy.

The duties of a governess should lie exclusively in teaching. If in presence of children, she should be teaching all day by word and deed. Not only in the school-room is the sphere of her labours, but out of doors when taking walks, and in the drawing-room. Whatever draws her attention from the training of her young charges is so much loss to them.

A great deal of bitterness is sometimes felt at the invidious position which many governesses are placed in by the parents whose children they teach. The situation has been defined as that of a baize door, which swings between the kitchen and the parlour. Allowing that such an uncomfortable position is not unfrequent, the fault rests principally with the governess herself. If she has a proper sense of the importance of her calling, and entertains a right appreciation of her true position, she will not fail to impress those around her with a feeling of esteem as far removed from patronage as from undue familiarity. But, if on the other hand, she loses sight of her dignified calling on some occasions, whilst expecting absolute deference on others, her pretensions to respect are apt to be regarded as ridiculous, whenever an unusual attempt is made to enforce her right.

However kind employers may be, it is best that a governess should bear in mind that her position in a family is not exactly an independent one. Although with commendable courtesy, the parents of children may place her apparently on the footing of a member of the family, it is advisable that she should acknowledge to herself that she is not in reality of their kindred. She should be on her guard, in fact, to keep within her own sphere, however tempted by circumstances to identify herself with that of children and friends belonging to the family. There is no degradation to the calling in this view. On the contrary, the observance of slight self-restraint is the most effectual means of preserving genuine esteem.

It ought to be unnecessary to comment on the danger which arises from repeating before servants and strangers conversations and remarks made relative to household and family affairs. Yet so frequently is this error committed, that a word of warning is not out of place. A governess should be beyond suspicion in the confidence which is naturally reposed in her. The sanctity of home

life is at an end whenever subject to similar unpardonable indiscretions.

Whenever it is possible, it is a great comfort to a governess to have a room to herself. Let it be ever so small an apartment, any one engaged the greater part of the day in teaching values the solitude which her own chamber affords. Privacy also tends to secure respect. At times, and under exceptional circumstances, when the presence of a governess is felt to be neither desirable nor desired, exclusion from the family circle is felt less keenly when in one's own room. Surrounded by the little personal comforts and resources which a well-balanced mind contrives to provide in the smallest space, the governess is mistress of her own home for the time being, and glad, perchance, to enjoy her liberty in her own way.

With the plan of studies, it is not advisable here to treat, save in as far as regards one chief point—regularity. That which wars against the success of most attempts at home-tuition is the want of punctuality. Having ascertained from the mistress of the house the hours at which the meals of the day are taken, a plan of study should be framed accordingly. Whatever interruptions may occur in other parts of the establishment, the school-room should be placed beyond their reach. When there, both governess and pupil should endeavour to consider themselves out of the house, and strangers to every one within it.

Apart from intellectual culture, the duties of a governess should consist mainly in the ability to instil into the minds of her pupils correct moral principles, and rules for guidance in the practical details of life. A mere knowledge of accomplishments does not suffice. Pianoforte playing, drawing, dancing, and singing, may be taught or not, according to the means and wishes of the parents; but right-mindedness cannot be dispensed with, without risking the future happiness of the pupil. In speaking of a governess's duties, it is implied that the teaching of young girls is chiefly in question. Boys, if confided to her care, are mostly of a tender age, and, consequently, fit for the same moral treatment as their sisters. Later in life their respective pursuits may necessitate different studies and different recreations. Up to the age of seven years, however, the more closely a boy is subject to female guidance, the more sensitive is he likely to be to tender reproofs, and appeals to the sympathetic faculties of his nature. Without some "womanish" teaching, the heart and judgment of boys are liable to be wanting in the true graces of spirit which pre-eminently distinguish the Christian character. These qualities are seldom acquired late in life; the seed-time is in infancy, and the best field for their development is a well-conducted, cheerful home, where sound-minded, affectionate women are the active ruling influence. All that the mother, or nearest female relative, may be in such cases to the rest of a household, should the governess be in the nursery or schoolroom. Her impartial reasoning, her spirit of justice, and reliable common sense, should be appealed to with confidence in all cases where disputed rights are in question, or whenever differences of opinion prevail. Compared with these sterling qualities, minor considerations should have no weight in selecting a governess for children.

As we have already remarked, it is not proposed in this place to describe a plan of intellectual studies. Some remarks may, nevertheless, be acceptable as to a general system to adopt in teaching young people. In the first place, no governess should consider herself capable of imparting any branch of knowledge with which she is not herself perfectly familiar. She should know her subject *well*. Having mastered its difficulties, she should be able to smooth the way for her pupils that no difficulties appear. This result can only be gained by a complete knowledge—not a smattering of knowledge. The benefit is twofold. The pupil not only learns with facility, but instinctively

regards her teacher with genuine admiration. It is to be deplored that the exacting demands of parents too often render these happy relations between pupil and governess impossible. No human being can, by any means, acquire the amount of learning and accomplishments one sees so often advertised for in public journals. Putting the miserable pittance offered to governesses as remuneration out of the question, such advertisements are folly, and can only be answered by persons whose needy circumstances compel them to secure a temporary home at any sacrifice of personal comfort and high principle.

Another chief point to bear in mind, in seeking to enter a family as governess, should consist in ascertaining the religious principles of the parents. It is most desirable that both the employer and the employed should be of the same faith, and observers of the same form of worship. A system of teaching, in which any reserve upon religious matters is imposed, cannot fail to have serious inconveniences. The extent to which religious instruction is to be imparted, is best left to the decision of the parents themselves. Some persons attach supreme importance to the matter, and others are equally indifferent. In any case a conscientious teacher will, under all circumstances, endeavour to make the Christian code the mainspring of her pupil's mind, whether much or little time be devoted to outward religious observances.

With regard to mental culture, a governess will confer an everlasting boon upon her charges if she can succeed in teaching them to *work alone*. Herein lies one of the greatest drawbacks to home-tuition. The governess is always at hand to refer to, and most young people, in consequence, do not sufficiently apply themselves to surmount difficulties. They are apt to get too much assistance in learning their lessons, preparing exercises, &c.; and for all purposes of self-application they are usually untrained. When it is considered how short a period of life is comprised in school-days, and how much there is to learn in after-life, it will be seen that the faculty of solitary study is one of the most important to cultivate. For this purpose it is desirable that a resident governess should place herself in the light of a visiting professor. Whatever the lesson to be acquired may be, she should give just as much personal attention as is necessary to make the subject clear to her pupil's mind. Having done so, she should leave the task to be completed by the child's own effort. If, added to the above practice, the pupil is old enough to reproduce the substance of the lesson in some form different from the original, a proof will be given that the lesson has been unmistakably committed to the memory. Reproduction, in fact, is the test of knowledge. If it were possible to make a child apply every lesson learnt, to some transaction or passing event in life, teaching and learning would possess an ever active interest for both pupil and teacher. A very successful mode of teaching young persons is by verbal explanation. Comparatively little "learning by heart" is needful, provided the teacher has the gift of illustrating by word of mouth the lesson to be acquired; at the same time guard must be kept, lest the illustration should pass beyond proper bounds, and merge into profitless chit-chat. Here again the best proof of the result will be found in the pupil writing down any notes she may have remembered during the lecture. Certain facts there are which must be learnt by heart. Of these, the principal dates of historical events, grammatical rules, and the technical terms used in scientific learning of every kind, are amongst the chief. The multiplication table, together with the tables of weights and measures in general use, are also important branches of rudimentary knowledge.

The most difficult of all tasks is generally considered that of teaching little folks to read. Some children have a natural aptitude for learning to read, and teach themselves almost. Others find reading a real stumbling-block, only

to be overcome by time. When the latter is the case, there is some danger lest intellectual culture should be retarded, upon the supposition that reading is the indispensable first step on the ladder of learning. This is an error to be avoided, particularly as the most promising children in other respects often show the greatest tardiness in learning to read. The very activity of the mind, and the rapidity with which one thought succeeds another, will often stand in the way of a brilliant intellect making the necessary start, whilst a dull-witted child may reach the journey's end without difficulty. However long the power of reading may be deferred, the child's studies in other subjects should proceed all the same. The steadying influence of mental application, in matters most remote, apparently, from the one desired object, will insure its advancement. All children of volatile minds, in fact, are liable to appear dunces at book-learning, simply because too much play is allowed their imagination. Curtail a random habit of thought in one subject, and power of application will appear in another.

When the memory is sufficiently strong to comprehend abstract reasoning at all, arithmetic will be found a very strengthening discipline of the mind, quite as essential for girls as for boys. As soon as a little child can place small objects in a row, it is a good plan to begin the rudiments of arithmetic by learning to count—passing from simple numeration to addition and subtraction. This can be done with reels of cotton, playthings, or any articles at hand, and the way is thus prepared for more ambitious efforts at calculation.

Writing is, generally, a very pleasing art with young people. Beginning with copying large capitals, children pass easily enough to the higher branches of calligraphy. As a general rule, there is not much to comment upon in the method according to which children are taught to write, except that it is better to begin at once with the use of pen and ink, instead of the ordinary slate and pencil. Many children, who can write very fairly on a slate, find themselves at a total loss to form the same characters with a pen. Whatever a child has to learn had better be taught in the right way at once.

Cultivation of the memory being an essential feature in the education of the young, learning poetry by heart is excellent practice. Books of select poetry abound, and may almost be taken indiscriminately, so good is the selection of pieces generally. In the repetition of poetry, great importance should be attached to the manner of delivery. The pupil should be placed at the further end of the apartment from where the teacher is seated, and in a measured and distinct voice should repeat the poem—every syllable should be as distinctly uttered as if the speaker were dictating. The various inflections that the voice is capable of giving, and the cadence intended by the poet, should be carefully expressed and studied.

Accomplishments, as the lighter branches of learning are commonly called, being generally considered indispensable to the liberal education of young ladies, something must be said on the subject. Unfortunately, more stress is usually placed on the variety of accomplishments a girl has acquired, than on the manner in which she acquires herself of any. So long as parents consider a superficial knowledge of music, drawing, dancing, and similar arts sufficient, so long will people of good taste be more offended than pleased by the exhibitions which are the result. After all, there is not time for everything in life; and it is unreasonable to suppose that a girl in her teens can excel in all the studies prescribed for her. Any attempt to do so must result in failure. It is better to be satisfied with less show of knowledge and more reality. In most children there are innate tastes and predominant dispositions. A wise parent will study these inclinations, and only require of her child that for which a natural tendency predisposes.

ANIMALS KEPT FOR PLEASURE.—BIRDS.

THE CANARY (*continued*): STANDARD PROPERTIES.

WE now proceed to describe the characteristics of the various classes of canaries. These are very numerous, and much stress is laid by those who rear these birds for competition at societies for exhibition, or for sale, upon certain characteristics in the forms, colours, and markings of the different varieties, which we shall now proceed to describe.

Norwich, Yorkshire, &c.—The jonque are a very rich yellow; the mealy, a very light yellow. The under-flue of both kinds should be a very rich white. The beak should be clear, short, and slender, tapering regularly to a point; the head roundish, the neck regularly expanding to the chest. The back ought to be wide and straight—well filled over the spine. The wings should be compact, the tips even, but not crossing; the chest round, wide, and full, gradually expanding from the neck. The body should be slightly flattened on the back and stomach, tapering from thence to the tail, which should be compact and thin. The legs and feet should be white, or clear light flesh-colour; the nails white; the toes and nails entire, and not twisted; and the feathers compact. Colours of under-flue, in both yellow and mealy, a clear bright silky white; outer feathers of a deep orange yellow; of mealy, light yellow. The points in perfection are estimated as follows:—Beak 2, head 3, neck 3, back 3, wings 3, tail 6, chest 3, body 3, legs and feet 6, feathers 12, colours 8, exterior feathers 12 each, jonque or mealy.

Crested.—The crest should be long, thin, and project horizontally to the ends. The beak clear and slender; the head small and flat. The crown (or crest) projecting horizontally over the eyes and beak; on the back of the head the feathers should lie close to the skull, having no ridge on its border. The neck should be slender; the back long and straight, and well filled over the spine; the wings long, compact, and close to the body; the inner borders of the flight-feathers meeting evenly on the loins, and their ends coming down to the tail, but not crossing at the tips. The chest round, and gradually expanding from the neck. The body long, slender, and gradually tapering from breast to tail. Tail thin, long, and straight, the tips of two feathers being visible at the extremity; upper surface straight the whole length of the spine. The legs and feet should be clear flesh-colour, or white; the nails white; and the toes not awry. The feathers should be close and silky, the colours a rich and regular orange or white, and the under-flue white. Length of bird, six inches. Points in perfection:—Beak 2, head 4, crest and crown 12, neck 8, back 4, wings 6, chest 4, body 8,

tail 8, legs 3, feet 2, feathers 9, colours 10, length of bird 10.

Clear Belgian.—There are two classes known under this name, distinguished by darker or lighter shades of colour. The head of a good Belgian should not be high, large, or round; the neck or body thick or short; nor should the legs be bent backwards at the middle joints. The beak should be slender, white, and clear; head small, with flattish top; neck long, slender, and concavely curved on the upper surface. The back should be long, and curving convexly; the shoulders high and narrow; the wings long, narrow, compact, and thin. The form of chest most approved in one case, resembles the breast-plate of one of the Life Guards; in the other, it is rounded. Body, long and tapering; tail long, thin, and curving downwards, the ends spreading but little. The legs should be long and clear, and stand very upright; feet long, nails and toes clear and slender, and not awry. The feathers close and compact; colours rich, clear, even, and regular; silky-white under-flue. Head and back to tail should form a continuous curved line; the legs should slightly incline forward near the body, above the central joint. Points in perfection:—Beak 2, head 8, neck 8, back 10, shoulders 9, wings, 12, chest 6, body 8, tail 7, legs 8, feet, toes, and nails, 3, feathers 10, colours 9, attitude 6. In accordance with the rules adopted by the Midland Singing Birds Society, and now acted on by judges at ornithological exhibitions, clear birds should not have a single feather foul or discoloured.



Fig. 1.

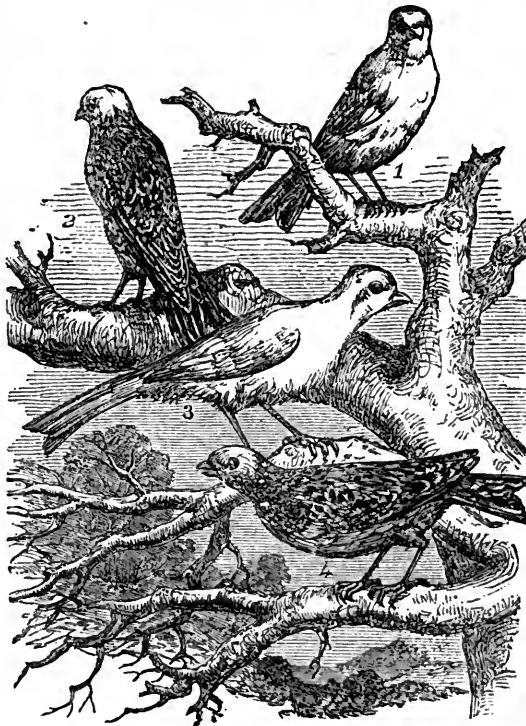

Fig. 2.

and in the mealy variety, white or buff. The legs and feet should be black. (The green colour is generally not quite so deep in the buff as in the yellow class. Birds having the richest colours in each class, if perfectly marked on both sides alike, are most highly prized). Points in perfection:—Beak 2, cap 10, eye-mark 12, wings 8, tail 10, legs and feet 10, under-surface from beak to tail, perfectly clear, 10, upper-surface, perfectly clear, 10.

The Lisards.—The beak of this bird is short and very dark; the head large, flattish, and the crown as wide in front as behind: the cap oval, large, regular, and richly-

coloured; eye (lid and lash), dark-coloured; neck short, clearly and thickly spangled, commencing from the back of the cap with spangles gradually increasing in size toward the centre of the back. The back should be wide, clearly and thickly spangled, the largest spangles in the centre, gradually decreasing in size towards the neck, sides, and upper tail-coverts, which should be yellow or buff, according to class; the bastard wings should be black; the pinion feathers, black in stalk above the lesser coverts, spangled clearly and thickly, having distinct black ticks near the tip on the centre, encircled by silver-grey or dark green, and fringed with white or yellow; the coverts, greater, lesser, and scapular, black in stalk and web, the latter being fringed with buff or orange; the flight-feathers (both web and stalk) black, but the web slightly fringed with buff or orange; belly, breast, and throat (from beak to tail of under surface), clear buff or orange; chest wide; the longest body, and the largest bird, the best; tail even, and not spreading at the end; web and stalk black, the web slightly fringed with buff or orange. Legs, feet, and nails extremely dark, and not twisted awry. Feathers, entire and compact, not pied or deficient; colours rich. In the golden-spangled, the under-flue is blue-black. In the silver-spangled the under-flue is a dark grey. The cap, spangle, fringe, &c., of the silver-spangled class, should resemble perfectly untarnished silver. Points in perfection:—Beak 5, head 8, cap 12, eye 5, neck 4, back 8, wings 10, tail 7, throat, breast, and belly, 10, chest 5, body 8, legs 5, feathers 10, colours 12.

Spangled.—By the term “spangled” is meant the partially constellated appearance given by the layers of short feathers, which partially overlap each other, their exposed ends having a black or dark centre diverging forward from the mid-rib, the tips of the web being fringed with yellow or buff.

Silver-spangled.—A semicircular fringe of silver-white, encircling a black tick round the point of a dark grey feather.

Golden-spangled.—A small, semicircular fringe of deep yellow, encircling a black tick round the point of a small dark-green feather. These feathers are on the down part, and below their tips, of a dark grey hue, or deep blue-black.

London Fancy.—Many years ago, a number of “canary finch societies” existed in London, where the birds were exhibited, which were afterwards known under this name. The following were their standard properties:—Cap, colour, magnitude, and regularity; the swallow and throat were celebrated for largeness; breast, for fairness and regularity; the legs and flue, for blackness. Some persons, before exhibiting these birds, have been known to wash them with water strongly impregnated with saffron, to improve their colour; this was not allowed by the societies, if detected. “The backs of these birds are always more or less spangled or mottled during the first year, and they are best for showing when from seven to nine months old. To produce a good breed, such feathers are as necessary in the hen as in the cock. After the first season, their feathers become lighter at each change. The first year, the wings and tail will be black; second, grey; third, lighter; and when five or six years old, a fine jonque, or mealy, all over.” The beak should be short, clear, and white; the head, wide and flattish; the crown, back and front, equally broad; the cap large, regularly formed, and of a rich colour; the neck short, regularly expanding from head to chest; round the throat should be a deep yellow or buff. The back should be straight, wide, and clear; the loins, clear rich yellow, or buff; the wings (all the flight-feathers) black, or very dark-green; tips, not crossing, but even and joining; all the feathers of the tail black to the quill, even, and compact; the breast should be full and wide, and in colour a buff

or rich yellow; the body (not including breast, back, or loins), clear buff or orange, with the under surface slightly flattened. The legs, feet, and nails, white, and not distorted. Feathers, close and compact; the colour of the under-flue should be black; the outer feathers of mealy birds, pale yellow fringed with white; the jonque birds, deep yellow and bright black. Points in perfection:—Beak 3, head 4, cap 12, neck 4, back 9, loins 6, wings 10, tail 9, breast 10, body 6, legs 8, colours 20, under-flue black 8, exterior feathers 12.

Our cuts on the previous page show—Fig. 1 the bird from the Canary Islands. No. 1, in Fig. 2, the Norwich and Yorkshire, of which there are several kinds; No. 2, the lizard (jonque); No. 3, the variegated Belgian; No. 4, the lizard (mealy).

ODDS AND ENDS.

To repolish Tortoiseshell.—When by wear, tortoiseshell articles have lost their polish, the polished surface may be restored to its original condition by carefully rubbing with powdered rotten-stone and oil. The rotten-stone should be very carefully sifted through the finest muslin. When all scratches on the surface of the tortoiseshell are thus removed, a brilliant polish may be given to it, by applying gentle friction with a piece of soft leather, to which some jeweller's rouge has been applied.

To clean Gold Watch Chains and other Ornaments, without wearing away the Metal.—Let the article required to be cleaned, stand for some time in a solution of caustic potash, until all the adhering dirt is removed. It should then be taken out of the water by means of a piece of stick, and rinsed in a large quantity of cold water, and placed on a soft clean cloth to dry. The solution of caustic potash may be made by dissolving one drachm of that substance in one ounce of water. It may also be made in a cheaper manner, by boiling four ounces of pearlash, and the same quantity of recently burnt quicklime in one pint of water for half an hour; then, pouring the hot liquid into a stone jar, and carefully stopping the mouth with a good, well-fitting cork, let it remain till cold. Then slowly and carefully pour off the clear solution for use. This method must not be used for rings or other articles that contain jewels, either gems or paste, or the silica, which is the principal ingredient in their composition, would be corroded by the potash.

To remove Marking-ink Stains from Linen and other Materials.—Two methods may be employed for the purpose of removing the silver by which the mark is caused. The first method is to convert the silver into an iodide, by applying to the stain, spirits of wine, in which iodine has been dissolved. The iodide of silver is then to be removed by means of a solution of the hyposulphite of soda, in which it is soluble. Another method consists in keeping wet the stains with chloride of lime for a few minutes, and then dipping the material in either a solution of the hyposulphite of soda, or in a solution of ammonia.

To preserve Lemon-peel.—Cut lemon-peel in thin slices, then prepare a stiff syrup of white sugar, and allow them to simmer together for about a quarter of an hour. When done, allow them to cool and put them into pots, tie down tightly with bladders, the same as any other preserve, excluding the air thoroughly. This is useful for garnishing dishes with, or it will make a good corner dish, as it has rather a pretty appearance.

French Polish.—Put into a stone bottle one quart of rectified spirits, one ounce shell-lac, two ounces seed-lac, one ounce gum sandarac, one ounce gum copal, one ounce camphor—the gums should be pounded; cork the bottle safely, and stand it in hot water until all the ingredients are dissolved, shaking the bottle often. A small quantity of the above is to be used at a time, and a small

portion of the furniture rubbed at once, and rubbed as quickly as possible, and done over as many times as desirable until the required polish is obtained.

Scraps and Fragments.—In large houses, pieces of old linen which are left from mendings, are useful for various purposes. The housemaid should reserve some for cleaning candlesticks and lamps; they are useful to clean plated goods, and to save better cloths, they may be used for dish and tea cloths. Old corks should be saved for fitting round candles instead of paper.

Warm Bedding for Winter.—Some time since, considerable attention was given to some coverlets which were said to combine the lightness and warmth of the eider-down quilt with a cheapness far greater than that of ordinary blankets. They were composed of a cotton wadding of a superior kind, enclosed and quilted in glazed calico; and they formed a coverlet having a warmth equal to three or four of the commoner kinds of blankets, although manufactured at the cost of a few shillings. As there are few things in which the families of the poor are more strikingly deficient than in warm bedding, the invention ought to prove of essential importance to them, and it is by no means without its utility to the rich, especially when suffering under protracted sickness and confinement—when a heavy weight of bed-clothes frequently becomes almost unendurable. In such cases, one of these wadding coverlets, the pressure of which is so slight, that it literally cannot be felt, will give quite as much warmth as can be required, even during the severest weather, and in the coldest apartments.

Sir Humphry Davy's Corn Solvent.—Potash, 2 parts; salt sorrel, 1 part. Mix in fine powder. Lay a small quantity on the corn for four or five successive nights, binding it on with rags.

Adulterated Vinegar.—Lead may be detected in vinegar by putting some hydrosulphuric acid, or bisulphuret of soda; the first-named giving a brown precipitate—sulphuret of lead; the latter a white precipitate—sulphate of lead. A clean iron plate, dipped in the acid, will give a rose-coloured coating of copper, if that metal be present. Ammonia also detects copper by producing an azure blue colour. Iron is detected by prussiate of potash producing a blue precipitate.

Natural Dentifrice.—The common strawberry is a natural dentifrice, and its juice dissolves the tartarous incrustations on the teeth, and removes the smell of bad breath.

Balsamic Vinegar for Sick Chambers.—Take of each of the following ingredients:—Rue, sage, rosemary, lavender, cassia, 1 ounce; two cloves; powdered camphor, 2 ounces; strong vinegar, half a gallon. Allow these to steep for a week.

SEASONABLE FOOD.

OCTOBER.

Meat.—Beef, veal, mutton, lamb, venison, pork.

Poultry and Game.—Geese, turkeys, fowls, pullets, chickens, wild duck, widgeon, teal, woodcocks, larks, grouse, pheasants, partridges, pigeons, snipes, hares, and rabbits.

Fish.—Oysters, lobsters, crabs, brill, gurnet, salmon-trout, dory, smelt, halibut, gudgeon, barbel, perch, carp, tench, herrings, eels.

Fruits.—Pears, peaches, apples, plums, figs, medlars, grapes, walnuts, filberts, nuts, quinces, damsons, pines.

Vegetables.—Turnips, potatoes, cabbages, cauliflowers, carrots, parsnips, beans, peas, onions, leeks, spinach, endive, celery, salsify, scorzonera, chardons, beet, parsley, mushrooms, salad of all sorts, sweet herbs of all sorts, garlic, shalots.

SOUVENIRS.

PLASTER-CASES, ALBUMS, ETC. (continued).

FIG. 1 is another device for a centre. It represents Pandora reeds, a shepherd's pipe and crook, and a garland of roses. Colour the pipes with very pale burnt sienna; shade them with deep burnt sienna. A cobalt blue ribbon binds the pipes. The crook is coloured with raw umber, shaded at the edges with burnt umber. The pipe, chrome yellow, shaded with raw umber, and afterwards gilt. The roses must be treated in the way already recommended, and may all be pink. For the crook and pipe may be substituted a lyre, with five strings. Colour it entirely with chrome yellow, shade with burnt umber, and afterwards with gold. After burnishing the gold, shade with burnt umber. It is not necessary to burnish it; dead gold looks well. The wreath should be of pink flowers and green leaves.

A harp, encircled by a garland, and a dove alighting beneath it is pretty. The harp should be treated in the same way as the lyre, only the sounding board left white, or just tinted a cream shade with a little raw sienna and vermilion, very pale, or Naples yellow. The garland should be roses and green leaves; the bird tinted with Indian ink. Put a few touches to indicate ground with brown madder, middle tint.

Fig. 2 is a cornucopia of flowers. Let the cornucopia be in gold, as already described; the flowers of varied colours—pink, yellow, damask, and blush roses, and mauve-coloured china-asters. The flowers twined round are cobalt-blue, pale, the fruit coloured after Nature.

Where embossed cards cannot be procured, the devices may be drawn round the edges and well coloured. Relieve all the flowers and leaves, in that case, by a dark-shaded line underneath each, half way round, and also on one side of the gold line to the border. A motto, or name, may be used, according to taste.

To make up the cards as a plaster-case, cut two pieces of paper an inch and a half wide the length of the cards. Double each in half. Securely gum one edge to one card, as shown in Fig. 3, page 178, from A to B. Gum the other from E to F. Cut another strip the same width, but a little longer than from A to E. Gum it along these, having first raised the other two pieces out of the way of it. When dry, gum it by the edges at each end to the two first strips of paper. Then, when dry, gum on the other card at the edges indicated from D to C in the first strip; or one piece may easily be carried all round. Then gum it from A to B. Put it in a book till dry. It must be slightly pressed to keep it flat. Then gum it from A to E, having folded the paper at the corner to do so. Lastly, gum from E to F. When completed, it will resemble Fig. 5; the paper sides must fold in at the dotted line, and the two cards be quite flat to each other. Silk or satin is a dainty substitute for paper. The inside is a folded book, like Fig. 6, page 178, plain, or supplied with two or three ribbons across to hold the plaster. It always has a loop, as at Fig. 5, to draw it from the case. Paper, silk, or satin can be used, or any pretty idea may be brought out for the inside. If paper, a pretty motto can be written on it. Many of the decorative designs we have given in the present and former volumes of the HOUSEHOLD GUIDE may be applied to this purpose with excellent effect. Fig. 3, on page 97 of vol. i., for instance, would make a good design.

To make an album, sew a number of sheets of coloured paper together in packets, like note paper; put the edges level; sew them to a strip of linen. Over this paste a strip of velvet or satin for a back. Let it dry. Then fix the cards to the silk or satin each side of the back. Lastly; the inside of each card should be lined with silk, satin, or moiré antique, of any favourite colour. Before this is fixed on with strong gum, put on *strings*. Take a piece of pink velvet the size of the two covers and to spare for

a back. Inside the back suspend a number of pieces of Chinese ribbon or silk, like the strings of a lyre, putting them as close as possible. You must in the next place gum them down on the wrong side of the velvet. Take a two-inch wide strip of velvet for a back, and gum on over these strings on the wrong side of the large piece of velvet. Let it dry, pressed in a book. Then gum the velvet, and gum the embossed cards. Lay the velvet, face down, on a table, and put on the cards about half an inch, or a quarter, apart. The strip of velvet put on makes a back between these. Press in a book till dry. The ribbon inside should just fill the back. Put a few leaves of gold-coloured paper, one inside the other, and slip through one of the strings. Fill them all the same way. Coloured Albert-sized note paper, is the best for this purpose.

To make up the ornamental cards to which our last article on this subject referred, procure several sheets of paper of various colours. The Albert-sized diamond note paper is very suitable for the purpose. Stitch each packet of it together. Take as many of these packets as you desire, and holding them close together, stitch a needle right through the whole, near the folded edge which forms the back; draw the thread through, and tie the ends, keeping the paper very close and flat, as it is to be when the book is finished. This is done in the centre of the edge, and repeated at the top and bottom. On page 129, vol. 1., we gave some explanations of book-binding for albums, which will render this description easier, if reference is made to them. Next take a strip of coloured velvet or rich silk, as long as the pages you have stitched, and wider than the back. With thick gum, attach this to the back and over each side. Take two pieces of the same material, each twice as large as the ornamental card which is to form the book cover. It is to double the upright way, and the fold to come to what will be the back. Gum half of each piece, and fix a cord on it. Press it under a weight four-and-twenty hours. Then gum the half of each piece of silk not fixed to the card, and secure one to each side of the pages sewn together. The silk is gummed to the outside leaf, the part joined to the card to the back. Press this again. The book is now finished, with a back of velvet or silk, and a lined fly-leaf of silk or velvet. Pink or blue velvet is very pretty for the purpose; so is white or coloured moiré antique. If the album is to contain scraps pasted in, one leaf must be neatly cut out nearly at the back, for every scrap inserted. On this principle scrap-books are made with guard leaves, otherwise the leaves would become too bulky, and the volume would not close.

A motto may aptly be drawn with colours on the book or fold of paper which contains the plaster, and paper of any fancy kind, or silk or satin, may be used to form this book. If satin is used, it is just as well to line it with paper, gumming the satin to the paper to stiffen it. It has also a pretty effect to edge the inner case with a band of embossed gold paper. The old-fashioned motto—

"May you never, never feel
A deeper wound than this can heal,"

if not quite classical, at least conveys a kindly sentiment.

Many persons who have not sufficient skill to draw may be able to colour designs, if furnished with the outline. In that case they can trace any of the illustrations selected for the purpose, on ordinary white transparent paper, on tracing-paper, or even on tissue paper. Take a sheet of thin note paper and some Venetian red, of which a large quantity can be purchased for a penny at any oil-shop. Lay the sheet of paper on an open newspaper, and with a piece of wadding liberally rub the Venetian red into it. Shake off gently any loose powder, place the red side downwards on the card, and lay on it the tracing. With a fine-pointed lead pencil draw over the outline, once and firmly, taking care not to let the tracing slip or diverge from its position during the process. Then lightly remove the papers. Charge a brush with a little carmine rubbed up with water on a palette or in a saucer. Use a small, fine brush. Draw the entire outline indicated by the red marks left by the Venetian red, or draw them simply with a pencil. If with carmine, let it completely dry. Afterwards shake away any loose red powder, and finally clean the card with a little clean bread, which should be cut from a fresh loaf, it being essential that it should be quite free from grease of any kind, and a little butter unperceived adheres to almost all bread from loaves whence bread and butter has been cut. The design can now be coloured and shaded from the copy.

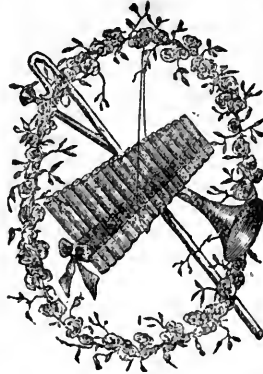

Fig. 1.

For those who are unable to draw with colours at all, we commend another way of constructing these souvenirs. Obtain a couple of pretty German scraps, such as adorn birthday cards, and gum them one on each of the cards which are to form the two sides of the album or plaster-case. If narrow wreaths of flowers can be obtained, they will serve as a pretty border. But a neat border can be made by drawing, with a pen filled with water-colour, several lines, alternately blue and scarlet. The lines should be very accurate, and meet exactly at the corners.

A card thus perfectly ruled with lines containing a verse or verses very neatly written in ink and printing letters, on pencil ruled lines, afterwards removed, makes a complimentary gift on a birthday or any other occasion, which many persons may feel pleasure in giving or receiving.

A few simple mottoes for inscribing upon plaster-cases will conclude our present article, and from amongst them the constructors of souvenirs will probably be able to extract a couplet with a sentiment congenial to their individual feelings.

I.

With close embrace, the wound you feel
This plaster will contrive to heal.

II.

I sorrow for your slightest pain—
May my gift yield you ease again.

III.

I would my little gift could heal
Each pang or wound that you may feel.

IV.

A little gift by friendship's hand conferred,
Is often to the costliest gem preferred.

BLACKING.—II.

BLACKING is also occasionally prepared into the composition of which india-rubber enters. A preparation of this kind is thus composed:—Take one pound and a quarter of india-rubber, and cut it into small pieces. Dissolve them by the aid of heat in one gallon of rape oil. To this solution add sixty pounds of ivory-black, and forty-five pounds of treacle. These substances are then to be thoroughly mixed. Now take a pound of gum arabic, and dissolve it in twenty gallons of vinegar. These are then to be mixed well together into a very smooth cream, and afterwards twelve pounds of sulphuric acid are to be gradually added. The mixture must then be constantly stirred for half an hour. The stirring should be repeated every day for a fortnight. The blacking should then be poured out into the vessels in which it is to be kept, and securely corked.

The same composition may be made in the form of paste. This is done by employing only five quarts of vinegar instead of the twenty gallons directed to be used.

As it is often more convenient to have the blacking in the shape of paste instead of liquid, we subjoin a few forms for making it. The one recommended by Dr. Ure consists of ivory-black, two pounds; treacle, one pound; olive oil, four ounces; well mixed together. To this, four ounces of sulphuric acid (oil of vitriol) is to be added. After the acid has ceased to act on the ivory-black, five ounces of vinegar, half an ounce of sulphate of iron dissolved in five ounces of water, and three-quarters of an ounce of gum arabic in fine powder, are then to be added, and all the materials well mixed together.

Another form is composed of treacle, one pound; ivory-black, one pound and a quarter; rape, sperm, or olive oil, two ounces; made into a paste with strong vinegar.

The following also makes a cheap blacking:—Ivory-black, two pounds; treacle, one pound; sweet oil, and oil of vitriol, four ounces of each; to be mixed to a proper consistence, with a sufficient quantity of beer bottoms.

COOKING.

FOWLS AND TURKEYS.

Boiled Fowl.—For this you need not employ a fowl in the bloom of youth, you may even take one of a certain age, provided it be not, as Byron defined the expression, “certainly aged,” in which case you will have to treat it as shown in our previous paper. Cut off the legs at the lower joint of the drumstick, truss it with the heart, liver, and gizzard inside it. Some cooks *will* boil a fowl in a cloth well floured inside, “to keep it white;” they do the reverse, by preventing the scum from rising, and if the cloth has the slightest sourness or soapy taste, the fowl gets the benefit of it, and the broth also. Baron Brisse will not allow a stuffed cabbage (with forcemeat) to be boiled in a cloth, because it absorbs the fat, every particle of which the cabbage wants for itself. Use, therefore, a cloth only for puddings and dumplings which *must* be held together in that way. Set the fowl to cook in plenty of cold water with a teaspoonful of salt in it. As fast as the scum rises, take it off. When it boils withdraw it a little, so as to simmer gently all the rest of the time, say two hours, more or less. Take the fowl out of the boiler by means of a broad tape with which it has been bound; you can then untie it on the dish without piercing it in any way. The tid-bits of a boiled fowl are the comb and wattles, the pinions, the side bones, and the rump. Whatever sauce is served with boiled fowl, some should be poured over it, to mask it. Oyster sauce and parsley sauce are both old-fashioned and both excellent; only oyster sauce should never boil after the oysters are in it, whereas the chopped parsley should be thrown into

boiling melted butter. As soon as boiled fowl is removed from the table, cut up the remains into joints, lay them on a smaller dish, and mask them with the sauce you have left, and set aside to appear neatly when cold.

Poulet au Riz (Fowl Stewed with Rice).—This favourite French dish is another result of cooking in a stewpan, which is neither boiling nor frying, but something between the two. Truss the fowl as before; you may stuff it, if you like, with a forcemeat, made according to your fancy. Envelop it with thin slices of white bacon tied round it with thread; they may be omitted, if they cause too much inconvenience. Put a good lump of butter in your stewpan, and in this partially cook your fowl, larded or not, continually turning it, and not letting it brown more than you can help; some cooks keep the fowl light-coloured, almost white. Then add enough chicken or veal broth, or water, to stew the fowl completely, with the lid close down, but occasionally shaken. Boil half or three-quarters of a pound of ready-steeped rice a quarter of an hour. When tender, but still in unbroken grains, pour off the water and let it dry in the saucepan by the side of the stove. Add to it enough of the fowl-gravy to moisten it, and heat them up together. Spread the rice so prepared on a dish, and on it lay the fowl, after removing the bacon, if any is used; then serve. The carver takes the fowl on a plate before him, and lays the joints on the rice in the dish, which is then handed round to the company. During the stewing, sweet herb roots, and spices may be introduced, if it is wished to heighten the flavour at all, but the simpler preparation the better; a slight seasoning with pepper and salt suffices.

Broiled Fowl.—For this the fowl must be decidedly young; a fat cockerel who has just attained his full growth is the best. After singeing and emptying it, cut off the claws, but leave the legs and toes on, also leave the head and neck. Split the fowl open along the back, from the bottom of the neck to the rump; lay it quite flat, breast upwards; truss it in that shape with small iron skewers and string, with the neck and legs in the position depicted in the eagles of heraldry. Boil it in that attitude together with the liver, gizzard, heart, and kidneys, in a large boiler of water slightly salted, until it is nearly done—that is, till it is just a *little* underdone. Then take it up with the liver, and put it aside to cool, flat. When cold, remove the skewers; cut off the comb and wattles; divide them and the liver into two or three pieces. Boil the heart and gizzard three-quarters of an hour longer, to make them tender; then halve and quarter them and put them with the rest. The fowl can be prepared thus far the day before, or early in the morning. When wanted, have a broad clear fire and a clean hot gridiron, and on this thoroughly broil your fowl, after smearing it with oiled butter, beginning with the under side, in order to cook completely the flesh attached to the bone, and finishing off by browning the upper surface of the breast, wings, legs, &c. While the fowl is broiling, make the following sauce:—In a stewpan or frying-pan, brown flour and chopped onions in butter; when nicely coloured, dilute with the chicken-boilings, if not too salt. When smooth and creamy, add thereto a little pepper and grated nutmeg, a good tablespoonful of catchup, a wineglassful of pickled mushrooms and their vinegar, and the cooked comb, liver, &c. You may also add a few olives peeled from their kernels. Let these heat well together without letting them *fry*. Lay your broiled fowl on a very hot dish, and pour this sauce *all over* it. A broiled fowl makes a handsome dish—a couple are still handsomer—which is always received with a hearty welcome. Few things are so showy at such a moderate expense.

Fricassee Fowl.—Singe, empty, and cut up your fowl into joints; throw them into cold water for an hour, you

may change it *once or twice*, if you want your fricassee *very white*. Rinse and drain them; then set them over a gentle fire in a well-tinned saucepan, and moisten them with cold water. When it begins to boil take the saucepan off the fire, strain the broth through a sieve and set it aside; drain the joints of fowl. These are the preliminaries; which may be done the day before, or on the morning of the dinner. Into a saucepan set on the fire, put a lump of butter, a little chopped bacon, and a small slice of ham. When the butter is melted, add the joints of fowl, and toss them in it for a few instants. When they begin to stiffen, dust them, shaking them in the saucepan all the while, with a bumping dessert-spoonful of flour. Then draw the saucepan to the edge of your stove, and moisten them with the broth reserved and any good uncoloured stock. Season with a bunch of sweet herbs and an onion stuck with cloves. Set the saucepan again on the fire; take off any scum that rises; and when the fricassee begins to boil, cover it down close with the saucepan lid. Let it simmer gently three-quarters of an hour. Take it off the stove; thicken the sauce with a couple of egg-yolks; shake it well; set it on the fire an instant; add a dash of vinegar; shake again and serve. The sauce must be brought to a good consistence and in no way thin.

Fricassee Fowl à la Bressane (Baron Brisse), a favourite French dish, which is named after La Bresse, one of the old provinces in the centre of France.—Choose a fowl which is white, as well as young and plump. Cut it up into small joints, as for an ordinary fricassee; throw them into cold water, and leave them there for a few minutes; then drain them well, and dry them in a napkin. Put a large lump of good butter into a frying-pan; when it is melted, add the joints of fowl. Season them with fine-chopped parsley, shallot, half a clove of garlic, pepper, and salt; fry them, turning and shaking them about. When they are done enough, beat up in a bowl three or four egg-yolks, with a good quantity of cream previously warmed. Take the frying-pan off the fire; pour the mixed cream and egg-yolks over the fowl in the pan; stir well with a wooden spoon, and serve hot. If you have any button mushrooms, you may add them to the joints of fowl, immediately before their frying is complete.

Turkey.—This valuable bird, we all know, was brought to us from Mexico soon after its discovery, where the Spanish conquerors found it and the guinea-pig domesticated from time immemorial. In consequence of the comparative recentness of this acquisition, great hopes had of late years been entertained of increasing the number of our domestic animals—of poultry especially—by introductions from foreign countries. The idea and the wish have taken form in various Acclimatisation Societies, first (under that name) in France, then in England, and then in our colonies. But, in truth, the Regent's Park Zoological Gardens were established at the outset, quite as much for the purpose of domesticating strange animals amongst us as of affording an interesting zoological display. They did what they could, but effected little. It is curious that the most promising efforts, in respect to the introduction and spread of creatures to be made articles of food, should most recently be connected with fish and shell-fish—oysters, salmon, trout, and other excellent species.

Roast Turkey.—There are several different ways of preparing a turkey for roasting, depending on custom, taste, occasion, and pocket. The simplest, which we have seen practised at excellent tables, is to truss it exactly like a fowl, except that the leg-shanks are always cut off; to roast it quite plain, without any stuffing, protecting its breast with paper, basting it sufficiently well at first with butter, and next with its own gravy; and then to serve it, with no other sauce than its own gravy, on a dish gar-

nished with water-cresses, and accompanied by a salad of the same, or other, in a bowl. The trouble this mode saves is obvious. It is sure to be a success with sensible eaters, as they get the pure flavour of the bird, unmixed with any taste that does not belong to it. As with roast fowl, the water-cress makes a happy contrast which will both please and surprise those who have not yet tried it. There should be *plenty* of the turkey, in proportion to the number of guests, in order to satisfy both those who like white meat best, and those who give the preference to the brown; and the cook is without excuse if she do not serve to perfection a roast to which she can give her undivided attention, unperplexed by complicated sauces, &c. The next simplest way is to stuff the crop of the turkey with veal stuffing; you may also partially or wholly fill the body with the same. You may vary the composition of the stuffing with sausage-meat and chopped mushrooms and oysters, &c. The two last are nice in their way, but more suitable for boiled turkey. We prefer the veal stuffing (already given), as more delicate. Both in this and the preceding case we advise the gizzard, heart, and liver to be roasted *inside* the turkey, and not fastened to the wings. The carver ought to be able to find them, and they will be *eatable*, whereas, roasted outside, they probably will not. This stuffing both improves the look of the turkey, and also helps it to *go a little further*. Stuffed turkey, besides its own gravy, is usually accompanied by

Bread Sauce.—Into a saucepan put as much fresh milk as will nearly fill your sauceboat. Add to it a dust of salt, the same of grated nutmeg, a few peppercorns, a blade or two of mace, and a middle-sized white onion, chopped very fine. Let these boil together, watching that they do not boil over. When the chopped onion is quite tender, the milk, &c., is fit for use. Grate into your sauceboat enough stale bread-crumbs to fill it about one quarter full. Over this pour enough of the hot milk, peppercorns and all, to soak it. Let it stand two or three minutes; then, after stirring up the heated milk, pour the rest of it over the bread, and stir all together. Be careful not to use too many bread-crumbs, in order not to make the sauce too thick. Bread sauce may be replaced, or assisted by

Onion Sauce.—Mash boiled onions to a purée by squeezing them with a spoon through an earthen cullender. Return them to the saucepan, season with pepper and salt, and make all smooth with a little butter and milk, or cream. Make the sauce quite hot, pour it into a hot sauceboat, and serve.

Turkey, stuffed with Chestnuts.—The turkey's crop may be filled with veal or other stuffing. Take a few more chestnuts than will completely fill the body of your bird, in case any of them should turn out bad. Cook them enough, but not too much, either by roasting over a brazier, or by boiling; peel off both the outer and the inner skin; look closely to see that there are no decayed or mouldy parts, and, with the chestnuts and the liver, stuff the turkey as full as it will hold, sewing it up with needle and thread. Then put it down to roast as before, allowing plenty of butter to make the gravy. As a good deal of this will be absorbed by the chestnuts, and retained in the belly of the bird (which will be all the better for it), you will do well to make a brown gravy to send up with it, by stewing the chopped heart and gizzard with a little minced beef, thickening the stock so obtained with flour browned in butter, and seasoning with pepper, salt, catchup, and red wine. A chestnuted turkey is none the worse for bread sauce, or onion sauce, or both.

Truffled Turkey is the most expensive and most highly-considered form in which the Mexican stranger appears. For those who will have it, the best plan is to procure it ready-truffled from France, completely prepared, and only requiring to be put down to roast. It will be the better

for the winter's journey, as birds so stuffed are always kept for several days afterwards, to allow the perfume of the truffles to penetrate the flesh. A truffled turkey will cost from one to five pounds, besides the carriage. A handsome specimen may be had for, say, about three guineas. But the price of truffles varies greatly from year to year, according to the season.

Our readers need hardly be reminded that the truffle, which resembles in appearance a misshapen black potato, is a species of fungus which grows entirely underground, and which has never yet been cultivated artificially, or yielded to the gardener's skill, as mushrooms do. It is found in some parts of England, but in small quantity and of inferior flavour. The principal supply comes from certain districts in the central and southern parts of France, where it is hunted up sometimes by pigs, but more generally by dogs trained to search for it. The truffles, ripe towards the close of autumn, coincide exactly with the turkey season. They are highly esteemed by French cooks (who use them extravagantly when they have the chance, sometimes making them ingredients in every meat dish at a dinner), and, in our personal opinion, considerably above their real value.

"The turkey," says Brillat-Savarin, "is the largest, and if not the most delicate, at least the most savoury of domestic poultry. It enjoys the singular advantage of assembling around it every class of society. When our farmers and wine-growers regale themselves on a winter's evening, what do we see roasting before the kitchen-fire, close to which the white-clothed table is set? A turkey. When the useful tradesman, or the hard-worked artist, invites a few friends to an occasional treat, what dish is he expected to set before them? A nice roast turkey, stuffed with sausages and Lyons chestnuts. And, in our highest gastronomical society, when politics are obliged to give way to dissertations on matters of taste, what is desired, what is awaited, what is looked out for at the second course? A truffled turkey. In my 'Secret Memoirs,' I find sundry notes, recording that, on many occasions, its restorative juice has illumined diplomatic faces of the highest eminence."

The cook will be delighted to learn that nothing can be easier to roast and serve than a truffled turkey, when she once has got it. Simple roasting and basting, with proper attention, like any ordinary joint, is all she has to think about. No sauces, no fiddle-faddles, nor anything, in short—except its own gravy with water-cresses or some kind of salad—are required as indispensable accompaniments.

Economically Truffled Turkey.—For a small turkey, take a quarter or a third of a pound, for a large one, half a pound, of truffles. Large tubers are to be preferred, with the fewest irregularities on their surface. Smell them, to be sure they are not mouldy. Wash them carefully, scrubbing off with a soft brush every particle of earth or grit that sticks to them; let them drain and dry. Do not peel them, but slice them across as thin as possible. Boil or roast a good quantity of the best chestnuts; after they are skinned and picked over, mix your sliced truffles with these, and with them fill the *body* of your bird two or three days before it is to be cooked. On the day of cooking, fill the *crop* of the bird with veal stuffing, and roast as before. Send up with it its own gravy in a hot sauce-boat. You may accompany your turkey with bread sauce and onion sauce, for the use of heretical epicures; but as a rule, the truffle admits no rival flavour to approach it. This mode, which is elegant and yet unpretending, will give quite as liberal a taste of truffles as will be cared for by people who are not *excessively* fond of them, and more than enough to satisfy many—for the passion for truffles is an acquired taste. Young folks are rarely capable of appreciating them; nor ordinary people. It requires an

education to understand them properly. But for those gifted with the true faculty, truffles are the superlative of edible substances. Irreverent novices make light of them, comparing them to turnips flavoured with tar. Turkey may be carved in two ways; first, according to the directions for carving a goose; secondly, by dividing it in halves, making of the third part, which contains all the *brown* flesh, what is called a *bonnet d'évêque*, or bishop's mitre, and which, in quite a small family, may be set aside for next day's use. To effect this, separate the thighs from the breast or fore-part of the bird, but leave them still connected with the back and side bones. Then break the back and separate it with your carving-knife, so as to divide the bird into two nearly equal halves. Set the hind parts on a dish, with the drumsticks in the air, and you will perceive its resemblance to a mitre. If warmed up next day, it is best treated as a stew, with savoury gravy and perhaps the addition of rice. Heated again in the oven, and served as a roast, it is apt to be dried up and overdone. If there is stuffing, it should be equally divided between the two halves. The fore part, containing the white meat only, is carved and distributed in the usual way.

Cold Turkey (cut up) is often useful for suppers, collations, luncheons, &c., especially as a whole turkey will make at least a couple of dishes, which may be placed, for the convenience of serving, at different parts of the same large table. Cut up the turkey completely, while hot, into pieces not larger than such as you would help; lay these neatly on your dishes, allotting to each dish an equal share of white and brown meat, of small pieces of stuffing, and of chestnuts, if any. Let the liver also go with these. Boil down the gizzard, heart, and neck, cut in pieces, with any scraps of skin, forcemeat, &c., removing, with the roast gravy, and a bit of knuckle of veal or beef, so as to form a stock that will make a stiffish jelly when cold. When the meat is done to rags, strain the stock from it through a cullender. Skim off the fat, and in it brown a dust of flour; then stir in the rest of the stock, and season it with pepper, salt, red wine, and catchup, and whatever else your judgment suggests. Pour some of this over the pieces of turkey in each dish, so that the bottom of the dish shall be fairly covered with it. Let them cool and stiffen before removing them. When wanted, garnish with fresh sprigs of parsley. It is clear that remnants of roast turkey may be made presentable cold in exactly the same way. Sometimes the thighs are reserved for broiling, previously to which they should be smeared with oiled butter and moderately seasoned with pepper and salt—unless you want devilled turkey, when the quantity of cayenne to be employed is entirely left to your discretion.

GARDEN DECORATION.

TASTE IN THE CONSTRUCTION OF ROCK-WORK, GROTTOS, ETC.

IN an article under the head of the Household Mechanic (see page 86 of this volume), we have given a few remarks on the construction of artificial rock-work, but we now propose to treat of the principles of taste in that description of garden decoration at greater length than our space then permitted us. The subject is entitled to full consideration, for rock-work may often be made of considerable use, more especially in town or suburban gardens, where space is necessarily limited; since by means of it the apparent extent may be increased, and paths, separated by judicious arrangements of this nature, may be brought almost close together without their proximity being observed; not to speak of its value in giving those picturesque forms and broken lines so pleasing to the eye, or in affording proper habitations to ferns and other

beautiful kinds of vegetation. And some remarks on the principles which constitute sound taste in this matter seem especially needed, since there are few subjects upon which more mistaken views are generally held, or in which bad taste is so rampant, as in what is known by the name of "rock-work." In some places we see a heterogeneous mixture of pebbles, flints, and shells, scattered loosely over a mound of earth. This may afford a place for growing certain descriptions of plants, and so far be useful, but it has no claim to be considered rock-work, and in itself, to a cultivated eye and thoughtful mind, its appearance will be anything but pleasing. But, far worse than this are the vulgarities we sometimes see perpetrated; plaster-casts (generally broken), oyster-shells, and even the remains of bottles and teacups, are, after their legitimate work is accomplished, made to do service as "decorations" of the rockery. These things call up associations the very reverse of those which it is the object of gardening and garden decoration to arouse. The real motive of ornamental gardening is to call back the mind, from the lowering dull influences of our artificial life, to the beauty and purity of Nature; and therefore those things which have an opposite tendency are wholly to be condemned.

We have recently seen, in the neighbourhood of St. John's Wood, a rockery, in the bottom of which are dens grated in front, and stocked with miniature wild beasts in

plaster! This is, of course, an evidence of taste on the part of the proprietor; but he must possess, as Beau Brummell said of George IV., a great deal of taste—and very bad.

Rock-work produces good effects, and is in true taste only when it is in harmony with the principles upon which Nature constructs her rocks. Hence the stratified arrangement of natural rocks, more or less inclining to the horizontal, should be followed in the layers of stones used in their artificial representatives, varied, as they are in Nature, by frequent irregularities, which should have the appearance of resulting from natural causes, such as the giving way of subsoils, the action of frost or rain, displacement by roots of trees, or by their own weight. Only under peculiar circumstances should any hewn stone, or other material which recalls human labour, be used. We have already spoken of the necessity for sometimes employing the refuse of the brick-field, but we recommend this only as a substitute for more fitting material. In flat districts, without quarries, such as that in which London is situated, the weight and bulk of real stone, which must necessarily be brought from a distance, render it costly, and it becomes necessary to use a substitute. Another makeshift substance, which may be used under these circumstances, is brick-work, covered with an irregular coating of Portland

cement, to which a stratified appearance and natural colour is given with oil-paint. We have seen good effects produced in this manner, but much skill and judgment are required to obtain it. Far better, where they can be had, are natural stones. In neighbourhoods where such abound, those newly dug from the quarry are least desirable, since they will for a long time retain their crude and unpleasing appearance; it will be long before moss can be made to cover them, and even in shape they will have a somewhat artificial look. Those which have been naturally exposed, as upon the hill-side or sea-shore, and which have thus received a rich colouring of moss and weather-stains, and whose forms have been worn into pleasing outlines by the action of the seasons, are best. The surface-tints obtained from exposure are of more importance for rock-work than beauty of colour in the substance and structure of the stone. Next best to these would be such as have been thrown aside for years among the neglected rubbish of quarries. Pebbles, except in

certain cases to be mentioned hereafter, are certainly not desirable, neither are flints. The larger the masses of stone and the more picturesque their shapes, the better will be their effect.

In some quarries are to be found crystallised masses of carbonate of lime or quartz, having a very beautiful appearance. These should not be used for outside purposes, though numerous builders of rock-work seem fond of employ-

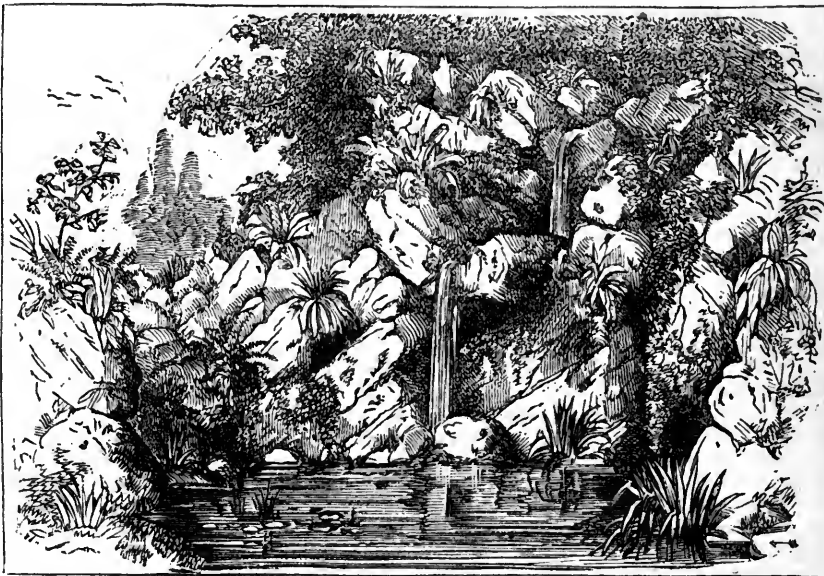

Fig. 1.

ing them largely whenever they can get them; they will not harmonise with surrounding objects, and are not in accordance with the laws of Nature, since crystal can only be formed where filtration takes place; but if a cavern is made in the rockery, these stones are admirably adapted for lining it; in such a situation Nature would herself have used them, and they will consequently appear in good taste.

Pebbles and shells will not look well as forming part of the rock-work itself; but if its base be washed by water, these things are good for forming the margin of the latter, to which they will make an appropriate border; or, if an artificial stream be part of the design, pebbles strewn in its course will have a pleasing effect.

Rock-work never looks well when raised against a wall, round the trunks of trees, or when it rises abruptly from a level lawn. Large trees or shrubbery form the best backgrounds for it; its base may sometimes be hidden by low shrubs, sometimes skirted by gravel paths, but where it can be made to rise from water the effect will be best. Between rocks and water there is a natural harmony; the two always look well in contact. If, therefore, it be possible to arrange a pond at the base of the rock-work, into which some of its jutting points may protrude, it should always be done. Generally it will be

convenient to make a pond, if the necessary water is to be obtained, as the earth dug out will be useful to form the foundation of the rock-work; the size may be proportioned to the space at command, and as good results may be gained on a small scale as on a large one.

In our former article we spoke of the necessity for the general shape of rock-work being governed by the situa-

tion in which it may be placed; we may add, however, to this, that where the ground will permit, a form inclining to that of a crescent will usually be best in appearance, the concave side forming the principal view. The height of a rockery of this shape would be greatest towards the middle, and decrease as it approached the ends. In our illustration (Fig. 1) we give an example, in which a miniature sheet of water is enclosed between the irregular horns of a crescent of rock. The supply pipe by which the former is fed is brought into the rock-work near the top, and miniature cascades are thus formed. In the work

of construction the lower stones will require to be laid, as already directed, on a bed of concrete or rubble; but this may be confined to the edges where the outer stones will rest, and need not be extended under the whole area of the work. For the interior a simple mound of earth, which should be well rammed, will be equally good. To obtain this earth, it will generally be

convenient, as already mentioned, to dig out a pond in front of the proposed rockery; but if there be difficulty in obtaining water supply, it will be better to get sufficient earth by making sunken paths at the base of the work, which will add to its apparent height and consequent effect. The principal front of the rockery should not be made to rise vertically or at a very steep angle; that is, not in its general inclination; some individual masses of stone should, for the sake of relief and variety, show perpendicular faces, or might even overhang; but, on the whole, a slope of about 45° will exhibit plants to the best advantage, and be more in character with ordinary

English scenery. Supposing natural stones to be used, the cement fastening them together should be kept out of sight as much as possible. Occasionally it will be impossible to wholly hide the cement, and, as it will not assume a green colour with age, like the surrounding stone, it will be well to mix a little Brunswick green with it.

At the back of the rockery, which will probably be only intended to be seen at a short distance, a more abrupt rise may be indulged in, which may be useful as affording shelter to ferns and other plants delighting in shade. In this a good feature may be made by the introduction of

a cavern, of larger or smaller size according to circumstances; ivy may be trained to droop over its entrance, and if it be on a sufficiently large scale to contain one or more seats, it will afford a deliciously cool retreat in summer; if too small for this purpose, it is of all others the place to keep a tame owl. (See Fig. 3.)

Where a pond is made it will be generally necessary to

"puddle" the bottom and sides, in order to make it hold water. Puddling consists of putting in a layer of clay and thoroughly kneading, so as to render it impervious. This will, of course, have to be concealed, and a stratum of gravel should be laid above, on which, for the sake of variety, larger stones should be scattered.

Every such pond should, of course, be stocked with gold and silver fish, unless large enough for the English kinds; and with lilies and water-plants generally, of which the more tender and valuable may be sunk in baskets of soil, and taken out during the winter.

In the construction of caverns, either in artificial or in the natural rock, the necessity for avoiding all trace of human labour does not hold good, since a cavern, if intended for a retreat, becomes a thing of use as well as of ornament, and good taste demands that it should be rendered commodious as well as pleasing to the eye. We are, moreover, accustomed to associate caves with

the idea of their having served as habitations for man in a rude state of society, and some adaptation, therefore, of their interior to human wants rather increases than diminishes the picturesque and romantic pleasure they arouse; but, for the same reason, nothing that is connected with modern life ought to find a place in them, and such furniture as they contain should be of a rude and primitive kind. In our illustration, Fig. 3, we have shown a cavern, in which the table is formed of the root of a tree.

If a person should be fortunate enough to possess a garden in an old stone quarry, or on which a natural cliff abuts, he will have an excellent opportunity for excavating a hermitage, which is a thing not only pleasing in itself, but interesting from its associations with poetry and romance. In our illustration (Fig. 2) we have shown such an one, which has been fitted with a Gothic window and doorway; and to those contemplating a work of this kind it may afford useful suggestions. If the cliff is of a nature to permit it, such as sandstone, the tracery may be pierced in the rock itself; or old tracery lying about a builder's yard, may be employed, as we have seen it at Maidstone.



Fig. 2.



Fig. 3.

HOUSEHOLD CHEMISTRY.

ON THE WATER CONTAINED IN FOOD.

WHEN organic tissues are dried so perfectly as to remove all the moisture that they contain, it is surprising to find what a large amount of weight they lose, some of course losing considerably more than others. It was found by Professor Owen that a jelly-fish which in the living state weighed about two pounds, was reduced when dry to only sixteen grains of solid matter, all the rest being water.

So also, if a man were taken and dried so perfectly as to take away all the water present in his tissues, we should, if unacquainted with chemistry, be greatly surprised at the loss of weight he would undergo. It would be found, for example, that if he weighed at the commencement of the experiment one hundred and fifty-four pounds, at the end, when completely freed from moisture, he would have lost one hundred and eleven pounds in weight. In life this fluid is being continually thrown off from the system, to a large extent by exhalation from its surfaces; but partly by the action of the skin, which is always exhaling so much fluid that it amounts to a considerable quantity in the course of twenty-four hours. But from the gradual way in which this process is carried on, we are scarcely conscious of its progress, unless the quantity thrown off is increased by the body being exposed to an increase of temperature in the atmosphere, or by the heat of our systems being raised by extra exertion. In fact, so long as the cutaneous perspiration is not increased to a larger extent than the atmosphere can at once dry up, we are scarcely conscious that it is going on. This gentle exhalation from the pores of the skin, being so slight in ordinary circumstances as not to be perceived, has therefore received the name of "insensible perspiration."

There is also another surface from which fluid is exhaled—the mucous membrane of the lungs. By this means also a large quantity of fluid is got rid of from the body. To prove that the lungs exhale moisture, it is only necessary to breathe upon a piece of cold glass, when it will be at once perceived that the surface becomes covered with damp or dew from the condensed moisture of the breath. One of the advantages of the continual exhalation of fluid from the body, probably, is that it serves to keep down the heat of the body to one given average of temperature. For however much the temperature of the atmosphere may vary, the heat of the human body in health is always found, when examined by a thermometer, to be at 98°. Of course, when the system is heated either by exposure to a hot atmosphere, or by violent exercise of any kind, its temperature tends to rise, but in that case as the amount of perspiration is proportionately increased, the heat is thus kept down. It is owing to this cause that men have been able to enter a hot oven, and, after taking in with them a mutton chop or steak, have remained in the oven until the meat was cooked. This they have done without being at all scorched by the extreme heat to which they were exposed. Under these circumstances the perspiration not only kept down the temperature of the body by its continual evaporation, but also by forming a non-conducting layer around, prevented the external heat from injuring the skin. It is, however, necessary in all cases where persons are exposed to this extreme heat, that the party inside the heated oven should be able to breathe cool air out of a tube carried through the wall of the oven into the atmosphere. It is also necessary that every metallic or other conducting substance, should be removed from the individual who is about to be subjected to this extreme heat. For instance, any money he might happen to have in his pocket would quickly burn him, if not previously removed. So also, if he went in with spectacles on, or wearing rings, his face and hands would be quickly

burnt at the parts where they were in contact with the metal.

In addition to the temperature of the body being thus kept at one regular and fixed degree of heat, the continual exhalation enables the skin and the mucous membrane of the lungs, to remove from the system many of the products of the decomposition of the body that is continually going on during life. Hence, from a knowledge of these facts may be learnt the importance of breathing as pure an air as the circumstances in which we may be placed will allow us; for the purer the atmosphere the more readily will the lungs get rid of the impurities from the blood. It also serves to show the immense importance of keeping the skin in as clean a condition as possible, so that its pores, being free from dirt, may be the better able to act, and thus aid in keeping the frame in a state of perfect health, and fit it as much as possible for warding off attacks of disease. After considering the large quantity of fluid required to keep the human frame in a state of health, it will not excite surprise that a large quantity of the food we consume should contain a considerable proportion of water in its composition. Thus it seems necessary to keeping the body in a state of health, that apart from the fluids taken as a drink, the solids we eat should also contain a certain amount of water. Indeed, no substance can be employed as food that is not soluble in water. This is not so strange as it may at first sight appear, for many substances that under ordinary circumstances are not soluble in water, when exposed to the action of the saliva, and gastric juice, assisted by the heat and trituration it meets with in the stomach, becomes so. Starch is an example of this. This substance is enclosed in a membranous envelope, which is perfectly insoluble in cold water under ordinary circumstances; but when mixed with saliva, and acted on by the gastric juice, the membrane bursts and the contents escape, and are then capable of being taken up as nourishment by the lacteals and absorbing vessels of the alimentary canal.

The various vegetables employed as food contain a large proportion of water. This is only what might be expected when the manner in which they grow is considered—the nourishment of plants consisting only of water, in which carbonic acid and ammonia are dissolved. This water enters through the minute pores, at the extremity of the roots, ascends the stem, and passes to every portion of the plant. While the sap is thus circulating through the plant and exposed to the action of sunshine, the carbonic acid gas and the ammonia become decomposed, the carbon, hydrogen, nitrogen, and some of the oxygen are retained by the plant for nourishment, while the remainder of the oxygen is thrown off from the surface of the leaves in the form of gas. That oxygen gas is thus liberated from the leaves of living plants may be proved by any one—all that is necessary being to place it in a bottle of water, exposed to bright sunshine, when numerous minute bubbles of gas will be seen issuing from the pores of the plant.

Vegetables differ greatly as to the quantity of water that enter into their composition—cabbages, for example, containing as much as 14 ounces 414 grains of water in each pound, or more than 93 parts of water in each 100. Carrots contain rather less water than cabbage, each pound having only 14 ounces. Turnips contain less water than cabbage, but more than carrots; their composition consists of 14 ounces 213 grains in each pound. Jerusalem artichokes contain only 11 ounces 264 grains in each pound. Each pound of potatoes contains as much as 12 ounces of water—every 100 pounds containing 74 pounds of that fluid. Beet-root contains 13 ounces and 124 grains of water in each pound. Cucumbers, as might be expected from their watery appearance, are almost entirely composed of water—16 ounces of that vegetable having 15 ounces and 173 grains in its composition. Garden-fruit also contains,

as might be expected, a quantity of water—one pound of gooseberries having 13 ounces of water; and the same weight of pears 184 grains more of that liquid; while, with regard to peaches, 11 ounces and 431 grains of water are contained in a pound.

HOUSEHOLD CARE OF PICTURES.—III.

It may naturally occur to our readers, that if the operations of cleaning which we have described in our former articles are to be periodically carried out, that in course of time the paint itself will be affected; and this would be so, were it not provided for. Pictures are generally protected by varnish, and when not, they ought to be protected by glass, in which case these operations can be dispensed with, or nearly so. When a picture has varnish on it, it is the varnish that is polished and cleaned, and not the paint. That old painters knew of the value of varnishes and adopted their use, is well proved as early as the fifth century, so those who employ varnish now have good precedents for the practice. We do not give directions as to varnishing pictures, although that operation is often very necessary, for the reasons before stated, to the proper preservation of pictures; because it so often requires the judgment of a person professionally acquainted with the subject, to decide the class of pictures it is safe to operate upon in this way.

Sometimes a bulging-out of the picture is observable at the sides or bottom; this is occasioned by a nail or wedge of the strainer having fallen behind. When this is the case, the picture should be held in a slanting position, face upwards, and a paper knife inserted between the canvas and the strainer, and the nail by this means removed. Any attempt to displace it from the front of the picture will only make the matter worse.

The best situations in which to hang pictures are those where there is a fair good light, neither too great heat nor damp, and where the pictures are not exposed to dust or splashes from soap and water when any cleaning is going on in the room. Thus, a good picture should never be hung in a dark corner, or in the shade of a heavy curtain, over a heated fire-place, or near doors or windows which are constantly opened. It is not always, of course, possible, in rooms with limited wall-space, to fix upon a perfect situation for each picture; but householders in such cases should hang the pictures according to their merits, giving the best picture the best situation. Rooms in which there are seldom fires are not good places to hang fine paintings. A moderately warm temperature, rendering the atmosphere dry, is essential for the proper preservation of pictures. The walls of staircases communicating with street-doors are not, therefore, fit places in which to hang pictures.

Such are the directions we should submit for the guidance of the householder or owner of pictures. We have striven to give the most simple and practical directions which experience of the picture art suggests. We have told the story of the vicissitudes to which household treasures of the pencil are liable, in the simplest terms we could choose, as being the most practical, and practical utility is the end we have in view. Those who have the good fortune to possess pictures of interest, may, we should hope, be left, in these days of diffusion of general knowledge, to appreciate them, as Dr. Barrow, in his admirable way, placed the painter before the moralist in the persuasiveness of the effects he could produce. "Precepts," said the great preacher, "have no vehement operation upon the fancy, and do soon fly the memory; but example, like a picture exposed to sense, having the parts orderly disposed and completely united, contained in a narrow compass and perceptible at one glance, easily insinuates itself into the mind, and durably rests therein.

This is the most facile, familiar, and delightful way of instruction."

In a future article we shall give some attention to a subject of even more general interest—namely, the Household Care of Photographs—a class of pictures which are susceptible to very injurious effects from neglect, and are to be found in all households.

HOME GARDENING.

THE CUCUMBER (continued).—DILL.—ENDIVE.

The Cucumber (continued from page 314).—The varieties of this much-esteemed plant are so numerous that it would be next to useless to give the whole of them; and, as such, we will content ourselves by enumerating a few of the best, to suit most purposes, which are as follows:—1, Early long green prickly; 2, Early short green prickly; 3, Sion House; 4, Dreadnought; and 5, Victory of England. The early long green prickly is a hardy and an abundantly bearing variety, although somewhat slow in coming to perfection, or, in other words, arriving at a bearing condition. The early short prickly is preferred by many growers for a first crop, and we are of that way of thinking ourselves, it being very prolific and quick in showing for fruit. Victory of England is an admirable kind for early forcing, and so are Dreadnought and Sion House. Those desirous of obtaining fruit about Christmas should sow seed the second or third week in August. Then, again, seed sown in May will produce plants that will bear fruit in July; while those reared from seed sown in January will give an abundant crop of fruit in March. The most suitable soil for the cucumber is the top spit of a meadow, and as this can be easily procured for a mere trifle, you cannot do better than accommodate the said plant with the same. In making up your bed, or beds, select a spot perfectly dry beneath, or rendered so by artificial means. This should be protected or sheltered from cold and starving winds, or otherwise the temperature will be materially lowered, and a waste of both labour and manure take place. As a preventive against this mishap, screens of a portable nature may be called into use for early work. The surface of the ground on which the bed is to be formed should be nearly level, and it will be as well, in making up the same, to fill the best part of the interior with such materials as half-spent linings, fresh leaves, and the like. This precaution will in general prevent over-heating, or "burning," as it is termed, and at the same time add to the permanency of the bed, by permitting the roots of the plants to descend with ease, and thereby ensure an abundance of food or nourishment during hot and dry weather. A bed, such as we should make up for the above purpose, ought to be at least four feet high at the back, but five feet would be still better. As soon as built, let some littersy manure be placed round the sides, as a preventive against searching winds, and as soon as the heat is well up—which it will be in four days from the time the bed was commenced—it should be watered thoroughly, closing the lights or glasses afterwards, to keep in the heat. In a day or two afterwards, a second and lighter watering may be given, after which it will be ready to receive the mounds of soil, one under each glass. The soil, or compost, at this early season, should be a mixture of one-half good turfy loam, and one-half well-rotted stable manure. As regards culture, two things are necessary; namely, a due regard to ventilation, and great care in the administration of moisture and regulation of the linings. Provided the bed is established as it ought to be, the heat will have to be furnished by the litter; for if the body of the bed is in a slightly fermentable state, there will always be bottom-heat enough; for such ought never to be permitted to rise above 90° nor fall below 70°. As we have

said before, a great deal of labour is involved in the culture of early cucumbers by the ordinary hotbed—to say nothing of the loss of much valuable manure—and the best, and in fact the only way to counteract this evil is to adopt some kind of screen for warding off the wind, such as frames covered with some waterproof material, closely-woven hurdles, and the like. Finally, ventilation, which is of vital importance at all times and in all seasons, should receive the greatest attention. For our own part, we are in favour of administering air night and day, more or less, so long as a good surface-heat, of not less than 70° by day, and from 60° to 65° by night, can be secured. The greater heat should be obtained between three and four in the afternoon, during which time the frame should be kept closed; after this, again, a little air may be given for the night, and the outsides of the bed be slightly sprinkled with tepid water.

Sowing for a Crop of Cucumbers in the Open Air, on the Natural Ground, without the aid of Dung.—To have a crop for pickling, sow the seed in a warm situation, and where the soil is light and rich, towards the end of May or beginning of June, or as soon as the weather is settled warm. After having dug the ground even and neat, form shallow basins in the soil, about one inch deep, and drop two or three seeds into each, and cover them with half-an-inch thickness of mould. When the plants are well up, they should be thinned out; that is to say, reduced to two in each patch, should the three seeds have germinated. These patches, or basins, should be formed in lines, or rows, six feet asunder, and three feet apart in the rows. After the plants have begun to run and advance in growth, the leading runners must be trained out on sticks as the others. They must be freely supplied with water two or three times a week, and more frequently in hot, dry weather, or the crop will fail. This crop will come on about the beginning of August, and continue in perfection up to the middle of September, when it will go off. The fruit should always be gathered quite young.

Dill.—This is a hardy biennial plant, of upright growth, somewhat resembling fennel, but smaller. The leaves are finely divided; stem single, slender, and terminated by an umbel of flowers, which appear in June and July. The plant being aromatic, the leaves are used to heighten the relish of some vegetable pickles, particularly cucumbers. Dill is raised from seed sown in March, April, or May, in an open spot of ground, either in drills a foot asunder, or broadcast, and raked in evenly. When the plants are up, they must be thinned out to eight or ten inches apart. The plant does not require transplanting, and therefore it must remain where sown. If the seed be sown in autumn, as soon as ripe, it will come the stronger next spring. To save the seed, leave a few of the early-sown plants until the autumn.

Endive.—This is, properly speaking, a hardy annual, with numerous root leaves, which are large, sinuate, toothed, and smooth; the stem is about two feet high, branched, and produces pale blue flowers in July and August. This plant is much esteemed in most families, and is cultivated for its stocky head of leaves, which, after being blanched to take away its bitterness, is used in stews and soups as well as in salads. There are many varieties in cultivation, but the green-curved and white-curved are the two best for general use, and the broad-leaved, or Batavian, for soups and stews. The former is considered superior for autumn and winter use, it being of a more stocky growth and hardier to stand the winter; though we must confess we have found the latter do equally well in most situations, when carefully attended to, and it comes in about the same time. All the varieties are raised from seed, and for a small early crop a little seed may be sown about the beginning of May; but for a full and successive crop in the autumn, winter, and early spring, sow any time from the end of July to the end of August.

THE TOILETTE.

RINGWORM (*concluded*).

Ringworm of the Beard, or *Sycosis*, is a very troublesome affection, and one which should always be treated by a medical man. In it little hard lumps form, and through the centre of these the hairs issue. These hairs are loosened, and readily come away, being themselves dry and brittle, as in all other forms of ringworm. The treatment consists in getting away all diseased hairs, and rubbing in some preparation which will destroy the parasitic vegetation.

Tinea decalvans is the name given to that form of loss of hair from the scalp, in which the production of smallish round patches, denuded entirely of hair, is the result. The hair is not, as in ordinary ringworm, thinned and shrivelled over a certain part; but it is quite lost from circular places, the scalp itself looking white and shining. Much discussion has taken place in the medical world as to the cause of this affection. Some affirm that it is not produced by the ravages of a vegetable parasite, but by atrophy of the hair bulk, though no definite reason is given why this atrophy should itself occur. On the other hand, the disease is said to be of "parasitic" origin by many who have laboriously and specially studied it for some years past. Mr. Erasmus Wilson takes the former view, but we take the latter. The weight of evidence, and especially the fact of the occasional contagiousness of the affection, and its occurrence together with the other unmistakable forms of ringworm, is in favour of the view which regards the disease as dependent upon the attack of a vegetable fungus. Certainly, the most successful treatment of the disease is one in which those agents which are capable of destroying fungi are employed with perseverance. When the bald patches first appear, or when they are enlarging their circumference, they should be well anointed, night and morning, with a pomade made as follows:—

Bichloride of mercury...	2 grains.
Lard	1 ounce.
Oil of lavender...	2 drops.

This ointment, if it produce little yellow pustular heads, should be omitted for a day or more, until the irritation has subsided, and be again had recourse to when the scalp has quieted down again. When the hair appears to be growing again (and at first it will show itself as very fine down), and when the patches do not increase in size, then we may alter the treatment, applying some stimulant application calculated to promote the re-growth of the hair. The following may then be used:—

Tincture of lytta	6 drachms.
Tincture of capsicum	1 drachm.
Glycerine	2 drachms.
Rose-water	5 ounces.

To be sponged on to the bald places night and morning, followed by a brushing of the scalp generally.

Sometime the scalp, in this form of ringworm, becomes puffy and tender. Under such circumstances, it is advisable to apply, three times a week, simple tincture of iodine only, during three weeks or a month. The ointment before mentioned, and the tincture of iodine, must not be used together, as, when brought in contact, they form a chemical compound of a very irritating nature.

Chloasma.—This is the name given to the fawn-coloured itching spots and patches that mostly appear about the front of the chest, but also on the neck, arms, stomach, and other parts, especially when covered by flannel. The patches sometimes commence as little red places, but mostly the first thing that attracts attention is the presence of little light-brown, itchy spots, which soon run

together so as to form irregular patches of variable extent. The itching is increased by warmth of all kinds. If these spots be scratched, a branlike scurfiness can be rubbed away. The disease is readily cured. It should be well washed, first of all, with soap and water, after which the following lotion should be applied freely for some minutes. This course should be followed twice a day, and continued for a fortnight after all appearance of disease has gone. The lotion is as follows:—

Hyposulphite of soda ... 4 drachms.
Distilled water ... 6 ounces.
Glycerine ... 2 drachms.

The lotion should be kept well corked, as it is apt to spoil by exposure to the air.

The other forms of ringworm are so rare, that it is not worth while to discuss them here.

THE TEETH AND THEIR MANAGEMENT.

Considering the important part the teeth play in preparing the food which we take, before its direct passage into the stomach, to be there digested; in adding to the personal comfort and appearance of the individual; in the performance of correct articulation; and considering also the serious disturbance of general health which disease of the teeth may originate, and the sufferings entailed by their premature, and to a great extent, preventable decay, it is really astonishing that persons in general do not pay more attention to the daily condition of their teeth, and the influences that are likely on the one hand to injure, and on the other to preserve them. The mere disfigurement caused by decayed teeth, which is so very common, is to our minds, one of the most positively objectionable things in human nature, and entirely deprives the man, and especially the woman, however attractive he or she may otherwise be, of the power to please, whilst the plainest individuals are often rendered decidedly pleasing in the eyes of most persons, by the possession

of a well-kept and regular set of teeth. Rousseau has said that a woman who has beautiful teeth cannot be ugly, and his remark is quite in accord with the general opinion of the world at large. We shall endeavour, therefore, to indicate the best means to be taken in order to keep the teeth in a sweet and sound state, and what should be done for the prevention of the commoner disorders to which the teeth are liable.

We needs must say a few words about the teeth themselves, as the number in the child and the adult respectively with their several names, very much puzzle mothers and nurses. Be it known, then, to our readers, that there are two sets of teeth, a first or temporary set, twenty in all, which merely serves the purposes of childhood. They begin to come when the infant is about half a year old, and generally are all in working order at two years old; after

which, they remain to be shed by the eleventh or twelfth year, and to be replaced by the permanent or second set of teeth, which number in all thirty-two—sixteen in each jaw. The first or temporary teeth, twenty in all, ten in each jaw, are made up of four incisors, two canines, and four molar or grinding teeth in each jaw. The second or permanent set are made up of in each jaw, four incisors, two canines, four bicuspid, and six molars or large grinders. The following figures represent these different teeth:—Fig. 1 shows the temporary teeth. Fig. 2 represents the left half of the upper jaw, with the permanent teeth: 1 are the incisors, there being two on the other side (the right); 2 is the eye tooth of the left side, 3 the two bicuspid or little grinders, and 4 the molars or large grinders, the last being the wisdom tooth. Mothers can now examine their children's mouths, and satisfy themselves exactly as to how their children are cutting their teeth. But one word as to the time at which the different teeth come. As the temporary teeth are shed, the permanent ones come forward and take the vacant spaces left unoccupied. When a child is between six and seven months of age, teething should commence, and

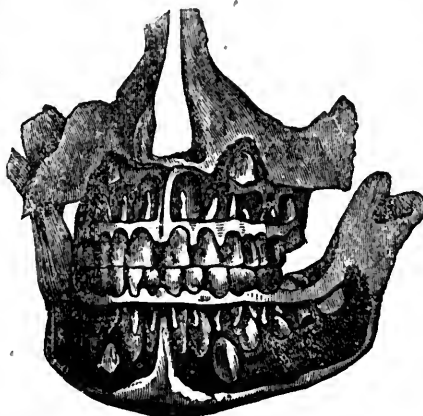

Fig. 1.

the first teeth to appear are the middle incisors of the bottom jaw; then, in a month's time, the upper central incisors; then, within the next two months—that is, by the time the child is ten months old, the lateral incisors—that is, the two in the upper and the two in the lower jaw—are through. At a year or fourteen months of age, the first molar comes, then the canine at eighteen months; and lastly, the second molar is cut at two years or a little more, when all the temporary teeth should be through. In the interval which elapses between the appearance of the complete set of the temporary teeth, and the cutting of the

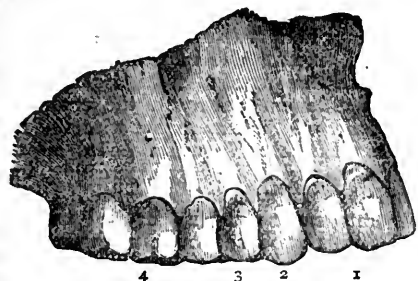

Fig. 2.

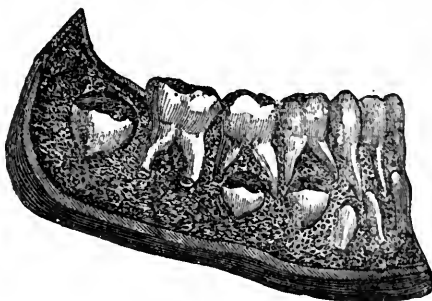

Fig. 3.

first permanent tooth, the jaw widens considerably, and lengthens backwards, so that there is plenty of room created for the additional teeth which are to appear presently; and the first tooth of the permanent set which appears, is the first of the three large molars or grinders, and this comes up behind the last of the two temporary grinders. This is shown in Fig. 3, which diagram represents the jaw of a child about six years of age, containing all the temporary teeth, and the first permanent molar. The other permanent teeth are seen embedded in the gum, and waiting to supply the places of the temporary teeth. The remainder are shed as follows:—

Middle incisors at	7 years.
Lateral incisors at	8 "
First bicuspid at	9 "
Second bicuspid at	10 "
Canine at	11 to 12 years.
Second molars at	12 to 13 "
Wisdom or last molars at	17 to 21 "

Sometimes the wisdom teeth are delayed a long time.

The Influences that act injuriously on the Teeth.—If we carefully examine the structure of a tooth, we shall find that it is such that its healthy condition is not readily affected by slight causes, but that this can only be deranged by some influence acting from within through the constitution, or from without by a chemical action. The outer part of the tooth or enamel is hard, not readily acted upon by solids or fluids, and therefore wears well. It has been found to contain little water in its composition, and is not soluble in ordinary fluids. The particles of which it is composed are closely packed together; it is a bad conductor of and is not affected by electricity, and its nutrition is very slowly carried on—that is, nutritive changes go on in it very tardily. It rests, in fact, the influence of external agencies acting upon it, except such as change its nature by a chemical action, as in the case of acids. The tooth itself embedded in the jaw, is supplied by nerves and blood-vessels that pass into and through the points of the fangs by openings, which any one may see for themselves in an extracted tooth. Hence its nutrition is much influenced by the condition of the nerves and the state of the blood, and especially by constitutional states inducing debility. The absence of debilitated constitutions, of vicious habits of civilisation and pampered tastes, accounts for the presence of such beautiful and perfect teeth amongst nations less favoured than ourselves, which excite so much admiration amongst travellers. An able writer very justly observes, "A child born perchance with an enfeebled build, is pampered with materials for its daily wants, which are dictated only by caprice and given for the sake of idleness or desire to quiet on the part of the parent. Such a child, treated with acid fruits and provided with sustenance that cannot support its growth and development, is directly subjected to both sets of destroying evils, local and constitutional. The teeth, improperly nourished by blood at a time when they require such nourishment, are being subjected to external agents which exert a direct chemical effect, and under the combined causes, the teeth of necessity become destroyed." This is true, not less of the child than of the adult. Let us see in what way the teeth may be affected from without, through the ordinary errors of diet and the like.

Influence of Diet on the Teeth.—At the earliest age, the influence exerted by diet must, of course, act through the blood upon the soft pulpy teeth as they lie embedded in the jaws, and before they are "cut;" and the teeth are thus influenced for the worse chiefly by a diet that is deficient in earthy matter—an exclusively or too distinctly starchy diet—such as arrowroot, sago, gruel, and the like, is not good for the teeth. The earthy portions of diet are found in milk especially, but also in the outer part of the wheat-grain, and means have been taken to separate them for the use of debilitated children, as in the "wheat phosphates" of the chemist. Recently it has been found that the bran itself can be so finely ground that it does not act as an irritant to the tender bowels of the infant, and "Entire Wheat Flour" may very well form part of the diet of infants who exhibit a tendency to late cutting of teeth, and such as are liable to rapid decay. Then again, a bad state of the health of mothers who are nursing, accounts for bad teeth in the child. The mother's milk should contain a large amount of such earthy matter as forms bone and teeth; but if the mother is weak, her milk may be deficient as regards these important constituents, and the child suffers in consequence. The teeth are certainly late in appearing, and perhaps ill formed, for the bony structures generally are soft. The mother who does not get a due allowance of good food, but who is half-starved, cannot supply the materials necessary to the production of good teeth. Happily, in the case of the infant, there is a prospect of a better state of things; faulty temporary teeth can be replaced by good per-

manent teeth, so that ill effects of poor diet may be rectified after a time, though the child of three, four, and five cannot masticate its food well, and may be liable to indigestion, debility, and so on; hence the very great importance of attending to the diet which is in part concerned in the preparation of these permanent teeth. Improper food may easily lead to their being of such a kind as to decay at an early date. "It is a critical point in the management of infants when the natural food, the mothers' milk, is being changed for the food which is to take the place of it for food. The place of this nitrogenised, fatty, and saline food, is too often filled up by a dietary in which only one of these elements is prominently supplied, and the result is as before, a depressed nutrition generally, with special deprivation of the necessary elements for the dental structures. The permanent teeth are, as a result, delicately formed, and in after-life, with the enamel imperfect and the dentine imperfect, they are susceptible to external agencies which, in firmly-built organs, would exert no mischief whatever." (Richardson.)

Young children should have good meat at least once a day, and plenty of milk, not diluted sky-blue, but the pure unadulterated thing, and as the writer thinks, should be encouraged to eat as much brown bread as possible, as assisting in the development of good teeth so far as the diet is concerned. Of course, much may be done to promote a right state of the teeth by correcting constitutional conditions, and these we shall briefly refer to by-and-by. At present, however, we proceed to speak of the influence which acids, sweets, and the like, exert upon the permanent set of teeth.

Action of Acids on the Teeth.—It is quite clear, that if the food itself which we take acts injuriously upon the teeth, it is through the action of the acid which it causes or leaves in contact with the teeth. Acids have the power of entering into combination with the earthy matters contained in the teeth, which, if this action were continuous and energetic, would be left quite soft. Some very valuable observations on the action of acids on the teeth were made some time since by Mr. Thomson. One of his experiments was to place a good tooth in nitric acid: in no less than half an hour the whole of the enamel was found to be dissolved, and in twenty-four hours the tooth was to all intents and purposes dissolved, except a few floating shreds of matter. The same result happened with other acids. In four days the juice of a lemon destroyed the enamel, and a similar result followed the experiment with the juice of a Seville orange. But Mr. Thomson varied his trials with acids still more, and it is very interesting, and of practical moment to know what he noticed. "He put a sound tooth into some vinegar that had been used for mixed pickles, this produced quite a contrary effect from any of the others, for it shrunk up the root, which became very black, but scarcely affected the enamel; this he attributed to the vinegar being impregnated by the vegetables it had been employed to preserve. He took a few acidulated drops, such as are sold by confectioners, and dissolved them in a glass; into the solution he put a tooth; in three days there was a visible change, but in six days the tooth was destroyed."

THE HOUSEHOLD MECHANIC.

HOW TO MAKE PICTURE-FRAMES.

IN these days of cheap pictures, when a really good engraving may be purchased for a shilling, the art of making suitable frames will be found worth acquiring by the household mechanic. Without pictures a room can scarcely be said to be furnished; and it often happens that pictures which would be a constant source of gratification if framed and hung, are left to decay in a portfolio,

because of the cost which must be incurred if the frames cannot be made at home. We therefore propose to show in this article how frames may be made at a small outlay; and as the work is light, and does not involve much expenditure, or require many tools, we doubt not that it will find favour with the amateur.

Before entering upon the details of frame-making, however, we will describe the most common mouldings so as to enable the tyro to at once select the pattern which he may think most suitable to the work in hand.

Fig. 1 is a simple "bead" moulding, and is one of the most easily manufactured. Fig. 2 is an "astragal," and is simply a bead, with a small square on each side of it; this also is very easily put together. Both of these mouldings are suitable for engravings, and they may be obtained of various widths, from half an inch to an inch and a half. Fig. 3 is called an "ogee;" this is made also of various widths, and sometimes it is enriched by inserting a smaller composition moulding, which adds greatly to the beauty of the frame. Fig. 4 is what is termed a "back ogee," and is rabbeted in the thickest part of the wood to receive the glass and the back-board. This moulding of course brings the picture forward very much, and it may often be used to advantage. Fig. 5 is called a "flat," and is mostly used in conjunction with the ogees, Figs. 3 and 4. Of course there is almost an endless variety of mouldings, but those we have shown are the most common and useful of them all.

Having selected a moulding suitable for the picture to be framed, the next thing will be to provide a mitre-box, for cutting the moulding at the required angle. This little piece of apparatus the amateur will have to construct for himself, unless he happens to be near a joiner's shop, when a workman will make him one for a few pence. It is, however, so simple an affair that it can be made at home in a few minutes, and consists simply of a base board, A, Fig. 6, about six inches wide and an inch thick, upon which is screwed another slip of wood, about three inches wide and about one and a half inches in thickness, as shown at B in the same figure. The upper portion, B, should be cut through with a fine saw, as shown in Fig. 7, exactly at an angle of forty-five degrees, and perfectly upright. The easiest way of obtaining this angle is to square over the upper portion of the mitre-block exactly equal to its width, and draw a line from corner to corner. Thus, if the upper slip, B, be exactly three inches wide, draw a line square across it at the centre, A, Fig. 7. Now measure accurately three inches on both sides of this, and square these over, as at B. If lines be now drawn from B B to C, they will be at an angle of forty-five with the line D D, which is that required for the mitre. The lines from B B to C should then be cut very carefully with a fine saw, and the mitre-block or box will be ready for use.

Besides this block, which is used for cutting the moulding to the required angle, a mitre-shoot is wanted, to enable the operator to plane the ends of the moulding so as to ensure an accurate fitting of the parts. The mitre-shoot is made in a similar manner to the mitre-block, except that it should be at least three feet long, and instead of being cut through at B and C, two slips of wood about an inch in thickness should be screwed to the upper portion, as shown in Fig. 8. These must, of course, be fixed at the same angle as the mitre, that is, forty-five degrees with the line A. These two pieces of apparatus, and a fine tenon-saw, with a rather long plane, such as a trying-plane, and two or three bradaws and a hammer, will comprise all the tools needed for putting picture-frames together; and when these are provided the work may be proceeded with.

It will be advisable for the tyro to select a moulding

of medium width upon which to commence the work, as both very large and very delicate ones are difficult of management to inexperienced persons. An ordinary ogee of about an inch and a half in width will be a very suitable size to experiment upon. The first thing will be to determine the size of the frame, which will, of course, be fixed by that of the picture, and will be between the rabbets of the moulding. The length of each part should then be measured, and marked on the moulding, and the four lengths cut by means of the mitre-block. The moulding should be held firmly against the upper part of the block with one hand, and the saw inserted in the cut of the mitre-box, when it can easily be cut to the required angle. When the four sides of the frame are thus cut off, the mitre-shoot should be placed upon the bench and, if possible, fixed. Each mitre should then be planed by holding the back of the moulding firmly against the slips on the upper portion of the mitre-shoot, and moving the plane, which must of course be worked on its side. The iron of the plane must be exceedingly sharp, and set so as to take off a very fine, thin shaving. When all the mitres are thus prepared, the frame may be put together. The best plan of effecting this is to brad four slips upon the bench or a flat board, so as just to enclose the outside of the frame. The parts may then be fitted together, and if all the mitres fit, which they will be sure to do if they have been properly prepared as above described, a little glue should be carefully brushed over the mitred parts of the moulding, taking care not to allow any to rise over the surface, and all the parts firmly pressed together and allowed to rest until the glue becomes set, of course enclosing the entire frame with the slips above-mentioned. A small slip of paper should be placed under each mitre, to secure any glue which may be squeezed out of the joints, or the frame will become attached to the bench, and the joints will probably be broken in the attempt to remove it.

For a frame of any ordinary size, the glueing, if properly done, will suffice to hold it together; but in the case of large or very heavy ones some additional security may be needed. Many persons brad the angles together; but this is at best a clumsy method, and should never be adopted except in extreme cases. A far better plan is to make a cut in the angle of the frame, somewhat obliquely, as shown in Fig. 9, with a sharp saw, and insert in it a slip of thin wood which has been well glued. This should be gently tapped into its place with a light hammer, and when the glue is dry the ends should be trimmed off with a sharp chisel. It will be as well to do this before the frame is removed from the clamps upon the bench, and it will be found to be ample security even in the largest frames the amateur is likely to construct.

The frame being thus put together, any glue which may have been pressed into the angles may be removed with a chisel, when it will be ready for glazing. There are three kinds of glass which are suitable for glazing pictures. These are patent plate, flatted crown, and picture sheet, which latter is merely the selected slabs of ordinary window glass. As a general rule, flatted crown will answer every purpose, and it is this which we should recommend to the tyro, as patent plate is very expensive, and sheet glass is often so wavy as to spoil the effect of the picture placed beneath it. When the glass is cut into the frame, a slip of paper should be glued or pasted round it and to the frame, so as to exclude the dust. The back-board having been cut in to fit the rabbet as nearly as possible, and planed on each side, the picture may be inserted in its place, and the back secured to the frame by means of small brads, when the whole should be covered with paper pasted to the back-board and to the frame, so as to exclude all dust and dirt.

In the case of frames for engravings of small size, the

simple moulding will generally be sufficient; but where the picture is large, or the frame is made of fancy wood, and not gilt, a gilded flat, similar to that shown in Fig. 5, is usually placed inside the other moulding. This inner moulding should be fitted into the outer frame, which must, of course, be made larger by the width of the flat. The mitring must be effected precisely as in the case of the outer part of the frame, and it is a very good plan to place this flat inside the glass, which will protect it from injury. When this is done, however, the print must be stretched on a slight frame of wood to keep it flat, as it will not be pressed by the back-board into immediate contact with the glass.

We think these instructions will enable the household mechanic to construct picture-frames with ease. The chief thing will be to get the apparatus for cutting the mitres perfectly true, and if this is once done the frames must fit at the angles, and may be easily put together. This is absolutely necessary to ensure success, and this is one reason for describing it so minutely. In making picture-frames there should be no fitting. Each part should be cut so accurately as to ensure its going well

past the outer angles, so as to form a kind of cross. In constructing a frame of this sort, the first thing will be to cut out and plane, perfectly straight and square, four pieces of wood of the required length, taking care to allow for the projecting ends.

When this is done, the size of the picture should be set out, and marked both on the end and side pieces; and beyond the line showing the size of the picture, the thickness of the wood should be indicated exactly by another line. The wood should now be marked at half-way through its depth by means of a gauge. These pieces should then be fitted together by cutting through the cross-lines, A A, with a very sharp sash-saw, down to the gauge line, B B, and the intervening wood cut out with a sharp chisel, of course taking care to so cut one piece from the back, and the other from the front, that they may fit one into the other. (See Fig. 10.) When all the parts are thus prepared, they may be fitted together; but they should not be driven quite tightly down until after the rabbeting has been effected.

Of course this rabbeting cannot be done with a plane in the ordinary way, on account of the projecting ends,

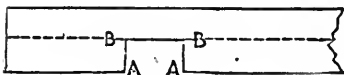

Fig. 10.

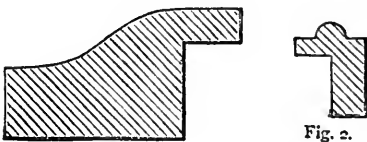

Fig. 4.

Fig. 2.

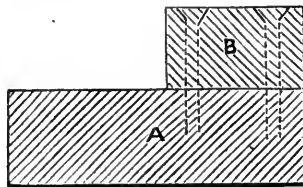

Fig. 6.



Fig. 5.

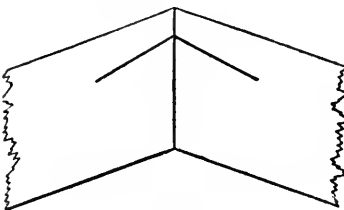

Fig. 9.

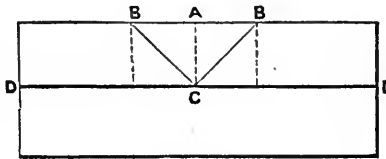

Fig. 7.

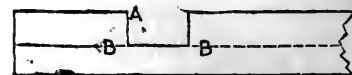

Fig. 10.



Fig. 1.

Fig. 3.

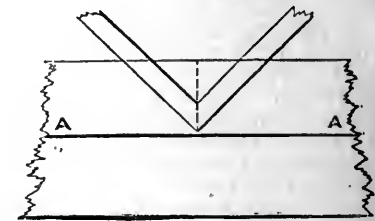

Fig. 8.

together with the other parts; and if this be not done at once, it cannot be done well at all. There are many kinds of moulding which may be procured in lengths at a cheap rate, and which are mostly of German manufacture. Some of these are veneered with rosewood, maple, or other fancy woods, and some are what is termed gilt. The German "gilding," however, is not gilding properly so called, which consists in covering the moulding with gold, in some form. The imported moulding is covered with a white metal, and varnished with a yellow varnish, to give it the requisite colour. This plan has some advantages. The frames may be washed when dirty, a course which cannot be adopted in the case of a properly gilt frame. On the other hand, however, the colour is not so good as in the case of real gilding, and whenever the varnish becomes chipped or scratched the alloy beneath it turns black. The greatest care should, therefore, be exercised in handling moulding of this sort, lest the varnish be damaged. As a general rule, a flat will not be required when a gilt moulding is used, but it is nearly always needed for frames of dark or fancy woods.

Besides the ordinary frames, such as we have described above, there is one other variety which is very popular, and is well suited for some subjects. This style of frame is known as the Oxford, and its peculiarity is that the ends of the wood of which it is constructed are allowed to run

which should be left solid. The best plan therefore is, to gauge round the inside of the frame where the rabbet is required, to the requisite depth with a cutting-gauge, and remove the wood with a very sharp chisel, exercising the greatest care in order not to damage the front edge, which is to receive the glass. If the outer edges are to be bevelled, this should now be done by means of a sharp spokeshave, taking care to work with the grain of the wood, so as not to split or roughen it. The frame will now be ready for putting together. The best plan for the amateur will be to cut the backboard perfectly square to fit into the rabbet, and, having placed a little glue in each part of the joints, to tap the parts tightly together, and leave the whole until the glue is set, when it will be found perfectly firm and very strong.

This sort of frame may be constructed of oak, or pitch pine, stained, and, as it can be made with the aid of so few tools, and those of so simple a character, it is one which at once commends itself to the amateur mechanic.

In conclusion, we would remark that, for small pictures or engravings, it is far better to use a neat, narrow moulding than one of elaborate pattern. In all cases the frame of a picture should simply hold a subordinate position, and should not for a moment attract attention from the picture which it contains, and this cannot be the case if it be heavy, large, or of a staring pattern.

HOUSEHOLD DECORATIVE ART.

CARDBOARD FRET-WORK FLOWER-POT ORNAMENTS.

PRETTY ornaments can be made for flower-pots by cutting out white cardboard. Fig. 1 is a very good design for the purpose. It is a *fleur de lis*, the common flag-flower of our country streams. Trace the shape of the panel, and on a large sheet of bonnet-board, draw four of these meeting at the sides, A to B, C to D, except the two ends. Beyond one of these leave half an inch of cardboard, the half cut through with a knife, and to join the four into the necessary circle to envelop the pot. Another way is to cut the four panels entirely separate, and join them together by strips of red paper, placed inside, down the sides. After the outline is drawn, cut out the device before cutting out the

encircle it in paper, and pin the two sides to the slope, making them at equal distances. Quarter these, and divide the slope equally between each side of the quarters, to keep them uniform. A pot-cover should be easy, not tightly-fitting.

Figs. 3 and 4 are more complicated designs, requiring greater care and skill in their execution; but not too difficult for the amateur to execute. The markings and shadings are painted on the silk or gelatine, with colours mixed either in water, oil, or varnish. Some useful hints on the nature of the requisite materials for this painting, and the best mode of using them, will be found in our article on Painting Decorative Fan-mounts, which the reader will find on page 305. The boards in which these designs are cut may be either painted or gilt, in the way which is fully described in our

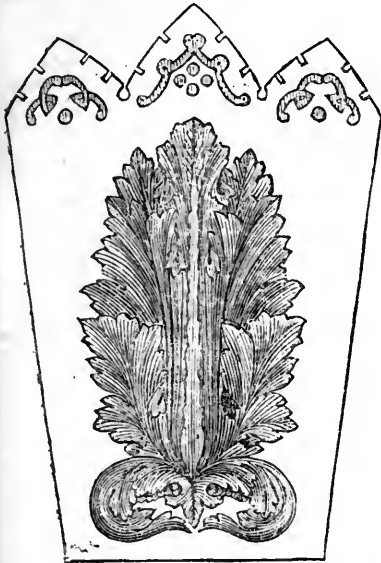

Fig. 2

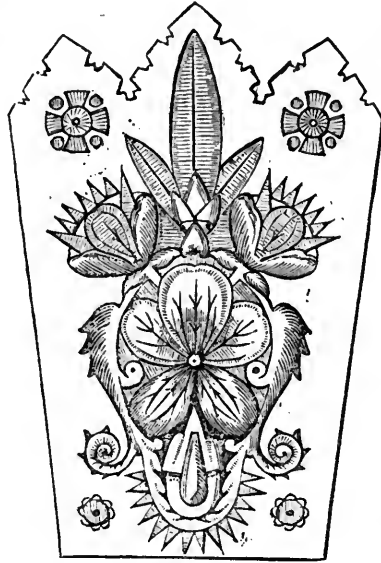

Fig. 3.

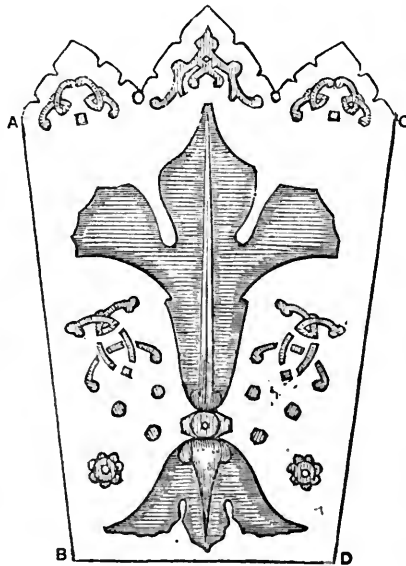

Fig. 1.

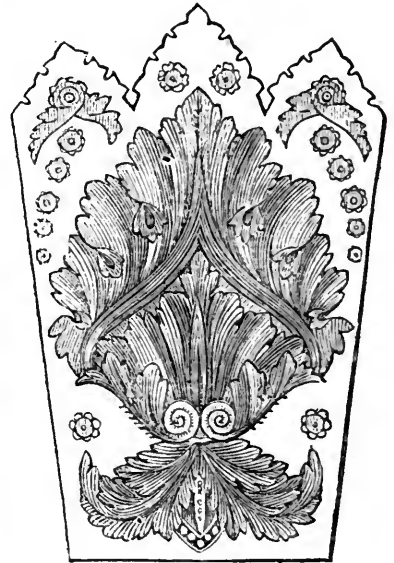

Fig. 4.

shape of the entire pot. To do this, place the card on a board, and work with the point of a very sharp pen-knife. On the clearness of the cutting out depends the beauty of the ornament. In Fig. 1 the upright spear, with its bulb centre, is left standing in cardboard in the midst of the excavation. Line all the open parts at the back with red gelatine. Silk, satin, or an entire lining of coloured paper may be substituted for the gelatine. Green, as a colour, has the next best effect to red, and after that orange or yellow. Fig. 2 is an arabesque design of acanthus leaves, with a centre of cord running through the figure. All the shaded portion is removed. The Gothic tops of the ornaments should be entirely above the flower-pot, and only the very lowest part of the card level with the top of the flower-pot. When larger or smaller ornaments are required, the design must be enlarged or reduced, and can no longer be traced. These ornaments make pretty presents, either a pair, or a set of three or five, to place in stands in a sitting-room. To obtain the size necessary for a pot,

article on Gilding, page 273. When painted, gilt paper mounted flat on thin cardboard may be substituted for the gelatine or silk with a pretty effect.

If the reader will turn to our articles on Carving and Fret-work, he will find in the designs illustrating those papers several suggestions, which a little ingenuity will serve to adapt for this purpose; and in the letterpress of the same articles many hints are given for cutting fret-work, which apply just as practically to the cutting of fret-work in cardboard. By taking

the centre portions of the designs Figs. 5 and 3, on page 248, with the corners of the same, but leaving out the lead-lines, a very suitable design would be obtained.

A very large variety of designs could be made, differing greatly from the above, but not less pretty or attractive. For instance, Fig. 5, page 200, would make an excellent fret-work border for a flower-pot ornament; but in cutting it, pieces of the cardboard would be removed, and these would have to be replaced on the gelatine or silk, and in the latter case with greater care.

INMATES OF THE HOUSE.—LEGAL.

LANDLORD AND TENANT (*continued.*)

In this paper we have appended a number of forms of leases and agreements, which it is hoped may be found useful to those who would dispense with professional assistance.

1.

Agreement for Letting an Unfurnished House on a Yearly Tenancy.

Memorandum of an agreement made and entered into this _____ day _____ A.D. 185 _____ between A. B., of _____, of the one part, and C. D., of _____, of the other part.

The said A. B. doth hereby agree to let, and the said C. D. to take, all that messuage, tenement, or dwelling-house, with the appurtenances, situate and being No. _____ in _____ Street, in the parish of _____, in the borough of _____, in the county of _____, [for the term of one year from the date hereof, and so on, from year to year] until one of the said parties shall give unto the other, in writing, six calendar months' notice to quit, at and under the yearly rent of £ _____ payable without deduction, except on account of the landlord's property and income tax, in equal quarterly payments, on the 25th day of March, the 24th day of June, the 29th day of September, and the 25th day of December, in each year; the first quarterly payment to be made on the _____ day of _____ next. And the said C. D. doth hereby agree with the said A. B. that he, the said C. D., his executors or administrators, shall and will, from time to time, during the period that he or they shall continue to occupy the said messuage and premises, under this agreement, keep repaired, at his or their own expense, all the windows, window-shutters, doors, locks, fastenings, bells, and all other fixtures in, upon, and belonging to the said premises, and leave the same in as good repair and condition as the same are now in—reasonable wear and tear, and accidents by fire, flood, and tempest, only excepted. In witness whereof the said parties hereunto have set their hands the day and year above mentioned.

A. B.
C. D.

2.

Agreement for Letting a House for Three Years.

Memorandum of an agreement made and entered into this _____ day of _____, between A. B., of &c., of the one part, and C. D., of &c., the other part.

The said A. B. doth hereby agree to let, and the said C. D. to take, all, &c. [*describe premises as in first form*], for the term of three years from the date hereof, at and under the yearly rent of £ _____, payable, without deduction, except on account of the landlord's property and income tax, in equal quarterly payments, on the 25th day of March, the 24th day of June, the 29th day of September, and the 25th day of December, in each year; the first quarterly payment to be made on the _____ day of _____ next. And the said C. D. doth hereby agree with the said A. B., that he, the said C. D., his executors or administrators, shall and will, from time to time, during the period that he or they shall continue to occupy the said messuage or premises under this agreement, keep repaired at his or their own expense all the windows, window-shutters, doors, locks, fastenings, bells, and all other fixtures, in, upon, and belonging to the said premises, and all the internal parts thereof, and so leave the same at the end of the said term (reasonable wear and tear, and accidents by fire, flood, and tempest only excepted); and also that he will not assign, under-let, or part with the possession of the said premises without the consent in writing of the said A. B., nor use the same other than and except as a private dwelling-house. And the said A. B. agrees to

keep all the external parts of the premises in good repair, Provided* always, that the said term hereby agreed to be granted shall cease and determine, and the said A. B., his executors, administrators, or assigns, shall have an immediate right of entry in case the rent hereby reserved shall (being demanded) be in arrear more than twenty days next after any of the said quarterly days on which the same is payable, or in case the said C. D., his executors or administrators, shall, after notice, refuse to observe and perform the agreements and conditions hereinbefore mentioned, or shall assign, under-let, or part with the possession of the said premises without such licence as aforesaid, or in case the said C. D. shall become bankrupt, or take, or attempt to take, the benefit of any Act for the relief of insolvent debtors, or shall permit any writ of execution to be levied on his goods. In witness, &c. &c. (as in first form).

3.

Agreement for Letting Furnished Lodgings.

Memorandum of an agreement made and entered into this 1st day of June, 18 _____, between A. B., of _____, of the one part, and C. D., of _____, of the other part, by which the said A. B. agrees to let to the said C. D., from week to week, from the date aforesaid, the drawing-room and bedroom on the first floor in his the said C. D.'s house in _____ Street aforesaid, ready furnished, and to supply the usual and customary attendance of his servants, in common with the other lodgers in the said house; together with the use of such linen, plate, glass, and china as are requisite, and as are reasonably fit and appropriate to a lodger occupying furnished apartments of the class in question, at the rent of £ _____ per week. And the said C. D. agrees to take the said rooms as aforesaid, with attendance and use of linen, plate, glass, and china, as aforesaid, at the rent aforesaid; and he further agrees that, if he shall damage or break any of the said furniture, linen, plate, glass, and china, of the said A. B. (damage by fair wear and tear only excepted), he will repair the same in such a manner as to restore them to their present condition and value, or will replace them by other articles of a similar description and of equal value to those damaged or destroyed. And it is further agreed that either party may determine the said tenancy at a week's notice. In witness, &c.

[NOTE.—The description of the rooms let must be made correct.]

4.

Short Form for the Letting of Small Tenements.

Memorandum of an agreement made and entered into the _____ day of _____ 18 _____, between A. B., of &c., and C. D., of &c.

The said A. B. hereby lets, and the said C. D. takes, the dwelling-house No. _____ Street, from the date hereof, from [quarter]† to [quarter],* at the rent of £ _____

per [quarter],* the said A. B. paying all rates and taxes. And it is also hereby agreed that the said C. D. shall make good all damage done to the windows, doors, shutters, and other fixtures belonging to the said dwelling-house while it is in his occupation (reasonable wear and tear, and accidents by fire and tempest, only excepted), and that the tenancy hereby created shall be determinable at a [quarter's]* notice by either landlord or tenant. (a). In witness, &c.

5.

Form for the Letting of Small Tenements, with very stringent Provisions for Eviction in case of Non-payment of Rent.

[Copy the preceding form to the point (a) and then

* The proviso, or any clause of it which may be thought undesirable, can be omitted.

† Or month.

proceed]. And it is further agreed that if the rent or any part thereof shall be unpaid on any day on which the same shall be due, or within days afterwards, or if the said [the tenant] shall not at all times observe and keep the several conditions and agreements hereinbefore mentioned, or quit and deliver up possession of the house according to notice, then, in either of such cases, and, without any demand whatsoever, it shall be lawful for the said [the landlord] or his agent immediately to enter upon and take possession of the house and premises, and the said [the tenant], and all persons claiming under him for ever, to expel and remove therefrom without any legal process whatever, and as effectually as any sheriff might do in case the said [the landlord] had obtained judgment in ejectment for the recovery of possession thereof, and a writ of *habere facias possessionem*, or other process, had issued on such suit, directed to such sheriff in due form of law, and that in case of such entry, and of any action being brought, or other proceedings taken for the same, by any person whensoever, the said [the landlord] or his agent may plead leave and licence in bar thereof, and that this agreement may be used as conclusive evidence of the leave and licence of the said [the tenant], and of all persons claiming under him for ever, to the said [the landlord], and all persons acting therein by his order for the entry or trespass, or other matters to be complained of, in such action or other proceedings. In witness, &c.

[NOTE.—Landlords of small tenements should have this form printed, and compel their tenants to execute a copy. By it the former will be able to eject the latter without legal proceedings if the rent is not regularly paid.]

6.

Agreement for the Lease of a Dwelling-house.

Memorandum of an agreement made and entered into the day of , A.D. 18 , between A. B., of &c., of the one part, and C. D., of &c., of the other part, whereby the said A. B., for himself, his heirs, executors, and administrators, doth agree to grant, and the said C. D., for himself and his executors and administrators, to take a lease by indenture of all that [*describe the premises and their situation, as in previous forms*] for the term of years, at the yearly rent of £ , payable by four equal payments, clear of all existing and future taxes, rates, deductions, and outgoings whatever, on the four usual quarter-days,* the first quarterly payment to be made on the day of next. And it is further agreed that the said lease shall contain covenants on the part of the said C. D., his executors and administrators, to pay rent, taxes, and rates; and also to keep the said premises during the said term, and deliver them up at its expiration, or sooner determination, in as good a state of repair and condition as they now are in (fair wear and tear only excepted); and also to insure the said premises from loss by fire during the said term in one of the insurance offices in London or Westminster, to be approved of by the said A. B., for the sum of £ ; and at all times to produce the policy or policies of such insurance, and the receipts for the premiums in respect of the same, to the said A. B., his heirs and assigns; and also to rebuild or repair the said premises, if destroyed or injured by fire, or otherwise; and also not to assign or under-let the said premises without licence in writing from the said A. B., his heirs and assigns; and also not to carry on, or permit to be carried on, in the said premises, the trade or business of a [*insert names of trades and businesses intended to be prohibited*], or any other noisome, dangerous, or offensive trade, business, or occupation; and

* If on any other days, mention them specially.

that the said indenture of lease shall contain a proviso empowering the said A. B. to re-enter on the said premises, and avoid the said term in case of non-payment of the reserved rent for twenty-one days after the same shall become payable, or in case of non-performance of any of the covenants of the said lease on the part of the said C. D. to be observed and performed. And also a proviso for the abatement or suspension of the said rent, during such time as the said premises may remain wholly or partially untenable or useless, in consequence of destruction, or damage by fire, flood, storm, or tempest, the amount of such abatement to be determined, in case of dispute, by the award of two arbitrators and an umpire, in the usual manner. And it is also further agreed, that the said lease shall also contain a covenant on the part of the lessor, that, subject to the payment of the rents and performance of the covenants by the said C. D., his executors, administrators, and assigns, he and they, the said C. D., his executors, administrators, and assigns, shall peaceably and quietly hold and enjoy the said premises for the term thereby demised. And it is further agreed, by and between the parties hereto, that the expense of preparing the said lease, and a counterpart thereof, shall be paid and borne by the said parties equally. And lastly, that the destruction of the said premises by fire or otherwise, before the execution of the said lease, shall not in anywise alter or vacate this contract. In witness, &c.

7.

Sale of the Goodwill of a Shop and Fixtures.

Memorandum of an agreement made the day of , 18 , between A. B., of &c., C. D., of &c., and E. F., of &c.

Whereas the said A. B. is at present the occupier of a house and shop, No. Street, which he holds for a term of three years, under an agreement dated the day of , as tenant to the said E. F. [and in which he does now, and has for some time carried on, the business of a grocer and tea-dealer.] And whereas the said term of three years will expire on the day of next. And whereas the said E. F. has let the said premises to the said C. D. for a term, to commence at the expiration of the term of the said A. B. And whereas an agreement has been entered into between the said A. B. and C. D. for the sale and purchase [of the goodwill of the said business of a grocer and tea-dealer, and also] of certain fixtures belonging to him, the said A. B., and now being in and upon the said premises: Now it is hereby witnessed that in consideration of the sum of £ , paid to him by the said C. D. (the receipt whereof is hereby acknowledged by the said A. B.), he, the said A. B., bargains, sells, and assigns unto the said C. D. [all his interest in or concerning the said trade or business of a grocer and tea-dealer, heretofore carried on by him at the said premises, and also] all the fixtures now being in, upon, or about the said premises, as per inventory annexed (a). And it is hereby further witnessed, that in consideration that the said A. B. will not remove the said fixtures now belonging to him, and being in and upon the said premises, before the expiration of his said term and tenancy, he, the said E. F., hereby agrees that he will not at any time claim the said fixtures on account of their not having been removed by the said A. B. before the expiration of his tenancy; and that he will permit the said C. D. to remove or sell them at any time during or previous to the expiration of his term in, or tenancy of, the said premises. In witness, &c.

Dated, &c.

A. B.
C. D.
E. F.

8.

Indemnity by a Landlord to a Tenant against Arrears of Rent, Rates, and Taxes.

I, A. B., the lessor of a certain house and premises, No. , in Street, in the parish of , in the borough of , in the county of , now about to be taken and occupied by C. D., as tenant, do hereby, in consideration of his so taking and occupying the said premises as such tenant, agree and undertake to indemnify the said C. D. from and against the payment of any rent, taxes, or rates, chargeable upon the said premises, or upon any person in respect of the occupation thereof, which shall have accrued due or become in arrear prior to the date of the commencement of his said tenancy or occupation. As witness my hand, this day of , 18 . A. B.

(Witness) E. F.

9.

Receipt for Rent.

April 2nd, 1870.

Received of Mr. A. B. the sum of £5, being one quarter's rent, due at Lady Day last, for the house No. 5, John Street.

£5.

C. D.

DOMESTIC MEDICINE.

FLATULENCE AND WINDY SPASM.

Flatulence is a common and an inconvenient complaint. People feel that they have got wind or air moving about in them and distending them, and not infrequently other people sitting near them hear the rumblings of the said air. Some diseases are only the aggravations of certain healthy states, and it is so with flatulence. It arises from an excess of gas in the stomach or intestines. These always contain a certain amount of gas or air. For the most part the gases contained in the stomach or intestines are the following—oxygen, nitrogen, hydrogen, carbonic acid, sulphuretted hydrogen, and carburetted hydrogen. There are three principal sources from which these gases proceed. The first is the atmospheric air. This is swallowed with the food and the saliva in considerable quantities. Some people have a bad habit, like cribbiting horses, of swallowing too much. But, without any fault of this kind, a good deal is properly swallowed with the food. The gas in the stomach consists mainly of oxygen and nitrogen in the proportion in which they exist in the atmospheric air. The second source of gas in the stomach and intestines is its secretion from the mucous membrane itself. It has been found that when a coil of intestine has been emptied of its contents, and tied above and below, after a time it comes to be filled with air. As there was no other source of air, this must have been secreted from the mucous membrane of the intestine itself. A third source of gas in the intestine is the decomposition of articles of food. The gases evolved from this source are more or less foetid. When digestion is healthy there is little or no offensive gas developed. But where it is otherwise, and especially where bile is defective or vitiated, then offensive and irritating gases are given off from the food, and cause pain, gripings, distension, and perhaps diarrhoea. We have before remarked that where the bile duct is diverted from the intestine, and made not to enter it, the animals become distended with offensive gas and lose flesh. So, then, there may be three sources of flatulence, or excess of gas in the stomach or bowels—First, the air may be swallowed; second, it may be secreted by the mucous membrane of the stomach or intestine; third, it may arise from decomposition of the food. Practically, the air in the first case is natural. It favours digestion, and

contributes to health. The oxygen mixes with the food in the stomach, and is absorbed into the blood. The nitrogen does not disappear so fast, and passes into the intestine, to be either taken from there into the blood or mixed with the fæces.

Practically, then, the cases of disorder or disease in which gas or flatulence is a troublesome symptom are the second and third of the above causes—viz., when it is secreted from the mucous membrane, or given out from decomposing food.

It will often take a doctor to determine the exact cause of flatulence in any given case. Perhaps, however, we can lay down a few simple rules whereby this annoying ailment may be controlled. If it is by itself—that is to say, if the patient is conscious of no other disease—then it probably arises from some simple defect of digestion. A slight laxative may be administered, such as a compound rhubarb pill or two at bed-time, after which the following mixture may be given:—Compound spirits of ammonia, 2 drachms; infusion of camomile, 8 ounces. Mix. A sixth part to be taken night and morning.

A very useful medicine in nearly all cases of flatulence is charcoal. It is sold by all chemists ready for use as a remedy in dyspepsia, and especially in cases of windy dyspepsia. The best form is vegetable charcoal. It has the property not only of absorbing the gases, but indirectly of toning the stomach, and preventing the formation of more gas. It is quite harmless. It may be given in cold water in the dose of a teaspoonful, or it may be taken in the form of capsules. The advantage of this latter form is that the medicine is taken in a dry form, in which it absorbs the gas best; but it is more easily swallowed with water, and acts very efficiently. Bragg's charcoal biscuits, manufactured from vegetable carbon, are used for this complaint, and are strongly recommended.

A great deal in all such cases depends upon the diet taken. This must to some extent be regulated by individual peculiarities. But certain general rules of diet should be observed. Fashionable and fancy meats, and all excess, should be avoided. Food should be taken frequently and not in large quantities. Beer of all sorts had better be avoided. If any stimulant is taken it should be a little claret or sound dry sherry, or very weak brandy and water. The bread eaten should not be new bread, and sometimes toast will be better than unprepared bread. The more simple the material of which dinners are composed the better. A little plain butcher's meat, well cooked, is generally as easily digested as anything that can be taken. Vegetables must be taken more carefully; though, if good, in small quantities they will be beneficial. Of course, all indigestible pickles and highly-buttered pastry must be avoided. After all, the more frequent errors of diet are long fastings, followed by some excess.

The habit of forming gas in the intestines is generally associated with some weakness or want of tone. Therefore, exercise, bathing in the morning, the avoidance both of fasting and excess, are points to be remembered, with stomachic tonics, such as the above.

There are some cases in which the formation of enormous quantities of gas is only part of other complaints—such as disease of the heart or disease of the liver—cases in which the circulation through the bowels is more or less obstructed, and in which as a consequence the absorption of gas is more or less hindered. Such cases are for the highest and best medical treatment, not for domestic medicine; though even in them the general rules given above will hold good.

Windy Spasm.—We may not leave this subject of flatulence without first describing cases in which there is great pain at the stomach or in the side, with a feeling of rapid and great distension, and popularly known as windy

spasm. Such attacks often occur at night, sometimes from error of diet; at other times from nervous causes. In persons of a gouty or rheumatic nature there may also be such attacks, with coated tongue, and urine loaded with pink or red deposit like brick-dust. The following prescription may be useful in such cases:—

Bicarbonate of soda	2 scruples.
Spirit of ether	1 drachm.
Peppermint water	6 ounces.

Mix. A fourth part to be taken every two or three hours till relieved.

Gentle friction over the part, or hot fomentations or a mustard plaister will also generally afford relief. If relief does not come soon medical advice must be sought.

MAKING SWEETMEATS.—III.

Ginger Drops.—Slice about an ounce of candied orange-peel into small pieces; put it with an ounce of sifted sugar into a mortar; beat both together until they form a smooth paste, when should be added half an ounce of pure pounded ginger and half a pound more sugar; then pound all this mixture, and add sufficient water to dissolve the sugar. Put all together into a saucepan, boil it to a caramel, and drop it in small pieces on clean writing paper. These form an excellent stomachic.

Caramel for Sugar Baskets, &c.—Put half a pint of water into a pan, the white of an egg, and one pound of finely-sifted loaf sugar. Whisk all these ingredients together until they boil, taking off the scum as it rises.

Allow it to boil five minutes. Let it pass through a strainer, after which put it again on the fire to boil, until it reaches caramel height (which may be known by taking out some of the syrup on a spoon handle, and plunging it quickly into cold water; if sufficiently done, the syrup will be quite crisp. To make a basket, or any ornament:—When the caramel is sufficiently cool, take a portion up into a spoon, and run it expeditiously in threads over the mould, which should be previously well oiled.

To make Barley Sugar.—Take a portion of syrup, made as the above receipt dictates, and put it into a saucepan with a spout or lip to it. Add also some grated lemon peel, and boil together till it reaches caramel heat, skimming it carefully as it boils. Have ready a marble slab well buttered, and pour the syrup along it—as much as is required for making it the usual thickness—twisting it at the same time, to assume the same appearance as seen at the shops.

Ginger Candy.—Mix together half a pound of sifted loaf sugar, half an ounce of pounded ginger, and one drachm each of pounded cloves and cinnamon; after which add a half wine-glassful of boiling water. Put this mixture on a fire, and boil slowly until it arrives at candy

height. Pour it on a greased slab or tin, and as it hardens cut it into squares. After, put them before the fire to harden, and then away into a tin box.

PORTABLE SCREEN OF IVY.

THIS is a very useful article for many purposes. A common window-garden flower box is made the length required, and mounted on castors. The size of the screen depends on the purpose for which it is wanted. A number of laths of wood, as long as the screen is to be high, must be placed upright at intervals all along the box, against the back of it, and resting on the bottom of it. Nail them in their places. A number more laths, as long as the box is wide, must now be fixed across these. Begin with the first an inch above the box. Fix it right across by two tacks, one at each extremity. Fix it to every lath with fine flower mounting-wire, uncovered. When all the laths are on, a trellis-work is formed which can

be observed through the foliage in the cut. It is painted green; when dry the box is filled with mould, and set with ivy plants, which will cover the trellis completely as they grow. The front of the box should be set thickly with lily of the valley, or scented violet roots, or sown in the summer with mignonette. Lilies of the valley give a particular fragrance that is not only delightful to inhale, but which is reputed to cure headache. This screen and box, without castors, may be mounted on the ledge of a staircase window with a bad look-out, or what is better still, fixed outside it, by means of a couple of strong hooks from the wall

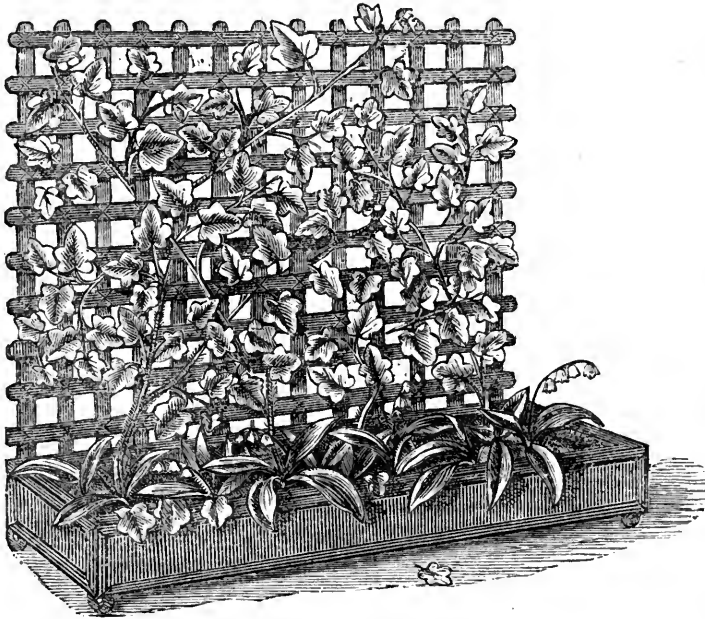

PORTABLE SCREEN OF IVY.

each side of the box, and above the window a nail each side, and one in the centre, to which three ropes are tied, and brought down outside the trellis-work to three hooks below the window, to protect it from the wind. One more rope should be bound from side to side, about the centre, and across the other three ropes. When the ivy has grown well, the machinery will be entirely covered. Where there are leads outside a window, the box would not need fixing. A single rope, carried from side to side, across the centre of the trellis and behind it, would prevent its being overset by the wind. Where a window has been stopped up from the outside, and is unsightly, such a box and screen can be fixed, and the ivy in time will drape the wall as well. In a back drawing-room, &c., with an unpleasant look-out, such a screen is very useful. The box may either rest on the sill inside, or stand upon castors on the ground. In a garden the box and portable screen may be prettily used to place before a summer house entrance when occupied, or to conceal parts of the garden wall, and so give a greater charm to a small and monotonous plot of ground; or it can be used to hide a back door, or some ugly nook or corner, or gardener's dust-hole; and it has this excellence, that whereas a

yearly tenant or leaseholder, on leaving his rented house and garden, must leave the ivy he has cultivated upon the wall; he may certainly take his portable screen with him. Screens of this kind covered with woodbine, clematis, and passion-flower, may be grown in the greenhouse, and when brought to perfection removed to the drawing-room or summer-room, and disposed in some part of the chamber with charming effect. For such a use the box trellis-work and should have some pretension, also, to refinement.

ANIMALS KEPT FOR PROFIT.—CATTLE.

REARING CALVES (continued.)

CALVES fed by pail get from one to two quarts of new milk each meal, according to size and age. Some feed twice, others three meals daily. As the calves get older, various substitutes are mixed in the milk in quantity as the calf will bear it—half a pint of oatmeal made into thick gruel may be quoted as an average for an ordinary sized calf six weeks old. Some substitute skim milk for new milk, but it does not answer well, for the calf requires more of it, and also of the other substitutes before it can get the requisite proportion of fatty matter the system requires; and, besides, skim milk is nearly devoid of the aromatic properties of new milk, so essential to its dietetic value. Almost every county has its own mode of “doctoring the pail,” and in the majority of cases, the food thus given is too sloppy. The more advisable plan is to give what new milk can be spared, and rich cooked food for the balance, containing no more liquid than healthy rumination requires.

Small farmers seldom bring up more than one calf per cow by the pail, and more commonly one calf to two cows, the remainder of the milk being used in the family. Large stock breeders sometimes bring up as many as six calves per cow, but three calves per cow is perhaps nearer the average.

Calves, whether suckled or fed by the pail, should be weaned gradually. Reduce the quantity by degrees, until “it is not worth the coming for,” and the calf will part with its milk without a grumble, and the cow with her calf; but it is the reverse with both if separated otherwise.

It is usual to calculate that a young heifer calf should be reared every fourth year purposely to take the place of its dam, but in practice, the rule has but a limited application on small farms. Thus the cow's first calf should, as a rule, not be her successor, and the third calf has generally more constitutional stamina than the second. And if the third calf is a bull, it does not require much reasoning to show that the cottager's young cow has to succeed not her dam, but her grand-dam, which involves too many young heifers on hand. Again the Alderney and Kerry are two of the best breeds for private family use, and nowhere can they be so profitably reared as on their own native ground, so that with few exceptions it is better to purchase young cows in the prime of milking, as afterwards directed, than to rear. If the cottager sells his milk, the Yorkshire mixed shorthorns and the Ayrshire cows give larger quantities of milk, but when fed on washy food they are sooner worn out, so that it is difficult to apply the fourth year rule in this case. Large dairymen and stock breeders in the country experience no difficulty in rearing their own cows, and also a surplus stock to supply large towns, selecting heifers from the best stocks at the proper age, and so on, as they are kept at less expense, both for food and attendance, and if a heifer runs to fat, as they occasionally do, they can be sent to the shambles without much loss or disappointment.

The usual period of gestation for a cow is nine months and nine days, or, as it is technically expressed, “nine months and as many days.” The shortest period on record where a healthy calf was produced, is 240 days,

and the longest, 321. It is seldom advisable to rear calves that come before 260 days, or after 300 days. Of 760 cows (Lord Spencer's experiment) the greater proportion after 284 days were bull calves, and the greater proportion before 284 days were cow calves.

THE COWHERD'S CALENDAR.

SERVED.	WILL CALVE:	SERVED.	WILL CALVE:
Jan. 1	Oct. 10	July 1	April 9
“ 7	“ 16	“ 7	“ 15
“ 14	“ 23	“ 14	“ 22
“ 21	“ 30	“ 21	“ 29
Feb. 1	Nov. 6	“ 28	May 6
“ 7	“ 10	Aug. 1	“ 10
“ 14	“ 16	“ 7	“ 16
“ 21	“ 23	“ 14	“ 23
“ 28	“ 30	“ 21	“ 30
Mar. 1	Dec. 7	“ 28	June 6
“ 7	“ 8	Sept. 1	“ 10
“ 14	“ 14	“ 7	“ 16
“ 21	“ 21	“ 14	“ 23
“ 28	“ 28	“ 21	“ 30
April 1	Jan. 4	“ 28	July 7
“ 7	“ 8	Oct. 1	“ 10
“ 14	“ 14	“ 7	“ 16
“ 21	“ 21	“ 14	“ 23
“ 28	“ 28	“ 21	“ 30
May 1	Feb. 4	“ 28	Aug. 6
“ 7	“ 7	Nov. 1	“ 10
“ 14	“ 13	“ 7	“ 16
“ 21	“ 20	“ 14	“ 23
“ 28	“ 27	“ 21	“ 30
June 1	Mar. 6	“ 28	Sept. 6
“ 7	“ 10	Dec. 1	“ 9
“ 14	“ 16	“ 7	“ 15
“ 21	“ 23	“ 14	“ 22
“ 28	“ 30	“ 21	“ 29
“ 1	April 6	“ 28	Oct. 6

The Cowherd's Calendar is used thus:—If you wish your cow to calve about the 4th of February, then opposite this date you will find April 28, the time to serve her with the bull. Again, if your cow comes in season about April 7, opposite is January 14, and if that is too early, you must wait. The time of serving should be carefully entered in your “Herd-book,” and also the time of calving, and the calf posted into your stock-book, under cow calves or bull calves, as the case may be; and this rule is as imperative for one cow as for a herd of a hundred.

COOKING.

TURKEYS (continued), GUINEA FOWL, PEA FOWL, PIGEONS.

Hashed Turkey, for those who object to cold meat, is easily done by preparing a gravy as above directed, and in it warming up the turkey, properly divided, with the remnants of stuffing or chestnuts, and the addition of a few kernelled olives or sliced gherkins, taking care that the hash does not boil. A little pickled walnut varies the flavour nicely. You may garnish with fried or toasted bread, or with buttered toast re-toasted.

Boiled Turkey.—Turkey boiled is often coupled with turkey spoiled, in which we hold there is more rhyme than reason. So far from spoiling it, boiling makes turkey a dainty dish most acceptable to persons with delicate stomachs who fear the richness of the roasted bird. It is scarcely a company dinner dish; but nothing can be nicer for a quiet supper, after an evening out, with a small party of intimate friends. Truss the turkey, as for roasting, stuffed with chestnuts and veal stuffing. Boil it like a fowl, *not* in a cloth, but bound with broad tape, to lift it out of the boiler. Oyster sauce is the best to go with it; but it may be accompanied with parsley and butter, Dutch sauce, or even good melted butter relieved with the least pinch of salt and horseradish, and made with its own boilings instead of water. Any left should be cut up as soon as removed from table, arranged on a fresh dish, and masked with the sauce remaining, or with some made

purposely afresh. So, garnished with green parsley, it will furnish a pretty little picking cold. With boiled turkey you may also eat celery sauce (purée of celery, diluted with milk or cream), chestnut sauce (*idem*), bread sauce, or onion sauce. We have more to say about turkeys, but, our space being limited, will conclude with a fact. Avignon (for a time the residence of the popes) has always been famous for good eating, and, as a natural consequence, for good eaters. A respectable president of the tribunal of that city had a proper sense of the turkey's merits. One day, stepping out of doors after dinner, he exclaimed, "Faith! we have just finished a magnificent turkey. It was excellent; crammed with truffles up to the beak, tender as a pullet, fat as an ortolan, perfumed as a thrush. We left, *ma foi*, nothing but the bones." "How many were you?" asked an inquisitive friend. "We were two." "Two!" "Yes; the turkey and I."

Guinea Fowl might take their place with game, for which they are used as substitutes, replacing pheasants after the shooting season is over. These must be birds hatched in the course of the previous summer, and will come in nicely during Lent and at Eastertide. They will hardly bear shutting up to fat *in coops*, but may be confined *in company* (even if you give them as co-mates old birds you do not intend to kill) in any airy roomy shed. The secret, however, of having them in good plight, is to feed them well from the moment they leave the shell. Very rarely will they ever become what is called *fat*, as compared with other poultry. Consequently, before putting them down to roast, they may be wrapped in very thin slices of sweet white bacon. They are trussed and dressed in exactly the same way as roast fowl or pheasant; they may be stuffed, or not, with veal or fancy stuffing, or truffled. Bread sauce and brown savoury gravy are indispensable accompaniments, to which onion sauce may be added. Those who wish to keep guinea fowl, ought to be reminded that they *pair* like partridges, instead of being polygamous, like pheasants and cocks and hens. Consequently, the eggs of guinea hens that have no mate are useless for hatching purposes; it also prevents your having any dependence, for breeding, on bought eggs coming from a farm where you do not know how they are kept. Guinea fowl's eggs are esteemed as delicacies. Although much smaller than a hen's, their shells are so thick that they take quite as long to boil. Although guinea fowl will not abandon their own home, they are of wandering habits, sleeping as often in the branches of some tall tree near the house as in the fowl-house, where they rarely lay their eggs, preferring to make their nest (a hole in the ground) amongst dead leaves, in a shrubbery, on a hedge-bank, or in a clump of nettles. Where villa grounds are closely crowded, a neighbour has as much chance of their eggs as their owner. They are noisy birds, giving the alarm at the slightest occurrence and signalling the approach of every stranger. * Although unarmed with spurs, the male is peevish and combative with other poultry. The eggs require a month to hatch, and it is best to confide them to a motherly bantam, who will cover nine. The young are exceedingly pretty. Their orange-red bills and legs, and the dark zebra-like stripes with which they are marked from head to tail, bear no traces of their parents' speckled plumage. No one who did not know, would guess from their appearance of what species of bird they were the offspring; and when first hatched, they are so strong and active as to appear not to require the attention really necessary to rear them. To be successful, the poultry-keeper must remember that they are natives of a hotter and a drier climate than our own.

The peacock was a state dish in olden time. "The vow of the peacock" is an historical custom; but long before *our* olden time, peacocks were in the highest esteem for the table. By the ancient Romans they were

considered first-class delicacies. Horace, translated by Francis, says—

"Should hunger on your gnawing entrails seize,
Will turbot only, or a peacock please?"

And in a note he adds that Quintus Hortensius was the first who gave the Romans a taste for peacocks, and it soon became so fashionable a dish that all people of fortune had it at their tables. Cicero pleasantly says, he had the boldness to invite Hirtius to sup with him even without a peacock. Marcus Aufidius Lurco made a prodigious fortune by fattening them for sale. The probable term of life with pea fowl is from eighteen to twenty years. They may be eaten as poults at nine months or a twelvemonth old. If fattened, they must be shut up together with any turkeys that they may have been associated with, and fed exactly the same; if confined alone, they pine. They are, however, like turkeys, an excellent viand at a much more advanced age, and without any fattening, provided they have been well fed, and killed at a proper season (that is, when they are not renewing their plumage), and are hung up in the larder a sufficient time before cooking. A disregard of these conditions has probably led to their being so little appreciated in modern times as a dainty dish. When dressed for table they should be stuffed with forcemeat or truffled, larded over the breast, or wrapped thereon in thin slices of white bacon, roasted at a gentle fire, and served with bread sauce and brown gravy, exactly like turkeys, partridges, or pheasants. White pea fowl are much prized by those who prefer rarity to real beauty.

Pigeons.—Everybody knows that domestic or dove-cote pigeons pair, and lay only two eggs; that the male bird takes his turn on the nest, and assists in feeding the young with undigested food from his own crop. There are, however, wild species which lay only *one* egg; and at least one of these, the North American passenger pigeon, makes its appearance (strange to relate) in countless flocks. Amongst the very numerous species of wild pigeons which are scattered nearly all over the world, only one, the blue rock dove (*Columba livia*), has been really domesticated. All the fancy breeds of pigeons are believed by many naturalists to be derived or descended from this; but fancy or loft pigeons are of such high antiquity that no certain conclusion can be safely arrived at respecting this matter, which is of great interest in a scientific point of view. The collared turtle (*Columba risoria*) becomes exceedingly, even troublesomely, tame, but cannot be trusted with its liberty, and, therefore, is not truly domesticated. So far as we learn, the flesh of all pigeons is good to eat, although reputed to be of a heating nature, if long persevered in as an article of diet. Wild pigeons, such as our wood pigeon, stock dove, and migratory turtle, may be regarded as game, in kitchen language. Some Australian species are little bigger than larks, others are as large as hens. The extinct dodo, the largest of all, was unquestionably a pigeon that could not fly.

As a rule, it may be stated that pigeons bred for the table are finer on the Continent than in England, though we are far from adding better flavoured. In the south especially, the runts (the largest breed), or crosses from them, are common, as they seem to have been 200 years ago. Mr. Edward Browne, in 1664, wrote to Mr. Craven, "Wee came home by the island of Nisida. . . . By this time you must conjecture wee had a good stomach to our supper, which wee made of pigeons, the best heare, without controuersy, in the world, as big as pullets." Our own blue rocks, however, with plentiful food, will breed nearly all the year round, except during moulting time, and in long-continued frosts. The flesh of the young birds is excellent, and by some connoisseurs is esteemed superior to that of any other species; but it must be made into

pies or stewed, being seldom fat enough to roast. For this purpose we must have recourse to the large lazy runts. "They say," saith Willoughby, "that the eating of dove's flesh is of force against the plague, insomuch that they who make it their constant or ordinary food are seldom seized by pestilential diseases; others commend it against the palsy and trembling; others write that it is of great use and advantage to them that are dim-sighted. The flesh of young pigeons is restorative, and useful to recruit the strength of such as are getting up, or newly recovered from some great sickness; to us it seems to be most savoury, and if we may stand to the verdict of our palate, comparable to the most esteemed."

Notwithstanding which favourable opinion there are communities which abstain from pigeons. In parts of Russia they are revered as emblems of the Holy Ghost, while the pigeons of Venice are the protégés of the city; they are fed every day at two o'clock; a dinner-bell is rung for them, and they are not allowed to be interfered with. Any person found ill-treating a pigeon is arrested. If it is his first offence he is fined; if he be an old offender he is sent to prison. It is believed in Venice that the pigeons are in some way connected with the prosperity of the city; that they fly round it three times a day in honour of the Trinity; and that their being domiciled in the town is a sign that it will not be swallowed up by the waves.

Pigeons à la Crapaudine.—Baron Brisse, one of the greatest living authorities on French cookery, boasts that he has at his fingers' ends no less than sixty-two ways of dressing pigeons. He gives their titles, some of which, as "Merry Pigeons" and "Pigeons in Plain Surtouts," are amusing; but our excellent English pigeon pie is not included on his list. One cause of this multitude of receipts is the convenience of pigeons, when there is a dove-cote at hand, in any scarcity of butcher's meat. Moreover, pigeons are more abundant on the Continent than with us, in consequence of the long, dry, warm summer, which favours their breeding; they are also finer, the domestic varieties being larger-sized than ours. *Pigeons à la crapaudine* are simply broiled pigeons, which you may vary according to your taste and appliances. After plucking and singeing the pigeons, and cutting off their feet, split them open down the back, empty them, saving the livers, and flatten them without breaking any bones, which is easily done by means of small iron skewers. Smear them with oiled butter; sprinkle them first with finely-chopped parsley, and chives or green onions, pepper and salt, and then with as much grated bread-crumbs as will stick to them. Broil them on a clear fire. If you have not the means of broiling convenient, you may do them, with care, in a cooking stove or American oven. For sauce: Brown butter and flour in a saucepan; dilute with broth and white wine; season with chopped parsley, shallots, and mushrooms, and add thereto the livers cut small. When the pigeons are nicely browned, and enough done without being dried, arrange them on a hot dish, and pour the sauce, after a boil up, over them. If mushrooms are not at hand, you may supply their place by putting a tablespoonful of catchup into the sauce.

The simplest and perhaps the best ways of cooking pigeons are:—Baked in a pie, quartered, with hard eggs and veal, flavoured with pepper, mace, and lemon-peel; boiled in a pudding, quartered, with veal or very tender beef; and stewed whole, with quite young frame horn-carrots, not more than a couple of inches long, or with green peas, or with mixed vegetables *à la jardinière*.

We have touched upon the rearing and fattening of pigeons for the table but slightly, as this subject will receive attention in a section of the HOUSEHOLD GUIDE to which it more properly belongs, namely, that under the head of "Animals Kept for Pleasure and Profit."

ANIMALS KEPT FOR PLEASURE.—BIRDS.

THE CANARY—STANDARD PROPERTIES (*continued*).

The Nottingham Variegation.—Pied birds, having the throat, breast, and belly, entirely white, buff, or yellow. Their points of perfection being 4 for clearness and richness of feather; 4 for evenness of marking, and being alike on both sides; 4 for blackness of beak, legs, feet, and nails. For beak 2, head 8, neck 8, back 10, shoulders 9, wings 12, chest 6, body 8, tail 7, legs 8, feet 3, feathers 10, attitude 6. These points to be taken from the applicable standard rules for clear Belgians.

The Yorkshire Variegation.—This class differs from the Belgian variegation only in two properties, cap and tail; the head being clear, but marked round the eyes; the tail evenly marked, with white or black feathers on each side; in the centre, the remainder of an opposite colour. Both above and below, the birds must be clear from head to tail.

Dutch Canaries.—These are very long birds, often longer than the Belgians, but differ from them in figure. They are straight from the beak to the tip of the tail; the neck is straight; the legs are bent at the joint; the skin is coarser, and the feathers are not so compact, but longer, broader, and coarser. The beak is slender, clear, and white; head flat and small; neck long and straight; shoulders high, flat, and well-filled; wings, long and compact; chest, slightly curved; body, very long, straight, and tapering; tail, long and thin; legs, long, and bent at the joint; feet and nails, long, clear, and not twisted; feathers, close and compact (sometimes the bird is frilled; some admire this, but it is said to arise from uncompactness of feather, &c.) Colours, rich, clear, and regular; attitude, as upright as a pouter pigeon. Points in perfection: Beak 2, head 3, neck 8, shoulders 9; wings 12, chest 6, body 8, tail 9, legs 4, feet and nails 3, feathers 10, colours 9, attitude 6.

Song of Canaries.—Birds most approved of as harmonious and delightful songsters are those that sing the following notes of the nightingale: the water-bubble, sweet jug, followed by a switling flut or trill, and the sprightly whisking, weeting, chowing, and fearing of the titlark. Some persons are satisfied with birds that sing a strong, long, and continuous song, without harsh or whining notes.

The Midland Singing Birds Society's requirements in good song are: greatest number and variety of notes; greatest harmony of song; greatest length of rolls or runs on the same notes, measured by seconds; greatest length of time without breaks, or least number of breaks within 15 minutes.

Mules.—All pied mules (to receive prizes at exhibitions) must show some distinct distinguishing marks of each parent bird, not resembling each other; having, when one parent is a canary, the best resemblance to canary properties. Any rare class of mule is most highly prized, if the distinguishing marks of each parent can be satisfactorily proved. Many British finches will pair with canaries, and we should be inclined to class them thus; best for song, linnets and goldfinches. Siskins will readily match with canaries; but the young are inferior song-birds. It is said that chaffinches, greenfinches, bramblefinches, bullfinches, and other birds will breed with canaries; but mules bred from these birds would only be valued for their plumage or variety, as they are indifferent song-birds. It is necessary to state that many dealers and fanciers believe that mules will not breed either with the races of their parents, or with mules of similar parentage to their own, and we have never seen the offspring of such birds at any ornithological exhibition. Some writers, however, express a contrary opinion.

We now give a few general remarks on the subject of purchasing the canary. When you have selected the

bird, do not, unless you are dealing with a tradesman of known respectability, suffer the dealer to touch your bird, but pay a deposit on the cage the bird occupies, and take your purchase home with you. Never buy a bird from those who hawk them about the streets, as, although cheap, they are as a rule more or less worthless, being the refuse stock of the dealers. In some cases, too, street vendors have been known to sell sparrows dyed and disguised to represent canaries.

The best time to buy a canary is that when they arrive in large numbers, fresh, strong, and healthy, from the country. This time is just before Christmas. Long after this the young birds usually become spoiled by the company of inferior songsters, and such noisy companions as macaws, fowls, dogs, &c. Handle your bird as little as possible, and get it into your own cage by placing the two open doors together, and if it is evening, put a

MATS FOR DINNER AND BREAKFAST TABLES.

THERE are many ornamental accessories, giving a finish to the dinner and breakfast table, in the manufacture of which the female members of the household may find pleasant and amusing employment. At the family dinner, for instance, when flowers are not required as a centre-piece for the table, a glass water-jug and goblets ought to occupy the vacant space. As these, however, would not be effective if placed on the white table-cloth, an ornamental mat is required for them to stand on. This may be very quickly and simply made, with the following materials:—A sheet of common pasteboard (rather thin), some fine French merino of the brightest scarlet, and plain white china buttons of different sizes, such as may be seen in our designs. These buttons may be purchased at 2½d. the gross at a tailor's trimming shop. The mat

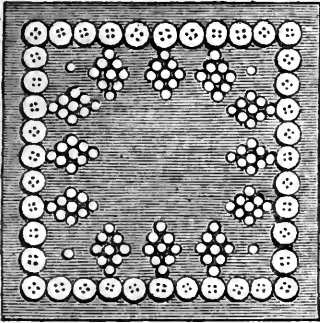

Fig. 1.

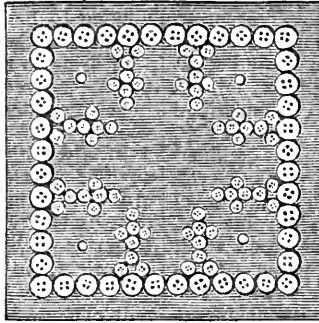

Fig. 2.

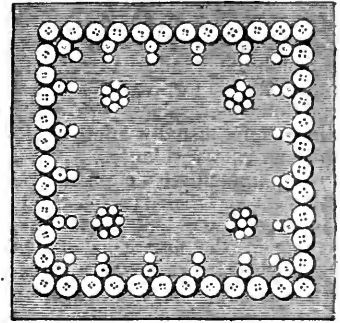

Fig. 3.

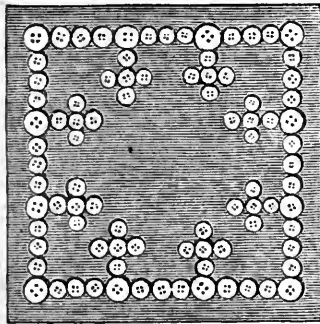

Fig. 4.

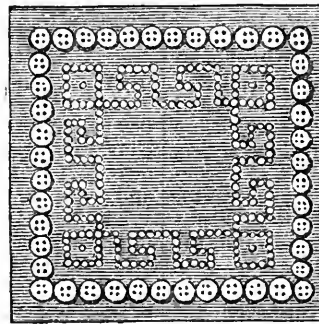

Fig. 5.

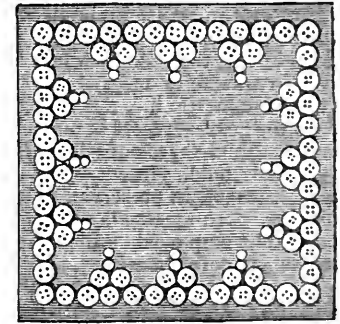

Fig. 6.

lighted candle in front of that you wish him to enter; then hang the bird-cage in the place it is to occupy. If your purchase is a young bird, do not hang it with any other noisy birds, but in a room by itself, as otherwise its song may suffer deterioration. Young canaries, being very imitative, are usually brought up under good tutors, such as the titlark and the nightingale, but they readily lose what they have been taught, and acquire bad habits, under the influence of bad company. The twitter of hen-canaries, in his hearing, will prove very mischievous. As he grows older he gets wiser, and only imitates his superiors.

When in good health, the bird is slender in shape, sprightly, and active; his excrement soon becomes dry and is of a darkish colour in the middle; he sits his perch bolt upright, and takes notice of what is going on around him. If you particularly wish your bird to sing by gaslight, you must darken the cage in the day-time, and not over-feed him. Where several birds are hung together, their cages should be so placed that they only hear but do not see each other.

should be 22 inches long, by 9 inches wide, and to these dimensions the pasteboard should be cut. The merino being of sufficient size to turn over the edge about an inch, should now be placed over the pasteboard, and tacked to it, so as to keep it stretched smoothly upon it, the edge being turned over on the wrong side. A straight row of buttons is now firmly sewn all along, about half an inch or less from the edge, taking the stitches through the pasteboard, which firmly fixes the merino in its place, and allows the tacking thread to be afterwards removed. After this, the design should be worked, and if the Grecian border (Fig. 5) should be chosen, it will look best in the smallest sized buttons. In Figs. 2 and 6 three different sizes of buttons are made use of, and in all cases they are sewn through to the pasteboard. For sewing on the buttons, white or scarlet silk may be selected, according to taste; the scarlet has a pretty effect, but the white gives a pure, dead look to the work, reminding one somewhat of a border of carved ivory laid upon the scarlet ground. When the design has been completed, the mat should be covered at the back with white glazed calico, which may

be turned in and felled down at a little distance from the outside edge. This mat will be found also useful for the breakfast table as a stand for the teapot, milk jug, and sugar basin. We give six designs for borders suitable for either breakfast or dinner-table mats. Perhaps for the former, Figs. 3 and 6 would be the best, as the wider and more elaborate patterns should be reserved for the centre of the dinner-table. We have given the dimensions suitable to an average table; but these can be varied, and the mat made larger or smaller as required. Scarlet flannel may be used instead of French merino, and is more inexpensive; but the latter has a delicacy and closeness of texture in which the former is deficient.

THE HOUSE.

THE STORE-ROOM.

THE rapidly-increasing value of land in every district easy of approach by rail has brought about a degree of discomfort in domestic architecture undreamt of in former times. Good housewives, accustomed to roomy stair-landings, long passages, large cupboards, and separate offices for various kinds of household labour, reconcile themselves with difficulty to the circumscribed dimensions usually afforded for domestic purposes in modern villa residences. Nor is the complaint confined to the immediate neighbourhood of large towns. Even remote rural districts are becoming a prey to the novel system of house-building and its attendant inconveniences.

One of the first acts of denial imposed upon most housewives, in order to meet existing circumstances, consists in giving up the keeping of any kind of stores. The nearest grocer's shop has become in most establishments the substitute for the store-room; and a poor substitute, at the best of times, that warehouse proves, entailing endless vexations and disappointments, which were unknown when it was the custom for all well-to-do families to provide for their daily wants in advance. Fitted with every requisite to meet the numberless emergencies that arise in domestic life, the compact little apartment was at once the general resort in moments of need, and a pleasing and healthful source of occupation to the female members of a household. Intent upon laying in stores, at convenient seasons, in preserving, pickling, herb-drying, sauce-making, sorting and arranging goods, much time was profitably employed, which now hangs heavily on the hands of many women.

If with the cessation of the above duties a corresponding amount of gain were secured, regrets on the subject need be but few. It is not so, however. The housekeeper's time and patience are now-a-days tried in checking accounts, which the system of giving daily orders to tradesmen entails; and servants are liable to be very much interrupted in their work by being sent on errands after forgotten items. Just at the last moment, before sending a dish to table, for instance, it is apt to be discovered that the principal ingredient is not at hand. People that can be ill spared from home at the time are obliged to be sent hither and thither to supply the deficiency, and, when obtained, the particular article is, perhaps, not of the quality desired. In illness, the need of a well-furnished store-room is painfully felt. The extreme importance of having really genuine stores at command at such times cannot be over-rated. Life or death may depend upon the quality of nourishment administered at the critical moment of a turn in the disease.

General as the custom has become of procuring most stores at the grocer's shop, upon the plea that there is no room in modern residences to keep such things at home, persons who may be disposed to try the experiment may easily do so, in most cases, where the plan is supposed to be impracticable. A very little room will hold a large

number of useful stores, provided a system of arrangement be observed. There is scarcely, in fact, a small villa in any of the principal suburbs of large towns that does not contain the kind of nook required. The circumstance of builders constantly committing the error of building rooms that are totally unfit for any domestic purpose whatever, save as lumber-rooms, comes to the aid of our suggestion. All that is wanted is ingenuity to convert these otherwise waste places into rooms where stores may be kept. Even a good-sized linen-press, placed on the landing of a staircase, may be made suitable to the purpose. Either place should be fitted with shelves, neither too far apart nor too broad. In the one case valuable space is lost, and in the other small articles are liable to be out of sight behind larger ones.

Some ventilation is necessary in whatever kind of room is devoted to the keeping of stores. If an ordinary window and chimney be present, no farther contrivance is needed. If not, perforated zinc, let in at the upper part of a door, will supply the needed air. If a linen-press of the kind alluded to be in use, a current of air should be supplied from the back or sides; as well as from the front.

Bearing in mind that limited space is generally all that can be spared for the purpose in question, the following suggestions will bear reference only to the most general wants.

Firstly, with regard to the purchasing of grocery, soap, candles, &c. Supplying a store-room entirely from an ordinary grocer's shop is not a profitable plan, either as regards the price or the quality of the provisions. The better mode is to ascertain what articles certain dealers are celebrated for, and to buy such things exclusively from such dealers. There are certain establishments, for example, that are noted for the excellence of their tea at moderate prices; others are equally famous for good and cheap coffee. When found, these tradesmen are the people to deal with, because, as they confine their business entirely to one article of sale, they are the most likely to exercise discrimination in the selection of their goods; and from being in a condition to buy in large quantities at the lowest market prices, they are enabled to sell at a proportionate scale of profit. As a general rule, whatever purchases may be desired should be made of the chosen firm direct. The goods should be paid for on or before delivery, and a discount taken for ready money payment.

The same line of conduct should be observed in laying in other descriptions of stores. In all cases where it is practicable, the manufacturer or the direct importer is the best agent to employ. Even if the price does not appear less than through other channels, the quality of the goods is likely to be superior, which comes to the same thing in the end. In the latter case, discretion should be used in the consumption of such stores.

The chief error to guard against in having articles of daily consumption in the house is a lavish habit in their use. In most households there is a tolerable average observable, and if any excess beyond the usual consumption becomes apparent, it may be assumed that there has been some mismanagement.

A pair of scales and a set of weights should form a part of store-room fittings. All articles given out should be weighed with the same precision as is customary at shops. It is perhaps needless to say that the door of a store-room should be fitted with a good key, small enough to be conveniently carried at all times in the housekeeper's pocket.

Reverting to the labour connected with the providing of stores, we will make a few suggestions that may be useful to the inexperienced. Beginning with *preserving*. Some people say that you can buy jams as cheaply as you can make them. Taking the actual cost into consideration, perhaps the difference in price is but trifling; but there is no comparison between the quality of the two articles. Home-made jams are really what they profess

to be, without the aid of substitutes generally used by the trade, and the former afford a valuable article of diet. If judiciously used, nothing is more conducive to the health of young children during the winter than home preserved fruit. The average quantity of sugar for preserving ripe fruit (and none other is profitable), is three-quarters of a pound to a pound of fruit. Some housekeepers recommend less, but their jams are apt to fail. With the above greater proportion of sugar, less boiling suffices; consequently, less loss is incurred by evaporation. Twenty minutes after jam has come to the "boil" is sufficient. "Preserving loaf sugar" is more profitable than moist sugar, and costs but little more. Loaf sugar is also drier, and has, therefore, higher preserving qualities. No skimming is required when loaf sugar is used. Jams should be tied down whilst *hot*—as soon after they are taken from the stove as possible. There is then no need of using oiled paper, brandy, &c. The pots should not only be thoroughly dry, but should be heated in the oven to be certain that there is no moisture about them. As soon as the jam is tied down, it should be placed on the shelf it is designed to occupy, leaving just a little space between each pot. One pot should not be placed upon another, neither should any other articles be suffered to rest on jams. Mildew is apt to form if these precautions are neglected.

The most profitable family jams for winter use are raspberry and currant, mixed in the proportion of one-third of raspberries to two-thirds of currants. Eaten with hot rice, plain boiled, this is a wholesome winter pudding for children. Black currant jam is equally useful for roll-puddings; and raspberry and strawberry jam for finer kinds of pastry, such as open tarts and the like. For the latter purpose the jam should not be added till after the crust is baked. Preserved rhubarb is not profitable if one has to buy the rhubarb. If it be of home-growth, the jam is well worth making. Mixed with orange marmalade, rhubarb jam is an excellent tonic relish for delicate appetites. Two-thirds of rhubarb to one of orange marmalade is a good proportion. Rhubarb jam for winter use should be made in the fall of the year—not before August. Stone fruits are not profitable preserved in sugar, but, if the expense be not objected to, they afford an agreeable change.

The most approved mode of preserving greengages, apricots, plums, &c., is boiling them in syrup. The fruit should first be stoned, care being taken not to bruise it. A syrup having been prepared by boiling sugar and water together for ten minutes, in the proportion of one pound of loaf sugar in a teacupful of water (quarter of a pint), the fruit should be added to the syrup, and be suffered to simmer till tender. The syrup and fruit should then be turned into a large dry pan, and the following day the process of boiling should be repeated for a quarter of an hour. At the second boiling, the kernels previously removed from the shells, and blanched, should be added. Skimming must be carefully attended to in this mode of preserving, otherwise the syrup will not look clear. The best time for the above preserves is August and September. The fruit should not be over-ripe. One pound of sugar to one pound of fruit should be allowed.

Fruit jellies are almost all made in the same way—namely, by simmering the fruit in a jar placed in boiling water till the juice is extracted. Then strain off the fruit and to every pint of juice add one pound of loaf sugar. Boil and skim for twenty minutes. Remove the jelly from the fire, and tie down in pots as described for jams. For black currant jelly allow a quarter of a pint of water to every pint of juice, in addition to the usual proportion of sugar.

Pickling is one of those preserving operations that are best done at home, even although the result should be that the articles pickled present a less brilliant appearance than those which are purchased at oil warehouses. Several

chief points are to be observed in pickling. The vinegar used should be of the strongest quality, and should not be boiled, but simply brought to scalding heat. This may be effected by steeping the required quantity of spice in vinegar, and setting it to stew gently for twelve hours on a trivet, or on a stove. The vinegar should then be strained from the spice, and used as required. A stock vinegar, useful for most purposes, may be prepared by mixing a quarter of a pound of black peppercorns with two ounces of allspice, half an ounce of cloves, and two ounces of bruised ginger. The above proportion of spice is sufficient for a quart of vinegar. The spice, when strained off, may be covered again with vinegar, and kept in the store-room for filling up jars from which pickles have been taken out. The best mode of preparing vegetables for pickling is to steep them in bay-salt and water, strong enough to float an egg, for twenty-four hours, from which they must afterwards be drained by lying on a sieve. When thoroughly saturated with salt the pickle may be added, and the jars tied down with several thicknesses of brown paper or bladder saturated with the vinegar pickle. Most pickles are better for being kept at least one year before they are used. No metal saucepans or spoons should be allowed to touch pickles. The least moisture will spoil all the work. Small onions, cauliflowers, gherkins, and walnuts are in most general favour. People who prefer digestibility to crispness par-boil the substances to be pickled in the brine of salt and water previously to adding the vinegar.

The preparation of sauces, flavoured vinegars, and dried herbs amply repays for the small amount of trouble such things demand. Our French neighbours are very diligent in these occupations, and to their forethought and intelligence may be attributed much of their success in cookery. The great point to bear in mind is, to be ready to turn to account all the good things which successive seasons bring, and not to rely on chance productions. All who are desirous of making store-sauces, &c., will find the autumn and the end of summer the most favourable time of the year. It is then that the ingathering of most of the herbs from which appetising relishes are made takes place, and the necessary ingredients may be purchased for a mere trifle, which are expensive to buy at other seasons. For instance, no store-room is complete without the following—and we may say that no good cookery can be complete without such flavours:—

Garlic Vinegar.—From Midsummer to Michaelmas is the best time, and twopennyworth of garlic will supply a family with vinegar of the kind for twelve months. The garlic should be simply peeled, cut in slices, and covered with strong vinegar in a wide-mouthed stoppered bottle. One or two drops of this vinegar will impart an agreeable flavour to most sauces, soups, and stews. No sauce, however, requires a more sparing use.

Shalot Wine is a more delicate preparation than the above, and may be used for the same purposes, if preferred. A quarter of a pound of shalots minced finely and covered with half a pint of sherry, should be left to soak for a few days. The wine should then be poured off, and added to the same quantity of freshly-chopped shalots, as at first. Repeat this process three times. Strain the wine from the shalots, and bottle for use. Shalots in August are about eightpence per pound.

Chili Vinegar is made by simply slicing chilies, and covering them with vinegar in closely-corked, wide-mouthed bottles. In August and September chilies are from fourpence to sixpence per dozen. A few drops of chili vinegar are a great improvement to winter salads, stewed steaks, &c. When the vinegar is sufficiently saturated with the chilies, the latter may be added to any mixed pickles that may be kept in store.

Tarragon Vinegar is invaluable for salads, and is almost always used by the French. Tarragon vinegar is

made by steeping the herb in vinegar, and bottling it off when strained, having been previously left two or three days to stand and settle.

Mint Vinegar is an excellent relish for cold mutton in the winter, and is made in the same manner as tarragon, with the exception that the mint, if finely chopped, may be eaten as in mint-sauce. All the above sauces should be kept in moderately small bottles closely corked, and tied down with parchment steeped in vinegar. When the parchment is dry, the top should be dipped in bottle wax. The latter process should not be performed till all the sediment has settled and been removed.

Dried Herbs are invaluable for winter use. The herbs should be gathered just before they bloom, that being the time when the flavour of the plant is strongest in the leaf. Having been dried by suspending in a kitchen, the leaves should be stripped from the stalks, and finely powdered by rubbing between the palms of the hand. They should then be put into bottles and tightly closed. Bottles about the size which usually contain anchovies are the best for this purpose. Lemon-thyme, marjoram, pennyroyal (the latter being essential for flavouring pork-sausages), and sweet basil are the most useful of the herbs in common use for soup, stuffing, forcemeat balls, &c.

Dried sage and mint are equally useful. Care is required to remove all roots containing grit before the drying begins. The above herbs may be mostly gathered between July and September.

A very convenient store-sauce will be found for broiled meat, devilled bones, &c., made of the following:—Two wine-glasses of mushroom catchup, one of walnut catchup, and a table-spoonful of Worcestershire sauce. These, mixed together and well shaken, are very handy when a relish is needed in a hurry; added to a little melted butter, the above is a very good accompaniment to fish.

Mushroom catchup is so well-known and well-established a favourite, that it is only needful to recommend its being made at home, in preference to being purchased at shops. Half a sieve of *flap* mushrooms, looking, in the basket, perhaps black and a little broken, may generally be bought in the markets, at the end of August, for 5s., and will make half a dozen wine-bottles of catchup, at the additional cost of the salt and spices for flavouring. The proportion of spices recommended in a preceding paragraph for pickle vinegar will serve for flavouring the catchup. Having cleared the mushrooms from the grit at the stems (provided the stems be left on the mushrooms), proceed to spread them in a large pan, in layers, sprinkling each layer plentifully with salt. The pan should then be tilted, in order to let the juice drain in a corner, where it may be easily removed by a cup. After a day or two's draining, fresh salt may be sprinkled on the mushrooms, and the mushrooms squeezed, which will cause the remaining juice to flow freely. These first juices should be saved separately, and make what is called "double catchup." The catchup should be boiled with the spices for about twenty minutes, and, having settled and become cold, it should be put into some bottles and corked. Fresh sediment will form in a few days, from which the catchup must be cleared, and finally bottled. Wine-bottles that have been used for containing spirits are best for this purpose, provided they have been kept closely corked. All utensils used in the making and preserving catchup should be perfectly dry.

The *second* catchup is made by pouring about three pints of water to the above quantity of mushrooms, adding fresh salt. After having been left to saturate for a day or so, the mushrooms should be boiled up and the liquid treated as above. The mushrooms themselves are still fit for immediate use, in stews, curries, and the like; and, if dried in a very slow oven, may be pounded and kept for winter use, to flavour hashes, stews, and soup.

Other stores will be treated of in a subsequent chapter.

ODDS AND ENDS.

To Sweeten Butter.—If you add $2\frac{1}{2}$ drachms of carbonate of soda to 1 lb. of butter having a rank flavour, it will render it perfectly sweet again. Dripping and lard may be also treated in the same way.

A Refreshing Drink.—Slice two oranges and one lemon into a jug with 2 oz. of candied sugar. Pour over this one quart of boiling water, keep stirring at intervals until cold. This is an excellent drink in warm weather.

Offensive Feet.—Take 1 part of muriatic acid to 10 parts of water. Rub the feet with this mixture every night before retiring to bed.

To take away Soot Stains from a Floor.—Dilute some sulphuric acid with water, and wash over the stained part. If you do not find the stain disappear, add a little more sulphuric acid, to make the mixture stronger.

The management of the Finger-nails.—The correct management of the nails is to cut them of an oval shape, corresponding with the shape of the fingers. Never allow them to grow too long, as it makes it difficult to keep them clean; nor too short, as it causes the tips of the fingers to become flattened, and enlarged, and turn upwards, which gives the hand an awkward appearance. The skin which grows in a semicircle on the top of the nail requires much attention, as it is often drawn on with its growth, dragging the skin below the nail so tight as to cause it to divide into what are termed agnails. This is to be prevented by separating the skin from the nail by a blunt half-circular instrument. Many persons cut this pellicle, which causes it to grow very thick and uneven, and sometimes damages the growth of the nail. It is also injurious to prick under the nail with a pen or penknife, or point of the scissors. The nails should be scrubbed with a brush not too hard, and the semicircular flesh pressed back with the towel without touching the quick. This method, if pursued daily, will keep the nails in proper order. When the nails are badly formed or ill shaped, the ridges or fibres should be scraped and rubbed with a lemon, and well dried afterwards; but if the nails are very thin, the above remedy will not do them any good, but might cause them to split.

To clean Gilt Jewellery—Cheap French Articles.—Wash the brooch, earrings, &c., with soap and water; rinse; and with a small, soft brush, wash the article with spirits of hartshorn.

To prevent Fleas.—Placing camphor in small bags about your person, and also about the beds, will send them away; or a few sprigs of wild myrtle and pennyroyal placed between the bed and mattress, or on the counterpane, will prevent them annoying you during sleep. It is a good thing to put a little essence of pennyroyal in the water in which you wash before retiring to rest. Pennyroyal will destroy most insects, or keep them away, as they have a *general dislike to the smell of it*.

To remove Stains from the Hands.—In paring apples or scraping new potatoes the hands become stained. By using pumice stone when washing the stains will be removed.

A Hint in Packing.—Feather beds and mattresses may be tied up in old carpets instead of blankets, when they will make neat packages; and large books may be placed in the centre, and prevent the possibility of the binding being damaged.

To Bleach Wool.—To 1 lb. of woollen yarn take 2 lbs. of powdered white chalk, and mix with cold water to a paste. Knead the yarn about in this for a short time, after which rinse in cold water and dry, and the wool will appear thoroughly cleansed and bleached.

Ivory Ornaments.—The French way to clean and preserve the colour of ivory ornaments, brooches, earrings, card-cases, bracelets, chains, &c.:—Place the articles to be cleaned in a basin of cold water, and allow them to remain

in it twenty-four hours. Take them out of the water, and lay them on a clean soft towel, but do not wipe them; they must dry by the air, and any water that remains in the carving of the ivory should be blown out; if allowed to settle on the ivory it would destroy the colour.

THE HOUSEHOLD MECHANIC.

PAINTING (*continued*).

Selection of Colours.—Nothing has yet been said on style in colouring. In this you should be guided by the use for which an apartment is designed, and in like manner, with regard to the decoration of articles of furniture, by the purposes of the apartment for which such articles of furniture are designed. Cheerfulness and brightness are the characteristics which should distinguish a drawing-room, and these may be best produced by the introduction of delicate tints of brilliant colouring and a considerable extent of gilding. The chief contrasts should be in the furniture, the brilliancy of which will derive additional effect from the walls being kept in due subordination, although taking part in general liveliness. The appearance of a library should be sombre and grave, the effect of which is greatly increased by its being situated upon a shady and quiet side of the house. No more colouring should be employed than necessary to lend a pleasing effect and to give the room an air of comfort. The decoration of a dining-room should be rich and substantial, and any contrasts introduced should not be remarkable, and no gilding should be employed except for the sake of relief. This style of decoration will be found best to correspond with the massive nature of the furniture. The decoration of bedrooms should wear the combined appearance of cleanliness, coolness, and cheerfulness. For halls and staircases the style of decoration should be simple, and wear a cool aspect. The object desired should be an appearance of height and good architectural effect, which is produced by the light and shadow. At the same time sufficient colouring should be employed to give a more covered appearance than the exterior of the house. For breakfast-rooms and parlours a medium style between that of the drawing-room and dining-room should be adopted, in accordance with the purpose, and guided by taste.

The Painting of Walls, Plaster and Stucco.—It is impossible to say too much in favour of the painting of walls; and much of the neuralgic and rheumatic pains now so prevalent is attributable to the fashion of papering the walls of houses. It is well known that the ceilings and many of the exterior, as well as all the interior, walls of the dwelling-houses of this country are finished in plaster, and one of the chief properties of this composition is its power of absorbing moisture, consequently the walls continually absorb an amount of moisture from the damp with which the air is generally charged; thus arises what are known as unaired rooms, and to air them requires more time than is generally counted for. Instead of decorating the walls with paste and paper, the first object in painting a house should be to render the interior walls impervious to the absorption of moisture from the atmosphere, and more especially in the case of bedrooms, where the evaporation of impure liquids not only aids in adding to the dampness of the walls, but renders them impure and unwholesome. With regard to the workmanship of the painting of walls, it is certain that no painting can be done with any effect until not only the surface is dry, but likewise the erection has been made sufficient time to admit of the mass having arrived at a good degree of dryness, for whoever will consider the expansive nature of water, as well in a condition of evaporation as of congelation, can soon answer the question, that when it meets with any impedi-

ment preventing its escape it forthwith opposes it. In the present instance, the evaporation would consist of acrid lime water, which would not only force off the paint itself, but would carry with it layers of plaster wherever its force found a centre. In the case of plaster or stucco upon wood-work the time required for drying is far less than is requisite for a groundwork of bricks. Before proceeding with directions for painting, it is necessary to call the attention of our readers to the qualities of white-lead, more particularly than before we had occasion. It is well known that white-lead is the material of most importance in paint, as it is the chief ingredient, and forms above four-fifths of the composition. Upon the quality of this article depends the durability of the paint, but it is most difficult to procure it free from adulteration. We often express our surprise at the difference of time workmanship lasts, but this is dependent upon the quality and purity of the white-lead employed, although the difference is at first imperceptible. There are three qualities manufactured, varying in price from about 25s. to 35s. per hundredweight. This, however, is but a slight difference when compared with the adulteration commonly practised with this article by the addition of fine whitening ground in oil, the detection of which adulteration is very difficult. The painting of plaster, stonework, or stucco is executed in the same manner as the painting of wood, using, however, oil without turpentine. The oil to be used is linseed or nut oil, boiled with driers. Should you suspect any portion of the work to be damp, it is a good plan to rub it over with a solution of glue and red-lead while hot. In applying the paint, do not lay it on too thickly, or the surface will be rough and uneven. The amount required may be easily known, as the work will continue to absorb the paint until it has had sufficient. It is impossible to say how many coats plaster or stonework may require, but a good criterion is to be guided by the absorption of the paint, as when the work ceases to absorb it may be considered to have been sufficiently painted. So long as the work continues to absorb, dull spots and patches are sure to appear. When possible, it is best to let two or three days elapse between each coating, excepting the last. For exterior work, some light colour is often preferred to pure white; to form a pretty cream colour add chrome yellow and a little Venetian red; for a deeper colour add a little burnt terra de Sienna, and for drab add raw umber, with a little Venetian red. Pea-green is a favourite colour for inside work, to make which take four parts of white-lead, one of mineral green, one of blue verditer, one of precipitate of copper, using as driers equal proportions of sugar of lead and burnt white vitriol. Grind them in linseed oil, and dilute to the proper substance with spirits of turpentine for the purpose of flattening, using the same ingredients, mixed with equal quantities of oil and turpentine, for the two coats preceding the flattening, the former being successively a trifle the deepest in colour; and in all cases it should be borne in mind that the last coat of paint before the flattening should be barely dry when the flattening is applied, the reason for which we have before explained.

HOME GARDENING.

DILL (*continued*)—FENNEL—GARLIC.

Dill (continued from page 332).—This plant delights in a light, rich, mellow earth in an open situation; therefore choose a compartment of this description, and dig it neatly and thoroughly over, and sow each sort separately, scattering the seeds thinly, and rake in evenly afterwards. As soon as the plants are an inch or two high, thin them out to two or three inches apart in every direction, so as to give them room to strengthen, previous to their final planting, or rather transplanting. When the plants are

from four to six inches high, transplant them out into rows fifteen inches asunder, and a foot distant from each other in the rows. The ground for this purpose being neatly dug over, as in the former case, draw drills at the distance above-mentioned with a hoe, and having taken up the plants, and dressed off their lower roots as well as a few of their outer leaves, insert them in the ground with a dibble, and furnish them with a little water as soon as planted, and continue to supply them with moisture from time to time, as occasion may require, in dry weather. Plant the first crop the latter end of June, and continue to plant successional crops every month till October. Also plant a few out during the month of November, in a frame, to secure them more effectually from the frost. As the plants advance in growth or towards maturity, tie up the leaves to blanch or whiten, and to render them crisp, tender, and mild in flavour. Do this work when the weather is dry, and in the winter season, when there is no frost. Perform the operation with strings of bass matting, tying the leaves up a little above the middle, moderately tight. If the soil be light and dry, earth them up about half-way, but if moist, make tying suffice for a time. The blanching will sometimes be complete in a week or rather better, if the weather is hot; and if not, it will sometimes take a fortnight or three weeks to accomplish the work. It must not remain more than five or six days after it is blanching before it is cut, as it will begin to rot, and particularly if the weather should turn out wet. This plant may be blanching under ordinary garden pots, inverted, as at Fig. 1, or for a mere trifle you may procure proper blanching covers, the same as used for sea-kale (Fig. 2); and this, in our opinion, is the best method in winter and wet weather, but we prefer tying up alone in summer and autumn. On the approach of winter cover

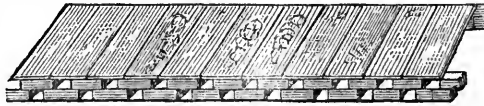

Fig. 3.

commonly grown are the common or sweet; dark-green leaved, and the Dwarf or Finocchio; this last variety is distinguished from the others by its tendency to swell in the stalk to a considerable thickness. It is blanched white and tender, and eaten with oil, vinegar, and pepper as a salad. All the sorts are raised from seed or offsets from the root of the old plant; but propagation by seed claims a decided preference, on account of its tap-root, which, if broken, never grows strong afterwards. It should be sown in drills, from fifteen to eighteen inches asunder, and when the plants have arrived at a sufficient height, that is to say, about an inch or better, they may be thinned out to a foot or eighteen inches apart. This

plant will remain in the ground several years, if not permitted to run up to seed, but cut down, and it will soon send up a succession of young leaves, both for present and continued supply. The stem of the Finocchio should be earthed up five or six inches to blanch, which, under ordinary circumstances and treatment, will be effected in ten days, or a fortnight at the outside. Where seed is required, some of the best stalks, if permitted to run up, will produce abundantly in the autumn.

Garlic.—This is a hardy, perennial bulbous-rooted plant, with long, linear, narrow leaves. It has a compound root of from ten to fifteen subordinate bulbs, called "cloves." It flowers in June and July. It is cultivated for the sake of its bulb, which is used for various purposes; generally only for a short time being introduced into the dish while cooking, and taken out again after a sufficient degree of flavour has been imparted. Garlic does best in a rich, dry, and light, but not recently manured soil. A fresh hazel loam, newly broken up, suits it best, as on such it runs fine, and worms and grubs do not infest it, such ground being generally clear and clean. Planting may be done any time from the beginning of February to the beginning of

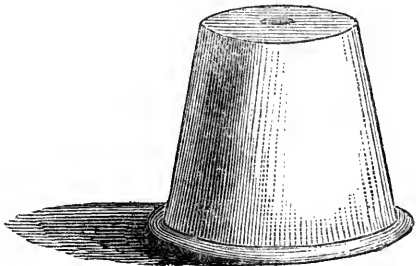

Fig. 1.

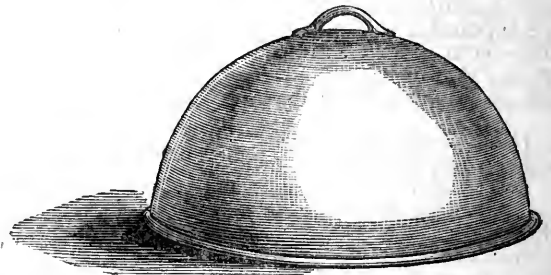

Fig. 2.

the plants thickly with straw, first making a kind of scaffold, or covering, to prevent the straw falling upon the plants. This is best made of boards resting upon bricks, as at Fig. 3. Should seed be required, you will merely have to permit a few plants to remain through the winter, and they will soon run to seed, which will ripen the latter end of summer; or, if you have no plants to spare for that purpose, a little seed may be sown in March or April, which, if properly thinned, will soon run up and ripen seed in autumn.

Fennel.—This is a perennial plant, from five to six feet high. It has finely cut leaves and capillary leaflets on a smooth, dark-green, branched, tubular stalk. It flowers in July and August, and the flowers are produced in little umbels at the summit of the branches, and are of a yellow colour. The tender stalks are sometimes used in salads, and the leaves boiled form an ingredient in many fish sauces, and raw, as garnishing for several dishes. The varieties

April, and the bulbs will do equally well. Having some good large roots, divide them into separate cloves or subordinate bulbs, plant them singly in rows eighteen inches asunder, and the same distance in the row, not less than an inch deep. Plant them in holes made with a blunt-pointed, or ended, dibble, dropping the clove to the bottom, and when the whole is planted, rake the ground even to cover in the holes. The plants will soon make their appearance above ground, when they must be kept clear of weeds. The bulbs will be full grown by the end of July or beginning of August, and the leaves changing colour and appearing decayed is the best criterion of their maturity, and then they may be taken up with safety. The leaves and stalks must remain to the bulbs, which must be spread in the sun to dry and harden, after which they must be tied up in bundles, and hung up for use as required. When so treated, they will keep good until the following spring and summer.

THE TOILETTE.

THE TEETH AND THEIR MANAGEMENT (*continued*).

MR. THOMSON made numerous other experiments, and found that acids were certain to destroy the teeth in a shorter or longer time. In making unfermented bread, eleven and a half fluid drachms of muriatic acid are used with twenty-two ounces of water and three pounds of flour; he added a small quantity of muriatic acid to that proportion of water, and placed a tooth in it, and found that in twenty-four hours the enamel was nearly all gone. He next took the same proportion of acid and water, and added an appropriate quantity of carbonate of soda, bringing the liquid to the same standard as is used in the manufacture of bread. The result was that in thirty hours, instead of twenty-four, a tooth placed in the solution had suffered in a like degree. He afterwards took muriatic acid in the proportion of one part acid to ten of carbonate of soda, and mixed with water; and this quantity of soda completely neutralised the acid; so that after some months, a tooth placed in the solution remained as perfect as when put there." From these experiments, Mr. Thomson concludes that all acids injure the teeth; and as we know that acids of various kinds are used in cooking to give seasoning to dishes in which they are placed; and also that acids are employed in the adulteration of food in daily use; the subject is, of course, one of serious importance. And acids act not only upon teeth removed from the body, but in a similar manner upon teeth still in the jaws of the living. But the question comes to be this, Are we ever to take acid things, or can we take them and prevent their injurious action? The answer is, Yes. They may be taken up to a certain strength, because the saliva, the flow of which is excited by acids, is alkaline, and can neutralise the acid, if it be not too strong. In many conditions of ill health the saliva is altered, being either deficient in quantity or in alkaline reaction, and then it is that acids will act injuriously. This is the case in dyspepsia, and in those cases in which the gums are unhealthy and tend to ulcerate. These latter conditions, it is most important to have rectified whenever they occur, and to avoid the use of acid substances whilst they are present. It must occur to the reader that acid medicines do harm if taken too strong, and that it is by far the best plan always to take them through a glass tube. Then it is a wise plan also when indulging in acids of various kinds, as in dessert or otherwise, to have recourse to a good washing of the mouth afterwards; and it behoves parents and others in charge of children, to eschew entirely the sweets into whose combination acids enter, particularly in the case of those children in whom there is reason to believe their teeth are likely to be unsound, and especially those in whom dyspepsia is actually present or impending.

Action of Confectionery on Teeth.—The mode in which sweets and sugars injuriously affect the teeth is by no means well understood. It is supposed, and rightly so, that all sweets, especially if taken in abundance, do harm, but the how or wherefore is not correctly appreciated. All sugars tend to undergo fermentation and to produce an acid similar to that which exists in vinegar; and it is in consequence of the collection of the saccharine matter between and about the teeth, which is subsequently decomposed, giving rise to the production of an acid which acts by dissolving the enamel, that harm is done. It stands to reason that if the sugar taken be in small amount, no harm results, because it is easily got rid of by the action of the saliva; but when the sugar taken is so large as to overpower the saliva, so to speak, it remains about the mouth to decompose and to hurt the teeth; so that children who are always indulged in sweetmeats are most certainly liable to do some damage to their teeth. The influence of decaying matters

collected about the teeth is to set up decomposition, sometimes of an acid nature, and so to do the teeth harm, just as in the case of sugar. It is a very curious fact that the sweetmeats that seem to be particularly agreeable to children are those into whose combination some sort of distinct acid enters, in addition to the sugar, and these are the very sweets that should be specially avoided. It is scarcely necessary to add that the use of sweets and acids is an additional reason for using the tooth-brush not sparingly, but frequently and resolutely.

Action of Drinks, Stimulants, Sea-air, Smoking, &c.—It has been said that very hot drinks act injuriously on the teeth; there is no evidence that this is the case when the teeth are well formed and the enamel remains uninjured; and this is equally true of spirits and wine, so far as their direct action upon the teeth is concerned. If stimulants are taken in such amount as to produce dyspepsia, in that case they lead, indirectly, to acid secretions that soften the teeth. How far salt meats do harm is a question, but there seems to be no reason to doubt that a salt diet tends to alter the nutrition of the gums, as in scurvy, and so may lead to early decay of the teeth. Where the latter are specially affected, it would seem to be accounted for by the use of an acid diet—lime and vinegar being largely taken to prevent scurvy—which directly destroys the teeth. The evidence that residence at the sea-side does not necessarily affect the teeth, so as to hurt them in any way is pretty conclusive. Smoking cannot be said to be an enemy to the teeth. On the contrary, there is reason to think that, to a certain extent, it may be a preservative, so long as it does not give rise to dyspepsia. It rather tends, when used in moderation, to cause an increased flow of saliva, which is of an alkaline character, and in that way prevents the injurious action of acids about the mouth. It is very likely that the relief of some cases of tooth-ache by smoking is to be accounted for by the action of the free flow of saliva caused by it, upon acid juices in the mouth, which find their way to exposed nerves, and so irritate. Immoderate smoking helps out the development of spongy and bleeding gums; it also induces dyspepsia, and so indirectly injures the teeth. Of all causes uncleanliness is one of the most fruitful sources of evil to the teeth. Foreign matter collects between the teeth, and then stays to be decomposed, and to give rise to the production of sour and acid secretion, which gradually destroys the enamel. What a strange thing indeed is it that people systematically omit to cleanse the teeth, and permit them to be so freely fouled as is the case in so large a number of the community. We shall say a good deal presently about the best modes of keeping the teeth clean and sweet. Meanwhile we will conclude this part of the subject with the observation that all gritty substances should be avoided as cleansing agents for the teeth. They gradually, when used, wear away the tooth and injure its structure. Any tooth-powder that is not soluble, or at least ground to an impalpable powder, we hold should be used with great care.

Cleaning the Teeth.—This simple operation is one that is sadly neglected. Its object is, first, to keep the teeth in a good state of preservation by preventing the accumulation of foreign matters about the teeth, and which by giving rise to acid hurt the teeth; secondly, to prevent the formation of tartar, which interferes with the close adherence of the gums to the teeth; and, thirdly, to keep the breath sweet and wholesome by preventing decomposing matters from lodging about the teeth. Many persons do not so much as merely wash their mouths out for the purpose of keeping the teeth clean, a practice carried into effect by many of the inhabitants of the East as a part of their religion, and which is attended—it may be unknown to them, but at any rate attended—with considerable benefit to their teeth. Many who attempt to clean their teeth, often do it in such an

THE HOUSEHOLD MECHANIC.

MAKING AND FIXING SHELVES.

ONE of the most useful things which the household mechanic can learn is the method of making and fixing, readily and securely, a shelf, wherever it may be required in the house. We will, therefore, at once proceed to give such instructions as will be needful to those who have never attempted such work.

In selecting the wood for shelves, care should be taken that the grain is not too short or full of large knots, which may render it too weak to bear the weight put upon it. The thickness required will depend upon the length as well as upon what it is expected to carry. If the extreme length is not more than four feet, one inch will be a suitable thickness, while, if it exceed this, one and a half inches will be safer. As a rule, a shelf should not be left to carry over six feet without a support, or it will sink in the centre, and probably draw off the bearers at the ends. For rough shelves in cellars or greenhouses, the readiest

and work out the bevelled part with a rabbet plane, as shown in the figure. The distance of the groove from the back of the shelf will depend upon the sizes of the dishes intended to be placed upon it. A very good rule is to allow an inch of inclination for every foot width in the dishes to be placed upon the shelf. This will be quite sufficient to ensure their complete safety, though, of course, allowance must be made for any projections from the plane surface of the dishes, in calculating this distance. Should the amateur not have the requisite tools in his possession for making the groove, as we have described it above, he may substitute for it a fillet of about three-eighths or half an inch in depth, which should be bradded upon the shelf, as shown in Fig. 2.

Where more than one shelf is required, the best plan of fixing consists in halving each one into an upright piece of wood, of the same width as the shelves, and about an inch in thickness, as shown in Fig. 3. The thickness of the shelf should be set out on the uprights, and the lines cut in about half an inch with a tenon

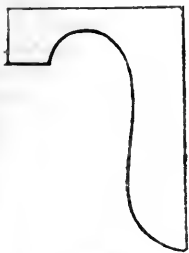

Fig. 7.

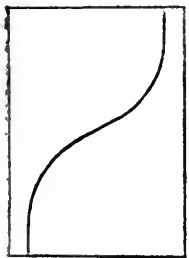

Fig. 4.

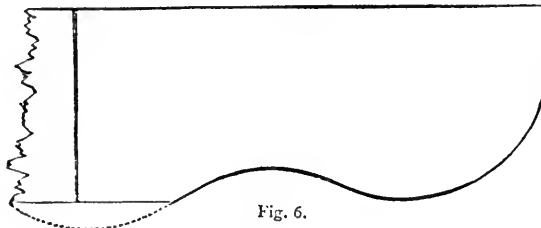

Fig. 6.

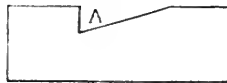

Fig. 1.

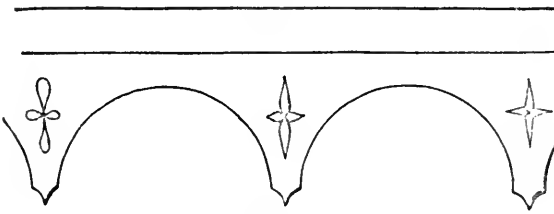

Fig. 5.



Fig. 2.

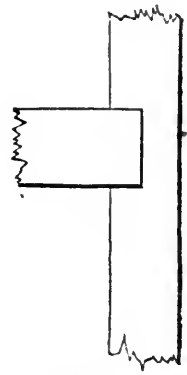

Fig. 3.

plan of fixing is to obtain two strong fillets of wood, about an inch in thickness and two inches deep, which may be secured to the brickwork by means of iron wall-hooks, which should be driven into the joints of the bricks, so as to secure the fillets tightly in the places required. The shelf should then be cut to fit tight between the two walls, and nailed to the supporting fillets. On no account should the shelf be trusted to fillets simply nailed upon and to the brickwork, as sooner or later the nails are sure to work loose, and allow the shelf to fall.

This rough-and-ready method of fixing, however, though well enough in cellars and places out of sight, is of course not adapted for other purposes, where neatness should be the rule. We will, therefore, now explain how this neater work should be executed. In the first place, the shelf, or shelves, should be planed on all sides, or they cannot be painted, and will hold the dust so much as never to appear clean. If they are intended to support plates or dishes, which are to be placed on edge against the wall, they must be grooved, or must have fillets bradded upon them, to prevent the plates slipping forward at the bottom. The best plan is to groove the shelf along its whole length, as shown in the section at Fig. 1. The depth of the groove at A being about three-eighths of an inch. The best plan of effecting this is to make a groove at A with a plough,

when the intervening wood may be split out with a sharp chisel of the requisite width. Of course, the uprights must be set out in pairs. When this is done, the whole may be put together, and the shelves nailed to the uprights through the back of the frame. If the set of shelves is to fit into a recess between two walls, the requisite length should be taken on a rod of wood, and the whole frame must of course be made to fit accurately into it. The best plan for fixing a frame of shelves of this sort is, to cut, with a dull, hard chisel, as many holes in the brickwork as may be considered necessary, to the depth of about three inches. Into each of these holes should be driven, very tightly, a wedge of wood, which should be cut off even with the surface of the wall. The position of each of these "plugs," as they are called, should be marked upon the wall before the shelves are placed in position, and when they are set up they may be secured in their places by screwing or nailing through the upright ends of the frame.

Where only one shelf is needed, it may be supported either by cutting a piece of wood under each end, or by fixing upon a fillet, as before described; but where this is to be done neatly, the wall must be plugged to receive the nails.

When a shelf is required which must be fixed independently of the walls, brackets will be necessary, which may be either of iron or wood. Iron brackets are now made of every size, and they are sold at such a cheap rate, that it is almost better to use them in preference to those of wood, as they have a very light and elegant appearance. In case these cannot be readily obtained, however, we give, in Figs. 4 and 7, two forms, which may easily be made by the amateur mechanic. That shown in Fig. 7 is the prettiest, when the appearance is of importance—while that form figured at Fig. 4 has this advantage, that, if properly cut, the pair of brackets is made at one operation. Both of these may be cut out with the turning, or keyhole saw, described in previous papers, and, when sawn out, the edges should be smoothed with a spokeshave. These brackets should not be less than an inch in thickness, and care must of course be taken to select sound wood, without flaw or split, from which to cut them, and also that they be not split in fixing. In this, as in all other cases, when good fixing cannot be obtained without, the walls must be plugged as before described.

In the case of shelves used for books, it is as well to arrange that they can be readily removed, and be replaced at the height required, to suit the size of the volumes. The easiest method of effecting this is to bore holes with a centre-bit in the ends of the frame supporting the shelves (which frame should be fixed) of about half an inch in diameter. Into these holes should be fitted pins of some hard wood, such as beech, and they should be allowed to project about an inch to receive the shelves; being placed two for each end of the shelf, and at such varying distances from each other, as may be required to allow of the insertion of the books. The shelves should not, however, be placed so closely down as to fit tightly to the books, but so as to leave a space of about two inches between the top of the tallest volume and the next shelf above it. The edges of the shelves should be covered with a strip of embossed leather, which should reach down to the top of the volumes placed on the shelf beneath. This will exclude dust, and add greatly to the neatness of effect. Another plan is to glue upon the edge of each shelf a slip of mahogany or other fancy wood, the lower edge of which may be cut by means of a turning-saw to any pattern selected, somewhat as shown in Fig. 5. This is also a very good plan, where the bearing of a shelf is long, or the shelf itself is weak; as, if the slip be not cut too deeply away it will impart much additional strength. The slip should be glued, not nailed, to the shelf, and small blocks glued into the angle inside.

One other shelf will include, we think, all those which the household mechanic is likely, in the ordinary course of matters, to be called upon to make and fix; that is, a wooden shelf, which is to be placed upon the stone one over the fireplace. It often happens that the stone mantelshelf becomes broken, chipped, or unsightly. In this case the best thing which can be done is to fix upon it another shelf of wood, which may be either of the same shape as that under it, or, better still, cut to some pattern upon its edge, somewhat as shown in Fig. 6. Care must be taken that it is not cut to less than the width of the shelf upon which it is placed, even in its narrowest part. This may be covered with cloth, or baize, of any tint chosen to suit the other fittings of the room, and the edge should be decorated with a deep, rich fringe, in the way fully described on page 361, vol. i. Wooden plugs should be driven into the wall, just above the old shelf, and to these the new one should be securely nailed. A shelf of this description is often a great adornment to a room, and will amply repay the trouble and labour expended in making and fixing it.

We think that these instructions will enable the household mechanic to make and fix shelves wherever they may be required; and would only remark, in conclusion, that the greatest care should be taken to set them perfectly level, as, if this be not done, the effect upon the eye is most unpleasant.

DOMESTIC MEDICINE.

GOITRE, OR DERBYSHIRE NECK.

ANOTHER name for this—in some districts common disease—is bronchocoele, from Βρογχος, the windpipe; κήλη, a swelling. The name signifies an enlargement or swelling of the part of the neck lying across the windpipe. There is a body in this part called the thyroid gland, consisting of two lateral lobes, each measuring usually two inches or upwards in length, and three-quarters of an inch in its thickest part, and a connecting part or isthmus, measuring nearly half an inch in breadth, and from a quarter to three-quarters of an inch in depth. It is called a gland, though almost nothing is known of its nature or uses in the human body. But in certain mountainous countries, as Switzerland or Derbyshire, it is apt to become enlarged, and the enlargement of it constitutes the disease we are describing, and which makes an unseemly and sometimes very big swelling on the necks of people, especially of women. It must not be supposed that the mountains are to blame for it; for some mountainous parts in Switzerland are free from it, and it is not met with in the Highlands of Scotland. Where it does prevail in Switzerland, it exists in low, damp, confined valleys rather than in elevated parts, and disappears as you ascend. In these localities the people generally live in houses very filthy, very hot, and altogether unhealthy. A peculiar, very low, and melancholy form of idiocy, called cretinism, co-exists with goitre in such parts. *Goitre* is also met with in some flat counties, as in parts of Cambridgeshire and Norfolk. It is common, too, in Nottingham. Very different causes of goitre have been assigned. According to some the cause is in the air; according to others in the water; and the tendency of inquiry is to show that the water drunk has much to do with the production of the disease. At one time it was thought that the drinking of snow-water from the glaciers was the cause of the disease; but this theory does not hold good. It would seem as if *hardness* of the water was the cause of goitre, and, to be more particular, that the water of limestone or magnesian limestone strata is that which most tends to produce goitre. Sir Thomas Watson quotes the following striking illustration from Mr. Maclelland, who has made numerous observations in India, as to the localities in which this disease occurs:—

“The valley of Baribice is elevated 4,000 feet above the sea. Its eastern extremity is composed of *clayslate*, and in five villages, containing 152 inhabitants, there is not one *goitre*. The other extremity of the valley is partly composed of limestone; and of 192 inhabitants, distributed in six villages, 70 are affected with goitre; but Duceyong, one of these villages, supplied with water from clayslate, has not a single case of the disease; while Agar, only half a mile distant, and containing 50 inhabitants, has no less than 40, and of that number 20 are cretins. They use the water which issues from an old copper mine in limestone, and which contains carbonate of lime and of soda, but no sulphate. Mr. Maclelland affirms that in the course of his personal inquiries, which extended over 1,000 square miles, and which were prosecuted without regard to any theory, no instance occurred in which goitre prevailed to any extent where the villages were not situated on or close to limestone rocks.”

Goitres sometimes attain to an enormous size, and sometimes only exist as an unusual fulness of the neck. Often

they occasion no practical inconvenience. At other times they are inconvenient from their bulk, pressing on the windpipe or the gullet.

There are certain cases known as cases of Graves's disease, from having been first described by Dr. Graves, of Dublin, in which, coincidentally with goitre, there exists a peculiar protrusion or prominence of the eyeballs, and a peculiar and quick intense action of the chest. But such cases are rare, and very distinct from the cases of simple goitre.

Treatment.—It will not be expected that we should go into particulars of treatment. It will easily be understood that it is difficult to cure a disease of this kind in persons living amid the causes of it—drinking the water and inhaling the air that favour the occurrence of the disease. But there are remedies for it, which we shall content ourselves with little more than mentioning. The great point, of course, is to get away from the locality in which goitre is, so to speak, manufactured. There are two great remedies, or rather, there is one great remedy—that is, iodine, taken internally, and applied in one form or another externally—and recent experience would seem to show that the best form of it for external application is the ointment of the red iodine of mercury, applied freely and allowed to dry in the heat of the sun. Such are the general principles of treatment. Often there are irregularities of many functions in persons with goitre, which require to be specially treated.

SEA-SIDE AMUSEMENTS.

SHELLS AND SHELL-WORK (*continued*).

WE resume our remarks on the decorative uses of shells and shell-work.

Arrangement of Shells.—The conchologist will be best guided in the arrangement of his shells by the nature and character, as well as the quantity and size, of the shells he has collected. Neat mahogany-wood tablets, of various sizes, covered with paper of a neutral tint, will be found convenient. Minute shells are best set off by a ground of black. Shells, whose interior or under-part is of deep rose-colour and black, or other beautiful tint, are admirably exhibited by being arranged on a plate of silvered glass, which may be either round, oval, or oblong. Glass slides, either plain or covered with paper of neutral tint, serve very well for tablets. Univalve shells may be affixed to a plain glass slide, so that either side may be examined by turning the slide over. For fixing the shells to the tablets, a gum prepared in the following manner will be found in every respect best for the purpose:—Take an ounce of gum tragacanth, and half-an-ounce of crystallised pure white gum arabic; let them dissolve in an equal amount of water; to which add from time to time a few drops of spirits of wine, which will prevent mould.

Parlour Ornaments.—Shells of beautiful tint on the inner and under surfaces, such as those whose under-parts are rose-pink and black, or of opal appearance, may be beautifully arranged at distances from each other upon a round plate of silvered glass, where the representation of their under-surfaces, as well as of their upper, will appear, at a side-view, as if floating in water. If the shells are of extra size, the largest should be placed in the centre, with a circle of the same or other kind round, but not too closely packed. This has a bold and elegant effect. They should be fastened with gum as before described, and the glass should be set on a gilded stand, covered with a bowed glass shade. The figure of an ancient Greek temple, the Colosseum, museum, obelisk, or ancient castle, either with clock-face or without, may be easily constructed roughly in deal-wood, and adorned with shells, so as to produce an elaborate

and effective ornament. It should be observed that the appearance of all such ornaments is greatly improved by their being set under a glass shade, which lends a lustre to them, and at the same time prevents their being handled. A common mantel-shelf clock, bought at a clockmaker's, may be adorned with advantage by this means, so as to render it a handsome ornament. The smallest kind of shells may be well used for the purpose of decking small wooden toys, which will render them well suited as appendages to the drawing-room whatnot, or to fill a cabinet, as well as for the furnishing of a naturalist's museum. A lady's work-table may be also elegantly adorned with shells, internally as well as externally, especially when shabby by wear, or constructed of simple plain deal. An especially useful purpose to which shells may be applied is the decoration of stands for baskets of sea-weed, grasses, or imitation fish. Thus the stand may be made of deal, and the glass shade manufactured by yourself at a nominal cost, directions for which we purpose giving in another place. The under-part of baskets where sea-weeds are arranged may also be decorated with shells.

Fig. 1 is a design for a shell-work window box of a very pretty description. It is suitable for parlour windows, especially of a cottage house, a kitchen window, or for greenhouse shelves. Large flowers may be made for this of what are called pincushion shells (the *Pecten*), a shell found on the coast about Hastings; they abound after stormy weather. They are white, orange, and pink. Select those entirely which are pink and white, or pink, to form the flowers. For a centre-shell the large black snail, common on almost any part of the English coast, may be used, and for the four corners other black snail shells. By using the black snail shells, and the oblong shells with mussel shells good designs may be obtained. The ground-work may be effectively filled up with small, deep orange-coloured snail shells, which are very common on the coast about Ramsgate, where they abound.

Another arrangement may be chosen by means of flowers formed with the orange-coloured pincushion shells, with limpets for the centre and corners. Edge the box with limpets, and ground it all over either with the very small shells, thickly powdered on wet glue, or with small black snails and little white cockles, or the small shell like a human finger-nail. For small shell-boxes we have used those sold with cigars. They answer admirably.

A Shell Basket.—A beautiful shell card basket may be made of a quantity of the simple white sea-shells, found in abundance on many coasts, especially at Calais and Tenby. They are not unlike the human finger nail. The shells must first be washed clean and perfectly dried. Mix some powdered crimson lake, and white, to a rose pink of three shades. Add a very little gum to it. Dip a number of shells in each shade. Also mix in water with a very little gum some French ultramarine and white to a corn-flower blue. Dye other shells with this. Dye a large proportion in emerald green tempered with white. A few shells of a spiral shape, and exceedingly small, are needed, and may be dyed in yellow ochre. A few very small white cowries are wanted. With strong glue or paper flower cement, used liberally, form a rose of the pink shells when the colour is quite dry. There is no heart visible, the shells are all wrapped over one another, the smallest inside, till a rose is made as large round as a florin. (See Figs. 4 and 5.) The shells must not be hastily joined, as the cement on each layer wants partially to dry before adding another. Therefore, commence all the flowers required, at the same time, and proceed by degrees; or the roses may be made of white shells, and when the cement is quite set and hard, dipped in the pink colour. Let this dry, and with a brush, tint the hearts darker. For imitating the corn-flower, fix on the box a circle

of the little yellow shells, upright, to form a centre of stamens. Form the ground of the basket with green shells, fixed all over in the glue or cement leaving spaces for the roses. Then put the blue shells round the yellow centres, placing them to turn over the reverse way to the rose shells. Lastly, fix on the roses. The basket used is of

brown, and a few money cowries. When your shells are selected, cover the box with gum or glue and whitening mixed very thickly, as a paste. The shells may be first arranged on a sheet of paper. They should be so well managed, that scarcely the smallest cranny is left anywhere uncovered. Where these very few dots of space

plain deal, turning over at the edges, which are completely covered with shells. But before fixing any of them in the bag, a square of plate-glass, shaped to fit it, is secured at the bottom inside the basket. When the shells are put on, a row of small cowries is used to frame the glass, and finish off the work agreeably. The outside is ornamented in the same way. Fig. 2 shows a basket made in this way, but of another shape.

Shell Work-box.

—The basis of this is a plain wooden work-box. Have the shells prepared. Those used may be English shells, or foreign, purchased from the persons who generally deal in such things. The box is a very handsome ornament. For the centre may be used a very large cowrie, about four inches long, from which the outer marking has been partially removed by pouring over it spirits of wine, leaving it white at the top, and shading the mauve and violet, to meet the remnant of the outer markings left near the base with brown and white spots. For

the four corners, four flat shells, not unlike oysters, with a row of holes half round the edge, would do well. These should also have the outer coat removed, and be of a perfect pearly silver colour. The four intermediate spaces could be filled by four smaller brown cowries, handsomely marked, but in the natural state, and about four inches long. For the rest of the box could be used a shell not unlike the cowries, but more slender and oblong, about an inch and a half long, of a pale speckly mauve, varied by a very few of the same shape of a rich dark

Fig 3

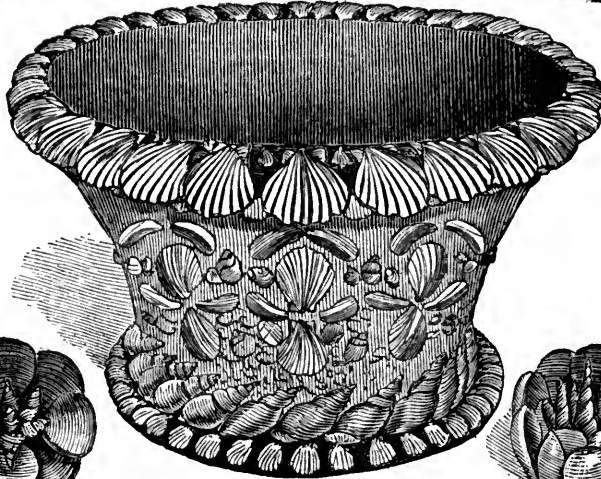
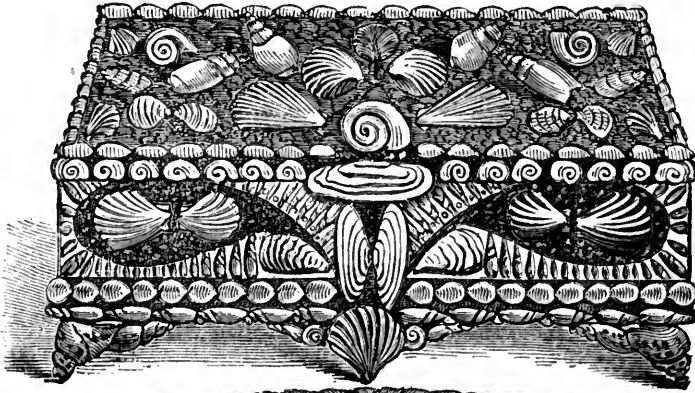

Fig. 5.

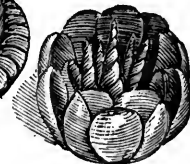

Fig. 4.

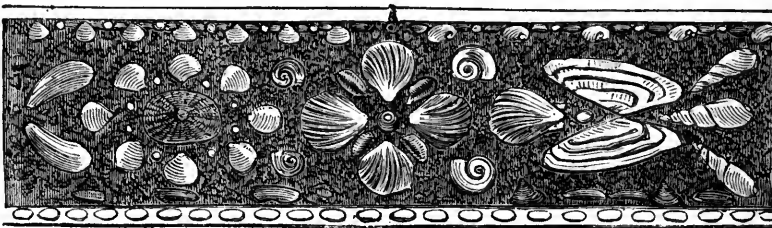

Fig. 1.

tolerably varied collection of shells. Sorting them and putting them together, according to their shapes and colours, before beginning the decorative work, and then starting with some kind of idea as to the general effect desired, will render the work very easy, and prevent any chance of blundering. Sand and powdered glass are sometimes used in combination with the shells. On pages 232 and 233 of this volume, the reader will find illustrations of the kinds of shells commonly to be met with on the British coast.

occur, drop on an Indian berry, the size of a small young pea, scarlet with a black spot on it. These can be bought of vendors of shells, minerals, &c. The shells on the top should overlap the edge a little, and meet those below, instead of showing the work. Round the edge of the lid place a row of money cowries. The sides of the box may be covered similarly.

Many of the commonest shells look very beautiful, if spirits of wine are poured over them. The commonest limpets, snails, periwinkles, and even oyster will then become worthy of choice work. To make a really beautiful box, it is well worth while to have the mussels polished. A beautiful shell to introduce is the *anomia*, a small, thin, silvery one, shaped like an oyster, to which it is found attached.

Abundance of these can be found at Tenby.

If the reader is ingenious, and has a taste for design, he may surprise even himself with the large number of pretty and attractive patterns which can be obtained from a

THE FLOWER GARDEN.

STYLE.

WHAT is more lovely than a flower? and of all the subjects and objects connected with household management and decorative art, what is so interesting or so perfectly pure and beautiful as a well-arranged flower-garden? Well-arranged: for, whether large or small, unless the garden be well and gracefully arranged, it loses half its beauty; and there are many ladies who are quite capable of taking an active part in the planning and flower arrangements of any sized garden. At any rate, the skill required to trace out a flower-garden is within the capacity of any woman who possesses taste and ingenuity, provided she gains a clear idea of what is wanted; and it will be very easy, with a little instruction, to acquire the art of designing flower-gardens with as much skill and taste as a professional landscape gardener, and to produce a much better result than is usually seen in the flower-gardens of the great majority of country residences.

Leaving botanical instruction and definitions of all kinds to botanical readers,* it will be best to proceed at once to business; for before we attempt to grow flowers it will be necessary to have the garden ready for their reception; therefore, the first thing to be done is to plan and lay out the garden. Of course, this recommendation has reference only to cases where a garden requires really to be converted from an entirely rough, uncultivated piece of ground, or to be remodelled to a superior style of arrangement; and, until the plan is decided, neither soiling, nor cultivation, nor the florist's work of any kind can be commenced.

There are several styles of garden plans, and the one to be chosen must depend on the taste of those who possess the ground to be laid out.

The most simple but least elegant arrangement for a garden consists of straight gravel paths surrounding a straight, narrow piece of ground, half of which is perhaps a lawn, and the other half a small kitchen-garden; but what can be more ungraceful than that represented at Fig. 1?

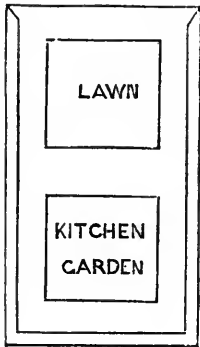

Fig. 1.

Fig. 2 represents a piece of ground at the back of a pretty cottage. It is a small garden, and laid out also by a lady, to produce effect and give a deceptive appearance, so important in the arrangement of small gardens, which, by winding paths and a few small trees and shrubs, may be made to assume a much more extensive appearance. From the cottage, A, the winding path deceives the eye; if it had been straight, the end of the small garden would have been immediately perceived. At B B are placed a few small trees and shrubs; the C's show flower-beds—the shaded portion is gravel; E is a rustic seat beneath limes, and D D D represents a row of small limes.

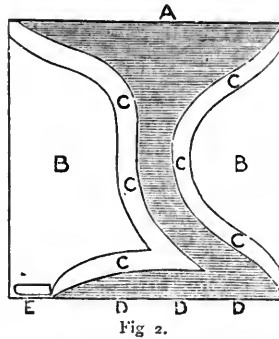

Fig. 2.

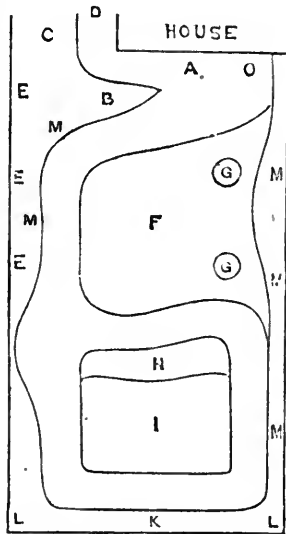

Fig. 3.

An improvement on Fig. 1 is very clearly made at Fig. 3, which is to be thus described:—At A, stone steps descend from the back of the house; at B is a triangular bed, with a few lilacs, next the house, which screen a small kitchen-garden, C, at the side of the house; D is a side door leading into the front garden; E E E is a little shrubbery; F the lawn; G G small flower-beds for standard roses; H is a raised bed—flowers in front, then rhododendrons, and at the back lilac, laburnum, pink May, and Guelder roses, to screen the kitchen-garden, I, from the house. At the end of the garden is a large bed of raspberries, K; and at the back of them rises a thick hedge, L L, dividing the garden from a meadow.

Nothing can be more gracefully elegant than the simple yet tasteful arrangement of this garden, which is about 200 feet long and 100 feet wide. Flowers are arranged down the sides, M M M M M, as well as in the bed, B; and under pretty graceful limes, opposite the pink May and Guelder rose, is placed a rustic seat. Near the house, at O, are planted a laburnum and peach. N N, Fig. 4, gives another form for the side bed of flowers. This garden is in spring one of the most gracefully picturesque that can be well imagined, and perhaps far more elegant than those laid out in the Italian or French styles.

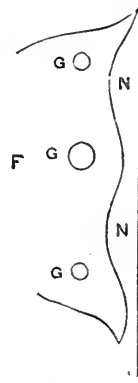

Fig. 4.

Fig. 3 may be considered a good specimen of a small English garden; and it was planned and arranged by an English lady, and may be yet more elaborately ornamented by converting the kitchen-garden, I, into a flower-bed, or by enlarging the bed H only.

If the lawn had more flower-beds on it, it would lose its usefulness for croquet; and there is really very little improvement required in any way. The sycamores, limes, and elder trees in the shrubbery, with the laburnums in the centre of the garden, give it a refreshing shade of green that is seldom surpassed in any large and elaborately ornamented garden; but the plan (Fig. 3) gives a very faint idea of what may be made of it when planted, and it would be more useful if the kitchen garden (should it be allowed to remain) were made twice or three times the length above represented. The flower bed and shrubbery at H are sufficiently large, and would receive no improvement by extension; but the kitchen garden should be large enough, with this addition, to grow four rows of peas for succession crops, four rows of French beans, a small bed of spinach, a few rows of strawberries, lettuces, herbs, and other vegetables; and this garden can be made to produce vegetables to serve a table for four in family. However lovely the flower garden, the importance of being able to eat vegetables freshly gathered needs no comment.

Each of the above-described plans is from a garden in existence, and is one of a large number visited to procure artistic and useful hints for the papers of which this is the first.

* See "Casell's Popular Educator," vol. i., page 23.

ANIMALS KEPT FOR PLEASURE AND PROFIT.—THE HORSE.

STABLING—STABLE ACCESSORIES—HARNESS, ETC.

Stabling.—At this time the rage for fine stabling is great indeed. We hear of nothing but "our new stables" in every other house we go to; and we are bound to say that though very neat, they are not essentially better than those to which we have been accustomed all our lives. Plate glass, mahogany doors, and enamel fittings are not essentials, though many seem to think them so. We will, however, enlighten our reader as to what are. Your first consideration will be that the situation be dry; a damp stable, like a damp house, is the parent of many ills. We are not now speaking of a stable for one or ten horses; we are only going to speak about such matters as are true of large and small establishments, having an eye, however, especially to the latter. Ventilation, light, and drainage are the three greatest considerations. Horses require plenty of warmth, but it should be the warmth of clothing, not of a stuffy and ill-ventilated stable. The air should be allowed to run through the upper part of the stable, not upon the horses. The manner in which this is managed will depend upon your other arrangements as to your loft. Light is said to affect horses' condition. We do not think so, and when the horse comes in to rest there should always be curtains to draw before the windows. If constant darkness is good for condition, it is said also to be bad for the eyesight, and to conduce to shyness. The preference of a loose box or a stall is unessential. If you have three or four under one roof, let there be a loose box, so that a sick or tired horse may have space to himself. Horses usually like to hear and see one another, and there are plenty of inventions by which they can now do so. The drainage of a stable must be entrusted to a competent person. It is a subject on which there cannot be two opinions, though there are twenty modes of arriving at the same end, more or less expensive. In like manner many opinions exist concerning the construction of lofts or granaries, and the means of shooting down the hay and corn most expediently for the groom and the horse; all these matters we shall give full attention to in a separate paper. See that the door-handles or fastenings are not in the way of your horse's ingress or egress, and that no draught comes beneath the threshold. Nothing so soon gives a horse greasy heels as the air upon his damp legs, should he be without bandages. Beware here of idle grooms. A stall should be not less than six feet wide, and as deep as circumstances will allow, to give plenty of gangway.

Some Few Accessories to the Stable.—The usual fittings of the present day are iron, and not, as formerly, a wooden manger and rack. Iron has the advantage of wear and tear, but—to be well done by any of the great houses—it is, of course, more expensive at first, although it may be found cheap in the long run. Wood has, however, one advantage, though no very great one. Horses, when being cleaned or looked at, are apt to catch hold of the manger with their teeth; and there can be no doubt that iron wears the teeth away more quickly than wood. There are, however, plenty of remedies for this trick. The manger and rack, when of iron, are usually placed on a level, and the low rack seems to have superseded the old-fashioned high one. A horse is said sometimes to get his feet into the low rack, but as the manger is equally low, he can do the same under either circumstances. If you decide upon the wooden mangers, take care that your material be good—the best of elm or oak. If we turn to the necessities of the harness-room and stable-yard, we shall find a great many details which a new master of horses will not be prepared for. In the harness-room there should be a stove or fire-place, and, if possible, a boiler, as hot water is essential at all times. There must be conveniences for

drying the saddles and harness. There must be a saddle-bracket for hanging the saddle upon, and hooks for bridles. If these be of iron, the two may easily be made together, a hook forming a part of the bracket. Figs. 4, 5, and 6 represent useful accessories. The former is an excellent piece of apparatus for drying the saddle, manufactured by the St. Pancras Ironwork Company. The advantage of this is that every portion of the saddle is exposed at once to the sun or fire, and the vapour arising is allowed to pass off freely, so that the saddle does not become sodden, and consequently rotten. Fig. 5 is a girth-drying frame, and Fig. 6 an iron saddle-horse, on wheels, which is praiseworthy because it allows the saddle to be removed and replaced without an unnecessary and damaging amount of handling, careless or otherwise.

Stable and Yard, with its Adjuncts.—Every horse should have a head-stall, or head-collar. It should be made of good leather; to this should be attached a rein on each side, which has a weight to keep them always away from the horse's legs. The cost of this article is about fourteen or fifteen shillings. Every horse must have clothing, which will of course vary according to circumstances. A large, full-sized suit would vary in expense from five pounds to six or seven. It should include a good body-roller, but, by economy, this expense may be reduced. Buy the best possible rug, well bound, and with straps at the side, so as to form a junction over the horse's chest; you want two of these. What is called the hood, for the neck and head, will have to be separately made. In the summer a lighter suit is used, of linen; but there are so many things in connection with this part of the stable business which can be learnt in a week, that it is needless to say more about them. Buckets are essentials, costing four or five shillings a-piece; and you should have at least two for each horse. Pitchforks, brooms, shovels, manure-baskets, and other like things, belong to every stable-yard, and are not expensive. Appertaining to the stable itself are the various brushes, the comb for the mane and tail, and what is called the curry-comb, which, in our opinion, ought never to be used, excepting on occasions when nothing else will remove the dirt from the roots of the hair. It ought to be used, in good stables only, for knocking out the dried dirt when the horse's coat is unnaturally long, or to remove the dust from the brush. A picker should be kept somewhere handy, for clearing away the dirt that accumulates in the horse's foot. Sponges will be necessary, and leathers, both of them expensive articles; but nothing is to be saved by economy in this respect. Bandages, both flannel and linen, will be required; the first, to warm the horse's legs after they have been washed, and the second, to keep his legs and feet cool, should there be a tendency to swelling or inflammation. Great care should be taken by the groom in putting on these bandages smoothly; and it is, though apparently simple, a rather delicate process. Scissors, of various kinds, should be kept in every stable, for the removal of long hairs, which cannot be otherwise got rid of; but they should be used very carefully. As you will, doubtless, desire that your own servant, if competent, should singe your horse, you must provide him with a lamp and other implements necessary; and if your horse be professionally singed—as he should be quite early in the season—he will certainly want it a second time, unless your servant has kept him down by a fortnightly use of naphtha or gas.

On Saddles and Bridles.—The advice to be given on this head is simple and clear. Experience only can teach you in what bridle your horse should be ridden. Every fresh mouth may require a new one. The simplest of all is the plain double-reined bridle commonly in use. As to saddles, go to the very best maker, and pay him his price, which may be £6 6s.; the only economy we can recommend is that it should have a plain flap, which will not spoil

by any amount of wet, such as may arise from tumbling into brooks when hunting. And so much for saddles and bridles.

Dentition of the Horse is a subject of great importance, but its full explanation would require more space than we have to spare. It is our purpose, therefore, only to examine the teeth of the horse so far as practical purposes are concerned. It will be sufficient to consider what are commonly known as the nippers, or six front teeth, of the upper and lower jaw. To ascertain the age of the horse, which is clearly the object of the buyer, it will be sufficient to take into consideration the nippers of the lower jaw only, as it is not until he has attained the age of seven years that it will be necessary to place any reliance upon the signs or marks of the upper jaw, or the still more elaborate functions of the molars, or grinders.

be found sufficient when seen by the illustration, Fig. 1. In a two-year old mouth the central nippers will have almost lost their mark; the two other pairs will also have undergone the same proportionate change; and there is scarcely anything further to be said that cannot be easily comprehended by the horseman. The three-year old mouth, however, presents a marked difference, inasmuch as the permanent teeth have begun to make their appearance. The two central nippers of the colt's mouth have now been exchanged for permanent teeth, which have grown to two-thirds the height of the remaining unchanged nippers. These central teeth are far larger than the others, and the mark is long and deep, and very dark-coloured. The marks in the rest of the nippers are nearly worn out. The illustration, Fig. 2, looked at by the light of this explanation, will be understood at once. At four

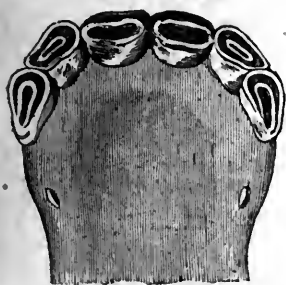

Fig. 2.

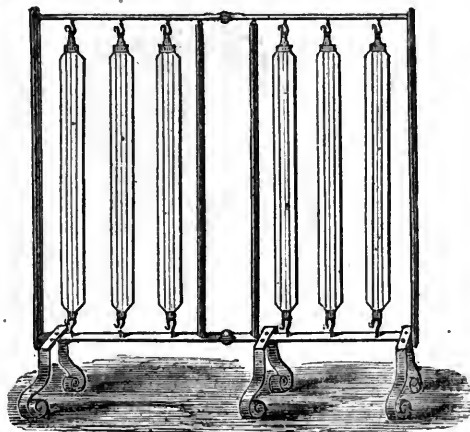

Fig. 5.

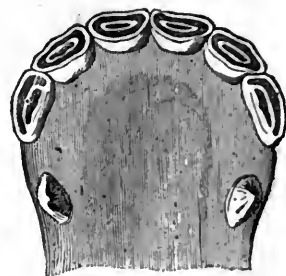

Fig. 3.

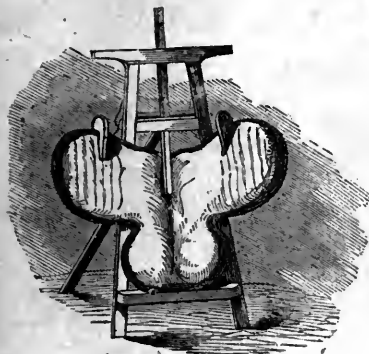

Fig. 4.

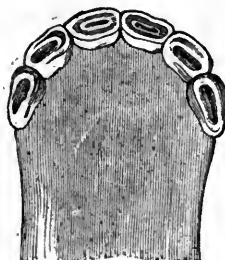

Fig. 1.

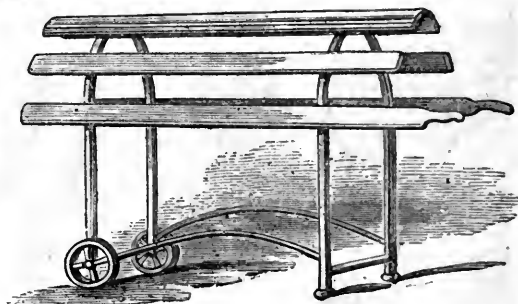
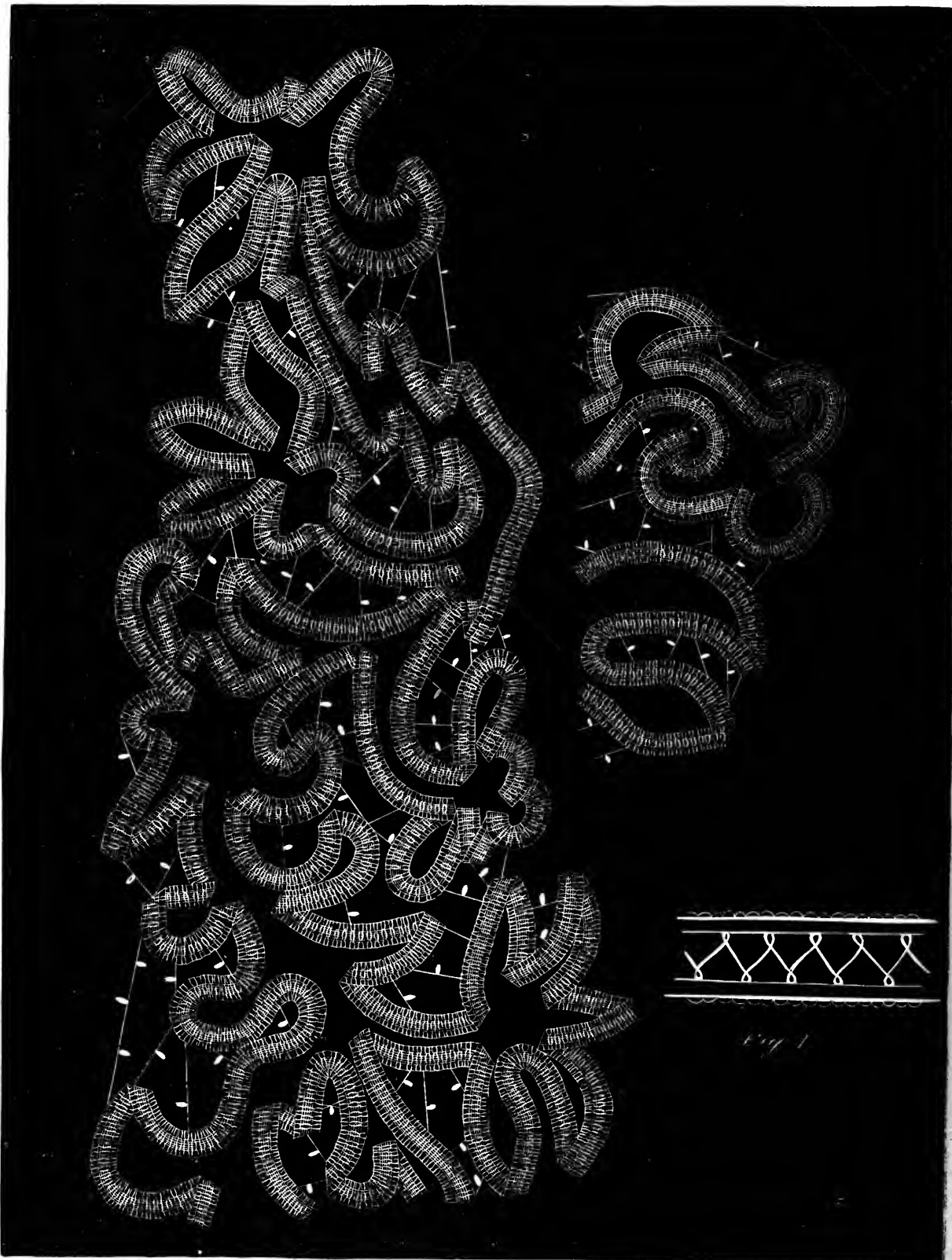

Fig. 6.

It is exceedingly difficult, without well-finished drawings, to give a proper illustration of the changes that take place; but we have added three plain illustrations of the horse's mouth, for the benefit of the purchaser, which we trust may be of service. Fig. 1 represents the six nippers of the lower jaw of a colt's mouth, at a year old, and may be explained as follows:—The mode of ascertaining the age, it must be borne in mind, is mainly by the mark in the centre of the tooth, and as the age of the colt increases the mark will become worn and faint. At about six months old the four centre nippers will begin to be level; at twelve months old the corner ones are also becoming so; but the difference is this—the mark in the centre teeth is wide and worn; in the next two it is darker; and in the corner teeth it is very dark and narrow: and thus far of the colt's mouth at one year old. It becomes necessary to warn the reader that these teeth are afterwards absorbed by what are called the permanent teeth of the horse; they do not, as used to be asserted, fall out to make way for the others. Perhaps this explanation will

years old, a further change will have taken place; the four centre teeth will be permanent, the centre pair will have the mark somewhat fainter; the next pair will be smaller, with the mark deeper, and the corner teeth smaller than they were, and the mark nearly effaced. One more addition—the tusks are four in number, two in each jaw, and they now begin to appear somewhat half an inch above the gum, sharp-pointed and curved; and they are not found in mares. Our next cut, Fig. 3, shows the nippers of the lower jaw of a five-year old mouth. It will be seen that the corner nippers have a long, deep mark, while those in the other nippers are beginning to wear away. The tusks are become convex on the other side, and the only material difference that need be remarked on for practical purposes between this and the next year is, that the mark on the centre nippers will be almost entirely worn out, there will be a little difference in colouring, and perhaps a slight depression. In the next pairs the marks will be shorter and broader, and the tusk will have grown to a considerable length.



LAPPET FOR THE MARY STUART CAP.

POINT LACE WORK.—VIII.

WE now give a design for the lappets to be attached to the Mary Stuart cap, which formed the subject of our last article. The braid and cotton used must in every respect match those employed for the cap itself, and the open stitches should be as varied as possible, all the stems and narrow portions being filled in with the plain overcast bars at Fig. 3, page 282, vol. i., or with the rope-like ones, at Figs. 2 and 3, page 356, vol. i. A sort of hem-stitch is occasionally used with advantage, in connecting two braids which run close together. It is done like the stitch known in plain work as *herring-bone*; but after the needle is brought through the braid, it should be passed through the thread of the last stitch, before being taken into the opposite braid to complete the stitch. This is done each time, and makes a little variety. From the size of this publication we have been compelled to divide this design, but the two parts will be found to fit exactly to each other, joining them in the width; and when the first lappet is completed, the pattern reversed will form the second one. They are to be joined to the cap at the *crosses* marked in our last paper by dotted bars, similar to those used throughout the design. We

and a half inches (one inch for two turnings); from D to E is fourteen inches, allowing half an inch for a turning; E to C, nine inches, allowing half an inch for a turning. For the back, Fig. 2, straight with the selvage, twenty-one inches long, allowing for two half-inch turnings—F to G. A whole inch is turned in all the way down from F to G; This is allowed for in the measure. G to H, nine inches; F to I, nine and a half inches; J to K twelve and a half inches. The distance from I to J is eleven and a half inches, and from J to H, fourteen inches. Turn

in half an inch everywhere but on the back half, from C to H, Fig. 2; there turn in a whole inch. Tack the back and front of one leg together. Cut the legs, reversing them in the tweed, to be right and left. At an inch and a half below the waist, F to G, Fig. 3, leave open four and a half inches for a pocket. Cut two pieces of lining, five inches wide and nine inches long, the shape of Fig. 7. Join them for a pocket with a mantua-maker's seam. Join the opening from A to B into the hole left for it in the seam of the leg. The side of the leg where an inch of tweed is turned in, the inch is stitched down inside the pocket; the other side has an inch wide false piece of tweed stitched on.

There are three buttons placed in front of the knickerbockers, as shown in Fig. 3, between A and B, and two each side of

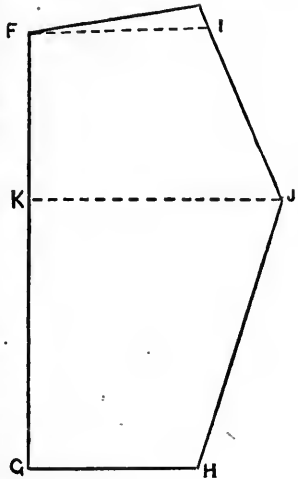

Fig. 2.



Fig. 8.

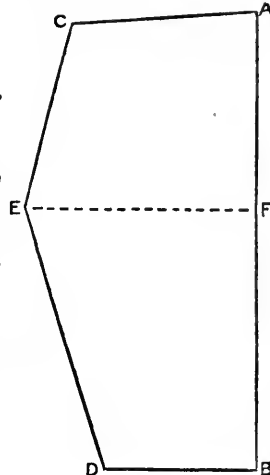

Fig. 1.

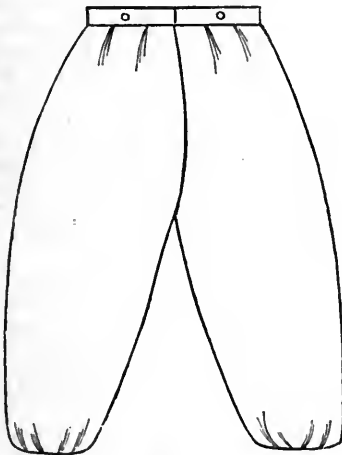

Fig. 4.

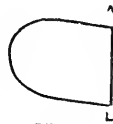

Fig. 7.



Fig. 5, Fig. 6.

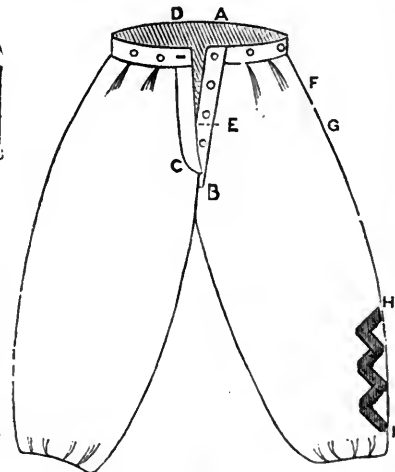

Fig. 3.

should recommend that either two open overcast rows, or one of open overcast and one of pearl edging be worked on the outer edge of the cap and lappets.

THE REARING AND MANAGEMENT OF CHILDREN.

KNICKERBOCKERS FOR A BOY OF EIGHT.

CUT the boy's knickerbockers in fine tweed, in four pieces, a front and a back for each leg. Take the pattern first on paper. Fig 1, the front leg, from A to B, straight down the selvage of the material, twenty-one inches, one inch of this is to turn in half an inch top and bottom; from A to C, nine inches, allowing as before an inch for two turnings; from F to E ten inches; B to D, the knee, eight

them. There are two more at the back of the band, as shown in Fig. 4.

The outer part of the leg is trimmed, from H to I, Fig. 3, beginning two inches above the hem, and extending ten inches up, in four diamonds of equal size, of very fine black braid, hemmed down both sides very flat and even, the ends let into the seams. Join the leg from E to D, Fig. 1. Cut a twilled lining the same; join it also. Tack it inside the leg, turnings inside. Make the other leg. Stitch the tweed of the two backs and one side of lining together from I to J, Fig. 2. Turn in the edge of the other side of the lining and hem it down. Cut the band in two pieces, twelve and a half inches long, joined in the centre of the back. The band is two inches wide, allowing one inch for the turnings at both edges. There are two pleats in the fronts of the knickerbockers, as shown in

Fig. 3; two towards the back, as shown in Fig. 4. Both turn towards the middle. Set on a false piece of tweed, nine inches long, no turnings allowed, one and a quarter inches wide. It is placed on from A to B, Fig. 3. The band is lined with a strip of black twill. Then this false piece is lined. The tweed is left with a raw edge from A to B, but the lining turned in and hemmed to it. A strip of lining is cut like Fig. 6, the edge of the front, D, to C, Fig. 3, turned in, and the lining stitched on at the back. Not only are the backs joined from I to J, Fig. 2, but the fronts also an inch up. In Fig. 3, pass the side D and C over A and B, and stitch it down across at E. Make a half-inch hem at the bottom of each leg, and run in an elastic.

Under drawers are always worn by boys. Cut these of pretty good longcloth—as they have a good deal of wear upon them—but not of an over fine quality, as they are not seen. Eightpence, ninepence, or tenpence a yard are fair prices. Cut them by the knickerbocker patterns, but not with a join down the outside, as those have. Tack the back and front paper pattern together down the straight part, and cut from the united piece. Make no allowance for a hem at the knees, as they are required shorter than the knickerbockers. Run and fell each leg together very neatly at the parts marked E to D, in Fig. 1, and also at the sloping edge, but not the front. Cut a slit from A to F, it is just as well to have it plenty long enough, for then the garment is less liable to be torn. Put in little gussets at the corners, and a false hem or a tape run on the right side, and turned down and hemmed on the wrong side. The front from C to E, is also bound with a false hem. These drawers are set in three bands, one each side of the front and one behind. They button to the braces, which boys of this age wear. Some people prefer to make the two legs entirely separate. They are then cut a couple of inches wider from I to J in Fig. 2, but not in any other part, so that here they may wrap an inch over; the band buttons well over. A single button is sufficient between C and E, Fig. 1, for under drawers. All the false hems should be cut on the straight.

Fig. 1 is the front half of one of the legs; Fig. 2, the back half of the same leg. It should be noticed that Fig. 2 is much broader at the seat than Fig. 1. The proper sit of the knickerbockers depends on observing this rule. We recommend any one making from this pattern, after having cut it in paper, to cut it out of some old or cheap lining, and run it together, having a couple of inches turned in at every part. Run it slightly to a band. Try it on the child, and take in or let out the pattern at any part that requires alteration. Even children's figures vary considerably.

All articles of clothing for boys sent to school should be marked, even the tweed and cloth suits. To manage this, write with marking ink his surname in full and the initials of his Christian name, on strips of half-inch wide tape, and very neatly hem one of these to each garment, in an inconspicuous place when on, but readily seen when off. Woollen shirts and socks may be marked in this way, for initials, which only can be done with worsted, are seldom sufficient to prevent mistakes. Write the name in the boots, and on the hat inside, or gum a written paper into the latter. The name, neatly marked on a strip of tape or card, can also be sewn inside the umbrella.

Many of the knickerbocker suits for little boys are made without any elastic at the knees, they are worn merely loose, and are trimmed round with a braid. Others are cut open a little way at the outside of the knee, the corners of the opening rounded off, and a braid trimming carried round half an inch within the edge. The braid meets of course above the opening, and it should be carried a little further up the outside of the leg in a fancy pattern, such as may be formed with loops, the upper one the smallest, or a couple of vandykes.

METHODS OF MAKING ICES AND ICED DRINKS.

Water-ices are made of the juices of ripe fruits, sweetened and frozen in the freezing-pot; but it must be remembered that if the juices are sweetened excessively they will not freeze. It is therefore generally necessary to test them with an instrument called a saccharometer. This applies equally to ice-creams and all drinks to be frozen; and for water-ices clarified sugar should be used, which may be prepared in the following manner:—To a quart of water add three pounds of sugar and half the white of an egg well beaten up. This should be boiled ten minutes and skimmed.

Strawberry Water-ice.—To a pound of red strawberries and half-a-pound of currants add a pint of clarified sugar. If desired, a little colouring matter may be used. The whole must then be strained through a hair sieve and frozen.

Raspberry Water-ice.—This may be made in the same manner as the foregoing, by merely substituting raspberries for strawberries.

Cherry Water-ice.—To one pound of cherries, slightly pounded with the stones in a mortar, squeeze the juice of two lemons, add a glass of noyau, or other wine or liqueur to taste, and colour if desired; put in the same quantity of water and clarified sugar as above; then strain and freeze.

Lemon Water-ice.—Juice of six lemons and one orange, and the rasped peel of two lemons. Ginger is sometimes added, or a glass of wine or liqueur. Clarified sugar and water as above; strain and freeze.

ICE-CREAMS.

Strawberry Ice-creams.—Rub one pound of red strawberries through a hair sieve, and add the juice of one lemon, a pint of cream, and half-a-pound of powdered sugar, or to taste; colour, if desired; strain and freeze.

Raspberry, Currant, and Pine-apple Ice-creams are made in the same manner.

Vanilla Ice-cream.—Rub half-a-pound of sugar and a stick of vanilla, pounded, through a hair sieve, and put them, with the yolks of two eggs and half-a-pint of milk, into a stewpan. Simmer over a slow fire, stirring all the time. When cool, add the juice of one lemon and one pint of cream; then freeze.

Ginger Ice-cream.—Put six ounces of preserved ginger in a mortar, and bruise it; add the juice of one lemon, one pint of cream, and half-a-pound of sugar; mix them well, strain through a hair sieve, and freeze.

Lemon Ice-cream.—Rasp two lemons on some sugar, and add this with their juice to one pint of cream and half-a-pound of sugar. Mix well, strain, and freeze.

Italian Ice-cream is made in the same manner, but with the addition of a wine-glass of brandy.

Orgeat Ice-cream.—Take one ounce of sweet almonds and a quarter of an ounce of bitter, one pint of cream, the yolks of eight eggs, and four ounces of sifted sugar. Blanch and pound the almonds with a little orange-flower water. Beat the yolks, add the sugar, and stir all round gently into the cream. Put the mixture on the fire, and whisk it round till it begins to thicken. Take it off, stir till cold, and then freeze it.

ICED DRINKS.

Cider-cup.—Put into a large jug a quart of sound cider, two glasses of sherry, a liquor-glass of brandy, a bottle of soda-water, two or three slices of lemon, half-a-dozen lumps of sugar, and a small quantity of grated nutmeg. In this, place a sprig or two of borage, or balm, and stir the whole well together; then add a few lumps of clear, pure ice. This should be made as short a time as possible before it is wanted.

Claret-cup.—Into a bottle of claret in a large jug pour a glass of sherry, or other wine, spirit, or liqueur, as may be preferred. Add the peel of a lemon, cut very thin, some lumps of pure, clear ice, and sweeten to taste. Let it stand half-an-hour or more; and, before using, pour in a bottle of iced soda or seltzer water; sprigs of borage, balm, or ver-bena, may be added. If preferred to lemon-peel, nectarines or peaches, cut in slices, or raspberries, may be used.

Moselle-cup.—To a bottle of Moselle in a jug pour a glass of sherry, or pale brandy, and add four or five thin slices of pine-apple, the peel of half a lemon cut very thin, some lumps of ice, and sweeten to taste. A bottle of iced soda or seltzer water must be added before using.

Sherry-cobbler.—Into a large tumbler, half-filled with ice powdered finely, put a large glass of sherry, the peel of half a lemon, and one or two teaspoonfuls of sifted sugar. Mix, and drink through a straw.

Iced-cream Soda-water.—Into a large tumbler, half-filled with finely-powdered ice, put a tablespoonful of fruit syrup, and rather less cream, and then fill with soda-water. This makes a delicious drink.

Where powdered ice has been mentioned in the above receipts, it is best to reduce it to that state, or rather to thin flakes, by the use of an ice-plane. Such an instrument may be bought for 7s. 6d.

In using the freezing-pot, for freezing ice-creams, &c., with ice and salt, it is usual to employ them in layers, in the proportion of four of the former to one of the latter. The reason why the freezing-pot is whirled round and round is—to bring every part of the mixture to be frozen into contact with the cold side of the vessel. When the freezing has taken place, the fact will be readily known by the difficulty of turning the machine. If the ices have to stand long before using, repeat the process, using fresh materials.

THE TOILETTE.

THE TEETH AND THEIR MANAGEMENT (continued).

ONCE a day at least some tooth powder—and we will give receipts for these presently—may be used. When the teeth have been well brushed, the mouth should be thoroughly rinsed out with cold water, which acts as a tonic to the gums. If the gums are tender or spongy, some astringent may be added to the water: we shall describe some washes presently. Smokers should be especially careful to cleanse the mouth. In addition to this systematic cleansing night and morning with the tooth-brush, and, if preferred, with the assistance of tooth powders, it is a very good plan to wash the mouth out freely with water after each meal; and it can do no harm, and would certainly do good, to brush the teeth gently after each meal. Of course, this involves spending a little more time upon the matter than most people consider they can spare, but it certainly repays the trouble expended. Offensiveness of the breath is one of the commonest results of not bestowing proper attention upon the cleansing of the teeth. Another cause of this most disagreeable condition is the presence in the mouth of rotten teeth, but we shall speak of this hereafter.

Tooth Powders.—A good tooth powder should not contain any gritty particles capable of acting mechanically, so as to injure the teeth or gums when rubbed on to them; nor any acid substances that are calculated to dissolve tartar by a chemical process, for those things which so act destroy the enamel of the teeth. Tooth powders should therefore be very finely ground, and be extremely soft to the touch. The chief ingredients of tooth powders are finely-powdered pumice-stone, cuttle-fish, bone, and charcoal. Cuttle-fish is the least objectionable, so far as the mechanical action of these four things upon the teeth is concerned; but charcoal is useful, inasmuch as it is an antiseptic—destroys decomposing matter. Prepared chalk

is not objectionable, unless there be a great disposition to the formation of tartar about the teeth. Those who are making tooth powders for themselves should therefore remember to reduce to the finest state of powder the ingredients they mix, and the actual powder they use to the teeth should feel perfectly smooth and soft when rubbed between the fingers. Some persons prefer to use chemical substances that do not act upon the teeth, but which are slightly gritty, sufficient to act mechanically, and quickly dissolve in the saliva, such as sulphate of potash, and cream of tartar; there is no objection to these. The best tooth powder, remembering what has been said before, is clearly one that combines several properties; in the first place, it should be such as to act in some slight degree mechanically, so as to displace foreign matters, but so that it does not injure the teeth when rubbed on to them; it should contain some substance capable of neutralising any acid that may be collected about the mouth—chalk will do this; and it should be a tonic to the gums; and, lastly, be agreeable to use. In making tooth powders, they should be thoroughly well mixed, and then be passed through a very fine sieve, so as to separate out any gritty particles. It is best when they are scented to keep them in well-stoppered bottles.

The following are some receipts for the best tooth powders. The first possesses those general qualities which we mentioned just now as desirable in tooth powders. Nos. 1 and 2 are those of Mr. Hulme:—

No. 1.

Cuttle-fish bone	3 ounces.
Prepared chalk	6 ounces.
Orris-root, finely powdered	4 ounces.
Powdered cinnamon	$\frac{1}{2}$ ounce.
Tannin	$\frac{1}{2}$ ounce.
Castile soap	$\frac{1}{2}$ ounce.

To be thoroughly mixed.

No. 2.

Castile soap	1 ounce.
Oil of cloves	20 drops.
Pumice...	1 ounce.
Prepared chalk	6 ounces.
Powdered orris-root	6 ounces.
Powdered dragon-blood	1 ounce.
Powdered cinnamon	$\frac{1}{2}$ ounce.
Tannin...	1 ounce.

To be well mixed.

If the breath be unpleasant, the following may be used:—

No. 3.

Charcoal	1 ounce.
Powdered cinchona bark	$\frac{1}{2}$ ounce.
Cream of tartar	2 drachms.
Otto of roses	2 drops.

To be well mixed.

No. 4.—Camphorated Chalk.

Precipitated chalk	15 ounces.
Camphor	1 ounce.

Rub up the camphor with spirits of wine, which enables the operator to reduce the camphor to a very fine powder, and then mix it thoroughly with the chalk. A few drops of scent of any kind may be added—either otto of roses, vanilla, or neroli. The preparation should be passed through a sieve before it is considered fit for use, and kept in an air-tight vessel or box. It may be coloured with a little carmine or red coral.

No. 5.—Hemel's Tooth Powder.

Bone of cuttle-fish, powdered	6 ounces.
Cream of tartar	1 ounce.
Orris-root	$\frac{1}{2}$ ounce.

Mix.

No. 6.—*Myrrh Dentifrice.*

Cuttle-fish bone	6 ounces.
Myrrh	2 ounces.
Orris-root	2 ounces.

Mix. Good for weak and spongy gums.

No. 7.—*Bark and Myrrh Dentifrice.*

Powdered cinchona bark	$\frac{1}{4}$ ounce.
Myrrh	$\frac{1}{4}$ ounce.
Powdered charcoal	$1\frac{1}{2}$ ounces.
Cloves	$\frac{1}{2}$ drachm.

Mix thoroughly. A tonic dentifrice.

No. 8.—*Aromatic Tooth Powder.* (Cooley.)

Cuttle-fish bone	4 ounces.
Calamus aromaticus	2 ounces.
Castile soap	1 ounce.
Oil of cloves	30 drops.

To be well mixed. A simple and very pleasant tooth powder.

No. 9.—*Quinine Dentifrice.* (Pelletier.)

Prepared red coral	3 ounces.
Myrrh, in powder	1 drachm.
Bisulphate of quinine	12 to 15 grains.

To be well mixed. A tonic preparation.

No. 10.—*Russian Tonic Tooth Powder.*

Powdered bark	4 ounces.
Orris-root	2 ounces.
Catechu	$1\frac{1}{2}$ ounces.
Myrrh	$1\frac{1}{2}$ ounces.
Sal-ammoniac	1 ounce.
Oil of cloves	20 drops.

To be well mixed together. This is one of the very best preparations for spongy or bleeding gums.

Tooth Pastes.—We have been rather liberal in our receipts for tooth powders, in order that we may suit them to the various ordinary wants of our readers. But there are those who very much prefer pastes or washes, and accordingly we propose to give the details of several useful compositions of the kind, which may be used as preferred with benefit. The tooth pastes are usually composed of honey, in addition to the ordinary ingredients that form tooth powders.

No. 1.—*Rose Paste.*

Cuttle-fish bone	1 ounce.
Prepared chalk	2 ounces.
Cochineal	$\frac{1}{2}$ drachm.
Honey of roses	3 ounces.
Otto of roses	6 drops.

Mix together.

No. 2.—*Castilian Tooth-cream.*

Castile soap, well pounded up	2 ounces.
Cuttle-fish bone, ditto	2 ounces.
Honey of roses	5 ounces.

Mix. Cooley says that this is superior to all other preparations of the kind for removing tartar and other matters from the teeth.

No. 3.—*Charcoal-paste.*

Chlorate of potash	60 grains.
Mint water	1 ounce.

These are to be well mixed together, the former being pounded up, and then are to be added and well incorporated with the above—

Charcoal, in fine powder	2 ounces.
Honey	1 ounce.

This is an admirable paste for those whose teeth are decaying, and who, in consequence, are troubled by offensive breath.

No. 4.—*Tonic Paste.* (Cooley.)

Prepared chalk	8 ounces.
Myrrh, in fine powder	2 ounces.
Finely powdered rhatany root	2 ounces.
Orris-root, powdered	1 ounce.

Honey of roses, enough to mix into a fine paste.

This is excellent in those cases in which the use of a remedy is called for to restore tone and healthiness to the gums.

Washes for the Mouth and Teeth.—Some persons much prefer using a wash for the mouth. Washes are very generally had recourse to in those cases where the gums are inclined to be soft and spongy, and tend to bleed; hence they generally contain some astringent preparation. The simplest wash that can be used is a little Eau de Cologne and water, the mouth being freely rinsed out after cleansing the teeth. A somewhat more astringent preparation is made by the addition of a little camphor to some spirits—a quarter of an ounce of camphor in two ounces of spirits of wine. A few drops of this solution are to be added to a wine-glassful of water for use. An admirable preparation is the following, called

Odoriferous Tincture of Myrrh.

Choice Turkey myrrh	1 ounce
Eau de Cologne	15 ounces.

Digest for seven days and then filter for use.

When the mouth has a tendency to be sore, and the gums also require a tonic, then we should recommend the next wash, made as follows:—

Borax	$\frac{1}{2}$ ounce.
Tincture of myrrh	1 ounce.
Water	1 ounce.
Honey of roses	2 ounces.

Mix.

The following is a powerful tonic. It is called

Hudson's Preservative.

Tincture of myrrh	3 ounces.
Tincture of bark	3 ounces.
Cinnamon water	3 ounces.
Arquebusade water	1 ounce.
Powdered gum	$\frac{1}{2}$ ounce.

Mix, and dilute with one or two parts of water.

When the gums are very spongy, in cases of bleeding gums as in scurvy, we commend the following:—

Tannin	$\frac{1}{2}$ drachm.
Tincture of tolu	2 drachms.
Tincture of myrrh	6 drachms.
Spirits of horseradish	2 ounces.

Mix, and dilute it with two or three or more parts of tepid water, and use as a mouth wash.

So much for tender gums. Now let us give some receipts for sweetening the breath, for taking away the smell of tobacco, and for preventing the injurious action of acid medicines.

Washes for Sweetening the Breath.—For those who wish to give an aromatic odour to the breath, and who do not suffer from decaying or bad teeth, we shall in our next paper give a variety of receipts.

ODDS AND ENDS.

Ornamental Chess Table.—A very pretty chess table can be made by arranging on any kind of white wood alternate squares of small oil-prints, or the prints may be alternated with squares of white paper. They must be cut and fitted with extreme precision, and very thoroughly fixed at all the corners, by means of strong glue. A border should be placed round; a light-brown scroll-work would look best, and a pattern by no means massive. Place a clean sheet of paper over the table, and an equal and moderately heavy weight, for about four-and-twenty hours, till the paper is thoroughly dry. Books are useful as weights. Then the table must be varnished. Or the table may be covered with a white or coloured varnish, and, before this is quite dry, the prints arranged on it dexterously with the fingers, so as to stick, taking great care not to touch the varnish between them. When that is hard, apply one or more coats of transparent varnish on the whole. The oil-prints should be of one kind and of one tone of colour, either light or dark. Landscapes may be chosen to decorate the table, or figures, or even heads. Oblongs may

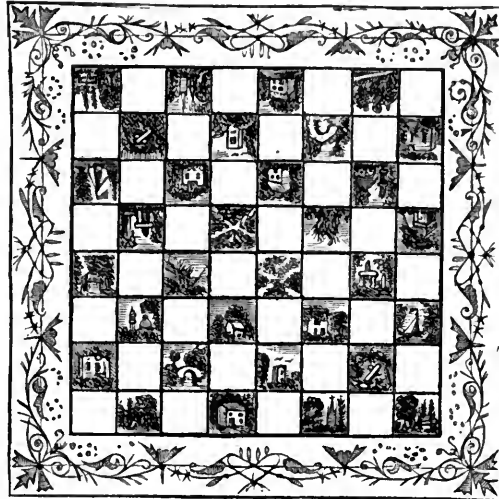

Fig. 9.

be used, if wide enough for the pieces to stand upon, but squares are better. Décalcomanie may also be made a means for decorating such a table. Cover the surface with white paper or white varnish, and when thoroughly dry and set, embellish alternate squares with small transfers. Afterwards varnish it. (See Fig. 9.)

Text Case (an Indian Pattern).—White perforated cardboard, 6 in. long, and the same height, cut the shape of Fig. 1 for

the back. For the front piece cut the cardboard the size *a b c d* and two narrow strips about 1½ in. wide, the height of from *c* to *a*. Bind these four pieces of cardboard with sarcenet ribbon, blue. Then cut out a portion of the square piece of card (Fig. 2), and bind the card with ribbon. Sew on to it the narrow pieces at *e, f, g, h*, and sew the other side to *a, b, c, d* of the back piece, to make a little case. Cut seven cards an inch smaller than the front piece of the case, Fig. 2, and mark in silk, or illuminate texts for each day of the week; bind each card with ribbon, and drop into the case. The text will show through the open part of the front piece of cardboard, and may be changed each day. Fix a loop of ribbon at the top of the case.

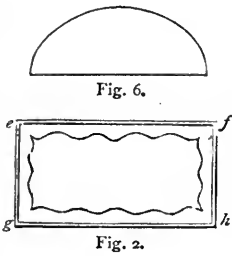

Fig. 6.

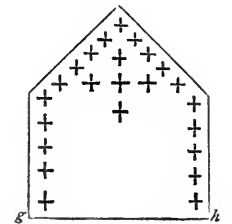

Fig. 2.

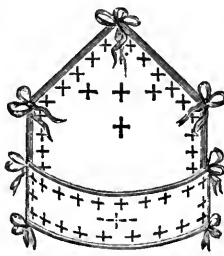

Fig. 8.



Fig. 7.

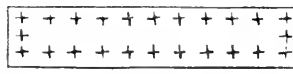

Fig. 5.

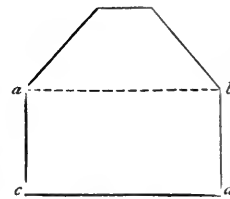

Fig. 1.



Fig. 3.

Toilette Tidy.—Perforated cardboard, about a quarter of a yard square, shaped as Fig. 4, worked in coloured Berlin wool, with a border formed of crosses, and pattern to taste in centre. A strip of perforated cardboard, about half a yard long and half a quarter wide, Fig. 5, is worked to match the back, Fig. 4. Both pieces are bound with sarcenet ribbon. Then take a piece of cardboard, a quarter of a yard long, and half a quarter wide, round off two of the corners, Fig. 6, and bind all round with narrow sarcenet ribbon. Sew the strip of cardboard, Fig. 5, to the rounded part of Fig. 6, and sew the two ends to Fig. 4, at *g, h*. Ornament with sarcenet bows. Hang at the side of the toilette, on the wall. The toilette tidy may be made any size or shape; and may be used by invalids if hung at the back of the bed, or fixed to the curtain; and it is also pretty for parlour use; handy to fix by the side of the fire, to hold odds and ends. The pattern of the star above mentioned will be found in Fig. 7.

To clean Block Tin Articles.—Wash the article perfectly clean in soap and water; dry it, and rub it all over with sweet oil; afterwards apply powdered whitening; then clean off, and polish with a soft cloth.

A Cheap Filter.—Take a large garden pot; cover the hole at the bottom with a piece of Turkish sponge. Upon this put some smooth clean pebbles to keep the sponge down. Fill up to within two or three inches of the top with one part of powdered charcoal, and two parts of fine sand. Cover the top of the pot with a piece of fine white flannel, tied tightly round the edge with a string, so as not to give or bulge. Set the flower-pot in a pan, and pour the water on to the flannel, allowing

the water to filter through the flower-pot into the pan, when the water will be found perfectly pure and clean.

To obtain very finely powdered Whitening, used for cleaning Plated Goods, &c.—Pour water on it, and when dissolved and settled at the bottom of the pan, pour off the water, and put more clean water on to it. Repeating this operation several times secures a very fine whitening. Spread it out to dry, and then put by in a box for use.

To clean Gilt Lamps, Chandeliers, &c.—Make some soapsuds with warm water and the best white soap, and after thoroughly wiping all dust off, wash over the article, going into the crevices with a tooth-brush and the soapsuds; after which dry thoroughly by wiping the article with a soft handkerchief.

COOKING.

WATER-FOWL (TAME AND WILD).

Roast Duck.—Several breeds of ducks, as the Aylesbury (white), and the Rouen, Rhone, or Rohan (neither of which terms we believe to be correct in point of fact), are esteemed for their size; by cooping they can be made very heavy, and, while still ducklings, brought to the state of "lumps of fat." It is a matter of taste. We prefer smaller breeds, such as the half-wild marsh ducks of Norfolk; or the *canards de rappel*, call-ducks of the north of France; or even good ordinary farmyard ducks that have got fat *at liberty*. These, shut up two or three days, with barley-meal and water to cleanse them, are, we think, finer in flavour than the former, and quite fat enough to please both the eye and the palate. In choosing ducks, the first point is that they should be fresh killed and fleshy; next that they be young, which is ascertained by the condition of their feet, bills, and bones generally. In old birds they are stout and solid; in young ones, the contrary. It is a mistake to pick the fattest and finest ducks; they are often, if not absolutely old, at least arrived at years of discretion. Two small tender ducks make a better dish than one large, handsome, hardfleshed drake. In fact, young ducks only are fit to *roast* (and delicious they are, nicely done in that way); middle-aged birds are only fit to stew, or to cook in the ways we are about to indicate.

After plucking, singeing, and emptying your duck, cut off the head and neck (leaving the stump not too short), the pinions, and the yellow-skinned legs and feet. Some leave the latter on (with the claws cut off), twisting them behind the duck before putting it down to roast; but they are of no use, except as ornaments and to give the carver additional trouble, and are better added to the rest of the giblets to make a stew or boil down into gravy. Chop up some parboiled onions; if chopped *raw*, and so put into the duck, they will often remain hard when the duck (if young) is roasted enough. Mix these with chopped or powdered sage-leaves, and with pepper and salt *in great moderation*. You may add bread-crumbs, if you wish to plump out the duck, or to temper the strength of the sage and onions. With this, stuff your duck at the belly-flap, and sew it up. Tie a string very tightly round the stump of the neck, over the skin, *to keep the gravy in* while roasting; tie the wing and leg bones close to the body with string. Expose it to gentle heat at first, and when thoroughly hot through, brown it off by bringing it closer to the fire. All thick and fat-skinned birds, like ducks and geese, should be dredged with flour and continuously basted while roasting; because, if the skin is dried and in the least degree burnt, it gives out an unpleasant oily flavour, which may completely spoil the roast; whereas, kept moist, plump, and unburnt, it is one of the nicest portions of it. No kind of water-fowl should be over-roasted; on carving, the presence of gravy should be perceptible in the substance of the breast. Before serving, remove the string from the neck and body. Send up its own gravy in a sauceboat; or, if you want *that* to eat with dumplings or for other purposes, you may make brown gravy with fried onions, browned flour, good stock-broth (made from the giblets, or other), pepper and salt, and red wine, or catchup, or some of Crosse and Blackwell's sauces. Green peas, if possible, to be in attendance.

Duck, done in a Stewpan.—Stuff and truss your duck exactly as above. Take a round-bottomed stewpan (earthen, by preference), and set it on the fire with a good lump of butter in it. When that begins to melt, put in your duck, with a few small onions whole; to which you may add small potatoes peeled, or (better) scraped, and small horn carrots. Keep turning the vegetables and the duck about in the butter, until the latter is nicely browned all over. Then dilute with good hot stock, until you have

enough gravy to stew the duck in. Put on the lid of the stewpan, and let it simmer gently till tender, which may take some time, as the duck, in this case, may be a "fine" one, and not necessarily in its earliest youth. When done, lay the duck on its dish, arrange the vegetables round it; skim the grease off the gravy, if it is too fat; thicken with a dust of flour; season to taste with pepper, salt, wine, lemon-juice, catchup, or whatever flavour you know to be preferred; give a good boil up, stirring all the while; pour it over the duck, and serve.

Duck, in a Stewpan, with Green Peas.—The method of roasting in a stewpan is exceedingly convenient and economical, when it is wished to avoid making a great *roasting* fire, as in the heats of summer, or when there is not much other cooking to be done. We therefore give two or three more receipts. The intelligent cook can extend the system, applying it to many small joints, such as legs of lamb, or quarter-pork, wild-fowl, pigeons, &c. Brown your duck in butter, in an earthen stewpan, or in default thereof, in a metal one with a rounded bottom. When nicely coloured, take it out. Brown a little flour in the butter remaining; dilute with good stock. Return your duck to the stewpan, with a quart or more of green peas, a bunch of sweet herbs including sage and mint if approved, pepper and salt. Stew till done over a gentle fire. Lay the duck on its dish, put the green peas and gravy round it, and serve. It will be seen that this very savoury mess can be prepared with merely a handful of fire.

Duck, in a Stewpan, with Turnips (highly esteemed).—Proceed exactly as above, seasoning, after the broth is added, with pepper and salt, bay-leaf, parsley, and some form or variety of onion. When the duck is three-parts cooked, fry in butter some turnips sliced across, and halved or quartered or cut into any fanciful shape, till they are nicely browned all over, but not cooked throughout. When the fat in which they were fried has drained away from them, put them to the duck, and let all stew gently until done enough. Serve the turnips round the duck, and the gravy, with the fat removed, poured over them.

Duck, stewed with Olives (slightly pretentious).—Proceed as above. When the duck is *nearly* done, add a wine-glassful of olives, peeled entire from the kernels. Season further with lemon-juice or vinegar and a little wine. Serve the olives and the gravy (thickened if you like) in the same dish with the duck. Olives are not so expensive that prudent people need deprive themselves of this little luxury. Quite old ducks are best prepared in the same way as goose or turkey *en daube*; *i.e.*, stewed closely shut up in a *daubière*.

Boiled Ducks.—For some dishes, otherwise simple, there is a secret talisman which confers upon them all their charm, and which is known only to the initiated. A dash of garlic, so slight as not to be recognised, is often a great improvement. A shred of horseradish in oyster sauce communicates a marvellous sapidity. Sweet basil has been given as the clue to mock turtle, and a wonderful effect it has. Boiled ducks are a delightful dish, when eaten in Anglesea. Returning from a visit to the Principality, we tried to reproduce them in England, and failed. The vaunted dish proved flat and mawkish. "Ducks boiled, ducks spoiled!" was the exclamation of our fellow-diners. A second attempt was made, with no better luck; at last, a benevolent Welshman whispered in our ear the magic syllables, "Salt your ducks before you boil them." Serve with onion sauce, or "smothered" with onions. Boiled goose, done in the same way, is excellent, and will agree with persons who dare not eat roast goose.

The Domestic Goose has already found a place in our cottage department: and there are not many ways of cooking it. Green goose (from four to six months old) is dressed in the same ways as roast duck, and will be similarly backed with plenty of green peas. The giblets

afford a nice variety. Foreign cooks, however, esteem turkey giblets much more highly than those from the goose; they use the pinions for garnishing several made dishes, including those of fish. We cannot agree with their estimate. Goose giblets contain more flavour, fat, and gelatine. After sufficient stewing with pepper and salt, and perhaps a little onion, they are ready to be converted into soup, a pie, or a ragoût. The best giblets of all, we hold, are those of the cygnet; unfortunately they are not to be had every day.

Hashed Goose.—Cut up the cold roast goose into small neat pieces. Fry sliced onions or shalots, with a dust of flour, in the goose-dripping left, or in butter. Stir in enough half broth, half red wine, to make gravy sufficient to warm up your goose in. Add pepper, salt, a bunch of sweet herbs, and give them a boil. Take the saucepan off the fire; put in the goose, and let it stew very gently for half an hour. Pile the goose in the middle of the dish; add lemon-juice to the sauce, and let it boil again. Pour it over the goose, and serve, garnished with toasted bread.

St. Martin's Goose.—We treat ourselves to goose at Michaelmas and Christmas, and the national way of dressing that very respectable bird has been already given. The French indulge in it on St. Martin's day, a feast intermediate between the two. Thrice in three months is not too often to eat goose, even if it has been tasted, green, at Midsummer; we, therefore, detail the mode of roasting, which is considered "regular" south of the Channel. Of course you select a fat, white-fleshed, young goose, assuring yourself of the latter fact by breaking the upper part of the beak, which ought to be tolerably fragile; but applying to a dealer, who has a character to lose, is the surest plan of all of getting a good one. When the goose is plucked, singed, and emptied, scald off the skin of the feet, cut off the nails, and wipe the feet and legs with a moist cloth. Cut off the neck close to the body, and the pinions at the wing-joint. Take the internal leaf-fat, or as much of it as you are likely to want; cut it into dice; set it on the fire in a stewpan; when it begins to melt, throw in two or three chopped onions. When they are nearly cooked, add the goose's liver chopped small, half a score or so of small sausage-meat balls, and as many roasted and carefully peeled chestnuts (thirty or forty), as your goose will hold inside it. Season these to taste with pepper, salt, and allspice; with them stuff the goose as full as it will stick; sew up the flap of the belly with needle and thread; truss it into form with string, and set it before the fire to roast. During the roasting, baste assiduously, dredging now and then with flour, and towards the close with the least dust of very finely powdered salt. On the hot dish, on which the goose is to be served, lay some slices of toasted bread; moisten these slightly with gravy from the latch-pan, and lemon-juice; they may also have a slight sprinkling of pepper. On these lay the roast goose, after removing the string with which it was bound wing and foot. Skim the fat off the gravy, and serve it at the same time in a sauceboat. It will be seen that this differs from the English way, mainly in the stuffing and in leaving the feet on; also in the absence of apple sauce, without which we hold roast goose to be incomplete. But chestnuts make a nice stuffing for any kind of poultry. We also should brown the gravy with a little flour and chopped onion fried in the fat, a glass of red wine, and a drop of lemon-juice.

Roast Cygnet.—Young swans are so called from their parents' French or Latin name, *cygne* or *cygnus*. Besides the black swan of Australia, there are several white species, natives of Europe, whose differences, though distinct and constant, would hardly be remarked by a careless eye. The swan of our rivers and ornamental waters is *Cygnus olor*, the mute or tame swan, which is only kept from flying away by having one of its wings pinioned. The mute swan pairs, and, arrived at the proper age, breeds freely,

bearing occasionally as many as nine, though six or seven are a very fair brood. The cygnets, when hatched, are of a slaty grey, inclining to mouse-colour, which gradually grows lighter. This is to be noted, because there is at least one species of wild swan whose cygnets are *white*. If well fed, their growth is rapid; and they *must* be well fed, because their weight should be considerable, with but little time to acquire it in, that period being included between the beginning of June and the end of November at longest. As soon as the white feathers begin to sprout through the grey ones, they diminish instead of increasing in weight. By Christmas they must all either be eaten or have emigrated, when the parents will begin to think of next year's family. A fat cygnet is a capital dish, enjoying too local a repute in England, and scarcely known on the Continent. Its stately appearance on the table is alone worth something. When cygnets are removed from their parents (neither of whom should at any time be allowed to become poor), to be fattened in a regular swan pond, it is usual to separate them at the end of August or the beginning of September. At first, immediately they have been "hopped" or "upped" from their native stream, grass is thrown to them into the water twice a day with their other food; but this is not continued for more than a fortnight. A coomb of barley is the established allowance to fatten each cygnet. The corn is put into shallow tubs, set just under water. Their weight in the feathers, when fattened, reaches from twenty-five to twenty-eight pounds, and sometimes, though rarely, as much as thirty. They are never better than in the month of November, when their merits deserve to be fairly tested. They may be had till Christmas; after which they are good for nothing. A bird weighing twenty-eight pounds before Christmas, has been known to shrink, in spite of high-feeding, to seventeen or eighteen pounds by the end of January. Cygnet is roasted in the same way as haunch of venison, *i.e.*, with a thick crust over it at first, to keep the gravy in. But this is by no means necessary. It may be treated like any other large joint, heated gradually through, protected with paper at the outset, most liberally and patiently basted, and then brought nearer to the fire to be browned and finished off. It should be stuffed full of beef steak, chopped fat and lean together, and seasoned with salt and pepper, or cayenne. Send up with it rich brown gravy and currant jelly, the latter hot as well as cold. Hashed in the way directed for goose, cygnet is excellent. It should then also be accompanied by currant jelly. For a large party, roast cygnet will be found anything but an extravagant dish, taking its "style" into consideration. Wild (or escaped) cygnets, that have been shot, are sometimes to be met with at the poulterer's. If fresh and in good condition, there is no reason why they should not turn out good, and be well worth purchasing at a moderate price. Swans' eggs are not often eaten here, unless by poachers. Major Mitchell, while exploring the river Glenelg, not only shot several black swans, which were numerous, but found their eggs among the bulrushes at the water's edge, and thought them a luxury.

Wild Fowl.—Many species of these are obtained by sportsmen, and they have many qualities in common. Those which frequent fresh waters are preferable for the table to those which live on the open sea, the latter being often fishy and oily, the natural consequence of the diet on which they exclusively feed. A knowledge of the different kinds is to be acquired by a study of the illustrated works on Ornithology, in which English literature is so rich. To choose them for kitchen purposes, first make sure that they are fresh (or at least not too forward) and in good condition, which is easy enough to ascertain; next, that they are young and tender, which is less obvious to ordinary observers, who will probably make the mistake of choosing the biggest and most showily-feathered birds. Now, the plumage affords an infallible test of

youth or age. Many water-birds—the gulls, for instance—do not attain their adult plumage till their third or fourth year; in others, the early plumage is still incomplete; besides which, birds of the previous summer have mostly their breasts (which should be white, grey, brown, or some *clear* colour) marked and stained, as it were, with muddy light-brown or grey. Such birds are sure to be young and tender, and are the ones to be selected.

Wild fowl are in season by the beginning of autumn, as soon as they have recovered from their summer moult; they are better a little later, when the longer nights give them more time to feed. In severe winters they arrive in greater numbers than in mild ones; and at the *beginning* of a frost they may still be in good plight. But after it has continued long, they will often be mainly made up of feathers and bone. They are mostly better before the middle of January than after it.

Wild Duck or Mallard, Roasted.—This is one of the best of wild fowl. Truss it as you would a tame duck, but it is not usual to stuff it. As soon as you have plucked and emptied it, boil down the giblets with a little bit of beef, to make savoury brown gravy, flavoured with lemon-juice and wine. Wild duck is better served a *little* more underdone than tame duck. Some carvers slice the breast, and dose it with cayenne, lemon-juice, and its own roast gravy—a mode of dressing admissible only when *everybody* likes high seasoning. The *bones* of the wild duck are smaller than those of the tame. The Polar duck or dun bird, the widgeon, the golden-eyed duck, the shoveller duck (rare), all excellent, are served in the same way. The teal, the jewel of water-fowl, if fat, should be laid each on its slice of toast, roasted before the fire, turning it now and then, and serving on the toast. The *coot*, on account of its black and very downy skin, is best flayed, cut into joints, and stewed with wine as a matelote. It then becomes excellent eating.

Stewed Teal.—Allow one teal for every two guests. Pluck, singe, and empty your birds; save the livers, hearts, and gizzards. Roast the teal till *nearly* done enough, either before the fire or in a saucepan. Save the gravy which comes from them. Let the teal get cold; they may be kept in that state until next day. Carve the teal in such a way as to have the wings with the portion of breast belonging to them, and the legs also with the bit of breast next to them, leaving the breast-bone, carcass, back, rump, and neck. Break up roughly in a mortar, or chop into several pieces, those carcasses, &c., and boil them with the livers, hearts, and gizzards, until you have extracted all the goodness. Strain off the liquor so obtained, mix with it the gravy from the roasted birds, and in it warm up the separated fleshy quarters of the teal, taking care never to let them come to a boil. Cut slices of stale crumb of bread large enough for a leg and a wing to lie on; fry them to a light brown; arrange them on your heated dish, and lay on each slice, with a spoon, a leg and a wing of your warmed-up teal. Thicken the gravy in your saucepan with a pinch of flour, season with salt and pepper or cayenne, and stir in a small glass of red wine. As soon as it begins to boil, pour it over the joints of teal and slices of fried bread lying in the dish. You may garnish with fried parsley, or lay a few slices of lemon round the edge of the dish. Widgeon and other small wild fowl may be dressed in the same way, as also pigeons: either of them makes an elegant and relishing dish. You help each guest, with a spoon, to a slice of the toast on which is laid a leg and a wing of the bird. Any of the above birds (to which the pretty little water hen and others may be added) make a delicious pudding, boiled in a crust in a basin, jointed or quartered, with a little beef or veal properly seasoned. Snipe pudding is the very best of these; but teal pudding is little inferior. There should be at least one snipe (not emptied) for each guest.

Wild Goose, when to be had, is a treat for lovers of wild fowl; and yet, strange to say, there is a prejudice against it, as *fishy*. Some few species of geese may indeed graze on sea-weed, and perhaps even swallow a few shell-fish when they happen to alight on the shore hard pressed by hunger; but, as a rule, there is no cleaner feeding bird than the goose, feeding upon herbs or grains, but preferring the former as the staple of its diet. We know no wild goose which is not excellent to eat, when obtained at the proper age and in good condition, including the Canada goose, probably escaped from some park. The white-fronted or laughing goose and the bean goose are not unfrequently offered for sale. The bernicle goose, much smaller, is rarer. This is the goose which the credulous vulgar once believed to be generated from shell-fish in the sea. The Brent goose, smaller still, is an excellent bird; killed inland it is delicious, and has a remarkable smell of truffles. Brent geese, when feeding on the shore at ebb-tide, have the cunning, as soon as the tide flows high enough to bear an enemy, to leave the mud and go out to sea, and there feed on the drifting weeds. All these are roasted and served in the same way as wild ducks. For variety's sake, or when there is a glut, in consequence of a large quantity having been killed at once, wild geese, as well as any of the preceding wild fowl, make an excellent pâté or pasty, of the same kind as venison pasty, or the humbler but very convenient pork pie. They may be disposed of either in a standing crust or in an earthen pâté-dish with a close-fitting lid. A satisfactory combination is made by taking a little bone, some cartilage or tendon for the sake of its gelatine, sufficient fat—to be supplied, if the meat has none, from white bacon or fresh pork—and plenty of the flesh of whatever constitutes the pâté. Pack these closely together, filling the interstices with minced fresh pork or veal, seasoned well, but not in excess; flavoured with bay-leaf, chopped shallot or onion, and lemon-peel; with bits of truffle (when possible), hard egg, and button mushrooms, interspersed here and there throughout its substance; and half a tumbler of wine, with a little catchup poured in, to prevent too much drying up. Bake this in a gentle oven, and let it stand at least twenty-four hours before cutting it up. It will keep some time, especially if untouched, and will be found improved and ripened at the end of three or four days.

Marbled Goose.—Take a fine mellow ox-tongue out of pickle, cut off the root and gristly part at the tip, wipe it dry, and boil it till it is quite tender; then peel it nicely, cut a deep slit in it the whole length, and lay a fair proportion of the following mixture within it: mace, finely beaten, half an ounce; nutmeg, ditto, half an ounce; cloves, ditto, half an ounce; two tablespoonfuls of salt; twelve Spanish olives, well pounded, without stones. Then take a barn-door fowl and a fine large goose; take from them all the bones. Lay the tongue inside the fowl; rub the latter outside with seasoning, and having ready some slices of ham divested of the rind, wrap them tightly round the fowl; put these again inside the goose, with the remainder of the seasoning, and sew it up; then make all very secure and in natural shape with a piece of new linen and tape, and put it into an earthen pan that will just contain it, with plenty of clarified butter, and bake it two hours and a half in a slow oven; then take it out, and, when cold, take out the goose, and set it in a sieve to drain; take off the butter and hard fat, which put again by the fire to melt—adding, if requisite, more clarified butter. Wash and wipe out the jar or pan, put the bird again into it, and take care that it is well covered with the warm butter; then tie the jar down with bladder and leather. When wanted for table, it must be treated as the venison to extricate it from the butter, and sent to table cold when it has been taken out of the cloth.—*Robinson.*

HOUSEHOLD DECORATIVE ART.

FANCY WORK WITH ACORNS—MODE OF DISPLAYING MINERALS, ETC., AS DRAWING-ROOM ORNAMENTS.

ACORNS may be made the medium of holding ferns in a variety of pretty ways, either in a room, or, still better, in a greenhouse, or small window garden, opening, perhaps, out of a back parlour or drawing-room. The acorns are soft when new, and a hole may be readily made by slipping through them a large twine packing-needle. Thread them on wire, a large round cut white glass bead between every one. The beads are sold by the row to milliners at places where such articles are

in the same manner, and may be suspended by a worsted cord, a metal chain, or acorns strung on wire with a hook at the end. Such baskets should be filled with moss and ferns, begonias (red-leafed), ice plants, and red-leafed American nettles mixed in them.

Horse-chestnuts will make similar baskets, not forgetting the alternate bead, which gives much lightness and finish to the look of the basket. An amber-coloured bead in place of a white one accords well with the chestnuts. A small white bean with a scarlet mark on it, called commonly "red robin," strings into pretty baskets. It must be threaded the narrow way, without beads, except, wherever there is a join, two beads together on the first wire, and a bead each side where the second wire crosses, and these should be large black ones. Nutmegs may be used also, and with red beads.

Boxes for greenhouses and staircase windows can be made with a mixture of acorns and pounded shells (Fig. 3). Cut all the acorns in half length-ways. Cover the box with glue. Make an edge each way of acorns, and then cover the box all over with rows of acorns moderately close together. Sift the pounded shell all over the box thickly between the acorns. The acorns are varied with cone seeds, and red berries cut in half.

Shells, Minerals, Insects, or Corals.—Small collections, if worth displaying at all, cannot be better arranged than on a pedestal consisting of a number of wooden circles raised one above another like steps. Let them first

be neatly constructed of wood, and then covered entirely with black velvet. If for shells, lay on the edges plenty of wadding, so that none of the black velvet shows there. Pink is the best. Some shells, however, are not well shown upon pink, and must have white wadding. The rule is this: white wadding for all coloured shells; pink wadding for white ones. Either arrange the white shells on a ledge by themselves, or give them squares of pink wadding. The circular pyramid will thus resemble ascents of black velvet and ledges of white or pink wadding adorned with shells. Write the name of each shell very neatly on a label, and with gum fix it to the ascent behind the shell. For minerals, cover the pyramid with crimson velvet, and the alternate ledges with white cloth. The sides of the wooden pyramid are covered with straight strips of velvet, wide enough to turn down over the ledge, top and bottom; and the edges are nicked out to make them lie flat. The cloth or velvet to cover the ledge is cut the right size in a hollow circle, and glued on its place. White shows up the colours of

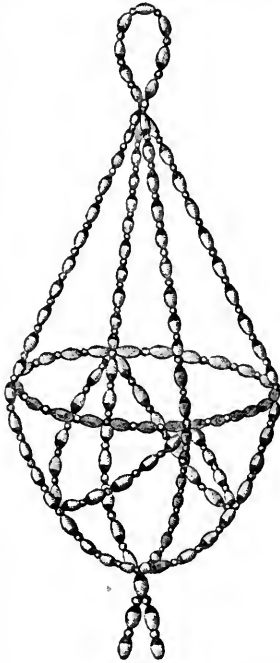

Fig. 2.

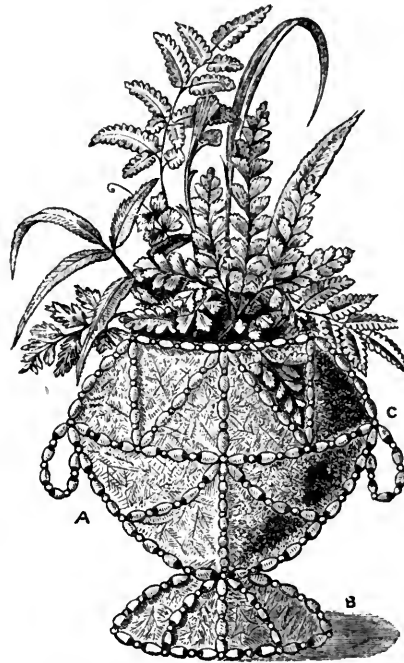

Fig. 1.

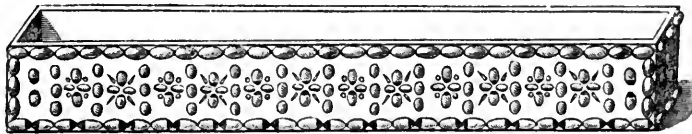

Fig. 3.

be two of them. Wire is much better than thread to join the parts of the urn. The number of acorns should be equal in relative parts, and in the rings between the side pieces the hooks must be well closed. Fill the basket with moss, and place the fern roots in the moss. The glass beads glisten out of the moss and the brown acorns like so many dew-drops.

Fig. 2 is an acorn hanging-basket. It is made precisely

the minerals best. This arrangement with white is also desirable for butterflies and insects. In all cases it will be found desirable to attach the name to every specimen. Perhaps the names look best if fixed close to, in advance, and a little to one side of each object. When the pyramid is finished and covered, nail it to the stand. For shells and minerals, arrange them first, and then from the inside strike through brass pins so that the mineral or shell may be put over the pin and thus secured in its place. To preserve the collection in good condition, place a glass shade over it. Cases formed in this way—one of shells, one of insects, one of minerals, one of corals and sea-weeds (the last should be entirely covered with black velvet)—not only form handsome ornaments, but instruct and help to form the tastes of the children of the house, raising their ideas from common and vulgar pleasures to scientific pursuits, and that insensibly and naturally. Children brought up amongst such ornaments are apt to be curious as to their nature, and by asking questions enable us to convey information of real utility, and, possibly, to develop tasks of a refining and elevating nature.

THE REARING AND MANAGEMENT OF CHILDREN.

MORAL INFLUENCE: TRUTH.

So important, from every point of view, is the habit of speaking the truth, that too much effort cannot possibly be made to render truthfulness a part of a child's nature, whilst the mind is yet plastic enough to receive true impressions, and the conscience still sensitive to tender rebuke.

Over-anxiety on the part of earnest-minded parents sometimes defeats the object they have in view in the cultivation of this principle. Shocked at the utterance of the first falsehood, they determine to check the earliest disposition to lie in the bud, and conceive that the most effectual plan is to visit the fault severely. By so doing, it is possible that they may confirm a habit, which with more lenient treatment would have had no existence.

It should be borne in mind that the random talk of little children is not to be interpreted as the deliberate expression of opinion arrived at after accurate observation. With them the love of prattling upon any subject that comes uppermost suggests words of which they neither know the value nor the meaning. Intent only on the evident interest which their narrative excites, little tongues continue to wag as long as they can secure a listener. This disposition to romance is greatly increased, if by injudicious questions the cue is given to enter into minute details. With such aid it is impossible to place a boundary to the limits which the child's active imagination may not overleap. Some sort of check is needed, but the utmost care is required to restrain the untaught mind within due limits, without stifling the play of fancy so natural in early childhood.

As soon as a child is old enough to understand the force of reasoning at all, the first thing to do is to teach him to represent things as they are, telling him at the same time that by so doing he is speaking the truth. For this end a patient habit of observation should be inculcated. Whilst very young—mere babes, in fact, on the mother's knee—little children should be induced to take notice of form, colour, and number. Long before they are capable of comprehending the higher object, these lessons may be usefully applied for the purpose of gradual intellectual development. The absence of this training involves a confusion of ideas which it is extremely difficult to overcome, when events crowd upon the child's mind in the more stirring scenes of life. The teaching recommended need not be of an uninviting nature. The most simple

toys afford the necessary means of instruction; it rests solely with the parent to make the most trivial playthings invaluable sources of mental culture.

For instance, the listless habit of looking at picture-books is not sufficient exercise for the active mind of most young children—they long for some information concerning the objects they gaze at. This disposition gives opportunity for explaining common-place facts. Having done so, the parent or teacher should ask the child to reproduce the information received, any error being carefully pointed out as soon as made. Whenever a child has attained sufficient power of observation to distinguish different objects, to define their colour, shape, and number, he is of an age to be held responsible for statements concerning more objects, and should be checked when discovered speaking at random. If a parent chooses to inculcate the principle of truthful speaking by such means, she will find that the faithful representation of common facts in early childhood has prepared the way for matters more difficult of discernment in mature years.

In most of the affairs of life in which a child has to take part, his statement is not of much moment; but it not unfrequently happens that questions affecting the character and honesty of a servant are weighed simply on the representation of little children. It then becomes a serious question, whether such witnesses are capable of distinguishing one fact or object from another. The misfortune is, that people in disputed points of the kind are apt to rely too implicitly on the disinterested judgment of a young child. "What motive," they ask, "can a child have in making a false statement?" The question, however, is not whether the child has any motive in speaking for or against a person, but whether he has been trained to speak correctly. It was this habit of observation which Dr. Johnson wisely directed to be cultivated, when he remarked that if a child said he saw a thing out of one window, when in fact he saw it out of another, he should be set right.

An undoubted source of untruthfulness is to be found in the habit of imposing secrecy on young children. Some persons are constantly cautioning little folks against speaking of what they have seen and heard. Too frequently threats of punishment, if found out in the act of "telling" are added, to give force to the prohibition. The poor little beings, thus threatened, are perhaps equally tempted to betray the secrecy imposed on them by the offer of a bribe. Says a nursemaid, perhaps, "Do not tell your mamma that I took you to such or such a place, or else I'll give you to a policeman." Says mamma, perchance, "Did you go to such or such a place? tell me, and I'll give you a nice cake." Between the terrors of the policeman on the one hand, and the love of cakes on the other, what can a bewildered little being be expected to do? whatever reply is made cannot, obviously, emanate from a conscientious desire of speaking the truth, since the still small voice of conscience is not very audible at the tender age we speak of. In early childhood the power of the senses overrules the convictions of conscience, and it depends mainly whether a child situated as described is physically and mentally weak or strong, greedy for nice things or otherwise, whether he braves out the unknown terrors of the policeman, or whether he succumbs to the pleasures of the promised cake.

The above are tests of truthfulness to which a child should never be subject. It is better to suffer grave doubts to have their sway for a time, than that a little child should be asked to act as a spy on the movements of those to whose care he is committed. If a servant, for instance, is untrustworthy at one time, she will probably be so at another, and the obvious remedy is to part with her. The same rule should apply in all relations where the management of young children is concerned. Those who live in their presence should be open as the day in

all their doings. They should not do before children things they would be ashamed to be found doing by strangers. If at any time a contrary course of conduct from what is habitual is observed, and a child asks the reason, a good reason should be assigned. Events are constantly occurring in household life, of which children were better not to be witnesses. The same occurs in conversation. It is not fitting that children should be listeners to all that their elders talk about. Instead, however, of imposing secrecy respecting what is seen and heard at such times, it is better at once to send children from the room, plainly telling them that their presence is not convenient.

Having succeeded in teaching children that it is truth to represent things as they are, the next task is to teach them that the contrary is untruth. They should be taught that truth is something that exists or has existed, and that untruth is the reverse. By this simple method they will soon be enabled to discover what is meant by truth, and to apply the lesson in more weighty matters than everyday pursuits. The foundation of a truthful disposition, as of every other virtue, rests chiefly on example. If a parent or nurse constantly speaks guardedly and acts openly in presence of a child, his conduct will almost to a certainty be straightforward, and his speech an unvarnished representation of facts; but if he is bewildered by the conflicting promptings of his own interest, and the double dealings of those around him, his judgment will naturally be vacillating, his perceptions obscured, and his actions influenced by whatever inclination may be most powerful at the moment.

Some children are said to have no power of speaking the truth. The defect is spoken of as natural, just as a physical malformation might be, and all attempts appear useless to remedy the evil. But these cases, if they exist at all, are of exceedingly rare occurrence, and are seldom heard of amongst the educated classes. Too vivid an imagination, if not judiciously checked, may tend to create an untruthful habit of speech in childhood which may continue to increase with years, or utter neglect of mental culture may produce the sad result. In either case the evil is not incurable. Left to their own guidance, all children would probably be untruthful. It is the value persons by whom they are surrounded set upon truthful statements, which constitutes the worth of truth. In nations where a high sense of honour does not prevail, truth is disregarded, and cleverness in lying is accounted a virtue. On page 246 of the present volume, in an article on the nurse and nursery-maid, a remedy for croup was given from the well-known work of an eminent physician on the maternal management of children. In adopting it, not more than from five to twenty drops according to age may be given. If given in larger doses, the remedy being, it must be remembered, a powerful one, it should only be done under medical advice.

ODDS AND ENDS.

Polishing Paste for Britannia Metal, &c.—Finely powder some rottenstone, mix it with some soft soap, enough to make a stiffish paste. To half a pound of this mixture add two ounces of oil of turpentine. It may be made up in gallipots or balls, will soon become hard, and will keep any length of time. When using it, mix a small portion with water and rub over the metal; afterwards rub with a clean cloth or wash-leather, and it will give a beautiful polish. The article to be polished must be thoroughly cleaned before the paste is put on.

To polish Patent Leather Boots.—Mix some turpentine and sweet oil together, and rub over the boots with the finger, and polish with a soft cloth. If there are any cracks in them, these should be filled up with the ordinary boot

blacking first, and any furniture polish may be applied, instead of the turpentine and oil, if preferred. This treatment renders them more lasting, and gives a good polish till the boots are entirely worn out. (See also articles on Blacking.)

Economy in Coals.—It is usual in many families to have a stock of coke as well as coal, and by having the coke broken up very small, a good fire will soon be produced. You may also effect a great saving in coal by having the ashes kept, mixing small coal or coal-dust with them, and throwing a small quantity of water on this mixture. Take some of this compost and put it at the back of the grate, fill up the front with coal, and it will all burn together brightly and clean, and save a great deal of trouble in sifting the cinders.

To clean and renovate Velvet.—With a stiff brush, dipped in a fluid composed of equal parts of water and spirits of hartshorn, rub the velvet very carefully. When the stains have disappeared, the pile of the velvet may be raised thus:—Cover a hot smoothing iron with a wet cloth, and hold the velvet spread over it. The vapour will raise the pile of the velvet with the assistance of an occasional whisk from a brush.

Best Way of making Gum-water.—Take half an ounce of gum arabic, put it in a wide-mouthed bottle, and pour upon the gum a gill of hot water; let it stand for a day, frequently stirring it, then add a wine-glass of gin. Shake the mixture well together, and cork the bottle tightly, covering it carefully with leather. Gum made in this manner will keep for a very long time without becoming mildewed. If it should become too stiff, add more gin.

To get a Tight Ring off the Finger.—If the finger on which a ring has been placed has swollen, and there seems a difficulty of removing the ring, pass a needle and cotton under it, pull the cotton up towards the hand, and twist the remaining cotton round the finger several times until it reaches the nail. By taking hold of the end nearest the hand, it is generally an easy matter to slide the ring off the finger, however much difficulty there may have appeared in doing so before the experiment was tried.

What to do when there is Leakage in a Housetop.—When a tile is loose, and the rain has found its way to the ceiling, a small spot will first appear; if then a gimlet is taken and a hole is bored, it will confine the flowing of the rain and staining of the ceiling to one part, which is better than allowing it to spread all over. A tub should of course be placed underneath to catch the water.

Incombustible Thatch.—If the straw be soaked in white-wash or lime, it will render it incombustible. This is worthy of the cottager's notice, as it makes such a roof almost fire-proof. Alum is sometimes used, but is not so good, as it will dissolve, and be washed out by the rain.

Economical way of Preserving Fruit.—When fruit is plentiful, a large quantity may be well boiled with a small quantity of sugar, and will keep for many months, if thoroughly done. Fruit thus saved comes in very handy for winter puddings.

To keep a Kitchen Table Clean.—A cook should always keep a piece of oilcloth ready, to put her saucepans and stewpans on when necessary; the oilcloth can be so much more easily cleaned than the table. A few common straw mats are also very handy in a kitchen, to save the table from being soiled.

Liebig Sandwiches.—For travellers or invalids, Liebig's Extract of Meat makes a very nice and nutritious sandwich. Directions:—Cut four thin slices of bread and butter, using the best fresh butter. Spread over two of the slices a thin layer of the Extract, with a little mustard. The Extract is generally sufficiently salt, but it may be added if desired. Place on the top of these two slices the other two slices of bread and butter; cut off the crust, or not, as required, and cut the slices into three.

COTTAGE FARMING.

PARK FARMING.

UNDER this heading we shall treat of the management of a few acres of grass land to be laid out in the form of a small park, or already so laid out, partly for pleasure and partly for profit, by growing enough hay as pasturage for one or more milch cows. Such parks are numerous in suburban districts about our large towns, and (from the facilities which are now afforded for living in the country, near railways) their number is annually increasing. The practice will also apply to the few acres of grass land under spade husbandry noticed in our last paper, and to those of mixed cottage husbandry in our next, where horse-mowing, tedding, and raking machines are not used.

The first thing is to put the land into a state for the profitable growth of grass under high farming, but distinct from sewage farming or irrigated meadow; and what we said in previous papers relative to draining, trenching, levelling, claying, and liming, apply here. But when the cottager is either a freeholder, copyholder, or long leaseholder, it may often be advisable to go to more expense in the permanent improvements in the outset, so as to get the park more quickly into a paying, healthy, and fertile condition. If we suppose the park consists of five acres, and that one acre is under pleasure ground or a narrow border, along a wall fronting the south or west, with

a gravel walk between it and the cow fence, it will leave four acres in grass, so that the question may be put practically thus:—

If £40 extra (*i.e.*, £10 per acre) will put the land into condition immediately, would it not be better to pay the money rather than have it lying for several years with an unsightly appearance? And £10 extra, if judiciously applied, will not unfrequently redeem itself in a few years, by making the whole investment for permanent improvements pay, when otherwise it would not.

Formerly, for general practice, we said trench two feet deep, we now say thirty inches, and if the land is a stubborn clay, put two inches deep of coal ashes, or burnt clay, sand, or gravel, in the bottom of the trench for the sake of drainage and bottom aeration. If this is done, and the land properly limed and manured, the young plants will strike their roots down to the ashes and burnt clay the first season, and from the extent of feeding ground, will soon become established, forming a close, thick, luxuriant carpet of the finer grasses.

What will this cost per acre? Clay can be burned on the spot for about sixpence per cubic yard of ashes, and applied for twopence; and as it would require about 700 cubic yards to the acre, it will thus cost £9. The remaining £1 will do the six inches' extra depth of trenching. If dust-cart ashes, sand, or gravel can be got at less than sixpence per cubic yard, they may be used.

Clay ashes are also applied to heavy clay land, at the rate of 100 to 200 cubic yards per acre, for mechanical as well as chemical purposes, and with the most beneficial results; and on very sour, stubborn clays, we should give at least 160 cubic yards, *i.e.*, one cubic yard of ashes per perch, deeply incorporated with the soil.

The burning is very variously performed. In some cases the surface soil is ploughed, dried in the sun, and burned in heaps or temporary kilns, with about 18 cwt. of stubble or wheat straw, the expense being as low as 12s.

In other cases the clay is dug up from below, and burned with an allowance of faggots or coals. The former is in some places termed "stifle-burning," or "clod-burning;" the latter generally "clay-burning." The clay is not burned to the same extent as for roads, garden-walks, railway ballast, &c. It is contract work, and should never be performed but by experienced workmen, thoroughly acquainted with the practice of burning.

The above data apply to very sour, stubborn examples

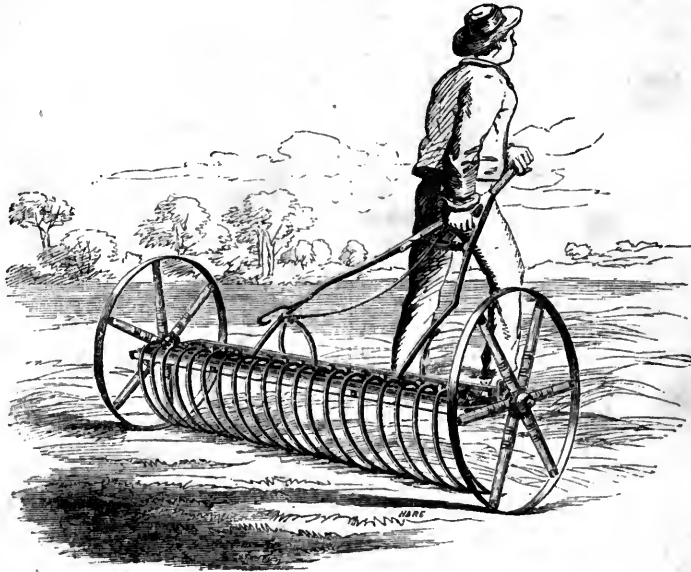

Fig. 1.

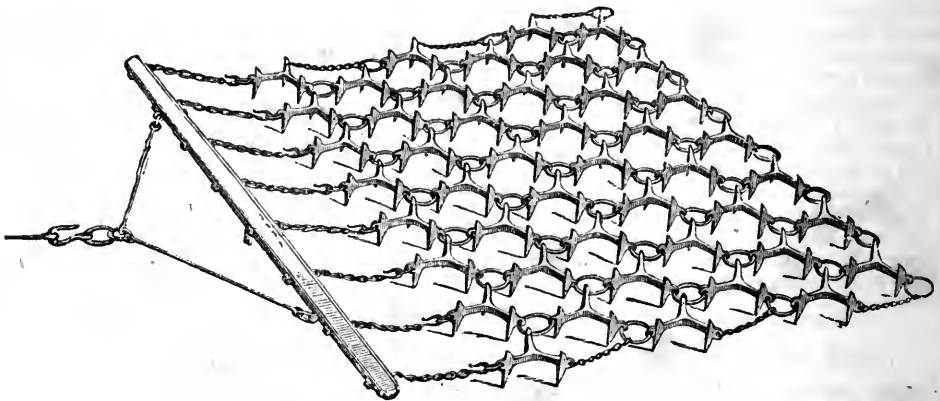

Fig. 2.

of clay; and where the bottom spit cannot be brought to the surface, and where the top spit has consequently to be retained upon the surface, a whole trench and the top spit of the second trench have to be wheeled or carted across to fill up the last trench, as explained under "Spade Husbandry." The second spit of the second trench is then turned into the bottom of the first over the two inches of ashes; the third spit is next thrown over it, and the first spit of the third trench is lastly thrown upon the top of the two, to form the surface soil.

In the vast majority of examples, draining and trenching, liming, and manuring will fit the land for the grass seeds. Draining will cost from £4 to £10 per acre, as formerly shown. Trenching two spits deep sixpence to eightpence per perch, or £4 to £5 6s. 8d. per acre; and trenching three spits deep ninepence to a shilling per perch, or £6 to £8 per acre, the workmen making 2s. 6d. per day.

Calcareous and chalky soils will not require lime, and many clays contain a sufficiency of lime naturally; but a grass crop is a great consumer of lime, and therefore when deficient in the soil naturally, it must be applied artificially. The quantity applied is very various, running from 100 to 1,000 bushels of shells per acre, on land being laid down to permanent pasture, the latter dose to sour, retentive clays. It should be well harrowed, or bastard dug with the digging-fork into the soil six inches deep

before the manure is applied. Rich compost, made with vegetable mould, stable dung, and common salt, is the best manure, 160 cubic yards per acre. If the land is lying in coarse old pasture, with much moss and effete vegetable matter, it may be pared two inches deep with a paring plough, and the sods collected for compost, at 30s. per acre; and this, mixed with 30 tons of stable dung and 20 cwt. of agricultural salt per acre, will form an excellent compost. It should be closely and carefully dug in with the spade, not more than six inches deep, the surface being brought to a fine level mould for the seed with the rake. The grass seeds

may be sown either in spring or autumn. We prefer the latter period (from August to the close of September) for the southern counties, and the former (April) for the northern. When sown in April, the land should be levelled, drained, and trenched during the previous November or December, so as to gain the full benefit of the winter frost. If sown in September, the trenching should be done as early in the season as

possible, so as to gain a summer fallow. The seed is best sown with a broadcast hand-sowing machine, an illustration of which will be given in our next paper. But cottage farmers whose farms are wholly in grass, only require such an implement for the occasion, and, if possible, should borrow one; otherwise the seeds may be sown by the hand, by some person who has learned the art of sowing, if the cottager cannot do it himself. From 50 lbs. to 60 lbs. of grass and 12 lbs. of clover seeds will be required per acre. The kinds will depend upon soil and climate. The following may be given for the heavy clays of the metropolitan counties:—1 lb. Sweet-scented Vernal Grass (*Anthoxanthum odoratum*), 2 lbs. Meadow Foxtail (*Alopecurus pratensis*), 3 lbs. Cocksfoot (*Dactylus glomerata*), 4 lbs. Timothy (*Phleum pratense*), 4 lbs. Hard Fescue (*Festuca duriuscula*), 2 lbs. Various-leaved Fescue (*Festuca heterophylla*), 2 lbs. Tall Fescue (*Festuca elatior*), 2 lbs. Spiked Fescue (*Festuca loliacea*), 4 lbs. Meadow Fescue (*Festuca pratensis*), 6 lbs. Italian Rye-grass (*Lolium italicum*), 5 lbs. Pacey's Perennial Rye-grass, 4 lbs. Com-

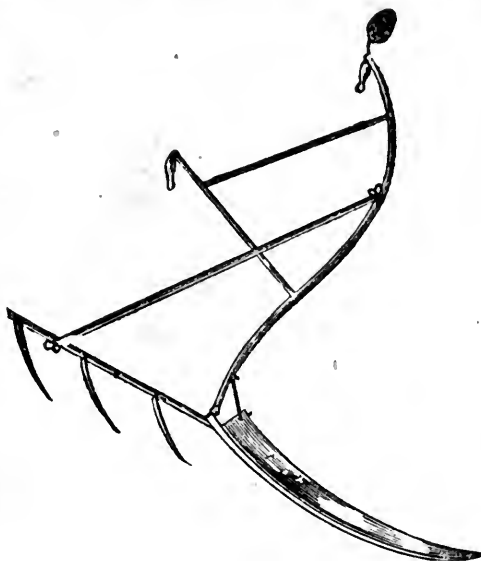

Fig. 3.

mon Rye-grass (*Lolium perenne*), 6 lbs. Evergreen Rye-grass, known also by the name of "Devon Evers," or "Eaver;" 3 lbs. Wood Meadow-grass (*Poa nemoralis*), 3 lbs. Evergreen Wood Meadow-grass (*Poa nemoralis sempervirens*), 3 lbs. Rough-stalked Meadow-grass (*Poa trivialis*), 3 lbs. Cow-grass (*Trifolium pratense perenne*), 4 lbs. Alsike Clover (*Trifolium hybridum*), 5 lbs. White Clover (*Trifolium repens*).

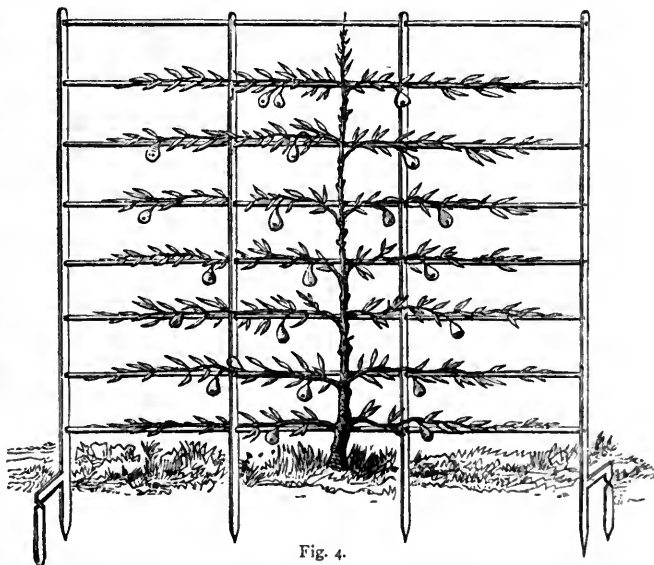

Fig. 4.

If a portion of the grass land next the cottage is to be kept as a lawn, the above mixture is not suited, as the Cock's-foot and other broad-leaved grasses are not only unsightly, but grow unequally after being mown. For lawns, sow on heavy soils 12 lbs. crested Dog's-tail (*Cynosurus cristatus*), 6 lbs. Hard Fescue, 2 lbs. Sheep's Fescue (*F. ovina tenuifolia*), 25 lbs. Fine-leaved Perennial Rye-grass (*Lolium perenne tenue*), 3 lbs. *Poa nemoralis*, 3 lbs. *Poa sempervirens*, and 2 lbs. of *Poa trivialis*. Some sow seven or eight pounds of white clover; but the above will form a fine carpet without it. If the lawn is shaded by trees, a larger quantity of the three meadow grasses may be sown. If any part of the meadow is shaded, an extra quantity of Cock's-foot, with *Poa nemoralis*, may be sown. The best plan of sowing shaded places of the meadow is, first to sow the whole with the general mixture, and then to go over the shaded places a second time with the few grasses that will grow under trees. The grass-seeds

should be thoroughly mixed, and it is better to sow the clovers or small seeds separately from the larger. The seeds may be covered by a stroke of a chain-harrow, Fig. 2.

Much old coarse meadow land can be renovated, as directed in page 211, vol. i. If there is much effete vegetable matter with moss, and if the land requires lime, then a lime compost—80 bushels of lime shells, mixed with 80 entire yards or so of earth, and 1 ton of agricultural salts to the acre, may be applied as a top-dressing. If the land is otherwise exhausted, 2 cwt. of superphosphate, 1½ cwt. of guano, and 1½ cwt. of muriate of potash per acre may also be applied. The top-dressing should be evenly spread, and well harrowed down to the roots of the grasses with the chain-harrow, Fig. 2. Half the above quantity of grass seeds may then be sown in September. Next year the hay crop should be mown short, so as to prevent the lodging and rotting out of the young grasses, and the milch cows should be sorted and not depastured, as they are liable to pull up the young grasses before they are properly established in the ground; and sheep are worse than cows. The ground may be enclosed with an iron hurdle ring-fence. The meadow would also be divided from the pasture with a similar fence, and the pasture should be divided into two small inclosures of one acre each. For large short-horn and Hereford cows, or other large breeds, the five-barred hurdle, illustrated on page 301, vol. i., may be used; but for the small cows, usually kept in small parks, a lighter four-barred hurdle, of the kind shown in Fig. 4, to which we shall have occasion to refer again. But wire screens or netting of various patterns are now cheap, and have many things to commend them. The St. Pancras Ironwork Company have always numerous patterns to show. The object of dividing the pasture is to enable the cottager to shift his cows from one field, when it becomes bare, to the other where there is plenty. By thus shifting grazing stock, grass of a finer quality, and much more of it, can be grown than when the cows are allowed to browse over the whole, not only injuring and soiling with their feet the grass in which they trample, but also preventing it from growing. And what is hay this year may be pasture next, should the manner in which the grounds are laid out so permit.

Fig. 1 is a tubular corn-drag, hay and corn rake, which we commend as a very efficient instrument, compared with common hay-rakes. Fig. 3 is a very useful implement, being a combination of the scythe and rake.

MAKING SWEETMEATS.—IV.

Barley-sugar Drops, to be made as directed for barley sugar (page 341 of this volume), only drop them in small pieces on a marble slab instead of long sticks. When cold, cover them with some pounded sugar, to keep them quite dry, and put them away in papers.

Acidulated Drops.—Grate a little lemon-peel, and put it into a saucepan with some pounded loaf sugar. Add a sufficient quantity of orange juice, together with two Seville oranges, to give the necessary flavour. This mixture should dry over the fire till of a proper consistence, when it should be dropped off the point of a knife on sheets of clean white paper.

Almond Hard-bake.—Boil one pound of sugar until it becomes brittle, when a little of it is put on a plate to cool. Have ready a quarter of a pound of almonds, blanched and split in halves. Put the flat side of them downwards on an oiled tin plate, and pour the sugar over them. When cold the hard-bake may be taken off the plate, and kept for use in a tin box.

Cocoa-nut Paste.—Procure two large-eyed cocoa-nuts, crack them, and keep the milk; shred the nuts into

small pieces, and add one pound of moist sugar and the milk. Put all together into a saucepan, and boil gently over a slow fire until the nut is perfectly soft. Keep stirring it occasionally, so that it may not burn to the saucepan; then turn it into a flat dish, and allow it to cool.

Almond Rock.—Take half a pound of sweet almonds, and one pound of loaf sugar. Beat the almonds in a mortar to a pulp; add three-quarters of the almonds cut in pieces. Mix all together with the whites of three eggs well beaten, and form into small rocky pieces, and bake on an oiled tin, in a slow oven.

Sugar Paste.—To make sugar paste, mix together one pound of flour, a quarter of a pound of sugar, quarter of a pound of butter, a little salt, and an egg, with a little water.

Rose Drops.—Dry half an ounce of red roses; reduce them to a very fine powder; sift them very carefully; and add them to one pound of finely powdered sugar. Add sufficient lemon-juice to make it into a stiff paste, and make the mixture scalding hot over the fire. Afterwards, drop it on to paper, and set it near a fire till the next day.

Spice Drops.—To a quarter of a pint of any white wine, put either ginger, mace, cinnamon, cloves, common pepper, Jamaica pepper, or cayenne in powder. Put into a saucepan and boil, keeping the lid on; afterwards strain, and add as much sugar as will make it a proper thickness. Let the drops dry without the application of heat.

How to make Lozenges.—Finely powder the sugar, then mix with it the flavouring—this may be essential oil, vegetable extract, a medicinal drug, or the juice of any fruit. After this add more powdered sugar and some powdered gum tragacanth, or gum arabic, and a little water. The mass is then rolled out with a glass rolling-pin to a proper thickness; then cut it into shapes or punch it out with tin punches of various shapes. Lay these on a wire sieve, and expose them to a gentle heat in a slow oven.

Cinnamon Lozenges.—Mix 7 ounces of cinnamon with 12 ounces of powdered white sugar and mucilage of gum tragacanth to a paste; cut into lozenges, and dry as above.

CHICORY.

ALTHOUGH chicory has sometimes been used for the purpose of forming an infused beverage alone, it is chiefly known from its being the substance usually employed to mix with coffee. By the addition of this root the latter article is enabled to be sold at much lower prices than when unmixed, and it gives to the infusion a body and apparent strength which otherwise it would not possess. Hence, in many families, the mixture is looked upon with favour, while the sale of it is eagerly promoted by the grocer, who finds his interest in so doing. As a matter of household economy, it will be well for us to examine into the nature of chicory, and to see whether the practice of using it is attended with any real advantage to the consumer.

Chicory or endive (*Cichorium intybus*) is a hardy perennial plant belonging to the botanical order *Compositæ*, and a variety of it grows wild in England. The cultivated kind, which is derived from the Continent, throws up a flowering stem as much as five feet in height, and bears flowers of a pale blue in July and August. The plant is sometimes grown in this country, as fodder for cattle, and is cut for that purpose just before it comes into flower.

Although an infusion of chicory was known as a drink to our ancestors some centuries ago, it is only within recent times that it has been extensively used, and about 1832 the dried roots were first imported in quantities from the Continent for admixture with coffee. For a time the same duty was imposed upon it as upon coffee berries

grown in our own colonies, which kept the consumption within moderate bounds ; but this duty was reduced in 1840, when, in consequence of the high prices of tea and coffee, the grocers memorialised the Government to make a concession in its favour. In 1845 the cultivation of it was introduced into our own country, and since then, as home-grown produce, it has been sold free of duty. The consequent cheapness of the article now caused it to be mixed with coffee to such an enormous extent, that, while the sale of so-called coffee rapidly increased, the quantity of berries imported became much diminished. This was naturally considered as a great loss to the public as well as to the revenue ; and to check undue admixture, the sale of chicory with coffee was, about fifteen years ago, rendered illegal, unless the purchaser received on the packet a printed intimation of the fact. This enactment has, however, remained to a great extent a dead letter, and in all the cheaper samples sold as coffee the greater proportion still continues to be chicory.

Chicory is prepared for the market by the growers by partially drying the roots. These are sold to the manufacturers, who wash, cut in pieces, and kiln-dry them, they are then ground between fluted rollers into a powder, which has a dark-brown appearance and a smell like liquorice. It is ascertained, however, that before this is sold to the grocers, it is commonly adulterated ; roasted and ground carrots, mangold-wurzel, lupin seeds, acorns, red earth, stale sea-biscuits, and other refuse farinaceous matter being used for the purpose. This adulteration is carried on to such an extent, that the grocer is able to buy ground chicory at a lower price than the roots when merely dried.

On behalf of mixed coffee and chicory it has been urged, that coffee, which would otherwise be a luxury beyond the reach of the poorer classes, is thus made available to them, and that the mixture affords a wholesome and nourishing beverage. As, however, the cheaper samples sold as coffee are proved to contain really little, and some almost none of that article, the first argument would appear to have little value. How far it may be regarded as wholesome and nourishing, and a good substitute for coffee, may be gathered from the following facts and opinions. It must be borne in mind that coffee derives its value as an article of food from two of its peculiar constituents—caffeine, a highly nitrogenised substance, similar to theine, the peculiar principle of tea, and from its volatile oils, which have a healthy, exhilarating effect on the nervous system, without subsequent reaction. Now to these no equivalent is to be found in chicory, of which the following would be a rough analysis :—

Water	17
Gum	19
Sugar	11
Bitter Extractive	18
Fatty Matter	2
Woody Fibre	30
Mineral Matter	3
					100

It will be seen from this, that, although chicory contains some little ordinary nourishing matter, it does not do so to any great extent ; and that a single cup of milk would supply more, at infinitely less cost, than many cups of the infusion, while of stimulating or refreshing qualities there is no trace.

But chicory is far less satisfactory when considered with regard to its wholesomeness. We are told by Dr. Hassall that the use of it produces heaviness, headache, and sometimes diarrhoea ; by Dr. Johnson that its prolonged and frequent use induces heartburn, cramp in the stomach, loss of appetite, constipation with intermittent diarrhoea, weakness of the limbs, tremblings, sleepless-

ness, a drunken cloudiness of the senses, &c. ; while Dr. Boer remarks that the continual use of chicory causes amaurosis and consequent blindness. In short, all these authorities are agreed that, if taken in quantity, it has a most prejudicial effect both upon the stomach and the nervous system.

We must infer, therefore, that chicory has no right to be considered as an equivalent to coffee, or as being in any way fitted to form a substitute for it ; and to buy an article, of which the commercial value would not exceed 6d. per pound, and whose real value is so doubtful, at even 1s. or 1s. 4d. per pound, must rather partake of the nature of extravagance than that of economy.

THE HOUSEHOLD MECHANIC.

OVENS.

THE old-fashioned oven, which is the simplest in construction, is specially employed for the baking of bread, but is also used for cooking joints, pies, and pastry. It consists of a large chamber, arched over at the top in the figure of an ellipsoid ; the floor, or bottom, and the sides, being paved with tiles or bricks placed as closely together as possible. The mouth of the oven or doorway is closed by an iron door. At the upper part of the oven is an enclosed closet, called the "proving oven," which is fitted with an iron grating for tins or dishes to stand upon.

This oven—a representation of which is given in Fig. 12—is best constructed of fire-bricks. The walls should be of considerable thickness in order that the heat may be better retained after the oven has once become hot. To heat these ovens, faggots, which consist of brushwood or the cuttings of trees and small logs, are employed. The wood having been heaped up in the oven, is lighted. The fuel being well ignited, the door is partially closed, remaining open only so much as is necessary for the admission of air to keep up combustion. The soot from the smoke of the burning wood is at first deposited on the sides and roof, but as soon as the walls have been heated to the proper temperature for bread-making, all the soot burns away ; the proper heat to which the interior must be raised for baking bread being from 480 to 500 degrees.

Formerly it was the custom in building ovens to place a white stone in some part of its interior, where it could be readily seen. So long as this stone was obscured with soot the person attending to the oven knew that the interior was not yet heated to the requisite degree. But when the soot was burnt off, and the stone appeared in view, clear and white, it was known that its walls were of the proper temperature.

In cases where the oven was not furnished with a stone, it was customary to ascertain the heat of the oven by introducing a stick, and passing it along the heated bricks. The stick so passed along the bricks or tiles, became charred by the heat, and left a black streak behind where it touched. When this black mark disappeared, owing to the heat of the interior burning it away, it was known that the temperature was heated sufficiently for use. The charred remains of the burnt wood were then immediately swept out, and the bread introduced as quickly as possible into the oven.

The remains of the firewood thus converted into charcoal are usually collected together and sold ; the value of the charcoal obtained being about equal to that of the wood used.

It is necessary, however, in heating the oven, not to employ any wood that contains resin or turpentine, otherwise the bread might contract an unpleasant taste.

There is much objection to the common, old-fashioned oven above described, for the operation of cleansing

the floor from the embers and ashes, requires considerable time for its proper performance, for if imperfectly cleansed, pieces of charcoal and ashes adhere to the bottom of the loaves of bread, and prove very distasteful to the consumer. A still greater time even than that necessary for cleansing the oven is required for inserting the loaves of bread, so that unless much more fuel is used than would be necessary for baking the bread under other circumstances, the oven becomes chilled before the loaves can be set in, and the quality of the bread is thereby greatly deteriorated and in addition there is the waste of fuel.

To remedy the objections attendant on the use of the wood oven, many ovens have of late years been constructed upon a pavement, based with solid brick-work, enclosed by an iron door, furnished with a damper to carry off the steam as it rises—the oven being heated with fossil coal.

it prevents the oven from chilling, while the bread is set in, and maintains a regular heat until the door can be closed. The furnace used for the coal may incline to the front, or in any convenient direction, provided the flame is delivered by the neck.

The advantages derived from the use of an oven constructed on this principle, are too patent to require recommendation.

Fig. 1 represents the plan of the oven. The furnace is situated at A, and the fire burns upon a grating of wrought iron bars, fixed an inch and a half below the level of the oven, in order that the cinders may be prevented from entering it. The furnace and ash-pit are closed in by a pair of cast-iron doors represented at A' and A, Fig. 3. The ash-pit, into which the ashes from the furnace fall, is represented at A, Fig. 2, and the door is marked A on the

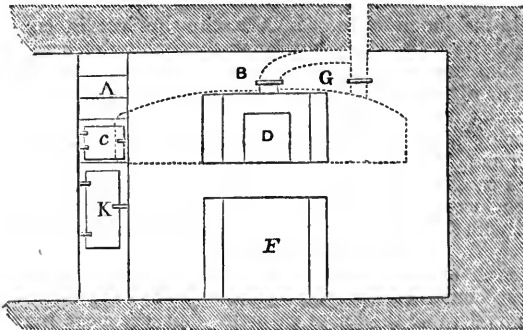

Fig. 10.

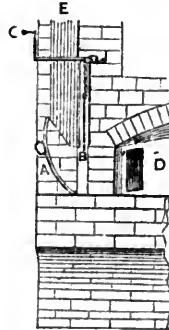

Fig. 4.

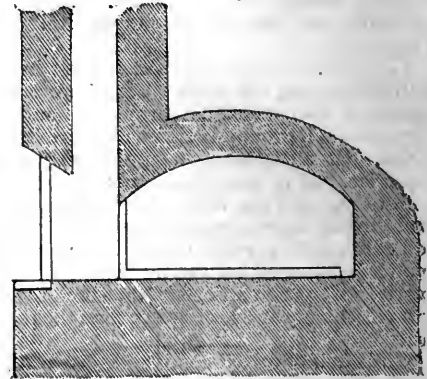

Fig. 12.

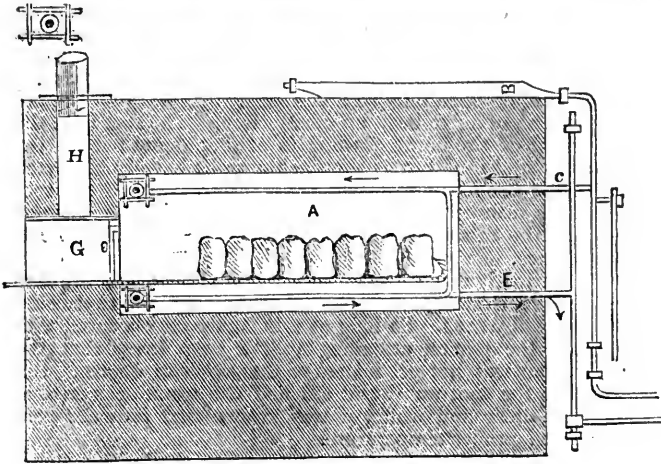

Fig. 13.

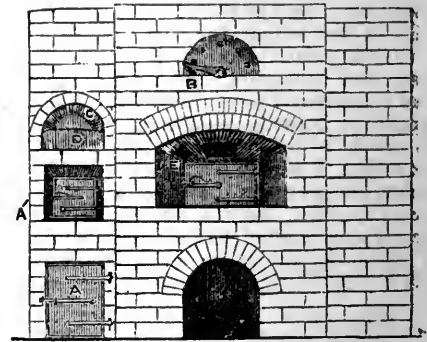

Fig. 3.

On one side of the oven is a furnace or fire-place, fitted with grating, ash-hole, and iron door, similar to that employed for a copper, with a partition to separate it from the oven, and open at one end. Above the furnace is a moderate-sized boiler or copper, with a cock at the bottom, and on one side of it is placed the proving oven; the whole being faced with brick and plaster.

To prepare the oven for baking, the boiler is filled with water, and the fire being kindled, the flame spreads around the oven, in a circular direction, all over its concavity, and makes it as hot as though it had been heated with wood. This is effected without the creation of any dirt or offensive smell, which so often prove injurious to the bread.

The smoke is conducted through an aperture or chimney which may be passed into the kitchen chimney. There is no necessity for removing the coal, which has been burnt to cinder while heating the oven, as, if allowed to remain,

elevation, Fig. 3. While the oven is heating, and the coals burning, the mouth is enclosed only by the curved cast-iron door or blower, represented at A in the section of the oven, Fig. 4, and also at D on the elevation, Fig. 5. This door or blower is so shaped for the purpose of forming a proper passage for the smoke to the flue C, Fig. 1, and is not hung, but put up and taken away by hand, as necessity requires. After the oven has been heated, and the bread is being baked, the curved door or blower is no longer required, and is consequently removed; the two doors of the oven and those of the furnace being then closed.

The mouth or opening of the furnace should be a foot and two inches in width, and a foot in height. An iron frame, as represented in Fig. 6, should be fixed round the mouth on the inside of the furnace; and be made to receive, at points marked A at the sides of Fig. 6, the fillets of the stopper represented at points marked A A A on representation of stopper, Figs. 7 and 8.

The door, B, Fig. 4, is fastened to an iron chain, and raised or let down at pleasure, by means of turning the lever C, Fig. 4; and B, Fig. 3.

The mouth of the oven should be made as small as possible, in order that the heat may not escape while the bread is being set in. An iron pin is attached to the handle of the lever with a chain, and over it is a semi-circular iron plate, fastened to the wall, with five holes drilled in it to receive the pin, by the use of which the height of the door, B, may be regulated at pleasure.

When the oven is sufficiently heated, the cast-iron stopper (Figs. 7 and 8) represented at B, Fig. 1, is drawn, by using the iron bar, Fig. 9, to the angle D, where it stops, as shown in Fig. 1. This being done, the man goes to the mouth of the furnace, and hooks the crooked end of the iron bar (Fig. 9) into the hole, B, of the stopper (Figs. 7 and 8), and pulls the fillet A A A (Fig. 7), into the frame of the furnace, upon which it fits. The stopper is made to slide, but not in a groove,

precaution of airing the coals first has been taken. This plan likewise prevents, in a great degree, the cold air intruding itself between the door and frame of the fire-place, which is consequent upon the difficulty of fitting iron doors to iron frames.

An oven on the improved construction, eight feet wide and seven feet deep, will hold eight bushels of bread; one nine feet wide and seven and a half feet deep will hold ten bushels of bread; and one ten feet wide and eight and a half feet deep will hold twelve bushels of bread.

Should an oven be required to hold less than eight bushels of bread, or more than twelve, it can of course be constructed by increasing or diminishing the proportions accordingly.

The oven here represented is eight feet wide and seven feet deep, and therefore, as stated above, is adapted to hold eight bushels of bread.

The fire-hole, or furnace, exhibited in Fig. 1, enters the

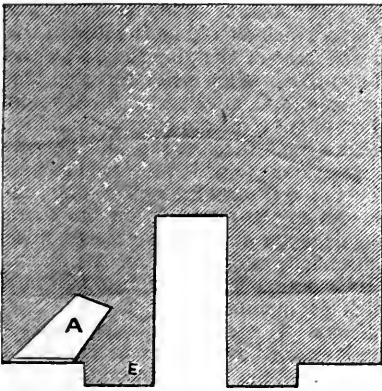

Fig. 2.

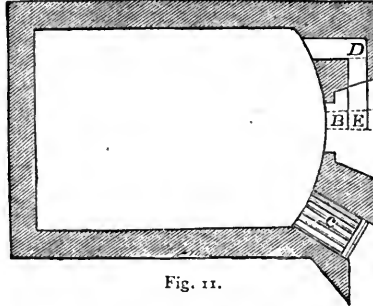

Fig. 11.

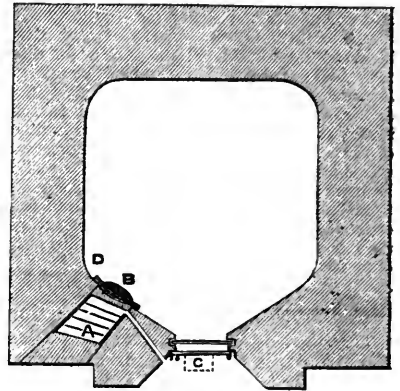

Fig. 1.

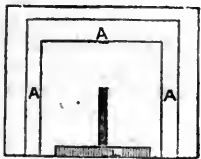

Fig. 6.



Fig. 8.

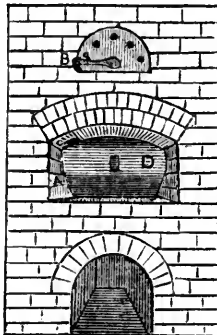

Fig. 5.



Fig. 9.

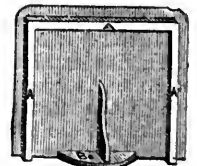

Fig. 7.

in order that it may not be prevented shutting by reason of the cinders falling into the groove.

At the top of the furnace is a small flue (represented at C, Fig. 1). This flue is about three inches square, and communicating with the flue of the oven. The use of this flue is to serve as a passage for the escape of the sulphur that remains in the cinders, and would spoil the bread while baking. The communication of this small flue of the oven is opened or closed by means of an iron slider (represented at E, Fig. 3). Over the furnace is a niche (represented at C, Fig. 3) with a boiler of hot water (represented by D, Fig. 3.)

In ovens of this construction, it has been determined that whatever the dimensions of the fire-place, it is always essential that the bars be set eight or ten inches in from the door. By this means a supply of coals will be kept ready, which should always be warmed before they are pushed forward into the furnace. The importance of this warming of the coals before used is well known to all who have experienced the effect of every fresh supply of coals upon the boilers of steam-engines, as the damping of the fire by fresh coals instantly stops the boiling, unless the

oven in a diagonal direction with the farthest corner; the sides of the oven are carried nearly straight, and turned as sharp as possible at the haunch and shoulder, this form being supposed to be better calculated to retain the heat than any other; the flue is immediately over the entrance, as shown at C, Fig. 1, and E, Fig. 4.

Welsh-lumps, or fire-bricks, are used for the furnace.

It is customary to introduce a quantity of old iron hoops, more especially around and over the oven, in order to keep the work together. This precaution is advisable on all occasions where great heat is required.

In building the oven one end of the crown is turned with bricks, as shown in the section, Fig. 4, and the centring, for building the brickwork upon, is formed by filling the void with sand, clay, or rubbish, which must be well trodden down, and formed to the shape or figure of the crown. When the upper work is finished, the sand, clay, or rubbish, which formed the centring, must be dug out from the mouth of the oven. Nothing wet or capable of retaining moisture should be used next to the oven floor; hence a stratum of flints is usually made use of, as it

receives the heat and retains it. The bricks forming the arch of the oven should be placed endwise, and they should be of the best and soundest description.

With regard to special improvements in ovens, and economy in baking, we give the following particulars, extracted from the *Builder* of the 10th February, 1849, and 6th April, 1850:—

“IMPROVEMENT IN OVENS.—I have long been anxious to turn the attention of practical men to a most important improvement in the construction of bakers' ovens. In a word, in place of the close, unwholesome oven now in use, I propose to substitute a ventilating one, securing at once the health of the journeymen, and saving a large quantity of a very valuable product, alcohol, to wit. The recent discovery, by M. Violette, of the carbonisation of wood by means of heated steam, is greatly calculated to further this desirable innovation. By means of steam, heated to 480° Fahrenheit, it has been ascertained that the dough is converted into a light, fragrant, well-baked, and well-tasted loaf. There is no risk attendant on the process, as the steam, after coming in contact with the bread, is suffered to escape, loaded with all the impurities emitted by the bread, not into, but beyond, the precincts of the bakehouse. The steam is generated by a helix, or spiral iron tube, placed in a common furnace, which would further serve to heat the oven and economise the steam, &c.—HENRY M'CORMAC, M.D.

“A NEW OVEN.—We yesterday saw tested a new oven, invented by Mr. M. Fitch, which, for dispatch and economy of fuel, will be deemed a godsend by all good housewives. The furnace is a circular fire cylinder of 8½ inches diameter; the fire divides at the lower end, right and left, into two cylinders of 6 inches diameter, and the heat ascends at each angle of the front of the oven, and enters two deflectors, which it traverses backwards and forwards, so as to secure equal heat all over the oven. Beneath the furnace is another oven for cooking joints. We saw a bushel of bread beautifully baked, and four shoulders of mutton cooked, at an expenditure of 8½lbs. of coals, which is a fraction less than a penny. After the heat is thus got up, the same could be done for a halfpenny, and the oven kept in operation all day for about 3½d. or 4d.—*Chelmsford Chronicle*.”

† *Ordinary Coal Oven*.—The erection of an ordinary coal oven—that is, one heated by coals—is represented by Fig. 10. D is the iron door of the oven, leading into its interior; c is the fire-grate by which the oven is heated; K is the ash-pit, into which the ashes fall; A is a boiler used for the purpose of keeping water hot for preparing the bread. The dotted lines indicate the flues by which the smoke from the furnace and the steam produced by the bread whilst baking escape; G is a damper employed to close the flue by which the smoke escapes, so soon as the oven has attained the proper temperature for baking; B is another damper employed for closing the flue by which the steam from the bread escapes. A, Fig. 11, represents the floor of the oven upon which the bread is placed; B, the oven door; C, the flue above the door by which the steam escapes; D, the flue by which the smoke from the furnace makes its way into the chimney; and E, the damper by which the smoke-flue is shut off. In order to test the heat of an oven in case of absence of a thermometer, or any accident having befallen it, throw a few pinches of flour on the floor of the oven. If the flour remains white more than a few seconds, it may be known that the temperature of the oven is too low; if, on the contrary, the flour becomes of a dark brown colour, it may be determined that the oven is too hot; but if the flour assumes a yellowish tinge, and appears slightly scorched, it is without doubt at a right temperature for baking. The temperature of an oven for baking varies in accordance with the goods to be baked. The general temperature is from 420° to 435° Fahrenheit, although it is sometimes required as low as 410° or as high as 450°.

Hot Water Oven.—The application of hot water pipes for the purpose of heating ovens has been tried with success. Ovens are heated by this process in the same manner as churches and large buildings are warmed. The pipes are filled with water, and immediately closed; provision, however, must be made for its expansion, &c. Fig. 13 represents an oven of this description. A is the oven full of loaves, surrounded by hot water

pipes. These pipes are heated by means of a furnace; situated on the left of the figure, and in which a coil of iron pipe is placed. The pipe which conveys the water round the oven is called the “flow-pipe,” and is represented by the letter B. At the top of the flow-pipe is an expanding tube, which contains the steam, and allows for the expansion of the water. Should the pressure, however, become too great for the expanding power of the tube, the steam will let itself off by means of a valve. At E is represented the return hot water pipe. G is the door of the oven. Above the door is a flue for the escape of the steam of the bread and vapours of the oven, which is represented by H. A regulating box containing three small levers is situated to the left of the flow-pipe. A nut is provided, so adjusted that should the temperature of the hot water pipe rise above the regulated point, its elongation causes this nut to bear upon the levers in the box, which, by lifting a straight rod, closes the damper of the furnace. The building of this oven differs only from that of an ordinary oven in the thickness of its walls. In order to retain the heat, the brickwork should be very thick and sound. We have already mentioned the coil of pipe which should be situated in the furnace; the external diameter of the pipe should be one inch, and the internal two-thirds of an inch; the pipe, too, should be of wrought iron. Connected with this coil should be a continuation of pipe for the purpose of lining the oven, which should be done both at top and bottom of its interior. The temperature to which the oven can be raised is regulated by the coil containing only an extent of pipe proportionate to the pipes within the oven. The temperature to which you should be able to raise the pipes is 550° Fahrenheit, and, therefore, the extent of coil in the furnace is so limited as to produce only this temperature, which is maintained at a fixed and uniform degree by means of a self-regulating adjustment. The regulation is carried on with great exactness, by means of the expansion of the upper ascending pipe close to the furnace acting upon the three levers contained in the box, and connected with the damper which regulates the draught. The movable nut at the bottom of the expanding pipe above mentioned, and situated near c in the figure, being adjusted to the right temperature, that temperature is thereby uniformly maintained. As any variation in the temperature of the water which circulates in the pipes at once sets the levers in motion, and the expansion of the thirty-sixth part of an inch is sufficient to close the damper, the precise temperature is maintained without trouble, and with the minutest precision. The temperature at which the oven should be maintained for baking varies between 410° and 440° Fahrenheit (dependent on the nature and size of the articles to be baked), therefore, when the brickwork has been raised to almost the same temperature as the pipes (which is very quickly effected by heating them to 550° Fahrenheit), the temperature desired for baking is procured by regulating the nut near the point c. The oven is provided with a thermometer, by which its temperature may be determined. Be very careful to keep the oven in a clean condition, and remove any remains of sugar or grease which may have run over from the dishes put into it. Puff paste requires a moderately hot oven; but if it is heated too greatly, the shape of the paste will be spoiled. For short crust a slower oven is required; for *petits choux*, one still slower. For raised pies, let it be as hot as for puff paste at first, and well closed so that the pies may not fall. Heat your oven for the puff paste, which must be baked the first, and then let the heat gradually decrease, and bake your pastry in rotation as it changes in its degree of heat. For soufflés or light puddings, have a gentle oven, and contrive so as to have them ready by the time they are wanted, or they will fall. Great attention must also be given to heating the oven for cakes, particularly if they are large.

COOKING.

RABBITS AND HARES.

Tame Rabbit, Fricassee.—Skin the rabbit as soon as it is killed. Let it hang in the larder a day and a night. Empty it, saving the liver and heart. Cut it up into joints; divide the back into three or four pieces; split the head, removing the eyes. Put all these into a bowl or deep pot, to “disgorge;” *i.e.*, pour boiling water over them, to blanch them and remove their tame taste. When cold, take them out and drain them; then throw them into cold spring water. Put into a stewpan a good lump of butter, large in proportion to the size of your rabbit, add to it as much cold sweet pork lard as you can take up with a large tablespoon. Brown these over the fire with a little flour. Throw in your rabbit, stirring it about, to bring each piece in contact with the bottom of the stewpan. When they are all nicely browned, take them out. Throw into the hot butter a few chopped onions. When they are cooked tender, return the rabbit, adding sprigs of parsley and thyme, with three sweet bay leaves and one or two cloves of garlic, minced fine. If garlic be objected to, use three or four shalots instead. But the truth is that many persons who hate the very name of garlic, relish the relief it gives to insipid dishes, when used without their knowledge in very small doses. Add a little hot water, and boil the whole together. Just before it is done enough, add a glass of red wine. The quality of tame rabbits much depends on their feeding and the cleanliness of the place in which they are kept. They should have plenty of corn, hay, breadcrusts, and other dry food; a moderate quantity of roots (carrots being preferable to any others), and very little green food, as cabbages, &c. The tame rabbit is not only inferior to the wild rabbit in respect to its flesh, but is afflicted with a propensity to infanticide and cannibalism. On the other hand, its fecundity and the rapidity of its growth enable poor people to indulge in an occasional treat of meat without going to the butcher's for it. The skin, too, is useful. Warren rabbits were always sold *skinned*, the owner counting as much on the skin as on the flesh for his profits. You may know a wild rabbit from a tame one thus:—Wild rabbits have the hair on their paws and the under part of their tail of a reddish colour. Consequently, to take in the unwary, certain dealers slightly scorch those parts in tame rabbits, in order to pass them off as wild ones. The trick may be found out by sniffing at the animal's paws; if they smell as though burnt, the specimen is, or was, a tame individual. To know young rabbits from old, you should inspect the paws. Underneath the forepaws, beneath the joint, young rabbits have a sort of protuberance about the size of a small pea; they have also a sharper pointed nose and a more easily-torn ear than elderly rabbits.

Curried Rabbit.—A curry in general is one of the convenient dishes that are easily served at a short notice, because it may be partially prepared beforehand. When not over-spiced, it is a wholesome tonic, and is so unlike anything else, that its occasional introduction makes a most agreeable variety in the family fare. The rabbit being flayed and emptied, cut it up into joints without washing or wiping, but leaving the blood adhering to the pieces. Fry them in plenty of butter till half done enough, turning them frequently, so as to brown them all over. Then take them out, and in the butter fry some thin-sliced onions to a nice light brown. This may be done the previous day, or whenever you have time. When the curry is wanted, put the half-fried rabbit and onions into a stewpan, with enough good stock-broth to stew them. When they are warmed through, mix in a basin a teaspoonful of flour, a bit of butter, a dust of salt, and one or two dessertspoonfuls of curry-powder, according to the strength you wish to have it, with a teacupful of warm new milk or cream. When

these are blended, stir them into the stew gradually, and keep stirring occasionally till the meat is tender. Then arrange it on a dish and pour the gravy over it.

Chicken is curried in the same way, as are also wild-fowl and other game. It is one of the best ways of dressing *old* partridges and pheasants, because they can be stewed, after frying, until quite tender. Cold meat can be curried, but the frying must be omitted, and the same precautions taken as with a hash, to prevent its becoming hard and tough. Cold fish is good curried, but it will hardly bear frying; for a curry of fresh fish, however—especially if of an oily nature, as eels—the previous half-frying is a great improvement.

Boiled rice is always served with curry. Many cooks lay the rice round the dish, and pour the curry into the middle, which is customary, but not the true Indian fashion. The curry and the rice are sent round separately, and each guest helps himself to each as he pleases. To boil the rice, wash it in two or three waters till it is white and perfectly free from dust, &c.; then throw it into boiling water slightly salted. Let it boil from twelve to fourteen minutes. Some rice takes a little longer to cook than other, depending on the quality or place of growth. You can ascertain this by taking out a few grains with a spoon. The rice, though tender, should remain whole and separate, and not be melted into a purée or mash. Drain off the water, and let the rice dry in the saucepan, off the fire, partially covered with the lid. It will so be kept hot, till required for serving.

Game curries may be varied, and also made to imitate more closely Indian sauces and modes of dressing, by adding to the gravy, together with the cream and curry-powder, a couple of apples chopped fine, the same quantity of chopped heart of cabbage, a little bit of minced *red* capsicum, and the juice of a lemon or a dash of vinegar. Then stew gently, stirring frequently till the meat is tender.

Curry, though of Eastern origin, is fairly naturalised in England. Foreign cooks have adopted it under the title of “Kari Indien;” but it is too warm and pungent to find much favour with them and their untravelled patrons. Curry-powder may be bought so good and cheap, that it is not worth taking the trouble to make it.

Rabbit, Plain Boiled, a favourite dish with invalids and persons not of robust appetite.—The rabbit being skinned and emptied (save the heart and liver) and the eyes removed, wipe it outside and in with a cloth, but do not wash it, except in the case of actual soiling. Stuff the rabbit with veal stuffing, with which white bacon, cut into small dice, has been mixed; sew up the belly with needle and thread; or, instead of the stuffing, you may fill the belly with white bacon cut into slices half-an-inch thick; or you may omit the bacon from the stuffing and from the inside of the rabbit, and boil with it, instead, a piece of white bacon weighing a couple of pounds or so, to be served with it on a separate dish. In any case, boiled rabbit should be accompanied by bacon. The heart and liver may either be chopped up and mixed with the stuffing, or boiled whole inside the rabbit; and, in whatever way it is cooked, the kidneys (dainty morsels) should be left in their places. When stuffed, truss the rabbit with the hind-legs under it, the fore-legs attached to the sides, and the head erect. Set it on the fire in cold water, and remove all scum as it rises. The boilings may then be used as broth. When it is coming to a boil, slip in six or eight large onions, cut partially across, to let the water penetrate them. When quite tender, take them out, and mash them with pepper, butter, and milk. After mashing, heat them up again in a saucepan. Take up the rabbit, place it on a hot dish, pour the mashed onions over it, and you then have “Rabbit Smothered with Onions.”

Warren rabbits are taken by turning a muzzled ferret

into their burrow, at the approach of which the rabbits, rushing out to make their escape, are caught in a net covering the mouth of their hole. A more extraordinary way of catching them is to attract them by a pipe or whistle imitating their cry. This mode was anciently employed in Spain, where the verb *chillar* was used to denote the proceeding. It was also not unknown in Provence. On hearing the sound, every rabbit left its hole even faster than if the ferret were behind them.

Matelote of Rabbit and Eel.—Why not? Ude calls a matelote a “hoche-pot.” Fish and flesh stewed together are not more incongruous than our every-day union of roast mutton with currant jelly, goose with apples, and pig with plums. The prime conditions of success are, that your rabbits be young, and if not wild, at least well-fed; and that your eel, as thick as your wrist, or nearly so, and alive, has passed several days in clear spring water. Skin and empty your eel, cutting it into two-inch lengths. Skin and empty your rabbits, saving the hearts and livers; cut them up into joints; split the heads after removing the eyes. Fry the joints of rabbit and the pieces of eel together in butter, dripping, or sweet pork-lard, till they are nicely browned and about half cooked. Take them out of the fryingpan, and put them in a stewpan with the livers and hearts, with pepper, salt, and a bunch of sweet herbs. Then fry either small button onions whole or larger onions sliced, with a little white bacon cut into dice. When they are browned, add them to the eel and rabbit. Brown flour in the fat left in the pan; dilute with broth; when smooth, pour it over the rabbit, &c., in the stewpan, and stew gently till all is tender. When done, pile the rabbit in the centre of a dish, and lay the bits of eel round it. To the gravy left in the stewpan, add a glass of good wine, a teaspoonful of essence of anchovy, or the flesh of an anchovy chopped small, and a few capers, or two or three gherkins cut small. Stir these together, and give them a boil, and then pour the sauce over the rabbit and eel. The great convenience of this receipt is, that if you have not the rabbit, you may stew the eel alone; if you have not the eel, you may stew the rabbit alone; and if you are lucky enough to have both, you may stew both together.

Rabbits are thought more of, now that they are become, in their wild state, much less plentiful, in consequence of the advance of agriculture and the employment of light lands for more profitable purposes than rabbit-warrens.

Roast Hare.—Nowhere is this excellent dish better served than in the United Kingdom; in few countries so well. Foreign cooks mostly divide a hare in two, after skinning and emptying, much in the same way as was described for carving a turkey so as to make a “bishop’s mitre.” The fore-part they convert into a *civet* or stew, the hind-quarters, the *râble*, the legs and loins, into a roast. There is certainly the convenience of having two small hot dishes differently prepared. The civet is always good; but the *râble*, for want of substance and stuffing, is mostly dried up, and is a very poor apology for roast hare, as we understand it at home. If a hare is old, it is better to turn the whole of it into a civet, or make jugged hare of it; if young, to roast it whole. Hares are best suited for roasting from the state of leverets till they are three-quarters grown, of which it is easy to judge from their size and weight. Old jack-hares, almost as heavy as a small sheep, are rarely fit for anything but soup or stewing, unless a spell of cold dry weather allows them to be kept an unusually long time. After Christmas, too, they are apt to become strong in flavour.

The “gameiness” of game depends upon the taste of the cook’s employers; some persons like it “high” to a degree which would render it uneatable by others. Nevertheless, young game (with the exception, perhaps, of the pheasant) possesses a sufficiency of its peculiar natural

flavour, while still comparatively fresh. During hot, close weather in September, game sometimes appears forwarder than it really is, giving needless alarm to the mistress of the house. The intestines of the creature are the first to decompose; and they may be advanced while the *flesh* is still quite good. In such cases, empty the game at once, wipe it inside with a coarse cloth, sprinkle with pepper and salt, and put a few lumps of charcoal inside it. This will keep it a few hours longer, if required; but the safest plan is to partially cook it, if not wanted to be served that day. In like manner, in hot weather, the presence even of maggots is no sure sign that game is unfit for table. They also attack the intestines first; the blow-flies instinctively deposit their eggs on the parts which decompose the quickest; those eggs hatch, and the maggots grow with great rapidity, and they will often show themselves while the meat, with management, may be still made acceptable to the epicure. The cook, however, must lose no time. On emptying a hare, she will ascertain the state of the kidneys, which may be left in their place if not too far gone. Some cooks like to show their skill by leaving the ears on the head for show.

Your hare skinned and wiped out inside with a cloth, stuff full with veal or turkey stuffing containing a liberal allowance of beef or veal suet; sew up the belly; tie the legs, fore and hind, close to the body with string, and fix the head with an iron skewer, so as to be in an erect position when laid on the dish. Put it down to roast, at some distance from the fire at first. Put a good lump of butter and a breakfastcupful of hot new milk or cream into the latchpan, and with them baste the hare as soon as it gets warm. When you judge it to be hot through, draw it nearer to the fire, and continue to baste until it is finished off, the time required for which will vary with its size and age. Hares should be roasted to a turn, neither dried up nor underdone, and without the least trace of bloodiness in any part. To avoid this in the fore-quarter, it is a good plan to cut the hare’s throat immediately before putting it down to roast, which will allow any moisture collected there to drain into the latchpan and enrich the gravy. Dredge now and then with flour while roasting. After removing the string and skewers, dish your hare dry, and serve it accompanied by currant jelly and its own gravy in sauceboats. Some like onion sauce to go with it; bread sauce also is admissible, though not necessary. Hare’s heart and liver can scarcely be turned to account when it is roasted. They may enter, divided, into soups and stews, but more for the flavour they give than for their substance.

HOUSEHOLD CARE OF PICTURES.—IV.

PHOTOGRAPHS.

THE beautiful art of photography has now become so popularised that there is scarcely a household in which an album of portraits, or a choice bit of landscape, produced by its means, is not to be found. This will not be wondered at, if we consider how much interest is naturally attached to the portrait of a dear friend, or to some scene either attractive for its picturesqueness or from its associations; or the marvellously low price at which such works are now produced. But there is one thing which prevents our being satisfied with photographic work, which is that it is not, strictly speaking, permanent. This has long been known, and unfortunately the evil has been greatly exaggerated; hence many hesitate before buying a large photograph, lest in the course of a few years the beautiful picture should become merely a piece of discoloured paper.

Of course, it is useless to deny the fact that some photographs do fade, because, if not properly finished and washed, they contain the elements of their own destruc-

tion in themselves; but long experience has shown that in many cases the fading is the result of improper treatment or gross carelessness, and we propose in this paper to show how such pictures may be kept and cared for, so as to obtain the utmost permanency of which they are capable.

In order to do this, it will be necessary, in the first place, to explain of what the picture consists, when the precautions required will almost suggest themselves. An ordinary photograph is produced upon paper which has received a coating of albumen, or white of egg; it is then treated with certain solutions of silver and gold, which metals in certain peculiar conditions, which we need not here explain, form the dark parts of the picture, the lighter portions being represented by the paper, as in most water-colour drawings. This film of metal, or rather these particles of metal, are liable to change under atmospheric influences, such as heat or damp, and also from the action of various gases, and the most frequent result of the change is that their colour alters from a dark to a lighter shade. But as it not unfrequently happens that some of the chemicals remain even in the lightest parts of the picture, these also change, and the parts which should be white become of a pale primrose tint. The presence of this tint in a photograph mostly indicates the commencement of fading, and no picture in which it prevails to any extent should be purchased.

It will from the foregoing remarks at once be seen that, as the material forming the picture is of so delicate a character and so susceptible of injury, the first precaution necessary is, that it should be framed, or so placed as to exclude it as far as possible from the air and all deleterious gases. A good plan is to place the picture between two clean plates of glass, and seal the edges by means of gummed paper or goldbeater's skin. It may then be placed in the frame and tacked up in the ordinary way. It is commonly supposed that light is injurious to photographs; this is a great mistake, as, under ordinary circumstances, they will last longer even in sunlight than in darkness. The conditions most fatal to such works are dampness in the walls on which they are placed, and the exclusion of light. Care should therefore be exercised in keeping them as dry as possible. The glass used for pictures is often the cause of them fading. Some glass exudes a kind of moisture from its surface, which is technically known as "sweating." It is, therefore, advisable to keep the photograph at some little distance from the glass, and this is best done by placing a cut-out mount of cardboard between it and the glass. This mount should be simply card, and should not be edged with metal, which is likely to affect the picture. If photographs are thus carefully mounted as soon as possible after purchase, there will be little or no fear of them fading very quickly; but it is absolutely necessary that they should be protected in some way from the adverse influences of damp and bad air.

In the case of small pictures, such as *cartes-de-visite*, it is not always possible to frame the whole of a large collection. Notwithstanding this, there are means by which their term of endurance may be greatly lengthened. In the first place, they should never be touched on the surface with the hand, as, besides the danger of soiling the prints, there is the still greater risk of leaving a trace of perspiration on them, which is sure to cause fading. *Cartes* should be placed at once in the album in which they are to remain, and of course the book or case itself should when not in use be kept closed, and in a dry place. An excellent material for the protection of small pictures has recently been introduced in the shape of very thin plates of mica, which may be inserted in the album over the picture, and which of course protect it from contact with the hand. When a picture is very highly valued, it is a good plan to secure this plate to the

card at the edges by means of slips of thin paper placed round the edges before insertion in the leaves of the album. Besides this plan, however, there is one which deserves to be universally adopted, both on account of its extreme simplicity, and of its great efficacy in preserving a photograph from injurious influences. This consists in coating the surface with an encaustic paste, made by adding to pure white wax as much benzole as will convert it into a paste. The picture to be coated should be secured to a clean board with drawing-pins, and its surface quickly and evenly coated with the paste aided by a pad of flannel covered with a piece of clean white linen rag. It should then be polished with a clean soft handkerchief, by means of a light circular motion. This will not only serve to protect the photograph, but will give it great depth of tone and brilliancy. Of course, pictures of any size may be thus treated; but, if very highly polished, the glare upon them is often somewhat offensive to persons of artistic taste. If either of the two plans mentioned be adopted, there will be but little difficulty in keeping the album in good condition. Besides pictures upon paper, however, there are two other kinds of photographs, of which specimens are to be found in almost every household. These are "positives" taken direct upon the glass, and daguerreotypes, which are produced upon plates of silvered copper. Both of these varieties may be regarded as permanent, if properly finished and carefully kept. In the case of photographs upon glass, the lighter parts of the picture consist of a very finely-divided deposit of metallic silver, which must be varnished if it is to be preserved in its original whiteness, while the darks are produced by means of a backing of black varnish, or by placing a piece of velvet or cloth behind the glass. If a picture of this description be placed in a damp situation, the varnish at the back is almost sure to crack, when of course the photograph is spoiled in appearance. This defect may easily be removed, however. The glass upon which the photograph is taken should be removed from the frame or mount in which it is kept, and the old and cracked film of varnish removed, and replaced by painting the back with Brunswick black, which may be procured at any oil-shop. Should it happen that the front surface is tarnished, it may be restored to its original brightness by means of a weak solution of cyanide of potassium, which should be thoroughly washed off when the whiteness is restored, or it will entirely destroy the image. At the best, however, this is a somewhat risky operation, and one which had better in most cases be handed over to the professional photographer.

The rules which we have given for the protection from damp of, and exclusion of air from, paper photographs, apply with equal force to those on glass. They also should be sealed up in suitable frames or cases, when they will last for years; but if left exposed to such injurious influences, their total fading will be certain, and only a matter of a few months, more or less.

In the case of daguerreotypes a still more rigid adherence to these rules is absolutely necessary. As we before mentioned, they are on plates of silvered copper; and every housewife knows how soon a polished surface of this material becomes tarnished and dull when exposed to the air. When daguerreotypes fade this is exactly what takes place. The surface becomes tarnished or oxidised. In this case, however, the same rough process cannot be employed to clean the plate, or, of course, the delicate film which forms the picture would be totally destroyed. The thin film of oxide may, however, be removed by chemical means, without injury to the picture, which should be removed from the case and placed in a solution of cyanide of potassium of about ten grains to the ounce of water, and carefully watched until the original appearance is restored. It should then be well

washed in distilled water, and carefully dried in front of a clear fire, removing the last drop of water by means of blotting-paper. When cleaned, it should be placed in a case and sealed up, so as entirely to exclude air, and be kept in a dry place. The greatest care should be taken to avoid touching the surface of a daguerreotype, as it is of so delicate a character that the slightest friction would inevitably destroy it. Fortunately, in the earlier days of photography, great care was exercised in fitting and sealing up the cases in which these pictures were kept; hence comparatively few of them have faded; but if, in case of accident from breakage of the glass, or from any other cause, the oxidisation or tarnishing has set in, it may be removed and the picture entirely restored by the process we have indicated.

The three varieties of pictures we have mentioned in this paper include all which are likely to be found in the household collection, and proper attention to the rules we have laid down will ensure the utmost permanence for them in each case. Photographs are exceedingly delicate chemical productions, and very little bad or unsuitable treatment will be sure to result in their destruction. If, on the other hand, they are carefully kept and properly treated, they will last for years; and as they increase so much in value as one by one the persons they represent pass from among us, it is certainly worth while to exercise all reasonable care in preserving them as far as possible. In conclusion, we would add a word of caution as to the use of cyanide of potassium. This salt is one of the most deadly poisons known to chemists, and consequently the greatest care should be taken to remove all traces of it from the house after use.

HOME-MADE WINES.

INTRODUCTION.

THE art of making wine has received comparatively small attention in this country, and even as a trade it dates back little more than a century, to a time when it was taken up by Mark Beaufoy, a Quaker residing at Bristol, who had abandoned his original trade of a distiller from conscientious scruples, and set up a vinegar factory. Previous to that time, and down to the year 1834, however, the excise defining all liquors made by infusion, fermentation, or otherwise, from fruit or sugar, or fruit and sugar mixed with other materials, as "sweets," held those who manufactured them in quantities exceeding 100 gallons, as subject to excise survey, and to this it may probably be due that the manufacture, up to the time of Mark Beaufoy languished in so utterly insignificant a condition. We have, however, such a large supply of cheap fruits, from which really good wines, many of which are sold under foreign names, and escape detection, may be made easily, and with simple inexpensive appliances, that it is a wonder they are not now more commonly prepared for household use. We think it can be hardly urged that the neglect of home-made wines is due to any want of information on the subject of their manufacture, seeing that the processes used therein are to be found in a more or less complete form in nearly every work on domestic matters, and in most collections of useful receipts. We shall now give directions for making these wines, premising that the methods given are those in ordinary use, and differ from such as trade manufacturers adopt, rather in the quantities than in the mode of operation.

The great element of success in making wines will be found in carefully regulating the fermenting process, which must not proceed either too slowly or too quickly. The character of the fermentation set up depends first upon the temperature; secondly, upon the proportion of saccharine matter; thirdly, upon the condition of the fruit when it was gathered; and fourthly, upon having the

correct relative proportions of the ingredients. To each of these points too much care and attention cannot possibly be given. Should the temperature be too high or too low, the proportion of sugar too small or too large, the fruit gathered in a wet, cold season, or the quantity of water be too much or too little, fermentation will be in either case imperfect.

A few words on the nature of vinous fermentation will not be out of place here. A decoction of any fruit or vegetable containing a large proportion of the sugar known to chemists as "grape sugar," when exposed to 70° of heat, in a vessel uncovered, or but partially covered, soon begins to ferment, that is to say, it becomes turbid, bubbles, and produces a mucilage, consisting of two parts, one of which is precipitated to the bottom of the vessel, while the other, rising to the top, forms what we call yeast. Should the quantity of the fluid be large, this process actively continues for several days, and gradually ceases, being a considerable time before it finally subsides. The fluid has then undergone vinous fermentation, and is entirely changed in its properties; its specific gravity is diminished; its sweet taste has entirely gone; it acquires a pungent spirituous flavour, and becomes brisk and transparent, forming beer, wine, cider, &c., according to the substance which has furnished the saccharine juice.

During the process of fermentation, carbonic acid gas is very largely generated, and from whatever the liquid has been prepared, it affords by distillation the light inflammable liquid, so well known under the name of "alcohol."

Fermentation is, in short, a process by which the elements of a compound are chemically changed. The name is derived from *fermentum*, and means "light and puffy," but we need not here dwell more fully on this subject, as the process (a very subtle and delicate one) will receive complete scientific treatment in our papers on Household Chemistry.

A writer on the subject of British wines, whose work is frequently referred to, attaches great importance to the subject, and says, "I confess that I should not have a high regard for the opinion of one of that class of wine drinkers who, regardless of the beautiful productions of a well-cultivated garden, and in a propitious season, would affirm that the best of our native wines are but rubbish; nay, many a well-informed man of business can negative such declamation by assuring us that the majority of the so-called foreign wines, as the champagnes, ports, sheries, &c., and possibly of which you might at that moment be partaking, and loading with the usual laudations of good society, have never been out of England."

The same author moreover adds, "If only one half the trouble, care, and attention, was paid by us, as is devoted to wine making in France, our productions would soon take their proper stand amongst the beverages of nations."

To make Four Gallons of Grape Wine.—As it will be scarcely possible to procure grapes enough to yield all the juice that will be required in a pure undiluted state, we must presume that some water will be used, but where trees abound, and there is no paucity of fruit, pure juice is vastly preferable, as giving a much richer and finer wine. Grapes vary in their quality, hence some yield more than others; but four or five pounds of really fine bunches may be supposed to contain one gallon of juice. Let us take 18 lbs. as our quantity. The first process is to pick off all the berries, carefully discarding any that are mouldy. Put them in an earthen pan, bruise and pour over them a gallon of cold water, stirring the whole gently; strain off the water, thus any bits of leaves or other extraneous matters will be washed away and caught by the sieve; but as the water will have taken up some juice, it must be retained for a future purpose. Bruise the berries effectually, but so as not to crush the seeds,

as this would spoil the taste of your wine. Drain off the juice through a bag or sieve, or employ a wine-press and hair bags, for these would effect the purpose most completely. Return the pulp or marc into an earthen vessel, pour upon it the water which washed the grapes, and again press out the juice. If four gallons of fluid be thus obtained, or three and a half gallons, the process is so far complete; but if the yield be short of the lesser of these quantities, either more grapes or more water must be added, as circumstances dictate. Put this prepared juice into a perfectly sweet eight-gallon cask, from which one of the heads has been removed, and either add the sugar at once, or let fermentation commence, and be established by the juice alone, a process which at a cool season of the year will be attended with little risk of running into vinegar; however, in either case it will be prudent to wash or smear the belt of wood above the surface of the liquor with a thick cream of lime, applied by means of a soft brush in such a manner as to avoid mixing much of the lime with the liquor. Care will effect all that is needful, because a small portion of pure lime will never do any harm; and the coating over the wood will effectually subdue any acidity which might be found by the splashing of the liquor.

Remove the cask and its contents to a cellar, where the temperature is steady at about 50 or 55 degrees. If the sugar be added at first, let the liquor be stirred now and then, till the solution be complete. Then place a flannel over the cask, and upon that the loose head, and leave time to effect the process; but if the juice be without sugar—which produces the finer wine—watch it till the hissing indicates fermentation. Then remove with a slice any bits of stalks or husks which may arise. Add the sugar at any time when these cease to be brought up, and renew the lining if the coat be washed off. Three pounds of sugar to each gallon of liquor, will suffice to form a perfectly dry wine, equal in strength to Moselle, and *that*, perhaps, in one year, or at the most in two. Four pounds will be required if the strength of sherry be aimed at. None but the best loaf sugar should be used.

Another remark remains. If the fermentation be begun and carried on for a few days without the sugar, let the liquors be barrelled immediately; after that be added and dissolved, but if the sugar be put in at first, then let the fermentation proceed in the cask for three or four days. No one can be at a loss to ascertain the progress of this mysterious process, because a pungent, fragrant odour is given out which is very manifest in uncovering the cask.

In making *dry wines* it is not of moment whether the cask or vessel to contain them be too large; a slow, protracted fermentation is the primary object; therefore, when fermentation has gone on in the tub for two or three days—that is, if the sugar be put in at first—let the liquor be turned into a perfectly clean and sweet barrel, or, what we should recommend from experience, into a glass carboy of rather greater capacity than that of the bulk of wine. No air capable of producing mischief will enter, while gas is generated within; therefore, when the wine is thus deposited, cover it in the cask with a piece of brown paper pasted with yeast, or butt it loosely, leaving a vent-pipe hole open; or, if in a carboy, secure its neck with brown paper, pierced with pin-holes, till the hissing noise subsides to a still and subdued state of action; then close the vessel effectually. Let the wine repose till March, when it will be necessary to bottle it, sulphured or fined, or racked into the casks wherein they are kept till October, and the processes must now be described. Messrs. Farrow and Jackson, of 18, Great Tower Street, London, have some excellent apparatus for racking and also for bottling, &c., which we can commend as admirably suited for these purposes. The racking must not be performed until the fermentation has, in a great measure, subsided, unless it be found necessary to check its too violent progress.

A portion of the natural leaven usually remains floating in very clear wine. Now it is known that the fumes of burning sulphur, termed by chemists sulphurous acid gas, powerfully attract the leaven, and form with it an insoluble substance. A piece of stout linen is to be steeped in melted brimstone, and this, when cold, is to be cut into strips three or four inches long, and one inch wide. A cask, being made perfectly clean, and fitted with a bung and peg, one of the sulphured strips is to be lighted and let down by means of a wire to within an inch or two of the bottom, and retained there till the vapours fill the cask. The wire may be withdrawn; but if the strip burn away and fall in, it will be of no consequence. The bung is to be put in the hole to keep in the sulphurous fumes, while a gallon of wine is drawn off; and this being ready, it is to be poured into the new cask, which is to be rolled about for several minutes in order to cause the absorption of the vapour, and afterwards put it on its stand to rest for one quarter of an hour. The whole of the wine may then be drawn off, excepting the dregs, tilting the cask very gently while the liquor is running. If this be adroitly done, the foul wine will scarcely exceed three pints, and this should go into bottles to settle, when the clear may be put into a cask or decanted off for use. After sulphuring, the wine should repose for two or three days, and then be fined, prior to which rinse out the first cask till the water comes away quite clear; then let it drain till it becomes perfectly dry. Isinglass, dissolved in a cup in a little hot water, and added to a half-pint of the wine, is the best thing for fining. About one drachm of isinglass in weight is sufficient for ten gallons of wine. It should be strained through a canvas bag, and then put into the cask. Then it should be rolled about to thoroughly incorporate the fining, and afterwards allowed to stand for three or four days, when the liquor will become perfectly bright and clear. Lastly, it is to be drawn off into the washed-out barrel or into bottles as the wine may indicate. The remaining dregs should be bottled off, and when settled should be put to the other wine. Wines should generally remain a year or two in the wood, and then, being bottled and kept another year, they become in prime condition.

Green Grape Wine made in August or September, to imitate Moselle, and therefore not very full-bodied, racked once in November, and kept in a stone bottle, by the addition of one bottle of sound Bucellas wine we have known to be ready for bottling, and of delicious flavour, by the 1st of the following March. The larger the proportions of sugar and water added, the more cheaply produced is the wine, but, as we have before said, it is, of course, inferior in quality to that produced more purely from the juice. It is a good plan when you gather the grapes for this purpose from your own vine, to pluck the berries as they ripen, so that you do not have different degrees of ripeness, some over-ripe and some not sufficiently ripened. A good wine, however, of a special character is made from unripe grapes and from the vine leaves and tendrils.

The Hon. Charles Hamilton's Method of making Wine from Unripe Grapes.—It is more than probable that different grapes, even in this immature state, would produce different wines; but these trials must be left to the efforts of individuals, and to the necessarily slow progress of experiment. With regard to the management, it must be founded on the operations followed in wine countries. It is, in the first place, obvious that the grapes should be suffered, from motives of economy, to remain on the vine while there is any hope of gaining an accession either of strength or sweetness. They should then be carefully separated from the stems, those which are mouldy or rotten being at the same time rejected. Some judgment will be required in proportioning the fruit to the water in the first instance, and to the sugar in the second. I

have said before that the grape, when ripe, consists of sugar, combined with vegetable extractive matter, or the fermenting principle, and certain salts, besides the astringent and flavouring matter. As the colour is not developed in the immature grape, it need not be noticed here; but the proportions of these ingredients vary materially according to the state of maturity. As a great part of saline and other constituents of the grape appears to be converted into sugar during the progress of maturation, it is plain that, weight for weight, there will be more of the principles contained in the immature than in the mature fruit. To form, therefore, a must of such a quality as shall resemble the natural must of ripe fruit, it is necessary that water should be added to the immature juice for the purpose of diluting, and thus diminishing the proportions of those saline matters which would otherwise confer on the wine a degree of harshness difficult to overcome. As it is impossible to give positive rules to meet the infinitely varying and undefinable degree of maturity in which the grapes must often be used, and as such rules would, in fact, but tend to mislead, I shall content myself with laying down some general principles, leaving the application to the ingenuity and observation of the operator. If the object be to produce a champagne wine, or the white wines of Bordeaux, a small proportion of crude grape will be required. Grapes barely half grown require, for the production of wines of this class, to be used in proportion of equality to water. If they are more grown the proportion may be increased; if less, it may be diminished. If the intention be to make a wine resembling hock, the proportion of grapes must be materially increased, and the wine, at first harsh, will, by a few years' residence in the cask, undergo that amelioration which time alone can give. To the proportions which I have described varying quantities of sugar may be applied. A proportion of 2 lbs. in a gallon of mixture will yield a very light wine, and of no great durability, resembling, under the proper treatment, the inferior classes of champagne wines, and, under a different mode, a wine resembling Barsac and the lighter of the Bordeaux wines. An increase of sugar to 3 lbs. will yield a wine equal in strength to the best sorts of champagne, or, if fermented to dryness, to the strongest of the white wines of Bordeaux. Larger doses of sugar will, doubtless, yield wines of different qualities, but of such proportions I cannot speak from experience. I may only caution the operator who shall undertake these trials that larger quantities of sugar require larger proportions of fruit, if it be his intention to work the wine to dryness, as the quantity of fruit above mentioned is barely sufficient to convert the proportion of 3 lbs. above named. With regard to the durability of these wines I may add that I have kept them for seven years, and during all that time with evident improvement. I should consider them to be as little liable to destruction as foreign wines of the very best fabric. While on the subject of sugar, I may also say that the general cause of failure in those wines which are made in this country from ripe grapes, is the deficiency of sugar, and that even these would be much improved by an addition of it. It is owing to this deficiency that these wines are perishable and easily converted into vinegar, the natural must being too aqueous to produce a durable wine. The proportion of sugar need not be larger in these cases; but, as before remarked, no positive rules can be given for it, since it must vary with the maturity and saccharine quality of the fruit,

circumstances which differ almost every season. Two modes of management may be adopted with regard to the fruit, either subjecting the skins to fermentation or not. In the first case a greater degree of austerity will be the result, and the wine will consequently vary in its quality. If the object be to make a wine resembling champagne, the skins may be operated on previously to the fermentation. If this manufacture be conducted on a large scale, the result of a second pressing may be reserved to make a distinct wine; if on a small one, it may either be mixed with the first or rejected altogether. But let me again inculcate that the wine is not made when the ingredients have been introduced into the vessel; it is then that the labour begins, and nothing but care and attention to every part and every minute circumstance of the subsequent processes can insure satisfaction and produce valuable results. To such uses may the immature fruit of the vine be converted, but the capacities of that plant are not even yet exhausted. Situations may be found in this country where the vine may not produce even immature fruit, yet still it can be directed to the end of wine-making. Chemical examination has proved that the young shoots, the tendrils, and the leaves of vines possess properties and substances exactly similar to the crude fruit.

Raisin Wine.—Pick and chop into small pieces twenty-eight pounds of raisins. Throw these into a deep tub, pour three gallons of rather hot water on these, and let them remain for twelve hours. Then turn it into a canvas bag, and with a press sufficiently powerful squeeze out the juice. Add to the raisins two gallons more hot water, and after twelve hours have elapsed, repeat the operation of squeezing; mix the two and add three pounds of white sugar, which must be perfectly dissolved. When the fermentation which will result from this is over, rack the liquor into a clean cask; bung it up securely for three months and then rack it again, mixing with it a quarter of an ounce of isinglass dissolved in a little wine. Then return the whole to the cask. After being in the cask closely bunged for twelve months, it may be bottled off. Care should be taken before bunging it up to ascertain that the cask is perfectly full.

Quince Wine.—Let the quinces be gathered when they are tolerably ripe, and in fine, dry weather, and rub off the down carefully with a linen cloth. Put them aside in hay for ten days, then divide them into quarters, remove the cores, and bruise them well in a mashing-tub with a wooden pestle. Squeeze out the juice with a press as above described, and strain the liquor through a fine sieve; in the next place warm it gently over a slow fire in a clean vessel, and skim it without suffering it to boil; sprinkle into it some powdered loaf sugar. Boil about a dozen large quinces, cut into thin slices, in a gallon of water, with a quart of white wine and two pounds of fine sugar; strain off the liquid part, add it to the juice of the quinces, mix them well together, and put them into a cask sufficiently large not to be filled. Let it stand to settle; put in two or three whites of eggs; then draw it off. More sugar may be added, if it is not sweet enough to your taste, and a quart of the best Malmsey.

The saccharometer will be found a desirable instrument, and should be used for ascertaining the gravity of the water when mixed with the bruised fruit, and in proportioning the sugar. The higher the gravity of the juice and water before adding the sugar, the less sugar will, of course, be required for complete fermentation.

ANALYTICAL INDEX TO VOL. II.

A.

Acid Drops, Making, 311
 — Stains, *see* Stains.
 Acidulated Drops, 374.
 Acorns, Fancywork with, Directions for, with Illustrations, 369.
 — as Chimney Ornaments, 90.
 Albums, *see* SOUVENIRS
 Alecost, *see* HERBS.
 Almond Hard-bake, *see* Hard-bake.
 — Rock, *see* Rock.
 Alpaca, White, 181.
 American Whitewash, *see* Whitewash.
 Ammonia, Sulphate of, Price, Properties, and Uses as a Manure, 15.
 AMUSEMENTS, *see* also SEA-SIDE AMUSEMENTS.
 AMUSEMENTS, HOUSEHOLD.—Buz, 8; the Knight of the Whistle, *ib.*; Catch the Ring, *ib.*; Scandal, *ib.*; Consequences, 9; The Performing Shadows, *ib.*
 —, The Game of Bézique, 69—71.
 —, The Game of Bézique (*continued*), 141, 142.
 —, The Game of Bézique (*concluded*), 281; Rules of the Game, *ib.*
 —, Cardboard Modelling, with Figures, 31, 32.
 —, Fancywork in Cardboard, 316, 317.
 —, Croquet, 293, 294.
 —, Kite-making, 149, 150.
 —, Kite-making and Kite-flying (*continued*), 188, 189.
 ANIMALS KEPT FOR PLEASURE AND PROFIT.—THE HORSE.—Breeding and Breaking (*concluded*), 26; Hacks and some Harness Horses, 26—28.
 —, Hack and Harness Horses, 55—58.
 —, Hack and Harness Horses (*continued*), 81, 82; Ponies and Pleasure Hacks, 82.
 —, Ponies and Pleasure Hacks (*continued*), 132—134.
 —, The Harness Horse, 145, 146.
 —, Coach Horses; Hunters, 220—222.
 —, Hunters (*concluded*); Stable Management and Feeding, 284—286.
 —, Stabling; Stabling Accessories; Harness, &c., 358, 359.
 ANIMALS KEPT FOR PLEASURE.—BIRDS.—The Canary, 209, 210.
 —, The Canary (*continued*), 230, 231.
 —, The Canary (*continued*).—Standard Properties, 321, 322.
 —, The Canary—Standard Properties (*continued*), 344, 345.
 ANIMALS KEPT FOR PLEASURE.—THE SILKWORM, 76, 77.
 —, The Silkworm (*continued*), 108.

ANIMALS KEPT FOR PROFIT.—CATTLE.—Management of a Cow on a Small Occupation: viz., the Family or Cottager's Cow, 7, 8.
 — (*continued*), 44, 45.
 —, The Housing, Feeding, and Management of Dairy Cows (*continued from p.* 310, vol. i.), 173, 174.
 —, Rearing Calves, 294, 295.
 —, Rearing Calves (*continued*), 342.
 ANIMALS KEPT FOR PROFIT.—PIGS.—Characteristics of the Chief English Breeds, 119—121.
 —, Housing, Breeding, and Rearing, 193—195.
 —, Feeding, Killing, and Curing, 287, 288.
 Anti-macassar, Directions, 251.
 ANTI-MACASSARS, *see* D'OYLEYS.
 Apple Water, Directions for Making, 192.
 Apples, 215.
 —, Buttered, Preparing and Cooking, 63, 64.
 —, Charlotte of, without a Mould, Preparing and Serving, 64.
 — and Rice, Preparing, Cooking, &c., 64.
 Apricots, Preserving, 347.
 Artichokes, Directions for Cooking and Serving, 218.
 —, The Jerusalem, Directions for Cooking and Dressing, 207.
 ARTIFICIAL CHALYBEATE WATERS, *see* CHALYBEATE WATERS.
 Artificial Manures, *see* Manures.
 Ashes, *see* Wood Ashes.
Asparagus officinalis, Particulars, with Directions for Dressing, Cooking, and Serving, 208.
 Asphalte for Garden-walks, Fowl-houses, Sheds, &c., 183.

B.

Babies' Diapers, Washing, 144.
 BABY-BOY'S HAT, *see* HAT.
 Bacon, Curing, Cooking, &c., 315.
 Baked Custard, *see* Custard.
 — Meat, *see* Meat.
 Balance Lever, 37.
 Balm, *see* HERBS.
 Banns (of Marriage), 46, 47; Act for Publication of, *ib.*
 Barley Sugar, To make, 341.
 — Drops, Making, 374.
 BAROMETER, THE, OR WEATHER-GLASS.—Historical and Explanatory Remarks, 241—243; Illustrations, 241;

Regnault's Barometer, 243; Illustration, 241; Barometer of Fortin, 243, 244; Illustration, 241; Daniell's Water Barometer, 244.
 BAROMETER, THE, OR WEATHER-GLASS (*continued*).—Gay-Lussac's Barometer, Particulars of, with Illustration, 296; the Common Barometer, Particulars of, and Illustrations with Improvements by Admiral Fitzroy, 296, 297; the Wheel Barometer, Particulars and Illustration, 297; Directions, with an Illustration, 298; How to read the Vernier, *ib.*
 Barrel Water-strainer, 37.
 Barrels, Wine and Beer, To clean, 80.
 Barrow, Illustration of, 237.
 Basil, *see* HERBS.
 Bastard Trenching, *see* Trenching.
 BATHING, *see* SEA BATHING.
 — DRESSES, LADIES', with Illustrations, 216—218.
 Batter for Frying Vegetables, 207.
 Bay Leaves, *see* HERBS.
 Bean-fly, 15.
 Beaumont, Dr., 2.
 Bedding, Warm for Winter, 323.
 Beef, 94.
 — Cheese, Directions, 164.
 — Griskins (of Cold Meat, Roast or Boiled), Directions, 163.
 —, Hashed, Directions, &c., 163.
 —, Minced (fresh), and Boiled Potatoes, Directions, 164.
 —, Salt, Directions for Salting, Dressing, Cooking, Vegetables, &c., 163.
 — Tongue, with Piquant Sauce, Directions for Dressing, Cooking, Serving, &c., 163, 164.
 Beef-tea Broth, Full Directions for Making, Scientific Account of, &c., 95.
 Beer, To prevent Drawn Beer becoming Flat, and to remove Tartness, 156.
 —, Bottled, To exclude the Air from, 286.
 — Barrels, *see* Barrels.
 Bell Pepper, *see* Capsicum.
 Berceauette, a Baby's, How to Dress, 12, 13; Figure of, 12.
 BERLIN WOOL MATS, Remarks and Directions, 224.
 BÉZIQUE, THE GAME OF, Popularity, Origin, and Advantages of, 69, 70; Mode of playing the Game, 70; the Score, 70, 71.
 — (*continued*), 141, 142.
 — (*concluded*), 281; Four-handed Bézique, *ib.*; Rules of the Game, *ib.*
 Bile, The, 3.

Bills, Remarks, 118; Bill of Exchange, Particulars and Form of, *ib.*; Inland Bill, Particulars, *ib.*; Foreign Bill, *ib.*; Directions, 119; *see* Note, Promissory.

— and Notes (*continued*).—Parties to a Bill or Note, 146; Partner, *ib.*; Married Woman, 146, 147; Transfer, 147; Indorsements, *ib.*; Stamp Duties, Table of, 147, 148.

— (*continued*), Foreign Bills of Exchange, Cheques, I O U's, 222—224.

— of Exchange, 147.

—, Foreign, Particulars, 222; Stamp, *ib.*; Usance, *ib.*; Protest, *ib.*; Example, 223; Rate of Interest, 224.

BIRDS.—The Canary (*which see*), 209, 210.

— (*continued*), 230, 231.

— (*continued*).—Standard Properties, 321, 322.

— (*continued*), 344, 345.

Births.—General Remarks, Historical Facts, Registration, &c., 110; Vaccination, Particulars relating to, Fine, &c., *ib.*

Blackcocks, Instructions for Purchasing, 139.

Black Currant Jam, Directions for Making, &c., 347.

BLACKING, Full Particulars of Different Kinds, with Receipts, 270, 325.

Black Merino, *see* Merino.

— Paper for tracing Patterns, How to make, 103.

— Silk, To revive, 14.

— Silk, To clean, Directions, 131.

— Silk Dress, To renovate; Another Way, 122.

Blanc-mange, Directions for Making, &c., 112.

Bleaching, *see* CLEANING.

Bleach Wool, To, 348.

Boards, To scour, 90.

Boiled Custards, *see* Custards.

— Mutton, *see* Mutton.

Boilers, Household, Exploding of, 129; Safety-valves, *ib.*; Illustration of Vertical Section of a Valve designed by Mr. L. E. Fletcher to prevent the Explosion of Circulating Boilers, *ib.*; Costs, *ib.*; Dimensions, &c., 129, 130.

Boiling Meat, *see* Meat.

Roils, Causes, 28; Treatment, *ib.*

Bone Phosphate, as a Manure, Price of, &c., 39.

Bones, Gelatine; Scientific Particulars, 95; use of a Papin's Digester, *ib.*; Value of in Cooking not so great as supposed, *ib.*

BOOKS, THE HOUSEHOLD CARE OF, 45, 46; General Rules and Remarks, 45; Removing Ink Spots, *ib.*; Iron-mould Spots, 46; Grease Spots, *ib.*; Bleaching the Paper, *ib.*; "Dog's Ears," *ib.*; Torn Leaves, *ib.*

—, Cost of binding, 77; Cloth Bindings, *ib.*; "Bound," "Half-bound," Artistic Taste in Binding, &c., 77, 78.

—, 301, 302.

—, *see* Worms.

Book-slides, 104, 105; Illustrations, 104.

Boots, *see* Patent Leather Boots.

Bottled Beer, *see* Beer.

Bottles, To clean, 202.

—, *see* Water Bottles.

Boxes, Card or Millboard, To make, 236.

Brackets, *see* Gilding.

Brass for Castings, Making, &c., 30, 31.

Brass-work of Furniture, Lacquered, To clean, 183.

Bread Fritters, *see* Sly Bread.

BREAD-MAKING, ON FLOUR USED FOR, 178, 179.

Bread Platter, Instructions for Designing, Carving, &c., 113, 114; Illustration, 113.

— Sauce, Directions for Making, 326.

—, 343.

Bridles, *see* Saddles.

Brill, The, Remarks, Dressing, Cooking, &c., 226.

Broccoli.—The Purple Cape, 10; Culture 10, 11; the Green Cape, 11; Culture, *ib.*; Grange's Early, *ib.*; Culture, *ib.*; the Green Close-headed Winter, *ib.*; Culture, *ib.*; Early Purple, *ib.*; Culture, *ib.*; Early White, *ib.*; Culture, *ib.*; Dwarf Brown Close-headed, *ib.*; Culture, *ib.*

— (*continued*).—The Tall Large-headed Purple, 30; Culture, *ib.*; the Cream-coloured, *ib.*; Culture, *ib.*; the Sulphur-coloured, *ib.*; Culture, *ib.*; the Spring White or Cauliflower, Variety, *ib.*; Culture, *ib.*; the late Dwarf Close-headed Purple, *ib.*; Culture, *ib.*; the Latest Green or Siberian, *ib.*; Culture, *ib.*

— (*continued*).—The Latest Green or Siberian, Mode of Cultivation, &c., 42.

Broiling Meat, *see* Meat.

Broken Walls, *see* Walls.

Bronchitis (*continued*).—Causes, 11; associated with Asthma, 11, 12; connected with certain Trades, 12; Treatment, *ib.*

Bronzing; to Bronze Images, 170.

Broth from Boiled Meat, 95.

—, Beef-tea, *see* Beef-tea Broth.

Brougham Horses, *see* HORSE, THE.

Brushes, *see* Gilding.

Brussels Sprouts, Description of, &c., 42; Culture, *ib.*

Bugs, Method of Destroying, 313.

Burns, Cure for, 219.

Butchers' Meat, *see* Meat.

Butter scientifically considered, &c., 117.

—, To sweeten, 348.

Buttered Apples, *see* Apples.

Buz (a Forfeit Game), 8.

C.

Cabbage, The; Particulars and Varieties of, 43; Culture, *ib.*

— Cake, Directions for, 207.

—, Chopped, Directions, 207.

— Plants, Cooking, &c., 207.

—, Portugal, *see* Couve Tronchuda.

—, *see* Red Cabbage.

Cabbages (*continued*).—The Cabbage, Directions for the Cultivation of (*continued*), 107; Seed-saving, *ib.*; the Red Cabbage, Particulars and Cultivation, *ib.*

Cake, *see* Potato-cake.

—, *see* Rock-cake, Soda-cake, Sponge-cake.

Cakes, *see* Sponge-cakes, Tea-cakes.

Calf's-head Cheese, Preparation of, 67.

—, Hashed (Calf's-head Ragoût), Preparation, Serving, &c., 67.

Calicoes, To stiffen, *see* Glue Stiffening.

Calves, Rearing.—Early Maturity, 294; Old Age, *ib.*; Breeding Herds, *ib.*; Directions for newly-dropped Calves, *ib.*; Suckling, 295; Cooked Food, *ib.*

— (*continued*), 342; Cowherd's Calendar, *ib.*

Cameo (Imitation), *see* Ornaments.

Camomile, Particulars and Cultivation, 278.

—, *see* HERBS.

Canary, The.—Remarks, 209; Cages,

209, 210; Illustrations, *ib.*; Breeding-cages, Particulars, 210; Illustration, 209.

Canary, The (*continued*).—Remarks, 230; to select Canaries, *ib.*; Birds for Breeding, *ib.*; General Treatment, *ib.*; Disorders of Canaries, *ib.*; Obstruction of the Rump-gland, 230, 231; Diarrhoea or Dysentery, 231; Costiveness, *ib.*; Asthma, *ib.*; Consumption or Decline, *ib.*; Epilepsy, *ib.*; Ulcers, *ib.*; Giddiness, *ib.*; Moulting, *ib.*

— (*continued*).—Different Varieties, Particulars:—Norwich, Yorkshire, &c., 321; Crested, *ib.*; clear Belgian, *ib.*; Variegated Belgian, *ib.*; the Lizards, 321, 322; Spangled, 322; Silver-spangled, *ib.*; Golden-spangled, *ib.*; London Fancy, *ib.*

— (*continued*).—The Nottingham Variegation, 344; the Yorkshire Variegation, *ib.*; Dutch Canaries, *ib.*; Song of Canaries, *ib.*; Mules, 344, 345.

Candle, Blowing out the, 287.

Candles, Fire through, 174.

Candy, *see* Ginger Candy.

— Cake, *see* Elecampane.

Capillaries, 3.

Caper-sauce, Directions for Making, &c., 112.

Capsicum, Particulars, 122; the *Capsicum cerasiforme*, or Cherry Pepper, Particulars, *ib.*; *Capsicum grossum*, or Bell Pepper, Particulars, *ib.*; Culture, *ib.*

Caramel for Sugar Baskets, To make, 341.

Card-case, Sealing-wax, Illustration of, 1.

Card-cases, Imitation Coral, Ivory, Jet, and Carved, Manufacture of, 1.

Carbonate of Lime, *see* Lime.

Carbuncle.—What a Carbuncle is, 28, 29; Causes, 29; Treatment, *ib.*; Medicine, *ib.*

Cardboard Modelling, 31, 32.—Coaches and Carriages, 31; Directions for Making a Miniature Brougham, 31, 32; Figure of, and Figures of Parts (12 in number), 32; Painting, *ib.*; Wheels, *ib.*; Lamps, *ib.*; Foot-mat, *ib.*; Roof, *ib.*

—, Fancywork in.—Raised Work with Perforated Card, Directions and Illustrations, 316, 317.

— Fret-work Flower-pot Ornaments, with Illustrations, 337.

Carpets, To clean, 202.

Carraway, *see* HERBS.

Carriage Horse, *see* HORSE, THE.

Carrot, The, Particulars, 122, 123; Culture, 123.

Carrots, Stewed, Directions, 206; Long-horn or Altringham as Carrot Soup, *ib.*

Carving in Wood, *see* Fret-work.

Case, Pamphlet, To make, 156.

Cashmere, 181.

Caskets, Imitation Coral, Ivory, Jet, and Cameo, Manufacture of, 1.

Casting in Plaster, *see* Plaster.

Castings, 31; Solid, *ib.*; Hollow, *ib.*

Catchup, Mushroom, Full Directions for Making, &c., 348.

Cats, Sick, 202.

CATTLE.—Rearing Calves, 294, 295.

—, Rearing Calves (*continued*), 342.

—, *see* Cow.

Cauliflower, The, Cultivation of, &c., 187.

— (*continued*), its Cultivation, 240.

— with Stuffing, Directions, 208.

Celeriac, Particulars of, 277; Culture, 277, 278.

Celery, Particulars of, Cultivation, &c., 278; Illustrations, 277.

- Celery (*continued*), Culture, 298.
 —, Fried, Preparing and Cooking, 207.
 —, Sauce, 343.
 Certificate, *see* Licence.
 Chain Harrow, *see* Harrow.
 CHALYBEATE WATER, ARTIFICIAL, Particulars of, and Making, 192.
 —, Particulars of, with Three Receipts, 317.
 Chandeliers (Gilt), To clean, 365.
 Chardoon, The, Particulars and Cultivation of, 123.
 — (*continued*), Cultivation of, &c., 187.
 Chardoons, Fried—Dressing, Frying, Stewing, 207.
 Charlotte of Apples, *see* Apples.
 Cheese, Scientific Remarks, Composition, &c., 156.
 —, Omelette with, How to Make, Cook, when to Serve, &c., 19.
 —, Potted, Making, &c., 66.
 —, Stewed, Preparation of, 66.
 —, *see* Calf's-head Cheese.
 —, Fritters, Preparation of, 66.
 —, Marmalade, Preparation of, 66.
 —, Paste, Making, 66.
 —, Patties, Preparation of, 66.
 Cheese-cakes, Making, &c., 66.
 —, Lemon, Directions, &c., 63.
 CHEMISTRY, HOUSEHOLD.—Food, 2, 3.
 —, Food (*continued*), 54, 55.
 —, Food (*continued*), 94—96.
 —, Food (*continued*), 117, 118.
 —, Food (*continued*), 156, 157.
 —, On the Water contained in Food, 330, 331.
 Cheques, Full Particulars of, 223, 224.
 Cherry Pepper, *see* Capsicum.
 Chervil, Particulars, Culture, &c., 298.
 —, *see* HERBS.
 Chess Table, Ornamental, To make, 365 ; Illustration, *ib*.
 Chicory, Full Particulars of, 374, 375.
 CHILDREN, THE REARING AND MANAGEMENT OF.—Clothing for Children of Six Years (*continued*), 20, 21 ; Paletôt for a Child of from Four to Six Years Old, 20, 21 ; Figures of Patterns of Parts, *ib*. ; to line the Jacket, 21 ; Figure of Paletôt complete, *ib*.
 —, Children's Clothing (*continued*), 180, 181.
 —, Clothing for a Girl Eight Years of Age, 91—93.
 —, Clothing for a Girl Eight Years of Age (*continued*), 99—103.
 —, Clothing for a Girl Eight Years of Age (*continued*), 196—198.
 —, Clothing for Girls Eight to Ten Years of Age, 271, 272.
 —, Knickerbockers for a Boy of Eight, 361, 362.
 —, Moral Influence: Obedience, 38, 39.
 —, Moral Influence: Love and Fear, 140, 141.
 —, Moral Influence: Truth, 370, 371.
 Children's Clothing, *see* Paletôt ; Clothing ; Pinafores.
 Chili Vinegar, *see* Vinegar.
 Chimney Boards, Ornamental.—Indian Board, 170 ; Wedgwood Board, *ib*.
 Chimneys on Fire, *see* Fire.
 China, To mend, 155.
 Chintzes, To stiffen, *see* Glue Stiffening.
 Chives, Particulars of, and Cultivation, 278.
 Chocolate, Directions for Making, 35.
 — and Coffee Custards, *see* Custards
 CHOOSING A TRADE, *see* TRADE.
 Chops and Cutlets, 114.
 —, Plain Fried, Directions for Dressing, Cooking, Serving, and Sauce, 114.
 — à la Jardinière, Preparing, Dressing, Cooking, Serving, &c., 115.
 Chyme, 3.
 Cider-cup, 362.
 Claret-cup, 363.
 Clary, Particulars of, Culture, &c., 298, 299.
 —, *see* HERBS.
 Cleaning, *see* Black Silk ; Merino ; Cloth Clothes ; Woollen Stuff ; Silks ; Carpets ; Gloves ; Swans'-down Cape or Tippet ; Velvet.
 CLEANING CLOTHING AND UPHOLSTERY, 15, 16 ; Woollen and Fancy Fabrics, 16 ; To clean Delicate Coloured Fabrics, *ib*. ; Figure, *ib*. ; to clean White Cashmere, White Lama, or White Alpaca, *ib*.
 —, To clean Coloured Fabrics, 75 ; Muslin Dresses, *ib*. ; Laces, 75, 76 ; to bleach Lingerie, Lace, and Embroidery, 76 ; to stiffen Linen, *ib*.
 —, Washing made Easy, Quick, and Unlaborious, 109 ; to clean Flannels and Woollen Hose, *ib*. ; General Washing made Easy, 109, 110.
 Clear-starching, 182.
 Cloth, To clean, 80.
 — Cloaks, Tweed, To clean, 14.
 — Clothes, To clean, Directions, 131.
 Clothing for a Girl Eight Years of Age.—Underclothes, 91—93. *See* Underclothes.
 — (*continued*)—Drawers for a Girl Eight Years of Age, with Patterns, 99—101.
 — (*continued*)—Night-dresses, 101—103 ; another Night-gown, 101—103.
 — (*continued*)—To make a Plain Skirt, with Patterns, 196 ; Dress and Tunic, with Patterns, 196—198.
 — for Girls Eight to Ten Years of Age.—Dresses, full Directions, with Patterns, 271, 272.
 — for Children, *see* CHILDREN, THE REARING AND MANAGEMENT OF.
 —, *see* Knickerbockers.
 — and Upholstery, *see* Cleaning.
 Clotted Cream, *see* Cream.
 Coach Horses, Historical Particulars, &c., of, 220.
 Coals, Economy in, 371.
 Coalfish, The, Remarks, &c., 263.
 Cocoa-nuts, 64.
 Cocoa-nut Cake, Making, &c., 64.
 — Cakes, Making, Baking, &c., 164.
 — Paste, 374.
 Cod, The, Remarks, Particulars, Directions for Cooking, &c., 255, 256.
 —, Baked Middle of, 256.
 —, Cold, (next day,) Directions, 262.
 — Steaks, Directions, 256.
 —, Salt, Particulars, Cooking, Serving, &c., 262 ; Egg Sauce for, *ib*.
 Cod's Head and Shoulders, Boiled, Directions, 262 ; Oyster Sauce for, *ib*. ; Directions for Helping, *ib*.
 — Sounds, Directions, 262.
 — Tongues, Directions, 262 ; Egg Sauce for, *ib*.
 Coffee, Directions for Making, 35.
 — as in France, 155.
 — Custards, *see* Custards.
 — Jelly, *see* Jelly.
 Cold, a Common, Particulars, 43 ; Nature and Symptoms, 43, 44.
 — (*continued*), Causes, 59 ; Treatment, *ib*.
 Coleworts, Particulars and Cultivation, 107.
 Colic, Particulars of, 43 ; Causes, *ib*. ; Treatment, *ib*.
 Cologne, *see* Eau de Cologne.
 Coloured Clothes, Washing, 144.
 — Fabrics, To clean, 75.
 — Muslins, Washing, &c., 144.
 — Plate IV., facing p. 193.—1. Asparagus on Toast ; 2. Cauliflowers ; 3. Salad ; 4. Potato Rissoles ; 5. Baked Tomatoes ; 6. Mashed Potatoes ; 7. French Beans.
 Consequences, Game of, 9.
 Conservatories, Remarks and Directions for the Erection of, with Illustrations, 228—230.
 —, Construction of (*continued*), Sashes, &c., with Illustrations, 289—291.
 Constipation, Particulars of, and Treatment, 69.
 Consumption, Remarks, 69 ; Nature of the Disease, *ib*.
 — (*continued*), Symptoms, 90 ; the Causes of Consumption, 90, 91 ; Climate, 91.
 — (*continued*), Impurity and Closeness of the Atmosphere, productive of, 106 ; Trades tending to produce, *ib*. ; Treatment, *ib*.
 COOKING :—
 —, Eggs, 5—7.
 —, Omelettes and Custards, 18—20.
 —, Omelettes, Custards, and Puddings, 35, 36.
 —, Custards (*continued*), Pies, Puddings and Cakes, 62—64.
 —, Cheese, Macaroni, Calf's - Head, Sweetbreads, Vol-au-vents, 66—68.
 —, Mutton, 82—84.
 —, Mutton (*continued*) ; Some Sweets and Savouries, 111, 112.
 —, Mutton (*continued*), 114, 115.
 —, Lamb, 115, 116.
 —, Pork, 116.
 —, Pie-crust, Pies, Patties, and Pâtés, 134, 135.
 —, Pies, Patties, &c., 157, 158 ; Pork, 158, 159 ; Poultry, 159, 160.
 —, Beef and Tripe, 163, 164.
 —, Veal, 189—191.
 —, Vegetables, 206—208.
 —, Vegetables (*continued*), 218, 219.
 —, Sea-fish, 226, 227.
 —, Sea-fish (*continued*), 255, 256.
 —, Sea-fish (*continued*), 262, 263.
 —, Sea-fish, Shrimps, Crustaceans, 283, 284.
 —, Crabs and Lobsters, 302—304.
 —, Sea-fish (*continued*), 314, 315.
 —, Bacon, &c., 315.
 —, Ham, &c., 315.
 —, Salt Pork, &c., 315.
 —, Fowls and Turkeys, 325—327.
 —, Turkeys (*continued*) ; Guinea Fowl, Pea Fowl, Pigeons, 342—344.
 —, Water-fowl (Tame and Wild), 366—368.
 —, Rabbits and Hares, 379, 380.
 Coprolites, Price and Properties of as a Manure, 15.
 Coral (Imitation), *see* Ornaments.
 Corals, Mode of Displaying, 369, 370.
 Cores, *see* Metal-working.
 Coriander, Particulars, 107 ; Culture, 108.
 Corn-drag, Tubular, Illustration, 372.
 Corn-salad, Particulars, 122 ; Culture, *ib*.
 —, Particulars of, Culture, &c., 299.
 Corn Solvent, Sir Humphry Davy's Receipt, 323.

- Costiveness.—General Remarks, 59; Two Kinds of, *ib.*
 — (continued).—Remarks, 68; Causes, *ib.*; Treatment, *ib.*
 Costmary, *see* HERBS.
 COTTAGE FARMING, *see* FARMING.
 Cottager, Manual Labours of, 238, 239.
 Counsellor's Pudding, *see* Pudding.
 Couve Tronchuda, or Portugal Cabbage, Particulars of, and Directions for Cooking, 208.
 Cow, Management of, on a Small Occupation: *viz.*, the Family or Cottager's Cow, 7, 8.
 — (continued), 44, 45; Family Dairy, 44; Feeding, *ib.*; Milking, 45; Figure of, 44; Milking Machine, 45.
 Cows, Dairy, the Housing, Feeding, and Management of (continued from p. 310, vol. i.), 173, 174.
 Cow-dung, Particulars, Value, and Mode of Application as Manure, 39.
 Crab, The, Remarks and Particulars, 302, 303; Dressed Crab, Directions, 303; Scaloped Crab, Directions, *ib.*
 Crape, To renovate, Directions, 131.
 Crayfish, The Fresh-water, full Remarks and Particulars, with Directions for Eating, Dressing, Cooking, &c., 283, 284.
 Crayon Drawings, To fix, 291.
 Crayons for drawing on Glass, To prepare, 291.
 Cream scientifically considered, 117.
 —, a Substitute for, 202.
 —, Ditto, 313.
 —, Clotted, Mode of Preparation, &c., 117.
 —, *see* Whipped Cream.
 Creams, *see* Ice-creams.
 Cress (American), Particulars and Culture, 299.
 — (Garden), Particulars and Culture, 299.
 Croquet, Particulars and Directions for Playing, 293, 294; Illustrations, 293.
 Crust, *see* Pie-crust.
 Cucumber, The: its Propagation under Bell-glasses and in the Open Air, 314.
 — (continued), Varieties, &c., 331; Soil, Ventilation, &c., 331, 332; Sowing for a Crop of Cucumbers in the Open Air, on the Natural Ground, without the Aid of Dung, 332.
 Curd scientifically considered, 117.
 — Custards, *see* Custards.
 Currant Custard, *see* Custard.
 — Syrup (Sirop de Groseilles), Making 62, 63.
 — Water, 192.
 Currants, Preserving, *see* Raspberry and Currant Jam.
 Curtain Bands, Directions for, 251.
 Curtains, Summer, To wash, 313.
 Cushions, Sofa, To stuff, 156.
 Custard, Baked, Instructions for Making, Baking, &c., 35.
 —, Baked, in a Crust, Instructions for Making, &c., 35.
 —, Currant, Directions for Making, with Particulars of, 62.
 — and Syrup, Directions for Making, Serving, &c., 62; Coloured Illustration, Plate III. (opposite p. 1).
 Custards, 18—20.
 —, Directions for Making, 35.
 —, Boiled, Directions for Making, 35.
 —, *see* Omelettes, Custards, and Puddings.
 —, Curd, Directions for Making, &c., 62.
 Cutlets, Broiled and Bread-crumbed, Directions for Dressing, Serving, Gravy, &c., 115.
 —, Plain Fried, Directions for Dressing, Frying, Serving, Sauce, Mashed Potatoes, &c., 114, 115.
 Cygnet, Roast, Particulars and Directions, 367.
 D.
 Dabs, *see* Flounders.
 Dairy Cows, *see* Cows.
 Damp Walls, *see* Walls.
 Deafness, General Remarks, 106, 107; Treatment, 107.
 — (continued), 126, 127; Treatment, 126; Deafness from Scarlet Fever, *ib.*; Deafness caused by Gout, 126, 127; Treatment, 127; Discharge from the Ear, *ib.*
 Debility, General Remarks and Particulars, 127.
 Decanters, To clean, 156.
 DECORATION, HOUSEHOLD, *see* FURNITURE AND DECORATION.
 Decorations, *see* Garden Furniture and Decorations.
 DECORATIVE ART, HOUSEHOLD; Imitation Ivory and Jet Ornaments for the Table, &c., 1.
 —, Casting in Plaster, 22—24.
 —, Indian Painting, in imitation of Ebony and Ivory, 65, 66.
 —, Fret-work and Carving in Wood, 84—86.
 —, Fret-work and Carving in Wood (continued), 103—105.
 —, Fret-work and Carving in Wood (continued), 113, 114.
 —, Fret-work and Carving in Wood (continued), 152, 153.
 —, Fret-work and Carving in Wood (continued), 184, 185.
 —, Fret-work and Carving in Wood (concluded), 300, 301.
 —, Skeleton Leaves (*q.v.*), 136—139.
 —, Glass Painting, 204—206.
 —, Glass Painting (continued), 247—251.
 —, Ornamental Jardinières, 257, 258.
 —, Gilding, 273—275.
 —, Cardboard Fret-work Flower-pot Ornaments, 337.
 —, Fancywork with Acorns; Mode of displaying Shells, Minerals, Insects, or Corals, as Drawing-room Ornaments, 369, 370.
 Dentifrice, Natural: the Strawberry, 323.
 Deodorisers, 15.
 Derbyshire Neck, *see* Goitre.
 Diabetes, 142, 143.
 — Insuperidus, 142.
 — Proper, or Diabetes Mellitus, Symptoms, 142, 143; Causes, 143; Treatment, *ib.*; Remedies, *ib.*
 Diapers, *see* Babies' Diapers.
 Diarrhoea, 143; Symptoms, *ib.*; Causes, *ib.*
 — (continued), Distinction between Cholera and Common Diarrhoea, 150; Treatment, *ib.*
 Dibbles, Various, 238.
 Die-sinking, 126.
 Diet, 29.
 Digestion, 2.
 Dill, Particulars, Cultivation, &c., 332.
 —, *see* HERBS.
 Diphtheria, Remarks, 150; Symptoms, 150, 151; Treatment, 151.
 Diphtheric Sore Throat, Remarks, with Treatment, &c., 151.
 DOMESTIC MEDICINE, *see* MEDICINE.
 Doublets, *see* Jewellers' Doublets.
 D'OYLEYS, ANTI-MACASSARS, &c., FROM NATURAL FOLIAGE, with Illustrations and Directions, 225, 226.
 Drainage, 237.
 Drawers for a Girl Eight Years of Age, full Directions, Admeasurements, &c., with Illustrations, 99—101.
 Drawing-room Ornaments, *see* Ornaments.
 Drawings, Coloured, *see* Oil-paintings.
 —, *see* Crayon Drawings.
 Dress, *see* Black Silk Dress.
 — and Tunic (Girl's), Particulars for Making, with Illustrations, 196—198.
 Dresses, *see* Clothing for Girls Eight to Ten Years of Age.
 Drill, *see* Hand-drill.
 Drink, Refreshing, 348.
 —, Pleasant Strengthening, Receipt for, 155.
 Drinks, *see* Iced Drinks.
 Dropsies — 1. Dropsy connected with Disease of the Heart, 171, 172; Treatment, *ib.* 2. Dropsy connected with Disease of the Liver, 172; Causes, *ib.*; Treatment, *ib.* 3. Dropsy connected with Disease of the Kidneys, or Bright's Disease, 172; Causes, *ib.*; Treatment, 172, 173. 4. Ovarian Dropsy, 173; Treatment, *ib.*
 Drunkenness—Remarks, 179; Treatment, &c., *ib.*
 Dry Meters, *see* Gas Meters.
 Ducks, Instructions for Purchasing, 139.
 Duck, Roast, Particulars, with Directions for Dressing, Cooking, Gravy, Accompaniments, &c., 366.
 — done in a Stewpan, Directions, 366.
 — done in a Stewpan with Green Peas, Directions, 366.
 — done in a Stewpan with Turnips, Directions, 366.
 — stewed with Olives, Directions, 366.
 —, Boiled, Directions, 366.
 —, *see* Wild Duck.
 Dutch Sauce, *see* Sauce.
 DYEING, A FEW WORDS ABOUT, 22.
 Dysentery, 195; Symptoms, *ib.*; Causes, *ib.*; Treatment, *ib.*
 Dyspepsia, Particulars of and Remarks upon, 214, 215; Symptoms, 215.
 — (continued), Causes.—1. Kinds of Food, *ib.*; 2. Want of Exercise and Fresh Air, *ib.*; 3. Mental Causes, *ib.*; 4. Bad Habits, *ib.*; 5. Personal Peculiarities, *ib.*; Treatment, 239, 240.
 — (concluded), Directions, 265, 266; Remarks and Advice concerning Opening Medicines and their Effects, 265; for Water Brash, Directions, 266; for Weakness of the Stomach, Directions, *ib.*; for Acidity of the Stomach, and for Heartburn, Directions, *ib.*; for Flatulence, Directions, *ib.*;
 E.
 Easel, *see* Table-easel.
 Eau de Cologne, To make, Directions, 103.
 Eel Patties, *see* Patties.
 — Pie, *see* Pie.
 Eggs, Remarks upon, 5, 6; their Remarkable Nature, 5; in Cookery (Hens' Eggs), 6; How to tell a Fresh Egg, *ib.*; Ways of Cooking, *ib.*; Roasted Eggs,

ib.; Boiled in the Shell, *ib.*; Poached Eggs, *ib.*; Fried Eggs, 7; Eggs done in their Dish, *ib.*; Hard-boiled Eggs, *ib.*; Scrambled Eggs, *ib.*; Beating Eggs, *ib.*

Eggs, Preservation of, 6.

—, Ducks', 6.

—, Turkey, 6.

—, Goose, 6.

—, Seagulls', 6.

—, Pullets', 6.

—, New-laid, 6.

—, When one cracks, 313.

—, Italian (à l'Italienne), Instructions for Preparing, 35.

—, Spun (Œufs en Filagramme), Instructions for Preparing, 35.

—, as Snow (Œufs à la Neige), Instructions for Preparing, 35.

—, in Paper Cases, Directions for Preparing and Baking, 35, 36.

—, Sauce, Directions, 262.

Elecampane Making, 311.

Electro-plate Stains, *see* Stains.

Embroidery, To bleach, 76.

Enamel Painting, 205, 206; *see* Glass Painting.

Endive, Particulars, Cultivation of, &c., 332.

Engraving, 126.

Envelope-holder, An Upright for, 105; Illustration, 104.

Epilepsy, Remarks, 266; Symptoms, *ib.*; Causes, 266, 267; Treatment, 267.

Erysipelas, Remarks, 279; Symptoms, *ib.*; Causes, *ib.*; Treatment, *ib.*

Erythema, Remarks, 279; *Erythema nodosum, ib.*; Causes, *ib.*; Treatment, *ib.*; *Erythema intertrigo, ib.*

Everton Toffee, *see* Toffee.

Extract of Meat, *see* Meat.

Eye, To remove a Speck or an Eyelash from, 202.

F.

Faintness—Remarks, 299; Causes, *ib.*; Treatment, 299, 300.

FANS, AND HOW TO MAKE THEM, with Illustrations, 305—308.

Farm, Cottage, Division of, 237, 238.

FARMING, COTTAGE.—Artificial Manures, 14, 15.

—, Artificial and other Manures (*continued*), 39.

—, Artificial and other Manures (*continued*), 60, 61.

—, Artificial and other Manures (*continued*), 236; Spade Husbandry, 236—239.

—, Park Farming.—Grass-land, Particulars, with Illustrations of Tubular Corn-drag, Chain-harrow, Combination of Scythe and Rake, and Four-barred Hurdle, 372—374.

Fœvus, see Ringworm.

FEATHERS, TO PREPARE, 195.

—, Screens of, *see* Screens.

Feet, Offensive, 348.

Fences, Fancy Method of Tarring, 171.

Fennel, Particulars of, and Cultivation, 350.

—, *see* HERBS.

Filberts, 215.

Filter, a Cheap, To make, 365.

Filters, 37.

Finger Bowls, with Rose-water, 280.

—, Glasses, 280.

—, Nails, The Management of the, 348.

Finnan Haddies, Directions, 263.

Fire, To check, when first discovered, 174, 175.

—, an Alarm of, How to proceed in Case of, 175.

—, Chimneys on, Directions, 175.

—, Clothes on, Directions, 175.

—, Loss of Life by, Precautions against, 175.

FIRES, HOW TO MANAGE, 185—187.

—, Fire through, 174.

—, ACCIDENTAL.—Ordinary Precautions, 174; Lucifer Matches, *ib.*; Candles, *ib.*; Gas, *ib.*; Fires, *ib.*; to check Fire when first discovered, 174, 175; Precautions against Loss of Life by Fire, 175; How to proceed in Case of an Alarm of Fire, *ib.*; Clothes on Fire, *ib.*; Chimneys on Fire, *ib.*

FIRE-PAPERS, STOVE-BOARDS, &c., Full Particulars and Instructions for Making, with Illustrations, 165—170; Flowers, 166; Curtains, 167.

—, Screens, Sèvres China, 170; Illustration, 165.

Fish.—Scientific Particulars of, 95; Relative Value of different Fish as Articles of Food, *ib.*; Respective Waste in different Kinds of Fish, *ib.*; Particulars of Difference in the Composition of the Edible Parts of Different Fish, *ib.*; Flesh-formers in Fish, *ib.*

—, Sea (Cooking), &c.—Turbot, Boiled, 226; the Brill, *ib.*; the Sole, *ib.*;

Boiled Sole, 226, 227; Baked Soles, Norman Fashion, 227; Fried Soles, *ib.*; the Lemon Sole, *ib.*; Flounders and Dabs, *ib.*;

Water Souchy, *ib.*; the Halibut, *ib.*; Halibut Souchy, *ib.*

— (*continued*).—The Plaice, 255; Plaice or Flounder, with Norman Sauce, *ib.*;

John Dory, *ib.*; the Cod, 255, 256; Cod Steaks, 256; Baked Middle of Cod, *ib.*

— (*continued*).—Boiled Cod's-head and Shoulders, 262; Oyster Sauce, *ib.*;

Cold Cod, next day, *ib.*; Salt Cod, *ib.*;

Egg Sauce, *ib.*; Cods' Sounds and Tongues, *ib.*; the Haddock, 262, 263;

Baked Haddock, 263; Stuffed ditto, *ib.*;

Finnan Haddies, *ib.*; the Whiting, *ib.*;

the Coalfish, *ib.*; Ling and Hake, *ib.*;

the Whiting Pout, *ib.*; the Gurnard, *ib.*

— (*continued*).—The Red Mullet, or Surmullet, 283; Oysters, *ib.*;

Oyster Pie, *ib.*;

Sea-urchins, *ib.*;

the Fresh-water Cray-fish, 283, 284; Shrimps, 284;

Shrimp Salad, *ib.*;

Shrimp Patties, or Vol-au-vent, *ib.*

— (*continued*).—Mackerel, Cooking, Various Ways, 314, 315. *See* Mackerel.

—, Seasonable, 127, 261, 323.

—, Smoking, 96.

Fishing, *see* Sea Fishing.

Flannels and Woollen Hose, To clean, Full Directions, with Illustrations, 109.

Flasks, *see* Moulds.

Flatulence and Windy Spasm.—Flatulence, Remarks, Methods of Prevention, Treatment, &c., 340; Windy Spasm, Particulars of, Treatment, &c., 340, 341.

Fleas, Method of Destroying, 313.

—, To prevent, 348.

Flesh-formers, 94.

Flounders and Dabs, Remarks, Cooking, &c., 227.

FLOUR, *see* BREAD-MAKING.

Flower Baskets, Hanging, Directions for Making, &c., with Illustrations, 291.

FLOWER GARDEN, THE.—Style, 357; Particulars, with Plans and Illustrations, *ib.*

—, Pot Ornaments, *see* Cardboard.

—, Pots, *see* Gilding.

—, STANDS, *see* FRUIT and FLOWER STANDS.

FLOWERS, DIRECTIONS FOR DRESSING GLASS STANDS OR DISHES WITH, with Illustrations, 264, 265.

FLY-CAGES, POINT-LACE PAPER, Directions for Making, with Illustrations, 252, 253.

Fondue of Cheese, Preparation of, and Serving, 66.

Food.—Digestion, Changes in the Mouth, Changes in the Stomach, Changes in the Intestines, Conversion of Food into Blood, 2, 3.

— (*continued*).—Animal Food, 54, 55; Nature of Flesh, 55.

— (*continued*).—Butcher's Meat, 94; Roasting Meat, *ib.*;

Boiling Meat, 94, 95; Beef-tea Broth, 95; Bones, Gelatine, 95; Fish, *ib.*;

Preservation of Meat, 95, 96.

— (*continued*).—Milk, 117; Composition of Milk, *ib.*;

Cream and Butter, *ib.*;

Skim Milk, *ib.*;

Curd, *ib.*;

the Curdling of Milk by Acids, 117, 118.

— (*continued*).—Cheese, 156; Whey, Sugar of Milk, 156, 157; Average Composition of good Cow's Milk, 157;

Adulterations of Milk, the Lactometer, *ib.*

—, On the Water contained in, Remarks, 330; Vegetables, 330, 331.

—, *see* Seasonable Food.

Fountains, full Particulars and Construction of, with Eight Illustrations, 97—99.

Fowl, the Common or Domestic, Remarks, full Particulars and Directions respecting Fowls for the Table, Dressing, &c., 159, 160.

—, Roast—Trussing, Serving, and full Particulars, 160.

—, Roasted on a String, not a Jack, 160.

—, *see* Water Fowl.

—, *see* Wild Fowl.

Fowls, Instructions for Purchasing, 139.

—, Directions for Dressing, Cooking, Sauces, &c.—Boiled, 325; Poulet au Riz (Fowl stewed with Rice), *ib.*;

Broiled, *ib.*;

Fricassee, 325, 326; Fricassee à la Bressane, 326.

—, Old; To cook, 160.

Fowl-houses, *see* Asphalte.

Fragments, 323.

Frame for a Photograph, Directions, 105; Illustration, *ib.*

Frames, *see* Picture Frames.

Frames, *see* Gilt Frames.

French Polish for Boots and Shoes, To make, 219.

French Polish, Directions for Making, 322, 323.

Fret-work and Carving in Wood.—General Remarks, 84; Tools, Particulars of, 84, 85;

Substitute for a Work-bench, 85; Figure of, *ib.*;

Sawing Fret-work, "Horse" for, 85, 86; Illustration, 85.

— (*continued*).—General Remarks, Woods, &c., 103, 104; Patterns, 104;

Directions, *ib.*;

End of a Bookslide, with Illustrations, 104, 105; Directions, *ib.*;

Table-easel, with Illustration, 105; Frame for a Photograph, with Illustration, *ib.*;

an Upright for a Standing Card-rack or Envelope-holder, *ib.*;

Illustration, 104.

Fret-work and Carving in Wood (*continued*).—Drawing the Design, Blocking out and Finishing, Directions, 113; Bread Platter, Directions, 113, 114; Illustration, 113; Inkstand, Directions, 113, 114; Illustrations, 113; Picture Frame, Particulars, 114; Illustration, 113.

—(*continued*).—Illustration of a Small Bracket, with Directions for Making, 152; Hanging Card-rack, Illustrations and Directions, 152, 153; Cover of a Large Photographic Album or Blotting Book, 152; Illustration, 153.

—(*continued*).—Staining, 184; Polishing and Varnishing, 184, 185; Illustrations, 184; Illustration of a What-not, 185.

—(*concluded*).—Hanging Book-shelves, 300; Illustration, 301; Fret-work Patterns, Series of, with Illustrations, 300, 301; Card Basket Design for, with Illustrations, *ib.*

Fret-work, *see* Cardboard.

Fruit, Seasonable, 127, 261, 323.

—, Preserving, 371.

—, Essences, 192.

—, Jellies, Directions for Making, &c., 347.

FRUIT AND FLOWER STANDS FOR TABLE DECORATION, Directions for Dressing, &c., 279, 280; Illustrations, 280.

FRUIT ROOM, TILE, Directions for, 215.

Furniture, To clean, 183.

—, Dirty or Stained, To clean, 183.

—, *see* Garden Furniture.

—, Home-made, Cheap, Simple, and Tasteful—Table, with Illustrations, 312, 313.

FURNITURE AND DECORATION, HOUSEHOLD, PRINCIPLES OF GOOD TASTE IN (*Introduction*), 9, 10; Fitness and Propriety, 9; Form and Colour, 10.

—, Wall Paper, 39—42.

—, Carpets and other Floor Coverings, with Illustrations, 200—202.

—, *see* Garden Furniture and Decorations.

G.

Game, Seasonable, *see* SEASONABLE FOOD.

GARDEN DECORATION, Taste in the Construction of Rock-work, Grottoes, &c., 327—329.

Garden Furniture and Decorations (*continued*), 33, 34; Square Seats or "Settles," 33; Making, *ib.*; Figures of, *ib.*; Rustic Table, Making, 33, 34; Figures of, 33; Rustic Seat with Back and Elbow, and others, Making, 34; Figure of, 33; Seat put round a Tree, Making, 34; Figure of, 33.

—(*continued*).—Summer-houses, Choice of Site, 71; Raising the Floor, *ib.*; Figure, 72; Erection, Uprights, &c., 71, 72; Roof, 71—75; Figures, 72; more Decorative Portions, 72—75; Illustrations of Various Designs for Summer-houses and Parts, 72, 73; Steps, 73, 74; Various Forms of Summer-houses, their Construction, 74; Timber for, *ib.*; Thatching, *ib.*; Tools, 75.

—(*continued*).—Rock-work, Materials for Erection of, &c., 86; Tree-beds, Directions for Making, *ib.*; Borders, full Particulars, with Description of the Various Kinds and Designs, 86, 87; Illustrations, 88, 89; Garden Brackets, their Construction and Various Designs,

87; Illustrations of, 88, 89; Elegant Novelty—"Watsonian Patent Fern Brick"—use of in Erecting Conservatory and other Walls, 87; Illustrations, 89; Another Novelty—"Foxley's Beaded Bricks"—to supersede Trellis-work, 88; Illustration of Wall constructed with, 87; Figure of Brick, 89; Window Boxes, Particulars and Description of, 88; Figure, *ib.*; Figure of Flower Box constructed of Ornamental Tiles, *ib.*; Flower-baskets, their Several Kinds, and Construction of in Wood, with full Directions, 88, 89; Figures of Parts, *ib.*; Illustration of Encaustic Basket or Vase, 88; Illustrations of other Vases, 89.

Garden Furniture and Decorations (*continued*).—Fountains, 97—99.

—, Palings, Paint for, 103.

—, Seats, *see* Garden Furniture.

—, Tables, *see* Garden Furniture.

—, Walks, *see* Asphalte.

GARDENING, HOME.—Broccoli, 10, 11.

—, Broccoli (*continued*), 30.

—, Broccoli (*continued*), Brussels Sprouts, Cabbages, 42, 43.

—, Cabbages (*continued*), Coleworts, Coriander, 107, 108.

—, Capsicum, Corn-salad, the Carrot, the Chardoon, 122, 123.

—, The Chardoon (*continued*), the Cauliflower, 187.

—, The Cauliflower (*continued*), 240.

—, Celeriac, Chives, Camomile, Celery, 277, 278.

—, Celery (*continued*), Chervil, Clary, Corn-salad, Cress, 298, 299.

—, The Cucumber, 314.

—, The Cucumber (*continued*), Dill, Endive, 331, 332.

—, Fennel, Garlic, 349, 350.

Garlic, Particulars of and Cultivation, 350.

—, Vinegar, *see* Vinegar.

Garters for Children superseded, 287.

Gas, Fire through, 174.

—, Meters, 17, 18; Description and Illustration of the Construction and Working of, 17; Measurement of, *ib.*; Mr. Clegg's Meter, *ib.*; Mr. John Malam's Meter, *ib.*; "Wet" and "Dry" Meters, *ib.*; Wet Meter, Description of, *ib.*; Figure of, *ib.*; Action of the Meter, *ib.*; Sectional View of, 18; Figure, 17; Arrangement for Measuring the Gas Consumed, 18; Figure, 17; Objections to Wet Meter, 18.

—(*continued*), The Dry Meter, 49, 50; Front View of, 49; Figures of Parts, *ib.*, Action of the Dry Meter, 50.

Gastric Juice, 2, 3.

Gaufres, Light (very tempting and nice), Making, Serving, &c., 64.

—, [Wafers] (Another Way), Making, Cooking, &c., 64.

Geese, Instructions for Purchasing, 139.

Gelatine, Scientific Particulars, 95; Modes of Formation, *ib.*; its Flesh-forming Power, doubtful, *ib.*; its Value as Food, *ib.*

Gilded Beadings, 199.

Gilding.—Particulars, Directions, Small Articles, &c., 273, 274; Brushes, with Illustrations, 274; to prepare Casts, *ib.*; Plaster Brackets, *ib.*; Illustrations, 273; Inside Window Boxes, Rustic Stands, &c., 274; Illustrations, 273; How Picture-frames are Gilt, 274, 275; Window Boxes, *ib.*; Illustrations, 273;

Flower-pots, 275; Articles of Furniture, &c., *ib.*; Illustrations, 273; Varnish for Gold, *ib.*

Gilding Leather, *see* Leather.

Gilt Frames, To revive, 90.

—, Lamps, To clean, 365.

Ginger Beer, Mrs. Rundell's Receipt for, 192.

—, Candy, To make, 341.

—, Drops, Making, 341.

Girls' Clothing, *see* Clothing.

Girth-drying Frame, Illustration of, 359.

Glass, *see* Stained Glass.

—, Houses, *see* Conservatories.

—, Painting, 204; Materials, *ib.*; Tools, *ib.*; Brushes, *ib.*; Stained Glass, 204, 205; Enamel Painting, 205, 206.

—(*continued*), Biting-in, 247, 248; Illustration, 249; Cutting-out, 249, 250; Illustrations, 248, 249; Leading, 250; Stained Glass, 250, 251; Illustrations, 248, 249; Enamel Painting, 250, 251; Illustrations, 248, 249.

Glaze, *see* Meat Glaze.

Gloves and Glove-cleaning, full Particulars, and Directions, 153, 154.

—, Coloured or Doeskin, To clean, Directions, 121, 122.

—, Kid, To clean, 14.

—, Wash-leather, Cleaning, &c., 155; Another Way, *ib.*

Glue, To make, 80.

—, Stiffening, for stiffening Dark Chintzes or Calicoes, 122.

Goffering, 181.

Goitres, Particulars, 354, 355; Treatment, 355.

Gold Watch Chains, &c., To clean, 322.

Goldsmith's Work: Engraving, Particulars, 125, 126.

Goose, The Domestic (Cooking), Particulars, 366, 367; Hashed, 367; St. Martin's Goose, *ib.*

—, *see* Wild Goose; Marbled Goose.

Gooseberries, Green, to preserve, full Directions, 63.

Gooseberry Pie, Green, Directions for Making, 63.

Gout, *see* Tisane for Gout.

Governess, The, Remarks, &c., concerning, 247.

—(*continued*), Remarks and Particulars, 319, 320.

Graining to Imitate Oak, 199.

Grapes, 215.

Grape Wine, *see* WINES.

Grass Land, 238.

—, 372—374, *see* FARMING.

Graves's Disease, *see* Goitres.

Grease-spots, To remove, 14.

Greengages, Preserving, 347.

Green Gooseberry Pie, *see* Gooseberry Pie.

Green Grape Wine, *see* WINES.

Grottoes, *see* Rock-work.

Ground Rice Pudding, *see* Rice Pudding.

Grouse, Instructions for Purchasing, 139.

Guano, where from, Qualities of, and Rules for Purchasing, 39.

—, Native, its Properties, Value, &c., 236.

Guinea Fowl, Cooking; Particulars and Description of the Guinea Fowl, 343; Trussing, Dressing, Stuffing, &c., 343; Sauces, 343.

—, Fowls' Eggs, 343.

Gum-water, To make, 371.

Gurnards, The, Particulars, Directions for Dressing, Serving, &c., 263.

Gypsum, *see* Lime, Sulphate of.

H.

Hacks and Harness Horses. — Hack and Harness Horse, 26; Price, *ib.*; Qualities, 26, 27; Vices, 27; Age, *ib.*; Size, *ib.*; Paces, *ib.*; Sex, *ib.*; Market, 27, 28.

—, The Omnibus Horse and Machiner, Particulars of, 55; Cart Horses, 55—58; Figure of Hack Horse, 56; of Harness Horse, *ib.*; of the Suffolk Punch, 57; of the Dray Horse, *ib.*; Particular Breeds of Cart Horses, 58; Particulars of the Clydesdale, *ib.*; of the Suffolk, *ib.*; of the English Cart Horse, *ib.*; of the Dray Horse, *ib.*

Hacks. — Covert Hack, 133; Illustration of, *ib.*; Park Hack, 133, 134.

—, *see* HORSE, THE.

Haddies, *see* Finnan Haddies.

Haddock, The, Remarks, 262, 263; Baked, 263.

Haggis, Directions, 111.

Hair, To wash, 13.

—, Pomatum for the, 13.

—, Diseased State of the, *see* Ringworm.

—, Loss of the, *see* Ringworm.

—, Disorders of the, and their Treatment (continued). — Thinning of the Hair, Causes of and Treatment for, 78, 79.

Hair-brushes, To wash, 13; Figures of, *ib.*

Hake, Remarks and Directions for Dressing, 263.

Halibut, The, Remarks and Particulars; Cooking, Serving, Sauce, &c., 227.

— Souchy, Directions, 227.

Hams, Keeping, &c., 315; a good Pickle for Hams to be Smoked, *ib.*; Curing a Warwickshire Ham, *ib.*

Hand Drill, with Illustration, 237, 238.

Handkerchief, *see* Pocket-handkerchief.

Hand-lines, *see* Lines.

Hard-bake, Almond, 374.

Hare, Roast, Full Particulars and Directions for Cooking, &c., 380.

— Cheese, Directions for Making, &c., 157, 158.

— Pâté, *see* Pâté.

Hares, Instructions for Purchasing, 139.

Harmattan, Illustration of, 132.

Harness, Single, *see* Single Harness.

Harness Horses, *see* HORSE, THE.

—, *see* Hack and Harness Horses.

Harrow, Chain, Illustration, 372.

Hash, 112.

Hashed Calf's Head, *see* Calf's Head.

Hat for a Baby-boy, How to make, 13; Figure of, 12.

HATS, AND HOW TO TREAT THEM, 154, 155.

Herb Mixture, Particulars, 219.

HERBS, THEIR DOMESTIC USES, PROPERTIES, AND CULTURE. — Remarks, 267; Thyme, *ib.*; Sage, *ib.*; Marjoram, 267, 268; Savory, 268; Mint, with Illustration, *ib.*; Parsley, *ib.*; Basil, 269; Clary, *ib.*; Tansy, *ib.*; Fennel, *ib.*; Dill, *ib.*; Tarragon, *ib.*; Chervil, with Illustration, *ib.*; Marigold, *ib.*; Illustration, 268; Rue, 270; Illustration, 269; Hyssop, 270; Illustration, 269; Rosemary, 270; Lavender, *ib.*; Balm, *ib.*; Camomile, *ib.*; Caraway, *ib.*; Laurel or Bay Leaves, *ib.*; Illustration, 268; Costmary or Alecost, 270.

—, Directions for Drying and Preserving, 219.

—, Dried, Remarks, 347.

—, Dried, Directions, 348.

Hiccough, To stop Ordinary, 287.

Hodge-podge, Directions for Making, &c., 164.

HOME GARDENING, *see* GARDENING.

HOME-MADE WINES, *see* WINES.

HORSE, THE, Breeding and Breaking (concluded); Expenses, 26; Rarey's Method, *ib.*

—, Feeding, *see* HORSE, THE; Stable Management and Feeding.

—, Hack and Harness Horses (continued). — The Cleveland, 81; Figure of "The Cleveland Short Legs," *ib.*; Other Varieties, *ib.*; Stabling, *ib.*; Food of the Agricultural Horse, *ib.*; Ponies and Pleasure Hacks: Ponies, their Usefulness, Uses, Various Classes, &c., 82.

—, Ponies and Pleasure Hacks (continued), 132—134; Illustrations, 132, 133; *see* Hacks.

—, The Harness Horse. — High-class Carriage Horse, 145; Illustration of, *ib.*; Light Phaeton and Brougham Horses, 146; of Single Harness, *ib.*

—, Coach Horses, 220; Hunters, 220—222. *See* Coach Horses; Hunters.

—, Hunters (concluded), 284, 285.

—, Stable Management and Feeding. — General Principles, 285; Feeding, *ib.*; Quantity, *ib.*; Hay, *ib.*; Oats, 286; Beans, *ib.*; Mash of Bran and Oats, *ib.*; Water, *ib.*; Green Meat, *ib.*; Turning out, *ib.*; Litter, *ib.*

—, Stabling; Stable Accessories; Harness, &c., 358, 359.

—, Dentition of, Particulars, 359.

Horses, *see* Hack and Harness Horses.

Horius Sicus, The Best and Easiest Mode of Drying Plants, 251.

Hose, *see* Woollen Hose.

HOUSE, THE. — The Store-room, 346—348.

—, Water Supply (continued), 36, 37.

—, Water Supply (continued), 260, 261.

HOUSE, INMATES OF THE. — DOMESTIC. — The Lady's-maid (concluded), 13, 14.

—, Laundry-maid—Washing at Home, 50, 51.

—, The Laundry-maid (continued), 143, 144.

—, The Laundry-maid (concluded), 181, 182; Nurse and Nursery-maid, 182, 183.

—, Nurse and Nursery-maid (concluded), 246, 247; The Governess, 247.

—, The Governess (continued), 319, 320.

HOUSE, INMATES OF THE. — LEGAL. — Husband and Wife, 46—48.

—, Births, 110.

—, Bills and Notes, 118, 119.

—, Bills and Notes (continued), 146—148.

—, Bills and Notes (continued), 222—224.

—, Landlord and Tenant, 258, 259.

—, Landlord and Tenant (continued), 338—340.

HOUSEHOLD AMUSEMENTS, *see* AMUSEMENTS.

— CHEMISTRY, *see* CHEMISTRY.

— DECORATIVE ART, *see* DECORATIVE ART.

— FURNITURE AND DECORATION, *see* FURNITURE AND DECORATION.

— MECHANIC, THE, *see* MECHANIC, THE HOUSEHOLD.

Houses, Letting of, *see* Landlord and Tenant.

House-top, Leakage, 371.

Hunters. — Remarks, 220, 221; a Poor Man's Hunter, 221; the Hunter Proper, 221, 222; Size, 222; Age, *ib.*; Illustration of High-class Northamptonshire Hunter, 221. *See* Steeplechaser.

— (concluded). — Irish Hunter, 284, 285; the Steeplechaser, 285.

Hurdle, Four-barred, Illustration, 373.

Husband and Wife. — Reciprocal Rights and Duties of, 46; Marriage, *ib.*; Disabilities and Incapacities, *ib.*; Different Modes by which the Marriage Contract may be entered into, 46, 47; Husband's Right in his Wife's Personal Property, 47; Wife's Clothing, Jewels, Trinkets, &c., *ib.*; her Paraphernalia, *ib.*; Husband's Right in his Wife's Leasehold Property, *ib.*; his Right in her Freehold Property, *ib.*; Settlements, 47, 48; Husband's Liabilities for his Wife's Debts, 48; Separation, *ib.*; Wife's Property after Desertion, *ib.*

Husbandry, *see* Spade Husbandry.

Hyssop, *see* HERBS.

I.

ICE. — Remarks and Particulars, with Directions for Building Ice-houses, Illustrated, 309—311; Freezing Mixtures, 311; Ice-making Machines, *ib.*; Ice-chests, *ib.*; Ice-safes, or Refrigerators, *ib.*

— Creams (Strawberry), 362; (Raspberry, Currant, and Pine-apple), *ib.*; (Vanilla), *ib.*; (Ginger), *ib.*; (Lemon), *ib.*; (Italian), *ib.*; (Orgeat), *ib.*

Iced-cream Soda Water, 363.

Iced Drinks, 362, 263. *See* under their Respective Heads.

ICES AND ICED DRINKS, METHODS OF MAKING, 362.

—, *see* Water-ices.

Indemnity, *see* Landlord and Tenant.

Indian Painting in Imitation of Ebony and Ivory, full Instructions, 65, 66; Three Illustrations (Fancy Border Chess-board and Box), 65.

Indigestion, 2.

Infants' Shoes, *see* Shoes.

Influenza, Symptoms, &c., 59; Causes, *ib.*; Treatment, *ib.*

INK, *see* WRITING INK.

— Stains, to take out from Mahogany, 48.

—, *see* Stains.

Inkstand, Instructions for Designing, Carving, &c., 113, 114; Illustration of, with Illustrations of Parts, 113.

INMATES OF THE HOUSE, *see* HOUSE.

Insects, Mode of Displaying, 369, 370.

Intestinal Juice, 3.

I O U's, Particulars of, 224.

Iron Stand, 286, 287.

Ironing, Directions, 144.

Italian Pudding, *see* Pudding.

Ivory Ornaments, Cleaning, &c., 348, 349. — (Imitation), *see* Ornaments.

IVY, PORTABLE SCREEN OF, full Particulars, with Illustration, 341, 342.

J.

Jam Omelettes, *see* Omelettes.

Jams, Directions for Making, Potting,

Keeping, &c., 346, 347. *See* under their respective Names.
 Jardinières, Ornamental, Remarks on, and full Directions for Making, with Illustrations, 257, 258.
 —, *see* Gilding (Flower-pots, 275).
 Jellies, *see* Fruit Jellies.
 Jelly, Coffee, Directions for Making, &c., 112.
 —, Sweet, for Twenty Guests, Directions for Making, &c., 112.
 Jerusalem Artichoke, *see* Artichoke.
 Jet, Imitation, *see* Ornaments.
 Jewellers' Doublets, &c., 48.
 Jewellery, Gilt, To clean, 348.
 John Dory, Particulars of, with Directions for Cooking, Serving, &c., 255; Remarks, *ib.*

K.

Kid Gloves, *see* Gloves.
 Kidney Omelettes, *see* Omelettes.
 Kidneys, Mutton, Broiled or Roasted—Directions for Dressing, Cooking, and Serving, 111.
 —, Stewed or Sautéd, full Directions for Dressing and Serving, 111
 —, Veal, ditto, 111.
 Kitchen Table, To keep clean, 371.
 Kite-making, 149, 150; Illustrations, 149.
 — and Kite-flying (*continued*), Fancy Kites, 188, 189; Illustrations, 188.
 Knickerbockers for a Boy of Eight.—Particulars, Directions for Making, &c., with Illustrations, 361, 362.
 Knight of the Whistle, The (a sort of modified "Blind Man's Buff"), 8.
 Knives, To clean, Directions, 251.

L.

Lace, Getting up, 181, 182.
 —, Border, *see* Lace.
 —, To clean, 75, 76.
 —, To bleach, 76.
 —, Gold and Silver, To clean, 90.
 LACE WORK, *see* POINT LACE WORK.
 Lacteals, 3.
 Lady's-maid (*concluded*).—To clean Trinkets, 13; to wash Hair, *ib.*; to wash Hair-brushes, *ib.*; Pomatum for the Hair, *ib.*; to remove Grease-spots from Silk, 14; to revive Black Silk, *ib.*; to keep Silk, *ib.*; to clean Kid Gloves, *ib.*; to clean Tweed Cloth Cloaks and other Woollens, *ib.*; to clean White Satin Shoes, *ib.*; the Teeth, *ib.*; Artificial Teeth, *ib.*; Nails, *ib.*
 Lamb.—General Remarks and Particulars, 115, 116; Hind-quarter, Fore-quarter, *ib.*; Mint-sauce for, Directions, 116; Salad with, *ib.*; Suitable Vegetables, *ib.*
 — Chops, with Cucumber Sauce; full Directions for Dressing and Cooking, 116.
 LAMPS, HOUSEHOLD.—Petroleum (not Paraffine) Lamps, full Particulars, with Illustrations, 202—204.
 —, *see* Gilt Lamps.
 Landlord and Tenant.—Remarks, 258; Leases for Years, 258, 259; Tenancies from Year to Year, 259.
 — (*continued*).—Agreements for Letting Houses, 338; Furnished Lodgings, *ib.*; Small Tenements, 338, 339; Leases, 339; Sale of the Goodwill of a Shop

and Fixtures, *ib.*; Indemnity against Arrears, 340; Receipt for Rent, *ib.*
 Lark Pâté, *see* Pâté.
 Larks, Instructions for Purchasing, 139.
 Laundry, Hints for the, 90.
 Laundrymaid.—Washing at Home, 50, 51; Washing-machines, 50; White Linen, *ib.*; Coloured Things, *ib.*; Flannels, *ib.*; White Things, 50, 51; Hanging-out, 51; Waistcoats and Trousers, *ib.*
 — (*continued*).—Washing, &c., 143, 144; to make Starch, 144; Ironing, *ib.*
 — (*concluded*).—Goffering, 181; Muslin Curtains, *ib.*; Cashmere, *ib.*; Merino, *ib.*; White Alpaca, *ib.*; Black Silk Stockings, *ib.*; Lace, *ib.*; Border Lace, 181, 182; Clear-starching, 182; Blonde, *ib.*
 Laurel, *see* HERBS.
 Lavender, *see* HERBS.
 Leading, *see* Glass Painting.
 Lease of a Dwelling-house, *see* Landlord and Tenant.
 Leases for Years, *see* Landlord and Tenant.
 Leather, To gild, 291.
 Leaves, Fancywork with, 29.
 Leeks, Directions for Use, 207.
 Lemonade, Directions for Making, 192.
 Lemon Cheesecakes, *see* Cheesecakes.
 — Peel, To preserve, 322.
 — Tarts or Tartlets, *see* Tarts.
 — Thyme, *see* HERBS.
 License, Special (for Marriage), 46, 47.
 License (for Marriage), Ordinary's or Surrogate's, 46.
 —, Superintendent Registrar's Certificate, with, 46, 47.
 —, Superintendent Registrar's Certificate, without, 46, 47.
 Liebig Sandwiches, 371.
 Light Gaufrés, *see* Gaufrés.
 Lime, Carbonate of, Forms in which it is used in Agriculture; its Uses, Properties, and Application, 15.
 —, Sulphate of (Gypsum); its Price, Uses in Agriculture, &c., 15.
 Linen, To stiffen, 76.
 —, Discoloured, To whiten, 313.
 —, Stains in, *see* Stains.
 Lines, *see* Sea Fishing.
 Ling, Remarks and Directions for Dressing, 263.
 Lingerie, To bleach, 76.
 Little Ladies' Tart, Making, 63.
 Liver, The, 3.
 Lobster, The.—Remarks and Particulars, 303, 304; Plain, Split, and Cracked, Directions, 304; with Piquant Sauce, *ib.*; Lobster Mayonnaise, *ib.*; Lobster Curry, *ib.*; Lobster Salad, *ib.*; Gratin of Lobsters, *ib.*
 Lodgers, Particulars, 259.
 Lodgings, Furnished, *see* Landlord and Tenant.
 Looking-glasses, To clean, 183, 251.
 Lozenges, How to make, 374.
 —, Cinnamon, 374.
 Lucifer Matches, Fire through, 174.
 Lymphatic System, 3.

M.

Macaroni *au gratin* (Ovened, with Cheese), Making, Serving, and Particulars of, 66.
 — Pudding (Sweet Dish), Preparation of, 66, 67.
 Mackerel, Directions for Dressing, Cooking, &c.—Broiled Mackerel and Tarra-

gon Butter, 314; Boiled Mackerel, *ib.*; Stuffed Mackerel, Broiled, *ib.*; Mackerel à la Poulette, stewed White, *ib.*; plain Boiled Mackerel, 314, 315.
 Mackerel Pie or Pâté, *see* Pie.
 Mahogany, New, To render like Old, 183.
 —, *see* Ink-stains.
 Makeshift Water-still, 37; Figure of, 36.
 — Well, 37.
 Mallard, *see* Wild Duck.
 Mangold-wurzel, Salt necessary to the Growth of, 14, 15.
 Manures, Artificial, &c.—Manufacture of, 14; Bones, Guano, Chopped Woollen Rags, &c., *ib.*; Agricultural Salt, 14, 15; Nitrate of Soda, 15; Nitrate of Potash (Saltpetre), *ib.*; Muriate of Potash, *ib.*; Wood-ashes, *ib.*; Sulphate of Ammonia, *ib.*; Carbonate of Lime, *ib.*; Sulphate of Lime (Gypsum), *ib.*; Coprolites, *ib.*
 — (*continued*).—Bone Phosphate, 39; Phosphoric Rock (Apatite), *ib.*; Phosphate of Lime, *ib.*; Sulphuric Acid, *ib.*; Guano, *ib.*; Specific Manures, *ib.*; Cow-dung, *ib.*; Pig-dung, *ib.*
 — (*continued*).—"Cottage Commode" or Earth-closet, 60; Engraving of, *ib.*; Arrangements for, *ib.*; General Rules for Manuring, 60, 61.
 — (*concluded*).—Native Guano, 236.
 —, Specific, Particulars and Price, 39.
 Maps, To mount, 156.
 Marble, To stain Artificially, 171.
 —, Sienna, Imitation of, 199.
 Marbled Goose, Directions for Dressing, Cooking, &c., 368.
 Marigold, *see* HERBS.
 Marjoram, *see* HERBS.
 MARKETING.—Poultry, Game, &c., 139.
 Marking-ink Stains, To remove, from Linen, &c., 322.
 Marmalade, Orange, Making, &c., 64.
 Marriage, Disabilities and Incapabilities for, 46; Different Modes of, 46, 47, *see* Husband and Wife.
 MATS FOR DINNER AND BREAKFAST TABLES.—Directions for Making, with Illustrations, 345, 346.
 Meat, Butcher's, Composition of, 94; Selection of, *ib.*; Difficult of Digestion, *ib.*; Digestible, *ib.*; to judge of the Quality of, Dr. Letheby's Directions, *ib.*
 —, Roasting, Chemical Changes, 94; Basting, *ib.*; Effects of the Heat upon, *ib.*; thorough Cooking a Safeguard against Parasitic Animals, *ib.*; Temperature, *ib.*
 —, Boiling of, Effects of Immersion in Cold or Lukewarm Water—Loss of Juice, &c., 94, 95; Effects of Immersion in Boiling Water—Retaining Juice, &c., 95.
 —, Broiling, 95.
 —, Baked, Chemical Changes, 94. *See* Meat, Roasting.
 —, Smoking, 96.
 —, Stewing, 95.
 —, Seasonable, *see* SEASONABLE FOOD.
 —, Extract of, 95; Beef-tea made from, *ib.*; Liebig's Mode of Preparing, *ib.*; Nutritive Value, *ib.*
 —, Preservation of, Scientific Particulars, 95, 96; Putrefaction of Flesh-formers, 96; Conditions of Putrefaction—Temperature, Water, Air, 96; Process of Putrefaction, *ib.*; Antiseptics—Salt, Saltpetre, Sugar, &c., *ib.*; Processes of Preservation:—I. Which depend on

Cold; 2. Which depend on the Removal of Water; 3. Which involve the Use of some Chemical Agent; 4. Which depend on the Exclusion of Air, *ib.*

Meat, Glazed (for Beef Tongue, or other Meats, to be served Cold), 164.

MECHANIC, THE HOUSEHOLD. — Gas Meters, 17, 18.

—, Gas Meters (*continued*), 49, 50.

—, Garden Furniture and Decorations (*continued*), 33, 34.

—, Garden Furniture and Decorations (*continued*), 71—75.

—, Garden Furniture and Decorations (*continued*), 86—89.

—, Garden Furniture and Decorations (*continued*), 97—99.

—, Cheap, Simple, and Tasteful Home-made Furniture, 312, 313.

—, How to make Picture-frames, 334—336.

—, Household Boilers, 129, 130.

—, Ovens, 375—378.

—, Painting, 175, 176.

—, Painting (*continued*): Imitating Fancy Woods and Marbles, 198, 199.

—, Painting (*continued*), 349.

—, Construction of Glass Houses and Conservatories, 228—230.

—, Construction of Glass Houses and Conservatories (*continued*), 289—291.

—, Making and Fixing Shelves, 353, 354.

MEDICINE, DOMESTIC.—Bronchitis (*continued*), 11, 12.

—, Boils, 28; Carbuncle, 28, 29.

—, Colic, 43; A Common Cold, 43, 44; A Common Cold (*continued*), 59; Influenza, *ib.*; Costiveness, *ib.*

—, Costiveness (*continued*), 68; Constipation, 69; Consumption, *ib.*

—, Consumption (*continued*), 90, 91.

—, Consumption (*continued*), 106; Deafness, 106, 107.

—, Deafness (*continued*), 126, 127; Debility, 127.

—, Diabetes: Diabetes Insipidus; Diabetes Proper, or Diabetes Mellitus, 142, 143; Diarrhoea, 143.

—, Diarrhoea (*continued*), 150; Diphtheria, 150, 151; Diphtheric Sore Throat, 151.

—, Dysentery, 195.

—, Dropsies, 171—173.

—, Drunkenness, 179.

—, Dyspepsia, 214, 215.

—, Dyspepsia (*continued*), 239, 240.

—, Dyspepsia (*concluded*), 265, 266; Epilepsy, 266, 267.

—, Erysipelas, 297; Erythema, *ib.*

—, Faintness, or Syncope, 299, 300.

—, Flatulence and Windy Spasm, 340, 341.

—, Goitre or Derbyshire Neck, 354, 355.

Merino, Black, To clean, 131.

—, 181.

Metal Working, 30, 31; Brass for Castings, &c., 30; Dies, *ib.*; Moulds, Flasks, or Casting-boxes, 31; Castings, 31; Solid Castings, *ib.*; Hollow Castings, *ib.*; "Cores," *ib.*; Moulds, Making, *ib.*

—, *see* Polishing Paste.

Mildew, see Stains.

Milk (as Food) scientifically considered, 117; its Composition, *ib.*; Curdling, 118.

Milk, Average Composition of good Cow's, 157.

—, Adulterations of, 157.

—, Curdling by Acids, scientifically considered, 117, 118.

—, Skin, scientifically considered, 117.

—, Substitute for, 313.

—, Sugar of, *see* Whey.

Milking, 45; Figure, 44

Milking Machine, 45.

Minerals, Mode of Displaying, 369, 370.

Mint, see HERBS.

—, Sauce, full Directions for Making, 116.

—, Vinegar, *see* Vinegar.

Mirrors, see Looking-glasses.

Modelling, see Cardboard Modelling.

Moral Influence, see CHILDREN, THE REARING AND MANAGEMENT OF.

Moselle-cup, 363.

Moths, to keep from Fur and Woollen Clothes, 155.

—, to Kill, 313.

Moulds for Metal-working, 31; Making, *ib.*

Mullet, Red, The, Remarks upon, Directions for Cooking, Gravy, Serving, &c., 283.

Muriate of Potash, see Potash.

Mushroom Catchup, see Catchup.

Muslin Curtains, 181.

—, Dresses, To clean, 75.

—, To smooth when Creased, 251.

—, Stained and Discoloured, To restore, 148.

Muslins, see Coloured Muslins.

Mutton.—General Remarks and Particulars, the Various Breeds and their Qualities, how to tell Good Mutton, Effect of the Rot, &c., 82, 83; Roast Mutton: Joints for Roasting, Particulars of, 83; all Joints of Mutton best Roasted without Stuffing, &c., *ib.*; Hanging and Condition of, for Cooking, *ib.*; the slow Roasting of Large Joints, Hot Dishes, Plates, &c., *ib.*; Cold Ham and Currant Jelly to be eaten with, *ib.*; The Shoulder: Roasting; Currant Jelly, Kidney Beans, and other Suitable Vegetables for, 83, 84; Minced Mutton, Particulars of, with Directions, 84; Hashed Mutton: full Particulars for Preparing, 84; Stuffed Leg of Mutton: Process of Stuffing with Red Herring, *ib.*

— (*continued*).—Shoulder of Mutton: Boned and Stewed, 111; Mutton Kidneys, Broiled or Roasted, *ib.*; Ditto, Stewed or Sautéd, *ib.*; Boiled Mutton, 112. *See* Sheep's Brains, Sheep's Head, Haggis.

— (Shoulder of), Boned and Stewed.—Instructions for Preparing and Serving, 111.

— (Boiled).—Directions for Cooking, Serving, and Sauce—the Leg, the Neck, the Shoulder, 112; Smoked Ox-tongue, a Companion Dish, *ib.*

— (*continued*).—Chops and Cutlets, 114; Chops, Plain Fried, *ib.*; Cutlets, Plain Fried, 114, 115; Cutlets, Broiled and Bread-crumbed, 115; Chops à la Jardinière, *ib.*

—, 94.

—, Kidneys, *see* Kidneys.

—, Pies, *see* Pies.

N.

Nails, 14.

Napkins, Table, 280.

Netted Shawl, The Saxe Weimar, Directions for Making, &c., 251.

New Mahogany, see Mahogany.

Night-dresses for a Girl Eight Years of Age, full Instructions, Admeasurements, &c., with Illustrations, 101—103; another Night Gown, 103.

—, Gown, *see* Night-dresses.

Nitrate of Soda, Potash, &c., see Soda, Potash, &c.

Note, Promissory, or Note of Hand, Particulars and Form of, 118; Directions, 119.

Notes, see Bills and Notes.

Nurse and Nursery Maid, Remarks and Directions, 182, 183.

— (*concluded*).—Instructions for, and Remarks concerning Dress, &c., 246, 247.

O.

Oak, see Graining.

Obedience, see CHILDREN, THE REARING AND MANAGEMENT OF.

ODDS AND ENDS.—Fancywork with Leaves, 29; Screens of Feathers, *ib.*; Diet, *ib.*

—, To clean Oilcloth, 48; to take out Ink-stains from Mahogany, *ib.*; to clean Paint, *ib.*; Jewellers' Doublets, &c., *ib.*

—, Ornamental Spills, how to make, with Figures, 61; Wafer Boxes, how to make, with Figures, *ib.*; to make a Box, with Figures, 61, 62; Pith Boxes and Beehives, how to make, 62; Figures, 61; Seed Boxes, how to make, 62; Faded Muslins, *ib.*

—, To clean Cloth, 80; to make Glue, *ib.*; to clean Wine and Beer Barrels, *ib.*; the Vine Disease, *ib.*

—, Acorns as Chimney Ornaments, 90; to clean Gold and Silver Lace, *ib.*; Hints for the Laundry, *ib.*; to scour Boards, *ib.*; Coffee Starch, *ib.*; to revive Gilt Frames, *ib.*; to wash New Black Worsted or Lamb's-wool Stockings, *ib.*

—, Paint for Garden Palings, &c., 103; How to make Black Paper for Tracing Patterns, *ib.*; to make Eau de Cologne, *ib.*; American Whitewash, *ib.*; to kill Worms, and prevent them Damaging Books, *ib.*

—, To clean Coloured or Doeskin Gloves, 121, 122; to clean a Swan's-down Cape or Tippet, 122; to renovate a Black Silk Dress, *ib.*; Glue Stiffening, *ib.*; False Pearls, *ib.*; to clean Plate, *ib.*

—, To clean Black Silk with very little Trouble and Expense, 131; Directions for cleaning Black Merino, or any Woollen Stuff, Black Cloth Jacket, Cloaks, or Gentlemen's Clothes, *ib.*; to renovate Crape, *ib.*

—, Washing Clothes, 155; to keep Moths from Fur and Woollen Clothes, *ib.*; Washing Chintzes, *ib.*; to clean Paint, *ib.*; Another Way, *ib.*; Coffee as in France, *ib.*; Wash-leather Gloves, *ib.*; Another Way, *ib.*; to mend China, *ib.*; Damp Walls, *ib.*; a Pleasant Strengthening Drink, *ib.*; to restore Plated Cruet-stands, Candlesticks, &c., when the Silver is worn off, *ib.*; the Simplest Method of Cooling Wine, *ib.*; Sirop de Poires, or Syrup of Pears, 155, 156; to prevent Drawn Beer becoming Flat, and to remove Tartness,

- 156; Shoes for Infants, *ib.*; to Stuff Sofa Cushions, *ib.*; to mount Prints or Maps, *ib.*; to clean Decanters or Water Bottles, *ib.*; Pamphlet Case, *ib.*
- ODD AND ENDS (*continued*).—To Bronze Images, 170; to Stain Marble Artificially, 171; Fancy Method of Tarring Fences, *ib.*
- , To clean Furniture, 183; to clean Dirty or Stained Furniture, *ib.*; to render New Mahogany like Old, *ib.*; to clean Lacquered Brass-work of Furniture, *ib.*; to make Coloured Drawings or Prints resemble Oil Paintings, *ib.*; Asphalte for Garden-walks, Fowl-houses, Sheds, &c., *ib.*; to sharpen and temper Saws and Edged Tools, *ib.*; to repair Broken Walls, *ib.*; to clean Looking-glasses, *ib.*; to clean Stone Steps and Stairs, *ib.*
- , A Substitute for Cream, 202; Tea, *ib.*; to clean Bottles, *ib.*; to remove a Speck or an Eyelash from the Eye, *ib.*; to cleanse Cloth or Silk from Spots of Wax, *ib.*; Another Receipt, *ib.*; Receipt for cleaning Silks, *ib.*; to clean Carpets, *ib.*; to cut Pencils, *ib.*; Paste, *ib.*; Sick Cats, *ib.*
- , To make French Polish for Boots and Shoes, 219; Herbs, *ib.*; Herb Mixture, *ib.*; Cure for Burns, *ib.*; Steel Ornaments, *ib.*; Orangeade at any Time of Year, *ib.*
- , Contamination by Zinc Tanks, 251; Anti-macassar, *ib.*; Curtain Bands, *ib.*; *Hortus Siccus*—the best and easiest Mode of Drying Plants, *ib.*; to smooth Muslin Dresses when Creased, *ib.*; to clean Looking-glasses and Mirrors, *ib.*; to clean Knives, *ib.*; the Saxe Weimar Netted Shawl, *ib.*
- , To exclude the Air from Wine or Bottled Beer, 286; Iron Stand, 286, 287; Blowing out the Candle, 287; to stop Ordinary Hiccough, *ib.*; Garters for Children superseded, *ib.*
- , Hanging Flower Baskets, 291; to use Salt Sea-water for Washing, *ib.*; to fix Crayon Drawings, *ib.*; to join Tortoise-shell, *ib.*; to prepare Crayons for Drawing on Glass, *ib.*; to preserve Delicate Steel Articles from Rust, *ib.*; Flexible Paint, *ib.*; to remove a Scorch Stain from Linen, *ib.*; to Gild Leather, *ib.*; to take out Spots of Pitch, Tar, or Turpentine from Linen, Silks, &c., *ib.*
- , To wash Summer Curtains, 313; Netted Sponge Bag, *ib.*; a Bright Teakettle, *ib.*; when an Egg Cracks, *ib.*; to remove Grease from a Wall-paper, *ib.*; a Method of Destroying Bugs and Fleas, *ib.*; to kill Moths, *ib.*; an Easy Way to Silver Glass, *ib.*; to whiten Linen which has Discoloured, *ib.*; to take Fresh Paint out of a Coat, *ib.*; Substitute for Milk or Cream, *ib.*; to keep Potatoes, *ib.*; Oil for Watches and Delicate Machinery, *ib.*
- , To repolish Tortoise-shell, 322; to clean Gold Watch-chains and other Ornaments, *ib.*; to remove Marking-ink Stains from Linen, &c., *ib.*; to Preserve Lemon-peel, *ib.*; French Polish, 322, 323; Scraps and Fragments, 323; Warm Bedding for Winter, *ib.*; Sir Humphry Davy's Corn Solvent, *ib.*; Adulterated Vinegar, *ib.*; Natural Dentifrice, *ib.*; Balsamic Vinegar for Sick Chambers, *ib.*
- ODDS AND ENDS (*continued*).—To sweeten Butter, 348; a Refreshing Drink, *ib.*; Offensive Feet, *ib.*; to remove Soot-stains from a Floor, *ib.*; the Management of the Finger-nails, *ib.*; to clean Gilt Jewellery and Cheap French Articles, *ib.*; to Prevent Fleas, *ib.*; to remove Stains from the Hands, *ib.*; a Hint on Packing, *ib.*; to bleach Wool, *ib.*; Ivory Ornaments, 348, 349.
- , Ornamental Chess-table, with Illustration, 365; Text Case, with Illustrations, *ib.*; Toilette Tidy, with Illustrations, *ib.*; to clean Block Tin Articles, *ib.*; a Cheap Filter, *ib.*; Whiteness for Cleaning Plated Goods, *ib.*; to clean Gilt Lamps, Chandeliers, &c., *ib.*
- , Polishing-paste for Britannia Metal, &c., 371; to polish Patent Leather Boots, *ib.*; Economy in Coals, *ib.*; to clean and renovate Velvet, *ib.*; to make Gum-water, *ib.*; to get a Tight Ring off the Finger, *ib.*; Leakage in a Housetop, *ib.*; Incombustible Thatch, *ib.*; Economical Way of Preserving Fruit, *ib.*; to keep a Kitchen-table clean, *ib.*; Liebig Sandwiches, *ib.*
- Oil for Watches and Delicate Machinery, 313.
- Oilcloth, To clean, 48.
- Oil-paintings, To make Coloured Drawings or Prints resemble, 183.
- Omelette, Anchovy, Instructions for Making, &c., 35; Sauce for, *ib.*
- , Bacon or Ham, Instructions for Making, &c., 19.
- , Cheese, Instructions for Making, Cooking, when to serve, &c., 18, 19.
- , Devilled (Indian), Instructions for Making, &c., 19.
- , Gardeners' (*à la Jardinère*), Instructions for Making, Serving, &c., 20.
- , Ham, *see* Omelette, Bacon.
- , Jam, *see* Omelette, Preserve.
- , Kidney, Veal, Mutton, Beef, Instructions for Making, &c., 19.
- , Onion, Instructions for Making, &c., 35.
- , Preserve or Jam, Instructions for Making, &c., 19.
- , Plain, Instructions for Making, Cooking, &c., 19.
- , Rum, Instructions for Making, Serving, &c., 19.
- , Salmon, Instructions for Making, Serving, Sauce for, &c., 19.
- , Soufflée, in a Mould, Instructions for Making, &c., 35.
- , Soufflée (Baked); Instructions for Cooking, Serving, &c., 20.
- , Sweet (plain), Instructions for Making, &c., 19.
- , Sweet Herb, Instructions for Making, Cooking, &c., 19.
- Omelettes, 18—20.—Cheese Omelette, 18; Omelette with Cheese, 19; Plain Omelette, *ib.*; Sweet Herb Omelette, *ib.*; Kidney Omelette, *ib.*; Bacon or Ham Omelette, *ib.*; Salmon Omelette, *ib.*; Sweet Omelette (plain), *ib.*; Rum Omelette, *ib.*; Preserve or Jam Omelettes, *ib.*; Devilled Omelette (Indian), 19, 20; Omelettes Soufflées, 20; Gardener's Omelette (*à la Jardinère*), *ib.*
- , General Advice concerning, 19, 20.
- , Custards, and Puddings.—Omelette Soufflée, in a Mould, 35; Onion Omelette, *ib.*; Anchovy Omelette, *ib.*
- Italian Eggs (*à l'Italienne*), *ib.*; Spun Eggs (Eufs en Filagramme), *ib.*; Eggs as Snow (Eufs à la Neige), *ib.*; Baked Custard, *ib.*; Baked Custard in a Crust, *ib.*; Chocolate and Coffee Custards, *ib.*; Boiled Custards, *ib.*; Eggs in Paper Cases, 35, 36; Lemon Tarts or Tartlets, 36; Counsellor's Pudding (Excellent), *ib.*; Italian Pudding, *ib.*
- Onion Sauce, Directions for Making, 326, 343.
- Orangeade, Directions for Making, 192.
- , at any Time of Year, Directions, 219.
- Orange Marmalade, *see* Marmalade.
- Ornaments, Drawing-room, How to make with Acorns, &c., with Illustrations, 369; Mode of displaying Shells, Minerals, Insects, or Corals, 369, 370.
- , *see* Acorns.
- , *see* Shells.
- , Imitation Coral, Ivory, Jet, and Cameo, for the Table, &c., 1.
- Ovens (Old-fashioned Wood), with Illustration, 375, 376; (Modern Coal) Full Particulars, with Illustrations, 376—378; "Improvement in," 378; "A New Oven," *ib.*; Ordinary Coal Oven, Particulars and Description, 378; Illustrations, 376, 377; Hot-water Oven, 378.
- Oyster Patties, *see* Patties.
- Oyster Pie, Directions, 283.
- Oyster Sauce, full Directions, 252.
- , Directions, 325.
- , 342.
- Oysters (Cooked), Remarks, &c., 283.
- P.
- Packing, A Hint on, 348.
- Paint, To clean, 48, 155; Another Way, 155.
- , Flexible, 291.
- , Fresh, To take out of a Coat, 313.
- , *see* Garden Palings.
- Painting.—Remarks and Directions, 175; Directions for Painting in White, 175, 176; Green Paint for Garden Purposes, 176; Painting to Imitate Fancy Woods, *ib.*
- (*continued*), Imitating Fancy Woods and Marbles.—Walnut Wood, 198, 199; Varnish for, 199; Gilded Beadings, *ib.*; Sienna Marble, *ib.*; Graining to Imitate Oak, *ib.*
- (*continued*), Selection of Colours, 349; The Painting of Walls, Plaster and Stucco, *ib.*
- , Glass, *see* Glass Painting.
- , Enamel, *see* Glass Painting.
- , in Imitation of Ebony and Ivory, *see* Indian Painting.
- Paletôt for a Child of from Four to Six Years old; full Instructions how to make and trim, with Patterns, 20, 21; How to line, with Patterns, 21.
- Pancakes, *see* Pork Pancakes.
- Pancreatic Emulsion, 3.
- Pancreatine, 3.
- Papin's Digester, 95.
- PARASOLS AND UMBRELLAS.—Particulars, Directions for Re-covering, &c., 318.
- Park Farming, *see* Farming.
- Parsley, *see* HERBS.
- , Sauce, Directions, 325.
- Partridges, Instructions for Purchasing, 139.
- Paste, 202.

- PATCHWORK**, Advantages of Making, 3.
 — Patterns, 3; Figures of, 4.
 —, Directions for Making, 3, 4.
 — Quilts and Counterpanes, 4, 5.
 — Quilts and Counterpanes, Bordering for, 5.
 —, Making, 24—26; Illustration, 25; Cushions, 26.
- Pâté**, Hare (Pâté de Lièvre), Directions for Making, 157.
 —, Lark, Directions, 135.
 —, *see* Pic.
- Patent Leather Boots**, To polish, 371.
- Patterns**, Tracing, How to make Black Paper for, 103.
- Patties**, Eel, 135.
 —, Oyster, Directions for Making, &c., 157.
- Peacock**, Particulars of, Dressing, Stuffing, &c., 343.
- Pea Fowl**, Cooking, &c., *see* Peacock.
- Pearls**, False, 122.
- Pears**, 215.
 —, *see* Syrup of Pears.
- Pencils**, To cut, 202.
- Pennyroyal**, *see* HERBS.
- Peppermint Drops**, Making, 311.
- Pepsine**, 2.
- Performing Shadows**, The, 9; Figures, *ib.*
- Phaeton Horses**, *see* HORSE, TILE.
- Pheasants**, Instructions for Purchasing, 139.
- PHILOSOPHICAL INSTRUMENTS FOR DOMESTIC USE**. — The Barometer or Weather-glass, 241—244.
 —, The Barometer or Weather-glass (*continued*), 296—298.
- Phosphate of Lime** as a Manure, Discovery of, Price, &c., 39.
- Phospho-guano**, as a Manure, *see* Phosphate of Lime.
- Phosphoric Rock** (Apatite), as a Manure, Whence Imported, Price, &c., 39.
- Photograph Frame**, *see* Frame.
- Photographs**, Frames for, Manufacture of, 1.
- Pickled Pork**, *see* Pork.
- Pickling**, Remarks and Particulars, 347.
- Picture-frame**, Construction of, Carving, &c., 114; Illustrations, 113.
- Picture-frames**, How to make, with Illustrations, 334—336.
 —, *see* Gilding.
- PICTURES, THE HOUSEHOLD CARE OF**. — Nature of, 51; Mode of Painting Early Pictures, 51, 52; Cleaning Pictures, *ib.*; Relining, 52; Damp Fatal to, *ib.*; Heat injurious to, *ib.*; Require to be hung in a Good Light, *ib.*; Glazing, 52, 53.
 —, Glazing, 128; Picture Cleaning, *ib.*; Dusting, Polishing, Ordinary Cleaning, &c., *ib.*
 —, 331.
 —, Photographs, 380—382.
- Pie-crust**, Remarks and Particulars, 134; Puff-crust, Directions, 134, 135; Standing Crust, 135.
 —, Eel, Directions for Making, &c., 157.
 —, or Pâté, Mackerel, Directions, 135.
 —, Veal, Directions, 135.
 —, *see* Gooseberry Pie; Pigeon Pic.
- Pies**, Mutton (Small), Directions, 135.
- Pigeon Pie**, 344.
- Pigeons**, Instructions for Purchasing, 139.
 —, Cooking, Historical Remarks, Particulars of, &c., 343, 344; Pigeons à la Crapaudine, full Directions for Dressing, Cooking, &c., 344.
- Pigs**. — Characteristics of the Chief English Breeds, Remarks and Particulars, 119, 120; Improved Berkshire and Improved Essex Breeds, 120, 121; Illustration of Essex Boar and Sow, 120; Illustration of Improved Berkshire Boar, 121.
- Pigs** (*continued*). — Housing, Breeding, and Rearing. — Directions, with Particulars and Illustrations of Rings and Troughs, 193—195.
 —, Feeding, Killing, and Curing, 287, 288.
- Pig-dung**, Particulars of, and Purifying, 39.
- Pilgrim's Potatoes**, *see* Potatoes.
- Pinafores**, Cutting out, Making, &c., 180, 181; Illustrations, 180.
- Pitch**, Tar, or Turpentine, To take out Spots of, from Linen, Silks, or Wool-lens, 291.
- Plaice**, Remarks, and full Directions for Cooking, Serving, &c., 255.
 — or Flounder, with Norman Sauce, Directions, 255.
- Plants**, Drying, *see Hortus Siccus*.
- Plaster**, Casting in, 22—24; Plaster of Paris, 23.
- Plate**, To clean, Directions, 122.
- Plated Goods**, To restore, 155.
- Plates**, *see* Coloured Plates.
- Plums**, Preserving, 347.
- Pocket-handkerchief**, Border for, 241—246; Illustrations, 244, 245.
- POINT-LACE PAPER FLY-CAGES**, *see* FLY-CAGES.
- POINT LACE WORK**. — Design for Lace to be turned over the Edge of the Square-cut Bodice, 53.
 —, Border for a Pocket-handkerchief, 244—246; Illustrations, 244, 245.
 —, Lamp or Candle Shade for the Table, Directions for Making, 277; Design for, 276.
 —, The Mary Stuart Cap, 291—293; Illustrations, 292, 293.
 —, Mary Stuart Cap, 361; Design for Lappets for, 360.
- Polish**, *see* French Polish.
- Polishing Paste** for Britannia Metal, &c., 371.
- Pomatum**, 13.
- Ponies**, *see* HORSE, THE.
- Pork** difficult of Digestion, 94.
 —, General Remarks, 116; Pickled Pork, *ib.*; Stewed Pork and Vegetables, *ib.*
 —, Pickled, Directions for Pickling, &c., 116.
 —, Roast, Cooking, &c., 159.
 —, Chops and Cutlets, full Directions for Dressing, Cooking, Vegetables, &c., 158, 159.
 — à la mode, Directions, 159.
 — and Apple Fritters, Directions for Dressing, 159.
 —, The French Country Way of Salting, 315.
 — Pancakes, Directions, 159.
 —, Scambled (American), Directions for Dressing, Serving, Vegetables, &c., 159.
 —, Stewed, and Vegetables, Directions, 116.
 —, *see* Sucking Pig.
- Port Wine Stains**, *see* Stains.
- Potash**, Muriate of, Price, Uses, &c., as a Manure, 15.
 —, Nitrate of (Saltpetre), as a Manure, Price, &c., of, 15.
- Potato Cake**, Sweet, Making and Serving, 64.
- Potatoes au Maître d'Hôtel**, Directions, 206; Mashed, *ib.*; Soufflée, *ib.*; Carthusian, *ib.*
- Potatoes**, To keep, 313.
- , Pilgrim's, Sweet (a Trappist Recipe), 64.
- Potted Cheese**, *see* Cheese.
- Poultry**, &c. — Marketing. — Turkeys, Fowls, Geese, Ducks, Teal and Widgeon, Pheasants, Grouse and Black-cocks, Partridges, Woodcocks, Snipes, Pigeons, Larks, Hares, Rabbits, 139.
 —, 159, 160.
 —, Seasonable, *see* SEASONABLE FOOD, 127, 261, 323.
- Prawns**, *see* Shrimps.
- Preservation of Meat**, *see* Meat.
- PRESERVED COLONIAL MEATS**. — Causes of Interest, &c., 79; Methods of Preserving, *ib.*; Manufacture of Extract—Liebig's Extract, 79, 80; Superiority of Australian over South American Extract, 80; Colonial Meats in the "Tinned" Form, 80.
- Preserving**, Directions for, 346, 347.
 — Fruit, Economical way of, 371.
- Prints**, To mount, 156.
 —, Coloured, *see* Oil Paintings.
- Promissory Note**, *see* Note, Promissory.
- Promissory Notes**, Tables of Stamp Duties payable on, 147, 148. *See* Bills and Notes.
- Prune Tisane**, *see* Tisane.
- Ptyaline**, 2.
- Pudding**, Counsellor's (excellent), Directions for Making, Boiling, and Serving, 36; Sauce for, *ib.*
 —, Italian, Making, Boiling, &c., 36; Sauce for, *ib.*
 —, Roly-poly (superior), Directions for Making, &c., 158.
 —, *see* Rice Pudding.
- Puddings**, *see* Omelettes, Custards, and Puddings.
- Puff-crust**, *see* Pie-crust.

Q.

Quince Wien, *see* WINES.

R.

- Rabbits**, Instructions for Purchasing, 139.
 — (Cooking), Directions; Tame Rabbits, Fricassee, 379; Carried Rabbit, *ib.*; Plain Boiled, *ib.*; Warren Rabbits, taking, &c., 379, 380; Matelote of Rabbit and Eel, 380.
- Ragoût**, 112.
- Raisin Wine**, *see* WINES.
- Ramequins**, Preparation of, 66.
 — Soufflés, 66.
- Raspberry and Currant Jam**, Directions for Making, &c., 347.
 — Vinegar, 192.
- Red Cabbage**, Particulars and Cultivation of, 107.
 —, Stewed, Directions, 207, 208.
- Red Mullet**, *see* Mullet.
- Registration of Births**, &c., 110.
- Rennet**, Action of, scientifically considered, 118.
- Rent**, Receipt for, *see* Landlord and Tenant.
- Reservoirs**, *see* Water Supply.
- Rhubarb Jam**, 347.
 —, Preserved, 347.
- Rice**, *see* Apples and Rice.
 — Pudding, Baron Brisse's, Baked in a Saucepan, Making, Serving, &c., 62.
 —, Ground, Baked, Directions for

Making, Serving, &c., 62; Syrup and Wine Sauce for, Making, *ib.*; Currant Syrup (*Sirup de Groselles*) for, Making, *ib.*

Rice Soufflée, Preparing and Serving, 63.

Ring, Tight, To get off the Finger, 371.

Ringworm.—Loss and Diseased State of the Hair consequent thereon, 93; *Favus* (various species), *ib.*; Ordinary Ringworm of the Scalp, 93, 94.

— Ordinary Ringworm of the Scalp (*continued*)—Treatment, 282; *Kerion*, *ib.*; Ringworm of the non-hairy Parts of the Body, or *Tinea circinata*, *ib.*

— (*concluded*).—Ringworm of the Beard, or *Sycosis*, 332; *Tinea Decalvans*—Treatment, *ib.*; *Chloasma*, Treatment, *ib.*

Roasting Meat, *see* Meat.

Rock, Almond, 374.

— Cake, Directions for Making, 112.

Rock-work, Grottoes, &c., Taste in the Construction of, with Illustrations, 327—329.

Roly-poly Pudding, *see* Pudding.

Rose Drops, 374.

Rosemary, *see* HERBS.

Rue, *see* HERBS.

S.

Saccharometer, The, 384.

Saddle-horse, Iron, on Wheels, Illustration of, 359.

Saddles and Bridles, Advice, 358, 359.

—, Apparatus for Drying, with Illustration, *ib.*

Sage, *see* HERBS.

Salad, Nantese, Directions for Preparing, 219.

—, Winter, Directions for Dressing, 219.

—, *see* Corn Salad.

Salads, Full Directions for Making, 218, 219.

Saliva, 2.

Salmagundi, Directions for Preparing, 218.

Salsify, Boiled, Particulars of, with Directions, 206; Dutch Sauce for, 207; Fried Salsify, *ib.*; Salsify and Cream, *ib.*

Salt, Agricultural, Price, Qualities, &c., of, as a Manure, 14, 15.

— Cod, *see* Cod.

Saltpetre, *see* Potash, Nitrate of.

Sandwiches, *see* Liebig Sandwiches.

Sauce, Dutch, Directions for Making, and Purposes for which it is suited, 207.

Sauces, Remarks, 347.

—, *see* Oyster Sauce; Egg Sauce; Parsley Sauce; Bread Sauce; Onion Sauce.

Savory, *see* HERBS.

Savouries, *see* Sweets and Savouries.

Saws and Edged Tools, To sharpen and temper, 183.

Scalloped Sheep's Brains, *see* Sheep's Brains.

Scandal (an Intellectual Game), 3.

Scorch Stain, To remove from Linen, 291.

Scorching, *see* STAINS.

Scraps, 323.

Screens of Feathers, 29.

Scythe and Rake (combined), Illustration, 373.

SEA BATHING, full Particulars and Directions with regard to, 211—214.

— Fish, *see* Fish.

— Fishing.—Remarks, 253; Lines, *ib.*; Hand-lines, 253, 254; Illustrations,

253; to make a Mackerel Line, 254; to make a Twisted Hair-line, *ib.*; Preservation of Lines, *ib.*; Snooding, *ib.*

Sea Kale, Particulars and Directions (two Entries), 208.

— Urchins (*Oursins*), Remarks and Particulars of, with Directions for Eating and Dressing, 283.

— Water, To use for Washing, Directions, 291.

— WEEDS, HOW TO OBSERVE, USE, AND PRESERVE THEM, 161—163; Illustrations, 161.

SEASIDE AMUSEMENTS.—Shells and Shell-work, 231—236.

—, Sea-fishing, 253, 254.

—, Shells and Shell-work (*continued*), 355, 356.

Sealing-wax Ornaments, &c., Manufacture of, 1.

SEASONABLE FOOD, 127.

—, 261.

—, 323.

Shalot Wine, 347.

Shavings for Fire-stoves, with Illustrations, 167—170; Flowers, Wreaths, &c., *ib.*

Sheds, *see* Asphalté.

Sheep's Brains, Roasted—Directions for Dressing and Serving, 111.

—, Scalloped—Directions for Dressing, 111.

Sheep's Head, Instructions for Dressing and Serving, 111, 112; Sauce for, 112.

Shell Ornaments, *see* Shells and Shell-work.

Shells, Mode of Displaying, 369, 370.

— and Shell-work.—Remarks and Particulars, 231, 234; Forty-five Illustrations, 232, 233; List of Illustrations, 234; Collecting Shells, *ib.*; Towing-nets for collecting Shells, *ib.*; Dredging, as a Means of Collecting Shells, 234, 235; Cleansing and Preserving Shells, 235; Shell Ornaments, *ib.*; Bedroom Ornaments, *ib.*; Illustration of Trinket Box, 236; Fastening on the Shells, 235, 236; to make Card or Millboard Boxes, 236; Tools and Apparatus for the Naturalist, *ib.*

— (*continued*).—Arrangement of Shells, 355; Parlour Ornaments—Window-box, *ib.*; Illustration, 356; a Shell Basket, with Illustrations, 355, 356; Shell Work-box, with Illustration, 356; Remarks, *ib.*

Shelves, Making and Fixing, Directions, with Illustrations, 353, 354.

Sherry Cup, 363.

Shoes, White Satin, To clean, 14.

— for Infants, To make, 156.

Shop and Fixtures, Sale of the Good-will of, 339.

Shoulder of Mutton, *see* Mutton.

Shrimp Patties, or Vol-au-Vent, Directions for Making, &c., 284.

Salad, Directions, 284.

Shrimps, Particulars of the Three Kinds (the Brown, Red, and the Prawn), 284; How to Shell, *ib.*; Uses of, *ib.*

Sick Chambers, Balsamic Vinegar for, Receipt, 323.

Sienna Marble, *see* Marble.

Silk, To keep, 14.

—, To remove Grease Spots from, 14.

—, *see* Black Silk.

—, Stains in, *see* STAINS.

— Stockings, *see* Stockings.

Silks, Receipt for Cleaning, 202.

Silk-worm, The, Full Particulars of, Rearing, Feeding, &c., 76, 77; Figure of, 76.

Silk-worm (*continued*).—General Remarks and Particulars, 108; The Cocoon of the Silkworm, Illustration, *ib.*; the Silk-worm Moth, Illustration, *ib.*; Desirability of the Advance of Sericulture, *ib.*

Silver Stains, *see* STAINS.

— Glass, To, An Easy Way, 313.

Single Harness, 146.

Skeleton Leaves, Historical Notes, Remarks, and Particulars, 136, 137; Illustration—Group of Skeleton Leaves and Seed-vessels, 136; Choice of Leaves, 136, 137, with Illustrations on this point, 138; Directions for Gathering, Preparing, Removing the Leaves, Bleaching, &c., 137, 138; Illustrations of Skeleton Leaves and Seed-vessels, 137; Subjects, 139; Mounting, *ib.*

Skim Milk, *see* Milk.

Skirt, Plain (Girl's), To make, Directions and Illustrations, 196, 197.

Sly Bread: Bread Fritters, Directions for Making, Serving, &c., 63.

SMOKE, HOW TO GET RID OF, AND MANAGE FIRES, 185—187.

Snipes, Instructions for Purchasing, 139.

Snooding, *see* Sea Fishing.

Soap, Ornamental, 24; How to Prepare, *ib.*; Figures, *ib.*

Soda, Nitrate of, Price and Use of as a Manure, 15.

Soda Cake, Directions for Making, Baking, &c., 112.

Soda-water, Iced-cream, 363.

Sole, The, Remarks, 226; Boiled Sole—Directions for Cooking, &c., 226, 227; Baked Soles, Norman Fashion—Directions, 227; Fried Soles, Directions, *ib.*; The Lemon Sole, *ib.*

Soot Stains, To take away from a Floor, 348.

Souchy, *see* Water Souchy.

Soup, Vegetable, Directions for Making, 206.

SOUVENIRS.—Albums, Making, &c., 177, 178; Illustrations, *ib.*

—, Plaster Cases, Albums, &c. (*continued*), Directions for Making; Illustrations, &c., 323, 324.

Spade Husbandry, Remarks, 236, 237; Drainage, 237; Trenching, with Illustrations, 237, 238; Bastard Trenching, 238; Illustration, 237; Tools, &c., 238; Illustration of Harvest or Forage Barrow, 237; Grass Land, 238; Various Dibbles, *ib.*; Hand Drill, *ib.*; Illustration, 237; Division of Cottage Farm, 238; Illustration, 237; Mode of Culture and Rotation, 238, 239.

Spasm, *see* Flatulence.

Spice Drops, 374.

Spinach, Directions for Cooking, Serving, &c., 219.

Sponge Bag, Netted, Directions for Making, 313.

— Cake, Directions for Making, Baking, &c., 112.

— Cakes, Small, Making, 64.

Spring-water, 36.

Stable, *see* Stabling.

—, Accessories to the, *see* Stabling.

— and Yard, with its Adjuncts—Particulars, 358.

Stabling, Remarks and Particulars, 358; Accessories to the Stable, *ib.*; Illustrations of, 359.

Stained Glass, 204, 205.

—, *see* Glass Painting.

STAINS, TO REMOVE VARIOUS KINDS OF.—
 Stains in Woollen Table-covers and Carpets, 148; (Another Method), *ib.*; Ditto from Floors or Mahogany, *ib.*; Port Wine, *ib.*; Mildew, *ib.*; Stains in Silk, *ib.*; Acid, Tea, Wine, and other Stains, *ib.*; Stains caused by Scorching, *ib.*; by Mildew, *ib.*; Linen, *ib.*; How to restore Stained and Discoloured Muslins, *ib.*; Oil Stains, *ib.*; Stains on Mahogany, &c., *ib.*; Silver and Electroplate Stains, *ib.*
 —, To remove, from the Hands, 348.
 Stairs, *see* Stone Steps and Stairs.
 Stamp Duties Payable on Promissory Notes, Tables, 147, 148.
 Standing Crust, *see* Pie Crust.
 Starch, To make, Directions, 144.
 —, Coffee, 90.
 Starching, *see* Clear-starching.
 Steel Articles, Delicate, To preserve from Rust, 291.
 — Ornaments, How to preserve, 219.
 Steeplechaser, Old-fashioned, Illustration of, 220.
 —, The, *see* Hunters, (285).
 Steps, *see* Stone Steps.
 Stewing Meat, *see* Meat.
 Stockings, Washing, 143.
 —, Black Silk, Washing, &c., 181.
 —, *see* Worsted.
 Stone Steps and Stairs, To clean, 183.
 Store-room, the, Particulars, with Directions, 346; Particulars of Stores, 346—348. *See* under their Respective Heads.
 STOVE-BOARDS, *see* Chimney Boards.
 Strawberries (Table Decoration), 280.
 Strawberry, *see* Dentifrice.
 Sucking Pig, full Directions for Dressing, Stuffing, Carving, &c., 158; Brown Gravy for, *ib.*; Plum Sauce for, *ib.*
 Sugar Paste, 374.
 Sulphate of Ammonia, *see* Ammonia.
 — of Lime, *see* Lime.
 Sulphuric Acid, for Dissolving Bones for Manure, Price, &c., 39.
 SUMMER AND OTHER DRINKS.—Whole-some Water, 192; Raspberry Vinegar, *ib.*; Artificial Chalybeate Water for Weakly Constitutions that require Iron, *ib.*; Fruit Essences, *ib.*; Ginger Beer, *ib.*; Apple Water, *ib.*; Lemonade, *ib.*; Tisane for Gout (Excellent though Simple), *ib.*; Prune Tisane for Irritation in the Throat, *ib.*; Tea made over-night, *ib.*; Orangeade, *ib.*; Currant Water, *ib.*
 Surmullet, *see* Mullet.
 Swans'-down Cape or Tippet, To clean—Directions, 122.
 Sweetbreads, Particulars, 67.
 —, White, Directions for Preparing, 67.
 —, Brown, Directions for Preparing, 67.
 —, Vol-au-vent of, full Particulars, 67, 68.
 Sweet Jelly, *see* Jelly.
 SWEETMEATS, MAKING.—Acid Drops, Everton Toffee, Elecampane or Candy Cake, Peppermint Drops, 311.
 —, Ginger Drops, Caramel for Sugar Baskets, &c., Barley Sugar, Ginger Candy, 341.
 —, Barley-sugar Drops, Acidulated Drops, Almond Hard-bake, Cocoa-nut Paste, Almond Rock, Sugar Paste, Rose Drops, Spice Drops, Lozenges, Cinnamon Lozenges, 374.
 Sweets and Savouries.—Rock Cake, 112; Soda Cake, *ib.*; Sponge Cake, *ib.*;

Sweet Jelly, for Twenty Guests, *ib.*;
 Coffee Jelly, *ib.*; Whipped Cream, *ib.*;
 Syllabubs, *ib.*; Blanc-mange, *ib.*
 Syllabubs, Directions for Making, &c., 112.
 Syncope, *see* Faintness.
 Syrup of Pears, Receipt, 155, 156.
 — and Wine Sauce, Making, 62.

T.

Table, Construction of, *see* Furniture, Home-made.
 TABLE DECORATION, *see* FRUIT AND FLOWER STANDS; Finger Bowls with Rose-water; Cards, Napkins, &c., with Directions, 280.
 — Easel, 105; Illustration, *ib.*
 — Napkins, *see* Napkins.
 — Ornaments, 1.
 TABLE L.—AVOIRDUPOIS WEIGHT, 352.
 Tansy, *see* HERBS.
 Tarragon, *see* HERBS.
 — Vinegar, *see* Vinegar.
 Tarring, *see* Fences.
 Tart, *see* Little Ladies' Tart.
 Tartlets, *see* Tarts.
 Tarts or Tartlets, Lemon, Directions for Making and Baking, 36.
 TEA.—General Remarks, &c., 123, 124; Chinese, Japanese, Tartar Modes of Making, 124; Descriptions and Qualities of Tea, *ib.*; of Black Teas; Congou, *ib.*; Souchong, *ib.*; Pekoe, *ib.*; of Green Teas; Hyson Skin, *ib.*; Hyson, *ib.*; Young Hyson, *ib.*; Gunpowder, *ib.*; Adulterations, Particulars of, *ib.*
 —, 202
 — made over-night, Directions, 192.
 — Stains, *see* STAINS.
 Tea-cakes, Making and Baking, 64.
 Tea-kettle, A Bright, 313.
 Teal, Instructions for Purchasing, 139.
 —, Stewed, Particulars, Directions, &c., 368.
 Teeth, The, 14.
 —, Stopping, 131.
 —, and their Management, with Illustrations, 333; The Influences that act injuriously on, 334; Influence of Diet on, *ib.*; Action of Acids on, *ib.*
 —, Particulars, 351; Action of Confectionery, *ib.*; Action of Drinks, Stimulants, Sea-air, Smoking, &c., *ib.*; Cleaning the Teeth, 351, 352.
 — (continued).—Tooth Powders—Sundry Receipts, 363, 364; Tooth Pastes—Receipts, &c., 364; Washes for the Mouth and Teeth, Particulars, Receipts, &c., *ib.*; Washes for sweetening the Breath, *ib.*
 —, Artificial, 14.
 —, Remarks and Particulars, 130; Fixing, 130, 131; Advantages and Management of, *ib.*
 —, *see* Dentifrice.
 Tenancies from Year to Year, *see* Landlord and Tenant.
 Text Case (an Indian Pattern), with Illustration, 365.
 Thatch, Incombustible, 371.
 Thyme, *see* HERBS.
 Tin, Block, To clean, 365.
 Topsy Cake, Making and Serving, 64; Coloured Illustration, Plate III.
 Tisane for Gout, Directions, 192.
 —, Prune, for Irritation in the Throat, 192.

Toffee, Everton, Making, 311.
 TOILETTE, THE.—Disorders of the Hair and their Treatment (continued), 78, 79.
 —, Ringworm, 93, 94.
 —, Ringworm (continued), 282.
 —, Ringworm (concluded), 332, 333; The Teeth and their Management, 333, 334.
 —, The Teeth and their Management (continued), 351, 352.
 —, The Teeth and their Management (continued), 363, 364.
 Toilette Tidy, with Illustrations, 365.
 Tongue, *see* Beef Tongue.
 Tools for Spade Husbandry, 237, 238.
 —, *see* Saws.
 Tortoiseshell, To join, 291.
 —, To re-polish, 322.
 TRADE, CHOOSING A.—Metal-working, 30, 31.
 —, Goldsmiths' Work: Engraving, 125, 126.
 Trenching, with Illustrations, 237, 238.
 Trinkets, To clean, 13.
 Tripes à la mode de Caen, full Directions for Dressing, &c., 164.
 Truth, *see* CHILDREN, THE REARING AND MANAGEMENT OF.
 Turbot, Boiled, Remarks; Quality; Freshness; Preparing; Cooking; Serving; Sauce for; Mayonnaise of, &c., 226.
 Turkeys (as Food), 94.
 —, Instructions for Purchasing, 139.
 —, Directions for Cooking, Stuffing, Sauces, &c.—Remarks, 326; Roast, *ib.*; Bread Sauce, *ib.*; Onion Sauce, *ib.*; Stuffed with Chestnuts, *ib.*; Truffled, 326, 327; Economically Truffled, 327; Cold, *ib.*
 —, Cooking (continued).—Hashed: Directions, 342; Boiled: Particulars and Directions, Sauces, 342, 343.
 Turnip-fly, 15.
 Turnips, Mashed, Directions, 112.
 Tweed Cloth Cloaks, *see* Cloth Cloaks.

U.

Under-clothes for a Girl Eight Years of Age, General Remarks, including Particulars of Shopping, Long-cloth, Cotton, Scissors, &c., 91; Chemise, full Particulars of Four Patterns, with Illustrations, 91—93.
 UPHOLSTERY, *see* CLEANING.
 —, *see* CLOTHING AND UPHOLSTERY, CLEANING.
 Urchins, *see* Sea-urchins.

V.

Vaccination, 110.
 Varnish (Fine), Directions for Making, 199.
 — for Gold, *see* Gilding.
 Veal, 94.
 —, Remarks and Particulars of the Several Joints, and How to Dress them, 189; Fillet of Veal, English Way, *ib.*; Veal Stuffing, 189, 190; Fillet of Veal, French Way, 190; Stewed Brisket of Veal, *ib.*; Brisket of Veal and Rice, *ib.*; Breast of Veal à la Marengo, *ib.*; Hashed Veal en Blanquette, as a White Fricassee, *ib.*; Veal Liver Pâté (with-out crust; to be eaten cold, *ib.*); White Puddings, 190, 191; Nouilles, 191; Nouilles with Ham (a counterpart of

- Macaroni with Cheese, *ib.*; Maintenon Cutlets, *ib.*; Fricandeau of Veal, *ib.*; Veal Cutlets without Bone (an Elegant and Delicate Dish, *ib.*)
 Veal Kidney, *see* Kidneys.
 — Pie, *see* Pie.
 Vegetable Soup, *see* Soup.
 Vegetables (Cooking, &c.). — Vegetable Soup, 206; Potatoes au Maître d'Hôtel, *ib.*; Mashed Potatoes, *ib.*; Souffléed Potatoes, *ib.*; Carthusian Potatoes, *ib.*; Stewed Carrots, *ib.*; Longhorn or Altringham Carrots as Carrot Soup, *ib.*; Boiled Salsify, *ib.*; Dutch Sauce, 207; Fried Salsify, *ib.*; Salsify and Cream, *ib.*; Fried Celery, *ib.*; Batter for Frying Vegetables, *ib.*; Fried Chardoons, *ib.*; The Jerusalem Artichoke, *ib.*; Leeks, *ib.*; Cabbage Plants, *ib.*; Cabbage Cake, *ib.*; Chopped Cabbage, *ib.*; Stewed Red Cabbage, 207, 208; Cauliflower with Stuffing, 208; Couve Tronchuda or Portugal Cabbage, *ib.*; Sea Kale, *ib.*; *Asparagus officinalis*, *ib.*
 — (*continued*). — Salmagundi, 218; Spinach, *ib.*; Artichokes, *ib.*; Salads, *ib.*; Nantese Salad, 219; Winter Salad, *ib.*
 —, Seasonable, 127, 261, 323.
 —, Scientific Remarks upon, *see* Food.
 —, Batter for Frying, *see* Batter.
 Velvet, To clean and renovate, 371.
 Venison, 94.
 Villi, 3.
 Vine Disease, The, So.
 Vinegar, Adulterated, Detection of, 323.
 —, Chili, Directions for Making, 347.
 —, Garlic, Directions, 347.
 —, Mint, Directions for Making, 348.
 —, Tarragon, Directions for Making, 347, 348.
 Vinegars, Flavoured, 347.
 Vol-au-vents, Full Particulars and Description of, 67, 68.
 —, *see* Shrimp Patties.
- W.
- Wafers, *see* Gaufres.
 Wall Paper, Taste in the Choice of, 39—
 42; Eight Patterns, 40, 41; French Designs, &c., 40—42.
 Wall Paper, To remove Grease from, 313.
 Walls, Damp, 155.
 —, Broken, To repair, 183.
 Walnuts, 215.
 Walnut Wood, Directions for Imitating by Painting, 198, 199.
 Washing made Easy, Quick, and Unlaborious, 109.
 —, General, made Easy, 109, 110.
 —, &c., 143, 144.
 — Chintzes, 155.
 — Clothes, 155.
 — at Home, *see* Laundry Maid.
 —, *see* Sea Water.
 Wash-leather Gloves, *see* Gloves.
 Watches, *see* Oil.
 Water, Wholesome, 192.
 —, Contamination by Zinc Tanks, 251.
 — Bottles, To clean, 156.
 — Fowl (Tame and Wild), *see* under Respective Heads.
 — Ices, Particulars of Making, 362; (Strawberry), *ib.*; (Raspberry), *ib.*; (Cherry), *ib.*; (Lemon), *ib.*
 — Souchy, Directions, 227.
 — Supply (*continued*), 36, 37; Construction of Wells or Water Reservoirs, 36; Impurities, Sewage, &c., *ib.*; Spring Water, *ib.*; Gases and Mineral Solutions of Spring Water, 37; Filters, *ib.*; River Water, &c., *ib.*; Formation of Small Well of Drinking Water, *ib.*; raising Water from make-shift Wells, *ib.*; Balance Lever, *ib.*; Figure of, 36; Barrel Water-strainer, 37; Sectional view of, 36; Makeshift Water-still for converting Sea into Fresh Water, 37; Figure of, 36.
 — (*continued*), With Illustrations, 260, 261.
 Wax, Spots of, To cleanse Cloth or Silk from, 202; Another Receipt, *ib.*
 Weather-glass, *see* Barometer.
 Weights and Prices, Table showing, 352.
 Wells, *see* Water Supply.
 Welsh Rarebits, Preparation of, 66.
 Wet Meters, *see* Gas Meters.
 Whey—Sugar of Milk, Scientific Notice, 156, 157.
- Whipped Cream, Directions for Making and Serving with Sponge Cake, &c., 112.
 Whitening for Cleaning Plated Goods, 365.
 Whiting, The, Remarks, Directions for Dressing, &c., 263.
 — Pout, The, Remarks and Directions for Dressing, 263.
 Whitewash, American, Directions, 103.
 Widgeon, Instructions for Purchasing, 139.
 Wife, *see* Husband.
 Wild Duck, Roasted, Particulars, Directions for Cooking, &c., 368.
 — Fowl, Particulars, 367, 368.
 — Goose, Particulars, with Directions for Dressing, Cooking, &c., 368.
 Window Boxes, *see* Gilding.
 Windy Spasm, *see* Flatulence.
 WINES, HOME-MADE.—Introduction, 382; Grape Wine, 382, 383; Green Grape Wine, 383; Wine from Unripe Grapes, 383, 384; Raisin Wine, 384; Quince Wine, *ib.*
 Wine, Cooling, 155.
 —, To exclude the Air from, 286.
 — Barrels, *see* Barrels.
 Wood Ashes, Components of, Uses and Value as a Manure, 15.
 — Carving, *see* Fret-work and Carving in Wood.
 Woodcocks, Instructions for Purchasing, 139.
 Woolen Hose, To clean, 109.
 — Stuff, To clean, Directions, 131.
 Woollens, To clean, 14.
 WORK-TABLE, THE.—How to Dress a Baby's Berceauette, 12, 13; How to make a Hat for a Baby-boy, 13.
 Worms, To kill, and prevent them damaging Books, 103.
 Worsted, New Black, or Lamb's-wool Stockings, To wash, 90.
 WRITING INK, Remarks and Full Particulars, 259.
- Z.
- Zinc Tanks, &c., Contamination of Water by, 251.

COLOURED PLATES.

- PLATE III.—Showing Arrangement of a Dinner-table, with Flowers *Frontispiece.*
 PLATE IV.—Asparagus on Toast, Cauliflowers, Salad, Potato Rissolos, Baked Tomatoes, Mashed Potatoes, French Beans *Facing page 193.*

LIST OF WORKS

PUBLISHED BY

MESSRS. CASSELL, PETTER, AND GALPIN.

Bibles and Religious Literature.

Bible, Cassell's Illustrated Family. Complete in One Volume, royal 4to, in cloth, gilt edges, 1,710 pp., 960 Illustrations, and Family Register, £1 11s. 6d.; calf, £2 10s.; morocco antique, £3 10s.

. Cassell's "Illustrated Family Bible" has attained a circulation of nearly *Half a Million*.

Bible, Cassell's Illustrated Family. Toned Paper Edition. Half morocco, gilt edges, £2 10s.; full morocco antique, £3 10s.; best full morocco elegant, £3 15s.

Bible, Cassell's Illustrated Family. Large Paper Edition. 1,494 pp., and Family Register. Cloth gilt, £2 10s.; flexible morocco antique, £4; full gilt morocco elegant, £5.

Bible, The Child's. 830 pp.; 220 Illustrations. Demy 4to. Being a Selection from the Holy Bible, in the words of the Authorised Version. Cloth elegant, gilt edges, £1 1s.; flexible leather binding, hand tooled, gilt edges, £1 10s.; best morocco elegant or antique, £2 2s.

. Nearly 60,000 copies of "The Child's Bible" have been already sold.

Bible, The Doré. Illustrated by GUSTAVE DORÉ. Complete in Two very handsome Volumes. Bound in cloth gilt, £8; morocco, gilt edges, £12; best polished morocco antique extra, £15.

Bible Dictionary, Cassell's. Complete in One or Two Vols., strongly bound in cloth, 21s.; in One Vol., strongly bound in russia or morocco, 40s. 1,159 pp., and nearly 600 Illustrations. Imp. 8vo.

Commentary, Matthew Henry's. Complete in Three Volumes. Cloth, lettered, £2 12s. 6d. Demy 4to, 3,308 pp.; numerous Illustrations and Maps.

Family Prayer Book, Cassell's. Cloth, 7s. 6d.; with gilt edges, 9s.; morocco antique, 21s. 398 pp., demy 4to.

Mission Life. A Record of Mission Work in all Parts of the Globe. Volume for 1870, containing about 800 pages letterpress, and numerous Engravings. Cloth, 5s.

Quiver, The. Volume for 1870. 840 pages letterpress, and numerous Engravings. Cloth, lettered, 7s. 6d.; gilt edges, 8s. 6d.

Children's Books.

Shilling Story Books. 96 pp., fcap. 8vo, cloth, lettered. Two Illustrations in each Volume.

Lottie's White Frock, and other Stories.
Helpful Nellie, and other Stories.
Only Just Once, and other Stories.
The Boot on the Wrong Foot, and other Stories.
Little Content, and other Stories. By EDITH WALFORD.
Little Lizzie. By MARY GILLIES. And other Tales.
Luke Barnicott. By WILLIAM HOWITT. And other Tales.
My First Cruise. By W. H. KINGSTON. And other Tales.
The Boat Club. By OLIVER OPTIC. And other Tales.
The Delft Jug. By SILVERPEN. And other Tales.
The Elchester College Boys. By Mrs. HENRY WOOD. And other Tales.
The Little Peacemaker. By MARY HOWITT. And other Tales.
Jonas on a Farm. By JACOB ABBOTT. And other Tales.

Shilling Toy Books. In demy 4to, stiff covers. With full-page Illustrations printed in Colours by KRONHEIM.

1. How Cock Sparrow Spent his Christmas.
2. The Adventures of Robinson Crusoe.
3. Queer Creatures. Drawn by One of Themselves.
4. Æsop's Fables. (21 Plates.)

Shilling Reading Books.

Evenings at Home. In Words of One Syllable. Cloth, limp, 1s.
Æsop's Fables. In Words of One Syllable. Cloth, limp, 1s.

Eighteenpenny Series of New and Original Works. Bound in best cloth, gilt edges, with Four Coloured Plates by KRONHEIM in each Book. 128 pp., fcap. 8vo.

Little Blackcap. And other Stories.
Tommy and his Broom. And other Stories.
Little Red Shoes. And other Stories.
Charlie's Lessons about Animals.
The Broken Promise. And other Stories. By the Hon. Mrs. GREENE.
The Holidays at Llandudno.
The Hop Garden: A Story of Town and Country Life.
Algy's Lesson. By S. E. DE MORGAN.
Hid in a Cave; or, The Lost Child.
Ashfield Farm; or, Ellen and Robert's First Journey from Home.
Grandmamma's Spectacles. By the Author of "A Trap to Catch a Sunbeam."
Little Fables for Little Folks.
Flora Selwyn: A Story for Girls.

Two Shilling Series of New and Original Works. Bound in cloth gilt, gilt edges, with Illustrations printed in Colours, 160 pp., fcap. 8vo.

Dr. Savory's Tongue. By Two SISTERS.
The Golden Gate. By H. G. B. HUNT.
Love and Duty. By ANNA J. BUCKLAND.
Brave Lisette. And other Stories. By Miss CARELESS.
Beatrice Langton; or, The Spirit of Obedience.
Owen Carstone: A Story of School Life.
The Boy who Wondered.
New Stories and Old Legends. By Mrs. T. K. HERVEY.
The Little Orphan.
The Story of Arthur Hunter and his First Shilling.
The Story of the Hamiltons.
The Hillside Farm.

Children's Books—continued.

Half-Crown Library. 160 pp., extra fcap. 8vo, handsomely bound in cloth gilt, with Illustrations and Ornamental Chapter Heads.

Labour Stands on Golden Feet. A Holiday Story for the Industrial Classes. Translated from the German of HEINRICH ZSCHOKKE, by Dr. JOHN YEATS.

Stories of the Olden Time. Selected and arranged by M. JONES, Author of "The Story of Captain Cook," &c.

One Trip More. And other Stories. By the Author of "Mary Powell."

Truly Noble: A Story. By MADAME DE CHATELAIN. **Autobiographies of a Lump of Coal and a Grain of Salt, &c.** By ANNIE CAREY.

Love and Life in Norway. By BJORNSTJERNE BJORNSEN. Translated from the Norwegian by the Hon. AUGUSTA BETHELL and A. PLESNER.

The Fishing Girl. By BJORNSTJERNE BJORNSEN. Translated from the Norwegian by F. RICHARDSON and A. PLESNER.

The Children's Library. A Series of Volumes specially prepared for Children. Beautifully Illustrated, and handsomely bound in cloth gilt, uniform in size and price.

The Children's Sunday Album. By the Author of "A Trap to Catch a Sunbeam." With upwards of 100 Engravings. A companion volume to "The Children's Album," by UNCLE JOHN. Cloth gilt, 3s. 6d.

The Story of Robin Hood. Illustrated with Eight Plates printed in Colours. Cloth, 3s. 6d.

The True Robinson Crusoes. A Series of Stirring Adventures. Edited by CHAS. RUSSELL. Cloth gilt, 3s. 6d.

The Merrie Heart. A Collection of Nursery Rhymes and Short Tales. Illustrated with Eight Coloured Plates from Designs by WALTER CRANE, and numerous smaller Engravings by J. SWAIN, from Drawings by ERNEST GRISSET, F. BARNARD, and others. Cloth gilt, 3s. 6d.

Off to Sea. By W. H. G. KINGSTON. With Eight Coloured Plates by KRONHEIM. Cloth gilt, 3s. 6d.

The Children's Album. Containing Coloured Frontispiece and nearly 200 Engravings, with Short Stories, by UNCLE JOHN. With several Pieces of Music. Twenty-sixth Thousand. 3s. 6d.

Old Burchell's Pocket: A Book for the Young Folks. By ELIHU BURRITT. 3s. 6d.

Peggy, and other Tales; including the HISTORY OF A THREEPENNY BIT, and THE STORY OF A SOVEREIGN. 3s. 6d.

Mince-Pie Island: A Christmas Story for Young Readers. By R. St. JOHN CORBET. 3s. 6d.

Cloudland and Shadowland; or, Rambles into Fairy Land with Uncle White Cloud. 3s. 6d.

The Queen of the Tournament, and Butterfly Ball at Maperley Hall. By the Author of "Mince-Pie Island." 3s. 6d.

Lily and Nannie at School: A Story for Girls. By the Author of "The Little Warringtons." 3s. 6d.

The Magic of Kindness; or, The Wondrous Story of the Good Huan. By the Brothers MAYHEW. With Eight Plates by WALTER CRANE. Cloth gilt, 3s. 6d.

On a Coral Reef: A Sea Story for Boys. By ARTHUR LOCKER. Cloth gilt, 3s. 6d.

King Gab's Story Bag; and the Wondrous Tales it contained. By HERACLITUS GREY. With Eight Plates by WALTER CRANE. 3s. 6d.

Crocker the Clown: A Tale for Boys. By B. CLARKE, Editor of "Kind Words." 3s. 6d.

Hours of Sunshine: A Series of Poems for Children. By MATTHIAS BARR, Author of "Little Willie," &c. With Sixteen Coloured Plates from Designs by OSCAR PLETSCH. 3s. 6d.

Playing Trades. By HERACLITUS GREY, Author of "King Gab," &c. With Sixteen Coloured Plates from Designs by J. BARFOOT. 3s. 6d.

The Happy Nursery. By ELLIS A. DAVIDSON. Containing Designs for Toys, New Games, &c. Cloth gilt, 3s. 6d.

The Angel of the Iceberg. And other Stories. By JOHN TODD, D.D. (New Edition.) 3s. 6d.

Drawing-Room Plays. Gilt edges, 3s. 6d.

Famous Regiments of the British Army. By WILLIAM H. DAVENPORT ADAMS. 320 pp. Four Illustrations and Coloured Frontispiece. 3s. 6d.

The Children's Library—continued.

Will Adams: The Adventures of the First Englishman in Japan. By WILLIAM DALTON. 3s. 6d.

Working Women of this Century: The Lesson of their Lives. By CLARA LUCAS BALFOUR. 436 pp. 3s. 6d.

ONE SYLLABLE SERIES.

Uniform with the Children's Library.

Æsop's Fables, in Words of One Syllable. With Eight Illustrations printed in Colours by KRONHEIM. 3s. 6d.

Sandford and Merton, in Words of One Syllable. With Eight Illustrations printed in Colours by KRONHEIM. 3s. 6d.

Reynard the Fox; the Rare Romance of, and the Shifts of his Son Reynardine. In Words of One Syllable. By SAMUEL PHILLIPS DAY. With Eight Coloured Illustrations by KRONHEIM, from Designs by ERNEST GRISSET. 3s. 6d.

The Pilgrim's Progress. Written in Words of One Syllable by S. PHILLIPS DAY. With Eight Coloured Illustrations by KRONHEIM. 3s. 6d.

The Swiss Family Robinson, in Words of One Syllable. By the Author of "The Boy's First Reader." Eight Coloured Illustrations from Designs by GRISSET, CRANE, &c. 3s. 6d.

Evenings at Home, in Words of One Syllable. By the Author of "The Children's Album." Eight Coloured Illustrations from the Designs of DOWNARD, BAYES, &c. 3s. 6d.

Five Shilling Books.

Home Chat with Our Young Folks. By CLARA MATÉAUX, Author of "The Story of Don Quixote," &c. &c. With 200 Illustrations.

The Story of Don Quixote. By CLARA MATÉAUX. Re-narrated in a familiar manner, especially adapted for Younger Readers, and illustrated with numerous Engravings. Crown 8vo. Illustrated with numerous Engravings. Crown 8vo.

Robinson Crusoe, Life and Adventures of. New Edition. Cloth plain, 5s.; full gilt, 6s. 6d.

Swiss Family Robinson. New Edition, complete. Cloth plain, 5s.; full gilt, 6s. 6d.

A Voyage to the South Pole. A New Story. By W. H. G. KINGSTON. Profusely Illustrated.

Scraps of Knowledge for the Little Ones; By JANET BYRNE, Author of "Picture Teaching."

Picture Teaching for Young and Old. A Series of Object Lessons Progressively Arranged, so as to teach the meaning of every term employed. With more than 200 Illustrations.

Picture Natural History. A Series of Plates numbering upwards of 600, in which the Animal, Vegetable, and Mineral Kingdoms are classified in Families. With Descriptive Letterpress. Edited by the Rev. C. BOUTELL, M.A.

Old Friends and New Faces. Demy 4to. Twenty-four Coloured Plates by KRONHEIM.

Six Shilling Books.

Esther West. By ISA CRAIG-KNOX. With Twenty-four full-page Illustrations.

Peoples of the World. By BESSIE PARKES-BELLOC. With about Fifty Engravings. Cloth gilt.

Little Songs for Me to Sing. Illustrated by J. E. MILLAIS, R.A.; with Music composed expressly for the work by HENRY LESLIE. Dedicated to Her Royal Highness the PRINCESS OF WALES, by Special Permission.

The Story of Captain Cook. By M. JONES. With about Fifty Engravings. Cloth gilt.

Seven and Sixpenny Books.

Bright Thoughts for the Little Ones. Twenty-seven Original Drawings by PROCTER. With Prose and Verse by GRANDMAMMA. Cloth gilt, gilt edges, 7s. 6d.

The Child's Garland of Little Poems: Rhymes for Little People. With exquisite Illustrative Borders by GIACOMELLI. Cloth gilt, 100 pp. fcap. 4to, 7s. 6d.

Favourite Poems by Gifted Bards. Illustrated, cloth gilt, 7s. 6d.

Beauties of Poetry and Gems of Art. With 32 Illustrations, cloth gilt, 7s. 6d.

Jewels Gathered from Painter and Poet. Cloth gilt, gilt edges, 7s. 6d.

Dictionaries.

- Bible Dictionary, Cassell's.** With 600 Illustrations. One or Two Volumes, 21s.; bound in morocco, 40s.
- Biographical Dictionary, Cassell's.** 1,160 pages, imp. 8vo. Illustrated with Portraits. Cloth, 21s.; half morocco or calf, 35s.
- Brewer's Dictionary of Phrase and Fable;** giving the Derivation, Source, or Origin of Common Phrases, Allusions, and Words that have a Tale to Tell. By the Rev. Dr. BREWER. Demy 8vo, 1,000 pp., cloth, 10s. 6d.
- Dictionary of the English Language, A.** 16th Edition. 3s. 6d.
- French and English Pronouncing Dictionary.** Crown 8vo, 956 pp., cloth, 3s. 6d.
- German-English and English-German Pronouncing Dictionary.** Crown 8vo, cloth, 864 pp., 3s. 6d.
- Latin-English and English-Latin Dictionary.** By J. R. BEARD, D.D., and C. BEARD, B.A. Cloth, 914 pp., 3s. 6d.
- Illustrated National Dictionary, The,** on the basis of Webster. With 250 Engravings. Crown 16mo, 1s.
- Webster's Etymological Dictionary.** 3s. 6d.
- Dictionary of Derivations, The.** By Professor SULLIVAN, LL.D. 11th Edition. 2s.

Educational Works.

- Algebra, Elements of.** Paper covers, 1s.; cloth, 1s. 6d.
- Anatomical Atlas, The.** Designed and Printed in Colours from Nature. Royal folio, with Index, 10s. 6d.
- Arithmetic.**
- Hudson's Arithmetic for School and College Use. With a copious Collection of Exercises, and Key. 1s. 6d.
 - Wallace's Arithmetic. Cloth, 1s. 6d.
 - Arithmetic for the Young. Cloth, 1s.
 - Elementary Arithmetic. Simple Rules. 4d. Key to Ditto, 3d.
 - Elementary Arithmetic. Compound Rules. 6d. Key to Ditto, 3d.
- Book-Keeping,** by Single and Double Entry. 1s. Ruled Account Books to Ditto, extra, 1s. 6d. each Set.
- Book-Keeping for the Million.** By THEODORE JONES. Cloth, 3s.
- Book-Keeping for Schools.** The English System. By THEODORE JONES. 2s.; cloth, 3s.
- Book-Keeping for Schools, The Key to.** 2s.; cloth, 3s.
- Books for Jones's System,** Ruled Sets of. 2s.
- Brewer's Series of First Books.** Price 6d. each.
- | | |
|--------------------------------------------------------------------------------------------------------------------------------------------------------------------------------------------|---------------------------------------------------------------------------------------------------------------------------------------------------------------------------------------------------|
| <ul style="list-style-type: none"> Reading and Spelling. Bible History. History of England. Geography. Science. Common Things. | <ul style="list-style-type: none"> French History. Astronomy. Chemistry. Facts and Discoveries. Grecian History. The History of Rome. |
|--------------------------------------------------------------------------------------------------------------------------------------------------------------------------------------------|---------------------------------------------------------------------------------------------------------------------------------------------------------------------------------------------------|
- Brewer's, The Young Tutor. First Series.** Being the First Six Books in this Series, bound in One Volume. Cloth, 3s. 6d.
- Brewer's, The Young Tutor. Second Series.** Being the latter Six Books in this Series, bound in One Volume. Cloth, 3s. 6d.
- Brewer's Guide to Every-Day Knowledge.** 284 pp., 2s. 6d.
- Cassell's Drawing Books,** for Joiners, Carpenters, Machinists, Builders, Cabinet Makers, Stonemasons, Tin-plate Workers, Plumbers, and Artisans generally.
- Linear Drawing.** By E. A. DAVIDSON. With 150 Illustrations. 128 pp., extra fcap. 8vo, cloth limp, 2s.
 - Orthographic and Isometrical Projection.** By the same Author. With 40 whole-page Diagrams. 128 pp., extra fcap. 8vo, cloth limp, 2s.
 - Linear Drawing and Projection. The Two Volumes in One.** Cloth, lettered, 3s. 6d.
 - Building Construction, the Elements of, and Architectural Drawing.** By ELLIS A. DAVIDSON. With 130 Illustrations. Extra fcap. 8vo, 128 pp., cloth limp, 2s.
 - Systematic Drawing and Shading.** By CHARLES RYAN, Head Master, Leamington School of Art. With numerous Illustrations and Drawing Copies. 120 pp., extra fcap. 8vo, cloth limp, 2s.
 - Drawing for Carpenters and Joiners.** By ELLIS A. DAVIDSON. With 253 Illustrations and Drawing Copies. 104 pp., extra fcap. 8vo, cloth, 3s. 6d.
 - Practical Perspective.** By ELLIS A. DAVIDSON. With 36 double-page Illustrations. 90 pp., cloth, 3s.
 - Drawing for Machinists.** By ELLIS A. DAVIDSON. With nearly 200 Illustrations and Diagrams. Extra fcap. 8vo, cloth, 4s. 6d.
- Cassell's Elementary Atlas.** 16 Coloured Maps. Fcap. 4to, 6d.
- Cassell's Preparatory Atlas.** 16 Coloured Maps. Crown 4to, 6d.
- Cassell's First School Atlas.** Coloured Maps. Crown 4to, 1s.
- Cassell's Handy Atlas.** 24 Coloured Maps, and Index. Crown 8vo, cloth, 2s. 6d.
- Cassell's Beginner's Atlas.** 24 Coloured Maps, and Index. Crown 4to, cloth, 2s. 6d.
- Cassell's Introductory Atlas.** 18 Coloured Maps, and Index. Cloth, 3s. 6d.
- Cassell's Select Atlas.** 23 Coloured Maps, and Index. Imperial 8vo, cloth, 5s.
- Cassell's Comprehensive Atlas.** 42 Coloured Maps, and Index. 10s. 6d.
- Chemistry.** Specially adapted for the use of Self-Students. Cloth, 1s.

Educational Works—continued.

Chemistry, Elementary. By the Rev. H. MARTYN HART. 290 pp., crown 8vo, cloth, 3s. 6d.

Copy-Books for Schools, Cassell's. With Set Copies on every page. 14 sorts. Price 2d each.

- | | |
|------------------------------|-----------------------------------|
| 1. Initiatory Exercises. | 9. Small Hand. |
| 2. Letters and Combinations. | 10. Text, Round, and Small Hands. |
| 3. Short Words. | 11. Introduction to Ladies' Hand. |
| 4. Capitals. | 12. Ladies Hand. |
| 5. Text Hand. | 13. Commercial Sentences. |
| 6. Text and Round. | 14. Figures. |
| 7. Round Hand. | |
| 8. Round and Small Hands. | |

** These Books are now very largely used in Schools, and have been described as the *cheapest* and *best* ever published.

Drawing Copies, Cassell's Popular.

- Series A. **Floral and Vegetable Forms.** Twelve Parts, 6d. each. Twelve Packets, on Cardboard, 1s. each.
- Series B. **Model Drawing.** Twelve Parts, 6d. each. Twelve Packets, on Cardboard, 1s. each.
- Series C. **Landscape Drawing.** Twelve Parts, 6d. each. Twelve Packets, on Cardboard, 1s. each.
- Series D. **Figure Drawing.** Twelve Parts, 6d. each. Twelve Packets, on Cardboard, 1s. each.
- Series E. **Animal Drawing.** Twelve Parts, 6d. each. Twelve Packets, on Cardboard, 1s. each.

The Drawing Copies, in 6d. Parts, and 1s. Packets on Cardboard, may be had in separate Parts or Packets.

Drawing Copies.

- Gregory's First Grade Self-teaching Free-hand Outline Drawing Examples.** By CHARLES GREGORY, Wolverhampton (Master of the Art Classes at the Willenhall Literary Institute, &c. &c.). In Two Packets, each containing Twenty-four Examples, on Card, price 1s. per Packet. Enlarged for black-board, 2s. 6d. per Packet.
- Gregory's Outlines from Models used in Schools,** on Twelve Cards, 1s.; and enlarged for black-board, 2s.
- Gregory's Outlines from Flowers.** Twelve large Cards, in Packet, 1s. 6d.
- Gregory's Easy Drawing Examples.** Twenty-four Cards, in Packet, 1s.; enlarged for black-board, 2s. 6d.
- First Examples in Freehand Drawing.** By WALTER SMITH. Price 2s.
- The School of Art Model and Object Drawing Book.** By WALTER SMITH, Head Master of the Leeds School of Art and Science. Price 3s.

English Grammar. By Professor SULLIVAN, LL.D. 85th Edition. 1s.

Etymology, a Manual of. By Professor SULLIVAN, LL.D. 3rd Edition. 10d.

English Spelling and Reading Book. With upwards of Fifty Illustrations, cloth, 1s.

Euclid, Cassell's. Edited by Professor WALLACE, A.M., of the Glasgow University. 1s.; cloth, 1s. 6d. Key to Ditto, 4d.

French, Cassell's Lessons in. By Professor FASQUELLE. New Edition, Revised and Improved. By Professor DE LOLME. Parts I. and II. in paper, 2s.; cloth, each 2s. 6d. Complete in One Volume, 188 pp., 4s. 6d.

French, Key to the Exercises in Cassell's Lessons in. 1s.; cloth, 1s. 6d.

French, Shilling Lessons in. By Professor DE LOLME. 1s.; cloth, 1s. 6d.

French, Sixpenny Lessons in. 6d.

French Manual. By Professor DE LOLME. Cloth, 3s.

French and English Correspondence for Boys. 2s. 6d.

French and English Correspondence for Young Ladies. 2s. 6d.

French and English Commercial Correspondence. 2s. 6d.

French Reader, The. New Edition. By Professor DE LOLME. Paper, 2s.; cloth, 2s. 6d.

Galbraith and Houghton's Scientific Manuals. Cloth, red edges.

- Arithmetic. Cloth, 3s. 6d.
- Plane Trigonometry, 2s. 6d.
- Euclid. Elements I., II., III. 2s. 6d.
- Euclid. Books IV., V., VI. 2s. 6d.
- Mathematical Tables. 3s. 6d.
- Mechanics. Cloth, lettered. 3s. 6d.
- Optics. 2s. 6d.
- Hydrostatics. 3s. 6d.
- Astronomy. 5s.
- Steam Engine. 3s. 6d.
- Algebra. Third Edition. Part I., 2s. 6d.; complete, 7s. 6d.
- Tides and Tidal Currents. New Edition, with Tidal Cards. 3s.
- Natural Philosophy. With 160 Illustrations. 3s. 6d.
- The Three Kingdoms of Nature. With 230 Illustrations. 5s.

Geography, Ancient, Modern, and Sacred. By Professor SULLIVAN, LL.D. 1s.

Geography Generalised; with Maps and Illustrations. By Professor SULLIVAN, LL.D. 2s.

German Reader, The International, for the Use of Colleges and Schools. By EDWARD A. OPPEN, of Haileybury College. 4s. 6d.

German, Lessons in. By W. H. WOODBURY. Parts I. and II., 2s.; cloth, each 2s. 6d. Complete in One Volume, cloth, 4s. 6d.

German, Key to Lessons in. 1s.; cloth, 1s. 6d.

German, Sixpenny Lessons in. By E. A. OPPEN, of Haileybury College. 6d.

Latin Reader, The. Adapted to "Cassell's Latin Grammar." Cloth, 1s. 6d.

The Literary Class Book. By Professor SULLIVAN, LL.D. 11th Edition. 2s. 6d.

Natural History of Commerce, The. By J. YEATS, LL.D. Intended for the study of Young Merchants, Manufacturers, and Business Men. 452 pp., crown 8vo, cloth, 5s.

Natural Philosophy, the Elements of. For the use of Schools. By the Rev. SAMUEL HAUGHTON, M.D., F.R.S., Fellow of Trinity College, Dublin. With 160 Illustrations. Cloth, 3s. 6d.

Natural Philosophy, in Easy Lessons. By Professor TYNDALL, F.R.S. Illustrated. New Edition, 2s. 6d.

Natural Philosophy, Hand-book of. Cloth, 1s.

Educational Works—continued.**Popular Education and School-keeping.**

By Professor SULLIVAN, LL.D. Second Edition. 2s.

Popular Educator, Cassell's New. Revised to the Present Date, with numerous Additions. Vols. I., II., III., IV., V., and VI. now ready, best cloth gilt, 6s. each; complete in Three Vols., half-calf, £2 10s.

Primary Series. An entirely new and original Series of Volumes, specially prepared for the use of Elementary, National, and other Schools, by first-class practical men.

Elementary Arithmetic: Simple Rules. 4d.

Key to ditto, 3d.
Elementary Arithmetic. Compound Rules. 6d. Key to ditto, 3d.

Elementary British History. 6d.

Elementary Geography. 4d.

England at Home: An Elementary Text-Book of Geography, Manufacture, Trade, and Commerce. 1s.

Our Bodies: An Elementary Text-Book of Human Physiology. 1s.

Our Houses, and what they are Made of. 1s.

Our Food. 1s.

Our First Grammar: an Elementary Text-Book. 1s.

The Uses of Plants in Food, Arts, and Commerce. With Illustrations. 1s.

Vegetable Physiology, in Easy Lessons, with numerous Illustrations. 1s. 6d.

The Animal Kingdom. With abundant Illustrations. Double Vol., cloth, lettered, 200 pp. 2s.

Fine Art

Æsop's Fables. With numerous Illustrations from Original Designs by ERNEST GRISET. Imperial 8vo, 236 pp., cloth gilt, gilt edges, 21s.

After Ophir. By Captain A. F. LINDLEY. Illustrated with about Sixty Engravings. Cloth gilt, 7s. 6d.

Arms and Armour. By CHARLES BOUTELL, M.A., Author of "English Heraldry." With numerous Engravings. 7s. 6d.

Beauties of Poetry and Gems of Art. With Thirty-two Illustrations by J. C. HORSLEY, R.A., J. TENNIEL, C. W. COPE, R.A., PICKERS-GILL, &c. With Ornamental Borders, &c. 7s. 6d.

Book of Historical Costumes, The. With 96 full-page Coloured Engravings. 50s.

British Army, The History of the. By Sir SIBBALD DAVID SCOTT, Bart. Dedicated, by special permission, to the Queen. Two Vols., 1, 178 pp., demy 8vo, cloth, £2 2s.

Bunyan. The Pilgrim's Progress. Cloth, 7s. 6d.; gilt edges, 10s. 6d.; morocco antique, 21s.

Bunyan. The Holy War. Uniform with above, and same price.

Chefs-d'œuvre of the Industrial Arts. With 200 Illustrations. By PHILIPPE BURTY. Edited by W. CHAFFERS, F.S.A. Cloth, 16s.; extra cloth gilt, 21s.

Crusoe, Life and Adventures of. With 100 Illustrations by MATT MORGAN, HARRISON WEIR, R. P. LEITCH, &c. Cloth, 7s. 6d.; full gilt, 10s. 6d.; morocco, 21s.

Primary Series—continued.

Right Lines in their Right Places; or, Geometry without Instruments. With Drawings on Wood by the Author. 1s.

CASSELL'S STANDARD READERS.

The Boy's First Reader. Standard I. With easy Spelling Exercises. Illustrated. 4d.

The Boy's Reader. Standard II. Containing Lessons in Reading and Spelling. With many Illustrations. 4d.

The Girl's First Reader. Standard I. With easy Spelling Exercises. Illustrated. 4d.

The Girl's Reader. Standard II. Containing Lessons in Reading and Spelling. Illustrated. 4d.

The Boy's and Girl's Reader. Standard III. Adapted to the Requirements of the Revised Code. Cloth, 7d.

The Boy's and Girl's Reader. Standard IV. 9d.

The Poetical Reader. Standard V. 208 pp., fcap. 8vo., cloth. 1s.

The Explanatory Reader. Standard VI. Cloth, 1s.

Science Popularly Explained. Cloth, 3s. 6d.

The Spelling-Book Superseded. By Professor SULLIVAN, LL.D. 1s. 4d.

Upwards of Four Hundred Words, Spelled in Two or More Ways by different Authors; with an Attempt to Settle their Orthography. By Professor SULLIVAN, LL.D. 10d.

Volumes.

Doré Gallery, The. Containing 250 of the finest Drawings of GUSTAVE DORÉ. Letterpress and Memoir by EDMUND OLLIER. Cloth gilt, £5 5s.; full morocco elegant, £10.

Doré Bible (see Biblical Literature).

Doré's Milton's Paradise Lost. Illustrated with full-page Drawings by GUSTAVE DORÉ. Cloth, £5; best polished morocco, gilt extra, £10.

Doré's Dante's Inferno. Cloth, £2 10s.; morocco antique, with gilt edges, £4 4s.; full morocco, £6 6s.

Doré's Dante's Purgatory and Paradise. Uniform with the INFERNO, and same price.

Doré's Don Quixote. With 400 Illustrations. Cloth, £1 10s.; half morocco, £2 5s.; full morocco antique, £3 10s.

Doré's Atala. By CHATEAUBRIAND. Cloth, £2 2s.; morocco gilt, £4 4s.

Doré's La Fontaine's Fables. With 86 full-page and many other Engravings. Cloth, £1 10s.; half morocco, £2 5s.; full morocco antique, £3 10s.

Doré's, The History of Croquemitaine, and the Times of Charlemagne. With nearly 200 Engravings. Cloth, £1 1s.

Doré's Fairy Realm. Illustrated with 25 full-page Engravings by GUSTAVE DORÉ. Cloth gilt, gilt edges, £1 1s.

Doré's, The Adventures of Munchausen. With 31 full-page Engravings. Cloth, 10s. 6d.

Fine Art Volumes—continued.

Doré's, The Legend of the Wandering Jew. Folio, 15s.; extra gilt, 21s.

English Heraldry. By CHARLES BOUTELL, M.A., Author of "Arms and Armour," &c. With 460 Engravings. Cloth, gilt top, 7s. 6d.

Favourite Poems by Gifted Bards. Illustrated with 24 Engravings by CORBOULD, THOMAS, SELOUS, and other eminent Artists. Cloth, gilt edges, 7s. 6d.

Foxe's Book of Martyrs. Illustrated with 181 Engravings. Plain cloth, 12s.; full gilt cloth, gilt edges, 15s.

Goethe Gallery. A Series of beautiful Photographs from KAULBACH'S Drawings of the Heroines of Goethe. Handsomely bound in morocco, 42s.

Goethe's Heroines. A Series of 21 exquisite Engravings on Steel. Cloth, lettered, £7 7s.

Greece, The Scenery of. By W. LINTON. Fifty exquisitely beautiful full-page Steel Engravings. Cloth, lettered, gilt edges, 42s.

Gulliver's Travels. By DEAN SWIFT. Illustrated with 88 Engravings by MORTEN. With an Introduction, Annotations, and a LIFE OF SWIFT, by J. F. WALLER, LL.D., M.R.I.A. Imperial 8vo, 400 pp., plain cloth, 7s. 6d.; full gilt cloth, gilt edges, 10s. 6d.; full morocco antique, 21s.

Illustrated Readings. Vol. I., cloth gilt, 7s. 6d.; full gilt, gilt edges, 10s. 6d. Vol. II., cloth, 7s. 6d.; full gilt, gilt edges, 10s. 6d. Or the Two Vols. in One, cloth, 12s. 6d.; half morocco, 15s.

Illustrated Travels: a Record of Discovery, Geography, and Adventure. Edited by H. W. BATES, Assistant-Secretary of the Royal Geographical Society. Vols. I. and II., each, cloth, 15s.; cloth, extra gilt, gilt edges, 18s. Or, the Two Vols. in One, cloth, 25s.; best cloth, gilt edges, 31s. 6d.; Roxburgh binding, 35s.

Illustrations, Millais'. A Collection of 80 Drawings on Wood by JOHN EVERETT MILLAIS, R.A. Cloth, gilt edges, 16s.

Insect World, The. From the French of LOUIS FIGUIER. With 570 Illustrations. Edited by E. W. JANSEN, Lib.E.S. Cloth, lettered, 16s.; extra cloth gilt, 21s.

Jewels Gathered from Painter and Poet. Cloth, gilt edges, 7s. 6d.

Log of the Fortuna, The. By Captain A. F. LINDLEY. Fcap. 4to, 256 pp., cloth gilt, 7s. 6d.

Ocean World, The. From the French of LOUIS FIGUIER. Edited by C. O. G. NAPIER; F.G.S. Cloth, lettered, 16s.; extra cloth gilt, 21s.

Old Friends with New Faces. With 24 full-page Illustrations, beautifully printed in Colours by KRONHEIM. 5s.

Pictures from English Literature. With 20 full-page Illustrations by J. C. HORSLEY, R.A., W. F. YEAMES, A.R.A., MARCUS STONE, J. GILBERT, H. K. BROWNE, W. CAVE THOMAS, LAWSON, HUGHES, BARNARD, FILDES, &c. &c. The Text by Dr. WALLER. Crown 4to, cl. gilt, 21s.

Poems and Pictures. Very handsomely bound in extra cloth gilt, 21s.

Reptiles and Birds. From the French of LOUIS FIGUIER. Edited by PARKER GILMORE, Esq. 18s.; extra cloth gilt, 23s.

Sacred Poems, The Book of. Edited by the Rev. R. H. BAYNES, M.A. Cl., plain, 7s. 6d.; cl., extra gilt, gilt edges, 10s. 6d.; morocco antique, 21s.

Schiller Gallery, The. A Series of Choice Photographs from KAULBACH'S Paintings of Scenery from SCHILLER. £5 5s.

Selection of One Hundred of the Finest Engravings by the late G. H. Thomas. Cloth gilt, 21s.

Thorwaldsen's Triumphal Entry of Alexander the Great into Babylon. Twenty-Two Plates, folio. 42s.

Vegetable World, The. With 471 Illustrations. From the French of LOUIS FIGUIER. Edited by C. O. G. NAPIER, F.G.S. Cloth, lettered, 16s.; extra cloth gilt, 21s.

Vicar of Wakefield, The, and POEMS. Beautifully printed on Toned Paper, and Illustrated with 108 Engravings. In one handsome imperial 8vo Volume, 378 pp., bound in cloth, 7s. 6d.; full gilt cl., with gilt edges, 10s. 6d.; full morocco antique, 21s.

World before the Deluge, The. With 233 Illustrations. From the French of LOUIS FIGUIER. Edited by H. W. BRISTOW, F.R.S. Cloth, lettered, 16s.; extra cloth gilt, 21s.

World of the Sea. With 18 Coloured Plates, and numerous Wood Engravings. Cl., lettered, 21s.

Hand-Books and Guides.

Bacon's Guide to America and the Colonies. With Maps, &c. Cloth, 2s. 6d.

Civil Service, Guide to Employment in the. Revised to the Present Time. Cloth, 2s. 6d.

Civil Service, Guide to the Indian. By A. C. EWALD, F.S.A. Cloth, 4s. 6d.

Guide to America for the Capitalist, Tourist, or Emigrant. By G. W. BACON, F.R.S. With Coloured Map, 1s.

Hand-Books, Cassell's Popular. Cloth, 1s. each; free by post for 13 stamps.

Art of Conversation. Ruled Account Books to do., extra, 1s. 6d. each set.
Book-Keeping, by Single and Double Entry. **Business.**

Hand-books—continued.

Chemistry.	Gardening.
Chess and Draughts.	Health & Physiology.
Domestic Pets.	How to Colour a
Domestic Recipes.	Photograph in Oil or
Drawing - Room	Water.
Magic.	Investments.
Elocution & Oratory.	Letter-Writing.
Emergencies.	Natural Philosophy.
Etiquette for Ladies and	Photography.
Gentlemen.	Railway Situations.

Household Guide, The—

Vol. I., with Two Coloured Plates, and 150 Illustrations. Cloth gilt, 6s.

Vol. II., with Two Coloured Plates, and numerous Illustrations. Cloth gilt, 6s.

Thames and Tweed—New Work on Fishing. By GEORGE ROOPER, Author of "Flood, Field, and Forest." 2s. 6d.

History.

England, Illustrated History of. Complete in Eight Volumes, bound in cloth, 6s. and 7s. 6d. each. Ditto, Four Volumes, strongly bound in half-calf, with full gilt backs and cloth sides, £4. The TONED PAPER EDITION, Volumes I., II., III., IV., and V. Cloth, each 9s.

England, History of, from the First Invasion by the Romans to the Accession of William and Mary in 1688. By JOHN LINGARD, D.D. In Ten Volumes. Cloth lettered, 35s.

History of the British Army. By Sir S. D. SCOTT, Bart. Two Vols. 100 Plates. 42s.

Miscellaneous.

A Poet-Hero. By COUNTESS VON BOTHMER. Being a Biography of the German War-Poet, Theodore Körner. Cloth, 10s. 6d.

Appropriation of the Railways by the State. By ARTHUR JOHN WILLIAMS, Barrister at Law. The People's Edition. Crown 8vo, 1s.

Arms and Armour, in Antiquity and the Middle Ages; also a Descriptive Notice of Modern Weapons. Translated from the French of M. P. LACOMBE, by CHARLES BOUTELL, M.A., Author of "English Heraldry." With Seventy-one Illustrations. Cloth, gilt top, 7s. 6d.

Belle Sauvage Library, The. Price 3s. 6d. per Vol., cloth, fcap. 8vo.

1. Pulpit Table Talk. By DEAN RAMSEY, M.A.
2. The Search for the Grail. By JULIA GODDARD.
3. Sermons for Boys. By the Rev. ALFRED BARRY, D.D., Principal of King's College.
4. The Life of Bernard Palissy, of Saintes. By HENRY MORLEY.
5. The Young Man in the Battle of Life. By DR. LANDELS.

Burritt, Elihu. Thoughts and Notes at Home and Abroad. Cloth, 6s.

Cassell's Magazine. Vol. I., New Series, containing "Man and Wife," by WILKIE COLLINS. 600 pp. of Letterpress and Engravings. Cloth, gilt lettered, 6s. 6d.

Daybreak in Spain. By the Rev. Dr. WYLIE. Being the first account that has yet appeared of the extraordinary reformation now going on in Spain, written with all the power and truthfulness of an eye-witness. Crown 8vo, 424 pp., with Twelve Illustrations. 6s.

History of the Pianoforte. By EDGAR BRINSMEAD. Illustrated. Cloth. 3s.

Natural History.

Cassell's Brehm's Book of Birds. Translated from the Text of Dr. BREHM by T. RYMER JONES, F.R.S. Monthly Parts, 7d., and Volumes, crown 4to, cloth plain, 7s. 6d.; extra cloth gilt, 10s. 6d. each. Vol I. contains Ten Coloured Plates and 384 pp. letterpress, with numerous Illustrations.

Figure Series, The.

The World before the Deluge. With 233 Illustrations. Cloth, lettered, 16s.; extra cloth gilt, £1 1s.

The Vegetable World. With 471 Illustrations. Cloth, lettered, 16s.; extra cloth gilt, £1 1s.

The Ocean World. With 427 Illustrations. Cloth, lettered, 16s.; extra cloth gilt, £1 1s.

The Insect World. With 576 Illustrations. Cloth, lettered, 16s.; extra cloth gilt, £1 1s.

Birds and Reptiles. With 307 Illustrations. Cloth, lettered, 18s.; extra cloth gilt, £1 3s.

Hood's Works. Vols. I., II., III., and IV., each containing 464 pp., and numerous Illustrations. Cloth, 5s. each.

Little Gem Series, The. Bound in cloth, 6d. each; red edges, 9d. each.

Shall we Know One Another? By the Rev. J. C. RYLE.

The Voice of Time. By J. STROUD.

Home Religion. By the Rev. W. B. MACKENZIE, M.A.

Penny Library of Popular Authors.

1. Foxe's Book of Martyrs. Price 1d.

2. Bunyan's Pilgrim's Progress. Price 1d.

Practical Poultry Keeper, The. By L. WRIGHT. Fourth Edition. With 36 Plain Illustrations. Cloth, 5s.; with 12 Coloured ditto, ditto, crown 8vo, 6s. 6d.

Quiz, Sketches by. Illustrated by "PHIZ." Cloth, 3s. 6d.

San Juan Water Boundary Question. By VISCOUNT MILTON, M.P. Cl., lettered, 10s. 6d.

The Stock Feeder's Manual. By Dr. CAMERON. Cloth, 5s.

Woman: Her Position and Power. By W. LANDELS, D.D. Being Essays on the social and moral position of Woman, her influence, duties, &c. Cloth, lettered, 5s.

Wonders, Library of. Fully Illustrated. A Series of Gift Books and School Rewards. Cloth gilt, gilt edges, each 5s.

Wonders of Animal Instinct.

Wonders of Bodily Strength and Skill.

Wonders in Acoustics.

Wonderful Balloon Ascents.

Wonderful Escapes.

Wonders of Architecture.

World of Wonders, The. With 130 Illustrations. Cloth, 7s. 6d.; full gilt, 10s. 6d.

The Transformations of Insects. (*Insecta, Myriapoda, Arachnida, and Crustacea.*) By P. MARTIN DUNCAN, F.R.S., Secretary of the Geological Society, and Professor of Geology, King's College, London. Being an Adaptation, for English readers, of M. EMILE BLANCHARD'S "Metamorphoses, Mœurs et Instincts des Insectes;" and a compilation from the works of NEWPORT, CHARLES DARWIN, SPENCE BATE, FRITZ MULLER, PACKARD, and others. Illustrated with 50 full-page, and numerous other highly-finished Engravings. Royal 8vo, 500 pp., handsomely bound in cloth gilt, 16s.

World of the Sea. Translated from the French of MOUQUIN TANDON, by the Rev. H. M. HART. With 18 Coloured and Tinted Plates, and numerous Wood Engravings. Best cloth, lettered, 21s.

Natural History—continued.

Natural History, Picture. Edited by the Rev. C. BOUTELL, M.A. With 600 Illustrations. Cloth, lettered, 5s.

Natural History, Cassell's Popular. Complete in Two Volumes, cloth, 30s. Do., Two Volumes, half-calf, full-gilt back, 45s. Do., Two Volumes, half-morocco, full-gilt, 50s. Do., with Coloured Illustrations, Four Volumes, cloth, 42s.

Poetry and the Drama.

Barr's Poems. New and Revised Edition. Cloth, 5s.

Book of Sacred Poems. With about 200 Illustrations. Edited by the Rev. R. H. BAYNES, M.A. Cloth, 7s. 6d.; full gilt, 10s. 6d.; morocco, 21s.

Bright Thoughts for the Little Ones. With Twenty-seven Original Drawings by PROCTER. Cloth, lettered, gilt edges, 7s. 6d.

Child's Garland of Little Poems, The. With exquisite Illustrative Borders by GIACOMELLI. Cloth gilt, 7s. 6d.

Favourite Poems by Gifted Bards. With Twenty-four Illustrations. Cloth, gilt edges, 7s. 6d.

Golden Leisures. By W. GORDON SMYTHIES. 1s.

Hours of Sunshine. By MATTHIAS BARR, Author of "Little Willie," &c. With Sixteen Coloured Plates. Cloth gilt, 3s. 6d.

Jewels Gathered from Painter and Poet. Cloth, gilt edges, 7s. 6d.

Poets, Cassell's Three-and-Sixpenny Editions of the. In fcap. 8vo, printed on Toned Paper, elegantly bound in cloth, extra gold and colours, 3s. 6d. each; best morocco, inlaid with enamel letter-piece, 6s. 6d. each. LONGFELLOW; SCOTT; BYRON; MOORE; WORDSWORTH; COWPER; MILTON; POPE; BURNS; THE CASKET OF GEMS; BOOK OF HUMOROUS POETRY; BALLADS, SCOTTISH AND ENGLISH; LIVES OF THE BRITISH POETS.

Poems and Pictures. With 100 Illustrations. Cloth gilt, gilt edges, 21s.

Shakespeare, Cassell's Illustrated. With 500 Illustrations. Imperial 8vo. Edited by CHARLES and MARY COWDEN CLARKE. Vol. I. (COMEDIES), 12s.; Vol. II. (HISTORICAL PLAYS), 10s. 6d.; Vol. III. (TRAGEDIES), 12s. 6d. The Complete Work, in Three Volumes, cloth lettered, uniform, £1 15s. Half morocco, £2 10s. The Separate Plays may be had, price 1s. each.

Travel and Adventure.

Illustrated Travels: a Record of Discovery, Geography, and Adventure. Edited by H. W. BATES, Assistant-Secretary of the Royal Geographical Society. Vols. I. and II., each, cloth, 15s.; cloth, extra gilt, gilt edges, 18s. Or, the Two Vols. in One, cloth, lettered, 25s.; best cloth gilt., 31s. 6d.; bound in Roxburgh, 35s.

North-West Passage by Land, The.

By Viscount MILTON, M.P., &c., and W. B. CHEADLE, M.A., M.D. Cantab., F.R.G.S. 21s. Ditto, ditto, smaller edition, complete, 6s.

Thoughts and Notes at Home and Abroad. By ELIHU BURRITT. Crown 8vo, 320 pp., cloth, 6s.

Serial Publications.

BOOK OF BIRDS. Monthly, 7d.

CASSELL'S MAGAZINE. Monthly, 6d.; Weekly, 1d.

BRITISH POETS. Monthly, 6d.

FAMILY BIBLE. Monthly, 7d.; Weekly, 1½d.

POPULAR EDUCATOR. Monthly, 7d.; Weekly, 1½d.

TECHNICAL EDUCATOR. Monthly, 7d.; Weekly, 1½d.

DORE DON QUIXOTE. Monthly, 7d.; Weekly, 1½d.

HOUSEHOLD GUIDE. Monthly, 7d.; Weekly, 1½d.

THE QUIVER. Monthly, 6d.; Weekly, 1d.

CHILD'S BOOK OF SONG AND PRAISE. Monthly, 6d.; Weekly, 1d.

MATTHEW HENRY'S COMMENTARY. Monthly, 7d.; Weekly, 1½d.

DORE BIBLE. Monthly, 2s. 6d.

ILLUSTRATED TRAVELS. Monthly, 1s.

HISTORY OF ENGLAND. Monthly, 7d.; Weekly, 1½d.

RAILWAY TIME TABLES AND TRADES DIRECTORY. Monthly, 2d.

Annuals, Almanacks, &c.

HENRY LESLIE'S MUSICAL ANNUAL for 1871. 5s.

THE HOUSEHOLD RECORD for 1871. Paper, 1s.; cloth, 1s. 6d.

MORTON'S FARMER'S ALMANACK for 1871. 1s.

CASSELL'S ILLUSTRATED ALMANACK for 1871. 6d.

THE SILVER BOW: Being THE QUIVER Christmas Annual for 1870. 6d.

Now Ready, price 2s. 6d.

Cassell, Petter, & Galpin's New Illustrated Catalogue for 1870:

Containing nearly ONE HUNDRED SELECTED ENGRAVINGS, from Designs by DORÉ, GRISET, T. MORTEN, W. CAVE THOMAS, MISS EDWARDS, G. H. THOMAS, F. BARNARD, &c. Printed on Fine Paper. Folio, with Coloured Frontispiece.

** For detailed particulars of all the Works inserted in the foregoing List, consult CASSELL, PETTER, and GALPIN'S DESCRIPTIVE CATALOGUE, supplied by all Booksellers, and forwarded post free by the Publishers.

BELLE SAUVAGE YARD, LONDON; & 596, BROADWAY, NEW YORK.



**PLEASE DO NOT REMOVE
CARDS OR SLIPS FROM THIS POCKET**

UNIVERSITY OF TORONTO LIBRARY

BioMed

